

AMATEUR RADIO

JANUARY 1990

R.R.P. \$3.00



THE WIA RADIO AMATEUR'S JOURNAL

KENWOOD NEW!



TS-790A ALL-MODE TRIBAND TRANSCEIVER

Work all the upper bands and gain access to the latest communications techniques with the all-new Kenwood TS-790A. This transceiver gives you access to the exotic world of VHF and UHF communications, including Satellite, Moonbounce, Grid-square DX and VUCC. All with legendary Kenwood ease and reliability.

Features include: All-mode Triband coverage: 144-148MHz, 430-450MHz, 1240-1300MHz, USB, LSB, CW, CW(N) and FM • 45 watts output (VHF) • Very high performance GaAs FET RF amplifier for high sensitivity and wide dynamic range • Dual watch function across bands • Band selection/exchange function • Satellite communication frequency correction for uplink/downlink operation • Auto-mode and auto repeater offset • 59 multi-function memories • Call channel function • Repeater Reverse • Memory scroll and shift • Multi-scan functions and much more!!



TM-231A 2M FM MOBILE TRANSCEIVER

This compact mobile transceiver delivers 50 watts of power with the controls at your fingertips.

Features include: • Multi-function microphone with Call, VFO, Memory Recall, and a Programmable key • Large amber display plus illuminated keys • 50/10/5 watts switchable power output • Sensitivity 12dB SINAD/less than 0.16uV • 20 multi-function memories • Programmable call channel • Selectable CTCSS encoder built in • Tone Alert system • Multi-mode scanning (band, programmable band, memory plus programmable band) • Options include remote control and digital recording.

KENWOOD ELECTRONICS AUSTRALIA PTY. LTD.

4E WOODCOCK PLACE, LANE COVE, SYDNEY, N.S.W., 2066
Ph. (02) 428 1455 Fax: (02) 427 6869.

Call now for further information and the name of your nearest authorised Kenwood dealer.

Please phone, or mail/fax for information

Name

Address

Postcode

Publication

Issue



Amateur Radio is published by the Wireless Institute of Australia, as its Official Journal on the last Friday of the previous month.

EXECUTIVE EDITOR

Bill Rice VK3ABP

MANAGING EDITOR

Graham Thornton VK3IY

NEWS EDITOR

Jim Linton VK3PC

SENIOR TECHNICAL EDITOR

Peter Gibson VK3AZL

TECHNICAL EDITORS

David Brownsey	VK4AFA
Don Graham	VK6HK
Evan Jarman	VK3ANI
Peter O'Connor	VK4KIP
Gil Sones	VK3AUI
Phil Steen	VK4APA
Roy Watkins	VK6XV

DRAFTING

Vicki Griffin VK3BNK

ADVERTISING

Ann McCurdy

All contributions and correspondence concerning the content of Amateur Radio should be forwarded to :-

The Editor
Amateur Radio
PO Box 300
Caulfield South
VIC 3162

Registered Office

3/105 Hawthorn Road
Caulfield North VIC 3161

Telephone: (03) 528 5962
(03) 523 8191

Fax: (03) 523 8191
(Non dedicated line)

Deadlines

	Editorial	Hamads
February	8/1/90	10/1/90
March	5/2/90	7/2/90
April	5/3/90	7/3/90

© Wireless Institute of Australia 1990

CONTENTS

Technical

Bandwidth Control for the VLF-LF Receiver	16
<i>Lloyd Butler VK5BR</i>	
Conversion of the Vinten MTR29 to Six Metres FM	14
<i>Ian Keenan VK3AYK</i>	
Digital Packets on Voice Repeaters in the Amateur Two-Metre Band	21
<i>Ian Milne VK7IR</i>	
More on the Yaesu FT-411	18
<i>Lew Whitbourn VK2ZIP</i>	
Weather Satellites Part III	22
<i>Paul Hayden VK4ZBV</i>	

General

Earthquake San Francisco and Amateur Radio	31
<i>Jim Linton VK3PC</i>	
Murphy's Corner (Errata)	39
The Contest	35
<i>Tony Mussen VK2CAM</i>	
VK3CYA — George from Echuca	34
<i>Des Greenham VK3CO</i>	
WIA Competition Details	38
Yeoval to Yeovil	37
<i>Joy Collis VK2EBX</i>	
1989 Annual Index	8

Operating

Awards	45
Contests	
Calendar, UBA Rules	41
Commonwealth Contest 1989 Results	42
Commonwealth Contest 1990 Rules	43

Columns

Advertisers Index	64	How's DX	39
ALARA	51	Intruder Watch	58
AMSAT	48	Morseword No 34	60
Club Corner	52	Over To You - Members' Opinions	58
Divisional Notes		Pounding Brass	47
Forward Bias	55	QSLs from the WIA Collection	54
VK2, VK3 Notes	56	Random Radiators	46
5/8 Wave	57	Silent Keys — Obituary	58
Educational Notes	55	Spotlight on SWLing	51
Editor's Comment	2	Stolen Equipment	64
Hamads	62	WIA Directory	2,3
		WIA News	2

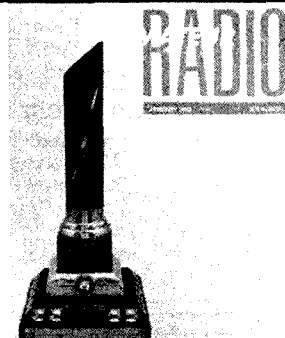

Cover

The recently refurbished Ross Hull Memorial Trophy. The inscription reads "To perpetuate the memory of an Australian amateur - an early member of the WIA - who devoted his life to the amateur cause and who pioneered the VHF field during his brilliant career as Editor of "QST" and "The Radio Amateur's Handbook". Born in Melbourne in 1902 his untimely passing in 1938 was a great loss to the amateur fraternity and the world of Radio Communications generally". Photo - Peter Hoare

End Of The Decade

It seems quite unusual for me to be typing an editorial; so much so that I don't quite know where to start! October was the last time I found myself faced with a blank sheet awaiting the first keystrokes of what became "No Free Lunches". This time the title would perhaps be more appropriate to next December, but 1990 is certainly the last year of the decade, and the 80th Anniversary of the foundation of the WIA. May it prove to be a very auspicious year for us all.

The November editorial (Ship of the Desert) was hand-written in a great hurry at Port Augusta, and then last month I was happy to hand the space over to Peter Gamble, who had much more of importance to say than is usually the case with my little waffle! But now, duty calls again, as it has on many occasions since we returned from VK5 in time for the November proof read. Since then we have had the November Publications

EDITOR'S COMMENT

BILL RICE VK3ABP EXECUTIVE EDITOR

meeting and the much deferred joint Executive/Council meeting (a busy week-end!), then the December proof read, plenty of editorial action (but still dragging the chain!) and tomorrow the December meeting, which is also the January deadline. Never a dull moment, is there?

Hopefully, having at least temporarily managed to get a few VK5 salt lakes out of the system, it may now be possible to catch up a little on the backlog of unanswered letters. Maybe even write up that long-promised item on the VK2ABQ antenna. And at least one correspondent has said he wants to see more about the VK3ABP wind and solar power systems on the boat. So my time is well booked up already over the holiday season. Holiday? As one of my work-place colleagues used to say before we both retired "At least it helps to keep us off the streets!".

Just to fill you all in on our

activities hinted at in the November issue, we did get to Lake Torrens, launched the boat (with great difficulty), sailed about a day and a half altogether, retrieved the boat (with even greater difficulty) and arrived back home unscathed a few days later. I am sure ours was the first trailer-sailer ever in Lake Torrens, and the only one. Even then, in the deepest part (Beda Arm) the water was barely a metre deep, and evaporating fast. But very recently (28 Nov—3Dec) there have been rains in South West Queensland which will probably put much more water into Lake Eyre North by about February or March. It's on again, folks! If it comes up to expectations this will be the Salt Lake Sailing Safari DXpedition to beat all previous attempts. We may have to install a fax aboard so I can edit by remote control! I hope that last sentence is a jest which doesn't come true, but

anything can happen on Lake Eyre. It's almost to the stage of having water in it more often than not, and they say the Greenhouse Effect is not yet upon us.

That's quite enough rambling about my favorite obsession. May we all, members of the Publications Committee, wish you all the very best for 1990. May it very truly be a Happy New Year! ar

Will this be your last issue of Amateur Radio magazine?

Was your subscription due on 1st January 1990?

Please pay your subscription immediately to ensure continuity of receipt of Amateur Radio magazine.

Wireless Institute of Australia

The world's first and oldest National Radio Society - Founded 1910
 Representing Australian Radio Amateurs - Member of the international Amateur Radio Union
 Registered Executive Office of the WIA: 3/105 Hawthorn Road, Caulfield North, Vic, 3161
 All mail to: **PO Box 300, Caulfield South, Vic, 3162** Telephone: (03) 528 5962 (03) 523 8191
 Fax: (03) 523 8191 (Non-dedicated line)

General Manager and Secretary: Bill Roper VK3ARZ

EXECUTIVE

President:	Peter Gamble	VK3YRP	VK1 Federal Councillor:	Kevin Olds	VK1OK
Vice Chairman:	Ron Henderson	VK1RH	VK2 Federal Councillor:	Peter Jeremy	VK2PJ
	George Brzostowski	VK1GB	VK3 Federal Councillor:	Peter Maclellan	VK3BWD
	Brenda Edmonds	VK3KT	VK4 Federal Councillor:	David Jerome	VK4YAN
	Bill Rice	VK3ABP	VK5 Federal Councillor:	Bill Wardrop	VK5AWM
Immediate Past President:	David Wardlaw	VK3ADW	VK6 Federal Councillor:	Neil Penfold	VK6NE
			VK7 Federal Councillor:	Joe Gelston	VK7JG

FEDERAL CO-ORDINATORS

Amsat:	Graham Ratcliff	VK5AGR	Int'l Travel Host Exch:	Ash Nallawalla	VK3CIT
Awards Manager:	Ken Gott	VK3AJU	QSL Manager (VK9, VK0):	Neil Penfold	VK6NE
Contest Manager:	Frank Beech	VK7BC	Standards & FTAC:	Rob Milliken	VK1KRM
Education:	Brenda Edmonds	VK3KT	Tapes (Federal News):	Bill Roper	VK3ARZ
EMC:	Hans Ruckert	VK2AOU		Ron Fisher	VK3OM
Historian:	John Edmonds	VK3AFU	Videotape:	John Ingham	VK5KG
Intruder Watch:	Gordon Loveday	VK4KAL	WICEN:	Bill Wardrop	VK5AWM

November Federal Meetings

After having been postponed twice because of the airline dispute, a quarterly meeting of the complete WIA Federal Executive, and a meeting of the Federal Council of the WIA, took place over the weekend of 18th and 19th November 1989. Despite a number of travel difficulties, Executive/Councillors from all interstate Divisions attended the meetings.

Executive and Council were disappointed that the local, Victorian Division member of Executive did not attend the Executive meeting, and that neither the Victorian Division Federal Councillor, nor either of the two Alternate Federal

WIA NEWS

BILL ROPER VK3ARZ GENERAL MANAGER & SECRETARY

Councillors, attended the Federal Council meeting.

A considerable amount of business was dealt with, and all delegates eventually wearily departed late on the Sunday afternoon.

WARC 92 WIA Team

Executive decided that David Wardlaw, VK3ADW, will be the WIA Planning Team Leader for WARC 92, and the other two members of the Planning Team will be Peter Gamble, VK3YRP, and Ron Henderson, VK1RH.

It was also decided that,

subject to available funding, the WIA contribution to the Australian government delegation to WARC 92 will be a minimum of one person and a maximum of two people.

Repeater Linking

Executive decided that the VK4 Division would prepare a draft submission to DoTC, including all technical specifications, and based on all material tabled by WIA Divisions, repeater groups and other interested parties.

This draft was to be circu-

lated to all Divisions before 22nd December 1989 for comment; and all Divisional responses are to be received at the Executive Office before the 23rd January 1990 meeting of the Executive.

Future Contest Managers

Executive resolved that, as from the Federal Convention to be held in April 1990, WIA Contest Management is to consist of a separate Contest Manager for each WIA Contest, with the Federal Contest Manager being a co-ordinator overseeing the operations of the individual Contest Managers.

The VK6 Division member of Executive, Neil Penfold, ad-

WIA DIVISIONS

The WIA consists of seven autonomous State Divisions. Each member of the WIA is a member of a Division, usually their residential State or Territory, and each Division looks after amateur radio affairs within their State.

Division	Address	Officers	Weekly News Broadcasts	1990 Fees
VK1	ACT Division GPO Box 600 Canberra ACT 2601	President Ted Pearce Secretary Jan Burrell Treasurer Ken Ray	VK1AOP 3.570 MHz VK1BR 2m ch 6950 VK1KEN 70cm ch 8525 2000 hrs Sun	(F) \$65.00 (G) (S) \$52.00 (X) \$39.00
VK2	NSW Division 109 Wigram St Parramatta NSW 2124 (PO Box 1066 Parramatta) Phone (02) 689 2417	President Roger Henley Secretary Peter Balnaves Treasurer David Horsfall (Office hours Mon-Fri 11.00 - 14.00 Wed 19.00 - 21.00)	VK2ZIG 1.845 MHz AM, 3.595 AM/SSB, 7.146 AM (1100 only) VK2CZX 28.320 SSB, 52 120 SSB 52.525 FM 144.12 (SSB) VK2KFU 147.000 FM(R) 438.525 FM(R) 584.750 (ATV Sound) 1281.75FM (R) Relays also conducted via many repeaters throughout NSW.	(F) \$59.00 (G) (S) \$47.00 (X) \$33.00
VK3	Victorian Division 38 Taylor St Ashburton Vic 3147 Phone (03) 885 9261	President Jim Linton Secretary Barry Wilton Treasurer Rob Hailey	VK3PC 1.840 MHz AM, 3.615 SSB, 7.085 SSB, 147.250 FM(R) Mt Macedon, VK3XV 147.225 FM(R) Mt Baw Baw VK3XLZ 146.800 FM(R) Mildura, 438.075 FM(R) Mt St Leonard 1030 hrs on Sunday	(F) \$65.00 (G) (S) \$52.00 (X) \$39.00
VK4	Queensland Division GPO Box 638 Brisbane Old 4001 Phone (07) 284 9075	President David Jones Secretary John Aarsse Treasurer Eric Fittock	VK4NLV 3.605 MHz, 7.118, 14.342, 18.132, 21.175, 28.400, VK4QA 52.525 regional 2m repeaters and 1296.100 0900 hrs Sunday VK4NEF Repeated on 3.605 & 147.150 MHz, 1930 Monday	(F) \$65.00 (G) (S) \$52.00 (X) \$39.00
VK5	South Australian Division Thebarton Rd West Thebarton SA 5031 (GPO Box 1234 Adelaide SA 5001) Phone (08) 352 3428	President Don McDonald Secretary Hans van der Zalm Treasurer Bill Wardrop	VK5ADD 1820 kHz 3.550 MHz, 7.095, 14.175, 28.470, 53.100, 145.000, VK5KHZ 147.000 FM(R) Adelaide, 146.700 FM(R) Mid North, 146.900 FM(R) VK5AWM South East, ATV Ch 34 579.00 Adelaide, ATV 444.250 Mid North (NT) 3.555, 146.500, 0900 hrs Sunday	(F) \$65.00 (G) (S) \$52.00 (X) \$39.00
VK6	West Australian Division PO Box 10 West Perth WA 6005 Phone (09) 474 2626	President Alyn Maschette Secretary Bruce Hedland Treasurer - Thomas	VK6KWN 146.700 FM(R) Perth, at 0930 hrs Sunday, relayed on 3.560, 7.075, 14.115, 14.175, 21.185, 28.345, 50.150, 438.525 MHz Country re- lays 3582, 147.350(R) Busselton 146.900(R) Mt William VK6OO (Bunbury) 147.225(R) 147.250 (R) Mt Saddleback 146.725(R) Al- bany 146.825(R) Mt Barker Broadcast repeated on 3.560 at 1930 hrs.	(F) \$56.00 (G) (S) \$45.00 (X) \$30.00
VK7	Tasmanian Division PO Box 1010 Launceston TAS 7250	President Mike Wilson Secretary Bob Richards Treasurer Peter King	VK7ZWW 146.700 MHz FM (VK7RHT) at 0930 hrs Sunday relayed on 147.000 VK7NRR (VK7RAA), 146.750 (VK7RNV), 3.570, 7.090, 14.130, 52.100, VK7ZPK 144.100 (Hobart) Repeated Tues 3.590 at 1930 hrs	(F) \$63.00 (G) (S) \$50.00 (X) \$38.00
VK8	(Northern Territory) is part of the VK5 Division and relays broadcasts from VK5 as shown (received on 14 or 28 MHz).			
Note: All times are local. All frequencies MHz.				
				Membership Grades Full (F) Pension (G) Needy (G) Student (S) Non receipt of AR (X)

vised that his Division will arrange for this new system to be in place by the 1990 Federal Convention.

6 and 10 Metre Beacons

Executive accepted the Federal Technical Advisory Committee's recommendation that the Australian 28.2 MHz international time shared beacon be located in Sydney, and that all other Australian 10 metre beacons be moved to the regional frequency of 28.191 MHz time shared as soon as practicable after 1st January 1990.

Executive also resolved that there are to be no beacons in the 50 - 52 MHz segment of the 6 metre band in those states with restrictions on band usage (VK1, 2, 3, 4, & 7); to agree with the VK8 proposal for a beacon on 50.056 MHz; not to support the use of any more discrete frequencies for beacons due to frequency limitations; and to adopt time sharing of beacons on 50.056 and 50.066 MHz, as and when additional demands are made for beacons in this segment of 6 metres, with 50.056 MHz to be used north of the Tropic and 50.066 MHz south of the Tropic of Capricorn.

Executive and WIA Members

Considerable time at the Executive meeting was spent discussing the continued objection by the VK3 Division as to what they perceive as the Executive and the Executive Office incorrectly communicating directly with clubs or members of the Victorian Division of the WIA on matters other than those directly related to membership subscriptions and/or renewals.

Executive considers that it, and the Executive Office, have been operating properly and in accordance with Article 46 of the Articles of Association of the WIA.

Nevertheless, because of the

VK3 Division's objections, Executive decided to seek from Divisions their views on which administrative matters they believe should not be dealt with by Executive and, conversely, those matters which they require Executive to carry out, with a view to producing a consensus list for adoption by Federal Council.

Federal Council Meeting

Two motions were put, discussed, and passed at the Federal Council meeting (known, in the terms of the Articles of Association, as an Extra-ordinary Federal Convention).

The first motion expressed the serious concern of the Council in regard to the broadcast of the VK3 Divisional President on 29th October 1989 because of it having the effect of promoting disunity within the amateur service by the use of selective quotations, emotive language, and distortion of the facts which Council considered as not being in the best interests of amateur radio.

The second motion set a very clear policy to be used by all Divisions of the WIA in their handling of the Federal News Tapes provided by Executive.

Further Meeting Details

Minutes of both the Executive and Council meetings have been provided to Divisions (the Executive meeting minutes alone consisted of 49 pages of material!), and members wanting to know more details of what went on at those meetings can obtain further information by contacting their local Federal Councillor.

Callsign Number Plates

Radio amateurs living in New

South Wales have been able to obtain "custom" amateur callsign number plates for their motor vehicles for some years. However, I understand that not many amateurs have availed themselves of this facility, possibly because of the high annual cost.

After decades of submissions by the WIA, the Victorian Road Traffic Authority has recently advised that they will now accept orders for "custom" registration plates which can take the form of an amateur two or three letter callsign. These plates will be available in various colours at a once only cost of \$260.00. Further details can be obtained from any "Vic Roads" office.

Copies of Magazine Articles

A considerable number of members have obtained copies of the Amateur Radio magazine 20 Year Index from the Executive Office since the facility was announced during October 1989. Approximately half of the indexes have been supplied in hard copy, about 30% on a 5 1/4 inch floppy disk in dBase III Plus .DBF file format, and the remainder on a floppy disk in ASCII format. Details of this index were provided on page 4 of October 1989 issue of Amateur Radio magazine.

Aubrey, VK6XY, has produced a compiled database version of the 20 Year Index which runs on an IBM PC as a stand alone .EXE file. This version of the 20 year Index is now available to members from the WIA Executive Office for \$10.00, which includes the floppy disk, plus packing and postage. Incidentally, Aubrey, with the assistance of Vic, VK6NL, is working on building a 20 year Amateur Radio magazine index to cover the years from 1950 to 1969.

No doubt due to the success of the 20 Year Index, our stocks of back issues of Amateur Radio magazine are rapidly depleting as members take advantage of the offer detailed on page 5 of the September 1989 issue.

Therefore, the Executive Office is now introducing a new service to members. When stocks of a back issue of AR are exhausted, a photocopy of the particular article in the back issue that is required will be supplied for a fee of \$2.50. If an article spreads over more than one issue of the magazine, it will cost an extra \$2.00 for photocopying of the relevant pages of each additional issue of AR in which the article appears.

In future, when you send in your order for a back issue of Amateur Radio magazine, please indicate the particular article in which you are interested.

The Executive Office has a complete library of Amateur Radio magazines from the first issue published in 1932.

Executive Office Flooded

A formerly prominent public figure once said "life wasn't meant to be easy". Tell me about it!

Recent times in the Executive Office have been rather hectic, what with the 1990 Call Book, the airline dispute, cross linking of repeaters, political bickering, censorship of the Federal Tapes, changing over to a new membership database computer, and the usual problems because of lack of adequate financial resources, just to name a few.

But it was almost the last straw when I opened the door of the Executive Office at 7.30 AM on Saturday, 18th November, to complete preparations for the weekend-long Executive and Federal Council meetings, and found myself walking in water.

A cold water pipe had burst, apparently only about two hours before I arrived, and had already flooded half the total floor area of the office.

Amidst the flurry of plumbers, mopping up of some of the water, and re-arranging of the furniture, the meetings eventually started more-or-less on time in the cramped, dry half of the

office.

However, for a period of two weeks, the Executive Office looked like a bomb had gone off! Half the carpet had to be pulled up and taken away for treatment (naturally, the half of the office that was flooded just had to be the records and filing section, and not the open work area!).

Piles of records, books, magazines, filing cabinets and assorted furniture were scattered around the building (the other tenants of the office building were very generous in their offers of temporary storage space), and the half of the office into which the staff were crammed looked like the set from "Stephoe and Son".

But we managed, and hopefully members did not notice any falling off in the services offered by the Executive Office during that traumatic period.

1990 WIA Fees Due

Have you paid your renewal fee yet?

During the second week of December, over 5500 members of the WIA received their annual membership renewal notices. Full details of the 1990 fees were explained in December issue of Amateur Radio magazine.

Please pay your fees immediately if you don't want to miss out on the special February 1990 "Reference" issue of Amateur Radio magazine. And don't forget, if you want to be "canny" with your money and transfer over to a three year membership, all you have to do is forward your remittance for an amount equal to 3 times the figure that appears on your renewal notice.

With all the discussion that has taken place over the past few months about the "catch up" increase in the WIA fees to a maximum of \$65.00 for a majority of the Divisions, it is worthy of note that the New Zealand equivalent of the WIA, the NZART, has also set its 1990 fees at \$65.00.

Incidentally, it is also interesting to note that the NZART

Call Book costs \$15.20 to NZART members, and \$20.25 to non-members.

Entries for the WIA 80 competition to win an ICOM IC-900A multi-bander system continue to pour into the Executive Office. Please remember that you need to be a financial member of the WIA as at 1st February 1990 to qualify for this exciting competition.

New JARL Satellite

When advising of the termination of the amateur satellite JAS-1/Fuji-OSCAR 12 as from 5th November 1989, Shozo Hara, the President of the Japan Amateur Radio League advised that JARL is preparing for its next satellite.

This new bird, the JAS-1b, will have the same mission configuration as that of FO-12, except for its orbit, and is expected to be launched in February 1990.

6 Metres in New Zealand

News from the NZART in New Zealand is that radio amateurs in that country have been granted limited use of the low end of the 6 metre band on conditions somewhat similar to those won for Australian amateurs by the WIA during the early part of 1989.

The New Zealand RFS has announced limited 24 hour use of the segment 50.00 to 50.15 MHz to specific amateurs operating from a fixed location not closer than 50 km from the service boundary of a TV Channel 1 service area or of a TV translator using Channel 1 as its input.

WIA Weekly News

Do you regularly listen to your Division's weekly news broad-

cast?

Have a look at the list of broadcast times and frequencies on page 3 of each issue of Amateur Radio magazine.

Collectively, the WIA Divisions provide for Australian radio amateurs one of the most comprehensive radio news services of any amateur society in the world. It is just one of the many services provided by the WIA which benefit all amateurs, not just members.

Each week a lot of people go to a lot of time and trouble to keep the Australian amateur up-to-date with amateur radio news and views, and the result is both comprehensive and professional. Many, many hours of work are put into each half hour broadcast.

As regular listeners will be aware, the one item which is usually the same in each Division's news broadcast is the weekly "Federal Tape". And members of the WIA will also know that many of the news items that appear on the "Federal Tape" also appear in WIA NEWS in Amateur Radio magazine, often in more comprehensive form.

How many members listen to the news broadcasts provided by other Divisions? Because each Division is an individual and separate member of the WIA, each Division's broadcast is different, often with differing viewpoints on the same news item. Quite often general news items will appear in one Division's broadcast and not in another.

It is most enlightening to learn what is happening in another state. Even though the majority of Divisions present their weekly news broadcast at staggered times on a Sunday morning, not everybody finds that a suitable time at which to listen. Therefore, it is quite common for news - seeking amateurs to tape record their Division's news broadcast, as well as the broadcasts from some of the other Divisions, and play them back at their convenience.

Do you keep yourself abreast of what is happening in the amateur community by listening to one or more of the WIA weekly news broadcasts?

WIA 80 Awards

The first dozen WIA 80 Awards have already been allocated and they all went to amateurs in North America. WIA 80 Award certificate No. 1 went to Michael Pagan, N2GBH, who qualified at 1240 Z on 4th November 1989, just 2 minutes ahead of Howard Hatch Jr, AB4DU, who made it at 1242 Z the same day.

Howard's certificate was endorsed "First for North Carolina", and the Federal Awards Manager, Ken Gott, VK3AJU, tells me that the first dozen certificates include ones with "First for" Florida, Maryland, Ohio, Mississippi, Iowa and Alabama endorsements. Certificate No. 6 went to Bruce Balla, VE2QO, endorsed "First for Canada".

Ken has initiated correspondence with the UK, USSR, and Japan, amongst a number of other countries, to see if there is interest in agreeing on a day, or days, when amateurs in those countries, who are interested in obtaining the WIA 80 Award, could count on sufficient VKs being on air.

If the interest from overseas is apparent, times and frequencies for these occasions during 1990 will be announced well in advance in the Federal Tapes and in Amateur Radio magazine.

Ken tells me he is not surprised that there have not been any VKs among claimants for low-number certificates. DX amateurs need only eight QSOs to win the Award, while VKs need eighty! "From what I hear on local nets," Ken said, "most VKs have taken the view that they have 14 months in which to make the QSOs, so there's really no hurry."

Ken went on to say, "All the same, it's a good idea to keep your WIA membership number by you in the shack, if you don't carry it in your head. When a stateside station asked me for my WIA number early in November, I was caught flat-footed and had to beg off for a couple of minutes to find it!"

The WIA 80 Award rules call for the quotation of your WIA

membership number which appears on your membership certificate or, failing this, the six-digit number on your Amateur Radio magazine address label. The full rules of this interesting award appear on page 4 of September 1989 issue of Amateur Radio magazine.

Amateur Exams

It is now nearly four years since the possibility of devolvement of amateur examinations was raised by the Department of Transport and Communications (DoTC). The process is finally nearly completed, and this seems to be an appropriate time to have an overall look at the devolvement story.

Amateur examinations were the last in a series of tests and examinations conducted by DoTC which it was prepared to hand over to external bodies. TAFE colleges had accepted responsibility for Broadcast Operator certificates, and examinations for Marine licences were being conducted by the Maritime College.

When it became apparent that a policy of full cost recovery was to be pursued in Commonwealth departments, DoTC approached the WIA with proposals for the external conduct of amateur examinations.

As with any change to existing conditions, this proposal generated a considerable amount of debate in the Australian amateur community, sometimes very heated, sometimes non-constructive. Fortunately, however, a majority of amateurs accepted the inevitable, and tried to offer useful suggestions.

Because of resource problems in DoTC, the matter moved fairly slowly until early in 1989 when Keith Carr-Glynn was appointed by DoTC to the position of Examinations Officer. Keith was able to pick up all the threads and concentrate on production of the necessary examination materials, a task which is now almost completed.

There has been close liaison between DoTC and the WIA at all times, and the current posi-

tion is as follows. The question banks for Novice theory, AOC/P/AOLCP theory and Regulations have been produced, a Morse code examination generating program has been produced by DoTC and refined by a VK1 WIA member, a computer program to generate question papers from the banks has been developed for DoTC by a VK5 WIA member, and procedures for accreditation of examinations have been published.

In addition, the new regulations brochures, DOCs 70, 71 and 72 have been completed and published.

All these examination materials have been circulated to all those people and organisations who had registered their interest with DoTC in conducting examinations (there are presently over 40 names on the DoTC list), and Keith Carr-Glynn has now stated that he is ready to receive examination papers for accreditation.

If there are any groups or individuals who wish to organise amateur service examinations, but have not yet registered their interest with DoTC, now is the time to check with Mr Keith Carr-Glynn at DoTC in Canberra, or with your WIA Division, for information on the procedures to follow.

ARRL DXCC on 10 MHz

The American Radio Relay League (ARRL) have recently announced that they will now accept QSLs for contacts on the 10 MHz WARC amateur band for credit for the CW, mixed and RTTY DXCC awards.

There are no date restrictions on this change, but please note that there will be no 10 MHz single band DXCC award, and contacts on the 10 MHz band are not valid for the ARRL 5-band DXCC award.

WIA video at ITU-COM 89

ITU-COM 89 was a very successful symposium and exhibition of various aspects of

communication organised by the International Telecommunications Union (ITU), and was held at the Palace of Expositions in Geneva from 3rd to 8th October 1989.

An amateur radio stand was erected at this exhibition by the International Amateur Radio Union (IARU) to demonstrate the value of the amateur service to non-amateurs.

This stand included a number of static exhibits, an operating packet-radio station, and a video room with continuously running videos supplied by ARRL, RSGB, JARL and the WIAI.

This was yet another example of your society working internationally in the continuing fight to protect the amateur service and frequencies.

VNG Update

Marion Leiba, Honorary Secretary of the VNG Users Consortium, tells me that DoTC has now granted VNG's experimental licence on 10 and 15 MHz for a period of one year ending on 30th November 1990, unless there are any serious complaints. Apparently DoTC are still considering the VNG application for 16 MHz.

Marion, who first discovered the existence of amateur radio when she became involved with the resurrection of VNG, has now passed her Novice and Limited licences, and shortly expects to achieve her AOC/P. Incidentally, Marion's Novice callsign is VK1VNG.

The article written by Marion entitled "VNG Update", which appeared on page 40 of the November 1989 issue of Amateur Radio magazine, has already been reproduced in at least three overseas shortwave listener magazines, and the photograph of Marion and her son featured on the front cover of the Spanish magazine, "Madridx".

Articles for AR

The articles published in Amateur Radio magazine are

voluntary contributions from members of the WIA. Therefore, the aim of the editors to produce a well balanced magazine each month depends almost entirely on what voluntarily submitted articles are in stock and have been processed ready for publication.

If Amateur Radio is not publishing articles that cover your particular interest in amateur radio, it is not because of any editorial policy, but because your fellow amateurs are not writing that type of article.

In the past couple of years, we have had a plentiful supply of articles for publication. So much so that many articles took up to 12 months before they were able to be published. However, the current supply of articles has dwindled to a relatively low level, and many more technical articles are needed.

At the December Publications Committee meeting it was decided to make the June 1990 issue of Amateur Radio magazine a special "Test Equipment" issue. In order to enable technical editing and drawings to be completed in time, this means articles for that special issue will need to be received by the Editor no later than the middle of March 1990.

How about joining in to make the June 1990 "Test Equipment" issue of Amateur Radio magazine a success by submitting your article on construction of a piece of test equipment, modification of test equipment, or even about a test procedure?

A prize will be awarded to the author of the test equipment article which is judged to be the best of those published in that issue of Amateur Radio magazine.

Details of the prize to be won will be announced next month, so start writing your article now.

New 1296 MHz Band Plan

The revised bandplan for the 1296 MHz amateur band, proposed by the VK4 Division at the April 1989 Federal Convention of the WIA, has been cleared
Continued on page 21

PERTH-MELBOURNE-SYDNEY-BRISBANE

SR STANDARD

NEW TWIN-BAND H/H TRANSCEIVER

(Not to be confused with other DUALBANDERS)
STANDARD HAVE DONE IT AGAIN! THE C528 IS THE FIRST H/H TWIN BANDER WITH COMPLETELY INDEPENDENT FUNCTIONS. WITH INCREDIBLE SENSITIVITY OF 0.16 uV FOR 12 dB SINAD, IT CAN ALSO BE USED AS A REPEATER ON VHF/UHF BAND. ALSO COVERS CELLULAR PHONE BANO 800-975 MHz FOR RX ONLY.

FEATURES:

- ★ Simultaneous reception of two bands
- ★ Simultaneous TX/RX (FULL DUPLEX)
- ★ Twin Frequency Display
- ★ Twin S-meter and other functions (squelch, busy scan etc)
- ★ Band not being used may be switched off
- ★ Independent controls (volume, squelch etc)
- ★ Independent Audio output for VHF & UHF
- ★ Dual monitoring of priority channels on UHF & VHF
- ★ Built-in DTMF for coded paging and squelch function
- ★ Tone Squelch capability (option)
- ★ Handheld Repeater Operation
- ★ 20 Channel Memory — Memory channels are inducted independently for VHF & UHF Band
- ★ High RF Power output — 5W on VHF & UHF with 13.8V DC
- ★ Power Save Function
- ★ Programmable offsets
- ★ Various Scanning Modes
- ★ High RX Sensitivity — 0.16 uV for 12 dB SINADI

• Incl. NICAD
Battery Charger &
Dry Cell Case

\$699



NEW SPECTRUM SCANNER — AX700E

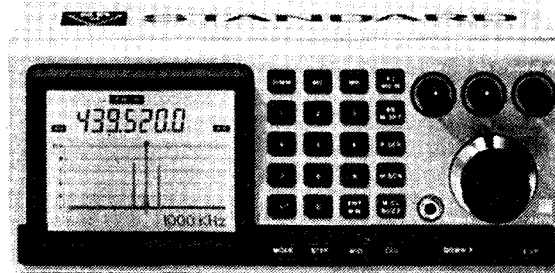

The strange looking liquid crystal display not only shows the frequency, mode, channel and so on, it also displays the spectrum over a range of 100, 250, or 1000 KHZ. The vertical line on the left hand side of the display shows the signal strength and the horizontal line along the bottom is the frequency range. The freq displayed at the top is the frequency at the centre of the line. Now comes the magic. Every time a signal comes up within the freq range, it will show up as a spike on the display. The light will show the signal strength and the position will indicate the frequency. By moving the cursor to the desired spike or unknown signal, its exact frequency will be displayed. To receive the new signal, just press a button. It is possible to monitor visually more than 100 channels simultaneously. If you are looking for a specific signal but you only know the band — just set up the appropriate band edges and then sit back and watch the display. Any appearing signal can be instantly spotted and tuned to in seconds.

FOR MORE INFO WRITE OR PHONE FOR BROCHURE!

FEATURES:

- ★ Large size spectrum display
- ★ Fast frequency selection
- ★ 100 Ch memory
- ★ Multiple search functions
- ★ Continuous freq coverage from 50-905 MHz
- ★ Multi mode: AM, FM W, FM N
- ★ Many other features

\$1050

NEW YEAR GIFT IDEAS

★ WORLD CLOCKS	\$39
★ Power Supplies	
7 amp	\$179
11 amp	\$229
★ Co-ax Relays	
N Type connectors	\$119
★ BNC Connectors	\$99
★ TELEREADERS	
Morse CWR 600E	\$399
RTTY CWR 900E	\$929
★ ELECTRONIC MORSE KEYS	
KP 100	\$299
KP 200 memory	\$589
★ Power/SWR meters	
DAIWA CN 410M 3.5-150 Mhz	\$139
EMITRON EPI 27 Mhz	\$59

★ MORSE PRACTISE OSCILLATORS	\$39
★ MORSE TUTORS — DATONG	\$275
★ BASE MICROPHONES	\$199
★ LOW PASS FILTERS — 1.5kw	\$99
★ AUDIO FILTER FROM DATONG	\$599
★ MORSE KEYS	from — \$55
★ IAMBIC KEYS FROM BENCHER	\$169
★ DUMMY LOADS	
20 Watt av 100 w peak M type	\$55
N type	\$79
★ DUMMY LOAD WATT METER	\$410
★ Co-axial Switches	
DAIWA 2 pos'n	\$49
DAIWA 4 pos'n	\$159
WELZ 2 pos'n N type	\$99

★ SOFTWARE FOR PK 232	\$199
IBM incl Weather Fax	\$199
COMMODORE 64 Inc Weather Fax	\$125
MACINTOSH	\$125
★ Co-ax Seal per roll	\$5
★ Multimeters	from \$39
★ Test Instruments inc freq counters	
★ Magnetic Bases	\$59
★ Soldering Station from Hakko	\$199
★ Transmitting Valves	
★ TOROID CORES	
★ CONNECTORS	
★ Co-ax Cable	
★ GDO Meters	\$99
★ Confidential Frequency Registers	\$29
★ CB Radios	
★ Receiving Scanning	from \$499
★ Lightning Surge Protectors	from \$39
★ Power Line Filters	from \$39
★ Service Manuals	from \$35
★ Insulators	from \$2.50
★ Mobile Antennas	from \$20
★ Shortwave Receivers	from \$299

ANOTHER SUPER ICOM SPECIAL from EMTRONICS ICOM IC 28A



Features

- 25 Watts Output Power
- Large LCO Readout
- Automatic Dimmer Circuit
- Compact Size
- 21 Memory Channels
- Dual Scanning Capability
- Simple Panel Design
- Options Available

LIMITED STOCK ONLY

\$499

BANKCARD
MASTERCARD & VISA
WELCOME

NSW & HEAD OFFICE:

92-94 Wentworth Ave., Sydney
NSW 2000. TLX: AA73990
PO Box K21 Haymarket, NSW 2000
Ph: (02) 211 0988 FAX: (02) 281 3508



EMTRONICS

VICTORIA:

248-244 Queen St. Melbourne
VIC 3000
Entrance from Lysons Lane St
Ph: (03) 670 0811 Fax: (03) 670 0330
Fax: (03) 670 0671

QUEENSLAND:

416 Logan Road, Stoney Creek
Qld 4120
Ph: 07 354 2585
FAX: 07 354 4316

WESTERN AUSTRALIA:

330 Albany Highway,
Victoria Park WA 6100
Ph: (09) 470 1118
FAX: (09) 472 3795

MAIL ORDERS
WELCOME

ANNUAL INDEX

1989

Title of Article	Author	Month	Page
**Administration			
53rd Federal Convention report	Bill VK3ABP & Brenda VK3KT	May	31
Bandplans for the Amateur Radio service		Feb	23
Convention information — agenda items		Apr	22
Convention information — annual reports		Apr	12
Electronics & Amateur Radio in Tasmanian education	Tony Clayton VK7AH	Jan	14
Emergency telephone numbers		Feb	29
IARU region 3 working group reports	Ron Henderson VK1RH	Jan	25
Planning for WARC 1992	Executive	Mar	39
Proposed revised Australian band plans	FTAC	Jan	22
Report of third AMSAT-UK colloquium	Graham Ratcliff VK5AGR	Aug	39
Scout Association of Australia		Feb	34
Seanet 88 convention report	David Rankin 9V1RH	Jun	28
Third party traffic for New Zealand	Jim Linton VK3PC	Apr	30
Writing a WICEN exercise	Trevor Connell VK8CO	Jun	31
ZL licensing for visiting VKs	Ross Garlick ZL3AAA	Aug	24
**Antennas, towers, lines, etc			
Analysis of the Z match antenna tuner	Lloyd Butler VK5BR	May	12
Antenna impedance matching (book review)	Ron Cook VK3AFW	Dec	57
Antenna impedance meter	Stan E Widgery VK3SE	Jan	56
Antenna mount for poles	Colin Mackinnon VK2DYM	Jul	15
ARRL antenna handbook (book review)	Harold Hepburn VK3AFQ	May	26
Broadside on 10	Richard Burdon VK6FKP	Oct	30
Not another article on the G5RV?	Don Knox VK1DX	Jan	18
On building a VSWR meter	Reg Fookes VK2AKY	Nov	06
Putting up an antenna tower and antenna	Tony Williams VK2DJW	Aug	18
Ringo antenna	Ian Crompton VK5KIC	Jan	16
Simple non-mathematical treatment of transmission lines	Godfrey Lucas VK2CJL	Oct	05
Stop your TH3 junior drooping	Arthur Brean VK6SY	Jan	12
SWR — a can of worms	John Sparkes VK6JX	Jun	32
The 5/8 mystery	Des Greenham VK3CO	Nov	09
Tilt-over wind-up antenna mast	Leigh Baker VK5UO	Sep	16
Transmission lines — measurement of their characteristics	Lloyd Butler VK5BR	Oct	20
Z match antenna tuning unit	Dean Probert VK5LB	May	18
**Awards			
Antarctic award		Jun	57
ARRL Diamond Jubilee award		Feb	51
Auckland Commonwealth Games award		May	41
Carie award		Aug	53
Central coast award		Jan	41
City of Wagga Wagga award		Apr	54
Connecticut DXA award		Dec	44
Council of Europe award change		May	41
DXCC updates		Feb	44
DXCC updates		Mar	35
European 1992 community award		Jan	41
Famparc awards		Aug	53
Fishers Ghost award		Sep	43
HMCS Protector award		Jul	52
Kittyhawk award		Apr	54
Liberian special prefix award		Jun	57
New USSR awards		Oct	42
Official approval for new ANZAC award		Dec	43
Pitcairn bicentennial award		Dec	43

Title of Article	Author	Month	Page
Publication Committee awards		Mar	02
Results of survey of VK awards		Oct	42
Ron Wilkinson achievement award		Apr	34
Russian R6K award		Apr	53
Special LX award		Mar	35
Tassie Trout award		Sep	43
VK6 Achievers award		May	43
WAVKCA issues		Mar	35
Westlakes ARC 25th anniversary award		May	42
**Book Reviews			
Antenna impedance matching	Ron Cook VK3AFW	Dec	57
ARRL antenna handbook	Harold Hepburn VK3AFQ	May	26
BATC — the ATV compendium	Doug White VK3BOW	Aug	08
Better TV & radio reception	Jim Linton VK3PC	Dec	30
Secret warfare	Rodney Champness VK3UG	Jun	58
**Computers & Programs			
Coil winding wisdom of Solomon — Commodore 64 version	Rob Abel VK2ERA	Sep	30
IBM log check and sorting program	Phil Connolly VK2BPC	Nov	24
Resistor selector program	Bruce Bathols VK3UV	Oct	27
RF impedance measurement program update	J Hodgkinson VK2BHO	Aug	13
RF impedance measurements	J Hodgkinson VK2BHO	Apr	08
**Contests			
13th West Australian 3.5 MHz			
CW & SSB contests rules		Jul	47
1st ARRL RTTY roundup		Jan	43
ALARA contest rules		Oct	40
All Asian DX contest 29th (1988)			
CW section results		Aug	49
All Asian DX contest 30th (1989) rules		Aug	50
Australasian sprint 1989 results		Dec	41
Australasian sprints CW and phone 1989 rules		May	36
Australian novice contest 1989 results		Sep	41
BARTG spring RTTY contest 1989 rules		Feb	20
Commonwealth contest 1988 results		Feb	19
Commonwealth contest 1989 rules		Feb	19
Commonwealth contest 1989 rules		Mar	30
CQ M DX contest 1988 results		May	39
CQ M DX contest 1989 rules		May	39
CQ world-wide 160 metre DX contest rules		Jan	42
French contest 1989		Jan	43
French contest 1990 rules		Dec	41
HF contest championship 1988 results		Aug	49
John Moyle memorial contest 1989 rules		Feb	17
John Moyle memorial field day contest 1989 results		Sep	41
LZ DX contest 1989 rules		Aug	49
National VHF/UHF field day contest 1990 rules		Nov	46
OK-DX-contest rules		Oct	41
RD opening address and autobiography	Bill Gronow VK3WG	Sep	06
Remembrance day contest 1988 results		Apr	46
Remembrance day contest 1989 rules		Jul	45
RNARS activity contest 1989 rules		Nov	45
Ross Hull memorial contest 1988 results		May	38
Ross Hull memorial contest 1989 rules		Nov	46
Sangster shield contest rules		Apr	49
Scandinavian activity contest condensed rules		Aug	51
Seonet world wide DX contest 1989 rules		Aug	51
Sunshine state Jack Files memorial contest		Jun	45
Sunshine state Jack Files memorial contest 1989 results		Oct	41

Title of Article	Author	Month	Page
Trial national VHF/UHF field day contest 1989 results		May	37
UBA contest 1989 rules		Jan	42
Venezuelan independence day contest		Jun	43
VK novice contest 1989 rules		May	35
VK-ZL-O contest 1988 results		Mar	32
VK-ZL-Oceania DX contest 1989 rules		Sep	42
**Digital communications			
Packet radio on HF	David Tan 9M2DT	Jan	11
Packet radio position paper	FTAC	Mar	42
Packet radio survey form	ACT packet radio group	Mar	56
RTTY AMTOR		Feb	40
Topical technicalities — digital encoding	Lindsay Lawless VK3ANJ	Jan	36
**EMC			
Articles on EMC		Feb	36
Interference, spectrum pollution and reception problems	Jim Linton VK3PC	Jul	23
Radiation immunity in domestic equipment	Hans Ruckert VK2AOU	Jul	09
**Equipment reviews			
FT736R multiband multimode transceiver	Gil Sones VK3AUI	Mar	12
ICOM IC-900A modular multi-band FM transceiver	Ron Fisher VK3OM	Nov	37
Realistic HTX-100 10 metre SSB/CW transceiver	Ron Fisher VK3OM	May	25
Stand alone prediction system (SAPS)	Gil Sones VK3AUI	May	08
Yaesu FT-411	Ron Fisher VK3OM	Jun	30
Yaesu FT470	Bruce Bathols VK3UV	Aug	26
Yaesu FT4700RH dual band FM transceiver	Gil Sones VK3AUI	May	24
**History			
Australian TV broadcast diamond jubilee	Jim Linton VK3PC	Apr	35
Awesome Orson — the big blow	Harry Atkinson VK6WZ	Jun	26
Down memory lane	Joe Ellis VK4AGL	Aug	16
Early background of our telegraph codes	Lloyd Butler VK5BR	Sep	24
How radio came to Pitcairn Island	Bob Lowry VK4FPO	Aug	21
More of Cyclone Orson	Ray Gray VK6RQ	Aug	17
Morse code is a myth	Mervyn Eunson VK4SO	Dec	16
Preston House revisited	Al Shawsmith VK4SS	Jun	25
QRP in the 1920's	Colin McKinnon VK2DYM	Jan	17
RAEM calling	Tony Smith G4FAI	Aug	18
Short history of communications	Ted Roberts VK4QI	Apr	65
Short history of communications (contd) 2	Ted Roberts VK4QI	Jun	26
Short history of communications (contd) 3	Ted Roberts VK4QI	Nov	41
The unique pedal wireless	Mervyn Eunson VK4SO	Sep	07
VI88XPO	Alan Shawsmith VK4SS	Jan	03
What an inspiration	Bruce Kendall VK3WL	Mar	42
**Miscellaneous technical			
A bitty analysis of the morse telegraph code	Lindsay Lawless VK3ANJ	Mar	07
Decibels made easier	Mervyn Eunson VK4SO	Nov	20
Fatal distraction — or is amateur radio a health hazard?	Morris Odell VK3DOC	Sep	34
How to record the weekly broadcast	Peter O'Connell VK2EMU	May	17
Introduction to synchro torque transmitters & indicators	Dean Probert VK5LB	Oct	14
Introduction to synchro torque transmitters & indicators. 2	Dean Probert VK5LB	Nov	31
Output impedance — source impedance			
— load impedance	Lloyd Butler VK5BR	Sep	10
Resuscitation of VNG	Marion Leiba	Mar	15

Title of Article	Author	Month	Page
Standard frequency transmissions		Feb	37
Tales of the unexpected	David Barneveld VK4BGB	Aug	14
The robot — 21st century technology	Ken McLachlan VK3AH	Jan	06
They say it never strikes twice in the same place	Barrie Gillings VK2DWC	Nov	27
Topical technicalities — power problems	Lindsay Lawless VK3ANJ	Apr	40
Transmission of data information by light	Paul Weaver VK6OF	Aug	09
Two metre mobile installation tips	Gil Griffith VK3CQ	Jul	14
VNG update	Marion Leiba	Nov	40
Weather satellites	Paul Hayden VK4ZBV	Sep	22
Weather satellites (continued) 2	Paul Hayden VK4ZBV	Oct	26
What's worse than radio blackouts?	Ken Gott VK3AJU	Jan	21
**Operating			
Abbreviations for CW work		Feb	49
Amateur radio club nets		Feb	42
ARRL DXCC countries list		Feb	44
Aussat supports JOTA		Apr	30
Aussies chat with space	Jim Linton VK3PC	Mar	10
Australian VHF, UHF and SHF records		Feb	38
Call sign suffixes		Feb	26
Designing a QSL card	Ken Matchett VK3TL	Jul	20
Dove to bear down on planet earth	Jim Linton VK3PC	Oct	34
Guide to the amateur satellite service		Feb	39
JOTA — 1989	Peter Hughes VK6HU	Sep	35
Morse code is a myth	Mervyn Eunson VK4SO	Dec	16
Redcliffe's field day	Jo-Anne VK4CYL & Rick VK4HF	Mar	08
Reflections on the John Moyle field day	Waldis Jurgens VK2DXV	Jan	08
Scandinavia on six	Harry Atkinson VK6WZ	May	07
Standard frequency transmissions		Feb	37
Try using Japanese morse code with Japanese stations	JA1AH	Jan	13
Unusual ship visits Australia	Ron Churcher VK7RN	Jul	19
**People			
Mrs Joan the Lighthouse	Jim Linton VK3PC	May	09
RD opening address and autobiography	Bill Gronow VK3WG	Sep	06
What an inspiration	Bruce Kendall VK3WL	Mar	42
**Places			
A perspective on amateur radio in VU-Land	Jim Linton VK3PC	May	23
China revisited	Wally Watkins VK4DO	Aug	20
Cobourg with an extra oscar	Jim Linton VK3PC	Aug	23
Houseboat on six	Richard Cortis VK2XRC	Jul	18
How radio came to Pitcairn Island	Bob Lowry VK4FPO	Aug	21
JARL Ham fair	David Wardlaw VK3ADW	Dec	35
John Flynn place - Cloncurry	Alan Shawsmith VK4SS	Mar	13
Pitcairn Island — A Ham's paradise	David Miller NZ9E	Apr	36
Preston House revisited	Al Shawsmith VK4SS	Jun	25
**Power supplies			
Portable or back-up battery use	Peter O'Keefe VK3YF	Apr	10
**Propagation			
Aircraft enhancement — another view	Ian Cowan VK1BG	Mar	18
Signals reflected via aircraft	Gordon McDonald VK2ZAB	May	10
Sporadic E propagation	Peter Stackpole VK1RX	Jun	20
**Receivers			
28 MHz broadband preamplifier	Lloyd Butler VK5BR	Apr	38
Better TV & radio reception (book review)	Jim Linton VK3PC	Dec	30
Crystal receiver	Don Law VK2AIL	Apr	14
How to record the weekly broadcast	Peter O'Connell VK2EMU	May	17

Title of Article	Author	Month	Page
Introduction to the superheterodyne receiver	Lloyd Butler VK5BR	Mar	21
Lambda diode regenerative receiver	Larry Osborne VK3ZSZ	Oct	29
Valve receiver conversions	Rob Gurr VK5RG	Dec	21
VLF-LF receiver — 10 kHz to 500 kHz	Lloyd Butler VK5BR	Dec	10
**Regulations			
Third party traffic for New Zealand	Jim Linton VK3PC	Apr	30
ZL licensing for visiting VKS	Ross Garlick ZL3AA	Aug	24
**Repeaters and beacons			
10 metre beacons		Feb	36
14 MHz beacons		Feb	35
Aeronautical beacons useful for propagation tests		Feb	28
Australian amateur repeaters		Feb	30
Australian beacons		Feb	27
New Zealand amateur repeaters		Feb	27
New Zealand beacons		Feb	35
US 10m FM repeaters		Feb	26
**Test Equipment			
1kW pep power meter	Frank Antonovic VK4AOI	Jun	18
Antenna impedance meter	Stan E Widgey VK3SE	Jan	56
How to use a dummy load (or ten)	Graham Rogers VK6RO	Oct	28
Measurement of distortion	Lloyd Butler VK5BR	Jun	08
On building a VSWR meter	Reg Fookes VK2AKY	Nov	06
RF impedance measurements	J Hodkinson VK2BHO	Apr	08
RF impedance measurement program update	J Hodkinson VK2BHO	Aug	13
Simple impedance bridge	Drew Diamond VK3XU	May	30
Simple logic probe	Mike Groth VK4CDG	Jul	13
Solid state conversion of Leader LSG11 signal generator	Andrew Hay VK7ZHA	Jan	29
Transmission lines — measurement of their characteristics	Lloyd Butler VK5BR	Oct	20
**Transceivers			
Digital VFO for your FT101ZD	Bob Fincher VK3BRF	Mar	28
Kenwood TS530S improved selectivity	Con Murphy VK6PM	Feb	60
Tearing the hair with Yaesu FT-7	Eric Brookbank VK2EZB	Aug	11
Timely tip for ICOM IC-2A owners	David Barneveld VK4BGB	Jun	19
TR-7 operation with VHF transverters	R L Drake Co	Dec	28
Two metre mobile installation tips	Gil Griffith VK3CQ	Jul	14
**Transmitters			
Low noise mic pre-amplifier	Ivan Huser VK5QV	Aug	12
Mosfet-4 VFO CW transmitter for 80M	Drew Diamond VK3XU	Nov	10
RF power linear using IRF mosfets	Lloyd Butler VK5BR	Nov	16
Topical technicalities — power problems	Lindsay Lawless VK3ANJ	Apr	40
**WICEN			
Great Victorian bike ride	Ted Borowiecki VK3DXK	Aug	21
WICEN co-ordinators		Feb	29
			ar

**HAVE YOU ENTERED THE WIA 80 COMPETITION?
THIS IS YOUR LAST CHANCE
REMEMBER, TO WIN YOU MUST BE FINANCIAL AS AT 1ST FEBRUARY 1990**

The Ultimate 2 Metre Hand-held Transceiver



The FT-411 is a top-of-the-line ultra compact 2 metre handheld offering an incredible array of features without the size and weight of previous sets. Expanding on the microprocessor controlled features of previous models, the front panel multi-function back-lit keypad allows easy frequency entry, selection of the 49 tunable memories (which store repeater shifts, or separate Tx/Rx frequencies), setting of the programmable-interval 'power-saver' system, as well as a host of other convenience features. CPU control also offers 2 VFO's, rotary dial tuning with 5 selectable tuning steps, a multi-function back-lit 6 digit LCD screen with bargraph Signal/P.O. meter, and a range of scanning options. Even VOX (voice-activated transmit) circuitry is provided, allowing hands-free operation with the optional YH-2 headset.

Yaesu have also recognised that a hand-held radio must be ruggedly constructed, and yet be small enough and light enough to carry around all day. Through the extensive use of surface-mounted components, a heavy duty die-cast rear panel, rubber gasket seals around all external controls and connectors, and a carry case supplied as standard, the FT-411 will provide reliable operation even in dusty or humid environments while measuring only 55 (W) x 155 (H) x 32mm (D), and weighting less than 550 grams (including a high capacity 1000mAh FNB-14 NiCd battery giving 2.5W output). A range of inexpensive optional accessories are also available to provide flexibility for users differing requirements. See ARA review Vol 12 Issue 3.

Complete Package: FT-411, FNB-14 7.2V NiCd, Carry Case, Antenna, Approved AC Charger.

**EXCLUSIVE
2 YEAR WARRANTY**

Optional Accessories

PA-6	DC Adaptor/Charger suit FNB9/10/14	D-3350	\$469
FNB-11	600mAh NiCd Battery (5W output)	D-3498	\$39.95
MH-12A2B	Speaker/Microphone	D-3496	\$99.00
YH-2	Mic/Earphone Headset	D-2115	\$49.95
		D-2200	\$49.95



**DICK SMITH
ELECTRONICS**

• NSW • Albury 21 8399 • Bankstown Square 707 4888 • Blacktown 671 7722 • Campbelltown 046127 2199
 • Chateau Chase 471 1955 • Chulora 642 8922 • Gore Hill 439 5311 • Gosford 25 0235 • Hornsby 477 6633
 • Hurstville 580 8622 • Liverpool 600 9888 • Maitland 33 7866 • Miranda 525 2722 • Newcastle 61 1896
 • North Ryde 88 3855 • Parramatta 689 2188 • Penrith 04732 3400 • Railway Square 211 3777 • Sydney City
 267 9111 • Tamworth 66 1711 • Warringah Mall 905 0441 • Wollongong 28 3800 • ACT • Fyshwick 80 4944
 • VIC • Ballarat 31 5431 • Bendigo 43 0360 • Box Hill 890 0699 • Coburg 031 383 4455 • Dandenong 794 9377
 • East Brighton 592 2366 • Essendon 379 7444 • Footscray 689 2055 • Frankton 783 9144 • Geelong 43 8804
 • Melbourne City 326 6088 • Richmond 428 1614 • Ringwood 879 5338 • Springvale 547 0526 • QLD
 • Brisbane City 229 9377 • Buranda 391 6233 • Cairns 311 515 • Chermside 359 6255 • Redbank 288 5599
 • Rockhampton 27 9644 • Southport 32 9863 • Toowoomba 38 4300 • Townsville 72 5722 • Underwood
 341 0844 • SA • Adelaide City 232 1200 • Beverley 347 1900 • St. Marys 277 9577 • Elizabeth 255 6099
 • Enfield 260 8088 • WA • Carrington 451 8666 • Fremantle 335 9733 • North Perth 328 6944 • Perth City
 481 3261 • Midland 250 1460 • TAS • Hobart 31 0800 • NT • Stuart Park 81 1977

*Yaesu stock not available at all stores; please call for availability

CONVERSION OF THE VINTEN MTR29 TO SIX METRES FM

IAN KEENAN VK3AYK
6 PRETORIA ST CAULFIELD SOUTH 3162

Over the last couple of years I have done several conversions of different types of ex commercial mobile low band transceivers to six metres FM. The interest shown was somewhat overwhelming. Recently the Victorian Division of the WIA disposed of a quantity of MTR 29 transceivers. For those lucky enough to get one, details are presented here to get it going on six FM. Melbourne has a new repeater on six metres, VK3RMS on Mt Dandenong, which gives almost blanket coverage of the metro area. Why not install your MTR29 in the car, and get away from the congestion found on two metres.

The Vinten MTR29 made an appearance on the market around the late sixties to early seventies. Generally it was available in 25 and 10 watt versions, namely the MTR29E and MTR29C respectively. Conversion details are given for both. Modifications to the receiver in both models are identical, but the transmitter PAs require individual attention. Before commencing the conversion, it is a good idea to give the unit a thorough visual inspection for missing or damaged components. If it is possible to check the radio on the original frequency for correct operation, do so, as this can save a lot of trouble later on. Remove the twenty years of accumulated grit and grime with a good clean up. Don't forget to evict the resident spider! He usually lives under the IF printed circuit board shield, located under the chassis. You will probably find that the speaker has a rather violent attack of the rattles when the receiver is unmuted. It is therefore best replaced.

Receiver Modifications

The receiver is basically constructed on three circuit boards;

1. RF front end/mixer/ crystal oscillator/multiplier
2. IF and demodulator
3. Audio and muting

The receiver IF frequency is 10.7 MHz and no tweaking of the slugs should be attempted, unless there is a specific fault due to the many pitfalls associated with the alignment of the IF for the unwary.

Moving now to the RF front end/mixer board — remove the shields from the front end coils. Parallel L1 with a 27pF ceramic capacitor, L2 33pF, L3 27 pF, L4 and L5 each with a 10 pF capacitor. These are placed in parallel with the existing capacitors. Then replace the cans. Strictly, the coils should be rewound, instead of just merely padded down to the new frequency. But I found, in this case, there was little alteration to the overall performance of the receiver. The multiplier chain requires no alteration, as the injection in the modified state will be on the high side of RF carrier frequency.

The new crystal formula then becomes;

$$f_{rx} = \frac{f_c + 10.7}{2}$$

so for 53.9 MHz (VK3RMS down link)

$$f_{rx} = \frac{53.9 \text{ MHz} + 10.7}{2} \\ = 32300.000 \text{ kHz}$$

Crystal spec 3rd overtone, Co max = 4.5 pF, ESR max = 30 Ohms holder HC6/7, input capacitance 15pF.

Receiver Alignment

Insert crystal into the appropriate socket, and apply twelve volts. Connect multimeter, on 2.5 Volt range, to test point TP 1 OSC (located behind the speaker on top of the chassis). Adjust the slug of coil 501 for maximum deflection, then adjust L6 for a dip (around .84V). This dip is not very pronounced but with careful attention is noticeable. Turn off the receiver several times, to ensure the oscillator restarts. Disconnect the meter and apply it to test point TP 5 LIM, located on the IF board. Apply a signal at the carrier frequency to the aerial connector. Hopefully, if the signal is large enough, you should be able to hear some signs of life from the speaker. Then adjust L1, L2, L3, L4, L5 and L7 for maximum deflection on the meter. Decrease the output of the signal generator as the front end is gradually brought into alignment. If nothing can be heard, try coupling the signal generator directly via a two turn coupling link into L5; then adjust L7 and L5 for maximum on the meter. Then re-apply the signal generator to the aerial connector, and repeat the

above procedure. Tuning should be repeated several times to ensure optimum results.

Note: All cans should be in place when doing this. Finally, net the receiver by applying a known accurate frequency to the aerial socket. With a multimeter on 2.5V range connected to TPG DISC, adjust trimmer C17 for zero meter reading. In my case, I found I had to add a 27pF capacitor in parallel with C17 to achieve this. If you are able to check the sensitivity, it should be about 20dB of quieting for .6 μV input (PD). Not the most sensitive receiver around — but if you feel inclined a preamp will fix that.

Transmitter Modifications

The transmitter is built in two main parts;

1. Exciter, which is built on the main chassis
2. PA board, which is located on the side of the chassis — access is gained by removing the four cover screws and taking off the cover.

The transmitter is phase modulated and, by a process of multiplication of the crystal frequency, the final carrier frequency is obtained. To shift the transmitter to six metres, one tripler stage is changed to a doubler, and the remaining coils in the exciter are padded with capacitance to bring them into the desired tuning range.

Parallel coil 563 with a 47 pF ceramic capacitor, 564 with 18 pF, 565 with 22 pF, and coils 566 and 567 both with 15 pF capacitors. By reference to the circuit diagram, the pin numbers and associated connections of the coils can be determined, and therefore the capacitors soldered directly to the coil base pins under the chassis. This saves pulling the whole can assembly apart.

The crystal formula is now:

$$f_{tx} = \frac{f_c}{12}$$

so for 52.9 MHz (VK3RMS up link)

$$f_{tx} = \frac{52.9 \text{ MHz}}{12}$$

$$= 4408.333 \text{ kHz}$$

Crystal spec - fundamental AT cut, Co max = 7 pF, EPR min = twice DE spec, holder HC/6U, input capacitance 35 pF.
10 Watt PA Mods (MTR29C)

This board consists of three power transistors 2N3866, 2N3375 and 2N3927 to provide the desired power output. Locate coil L200 (on neosid former), and rewind it with eight and a half turns close-wound, using the same gauge wire as the original coil. Moving to coil L201 (neosid former), rewind it with five and a half turns close-wound. The PA output coil L203 should be rewound with fourteen turns close-wound with same wire gauge as the original coil. Finally parallel C215, the PA output loading capacitor, with a 33pF ceramic capacitor.

25 Watt PA Mods (MTR29E)

This consists of three stages. A 2N3866 drives a 2N3927, followed by two 2N3927 transistors in parallel in the output stage. The coil associated with the 2N3866 collector output circuit (wound on neosid former) should be rewound with three and a half turns close.

The driver coil (2N3927), which is air wound situated in the middle of two variable capacitors, is rewound with five turns. The two PA output coils are each rewound with five and half turns wire of the same gauge as the original coils. I found during alignment that this board was subject to large spurious problems. If you are unlucky enough to encounter this, the following components should be altered;

1. R126 (exciter) from 100 Ohms to 56 Ohms.
2. The resistors from base to ground of the three 2N3927 transistors on the PA board should each be changed to 47 Ohms.
3. The two 100 pF capacitors feeding the bases of the PA transistors should be changed to 150 pF.

Note: For both the 10 and 25 Watt models, no change is required to the TX output filter.

Transmitter Alignment

Plug the tx crystal into the appropriate socket, connect a power meter to the aerial socket and apply 13.8 V. Operate the push to talk, and with a sensitive high impedance AC voltmeter, locate pin 5 of coil 559, and check it is about 3 volts rms. Next move the AC voltmeter to the base of Q102. Adjust coil 559 for max - about 100mV. Move meter to base of Q103 and adjust coil 560 for max - about 1 Volt rms. Move to base of Q104 and tune coil 561 for max - about 1 Volt rms. With meter connected to the base of Q105, tune coil 562 for max - about 2.3 Volts. Connect meter to base of Q106, and tune 563 for max around 2 Volts AC. Move meter to Q107, and tune slugs of 564 and

565 for max around 2.5 Volts AC. Place meter on pin 5 of coil 567, and adjust 566 and 567 for max - approx .8 volts. Set the supply voltage to 11 volts and repeat above. This ensures the exciter will operate at low voltage. Moving to the respective PA boards, adjust the various stages for maximum output power. Raise the supply voltage to 13.8 Volts and recheck PA board tuning, repeating tuning several times until maximum power is obtained. Remove the crystal and ensure the output power falls to zero. If not, check the PA alignment again. For the MTR29C, the power output should be 10 to 15 watts for slightly over 2 amps, and the MTR29E about 25 to 30 watts for around 5 amps of supply current. Finally, check the carrier frequency by adjusting the crystal netting trimmer C101 for correct frequency. The deviation should be checked with another station for correct level ie 5kHz.

In this description, I have not included the MTR29A. This unit is very common, and the receiver and transmitter exciter modifications described here apply. However, there are differences in the PA board. Those who have an MTR29A, and are contemplating converting it to six metres, might care to contact me if they are stuck!

As stated earlier, the receiver is not very sensitive by todays standards. I would therefore recommend a pre-amp be fitted to the front end. A suitable FET pre-amp was described in the ARRL handbook. Otherwise, you will find others on the band will hear more than you!

In this description, I have endeavoured to make the actual conversion as simple as possible. If you are going to crystal up the unit to operate on 53.5 MHz simplex, a word of warning. The crystal for the receiver when calculated is 32.1 MHz which is third overtone. The fundamental frequency is 10.7 MHz, which is right in the middle of the receiver IF frequency! Not good at all. Therefore avoid this frequency and others close to it. If the local oscillator is injected on the low side, this problem will be solved, but the local oscillator coils will have to be rewound, since they will be taken way past their normal tuning range. Some alterations to the oscillator feed back may also be necessary. For all other frequencies within the band, no problems should be evident and conversion details here apply.

The whole conversion takes about three hours, and at the end you will have gained that sense of pride from doing it yourself, and above all, extra technical knowledge to help you in your hobby. Circuit copies are available from the WIA executive office, at a cost of \$2 each.

ar

WIA 80TH Anniversary Edition of the 1990 Call Book

Be quick

buy your copy
now from your
WIA Divisional
Bookshop

Special Price to WIA
members of

\$8.50

Plus Postage and
Handling

\$1.50 approx.
depending on Division

VHF COMMUNICATIONS MAGAZINE

1990 Subscribers

Make sure you send your
subscription for
VHF Communications
Magazine separately to:

**"VHF COMMS"
PO BOX 300
SOUTH CAULFIELD
VICTORIA 3162**

By January 31st. 1990

NEW PRICES:

Airmail Subscription: \$40.50
Surface Mail: \$28.00

BANDWIDTH CONTROL FOR THE VLF-LF RECEIVER

LLOYD BUTLER VK5BR
18 OTTAWA AVE PANORAMA 5041

In the VLF-LF receiver described in my previous article, AR Dec 89, the bandwidth was set at 3.7 kHz by two Murata 455 kHz Type SFD455D ceramic filters. This bandwidth is ideal for medium bandwidth type modes, such as AM speech, but wider than necessary for narrow band mode signals which exist at frequencies below 100 kHz. These signals are received in the presence of very high noise levels which are inherent to the LF spectrum and the low end of the VLF spectrum. For these signals, an improvement in signal to noise ratio can be achieved by reducing the bandwidth of the receiver. As it turns out, the bandwidth can be narrowed quite simply by switching in a minor circuit change

around one of the two ceramic filters.

Curve A of figure 1 plots the spectral response of the original ceramic filter circuit shown in figure 2. The bandwidth of the circuit can be narrowed to less than 1 kHz, by decreasing the 56 pF inter-filter coupling capacitor to 4.7 pF and terminating the filter in a high impedance. The resultant spectral response is shown by curve B of figure 1. The high impedance can be achieved by increasing the value of terminating resistor. However, in the receiver circuit, this resistor is also an input return for the following operational amplifier. Increasing its value without a corresponding change at the amplifier inverting input would affect the DC offset of the amplifier. To avoid changing the inverting input components, the high impedance was achieved by inserting a 4.7 mH choke in series with the original 3 kOhm terminating resistor. The modified circuit for narrow bandwidth is shown in figure 3.

Examining again the narrow bandwidth curve B of figure 1, it can be seen that it peaks at 457.6 kHz. This works out quite well for centring a frequency to give an audio beat with the beat frequency oscillator (BFO) which is locked at 456.85 kHz. Referring back to the original VLF-LF article, the BFO was locked by an element in the same type of ceramic filter unit as used to control the IF bandwidth.

To achieve switching between wide and narrow band, it was found that this

could easily be achieved by switching the inter-filter coupling capacitor between 56 pF and 4.7 pF and leaving the 4.7 mH choke in place for both conditions. Figure 4 shows the effect of the choke when leaving it in circuit for the wideband condition. Curve A is the spectral response of the original circuit of figure 2 and curve B is the response with the choke in circuit. It can be seen that the latter condition gives an actual 6 dB gain at the expense of around 3 dB of asymmetrical ripple in the response curve. Whilst the ripple looks untidy on paper, its effect on the practical performance on the receiver is unnoticeable. Furthermore, the 6 dB of gain improvement is also a 6 dB improvement in overall re-

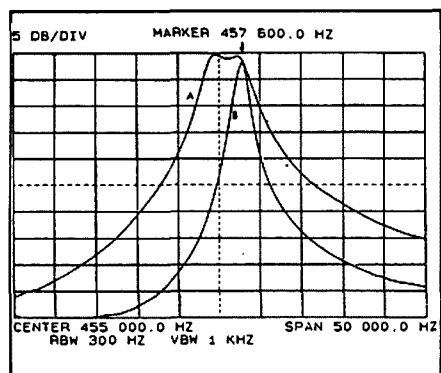

Figure 1
A. Response of the original wideband filter circuit.
B. Response of the narrow band filter circuit.

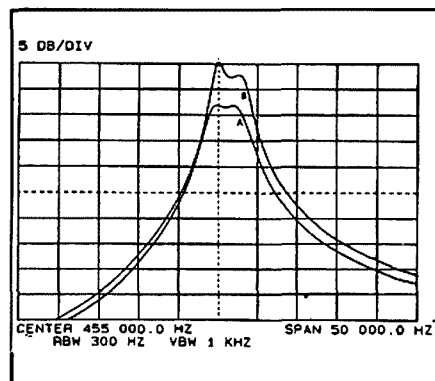

Figure 4
A. Response of original wideband filter
B. Response of wideband filter with 4.7 mH choke left in circuit

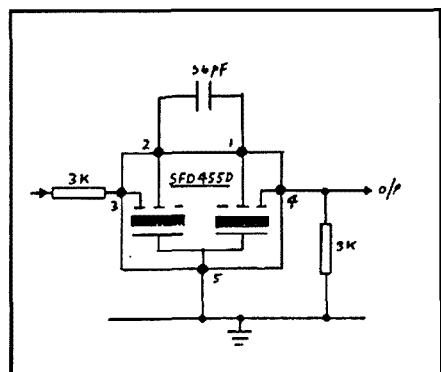

Figure 2 Original wideband filter circuit

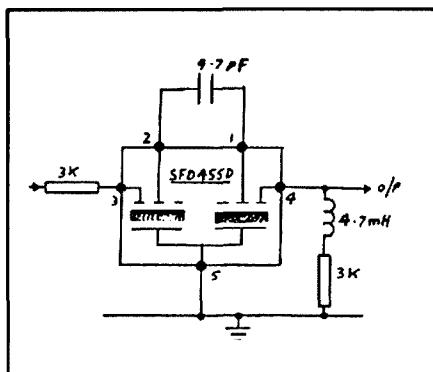

Figure 3 Narrow bandwidth filter circuit

ceiver sensitivity which assists reception at the 500 kHz end of the tuning range where the sensitivity falls away.

The switchable bandwidth control circuit is shown in figure 5. This was applied to the first ceramic filter in the IF chain because it was the easiest one to access on the already wired up board. (The modification could actually be performed without even removing the card from the receiver box.) Of course, there is no reason why the modification could not have been carried out on the second filter had it been more convenient to achieve. The bandwidth switch was mounted on the receiver front panel and connected into

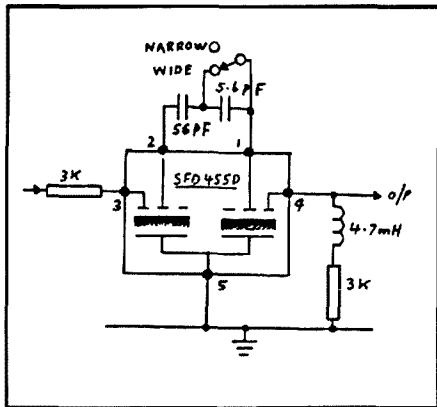

Figure 5 Filter circuit with wide/narrow bandwidth switching

the circuit board via a twisted wire pair. In the circuit shown, the 4.7 pF coupling capacitance for narrow band operation is formed from the series connection of 5.6 pF and 56 pF. Part of the 5.6 pF capacitance is made up of capacitance in the twisted wire pair to the switch. For wide band operation, the 5.6 pF section is shorted out so that the coupling capacitance becomes 56 pF.

Other Applications

The bandwidth control circuit was intended specifically for the LF-VLF receiver but it could well be fitted to any receiver with a 455 kHz IF channel to improve the reception of narrow band mode signals. The Murata ceramic filter is a very versatile little unit considering its cost and size. It can be purchased for but a few dollars and has dimensions of only 7mm x 6mm x 7mm. I have found that by altering the values of source resistance, load resistance and inter-filter coupling capacitance, bandwidth can be set at a range of values between 1 kHz and 7 kHz. (Circuit detail for a bandwidth as wide as 7 kHz was included in the previous article on the VLF-LF receiver.) Not to be overlooked is the additional application of the filter for crystal control of the beat frequency oscillator (refer again the previous VLF-LF receiver article). ar

1990 Advertising Rates

For the second year in succession, the WIA has managed to hold contract advertising rates at the 1988 level, although casual rates have increased by 7% in accord with CPI. An innovative, corporate style, front cover advertising facility has been made available (full details on request), and a 15% discount is being offered to advertisers for additional space advertising in the same issue.

Mono — Camera Ready	Casual	x3	x6	x12
Full Page	\$495	\$420	\$380	\$345
Half Page	\$305	\$260	\$239	\$225
One Third Page	\$205	\$181	\$158	\$136
One Sixth Page	\$128	\$115	\$100	\$90
One Twelfth Page	\$83	\$75	\$65	\$60
Business Card Size	\$75	\$70	\$56	\$45

Mono — Not Camera Ready — Additional Production Costs

	Full Page	Half Page	One Sixth Page
Full Page	\$50		\$30
One Third Page	\$20		\$10
Business Card Size	\$10		

Cover — Four Colour	Casual	x3	x6	x12
Outside Back Cover	\$795	\$720	\$680	\$645
Inside Front Cover	\$720	\$645	\$605	\$570
Inside Back Cover	\$695	\$620	\$580	\$545
Front Cover Corporate Style Advert 1/3 Page	\$745	-	-	-

(Contact advertising manager for details)

Cover — Two Colour	Casual	x3	x6	x12
Inside Front Cover	\$590	\$515	\$475	\$440
Inside Back Cover	\$565	\$490	\$450	\$415

Spot Colour \$140

Special Position In Internal pages \$20

Multiple Advertisements In One Issue

15% discount on additional space.

Material Specifications...

Maximum sizes of camera ready material to be:-
 Full Page — Not to exceed 190mm by 240mm
 Half Page — Not to exceed 190mm by 120mm
 Third Page — Not to exceed 60mm by 240mm.

Camera ready artwork for internal pages is to be 85 line screen bromides or film negatives.

Four colour artwork for covers is to be film positives with 100 to 150 line screen.

Advertising Manager Ann McCurdy

ar

ANTENNAS & ACCESSORIES

We manufacture a comprehensive range of HF, VHF and UHF antennas, baluns, power dividers etc to suit your application. Three of our log periodics provide continuous coverage from 13-30 MHz including WARC frequencies, and replace outdated tri-banders. Now in use in 24 overseas countries and 6 continents.

- CREATE ROTATORS, COAX CABLES & NON-CONDUCTING GUY HALYARD MATERIALS
- COMPLETE RANGE MIRAGE (USA) 5-YR WARRANTY 6M, 2M, 70CM AMPS & WATT SWR METERS
- HIGH GAIN VHF & UHF AMATEUR, SCANNING & TV ANTENNAS
- SELECTION OF POWER CHIPS AT FRIENDLY PRICES

- HARD-DRAWN ANTENNA WIRE
- AUST/NZ DISTRIBUTOR FOR CREATE ANTENNAS/ROTATORS & PHYLSTRAN (KEVLAR) NON-CONDUCTING GUYING MATERIALS
- BUTT SECTION TRIANGULAR ALUMINIUM TOWERS FOR FIXED OR TILT-OVER APPLICATIONS (REFER MARCH/APRIL 1987 AR
- VSWR/PWR METERS TO 1300MHZ)

Write or phone for free catalogue

ATN ANTENNAS

56 Campbell Street
 Birchip Vic 3483
 Phone: (054) 92 2224
 Fax: (054) 92 2666

MORE ON THE YAESU FT-411

LEW WHITBOURN VK2ZIP
PO Box 218 LINDFIELD NSW 2070

This micro-sized 2m hand-held radio was reviewed by Ron Fisher, VK3OM, in the June 1989 issue of AR. I wanted to know more about this exciting radio so I approached DSE's Amateur Radio manager, Chris Ayres (VK2YUS), who agreed to let me do a few extra measurements. Here are the results!

Overview Of The FT-411

The FT-411 is the first full featured micro-sized 2m hand-held to reach Australia. It is the same size as the FT-23/73 but with full DTMF (Dual Tone Multi Frequency) keyboard, 49 memories and comprehensive scanning facilities. This makes it comparable in size to the Kenwood TH-25A/45A and the Icom IC-u2A/4A. A UHF version, the FT-811, is on the way. See Ron Fisher's review for photos and other details.

Memories, PLL And Scanning

There are 48 memories, labelled 1 to 48, and a call channel memory labelled C. Memories 47 and 48 are also labelled L and U and serve as lower and upper limits for programmed scan, but are otherwise like the others. All memories can store offset, subaudible tone status (ENCODE or ENCODE/DECODE — with optional FTS-17 tone board). The 411 also has ten separate memories for DTMF code sequences up to 15 digits, which can be transmitted as desired on any operating frequency. The FT-411 has two VFOs (A and B) with independently selectable step size (5, 10, 12.5, 20 or 25 kHz). The 4 x 4 keyboard controls all these functions in a manner that I found user friendly (the Yaesu FT-209/709 did less with a 5 x 4 keyboard). Second functions for all keys are obtained by pressing the bottom right hand key, the "function" key, which then remains active for 5 seconds (this was 3-4 seconds for the FT-209).

The PLL (Phase Locked Loop) of the FT-411 must lock up somewhat faster than that of previous radios, because the scanning and power saver cycle times are somewhat faster. The radio can scan through 20 memories in 3.1 s, or 150 ms

per step for any arbitrary sequence of frequencies in the 2m band. When scanning consecutive frequencies (band scan) the FT-411 takes only 70 ms per step. This is FAST.

This speed is reflected in the power saver, which has an "on" time of only 30 ms. The "off" time can be programmed to ten different values between 30 ms and 1000 ms. The FT-209 needed an "on" time of 300 ms. To indicate the consequences of this I show the power-saver performance of both the 411 and the 209 in the table below.

Saver Code	Off Time (ms)		Av. Rx Current (mA)	
	FT-209	FT-411	FT-209	FT-411
1	300	30	26.5	23
2	600*	70	20.3	16.2
3	900	100	17.3	13.8
4	1200	200*	15.4	10.4
5	1500	300	14.2	9.1
6	1800	500	13.3	7.9
7	2100	700	12.6	7.4
8	2400	800	12.1	7.2
9	2700	1000	11.7	7.0
0	3000	11.4	-	-

Note that both radios have a current drain of 40 — 45 mA with saver off — Asterisks show default saver settings. Clearly the FT-411 allows you to use the same or lower average receiver current with much lower probability of missing short calls.

I think Yaesu have missed an opportunity with this fast PLL. Its speed is such that acceptable scan speeds could have been obtained by allowing power saving while scanning. No radio that I know of does this at present — and probably no previous radio had a fast enough PLL to make it feasible. However, you can trick the FT-411 into doing a very slow memory scan, with power saving, by putting it into priority mode while memory scanning. (You could also do this with the FT-209, but with one difference. On the 209, all scanning stopped when an occupied memory was encountered, but the 411 just keeps on scanning in accordance with the selected scan resume mode.)

Scan Modes

The FT-411 will scan through the whole range of the radio in the current VFO steps as set up by the user, or between the upper and lower limits set in memories

47 and 48, in steps determined by the previously selected VFO, or it will scan through all its memories. It is possible to designate memories to be skipped during scanning.

Although it has very little to do with scanning, I might mention here that the 411 allows you to "hide" memories. As far as I can see, this is effectively a procedure for erasing the contents of any memory. However, Yaesu call this hiding because you can recover the data in a given memory location (2 — 48) as long as you haven't overwritten it since erasing (hiding) it.

Scan Resume Modes

There are two user selectable modes labelled P and 5: Pause and 5 seconds. In the "P" mode the radio resumes scanning about 3 seconds after the mute closes. In the "5" mode it resumes scanning after 5 seconds, regardless of mute status.

Transmitter

The FT-411 offers transmit powers of about 2.5 W with 7.2 V (6 NiCad cell) battery packs and 5 W with 12 V (10 cell) battery packs. The measured power output (at 146 MHz), current drain and efficiency, as a function of supply voltage is shown in the table below. The variation between 144 and 148 MHz is negligible.

Supply Voltage (V)	Current (A)	Output Power (W)	Overall Efficiency
5.5	.7	1.35	.35
6	.76	1.68	.37
6.5	.83	1.98	.37
7	.89	.231	.37
7.2	.92	2.45	.37
7.5	.96	2.74	.38
8	1.02	3.12	.38
8.4	1.07	3.44	.38
9	1.14	3.78	.37
9.6	1.20	4.42	.38
10	1.24	4.8	.39
11	1.33	5.3	.36
12	1.38	6.0	.36
13	1.30	6.0	.36
14	1.28	6.0	.33
15	1.27	6.0	.31

The efficiency is good. The radio attains maximum efficiency at quite low voltages (~7.2 V). Clearly there is no

advantage in supplying more than 12 V to this radio. Low power was 0.45 W for a current drain of 0.48 A for all supply voltages between 5.5 and 15 V. The efficiency on low power varies from 0.17 at 5.5 V to 0.06 at 15 V. The LCD power indication shows 5 bars on low power and 12 bars on high power — regardless of the actual power level.

Receiver: 144 to 148 MHz

The receiver uses two bipolar transistors in a single package (labelled 1MX5) as RF amplifier stages preceding a bipolar mixer (2SC3120) feeding the first IF at 17.3 MHz. Local oscillator injection is via the base of the mixer transistor. As noted by Ron Fisher, there are a number of filters preceding the mixer, but these are not so much for 144-148 MHz selectivity as for controlled band pass from 130 — 180 MHz — see the next section.

At 146 MHz I measured a sensitivity of 0.17 μ V for 12 dB of quieting and 0.22 μ V for 20 dB of quieting. Variation in sensitivity from 144 to 148 MHz is shown below (microvolts input for 12 dB of quieting).

FREQ (MHz)	144	145	146	147	148
SIGNAL (μ V)	0.175	0.17	0.17	0.165	0.16

The LCD signal strength meter sensitivity is as follows (number of bars for signal input in microvolts):

NO of BARS	SIGNAL (μ V)
1	0.5
2	0.76
3	1.2
4	1.4
5	1.8
6	2.2
7	2.6
8	3
9	3.8
10	4.3
11	5
12	6

No bars are activated when the mute opens, unless the signal strength is 0.5 microvolts or more.

The receiver current without power saver is 42 mA. This rises to 60-70 mA with moderate audio and about 15 mA at maximum audio levels. The quality of the audio from the small speaker is surprisingly good, but not loud enough for comfortable listening in the average small car.

I am not really sure how to measure adjacent channel rejection. With the receiver tuned to 147.000 MHz I found that 1 V RMS signals at 146.975 or 147.025 MHz caused only 1 dB of quieting. This seems very good indeed, but since 1 V is about 140 dB greater than the

0.17 μ V sensitivity (for 12 dB of quieting) at 147.000 MHz, it is obviously something different from the 60 dB adjacent channel rejection quoted by Yaesu!

The receiver is very sensitive and gives surprising performance using only the 110 mm "Rubber Ducky" supplied with the radio. However, when connected to a quarter wave aerial on a car, or to a base aerial, the receiver exhibits some over-load problems. This is not surprising in view of its sensitivity, the broad front end (see next section) and the simple bipolar mixer with base injection. However, the radio is mostly well behaved with the rubber ducky antenna, which is what it is designed for.

It is probably to be expected that receiver performance might be a casualty in such a small full-featured radio. This being the case, I think the time might be coming when a switchable RF attenuator could be necessary. With a transmit power of 2.5 or 5 W you will drop out long before the signal from a 25 W repeater gets down to 0.17 μ V. My guess is that most repeaters don't have sensitivities as good as 0.17 μ V, so a 10 dB receiver attenuator would make for more comfortable receiving and improved transmitter-power-limited coverage with an external aerial. The other solution would be an external 144 — 148 MHz cavity or band pass filter to be used between the radio and an external aerial — an excellent homebrew project!

130 — 174 MHz Receiver Coverage

When I first received the FT-411 from DSE it had 144 — 148 MHz transceive capabilities. However, I knew that American models boast 140 — 174 MHz receiver coverage, so I asked Chris Ayres why Australian amateurs could not have this feature as well. The problem was that the modification that gives extended receiver coverage also increases transmitter coverage, to 140 — 150 MHz. After checking with the WIA, Chris Ayres agreed that amateurs wanting the increased coverage could return their FT-411 radios to DSE for modification at no cost. Naturally I asked for the modification to be done on the review unit. It was done overnight, without any clues about how, with the following results.

I should note first that with this modification done, the responsibility for operating within the 144 — 148 MHz band lies with us amateur users. If we are not responsible in this regard we will suffer the consequences!

When I received the modified FT-4111 noticed that the receive coverage actually goes from 130 to 174 MHz, so I decided to measure and graph its sensi-

tivity and image rejection over this range. After a bit of confusion I discovered that the FT-411 actually switches from high-side injection (i.e. local oscillator frequency = dial frequency + intermediate frequency) to low-side injection (LO = dial — IF) as it is tuned from 156.995 MHz to 157.000 MHz. (The first IF frequency is 17.3 MHz). This reduces the range that the VHF VCO, which is in effect the local oscillator, must tune through for the radio to cover the 44 MHz between 130 & 174 MHz. In fact, the full range of the VCO is from 139.7 MHz, required for receiving at 157.00 MHz, to 174.295, required for receiving at 156.995 MHz. By measuring the sensitivity of the radio at dial frequencies between 130 and 174 MHz, and their images, I was in fact able to measure receiver sensitivity from 122.4 MHz (139.7 — 17.3 MHz) to 191.595 MHz (174.295 + 17.3 MHz), as shown in Fig 1. This is a bit confusing so the figure shows three frequency axes — the actual frequency being received, the dial frequency and the VHF VCO (or LO) frequency. Some frequencies can be received for two different dial frequencies, with negligible difference in sensitivity as far as I could see, so you can get confused about what is signal and what is image. For example, the radio receives 165 MHz for dial frequencies of 165 MHz or 130.4 MHz (= 165 — 34.6 MHz). To add to the confusion, note that at some dial frequencies the radio is actually more sensitive at its image. For example, at a dial frequency of 174 MHz the sensitivity is about 24 μ V (for 12 dB noise quieting) at 174 MHz or about 0.2 μ V at 139.4 MHz (= 174 — 34.6 MHz), an image enhancement of greater than 60 dB!

What does all this mean? As far as I can tell, it means that the front end filters of the FT-411 give the broadest possible band-width without sacrificing performance between 140 and 150 MHz, where the rejection of the image at 174.6 — 184.6 MHz is between about 60 dB and 80 dB. This is highly desirable because of the strong TV signals likely to be encountered in the 180 MHz region. Meanwhile, a casualty is that the sensitivity from 165 to 174 MHz is not great. In fact the sensitivity at 174 MHz is quite poor; about 24 μ V for 12 dB NQ.

As mentioned above, the sensitivity measured at any frequency accessible on two different dial frequencies was negligibly different on those two dial frequencies. This suggests that the local oscillator injection level is fairly constant over the 139.7 to 174.295 MHz range. The ultimate test of this was to compare the sensitivity at 156.995 MHz (where the LO is 174.295 MHz) with that at 157.000 MHz (where the LO is 139.7 MHz). The

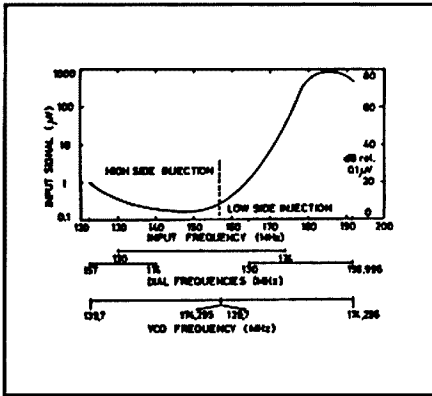

Fig 1 FT-411 Receiver Sensitivity

sensitivities at these two frequencies were 0.23 and 0.26 μV for 12 dB NQ respectively, conforming that there is very little change in the level of the LO as it jumps from 174.295 to 139.7 MHz! This in turn leads me to assert that the curve of Fig 1 reflects largely the bandpass filter characteristic of the front end of the receiver, assuming that the mixer efficiency is constant over the range of frequencies concerned.

Using the radio with a half-wave antenna in my home, I did not notice any gross overload problems. I found that I could hear both sides of many simplex communications in the VHF marine band (156 — 163 MHz) between ferries on Sydney harbour, about 10 — 20 km away. The 25 kHz step size is ideal for the marine band but at higher frequencies (165 — 174 MHz) a 30 kHz step size is desirable. Yaesu please note!

Battery Packs And Size

Yaesu quote the FT-411/811 as being identical in size to the FT-23/73, at 55 mm wide by 32 mm deep by 139 mm high with the FNB-10 (7.2 V, 600 mAh) battery pack. Actually, the FT-411 is supplied with the FNB-14 (7.2 V, 1000 mAh) battery pack, which increases the quoted height to 155 mm. These are not really "overall" dimensions, mostly because of the "power bulge" under the PTT button.

My measured dimensions (in mm) are:

Dimension	FT-23/73	FT-411/811
Main Width	54.5	54.5
Width including PTT	62	62.5
Width inc PTT + Wrist Strap Mount	67.5	67
Depth	32	33
Main Height	75.5	76.5
Height including Knobs	86	87.5
Height of PTT		
Power Bulge	44	50

Some of the battery packs for the FT-411/811 are bigger than the radio, so a comparison of their sizes and capacities

is pertinent. The table below shows a number of their dimensions and a figure of merit proportional to volumetric efficiency, the stored energy in Joules per metre of length. For those who may want to convert these to Joules per unit volume, the cross sectional dimensions of the packs are 55 mm by 32 mm.

Type No	Length (mm)	Radio & Battery (mm)	V 7.2	Cap (mAh)	Figure of Merit (Joules/Metre)
FBA/FNB-9	46	122	7.2	200	31.3
FBA/FNB-17	51	127	7.2	600	84.7
FBA/FNB-10	63	139	7.2	600	68.6
FNB-11	112	188	12	600	64.3
FNB-12	79	155	12	500	75.9
FNB-14	79	155	7.2	1000	91.1

Note that the FBA type packs are for fitting your own cells. These would be AAA size (180 mAh) for the FBA 9 or AA size (450, 500, 600 or 700 mAh) for the FBA 10 and 17. The capacities and figure of merit shown in the table refer to the FNB packs. The FNB-14 supplied with the radio has the best volumetric efficiency, but my choice would be the new FNB-17 because of its smaller size. Both the FNB-14 and the FNB-17 will soon be available from DSE as spare parts, both for \$99, so it could be a difficult choice! It wouldn't be worth bothering with the 200 mAh FNB-9, which is almost as big as the FNB-17. However, if Yaesu were to develop a 200 mAh pack with decent volumetric efficiency it would make for a very small package. Another combination that would be interesting would be an FBA-17 with six 700 mAh AA cells — this would have a figure of merit of 98.8 J/m! When the FBA-17 becomes available it will be interesting to see how Yaesu have engineered a 51 mm pack to hold 50 mm long cells but perhaps DSE will come to the rescue with their S-3312 600 mAh cells, which are a little under 49 mm long.

Using the FT-411 with the FNB-14 and FNB-10 packs, I found it fitted into a coat pocket much better with the latter. Also with this pack it compares more than favourably in size with its two main competitors, the Icom IC- μ2A (59 mm x 28 mm x 117 mm with the 120 mAh BP-21 or 146 mm with the 270 mAh BP-22) and the Kenwood TH-25AT (58 mm x 29.5 mm x 137.5 mm with the 600 mAh PB6 battery pack).

Battery Capacity And Charging

It has to be said that the 1000 mAh FNB-14 battery pack supplied with the FT-411 is very good value. On the default battery saver setting the receiver current drain is about 16 mA, giving a useful life of a few days to a week with modest usage. This for me was a new experience

— I had to charge the pack only a few times during a period of a few weeks. While I was at it, I measured the charging current from the M-9517 charger supplied with the radio, which plugs into a 2.5 mm phono socket in the side of the FNB-14. (The socket is connected to the battery via a silicon diode, which prevents discharging through the socket — the FNB-10 has the same arrangement.) The charger is a standard DSE catalogue item, for charging NiCad packs from 7.2 V to 12 V. I found that the charging current started at about 200 mA with a flat FNB-14 and dropped to about 120 mA within 1 to 2 hours. The charger is actually a 12 V, 200 mA maximum plug pack with "loose" regulation — i.e. probably a series resistor. Assuming a constant current of 120 mA, I infer a charging time of $1.4 \times 1000/120$ h or 11.7 h. DSE suggest a charge time of 13 h for the FNB-14 but I found some inconsistencies in the figures quoted for the M-9517 in various places, so I suggest that users who want to charge their batteries optimally should check the charging current. Because of the loose regulation of the charger it seems quite conceivable that the charging current could vary somewhat from one unit to another.

I also checked the capacity of the FNB-14 by discharging it into a 100 ohm load and monitoring its voltage on a chart recorder. On three separate occasions, after varying charge times between about 9 and 12 hours, I measured capacities of 967, 977 and 992 mAh. This is a very satisfactory result and suggests that a charge time somewhat less than 13 hours is perfectly adequate.

Summary

The micro-sized, full-featured FT-411, with its "1000 mAh is forever" battery pack is a stunning radio. It does come with a soft case (CSC-37), which was not supplied with the unit lent to Ron Fisher for review. The CSC-37 has a clear plastic window over the whole keyboard/display area — much better than the case for the FT-209, which left the keyboard exposed. The illuminated display is quite readable and the keyboard illumination is both beautiful and functional — it only draws 75 mA too! The CTCSS encode/decode/pager option is available ex-stock from DSE for \$106, which is about half the price of units for earlier radios — if you could ever get one! As with most keyboard programmable radios the DTMF functions are standard. I can't think of anything else you could want in a 2m handheld!

Thanks to Chris Ayres and Dick Smith Electronics for the extended loan of the review unit, Serial No. 9D0801071 ar

DIGITAL PACKET ON VOICE REPEATERS IN THE AMATEUR 2-METRE BAND

IAN MILNE VK7IR

25 LEWIS AVE SEVEN MILE BEACH 7170

The rapid evolution of Digital Communications has resulted in the recent general availability of "Packet" terminal units, which are in use on many Amateur Bands, including those employing repeaters.

Voice traffic repeaters are established on the 144-148 MHz band and are well utilised — recently, the increased presence of Digital traffic on some of these repeaters has led to irritation and ill-feeling from those who are not participating.

To a "Voice" user, the bursts of Digital Data can be extremely irritating — akin to the effect of "Button-Pushing" often encountered. This is causing considerable friction between users of the two modes; clearly they are incompatible on the same channel.

In approaching the problem, it is important to be positive, recognising the rights and needs of both groups; the following solution is suggested as a possible answer to resolving the conflict, without inflicting the hardship of great expenditure on any group, and conserving the spectrum as effectively as more complex solutions.

Proposal

- (1) The voice repeater's receiver would remain on its normal input frequency, say 146.1 MHz.
- (2) The audio output of the receiver would be fed to a "Bit-Stream" detector, which would recognise the two tones present in the Packet.

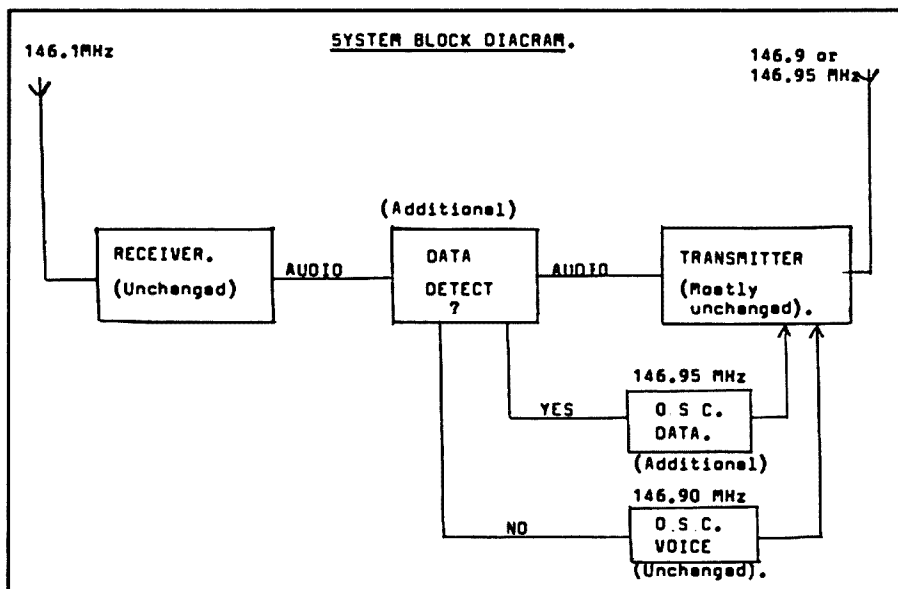

System Block Diagram

- (3) On voice, the repeater would work normally, with its input and output frequencies unchanged.
- (4) On "Packet" the data detector would switch-in a separate transmit oscillator, which would shift the repeater output freq to, say 146.95 MHz, to re-transmit to packet users, whose receivers would be set to this frequency. Thus, the voice users would hear no annoying tones, and the Packet users would have no voice signals

to contend with.

Note

- Only small, comparatively inexpensive modifications.
- No increase in Frequencies over an additional single-channel Repeater — good use of Spectrum.
- The passage of "Opposite Mode" Traffic would be inhibited by the Data Select Logic, preventing mixed transmissions. ar

WIA NEWS

Continued from page 6

by the Civil Aviation Authority (CAA) as reported on page 6 of December 1989 issue of Amateur Radio magazine.

At their November meeting, the WIA Executive formally adopted this new bandplan, and the 1296 MHz bandplan shown as Plan B on page 31 of the 1990 Australian Radio Amateur Call Book is now the current amateur service bandplan for that band in Australia.

Sponsors of 1296 MHz repeaters should take note of this plan when seeking repeater licences.

WIA Video Tape Library

Are you aware that every radio club in Australia can provide its members with a quality technical lecture on a wide variety of amateur radio subjects by making use of the WIA Federal Videotape Library.

Tapes can be provided in U-Matic, VHS, Beta and Video 8 formats and, especially for WIA affiliated clubs, this service is inexpensive and easy.

Full details of this excellent facility last

appeared on page 38 of the November 1988 issue of Amateur Radio magazine, but will be published again, together with the comprehensive list of available videos, in the February 1990 "Reference" issue of Amateur Radio.

John Ingham, VK5KG, tells me that the latest tapes to be added to the library, which will be of particular interest to experimenters, are "Clem Tilbrook VK5GL on Crystal Grinding" and "Introducing Microwave" presented by Des Clift, VK5ZO.

If you want more information about the Federal Videotape Library, contact your Division. ar

WEATHER SATELLITES PART III

PAUL HAYDEN VK4ZBV
38 LUTZOW ST EKIBIN 4121

(Continued from October issue)

Early satellites equipped with scanning radiometers produced an image with inherent panoramic distortion, (milk bottle dist). The result of scanning a round body (earth) with a rotating constant speed scanner in space is a picture similar to that produced by wrapping a flat picture or map around a milk bottle then viewing it at arm's length. As the picture curves towards the sides of the bottle the geometric distortion of the image increases rapidly.

Current NOAA and METEOR satellites overcome this geometric distortion by means of electronic linearity correction performed on board the spacecraft before transmission.

APT Weather Facsimile Format - WEFAX

APT SR mode images are pictures transmitted direct from the low polar orbit satellite's scanner in real time.

Geostationary satellites do transmit some real time pictures, but the huge quantity of data in these images is difficult for an amateur station to record and process or display. (4,800 pixels by 4,800 lines = 23 million bits per pix).

The advantages of pictures from geostats are available to small amateur stations, not in real time, but within a period of 30 minutes to an hour, the time required to process the image by computer on the ground into the WEFAX format.

WEFAX pictures are received from a satellite, recorded, processed, enhanced, gridded (lat, long, coastlines), then formatted and retransmitted to a satellite for transmission to APT WEFAX stations. This might not be via the same satellite.

They are low resolution images with a video bandwidth of 1600 Hz, amplitude modulated (white 80%, black 5%) on to a 2400 Hz audio subcarrier. The result (800Hz to 4000 Hz) can be tape recorded for future replay.

The image format is 800 lines of picture, 800 picture elements per line, with a 1 to 1 aspect ratio (square pix). The line

rate of 4 Hz (240 rpm) requires 200 seconds per picture. The WEFAX picture begins with three seconds of 300 Hz start tone (square wave), 5 seconds of phasing signal short black pulse (12.5 ms) on a white line (237.5 ms), 800 lines of pix with either 7 cycles of 840 Hz or a narrow white bar as a line start signal, and ends with 5 seconds of 450 Hz stop tone (square wave.)

The WEFAX format is designed for automatic control of facsimile receivers. The index of co-operation is 267.36 (this number relates to the drum diam and stylus leadscrew pitch needed to get a square picture) to give the right aspect ratio.

From 36,000 kms altitude the earth is quite small. It subtends an angle of about 17 degrees. This simplifies the image scanning process, but limits the antenna gain on the satellite if the full hemisphere is to receive the satellite signals (beam width fairly large.)

WEFAX images can be in visible light or infrared and can be computer enhanced to highlight special features of the weather. The DVORAK hurricane curve is the enhancement used to highlight tropical cyclones, with IR the range +2 deg. C to -70 deg. C are highlighted and can be separated from the remainder of the image.

Other curves can be used to enhance ocean water temperature measurements, formation of frost, snow, land temperatures, etc. These are some of the 200 curves available to process satellite images by reinterpreting the grey scales of the picture.

Weather Satellite Receivers VHF

The frequency band 136 to 138 MHz is set aside in most parts of the world for space to earth communications (the German V2s were the first to use it.)

The band 137-138 is where the APT transmissions take place. This is in Australian TV channel 5A.

The NOAA satellites use two frequencies.

NOAA 10 137.50 MHz switchable
NOAA 11 137.62 MHz if in conflict
NOAA 9 137.62 MHz or test mode
The METEOR series use a number of

frequencies; common ones are:

METEOR 2-16 137.4 MHz
METEOR 2-17 137.3 MHz
METEOR 3-2 137.85 MHz

(combination sat/freq current as at February 1989 but subject to change.)

Less common METEOR frequencies used include:

137.06, 137.12, 137.15, 137.33, 137.45, 138.80 MHz.

The VHF APT transmissions from polar orbiting satellites use wide band frequency modulation with no pre-emphasis.

The deviation of the NOAA satellites is +/- 18 kHz.

The maximum modulating freq is 4000 Hz, and the doppler shift +/- 3 kHz.

Allowing 3 kHz for tx and rx freq errors the practical receiver should have an IF bandwidth of 50 kHz.

The METEOR satellites are reported to have a smaller deviation, +/- 10 kHz, and require a receiver IF bandwidth of 30 kHz. But we have seen METEOR S with more deviation than NOAA S.

From this we can see that the IF bandwidth is a problem, since most FM receivers are either narrow 15 kHz bandwidth (comms), or wide 150 kHz bandwidth (FM broadcasting, TV sound).

One of the solutions to this problem is to obtain a crystal filter from an old mobile. When there were less mobile stations about, the channels were wider than in today's crowded spectrum.

The popular scanning receivers are not suited to serious satellite work as the bandwidths are tailored to communications or broadcasting only, and often don't include 136-138 MHz.

A second solution and the one that I favour is the use of a crystal locked converter and a tuneable IF receiver. The old ex army FM transceivers (PLESSEY mobiles B47/48, C45/46 or the USA army type PRC9/10 manpack), covering the range 23-38 MHz or 38-56 MHz are 50 kHz wide and perform well.

Mine have been converted to solid state. With AOS at typically 3000 km, a path attenuation of 146 dB at 137 MHz and a transmitter power of 5 watts, the receiver should be capable of 20 dB of quieting at 0.5 microvolts. The use of a JFET/MOSFET preamp enables this performance to be reached easily.

The standard 2 metre rig with a converter will allow you to hear the satellites but the limited IF bandwidth will not produce good pictures. Also with a 10.7 MHz IF most two metre rigs have their local oscillator in the range 133.3 to 137.3 MHz complicating the design of the converter.

One advantage of this is that I can use the local oscillator of my IC22S as a signal source to check my satellite receiver. As the sensitivity of the system is improved you park the car with the mobile receiver turned "on" further down the street.

(148 - 10.7 = 137.3 METEOR 2.16).

For the home constructor the following weather satellite receiver kits are available, Aust Electronics Monthly, Germany VHF Comms, USA Hamtronics, UK Cirkits.

We hope to present a local kit in the near future.

The VHF Comms design (boards available from New Zealand) has a scanning local oscillator to help find new satellites or changes of freq, and the use of a phase locked loop detector for best s/n at low signal strengths.

Automatic frequency control of the receiver is a natural next step after scanning. When a signal is heard the scanning stops (controlled by the squelch circuit) and the low pass filtered output of the discriminator is connected to the voltage control of the local oscillator to lock the receiver to the incoming signal. This tracks out the Doppler shift and keeps the signal in the middle of the IF passband.

A time delay in the return to sweeping is desirable so that if the signal is lost due to a fade the picture is not disrupted more often than necessary.

The 137 MHz band is not often affected by the day to day changes in the ionosphere. There are days when the effects do reach 137 MHz.

The most often seen result is a series of slow deep fades produced by multipath signals (the main signal and reflected signal add and subtract). This is normally found on days when six metres is open (a good DX indicator).

On the days when two metres is open, the effect on the picture is to completely shred up the signal. A mixture of deep fades of short duration, and many multiple path signals completely destroy the image.

The use of a post detection audio band pass filter (800 Hz to 4000 Hz) to limit the bandwidth of the recovered video to remove high freq noise is desirable as the FM system has no pre-emphasis (any de-emphasis in the receiver should be re-

moved.)

The video should be extracted before the volume control of the receiver to provide a constant level to the tape recorder or display device.

The use of an automatic gain control on the video to compensate for the different satellite's FM deviation is not as desirable as it may seem. It tends to produce flatter pictures due to the reduced dynamic contrast range, and also produces long term streaking on the picture background. Automatic recording level control used in some tape recorders will also produce this effect.

The predictable pass times, stable low signal strengths, and the wide bandwidth of APT satellite signals offer the amateur a good source of signals for experimentation with antenna design, low noise preamps, receiver designs, more exotic types of FM detectors, phase locked loops, synchronous detectors, extended threshold demodulators, FM bandwidth compression techniques, or squelch circuits, without the need for expensive or hard to get test equipment.

One of the dilemmas facing the builder of a weather satellite receiver is the choice of local oscillator type. The multitude of frequencies makes the use of crystal oscillators an expensive business, unless the builder has a good junk box.

The frequency range to be covered (137 to 138 MHz) is about five times too wide to be covered by the use of a variable xtal oscillator (VXO).

The simple frequency synthesizer circuits now possible thanks to the use of large scale integration (LSI) and emitter couple logic (ECL) combined with a read only memory (ROM) chip are a practical alternative, with the advantages of quick freq change (scanning) with precise frequency control.

A crystal converter and a tuneable first intermediate frequency of about 30 or 40 MHz will provide the frequency stability necessary over the one MHz tuning range.

The last option is the voltage controlled oscillator. Its inherent frequency drift problems can be overcome by the use of automatic frequency control (AFC), and a low frequency sawtooth voltage to sweep the oscillator over the band as it searches for a signal to lock on to.

WEFAX Super High Frequency Receivers

The design and home construction of a 1691 MHz receiving system to produce pictures from a signal of -134 dBm or 0.044 microvolts on 50 ohms seems daunting at the first look (and possibly the second look as well). When it is up and

running you have a sense of achievement, and plans for the next version firmly in place.

The geostationary satellite that provides coverage of Australia, is the Japanese GMS 3. Its specifications differ from GOES and METEORSAT in FM deviation. The GOES and METEORSAT both use +/- 9 kHz deviation and require an IF bandwidth of 26 kHz.

The GMS satellite uses +/- 126 kHz deviation, and needs an IF bandwidth of 260 kHz. The bandwidth being 10 times wider receives 10 dB more noise.

This means that we cannot use overseas designs unless we redesign to provide the wider IF bandwidth and lower noise performance required. To produce a usable signal we require a larger antenna to compensate or a lower noise figure in the receiver, or both.

To obtain a reasonable noise figure a special low noise bipolar transistor can provide 1.5 - 2 dB NF. The use of a GaAsFET can lower this to 1 dB NF or less.

Due to the loss in coaxial cable at 1691 MHz most WEFAX receivers are mounted on the back of the parabolic dish and fed via a short length of large low loss cable from the antenna preamp mounted on the dish feed. The power feed for the preamp can be fed up the centre conductor of the coax.

A common system used overseas is to use a crystal locked converter on the dish and feed an IF typically 137 MHz back to the stations VHF APT receiver; this is not satisfactory with GMS, as the APT receiver bandwidth is too narrow (by a factor of 10.)

The antenna required for the SHF receiving system must bridge the gap between the flux density of the satellite signal -134 dBm and the performance of the receiver -107 dBm.

The difference of 27 dB or 500 times must be made up by the antenna. At 1691 MHz this requires a parabolic dish of at least 2.5 metres diameter.

The use of a low noise preamplifier mounted on the feed of the dish can provide a reserve of gain to make up for losses like the feedline and connector losses. (2.5 metres of RG 213 has about 3 dB loss. Without the preamp this loss would be added to the NF of the receiver.)

The SHF radio frequency part of the receiver can be either tuned cavity resonators, air spaced transmission lines, (low loss) printed circuit stripline, or interdigital filter construction.

The bipolar transistor (NEC) NE6435 used in a typical low noise amplifier (LNA) circuit has the emitter directly grounded (for stability) and requires careful bias adjustment to ensure the lowest noise

figure possible.

GaAsFETS (MIT) MGF1402 or MGF1200 can provide a better noise figure but again the bias adjustment is critical if the devices are to meet expectations.

The input matching in the LNA is the most critical circuit, the Q of this circuit must be as high as possible as its losses degrade the amplifier NF.

The local oscillator chain should be crystal controlled, as the highest practical xtal oscillator freq typically 100 MHz (5th overtone) will have to be multiplied by 15 to produce the local oscillator frequency for the conversion to 137 MHz.

If the xtal is subjected to temperature change and its frequency drifts 1 kHz (at the 20 MHz fundamental frequency) the injection freq shifts 75 kHz as does the IF, so care is required in design and construction for freq/temperature stability.

The low noise preamp at the focus of the dish can also be subjected to large temperature extremes. Don't paint your dish high gloss white or silver unless you want to cook your prized LNA.

Waterproofing of connectors, cables, LNA and receiver are important when you have only a small carrier to noise ratio in your system, as every dB counts.

A source of SHF signal is handy when building low-noise amps, converters and receivers. A well shielded, small xtal oscillator on a sub multiple of 1691 MHz, modulated and multiplied provides a stable low level signal for alignment.

When the SHF receiving system is up and running the oscillator can be hung up in the shack with a small ground plane antenna (4.5 cm) as a talking point. The SHF beacon signal may save you dismembering your system the first day the satellite fails to show on time.

An alternative source of alignment is your station's 6 metre rig tuned to 52.84375 MHz. The transmitter's 32nd harmonic should be audible.

Kits for LNAs and SHF converters and receivers are available from Germany (VHF Comms) and the USA (Microcomm Inc).

Most amateur WEFAX stations are home constructed and designed.

Antenna System for Weather Satellites VHF

The VHF APT signals from the polar orbiting satellites are of sufficient signal strength that they can be heard on a simple quarter wave vertical with a ground plane.

The serious weather satellite watcher will soon want something better. There are two antenna types - the low gain

omnidirectional, and the higher gain directional.

The high gain directional antenna, because it is directional, must track the satellite as it moves across the sky. A computer can supply data for azimuth/elevation control system.

The antenna, a Yagi/Uda or helical, should provide circular polarization to match the satellite's right hand circular transmissions.

Unless you have a motorized az/el mount and a computer, both looking for a job, the degree of complication and expense of such a system is not justified.

The combination of a low gain omnidirectional antenna with a good low noise preamplifier mounted at the mast head will produce good quality pictures from horizon to horizon. Two antennas used in this way are the half wave vertical J-pole antenna, and the turnstile or crossed dipoles with reflectors (wide spaced) pointed straight up. Crossed dipoles fed in quadrature produce circular polarization so this antenna must be built carefully to match the satellites right hand circular signal. Only the NOAA series seem to be rhc, the METEOR series appear to be linear or plane polarization.

When linear polarization is received on a circular polarized antenna the maximum loss is 3 dB, compared with the correct polarization (vert or horiz.) If the satellite is rhc and the ground station lhc, the loss can be as high as 20 to 30 dB.

Switchable polarization is an advantage on the rare occasions when the signal from the satellite changes polarization on the way down through the ionosphere. This phenomenon normally only lasts for a few seconds to a minute or two.

Super High Frequency Antenna Systems for Weather Satellites

The parabolic dish is the only practical antenna for serious S band weather satellite watchers. This is because of the high antenna gain required to produce a satisfactory carrier to noise ratio at the input to the receiver.

The diameter of the dish determines the gain,

Diameter (metres)	Gain (dBi at 1690 MHz)
0.6	18 (2ft diam)
1.2	24 (4ft)
1.5	26 (5ft)
1.8	27.5 (6ft)
2.0	29 (6.5ft)
2.4	30 (8ft)
3.0	32 (10ft)

The first step when designing an S band receiving system is to examine the technical specifications of the satellite

signal, the nominal radiated power (erp transmitter power and spacecraft antenna gain) and the free space path loss at the freq (1691 MHz). This gives the expected signal power on the ground.

Typical spacecraft transmitters run 5 watts or +37 dBm limited by solar power budget and solid state transmitter power amps. The spacecraft size at launch and the beamwidth to provide full earth disc cover by the antenna, limit the spacecraft antenna gain to 17 dBi (dish 0.6 metres) resulting in an EIRP about +54dBm.

The path loss $L=32.4 \text{ dB} + 20 \log_{10}(DF)$ where D equals the path in km, 35,800 km (altitude), the actual path slope range will be longer) and F equals the freq 1691 MHz. This gives a path loss approx 188 dB.

With +54 dBm -188 dB loss the signal on the ground is -134 dBm nominal or 0.044 microvolts on 50 ohms.

The next step is to determine your expected receiver performance based on noise factor and bandwidth. If we assume a noise figure for the system (preamp, cables and receiver) of 3.5 dB and the 200 kHz needed for the GMS 3 satellite we get the answer.

Thermal noise level = 174 dBm + 10 \log_{10} (BW) + 10 \log_{10} (NF) where BW equals receiver bandwidth 200 kHz, and NF equals the NOISE FACTOR (2.2) not FIGURE (3.5 dB).

The result of this calculation gives a receiver threshold of -117.5 dBm or 0.3 microvolts. Not bad, except the signal we want is -134 dBm or 16.5 dB below the front end noise of our receiver.

(0 dBm = 1 milliwatt in 50 ohms)

So now we know the importance of antenna gain. With a 0.6 metre dish the satellite signal should equal the receiver noise. With a 1.8m diam dish the signal will exceed the noise by 10 dB (if you have not fudged your NF estimate.)

I chose a 2.4 metre (8ft dish) to give me a few extra dB of carrier to noise ratio.

There has been a number of magazine articles on SHF loop yagi antenna designs for weather satellite receiving systems. They are designed for METEOR-SAT or GOES systems. The IF bandwidth of those systems is 30 kHz, which gives an 8.25 dB improvement in receiver performance allowing a quad stack of loop yagis to be used. The GMS 3 wide bandwidth signal is audible on loop yagis, but the signal to noise ratio is not satisfactory for good pictures.

New parabolic dishes are very expensive. When one is upgraded the old one has little value other than as scrap metal and is normally disposed of as such. The value depends on size, weight, location (they are heavy, awkward, and if the

other side of the black stump, of little interest.)

Telecom, TV stations, antenna manufacturers, are possible sources (starting prices \$50 up) slightly damaged, dented dishes are a good buy if you are able to panel beat out the dents to less than 1/10 wavelength at 1691 MHz (1.7 cm).

Home construction is quite feasible with several different types. The simplest form is the stressed rib form like a beach umbrella covered with wire mesh (1 cm sq.) Segmented sheet metal construction pop rivetted together is a possibility. Fibreglass with wire mesh formed on a sand mould is also popular. All forms of construction are well documented (see bibliography.)

It is most unlikely that the feed or launcher will be on the dish if you buy one, and even less likely that it will be of any use to you if it is, except to provide one important piece of data, the focal length from the dish to the feed point. The gain specified for a parabolic dish is based on the assumption that the dish and the feed horn are matched to each other. This means that the signal radiated by the feed fully illuminates the dish but does not spill over outside the dish (the beamwidth of the feed at the -10 dB points subtends the same angle as the dish seen from the focal point.)

If this feed angle is correct for transmitting, then the feed is optimum for receiving. If the dish has no feed then the focal length must be calculated as the first step in the design process. $F = (\text{diameter squared}) / (\text{sixteen times the sagitta})$, where $F = \text{focal length}$ and S the sagitta (depth of the dish.)

We can now calculate the second step, and find the F to D ratio. This figure will allow us to select the feed type to match the dish shape. The optimum F to D ratios range from 0.5 to 0.8. With F/D 0.5 the feed needs a beamwidth of 60 deg at -3 dB points (120 deg - 10 dB points) to illuminate the dish fully. With F/D 0.8 the feed beamwidth required is 40 deg at -3 dB.

The next step is to design a feed with the required beam width to suit your dish. Too wide or too narrow a beamwidth will cause a loss of gain.) Home constructed dishes with F/D of 0.56 can be fed with a simple circular wave guide feed the size and shape of a large coffee tin (12cm diam 18cm long made of brass so it won't rust) containing a 1/4 wavelength (3cm) monopole antenna spaced 3cm from the back of the feed.

The feed must be placed so the focal point of the dish is inside the mouth of the feed which is then adjusted in/out for maximum signal. Then the feed is rotated to line up with the satellite signal

polarization (maximum signal). The need to offset the polarization of the feed to suit the satellite is because if, for example, it is horizontal at the equator, then if the receiving antenna is located at say 27 degrees south, the horizon of this station will be at an angle of 27 degrees to the reference horizon (at the equator.) The beamwidth of the whole antenna system is dependent on the gain. With 30 dB gain the -3 dB point beamwidth is 5 degrees. You must aim to +/- 1 degree.

This is no problem with a geostationary satellite as they keep station +/- 0.5 degs or better.

But tracking a fast moving polar orbiting satellite around the sky with a five degree beamwidth antenna is a whole new ball game!

Display Devices for Weather Satellite Pictures

There are three common methods used to display weather satellite pictures:

1. Slow Scan Cathode Ray Tube Monitors.
2. Direct-Printing Facsimile Systems.
3. Digital Scan Converters.

The first method uses a cathode ray tube or TV tube to convert the electrical signals into visible light, here we run into a real problem. With normal television, each picture is completed in 1/25th of a second and as the eye can retain an image for 1/20th second or longer we see a complete picture on the screen. When it takes 1/2 second (120rpm) or 1/4 second (240rpm) to scan each line of picture, and up to 14 minutes of picture on a full overhead pass from a polar orbiter, the picture on the screen seen by the eye is a small dot of varying intensity as it scans across the screen two or four times per second.

Even with a long persistence phosphor (P7) tube, the trace stored on the phosphor only last a few seconds, so it is not possible to see much of the picture. The quick solution to this problem is to photograph the CRT trace for the duration of the picture, the film stores each line of the picture as it is scanned, on development the whole picture can be seen.

The chief drawbacks of photography are the cost, particularly if you opt for the convenience of the instant (Polaroid) pictures approach. Or the time delay if you settle for the less expensive 35mm roll film system. If you take several pix a day, by the time the film has been exposed, developed and printed the first pictures are a week old.

So, while a CRT display and photographic system can produce excellent

results with a simple electronic system the photographic costs, and the processing delays are significant penalties.

Direct-Printing Facsimile

The second device, the direct-printing facsimile machine, is expensive to purchase new, and rare on the surplus market. Home construction is possible, even without an extensive workshop. There are several simple designs able to be built with hand tools that produce excellent pictures much cheaper than photographic means and in real time.

The basic FAX machine is a mixture of electronic and mechanical components, it consists of a drum rotated by a motor at the line rate of the satellite, 120 rpm or 240 rpm. The drum speed must be constant so a synchronous ac motor driven by a xtal clock, divider chain and power amplifier is used. Driving the motor from the mains is not practical due to the short time variations in the frequency of the power generation system. The drum is covered with an electrically sensitive, conductive paper, metal coated, or chemically impregnated (Fax paper, depth sounder paper) which is grounded by the metal drum.

A metal stylus of fine steel wire resting lightly on the paper on the drum is fed with amplified video. Approx 240 volts p/p

TRANSAUS Communications

53 Broadway St
Cobram 3644
PO Box 282

Phone 058-722433
FAX 058 721104

Fred VK3APA - Chris VK3VKX

We Buy and Sell
new and used amateur
equipment

We Trade - We Guarantee
Used Equipment

**In Stock at time of
advertising :**

New	Used	
IC735	FT901	IC720A
IC725	FT200	TS520
IC28A	FT290R	FT707
IC275H	FL2000B	IC271H
IC2SAT	IC730	
IC2GAT	FT2FB	
IC7000		
IC751		

through a current limiting resistor will produce black on the paper. Reducing the voltage to less than approx 20 volts will leave the paper white, and voltages between 240 and 20 produce various shades of grey. The stylus is moved slowly along the drum as it rotates, tracing a long spiral around the drum. The stylus feed is a long leadscrew driven by gears from the drum, or by a second synchronous motor. The drum diameter, the pitch of the lead screw, the motor rpm, must be carefully selected to give a magic number called The Index of Cooperation.

For WEFAX pictures the IOC should be 267.36. (The index number represents the product of the drum diam and the number of lines scanned in the unit of measurement used.)

Applying the above, a 50mm diam drum means the stylus must draw 5.347 lines/mm. At 240 rpm the drum takes 1/4 second to draw one line. The stylus must traverse 1mm along the drum in 1.33 seconds. In 200 seconds, it will move 150.3mm, so a drum circumference 157mm and the line 20/21 of that or 149.6mm long gives an aspect ration almost 1:1. If the IOC is not correct, the picture aspect ratio (1:1 for WEFAX) will not be correct - either the picture instead of being square will be long and narrow, or it will be short and wide, and your cyclones will not be round either.

Commercial FAX machines may not run at the correct RPM for satellite pictures and the IOC may not be correct either, so care is required before you rush out and buy that bargain.

The power amplifiers used to drive the synchronous motors and the stylus produce voltages that are dangerous, so suitable care in design and the use of interlocks on covers should be considered.

A well built FAX machine is capable of producing over 800 picture elements per line with 800 lines per pix giving a picture of 640,000 elements. (Compared with a good quality television picture of only 247,825 elements.)

Digital Scan Converters

A Digital Scan Converter collects the incoming picture from the satellite receiver, and converts it into a fast scan television picture for display on a normal TV set or video monitor. The basic scan converter consists of an analog to digital converter (ADC), a write control circuit, a read/write memory (RAM), a read control circuit, a digital to analog converter (DAC), and a television waveform generator.

In a typical digital scan converter, the incoming audio subcarrier, 2400 Hz (+/-

1600 Hz video sidebands) is filtered to remove both low and high frequency noise, then rectified to recover the video signal waveform (varying from black to white or hot to cold) which makes up the image. The video waveform is sampled 256 times each line (in a half or a quarter of a second) by a FET sample and hold circuit and fed into an analog to digital converter chip where the analog voltages become six bit digital words. These are written into a 64 kb dynamic memory and stored (depending on the selected mode the memory may take from 2 minutes to 12 minutes to fully load the picture.)

When the picture is stored in memory, it is then read by the read control circuit at the rate of 256 (six bit) words every 52 microseconds, or a complete picture every 50th of a second. The six bit words are fed into a high speed digital to analog converter to reconstruct the video waveform. With sync pulses added it is now formatted into a fast scan television picture. A picture of 256 pixels/line with 256 lines of information (6 bit words provide 64 steps of grey scale) is available with 64 k by 6 bits of memory.

To improve the picture quality to 512 pixels x 512 lines would increase the memory requirements by a factor of four to 256 k by 6 bits. This would then require a high resolution monitor to view the non-standard television picture produced. It is quite possible to equip the scan converter with say 640 k of memory and load up 10 pictures, and then scan the read control circuit from page to page to show a moving picture of the cloud pattern changes over a period of time.

The use of a UART or similar chip makes it possible to download or upload the contents of the memory to a disk drive for storage, and future reloading in a fraction of the original time (20 seconds).

Scan converters can be dedicated hardware devices eg: the VHF Comms design, a dedicated hardware/software microprocessor controlled device or resident in software in a home computer. At present, programs are available for AMIGA, IBM, C64, and Tandy Cocom computers. The quality of the reproduced image varies depending on the graphics ability of the host computer and varies from brilliant to interesting (as do the prices of the software, \$20 to \$2500.) One drawback with the use of your PC for satellite pictures is that it is tied up for a lot of the time displaying pictures when it should be earning its keep on more important tasks.

Computer Programs for Satellite Tracking

The use of home computers to provide

tracking information on weather satellites has been one of the big advances in amateur satellite experimentation during the last ten years. In 1979, Sat Trak International introduced a series of four programs for the Apple, TRS 80, and the Sorcerer, which used the NASA supplied two line data set of orbital parameters to calculate and predict satellite passes. Sat Trak was intended for visual as well as radio observations, and although a little slow, soon made the traditional plotting board and tracking diagram obsolete, at least for the satellites for which data was available.

The AMSAT Phase III spacecraft project required a number of ground command stations. The AMSAT president Dr Tom Clark W3IWI, a professional astronomer by trade, was responsible for the development of the software to provide reliable and accurate azimuth, elevation and Doppler predictions. The resulting software and documentation, published in ORBIT magazine March '81, has become the definitive work on satellite tracking, translated to all the common computers. It was written in North Star BASIC and contained the best features of many of the existing programs from all over the world. The W3IWI software became the basis for many "new" programs. The next step in development was the plotting of the track on a map of the world (a feature of the original Sat Trak prog "trak" but now in multi colour.)

The next development was the addition of the satellite footprint, a circle showing the area visible from the satellite. Like they say on VHF, "If you can't see it, you can't work it". At VHF the signal is almost line of sight as little refraction is noted.

The goal of Tom Clark W3IWI with his BASIC ORBIT program was an accuracy of 10 km with orbits of 40,000 km. This requires regular updates of the orbital elements.

Most satellite tracking programs require a minimum of six primary elements. The classical Keplerian Element set are:

- (1) Inclination
- (2) Eccentricity
- (3) Argument of Perigee
- (4) Right Ascension of Ascending Node
- (5) Mean anomaly
- (6) Semi-Major Axis or Mean Motion

The exact time at which the Keplerian element set describes the orbit is called the Epoch (year, month, day, hour, min, seconds to six decimal places.)

With satellites in simple polar orbits, the need to change orbital elements is greatly reduced and updating every three months is normally adequate (unless solar

activity is high or the orbit is rather low, like Oscar 9.)

When an unidentified satellite is heard, a different program is required, an example is ASCOT (Any Satellite Circular Orbit Tracking) by John Branegan GM4IHJ. This allows an educated guess to be compared with actual reception times and then rapidly narrowed down to a respectable figure.

Weather Facsimile on IBM PC Clones

The September 1988 edition of the ARRL publication QEX contains construction details of a false colour weather facsimile display board for IBM PC or clones by Paul Shuch N6TX. The design of the card follows standard practice and would make a good starting point for anyone designing a computer based display.

After video bandwidth limiting, automatic level control, full wave rectification, and residual subcarrier filtering, an analog to digital converter digitizes the image into a string of 8 bit words (256 level) which are written on command into the computer memory for storage, processing and display under software control.

Elmer Schwittek K2LAF has written a number of programs for the IBM PC to display HF weather facsimile, REAL TIME BAS, WEFAX BAS, MAGNIFY BAS, were some of his early contributions on the subject. His new MULTIFAX EXE software is available in two versions: Version MF 2.1 is for PC with CGA card and provides 4 colours, Version MF 3.0 for EGA card provides 4, 8 or 16 colours. Unfortunately MULTIFAX is not monochrome compatible with MDA or HGA cards. The board described fits inside the PC and requires only the 2400 Hz AM subcarrier from the WEFAX SHF receiver.

The FAXBOARD is not available commercially, but with only 5 IC it should not be difficult for a radio amateur to construct given the design data.

There is no indication of the suitability of the software for APT pictures from polar orbiting satellites, but given the similarity of the received data this should present no difficulty. At present the software uses only a fraction of the stored data, so future versions to utilize the data more fully can be expected, including local version of the board and software.

References:

ARRL Publication QEX, September 1988: A Weather Facsimile Display Board for the IBM PC, by Paul Shuch N6TX.

ARRL Publication QST, June 1985:

WEFAX Pictures on Your IBM PC, by Elmer Schwittek K2LAF.

ARRL Publication QST, December 1986: HF WEFAX on the IBM PC, by Elmer Schwittek K2LAF.

For more information contact the Queensland WEASAT Group, c/- VK4ZBV.

Glossary of Terms Related to Satellites

Anomalistic Period: The time between successive passes through perigee.

AOS (Acquisition of Satellite/Signal): The time when the satellite comes above the horizon, or the signal is first received depending on whether you are a visual or radio observer.

Apogee: The point in the orbit when the satellite is farthest from the centre of the earth (apopsis).

Argument of Perigee: The geocentric angle between perigee and the equator crossing on the ascending node.

Ascending Node: The point on the equator where the satellite crosses the equator into the northern hemisphere.

Attitude: The position of the axis of the satellite related to some other fixed reference coordinates (eg: the orbital plane.)

Azimuth: A bearing (horizontal) relative to true north or other specified reference.

Bulge of the Earth: Difference between equatorial and polar radii of the earth.

Celestial: Prefix to designate lines or points projected onto the celestial sphere.

Celestial Sphere: An imaginary sphere of infinite radius centred on the earth's centre.

Descending Node: The point on the equator where the satellite crosses the equator into the southern hemisphere.

Direct Orbit: An orbit with inclination between 0 deg and 90 deg (prograde orbit.)

Doppler Shift: To a stationary observer the frequency of a moving radio transmitter varies with the transmitter's velocity. When a satellite is moving towards an observer its transmitter frequency will shift high, decrease to normal at TCA and shift low in frequency as the satellite speeds away.

Eccentricity: The shape of the orbit. A true circular orbit has zero eccentricity. Eccentricity is dimensionless, a flat ellipse tends towards one.

Elevation: The angle between the horizontal and a line from the observer to the satellite.

Epoch: The time at which the measurement of the satellite parameters was made.

Equator Crossing (EQX): The point on the equator where the satellite crosses

MFJ VHF/HF PACKET RADIO CONTROLLERS

Now with:

- Easy Mail
- WeFax
- KISS
- 32K RAM

With the MFJ1270B You get more features than any other packet controller — the new Easy Mail Personal Mailbox, HF/VHF Modems, WeFAX reception, KIS, and a one year unconditional guarantee and more for only \$299 including sales tax Plus Freight \$12 with-in Australia



You can double your fun by operating both VHF and HF packet because you get **high performance** switchable VHF/HF modems.

You get the **Easy Mail™** Personal Mailbox with soft-partitioned memory so you and your ham buddies can leave messages for each other 24 hours a day.

In MFJ's new WeFAX mode you can print full fledged weather maps to screen or printer and save to disk using an IBM compatible or Macintosh computer with an MFJ Starter Pack.

A new **KISS** interface lets you run TCP/IP. They also come **NET ROM** compatible -- **no modification needed!**

You also get 32K RAM, a one-year unconditional guarantee and you can use 12 VDC or the included 110 VAC power supply.

For dependable HF packet tuning, the **MFJ-1274** gives you a high resolution tuning indicator that's accurate to within 10 Hz -- and it's only **\$50.00 more**

HOW TO ORDER

MFJ1270B TNC Controller \$299.00

MFJ1274 TNC Controller with tuning indicator built in \$349.00

MFJ STARTER PACKS

Include interface cable, software on disc and complete instruction ... everything you need ... order as listed below

MFJ1284 for IBM or compatibles \$24.95

MFJ1282 for C64/128/VIC 20 \$24.95

MFJ1278 for Macintosh \$24.95



44 Stafford St Huntingdale 3166
P.O. Box 281 Oakleigh 3166
Phone (03) 543-3733 Fax (03) 543 7238
BankCard, Visa, Master Card Welcome

into the northern hemisphere is quoted in degrees WEST longitude.

Equatorial Orbit: Orbit with zero degrees inclination.

First Point of Aries: The Astronomer's reference point in the constellation of ARIES. (see Right Ascension of the Ascending Node).

Footprint: The area of the earth visible from the satellite, or the area covered by the satellite's antenna.

Geostationary/Geosynchronous: A satellite in a west-to-east orbit of the earth at an altitude of 35,870 km. At this altitude it circles the axis of the earth once in 24 hours (its orbit is synchronous with the earth below.)

Graveyard: Two points on the geostationary orbit path at subsatellite longitudes of 105 deg W and 75 deg W where unconstrained geostationary satellites collect due to the earth being an oblate spheroid. (see oblate spheroid).

Greenwich Meridian: An imaginary line from pole to pole that passes through the observatory at Greenwich (near London) where it is represented by a brass strip approx 1/4 inch wide across the forecourt marking the zero meridian. (Satellite calculations are based on degrees WEST from the Greenwich Meridian.)

Greenwich Mean Time, GMT (ZULU Time): Now replaced with UTC (See UTC).

Great Circle Geometry: The spherical trigonometry used to calculate the bearing and distance between two points on the earth's surface.

Gregorian Calendar: The civil calendar introduced by Pope Gregory 13th in 1582 deleted the accumulated error of 11 days caused by the Julian calendar having a year eleven minutes ten seconds too long. It was introduced to the English in 1752.

Half Great Circle Angle: The angle between a line from the observer to the centre of the earth and a line from the satellite to the centre of the earth (used in satellite programs.)

Inclination: The angle between the plane of the satellite orbit and the equatorial plane. An inclination of 0 to 90 degrees produces prograde orbit. An inclination of 90 to 180 degrees is called a retrograde orbit.

Increment: The difference in degrees between the equator crossings at the start and end of one orbit (approx equal to the earth's rotation in one orbit period.)

Julian Days/Dates: The solar calendar used by astronomers, introduced by Julius Caesar in 46 BC based on the ancient Egyptian calendar with 365 days and 6 hours each year for three years and 366 days every fourth year. A Julian day

starts at noon (UTC) - noon on 31st December 1899 was the start of Julian day 2415020. A quick calculation gives us 00:00:00 hrs UTC on January 1985 as Julian date 2446066.5 (the decimal fraction of a day indicates the time.)

Keplerian Elements: The name given to a set of parameters describing the orbit of a satellite in honour of the German astronomer and mathematician Johannes Kepler (1571-1630) who derived the mathematical description of elliptical orbits from his study of the planets and the sun, described in his best sellers, *Astronomia Nova* (1609) and *De Harmonice Mundi* (1619.)

Keplerian Element Set: The eight parameters describing a satellite's orbit, Epoch, Inclination, RAAN, Eccentricity, Arg of Perigee, Mean Anomaly, Mean Motion, Semi Major Axis.

Latitude: Latitude is measured in degrees of arc north or south from the equator. Lines of constant latitude run east/west and are parallels.

Longitude: Longitude is measure in degrees of arc east or west of the prime (Greenwich) meridian, (meridians are lines of constant longitude from pole to pole.)

LOS (Loss of Satellite/Signal): The time when the satellite goes below the horizon, optical or radio.

Mean Anomaly: Describes how far around the orbit from the Perigee the satellite was at Epoch. Normally in degrees (0-360), it can be given as a decimal part of one orbit (0-1), or as phase based on 0 to 256. (A concession to binary counters and computers with a modulo 256 software clock.)

Mean Motion: The number of orbits per day through perigee.

Molniya Orbit: A highly elliptical orbit used by Russian comsats, apogee of 40,000 km and perigee of 500 km gives an orbit period of 11 to 12 hours suited to high latitude communications. With 3 satellites following in the same orbit 24 hour coverage can be provided to the whole USSR (comms & TV broadcasts.)

Oblate Spheroid: A rude term used by astronomers to describe the earth, it means squashed, flattened at the poles, and bulging at the equator. The effect of this is to produce graveyards (see *graveyards*). The flattening is calculated at about one part in 298.2 giving an equatorial radius = 3963.18 vs polar radius = 3949.89, a difference of 13.2 miles.

Orbit: One complete circuit of the earth from EQX to EQX, or Perigee to Perigee. They are different, leading to the confusion of two different orbital periods.

Orbital Elements see *Keplerian Elements*:

Perigee: The point on the orbit where the satellite is closest to the centre of the earth, usually defined as Arg of Perigee in orbital elements.

Perigee Rate: The rate of change of the argument of perigee (degrees per day.)

Precession Rate: The angular change of the orbital plane relative to fixed space reference (+/- degrees per day, see *sun synchronous*).

Period: The time to complete one revolution on the earth. Nodal period is the time from EQX to EQX. Anomalous period is the time from Perigee to Perigee. (They are different, for EQX progs use nodal. With Keplerian elements the reciprocal of Mean Motion equals Anomalous period.)

Right Ascension: The arc measured eastward, along the celestial equator, from the Vernal Equinox to the great circle passing through the celestial poles, and the object projected onto the celestial sphere (given in hours and minutes 24 hours = 36 deg.)

Right Ascension of the Ascending Node (RAAN): The Keplerian element RAAN is the angle between the First Point of Aries and the ascending node equator crossing, this relates the orbital plane of the satellite with respect to the stars for calculations of perturbations.

Retrograde Orbit: One with inclination between 90 to 180 degrees.

Revolution (REV): The number of revolutions (orbits) from launch.

Semi Major Axis: One half of the major axis from apogee to perigee. (Not normally supplied as an element; it is calculated from the mean motion.)

Sidereal Time: STAR time differs from SOLAR time due to the approx 366 rotations of the sun/earth axis every year of 365 days. The sidereal day is 365/366 solar days or about four minutes per day shorter. This gives a correction factor of 1.0027379093 to which must be added a year factor from the Nautical Almanac. Programs that use Keplerian elements (star based) must use sidereal time.

Satellite in Eclipse: A satellite is in eclipse when the earth prevents sunlight from reaching it. For geostationary satellites the eclipses start 23 days before the equinox and end 23 days after the equinox. Loss of power from the solar array lasts from a few minutes up to one hour maximum and the satellite runs on its batteries.

Solar Time: See *UTC* for details.

Sun Transit Outage: This loss of signal is caused when the sun passes directly behind the satellite as seen by the ground station antenna. The radio frequency output of the sun completely overrides the satellite signal. (The outage can be predicted and lasts up to 10 min-

utes on several days each year.)

Subsatellite Point: The point on the earth's surface intersected by a line from the satellite to the centre of the earth, also called the Nadir.

Sun-Synchronous Orbit: Nominally a retrograde, quasi-polar orbit such that the satellite crosses the equator on the ascending node always at the same local (solar) time.

Time of Closest Approach (TCA): Time when the doppler shift on a signal from a satellite passes through zero.

Universal Time (UTC): The Standard Time for space operations, scientific and engineering purposes is universal time. It is essentially mean solar time at the Greenwich Observatory near London, England.

Van Allen Belt: A band of intense radiation caused by charged particles trapped in the earth's magnetic field (the charged particles result from cosmic rays entering the atmosphere). The term intense means GM counts avg 20/sec at 100 miles to 25,000/s at 2,500 miles, dropping off at 3,500 miles. Radiation levels are so intense that they pose a serious risk to satellite electronic components, as well as any crew manning the craft. The belt is most intense over the equator and minimum over the poles.

Bibliography:

The following list of references (by no means complete) provides a good selection of information on the subject of weather satellites. Some of the references are now of historical importance only. Due to the changes in technology, the designs may be dated but the basic principles are as sound now as they were then.

Scientific American

The American Scientist (C.L. Strong), Jan 1974.

A Satellite Receiver for the Home (E. Ruperto), Jan 1974.

Wireless World

Weather Satellites Ground Station (G. Kennedy), Nov 74 - Jan 75.

Weather Satellites Picture Facsimile Machine (G. Kennedy), Dec 75 - Mar 76.

Meteosat Earth Station (M. Christieson), Jun - July 79.

High Resolution Weather Satellite Pictures (M. Christieson), Nov 81 - Jan 82.

Meteosat High Resolution Images (M. Christieson), Aug 82.

Satellite Tracking by Home Computer (Neoklis Kyriazis) Aug - Sep 81.

Contrast Expansion Processor (P.E. Bayliss, R.J. Brush), Dec 73.

Tracking Satellites with a Microprocessor (P. Jefferson), Apr 83.

ARRL Publication, The Satellite Experimenter's Handbook (Davidoff.)

QST (ARRL).

Amateur Reception of Weather Satellite Picture Transmissions (Anderson), Nov 65.

Evolution of an Amateur Weather Satellite Picture Station (McKnight), Apr 68.

A Cathode Ray Tube Display Unit for Sat Weather Pix (Spillane), Jun 69.

An S-Band Receiving System for Weather Satellites (G. Emiliani, M. Righini), Aug 80 (recommended reading even though design is dated.)

Printing Pix from your Weather Geostat Sat (G. Emiliani, M. Righini), Apr 81.

Producing Weather Satellite Pictures at low cost (Winkler), Jun 78.

Locating Geosynchronous Satellites (Johnston), Mar 78.

Digital Signal Processing for the Experimenter (Olsen), Nov 84.

MAGPUBS

A Special Service of the Wireless Institute of Australia

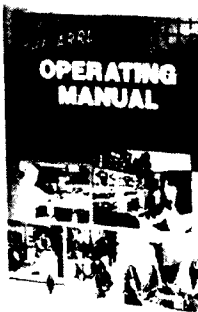

The Operating Manual

The new Operating Manual from the ARRL is the most complete book about Amateur Radio On-The-Air operating ever produced! If you really want to be "IN" on what is happening in Amateur Radio today, you need a copy of the third edition of the *ARRL Operating Manual*. In the Operating Awards chapter more than eighty-seven popular Operating Awards are described and illustrated in full colour. **Topics Covered include:** Shortwave Listening The Amateur Radio Spectrum Basic Operating Antenna Orientation DXing Overseas DXing / OXpeditions Emergency Communications Image Communications Contests Operating Awards RTTY Communications Packal Radio FM & Repeaters Satellites VHF/UHF Operating Satellites Image Communications References

8 1/2" x 11" 1 1/4" thick

Stock # BX192 \$30.00

AMSAT-NA 6th Space Symposium

Proceedings of the 6th AMSAT-NA Space Symposium & Annual Meeting held November 11-12, 1988 at Atlanta, Georgia. **Contents:** Polar Bridge Skitrek "Wrapup" AMSAT-NA Microsat Pacsat Program The DSP Project Update Toward the Future in the Amateur Satellite Program Abstract Satellite Orbital Characteristics during the Pre-Relaunch Phase H11 OSCAR 12 and the Future Japanese Satellite Project The AMSAT Phase IV Project The AMSAT TARP DSP I Project Hardware Design Microsat Project Using CPL Hardware Unified File Management Scheme for the Multi-Microsats The Mt. Toxaway Nth Carolina Microwave Beacons & Linear Translator Abstract: The RS-11 Ionospheric Experiment PAC CAT Software Space Station Amateur Radio Station Amateur Radio Satellites: An Educational Experience Project RACAR (Ballon Carrying Amateur Radio) The Launch of NOAA II Weather Satellite: A Mission Profile

8" x 11" Stock # WIA 199 \$24.00 less 10%

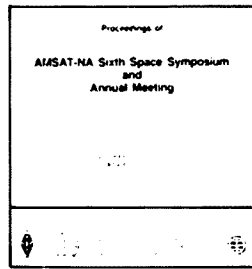

THE ARRL ANTENNA BOOK

THE ARRL ANTENNA BOOK

New for 1989 the 15th Edition

The 15th Edition of The ARRL Antenna Book has been dramatically expanded in a similar fashion to recent editions of the *ARRL Handbook*. We've drawn on material produced for the ARRL Technical Department and from 16 well-known outside authors who have done much to contribute to the state-of-the-art in antenna and transmission line design.

With 30 chapters, this edition is certainly big (8 1/2 inches and 1 1/4 inches thick) and I think you'll find better than any previous edition. Every page of this book has been set in new type and prepared in a layout that we feel is appealing. While most of the content of previous editions has been retained, the text has been totally re-edited and much new material has been added.

8x11" 700 pages

Stock # BX181 \$38.00

The SHORTWAVE PROPAGATION HANDBOOK

George Jacobs, W3ASK & Theodore J. Cohen, N4XX

2nd Edition — George Jacobs and Theodore J. Cohen, the two leading authorities on Propagation have teamed up to produce what will be the definitive work on this fascinating subject. For the first time anywhere, propagation is explained in simple language whereby the average reader can fully understand, use, and produce their own propagation data. This book truly is must reading for the Radio Amateur, Shortwave Listener and all others who make use of the shortwave radio spectrum. Information contained in this book should enhance significantly one's ability to understand and to make better use of the ionosphere whether one is a radio amateur interested in world-wide communications, a shortwave listener interested in receiving radio broadcasts from all corners of the world, or a CBER trying to understand skip interference. We feel that this book is one of the most useful — and usable — volumes available today on the subject of propagation. It is a book intended to be used as well as read.

6" X 9" 150 Pages Stock # WIA 290 \$18.50 less 10%



The above books, plus many more, are available from your WIA Divisional Bookshop.

All items are plus postage and handling where applicable. If not in stock at your Divisional Bookshop, order will be taken and filled promptly.

The VIP:A VIC Image Processor (G. Zehr), Aug 85.

73 Publication. The Weather Satellite Handbook (R.E. Taggart) 4th Edition.

73 Magazine.

Amateur Weather Satellite Reception (Taggart), May 76.

Be a Weather Genius. Eavesdrop on GOES (Taggart), Nov 78.

Direct Printing FAX (Taggart), Nov-Dec 80.

73 Magazine Weathersat Columns (Dr. R. Taggart) Oct 86 - Jul 88.

ORBIT (AMSAT US).

BASIC ORBITS by Tom Clark W3IWI. The Definitive Work on Satellite Tracking. (Orbit Mar/Apr 1981.)

AMSAT UK. Satellite Tracking Software for the Radio Amateur (Brangan).

VHF Communications. (UKW-Berichte) German.

Reception of the Meteorsat Weather Satellite (Brittan), No. 3/78.

Calc of Elev/Azimuth for Meteorsat (Lentz) No. 3/78.

More Details on Reception of Meteorsat (Lentz) No. 4/78.

A System for Reception and Display of Meteorsat Images (Tellert)

part 1 Concept and Parabolic Antenna No. 3/79 part 2 Meteorsat converter VHF receiver No. 4/79

part 3 VHF Receiver Image processing No. 1/80.

part 4 Image Proce, Power supply and Motor Amp No. 2/80

part 5 Video board, Stylus driver No. 3/80

part 6 Stop start logic, drum oscillator No. 4/80

part 7 FAX Machine Mechanical Construction No. 1/81

part 8 Control Module for the CRT No. 2/81

part 9 CRT X and Y amps and EHT supply No. 3/81

A Simple Weather Sat converter for use with 2 meter FM Receivers No. 4/80

Antennas for Reception of orbiting Weather Sats 137 MHz No. 4/81

Forecasting the Reception Times of orbiting Satellites No. 4/81

A Receive Converter for the GEOSATS, METEORSAT-GOES-GMS (Roble)

part 1 The SHF-Module No. 4/81

part 2 The local oscillator No. 1/82

A Digital Storage and Scan Converter for Weather Sat Pix (Vidmar)

part 1 Electronic Module No. 4/82

part 2 Storage Module No. 1/83
part 3 Synthetic Colour Module No. 2/83

Preliminary Experience with Digital Storage Module No. 2/83

A 2400Hz Generator for sync of METEOR Satellites (Editors) No. 1/84

The GOES Series of Geostationary Weather Satellites (Brittan) No. 2/84

A Low Noise METEORSAT Converter with GaAs-FET Preamp and Mixer (Bartkowiak) No. 1/85

A Digital Multiple Image Storage for Weather Sat Images (Hufenbecher - Store up to 10 pix in memory) No. 1/85

Colour Module with Composite Output for Weather Sat Images (Editors) Mods to Synthetic Colour Board No. 1/85

FM/AM Converter for Facsimile Reception and Picture Display with the YU3UMV Picture Store (Knoeff) No. 3/85

Digital PIX Storage for SSTV, FAX and WEFAX (Schroeter, Driesche) (Single board version of YU3UMV Scan Conv) No. 1/86

PC Interface for the YU3UMV Weather Pix Store (Oppermann) (Adds Disk Drive Storage to YU3UMV Scan Conv Load pix in 20 sec) No. 3/87

Receiving METEORSAT with Yagis (Schaumburg) (Not a good system for GMS receivers due to reduced Thresholds) No. 1/88

GRAFTRAK and MIRAGE Interface (Tracking Prog) (Eichel, Rath) No. 2/88

Digital Signal Processing Techniques for Radio Amateurs (Vidmar) (Theoretical Part, Insight to the next generation of Pix systems). (Construction details should be in the 89 Editions) No. 2/88

Timer/Zoom Unit for YU3UMV Image Store (Gottwaldt) (Extra features for YU3UMV Digital Scan Conv) No. 3/88

The following publications by NASA, ESSA and NOAA have been obtained from the National Technical Information Service NTIS, US Department of Commerce, 5285 Port Royal Road, Springfield, Virginia 22161 USA.

Historical References (dated but sound basic information on the subject).

NASA SP 5080 Weather Satellite Picture Receiving Stations C.H. Vermillion 1969 (Valve Receiver)

ESSA APT Users Guide (1965)

NASA/ESSA Applications Technology Satellite (ATS 3) WEFAX Exp Guide (1968).

ESSA Direct Transmission System Users Guide (1969).

NASA ITOS (1969).

NOAA/NESS Modified Version of the

Improved TIROS Operational Satellite. ITOS D_G (A. Schwalb) 1972.

NASA TN D 7994 Weather Satellite Picture Receiving Stations APT Digital Scan Converter (Vermillion & Kamowski) 1975.

Current References:

NOAA/NESS: TIROS-N Series Direct Readout Services Users Guide (1982).

NOAA/NESS: The GOES Users' Guide (D. Clark) 1983.

The address below provides access to two experts on US weather satellites:

The United States Department of Commerce

National Oceanic and Atmospheric Administration NOAA

Dr Thomas D Potts E/PO2

(Satellite Program Specialist)

National Environment Satellite Data and Information Service

Washington DC 20233.

The United States Department of Commerce

National Oceanic and Atmospheric Administration NOAA

1. Direct Readout Station Operators and Data Users (APT) contact DR THOMAS D POTTS E/P02 (Satellite Program Specialist).

2. WEFAX Stations and Users contact MR JAMES R GREEN. (WEFAX Coordinator, Data Collection and Direct Broadcast Branch). Mr James R. Green (WEFAX Coordinator, Data Collection and Direct Broadcast Branch)

National Environment Satellite Data and Information Service

Washington DC 20233.

National Oceanic and Atmospheric Administration NOAA

National Environmental Satellite. Data and Information Service WASHINGTON DC 20233.

NASA Prediction Bulletin.

Sets of "orbital parameters" are available from the following address (note this is the same data you will find as "Keplerian Orbital Elements" on this bulletin board):

NASA Goddard Space Flight Centre
Code 513, Greenbelt MD 20771.

Australian Electronics Monthly

Simple Antennas for Weather Satellites (Harrison), Jul 86.

Equator Crossing Program (Commodore) (Butler), Jul 86.

Low Cost Decoder to Print Weather Satellite Pictures with your Computer (Moffat), Jul 86.

A Signal-Operated Cassette Recorder Controller for Scanners and Short Wave Receivers (Moffat), Mar 86.

A VHF Receiver for Weather Satellites (Day), Feb 88.

continued on page 31

EARTHQUAKE SAN FRANCISCO AND AMATEUR RADIO

JIM LINTON VK3PC

When the devastating earthquake hit Northern California on October 18, 1989, news of the disaster across the Pacific coupled with the lack of communications into the area caused anguish for Australians who feared for the safety of relatives and friends.

A line of communication which can remain open during such disasters is amateur radio. Sam Voron VK2BVS, a leading exponent of third party traffic handling, and others, sprang into action. It was nothing new for Sam, who had been involved in a number of similar activities of handling health and welfare traffic to and from disaster areas. Among those involved in the Australia-wide effort were Ken VK3CKK, Karl VK2EMF, Ray VK6RQ, and Phil VK2KEV on the NSW north coast who linked up with John VK4CY, Don VK4YI and Ron VK4BG.

In Adelaide, Den VK5LS was handling Red Cross traffic, and Larry VK4ALV took some of the load off the International Amateur Radio Network (IARN) by handling traffic using AMTOR.

Sam Voron is the Australian Director of the IARN, which had organised with the US State Department in Washington for US embassies to divert health and welfare traffic through the worldwide amateur radio network. This left diplomatic and government channels free to concentrate on the handling of emergency and official communications.

The Australian Department of Foreign Affairs in Canberra set up an earthquake telephone hotline for inquiries from the public, and referred many of the callers to the amateur radio volunteers. In Australia, through the IARN, some 400 messages from the general public were handled and passed to the United States. The local news media readily publicised the availability of the amateur radio network method of getting a message through when the normal international telephone system was clogged. Sam said: "The radio broadcast stations and newspapers listed the phone numbers of radio amateurs throughout Australia and the phones virtually didn't stop ringing".

The voluntary service provided by radio amateurs was a news story in itself.

Excellent coverage was achieved on television including the *Hinch at 7* program, *Good Morning Australia* channel 9, the National Nine News, and Channel Seven News. Commercial and ABC radio stations ran stories including telephone contact numbers where the public could seek further details on how to send a message to the quake area. Sydney station 2-DAY-FM actually put out a request for volunteers to operate VK2DTN (Disaster Traffic Net - the International Amateur Radio Club station) at Sam's QTH, and 17 people with no prior experience pitched in taking phone calls and filing messages.

The WIA Victorian Division put The Age newspaper in Melbourne in direct touch with Sam, resulting in a sizeable story about Sam and a picture of Ken VK3CKK. Sydney's North Shore Times had a front page story about the activity. The newspaper received such a good response from readers to the article, the editorial staff decided to do a follow up story.

During the Jamboree on The Air weekend, which immediately followed-up the mid-week earthquake, a few JOTA stations contacted VK2DTN for a quick on-air chat to give scouts and guides a first hand account of the role amateur radio played during natural disasters. "It was an example of the type of publicity amateur radio needs and perhaps it will inspire other radio amateurs to help with the public relations side of our hobby," Sam said.

The Department of Transport and Communications rang to congratulate Sam and express its approval and appreciation of what was being done by the Amateur Radio Service. Sam said: "The amateur fraternity in the United States and Australia have traditionally been responsive to the need for communication channels during emergencies." "History is just filled with examples of the radio amateurs in both countries playing their part and helping the community."

This decade has seen a further development of that activity in Australia, due to the granting of third party traffic handling privileges in 1980. It has

brought Australia and the US closer together when a natural disaster occurs. It doesn't matter whether the disaster is in those two countries, or virtually anywhere in the world, the radio amateurs of these two countries harness together to do their bit.

Sam said: "No other country apart from Australia and the United States have captured so much public attention and national media exposure of this type during emergencies." There were many countries which were, unfortunately, not using the Amateur Radio Service to its full potential during disasters, he said.

"Perhaps because they have not had the history of experience and preparedness to use widescale third party traffic handling for the benefit of the general community" Sam said.

ar

Weather Satellites

from page 30

Assembling Your VHF Weather Satellite Ground Station, Apr 88.

Predicting Weather Satellite Passes from Data Transmitted by AXM (Webb, Hayden), Sep 87.

The following publications are listed as general reading. My copies all came from book shops and publishers' remainders sales.

Observing Earth Satellites (D. King-Hele) - Good source of information on the theory of orbits at a practical level.

Satellites and Scientific Research (D. King-Hele) - Older, more technical version of the above book.

Earth Watch (C. Sheffield) A Survey of the World from Space - Good selection of LANDSAT pictures.

Man on Earth (C. Sheffield) The Marks of Man on the World - LANDSAT shows the signs left by man.

The Complete Encyclopaedia of Space Satellites (Caprara translated from Italian) - Lists all satellites from Sputnik-1 to late 1986.

continued on page 37

THE GEORGE BUSH, MA MIKHAIL GORBACHE

What has made Icom's range of transceivers world leaders in their class? Could it be the uncompromising standards of a George Bush? Is it the durability of a Maggie (Iron Lady) Thatcher? Or the innovative thinking of a Mikhail Gorbachev?

It is, in fact, a combination of all three.

Which has led millions of radio users around the world to choose Icom. Their vote has made Icom the world leader of transceivers.



Announcing the IC-726. An advanced, HF/50MHz transceiver that combines VHF technology with the latest in sophistication. Designed for amateurs or veterans, and ideal for mobile users. 26 programmable memory channels, multi-mode transmitting and receiving and a host of other features and options.

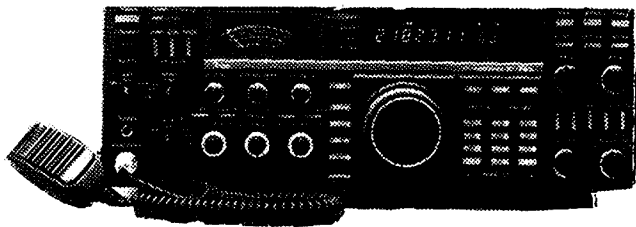

The Icom IC-765 HF transceiver features DDS synthesiser, high speed auto tuner, built-in AC power supply, 99 programmable memories, keyboard frequency entry, band stacking register, general coverage receiver 100KHz-30MHz, CI-V system for PC control and rack mounting dimensions.

The Icom IC-32AT dual band FM transceiver outputs 5.5W and has a full duplex crossband operation, on/off switchable power saver and 20 double-spaced memory channels that can store two frequencies. The programmed scan function scans all frequencies between two programmable frequencies. And Priority Watch monitors the Call Channel, a memory channel or all the memory channels in succession, every five seconds.

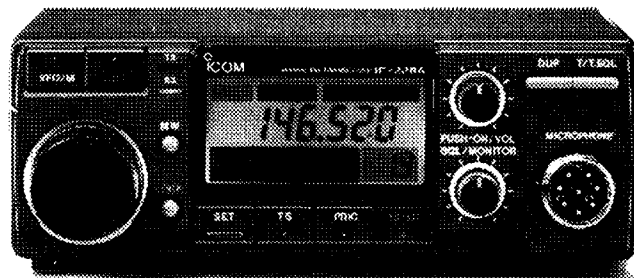

The Icom IC-228A (25W) and IC-228H (45W) mobile FM 144MHz transceivers are compact and easy to operate with 20 memory channels, multi-colour LCD programmed and memory scans, variable tuning steps, priority watch, main controls lit for night operation.

REGRET THATCHER AND V OF TRANSCEIVERS.



The Icom IC-475A (25W) and IC-475H (75W) 430 MHz All Mode transceivers are designed for packet mode with direct digital synthesizer (DDS), 99 memory channels, USB, LSB, CW, FM, passband tuning and adjustable IF notch filter.

or an external 12v DC supply. Auto power off function, scanning, scan skip, clock and time function, an optional pager and more.



The Icom IC-275A (25W) and IC-275H (100W) All Mode 144MHz transceivers are designed for packet mode and feature direct digital synthesizer (DDS), 99 memory channels, USB, LSB, CW, FM, and passband tuning.



The Icom IC-575A (10W) and IC-575H (100W) 28/50 MHz All Mode transceivers have a receiver coverage of 26-56 MHz and are equipped with direct digital synthesizer (DDS), 99 memory channels, and passband tuning.

The remarkable IC-2SAT is the ultimate in mini handheld high performance 2M FM transceivers. With convenient keyboard, rechargeable batteries, 5W output (opt. with a 13.2v battery pack), 48 memories, a call channel and a variety of other sophisticated super multi functions. Plus 18 optional extras. Another marvellous breakthrough in miniaturized hand helds.

The ICOM IC-4SA an amazing 70cm midget hand held. Comprising 48 memories plus 1 call channel, operating from batteries with 5 watts output at 13.8v

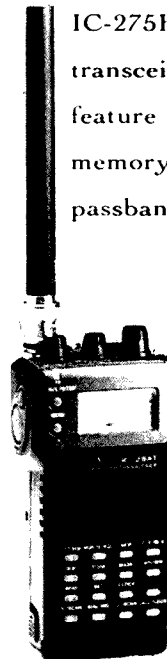

Call Melbourne on (03) 529 7582 or interstate on (008) 338 915 for your nearest Icom stockist.

ICOM

IC0 0047

VK3CYA - GEORGE FROM ECHUCA

DES GREENHAM VK3CO
16 CLYDESDALE COURT MOOROPNA 3629

There are very few two metre operators in Victoria who have not heard the familiar cheery voice on one of the FM repeaters say, "This is George from Echuca". Yes, George is a very well known personality who is always friendly and co-operative and enjoys meeting new people whether they are locals or inter-staters passing through this State heading north or south.

Who is George, and what is his story??

Why is he such a regular on the two metre FM band?

It has been my privilege to know this fellow for some years, and I will tell his special and unique story, not to bring him publicity or fame, but to let it be known in the hope that his story may be an inspiration to others in a similar situation . . .

George Harvey was a farmer just out of Echuca following the normal life of a "man on the land" until 1965 when an accident occurred that would change his life. Whilst felling a tree, he was struck heavily by a large branch just behind his head. The blow struck a critical spot, instantly paralysing George, making him a quadriplegic. He was transferred to the Austin Hospital for the next 14 1/2 months where he was faced with the realisation that the damage was permanent and he would never move again.

After returning to Echuca, the farm was sold and George and his wife Elma moved into a house in the town close to the hospital and medical services. At this time, there was little quality of life for George - he would sit all day in his wheelchair immobilised. He would gaze into space in total boredom with nothing to exercise his keen and active mind. In 1979, through a friend, he was introduced to CB radio. This medium enabled him to contact people "outside". He regularly spoke to truckies and CB enthusiasts until a chance meeting with two amateurs changed his life. Through their encouragement and tuition, George quickly learnt Morse code, and regulations. Because of his quadriplegic status, a special oral Morse test was arranged.

After some seven months of concentrated study under difficult conditions, George was able to pass the Novice examination, taking up the call sign VK3VYX. With an HF antenna and a FT-707, George was now active on 80 metres and 15 metres, making new friends on



George and XYL Elma pictured at the VK3CYA rig.

these bands. George was not yet satisfied - he wanted to operate on all bands without restriction. This meant more study and effort. With dedicated help from XYL Elma, George passed the full theory and then operated VK3KYA. This was in 1983. Still persistent, further efforts produced a full call in 1985. Today, George can be regularly heard as VK3CYA.

Now set up with a TH3 tri-band beam for 10, 15 and 20 metres, a trap-tuned dipole for 40 and 80 metres and a 12 element beam for two metres, George is well equipped. After working numerous bands, George has finally settled on two metres FM mode as his favourite band, where he can be regularly heard from early morning until evening on the "Wombat" 6650 repeater, often facetiously referred to as "George's Repeater!!" Most operators have some form of record where other operator's names are recorded - some use computers or quick reference card systems to avoid the embarrassment of not remembering the name of the guy you spoke to yesterday!! George, because of his disability, cannot write down names or operate a computer, BUT he has developed something better - a phenomenal memory. He will be called by someone he hasn't spoken to for months and he will immediately answer the

person by name. It is also not unusual for him to produce the name of the guy's wife or girl friend and other personal details on instant recall - better than any computer or card system!

There are many people in the amateur world suffering disabilities who use this medium to "keep in touch" and to meet and make new friends. George is very definite in his view that Amateur Radio is the best hobby that any disabled person could embrace.

Just recently, George has had an intra-ocular eye implant operation to correct a cataract condition. Simultaneously with this operation George celebrated his 71st birthday!

When next you travel to Victoria from the north on either the Newell or the Hume highways, give George a call on two metres - you will enjoy talking with him and if you are particularly fortunate, you may hear a new yarn from his inexhaustible stock of stories, ranging from pure white to VERY blue! Good luck George, you are an inspiration to all of us.

ar

Have you advised
DOTC of your
new address?

THE CONTEST

TONY MUSSEN VK2CAM
13 BROTHERS ST DUNDAS 2117

If you like a good yarn, and most of us do, then don't read any further. I'm not a writer and the following is based loosely (in places very loosely) on the truth.

It all started when Johno VK2JJM announced on the regular evening 80mtr "Castaways" net one night, "Why don't we have a go at the Contest?" "What Contest?" came the replies. "The John Moyle", says Johno, "what else?"

John Martin, JJM, John Moyle. Now you know how the Net got the name, the "Castaways". No self respecting Net would have such a thick bunch. But back to the Contest.

Thinking it best to try and humour him, those that could, agreed to attend a War Council at Johno's QTH. Once there, Johno was elected Chairperson and someone said they would take some minutes. Well, there was a lot of talk, not much in the minute book and the highlight of the evening was the excellent supper kindly provided by Ann, Johno's wife.

I'm not sure why, but a second War Council was called, and at the same QTH. Must have been the supper I thought! But this time it was different. They had got themselves all inspired, poor devils. Gear was being arranged and people allocated specific jobs like Ron VK2VND agreeing to be cook. This no doubt because of his many Safaris to the Cape, like in Cape York up Queensland way. "Never lost a man", said Ron, "not with my cooking", so cook he was.

It was decided that we should rough it, so Ralph VK2PEJ said he would take his Jayco campervan for use as the studio. Johno said he could supply an 8 man (person) tent for sleeping quarters. Ron said HE would take care of HIS cookhouse. Then came Air Beds and Pumps, Sleeping Bags, a Petrol Generator, (Ron again). Three fridges "3 fridges?", lighting, you name it. We are going to need a truck I thought, a BIG truck. This was confirmed when our cook, now drawing deep on his Cape York trips, and no mean fool with a computer to boot, presented each of us, not only with a complete list of personal requirements, less Barra-Rods and Lures, no fishing trip this one, but a printout of each meal, just one look at the Menu confirmed my fears regarding the truck. Maybe a semi would do? But I didn't know any semi owners.

My job was to contact the relevant Council. This I did and having the interest of Amateur Radio very much in mind

and anxious to make a good impression for our Hobby, including several conditions that we would undertake to comply with, should permission be granted. I'm please to report that the Council Engineer was most helpful. In view of the short time before the John Moyle Contest, he rang me giving his permission and said there was a confirming letter in the post. He also wished us good luck. I think there is a message there, like do the right thing, it often pays off.

Ron and I were to do the shopping for the food - first mistake. Never let two blokes loose in a Supermarket. People employed to stack shelves etc, found themselves running around the place, each clutching their (VK2VND) computer generated list of the items still required to fill our quickly overflowing trolleys. Talk about bedlam! And when other would-be shoppers started to leave the store in droves we were confronted by the Manager, personally escorted to the almost empty checkouts and thanked through what I thought were rather clenched teeth for our patronage. He



Going by the brook, the driving of the station earth stake. L to R Ralph VK2PEJ, Johno VK2JJM with Basil VK2EQY supervising.



Outside the cookhouse or the parade of hats.. L to R Kevin VK1KKK, now VK1KM, Basil VK2EQY The CO, Tony VK2CAM, then, John VK2JJM and John, far right, VK2DEJ.

even suggested that perhaps next time we shop some place else. I think that our mind changing at the checkout re type and quantity of various items just may have been the last straw. Oh Well!

Off to the green grocer. "Plenty of greens", said Ron, "no scurvy in my camp". "Heavens", I thought - "scurvy". We were only to be away for two days, still he HAD been to Cape York and HE was the cook. Next the butcher, oh brother! Ron insisted that each steak be weighed and would only accept those of equal weight, even the snags had to be counted into eight individual lots. "No complaints in my camp," said our cook. I was starting to worry about our cook, and I was not alone. I heard some muttering from the butcher which I didn't quite catch but which must have conveyed something to his many waiting customers.

All this happened on the Friday and with good WX reports an early start had been arranged for the following day. Saturday dawned and the convoy consisting of cars, some towing trailers, station wagons all loaded to the roof, plus of course Ralph and the mobile studio formed up in the pouring rain. "It'll clear", announced Johno. Now I like a man with confidence and I like Johno, but at the moment I had little confidence and my feelings towards Johno were in some doubt. Maybe the fact that I had left a nice comfortable bed at 4.00 am had something to do with it, and for what?

Still, everything had been well arranged, even the 2 m frequencies had backups to the backups so that the convoy would always be in touch. Well we had some good QSOs, but never with each other. Somehow no two vehicles seemed to be on the same frequency at the same time and poor old Kevin then VK1KKK, now VK1KM, who was mobile up from the ACT, never did find any of us until he arrived at the camp site. Still Johno's WX prediction proved right, the rain did stop. Now all we had to contend with, because of our height some 3,500 ft, was the condensation from the low cloud constantly dripping from the trees.

The first thing we did was to elect a Commanding Officer, Basil VK2EQY got the job without dissent as he was the oldest. Basil was over Seventy when he took up Amateur Radio, and in the short space of two years went from Novice to full call, no mean achievement, and a keen Amateur to boot. Anyway, Basil was dispatched into the bush complete

with 2 metre hand held and instructed to report in on Simplex on a regular basis. So with the CO out of the way all the pre-planning at the War Council meetings came to the fore, just like a well oiled machine. With not much more than an hour to go before we were due on air, this was to be a 24 hour attempt in case I forget to tell you, it was priority first, Ron wanted his cook house up, Johno said we should all blow up our Air Beds, Kevin said no camp was a camp without a fire and proceeded to clear a safe area, Ralph said he needed level ground for the campervan, I mean studio, John VK2KAV from now on to be referred to as Kav, official Photographer to the party asked "Should he start shooting now?", and I was trying to remember just where that bottle of Port had been stored.



General view of the portable station site. Frank VK2FTD alongside his vehicle. Cookhouse - sleeping quarters - studio?

The 2 mtr crackled, it was the CO, "Could we hear him", "Yes, Basil we can hear you." "Where are you?" "I'm here," came the reply. "Good" said someone. End of QSO. Don't ask me how but in next to no time, Ron, the cook house temporarily forgotten, had the Dipole Antenna up. Next I helped Ron place the 240 volt petrol generator behind the Council Toot, a new building and still without a roof. An umbrella was permanently placed near the door later, the drips from the trees, remember? Power leads were run, power boards installed inside plastic bags, the drips again, the three portable fridges connected to the power. At least the food was going to be OK, none of the scurvy for us. A hole had been scooped out of the soft top soil and a flat rock was readied to lift the vans opposite wheel.

Now, with Ralph behind the car wheel and everyone, except Kav (he was taking pictures) giving conflicting directions, somehow or other the Jayco Studio was correctly placed to Ralph's satisfaction. I think it was about this time that someone said that he had read in a book once, that an Amateur station should have an earth stake, we all agreed that we too would



The failed no 1 rig. L to R Basil VK2EQY, the CO, John VK2JJM, the rig's owner, Tony VK2CAM, foreground is John VK2DEJ.

have an earth stake. That was, until we tried to drive it, almost solid rock under that loose dirt covering. But at last we got something down to a reasonable depth and everyone was happy that things were being done by the book. I think the 2 m spoke again at this point, it was the CO once more, "Could we hear him?", "Yes Basil we can hear you. Where are you?" "I'm here", came back the 2 m, "Good", said Johno, "now switch it off". "No way", said Kevin from his circle of stones, the chosen fire site, "He's the CO". "True" replied Johno, "leave it on".

With what seemed only minutes to go the Rig was powered up. We were about to go to air in what for most if not all was our first attempt at a 24 hour Portable Station in the John Moyle Memorial Contest. It was then that "Murphy" our constant companion since first light this morning struck once more. Steam and smoke belched briefly from the rig followed by a silence so complete that all that could be heard was the stepped up patter of drips as they hit the studio roof. Johno - it was his rig - passed out. Ron though it was a good time to put the billy on. I still couldn't find that bottle of Port and Kav took a photo of Ralph, who, being as he was a good mate of Johno's thought he may as well pass out too. Kevin lit his fire, the 2m remained silent.

I'd better explain at this point that the party was to consist of eight operators, namely: Basil VK2EQY Commanding Officer; Johno VK2JJM Contest Manager; Ron VK2VND Cook; John VK2KAV Photographer; Kevin VK1KKK now VK1KM OC Safety also known as our Federal Member (unelected); Ralph VK2PEJ Equipment Officer; Don VK2AFT Back up rigs; and yours truly VK2CAM (not considered worthy of any title); also an uninvited bloke called Murphy.

It would seem that the latter had been in things from the very start because Don VK2AFT came down with a rotten virus and despite a vain attempt not to let us down was much too ill to attend, and

much to our sorrow had to drop out. This latter point was really brought home to us with the now silent No.1 rig, no back ups. Well it just happened that when loading the car I had packed the FT7B, just in case. Do you know that little rig ran almost non stop for nearly 25 hours and never missed a beat. At last the Two Metre gave voice, "Time we were on air you blokes, What are you doing?" "Where are you Basil?", "I'm still here!", "Good" was the reply yet again and this time we did switch it off.

And so it was, at the due time and date Ron put out our first call, the Contest had begun. After lunch Frank VK2FTD along with his cousin Jane, a visitor to Oz from the UK, joined the party. This helped with the operating as we had lost the services of Don, crook with the virus. Another windfall was the arrival of John VK2DEJ. Now Don knows his way around the HF bands and was able to assist us greatly. Ron because of his cooking duties was to do less operating, but somehow managed to do both in no short measure. Quite a few were seen to ease their belts a little as meal after meal was prepared and eaten.

One bloke I have not mentioned so far is old Redeye, the phantom operator. Seems somebody came across a bottle of Port somewhere and never let on, well I'm not going to let on either.

So, there it is. Space will not permit all to be recorded but it was a fantastic weekend in very good company and we still recall highlights on air to this day. Time and memory have bent and twisted certain events something terrible.

Our thanks to Johno who did an excellent job with the log on our return, even to the extent that every member was given a copy as a keepsake. Also Kav for recording so much on film, really great. Points? Yes we go a few, not enough to win, but taking part, that's winning, isn't it? ar

PREVENT PIRATES !

**MAKE SURE YOU
SELL YOUR
TRANSMITTER TO A
LICENSED AMATEUR**

YEOVAL TO YEOVIL

Joy Collis VK2EBX Yeoval 2868

As the on Amateur Radio operator in Yeoval NSW, I was virtually "adopted" by the Yeovil (Somerset) Amateur Radio Club in December 1984, but for obvious reasons, could not participate in Club activities, other than radio communication whenever possible.

When OM Dan and I visited England in April it seemed an appropriate time to "drop in" and put some faces to the voices! Accordingly, we hired a car and gingerly headed out on to the motorways in the direction of Somerset. The English weather was "weepee" as usual, but the birds were singing, the grass was green, and who cared about a little precipitation?

We arrived in Yeovil about mid-afternoon, and after asking directions and driving twice around the same roundabout, we finally found our way to the QTH of Don G3NOF and his wife Joan, who had very kindly offered to put us up (and put up with us), and who proceeded to spoil us thoroughly for the duration of our stay.

We were certainly unprepared for the warmth of the welcome we received from the "Yeovilians", beginning with an invitation to the Mayor's Parlour to meet the Mayoress of Yeovil Mrs Bridget Dollard, followed by dinner at an old English cottage converted to a restaurant a few miles from Yeovil.

Dining with Mayoresses is not something that features very often among our normal activities in Yeoval, but Mrs Dollard's cheerful, friendly nature and a very enjoyable meal made it a most memorable occasion.

The following evening we were guests of the Yeovil Amateur Radio Club at a dinner held at the "King's Arms" Montacute, (a little village near Yeovil). Understandably, there was plenty of lively conversation to accompany the delicious food. Another evening we will not forget in a hurry, and a great opportunity to meet so many club members.

Our last evening in Yeovil was spent at a club meeting, although I don't think much business was attended to that night. Again, plenty to talk about, and definitely no QRM, QRN or any other type of interference.

Our daytime activities included a visit to the Quedam shopping area with Mrs Pat Carter of Baker Travel, whom we had previously met in Yeoval, and who



Dan and Joy Collis VK2EBX, with members of the Yeovil amateur radio club.

has been instrumental in the twinning of the two towns.

Our "itinerary" included tours of the surrounding countryside with Don and Joan, among them a visit to the Fleet Air Arm Museum and Yeovilton, Sherbourn Castle, East Coker (the birthplace of William Dampier) and a trip to Cheddar.

Don proved to be a veritable mine of information, with a detailed knowledge of Somerset history, both ancient and modern, which made every excursion very interesting.

All good things come to an end, of course, and the time came to say our regretful farewells, head out to do battle with the traffic once more, and return to Cranbrook in Kent, our "home base" while in England.

We are most grateful to everyone who contributed to giving us such a wonderful time in Yeovil, especially Mrs Dollars, Mrs Carter, Don and Joan McLean and all our friends at the Yeovil Amateur Radio Club, where the true spirit of amateur radio is very much alive and well.

Thanks to one and all.

Further to the article submitted regarding visit to Yeovil, Somerset: Tim Healey G4WMV, Chairman of the Yeovil Amateur Radio Club, died suddenly during July.

He will be greatly missed by family, all club members, and children at the school where he was a teacher. We were privileged to have met him. ar

from page 31

The Encyclopedia of Soviet Spacecraft (D. Hart)

The Encyclopedia of US Spacecraft (B. Yenne)

(The last two can be downloaded to the kids at Xmas after you read them.)

Weather Satellite Help File

The Queensland Weasat Group hope

you have found our weather satellite data files of interest. If you have any questions we have not covered, or are interested in talking to us about the subject, we invite you to contact us via the Brisbane BBS, C/- VK4ZBV, or by mail to:

Paul Hayden VK4ZBV
38 Lutzow Street
Ekibin Brisbane
QLD 4121.

continued on page 44

WIA 80 COMPETITION!

CELEBRATE THE 80TH ANNIVERSARY OF THE FIRST AND OLDEST NATIONAL RADIO SOCIETY IN THE WORLD

WIN

AN ICOM IC-900A MULTI-BANDER SYSTEM VALUED AT \$2000

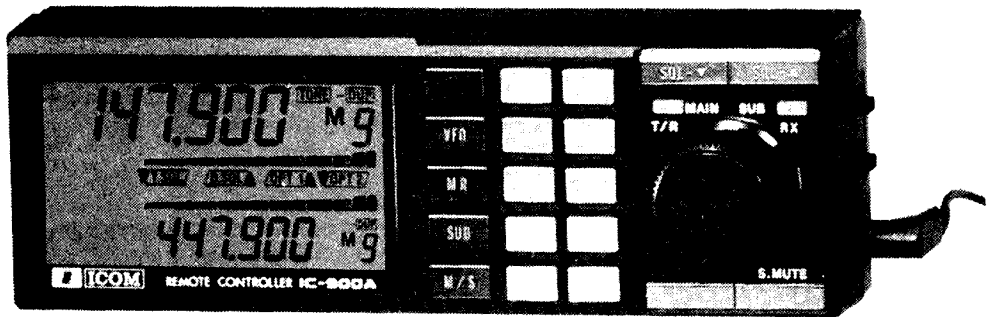

Remote Controller

How would you like to win a fantastic ICOM IC-900A series multi-band mobile control unit, complete with modules for two metres and 70 centimetres, plus your option of either six metres or 10 metres?

Thanks to ICOM Australia Pty Ltd, the winner of this competition will receive a magnificent IC-900A multi-bander system set up for 144 and 432 MHz operation, and will be able to select either the additional six-metre or 10-metre module.

However, you could still be a winner, even if you do not win this IC-900A. The three runners-up in this great competition will receive a full refund of their 1990 WIA membership fees, worth up to \$65.00 each.

Who can enter?

This great contest is open to any person who is a financial member of the WIA as at 1st February 1990, except that employees or office bearers of the WIA Divisions and Executive are not eligible to win a prize.

How to enter?

Easy! Fill in this form by completing, in less than 30 words, the statement "I am a member of the WIA because . . .", place it in an envelope together with your address label accompanying this issue of Amateur Radio magazine, and post it to "WIA 80 Competition, PO Box 300, Caulfield South, Vic, 3162", to reach us no later than 1st February 1990.

A photocopy of this form may be used if you do not want to cut up Amateur Radio magazine, but the Amateur Radio address label must be the label used to mail this issue of Amateur Radio magazine to you. This competition will be run over a period of three months, and WIA members can enter three times if they so desire.

The winning entries will be selected by a judging panel, and the winners will be announced in the March 1990 issue of Amateur Radio magazine.

WIA 80 Competition PO Box 300 Caulfield South Vic 3162

Dear Sirs,
I wish to enter the WIA 80 competition, and accept the rules as published.

I am a member of the WIA because

.....

.....

.....

(Complete this statement in 30 words or less)

Callsign or Membership Number Signed

HOW'S DX

STEPHEN PALL VK2PS
PO Box 93 DURAL 2158

Laos is on the air - XW

A very happy New Year to you all, full with DX opportunities.

The past year has seen a few big "DX" stories: the 40WPA activity from Yemen, - the planned activation of 70 from the Democratic Republic of Yemen which turned out to be a non event, - then those which turned into reality: 3D2 Rotuma, T33 Banaba Island, - 3D2 Conway Reef, - ST0 Southern Sudan, - D2 Angola just to name a few. By the time you read this, 3Y Bouvet Island should have commenced activity, and now the first regular authorized activity for many years, from Laos, XW.

I was doing my regular afternoon check on the bands on the 15th of November when I heard the news: The Government of Laos has agreed to the resumption of radio amateur activities. Reports of the first QSOs came thick and fast.

After a few days, a clear picture has emerged: with the assistance of Japanese amateurs a Club station has been established with the call sign XW8KPL. It operates usually between the hours of 0130 and 1100 UTC. Quite a number of VKs and ZLs have now exchanged reports with Laos with the assistance of Ben, YB3CN, net controller in the South Pacific area for the W2MIG net on 14165 kHz. Check-in time is at 0945 UTC. The operator of XW8 is: Mr Inh SI-PHACHANH, Deputy General Director of KSPH which is a Laotian News Service. The address is: PO Box 310, Vientiane, Peoples Democratic Republic of Laos. Do not send "green" stamps, just 3 IRCs and a self addressed reply envelope.

On the other hand, Ben, YB3CN has agreed also to act as a "de facto" QSL manager. His address is: B Byenantea Box 545 Surabaya 6001 Indonesia.

Expect some interesting activity from Laos. The Hungarian group which operated a year ago from Vietnam, will visit Laos late November and it is planned that they will activate Spratly Islands early in December, but more of this in the next issue of "AR". A number of Japanese amateurs are likely to operate from Laos early in the new year.

What rare and "dormant" country is on the Exciting "DX" list of the future? Perhaps A51 Bhutan? Jim, VK9NS is working hard on this problem.

More news about this possible planned activity later.

Midway Islands - KH4

Gary, NY6M/KH2 and Bob KD7P/NH2 both are stationed in Guam. During the "CQ" CW DX Contest and afterwards they were active on several bands as NY6M/NH4 and KD7P/NH4 from Midway Islands. QSLs to their home call.

Macquarie Island = VKØ

By the time you read this, Grahame VKØ has left Macquarie Island for a well earned rest. he will be replaced by John, who intends to operate under the call of VKØJR. Grahame's QSLs go via VK9NS.

New DX Countries

It has been reported from several sources that the DXCC Committee of the ARRL has decided to accept Banaba Island (T33) and Conway Reef (3D2) as a new DX country. The 10 MHz. WARC Band is now accepted for the DXCC award for mixed, CW or RTTY mode. This decision will lead to more activity on this quite useable DX Band.

WARC Bands

It pays to listen, and be aware of, what goes on in the 10 MHz, 18 MHz, and 24 MHz bands. The 18 MHz band proves itself to be a good DX band. One evening (local time) within half an hour I worked UR2, LA8, JR1, KL7, W4. Most of them in the CW mode around 1100 UTC. This band is also quite useful for VK traffic around 0400 UTC.

New Prefixes

I worked Ray VY2ATP on Prince Edward Island Canadian Amateurs (VE1) who are located on that island may use the new prefix of VY. Eventually all stations will change to the new prefix which at present is optional.

There are prefix changes in other parts of the world also. Franz Josef Land in the future will use the prefix 4K2, the Soviet European islands 4K3, the Soviet Asiatic Islands 4K4. The Russian operations in Antarctica will continue to operate with the 4K1 prefix. It is reported that 4K2DX will be the new callsign of UAØIL the well known Franz Josef Land station 4K1F located in the south Shetland Islands.

VHF/UHF An Expanding World

Eric Jamieson VK5LP - "The Voice by the Lake" wishes to apologise to his readers for the absence of his column this month. Eric is confined to hospital. This is the first deadline he has missed in twenty years. We wish Eric a speedy return to good health - Ed ar

Murphy's Corner

Wasn't that a good photo of Federal President Peter Gamble VK3YRP on last month's cover? The highly competent photographer should have been acknowledged. He was none other than the ever willing John Friend VK3ZAB. John has just returned from hospital, following an operation, and we wish him a speedy recovery.

On P35 of the December issue, we managed to corrupt the call-signs of two individuals in the picture:

JA1AH should have read JA1AN and ZL2AHJ was really ZL2AMJ.

ar

A Call to all Holders of a Novice Licence

Now you have joined the ranks of amateur radio, why not extend your activities?

The Wireless Institute of Australia (N.S.W. Division) conducts a Bridging Correspondence Course for the AOC and LAOC Examinations.

Throughout the Course, your papers are checked and commented upon to lead you to a successful conclusion.

For further details write to:

The Course Supervisor
WIA
PO Box 1066
Parramatta NSW 2124
(109 Wigram Street, Parramatta)
Phone: (02) 689 2417

11am to 2pm Monday to Friday
7 to 9pm Wednesday

The Baltic States will also change their prefixes: Latvia will operate under YL, Lithuania as LY and Estonia as ES.

During October some Nigerian stations used the prefix 5N29 in celebration of the 29th anniversary of independence. Both the SSB and CW sections of the "CQ" World Wide Contest produced the usual crop of rare prefixes: the delight of prefix hunters. 4UØITU by a group of USA amateurs, J6 Santa Lucia, USA amateurs, P4OGD Aruba by John W2GD, PJ4U from Bonnaire by K3IPK, S92LB Sao Tome and Principe by Walt DJ6QT, — VP5T Caicos and Turks by NM2Y and several other rare prefixes. The special prefixes of: CT500A, CT500B, CT500C, CT500D celebrated in December the discoveries made by Portuguese explorers 500 years ago.

Nauru C21 And Western Samoa 5W

Lee, VK2LEE reports that Jon C21AJ has started his two years contract on the island which has a population of 8000. QSL to Jon Leeman PO Box 29 Republic of Nauru Central Pacific.

Lee also reports that Pete 5W1KT has set up shop for two years in Western Samoa. Pete intends to be active also in the CW and RTTY mode. His address is: PO Box 1672 Apia, Western Samoa, South Pacific.

Interesting QSOs And QSL Managers

BY5HZ — Han — 28499 kHz at 0405 UTC. QSL to: PO Box 804, Hangzhou, PRC.

ZF2OC — Chuck — 21205 kHz at 0508 UTC. QSL to: KC3ET.

N8BJQ/KH9 — Wake Island — 21026 kHz at 0647 UTC. QSL to: N8BJQ.

YJ8NMB — Marek in Port Vila — 21200 kHz. 1027 UTC. QSL to: Box 217 PO Port Vila, Vanuatu.

KH6JEB/KH7 Rick on Kure Island, 14222 kHz at 1055 UTC. QSL to home call.

KG4SG Sid on Guantanamo Bay, 14165 kHz at 1143 UTC. QSL to: KK8X.

VP5JM Judy (YL) on Caicos, — 14165 kHz at 1200 UTC. QSL to: W3HNC.

PJ 2 WOL Erwin in Curacao, — 14165 kHz at 1111 UTC. QSL to: PO Box 3509, CURACAO West Indies or via the Bureau.

BZ1FB Meng in Beijing, 14165 kHz at 1115 UTC. QSL to: KF7SH

CEZIG Jaime on Easter Islands, 21205 kHz at 0528 UTC. QSL to: NR8J.

5N9FEA Elie in Nigeria, 1422 kHz at 0638 UTC. QSL to: PO Box 65, Zaria, Nigeria.

N9AG/J6L Scott on S.Lucia, 21205 kHz at 0514 UTC. QSL to home call.

HP2/KC4BFBK 14222 kHz at 0557 UTC. QSL to: home call.

V29OA in Antigua, 14226 kHz at 1115 UTC. QSL to: W7KNT.

VQ9PN Pat on Diego Garcia, 14226 kHz at 1202 UTC. QSL to: N4DQY.

P43HM Hum on Aruba Island, 14 MHz. QSL to: PO Box 2066 Aruba West Indies.

KG4DD Doug in Guantanamo Bay, 28 MHz at 0103 UTC. QSL to: WD8QCU.

T3ØNAD Box in West Kiribati, 28 MHz, 2200 UTC. QSL via J01CRA

3X1SG Edmond in Republic of Guinea, 28 MHz 2319 UTC. QSL to: ON7GV.

OY6FRA Faroe Isl 28 MHz. QSL to call-book address.

AH2BE/KH9 Edward, Wake Island. QSL to: KA6V.

9M6KT QSL to: KL7GRF FK8FA Aimee (YL) PO Box 447, Mont Dore, New Caledonia.

H44GR QSL to: PO Box 127, Honiara, Solomon Islands. KA5UWN/KH2 QSL to: WD5GIV.

WB6PZF/KH6 QSL to Box 242, Captain Cook, Hawaii 96704, USA.

HKØNZI QSL to PO Box 1019 St Andres Isl Colombia.

HKØHEU QSL to: PO Box 3501 St Andres Isl Colombia.

5N9NRK QSL to: HB9WU. 9Y4RJS QSL to: PO Box 3495 La Romain, Trinidad.

NT2X/NHØ QSL to: KQ1F. HC8U QSL to: W6UE. 5W1HK QSL to: SM7PKK.

ZK2RY QSL to: OH3GZ. KH8/SM7PKK QSL to: SM7PKK. T28RW QSL to: ZL1AMO.

YJØR QSL to: OH1RY.

From Here And There and Everywhere

EL2WK Bill and his wife Doreen EL2DK are back in Liberia after a well deserved holiday back home. They are active again on 14 MHz at their usual time around 0600 UTC QSL to: G3OCA.

I was fortunate to work Iris Colvin W6QL, who was working from Niger under the Call 5U7QL. Whilst typing this report I had a bit of a listen on the band. There she was again in Burkina Faso, and I worked her with her XT2KG call. QSL for both calls to YASME PO Box 2025 Castro Valley CA 94546 USA.

Javier, XF4T from Revilla Ggedo Island can be heard with a very strong signal on 14222 or 14226 at around 1200 UTC. QSL to: XE2TCQ Jose Javier C Quinones, PO Box 66-D, Tijuana-Baja California, 22150 Mexico.

Had a pleasant QSO with Olle, SMØIG/P/YN in Managua, Nicaragua. Olle is a news-correspondent for "Radio Freedom", and he hope he will be at that QTH until June 1990. ED8URL was a special commemorative station — for the Canary Islands Amateur Radio Club. QSL to: EA8ZY PO Box 221 Las Palmas 35080 Canary Islands.

LU6ELF/D2 has now a QSL Manager: Carlos, N4THW.

ZK3 Tokelau Islands. Matts SM7PKK proposed visit to these islands was abandoned because of boat transportation difficulties at this time of the year. Les VK4DA says he finally worked all the 40CQ Zones in five years with 50 Watts and a G5RV antenna. In his opinion, the 15 mtr Band is really shaping up for very good DX.

Interesting QSLs Received

9X5AA, 7P8DX, A61AC, CX2CS, TX3DA, HC5AI, 3D2VV, AH9AC, FF10SB (French DX Foundation Club Station) HK6GLR.

The Big Question!

For my own information as an "acting" editor of this DX Column, I want all the readers who actually do read this column to drop me a line and express their opinion of the usefulness of this column. No lengthy formal letters are needed. Comments on the back of your QSL card will be sufficient. I want to know: Do you read this column? Always? Or just from time to time? Are you an active DX'er? Do you find the information in this column useful, or you find it as an "old hat" repeat news? What changes should I make in the column? What do you want to hear about DX in this column? Shall I continue writing this column, or shall I give up the ghost? Your constructive ideas are wanted. Out of a readership of about 8000 or more, hopefully I expect to receive at least a dozen or so replies from all those, whose particular interest in amateur radio is "DX"-ing. When do I want these comments? Yesterday would have been better, but today will be sufficient. Do it now. today. I will keep you posted about the result. Thank you.

Finally I want to thank all those who contributed with news, comments and info for this issue: namely Pat VK2RZ, Lee VK2LEE, Les VK4DA and the "QRZ DX" weekly news Bulletin.

Please keep up the good work, and send me the news, I cannot be continuously 24 hours on the band to see what is happening. 73 and good DX to all of you.

Late Stop Press

After considerable delay and confusing rumours, the Hungarian DXpedition to Laos commenced operations on 8/12/89. Call signs are: XW8DX (SSB) and XW8CW (CW). They were heard around 0900 UTC on 21235. They were also working on 21035, 28025 and 28495. QSL to F6HIZ. I worked them on 9/12/89. ar

CONTESTS

FEDERAL CONTEST MANAGER FRANK BEECH VK7BC
37 NOBELIUS DRIVE LEGANA 7277

Contest Calendar

January

- 1-6 Ross Hull memorial contest.
27-28 REF VHF/uHF National Field Day contest. (Rules November "AR").
28th REF French contest CW section. (Rules December "AR").
27-28 UBA Belgian UBA contest (Rules this issue).

February

- 24-25 REF French contest, Phone section (Rules December "AR").
24-25 UBA Belgian contest, Phone section. Rules this issue.

March

- 10-11 RSGB Commonwealth contest. Rules this issue.
17-18 NZART National Field Day contest.
17-18 WIA John Moyle Memorial Contest. (Rules next month.)

From the result of the 1989 Commonwealth contest, when conditions were "not the best" it is very pleasing to note that from the leading ten stations 3 were VKs.

From the Belgian national society, I have received a booklet containing the results of the 1989 UBA contests. This is far too lengthy to print out in full so I will list the results of the VK stations mentioned.

In the CW section, single operator, single band. (20m) two VKs are listed, VK5AGX with a score of 2752 points, and a certificate winner.

VK4TT with a score of 282 points.

In the single operator multiband section, only two VKs appear;

VK8XX with 11310 points, and a certificate.

VK2BQQ with 1020 points.

From the SSB section of the contest the following VK station is mentioned.

Single operator, single band;

VK4KRP with a 10m score of 1859 points.

Commonwealth Contest

Rule 7: to those of us who do not bother to scrutinise the rules of this contest because they are so predictable, please read this rule 7, as it will be worth looking out for the various HQ stations mentioned, they being worth 20 points! The contest manager G3FXB has asked me to bring the matter of HQ stations being set up by the institute to promote activity in the contest. It would appear

that the other societies may be using the equivalent to our official institute call signs as bonus sources. This would have to be debated at federal level, and is something that the next contest manager will have to look into.

I hope you all enjoyed the Ross Hull memorial contest and took advantage of the alternate location section. Please send in a log. The second trial VHF/UHF contest later on this month should give you all another excuse to get the portable gear tweaked up, and try that location that you like the look of. Please have a go this year, and perhaps the idea of this contest could become a permanent feature in the WIAs contest calendar.

UBA Contest 1990

Rules

The Union of Belgian Amateurs invites all amateurs worldwide to participate in this contest.

European Community

The UBA has the honour to announce that this contest will be challenged under the Patronage of Mr Jean Dondelinger, Member of the Commission, responsible for Communication, information and Culture.

1 Name and Aim:

To contact as many Belgian and other amateurs as possible and to provide a way to achieve the WABP and the EC Awards in the "UBA Contest".

2 Periods:

Last full weekend of January and February each year from 13.00 UTC Sat to 13.00 UTC Sun CW 27-28 January—SSB 24-25 February.

3 Classes:

A. Single Operator Single Band (SOSB). B. Single Operator Multi Band (SOMB). C. Multi Operator Single Transmitter (MOST). D. QRP 10 Watt input, as class B. E. SWL as class B.

4 Bands:

10.15.20.40.80 m. Frequencies according to IARU Regio 1 Bandplan. CW: 3.500 — 3.560; 7.000 — 14.00 — 14.060. 21.000 — 21.080; 28.000 — 28.100 MHz. SSB: 3.600 — 3.650; 3.700 — 3.800; 7.040 —

7.100; 14.125 — 14.300; 21.400; 28.500 — 28.800 MHz.

5 Contest Call:

CW "TEST UBA"; SSB "CQ UBA". Exchange: RS(T) + serial number starting from 001. Note that Belgian stations give their province abbreviation which is part of the exchange (e.g. 59001/AN).

6 Scoring:

QSO with ON, DA1 and DA2 counts 10 points. Q S O with other European Community member stations as listed below counts 3 points. Q S O with any other station counts 1 point.

7 Multipliers: All Belgian provinces; AN, BT, HT, LB, LG, LU, NR, OV, WV Each of the prefixes; ON4, ON5, ON6, ON7, ON8, ON9, DA1, DA2 All other countries from the European Community; CT, CU, DL, EA, EA6, EI, F, G, GD, GI, GJ, GM, GU, GW, I, IS, LX, OZ, PA, SV, SV5, SV9, SY, TK, ZB2. A total of max 42 per band.

8 Final Score: Total QSO points times the total number of multiplier points.

9 Special Conditions:

None

10 Logs

Showing date, time (UTC), station worked, exchange with respective serial number, multipliers and points. Only note multiplier first time. Use a separate log for each band. Each entry must have a summary sheet showing all the scoring information, class of entry, mode, name(s), call sign(s), full address and a signed declaration. The IARU R1 standard format sheets are recommended.

Remarks:

Computer print-outs are accepted provided they have the same format as hand written logs. Computer logs on 5 1/4 disk can only be accepted when the format is MS-DOS/ASCII.

SWL Rules:

Only stations taking part in the Contest may be logged for scoring purposes. Logs should show in columns; Time (UTC), call sign of "Station Heard", complete exchange sent by this station, call sign of station being worked, a RS(T) report on "Station Heard" at SWLs QTH new multiplier and points claimed. If both sides of a contest contact are heard

they may be claimed as separate stations and the callsigns are to appear in the "Station Heard" column as in the example given over.

A station may only appear once per band as station heard. In the column "Station Worked" the same station may not be logged more than 10 times per band.

Time UTC	Station Heard	Exchange Sent	Station Worked	RS(T) SWL	Bonus /Mult.	Points	Check Only
10:11	ON7AR	59121/AN	UQ2GWW	58	ON7-AN	10	
10:11	UQ2GWW	59198	ON7AR	59		1	
10:13	E17M	59212	ON7AR	57	EI	3	

Commonwealth Contest 1989

11 Declaration:

"I declare that all contest rules and all the rules and regulations for amateur radio operations in my country have been observed and adhered to. I accept the decisions of the Contest Committee."

12 Address for logs:

UBA HF contest committee Galicia Jan ON6JG Oude Gendarmeriestraat, 62B-3100 Heist op den berg Belgium

13 Deadline:

All entries must be post-marked not later than 30 days after the contest.

14 Awards:

The new "UBA CONTEST AWARD" will be sent to the highest scoring station in each class from each country. Other participants receive a certificate provided they contact at least 40 stations. The EC TROPHIES go to the EC winners of class B from each event. A special engraved plaque is donated by ON6JG to the OVER ALL winner of class B in the SSB contest.

15 Penalties & disqualification:

Penalties for:

- Incomplete or incorrect exchange, NIL points
- Deduction of 3 times QSO value for any unmarked duplicate contact.

Disqualification applies for:

- Incomplete or late entry (the latter will be treated as check-log).
- violation of the rules.
- Unsportmanlike behaviour.
- excessive number of unmarked duplicates (>2%).

These rules conform to the IARU Regio 1 Contest Standard Format.

Position	Callsign	Score	80m	40m	20m	15m	10m
1	* VE6OU/3	6847	425	1480	1955	1744	1243
2	* 6Y5HN	6754	225	1494	2035	1835	1165
3	* ZL3GQ	5727	449	1280	1720	1548	730
4	* VE7CC	5699	50	1055	1984	1415	1195
5	* VK2APK	5418	395	880	2065	1170	908
6	* VK6LW	5305	50	725	2100	1335	1095
7	* GXFXB	5295	300	1055	1552	1423	965
8	* VK4XA	5270	250	780	1595	1330	1315
9	G3PEK	4790	445	1035	1415	1110	785
10	G3MXJ	4765	230	910	1575	1120	930
11	G4BUO	4645	280	810	1455	1175	925
12	G4OBK	4465	310	795	1455	1115	790
13	G3LET	4419	260	959	1400	1085	715
14	* ZL1AI2	4160	435	865	1290	1060	510
15	VK6DZF	3979	0	560	1709	1110	600
16	VE3ST	3858	130	775	1548	910	495
17	* 9J2BO	3819	99	470	870	990	1390
18	VK2AYD	3622	150	680	1402	805	585
19	VE5RA/7	3605	0	655	1305	890	755
20	G3NOM	3575	125	635	1115	945	755
21	* VK5AGX	3534	380	645	1379	720	410
22	VE7UZ	3464	25	585	830	964	1060
23	G2QT	3419	150	565	1099	860	745
24	* V01AW	3265	255	350	1020	785	855
25	* VK3MR	3169	200	839	1105	650	375
26	* VE2KN	3120	105	290	1510	805	410
27	VK5GZ	2910	350	475	1145	730	210
28	VE3JKZ	2890	75	485	1105	650	575
29	VK3ZC	2755	125	655	1210	610	155
30	G3KMQ	2740	230	440	1030	525	515
31	ZL1HV	2700	150	630	1005	665	250
32	VK5BN	2630	250	455	800	600	525
33	VK4XW	2595	280	620	825	665	205
34	G3TBK	2585	0	405	755	990	435
35	VK2AQF	2494	125	375	1090	724	180
36	G3JJG	2385	100	325	805	650	505
37	* ZL2TX	2375	0	325	1025	1025	0
38	G3EBH	2365	0	235	775	730	625
39	* VE4JB	2350	0	460	810	860	220
40	G5MY	2335	50	380	1055	575	275
41	GW3HGJ	2313	100	465	970	494	284
42	* VE6BF	2277	0	225	873	644	535
43	G3OLU	2250	25	175	875	585	590
44	GM3CDX	2235	0	230	960	620	425
45	G3EFS	2190	125	415	680	645	325
46	G4WYG	2170	75	125	890	545	535
47	VK2DID	2134	280	200	804	475	375
48	VK6RU	2112	0	285	1110	542	175
49	G3SEP	2110	125	480	525	555	425
50	G3VW	1989	0	300	789	485	415
51	*M VK6AJ	1930	-	-	1930	-	-
52	G3MPB	1920	0	355	835	480	250
53	* VS6UO	1915	0	300	885	385	365
54	8 VE1ZZ	1879	500	690	689	0	0

Remember to leave a three second break between overs when using a repeater.

55		G3SWH	1875	75	250	770	480	300
56	*	ZD8JP	1850	125	440	565	205	515
57		G2HLU	1849	50	304	760	440	295
58		G3ESF	1800	0	280	795	355	370
59		VK2EL	1785	0	275	660	595	255
60		G3GLL	1770	125	200	685	445	315
61		VK28QQ	1745	0	599	802	224	120
62		GW4XXF	1707	125	150	678	380	374
63	*	VK7RY	1699	125	460	635	430	49
64	*	5NOBRJ	1634	49	180	530	225	650
65		VK3KS	1629	0	0	895	559	175
66		VK3MJ	1613	0	0	759	654	200
67		G3NKS	1575	125	350	700	145	255
68		G3FKH	1569	0	0	844	425	300
69		G3VDL	1560	76	235	535	440	275
70	*	VU2PTT	1545	0	305	910	0	330
71		G3AWR	1440	0	125	580	435	300
72=		G3HJF	1420	0	50	430	430	510
72=		VK3DNC	1420	0	275	610	435	100
74		G3NKC	1389	50	174	640	250	275
75		G3KSH	1333	150	254	754	125	50
76	*M	G3RTE	1330	-	-	-	1330	-
77		G4LZB	1250	0	50	725	250	225
78	M	VK4TT	1240	-	-	1240	-	-
79		VK3DQ	1223	25	423	340	310	125
80		G3JKY	1160	0	25	655	330	150
81	*	VP2MT	1120	0	0	565	185	370
82		G3WRR	1115	0	75	375	440	225
83		VK400	1109	230	205	469	205	0
84		VK2AIC	1100	0	0	450	400	250
85	*M	G3PJT	1059	-	-	-	-	1059
86		G4K GK	1009	0	25	609	175	200
87		G4HZV	1000	0	0	500	300	200
88		G3CSR	980	0	0	350	380	250
89		G38PM	969	100	99	460	235	75
90	M	VK2KM	955	-	-	955	-	-
91		G3DPX	925	0	75	375	150	325
92	*M	VK7RO	910	-	910	-	-	-
93		VK38DH	902	0	0	400	302	200
94		5NOELT	895	0	130	325	250	190
95	M	G4AZN	865	-	-	-	865	-
96		VK3XF	805	200	225	380	0	0
97	M	VK3JI	794	-	-	794	-	-
98		G6NK	739	0	0	539	200	0
99		VK5HO	733	175	280	50	200	48
100		VK6RZ	730	0	365	215	50	100
101	*M	VE3HX	715	-	-	-	-	715
102		G2BLA	710	0	199	319	165	125
103	M	G4IQM	705	-	-	-	-	705
104		VE1EP	643	48	80	425	100	0
105		G4CZB	649	74	50	175	200	150
106		VE21	633	0	278	185	170	0
107		GW3SB	600	0	0	275	225	100
108=	M	VU2UR	595	-	-	-	-	595
108=	*	Z23JO	595	0	25	140	25	405
110	*M	GM3CFS	575	-	-	575	-	-
111	M	G4UZN	570	-	-	-	-	570
112		ZL38J	565	0	75	490	0	0
113	*M	G4ZOB	555	-	555	-	-	-
114		VE1GI	554	66	110	140	216	22
115		VE3OMM	545	0	180	125	240	0
116		VK3FC	534	125	409	0	0	0
117	M	VK3XB	455	-	-	-	-	455
118	M	G3VLL	450	-	-	450	-	-
119	*M	VE2ZR	425	-	-	-	425	-
120		G3HAL	250	0	0	225	0	25
121	M	VE2FFE	246	-	-	246	-	-
122		G8QZ	125	0	75	0	25	25
123		M	VE2ICU 88	-	-	-	-	88
124	M	VE8ID	50	-	-	50	-	-

Note: award winners marked with asterisks, monoband entries marked "M".

IAN J TRUSCOTTS

ELECTRONIC WORLD

FOR ALL YOUR COMPONENT
REQUIREMENTS

MAIL ORDERS WELCOME

AMATEURS REBUILD YOUR TRANSCEIVER NICAD PACKS OR LET US DO IT FOR YOU

- **LARGE RANGE
NICAD
BATTERIES
AVAILABLE**
- **SPECIAL PACKS
MADE-UP TO
YOUR
REQUIREMENTS**
- **ICOM
REPLACEMENT
NICAD BATTERY
PACKS**
- **ALSO SEALED
LEAD ACID AND
GELL CELLS
AVAILABLE**

**SEND S.A.S.E. FOR
FURTHER
INFORMATION**

**30 LACEY
STREET
CROYDON 3136**

Phone: (03) 723 3860
(03) 723 3094

Listener's Section

Position	Call sign	Score	80m	40m	20m	15m	10m	1
RS24775	2718	228	565	955	445	525	2	
BRS1066	2540	125	370	1080	590	375	3	
BCRS195	1397	200	280	487	225	205		

Commonwealth Contest 1990 Rules

(Participation in this contest will count towards the HF Contest Championships for UK entrants).

1. Date and time: 12:00gmt Saturday 10th March to 12:00gmt Sunday 11th March 1990.

2. Aims: The Commonwealth Contest is intended to promote contacts between stations in the British Commonwealth and Mandated Territories.

3. Sections: Single-operator entries only from RSGB members resident in the UK, and licenced radio amateurs within the British Commonwealth or British Mandated Territories. Entries may be single OR multi-band (single band entries should claim points on one band only; details of contacts made on other bands should be in the form of a checklog and will not score points or bonuses; multi-band entries will not be eligible for "single-band awards"). Entries will not be accepted from GB prefixes, nor marine or aeronautical mobiles.

4. Bands and mode: A1A only in the 3.5, 7, 14, 21 and 28MHz bands. Entrants should operate in the lower 30kHz of each band, except when contacting novice stations that operate above 21030 and 28030 kHz. Cross-band contacts will not count for points or bonuses.

5. Operation: Entrants must operate from the same location during the contest and strictly within the terms of their amateur licence. Entrants may not receive any assistance whatsoever during the contest, including the use of spotting nets or other bonus assistance.

6. Exchange: Contacts may be made with any station using a British Commonwealth prefix, except those within the entrant's own call area. A contest exchange consists of RST and serial number (starting at 001 and increasing by one for each successive contact).

7. "Headquarters" stations: Commonwealth society HQ stations active during the contest will also send "HQ" after the serial number to identify themselves. Every HQ station and counts as a separate call area (and thus attracts the 20 point call area bonus), and entrants may contact their own HQ stations for points.

8. Scoring: Score 5 points for each completed contact, plus a bonus of 20 points for each of the first three contacts on each band with a given Commonwealth call area (as shown in the accompanying list). Note that all

UK prefixes count as one call area, and UK entrants may not contact other UK entrants. Duplicate contacts must be clearly marked as such and no points or bonuses may be claimed (unmarked duplicates will be penalised at ten-times the claimed points plus the points themselves, and entries with more than five such dupes may be disqualified). Dupe sheets would be appreciated by the adjudicator.

9. Documentation: Use separate log sheets on each band, in the standard format. RSGM HVC1 contest log sheets are preferred, although overseas entrants may use similar sheets from their national societies. Computer-printed entries should follow the same format, showing call sign, RST/serial number sent, same received, bonus points and points claimed against each contact. Complete a cover sheet with details of the station and operator, total claimed scores on each band and grade total, plus your correspondence address. All entries should include signed declaration as follows: "I certify that the station was operating within the terms of my amateur licence and that I observed the rules in spirit of the contest".

10. Entries: Send your entries to the RSGB HF Contest Committee, PO Box 7 Lichfield, Staffs WS13 6UJ, ENGLAND to arrive before April 9th 1990 (overseas entrants are advised to forward their logs by airmail as late entries will be treated as checklogs). To receive a personal copy of the 1990 results and 1991 rules, overseas entrants should include a self addressed envelope and sufficient IRCs for return postage. Entries become RSGB property. In the event of any dispute, the ruling of the council the RSGB shall be final.

11. Receiving section: rules as for the transmitting section except that (a) Holders of transmitting licences for frequencies below 30MHz are not eligible. (b) to count for points, stations outside the entrant's own call area must be heard making contest contacts (CQ or test calls, non-contest contacts and station in the entrant's call area do not score points. (c) Logs should show: gmt, station heard and RST and serial number sent station worked, and points claimed. (d) Score 5 points for each static heard, plus 20 bonus points for each of the first three stations heard each Commonwealth call area on each band (all UK prefixes count as one call area). HQ stations count as separate call areas. A given "station heard may only be logged once on each band, and a given "station worked" may only appear once in every three contacts logged. If both stations in contact are heard, they may both be logged separately as "stations heard".

12. Awards: (a) Multi-band section: overall

leader wins the Senior Rose Bowl; runner-up wins the Junior Rose Bowl; leading UK entrant wins the Colin Thomas Rose Bowl; leading stations in each call area receive certificates of merit. (b) Single-band section: certificates of merit to the leading overseas and UK entrants on each band. (c) Receiving section: winner receives the Receiving Rose Bowl; leading entrants in each continent win certificates of merit.

Weather Satellites

from page 37

I wish to thank those who have helped me with their encouragement, support, ideas, and learned opinions. I must give a special mention to my colleagues, Phil Webb, Allan Abbott and Jim Whitaker, for the many hours of stimulating debate on the subject. My thanks to Herb ZEV, Brian AHD, and Lee CXX, for providing the stimulus necessary to start the project in the first place. And last, but not least, my wife (and chief proof reader) Jean, and our family for their forbearance. 73, Paul.

ar

World Bank Callsign

The United Nations has issued the call sign 4U1WB to the World Bank Amateur Radio Club which is located in Washington DC. The club station is activated on the HF bands by staff of the World Bank, a body funded by governments from around the world, which lends money to developing and underdeveloped countries. Contacts with 4U1WB will count as mainland USA for the DXCC. QSL via KK4HD.

JIM LINTON VK3PC

ar

**Repeaters
additions, deletions,
alterations.**

**Have you advised the
WIA of changes needed
to the repeater list?**

AWARDS

KEN GOTT VK3AJU FEDERAL AWARDS MANAGER
38A LANSLOWNE RD ST KILDA 3183

Support the WIA in order to
protect Amateur Radio
frequencies at WARC 92

Overseas Demand For WIA 80 Award Running Strong

As mentioned in Bill Roper's column (see p5), North American amateurs quickly scooped the pool of low-numbered WIA 80 award certificates.

Certificates endorsed "first for Alabama, first for North Carolina" and for some other states have also been posted off, but more than three dozen US states are still open for these endorsements. You might care to spread the word if you come across US amateurs interested in the award, a reproduction of which appears on this page.

First VK Winner

Meanwhile, the first VK to win the WIA 80 award is Alick Pickford VK2EF of Tuross Head.

Alick completed his 80 QSOs within November, all on SSB, and his certificate has been endorsed accordingly — along with the fact that it is the first one awarded to a VK.

It is, of course, also the first awarded to a VK2 — meaning that as this column is being written, the field is open for claims for first certificate to be awarded to a VK3, VK4, etc.

And, in case you've forgotten, the rules for obtaining the WIA 80 award appeared on p4 of the September issue of AR.

ARRL Awards

Just in case there is any confusion: I am authorised by ARRL to certify applications for its Worked All States (WAS) award, but not its DXCC. For that, you have to send those precious cards to the USA.

I can, of course also supply application forms for the ARRL WAS. Please enclose a SASE if you need the form.

WIA And Other VK Awards

All being well, the information supplement in the next issue of AR will contain an updated reprint of the rules for all federal WIA awards, along with brief listings, addresses, etc, of all awards currently on offer from VK divisions, zones, clubs and special interest groups.

My thanks to all who responded to the

WIRELESS INSTITUTE OF AUSTRALIA 80th Anniversary Award 1910-1990

On March 11, 1910, wireless experimenters came together at the Hotel Australia, Sydney, in a spirit of friendship and common purpose. Their aim was to unite for the protection and advancement of their pursuit. The world's oldest radio society, the Wireless Institute of Australia, was thus founded.



This is to certify that
has submitted satisfactory evidence of having communi-
cated with the required number of WIA members in its 80th
year.

Dated Certificate No. President

questionnaires I sent out to gather the infor-
mation needed to complete this survey of the
VK award situation.

New Awards From Belgium, Linz

The Belgium amateur radio society is offer-

ing a new award for 144 contacts with stations
in the European Community.

Austrian amateurs are celebrating the
500th anniversary of the city of Linz, capital
of Upper Austria, with a new award certifi-
cate.

Copies of the rules for these two new awards
are available on receipt of a stamped self-
addressed envelope. Please write to my ad-
dress, rather than to the WIA office ar

RANDOM RADIATORS

RON COOK VK3AFW AND
RON FISHER VK3OM

Reasons Why

Some time back the Editor promised a new column on aerials. We had in fact agreed to compile a regular column, six times a year, about a month prior to the announcement, but it has taken us a little while to start.

The intention is to provide a forum where short notes on aerials and associated matters can be presented to you, the reader. We hope that you will have some contributions which we can use. Don't worry about providing a fully prepared article, some notes and a sketch will suffice, we will do the rest, with some help from the publications team. Of course if the drawings are of camera-ready quality, so much the better and the quicker the article will be published. We reserve the right to make comments on the article, particularly if by so doing readers with less experience may be helped.

Another source of input will be articles published in past issues of "AR" and in other journals which we think are worthy of being brought to the attention of members of the WIA. This month's column features such articles. Some original information may from time to time be presented by either or both of us, but we hope that it will not be necessary to do that very often.

Now to the technical side

In August 1987, Yardley Beers, W0JF, presented an article in "Ham Radio" titled "Designing Trap Antennas: a New Approach" in which he showed that there is another way to build trap antennas. The conventional method is to take a dipole at some frequency, fit traps (parallel LC circuits) resonant at this favoured frequency, and then add extra wire to resonate the system on a second lower frequency. This gives a dipole on the higher frequency, with the traps acting as insulators, and a loaded dipole on the lower frequency - two bands in one antenna. While this works very well there are some losses associated with the traps due to the high voltages and currents at resonance.

Yardley has a scheme where the traps are resonant at the geometric average of the two operating frequencies (the square root of the product of the two desired frequencies), thus the traps are never used on resonance and become impedance altering circuits rather than traps. A dipole for use on the 18 MHz and 25 MHz bands uses tuned circuits reso-

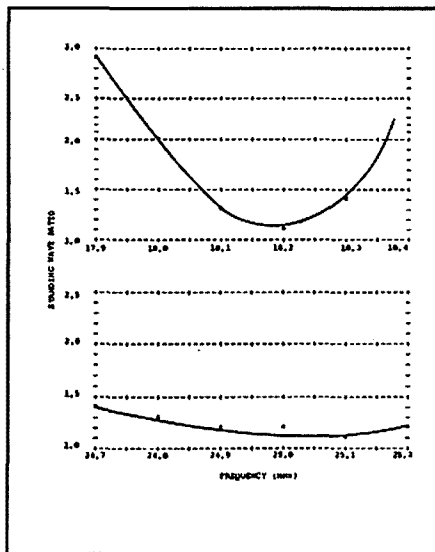

Fig 1 SWR vs. frequency for trapped dipole for use in 18.068-18.168 MHz and 24.890-24.990 MHz bands. The antenna is 20 feet, 10 inches long and has traps placed 15 feet, 2 inches apart, equidistant from the centre feedpoint. The traps use 50-pF capacitors and are self-resonant at 21.2 MHz.

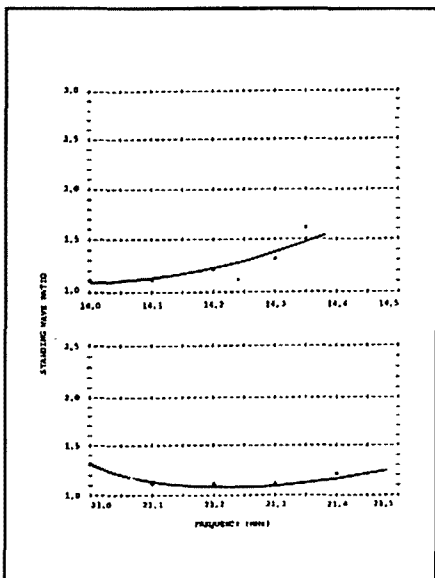

Fig 2 Standing wave ratio vs. frequency for a trapped dipole for use in the 14- and 21-MHz bands. The antenna is 24 feet, 7 inches long and has traps placed 14 feet, 5 inches apart, equidistant from the center. The traps use 50-pF capacitors and are self-resonant at 17.4 MHz.

nant at 21.2 MHz. See Fig. 1 for details of dimensions and the VSWR curves. The antenna is less than 21 feet long and is made of 14 swg wire. For 18 MHz operation the antenna is extended to a full electrical half-wave dipole by the inductance of the parallel tuned circuits and for 25 MHz operation the capacities of the circuit above resonance shortens the antenna electrically. On both bands there is current flowing in the whole of the wire and some gain results at the higher frequency. The traps are never used on their resonant frequency, whence it may be argued that their losses are reduced.

Of course they should no longer be called traps as they don't trap anything in this configuration.

Fig 2 gives details of a similar dual band dipole for 14 and 21 MHz. The design technique is reasonably complicated and requires the use of a programmable calculator or a computer and is iterative. For details the reader is referred to the original article.

Two other interesting antennas have been described in May 1988 issue of "Ham Radio". One is the "Carolina Window".

The Windom, invented by L G Windom, W8GZ, in the 1920s, is an antenna that enjoyed popularity as a multiband antenna world wide up until the mid 1950s in VK when the introduction of TV hastened its demise. As with many multiband antennas, it radiates harmonics very well and in those days many rigs had significant harmonic output in the VHF region. The Windom is basically an 80 metre dipole fed with a single wire, the idea being that the wire has an average impedance of around 500 ohms and that a tapping point could be found on the antenna where a resistance of about this value was seen on even harmonics of 3.6 MHz. For the higher frequencies and suburban lots the triband beam soon became more popular, but recently there has been interest in a simple wire antenna that could be used on all bands, even if some compromise was involved.

This version of the Windom, shown in Fig 3, is a flat top cut for 3.550 MHz and fed off-centre with a 4:1 balun and 50 ohm coax. It reputedly works well on 20 metres and should work quite well on 80 and 40 metres. Operation on other frequencies should be "useful" if it is erected horizontally, without bends and is reasonably well elevated. It will be necessary to use an ATU to get a low VSWR.

A VSWR above 1.3:1 is likely to reduce the output of a modern transceiver due to the action of the SWR protection circuitry. So while a VSWR of 2:1 is considered low in most circles, it is desirable to reduce it further for amateur equipment.

Further the use of a balun with VSWR exceeding 3:1 may cause other problems. It is recommended that if the Carolina Window exhibits a VSWR of about 3:1 or more on some frequencies, then operation should be avoided on these frequencies. Baluns are designed to

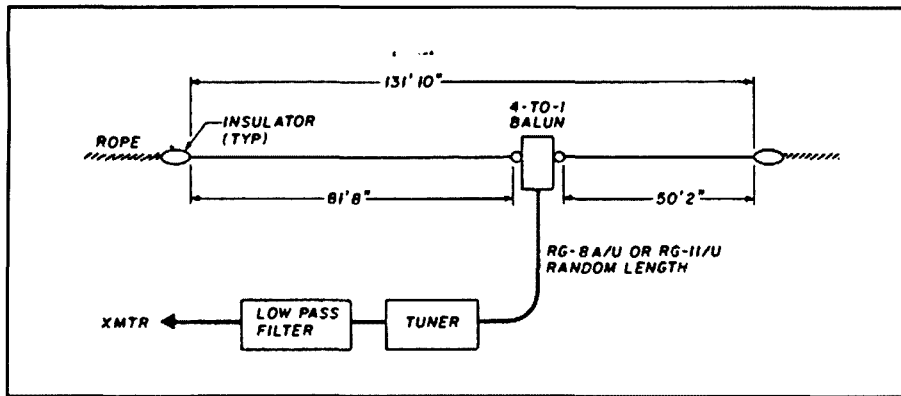

Fig 3 The "Carolina Windom" antenna works 80-10 with tuner. WA4LVB recommends that the antenna be 35 feet or higher above ground.

transform balanced loads to unbalanced loads with a defined ratio and specified loads. If the antenna impedance varies considerably from the design value, then the balun can no longer be expected to work efficiently. For example, a toroidal balun could produce harmonics of the rf signal if a high applied rf voltage causes the flux density to approach the core's saturation level. This could occur if the input power were too high or if the impedance mismatch were unfavourable. Baluns wound on rods are less likely to saturate due to the long air path and so are less prone to produce harmon-

ics, but they too have their limits.

The main advantage of this version seems to be that coaxial feed can be used and thereby the radiation is confined to the flat-top section, hence less rf in the shack and perhaps less chance of TVI. It's certainly worth trying if you want a simple, multiband, coax-fed antenna. For those with limited space up to about 10 metres (33 feet) of the far end from the feed point could be bent down at right angles. Bending the short end is not recommended.

The last aerial for presentation this month

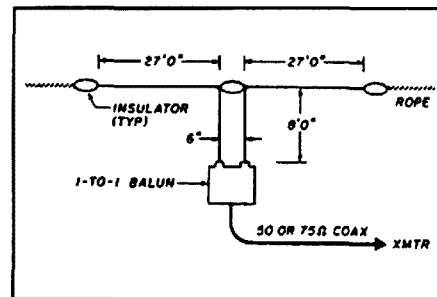

Fig 4 7- and 21- MHz colinear antenna

is a relative of the ubiquitous G5RV. Attributed to G3TKN, it is a 55 foot .long dipole with an 8 foot long matching stub to provide a shortened half wave dipole on 7 MHz and a 2 element collinear array with some 3dB gain on 21 MHz. Details are given in Fig 3.

Performance should be better than using a standard 40 metre dipole for multi-band operation because of the matching system.

Well that's it for this month. Next time we will present some aerial ideas from other journals. In the meantime if you have any suggestions or contributions to offer please send them c/o the Editor of AR. We are also prepared to try and answer any questions you have on aerial matters.

73 from me and 73 from him – the two
Rons ar

POUNDING BRASS

GILBERT GRIFFITH VK3CQ
7 CHURCH ST BRIGHT 3741

An established interest in Morse Code is part of being a Morsiac (I refuse to call us Morsepersons!), and I seem to collect a lot of literature and hardware with code associations. This comes in handy if I want to introduce a newcomer to the code, as I know where to point him for books, instruction or on-air practice. In the past few months I have been sent a complete cassette based course and a couple of books, and have read about two other methods of teaching code in overseas magazines. At present my 7 year old son is trying to learn his letters but his attention span is only about 10 minutes a day! My daughter who is 11, still remembers the first couple of groups she learned 2 years ago, so I hope to interest her in the complete WIA course in the near future, maybe over the winter. I will report on any findings asap.

Did anyone get hold of the paperback "The Longest Wire" by Hugh Atkinson which I mentioned in March 1989? I have since lent the book to two people interested in the code and they are showing increased interest after reading it. Anything that stimulates an interest in Morse code can be helpful in further-

ing its cause, and a small library related to the subject may even stimulate your own interest as well as your friends.

When I visited the Wagga convention in November 89 I met Stewart Day VK3ZDG, of Stewart Electronic Components in Melbourne. Not only did he have a couple of Bencher paddles on display, together with dozens of books and magazines, but he sold me one. Just what I've always wanted! You can now have a real Bencher paddle for \$132 (black) or \$162 (chrome) which I reckon is an excellent price for a top piece of equipment.

Stewart also gave me a book entitled "Morse Code-The Essential Language" by L Peter Carron Jr, W3DKV, and after reading it I have to say that this book is essential for Morsiacs. The first chapter, "Why The Code" gives all the reasons, and then some, that we use to encourage its use, as well as some examples such as recent rescues. Chapter 2 gives 22 pages of its history, and chapter 3 onwards give details of the code, how to learn, how to increase speed, hardware etc. Of interest to me, as I have seen so many, are the groups used in first learning the code. They are: E T A R, N D K C X Y, I S H V J B, W L

P U F ?, M O G Z Q, 1 2 3 4 5, 6 7 8 9 0 ERROR, and two more groups of punctuation and abbreviations. This seems a long way from EISH5 etc which was the one I used first.

If you are looking for a gift idea, or just something for yourself, at \$9.00 this book is a mini-bible for Morsiacs. And get this, there is a tear-out page in the back that asks for your comments and improvement ideas for future editions that you can send to the publishers (ARRL), what a good idea!

Gary Bold's (ZL1AN) column "The Morseman" in November's "Break In" had some interesting reading and featured some comments from Mel ZL2TFQ, which included the following two paragraphs.

"Without the benefit of recorded information, it would appear that I have been "stuck" at 10 to 12 wpm for two to three months, but a glance at the chart (Mel, an engineer, logged all his practice sessions) shows that though only slight, there has been an improvement.

If one makes an arbitrary threshold of, say, five percent error, that threshold has shifted from 12wpm to 18wpm, an improvement of no less than 50 percent! Perhaps if others were to note their efforts they would also show similar rates of improvement, which may help some of the depression that sets in on occasion."

Briefly, Mel's method is to copy up to "brain overload" speed and log the error rates per 100 words on a graph. The results show the

improvement, which probably comes about by **trying** to copy the higher speeds in the first place, rather than telling oneself constantly that one is "stuck".

Gary also mentioned the Samson electronic keyers which come from Frank G5BM (QTHR). Top of the range is the ETM-8C which I reviewed in AR in July 1986. If they are still

available in Australia I will let you know (or the importers might let me know). Mine is still going well, and on the original set of batteries too! Despite the modifications I have made which include a jack socket for an external paddle, and a switch to change the "sense" of the paddles, ie the dots on the right paddle and dashes on the left for left-handed opera-

tion from the inbuilt paddles, while normal sense is used for the external paddles for the right hand.

John Day of Stewart Electronic Components assures me that they have Benchers and books in stock, so check out their advert elsewhere in the magazine for the address.

ar

AMSAT

MAURIE HOOPER VK5EA
11 RICHLAND ROAD NEWTON 5074

National Coordinator
 Graham Ratcliff VK5AGR

Information Nets
 AMSAT Australia
 Control: VK5AGR
 Amateur Check In: 0945 UTC Sunday
 Bulletin Commeces: 1000 UTC
 Primary Frequency: 3.685 MHz
 Secondary Frequency: 7.064 MHz

AMSAT SW Pacific
 2200 UTC Saturday, 14.282 MHz
 Participating stations and listeners are able to obtain basic orbital data including Keplerian elements from the AMSAT Australia net.

This information is also included on some WIA Divisional Broadcasts.

AMSAT Australia Newsletter And Computer Software

The excellent AMSAT Australia Newsletter is published monthly by Graham VK5AGR on behalf of AMSAT Australia and now has about 270 subscribers. Should you also wish to subscribe, send a cheque for \$20 payable to AMSAT Australia addressed as follows:

AMSAT Australia, GPO Box 2141, Adelaide 5001.

The Newsletter provides the latest news items on all satellite activities and is a "must" for all those seriously interested in amateur satellites. Graham also provides a Software Service in respect to general satellite programs made available to him from various sources. To make use of this service, send Graham a blank formatted disk and a nominal donation of \$10 per item to AMSAT Australia together with sufficient funds to cover return postage. To obtain details of the programs available and other AMSAT Australia services send a SASE to Graham.

Stop Press — New Satellite Software Release For IBM & Compatibles

Graham has advised of the release of InstantTrack V1.00 by AMSAT-Australia for a \$30 donation plus disks and return postage. The program requires two 360K disks or one 720K 3 1/2" disk or one 1.2M 5 1/4" disk. (It is being distributed in the US for US\$50 which includes the disk and postage within the US!) The following summarizes some of the excellent features offered by this program.

InstantTrack V1.00

Copyright (c) Franklin Antonio, 1989

Introduction...

(from the software document)

InstantTrack was designed to assist amateur radio operators who need to track a large number of earth-orbiting satellites, point antennas at them in real time, estimate when communications links will be possible with operators in other parts of the world, etc. InstantTrack has several features that make it unique among satellite tracking programs, and a few features which, while not unique, are relatively uncommon among low cost satellite tracking programs. Some of these are:

Speed — InstantTrack is faster than any other tracking program. Humans should never wait for computers.

Ease of use — Most commands are a single keystroke. Usually tedious functions are fully automated.

Automated orbital element entry — In-

AMSAT-OSCAR-13 Satellite Schedule
 Station: Adelaide

	0	1	2	3	4	5	6	7	8	9	10	11	12	13	14	15	16	17	18	19	20	21	22	23	
01Jan90	BBL							bb																	
02Jan90	LL						b																		
03Jan90																									
04Jan90																									
05Jan90																									
06Jan90																									
07Jan90																									
08Jan90																									
09Jan90																									
10Jan90																									
11Jan90																									
12Jan90																									
13Jan90																									
14Jan90																									
15Jan90																									
16Jan90																									
17Jan90																									
18Jan90																									
19Jan90																									
20Jan90																									
21Jan90																									
22Jan90																									
23Jan90																									
24Jan90																									
25Jan90																									
26Jan90																									
27Jan90																									
28Jan90																									
29Jan90																									
30Jan90																									
31Jan90																									
01Feb90																									
02Feb90																									
03Feb90																									
04Feb90																									
05Feb90																									
06Feb90																									
07Feb90																									
08Feb90																									
09Feb90																									
10Feb90																									
11Feb90																									
12Feb90																									
13Feb90																									
14Feb90																									
15Feb90																									
16Feb90																									
17Feb90																									
18Feb90																									
19Feb90																									

LEGEND: Lower case - omni antenna "o" transponder off "-" below horizon

stantTrack reads the popular NASA and AMSAT format satellite element files and updates its database automatically. You need never again manually enter dozens of 10 digit numbers.

Automated time setting — InstantTrack automatically sets time on your computer by accessing the NBS time service via your modem.

Instant Visibility — InstantTrack shows you the positions of your "favourite" satellites, even before you issue the first keystroke. The menu of 200 satellites shows you which are visible from your location even before you select a satellite. The menu of 1754 cities shows you which cities are visible from the selected sat.

Graphics — InstantTrack displays full color high resolution (EGA/VGA) maps of the Earth, showing satellite and observers position, two kinds of satellite footprint, grayline, etc (Map projection is selectable.) Users can also select either a diagram of the satellite's orbit showing orientation of the satellite, or a map of the sky, showing the satellite's position against the stars. You can move from map to map or satellite to satellite with a single keystroke, instantly.

Large No of Sats & Stations — InstantTrack supports a database of 200 satellites and 50 observer locations. A unique grouping feature allows you to categorize satellites, and perform most operations on either a selected group, or the entire database.

City Database — InstantTrack includes a database of 1754 cities worldwide. Locations of the satellite (sub-satellite points) and observers are displayed relative to the nearest city! Observing stations can be specified by entering as little as their city name!

Satellite Covisibility — InstantTrack shows you when satellites can see other satellites (ie when crosslinks are possible), when satellites are in eclipse (in the shadow of the earth), etc. This display, of course, updates in real-time, so you can see crosslinks appear and disappear.

Satellite Offpointing — (sometimes called Squint Angle) InstantTrack computes the angle by which the satellite's antennas are pointed away from you. Helps you understand why quality of communications via satellites such as Oscar-10 and Oscar-13 (spin-stabilized satellites with directional antennas) varies.

InstantTrack's graphics show you where a satellite's antennas are pointing. Maps display a contour line of squint angle. Stations within this line have low squint, and can establish the best links via such satellites.

Path Loss — InstantTrack shows the path loss between your station and the satellite in realtime.

Schedules — InstantTrack can show you the next three weeks schedule for a satellite, or one day's schedule for 20 satellites on one screen.

Realtime Rotor Control — InstantTrack supports realtime antenna rotor control via the Kansas-City-Tracker interface.

Background Mode — A unique background mode allows you to track satellites & point antennas in real-time while you run other programs.

Sun & Moon — InstantTrack tracks the Sun & Moon as well.

Tracking Multiple Stations — You can see the computed parameters (azimuth, elevation, squint, etc) both from your perspective and from the perspective of the station at the other end of the satellite link.

Documentation — Extensive and Tutorial.

Online Help — InstantTrack contains an online help facility.

Required Hardware
Any IBMPC, or AT, PS2, clone, etc with at least 512k memory. Any display type is ok for the text mode screens. Maps presently require EGA or VGA display. I'm not particularly fond of the ancient CGA boards; If you have one of those, beware that I have taken no steps to avoid "CGA snow". A numeric coprocessor (8087 or 80287) is NOT required, but it is recommended. InstantTrack isn't really Instant without a coprocessor, but it will still probably be faster at most things than any other tracking program. A mouse is NOT required, but can be used on the map screens. Due to the large file sizes involved, a hard disk is strongly advised.

OSCAR 13 News

The satellite has undergone an attitude change, and the following schedule and magnetorquing information have been supplied by Graham VK5AGR.

M de VK5AGR 20 Nov 89 **
New AO-13 Transponder Schedule**
Mode-B: MA 000 to MA 110
Mode-JL: MA 110 to MA 145
OFF: MA 145 to MA 146
(with only General Beacon ON)
S-Beacon: MA 146 to MA 147
Mode-S: MA 147 to MA 150
NB 2m and 70cm omni antennas will be in operation from MA 225 to MA 35.
Mode-SB: MA 150 to MA 160
Mode-B: MA 160 to MA 255

N QST de G3RUH 1989 Nov 21 @ 1745 utc
Magnetorquing Finished
Peri Sun Earth Sens Alon Alat Spin
1 1090/1 30 1091/34/28 200 -6 —
2 1091/2 32 1092/30/25 194 -5 —
3 1092/3 32 1093/28/23 189.0 -2.7 —
4 1094/5 32 1095/25/21 183.5 -1.1 28.34
5 1096/7 29 1096/23/20 179.3 +1.6 28.63
6 1098/9 26 1099/23/19 178.8 +3.8 29.39
Final attitude estimated as below. Rates of

change Alon +0.016 deg/day. Alat -0.094 deg/day.

Good DX! 73 GRR/JRM

Solar Eclipses

From James Miller G3RUH
L de G3RUH Nov 16 102utc—* Solar eclipses over *—

The next series of eclipses of the Sun by Earth lasts 3 weeks, from 1990 Feb 27 [Tue] — 1990 Mar 21 [Wed]. Longest 90 minutes on Mar 10, orbit 1329, MA 34-67. There is an annular eclipse of the sun by the Moon on 1990 Jan 26 [Fri] orbit 1240, MA 25-34 lasting 26 minutes reaching a maximum obscuration of 85%. Satellite visible from Australia and the Pacific.

Fuji OSCAR-12

(JAS-1) Has Been Shut Down

The Japanese Amateur Radio League announced on November 1st, 1989 that FO-12 would be shut down, and that its "brother" JAS-1b would be launched in February 1990. JAS-1/Fuji-OSCAR 12 has operated for 3 years. Power generation had decreased with time to an average value of less than 3 watts, which was not enough to meet even the minimum power requirement. Therefore, after deliberation, JARL decided that the operation of FO-12 should be terminated on 5 Nov 1989. FO-12 will be succeeded by JAS-1b in February 1990. JAS-1b will be equipped with Gallium Arsenide solar cells to boost the power budget.

From HR AMSAT New Service Bulletin 322.01 from AMSAT HQ

Microsat/Uosat Launch Date Is Advanced!

Now Set For January 9, 1990

In what is considered a surprise announcement, Arianspace officials have informed AMSAT-NA and University of Surrey this week that the launch date of the MICROSATs and the UOSAT D/E satellites has been **ADVANCED 10 DAYS!** The launch date is now planned for January 9, 1990. This change in the launch date is the direct result of the postponement of the previous mission, designated by Arianspace as V35A, and was planned to lift-off on Dec 13th. It appears that the problem with the V35A mission is caused by one of the primary payloads, known as "SUPERBIRD B," which is having technical problems and will not be ready for launch on Dec 13th. So Arianspace officials have decided to use this extra time to prepare for the

next ARIANE flight, known as the V36A mission; they feel that moving the MICRO-SAT/UOSAT launch date ahead ten days is feasible. Since the MICROSATs and UOSAT D & E, along with the primary payload SPOT-2, are ready to fly, the launch campaign will now begin on November 27th. That is the day in which the payload integration teams from AMSAT and the University of Surrey, along with their satellites, will arrive in Kourou, French Guyana. By Dec 20th all of the payloads will be fully integrated aboard the ARIANE IV rocket and the teams will then return home on December 23rd. After a short Christmas break, the final AMSAT/UOSAT teams will then travel back to Kourou and will stay there and monitor their respective satellites until the launch on January 9th.

DXpeditions Using OSCAR 10 And 13

The Legion of Indianapolis DXers of Indianapolis, Indiana will conduct a DXpedition to Bouvet Island (the second rarest radio country on the amateur bands and has not been activated for at least 10 years) in the first two weeks of February 1990 using the callsign 3Y0B. They will operate on all bands including OSCAR-10 and OSCAR-13. The operator at Bouvet Island will be Chip Margelli K7JA who was the operator during the 4J1FS operation. Operation is planned from Bouvet Island from February 1st to February 14th 1990. On OSCAR-10 & OSCAR-13 Chip as 3Y0B will downlink on 145.900 and listen on the same frequency. QSL information via WA9VGY.

Also a DXpedition is planned by CE3BFZ and KL7GRF to Juan Fernandez Island which is 600 miles northwest of Santiago, Chile callsign CE0Z suffix unknown until callsigns are assigned in about one week. Operation will be on HF, 6m, OSCAR-10 and OSCAR-13 during period April 4th to April 11th 1990. On OSCAR-10 and OSCAR-13 John KL7GRF will downlink on 145.890 and will listen on 145.895 to 145.905 QSL OSCAR and 6m contacts to VE6LQ. The QSL manager for HF contacts will be announced later.

73s from Maurie VK5EA

ar

**When you buy
something from one
of our advertisers,
tell them you read about
it in the
WIA Amateur Radio
magazine.**

Satellite Activity For August/September 1989

1 Launches

The following launching announcements have been received:-

Int'l Number	Satellite	Date	Nation	Period min	Apog km	Perig km	Inc deg
1989 -							
067A	BSB-R1	Aug 27	UK	1435.8	35787	35777	0.15
068A	COSMOS 2037	Aug 28	USSR	116.1	1537	1503	73.6
069A	USA 43	Sep 04	USA				
069B	USA 44	Sep 04	USA				
070A	GMS 41	Sep 05	Japan	663.0	37397	197	28.7
071A	SOYUZ TM-8	Sep 05	USSR				
072A	USA 45	Sep 06	USA				
073A	RESURS-F5	Sep 06	USSR	88.7	261	189	82.3
074A	COSMOS 2038						
	through	Sep 14	USSR	114.0	1435	1394	82.6
074F	COSMOS 2043						
075A	COSMOS 2044	Sep 15	USSR	89.3	294	216	82.3
076A	COSMOS 2045	Sep 22	USSR	89.6	322	216	70.1

2 Returns

During the period seventy one objects decayed including the following satellites:-

1989-024A	COSMOS 2007	Sep 22
1989-056A	COSMOS 2031	Sep 15
1989-063A	RESURS-F 4	Sep 14
1989-065A	COSMOS 2036	Sep 05
1989-073A	RESURS-F 5	Sep 22

3 Notes

1989-067A

BSB-R1 is a UK direct broadcasting satellite known as "MARCOPOLO 1".

1989-070A

GMS 4 is a Japanese geostationary Meteorological satellite. It has transmitters on the following frequencies:- (MHz)

468.875 468.883 468.924

1681.6 1684.0 1687.1 1688.2 1690.2 1691.0

1694.0 1694.3 1694.7

2280.72

1989-071A

SOYUZ TM-8 docked with orbiting space complex MIR on September 7, 1989.

1989-073A

RESURS-F 5 was launched using the SOYUZ launch vehicle. It carried multispectral photographic equipment and West German biotechnological low gravity experiments.

1989-075A

COSMOS 2044 carried two monkeys and other biological subjects for gravity and radiation studies.

BOB ARNOLD VK3ZBB

Amateur Radio In Thailand

There should be plenty of activity from Thailand on the HF bands soon with lots of stations using the HS prefix. As previously reported in AR magazine, Thai authorities in 1989 gave the go ahead for amateur radio in that country. The Post and Telegraph Department of Thailand has given thousands of prospective radio amateurs application forms for a soon-to-be-held novice licence exam.

A number had already taken the exam for an intermediate licence, and after they pass an 8 wpm morse test in English will be allowed on the HF bands. This will make the first time that Thai nationals have been legally permitted to use HF. The WIA is approaching DOTC to seek a reciprocal licensing agreement between Australia and Thailand.

JIM LINTON VK3PC

ar

SPOTLIGHT ON SWLING

ROBIN L HARWOOD VK7RH

52 CONNAUGHT CRESCENT WEST LAUNCESTON 7250

Welcome to 1990 and I do hope that you have good propagation throughout the year. By now, we should have come to the peak of current Solar Cycle and the daily flux should slowly decline. The geomagnetic disturbances should also decline, as it has been my experience that these are more noticeable on the upswing of the cycle.

There have been some alterations to DX programmes for enthusiasts. As I did mention in last month's column, Radio Australia made alterations to their English language output, concentrating on their Asian and Pacific audiences. This means that there has been a re-arrangement of programme releases. "Communicator" will now be heard on Sundays at 1400 to Asia, 0730 on Mondays to the Pacific and at 1030 on Fridays to Asia. The daily propagation reports have also been deleted, since Mike Bird's resignation from RA, although I have heard him continue giving the weekly summary on propagation conditions on Radio Netherland's "Media Network".

HCJB's popular "DX Partyline" is now heard on Mondays at 0800 repeated at 1030. Because of Brend Aldred's other programming commitments, it was decided that the

Saturday release should be dropped. On Wednesdays at the same times, "Ham Radio Horizons" hosted by John Beck is heard. The best frequencies for HCJB are still reliable 6130 and 9745 yet 11925 can be patchy.

The World Service of the "Christian Science Monitor" has re-opened their Saipan relay with a new callsign KHBI. The station has changed their format to be identical with the rest of the CSM output, instead of the pop music base that was on KYOI. KHBI is heard here excellently on 17855 kHz from 0800 till 1000 in English.

Yet another American religious broadcaster has come on the air. WWCR — World Wide Christian Revival, based in Nashville, Tennessee has been logged here on the non-allocated frequency of 15690 kHz between 2000 and 0200 with religious programming at good levels. This station reinforces the trend for religious broadcasters to obtain HF broadcasting licenses. KUSW in Salt Lake, Utah on 15585 started out as a commercial operation, but was taken over or leased by an American religious organization who also lease facilities in Equatorial Guinea (Africa). Commercial radio on shortwave has been a failure, the

only one left is WRNO in New Orleans and that is also heavily dependent on religious sponsorship on Sundays to stay afloat financially.

In mid-November, I was somewhat surprised to receive a copy of the International Listening Guide, as were many other SWLs and DXers. The ILG had not been seen for 12 months prior to this, and the publisher claims that he has now ironed out the bugs, yet most of us who have been subscribing to it, will be reserving their judgement by the performance of the publisher to get the ILG out on time. This year I may subscribe to the WRTH "Downlink" which is to be a supplement to the 1990 World Radio Handbook.

The Red Cross Broadcasting Service in Geneva advises me that the next broadcast to Australasia will be on Monday January 1st from 0740 till 0757 on 13685 kHz, repeated on Thursday January 4th at the same time and frequency. Also on Monday January 29th and Thursday February 1st, there will be another programme in English. These will be at the same time and frequency. Back-up frequencies for the 0740 releases are 17670 and 21695 kHz, which are the normal Swiss Radio International Frequencies.

Well, that is all for the first column in 1990, so don't forget if you do have any news or comments, please feel free to drop me a line to the QTHR at the head of this column. Until next time, the very best of listening and 73.

ar

ALARA

JOY COLLIS VK2EBX

PO Box 22 YEOVAL 2868

about "Radio Waves and Amateur Radio".

Several members celebrated long periods as amateur radio operators, notably Mavis VK3KS who notched up 50 years, and Clarrie VK3UE and Joyce VK2MI, 40 years of amateur radio.

1989 was the year we lost our oldest member, Liz W3CDQ, 90 years of age. We were also saddened by the loss of Joan VK3NLO. On a brighter note, it was also the year we "enrolled" our youngest member — Kathy, (daughter of Chris ZL2BQW), seven years old.

The highlight of the year for me was a trip to Canada and England in April, and meeting Canadian ALARA members, and members of the Yeovil (Somerset) ARC.

Well — 1989 is behind us. Now to see what we can do with the infant 1990!

ALARA Contest

The eighth ALARA Contest once again had to compete with other contests on 11th November, 1989. However some very good scores were achieved, and it proved to be a very enjoyable event for all who participated.

Unfortunately the gremlins again played havoc with my INTENDED "contesting," as this area experienced stormy conditions for most of the day, necessitating closing down of operations at frequent intervals. This was

AMATEUR RADIO, January 1990 — Page 51

The Year That Was!

Before settling into the routine of writing 1990 instead of 1989 on everything, perhaps we will have a brief resume of last years activities:

It was an important year for at least two DX YL organizations:

YLRL held their 50th Anniversary, celebrated with a Convention in Hawaii in June, and the issue of a special Award to mark the occasion.

BYLARA celebrated their 10th Anniversary, the main function being a Rally at Drayton Manor.

New YL awards included the launching of the WARO Mountain Buttercup Award.

There was YL activity from many rare and unexpected locations, notably Kirsti VK9NL and Laila WA4ZEL from Svalbard (JW) in June; Alice N4DDK, Audrey N7HAT, Mary KA0MX and Mary Lou NM7N from Wallis Island (FW) in July, and Doreen EL2DK,

Liberia. Iris Colvin operated from many USSR localities, and later from a number of rare African countries. Florence F6FYP operated CN2YL in October, and there was also YL activity from Turkey (TA2YA) Iraq (YIIBGD) and the Virgin Islands (KP2). It all makes YL-DXCC a lot easier to attain.

ALARA made contributions to amateur radio in 1989 through involvement with JOTA, WICEN, clubs, schools, etc. Cathy VK3XBA became Federal Treasurer of the WIA; Meg VK5AOV Secretary of the Adelaide Hills Amateur Radio Society and Coral VK8NCH President of the Darwin Amateur Radio Club.

ALARA members participated in many other activities during the year, including running the refreshment stall at the Adelaide Hills Amateur Radio Club annual "Buy and Sell" (VK5 members), being represented at the Sydney Games and Hobbies Expo, assisting with the organisation of Amateur Radio Club activities and welcoming travelling DX YLs (and accompanying OMs) into their homes. My "extra-ordinary" activity was a talk to Year Nine students at the local school



VK8NCH Coral



DL2HBM Marga Bergman

With improving propagation on 10 metres there is renewed interest once again in the International Ten-Ten Club, which issues some very beautiful awards. Many ALARA members are also members of this organisation.

Congratulations to Sue VK5AYL on becoming a very youthful grandmother. At the time of writing she only has 2 metre gear, but hopes to be able to get on the HF bands at a later date.

During the ALARA Contest Bev VK6DE worked 40 ALARA members in eight different countries, which must be something of a record! As Bev remarked, "I didn't get much sleep."

Another sleepless member was Aimee FK8FA, who kept going for much of the allotted 24 hours.

Please note: During daylight saving time the official ALARA Net on Monday evenings is held at 1000 UTC.

Errata from December column:
Mary Ketzler's callsign is KA00MX — not KA00MH.

Alarameet

In september this year the third ALARA get-together will be held in Dubbo, NSW. Plans for this event are well in hand, and we hope to make it the best ever.

Bookings and enquiries to Maria VK5BMT.

New Members

Only one new member this time around. Welcome to Daphne VK4IA.

May 1990 be a very happy and prosperous year for all.

CLUB CORNER

Coffs Harbour and District ARC

JOHN WILLIAMS VK2BUI

Amateur Radio Goes to the People

It was Arnold VK2ADA's idea - he felt that Amateur Radio needed publicity, and the Club of which he was President agreed. It was to be a public relations exercise a little different from most, in that Club members would man a working display of various Amateur Activities, in a public shopping centre; no preaching to the converted for these fellows!

The Coffs Harbour and District Amateur Radio Club is a small group of around twenty-five. It was formed ten years ago, and some of the original members are still actively involved. You've probably met some of them at one of the famous Urunga Field days - Urunga is only a short distance south of Coffs.

The display was to be open Saturday, so on the Friday afternoon, four members spent some time setting up antennas on the nine acre roof of the Park Beach Plaza Shopping Centre, about five kilometres north of Coffs, and one of the biggest Regional Shopping Centres in Australia. It was a great ground plane for the 18AVT Trap Vertical - no radials needed, and the antenna mounted easily on a huge metal department store sign, along with a Slim Jim for 2M Packet Radio via the Club's repeater VK2RCH. Cables were snaked through a ventilator and left ready for connection to the gear next day.

Saturday, 7am, saw the really keen ones roll up with various bits of gear in tow - a complete VHF Packet set-up, two HF Transceivers, some equipment for showing videotapes of ATV programmes, and just so that the public wouldn't think it was all black boxes, some examples of home brew. Of course, 2M gear was available to demonstrate communication both on simplex and through the Club's voice repeater VK2RCH.

The shopping centre was to be open until 4pm, so the crew settled in and began the task of promoting Amateur Radio to the public. Some people stopped and stared, others came over for a closer look, while a few asked tricky technical questions. Some even completely ignored the impressive display, and went on their way, oblivious to the loss of not having seen the Coffs crew in action!

Club members rolled in at various times through the day, and thus the task of manning the display was made easier for everyone. Some of the faces seen included, Dick VK2RM, Bob VK2AWA, John VK2BUI, Ken VK2DGT, Brian VK2DLM, Merv VK2DMS, John VK2GJK, Emil VK2NEH, Steve VK2YSM.

Packing up the gear and dismantling the



VK5NEI Janet Bulling

disappointing, but on the credit side it was good to catch up with many members I do not often hear on air, and especially some of the DX members.

We would like to thank the OMs who joined us. Your participation was very much appreciated.

We hope to have the results in time for next months Amateur Radio.

Bits And Pieces

Poppy VK6YF had a busy time in October assisting with the organisation of several amateur radio displays, and doing some useful public relations work.

antennas took hardly any effort at all - keeping it simple had made the day.

The consensus was, that as the public in-

terest had been aroused, and we had some fun at the same time, perhaps we should give serious consideration to doing it again, next year!

ties on the Ham Calendar. Don't miss out on it in 1990, it is sure to be bigger and better.

Overall winner of events was Paul VK3DIP. Runner up was Alex VK3BQN. Home Brew Competition Winner was Moss VK7IP with an excellent 1296 2C39 Linear Amp. Home-Brew Antenna Competition Winner for best performing 144 MHz antenna was Charlie VK3BRZ, while the best 70 cm antenna was produced by Paul VK3DIP.

Raffle Winner	\$100 Petrol	Ross VK3CBL
2nd Prize	-	Cliff VK3CCB
Door Prize	-	Bob VK3BNC

The Ballarat Amateur Radio Group would like to thank the many firms and smaller traders for setting up stalls on the day. Thanks also to all those who attended and made it our Best Ever Hamvention. The club would like to hear of any ideas that may improve it in any way.

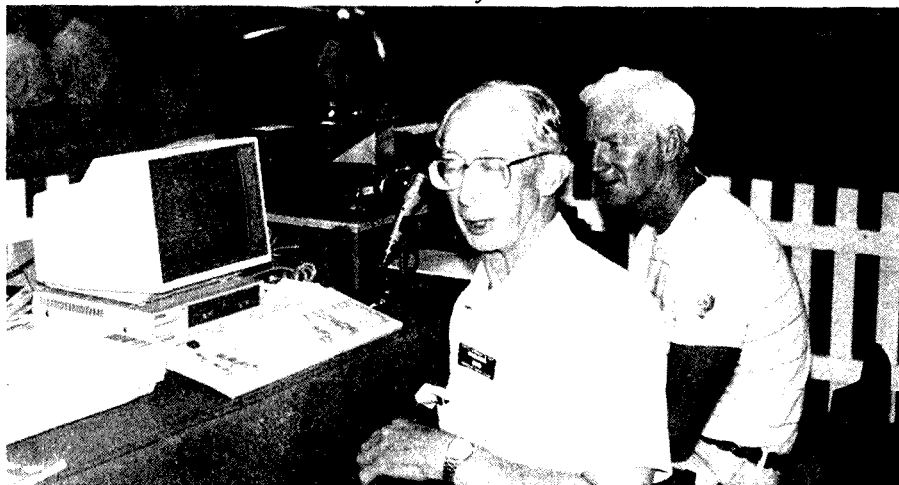

Bob VK2AWA caught in an expressive moment while explaining the intricacies of Packet Radio. Brian VK2DLM looks on intently!



HF, Packet, ATV on display at the shopping centre.



Ballarat Hamvention 1989. L to R Paul McMahon VK3DIP, Andy Squires VK3DTP, George Fowler VK3DOK.

Report On Ballarat Hamvention

KEVIN HUGHES VK3WN

On Sunday 29th October 1989 the Ballarat Amateur Radio Group held its annual Hamvention at Sebastopol, 7 kms south of Ballarat. Over 300 amateurs and their families attended. Forty trading tables were in full swing with the latest in ham gear, as well as preloved equipment. Most visitors went home with cars full, after seeking out the bargains.

Visitors from VK 2, 3, 5, 7, 9 were present. A delightful barbecue lunch was served along with fruit salad and cream. Free coffee and drinks were on tap all day. The catering was carried out by the Ballarat Amateur Radio Group Ladies.

The Ballarat Hamvention is now well established as one of the most enjoyable activi-



Ballarat Amateur Radio Group member Jeff Pigdon with a group of Scouts from 1st Woody Yallock Scout Group at JOTA 1989.

QSLs FROM WIA COLLECTION (20)

KEN MATCHETT VK3TL HON CURATOR WIA QSL COLLECTION
PO Box 1 SEVILLE VIC 3191

Italian Somaliland

As mentioned in last month's article, present-day Somalia was formed from the former British colony of British Somaliland and Italian Somaliland. It is a Muslim country which has been designated by the UN as a "Least Developed Country". Even since gaining independence in July 1960, the country has been plagued by political unrest and army revolts. Starting off as a Parliamentary Democracy (which lasted until 1969), the country has become a Republic under military leadership. The country's main economy is livestock-rearing, but it has a long history as an Arab trading post exporting supplies of frankincense and myrrh to Saudi Arabia and other Middle East countries.

The former colony of Italian Somaliland (also referred to as "Somalia") lay to the east with its shore line bordering the Indian Ocean. To the north it extended to the "Horn of Africa". The colony had its origins in 1889 when the Sultan of Zanzibar sold his ruling rights over the territory to Italy. Thus the Italians became interested in Somalia quite late, compared with their English counterparts. It was the Horn of Africa (the most north-easterly part of the continent) that was the only area not then claimed by either the English or the French (The latter power had established trading posts in what is present day Djibouti, just to the west of Somali). Widely felt changes in colonial administration resulted from the fascist regime of Mussolini, who came to power in 1922. After Italy's defeat in East Africa (in 1941), the military administration continued to depend greatly upon the Italian civilian population in the colony to operate public services. Although administered by the British, Somalia remained an Italian possession in all but name, but this ended when allied leaders at the Potsdam Conference in 1945 agreed that former Italian colonies would not be returned to Italy at the end of the war.

MS4A

This QSL, dated May 1949, resulted from a QSO by Ted Jenkins, VK3QK (SK) who was licensed in 1937. Bearing the uncommon prefix MS4, it was used for a short time after World War 2 by Italian stations in Somaliland. The MS4 prefix was used concurrently with the British occupation forces prefix of MD4 and was sometimes listed together with that prefix in DXCC country lists. It was gradually replaced by I5 call-signs.

I5AAW

Nowadays one associates the prefix I5 with stations in the Tuscany region of Italy, but it was used in the 1950s, by stations in Italian Somaliland. The letter I was amongst the earliest prefix assignments made and was given to Italy together with its colonies. Despite this, we find no listing of the actual I prefix for Italian pre-war external territories, although the country of Italian Somaliland itself is listed. It was, (and still is) ARRL policy to refrain from identifying "new countries" with prefixes until the official prefix allocation by government has been made. Thus the country was listed without an accompanying prefix. A trusteeship was gained by Italy over its former colony in 1949, but it is interesting to note that before this date the former Italian colony was still identified as "Italian Somaliland" in early post-war DXCC listings, despite the fact that Italian colonial rule had come to an end long before. After the granting of the trusteeship to Italy, the country was again referred to as "Italian Somaliland" and the I5 prefix was then used, the first of such prefixes being issues in the early 1950s. The I5AAW QSL (dated Jan 1956) shown here was from an Italian national, Carlo Bortoloni. On the reverse side of the card, Carlo states that he was the wireless technician for the Italian Oil Co at Bender Belia, 600 miles north-east of the capital city of Mogadisco. It was a QSL resulting from an Australian SWS report by the late Eric Trebilcock, BERS-195, one of the best-known short-wave listeners in the world of amateur radio.

Thanks

The Wireless Institute of Australia would like to express its thanks to the following for their contribution of QSL cards towards the Collection :

(Supplementary List)
Bill VK4LC (ex VK3AHO)
Frank VK2QL
Tom VK6MK
Barry VK5BS
Ray VK3RF
Doug VK4UG
Bill VK4UB (ex VK9WD)
Stan VK3UE (VK4LF)
Chinese Radio Sports Assoc. (BY4AA)

Also to the friends and families of the following "silent keys" (Supplementary List)

Eric Thomas VK3ZL
Cardwell (Cardy) McQuillan VK3ACD

DX QSL Contributors' Ladder

(See "AR" March 1989)

Herewith a list of contributors together with special QSLs that have kindly been donated to the WIA Collection (Supplementary List):

Barry VK5BS Prefixes: S88, 3X1, RZØ, UG5, P4Ø
Ray VK3RF Prefixes: JY4, 9i15, W2Ø, HT7, JWI, P43, 9ZY, 6J5 (Revilla Gigedo) 9H5Ø, UK4, RZ1, Special Calls : YTØEXY, J73A
Frank VK2QL Prefixes: DL5Ø, JAIBRK/JB8 (Torishima), XU9, Special Calls : DUØPAR, HM9A/P

As mentioned in last month's notes, a new Contributors' ladder has now been formed. The winner of the 1989 competition was Robin VK6LK from Margaret River in Western Australia and one of our top DX-ers. More to say about this in a future issue of "Amateur Radio".

The 1990 DX QSL Contributors' Ladder:

Ray VK3RF 24 points
Barry VK5BS 12 points
Frank VK2QL 8 points

Everybody starts from scratch again, but the task of adding to the WIA collection of prefixes and especially allocated call-signs is becoming increasingly difficult (even for our best DX-ers) but why not give it a go? Please write for a "Wanted Prefixes" list.

Thanks to all contributors. Keep up the good work. If you would like to play a part in building up the WIA QSL collection and to save something for the future, would you please send a half dozen (more if you can spare them) QSLs which you feel would really help the collection along. All cards are appreciated, but we especially need commemorative QSLs, special event stations QSLs, specially assigned QSLs (eg VK4RAN) pre-war QSLs, unusual prefixes, rare DX and pictorial QSLs of not so common countries. Could you help? Send to PO Box 1, Seville 3139, or phone (059) 643 721 for card pick-up or consignment arrangements for larger quantities of cards.

Thanks

ar

EDUCATION NOTES

BRENDA EDMONDS VK3KT
PO Box 565 Mt WAVERLEY 3149

As described in another part of this issue, the devolvement procedures are now almost completed. The February exam will be in the traditional form, with the Regulations based on the old Handbook, but after February the only examinations to be conducted by DOTC will be those for "special cases" where a candidate is unable for medical reasons to attempt a normal exam.

There are now over forty names on the circulation list for devolvement materials. Each of those by now should have received the three Questions Banks, the Morse code generating computer disc, the "procedures" manual and the computer program for generating exam papers from each bank. This represents not only a considerable amount of effort by the Examinations Officer (practically single-handed) but also a significant cost which the DOTC has borne. It is to be expected that in the future some degree of cost recovery may have to be imposed.

At the Executive meeting in November, it was resolved that, on completion of the de-

volvement organisation, the WIA should recognise the effort and efficiency of the Examinations Officer in an appropriate manner. He is to be congratulated on both the care and attention given to the job and on the manner in which he kept all interested parties informed during the process. He seems also to have stimulated renewed interest where enthusiasm for devolvement had been flagging when the machinery was moving so slowly.

The organisation is now sufficiently advanced for intending examiners to start submitting papers for accreditation. The procedures have been discussed previously. It is recommended that at first the papers be taken wholly from the question banks, as that will speed the process and allow better comparison or papers. There will inevitably be some hitches and hiccups in the early stages, but at present all seems to be going smoothly.

I have previously asked for input from those running classes or intending to arrange exams. I would now like to set up an informal committee, with representation from all Divi-

sions, to monitor the new system, to provide exam facilities for those who may not have easy access to them, to extend and review the question banks and to collect, collate and circulate as much information as possible.

A trial period of one to two years is probably needed for us to be able to identify any questions which should be deleted, and to build all the banks to a satisfactory size and distribution. If any readers have on hand questions that they are prepared to contribute to the banks, I would be happy to receive them and submit them for inclusion. Those who have access to the printed version of the banks will be able to work out which sections would benefit by being extended.

The handing over of examination procedures to the amateur body is a major advance in the history of our hobby, probably equal in importance to the establishment of the Novice licence. We have the opportunity now to examine candidates under conditions which suit them, at any time. It is to be hoped that all those who are at present on the mailing list will maintain their interest, and that a few more from other areas will join, so that we will have nationwide coverage. I look forward to hearing what you are doing about exams in your area. If I can assist in any way, please write to the above address. **ar**

DIVISIONAL NOTES

FORWARD BIAS

PHIL CLARK VK1PC

Hi there!

Well, forward bias has not appeared for a while and I have been asked to have a go, so this is my first attempt!

The ACT division has had quite a few activities recently, the biggest one being the Esanda International Car Rally, held on the 17th, 18th and 19th of November.

The ACT division was requested to provide safety and scoring communications for the event, which was held over a large area, extending from the central area of Canberra out into the Brindabella ranges to the West. Paul VK2CJ, volunteered to organise the division's role. (I reckon he must want his head read to volunteer for this!). In the final outcome, he was commended by both the rally organisers and the divisional participants for his work. Paul planned for two nets to operate simultaneously using the two metre repeater located on Black Hill, near the Tidbinbilla deep space tracking station, and the 70 cm repeater on Isaacs Ridge. The reason for this selection instead of the repeaters on Mt Gin-

ini was because of terrain masking of the path to Mt Ginini from some parts of the rally circuit.

The entire communications system operated faultlessly from start to finish of the rally, and was able to pass scores back to rally control with such efficiency, that an updated position list was able to be faxed back to crews and drivers in the field within 20-30 minutes of section scoring being done! Thanks must go to the ladies who operated the station at rally HQ for the way they handled a tremendous volume of traffic, and a special thanks to rally director Mike Bell for his help and advice.

In all, some 30 amateurs took part during the rally. The safety communications proved their worth on several occasions, when it was necessary to clear people or vehicles from the rally course while the rally was in progress! There are just too many to mention individually, so a general thank you and a very well done to all who took part

The final divisional meeting for 1989 was held on the 27th of November, and was the traditional social meeting and trash and treasure night. Conviviality was the theme, and it certainly made the bargaining for treasure spirited and the trash to look like treasure!

The first meeting for 1990 will be held on 22nd January.

The division has an interesting program lined up for meetings in 1990, (the new decade in case you did not notice!) and one meeting

that will interest a lot of mobile operators will be the one where Paul, VK1BX will give a talk on connections, return current paths and electronic compatibility in the harsh electronic environment of motor vehicles.

I would like to thank the many speakers who have entertained and educated us at the meetings during 1989, particularly those from the electricity authority and the NSW SES.

If you have any suggestions for speaker subjects at the monthly meetings, let any member of the committee know, and we will try and fit them in. Our aim is to provide what the members want.

Some other activities that have proved popular are the reintroduction of fox hunts and the division's buying program that has provided equipment and parts to members at discount prices. These will be continuing in 1990.

I would like all members to give some thought to nominating for committee positions at the Annual General meeting coming up soon. It is NOT a hard job and does not take up much time, but it will give you a chance to see some of the day-to-day problems that crop up with the running of the division. If you feel that something is not being done correctly, or that you have the knowledge and experience to do something better for the division, this is your opportunity to make a valuable contribution.

Well, I hope that all had a safe and pleasant Christmas/New Year (and that you got lots of amateur goodies!) and I look forward to seeing you at the meetings during the year.

VK2 NOTES

TIM MILLS VK2ZTM

Welcome to 1990

This is another important year for the WIA - 80 years ago it was started in NSW and over the following couple of decades there were Divisions formed in every state. It is the Division which even today continues to provide the Membership Services with a national point to cover the government and international liaison. These tasks, as well as production of our magazine 'AMATEUR RADIO' are all funded by our annual Membership dues. This year regrettably has seen an increase in the annual dues, and it is now that the majority of Members receive their renewals. The continued membership of everyone is important but there may be a few who feel the new level beyond their means.

There are several grades of membership and the VK2 Division amounts are lower than the recommended dues. Full and Associate are \$59.00; Concession, Needy and Student \$47.00; and No "AR" (old Family grade) \$33.00. The fee consists of both a Divisional and Federal component. The Divisional amount on the \$59 and \$33 levels is \$10.00 and on the \$47 is \$7.80. It is from the Divisional portion that the various Membership Services are funded, like the Library, Office, QSL Bureau, Broadcasts, to name a few.

Annually there is a small percentage of Members who for various reasons do not renew. If you fall within this grouping please contact the Divisional Secretary so that we may be aware and in turn save the Division the expense of reminder notices. There may also be ways that the Division can assist, if it is the level of the annual fee which may be preventing you from renewing.

Don't forget there is the option of renewing for a three year period at three times the appropriate annual fee.

Hopefully, the majority of the Membership takes an option which includes our magazine "AMATEUR RADIO", for the printed word is important in conveying all forms of information about the hobby and the Institute.

The next important method of Membership information is via the Divisional broadcast - the first for 1990 will be on January the 14th.

May 1990 be a good year for you in all matters, including "Amateur Radio".

Broadcast and Office

The first formal broadcast for 1990 will be on Sunday the 21st January. There will be a transmission of technical material at the usual

times, 1045 and 1915 on Sunday the 14th, including any major items of news to hand. During the holiday period the telephone news headlines on (02) 651 1489 will be updated as required. A note to clubs and groups who submit items for the broadcast. Please write or type these separately to any other matters sent to the office, it helps everyone.

Taree is the latest region to be added to relays of the broadcast, using local repeaters. Automatic relays of the Sunday broadcasts from VK2WI are made into Wollongong, Western Blue Mountains, Central Coast and Newcastle. Manual relays are made at Orange, Tamworth and Lismore and now Taree. It would be nice to see this coverage also extended into the mid North Coast, New England, Far South Coast and the Riverina. Perhaps clubs in these regions could think about it. The additional HF frequency on 30 metres, 10125 kHz is proving useful. There are times when there has been signal fadeout and 40 continues to support statewide coverage. There were a couple of occasions late last year when 40 was out and 30 carried the day.

The Parramatta office is closed over the holiday period. The first day will be Monday the 15th and the first Wednesday evening will be the 17th. Mail to PO Box 1066, Parramatta, NSW 2124 will be regularly cleared and processed.

Slow Morse Sessions

There has been a time shift with the VK2BWI - 80 metre morse practice sessions until the end of daylight saving in March. The new time will be 8 pm, EAST (0800 UT) start on the usual frequency of 3550 kHz. The session will be followed by the VK5 segment. If you are able to assist by being an operator for the VK2BWI sessions, would you contact Ross VK2BRC, via the net for details. The present operators do an excellent job, but additional personnel on the roster helps ease the work load.

WICEN (NSW) Inc

Exercise dates for 1990 include the Bungonia Cave rescue training weekend, March 10th and 11th. The City to Surf early August. The Hawkesbury Canoe Classic, the 3rd & 4th November.

Coming Events

Sunday the 18th February for the Gosford Field Day at the usual venue, the Gosford Showground. Urunga Convention over Easter and the Oxley Region Field Day in June. Regular events like the Trash and Treasure

afternoons and Postcode contests will be notified in the broadcasts.

New Members

A warm welcome is extended to the following who were in the intake of new members for November 1989.

P L Beard	VK2AFX	Armidale
B L Bennetts	VK2BBE/ VK1BB	Ocean Shores
R H Brockman	Assoc	Blackheath
G I Denney	VK2JGI	West Wollongong
J A Goodwin	VK2KHJ	Walcha
K W Grimm	VK2XHM	Figtree
J A Heath	VK2DVH	St. Marys
A J Herro	VK2PZG	Strathfield
D Hoy	Assoc	Harrowitch
E S Lensson	VK2XHC	Newtown
N F Murphy	VK2GAN	Old Bonalbo
D Milgate	VK2KHF	Gilgandra
S McFadyen	Assoc	Crows Nest
H Schwitter	Assoc	Cowan
V N Stafford	VK2XOI	Copacabana
A Stone	VK2VTS	Berkeley
R A Steel	Assoc	Walcha
A Umhang	VK2CO	Toongabbie
C E Webb	VK2CO	Unanderra
M T Welsh	Assoc	Berala
D R N White	Assoc	Goolwa

VK3 NOTES

JIM LINTON VK3PC

New Federal Councillor

The WIA Victorian Division Council has appointed Peter Maclellan VK3BWD as Federal Councillor for Victoria. He will represent the Victorian Division on matters of national or international importance. The Federal Councillor sits on the supreme policy making body of the WIA, the Federal Council, which consists of a Councillor from each of the seven autonomous Divisions.

Peter Maclellan's appointment as Federal Councillor has been welcomed by Peter Mill VK3ZPP who steps down from that office, but will continue to play a role as the Alternate Federal Councillor. The Divisional President, Jim Linton VK3PC, remains as 2nd Alternate Federal Councillor.

Microwave Users Register

Do you use the microwave bands, or know of others who do? Then let the WIA Victorian Division know so a microwave users register can be started. The allocations on these higher bands could be under threat - and

unless the WIA is aware of activity on them, it's a difficult task to adequately defend these bands based on accurate information.

The register would also enable the WIA Vic Div to contact microwave users to seek their views. Send details of call signs, bands and modes used to: Microwave Register, WIA Vic Div 38 Taylor Street Ashburton Victoria 3147.

Classes for a Declining Hobby

Classes in theory and Morse Code instruction will be conducted by the WIA Victorian Division starting next month, in the eastern suburb of Canterbury. Classes for the Novice licence begin soon. Anyone interested would be advised to urgently contact the Divisional Office as soon as possible. Enrolments are also open for an AOCB bridging course which begins in August.

The hobby of amateur radio in Australia is experiencing a downturn, with virtually no growth in the numbers of radio amateurs. The annual growth rate has slumped to about one half of one per cent. We should be attracting CB operators who have tasted excellent DX during this sunspot cycle peak, and other interested in hobby communications. Our hobby is for all age groups. We have a product to market. It is competing with many other leisuretime activities. So, concerned about the decline in radio amateur numbers, the WIA begins 1990 with a think-tank exercise to find effective ways of promoting amateur radio.

Examinations Service

Trial Novice and AOCB theory exams have been conducted by the Division for prospective radio amateurs and those wanting to upgrade. Requests for trial exams have been received from throughout Australia. The exercise was very labor intensive but proved worthwhile. Sets of the trial papers are still available at a cost of \$12 per exam, which includes an answer marking service.

Perhaps you are, or know someone who is, a candidate for the DOTC exams next month - the trial theory exams could help with preparation for the real exam. While on the subject of exams, the WIA Victorian Division has submitted a series of theory and regulations examinations to DOTC for approval, to be used when the Division begins conducting exams in March under the devolvement process.

ar

This space could be earning you money!

5/8 WAVE

JENNIFER WARRINGTON VK5ANW

VK5WI

A Short (?) History of the 40-metre Relays Well, that was what I intended when I thought of the idea, but like the proverbial 'snowball going down-hill' the whole thing started to gather momentum and I was in danger of being overtaken! I would like to thank the three current operators Murray VK5ZQ, Ross VK5KF and Ron VK5ZR, whose assistance I sought in obtaining the details. Little did I know, that this information would take me back much further and become far more complex than I ever imagined. Added to this I decided to look up 'VK5WI' in Marlene Austin's book - it runs to four pages! Here then are just some of the highlights in the history of '5WI' and in particular the 40m Relay of the Sunday Morning Broadcast (if the editor decides that I've exceeded my quota we may have to continue this next month!)

VK5WI started as 'S519' on Sept 6th 1921. In Nov 1924 it became '5AV' and became '5WI' on 28.6.1925.

6.9.33 Division accepted an offer by Cliff Moule (callsign unknown) to broadcast official Institute news on 80m on Sunday nights.

5.12.34 Telephone approved for 5WI on 80m.

1.9.35 Students Tx 'VK5WI Junior' now on air. (note: Big Tx 5WI, conspicuous by its absence!)

1.6.37 Les Pearn VK5PN conducts the WIA session on 7Mc at 9am. (it's interesting to note that Chris Whitehorn the current 5PN, also plays a big part in Sunday morning broadcasts, as an operator, as co-ordinator of the roster of relay ops, and as a past (and currently relieving) Producer.)

The war intervened, then in March '47 Reg Harris VK5RR did the B/cast on 7195 kHz on Sun at 10am. By Aug that year there was also a B/cast on Sun at 7.30pm, but it's not clear whether both continued together)

(Reg has recently returned as a 10m Relay Op!)

28.2.59 5WI, 10am, 7146 kHz to be relayed on 50, 144 and 288 MHz.

7.7.59 B/cast time changed from 10am to 9am to fit in with use of 7146 kHz by other Divisions.

6.6.61 Approval granted for relays to be conducted on 3.5, 14.2, 50.2, 144 and 292 MHz.

16.8.63

Council Members to be rostered to prepare material and a tape-recorder to be purchased.

Neil White VK5WN to relay B/cast on 1.8 and 50 MHz.

May '64

Murray VK5ZQ had (according to Marlene's book) been operating '5WI' (presumably on 7 MHz at this was still the originating frequency). Preparation of tapes was done by Geoff Taylor VK5ZCQ (now TY) and Brian Tideman VK5TN.

30.3.68

Ross Dow VK5KF did some frequency checks, etc. with Geoff VK5TY to prove relay OK, and on 31.3.68 Ross did his first relay from 3.5 to 7 MHz. (This is where it gets a bit confusing. Murray remembers swapping frequencies with Ross at some stage to avoid interference problems that Ross was suffering)

4.8.68

5WI changed to 1.8 MHz for the originating B/cast.

25.8.68

John Godsen VK5LV did the originating B/cast on 1.8 MHz. Murray was relaying on 80m and Ross was relaying on 40m which he continued to do until unpredictable work commitments on Sunday mornings forced him to give up on 28.10.73.

7.4.74

Murray shifted to 40m, where presumably he continued to do the relay every week until June '78, when Ron VK5ZR joined him and they continued to alternate each week for the next 7 years.

3.3.85

Ross once again joined the team, and they have been doing it on a three weekly basis ever since.

I don't know how many man-hours of dedication this would add up to, but I know that it must be 100s. To say 'THANKYOU' to these three seems somehow very inadequate.

Diary Dates

Jan 23rd 1990 Buy and Sell Night (brief business meeting with ESC, Publications, QSL Buro, etc)

No meeting on Jan 30th

Feb 27th General Meeting - Speaker, Ian Hunt VK5QX on "Mobile Installations" ar

INTRUDER WATCH

GORDON LOVEDAY VK4KAL FEDERAL INTRUDER WATCH CO-ORDINATOR
RUBYVALE 4702

The New Year should begin with all new promises to oneself. Mine is not to let up on new ideas re Intruder Watching. So this month I'll start with a few basics. Technical knowledge possessed by monitoring personnel may vary from the elementary to the very advanced. Regardless of their level of skill, ALL monitors are capable of providing useful input to their section of Monitoring System.

The basic equipment for any monitoring station is a radio receiver, antenna and a pair of ears (one will do), PLUS the operator's ability to learn the limitations of each. Being volunteers, monitors must be free to dedicate as much of their time to the MS as their personal commitments permit. It is suggested that LESS than 2 hrs weekly results in loss of familiarity with patterns of activity on

the bands being monitored. Monitors who wish to specialise in specific types of transmissions, i.e. A1A or F1B only, should do so. Some monitors prefer to check a particular band., This I encourage. The end result is a person with an intimate knowledge of the particular brand. Modern receivers leave very little room for inaccuracy. However, older receivers' dial readings can be improved by :

1. Maintaining a constant room temp.
2. Using a crystal calibrator to check the dial accuracy against a recognised frequency standard. All calibration should be done on the band and in the mode being used to detect the intruding signal.

Next month I hope to cover the Frequency measurement of signals. ar

SILENT KEYS

We regret to announce the recent passing of

Mr J S Burns VK5UJ
Mr Norv Canfield W6KKF

Norv Canfield W6KKF

It is with deep regret that I advise the passing of a very dear friend Norv Canfield W6KKF of Petaluma, California. At the age of 88 years, Norv became a silent key on 17th October 1989.

A real "old old timer". Norv transmitted his first unlicensed radio signals prior to the first world war. His original callsign 9BVG was

listed in 1922.

Norv was a very proud member of the Radio Amateur Old Timer's Club of Australia. He obtained pleasure from reading the club's journal.

Over the years, from our first CW contact, our friendship with the Canfield family developed. My wife and I had the pleasure of being a part of that family when we visited Petaluma in May 1983.

Communication over recent years has been via the mail man.

Norv is survived by his wife Rose and daughter Arlene and her family to whom we extend our deepest sympathy.

We reflect on very happy memories but mourn the passing of Norv Canfield W6KKF. Al Pearson VK2CU. ar

OVER TO YOU

ALL LETTERS FROM MEMBERS WILL BE CONSIDERED FOR PUBLICATION AND SHOULD BE LESS THAN 200 WORDS.

THE WIA ACCEPTS NO RESPONSIBILITY FOR OPINIONS EXPRESSED BY CORRESPONDENTS.

Hands Free

I refer to a letter by G H Cranby VK3GI in the October issue regarding the use of a microphone while mobile. Also other correspondence on this subject.

Your readers might be interested in a homebrew item I used for some years on my Mazda Capella.

The head restraint on this car is supported on two chrome rods inserted into the back of the seat and I fitted a plastic zippy box between these supports.

Inside the box was a speaker facing forward, and a battery. On the passenger side of the box was fitted an elbow and into this was screwed a flexible gooseneck with an Electret microphone element in the end.

On the front of the box, towards the passenger side, I fitted a lever switch with the lever

1990 New Zealand Celebrates

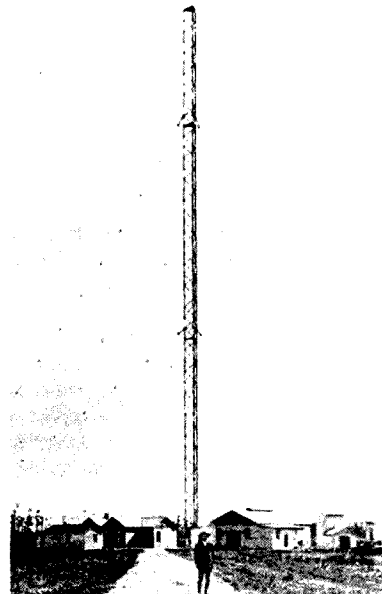

VLA Awanui NZ during its spark transmitter career.

In 1990 New Zealand will celebrate 150 years of Nationhood from the signing of the Treaty of Waitangi in 1840. Coincidentally, it will be 60 years since the NZ Post and Telegraph "spark" wireless station VLA closed down. From February 10th through 28th 1990 radio amateurs will celebrate both events with the operation of an amateur station on the site of the old station. The special callsign ZM1VLA will be used, and operations will be phone and CW and packet modes on all bands throughout the above period. A special QSL card will be sent to all stations who contact ZM1VLA.

The photograph shows how VLA looked in 1913. Now only the buildings (in good repair) and the massive guy anchors remain. The original station operated 600 and 2000 metres with power levels near 10 — 15 kw. The mast stood some 400 feet high, and was felled in February 1930.

Awanui is located near the northernmost point of North Island, New Zealand.

B H BOWLINGS
(ZL1WB)
TRUSTEE ZM1VLA
ar

extended by a piece of nylon tube about 2 inches long. The microphone was lined up towards the left of my mouth and did not hinder any movement.

To speak, the right hand was quickly brought up to the left shoulder, the switch snapped down and the hand back to the wheel in a second without taking the eyes from the road.

To receive, it only required a lift of the left shoulder to operate the switch. The transceiver, a Philips FM320 UHF CB unit was fitted under the dash in the usual manner.

PETER A RUSSELL L50567
17 ABELIA ST
ELIZABETH VALE 5112

Subsidies and other Topics

The WIA should apply for a federal government subsidy. Other magazines do. Even homosexuals received a magazine subsidy, still continuing as far as I know. Yes, Alan Williams — VK3GAW — the government can take over your station for various reasons and even deputise others to do so. Prices of publications here as well as overseas, have all risen steeply. The escalating cost of paper is one factor.

How many of these publications give concessions to certain groups? As for comments by HWM Kop-VK5KUJ (Sept 1989), yes we certainly need many more members. If he thinks he is paying too much then why not leave some of his other organisations, maybe all, except the WIA which exists to serve all amateurs. We need a powerful lobby or voice or the day will come when there will be no amateur bands — no amateur radio. We must lobby hard or go under.

I cannot see why limited licensees should not be allowed to use 10 metres via cross-band repeaters.

Regarding HF without morse, any federal government can drop these requirements any time they like along with the allocation of any bands.

Look what happened to the 6 metre band and Channel 0, the 11 metre band and even sections of what was the amateur 80 metre band. Politicians are interested in votes. International or any law takes a back seat to votes.

Re "JOTA or JOKE" I have seen similar behaviour by uncontrolled juniors, bored, and uninterested. Solution (A) leave them home or take them somewhere else or (B) chain them up outside! I think, David (VK4BGB), you will find these "whingers" will be loudest if there is any loss in our band or operating privileges. In fact they will be the first to blame the WIA.

GRAHAM J MUIRHEAD VK4WEM
23 CUNNINGHAM ST
WARWICK 4370

(Your Division has volunteered to investigate the possibility of a subsidy. Graham. The answer to your unpublished question about videotapes is the listing by VK5KG on p38 of the Nov 1988 issue. Ed)

Justifying The Amateur Service

WARC '92 will be convened to revise part of the International Table of Radio Frequency allocations. The revision might affect the amateur allocations so Executive has decided to seek representation on the Australian delegation.

The form of representation and its effectiveness is suggested by various statements made recently, for example:

From DOTC Doc 70, 71 and 72 — "Because of changing technology and changing community needs, no user has a permanent right to any portion of the spectrum, which is a public resource". and "Renewal (of a licence) is not and can not be automatic due to changing community demands on the radio frequency spectrum".

A senior UK DTI officer — "Any moment that the radio spectrum stands unused because of regulatory constraints when somebody could be using it, is an opportunity cost or loss that makes the community that much poorer".

Those quotes, and many similar indicate an administrative concern that spectrum use must be a cost benefit to the community. The amateur service cannot justify its spectrum occupancy with a cost benefit analysis. Therefore it must prove that "self training, intercommunication, and technical investigation carried on by amateurs" is worth foregoing opportunities for commercial profit. That is a task for every member of the service. It cannot be entrusted to one or two representatives.

The report of the 1959 WARC by the late John Moyle was published in AR, March 1960, and summarised in AR, Sept '79. Two quotes are relevant — "...Amateur problems, important though they are to us, are only a small part of the incredibly complex pattern of modern communications. "and — "I believe that every Amateur who tacks his licence to the wall must shoulder an inescapable responsibility to his fellow Amateurs and to the Amateurs of the future. If he fails them, they must suffer and may even cease to be".

There is much apathy to be corrected. paying an annual subscription is not the end of member responsibility. Members must offer for service in divisional councils and aspire to Executive status. An entrenched group of officials is the first indication of a decaying organisation (*ie no new volunteers. Ed*).

The highest priority task for Executive is to convince members that they should care about survival, which depends on the community

and administration assessment of their worth.

LINDSAY LAWLESS VK3ANJ
BOX 112 LAKES ENTRANCE 3909

Cost Of Membership

Thanks for a super magazine.

There has been some correspondence recently regarding Membership of the WIA. I would like to add my "Two penny worth".

I have recently been in contact with the Editor of the Australian Ultra Light Magazine and have enclosed the correspondence for your perusal and possible inclusion in your Magazine. I have underlined what I consider to be the nub of the reply from the Ultralight Federation. (*Space does not permit reprinting. Essentially it states that flying an Ultralight necessitates a Federation-issued certificate. Ed*)

With the current policy of Devolvement by DOTC it would seem logical that the WIA not only conduct examinations for potential Amateur Radio Operators, but also issue their licences. In other words, you don't get a Radio Station Licence issued or renewed unless you are a financial member of the WIA. The WIA would then make one bulk payment to DOTC for all the bands that Amateurs are authorized to use.

As an aside, ask the average golfer or bowler how much an afternoon's sport costs by the time they pay green fees, a few beers and the odd raffle ticket. Blokes I have spoken to spend more on a Saturday afternoon than I do in a year on my Ham Licence and WIA membership.

RAY HINKS VK4LU
4 PLANT ST WEST END
TOWNSVILLE 4810

Smug And Pompous

As a rank and file member of the WIA, I should like to protest at the smugness, the pomposity and the patronising attitude which permeates every utterance of the Federal Executive Office, whether it is printed in Amateur Radio or contained in the Federal tapes broadcast each week. As an example, in attempting to justify the forthcoming Federal fee increases, the Federal Office has said, in effect, "It is all too complex to explain, and you would have to be involved with the Federal body to understand, but be assured that the current managerial structure is necessary, and this fee level is necessary to support it". Well, I, for one, remain unconvinced.

The Executive Office apparently fails to realise that the WIA present membership, although less than fifty percent of licensed amateurs, has been sustained at that level by two groups. One group is those who want to

receive Amateur Radio, mainly because of its technical content, while the other feels that it is essential that the amateur fraternity has a representative body. When the contents of recent issues of Amateur Radio are examined, it would appear that the former group has little incentive to continue membership. The latter group, while adhering to its views, must be increasingly doubtful as to the suitability of the present Executive Office to represent it, and increasingly reluctant to pay escalating fees to finance the empire-building program on which the Executive Office seems to have embarked. The outcry which I have read and heard concerning future fees leads me to believe that, when these fees become effective, the defection of members from the WIA will be much greater than the Executive Office expects. Consequently, fees for remaining members will become progressively greater and will, by the law of diminishing returns, eventually result in the demise of the present structure. This will be no great loss and will clear the way for the emergence of a representative body confined to fundamental issues and requiring only moderate fees. Such a body would undoubtedly receive widespread support. As far as I am concerned, such a development cannot come too soon.

S V ELLIS VK2DDL
82 TAREE ST TUNCURRY 2428

(We have obviously failed to convince you, OM! You did not give your first name. When "the way is cleared" who is offering to form your "representative body"? Might it not be better to improve the existing body rather than hasten its destruction as you seem to desire? Ed)

Appeal From India

I am an enthusiastic Ham radio operator having call sign VU2MBX, licence no 2754, Grade II, working as a lecturer in medical college.

I am writing this letter because my personal efforts at assembling a station have failed. Construction is very difficult because for old circuits we cannot get valves and new ones use unobtainable things like toroids. No company manufactures Ham equipment in India. The only source is surplus or import. Most do not sell their equipment because they are still using it. Import of new instruments with duty @ 25% will cost RS 25,000 which is as costly as \$25,000 would be to people on Australian salaries.

I am the only Ham in this city and have been using stations of friend hams in Rajkot City which 90 kms away by road.

I wonder if any of your readers could extend help to me. I would be delighted to get any surplus out dated HF or 2 metre rig or kit. Anything of medium power which can be made to work.

Thanking you in anticipation.

MAGANLAL A GADHIA VU2MBX
DEPT OF PHYSIOLOGY
MP SHAH MEDICAL COLLEGE
JAMNAGAR GUJARAT STATE 361008
INDIA

VNG

There has been a good deal of publicity in AR during the last year about this station. So far I have not seen a single benefit detailed that supports its re-introduction. Perhaps its continued operation benefits some users, but whom?

On the other hand the VNG transmission interferes with the reception of WWV, a service which has served a large and widely dispersed "consortium" for decades.

WWV has enhanced its capabilities during this time, but it has always maintained its basic simplicity. That is, accurate time signals preceded by a plain language message are transmitted virtually every minute.

This facility is of greater value to a much larger "consortium" of user that those seeking to resurrect VNG and should be maintained free from interference.

I would suggest that the WIA should give this matter further consideration and adopt a policy that will ensure WWV can continue to be used in future decades.

D H WATKINS VK2DDR
9 WILLAWA STREET BALGOWLAH
NSW 2093

**Have you entered the
WIA 80
competition?**

**This month is your
last chance.**

**Remember, to win
you must be
financial as at
1st February
1990**

BACK ISSUES

of AR available to
WIA members

Jan 1969 to Dec 1987
\$2.50 each

Jan 1988 to current issue
\$4.00 each

(Some issues out of stock)

Prices include postage
AR Back Issues
PO Box 300
Caulfield South Vic 3162

Morseword No 34

Solution on page 63

Across

- 1 Swerve
- 2 Unoccupied
- 3 Discourteous
- 4 Submerge
- 5 Inlet
- 6 Very dry
- 7 Everyone
- 8 Expectorate
- 9 Negligent
- 10 Bulk

Down

- 1 Icy rain
- 2 She's a fairy
- 3 Untruths
- 4 Top pupil
- 5 Lease
- 6 Part of speech
- 7 Squander
- 8 Knife
- 9 Platform
- 10 Nullify

	1	2	3	4	5	6	7	8	9	10
1										
2										
3										
4										
5										
6										
7										
8										
9										
10										

Audrey Ryan © 1989

SYDNEY ATV

BARRY McNEIL VK2 FP
SYDNEY ATV GROUP
PO BOX 142 WINMALLEE 2142

As secretary of the Sydney ATV group (SATVG), I have noticed the lack of liaison and even awareness other ATV groups within Australia. I was recently posted to Melbourne and had the pleasure of discussing ATV with Peter Cossens, VK3BFG and the VK3 ATV boys. I am now on a posting in Brisbane, and am ATViing with the SEQATV group. I have realised that the groups throughout Australia need to liaise more closely. This is evidenced by the fact that in trying to work out gentlemen's agreements with band plans, ideas etc, many a long and expensive call on the 600 ohm line has been made between ATV groups.

The SATVG has a gasbag net every Monday night at 1930 local with net control being viewed on TV ch 35. The ATV repeater is crosslinked on to repeater 147.300, for those stations without access to ch 35 or for mobile or portable stations. ATV sound is on the repeater's output, whilst stations calling in on the repeater have their sound come out on

ch 35. Access to our repeater is via 426.25 MHz horizontally polarised. If you do not have TV sound, then 2 metres sound via 147.400 is re-transmitted on ch 35. Our ATV simplex liaison frequency is 147.425 MHz. The repeaters are at Springwood in the Blue Mountains west of Sydney. A tuning test card and information pages are transmitted whilst the repeater is not in use. This only operates at certain times however. Repeater control is via 2 metres touch tone; a picture alone will not trigger it, nor will a carrier as a picture detector is fitted. Our repeater output is 120 Watts peak horizontal sync into four 4 element horizontally polarised beams which the local white cockatoo community turned into a community perch. A magnificent effort has gone into the building of the repeater by our president Julie Kentwell VK2XBR, who succeeded where all others have failed in establishing a working Sydney group, and for building a fine repeater. Much credit must go to other members, for their excellent contributions, such as Ralph, VK2ZRG, Paul VK2PMD, John VK2TJM, etc, and of course myself, for writing this magnificent article for you! (Modest too, Barry? Ed)

The Sydney ATV group has close ties and excellent communication with the Gladesville ATV group, which transmits live programs as well as WIA news, excellkent AOCF training

video thanks to Ron, VK2DQ, and other programmes of technical interest. Gladesville transmits on Wednesdays from 1900 local. This program is retransmitted on Friday evenings from 1900 local, as well as transmissions on Saturday and Sunday from 1700 local.

The SATVG also transmits the WIA morning news broadcast every Sunday morning on ch 35 ATV sound.

Recently, the SATVG ran a live telecast from a Cessna 172, the aircraft being piloted by myself, and Wayne VK2XWC at the camera. However, due to fault in the aircraft transmitter, this was not as successful as we would have liked. The next attempt will be more successful, having learned by our test flight. When we do, you will read about it in your magazine.

Despite rumors from interstate that the SATVG is dead and dying, we are going from strength to strength, and it is growing bigger each day. We are here to stay. Written correspondence to the SATVG can be sent to us at PO Box 142 Winmallee 2142.

From now on, the SATVG will be monitoring 3620 kHz during our gasbag net on Monday evenings from 1930 local. We look forward to hearing from the other ATV groups and interested parties throughout Australia and overseas. ar

VNG TIME CODE

SECONDS MARKERS NORMALLY 50ms. OF 1000Hz.
 SECONDS MARKERS 55-58 ARE 5ms. OF 1000Hz.
 SECONDS MARKER 59 OMITTED.
 MINUTE MARKER IS 500ms. OF 1000Hz.
 DURING 5th, 10th, 15th ETC. MINUTES,
 SECONDS MARKERS 50-58 ARE
 5ms. OF 1000 Hz.

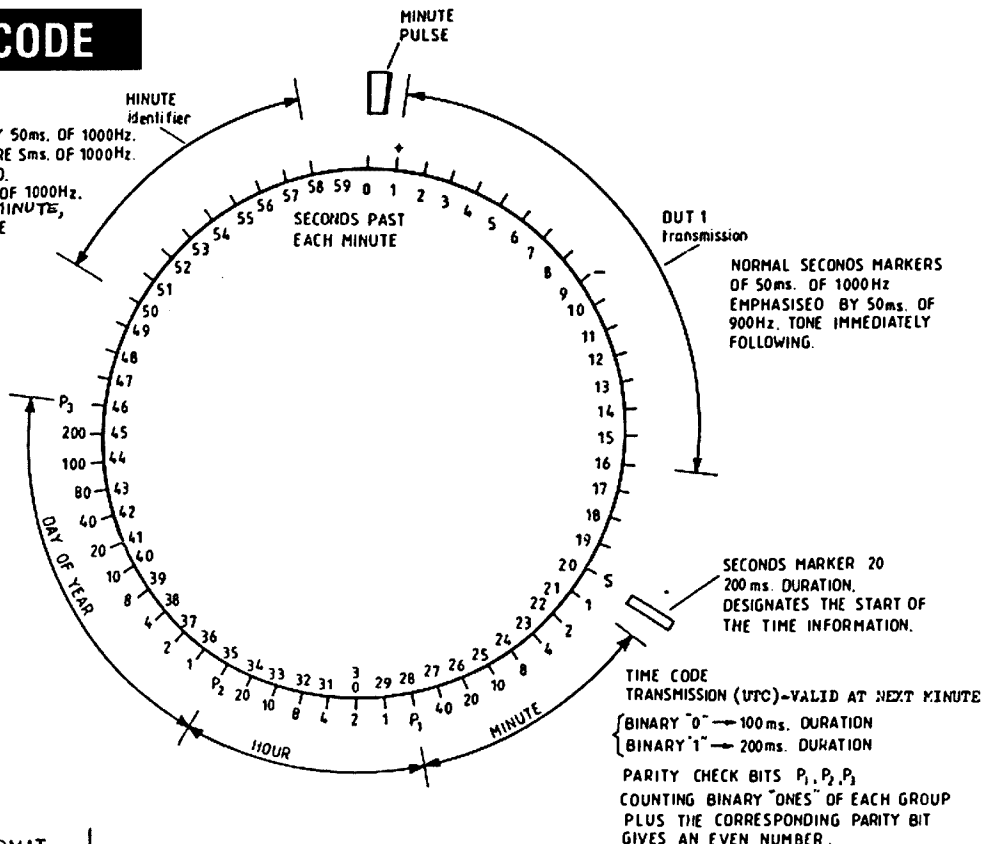

VNG TIME CODE FORMAT

HAMADS

TRADE ADS

SATFAX: Weather satellite picture receiving program for IBM XT/AT. Displays in 64 colours. Needs EGA colour monitor & card, AM demodulator & ADC interface. \$45 + \$3 postage ***
RADFAX2: HF weather fax, morse & RTTY receiving program for IBM XT/AT. Needs CGA, SSBHF, FSK/Tone decoder. Also "RF2HERC": & RF2EGA", same as RADFAX2 but suitable for Hercules & EGA cards respectively. \$35 + \$3 postage *** All programs are on 5.25", 360K floppy & full documentation. ONLY from M.Delahunty, 42 Villiers St. New Farm 4005 OLD. Ph (07) 358 2785.

AMIDON FERROMAGNETIC CORES: For all receiver and transmitter applications. Send large SASE for data and price to RJ & US Imports, Box 157, Mortdale NSW 2223. (No enquires at office please...11 Macken St, Oatley). Agencies at: Geoff Wood Electronics, Lane Cove; Webb Electronics, Albury; Electronic Components ACT; Truscott Electronics Vic; Willis Trading Co WA; Associated TV Service Hobart.

FOR SALE — ACT

YAESU FT-ONE transceiver C/W key paddle and manual \$1900.00 Kenwood TS520 C/W digital readout and manual \$550.00. Kenwood TS820 C/W external speaker and manual \$700.00. Wilson 4EL 20/15/10 Yagi unused. Realistic DX160 coms receiver C/W external speaker \$80.00 Trio SG402 sig gen 100 kHz-10 MHz \$200.00 Trio SG202A audio gen 20Hz-20kHz \$200.00, 12V 2A power supply \$15.00. Welz 100 W dummy load \$40.00. Kenwood YK88CN xtal filter \$60.00. 28 MHz mobile antenna \$30.00. Morse key. Log periodic antenna — possibly 8 elements enquires to Eric VK1EP (062) 49 6437 QTHR All above reasonable offer accepted.

FOR SALE — NSW

YAESU FT209R hand held \$375 ono and Tektronix S4-5B oscilloscope mainframe type with dual channel plug-in and probes \$250 ono John VK2XNJ 673 2308.

YAESU FT7HF transceiver plus FL110 amplifier. Good condition. Amplifier has fault on 40m. Jeff Brill VK2FBK (069)311490 QTHR VK2KBK \$450.

YAESU FT102 150 Watt HF transceiver, with narrow SSB filter, wide AM filter, YM-38 desk mike, SP-102 speaker and manuals. \$1150 ono.

TRIO 1303G oscilloscope/RF monitorscope \$200 ono.
ATN 11 elt 70cm yagi, new, unused \$90 ono. Paul VK2ATR (049) 59 1788 (BH) (049) 59 3748 (AH).

DSE Commander 2m TXVR in good working order \$190 Rick VK2KRH (048) 71 1067 after

5pm licensed amateurs only.

TRANSCIEVER FT7 pwr supply mike SWR meter phones morse key manual vey good condition. George VK2YT phone 625 2602.

YAESU FT101E transceiver in excellent condition with oskerblock — \$450. VK2BAL (02) 44 4135.

TRIO TS520D HF transceiver in VGC with DG5 digital readout, 12VDC module, CW filter, spare finals & driver manual & mods. \$575. Ken VK2YKM (066) 24 2433 (BH) (066) 24 3197 (AH).

YAESU FT480 2 metre allmode transc.with speech read-out \$525 ono. Frank VK2ZI QTHR (080) 88 2000.

YAESU FT209RHA 2m transceiver FWB4 battery PA3 charger car adapter MH12A2B speaker-mic YC18C — charger all in as new condition. Price \$500 (063) 67 5095 QTHR VK2DBI.

YAESU FV107 external VFO good condition suit most older Yaesu transceivers \$75 (063) 67 5095 QTHR VK2DBI.

FOR SALE — VIC

CICADIA 300 dataphone modem. \$150.00 in VGC — ono. Radio Shack, DMP100 dot matrix printer with serial and parallel connections plus also a new ribbon and manual \$200, ONO VGC must sell — Arthur VK3CUA QTHR Ph (054) 43 7425.

ICOM 271A 2 mtr all mode 5 or 25W mic manual excellent cond. \$975 licenced amateurs only. Andy VK3UJ QTHR (03) 735 3335.

SAGEM teleprinter with tape punch and reader. Dot matrix printer and power supply. Very good condition \$300 ONO VK3CQ QTHR or phone (057) 55 1158 (BH).

YAESU FT400 good working order with matching speaker and desk mike 1 spare final tube \$300 ONO Charlie VK3KAY (053) 31 7425.

TONO 7000E communications computer C/W manual, circuit and many spares \$465. Sanyo VCA-700B&W CCTV system C/W manual \$300. VK3KC Ken (051) 27 4054.

STAND alone Viatel modem complete with push button phone, full alpha-numeric keyboard hardly used. \$75. VK3XRS (Roger) phone (051) 56 8291.

FOR SALE — QLD

YAESU FTV-700 transverter. All mode. 2 metre and 70cm modules. Connecting cables, original packing, manual. Recently serviced by authorized agent. \$500 — Ross VK4IY QTHR (075) 65 1445.

3 section 55ft hills telescopic/hinge-over tower excellent condition \$300 ONO. John VK4WLX QTHR tel (071) 94 7443.

FOR SALE — SA

TELCON semi air spaced twin coax 2kW to 2m, transmitting tubes 4-65A; 4E27(813) Grundig reel-to-reel recorder two sets tubes KW2000; Portable Diathermy 600 watts 7 metres; Post-war receiving tubes new ribbon micro — VK5LC QTHR (08) 271 6841.

FOR SALE — WA

DECEASED estate FT-101E \$350. FRG-7 \$200. 2m FT-203R \$350, (Plus car adapter). Emtron AE tuner EAT-300A \$100. Clipsal Morse Key \$25. Kenpro Rotator Control Box \$100. VK6AST QTHR (09) 454 6877.

FOR SALE — TAS

600HZ CW filter for FT101E Yaesu transceiver Col VK7LB QTHR (003) 39 3171.

WANTED — ACT

KINGSLEY radio type K/CR/11 RAAF type AR7 with the five bands ABCDE coils. Les Jay Dickson College VK1NAT (062) 47 5377.

WANTED — NSW

TRIBAND beam also antenna tuner (066) 72 2462 VK2AVS QTHR.

POWER SUPPLY for BC779 receiver (Hammarhund Super Pro). Also looking for old battery chargers, eliminators and rectifier units eg Emmco, Tungal, Philips, Valley, Balkite, etc. Also needing old transmitting tubes for collection. Brian VK2EFD QTHR (049) 77 2178.

TS130 WARC bands price and condition to Bill (042) 32 2892 night.

WANTED — VIC

TRS80 cc (6809E) EC basic programs for AR or any other type of CC programs. Hoping to put a library together will be much appreciated (disk or tape). Arthur Pantazis 62 Honeysuckle St Bendigo 3550 PH (054) 43 7425.

BOOK secret warfare by Pierre Lorain translated by David Kahn. Phil VK3APG (052) 48 1461 QTHR.

WANTED — QLD

FILTERS for TS430S YK88CN YK88SN YK88A; manual or copy for Plessey oscilloscope TSG802 also TSG402 reimbursement paid. R Male 13 Henzell St Redcliffe 4020 (07) 284 6432.

BALUN for dipole, quantity co-ax also ant changeover switch VK4EAB (071) 83 5162.

OLD mantle model b/c receiver even if not working but complete — QTHR Barrie VR4LN (071) 82 2675.

BG 348 RX — working — BC221 — Command tnx — any frequency — QTHR Barrie VK4LN (071) 82 2675.

BUY manuals or circuits army PRC26 set, 8C reception set, university TST12 valve tester, parts list army 128 set or can swap other manuals VK4EF 97 Jubilee Tce Bardon QLD 4065 (07) 366 1803 AH please.

WANTED — SA

MINI-PRODUCTS HQ-1 hybrid quad mini-beam in working condition reasonable price. Bill VK5NWL QTHR (08) 255 6976.

WANTED — WA

REQUIRE volumes 6-8-9 Australian Radio Service Manuals. Have for exchange vols 1 & 11. Roy VK6COP QTHR. (09) 457 8179.

WANTED intruder watch observers in VK6 free tapes logs and assistance available contact VK6RO Graham on (097) 451 3561 or QTHR.

Support the advertisers who support Amateur Radio magazine.

AR 20 YEAR INDEX

IBM format 5 1/4 inch floppy disk dBase III Plus
 .DBF file \$10.00
 ASCII \$10.00
 Compiled
 .EXE file \$10.00
 36 page printout \$5.00

Prices include disk (where applicable) and postage.

AR 20 Year Index
 PO Box 300
 Caulfield
 South Vic
 3162

Solution to Morseword No 34

From page 60

	1	2	3	4	5	6	7	8	9	10
1
2
3
4
5
6
7
8
9
10

Across:

1 skew 2 idle 3 rude 4 sink 5 bay
 6 arid 7 all 8 spit 9 lax 10 mass

Down:

1 sleet 2 fay 3 lies 4 dux 5 hire
 6 noun 7 waste 8 stab 9 dais
 10 negate

HAMADS

Please Note: If you are advertising items For Sale and Wanted please use a separate form for each. Include all details; eg Name, Address, Telephone Number (and STD code), on both forms. Please print copy for your Hamad as clearly as possible.

*Eight lines free to all WIA members, ninth line for name and address Commercial rates apply for non—members. Please enclose a mailing label from this magazine with your Hamad.

*Deceased Estates: The full Hamad will appear in AR, even if the ad is not fully radio equipment.

*Copy typed or in block letters to PO Box 300, Caulfield South, Vic 3162, by the deadline as indicated on page 1 of each issue.

*QTHR means address is correct as set out in the WIA current Call Book.

*A courtesy note will be forwarded to acknowledge that the ad has been received.

Ordinary Hamads submitted from members who are deemed to be in general electronics retail and wholesale distributive trades should be certified as referring only to private articles not being re—sold for merchandising purposes.

Conditions for commercial advertising are as follows: \$22.50 for four lines, plus \$2.00 per line (or part thereof) Minimum charge — \$22.50 pre—payable.

State:

- Miscellaneous
- For Sale
- Wanted

Name:

Call Sign:

Address:

STOLEN EQUIPMENT

Stolen in October from the home of R Ross-Wilson VK2FIT 111 James St Leichardt 2040

- Kenwood TS440S with tuner Ser No 7090271
 - Kenwood PS50 power supply
 - Kenwood MC85 desk microphone
- Contact owner or local police

Stolen from A M Simpson VK4AAE Mt Nebo Rd Jolly's Lookout Via Samford on Friday 27 October 1989

- YAESU FT-290R 2M transceiver with Nicads Ser No SF280702
- Telequipment Oscilloscope Mod. S51
- EMTRONICS noise bridge Ser No EM342
- YAESU FT707 WARC HF transceiver with the following:
- YAESU FC-707 antenna tuner Ser No 1N180265
- YAESU FV-707DM external digital VFO Ser No OLO60097
- YAESU FP-707 power supply Ser No 4C050487

Contact owner VK4AAE or your local police station. ar

TRADE PRACTICES ACT

It is impossible for us to ensure the advertisements submitted for publication comply with the Trade Practices Act 1974. Therefore advertisers and advertising agents will appreciate the absolute need for themselves to ensure that the provisions of the Act are complied with **strictly**.

VICTORIAN CONSUMER AFFAIRS ACT

All advertisers are advised that advertisements containing only a PO Box number as the address cannot be accepted without the addition of the business address of the box-holder or seller of the goods.

TYPESETTING : Redfords Media
25 Glenferrie Rd
Malvern 3144
Tel: (03) 500 0377

PRINTING: Industrial Printing
Richmond

MAIL DISTRIBUTION: Polk Mailing Co.
PO Box 140,
Collingwood,
Vic. 3066
Tel:(03) 417 5161

The opinions expressed in this publication do not necessarily reflect the official view of the WIA, and the WIA cannot be held responsible for incorrect information published.

ADVERTISER'S INDEX

Advertising Rates	17
ATN Antennas	17
Callbook	15
Dick Smith Electronics	13
Electronics Australia	IBC
Emtronics	7
Ian J Truscott's Electronic World	43
Icom Australia	OBC, 32,33
Kenwood Electronics Aust.	IFC
Magpubs	29
Stewart Electronic Components ..	27
Transaus	25
VHF Magazine	15
WIA NSW Division	39

TRADE ADS

M Delahunty	62
RJ & US Imports	62

HOW TO JOIN THE WIA

Fill out the following form and send to:

The Membership Secretary
Wireless Institute of Australia
PO Box 300
Caulfield South, Vic 3162

I wish to obtain further information about the WIA.

Mr, Mrs, Miss, Ms:

Call Sign (if applicable):

Address:

.....

State and Postcode:

Radio Amateurs: Have you checked out EA lately?

No doubt most radio amateurs are aware that *Electronics Australia* is by far this country's largest-selling electronics magazine, as well as being its oldest (we began way back in 1922, as *Wireless Weekly*). But have you looked inside the magazine lately?

Remember Jim Rowe, VK2ZLO? Jim used to be Technical Editor, and then Editor – back in the late 1960's and 1970's. You may recall some of the amateur radio and test equipment projects he developed, which proved to be extremely popular. Well, Jim is back at the helm of the magazine, and has been busy giving it a new lease of life.

You'll now find lots of new 'departments' in the magazine, including Solid State Update (with news of new semiconductor devices), Silicon Valley Update (news from the USA) and What's New in Entertainment Electronics. Plus all of your old favourites like Forum, The Serviceman, Circuit and Design Ideas and so on. And of course plenty of 'meaty' technical articles and construction projects.

What about *amateur radio* projects? Well, as you can see there are more of these than before – but but we're very interested in publishing more. So if YOU have developed an exciting amateur radio project, please contact Jim Rowe by writing to him at EA, 180 Bourke Road, Alexandria 2015. Or phone him on (02) 693 6620, to discuss the possibility of publishing it as a contributed article. As well as earning a fee, you'll also be helping to boost interest in amateur radio!

Take a look at the new, rejuvenated *Electronics Australia* – on sale at your newsagent at the beginning of every month. Or subscribe now, by phoning (02) 693 9517 or 693 9515.

FEATURES IN OUR JANUARY ISSUE:

AMATEUR RADIO KITS IN AUSTRALIA & THE USA

The first of two articles by Tom King, VK2ATJ, surveying what's available in kits for radio amateurs both here and overseas. Don't miss it if you're into home brewing!

25 AMP POWER SUPPLY FOR 13.8-VOLT GEAR

Commercial power supplies of this rating cost over \$700, but you can build this one for much less. It's really husky, too...

SIMPLE SM RECEIVER

Another project to encourage more home brewing: a low cost, easy to build FM receiver tuning 50-54MHz, and suitable for use as a tuneable IF.

Electronics Australia

Australia's Top Selling Electronics Magazine

WITH ALL THE FEATURES IN ICOM'S NEW MOBILE TRANSCEIVERS, IT'S A WONDER THEY'RE STILL MOBILE.

ICOM have packed so many functions into the IC228A and IC2400A mobile transceivers, you'd think there was no way you could still make them so compact. (It might explain why nobody else has made a transceiver with so many features).

One of the features both transceivers share is back lit control knobs for visibility in bad lighting conditions.

There are various power outputs across the range, from 25W to 45W.

For novices, the 228A can be reduced to 10W.

The programmed Scan function scans all frequencies between two programmable set frequencies, while the Memory Scan function scans all memory channels except, of course, those you lock out.

Thanks to the pocket beep, you'll never miss a call. By installing a UT-40 Tone Squelch Unit (this is sold separately) the transceiver functions as a pager. When the frequency of a received tone equals the tone frequency you set, a thirty second alarm is emitted over the speaker.

As for monitoring the input frequency when you work a repeater, that's as simple as pushing the Monitor Switch on the front panel to open the squelch and check the frequency.

Every five seconds, Priority Watch in the IC2400A monitors the operating Channel, and one or all memory channels in succession. And that's while you operate! No longer do you have to flip back and forth between frequencies.

While the IC228A has 20 memory channels the more advanced IC2400A has 40, plus two call channels. Each channel stores all the information required to work a repeater.

With the IC2400A there are 20 double-spaced memory channels for 2 metres and 70 cm.

What's more, the IC2400A offers full duplex facility. Which means you can now simultaneously transmit on one band and receive on the other. You never have to wait for a long "over". You have full "break in". In fact, you can talk as easily as talking over the phone.

With all these functions in one small compact mobile, it really is a wonder they're still so compact and mobile.

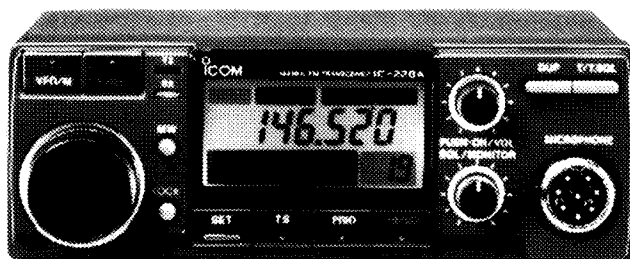

IC228A

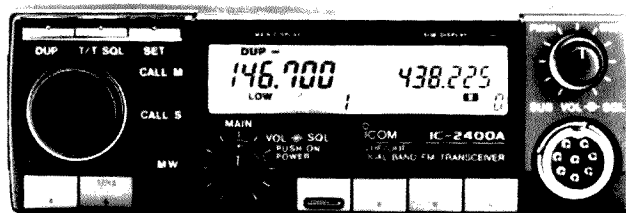

IC2400A

Call ICOM on (008) 338 915 for details on ICOM products and your nearest stockist.
Melbourne callers (03) 529 7582. ICOM Australia Pty. Ltd., 7 Duke Street, Windsor, 3181.

ICOM

AMATEUR RADIO

FEBRUARY 1990

RRP \$3

Special Data
Reference Issue



THE WIA RADIO AMATEUR'S JOURNAL

KENWOOD NEW!



TS-790A ALL-MODE TRIBAND TRANSCEIVER

Work all the upper bands and gain access to the latest communications techniques with the all-new Kenwood TS-790A. This transceiver gives you access to the exotic world of VHF and UHF communications, including Satellite, Moonbounce, Grid-square DX and VUCC. All with legendary Kenwood ease and reliability.

Features include: All-mode Triband coverage: 144-148MHz, 430-450MHz, 1240-1300MHz. USB, LSB, CW, CW(N) and FM • 45 watts output (VHF) • Very high performance GaAs FET RF amplifier for high sensitivity and wide dynamic range • Dual watch function across bands • Band selection/exchange function • Satellite communication frequency correction for uplink/downlink operation • Auto-mode and auto repeater offset • 59 multi-function memories • Call channel function • Repeater Reverse • Memory scroll and shift • Multi-scan functions and much more!!



TM-231A 2M FM MOBILE TRANSCEIVER

This compact mobile transceiver delivers 50 watts of power with the controls at your fingertips.

Features include: • Multi-function microphone with Call, VFO, Memory Recall, and a Programmable key • Large amber display plus illuminated keys • 50:10:5 watts switchable power output • Sensitivity 12dB SINAD/less than 0.16uV • 20 multi-function memories • Programmable call channel • Selectable CTCSS encoder built in • Tone Alert system • Multi-mode scanning (band, programmable band, memory plus programmable band) • Options include remote control and digital recording.

KENWOOD ELECTRONICS AUSTRALIA PTY. LTD.

4E WOODCOCK PLACE, LANE COVE, SYDNEY, N.S.W., 2066
Ph (02) 428 1455 Fax (02) 427 6869
Call now for further information and the name of your nearest
authorised Kenwood dealer.

Please phone, or mail/fax for information

Name _____

Address _____

Postcode _____

Publication _____ Issue _____



Amateur Radio is published by the Wireless Institute of Australia, as its Official Journal on the last Friday of the previous month.

EXECUTIVE EDITOR

Bill Rice VK3ABP

MANAGING EDITOR

Graham Thornton VK3IY

NEWS EDITOR

Jim Linton VK3PC

SENIOR TECHNICAL EDITOR

Peter Gibson VK3AZL

TECHNICAL EDITORS

David Brownsey	VK4AFA
Don Graham	VK6HK
Evan Jarman	VK3ANI
Peter O'Connor	VK4KIP
Gil Sones	VK3AUI
Phil Steen	VK4APA
Roy Watkins	VK6XV

DRAFTING

Vicki Griffin VK3BNK

ADVERTISING

Ann McCurdy

All contributions and correspondence concerning the content of Amateur Radio should be forwarded to: -

The Editor
Amateur Radio
PO Box 300
Caulfield South
VIC 3162

Registered Office

3/105 Hawthorn Road
Caulfield North VIC 3161

Telephone: (03) 528 5962
(03) 523 8191

Fax: (03) 523 8191
(Non dedicated line)

Deadlines

	Editorial	Hamads
March	5/2/90	7/2/90
April	5/3/90	7/3/90
May	9/4/90	11/4/90

CONTENTS

Technical

A Few Tips on the Design of the Noise Bridge6
Lloyd Butler VK5BR

Reference Data

ARRL DXCC Countries List24	Simplex Repeaters.....20
ATV Repeaters21	Standard Frequency Transmissions 15
Band Plans10	Stolen Equipment Register29
Beacons (Aust)21	Television Frequencies24
Broadcast Station Data21	VHF, UHF and SHF Records (Aust)29
Call Sign Suffixes14	VK ZL Aeronautical Beacons 15
Duplex Repeaters 18	WIA Videotape Library31
Emergency (WICEN) Skeds 15	6 Metre Beacons17
International Call Signs27	10 Metre Beacons16
Radio Australia English Schedules .23	14 MHz Beacons15

Operating

Awards - WIA Awards Available42
Contests, Calendar, John Moyle 1990 Rules40

Columns

Advertisers Index64	HF Predictions59
ALARA49	How's DX37
AMSAT46	Intruder Watch56
Club Corner50	Morseword No.3553
Divisional Notes	Over to you - Members' Comments 57
VK2 Notes54	Pounding Brass45
VK3 Notes, 5/8 Wave55	QSLs from the WIA Collection51
VK6 Notes, VK7 AGM56	Repeaters44
Educational Notes53	Silent Keys - Obituary57
Editor's Comments2	Spotlight on SWLing49
EMC Report39	VHF/UHF An Expanding World35
Hamads62	WIA Directory2,3
	WIA News3



Cover

Our Feb cover shows the antenna mast for 2m repeater VK6REX at Exmouth Gulf, and a view from the platform 30 feet from the mast's top. Seriously, VK6REX is sited on Tower Zero at the joint Australia — US Naval Communications Station Harold E Holt near Northwest Cape. At a height of 1,275 feet (389m) it is the highest repeater antenna on a man-made structure in Australia. Ken VK3AJU who took the photos said that he went to the tower top like a lion and came down like a lamb! The view however was magnificent!

Many Hands

Many hands make light work, according to the old proverb. No doubt that the converse also applies, particularly to the activities of the WIA, almost all of which are critically dependent on voluntary effort to get them done. One of the more successful of these activities is WICEN, some of its doings being recorded from time to time in our occasional column of WICEN News.

WICEN really "gets going" in major national disasters such as bushfires and floods, cyclones and now even earthquakes. Until Newcastle a few weeks ago, we thought Australia had some kind of immunity from damaging earthquakes, but now we know better. In any of these emergencies, as soon as regular public communication links are overloaded or interrupted, WICEN may be called into action to provide emergency communications, either local or Australia wide.

Provision of such a volunteer service needs a substantial number of enthusiastic volunteers, having the right kind of equipment available at short notice, and trained in its use according to standard operating procedures.

EDITOR'S COMMENT

BILL RICE VK3ABP EXECUTIVE EDITOR

This is achieved by provision on a regular basis of communications to various charitable or sporting activities. Here in VK3, the Great Victorian Bike Ride, the Red Cross Murray River Canoe Marathon, the Marlay Point Overnight Sailing Race, Walk against Want, and various Fun Runs and car trials are all helped by WICEN communications, and in turn WICEN participants obtain "hands-on" operating experience.

Would you like to be part of such an active and enthusiastic group? Find who your local WICEN area people are, and I'm sure they will welcome you. There are too many names for me to list here, but a few queries around the bands or channels should tell you what you need to know. I hope you can help WICEN more than I've been able to over the last few years. Every time an exercise is programmed, it always seems to clash with an urgent AR job like proof-reading or whatever!

Not only WICEN needs more volunteers. There is an urgent

need for Melbourne-based members of Executive. At least two are needed to take some of the

load off the too-few hands we have now. And someone qualified in accountancy would be more than welcome to fill the vacant position of Federal Treasurer. Few hands make heavy work. We know it only too well, but we'd love to experience the converse. It would be a pleasant change! ar

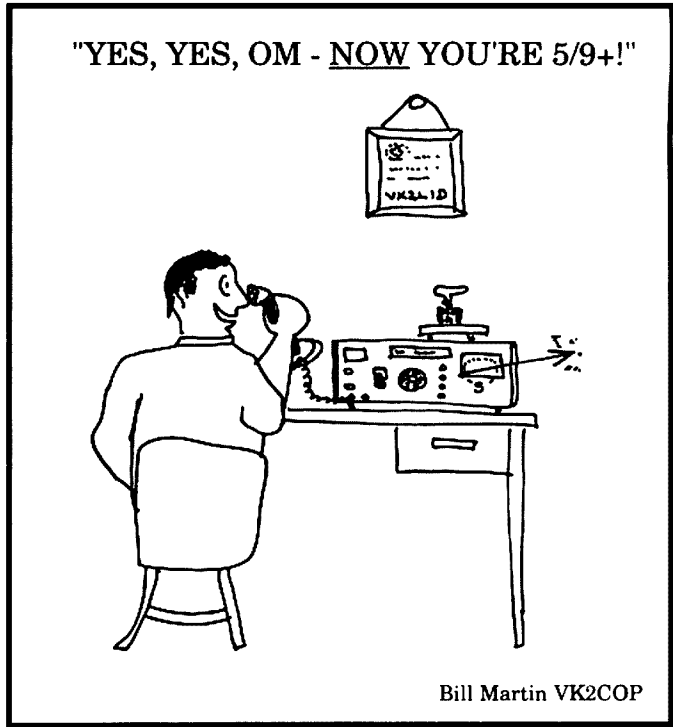

Wireless Institute of Australia

The world's first and oldest National Radio Society - Founded 1910
 Representing Australian Radio Amateurs - Member of the International Amateur Radio Union
 Registered Executive Office of the WIA: 3/105 Hawthorn Road, Caulfield North, Vic, 3161
 All mail to: **PO Box 300, Caulfield South, Vic, 3162** Telephone: (03) 528 5962 (03) 523 8191
 Fax: (03) 523 8191 (Non-dedicated line)

General Manager and Secretary: Bill Roper VK3ARZ

EXECUTIVE

President:	Peter Gamble	VK3YRP	VK1 Federal Councillor:	Kevin Olds	VK1OK
Vice Chairman:	Ron Henderson	VK1RH	VK2 Federal Councillor:	Peter Jeremy	VK2PJ
	George Brzostowski	VK1GB	VK3 Federal Councillor:	Peter Mill	VK3ZPP
	Brenda Edmonds	VK3KT	VK4 Federal Councillor:	David Jerome	VK4YAN
	Bill Rice	VK3ABP	VK5 Federal Councillor:	Bill Wardrop	VK5AWM
Immediate Past President:	David Wardlaw	VK3ADW	VK6 Federal Councillor:	Neil Penfold	VK6NE
			VK7 Federal Councillor:	Joe Gelston	VK7JG

FEDERAL CO-ORDINATORS

Amsat:	Graham Ratcliff	VK5AGR	Int'l Travel Host Exch:	Ash Nallawalla	VK3CIT
Awards Manager:	Ken Gott	VK3AJU	QSL Manager (VK9, VK0):	Neil Penfold	VK6NE
Contest Manager:	Frank Beech	VK7BC	Standards & FTAC:	Rob Milliken	VK1KRM
Education:	Brenda Edmonds	VK3KT	Tapes (Federal News):	Bill Roper	VK3ARZ
EMC:	Hans Ruckert	VK2AOU		Ron Fisher	VK3OM
Historian:	John Edmonds	VK3AFU	Videotape:	John Ingham	VK5KG
Intruder Watch:	Gordon Loveday	VK4KAL	WICEN:	Bill Wardrop	VK5AWM

Reference Issue

Following a practice started last year, this issue of Amateur Radio is the annual "Reference Issue".

In order to incorporate the number of pages required for the data section, the editors have had to cut down in other areas of the magazine.

That includes WIA NEWS!

Amateur Radio Awards

One of the more difficult tasks of the Amateur Radio Publications Committee each year is the selection of the winners of the three magazine awards.

After much deliberation at the

WIA NEWS

BILL ROPER VK3ARZ GENERAL MANAGER & SECRETARY

December meeting of the Committee, the following winners were selected for 1989.

The **Technical Award**, for the best technical article published during the year, was awarded to **Peter Stackpole, VK1RX** for his article "Sporadic E Propagation" that was published in the June issue of Amateur Radio. Peter received a cheque for \$100.00.

The **Al Shaws Smith Journalistic Award**, for the article on a radio theme considered best to display literary merit, was awarded to **Barrie Gillings, VK2DWC**. Barrie's article "They Say It Never Strikes Twice in the Same Place" appeared in the November issue of our magazine,

and he received an engraved wall plaque as well as a cheque for \$100.00.

The **Higginbotham Award**, for meritorious service to amateur radiogenerally, was awarded to **Eric Jamieson, VK5LP** because of his contribution to VHF/UHF. Eric's "VHF/UHF - An Expanding World" column has appeared in Amateur Radio each month over the past 20 years. A cheque for \$100.00 has been presented to Eric.

It is only through the efforts of many members of the WIA, such as these three award winners, that Amateur Radio magazine is such an interesting and informative magazine. Therefore, it is a

pleasure for the WIA to be able to recognise people such as these three in this manner, and tangibly reward their efforts.

Are you going to be eligible for any of these prestigious awards in 1990?

First Devolved Exams

A note from Meg Box, VK5AOV, Secretary of the Adelaide Hills Amateur Radio Society, advises that on Saturday, 25th November 1989, the Adelaide Hills ARS conducted the first amateur radio examinations to be held by a body other than the DoTC.

Congratulations to the two persons who gained their Full Theory, the only successful candidates on this occasion.

WIA DIVISIONS

The WIA consists of seven autonomous State Divisions. Each member of the WIA is a member of a Division, usually their residential State or Territory, and each Division looks after amateur radio affairs within their State.

Division	Address	Officers	Weekly News Broadcasts	1990 Fees
VK1	ACT Division GPO Box 600 Canberra ACT 2601	President Ted Pearce Secretary Jan Burrell Treasurer Ken Ray	VK1AOP 3.570 MHz VK1BR 2m ch 6950 VK1KEN 70cm ch 8525 2000 hrs Sun	(F) \$65.00 (G) (S) \$52.00 (X) \$39.00
VK2	NSW Division 109 Wigram St Parramatta NSW (PO Box 1066 Parramatta) 2124 Phone (02) 689 2417 Fax (02) 633 1525	President Roger Henley Secretary Peter Balnaves Treasurer David Horstfall (Office hours Mon-Fri 11.00 - 14.00 Wed 19.00 - 21.00)	VK2ZIG 1.845 MHz AM, 3.595 SSB (1915 only), 7.146 AM (1045 only) VK2CZX 10.125 SSB (1045 only), 28.320 SSB, 52.120 SSB 52.525 FM 144.12 (SSB), 147.000 FM(R) 438.525 FM(R) VK2KFU 584.750 (ATV Sound) 1281.75FM (R) Relays also conducted via many repeaters throughout NSW.	(F) \$59.00 (G) (S) \$47.00 (X) \$33.00
VK3	Victorian Division 38 Taylor St Ashburton Vic 3147 Phone (03) 885 9261	President Jim Linton Secretary Barry Wilton Treasurer Rob Hailey	VK3PC 1.840 MHz AM, 3.615 SSB, 7.085 SSB, 147.250 FM(R) Mt Macedon, VK3XV 147.225 FM(R) Mt Baw Baw VK3XLZ 146.800 FM(R) Mildura, 438.075 FM(R) Mt St Leonard 1030 hrs on Sunday	(F) \$65.00 (G) (S) \$52.00 (X) \$39.00
VK4	Queensland Division GPO Box 638 Brisbane Qld 4001 Phone (07) 284 9075	President David Jones Secretary John Aarsse Treasurer Eric Fittock	VK4NLV 1.825, 3.605, 7.118, 14.342, 18.132, 21.175, 28.400, MHz VK4QA 52.525 regional 2m repeaters and 1296.100 0900 hrs Sunday VK4NEF Repeated on 3.605 & 147.150 MHz, 1930 Monday	(F) \$65.00 (G) (S) \$52.00 (X) \$39.00
VK5	South Australian Division 34 West Thebarton Rd Thebarton SA 5031 (GPO Box 1234 Adelaide SA 5001) Phone (08) 352 3428	President Don McDonald Secretary Hans van der Zalm Treasurer Bill Wardrop	VK5ADD 1820 kHz 3.550 MHz, 7.095, 14.175, 28.470, 53.100, 145.000, VK5KHZ 147.000 FM(R) Adelaide, 146.700 FM(R) Mid North, 146.900 FM(R) VK5AWM South East, ATV Ch 34 579.00 Adelaide, ATV 444.250 Mid North (NT)3.555, 146.500, 0900 hrs Sunday	(F) \$65.00 (G) (S) \$52.00 (X) \$39.00
VK6	West Australian Division PO Box 10 West Perth WA 6005 Phone (09) 474 2626	President Alyn Maschette Secretary Bruce Hedland Treasurer Thomas	VK6KWN 146.700 FM(R) Perth, at 0930 hrs Sunday, relayed on 3.560, 7.075, 14.115, 14.175, 21.185, 28.345, 50.150, 438.525 MHz Country re- lays 3582, 147.350(R) Busselton 146.900(R) Mt William VK6OO (Bunbury)147.225(R) 147.250 (R) Mt Saddleback 146.725(R) Al- bany 146.825(R) Mt Barker Broadcast repeated on 3.560 at 1930 hrs.	(F) \$56.00 (G) (S) \$45.00 (X) \$30.00
VK7	Tasmanian Division PO Box 1010 Launceston TAS 7250	President Mike Wilson Secretary Bob Richards Treasurer Peter King	VK7ZWW 146.700 MHz FM (VK7RHT) at 0930 hrs Sunday relayed on 147.000 VK7NRR (VK7RAA), 146.750 (VK7RNW), 3.570, 7.090, 14.130, 52.100, VK7ZPK 144.100 (Hobart) Repeated Tues 3.590 at 1930 hrs	(F) \$63.00 (G) (S) \$50.00 (X) \$38.00
VK8	(Northern Territory) is part of the VK5 Division and relays broadcasts from VK5 as shown (received on 14 or 28 MHz).			
Note: All times are local. All frequencies MHz.				
Membership Grades				Three year membership available
Full (F) Pension (G)				to (F) (G) (X) grades at fee x 3
Needy (G) Student (S)				times
Non receipt of AR (X)				

These examinations were authorised for trial purposes under the new syllabus, which is not "official" until 21st February 1990, and DoTC will not issue a certificate or licence before that date.

The Adelaide Hills ARS Examinations Officer, Marshall Emm, VK5FN, reports that he was pleased with the way the examinations went. More details can be obtained from Club Corner in this issue of Amateur Radio.

GM4VIR Receives MBE

Scottish radio amateur Alexander Anderson, GM4VIR, was awarded an MBE in this year's United Kingdom New Years Honours List for his work following the Lockerbie Air Disaster.

GM4VIR was co-ordinator of the regional branch of RAYNET, the amateur radio network, which was highly commended by the regional council for its communications after the crash.

It is great to see this public recognition of the valuable service the amateur service provides in times of disasters and emergencies.

More Articles Needed

As readers of Amateur Radio magazine will realise, the articles published in this journal are almost entirely the volunteer efforts of members of the WIA.

Sometimes the editors are inundated with articles submitted for publication, and that has been the case over the past two years or so. Because of this plentiful supply of articles for publication, many authors have had to wait patiently for up to 12 months before seeing the fruits of their labours appear in print.

At other times, such as now, the reserve of articles is so low that the editors may have to consider reprints from other publications.

Therefore, now is the time for you to do what you had been thinking about for a long time, but kept putting off. Writing that article

for Amateur Radio magazine!

That different piece of equipment that you built and it worked.

That experiment with an antenna that surprised you with its results.

That useful modification you made to a commercial rig.

That exciting or humorous operating experience.

The list is endless! Share your ideas, discoveries and experiences with other amateurs. Feel the excitement of seeing your efforts in print.

Naturally, it would be ideal if your article was submitted to us in the form of a professional manuscript. But only a small percentage of articles is received in that form.

The Publications Committee has a team of competent technical editors to help you in knocking that idea of yours into shape. There is a professional draftsman available to redraw your circuits and diagrams if your drawing skills are below a publishable standard.

Send plenty of photographs with your article, preferably black and white prints, but the editors will consider virtually any style of photograph.

Experience the satisfaction of sharing your experiences and ideas with other amateurs, perhaps win an award, perhaps be republished overseas.

Incidentally, digressing for a moment, I wonder how many readers realise that Amateur Radio magazine is one of the most quoted and reprinted amateur radio magazines in the world. Each month I speed read a large number of amateur radio magazines that the WIA receives from overseas, in an attempt to keep abreast of what is happening in our hobby worldwide. Not a month goes by without me noting at least one reference to, or reprint of, an article originally published in our magazine.

So how about it? Dig out your pens, typewriters and cameras. Inundate the editors with a rush of articles for your magazine.

Special June Issue

As mentioned last month, the June 1990 issue of Amateur Radio magazine will be a special "Test

Equipment" issue. The Editors are looking for articles on construction of test equipment, modification of test equipment, and test procedures for this special issue.

Articles need to be received at this office no later than the middle of March so that the articles can be prepared for publication in the June issue.

A prize will be awarded to the author of the test equipment article which is judged to be the best of those published in this special issue of Amateur Radio magazine. Negotiations are still continuing on just what that prize will be, but it will be very worthwhile.

Have you started writing your test equipment article for June issue of Amateur Radio magazine?

December Front Cover

As anyone who has ever been involved with the publishing of Amateur Radio knows, if the magazine looks great, most readers accept it without comment.

The last few issues of the magazine, which we think are the best published for some time, have produced very little feedback from readers.

However, one of the things that makes the hobby of amateur radio so interesting is that radio amateurs are a very individualistic breed, and cover a broad spectrum of ideas and opinions.

Such was evident with comments received about the front cover of the December 1989 issue.

Many complimentary comments were received about this cover picture. However, we also received a few critical comments.

One comment was most scathing because we did not have a "Christmassy" front cover. Another objected to the "reds and browns" colours predominating as they are "angry and antagonistic colours". Apparently we should only use the "cool" colours of blues and yellows (the January cover was produced before this latter comment was noted). The Amateur Radio colour printing process uses only four colours,

and we do not always get the correct tonal reproduction of colours.

Yet another comment indicated concern that Peter Gamble was holding a cordless telephone and not an amateur handheld transceiver. The intent of this aspect of the photograph was to suggest that nearly all the time Peter used to spend enjoying the operating and construction pleasures of amateur radio is now taken up with the demanding and time consuming business of being Federal President of the WIA.

Incidentally, John Friend, VK3ZAB, the Amateur Radio photographer, takes a great photograph, doesn't he?

A final comment expressed disgust at the creation of a "personality cult" by publishing a photograph of the Federal President on the front cover of the magazine. Let me ask you this question. Did you know who was the President of your organisation before you saw the cover of December Amateur Radio magazine?

How does that saying go? "You can only please some of the people some of the time..."

New Members Computer

The membership database computer is an essential part of the operations of the Executive Office of the WIA. Amongst a host of other tasks it maintains a database of members, prints address labels each month for Amateur Radio magazine, prints subscription reminder notices, processes payment of subscriptions, and combines WIA and DoTC records to produce the Call Book listings.

Many years ago, some of these tasks were done under contract by the Monash University EDP Department. When membership of the WIA grew to the stage where it was economically viable to purchase its own computer, after much deliberation a Cromemco CPM computer was purchased and installed.

This computer has given stirring service for many years, but old age has been catching up with it, and hardware failures were

becoming more of a problem.

The last straw occurred a few months ago when we were advised that support for this computer in Australia was no longer available. This meant that, if certain components failed, there could have been delays of up to six weeks before replacement components were supplied.

After initial discussions involving amounts of about \$25,000 for a replacement computer and programming, the WIA finally purchased a new computer in November that is now up and running. The total cost for this new computer, streaming tape backup, and professional programming finally came to less than \$9,000.

For the information of the computer minded members, the new unit is an IBM clone AT with an 80286 processor running at 26 MHz. It has 1 megabyte of RAM on board, an 80 Mb voice coil hard disk, 1.2 Mb and 360 K floppy drives, a 60 Mb streaming tape cartridge backup unit, and uses a DOS version of Informix 3.3 for most of the membership database related functions.

Probably the most dramatic difference in the new system is that the time for generating the Amateur Radio address label file has been reduced from four hours on the Cromemco to 25 minutes on the AT.

Many of the programs had to be run overnight on the Cromemco. These programs can now be run during office hours, and the computer does not have to be left on each night.

Whereas the Cromemco used to take over five minutes to bring on line from a cold start, the AT can be processing a member query within 60 seconds of switch-on.

Besides this new membership database computer, the three IBM XT clones are still in constant daily use in the Executive Office for wordprocessing, accounting, and a variety of administrative database purposes.

Support Our Advertisers

Any publication such as Amateur Radio magazine depends to a large degree upon its advertis-

ers. As well, the advertisers depend on our magazine.

The WIA is appreciative of the very worthwhile support given to our journal by our advertisers, particularly those advertisers who have been supporting Amateur Radio for many years.

Show your appreciation of these Amateur Radio advertisers by buying all your amateur radio requirements only from them. When you do so, let them know that you also appreciate their continued support for your magazine.

Remember, without these advertisers, Amateur Radio would not survive in its present format.

Member Renewals

If for no other reason, 1989 will be remembered in WIA history as the year when the WIA publicly agonised over the decision to make a quantum increase in the membership fees. The necessity for the fees to "catch-up" arose because the below-CPI increases of the past 10 to 15 years had placed the organisation in a financially difficult situation.

Even so, despite the increase, full membership of most of the Divisions only costs \$1.25 a week; and concessional membership only costs \$1.00 a week.

With the debate that raged in print and on the air for several months, and the resultant changing of decisions, no one can say that the outcome was not the result of much deliberation, anguish and public discussion.

Each year, when the bulk of members subscription renewals become due, generally about 400 members do not renew, but these dropouts are generally compensated for by the new members gained during the year. Some members advise that they are no longer active in amateur radio for a variety of reasons, some find that in determining their financial priorities the WIA has to miss out, and some resign because they are not happy with some aspect of the WIA.

In the past, most membership renewals were received without comment, and most resignations become known simply because of

non-payment of the subscription fee. This year, no doubt because of the long drawn out public debate on the fee increases, it is different. Many members renewing are attaching notes and letters to their remittances. Many more than is usual, of those who are resigning, are letting the WIA know why.

Even though the Executive Office is closed at the time I am writing this, 1619 items of mail have been processed in the past four days. Peter Gamble, the Federal President, and Executive member Brenda Edmonds, have spent two full days in the office this week helping the Executive Office staff in replying to some of these letters.

Many of the letters are encouragingly supportive, such as this one....

"Glad to see that the fee has been raised to be more in line with the professional service that we receive from the WIA.

Amateur Radio can be great fun but could not exist without serious control and representation by WIA, RSGB etc.

Please debit my Visa card with membership \$65.00, donation to funds \$25.50." Others offer several constructive suggestions and criticisms and, regrettably, a couple have been abusive and offensive, such as the ungentlemanly amateur who sent back his renewal notice with "go to hell" scrawled across it. ar

DOTC Interference Investigation Update

The introduction of a \$60 up-front charge by DOTC before it investigates individual complaints of broadcast radio and TV reception difficulties will be introduced soon. A recent amendment to the Broadcasting Act passed by Federal Parliament has cleared the way for DOTC to make a charge before it investigates such complaints.

The background to this move was fully explained in AR magazine last July "Interference, spectrum pollution and reception problems".

DOTC has sent copies of its new booklet "Better Television and Radio Reception: Your Self-held Guide" to about 2500 technicians and antenna installers around Australia. This is aimed to boost their knowledge of the causes of reception difficulties, often mistaken for being the result of interference. The booklet was reviewed in the December edition of AR magazine and is available free from DOTC state offices and district radio inspectors.

Phone Patch Deregulation

The interconnection of radio equipment with Telecom's telephone network has been deregulated, but there is still a requirement to use only approved interconnect devices. Telecom has advised that charges for the interconnection of radiocommunications systems will no longer be levied. This followed a decision made by Austel, the independent regulatory body for telecommunications. Telecom had charged amateur radio stations using phone patch facilities an access charge of \$2 a month.

Approval from Telecom for connection to its network is no longer required. However all radio amateurs are reminded that only authorised interconnection devices can be used for phone patch. Among the permitted equipment is the WIA Amateur to Telecom line isolation unit (LIU) — a homebrew unit which meets the technical standards needed to isolate radio equipment from the telephone line. The WIA is required to test all of the LIU's to ensure they use the correct components and are constructed in accordance with the required standards.

Around 50 LIU's have been built by radio amateurs, and passed for an approval number after the WIA testing procedure.

JIM LINTON VK3PC

ar

A FEW TIPS ON THE DESIGN OF THE NOISE BRIDGE

LLOYD BUTLER VK5BR
18 OTTAWA AVE PANORAMA 5041

Introduction

This is not intended to be a complete presentation on the noise bridge, which has been well described in amateur radio journals and in particular in articles in the March, April and May 1981 issues of Amateur Radio, by Bob Slutzkin VK3SK. The article does present a few ideas which result from my own experimentation with the noise bridge, and discusses a different type of signal source for the bridge.

The Typical Circuit

A typical noise bridge circuit is that of the Palomar model shown in figure 1. In this and most other noise bridges, a continuous wide band spectrum of noise is generated by passing current through a semiconductor diode. The noise is amplified in a number of transistor stages to a suitable level as a source for the AC bridge. The advantage of the wideband noise is that no tunable oscillator is required and measurement of resistance and reactance can be carried out at the frequency desired, without adjustment of the source. Measurements of the resistance and reactance of an antenna system can easily be made at the actual operating frequency of the antenna.

The output of the bridge is detected by a radio receiver tuned to the operating frequency and the bridge is balanced for a minimum in the noise level output of the receiver or for a dip in its 'S' meter reading.

In using the bridge to measure antenna constants, there is often a problem in resolving the precise null point of the bridge because, as the null is approached, the noise from the bridge is masked by incoming noise received by the antenna. The minimum in level of noise from the bridge is more easily identified, in the presence of antenna noise, if the source is heard as an audio tone. A circuit of a bridge signal source, which adds a tone component, has been published in recent issues of the ARRL Handbook and in the October 1987 issue of QST. In this source, the noise is modulated by an NE555 timer, free running at 1000 Hz. According to the QST article, the tone is heard in the presence of noise when adjustment of the bridge approaches the null. In the following text, I will introduce a differ-

ent type of wideband signal source which, when detected, produces a strong audio tone in the receiver output.

A Different Signal Source

For the source introduced, the signal is initiated from a 500 Hz square wave oscillator which switches state at high speed to generate harmonics well into the upper HF spectrum. In a perfect square wave, the harmonics are of odd order so that harmonic frequency components are generated at 1000 Hz intervals of frequency. The amplitude of each harmonic component is inversely proportional to its harmonic order so that the third harmonic component is one third the amplitude of the fundamental component, the fifth harmonic component is one fifth the amplitude of the fundamental component and the 'n'th component is one 'n'th the amplitude of the fundamental component. Given that $\Theta = 2\pi ft$, we can express the fundamental and harmonic components as follows:

$$A = a \cdot \sin \Theta + \frac{a}{3} \sin (3\Theta) + \frac{a}{5} \sin (5\Theta) + \dots + \frac{a}{n} \sin (n\Theta)$$

The first term represents the fundamental frequency and each following term represents a harmonic with its relevant denominator dividing by 3, 5 or 'n' & etc.

If we feed the square wave through a differentiating network, we can represent this operation by mathematical differentiation in the previous expression of A with respect to Θ . The derivative of $\sin (n\Theta)$ is simply $n \cdot \cos (n\Theta)$ and thus our differentiated expression

becomes the following:

$$\frac{dA}{d\Theta} = a \cdot \cos \Theta + 3a \cdot \cos (3\Theta) + 5a \cdot \cos (5\Theta) + \dots + na \cdot \cos (n\Theta)$$

It can be seen that in each harmonic term of the expression, the new multiplier in the numerator cancels out the denominator and therefore all harmonic terms have the same amplitude as the fundamental term.

As demonstrated in the previous paragraph, feeding the square wave output through a differentiating network provides a continuous spectrum of equal amplitude harmonic components spaced at 1000 Hz intervals. The network is a simple circuit of series capacitance and shunt resistance and in achieving differentiation, all frequency components are attenuated to the same very low level as that of the highest frequency component. Because of the low level, considerable amplification is needed, following the differentiating network, to raise the level sufficiently to operate the bridge. The system of square wave generation, differentiation and amplification, as a source to feed the bridge, is shown in the block diagram, figure 2.

To carry out the functions described, a single High Speed CMOS Hex Inverter Type 74HCO4 is used as shown in figure 3. The reason for using a CMOS device will be explained when amplification is discussed. The high speed version was selected to handle frequencies well into the high frequency end of the HF band. Inverter sections A and B are used in an astable multivibrator circuit which generates the 500 Hz square wave. Inverter C is a buffer stage which drives the differentiating network C5-R5, the output of which feeds an operational amplifier type of circuit made up of inverters D, E and F.

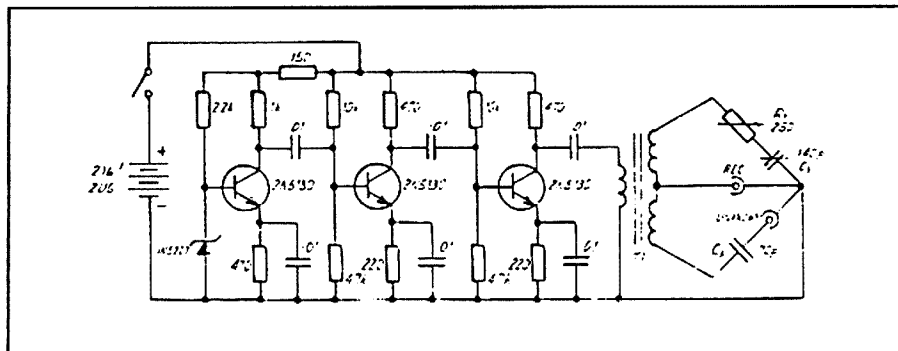

Figure 1 Palomar noise bridge using diode as noise source

Radio Amateurs: Have you checked out EA lately?

No doubt most radio amateurs are aware that *Electronics Australia* is by far this country's largest-selling electronics magazine, as well as being its oldest (we began way back in 1922, as *Wireless Weekly*). But have you looked inside the magazine lately?

Remember Jim Rowe, VK2ZLO? Jim used to be Technical Editor, and then Editor – back in the late 1960's and 1970's. You may recall some of the amateur radio and test equipment projects he developed, which proved to be extremely popular. Well, Jim is back at the helm of the magazine, and has been busy giving it a new lease of life.

You'll now find lots of new 'departments' in the magazine, including Solid State Update (with news of new semiconductor devices), Silicon Valley Update (news from the USA) and What's New in Entertainment Electronics. Plus all of your old favourites like Forum, The Serviceman, Circuit and Design Ideas and so on. And of course plenty of 'meaty' technical articles and construction projects.

What about *amateur radio* projects? Well, as you can see there are more of these than before – but but we're very interested in publishing more. So if YOU have developed an exciting amateur radio project, please contact Jim Rowe by writing to him at EA, 180 Bourke Road, Alexandria 2015. Or phone him on (02) 693 6620, to discuss the possibility of publishing it as a contributed article. As well as earning a fee, you'll also be helping to boost interest in amateur radio!

Take a look at the new, rejuvenated *Electronics Australia* – on sale at your newsagent at the beginning of every month. Or subscribe now, by phoning (02) 693 9517 or 693 9515.

Electronics Australia

Australia's Top Selling Electronics Magazine

FEATURES IN OUR FEBRUARY ISSUE:

AMATEUR RADIO KITS IN AUSTRALIA & THE USA

Second part of our survey by Tom King, VK2ATJ, looking at what's available in kits for radio amateurs both here and overseas. Don't miss it if you're into home brewing!

ANTENNA TEST RANGE USES MODEL SHIPS

How do you work out how an antenna will perform on a Navy ship, surrounded by a forest of assorted metalwork? Australian Defence Industries uses a fancy modelling range...

12/30V CONVERTER

Like to use our simple 2m NBFM transmitter in a car? Here's a simple, low cost 12/30V converter to allow this to be done.

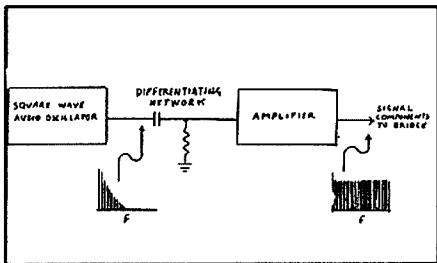

Figure 2 Wideband signal source produced from differentiated audio square wave

Operation of the amplifier requires further explanation. Use of CMOS inverters for linear amplification was described in Dick Smith Electronics publication *Experimental Electronics* (Aug-Sept, 1984). If negative feedback is applied from the complementary output stage of a CMOS inverter back to its input gate, the output stage operating point centres at a potential between that of its two supply rails and the inverter can operate in a linear mode. The feedback can be applied across one inverter or three inverters for correct phasing. It is important that, as far as DC potentials are concerned, the input gate must float and this is the purpose of C8 in my circuit. The three inverters are connected in tandem to form an operational amplifier type circuit in conjunction with R4 and R6. The resistance ratio of these resistors determines the low frequency gain.

The Dick Smith publication made no reference to the high speed version of CMOS but I soon discovered that, connected as a linear amplifier, this version had a great desire to oscillate in its own right around 50 to 100 MHz. To "tame the beast" and prevent a response peak at high frequencies, components C4, R7, L1 and C7 were added.

The discussion has evolved around a perfect 500 Hz square wave oscillator with only odd harmonic components which, when they beat together in an AM detector, produce 1000 Hz tone. In practical operation, the oscillator shown delivers quite a high level of even harmonics which beat with the odd order harmonics to produce 500 Hz. The audio tone thus sounds more like a 500 Hz tone with composite harmonics.

One aim in designing the circuit was to provide the complete signal source with the one only integrated circuit package shown. This aim was not quite achieved. My original home built noise bridge used the diode noise source based on the type of circuit shown in figure 1. The new tone based source proved to have lower level output than the original noise source and I corrected this level anomaly by feeding the new source through the last transistor amplifier stage of the original noise source. This transistor stage is shown in figure 3 as part of the new complete circuit diagram.

A characteristic of this type of signal source

is that, when detected by a radio receiver, the receiver must be set up for AM detection to hear tone. If the receiver is set for single sideband operation with a beat oscillator, noise is heard but not tone. The same characteristic applies to the modulated noise type of signal source which was discussed earlier.

The Bridge Coupling Transformer

Some care has to be taken in making the coupling transformer which must have an accurately balanced secondary to feed the two halves of the bridge. A 9mm toroidal core, with a primary winding of 10 turns and two secondary windings of 10 turns, does the job nicely. Ferrite material with a permeability around 120 is suitable but this is not critical. To obtain high coupling efficiency in such a transformer, it is normally necessary to wind the primary and secondaries together in multifilar form, that is, the three winding wires are first twisted together and then wound on the core as one. Unfortunately, this results in a high capacitance between the primary and secondaries and as the primary is unbalanced, the secondary windings have a reflected capacitance unbalance.

The primary to secondary capacitance can be reduced by winding the primary on one side of the toroidal core and bi-filar winding the secondaries on the opposite side. This is illustrated in figure 4. Unfortunately, this method of winding introduces a high leakage inductance which is reflected back in series with the primary and causes some signal loss. For this particular application, the signal loss is a worthwhile trade-off to reduce capacitance unbalance in the secondaries.

Bridge Components

A general circuit arrangement for the bridge is included in figure 3. Actual capacitance

values are not critical as precision is defined by calibration after construction. The main requirement is that the fixed capacitor in series with the 'unknown' has a value near half the maximum capacitance of the variable capacitor in the opposite bridge arm. This ensures that balance for zero reactance at the 'unknown' occurs near the centre of the variable capacitor tuning range and that both positive and negative reactance at the 'unknown' can be balanced either side of the zero.

Because antenna feeder systems are normally arranged to reflect low values of antenna resistance, a low resistance non inductive potentiometer is required to provide good resolution in the variable resistance section of the bridge. Obtaining a suitable potentiometer can be a problem. My original bridge used a 1000 ohm carbon potentiometer with a logarithmic scale and the expanded part of that scale was used to give fine resolution of the low values of resistance. This potentiometer eventually became noisy and I replaced it with a good Allen Bradley 100 ohm linear carbon potentiometer which I had luckily obtained. To extend the range above 100 ohms, I connected in series a small rotary switch which selected one, or any number up to seven, additional 100 ohm resistors. This provided an adjustable range of 0 to 800 ohms. In figure 3, the variable resistance is represented by R12 shown for simplicity as a single resistance.

Assembly

There are several inexpensive boxes made of light gauge aluminium which are distributed by Dick Smith Electronics. The smallest of these nicely houses the noise bridge unit. The potentiometer, variable capacitor, battery switch and connectors for the 'unknown' and the receiver input, must be accessible and are mounted on the box itself. The remainder of the components can be fitted on vero or other type of blank circuit board which is fitted inside the box. The unit is powered by a 9V battery. It is a good idea to wire in an LED

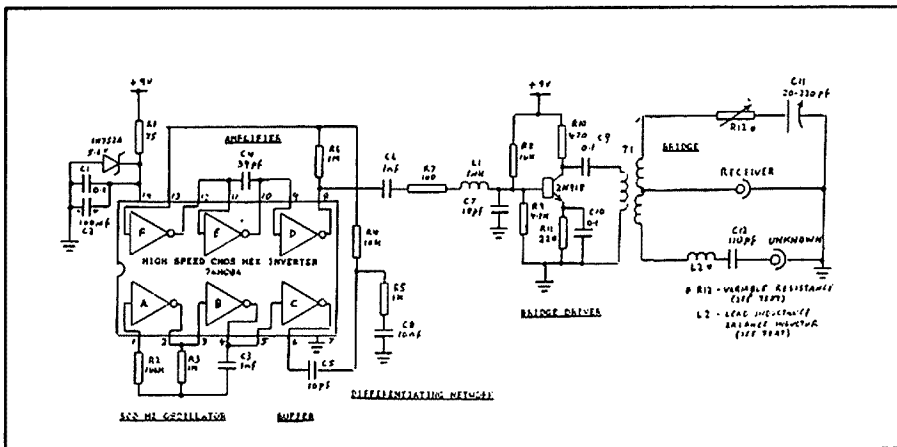

Figure 3 Bridge with wideband signal source to produce a tone on AM demodulation

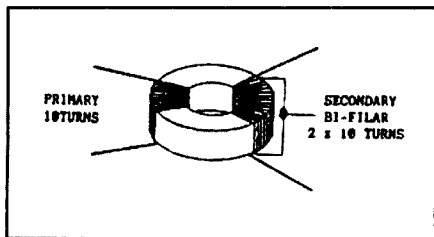

Figure 4 Method of winding primary & secondary on toroidal core

indicator across the power rails to draw attention to the battery load being on. I find that batteries often have to be replaced because I forget to turn equipment off rather than because of extended usage!

Wiring leads in the bridge circuit should be kept as short as possible to minimise lead inductance although it is difficult to avoid some long leads in connecting up the potentiometer and the variable capacitor.

Lead Inductance In The Bridge Arms

Wiring leads in the bridge arm containing the potentiometer and the variable capacitor are likely to be much longer and have much higher inductance than those in the bridge arm containing the connector for the 'unknown'. If the reactance zero setting is to be at the same point on the calibration scale for all frequencies, the inductance in the 'unknown' bridge arm must be increased by lump inductance to make the inductance in both arms equal. I was able to achieve this by adding a small coil of 22 gauge tinned copper formed around a knitting needle. In my own case, the adjustable bridge arm had been complicated by the variable resistance arrangement and had accountable inductance.

To trim the coil, I started with about 12 turns which over-compensated the circuit. Turns were trimmed off until the zero reactance point of the variable capacitor was identical for the extreme frequencies of 2 MHz and 30 MHz. (This was done with a 50 ohm resistance across the 'unknown' terminals and the variable resistance set for balance of the 50 ohms.)

Calibration

Calibration of the variable resistance arm of the bridge is a necessary requirement but is quite easy to carry out. Calibration of the variable capacitance to provide a reactance scale is not quite so straight-forward. If the use of the bridge is only to match up the antenna tuner to reflect 50 ohms resistance to the transmitter, calibration of the capacitance scale might not be needed.

The scale of the variable resistance arm can be calibrated by direct measurement of

the potentiometer resistance using a standard DC or low frequency AC resistance bridge or using a digital multimeter set to the ohms scale. The ohms scale of a moving coil multimeter can also be used but this should first be checked against some reference fixed resistors so that correction for any inaccuracy can be made. (Moving coil multimeters are not renowned for their high accuracy on the ohms scale.)

Another method of calibrating the variable resistance scale is to operate the bridge at a normal HF operating frequency and substitute different values of fixed resistor connected as the 'unknown'. In this case, as for normal operation of the bridge, both resistance and capacitance variables are adjusted for a noise null. The capacitance null is the adjustment for zero reactance and from this adjustment, the zero point can be marked on the reactance scale. The resistance scale is marked as defined by the substitution resistors, any additional AC resistance component in the bridge circuit is taken into account and if carried out at extremes of frequencies, it can show up any AC resistance component which varies with frequency. If a good quality carbon or cermet potentiometer is used, this should not occur.

The general practice in noise bridges has been to calibrate the variable capacitor in terms of plus and minus capacitance, as referred to the zero reactance point and provide a calibration curve of reactance at 1 MHz against capacitance. For my own bridge, I thought it was a better idea to eliminate the calibration curve and mark the dial calibration directly in values of reactance at 1 MHz.

To calibrate the reactance scale, the receiver is set to 1 MHz and inductors and capacitors in a range of fixed values are substituted in turn as the 'unknown'. The inductors used set points of positive reactance and capacitors used set points of negative reactance. Using the inductors, both the variable capacitance and variable resistance are ad-

justed for a null. The variable resistance is needed to balance the loss resistance of the inductor. Using the capacitors, the variable resistance is set to zero, assuming negligible resistance loss in the capacitors.

Tables A and B list preferred values of inductors and capacitors which individually, or in combination with others, give a reactance at 1 MHz close in value to suitable incremental calibration marks. Fixed inductors are not usually a plentiful item in the radio shack and hence the inductors have been restricted to four different values which, in some cases, are series connected to obtain the reactance required. The error factors in using the precise preferred values are also given in the tables. In using 'off the shelf' inductors and capacitors, with a given manufacturer's tolerance, a general accuracy of 10% might be expected. For the purpose of tuning up antennas, this accuracy is probably adequate.

Some Final Remarks

The noise bridge is a very useful addition to the radio shack to assist in matching the aerial system and to determine what impedance components are seen looking into the antenna feeders. It is a simple device which can easily be built by the most inexperienced radio amateur. In its testing and calibration, it is an excellent device for the novice to get the feel of what AC resistance and reactance is all about. It can be calibrated by simple substitution of 'off the shelf' resistors, capacitors and inductors so that other test equipment is not needed.

In providing a few tips on the noise bridge, I have introduced a new idea for a wideband signal source which demodulates as an audio tone rather than wideband noise. Perhaps others, who already have a noise bridge, might like to experiment with this idea. ar

Table A

Selection Of 'Off The Shelf' Inductors

Calibration Reactance ohms	Preferred Inductor Value μH	% Error
100	15	6% low
200	33	4% high
300	47	1.6% low
400	47 + 15	3% low
500	47 + 33	0.5% high
600	47 + 33 + 15	0.6% low
700	100 + 15	3% high
800	100 + 33	4% high
900	100 + 47	3% high
1000	100 + 47 + 15	2% high

Table B

Selection Of 'Off The Shelf' Capacitors

Calibration Reactance ohms	Preferred Capacitor Value pF	% Error
100	1500	6% high
200	820	3% low
300	560	5% low
400	390	2% high
500	330	3% low
600	270	2% low
800	200	0.5% low
1000	150	6% high
1500	110	3.5% low
2000	82	3% low
3000	56	5% low

WIA 1990 DATA LIST

BRUCE R KENDALL VK3WL DATA EDITOR

The following information has been compiled as a service to members. The contents came from various sources and our thanks must go to those who contributed. Information has been checked as correct at the time of compilation, but some errors will be inevitable. Should any individual, group or organisation have amendments or suggestions for further data editions these will be most welcome and should be addressed to: Data Information Update, WIA Executive Office, PO Box 300, Caulfield South Vic 3162. Only by this type of feedback can we hope to maintain an up-to-date and accurate data base.

Band plans for the Amateur Radio Service

1. The MF Band

- 1.1 The 1.8 MHz Band (160 Metres)
1.800 - 1.875 MHz

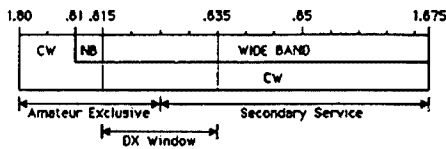

1.870 +/- 4kHz
Avoid these frequencies

2. The HF Bands

- 2.1 The 3.5 MHz Band (80 Metres)
3.500 - 3.700 MHz and
3.794 - 3.800 MHz

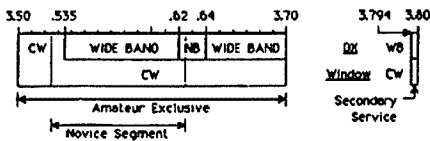

3.794 +1kHz
Avoid these frequencies

- 2.2 The 7 MHz Band (40 Metres)
7.00 - 7.300 MHz

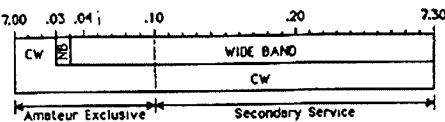

- 2.3 The 10MHz Band (30 Metres)
10.100 - 10.150 MHz

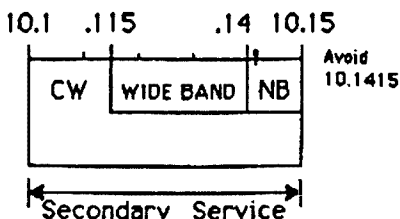

10.1415 +/- 4 kHz
Avoid these frequencies

- 2.4 The 14 MHz Band (20 Metres)
14.000 - 14.350 MHz

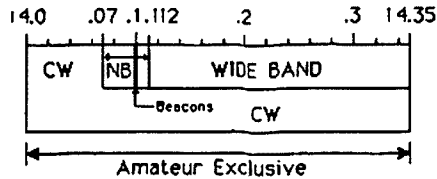

- 14.100 +/- 500 Hz Beacon Guard Band
14.230 SSTV calling frequency
14.250 FAX calling frequency
14.095 - 14.112 Packet Radio (NB:
Avid beacons 14.100)

- 2.5 The 18 MHz Band (17 Metres)
18.068 - 18.168 MHz

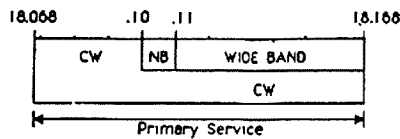

- 2.6 The 21 MHz Band (15 Metres)
21.00 - 21.450 MHz

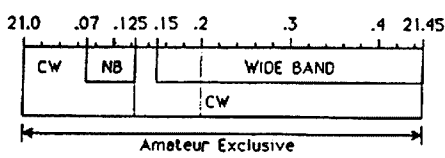

- 21.150 +/- 500 MHz IBP Beacon Guard Band
21.340 +/- 5 kHz SSTV

- 2.7 The 24 MHz Band (12 Metres)
24.890 - 24.990 MHz

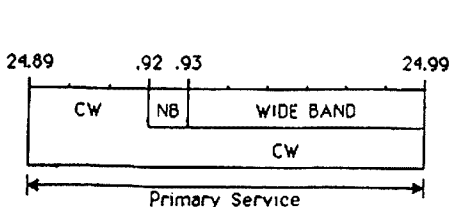

- 2.8 The 28 MHz Band (10 Metres)
28.000 - 29.700 MHz

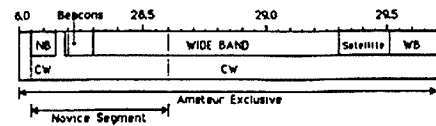

- 28.190 - 28.200 IBP Beacon Segment
28.200 - 28.300 Existing Beacons until 1 Jan 1990
28.680 +/- 5 kHz SSTV
29.300 - 29.510 Satellite Down Link
29.510 - 29.700 Wide Band (FM)
29.520 - 29.580 FM Repeater Inputs (Note 1)
29.600 FM Simplex
29.620 - 29.680 FM Repeater Outputs (Note 2)

Note: 1

Four repeater channels have been allocated, spaced at 20 kHz with 100 kHz offset.

3 The VHF Bands

- 3.1 The 50 MHz Band (6 metres)

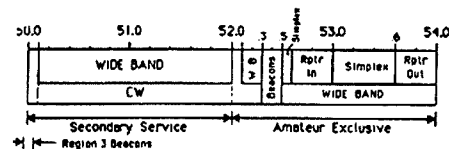

- 50.000 - 52.000 Restricted use segment (Note 1)
50.000 - 50.100 CW
50.000 - 50.010 EME
50.100 - 52.000 CW/Phone
50.110 DX Calling Frequency
52.000 - 52.010 EME
52.010 - 52.050 DX CW
52.025 CW calling frequency
52.050 MS calling frequency
52.050 - 52.100 DX CW/Phone
52.075 RTTY calling frequency
52.100 Phone calling frequency (primary)
52.100 - 52.300 CW/Phone
52.200 Phone calling frequency (secondary)
52.300 SSTV calling frequency
52.300 - 52.400 Beacons - secondary (Note 3)

SCOOP PURCHASE

Huge Savings on the FT-767GX All Mode Transceiver!



HF, 2m, 6m and 70cm

The FT-767GX is the **only** transceiver that offers such a high level of performance on all the H.F. bands, as well as on the 6M, 2M, and 70cm bands! A vast array of both 'operator convenience' and 'DX improving' controls are provided by the 2 microprocessors, while attention to detail in the RF circuitry provides up to 104dB receiver dynamic range (in CW-narrow mode), and transmitter 3rd order I.M.D. of -35dB (at 100W output, 14MHz). Compare the following features with any other radio.

- All band coverage from 1.8 to 440MHz (100W max H.F., 10W max VHF/UHF)
- All modes - SSB, CW, FM, AM, FSK (on HF, VHF, and UHF)
- Upconverting triple conversion H.F. receiver covering 100kHz to 30MHz, with choice of RF amplification or direct mixer feed.
- Heavily optioned - inbuilt 600Hz CW filter, inbuilt 6kHz AM filter, RF speech processor, I.F. notch and I.F. shift filters, inbuilt heavy duty AC power supply, inbuilt automatic H.F. antenna tuner, high stability PLL (+/- 3ppm), data IN/OUT sockets for packet T.N.C. connection, all mode squelch.

- Revolutionary facilities include a digital wattmeter and auto calculating SWR meter (for HF, VHF, and UHF!), programmable tuning steps for each mode (from 10Hz to 99.9kHz!), and a front panel TX shift control which allows the operator to adjust the carrier point of the SSB transmit signal to suit his voice characteristics! A large digital display, and keyboard frequency entry are, of course, standard features.

- **2 Year Warranty**, the longest in the industry!
- **BONUS MH-1 hand mic**

See ARA reviews,
Vol. 12 issues 6
and 7.
D-2935

\$3495

SAVE \$500!

Limited stocks!



YAESU STOCKS NOT HELD AT ALL STORES. PLEASE CONTACT YOUR LOCAL STORE FOR STOCK AVAILABILITY, OR ORDER BY PHONE...

• NSW - Albury 21 8399 • Bankstown Square 707 4888 • Blacktown 671 7722 • Campbelltown (048) 27 2199
 • Chittwood Chase 411 1955 • Chullora 842 9922 • Gerra Hill 439 5311 • Gosford 25 0235 • Hornsby 477 8633
 • Hurville 580 8622 • Liverpool 600 9888 • Maitland 33 7866 • Miranda 525 2722 • Newcastle 81 1898
 • North Ryde 88 3855 • Parramatta 889 2188 • Penrith (047) 32 3400 • Raby Square 211 3777 • Sydney City
 267 9111 • Tarragong 66 1711 • Warringah Mall 905 0441 • Wollongong 28 3800 • ACT • Fyshwick 80 4944
 • VIC • Ballarat 31 5433 • Bendigo 43 0388 • Box Hill 890 0699 • Coburg (03) 383 4455 • Dandenong 794 9377
 • East Brighton 592 2386 • Essendon 379 7444 • Footscray 689 2055 • Frankston 783 9144 • Geelong 43 8866
 • Melbourne City 326 8088 • Richmond 428 1614 • Ringwood 879 5338 • Springvale 547 0522 • QLD
 • Brisbane City 229 9377 • Brisbane 391 6233 • Cairns 311 515 • Chermside 359 6255 • Redbank 288 5599
 • Rockhampton 27 9644 • Southport 32 9853 • Toowoomba 38 4300 • Townsville 72 5722 • Underwood
 341 0844 • BA • Adelaide City 232 1200 • Bevanley 347 1900 • St. Marys 277 8977 • Elizabeth 255 6099
 • Enfield 260 6088 • WA • Cannington 451 8666 • Fremantle 335 9733 • North Perth 328 8944 • Perth City
 481 3261 • Midland 250 1460 • TAS • Hobart 31 0800 • NT • Stuart Park 81 1977

ORDER BY PHONE TOLL FREE (008) 22 6610

DICK SMITH
ELECTRONICS

52.400 - 52.500	Beacons - primary (Note 3)	144.20	Phone calling (secondary)	434.275 - 434.975	FM repeater inputs
52.500 - 52.600	General all modes	144.30	SSTV calling	435.000 - 438.000	Satellites
52.525	International FM Calling	144.40 - 144.50	Beacons-primary (Note 3)	438.025 - 439.975	FM repeater outputs & simplex
52.600 - 54.000	FM simplex and repeaters (Note 2)	144.50 - 144.60	Beacons-secondary (Note 3)	438.025 - 438.725	FM repeater
52.600 - 52.975	Repeater inputs - allocated two/state	144.800 - 144.900	Data Transmission	438.025	Mobile voice (secondary)
53.000 - 53.400	General all modes	144.925 - 144.975	CW Beacons	438.125	RTTY
53.400 - 53.575	Simplex frequencies	145.700 - 146.000	Satellite Segment	438.175	Mobile voice (secondary)
53.500	National FM calling	146.450	Primary voice	438.225	Mobile voice (secondary)
53.600 - 53.975	Repeater outputs	146.500	National calling (primary)	438.275	WICEN portable
		146.600	RTTY	438.325	Mobile voice
		147.300	ATV Liaison	438.375	Mobile voice (secondary)
		147.325	RTTY	438.425	Mobile voice
		147.350	RTTY	438.475	Mobile voice
		147.400	ATV Liaison	438.525	Mobile voice (national primary)
		147.425	ATV Liaison	438.575	Data
		147.450	ATV/SSTV/FAX	438.625	WICEN portable
		147.475	SSTV/FAX Liaison	438.675	Mobile voice (secondary)
		147.500	National calling (secondary)	438.725	RTTY
		147.550	Micro nets	438.750 - 439.250	FM simplex
		147.575	Data nets	438.775	RTTY
		147.600	Data packet	438.800	WICEN

Notes:
 1) DOC provided the conditions for use of 50-52 MHz in a revision to DOC71 as follows:

Amateur stations are permitted to operate within this band subject to the conditions set out below:

- (i) No interference is caused to the reception of channel 0 transmissions;
- ii) In New South Wales, Victoria, Queensland and Tasmania operation is restricted to:
 - (a) the sub-band 50.05 to 50.20 MHz;
 - (b) locations outside the following minimum radial distances from:
 - Television channel 0 main stations 120 km
 - Television channel 0 translators stations 60 km
 - Television translator stations with channel 0 inputs 60 km

(c) emission mode 200HA1A with a maximum transmitter power of 100 watts pY; and

(d) emission mode 4K00J3E with a maximum transmitter power of 100 watts pX.

(iii) In the Australian Capital Territory operation is restricted to:

- (a) the sub-band 50.05 to 50.20 MHz;
- (b) emission mode 200HA1A with a maximum transmitter power of 100 watts pY; and

(c) emission mode 4K00J3E with a maximum transmitter power of 100 watts pX.

2) The repeater split is 1 MHz and channel spacing 25 kHz.

3) The beacon frequencies are allocated in accordance with the beacon plan on a state basis (ie VK1, 52.410; VK2, 52.420 MHz etc).

Notes:
 1) FM channels spacing is 25 kHz and repeater offset is 600 kHz.

Note 2:
 2) FM channel numbers designated by last four digits of (repeater output) frequency.

3) The beacon frequencies are allocated in accordance with the beacon plan on a state basis.

4 The UHF Bands

The 420 MHz Band (70 centimetres)

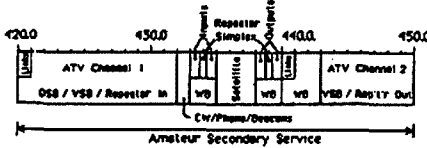

420.0 - 450.0 MHz	
420.00 - 432.00	ATV channel, 1 DSB/VSB
426.25	Vision
431.75	Sound
420.05 - 421.00	Repeater linking - A pairs (Note 4)
432.00 - 432.01	DX EME
432.01 - 432.025	DX CW
432.025	Calling frequency
432.025 - 432.050	DX MS
432.050	Calling frequency
432.050 - 432.075	DX RTTY
432.075	Calling frequency
432.075 - 432.100	DX Phone
432.100	Calling frequency (primary)
432.100 - 432.200	Phone
432.200	Calling frequency (secondary)
432.200 - 432.300	SSTV
432.300	Calling frequency
432.300 - 432.400	CW/Phone
432.400 - 432.600	Beacons (Note 5)
432.600 - 433.000	General all modes
433.025 - 434.975	FM repeater inputs & simplex
433.025 - 433.725	FM repeater inputs
433.750 - 434.250	Simplex

Notes:
 1) FM channel spacing is 25 kHz and repeater offset is 4 MHz.

2) FM channel numbers designated by last four digits of (repeater output frequency).

3) FM channels with no specific recommended use may be used for any purpose.

4) A pair of frequencies are to be used for repeater linking. Maximum power for inter repeater linking is 5 watts.

5) The beacon frequencies are allocated in accordance with the beacon plan on a state basis.

3.2 The 144 MHz Band (2 metres)
 144.0 - 148.0 MHz

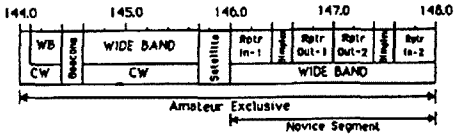

144.0 - 144.01	EME
144.01 - 144.05	DX CW
144.025	CW calling
144.050	MS calling
144.05 - 144.10	DX CW/Phone
144.075	RTTY calling frequency
144.10	Phone calling (primary)

432.200 - 432.300	SSTV
432.300	Calling frequency
432.300 - 432.400	CW/Phone
432.400 - 432.600	Beacons (Note 5)
432.600 - 433.000	General all modes
433.025 - 434.975	FM repeater inputs & simplex
433.025 - 433.725	FM repeater inputs
433.750 - 434.250	Simplex

4.2 The 576 MHz Band (50 centimetres)	576.0 - 585.0 MHz
	Only existing ATV repeaters will be permitted in this band
	578.00 - 585.00 ATV, VSB or repeater output
	579.25 Vision carrier
	584.75 Sound carrier

4.3 The 1240 MHz Band (23 centimetres)
1240.0 - 1300.0 MHz

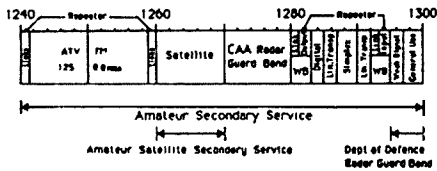

Frequency (MHz)	Details
1240.00 - 1241.00	FM Relays and Links (Note 3)
1241.00 - 1259.00	ATV Channel
1259.00 - 1260.00	FM Relays and Links (Note 3)
1260.00 - 1270.00	Satellite Communication (WARC 1979)
1270.00 - 1280.00	General use except in areas where these frequencies are in use for Radio Location (Note 4)
1280.00 - 1281.00	FM Relays and Links (Note 3)
1281.05 - 1283.00	FM Repeater outputs
1281.05	RTTY
1281.10	Mobile voice
1281.15	RTTY
1281.20	Mobile voice
1281.25	Data
1281.30	Mobile voice
1281.35	Data
1281.40	Mobile voice (secondary)
1281.45	
1281.50	Mobile voice (primary)
1281.60	Mobile voice (secondary)
1281.65	Mobile voice
1281.70	Mobile voice
1281.80	Mobile voice
1281.85	ATV Liaison
1281.90	Mobile voice
1281.95	ATV Liaison
1282.00	Mobile voice
1282.10	Mobile voice
1282.15	RTTY
1282.20	Mobile voice
1282.25	RTTY
1282.30	Mobile voice
1282.35	Data
1282.40	Mobile voice
1282.45	Data
1282.50	Mobile voice
1282.60	Mobile voice
1282.70	Mobile voice
1282.80	Mobile voice
1282.90	Mobile voice
1283.00	Mobile voice
1283.00 - 1285.00	Digital and Packet Radio
1285.00 - 1287.00	In-band Linear Transponder
1287.00 - 1290.00	General use FM Simplex
1288.50	National FM Simplex Calling Frequency
1290.00 - 1292.00	In-Band and Cross Band Linear Transponder

1292.00 - 1293.00	FM Relays and Links (Note 3)
1293.00 - 1295.00	FM Repeater inputs
1295.00 - 1297.00	Weak signal modes, except in areas where these frequencies are in use for Radio Location (Note 4)
1296.40 - 1296.59	Beacons (Note 5)
1297.00 - 1300.00	General use except in areas where these frequencies are in use for Radio Location (Note 4)

Notes:

- 1) FM channel spacing is 25 KHz and repeater offset is 12 MHz.
- 2) FM channels with no specific recommended use may be used for any purpose.
- 3) A pair of frequencies are to be used for repeater linking. Maximum power for inter-repeater linking is 5 watts.
- 4) In Australia, some Department of Aviation RADAR's are centered on 1275.0 MHz and 1305.0 MHz, while some Department of Defence RADAR's are centered on 1300.0 MHz. Accordingly the frequencies 1270.0 to 1280.0 MHz and 1295.0 to 1300.0 MHz are allocated as a guard band to ensure no harmful interference is caused to the primary user.
- 5) The beacon frequencies are allocated in accordance with the beacon plan on a state basis.

4.4 The 2300 MHz Band (13 centimetres)
2300.0 - 2450.0 MHz

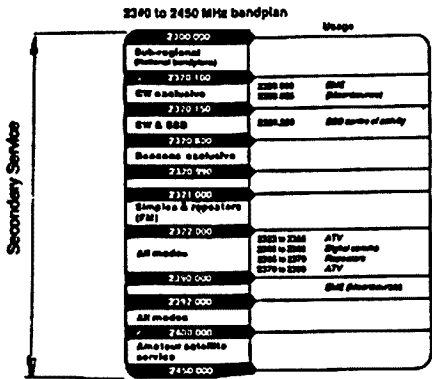

2300.000 - 2320.100 MHz	General use
2320.100 - 2320.150	CW
2320.000	EME (moon-bounce)
2320.025	EME (moon-bounce)
2320.150 - 2320.800	CW & SSB
2320.800 - 2320.990	Beacons
2320.990 - 2321.000	General use
2321.000 - 2322.000	Simplex & repeaters FM
2322.000 - 2390.000	All modes
2322 - 2355	ATV
2355 - 2365	Digital comms
2365 - 2370	Repeaters
2370 - 2390	ATV
2390.000 - 2392.000	EME (moon-bounce)
2392.000 - 2400.000	All modes

MFJ VHF/HF PACKET RADIO CONTROLLERS

- Now with:
- Easy Mail
 - WeFax
 - KISS
 - 32K RAM

With the MFJ1270B You get more features than any other packet controller — the new Easy Mail Personal Mailbox, HF/VHF Modems, WeFAX reception, KIS, and a one year unconditional guarantee and more for only \$299 including sales tax Plus Freight \$12 with-in Australia



You can double your fun by operating both VHF and HF packet because you get high performance switchable VHF/HF modems.

You get the Easy Mail™ Personal Mailbox with soft-partitioned memory so you and your ham buddies can leave messages for each other 24 hours a day.

In MFJ's new WeFAX mode you can print full fledged weather maps to screen or printer and save to disk using an IBM compatible or Macintosh computer with an MFJ Starter Pack.

A new KISS interface lets you run TCP/IP. They also come NET ROM compatible -- no modification needed!

You also get 32K RAM, a one-year unconditional guarantee and you can use 12 VDC or the included 110 VAC power supply.

For dependable HF packet tuning, the MFJ-1274 gives you a high resolution tuning indicator that's accurate to within 10 Hz -- and it's only \$50.00 more

HOW TO ORDER

- MFJ1270B TNC Controller \$299.00
- MFJ1274 TNC Controller with tuning Indicator built in \$349.00
- MFJ STARTER PACKS**
- Include interface cable, software on disc and complete instruction ... everything you need ... order as listed below
- MFJ1284 for IBM or compatibles \$24.95
- MFJ1282 for C64/128/VIC 20 \$24.95
- MFJ1278 for Macintosh \$24.95



44 Stafford St Huntingdale 3166
P.O. Box 281 Oakleigh 3166
Phone (03) 543-3733 Fax (03) 543 7238
BankCard, Visa, Master Card Welcome

2400.000 - 2450.000 Satellites

5 The SHF Bands

5.1 The 3300 MHz Band (10 centimetres)
3300.0 - 3600.0 MHz



3300.000 - 3456.000 MHz All modes
3400.000 - 3410.000 Satellites
3456.000 - 3458.000 Narrow band, CW/EME/SSB
3456.250 Centre of activity
3458.000 - 3600.000 All modes

5.2 The 5650 MHz Band (5 centimetres)
5650.0 - 5850.0 MHz

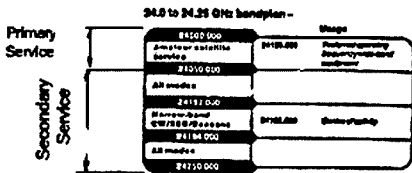

5650.000 - 5670.000MHz Satellite uplink
5670.000 - 5760.000 All modes
5760.000 - 5762.000 Narrow band CW/EME/SSB
5760.250 Centre of activity
5762.000 - 5830.000 All modes
5830.000 - 5850.000 Satellite down link

5.3 The 10 GHz Band (3 centimetres)
10.0 - 10.5 GHz

10 GHz PROVISIONAL BAND PLAN

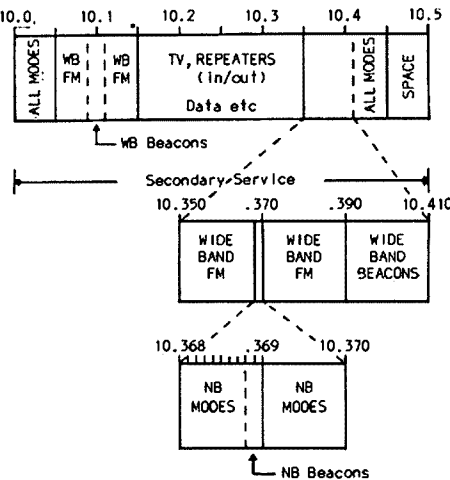

10.00 - 10.05GHz All modes
10.05 - 10.15 Wide Band FM
10.10 - +/- Wide Band Beacons
10.15 - 10.35 TV, Repeaters (in/out), data etc.
10.150 Packet (1 MHz BW)
10.35 - 10.41 Wide Band Modes
10.39 - 10.41 Wide Band Beacons

10.368 - 10.370 Narrow Band Modes
10.368 - 10.3684 Narrow Band Beacons
10.41 - 10.45 All modes
10.45 - 10.50 Space - Satellite Comms

Based upon UK band plan as notified to IARU Region - 1

5.4 The 24GHz Band Plan (1 centimetre)
24.00 - 24.25GHz

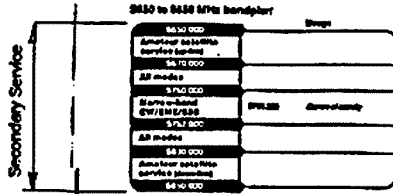

24.000 - 24.050 GHz Satellites
24.050 - 24.125 All Modes
24.125 Preferred wide band frequency
24.125 - 24.194 Narrow band CW/SSB/Beacons
24.192 Centre of activity
24.194 - 24.250 All modes

5.5 The 47 GHz Band Plan (6 Millimetre)
47.00 - 47.20 GHz

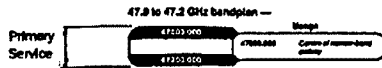

47.000 - 47.2000 GHz All modes
47.088 Centre of narrow band activity

No band plans have been prepared for the remaining microwave bands.

5.6 75.5 - 81.0 GHz (4 Millimetre)

Service	Band (GHz)	Status
Amateur	75.5 - 76	Primary
Amateur Satellite	75.5 - 76	Primary
Radio Location	76 - 81	Primary
Amateur	76 - 81	Secondary
Amateur Satellite	76 - 81	Secondary

5.7 142 - 149 GHz (2 Millimetre)

Service	Band (GHz)	Status
Amateur	142 - 144	Primary
Amateur Satellite	142 - 144	Primary
Radio Location	144 - 149	Primary
Amateur	144 - 149	Secondary
Amateur Satellite	144 - 149	Secondary

5.8 241 - 250 GHz (1 Millimetre)

Service	Band (GHz)	Status
Radio Location	241 - 248	Primary
Amateur	241 - 248	Secondary
Amateur Satellite	241 - 248	Secondary
Amateur	248 - 250	Primary
Amateur Satellite	248 - 250	Primary

CALL SIGN SUFFIXES

Amateur station call signs normally commence with the letters "VK" followed by a numerical State identifier (ie: 1/2/3/4/5/6/7/8/9/ or 0). However, to commemorate special events, the use of "VI" or "AX" may be authorised on a temporary basis.

The alphanumeric series outlines is suffixed with up to three letters which indicate the class of amateur licence held and the individual identity of the station. Call sign suffixes are allocated according to the following table:

Two Letter Suffixes:

All two-letter suffixes except "AA" and "WI" indicate a full call licensee. AA = Official DOTC call sign. WI = Allocated to the Wireless Institute of Australia

Three Letter Suffixes:

- AAA-AZZ = Full call licensees
- BAA-BZZ = Full call licensees
- CAA-CXX = Full call licensees
- DAA-DZZ = Full call licensees
- EAA-EZZ = Full call licensees
- FAA-FZZ = Full call licensees
- GAA-GZZ = Full call licensees

(Note: GGA-GGZ - allocated to the Girl Guilds Association)

- HAA-HZZ = Not allocated
- IAA-IZZ = Not allocated
- JAA-JZZ = Combined licensees

KAA-KZZ = Combined licensees

- LAA-LZZ = Novice licensees
- MAA-MZZ = Novice licensees
- NAA-NZZ = Novice licensees
- OAA-OZZ = Not allocated
- PAA-PZZ = Novice licensees
- QAA-QZZ + = Not allocated, can be confused with Q codes

RAA-RZZ = Beacons and repeaters

SAA-SZZ = Full call licensees (Note: SAA-SDZ - allocated to the Scout Association)

- TAA-TZZ = Limited licensees
- UAA-UZZ = Limited licensees
- VAA-VZZ = Novice licensees
- WAA-WZZ = Full call licensees (Note: WIA-WIZ allocated to the WIA)
- XAA-XZZ = Limited licensees
- YAA-YZZ = Limited licensees
- ZAA-ZZZ = Limited licensees

Note: Certain "non-standard" suffixes are allocated including: RAN, GGx, TTx, ITU, BSx, Sx, etc.

14 MHz Beacons

This series is sponsored by the Northern Californian DX Foundation. The beacons all operate in turn on the one frequency of 14.100 MHz. The series starts on the hour. They send the following series of signals at the powers indicated:

QST de (callsign) 100W
 ... 100W
 ... 10W
 ... 1W
 ... 0.1W
 sk de (call) 100W

The call sequence is as follows:

T+0 min	4UIUN/B	New York
T+1	W6WX/B	Stanford
T+2	KH60/B	Honolulu
T+3	JA21GY	Ise City
T+4	4X6YU/B	Tel Aviv
T+5	OH2B	Espoo
T+6	CT3B	Funchal
T+7	ZS6DN/B	Pretoria
T+8	LU4AA	Santa Cruz
T+9	HK4LR/B	Colombia

VK Aeronautical Beacons useful for Propagation Tests

VK1	Canberra	NDB	263 kHz	CB
		VOR	116.7 MHz	
VK2	Sydney	NDB	317 kHz	SY
		VOR	115.4 MHz	
	Lord H. Is	NDB	272 kHz	LHI
VK3	Melb	NDB	356 Khz	EN
		VOR	114.1 MHz	ML
VK4	Brisbane	NDB	302 kHz	BN
		VOR	113.2 MHz	
	Cairns	NDB	364 kHz	
VK5	Adelaide	NDB	362 kHz	AD
		VOR	116.4 MHz	
VK6	Perth	NDB	400 kHz	PH
		VOR	113.7 MHz	
	Pt Hedland	NOB	260 kHz	PD
		VOR	114.1 MHz	
VK7	St Helens	NDB	392 kHz	STH
	Strahan	NDB	257 kHz	SRN
	Hobart	VOR	112.7 MHz	HB
VK8	Alice Sps.	NDB	335 kHz	AS
		VOR	115.9 MHz	
	Darwin	NDB	344 kHz	DN
		VOR	112.4 MHz	
VK9	Cocos Is.	NDB	305 kHz	CC
	Norfold Is.	NDB	260 kHz	NF
	Christmas Is.	NDB	341 kHz	XXM

ZL Aeronautical Radio beacons

Station	Call-Sign	Freq. kHz
Ashburton	AS	254
Chatham Is.*	CI	322
Christchurch	CH	274
Dunedin	DN	338
Gisborne	GS	346
Hokitika	HK	310
Kaikoue	KI	326
Kaitaia	KT	238
Napier	NR	354
Nelson	NS	394
New Plymouth	NP	370
Oamaru	OU	302
Tauranga	TC	266
Wairoa	WO	246
Waiuku	WI	254
Wanganui	WU	382
Waverley	WY	330
Wellington	WN	298
Westpoint	OT	398
Westport	WS	278
Whakatane	WK	362
Whangarei	WR	386
Whenuapai	WP	206
Wigram	WG	406
Woodend	OD	262

*No 24-hour service. Operated only on request through Chatham Island Radio ZLC.

Emergency

First aid in case of shock Ref. P. 120 (last page) 1990 Call book.

All emergency services, all states, Dial 000.

Federal Sea Safety and Surveillance Centre (062) 47 6666/47 5244

Natural Disasters Organisation (062) 46 6600

(charges can be reversed)

Standard Frequency Transmissions

Station	Frequencies (MHz)	Location
WWV	2.5,5,10,15,20	Colorado, USA.
WWVH	2.5,5,10,15.	Hawaii, USA
VNG	5,10,15.	Llandilo, NSW.
Omega	13kHz	Darriman, Vic.
NPN	21.76, 17.53, 13.38, 8.15, 4.955.	Guam
NPM	22.593, 16.457, 13.655, 9.05, 4.525.	Hawaii, USA.
ZLW/ZMO	131.05 kHz 417.5 kHz	Wellington, NZ.

Wireless Institute Civil Emergency Network (WICEN)

Primary	Secondary Frequencies
3.600 MHz	(+25 kHz SSB
7.075	-25 kHz CW)
14.125	
21.190	
28.450	

Wicen Nets

VK1	None		
VK2	THU	1100Z	7150 repeater
VK3	SUN	1030Z	3.600 MHz
VK4	SUN	2230Z	7.075 MHz
(as required Brisbane Stormwatch 7000 repeater)			
VK5	WED	1000Z	(+30 summer-time) 7000 Repeater
		1000Z	(+1h summer-time) 3.600 MHz
VK6	WED	1200z	3.600 Mhz
VK7	None		
VK8	Refer	VK5.	

VHF COMMUNICATIONS MAGAZINE

1990 Subscribers

Make sure you send your subscription for VHF Communications Magazine separately to:

"VHF COMMS"
 PO BOX 300
 SOUTH CAULFIELD
 VICTORIA 3162

NEW PRICES:

Airmail Subscription: \$40.50
 Surface Mail: \$28.00

ANTENNAS & ACCESSORIES

We manufacture a comprehensive range of HF, VHF and UHF antennas, baluns, power dividers etc to suit your application. Three of our log periodics provide continuous coverage from 13-30 MHz including WARC frequencies, and replace outdated tri-banders. Now in use in 24 overseas countries and 6 continents.

- CREATE ROTATORS. COAX CABLES & NON-CONDUCTING GUY HALYARD MATERIALS
- COMPLETE RANGE MIRAGE (USA) 5-YR WARRANTY 6M, 2M, 70CM AMPS & WATT SWR METERS
- HARD-DRAWN ANTENNA WIRE
- AUST/NZ DISTRIBUTOR FOR CREATE ANTENNAS/ROTATORS & PHYLSTRAN (KEVLAR) NON-CONDUCTING GUYING

- MATERIALS
- HIGH GAIN VHF & UHF AMATEUR, SCANNING & TV ANTENNAS
- BUTT SECTION TRIANGULAR ALUMINUM TOWERS FOR FIXED OR TILT-OVER APPLICATIONS (REFER MARCH/APRIL 1987 AR)
- SELECTION OF POWER CHIPS AT FRIENDLY PRICES
- VSWR/PWR METERS TO 1300MHZ

Write or phone for free catalogue

ATN ANTENNAS

56 Campbell Street
 Birchip Vic 3483
 Phone: (054) 92 2224
 Fax: (054) 92 2666



All Types Of Electron Tubes Available

Over 20,000 Types

Available Ex Stock USA.

Ex Our Stock — Brand New

6BR7	12AX7
6L6GT	E88CC
6550	KT88
6550A	0A2
7591A	4CX250B
ECL85	TH328
EL34	
EL83	
E810F	

New Or Tested (Limited Qty)

2E26	\$10	1625	\$15
211	\$15	ARD26	\$10
801	\$10	CV1363	\$50
802	\$10	TR1616	\$10
803	\$20	UY5103	\$10
805	\$25	VT4C	\$15
807	\$10	VT25A	\$10
809	\$40	VT225	\$10
813	\$45	866	\$10

All Plus Postage And Packing

For Sale

2 x Electronic regulated batt chargers 24V 15A	\$150
2 x Ditto 48V 10 A (Weight 40 Kg)	\$150
1 x Fax G2	\$60
1 x FM two way Pye radio 80 MHz	\$30
1 x Systron Donner propagation delay type 8120	\$250

Engineering Design and Systems P/L

27 Buckley Street, Marrickville 2204

Tel: (02) 519 7007, 51 5388

Fax: 517 1406

10 METRE BEACONS

Freq.	Call	Operation	Location	Notes
28.050	PY2GOB		Sao Paulo, Brazil	15W, vertical.
28.175	VE3TEN	C	Ottawa, Ontario, Canada	10W, ground plane
28.195	1Y4M		Bologna, Italy	20W,5/8 ground plane
28.200	GB3SX	C	Crowborough, UK	8W, dipole
28.200	KF4MS	C	St Petersburg, Florida, USA	75W, ground plane
28.201	LU8ED		Buenos Aires, Argentina	5W
28.2025	ZS5VHF		Durban, Rep of South Africa	15W, ground plane
28.205	DLIIGI	C	Mt Predigtstuhl, West Germany	100W, vertical dipole
28.207	W8FKL	C	Venice, Florida, USA	10W, vertical
28.208	WA110B	C	Marlborough, Massachusetts, US	75W, vertical
28.210	3B8MS	C	Mauritius	ground plane
28.210	K4KMZ	I	Elizabethtown, Kentucky, USA	20W, vertical
28.212	EA6RCM		Palma de Mallorca, Spain	4W, 5el NNE
28.2125	ZD9Gi	C	Gough Is South Atlantic	ground plane
28.215	GB3RAL	C	Slough, Berkshire, UK	20W, ground plane
28.215	LU4XI		Puerto Deseado, Argentina	
28.220	5B4CY	C	Zyvi, Cyprus	26W, ground plane
28.222	W9UXO	C	Lake Bluff, Illinois, USA	10W, ground plane
28.2225	HG2BHA	C	Tapolca, Hungary	10W, ground plane
28.2275	EA6AU	C	Mallorca, Balearic Is, Spain	10W 5/8 ground plane
28.230	ZL2MHF	C	Mt Climie, New Zealand	1W, vertical dipole
28.231	N4LMZ	C	Mobile, Alabama, USA	2W, 5/8 ground plane
28.232	W7JPI/AZ	C	Sonoita, Arizona, USA	5W, 3el Yagi NE
28.233	KD4EC	C	Jupiter, Florida, USA	7W, ground plane
28.235	VP9BA	C	Hamilton, Bermuda	10W, ground plane
28.2375	LA5TEN	C	Oslo, Norway	10W, 5/8 ground plane
28.240	OA4CK	C	Lima, Peru	10W
28.2405	5Z4ERR	C	Kiambu, Kenya	
28.2425	ZS1CTB	C	Capetown, Rep of South Africa	20W, 1/4 vertical dipole, NW/SE
28.245	A92C		Bahrain	
28.247	EA3JA		Barcelona, Spain	
28.2475	EA2HB	I	San Sebastian, Spain	6W, ground plane
28.248	K1BZ	C	Belfast, Maine, USA	5W, vertical dipole
28.250	Z21ANB	C	Bulawayo, Zimbabwe	15W, ground plane
28.250	4N3ZHK		Yugoslavia	1W, vertical
28.252	WB4JHS	I	Durham, North Carolina, USA	7W, vertical
28.254	KB2EAR	I	Kendall Park, New Jersey, USA	
28.255	LU1UG		Gral Pico, Argentina	5W, ground plane
28.2575	DK0TEN	C	Konstanz, West Germany	40W, ground plane
28.260	VK5WI	C	Adelaide, SA, Australia	10W, ground plane
28.262	VK2RSY	C	Sydney, NSW, Australia	25W, ground plane
28.264	VK6RWA	C	Perth, WA, Australia	
28.266	VK6RTW	C	Albany, WA, Australia	
28.266	KB4UPI	C	Birmingham, Alabama, USA	50W, 1/4 vertical
28.2685	W9KFO	I	Eaton, Indiana, USA	0.75W, vertical
28.270	ZS6PW	C	Pretoria, Rep of South Africa	10W, 3el Yagi on G-land
28.270	VK4RTL	C	Townsville, QLD, Australia	
28.2725	9L1FTN	I	Freetown, Sierra Leone	10W, vertical dipole
28.275	AL7GQ	C	Jackson, Mississippi, USA	0.5/1W, broadside loop
28.2755	N6RDX	I	Stockton, California, USA	20W, 3el Yagi
28.2775	DF0AAB	C	Kiel, West Germany	15W, ground plane
28.280	YV5AYV		Caracas, Venezuela	10W, rotary beam on Europe
28.280	LU8EB		Buenos Aires, Argentina	5W
28.282	VE1MUF	C	Fredrickton, NB, Canada	0.5W, dipole
28.284	VP8ADE	C	Adelaide Is, Antarctica	8W, vertical beam to G-land
28.286	KA1YE		Rochester, New York, USA	2W, vertical dipole
28.287	W8OMV		Asheville, North Carolina, USA	5W, ground plane
28.287	H44SI	C	Honiara, Solomon Is	15W, ground plane
28.288	W2NZH	I	Moorestown, New Jersey, USA	5W, ground plane
28.290	VS6TEN	C	Mt. Matilda, Hong Kong	10W, vertical
28.292	ZD8HF		Ascension Island	
28.2925	LU2FFV		San Jorge, Argentina	5W, ground plane
28.295	WB8UPN	I	Cincinnati, Ohio, USA	10W, vertical
128.296	W3VD	C	Laurel, Maryland, USA	1.5W, vertical dipole
28.297	WA4DJS	I	Ft Lauderdale, Florida, USA	10W, 76 meter longwire
28/300	PY2AMI	C	Sao Paulo, Brazil	10W, vertical dipole
28.301	ZS1LA	C	Stillbay, Rep of South Africa	20W, 3el Yagi NW
28.315	ZS6DN	C	Irene, Rep of South Africa	100W, vertical
28.888	W6IRT		North Hollywood, California, USA	5W, ground plane, code-practice
28.992	DLOANN		Nuernberg, West Germany	1W, delta loop

6 METRE BEACONS

Frequency	Callsign	Location	LOC	ERPW	Mode	Source	Date
50.000	G3BUX	Sheffield	-	-	-	Rad Com	12/88
50.004	PY1RO	Rio De Janeiro	-	-	-	AR	12/88
50.005	H44HIR	Honiara	Q190	10	-	AR	12/88
50.005	ZS2SIX	Port Elizabeth	KF25	10	A1A	AR	2/89
50.011	JA2IGY	Mie	PM84	-	-	AR	2/89
50.015	PJ4B	-	FK52TF	-	-	ZL2KT	21/3/89
50.015	SZ2DH	Athens	KM18	-	-	AR	2/89
50.017	JE6ZIH	Miyazaki	PM51RU	-	-	ZL3AAU	2/4/89
50.020	GB3SIX	Anglesey	IO73TJ	100	FIA	AR	12/88
50.020	JA6ZIH	Japan	PM51	-	-	AR	2/89
50.024	ZS6LW	Pretoria	-	-	-	Rad Com	10/88*
50.025	6Y5RC	Kingston	FK17	40	FIA	AR	12/88
50.028	JA7ZMA	Fukushima City	QM07	-	-	AR	2/89
50.030	CT0WW	Portugal	IN61	-	-	AR	2/89
50.033	ZD8VHF	Ascension Is	II22TB	50	-	AR	1/89
50.035	H1JX	-	-	-	-	AR	12/88
50.035	ZB2VHF	Gibraltar	IM76HE	100	AIA	AR/R Com	12/88
50.038	FY7THF	French Guina	GJ35	-	-	AR	2/89
50.0425	GB3MCB	St Austell	IO70	-	-	Rad Com	11/88
50.045	OX3VHF	Greenland	GP60QQ	20	AIA	AR	12/88
50.048	VE6ARC	-	-	-	-	AR	12/88
50.050	GB3NHQ	Potters Bar	IO91VQ	15	FIA	AR	12/88
50.0575	TF3SIX	Iceland	HP94	-	-	AR	2/89
50.060	W1XJ/B	-	-	-	-	ZL3AAU	25/3/89
50.060	ZS6DN/B	Pretoria	KG44	100	-	AR	2/89
50.062	PY2AA	Sao Paulo	GG66	25	AIA	AR	2/89
50.0625	GB3NGI	-	-	-	-	Rad Com	11/88*
50.064	WD7Z	Arizona	EL59	-	-	AR	2/89
50.065	GJ4HXJ	England	IN89	-	-	AR	2/89
50.065	NB30/1	Rhode Is	FN41	-	-	AR	2/89
50.065	WD7X/B	New Mexico	DM75	-	-	ZL3AAU	12/3/89
50.066	VK6RPH	Perth	OF78	-	-	AR	12/88
50.067	WA6IJZ	-	-	-	-	AR	12/88
50.068	K6FVXB	-	CM88	-	-	ZL3AAU	2/3/89
50.074	ZS4SA	Deneysville	-	-	-	Rad Com	10/88*
50.075	VS6SIX	Hong Kong	OL72	30	-	AR	1/89
50.075	ZS5SIX	-	-	-	-	Rad Com	11/88*
50.078	T12NA	Costa Rica	EK70	-	-	AR	2/89
50.080	HC8SIX	Galapagos Is	E159	-	-	AR	2/89
50.080	KH6JJK	Hawaii	BL11	-	-	AR	2/89
50.085	9H1SIX	Malta	JM75FV	-	-	RC 6/87 AR	12/88
50.086	VP2MO	Montserrat	FK8	-	-	AR	2/89
50.088	VE1SIX	New Brunswick	FN65	-	-	AR	2/89
50.089	WA6JRA	-	-	-	-	AR	12/88
50.090	KJ6BZ	Johnston Is	AK56	-	-	AR	2/89
50.090	ZF2KZ	Cayman Is	EK99	-	-	AR	12/88
50.092	W5GTP	Louisiana	EM40	-	-	AR	2/89
50.099	KP4EKG	Puerto Rico	FK68	-	-	AR	2/89
50.099	VP5D	-	FL**	-	-	ZL3AAU	7/4/89
50.100	HC2FG	Ecuador	F107	-	-	AR	2/89
50.100	KG6DX	Guam	QK23KL	-	-	AR	12/88
50.100	ZS3E	-	JG87	-	-	ZL2BGJ	26/2/89
50.110	A61XL	U Arab Emir	LL74	-	-	AR	2/89
50.110	BY4AA	China	-	-	-	AR	12/88
50.120	4S7EA	Sri Lanka	MJ97	-	-	AR	2/89
50.321	ZS5SIX	South Africa	KG50	-	-	AR	2/89
50.490	JG1ZGW	Tokyo	PM95	-	-	AR	12/88
50.499	5B4CY	Zyyi	KM54PS	-	-	AR	2/89
50.500	FK8KAB	-	-	-	-	AR	12/88
50.904	ZS1SIX	-	-	-	-	Rad Com	11/88

51.020	ZL1UHF	Nihotupu	-	25	F1	AR	2/89*
51.030	ZL2MHB	Napier	RF80	10	F2	AR	2/89*
51.225	ZL2VHT	Inglewood	RF70	30	F2	NZART Call Bk	88+

52.013	P29BPL	Port Moresby	-	-	-	AR	12/88
52.100	ZK2SIX	Niue	AH50	-	-	AR	12/88
52.150	VK0CK	Macquarie Is	-	-	-	-	-
52.200	VK8VF	Darwin	PH57	15	-	AR	12/88
52.250	ZL2VHM	Pahiatua Track	RE79	8	F1	NZART Call Bk	88 +
52.310	ZL3MHF	Aylesbury	RE66	-	-	NZART Call Bk	88
52.320	VK6RTT	Wickham	OG89	-	-	AR	2/89
52.325	VK2RHV	Newcastle	QF57	-	-	AR	2/89
52.330	VK3RGG	Geelong	QF21	-	-	AR	2/89
52.345	VK4ABP	Longreach	QG26	-	-	AR	2/8

952.350	VK6RTU	Kalgoorlie, WA						
52.370	VK7RST	Hobart	QE37	-	-	AR		12/88
52.410	VK1RCC	Mt Majura						
52.418	VKOMA	Mawson						
52.420	VR2RSY	Sydney	QF56	-	-	AR		12/88
52.425	VK2RGB	Gunnedah	QF59	-	-	AR		12/88
52.435	VK3RMV	Hamilton	QF12	-	-	AR		2/89
52.440	VK4RTL	Townsville	QH30	-	-	AR		2/89
52.445	VK4RIK	Cairns	QH23	-	-	AR		2/89
52.450	VK5VF	Mount Lofty	PF95	-	-	AR		2/89
52.460	VK6RPH	Perth	OF78	-	-	AR		2/89
52.465	VK6RTW	Albany	OF84	-	-	AR		2/89
52.470	VK7RNT	Launceston	QE38	-	-	AR		2/89
52.485	VK8RAS	Alice Springs	PG66	-	-	AR		2/89
52.490	ZL2SIX	Blenheim	RE68	10	F1	NZART Call Bk		88+
52.510	ZL2MHF	Mt Climie	RE78BU	4	E1	NZART Call Bk		88

*Not Operational +Status Unknown'Source' call signs indicate beacons heard in ZL

DUPLEX REPEATER LIST FEBRUARY 1990

OUT PUT TXFREQ	INPUT RXFREQ	SITE	COVERAGE	OUT PUT TXFREQ	INPUT RXFREQ	SITE	COVERAGE
146.9000	146.3000	Black Hill	VK1RAC	438.2250	433.2250	Port Kembla	VK2RUW
146.9500	146.3500	Mt Ginini	VK1RGI	438.2750	433.2750	Chatswood	VK2RWS
438.3750	433.3750	Isaacs Ridge North	VK1RIR	438.3250	433.3250	Mt Marie	VK2REE
438.5250	433.5250	Mt Ginini	VK1RGI	438.3250	433.3250	Grenfell	VK2RWM
29.6200	29.5200		VK2RAH	438.3750	433.3750	Kurradjong Heights	VK2RUT
53.625	52.625	Sugarloaf Range	VK2RSN	438.4250	433.4250	Hurstville	VK2RUH
53.8500	52.8500	Dural	VK2RWI	438.4750	433.4750	Chatswood	VK2RRS
146.6250	146.0250	Byron Bay	VK2RBB	438.5250	433.5250	Middle Brother	VK2RPM
146.6250	146.0250	Razorback	VK2RLD	438.5250	433.5250	Dural	VK2RWI
146.6500	146.0500	Mt. Coramba	VK2RCH	438.6250	433.6250	Merewether	VK2RUM
146.6500	146.0500	Mt. Bindo	VK2RDX	438.6750	433.6750	Mt Sugarloaf	VK2RAN
146.6500	146.0500	Terry Hie Hie	VK2RMI	438.6750	433.6750	Nightcap Range	VK2RSC
146.6750	146.0750	Blacktown (RTTY)	VK2RTY	438.6750	433.6750	Willans Hill	VK2RTW
146.7000	146.1000	Mt Canobolas	VK2RAO	438.7250	433.7250	Sublime Point	VK2RIL
146.7000	146.1000	Milton	VK2RMU	1281.7500	1293.7500	Dural	VK2RWI
146.7000	146.1000	Middle Brother	VK2RPM	29.6400	29.5400		VK3RHF
146.7250	146.1250	Somersby	VK2RAG	53.5500	52.5500	Wattle Glen	VK3RMH
146.7500	146.1500	Mumbulla Mt.	VK2RFS	53.5750	52.5750	Dandenong	VK3RDD
146.7500	146.1500	Mt Gibraltar	VK2RHR	53.6750	52.6750	Lake Mountain	VK3RTN
146.7500	146.1500	Mt Crawney	VK2RTM	53.9750	52.9750	Mt Buller	VK3RGM
146.7500	146.1500	Mt Flackney	VK2RWG	146.6500	146.0500	Donalds Knob	VK3REG
146.7750	146.1750	Sugarloaf Range	VK2RTZ	146.6500	146.0500	Mt Wombat	VK3RGV
146.8000	146.2000	Needle Mtn	VK2RCC	146.7000	146.1000	Mt Mitta Mitta	VK3RNC
146.8000	146.2000	Goonellabah	VK2RIC	146.7000	146.1000	Ouyen	VK3RON
146.8000	146.2000	Heathcote	VK2RLE	146.7500	146.1500	Mt Bunninyong	VK3RBA
146.8000	146.2000	Kendell Trig	VK2RTD	146.8000	146.2000	Mt. Tassie	VK3RLV
146.8250	146.2250	Bundook Mountain	VK2RET	146.8000	146.2000	Mildura	VK3RMA
146.8500	146.2500	Mt Kaputar	VK2RAB	146.8500	146.2500	Kinglake	VK3RMN
146.8500	146.2500	Mt Murray	VK2RAW	146.9000	146.3000	Smeaton Hill	VK3RBS
146.8500	146.2500	Mt Bingar	VK2RGP	146.9000	146.3000	Mt. Nowa Nowa	VK3REB
146.8750	146.2750	Terrey Hills	VK2RMB	146.9000	146.3000	Swan Hill	VK3RSH
146.9000	146.3000	Mt Sugarloaf	VK2RAN	146.9500	146.3500	Mt William	VK3RWZ
146.9000	146.3000	Boona Mount	VK2RRT	147.0000	146.4000	Mt Anakie	VK3RGL
146.9250	146.3250	North Ryde	VK2RGR	147.0000	146.4000	Mt Big Ben	VK3RNE
146.9500	146.3500	Glenn Innes	VK2RNE	147.0250	147.6250	Mt Fatigue	VK3RGS
146.9750	146.3750	Mt Sugarloaf (RTTY)	VK2RAN	147.0500	147.6500	Mt Livingstone	VK3RGO
147.0000	146.4000	Dural	VK2RWI	147.0500	147.6500	Robinvale	VK3RVL
147.0250	147.6250	Paddington	VK2ROT	147.0500	147.6500	Mt Warrnambool	VK3RWL
147.0500	147.6500	Mount Druitt	VK2RBM	147.0750	147.6750	Heathmont	VK3RCR
147.1000	147.7000	Grenfell	VK2RWM	147.1000	147.7000	Mt Porepunkah	VK3RPB
147.1000	147.7000	Mt Arthur	VK2RZL	147.1000	147.7000	Bass Hill	VK3RSG
147.1500	147.7500	Chatswood	VK2RWS	147.1250	147.7250	Geelong	VK3RGC
147.2000	147.8000	Mt Cambewarra	VK2RSD	147.1500	147.7500	Mt Alexander	VK3RCV
147.2250	147.8250	Lane Cove	VK2RST	147.1750	147.7750	Olinda	VK3REC
147.2500	147.8500	Asquith	VK2RNS	147.2250	147.8250	Mt Baw Baw	VK3RWG
147.2750	147.8750	Sublime Point (R/V)	VK2RIL	147.2500	147.8500	Mt Macedon	VK3RMM
147.3000	147.9000	Springwood	VK2RTS	147.2750	147.8750	Mt Cawley	VK3ROW
147.3750	147.9750	Cabbage Tree Mtn	VK2RGL	147.3000	147.9000	Victoria Wide	VK3RWP
147.9250	147.3250	Mt Gray	VK2RGN	147.3500	147.9500	Olinda	VK3RTY
438.0750	433.0750	Somersby	VK2RAG	434.2750	439.2750	Mt Macedon	VK3RMM
438.1750	433.1750	Terrey Hills	VK2RMB	438.0750	433.0750	Mt St Leonard	VK3RMU
438.1750	433.1750	Doughboy Mountain	VK2RNT	438.1750	433.1750	Devils River	VK3RUG

OUT PUT TXFREQ	INPUT RXFREQ	SITE
438.2250	433.2250	Olinda
438.2750	433.2750	Victoria Wide
438.3750	433.3750	Carrajong
438.4750	433.4750	Mt Hollowback
438.4750	433.4750	Bendigo
438.5250	433.5250	Mitcham
438.5250	433.5250	Mt Stanley
438.5250	433.5250	Merbein
438.6250	433.6250	Victoria Wide
438.6750	433.6750	Mt William
439.3750	434.3750	Glen Waverley
439.4250	434.4250	Chesney Vale
439.5750	434.5750	Mt Anakie
439.7250	434.7250	Arthurs Seat
53.7250	52.7250	Calliope Range
53.7250	53.1250	Mount Haren
146.6250	146.0250	Gladstone
146.6500	146.0500	Roma
146.6750	146.0750	Mt Kiangarow
146.6750	146.0750	Longlands Gap
146.7000	146.1000	Mt Archer
146.7000	146.1000	Mt Stuart
146.7000	146.1000	Springbrook
146.7000	146.1000	Mount Isa
146.7250	146.1250	Mt Gordon
146.7500	146.1500	Mt Lofty
146.7750	146.1750	Proserpine
146.8000	146.2000	Mt Goonaneman
146.8000	146.2000	Thursday Island
146.8000	146.3500	Weipa
146.8500	146.2500	Buderim
146.8750	146.2750	Chinchilla
146.9000	146.3000	Mt Stradbroke
146.9000	146.3000	Calliope Range
146.9250	146.3250	Mount Mee
146.9500	146.3500	Mt Bellenden Ker
146.9750	146.3750	Blue Mtn Nebo
147.0000	146.4000	Mt Glorious
147.0000	146.4000	Black Mtn
147.1000	147.7000	Boulder Mtn
147.1500	147.7500	Spring Hill
147.1500	147.7500	Kedron
147.3000	147.9000	Mt Glorious
147.3500	147.9500	Mt Inkerman
147.6500	147.0500	Mt Cotton
147.6750	147.0750	Mt Cotton
147.8250	147.2250	Manly West
147.8500	147.2500	Mt Devlin
438.0250	433.0250	Mt Tamborine
438.0750	433.0750	Buderim
438.2250	433.2250	Mt Stuart
438.2250	433.2250	Springbrook
438.3750	433.3750	Ipswich
438.4250	433.4250	Proserpine
438.4750	433.4750	Maleny
438.5000	433.5000	Hodgson Range
438.5250	433.5250	Mt Coot-Tha
438.6250	433.6250	Spring Hill
438.6250	433.6250	Kedron
438.6750	433.6750	Mt Goonaneman
438.7000	433.7000	Mt Mowbullan
438.8250	433.8250	Mt Boulder
438.9500	433.9500	Redbank Plains
439.2750	434.2750	Toowoomba
439.3500	434.3500	Mount Haren
146.6500	146.0500	Naracoorte
146.6750	146.0750	O'Halloran Hill
146.7000	146.1000	The Bluff
146.8000	146.2000	Coolanien
146.8250	146.2250	Angaston
146.8500	146.2500	Houghton
146.9000	146.3000	Mount Gambier

COVERAGE

Melbourne
WICEN Portable
Gippsland
Ballarat
Bendigo
Melbourne
Wangaratta
VK3RRU
WICEN Portable
The Grampians
Melbourne
Benalla
Geelong
Melbourne
Gladstone
Cairns & Dist
Gladstone
Roma
Atherton
Rockhampton
Townsville
Gold Coast
Mount Isa
Bowen
Toowoomba
Bundaberg
Cape York
Sunshine Coast
Chinchilla
Ipswich
Gladstone
Redcliff
Cairns
Sarina
Brisbane
Mackay
Gympie
Brisbane
WICEN Portable
Brisbane & Dist
Burdekin
Brisbane
Brisbane
Brisbane
Brisbane & Dist
Sunshine Coast
Townsville
Gold Coast
Ipswich
Mackay
Clermont
Brisbane
Brisbane
WICEN Portable
Bundaberg
Darling Downs
Gympie
Brisbane
Toowoomba
Cairns & Dist
Naracoorte
Pt Pirie & Dist
Cowell
Barossa Valley
Adelaide
Mt Gambier

MAGPUBS

A Special Service of the Wireless Institute of Australia

When it comes to
**AMATEUR
RADIO QSL's...**

**1990
callbooks**

NOW READY!

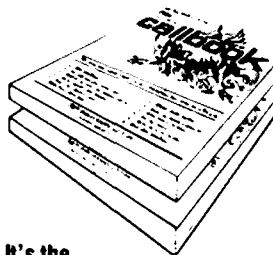

It's the
ONLY BOOK!
US or DX Listings

Here they are! The latest editions 1990. World-famous Radio Amateur Callbooks, the most respected and complete listing of radio amateurs. Lists calls, license classes, address information. Loaded with special features such as call changes, prefixes of the world, standard time charts, world QST bureaus and more.

The North American Callbook lists the calls, names and address information for over 500,000 licensed Radio Amateurs in all countries of North America from Canada to Panama, including Greenland, Bermuda and the Caribbean Islands plus Hawaii and US possessions.

The International Callbook lists over 500,000 licensed amateurs in countries outside North America. Its coverage includes South America, Europe, Africa, Asia, Australia and the Pacific area (exclusive of Hawaii and the US possessions).

Order both Callbooks now and save at these special prices.

WIA288 1990 North American Callbook \$58.50 less 10% for WIA Members

WIA289 1990 International Callbook \$62.50 less 10% for WIA members

WIA 005 The two Callbook set \$109.95 less 10% to WIA members

The 1990 ... ARRL Handbook ...

This is the most comprehensive edition since the Handbook was first published in 1926. The sixty-seventh edition contains over 1200 pages and over 2100 tables, figures and charts. Added to this edition are new antenna projects including two high-performance Yagis for 144 and 432 MHz designed by Steve Powlishen, K1FO. Dick Jansson, WD4FAB has completely revised the space communications chapter, which includes his innovative array for AO-13 Mode L.

As always the Handbook includes many chapters of construction projects, including:

- * Power supplies, Keyers and Measuring Devices
- * QRP transmitters and VHF/UHF preamps
- * A High-performance communications receiver
- * High-power HF and VHF amplifiers
- * Digital audio memory keyer

The Handbook has always been known as a reference for component data. There is an entire chapter devoted to everything from tube and transistor specifications to aluminum tubing sizes. There is up-to-date information on digital techniques and operating practices ... and ... much ... much more.



Order Stock Number **WIA287**

\$52.90 less 10% WIA Members

THE ARRL ANTENNA BOOK

New for 1989 the 15th Edition

The 15th Edition of The ARRL Antenna Book has been dramatically expanded in a similar fashion to recent editions of the ARRL Handbook. We've drawn on material produced for the ARRL Technical Department and from 16 well-known outside authors who have done much to contribute to the state-of-the-art in antenna and transmission line design.

With 30 chapters, this edition is certainly big (8 x 11 inches and 1 1/2 inches thick) and I think you'll find better than any previous edition. Every page of this book has been set in new type and prepared in a layout that we feel is appealing. While most of the content of previous editions has been retained, the text has been totally re-edited and much new material has been added.

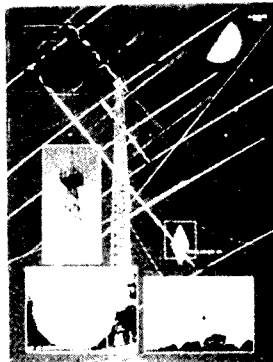

8x11" 700 pages Stock # WIA 161 \$36.00 less 10%

The above books, plus many more, are available from your WIA Divisional Bookshop.

All items are plus postage and handling where applicable if not in stock at your Divisional Bookshop, order will be taken and filled promptly

Simplex Repeater List

OUT PUT TXFREQ	INPUT RXFREQ	SITE	COVERAGE	Freq	Site	Coverage
147.0000	146.4000	Crafers	VK5RAD Adelaide			
438.3250	433.3250	Mount Gambier	VK5ROH	144.8000	Mt Ginini	VK1IRGI SE NSW
438.4250	433.4250	Angaston	VK5RBV Barossa Valley	144.8000	Terrey Hills	VK2RMB Sydney
438.5250	433.5250	Crafers	VK5RVP Adelaide	144.8500	Dural	VK2RWI Sydney & Dist
1381.2500	1261.2500		VK5RWH Adelaide	144.9000	Hornsby	VK2RPH Sydney
29.6300	29.5300		VK6RHF Perth	145.0500	Mt Nardi	VK2RPL Lismore
53.8000	52.0000	Tic Hill	VK6RTH Perth	147.5750	Mt Kaputar	VK2RAB Gunnedah
146.6500	146.050	Bunbury	VK6RSW Bunbury	147.5750	Mt Canobolas	VK2RAO Orange
146.6750	146.0750	Whim Creek	VK6RCA Carnarvon	147.5750	Mt Murray	VK2RAW Wollongong
146.7000	146.1000	Roleystone	VK6RAP Perth	147.5750	Mt Coramba	VK2RCH Coffs Harbour
146.7250	146.1250	Albany	VK6RAL Albany	147.5750	Mt Bindo	VK2RDX East NSW
146.7500	146.1500	Esperance	VK6RES Esperance	147.5750	Mt Bingar	VK2RGF Griffith
146.7500	146.1500	Koolan Island	VK6RKI Koolan Island	147.5750	Pt Lookout	VK2RLO
146.7500	146.1500	Lesmurdie	VK6RLM Perth	147.5750	Mt Nardi	VK2RPL Lismore
146.8000	146.2000	Tic Hill	VK6RTH Perth	147.5750	Middle Brother	VK2RPM Port Macquarie
146.8000	146.2000	Karratha	VK6RWP Karratha	147.5750	High Range	VK2RPS South Highlands
146.8250	146.2250	Mt Barker	VK6RAA Albany	147.5750	Mt Tumorrana	VK2RPT Tumut
146.8500	146.2500	Northwest Cape	VK6REX Exmouth	147.5750	Grundy's Mountain	VK2RPW Tamworth
146.8500	146.2500	Kambalda	VK6RKB Kalgoorlie	147.5750	Mt Cambewarra	VK2RSD Nowra
146.8750	146.2750	O'Connor	VK6RSR Perth	147.5750	Mt Crawney	VK2RTM
146.9000	146.3000	Mt William	VK6RMW Bunbury	147.6000	Somersby	VK2RAG Gosford
146.9500	146.3500		VK6RPD Perth	438.8750	Mt Nardi	VK2RPL Lismore
146.9500	146.3500	Shay Gap	VK6RSG Shay Gap	144.4350	Mt Bainbridge	VK3RMV
146.9750	146.3750	State Wide	VK6REE WICEN Portable	144.8000	Red Hill	VK3RPK Melbourne
147.0000	146.4000	Kalgoorlie	VK6RAK Kalgoorlie	144.8000	Sunbury	VK3RPS Melbourne
147.0000	146.4000	Fairfield	VK6RAW Katanning	144.9000	Lysterfield	VK3RPP Melbourne
147.0000	146.4000	State Wide	VK6REE WICEN Portable	147.5250	Mt Tassie	VK3RBB Gippsland
147.0000	146.4000		VK6RCN Geraldton	147.5500	Chirnside Park	VK3RMC Melbourne
147.0000	146.0000	Port Hedland	VK6RNW Port Hedland	147.5750	Carrajung	VK3RGU
147.0500	147.6500	Roleystone	VK6RTY RTTY Perth	147.5750	Mt Wombat	VK3RGV Shepparton
147.1000	147.7000	Mt Mambup	VK6RWC Perth	147.5750	Mt St Leonard	VK3RMU Melbourne
147.1750	147.7750	W A Wide	VK6RIC WICEN Portable	147.5750	Mt Stanley	VK3RNU Wedonga
147.2000	147.8000	Cataby	VK6RCT Cataby	147.5750	St Albans	VK3RPA Melbourne
147.2250	147.8250	Hoddywell	VK6RHW Toodyay	147.5750	Mt Warrenheip	VK3RPC
147.2500	147.8500	Saddleback	VK6RMS Boddington	147.5750	Mt William	VK3RPG Grampians
147.3000	147.9000	Ocean Hill	VK6REN Eneabba	147.5750	Bendigo	VK3RPM Bendigo
147.3500	147.9500	Busselton	VK6RBN Busselton	147.5750	Sunbury	VK4RPS Melbourne
438.2250	433.2250	Tic Hill	VK6RTH Perth	147.5750	Merbein	VK3RRU
438.5250	433.5250	Roleystone	VK6RUF Perth	147.6000	St Albans	VK3RPA Melbourne
438.6750	433.6750	Busselton	VK6RBN Busselton	147.6000	Sunbury	VK3RPS
53.8250	52.8250	Mt Duncan	VK7RMD Hobart	432.4350	Mt Bainbridge	VK3RMV
146.6250	146.0250	Mt Duncan	VK7RAD Rt/Data Hobart	432.4500	Macleod	VK3RAI
146.7000	146.1000	Mt Wellington	VK7RHT Hobart	439.2000	St Albans	VK3RPA
146.7500	146.1500	West Ulverstone	VK7RNW Ulverstone	144.8500	Mt Coot-tha	VK4RZB Brisbane
146.9000	146.3000	Snow Hill	VK7REC East Tas	144.900	Mt Archer	VK4RAR Rockhampton
147.0000	146.4000	Mt Barrow	VK7RAA NE Tas	144.9000	Mt Goonaneman	VK4RBS Bundaberg
147.2500	147.8500	Mt Faulkner	VK7RAF Hobart	144.9000	Calliope Range	VK4RGA
438.5000	433.5000	Barren Tier	VK7RIN Central Tas	144.9000	Wilkes Knob	VK4RZC Sunshine Coast
438.5500	433.5500	Mt Arthur	VK7RAB NE Tas	145.0500	Mt Cotton	VK4RBT Brisbane
438.5750	433.5750	Millers Bluff	VK7RER Hobart	147.6000	Maleny	VK4RSA
438.6000	433.6000	Mt Nelson	VK7RTC Hobart	147.6000	Springbrook	VK4RZA Gold Coast
43.6500	433.6500	Table Cape	VK7RAC NW Tas	147.6000	Mt Coot-tha	VK4RZB Brisbane
146.6500	146.0500	Nhulunbuy	VK8RMS Gove	147.6000	Wilkes Knob	VK4RZC Sunshine Coast
146.7000	146.1000	Karama	VK8RDA Darwin	147.6000	Mt Perseverance	VK4RZD Toowoomba
146.9500	146.3500	Alice Springs	VK8RCA Alice Springs	432.5450	Mt Archer	VK4RAR
147.0000	146.4000	Palmerston	VK8RTE Darwin	144.5500	Glencoe	VK4RSE
438.2750	433.2750	Darwin	VK8RDN Darwin	144.8000	Mount Lofty	VK5VF Adelaide
				147.5750	The Bluff	VK5RMN Pt Pirie & Dist
				147.5750	Mount Graham	VK5RPM Naracoorte
				147.5750	O'Halloran Hill	VK5RSV Adelaide
				52.3200	Cape Lambert	VK6RTT
				52.4600	Nedlands	VK6RPH
				144.6000	Cape Lambert	VK6RTT
				144.8500	Mt Barker	VK6RAA Mt Barker
				144.8500	Fairfield	VK6RAW Katanning
				144.8500	Tic Hill	VK6RDT Perth
				144.8500	Saddleback	VK6RMS Boddington
				52.4700	St Leonards	VK7RNT
				147.5750	Snow Hill	VK7RED
				147.5750	Mt Nelson	VK7RIT
				147.5750	Highfield	VK7RTY
				147.6000	Alice Springs	VK8BBS

PREVENT PIRATES

make sure you sell your
transmitter to a
licensed amateur.

ATV Repeater List - January 1990

Outputs Tx1FREQ Tx2FREQ	Input RFREQ SITE	COVERAGE
579.2500	440.3000 Kariang	VK2RTG Gosford
579.2500	444.2500 Mt Big Ben	VK3RTG Wodonga
579.2500	428.3750 Swan Hill	VK3REX Swan Hill
579.2500	426.2500 Olinda	VK3RTV Melbourne
579.2500	426.2500 Bendigo	VK3RMZ Bendigo
579.2500	426.2500 Spring Hill	VK4RTV Brisbane
579.2500	428.3750 Mt Stuart	VK4RAT Townsville
579.2500	444.2500 O'Halloran Hill	VK5RTV Adelaide
579.2500	428.3750 Roleystone	VK6RAP Perth
428.3750 -		
431.7500	444.2500 Mt Duncan	VK7RTV Hobart
579.2500	446.3750 Kelcey Tier	VK7RAE

Beacons - February 1990

Freq Site		
52.4100	Mt Majura	VK1RCC
144.4100	Mt Majura	VK1RCC
432.4100	Melba	VK1RBC
1296.4100	Melba	VK2RBC
52.3250	Tighes Hill	VK2RHV
52.4200	Dural	VK2RSY
53.6250	Sugarloaf Range	VK2RSN
144.4200	Dural	VK2RSY
144.9500	Turrumurra	VK2RCW
432.4200	Dural	VK2RSY
1296.4200	Dural	VK2RSY
52.3300	Mt Anakie	VK3RGL
53.9000	Olinda	VK3RMS
144.4300	Glen Waverley	VK3RTG
144.5300	Mt Anakie	VK3RGG
144.5350	Moe	VK3RGI
144.9500	Mt Waverley	VK3RCW
146.7000	Ferny Creek	VK3RML
432.4300	Glen Waverley	VK3RTG
432.5300	Mt Anakie	VK3RGG
432.5350	Mt Buninyong	VK3RMB
52.4400	Mt St John	VK4RTL
52.4450	Mount Haren	VK4RIK
144.4000	Mt Mowbullian	VK4RTT
144.4450	Mount Haren	VK4RIK
144.4450	Mt Stuart	VK4RTL
432.4400	Mt Coot-Tha	VK4RSD
432.4450	Mount Haren	VK4RIK
432.4450	Mt Stuart	VK4RTL
1296.4400	Mt Coot-Tha	VK4RSD
1296.4450	Mount Haren	VK4RIK
52.4500	Adelaide	VK5VF
50.0660	Perth	VK6???
52.3200	Cape Lambert	VK6RTT
52.3500	Kalgoorlie	VK6RTU
52.4650	Albany	VK6RTW
144.0200	Busselton	VK6RBS
144.4650	Albany	VK6RTW
144.6500	Kalgoorlie	VK6RTU
145.0000	Cloverdale	VK6RPH
420.1000	Roleystone	VK6RAP
432.0600	Busselton	VK6RBS
432.1400	Cloverdale	VK6RPR
432.4650	Albany	VK6RTW
432.5650	Kalgoorlie	VK6RTU
434.9250	Lesmurdie	VK6RWC
1296.1800	Busselton	VK6RBS
1296.4200	Nedlands	VK6RPR
52.3700	Mt Nelson	VK7RST
62.4700	St Leonards	VK7RNT
144.4700	Newnham	VK7RMC
50.0560	Darwin	VK8VF
50.2000	Fannie Bay	VK8VF
52.4850	Alice Springs	VK8RSB
144.0100	Darwin	VK8VF
144.4850	Alice Springs	VK8RSB

Broadcasting Stations

Legend

The following symbols used against Australian stations denote:

* Relays or transmits relayed programmes

+ Position not shown due to use of two transmitter towers widely separated

@ Power drops to 1KW at night

-T After call-sign signifies translator station

% Directional antenna

Station	Ident	Freq (kHz)	Position	
New South Wales				
Albury	2AY	1494	36 03'S	146 58'E
Armidale %	2AD	1134	30 33'S	151 36'E
Armidale *	2AN	720	30 30'S	151 40'E
Bathurst % H24	2BS	1503	33 22'S	149 32'E
Bega *	2BA	810	36 43'S	149 49'E
Bega %	2BE	765	36 44'S	149 56'E
Bourke	2WEB	585	30 06'S	145 59'E
Bowral	2ST-T	1215	34 29'S	150 24'E
Broken Hill	2BH	567	31 56'S	141 27'E
Broken Hill % *	2NB	999	31 56'S	141 29'E
Byrock % *	2BY	657	30 39'S	146 25'E
Canberra % H24	2CA	1053	35 14'S	149 07'E
Canberra % H24	2CC	1206	35 13'S	149 07'E
Canberra *	2CN	666	35 13'S	149 07'E
Canberra *	2CY	846	35 13'S	149 07'E
Canberra	2XX	1008	35 13'S	149 07'E
Cobar	2DU-T	972	31 32'S	145 51'E
Coffs Harbour H24	2CS	639	30 29'S	153 02'E
Cooma	2XL	918	36 14'S	149 09'E
Cooma	2CP	1602	36 14'S	149 08'E
Corowa *	2CO	675	35 57'S	146 25'E
Cumnock *	2CR	549	32 56'S	148 42'E
Deniliquin	2QN	1521	35 37'S	144 55'E
Dubbo	2DU	1251	32 16'S	148 40'E
Glen Innes *	2GL	819	29 47'S	151 46'E
Gosford % *	2GO	801	33 20'S	151 28'E
Goulburn	2GN	1368	34 45'S	149 42'E
Grafton %	2GF	1206	29 40'S	152 59'E
Grafton *	2NR	738	29 29'S	153 07'E
Griffith %	2RG	963	34 20'S	146 08'E
Gunnedah	2MO	1080	30 59'S	150 13'E
Inverell	2NZ	1188	29 47'S	151 13'E
Katoomba	2KA	783	33 43'S	150 23'E
Kempsey %	2MC	531	31 06'S	152 50'E
Kempsey *	2KP	684	31 00'S	152 57'E
Lismore	2LM	900	28 46'S	153 21'E
Lithgow *	2LG	1395	33 29'S	150 09'E
Lithgow %	2LT	900	33 24'S	150 06'E
Moree	2VM	1530	29 29'S	149 54'E
Moruya	2BE-T	765	35 51'S	150 08'E
Mudgee % H24	2MG	1449	32 35'S	149 34'E
Murwillumbah *	2ML	720	28 15'S	153 30'E
Murwillumbah %	2MW	972	28 19'S	153 30'E
Muswellbrook % *	2NM	981	32 18'S	150 50'E
Muswellbrook % *	2UH	1044	32 14'S	150 55'E
Narooma	2BE-T	1584	36 14'S	150 09'E
Newcastle H24	2HD	1143	32 52'S	151 42'E
Newcastle H24	2KO	1413	32 51'S	151 42'E
Newcastle *	2NA	1512	32 48'S	151 40'E
Newcastle	2EA	1584	32 52'S	151 42'E
Newcastle *	2NC	1233	32 48'S	151 40'E
Nowra % *	2ST	999	34 53'S	150 32'E
Orange %	2GZ	1089	33 27'S	149 07'E
Parkes	2PK	1404	33 10'S	148 13'E
Penrith	2KA-T	1476	33 44'S	150 40'E
Sydney *	2BL	702	33 56'S	150 53'E
Sydney H24	2CH	1170	33 51'S	151 05'E
Sydney %	2EA	1386	33 50'S	151 04'E
Sydney *	2FC	576	33 56'S	150 53'E
Sydney H24	2GB	873	33 49'S	151 05'E
Sydney H24	2KY	1017	33 50'S	151 04'E
Sydney H24	2SM	1269	33 50'S	151 04'E
Sydney H24	2UE	954	33 51'S	151 04'E

Sydney H24	2UW	1107	33 51'S	151 05'E	Gympie %	4GY	558	26 10'S	152 50'E
Sydney % H24	2WS	1224	33 48'S	150 55'E	Hughenden *	4HU	1485	20 51'S	144 11'E
Tamworth	2TM	1287	31 10'S	150 55'E	Hughenden	4GC-T	765	20 51'S	144 11'E
Tamworth *	2NU	648	30 47'S	150 44'E	Innisfail %	4KZ	531	17 32'S	146 03'E
Taree * %	2TR	756	31 50'S	152 25'E	Julia Creek % *	4JK	567	20 39'S	141 49'E
Taree	2RE	1557	31 55'S	152 28'E	Kingaroy *	4SB	1071	26 24'S	151 50'E
Wagga Wagga	2WG	1152	35 02'S	147'25'E	Longreach	4LG	1098	23 23'S	144 17'E
Wallsend % H24	2NX	1341	33 53'S	151 41'E	Longreach *	4QL	540	23 23'S	144 17'E
Wilcannia *	2WA	1584	31 33'S	143 23'E	Mackay %	4QA	756	21 06'S	149 13'E
Wollongong	2EA	1485	34 32'S	150 53'E	Mackay %	4MK	1026	21 07'S	149 13'E
Wollongong H24	2WL	1314	34 31'S	150 52'E	Maryborough	4MB	1161	25 28'S	152 44'E
Wollongong *	2WN	1431	34 32'S	150 52'E	Moranbah	4HI-T	1215	22 00'S	148 02'E
Wollongong %	2OO	1575	34 29'S	150 47'E	Mossman *	4MS	639	16 25'S	145 23'E
Young %	2LF	1350	34 20'S	148 20'E	Mount Isa	4LM	666	20 43'S	139 30'E
					Mount Isa *	4MI	1080	20 40'S	139 30'E
Victoria					Nambour %	4SS	828	26 38'S	153 05'E
Albury/Wodonga	3AB	990	36 06'S	146 54'E	Oakey	4AK	1242	27 28'S	151 45'E
Ballarat % H24	3BA	1314	37 32'S	143 56'E	Pialba % *	4QB	855	25 16'S	152 49'E
Bendigo	3BO	945	36 42'S	144 13'E	Rockhampton *	4RK	837	23 27'S	150 27'E
Colac %	3CS	1134	38 19'S	143 32'E	Rockhampton	4RO	990	23 35'S	150 51'E
Geelong %	3GL	1341	38 10'S	144 27'E	Roma	4ZR	1476	26 33'S	148 49'E
Hamilton	3HA	981	37 41'S	142 01'E	Southport *	4SO	1593	28 02'S	153 26'E
Horsham %	3WM	1089	36 45'S	143 34'E	St George % *	4QW	711	28 00'S	148 40'E
Horsham	3MW	594	36 39'S	142 16'E	Thursday Island *	4TI	1062	10 35'S	142 13'E
Maryborough % *	3CV	1071	37 02'S	143 49'E	Toowoomba H24	4GR	864	27 36'S	151 55'E
Melbourne % H24	3AK	1503	37 45'S	145 06'E	Townsville % H24	4AY	891	19 19'S	147 02'E
Melbourne *	3AR	621	37 43'S	144 47'E	Townsville % H24	4TO	774	19 19'S	147 02'E
Melbourne H24	3AW	1278	37 44'S	145 06'E	Townsville * H24	4QN	630	19 31'S	147 20'E
Melbourne	3CR	855	37 49'S	145 00'E	Tully	4KZ-T	693	18 00'S	145 56'E
Melbourne	3EA	1224	37 37'S	144 56'E	Warwick %	4WK	963	28 01'S	151 58'E
Melbourne H24	3KZ	1179	37 44'S	145 07'E	Weipa	4WP	1044	12 37'S	141 53'E
Melbourne *	3LO	774	37 43'S	144 47'E					
Melbourne %	3MP	1377	37 56'S	145 13'E	South Australia				
Melbourne * H24	3TT	1026	37 44'S	145 06'E	Adelaide * % H24	5AA	1386	34 45'E	138 36'E
Melbourne H24	3UZ	927	37 44'S	145 06'E	Adelaide * H24	5AD	1323	34 50'S	138 35'E
Melbourne H24	3XY	1422	37 44'S	145 06'E	Adelaide *	5AN	891	35 06'S	138 31'E
Mildura	3MA	1467	34 11'S	142 07'E	Adelaide %	5CL	729	35 06'S	138 31'E
Meo % *	3MT	720	37 09'S	147 40'E	Adelaide H24	5DN	972	34 50'S	138 34'E
Sale %	3TR	1242	38 03'S	147 02'E	Adelaide *	5KA	1197	34 50'S	138 35'E
Sale *	3GI	828	38 11'S	147 06'E	Adelaide	5UV	531	34 50'S	138 35'E
Shepparton	3SR	1260	36 23'S	145 32'E	Crystal Brook *	5PI	1044	33 19'S	138 16'E
Swan Hill	3SH	1332	35 25'S	143 34'E	Leigh Creek South *	5LC	1602	30 36'S	138 24'E
Wangaratta %	3NE	1566	36 19'S	146 22'E	Mount Gambier *	5MG	1584	37 49'S	140 47'E
Warragul %	3UL	531	38 06'S	145 55'E	Mount Gambier % * H24	5SE	963	37 48'S	140 43'E
Warrnambool %	3YB	882	38 20'S	142 30'E	Murray Bridge *	5MU	1458	35 07'S	139 15'E
Warrnambool *	3WL	1602	38 22'S	142 30'E	Naracoorte % *	5PA	1161	36 57'S	140 40'E
					Port Augusta % *	5AU	1242	32 50'S	137 56'E
					Port Lincoln *	5LN	1485	34 44'S	135 53'E
Queensland					Port Pirie *	5CK	639	33 21'S	138 15'E
Atherton %	4AM	558	17 02'S	145 29'E	Renmark *	5MV	1305	34 16'S	140 37'E
Atherton *	4AT	720	17 18'S	145 33'E	Renmark *	5RM	801	34 14'S	140 38'E
Biloela *	4CC-T	927	24 24'S	150 30'E	Streaky Bay % *	5SY	693	32 45'S	134 12'E
Brisbane % H24	4BC	1116	27 32'S	152 58'E	Tumby Bay H24	5CC	765	34 15'S	136 20'E
Brisbane % H24	4BH	882	27 28'S	153 09'E	Woomera *	5WM	1584	31 12'S	136 49'E
Brisbane % * H24	4BK	1296	27 28'S	153 07'E					
Brisbane	4EB	1053	27 31'S	153 00'E					
Brisbane H24	4IO	1008	27 23'S	153 14'E	Western Australia				
Brisbane %	4KQ	693	27 23'S	153 14'E	Albany *	6AL	630	35 01'S	117 49'E
Brisbane *	4QG	792	27 19'S	153 01'E	Albany	6VA	783	35 01'S	117 51'E
Brisbane *	4QR	612	27 19'S	153 01'E	Bridgetown *	6BY	900	34 03'S	116 10'E
Bundaberg %	4BU	1332	24 51'S	152 24'E	Bridgetown *	6BR	1044	35 56'S	116 07'E
Cairns %	4CA	846	16 54'S	145 49'E	Broome *	6BE	675	17 58'S	122 14'E
Cairns *	4QY	801	17 03'S	145 47'E	Bunbury *	6TZ	963	33 21'S	115 45'E
Charleville	4VL	918	26 23'S	146 12'E	Busselton *	6BS	684	33 39'S	115 13'E
Charters Towers	4GC	828	20 04'S	146 18'E	Carnarvon *	6CA	846	24 52'S	113 40'E
Cloncurry	4LM-T	1458	20 42'S	140 30'E	Carnarvon	6LN	666	24 52'S	113 40'E
Cunnamulla	4VL-5	1584	28 07'S	145 41'E	Collie *	6CI	1134	33 22'S	116 11'E
Dalby	4QS	747	27 09'S	151 18'E	Dalwallinu *	6DL	531	30 17'S	116 36'E
Dysart %	4HI-5	945	22 35'S	148 22'S	Derby *	6DB	873	17 21'S	123 40'E
Eidsvoll *	4QO	855	25 24'S	151 07'E	Esperance	6ED	837	33 45'S	121 51'E
Emerald *	4QD	1548	23 26'S	148 09'E	Esperance %	6SE	747	33 46'S	121 52'E
Emerald %	4HI	1143	23 32'S	148 12'E	Exmouth *	6XM	1188	21 58'S	114 08'E
Gladstone % *	4CC	927	23 51'S	151 14'E	Exmouth	6LN-T	747	21 58'S	114 08'E
Gold Coast %	4GG	1197	28 00'S	153 24'S	Geraldton	6GE	1008	28 44'S	114 37'E
Gordonvale	4CA-T	954	17 08'S	145 51'E	Geraldton *	6GN	828	28 44'S	114 37'E
Gympie %	4GM	1566	28 13'S	152 41'E					

Kalgoorlie *	6GF	648	30 47'S	121 24'E
Kalgoorlie	6KG	981	30 44'S	121 30'E
Karratha	6KA	1260	20 44'S	116 50'E
Katanning *	6WB	1071	33 39'S	117 30'E
Kununurra *	6KW	756	15 46'S	128 44'E
Mandurah	6MM	1116	32 38'S	115 48'E
Manjimup %	6MJ	738	34 19'S	116 08'E
Merredin *	6MD	1098	31 30'S	118 12'E
Mount Newman *	6MN	567	23 21'S	119 44'E
Mount Tom Price *	6TP	567	22 42'S	117 46'E
Mount Tom Price *	6KA-T	765	22 42'S	117 46'E
Narrogin *	6NA	918	32 58'S	117 13'E
Northam *	6AM	864	31 40'S	116 37'E
Northam *	6NM	612	31 40'S	116 41'E
Pannawonica *	6PN	567	21 40'S	116 20'E
Paraburdoo *	6PU	567	21 13'S	117 40'E
Paraburdoo *	6KA-T	765	23 13'S	117 40'E
Perth * H24	6IX	1080	31 56'S	115 55'E
Perth * H24	6KY	1206	31 56'S	115 55'E
Perth %	6NR	927	32 01'S	115 54'E
Perth * H24	6PM	990	32 00'S	115 50'E
Perth * H24	6PR	882	32 00'S	115 49'E
Perth *	6WF	720	31 51'S	115 49'E
Perth *	6WN	810	31 51'S	115,49'E
Port Hedland *	6PH	603	20 24'S	118 40'E
Port Hedland	6NW	1026	20 23'S	118 35'E
Wagin *	6WA	558	33 20'S	117 05'E
Wyndham *	6WH	1017	15 28'S	128 06'E

Tasmania				
Burnie	7BU	558	40 58'S	145 44'E
Devonport	7AD	900	41 10'S	146 19'E
Fingal % *	7FG	1161	41 41'S	147 52'E
Hobart	7HO	864	42 55'S	147 19'E
Hobart %	7HT	1080	42 56'S	147 30'E
Hobart *	7ZL	585	42 55'S	147 30'E
Hobart % *	7ZR	936	42 55'S	147 30'E
Kelso % *	7NT	711	41 06'S	146 47'E
Launceston %	7EX	1008	41 27'S	147 13'E
Launceston	7LA	1098	41 23'S	147 09'E
Queenstown *	7QN	630	42 03'S	145 31'E
Queenstown	7QT	837	42 06'S	145 32'E
Saint Helens *	7SH	1584	41 20'S	148 17'E
Scottsdale %	7SD	540	41 06'S	147 32'E

Northern Territory				
Alice Springs	8HA	900	23 46'S	133 52'E
Alice Springs *	8AL	783	23 46'S	133 52'E
Alice Springs	VL8A	2310 Ngt	23 49'S	133 51'E
		4835 Day		
Darwin	8DN	1242	12 26'S	130 51'E
Darwin	8DR	857	12 25'S	130 51'E
Gove *	8GO	990	12 11'S	136 47'E
Jabiru *	8JB	747	12 40'S	132 53'E
Katherine * H24	8KN	639	14 24'S	132 11'E
Katherine*	8DN-T	765	14 27'S	132 16'E
Katherine	VL8K	2485 Ngt	14 24'S	132 11'E
		5025 Day		
Tennant Greek* H24	8TC	684	19 40'S	134 11'E
Tennant Creek	VL8T	2325 Ngt	19 40'S	134 16'E
		4910 Day		

Note:
8DR transmits on 857 kHz 12 39'40"S 131 02'13"E every Tuesday b/n 1430Z and 1530Z. 8DN freq 765 kHz retransmits 8DN 1242 kHz programs to Katherine.

Radio Australia (RA) Transmission Schedule

RA Transmitters

Radio Australia broadcasts through transmitting stations at Shepparton, Carnarvon and Darwin.

ASIA

English Service

23 hours daily reaching Bangladesh, Brunei, Burma, China, Hong Kong, India, Indonesia, Kampuchea, Korea, Laos, Malaysia, Pakistan, Philippines, Singapore, Sri Lanka, Taiwan, Thailand and Vietnam.

0000 - 0100	15240kHz
0100 - 0900	21720 kHz
0100 - 0910	17715 & 17750 kHz
0900 - 1100	17830 kHz
0900 - 1130	11895 kHz
1100 - 1330	9770 kHz
1200 - 1730	7205 kHz
1330 - 1530	9580 kHz
1400 - 1530	6035 kHz
1530 - 1730	9770 kHz
1530 - 2100	6035 kHz
1800 - 2100	7215 kHz
2200 - 2400	15240 kHz
0000 - 0900	15395 kHz

Broadcasting through Carnarvon, Darwin and Shepparton

PAPUA NEW GUINEA

Programs in English

Times shown are universal time coordinated.

Add for Local Time: +9 Irian Jaya; +10 Papua New Guinea, Bathurst and Melville Island; +11 Vanuatu.

English Service

Twenty-three hours daily reaching Papua New Guinea, Irian Jaya, Vanuatu, Bathurst and Melville Islands. Includes broadcasts in widely used regional English.

Regional English:

0800 - 0945 6080, 9760 & 5995 kHz

English:

0100 - 0930	15165 kHz
0900 - 1000	11800 kHz
1100 - 1300	11800 & 9710 kHz
1200 - 2030	6080 kHz
1400 - 1600	11800 & 9710 kHz
2000 - 2130	9620 kHz
2100 - 2400	15160 kHz
2330 - 0230	17725 kHz

English Service (continuous broadcasts)

0130 - 0530	17715 kHz
0200 - 0730	17795 kHz
0300 - 0800	15160 kHz
0400 - 0700	15320 kHz
0600 - 0840	11910 kHz
0730 - 0930	11720 kHz
0800 - 2130	9580 kHz
0800 - 2000	6045 kHz
1100 - 2000	5995 kHz
1200 - 2030	6060 kHz
1800 - 2100	7215 kHz
2100 - 0100	17795 & 15160 kHz
2100 - 0730	15395 kHz
2100 - 1000	15240 kHz
2200 - 0100	15320 kHz

PACIFIC

Programs in English.

Times shown are universal time coordinated.

Add for Local Time: +10 Micronesia, Guam; +11 New Caledonia, Micronesia, Vanuatu, Solomon Islands, Wallis and Futuna; +11.30 Norfolk Island, Nauru; +12 New Zealand, Kiribati, Fiji, Tuvalu; +13 Tonga.

Subtract for Local Time: -10 Cook Islands, French Polynesia, Hawaii; -11 Niue, Western Samoa and American Samoa.

AFRICA

Programs in English and French reaching Western and Southern Africa.

Times shown are universal time coordinated.

Add for Local Time: +1 Cameroon, Nigeria, Zaire; +2 Botswana, Lesotho, Malawi, South Africa, Zambia and Zimbabwe; +3 Djibouti, Ethiopia, Kenya, Madagascar, Tanzania, Uganda; +4 Mauritius, Seychelles.

English Service

Three-and-a-half hours daily.
0400 - 0730 17865 kHz
Broadcast through Shepparton.
0300 - 0400 15320 &
17865 kHz

Broadcast through Shepparton

RA NEWS REPORTING

English Service

World News: ten-minute bulletins every hour on the hour.

World and Pacific News: ten-minute bulletins at 0900, 1000, 1800, 1900 and 2000 on frequencies directed to the Pacific.

Australian News: ten-minute bulletins at 0130, 0430, 0830, 1230, 1630, 1830, 2030 and 2330.

Report from Asia: background to the news from RA correspondents. Saturday 1410, 1710, 2010 and 2310.

The Week in Canberra: News from the Australian national capital. Friday 1410, 1810, 2010 and 2210.

Television Frequencies

Australia			
	Channel	Frequency	
VHF		Vision	Sound
Band I	0	46.25	51.75
	1	57.25	62.75
	2	64.25	69.75
VHF	3	86.25	91.75
Band II	4	95.25	100.75
	5	102.25	107.75
	5A	138.25	143.75
VHF			
Band III	6	175.25	180.75
	7	182.25	187.75
	8	189.25	194.75
	9	196.25	201.75
	10	209.25	214.75
	11	216.25	221.75

International TV Frequencies (MHz) VHF

New Zealand			
	Channel	Frequency	
VHF		Vision	Sound
Band I		45.25	50.75
	2	55.25	60.75
	3	62.25	67.75
Band III	4	175.25	180.75
	5	182.25	187.75
	6	189.25	194.75
	7	196.25	201.75
	8	203.25	208.75
	9	210.25	215.75

European (CCIR)

Channel	Frequency	
	Vision	Sound
E2	48.25	53.75
E3	55.25	60.75
E4	62.25	67.75
E5	175.25	180.75
E6	182.25	187.75
E7	189.25	194.75
E8	196.25	201.75
E9	203.25	208.75
E10	210.25	215.75
E11	217.25	222.75
E12	224.25	229.75

UK

Channel	Frequency	
	Vision	Sound
B1	45.00	41.50
B2	51.75	48.25
B3	56.75	53.25
B4	61.75	58.25
B5	66.75	63.25
B6	179.75	176.25
B7	184.75	181.25
B8	189.75	186.25
B9	194.75	191.25
B10	199.75	196.25
B11	204.75	201.25
B12	209.75	206.25
B13	214.75	211.235

Australian UHF Frequencies

Band IV
between 520-585 MHz
Band V
between 614-820 MHz

Notes

1. B IV will be used for Main Stations

2. B V will be used for Translators
3. Planned for 7 MHz channels.

CCIR-UHF Frequencies

Europe, the UK and many other countries utilize the same band IV and Band V Frequencies

Channel	Band IV	(CCIR)
	Vision	Sound
21.	471.25	477.75
22.	479.25	485.75
23.	487.25	493.75
24.	495.25	501.75
25.	503.25	509.75
26.	511.28	517.75
27.	519.25	525.75
28.	527.25	533.75
29.	535.25	541.75
30.	543.25	549.75
31.	551.25	557.75
32.	559.25	565.75
33.	567.25	573.75
34.	575.25	581.75
35.	583.25	589.75
36.	591.25	597.75
37.	599.25	605.75
38.	607.25	613.75
39.	615.25	621.75
40.	623.25	629.75
41.	631.25	637.75
42.	639.25	645.75
43.	647.25	653.75
44.	655.25	661.75
45.	663.25	669.75
46.	671.25	677.75
47.	679.25	685.75
48.	687.25	693.75
49.	695.25	701.75
50.	703.25	709.75
51.	711.25	717.75
52.	719.25	725.75
53.	727.25	733.75
54.	735.25	741.75
55.	743.25	749.75
56.	751.25	757.75
57.	759.25	765.75
58.	767.25	773.75
59.	775.26	781.75
60.	783.25	789.75
61.	791.25	797.75
62.	799.25	805.75
63.	807.25	813.75
64.	815.25	821.75
65.	823.25	829.75

ARRL DXCC COUNTRIES LIST

Note: Third party traffic permitted with special events stations in the United Kingdom having the prefix GB only, with exception that GB3 stations are not included in this agreement.

Note: * Indicates current list of countries for which QSLs may be forwarded by the ARRL membership outgoing QSL service.

Note: †Indicates countries with which US amateurs may legally handle third-party message traffic.

PREFIX	COUNTRY	PREFIX	COUNTRY	PREFIX	COUNTRY
A2*	Botswana	CA-CE+*	Chile	D4*	Cape Verde
A3	Tonga	CE9/KC4A	Antarctica	D6**	Comoros
A4*	Oman	CEØ*	Easter Is	DA-DL2*	Fed Rep of Germany
A5	Bhutan	CEØ*	San Felix	DU-DZ*	Philippines
A6	United Arab Emirates	CEØ+*	Juan Fernandez	EA-EH*	Spain
A7	Qatar	CM,CO+*	Cuba	EA6-EH6*	Canary Is
A9*	Bahrain	CN*	Morocco	EA8-EH8*	Balearic Is
AP-AS	Pakistan	CP+*	Bolivia	EA9-EH9*	Ceuta* and Melilla
BV	Taiwan	CT*	Portugal	EI-EJ*	Ireland
BY,BT,BZ*	China	CT3*	Madeira Is	EL†	Liberia
C2*	Nauru	CU*	Azores	EP-EQ*	Iran
C3*	Andorra	CV-CX+*	Uruguay	ET	Ethiopia
C5+*	The Gambia	CYØ	Sable Is	F*	France
C6*	Bahamas	CYØ	St Paul Is	FT8W*	Cozet
C8-9	Mozambique	D2-3*	Angola	FT8X*	Kerguelen Is

PREFIX	COUNTRY	PREFIX	COUNTRY	PREFIX	COUNTRY
FT8Z*	Amsterdam & St Paul Is	OH0*	Aland Is	VK9†*	Mellish Reef
FG*	Guadeloupe	OJ0*	Market Reef	VK9†*	Norfolk Is
FJ,FS†*	Saint Martin	OK-OM*	Czechoslovakia	VK0†*	Heard Is
FH2*	Mayotte	ON-OT*	Belgium	VP2E ¹⁵	Macquarie Is
FK*	New Caledonia	OX*	Greenland	VP2M ^{15*}	Anguilla
FM*	Martinique	OY*	Faroe Is	VP2V ^{15*}	Montserrat
FO*	Clipperton Is	OX*	Denmark	VP5*	Brit Virgin Is
FO*	French Polynesia	P2†*	Papua New Guinea	VP8*	Turks & Caicos Is
FP*	St Pierre & Miquelon	P4†*	Aruba	VP8,LU*	Falkland Is
FR/G*	Glorioso Is	PA-PI*	Netherlands	VP8,LU*	South Georgia Is
FR/J,E*	Juan de Nova, Europa	PJ2,4,9*	Bonaire, Curacao (Neth Antilles)	VP8,LU*	South Orkney Is
FR*	Reunion		St Maarten, Saba, St Eustatius	VP8,CE9,HF0,LU,4K1*	South Sandwich Is
FR/T*	Tromelin	PJ5-8*	Brazil		South Shetland Is
FW*	Wallis & Futuna Is	PP-PY†*	Brazil	VP9*	Bermuda
FY*	French Guiana	PP0-PY0†*	Fernando de Noronha	VP9*	Chagos
G*#	England	PP0-PY0†*	St Peter & St Paul Rocks	VR6†	Pitcairn Is
GD*	Isle of Man	PP0-PY0†*	Trinidad & Martin Vaz Is	VS2*	Hong Kong
GI*	Northern Ireland	PZ*	Suriname	VU*	India
GJ*	Jersey	S2*	Bangladesh	VU*	Andaman & Nicobar Is
GM*	Scotland	S7*	Seychelles	VU*	Laccadive Is
GU*	Guernsey & Dep	S9	Sao Tome & Principe	XA-XI†*	Mexico
GW*	Wales	S0 ^{1,32}	Western Sahara	XA4-X14*	Revilla Gigedo
H4*	Solomon Islands	SA-SM*	Sweden	XT ¹⁷	Burkina Faso
HA,HG*	Hungary	SN-SR*	Poland	XU	Kampuchea
HB*	Switzerland	ST*	Sudan	XW	Laos
HB0	Liechtenstein	ST0*	Southern Sudan	XX9	Macao
HC-HD†*	Ecuador	SU*	Egypt	XY-XZ	Burma
HC8-HD8†*	Galapagos Is	SV-SZ*	Greece	Y2-Y9 ³⁰	German Dem Rep
HH†*	Haiti	SV5*	Dodecanese	YA	Afghanistan
HI*	Dominican Rep	SV9*	Crete	YB-YH ²¹	Indonesia
HJ-HK†*	Colombia	SV/A*	Mount Athos	YI*	Iraq
HK0†*	Malpelo Is.	T2 ¹¹	Tuvalu	YJ*	Vanuatu
HK0†*	San Andreas & Providencia	T30	W Kiribati (Gilbert & Ocn Is)	YK*	Syria
HL*	Korea	T31	C Kiribati (Brit Phoenix Is)	YN†*	Nicaragua
HO-HP†*	Panama	T32	E Kiribati (Line Is)	YO-YR*	Romania
HQ-HR†*	Honduras	T5	Somalia	YS†*	El Salvador
HS*	Thailand	T7*	San Marino	YT-YU, YZ*	Yugoslavia
HV*	Vatican	TA-TC*	Turkey	YV-YY†*	Venezuela
HZ	Saudi Arabia	TF*	Iceland	YV0†*	Aves Is
I*	Italy	TG,TD†*	Guatemala	Z2*	Zimbabwe
IS0,IM0*	Sardinia	TI,TE†*	Costa Rica	ZB2*	Gibraltar
J2*	Djibouti	T19†*	Cocos Is	ZC4 ^{30*}	UK Sov. Base Areas on Cyprus
J3†*	Grenada	TJ	Cameroon		St Helena
J5	Guinea-Bissau	TK*	Corsica	ZD7	Ascension Is
J6†*	St Lucia	TL†	Central African Rep	ZD8*	Tristan da Cuha & Gough Is
J7†*	Dominica	TN*	Congo	ZD9	Cayman Is
J8†*	St Vincent & Dep	TR ¹⁰	Gabon	ZF*	Sth Cook Is
JA-JS*	Japan	IT ¹¹	Chad	ZK1*	Nth Cook Is
JD1 ⁵	Minami Torishima	TU ¹²	Ivory Coast	ZK2	Niue
JD1 ⁵	Ogasawara	TY ¹³	Benin	ZK3	Tokelau Is
JT-JV*	Mongolia	TZ ¹⁴	Mali	ZL-ZM*	New Zealand
JW*	Svalbard	UA1,3,4,6*	European Russian RSFSR	ZL7*	Chatham Is
JX*	Jan Mayen	UA1*	Franz Josef Land	ZL8*	Kermadec Is
JY†*	Jordan	UA2*	Kaliningrad	ZL9*	Auckland & Campbell Is
K,W,N,AA-AK	United States of America	UA9,0	Asiatic RSFSR	ZP†*	Paraguay
KC6 ^{2*}	Ref. V6	UB, UT, UY*	Ukraine	ZR-ZU*	South Africa
KC6 ^{2*}	(W Caroline Is) Belau	UC*	Byelorussia	ZR2-ZU2*	Prince Edward & Marion Is
KG4†*	Guantanamo Bay	UD*	Azerbaijan	ZR3-ZU3*	(Namibia) SW Africa
KH1†	Baker, Howland Is	UF*	Georgia	1A0 ¹	Sov. Mil. Order of Malta
KH2†*	Guam	UG*	Armenia	1S ¹	Spratly Is
KH3†	Johnston Is	UH*	Turkmenistan	3A*	Monaco
KH4†*	Midway Is	UI*	Uzbekistan	3B6,7*	Agalega & St Brandon
KH5†	Palmyra, Jarvis Is	UJ*	Tadzhikistan	3B8*	Mauritius
KH5K†	Kingman Reef	UL*	Kazhikistan	3B9*	Rodriguez Is
KH6†*	Hawaiian Is	UM*	Kirghizia	3C	Equatorial Guinea
KH7†	Kure Is	UO*	Moldavia	3C0	Pagalu Is
KH8†*	American Samoa	UP*	Lithuania	3D2*	Fiji & Rotuma Is
KH9†	Wake Is	UQ*	Latvia	3D6†*	Swaziland
KH0†*	Mariana Is	UR*	Estonia	3V	Tunisia
KH7†*	Alaska	V2†*	Antigua & Barbuda	3W, XV	Vietnam
KP1†	Navassa Is	V3†*	Belize	3X	Guinea
KP2†*	Virgin Is	V4 ^{16†}	St Christopher & Nevis	3Y*	Bouvet
KP4†*	Puerto Rico	V6	Federated States of Micronesia (ref KC6)	3Y*	Peter Is
KP5 ²¹	Desecheo Is	V7	Marshall Is (ref KX6)	4J1	Malyj Vystotkij Is
KX6*	Ref. V7	V8*	Brunei	4P-4S*	Sri Lanka
LA-LN*	Norway	VE,VO,VY†*	Canada	4U†*	ITU Geneva
LO-LW†*	Argentina	VK†*	Australia	4U	HQ, United Nations
LX*	Luxembourg	VK†*	Lord Howe Is	4W	Yemen
LZ*	Bulgaria	VK9†*	Willis Is	4X,4Z†*	Israel
OA-OC†*	Peru	VK9†*	Christmas Is	5A	Libya
OD*	Lebanon	VK9†*	Cocos-Keeling Is	5B*	Cyprus
OE*	Austria	VK9†*		5H-51	Tanzania
OF-OI*	Finland				

PREFIX

5N-50*
 5R-5S
 5T18*
 5U¹⁹
 5V*
 5W*
 5X
 5Y-5Z*
 6V-6W²⁰
 6Y†*
 7O
 7P*
 7Q
 7T-7Y*
 8P*
 8Q
 8R†*
 9G²²†
 9H*
 9I-9J*
 9K*
 9L†*
 9M2,4²³
 9M6,8²³
 9N
 9Q-9T*
 9U²⁴
 9V²⁵
 9X²⁴
 9Y-9Z†*
 J2/A*

COUNTRY

Nigeria
 Madagascar
 Mauritania
 Niger
 Togo
 Western Samoa
 Uganda
 Kenya
 Senegal
 Jamaica
 People's Dem Rep of Yemen
 Lesotho
 Malawi
 Algeria
 Barbados
 Maldives
 Guyana
 Ghana
 Malta
 Zambia
 Kuwait
 Sierra Leone
 West Malaysia
 East Malaysia
 Nepal
 Zaire
 Burundi
 Singapore
 Rwanda
 Trinidad & Tobago
 Abu Ail, Jabal at Tair

DXCC NOTES

1 Unofficial prefix.
 2 (DA-DL) Only contacts made September 17, 1973 and after, count for this country.
 3 (Y2-Y9) Only contacts made September 17, 1973 and after, count for this country.
 4 (FR) Only contacts made June 25, 1960 and after, count for this country.
 5 (JD,KA1) Formerly Marcus Island.
 6 (JD,KA1) Formerly Bonin & Volcano Islands.
 7 (P2) Only contacts made September 16, 1975 and after, count for this country.
 8 (TL) Only contacts made August 13, 1960 and after, count for this country.
 9 (TN) Only contacts made August 15, 1960 and after, count for this country.
 10 (TR) Only contacts made August 17, 1960 and after, count for this country.
 11 (TT) Only contacts made August 11, 1960 and after, count for this country.
 12 (TU) Only contacts made August 7, 1960 and after, count for this country.
 13 (TY) Only contacts made August 1, 1960 and after, count for this country.
 14 (TZ) Only contacts made June 20, 1960 and after, count for this country.
 15 (VP2) For DXCC credit for contacts made May 31, 1958 and before, see page 97 June 1958 QST.
 16 (T2,VR8) Only contacts made January 1, 1960 and after, count for this country.
 17 (XT) Only contacts made August 5, 1960 and after, count for this country.
 18 (58) Only contacts made June 20, 1960 and after, count for this country.

19 (5U) Only contacts made August 3, 1960 and after, count for this country.
 20 (6W) Only contacts made June 20, 1960 and after, count for this country.
 21 (8F,YB) Only contacts made May 1, 1963 and after, count for this country.
 22 (9G) Only contacts made March 5, 1957 and after, count for this country.
 23 (9M2,4,6,8) Only contacts made September 16, 1963 and after, count for this country.
 24 (9U,9X) Only contacts made July 1, 1962 and after, count for this country.
 25 (9V) Only contacts made September 16, 1963 to August 8, 1965, count for West Malaysia.
 26 (D6,FH8) Only contacts made July 5, 1975 and after, count for this country.
 27 (KP5,KP4) Only contacts made March 1, 1979 and after, count for this country.
 28 (KC6) Includes Yap Is. January 1, 1981 and after.
 29 (KC6) Includes Yap Is. December 31, 1980 and before.
 30 (ZC4) Only contacts made August 16, 1960 and after, count for this country.,
 31 (P4) Only contacts made January 1, 1986 and after, count for this country.
 32 Contacts with Rio de Oro (Spanish Sahara), EA9, also count for this country.
 Δ Also ATØ, DFØ, FT8Y, LU, OR4, VKØ, VP8, Y8, ZL5, ZS1, ZXØ, 3Y, 4K1, 8J1, etc.
 QSL via country under whose auspices the particular station is operating. The availability of a third party traffic agreement and a QSL Bureau applies to the country under whose auspices the particular station is operating.

Deleted Countries

Credit for any of these countries can be given if the date of contact with the country in question agrees with the date(s) shown in the corresponding footnote.

Prefix	Country
AC ^{1,2}	Sikkim
AC4 ^{1,3}	Tibet
C9*	Manchuria
CN2*	Tangier
CR8*	Damao, Diu
CR8*	Goa
CR8, CR10*	Portuguese Timor
DA-DM*	Germany
EA9*	Ifni
ET2 ¹⁰	Eritrea
FF ¹¹	Fr West Africa
FH, FB8 ¹²	Comoros
F18 ¹³	Fr Indo China
FN8 ¹⁴	French India
FQ8 ¹⁵	Fr Equatorial Africa
HKØ ¹⁶	Bajo Nuevo
HKØ,KPE,KS4 ¹⁶	Serrana Bank & Roncador Cay
11 ¹⁷	Trieste
15 ¹⁸	Italian Somaliland
JD1/7J1 ¹⁹	Okino Tori-Shima
JZØ ²⁰	Netherlands N Guinea
KR6,8, JR6,KA6 ²¹	Okinawa (Ryukyu Is)
KS4 ²²	Swan Islands
KZ5 ²³	Canal Zone
P2,VK8 ²⁴	Papua Territory
P2,VK9 ²⁴	Terr New Guinea
PK1-3 ²⁵	Java
PK4 ²⁵	Sumatra
PK5 ²⁵	Netherlands Borneo
PK6 ²⁵	Celebe & Molucca Is
UNI ²⁶	Karelo-Finnish Rep
VO ²⁷	Newfoundland, Labrador
VQ1,5H1 ²⁸	Zanzibar
VQ6 ²⁹	British Somaliland
VQ9 ³⁰	Aldabra
VQ9 ³⁰	Desroches
VQ9 ³⁰	Farquhar
VS2,9M2 ³	Malaya
VS4 ³¹	Sarawak
VSH9 ³²	Kuria Muria Is
ZC5 ³¹	British North Borneo

ZC6,4X1³³
 ZD4³⁴
 1M^{1,35}
 7O/V9K²⁶
 8Z4³⁷
 8Z5,9K3³⁸
 9S4³⁹
 9U5⁴⁰
 41
 42

Notes
 1 Unofficial prefix.
 2 (AC3) Only contacts made April 30, 1975 and before count for this country. Contacts made May 1, 1975 and after, count as India (VU).
 3 (AC4) Only contacts made May 30, 1974 and before, count for this country. Contacts made May 31, 1974 and after count as China (BY).
 4 (C9) Only contacts made September 15, 1963 and before, count for this country. Contacts made September 16, 1963 and after count as China (BY).
 5 (CN2) Only contacts made June 30, 1960 and before, count for this country. Contacts made July 1, 1960 and after count as Morocco (CN).
 6 (CR8) Only contacts made December 31, 1962 and before, count for this country.
 7 (CR8, CR10) Only contacts made September 14, 1976 and before, count for this country.
 8 (DA-DM) Only contacts made September 16, 1973 and before, count for this country. Contacts made September 17, 1973 and after, count as either FRG (DA-DL) or GDR (Y2-Y9).
 9 (EA9) Only contacts made May 13, 1969 and before, count for this country.
 10 (ET2) Only contacts made November 14, 1962 and before, count for this country. Contacts made November 15, 1962 and after, count as Ethiopia (ET).
 11 (FF) Only contacts made August 6, 1960 and before, count for this country.
 12 (FH, FB8) Only contacts made July 5, 1975 and before, count for this country. Contacts made July 6, 1975 and after, count as Comoros (D6) or Mayotte (FH).
 13 (F18) Only contacts made December 20, 1950 and before, count for this country.
 14 (FN8) Only contacts made December 31, 1954 and before, count for this country.

15 (FQ8) Only contacts made August 16, 1960 and before, count for this country.
 16 (HKØ,KP3,KS4) Only contacts made September 16, 1981 and before, count for this country. Contacts made September 17, 1981 and after, count as San Andres (HKØ).
 17 (I1) Only contacts made March 31, 1957 and before, count for this country. Contacts made April 1, 1957 and after, count as Italy (I).
 18 (I5) Only contacts made June 30, 1960 and before, count for this country.
 19 (JD1/7J1) Only contacts made May 30, 1976 to November 30, 1980 count for this country. Contacts made December 1, 1980 and after, count as Ogasawara (JD1).
 20 (JZØ) Only contacts made April 30, 1963 and before, count for this country.
 21 (KR6,9, JR6,KA6) Only contacts made May 14, 1972 and before, count for this country. Contacts made May 15, 1972 and after, count as Japan (JA).
 22 (KS4) Only contacts made August 31, 1972 and before, count for this country. Contacts made September 1, 1972 and after, count as Honduras (HR).
 23 (KZ5) Only contacts made September 30, 1979 and before, count for this country.
 24 (P2,VK9) Only contacts made September 15, 1975 and before, count for this country. Contacts made September 16, 1975 and after, count as Papua New Guinea (P2).
 25 (PK1-6) Only contacts made April 30, 1963 and before, count for this country. Contacts made May 1, 1963 and after, count as Indonesia (YB).
 26 (UN1) Only contacts made June 30, 1960 and before, count for this country. Contacts made July 1, 1960 and after, count as European RSFSR (UA).
 27 (VO) Only contacts made March 31, 1949 and before, count for this country. Contacts made April 1, 1949 and after, count as Canada (VE).
 28 (VQ1,5H1) Only contacts made May 31, 1974 and before, count for this country. Contacts made June 1, 1974 and after, count as Tanzania (5H).
 29 (VQ6) Only contacts made June 30, 1960 and before, count for this country.
 30 (VQ9) Only contacts made June 28, 1976 and before, count for this country. Contacts made June 29, 1976 and after, count as Seychelles (S7).
 31 (VS2, VS4, ZC5, 9M2) Only contacts made September 15, 1963 and before, count for this country.

Contacts made September 16, 1963 and after, count as West Malaysia (9M2) or East Malaysia (9M6,8).
 32 (VS9H) Only contacts made November 29, 1967 and before, count for this country.
 33 ((ZC6,4X1) Only contacts made June 30, 1968 and before, count for this country. Contacts made July 1, 1968 and after, count as Israel (4X).
 34 (ZD4) Only contacts made March 5, 1957 and before, count for this country.
 35 (1M) Only contacts made July 15, 1972 and before, count for this country. Contacts made July 16, 1972 and after, count as Tonga (A3).
 36 (7O/VS9K) Only contacts made March 10, 1982 and before, count for this country.
 37 (8Z4) Only contacts made December 25, 1981 and before, count for this country.
 38 (8Z5,9K3) Only contacts made December 14 and before, count for this country.
 39 (9S4) Only contacts made MARCH 31, 1957 and before, count for this country.
 40 (9U5) Only contacts made July 1, 1960 to June 30, 1962, count for this country. Contacts made July 1, 1962 and after, count as Burundi (9U) or Rwanda (9X).
 41 (Blenheim Reef) Only contacts made May 4, 1967 to June 30, 1975, count for this country. Contacts made July 1, 1975 and after, count as Chagos (VQ9).
 42 (Geyser Reef) Only contacts made May 4, 1967 to February 28 1978 count for this country.

Prefix Cross References

A8 = EL
 AC (before 1972) = A5
 AH = KH
 AL7 = KL7
 AM-AO = EA
 AT-AW = VU
 AX = VK
 AY-AZ = LU
 CF-CK = VE
 CL = CO
 CQ-CS = CT
 CR3 (before 1974) = J5
 CR4 (before 1976) = D4
 CR5 (before 1976) = S9
 CR6 (before 1976) = D2
 CR7 (before 1976) = C9
 CR9 (before 1985) = XX9
 CT2 (before 1986) = CU
 CXØ = CE9/VP8
 CY-CZ = VE
 CY9 (before 1985) = CYØ
 DM-DT (before 1980) = Y2-9
 EAØ (before 1969) = 3C
 EK, EM-EO, ER-ES, EU-EZ = U
 FA-FF (after 1981) = F
 FA (before 1963) = 7X
 FB8 (before 1961) = 5R
 FB8 (before 1985) = FT
 FC (before 1985) = TK
 FD8 (before 1961) = 5V
 FE8 (before 1961) = TJ
 FL (before 1978) = J2
 FU8 (before 1982) = YJ
 GB = G
 GC (before 1977) = GJ/GU
 H2 = 5B
 H3 = HP
 H5 (Bophutatswana) = ZS
 H7 = YN
 HE = HB
 HM (before 1982) = HL
 HT = YN
 HU = YS
 HW-HY = F
 J4 = SV
 KA1 = JD1
 KA2AA-KA8ZZ = JA
 KB6 (before 1979) = KH1
 KC4 (Navassa) = KP1
 KG6 (before 1979) = KH2

KG6I (before 1970) = JD1
 KG6R,S,T (before 1979) = KHØ
 KJ6 (before 1979) = KH3
 KM6 (before 1979) = KH4
 KP4 (Desecheo) = KP5
 KP6 (before 1979) = KH5
 KS6 (before 1979) = KH8
 KV4 (before 1979) = KP2
 KW6 (before 1979) = KH9
 L2-9 = LU
 LY = UP
 M1 (before 1984) = T7
 MP4B (before 1972) = A9
 MP4M (before 1972) = A4
 MP4Q (before 1972) = A7
 MP4T,D (before 1972) = A6
 NH = KH
 NL7 = KL7
 NP = KP
 OQ (before 1961) = 9Q
 PR (before 1986) = PJ
 PX (before 1970) = C3
 RA,RN = UA
 RB-RR = UB-UR
 RS-RZ = U
 S4 (Ciskei) = ZS
 S8 (Transekei) = ZS
 T4 = CO
 T4 (Venda) = ZS
 TH,TM,TO-TQ,TV-TX = F
 UN,UV,UW,UZ = UA
 V9 (Venda) = ZS
 VA-VG = VE
 VH-VN = VK
 VK9 (Nauru) = C2
 VP1 (before 1982) = V3
 VP2A (before 1982) = V2
 VP2D (before 1979) = J7
 VP2G (before 1975) = J3
 VP2K (before 1984) = V4 or VPW3
 VP2L (before 1980) = J6
 VP2S (before 1980) = J8
 VP3 (before 1967) = 8R
 VP4 (before 1963) = 9Y
 VP5 (Jamaica) = 6Y
 VP6 (before 1967) = 8P
 VP7 (before 1974) = 8P
 VQ2 (before 1965) = 9J
 CQ4 (before 1964) = 5Z
 VQ5 (before 1963) = 5X
 VQ8 (before 1969) = 3B
 VQ8 (Chagos) = VQ9
 VQ9 (Seychelles) = S7
 VR1 (before 1980) = T3/31
 VR2 (before 1971) = 3D2
 VR3 (before 1980) = T32
 VR4 (before 1979) = H4
 VR5 (before 1971) = A3
 VR8 (before 1979) = T2
 VS1 (before 1966) = 9V
 VS5 (before 1985) = V8
 VS7 (before 1949) = 4S
 VS9A,P,S (before 1968) = 7O
 VS9M = 8Q
 VS9O (before 1961) = A4
 VX-VY = CY/VE
 WH = KH
 WL7 = KL7
 WP = KP
 XJ-XO = VE
 XP = OX
 XQ-XR = CE
 XV = 3W
 XX7 (before 1976) = C9
 YL = UO
 ZB1 (before 1965) = 9H
 ZD1 (before 1962) = 9L
 ZD2 (before 1961) = 5N
 ZD3 (before 1966) = C5
 ZD4 (before 1958) = 9G
 ZD5 (before 1969) = 3D6
 ZD6 (before 1965) = 7Q
 ZE (before 1981) = Z2-9
 ZK9 (1983) = ZK2

ZM6 (before 1963) = 5W
 ZM7 (before 1984) = ZK3
 ZS7 (before 1969) = 3D6
 ZS8 (before 1967) = 7P
 ZS9 (before 1967) = A2
 ZV-ZZ = PY
 3B=3C (before 1968) = VE
 3G = CE
 3Z = SP
 4A-4C = XE
 4D-RI = DU
 4J-4L = U
 4M = YV
 4N-4Q = YU
 4T - OA
 4U1VIC = OE
 4V = HH
 5J-5K = HK
 5L-5M = EL
 6C = YK
 6D-6J = XE
 6O = T5
 6T-6U = ST
 7A-7I = YB
 7G (before 1967) = 3X
 7J-7N = JA,JD
 7S = SM
 7Z = HZ
 8A-8I = YB
 8J-8N = JA
 8O = A2
 8S = SM
 9A (before 1984) = T7
 9B-9D = EP
 9E=9F = ET

Allocation of International Call Signs

Call Sign	Allocated To
AAA-ALZ	United States of America
AMA-AOZ	Spain
APA-ASZ	Pakistan (Islamic Rep of)
ATA-AWZ	India (Rep of)
AXA-AXZ	Australia
AYA-AZZ	Argentine Republic
A2A-A2Z	Botswana (Rep of)
A3A-A3Z	Tbnga (Kingdom of)
A4A-A4Z	Oman (Sultanate of)
A5A-A5Z	Bhutan (Kingdom of)
A6A-A6Z	United Arab Emirates
A7A-A7Z	Qatar (State of)
A8A-A8Z	Liberia (Rep of)
A9A-A9Z	Bahrain (State of)
BAA-BZZ	China (People's Rep of)
CAA-CEZ	Chile
CFA-CKZ	Canada
CLA-CMZ	Cuba
CNA-CNZ	Morocco (Kingdom of)
COA-COZ	Cuba
CPA-CPZ	Bolivia (Rep of)
CQA-CUZ	Portugal
CVA-CXS	Uruguay (Oriental Rep of)
CYA-CZZ	Canada
C2A-C2Z	Nauru (Rep of)
C3A-C3Z	Andorra (Principality of)
C4A-C4Z	Cyprus (Rep of)
C5A-C5Z	Gambia (Rep of the)
C6A-C6Z	Bahamas (C'wealth of the)
C7A-C7Z*	World Meteorological Org
C8A-C9Z	Mozambique (People's Rep of)
DAA-DRZ	Germany (Fed Rep of)
DSA-DTZ	Republic of Korea
DUA-DZZ	Philippines (Rep of the)
D2A-D2Z	Angola (People's Rep of)
D4A-D4Z	Cape Verde (Rep of)
D5A-D5Z	Liberia (Rep of)
D6A-D6Z	Comoros (Fed & Islamic Rep of the)
D7A-D9Z	Republic of Korea
EAA-EHZ	Spain
EIA-EJZ	Ireland
EKA-EKZ	Union of Soviet Socialist Republics

ELA-ELZ	Liberia (Rep of)	S7A-S7Z	Seychelles (Rep of)	3BA-3BZ	Mauritius
EMA-EOZ	Union of Soviet Socialist Republics	S9A-S9Z	Sao Tome & Principe (Dem Rep of)	3CA-3CZ	Equatorial Guinea (Rep of)
EPA-EQZ	Iran (Islamic Rep of)	TAA-TCZ	Turkey	3DA-3DM	Swaziland (Kingdom of)
ERA-ESZ	Union of Soviet Socialist Republics	TDA-TDZ	Guatemala (Rep of)	3DN-3DZ	Fiji
ETA-ETZ	Ethiopia	TEA-TEZ	Costa Rica	3EA-3FZ	Panama (Rep of)
EUA-EWZ	Byelorussian Soviet Soc Republic	TFA-TFZ	Iceland	3GA-3GZ	Chile
EXA-EZZ	Union of Soviet Socialist Republics	TGA-TGZ	Guatemala (Rep of)	3HA-3UZ	China (People's Rep of)
FAA-FZZ	France	THA-THZ	France	3VA-3VZ	Tunisia
GAA-GZZ	United Kingdom of Great Britain & Northern Ireland	TIA-TIZ	Costa Rica	3WA-3WZ	Vietnam (Socialist Rep of)
HAA-HAZ	Hungarian People's Republic	TJA-TJZ	Cameroon (United Rep of)	3XA-3XZ	Guinea (People's Revolutionary Rep of)
HBA-HBZ	Switzerland (Confederation of)	TKA-TKZ	France	3YA-3YZ	Norway
HCA-HDZ	Ecuador	TLA-TLZ	Central African Republic	3ZA-3ZZ	Poland (People's Rep of)
HEA-HEZ	Switzerland (Confederation of)	TMA-TMZ	France	4AA-4CA	Mexico
HFA-HFZ	Poland (People's Rep of)	TNA-TNZ	Congo (People's Rep of the)	4DA-4IZ	Philippines (Rep of the)
HGA-HGZ	Hungarian People's Republic	TOA-TOZ	France	4JA-4LZ	Union of Soviet Socialist Republics
HHA-HHZ	Haiti (Rep of)	TRA-TRZ	Gabon Republic	4MA-4MZ	Venezuela (Rep of)
HIA-HIZ	Dominican Republic	TSA-TSZ	Tunisia	4NA-4OZ	Yugoslavia (Socialist Fed Rep of)
HJA-HKZ	Colombia (Rep of)	TTA-TTZ	Chad (Rep of)	4PA-4SZ	Sri Lanka (Dem Socialist Rep of)
HLA-HLZ	Republic of Korea	TUA-TUZ	Ivory Coast (Rep of the)	4TA-4TZ	Peru
HMA-HMZ	Democratic People's Rep of Korea	TVA-TXZ	France	4UA-4UZ*	United Nations Organisation
HNA-HNZ	Iraq (Rep of)	TYA-TYZ	Benin (People's Rep of)	4VA-4VZ	Haiti (Rep of)
HOA-HPZ	Panama (Rep of)	TZA-TZZ	Mali (Rep of)	4WA-4WZ	Yemen Arab Republic
HQA-HRZ	Honduras (Rep of)	T2A-T2Z	Tuvalu	4XA-4XZ	Israel (State of)
HSA-HSZ	Thailand	T3A-T3Z	Kiribati Republic	4YA-4YZ*	International Civil Aviation Org
HTA-HTZ	Nicaragua	T4A-T4Z	Cuba	4ZA-4ZZ	Israel (State of)
HUA-HUZ	El Salvador (Rep of)	T5A-T5Z	Somali Democratic Republic	5AA-5AZ	Libya (Socialist People's Libyan Arab Jamahiriya)
HVA-HVZ	Vatican City State	T6A-T6Z	Afghanistan (Dem Rep of)	5BA-5BZ	Cyprus (Rep of)
HWA-HYZ	France	T7A-T7Z	San Marino (Rep of)	5CA-5GC	Morocco (Kingdom of)
HZA-HZZ	Saudi Arabia (Kingdom of)	UAA-UQZ	Union of Soviet Socialist Republic	5HA-5IZ	Tanzania (United Rep of)
H2A-H2Z	Cyprus (Rep of)	URA-UTZ	Ukrainian Soviet Socialist Republic	5JA-5KZ	Colombia (Rep of)
H3A-H3Z	Panama (Rep of)	UUA-UZZ	Union of Soviet Socialist Republics	5LA-5MZ	Liberia (Rep of)
H4A-H4Z	Solomon Islands	VAA-VGZ	Canada	5NA-5OZ	Nigeria (Fed Rep of)
H6A-H7Z	Nicaragua	VHA-VNZ	Australia	5PA-5QZ	Denmark
H8A-H9Z	Panama (Rep of)	VOA-VOZ	Canada	5RA-5SZ	Madagascar (Dem Rep of)
IAA-IZZ	Italy	VPA-VSZ	United Kingdom of Great Britain & Northern Ireland	5TA-5TZ	Mauritania (Islamic Rep of)
JAA-JSZ	Japan	VTA-VWZ	India (Rep of)	5UA-5UZ	Niger (Rep of the)
JTA-JVZ	Mongolai People's Republic	VXA-VYZ	Canada	5VA-5VZ	Togolese Republic
JWA-JXZ	Norway	VZA-VZZ	Australia	5WA-5WZ	Western Samoa
JYA-JYZ	Jordan (Hashemite Kingdom of)	V2A-V2Z	Antigua & Barbuda	5XA-5XZ	Uganda (Rep of)
JZA-JZZ	Indonesia (Rep of)	V3A-V3Z	Belize	5YA-5ZZ	Kenya (Rep of)
J2A-J2Z	Djibouti (Rep of)	V4A-V4Z	St Christopher & Nevis	6AA-6BZ	Egypt (Arab Rep of)
J3A-J3Z	Grenada	V8A-V8Z	Brunei	6CA-6CZ	Syrian Arab Republic
J4A-J4Z	Greece	WAA-WZZ	United States of America	6DA-6JZ	Mexico
J5A-J5Z	Guinea-Bissau (Rep of)	XAA-XIZ	Mexico	6KA-6NZ	Republic of Korea
J6A-J6Z	Saint Lucia	XJA-XOZ	Canada	6OA-6OZ	Somali Democratic Republic
J7A-J7Z	Dominica	XPA-XPZ	Denmark	6PA-6SZ	Pakistan (Islamic Rep of)
J8A-J8Z	St Vincent & the Grenadines	XQA-XRZ	Chile	6TA-6UZ	Sudan (Dem Rep of the)
KAJ-KKZ	United States of America	XSA-XSZ	China (People's Rep of)	6VA-6WZ	Senegal (Rep of the)
LAA-LNZ	Norway	XTA-XTZ	Burkina Faso	6XA-6XZ	Madagascar (Dem Rep of)
LOA-LWZ	Argentina (Rep of)	XUA-XUZ	Democratic Kampuchea	6YA-6YZ	Jamaica
LXA-LXZ	Luxembourg	XVA-XVZ	Vietnam (Socialist Rep of)	6ZA-6ZZ	Liberia (Rep of)
LYA-LYZ	Union of Soviet Socialist Republics	XWA-XWZ	Lao People's Democratic Republic	7AA-7IZ	Indonesia (Rep of)
LZA-LZZ	Bulgaria (People's Rep of)	XXA-XXZ	Portugal	7JA-7NZ	Japan
L2A-L2Z	Argentina (Rep of)	XYA-XYZ	Burma (Socialist Rep of the Union of)	7OA-7OZ	Yemen (People's Dem Rep of)
MAA-MZZ	United Kingdom of Great Britain & Northern Ireland	YAA-YAZ	Afghanistan (Dem Rep of)	7PA-7PZ	Lesotho (Kingdom of)
NAA-NZZ	United States of America	YBA-YHZ	Indonesia (Rep of)	7QA-7A	Malawi (Rep of)
OAA-OCZ	Peru	YIA-YIZ	Iraq (Rep of)	7RA-7RZ	Algeria (Algeria Dem & Popular Rep)
ODA-ODZ	Lebanon	YJA-YJZ	New Hebrides	7SA-7SZ	Sweden
OEA-OEZ	Austria	YKA-YKZ	Syrian Arab Republic	7TA-7YZ	Algeria (Algerian Dem & Popular Rep)
OFA-OJZ	Finland	YLA-YLZ	Union of Soviet Socialist Republics	7ZA-7ZZ	Saudi Arabia (Kingdom of)
OKA-OMZ	Czechoslovak Socialist Republic	YMA-YMZ	Turkey	8AA-8IZ	Indonesia (Rep of)
ONA-OTZ	Belgium	YNA-YNZ	Nicaragua	8JA-8NZ	Japan
QUA-OZZ	Denmark	YOA-YRZ	Romania (Socialist Rep of)	8OA-8OZ	Botswana (Rep of)
PAA-PIZ	Netherlands (Kingdom of the)	YSA-YSZ	El Salvador (Rep of)	8PA-8PZ	Barbados
PJA-PJZ	Netherlands Antilles	YTA-YUZ	Yugoslavia (Socialist Fed Rep of)	8QA-8QZ	Maldives (Rep of)
PKA-POZ	Indonesia (Rep of)	YVA-YYZ	Venezuela (Rep of)	8RA-8RZ	Guyana
PPA-PYZ	Brazil (Federative Rep of)	YZA-YZZ	Yugoslavia (Socialist Fed Rep of)	8SA-8SZ	Sweden
PZA-PZZ	Suriname (Rep of)	Y2A-Y2Z	German Democratic Republic	8TA-8YZ	India (Rep of)
P2A-P2Z	Papua New Guinea	ZAA-ZAZ	Albania (Socialist People's Rep of)	8ZA-8ZZ	Saudi Arabia (Kingdom of)
P3A-P3Z	Cyprus (Rep of)	ZBA-ZJZ	United Kingdom of Great Britain & Northern Ireland	9AA-9DZ	Iran (Islamic Rep of)
P4A-P4Z	Aruba	ZKA-ZMZ	Northern Ireland	9EA-9FZ	Ethiopia
P5A-P9Z	Dem People's Republic of Korea	ZNA-ZOZ	New Zealand	9GA-9GZ	Ghana
QAA-QZZ	(Service abbreviations)	ZPA-ZPZ	United Kingdom of Great Britain & Northern Ireland	9HA-9HZ	Malta (Rep of)
RAA-RZZ	Union of Soviet Socialist Republics	ZQA-ZQZ	Paraguay (Rep of)	9IA-9JZ	Zambia (Rep of)
SAA-SMZ	Sweden	ZRA-ZUZ	United Kingdom of Great Britain & Northern Ireland	9KA-9KZ	Kuwait (State of)
SNA-SRZ	Poland (People's Rep of)	ZVA-ZZZ	South Africa (Rep of)	9LA-9LZ	Sierra Leone
SSA-SSM	Egypt (Arab Rep of)	Z2A-Z2Z	Brazil (Federative Rep of)	9MA-9MZ	Malaysia
SSN-STZ	Sudan (Dem Rep of the)	Z3A-Z3Z	Zimbabwe (Rep of)	9NA-9NZ	Nepal
SUA-SUZ	Egypt (Arab Rep of)	Z4A-Z4Z	United Kingdom of Great Britain & Northern Ireland	9OA-9TZ	Zaire (Rep of)
SVA-SZZ	Greece	Z5A-Z5Z	Monaco	9UA-9UZ	Burundi (Rep of)
S2A-S3Z	Bangladesh (People's Rep of)			9VA-9VZ	Singapore (Rep of)
S6A-S6Z	Singapore (Rep of)			9WA-9WZ	Malaysia
				9XA-9XZ	Rwanda (Rep of)
				9YA-9ZZ	Trinidad & Tobago

Reproduced with permission from ARRL DXCC Countries List, April 1989.
© 1989 The American Radio Relay League, Inc.
Newington, Connecticut 06111, USA.

Australian VHF, UHF and SHF records

Correct as at 1-1-90

Legend

* - Australian record # - New record since last edition

1. Home/Portable Category

Australian Capital Territory

50 MHz No claim
144 MHz VK1RH to VK1ZJR 1/03/87 16.3 km

New South Wales

50 MHz VK2ASZ to VE1ASJ 6/04/81 16,654.4 km
144 MHz VK2ZRU to VK6AOM 13/12/86 2,697.9 km
432 MHz VK2ZAB to ZL1AKW 13/01/88 2,299.8 km
576 MHz VK4ZRF/2 to VK4ZSH/4 11/12/81 255.4 km
1,296 MHz VK2BDN to ZL1AVZ 9/12/82 2,132.7 km
2,300 MHz VK2ZAC/2 to VK2BDN/2 19/05/73 159.9 km
3,300 MHz VK2AHC/2 to VK2SB/2 16/01/77 114.1 km
5,650 MHz VK2AHC/2 to VK2SB/2ZND/2 12/04/75 114.1 km
10,000 MHz VK2AHC/2 to VK2SB/2ZND/2 12/04/75 114.1 km

Victoria

50MHz VK3OT to VP2VGR 17/03/81 16,663.3 km
144MHz VK3YLR/3 to VK6KZ/6 23/01/80 2,784.4 km
432MHz * VK3ZBJ to VK6KZ/6 23/01/80 2,715.9 km
576MHz *# VK3ZBJ to VK3KAJ/5 25/2/89 382.9 km
1,296MHz *VK3ZBJ to VK6WG 18/03/88 2,449.3 km
2,300MHz VK3ZHP to VK7HL 12/01/85 427.3 km
3,300MHz VK3KAJ/3 to VK3ZBJ 25/01/86 244.3 km
5,650MHz No claim
10,000MHz * VK3KAJ/3 to VK3ZBJ/3 8/02/86 252.1 km

Queensland

50MHz VK4AYX to DL3ZM/YV5 18/03/81 15,582 km
144MHz * VK4ZSH/4 to JA7OXL 24/04/83 6,616.9 km
432MHz VK4LC to ZL3TAL 24/11/82 2,283.4 km
576MHz VK4ZRF/4 to VK4ZSH/4 7/12/81 377.6 km
1,296MHz AX4NO/4 to AX4ZT/2 12/04/70 402 km
2,300MHz No claim
3,300MHz No claim
5,650 MHz No claim
10,000 MHz VK4ZNC/4 to VK4ZSH/4 9/11/81 170.6 km

South Australia

50MHz VK5KK to XE1GE 9/04/79 14,078 km
144MHz VK5ZEE to ZL1HH 15/01/86 3,458.8 km
432MHz VK5NY to VK7JG 21/05/85 995.0 km
576MHz * VK3KAJ/5 to VK3ZBJ 25/2/89 382.9 km
1,296MHz *# VK5MC to VK6KZ/6 23/01/80 2,289.4 km
2,300MHz * VK5QR to VK6WG 17/02/78 1,885.5 km
3,300MHz * VK5QR to VK6WG 25/01/86 1,885.5 km
5,650MHz *# VK5NT to VK5ZO/P 12/11/89 176.4 km
10,000MHz VK5CU/5 to VK5MW/5 30/12/71 95.7 km

Western Australia

50MHz * VK6BE to JA8BP 30/10/58 8,833 km
144MHz VK6KZ/6 to VK3YLR/3 23/01/80 2,784.2 km
432MHz * VK6KZ/6 to VK3ZBJ 23/01/80 2,715.9 km
576MHz VK6KZ/6 to VK6HK 16/01/83 196.4 km
1,296MHz * VK6WG to VK3ZBJ 18/03/88 2,449.3 km
2,300MHz * VK6WG to VK5QR 17/02/78 1,885.5 km
3,300MHz * VK6WG to VK5QR 25/01/86 1,885.5 km

Tasmania

50MHz VK7JG to W5FF 17/04/82 13,765 km
144MHz VK7ZAH to VK4ZAZ 1/01/67 1,910 km
432MHz VK7JG to VK5NY 21/05/86 995.0 km
1,296MHz VK7AH to VK3AKC 17/02/71 439 km
2,300MHz VK7HL to VK3ZHP 12/01/85 427.3 km

Northern Territory

50MHz * VK8GB to 9Y4LL 10/04/82 18,665.4 km
144MHz VK4ZSH/8 to JA7OXL 24/10/82 6,460.9 km

2. EME Category

144MHz VK3ATN to K2MWA/2 28/11/66 16,761 km
432MHz VK6ZT to K2UYH 29/01/83 18,726.4 km
1,296MHz VK3AKC to W2NFA 6/10/73 16,713 km

3. ATV Category

432MHz VK7EM/T to VK3ZPA/T 13/12/72 413 km

4. Mobile Category

144MHz VK3KAJ/M to VK6BE 25/1/86 2,224.5 km
432MHz VK3KAJ/M to VK6BE 25/1/86 2,224.5 km
576MHz *# VK3KAJ/M to VK3ZBJ 26/2/89 122.5 km
1296MHz *# VK3ZJC/M to VK3KKW/M 16/9/89 137.6 km

5. Digital Modes Category

52MHz *# VK3ZJC to VK8ZLX 26/12/88 1906.3 km

Stolen Equipment Register

The Stolen Equipment Register is one of many services offered to members by the Wireless Institute of Australia. It has now been in operation since 1980, and is maintained on a computer database in the Federal Office. At regular intervals, updates of the complete list, sorted into categories of: Equipment Manufacturer/Model, Owner, Date Stolen are distributed to each Division. Members wanting to take advantage of this register, either to publicise the theft of their equipment, or to check equipment they are about to purchase, may contact their Division, or write or telephone the Executive Office.

Any telephone reports of stolen equipment must be followed immediately with written confirmation of the details. For maximum efficiency, these details should include: Manufacturer's name, Model, Type of equipment, Serial number, Date stolen, Owner's name, address and call sign, Any distinguishing features or modifications, Police contact (if any). When equipment is recovered, it is important that you advise the Executive Office as soon as practicable. This list is the most up-to-date information we have at the time of going to press, but is based entirely on information received from you, the member. Would all readers please check this list and immediately advise if there are any amendments required.

WIA DATABASE LIST OF UNRECOVERED STOLEN EQUIPMENT AS AT 6 Jan 1990

*Manufacturer	Model	Description	Serial No	Owner	Stolen	Recovered	Published Comment
AZDEN	PCS-3000	2M FM MOBILE	36738	VK2KCV	01-Jun-87	-	NO MICROPHONE - NO BRACKET
DICK SMITH	AUDIO	GENERATOR		VK2XJC	15-May-85	01-Aug-85	-
DICK SMITH	EXPLORER	70CM FM TRANSCEIVER		VK2KUR	24-Sep-84	01-Jan-85	EXTENSIVE MODIFICATIONS
DRESSLER	EVV2000	2M PRE-AMP	1027	VK2XJC	15-May-85	01-Aug-85	-
ELECTROPHONE	TX470T	UHF TRANSCEIVER	50600672	VK6ZPL	11-Apr-87	-	-
EMTRONICS	NOISE BRIDGE		EM342	VK4AAE	27-Oct-89	-	-
GALAXY	5		5672V2118	VK3UB	06-Jun-87	-	REMOTE VFO
GALAXY	5		5503V1309	VK3UB	06-Jun-87	-	REMOTE VFO
ICOM	IC02A	2M FM HANDHELD	23186	VK2FZH	09-Jun-89	01-Aug-89	WITH BP3 AND BC25E
ICOM	IC202		41013616	VK3ZBI	01-Oct-85	01-Mar-87	-
ICOM	IC202		03482	VK3ZJY	11-Aug-87	01-Oct-87	-
ICOM	IC202		5144	VK4ZSH	03-Sep-85	01-Nov-85	-
ICOM	IC211	2M M/MODE T/CEIVER	6804309	VK3BRV	17-Oct-84	01-Jan-85	-
ICOM	IC215	2M FM PORT T/CEIVER	05156	VK2AMX	20-Nov-84	01-Mar-85	-
ICOM	IC22		12266	VK3BLC	29-Apr-85	01-Jul-85	-
ICOM	IC22A		3402112	VK2ZIG	01-Jul-87	-	-
ICOM	IC22A		1914	VK4ZSH	03-Sep-85	01-Nov-85	-
ICOM	IC22A		8853	VK3ZU	03-May-84	01-Jul-84	-
ICOM	IC22A	2M FM TRANSCEIVER	FALLEN OFF	VK3YV	21-Aug-87	-	EARLY MODEL - 22 CHANNELS
ICOM	IC22S		62014533	VK3KAW	23-Dec-85	01-Mar-87	-
ICOM	IC22S	2M TRANSCEIVER	11912	VK2ETJ	06-Mar-88	-	PRE-AMP, SOCKET
ICOM	IC22S		14727	VK3ME	14-Aug-85	01-Nov-85	-
ICOM	IC22S	2M FM TRANSCEIVER	15674	VK2CIB	11-Feb-89	-	-
ICOM	IC22S		14957	VK3DYZ	11-Sep-84	01-Nov-84	-
ICOM	IC22S	VHF FM TRANSCEIVER	07570	VK3KJA	14-Dec-87	-	DIGITAL READOUT
ICOM	IC25A	2M FM TRANSCEIVER	03831	VK2DPM	04-Nov-84	01-Jan-85	VFO MODIFIED
ICOM	C280	TRANSCEIVER	02592	VK2BVW	30-Mar-88	-	-
ICOM	IC290H		17701965	VK3ZBI	01-Oct-85	01-Mar-87	-
ICOM	IC290H		17703342	EMTRONICS	17-Feb-86	01-Mar-86	-
ICOM	IC2A		12213830	VK3YOD	02-Dec-83	01-Jul-84	SPARE BATTERY PACK

*Manufacturer	Model	Description	Serial No	Owner	Stolen	Recovered	Published Comment
ICOM	IC2A		12209700	VK2AHF	08-Sep-87	-	-
ICOM	IC2A	144 MHZ FM H/HELD	12213837	VK5ABY	22-Dec-88	01-Mar-89	-
ICOM	IC2A	2M H/HELD T/CEIVER	29901052	VK2CKD	05-Feb-86	01-Apr-86	-
ICOM	IC2A	2M FM HANDHELD	04484	VK1MX	21-Jan-85	01-Apr-85	VINYL CASE
ICOM	IC3200		01046	VK2CIM	02-Aug-87	-	-
ICOM	IC45A	70CM FM TRANSCEIVER	01876	VK2DPM	04-Nov-84	01-Jan-85	-
ICOM	IC45A		18351005	VK3KJC	22-Feb-84	01-Jul-84	MEMORY BACKUP UNIT
ICOM	IC490A	70 CM TRANSCEIVER	16101192	VK3BVO	01-Mar-83	01-Jul-84	-
ICOM	IC4E		18103021	VK3YOD	02-Dec-83	01-Jul-84	SPARE BATTERY PACK
ICOM	IC4E			VK2KZZ	16-Aug-87	-	CALLSIGN ENGRAVED
ICOM	IC502		00618	VK3ZJY	11-Aug-87	01-Oct-87	-
ICOM	IC551		01273	VK4ZSH	03-Sep-85	01-Nov-85	INCLUDING FM, VOX
ICOM	IC551		9401253	VK3ZBI	01-Oct-85	01-Mar-87	-
ICOM	IC551D	6M TRANSCEIVER	99003878	VK3YSG	01-Jan-84	01-Jul-84	-
ICOM	IC701	TRANSCEIVER	8001039	VK2???	15-Feb-88	-	-
ICOM	IC701PS	POWER SUPPLY	7800978	VK2???	15-Feb-88	-	-
ICOM	IC720A		06242	VK4ZSH	03-Sep-85	01-Nov-85	-
ICOM	IC730		13806798	MELB UNIV	18-Sep-85	01-Nov-85	HOME BREW POWER SUPPLY
ICOM	IC735		36304455	EMTRONICS	17-Feb-86	01-Mar-86	-
ICOM	ICPS20	POWER SUPPLY	10101966	VK3YSG	01-Jan-84	01-Jul-84	-
KDK	2025 MK II	2M TRANSCEIVER		VK2ETJ	06-Mar-88	-	DEFUNCT FINAL
KDK	FM2025 MK	2 2M FM TRANSCEIVER	A 5020	VK2AML	03-Jul-88	-	SHARPE MICROPHONE
KDK	MULTI 7	2M HANDHELD		VK2TJB	09-Feb-88	-	DRIVERS LICENCE NO. ENGRAVED
KENWOOD	AT180	ANTENNA TUNER	0020450	VK2???	11-Nov-87	-	-
KENWOOD	AT200	ANTENNA TUNER	820049	VK2DCB	16-Aug-84	01-Nov-84	-
KENWOOD	DG5	DIGITAL DISPLAY	730475	VK2DCB	16-Aug-84	01-Nov-84	-
KENWOOD	DM81	GRID DIP OSCILLATOR	4020163	VK2KLF	10-Aug-89	-	STENCILLED IN 20MM BRIGHT YELLOW
KENWOOD	MC-50	DESK MICROPHONE	N/A	VK5ABY	22-Dec-88	-	-
KENWOOD	MS1	MOBILE MOUNT	-	VK5BJA	30-May-89	-	-
KENWOOD	SP520	SPEAKER		VK2DCB	16-Aug-84	01-Nov-84	-
KENWOOD	TM221A	2M FM TRANSCEIVER	8110722	VK2CCD	09-Apr-88	-	-
KENWOOD	TM221A		8022541	VK3ZJY	11-Aug-87	01-Oct-87	-
KENWOOD	TR2400	2M FM HANDHELD	0061926	VK2PJ	20-Apr-85	01-Jul-85	CALLSIGN ENGRAVED
KENWOOD	TR2400		0061950	VK2DPM	28-Aug-84	01-Nov-84	-
KENWOOD	TR2500		3040009	VK2ZQC	29-May-85	01-Aug-85	MICROPHONE AND CHARGER
KENWOOD	TR2500		3033045	VK2DYW	18-Feb-87	-	-
KENWOOD	TR2600A	2 M HANDHELD	5060895	VK5BJA	30-May-89	01-Jul-89	INCLUDING RUBBER DUCK ANTENNA
KENWOOD	TR2600A	HANDHELD	7030631	VK5AAR	03-Oct-86	01-Mar-87	-
KENWOOD	TR2600A	2 M HANDHELD TCVER	5060934	VK2KLF	10-Aug-89	-	MISSING HAND STRAP
KENWOOD	TR7850	2M FM TRANSCEIVER	1111125	VK2CCK	07-Feb-86	01-Apr-86	-
KENWOOD	TR7850		202080	VK2DED	06-Mar-84	01-Mar-87	"N" CONNECTOR
KENWOOD	TR7850	2M FM H/HELD T/CEIVRM	2020561	VK2ALK	22-Oct-88	01-Jan-89	-
KENWOOD	TR7950		4010747	VK2TVG	08-Aug-85	01-Nov-85	-
KENWOOD	TR9000	2M TRANSCEIVER	1050780	VK3YSG	01-Jan-84	01-Jul-84	-
KENWOOD	TR9000		1020527	VK2KAH	03-Jan-87	01-Mar-87	ADDITIONAL MEMORY SWITCH
KENWOOD	TS120S	TRANSCEIVER	950819	VK2???	11-Nov-87	-	-
KENWOOD	TS120V		0081224600	VK2VWN	03-May-85	01-Jul-85	MT35 MICROPHONE
KENWOOD	TS130S	TRANSCEIVER	40401C8	VK2BVW	30-Mar-88	-	-
KENWOOD	TS130S	HF SSB TRANSCEIVER	1090168	VK5ABY	22-Dec-88	01-Mar-89	-
KENWOOD	TS130SE		2060697	VK2KAH	03-Jan-87	01-Mar-87	-
KENWOOD	TS430S		4010322	VK2XJC	15-May-85	01-Aug-85	INCLUDING FM, FILTER
KENWOOD	TS440S	HF TRANSCEIVER	7090271	VK2FIT	24-Oct-89	-	WITH PS50 PSU & MC85 DESK MIC
KENWOOD	TS520S		820972	VK2DCB	16-Aug-84	01-Nov-84	-
KENWOOD	TS520S	HF TRANSCEIVER	?	VK2FZH	09-Jun-89	01-Aug-89	STICKER FROM "TURKEY RADIO"
KENWOOD	TS700A		350409	VK3ZJY	11-Aug-87	01-Oct-87	-
KENWOOD	TS930S		3050176	VK7JG	13-Jan-83	01-Jul-84	-
KENWOOD	VF0520	EXTERNAL VFO		VK2DCB	16-Aug-84	01-Nov-84	-
KYOTO	FM144-10	2M FM TRANSCEIVER	5027	VK2KUR	24-Sep-84	01-Jan-85	CALLSIGN ENGRAVED
LEADER	LSG11	SIGNAL GENERATOR	0041244	VK3KJA	14-Dec-87	-	-
LEADER	LSG16	SIGNAL GENERATOR	1081098	VK3YSG	01-Jan-84	01-Jul-84	MISC BITS ALSO
MIRAGE	B1016	2M 160W PWR AMP	550779	VK3KAW	23-Dec-85	01-Mar-87	-
REALISTIC	AX190	HF RECEIVER	500111	VK3KJA	14-Dec-87	-	-
REALISTIC	SP190	SPEAKER ENCLOSURE	20-5191	VK3KJA	14-Dec-87	-	-
REGENCY	HX2000	HANDHELD		DSE VIC	13-May-85	01-Aug-85	-
SAIKO	SC7000	SCANNER		VK2XJC	15-May-85	01-Aug-85	BNC ANTENNA SOCKET
SONY	2001D	COMMUNICATIONS RECVR?		VK2FZH	09-Jun-89	01-Aug-89	BROKEN ANTENNA
TELEQUIPT	551	OSCILLOSCOPE		VK4AAE	27-Oct-89	-	-
TEMPO	1S	2M HANDHELD	012240	VK3UB	06-Jun-87	-	-
THORN	B&W TV		107512	VK2XJC	15-May-85	01-Aug-85	MOD FOR COMPUTER
TOKYO	HL160V	2M POWER AMPLIFIER	829331	VK2XJC	15-May-85	01-Aug-85	-
TOKYO	HL86V	6M POWER AMPLIFIER	819595	VK2XJC	15-May-85	01-Aug-85	-
TOKYO	HL90U	70CM POWER AMP	8304246	VK2XJC	15-May-85	01-Aug-85	-
TRIO	CS1560A2	CRO	10-20171	VK3YSG	01-Jan-84	01-Jul-84	-
UNIDEN	2020		50806009	VK2KSY	16-Sep-85	01-Nov-85	-
WELZ	SP200	SWR/PWR METER	600384	VK2XJC	15-May-85	01-Aug-85	-
YAESU	FAS14R	REMOTE ANT SEL	140138	VK3KJA	14-Dec-87	-	-
YAESU	FC707	ANTENNA TUNER	11140765	VK3DHV	01-Jun-87	-	-
YAESU	FC707	ANTENNA TUNER	11140775	VK2DBB	28-Apr-86	01-Jul-86	-
YAESU	FC707	ANTENNA TUNER	1N180265	VK4AAE	27-Oct-89	-	-
YAESU	FL2010	2M LINEAR AMPLIFIER	1L031300	VK3DKO	25-Aug-88	-	MOUNTED IN CRADLE
YAESU	FP707	12V 20 AMP P/SUPPLY	1H120548	VK5ABY	22-Dec-88	01-Mar-89	-
YAESU	FP707	POWER SUPPLY	4C050487	VK4AAE	27-Oct-89	-	-
YAESU	FRA7700	ACTIVE ANTENNA	2H050293	VK2???	11-Nov-87	-	-
YAESU	FRG7		299L26099	VK3ZLY	28-Jul-83	01-Jul-84	-
YAESU	FRG7700	RECEIVER	3M260983	VK2XPU	01-Aug-89	-	-
YAESU	FRG7700	RECEIVER	2K210752	VK2???	11-Nov-87	-	-

YAESU	FRT7700	ANTENNA TUNER	2K070479	VK2???	11-Nov-87	-	-
YAESU	FT101B	HF TRANSCEIVER	83L102373	VK3KJA	14-Dec-87	-	-
YAESU	FT101E	HF TRANSCEIVER	8G350283	VK2SS	29-Jun-84	01-Nov-84	-
YAESU	FT101E	HF TRANSCEIVER	7K/301042	VK5EZ	08-Jul-89	01-Sep-89	-
YAESU	FT101E	HF TRANSCEIVER	8L370414	VK3DYZ	11-Sep-84	01-Nov-84	-
YAESU	FT107M	HF TRANSCEIVER	11110012	VK2ALN	03-Mar-87	-	-
YAESU	FT200	HF TRANSCEIVER	2K332252	VK3DYZ	11-Sep-84	01-Nov-84	-
YAESU	FT207R	2M HANDHELD	1D132704	VK2ETJ	06-Mar-88	-	-
YAESU	FT207R	2M FM HANDHELD	10132725	VK2EMC	04-Mar-85	01-May-85	BATTERY COVER MISSING
YAESU	FT208R	2M FM HANDHELD	4E382078	VK2PJ	29-Mar-89	01-Jun-89	FAULTY VCO
YAESU	FT208R		3N350964	VK2CBA	30-Jul-85	01-Mar-87	-
YAESU	FT209R		4L06245	DSE VIC	13-May-85	01-Aug-85	-
YAESU	FT209RH		4K050838	VK3CE	01-Jan-85	01-Mar-85	BLUE VINYL CASE
YAESU	FT209RH		5K190401	VK2HW	21-Feb-86	01-May-86	LEATHER CASE
YAESU	FT224		6G307290	VK3OV	28-May-87	-	-
YAESU	FT230			VK2EQD	18-Aug-87	-	-
YAESU	FT230R		4H081794	DSE VIC	13-May-85	01-Aug-85	-
YAESU	FT290R	2M FM TRANSCEIVER	2D100942	VK3DKO	25-Aug-88	-	CALLSIGN ENGRAVED
YAESU	FT290R	2M TRANSCEIVER	3C260713	VK2EGD	12-Nov-86	01-Feb-87	-
YAESU	FT290R		1L081321	VK3KJC	22-Feb-84	01-Jul-84	-
YAESU	FT290R	2M TRANSCEIVER	1M081340	VK2VE	04-Jan-87	01-Mar-87	OWNERS NAME
YAESU	FT290R	2M TRANSCEIVER	5G450016	VK7HW	18-Apr-88	-	MOBILE BRACKET
YAESU	FT290R		4E360554	VK3KGG	01-Jun-85	01-Aug-85	VINYL CASE
YAESU	FT290R	2M TRANSCEIVER	SF 280702	VK4AAE	27-Oct-89	-	COMPLETE WITH NICADS
YAESU	FT480R		1H12069	VK1ZUR	29-May-84	01-Jul-84	-
YAESU	FT620		010489	VK4ZSH	03-Sep-85	01-Nov-85	-

VIDEOTAPE LIBRARY

Now every Radio Club can provide their members with quality technical lectures on subjects covering the whole range of Amateur Radio activities by taking advantage of the WIA Federal Videotape Library. You'll find this a boon, particularly if yours is a country club which often has difficulty obtaining a variety of expert lecturers for its regular meetings. (Individual Amateurs and Librarians should take note of the Duplication Fees at the end of this.)

For Radio Clubs affiliated with the WIA it's inexpensive and easy.

Here's how it works...

For those titles for which the WIA does NOT hold a copy-right licence, all you have to do is...

Supply the Videotape Co-ordinator with a videocassette in a Video Cassette Box "Postpak", and Enclose Address and Stamps for return postage and the program is free for you to use in support of Amateur Radio in your area... including copying and transmission over the air if you wish.

Those programs which are copyright marked 'c' below, are available only ON LOAN.

To obtain any of them send with your request...

Information about your preferred VCR format.

A statement signed by a Responsible Officer of your Club that "I undertake that while (Program Title) is assigned to me, I will not allow it to be transmitted over the air, nor copied by any means whatsoever, and that I will return the same promptly

after showing."

Enclose Address and Stamps for postage to you The present "available formats" are as follows...

VHS - Size 200 x 110 x 30mm, Mass 350gr.

* Standard Play 4Hr max, or Long Play 8Hr max as requested.

* Standard Sound - "Dolby" On or Off as requested. "Hi-Fi" FM Sound also present on all VHS cassettes.

BETA - Size 160 x 100 x 30mm, Mass 300gr.

Standard Play 3Hr 15min max only.

Standard Sound only (No "Dolby").

VIDEO 8 - Size 103 x 68 x 20mm, Mass 80gr.

* Standard Play 1 1/2Hr max, or Long Play 3Hr max as requested

"Hi-Fi" FM Sound is Standard (No "Dolby").

Obviously the smaller and lighter the cassette, the less the postage. * Note: Be sure to request Standard or Long Play, "Dolby" On or Off.

NOTE TO INDIVIDUAL AMATEURS: Since the inception of the WIA Federal Video Service, cassettes have been made freely available to all comers, especially to isolated Amateurs. However, recently there has been a rapid rise in the number of requests from individual Amateurs, some asking for over 10 hours of programs at a time.

Video duplication is a real-time, one-at-a-time operation for which the costs of maintenance of the equipment is not small. Obviously the Service is much more economical if (say) one tape is seen by 30

members of a club than if each of the 30 members were to request their own personal copy. Indeed, if EVERY member of the WIA requested just ONE program it would take about 4 YEARS at 40 hours a weeks to service!

So in an effort to encourage requests from Groups of Amateurs rather than Individuals, from now on a Duplication Fee of \$2 per hour or part thereof will be payable in advance for all requests from Individual Amateurs. All such Fees will go towards upkeep of the duplication equipment.

NOTE TO LIBRARIANS: A number of Educational Institutions have already availed themselves of the technical lecture tapes from the WIA. While this service will continue to be available, from now on a Duplication Fee of \$10 per hour or part thereof will be payable in advance by all Institutions not affiliated with the WIA. All such Fees will go towards the production costs of future Technical Lectures.

NOTE RE TAPE CASSETTE QUALITY: The WIA Videotape Co-ordinator retains the right to refuse to copy onto inferior quality video tape. In the past such tape has caused many hours of wasted time through clogged heads, and in future only reputable brands of video tape will be accepted. In particular, although not always in itself a guarantee of quality, use only those VHS cassettes which carry the official "VHS" logo.

WIA VIDEOTAPE PROGRAM TITLE LISTING as of 1/1/90

See Note	TITLE (in chronological order within each subject grouping)	Lecturer	Prod.	Approx Dur.	Col/ B&W	Year Prod	Description and/or Other Information
	AMATEUR RADIO - HISTORIC INTEREST						
c	Wireless Telegraphy -circa 1910		?	10mins	B&W	1910	Archive material courtesy David Wardlaw
			VK3ADW				
c	Amateur Radio (TV Pilot Program)		WIA NSW	30mins	B&W	1968	Archive material courtesy TEN channel 10
-	Opening of Burley Griffen Bldg - SA HQ		VK5KG	50mins	Colour	1977	Archive material
-	ATV in Australia 1978 - made for British ATV Club		VK5KG	30mins	Colour	1978	Archive material
-	ATV in United Kingdom 1978 - reply from BATC		G8CJS	30mins	Colour	1978	Archive material
-	History of ATV in South Australia		VK5KG	30mins	Colour	1980	Archive material, still building
-	Opening of Amateur Radio House - NSW HQ		VK2BDN & VK2ZQC	1' 42"	Colour	1983	Archive material
-	VK2 75th Aniv. Seminar Keynote Speeches		WIA NSW	2' 15"	Colour	1983	Dr. David Wardlaw & State Manager DOC
c	Heard Island Dxpeditons		ch 2,7,9,10	20mins	Colour	1984	Archive material; NO LOAN OR COPY AVAILABLE
-	Heard Island Dxpediton		VK2BCC WIA NSW	60mins	Colour	1986	Raw Unedited; from 1986 VK2 Seminar
	AMATEUR RADIO - PROMOTIONAL						
o	The Ham's Wide World		ARRL	27mins	Colour	1969	Superseded by "The World of Amateur Radio"
-	This is Amateur Radio		ARRL	15mins	Colour	1970	Pitched at teenagers
-	Moving Up to Amateur Radio		ARRL	11mins	Colour	1975	Pitched at CBers
c	7J1RL DXpedition		JARRL	60mins	Colour	1976	General Amateur Radio interest; LOAN ONLY
-	This Week has 7 Days looks into Amateur Radio		HSV7	25mins	Colour	1978	Pitched at teens; includes some ARRL footage
o	The World of Amateur Radio		ARRL	26mins	Colour	1978	Superseded by "The New World of Amateur Radio"
-	Amateur Radio - The National Resource of Every Nation		VK5KG	6mins	Colour	1979	Encapsulates AR; good for public exhibitions

THE GEORGE BUSH, MA MIKHAIL GORBACHE

What has made Icom's range of transceivers world leaders in their class? Could it be the uncompromising standards of a George Bush? Is it the durability of a Maggie (Iron Lady) Thatcher? Or the innovative thinking of a Mikhail Gorbachev?

It is, in fact, a combination of all three.

Which has led millions of radio users around the world to choose Icom. Their vote has made Icom the world leader of transceivers.



Announcing the IC-726. An advanced, HF/50MHz transceiver that combines VHF technology with the latest in sophistication. Designed for amateurs or veterans, and ideal for mobile users. 26 programmable memory channels, multi-mode transmitting and receiving and a host of other features and options.

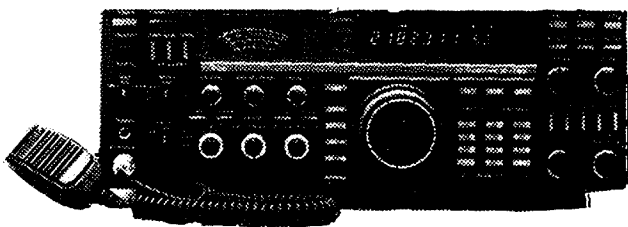

The Icom IC-765 HF transceiver features DDS synthesiser, high speed auto tuner, built-in AC power supply, 99 programmable memories, keyboard frequency entry, band stacking register, general coverage receiver 100KHz-30MHz, CI-V system for PC control and rack mounting dimensions.



The Icom IC-32AT dual band FM transceiver outputs 5.5W and has a full duplex crossband operation, on/off switchable power saver and 20 double-spaced memory channels that can store two frequencies. The programmed scan function scans all frequencies between two programmable frequencies. And Priority Watch monitors the Call Channel, a memory channel or all the memory channels in succession, every five seconds.

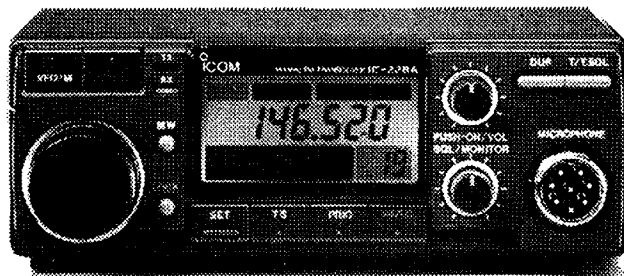

The Icom IC-228A (25W) and IC-228H (45W) mobile FM 144MHz transceivers are compact and easy to operate with 20 memory channels, multi-colour LCD programmed and memory scans, variable tuning steps, priority watch, main controls lit for night operation.

REGRET THATCHER AND V OF TRANSCEIVERS.



The Icom IC-475A (25W) and IC-475H (75W) 430 MHz All Mode transceivers are designed for packet mode with direct digital synthesizer (DDS), 99 memory channels, USB, LSB, CW, FM, passband tuning and adjustable IF notch filter.

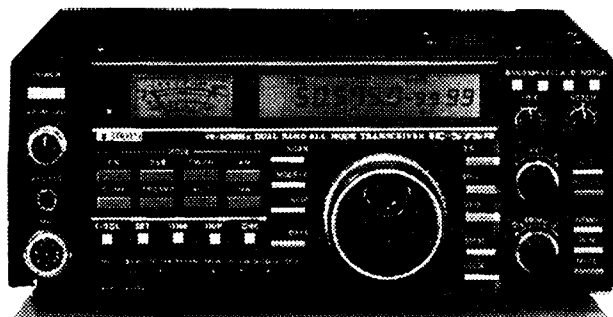

The Icom IC-575A (10W) and IC-575H (100W) 28/50 MHz All Mode transceivers have a receiver coverage of 26-56 MHz and are equipped with direct digital synthesizer (DDS), 99 memory channels, and passband tuning.

The ICOM IC-4SA an amazing 70cm midget hand held. Comprising 48 memories plus 1 call channel, operating from batteries with 5 watts output at 13.8v



or an external 12v DC supply. Auto power off function, scanning, scan skip, clock and time function, an optional pager and more.

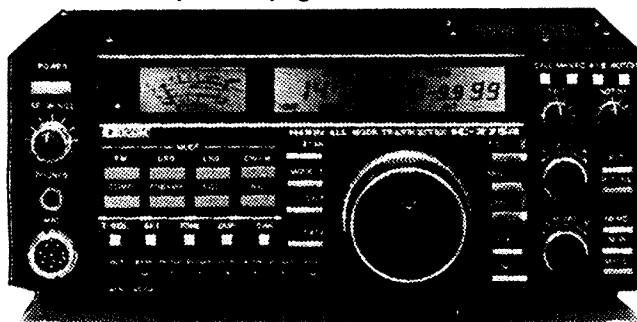

The Icom IC-275A (25W) and IC-275H (100W) All Mode 144MHz transceivers are designed for packet mode and feature direct digital synthesizer (DDS), 99 memory channels, USB, LSB, CW, FM, and passband tuning.

The remarkable IC-2SAT is the ultimate in mini handheld high performance 2M FM transceivers. With convenient keyboard, rechargeable batteries, 5W output (opt. with a 13.2v battery pack), 48 memories, a call channel and a variety of other sophisticated super multi functions. Plus 18 optional extras. Another marvellous breakthrough in miniaturized hand helds.

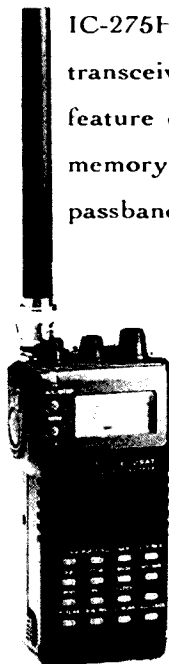

Call Melbourne on (03) 529 7582 or interstate on (008) 338 915 for your nearest Icom stockist.

ICOM

ICO 0047

See Note	TITLE (in chronological order within each subject grouping)	Lecturer	Prod.	Approx Dur.	Col/ B&W	Year Prod	Description and/or Other Information
-	The New World of Amateur Radio		ARRL	28mins	Colour	1988	Supersedes "The World of Amateur Radio"
ANTENNAS							
c	G6CJ's Aerial Circus		G6CJ WIA	90mins	B&W	1977	THE Definitive Antenna Lecture; LOAN ONLY
-	Wire Antennas		VK5RG VK5KG	40mins	B&W	1978	Antennas for HF and Antenna Tuners
-	Loaded Wire Antennas		VK5NN VK5KG	50mins	Colour	1980	Using Inductive and Capacity loaded Antennas
w	Antennas and Directivity		VK2BBF OTC	73mins	Colour	1985	Lecture given to a group of Radio Amateurs
-	Antenna Rotator Systems		VK5AIM VK5KG	50mins	Colour	1986	Servicing the several different types
-	Broadband Antennas		VK5RG VK5KG	62mins	Colour	1986	Includes terminated antennas
ATV - ACTIVITY							
o	ATV in Australia 1980/81 - Made for British ATV Club		VK5KG	60mins	Colour	1980	Clips from ATV Groups in VKs 2,3,4,5 & 7
o	ATV in United Kingdom 1978/81		G8CJS	30mins	Colour	1981	Remake of their previous effort
o*	CQ ATV DX International 1983		WB2LLB	60mins	Colour	1983	ATV in USA and Europe
o	ATV in Victoria, 1984		VK3AHJ	54mins	Colour	1984	Courtesy of "The Roadshow Gang"
-	Hello from America! - Made for British ATV Club		WBOQCD	100min	Colour	1988	Clips from ATV Groups in the USA
ATV - GENERAL INTEREST							
-	Low Definition Television	Chris Long	VK5KG	25mins	Colour	1982	Re-creation of TV as transmitted by Baird
-	Model Aero-Nautical Mobile ATV		VK5GO VK5KG	6mins	Colour	1983	ATV camera & TX mounted in a model aeroplane
-	VK5RCN - Aust's first wind powered ATV rptr.		VK5KAU VK5KG VK5RCN	61mins	Colour	1986	A tour in and around
-	Australian TV History - The Untold Story	Chris Long	VK5KG	56mins	Colour	1988	Lecture to Radio Amateurs Old Timers Club
-	Australian TV History - Part 2	Chris Long	VK5KG	49mins	Colour	1988	Technical slides not used in the above
NEW	The Development of the TV Test Card	George Hersee	G8PTH	43mins	Colour	1988	Made for BATC by the BBC Training Dept
ATV - TECHNICAL							
o	The Signal to Noise Story		VK3ATY VK3AHJ	45mins	Colour	1982	Superseded by "UHF Pre-amplifiers" (below)
-	UHF Preamplifiers		VK3ATY VK3AHJ	45mins	Colour	1983	Explanation and demo. of low noise preamps
-	Getting Started in Amateur Television		VK5KTV VK5KG	55mins	Colour	1983	How to set up an ATV station
-	Testing ATV Transmitters		VK5KG VK5KG	50mins	Colour	1983	How to correctly measure ATV systems
o*	High Definition TV Tutorial	Don Fink	WB2LLB	60mins	B&W	1983	A look at what is to come in Broadcast TV
o*	ATV Hamfest, York Pennsylvania, Sept.'83	Various	WB2LLB	6hrs	Colour	1983	Various ATV technical lectures from USA
COMPUTERS							
-	Demo. of VK5RTV's Micro-Computer Controller #1		VK5KG VK5KG	10mins	Colour	1979	First u-Computer controlled repeater in VK
o	Understanding Micro-Processors		VK5PE VK5KG	60mins	Colour	1980	A somewhat dated technical description
o	An ATV Hamshack Micro-Computer		VK3AHJ VK3AHJ	10mins	Colour	1981	Describes now unavailable microcomputer kit
-	Getting Started in Amateur Micro-Computers		VK5JF VK5KG	33mins	Colour	1983	Demo. of hard- & software for Amateur Radio
DATA TRANSMISSION							
-	Getting Started in Amateur RTTY		VK5JM VK5KG	85mins	Colour	1983	RTTY using teleprinters and Micro-Computers
-	Amateur Packet Radio		VK5AGR VK5KG	60mins	Colour	1984	Theory and Demonstration.
-	Packet Radio - 10 months on		VK2KYJ & VK2AAB WIA NSW	65mins	Colour	1985	Raw Unedited; from 75 aniv. VK2 Seminar
w	X25 Protocols and Packet Switching		VK2ZXB OTC	47mins	Colour	1986	Lecture given to a group of Radio Amateurs
MICROWAVE TECHNIQUES							
NEW	Introducing Microwaves	Des Clift	VK5ZO PJ Video	74mins	Colour	1988	"Nuts & Bolts" expert technical lecture
PROPAGATION							
-	Getting Started in Understanding the Ionosphere		VK5NX VK5ZBD	50mins	Colour	1983	How the Ionosphere aids HF communication
-	VHF Signal Enhancement by Aircraft		VK2ZAB WIA NSW	70mins	Colour	1986	Raw Unedited; from 1986 VK2 Seminar
SATELLITES							
o	Getting Started in Amateur Satellites		VK5HI & VK5AGR VK5KG	60mins	Colour	1983	Superseded (see below)
o	An Introduction to Amateur Satellites (Pt 1)		VK5AGR VK5KG	60mins	Colour	1984	An overview of Amateur Satellite working
o	Micro-Computer Aids to Satellite Tracking (Pt 2) *		VK5KG	30mins	Colour	1984	Programs for tracking & decoding telemetry
-	Using Phase III Amateur Satellites		VK5HI VK5KG	90mins	Colour	1984	History, construction & use of high orbit sats.
-	The Amsat Oscar Phase 3 Story	Dr. Karl Meinzer	DJ4ZC VK5KG	80mins	Colour	1985	"The Father of Oscar" includes film of launch.
-	Antennas for Satellites	Dr. Trevor Bird	WIA NSW	75mins	Colour	1986	Raw Unedited; from 1986 VK2 Seminar
SPACE GENERAL INTEREST							
-	Apollo 13 Disaster		VK5JM VK5KG	90mins	Colour	1980	Australian tracking procedure saved Apollo 13
o	SSTV Pictures from Space - Voyager		VK5KG	15mins	Colour	1983	SSTV pix converted from Saturn fly past
-	Aussat - Australia's Domestic Comms. Satellite		VK5JM VK5KG	62mins	Colour	1984	Technical description of services offered
-	Amateur Radio's Newest Frontier	ARRL	26mins	Colour	1985	Amateur Radio in Space; General P.R.	
-	Working W5LFL in orbit from VK1ORR	Richard Elliot	23mins	Colour	1986	Raw Unedited actuality footage	
MISCELLANEOUS							
-	An Auxiliary Battery Charger		VK5NX VK5KG	30mins	Colour	1981	Charging a second mobile battery
-	Lecture - Winning Foxhunts		VK5TV VK5KG	45mins	Colour	1981	How to do it from one who has!
-	Getting Started in Amateur Construction		VK5AIM VK5KG	50mins	Colour	1983	Mechanical hints for novice constructors
-	Comms. Consequences of Nuclear War	Dr. John Coulter	VK5ZBD	60mins	Colour	1983	Why your gear may not survive even if you do!
-	The Far Eastern Broadcasting Company		VK5KG	60mins	Colour	1984	How a Short Wave Broadcaster operates
-	The Aust. "Over the Horizon Radar"	Dr. Phil Whitham	VK5KG	60mins	Colour	1984	How the "Australian Woodpecker" works
-	What to Expect when the RI Calls!	Geof Carter	DOC VK5KG	34mins	Colour	1984	Geof is a Dept of Comms. Field Officer
-	Doppler Direction Finding for Foxhunters		VK2BYY WIA NSW	43mins	Colour	1985	Raw Unedited; from 75 aniv. VK2 Seminar
w	Fitting BNC Connectors		OTC	7mins	Colour	1985	Correct Assembly of Crimp type BNC plugs
w	Handling Static Sensitive P.C.Bs.	Paul Tardent	OTC	6mins	Colour	1986	Improving reliability of Printed Ccts.
-	Extra License Grades		VK2ZTB WIA NSW	70mins	Colour	1986	Raw Unedited; from 1986 VK2 Seminar
-	Thick Film Modules		VK5DI VK5KG	45mins	Colour	1988	Descr. of modules available from VK5 WIA
NEW	Quartz Crystals	Clem Tilbrook	VK5GL VK5GL	106min	Colour	1988	"Nuts & Bolts" expert technical lecture

NOTE: c = Copyright; no copy service.. * = Optically Converted to PAL from NTSC by
w = available ONLY to Radio Clubs Affiliated with the WB2LLB; noticeable flicker.
WIA as per agreement with OTC. o = program now out of date

Standard Formats: "Beta"; "Video-8" St & L Play; "VHS" St & L Play, "Dolby" and "Hi-Fi" sound - please specify when ordering.

WIA VIDEOTAPE NEW PROGRAM TITLE LISTING as of 1/1/90

See TITLE (in chronological order Note within each subject grouping)	Lecturer	Prod.	Approx Dur.	Col/ B&W	Year Prod	Description and/or Other Information
MICROWAVE TECHNIQUES n Introducing Microwaves	Des Clift	VK5ZO PJ Vid	74mins	Colour	1988	"Nuts & Bolts" expert technical lecture
AMATEUR TELEVISION: GENERAL INTEREST n The Development of the TV Test Card	George Hersee	G8PTH	43mins	Colour	1988	Made for BATC by the BBC Training Dept
MISCELLANEOUS n Quartz Crystals	Clem Tilbrook	VK5GL VK5GL	106min	Colour	1988	"Nuts & Bolts" expert technical lecture

n = New Addition Standard Formats: Beta; Video 8 St & L Play; VHS St & L Play, "Dolby" and "Hi-Fi" sound - please specify when ordering.

VHF/UHF AN EXPANDING WORLD

ERIC JAMIESON VK5LP
9 WEST TERRACE MININGIE 5264

All times are Universal Time Co-ordinated and indicated UTC

Amateur Bands Beacons

In accordance with current practice only changes to the beacon list appear this month. New listings are:

50.062	KH6HME	Hawaii
50.066	AL7C	Alaska
50.074	KH6HI	Hawaii

Return To The Fold

After a stay in hospital of almost eighteen weeks I was fortunate to be allowed home on the Saturday before Christmas and what a welcome sight it was after such a long absence. For all who have enquired and those who are interested, I am pleased to report that the third operation on my back appears to have been a success. With continuing exercises and physiotherapy a reasonable degree of walking should be possible although it may take twelve months to achieve. However, I have always been known as a fighter so while there is life there is hope! Many thanks for your cards and phone messages.

For several months these notes have been prepared under extremely difficult circumstances culminating in no notes for January due to an operation being scheduled at the time. I thank readers and the Editor of AR for understanding the position.

The Higginbotham Award

My stay in hospital was considerably brightened one day when I received notification that the 1989 Higginbotham Award was to be mine.

I am indebted to the Selection Committee for the bestowal upon me of this award. It is the second time I have received it, the first being in 1976.

While I have always believed in the worth of amateur radio and the VHF and UHF bands in particular, I have never aimed for such recognition; I have always believed there was a task to be fulfilled and tried to do that to the best of my ability. That my efforts have been recognised is an unexpected bonus — thank you.

Six Metres

During December six metres has been much as expected. There have been some very good Es openings around the country but they have not been sustained as one expects during periods other than the peak of the sunspot cycle. That this situation exists now is amply demonstrated by the very sporadic nature (no pun intended) of band openings between Christmas and New Year.

Nevertheless, there have been some good contacts to YJ8, FK,3D2 and ZL via Es and some of these have extended as far as VK5. ZLs and VK7s were noted around 0200 on 28/12, later at 0813 Garry VK5ZK worked YJ8GP; then many hours of VK4 to VK5 and other States on 29/12; on 30/12 it was the turn of VK6AOM from Esperance and others from Perth, to VK1, 2, 4, 5 and 8. During the morning of 31/12 VK2AAC was observed working VK9NS whose signal extended into VK5. Many other VK2s were noted, also VK1RK.

However, we cannot match the Northern Hemisphere where it has been noted the JAs have been working to KL7, W and VE7.

According to Bill Tynan's "The World Above 50 MHz" in January 1990 QST, September 1989 brought scattered openings, but between 13 and 16 October there were notable openings, producing long path contacts to Japan and covering an area from Virginia to Oklahoma. Stations further south and to the east made many JA contacts. VP5D running 10 watts worked more than 100 JAs! The long path propagation for the first time extended to Hawaii and six metre operators there obtained their first European contacts. KH6HI reported that beginning at 0800 on 14/10 he worked 5B4AZ, ZC4MK, SV1DH, SV1AB, SV1OE and eight 9H1 stations. Bert said the

5B4CY beacon was still in when he closed at 1100. Several other KH6s were included, which resulted in WAC for some. No KH6 had previously been able to qualify for this award.

On 23/10 South Africa became available to several areas of the US. WA6BYA worked Z23JO in Zimbabwe; later he and N6AMG and K6QXY worked ZS3AT and ZS3E. These were eventually worked by stations in Ohio and Texas. On 7/11 an excellent opening allowed K71CW to hear Z23JO on his IC-502 and whip antenna!

Between 25/10 and 31/10, W6JKV and K6MYC visited the island of Ponape in the Republic of Micronesia, taking a two metre EME set-up plus six metres, on which band they had QSOs with four KL7s, six KH6s, six 9H1s, one ZL, five VS6s, 14 VKs, the western portions of the US and Canada, KG6DX and some 300 JAs. The calls used were V63JT and V63AU.

Letters

Several letters arrived while I was in hospital, and must now be mentioned.

Don, VK6HK, has written to include an update of his Six Metres Listing and added that his recent most memorable day was on 31/10/89 when the band opened to Europe around 0830. He had 50 QSO's (which included some phone and CW duplicates) in G, GJ, GW, PA and SM. One beacon, GB3NHQ, was copied at 559. Signals ranged from threshold to S9 until about 1045. Plotting the Maidenhead Locator Squares for all these contacts showed the target area was confined to an arc of shallow width from Wales, Southern England, Holland and Sweden.

Graham, VK6RO, has lifted his score to 17 countries when he worked PAOHIP at 1052 and PA3ANU at 1114 on CW on 27/10; on 28/10 he worked VS6XVD and VS6XCL around 1150.

Steve, VK4KHQ, writes from Mount Isa to say that six metres had been relatively quiet since 7/1/89 despite hearing beacons in VK2, 4, 5 and 8. When the band is open to JA Steve usually tries RTTY and has had a number of successful contacts using this mode. On 6/10/89 he worked JH1WHS for the eighteenth time, including six RTTY contacts.

Bruce, VK4KIT, also of Mount Isa, worked KG6DX on 19/8 and VS6XWU on 28/10 at 1313 UTC. A comment from Bruce was that 49 MHz video signals have been audible from the north to NNW on most days of the year between 0400 and 0800 and again from 0900 to 1300.

Neville, VK2QF, in a letter dated 5/11/89

said to that date 50 MHz had been rather unproductive. Only two new countries had been worked — HH7PV at 2138 on 19/9 and V63JT at 0502 on 28/10, giving him 51 countries confirmed and a final total of 54 countries when the above two and XF4L reply. I attempted a follow up to determine the present position but four telephone calls could not catch up with the elusive Neville!

Nev commented that to 5/11 nothing had been heard from Europe despite many hours of monitoring and calling. Moscow and Scandinavian TV were prominent. On 29/10 with 48.250 and 49.750 videos at S9, he found another video on 53.7396 at 0850. This was subsequently identified as an Italian inverted channel (video at the high end and audio on 48.2396), however no contacts were made.

Commenting on the 50 MHz beacon situation, Neville believes there is little value in beacons as most amateur stations have a greater ERP and contacts are usually established without reference to the beacons. Also, the Wagga Channel 0 TV 100 kw of video on 46.24 and 10 kw of sound on 51.74 are becoming well known overseas; these frequencies, together with those of other TV stations and two-way radio traffic and paging signals between 40 and 50 MHz all provide useful warnings of possible contacts on 50 MHz.

Brunei

Andrew, V85DA, at Brunei said in a November letter that apart from almost daily openings to JA there has been little six metre activity from his area. On 6/11 he could hear the JAs working to the west coast of USA, V63 etc. but nothing at Brunei. However, at 0200 he worked HL9TG with 559 fluttery signals.

He comments that it appears the F2 layer works well away from the equator, but the E layer is so excited in equatorial regions that no signals can get down to the ground. So F layer supports DX and E layer traps the signals between E and F until it gets out to a low E-ionisation area. That's the way he sees it!

Looking at Andrew's list of contacts for September/October/November there are a couple of hundred JAs, almost daily contacts to Darwin through September; 25/9 at 1444 to VS6XVD and VS6XCL and on 11/10 VS6WV. On 25/10 at 1320 he worked VK8AH who reported he had worked 9H, SV and had heard European beacons. 1/11; 9V1RH reported PA to VKQSOs had occurred on 30 and 31/10.

Regarding the value of 52 MHz, Andrew says it is educational to hear what signals are on that part of the band when the band is open to JA. At times he can hear FM conversations on every 10 KHz from 52 to 54 MHz. On 52.525 there seems to be a packet BBS station which makes it rather pointless calling CQ DX on that frequency. Another interesting signal sounded like a repeater, with squelch tails, mobile flutter, traffic noises etc., but then, officially, there are no repeaters in Japan!

During a September spell in Darwin, Andrew was given royal treatment by the local amateurs. Rex VK8RH has a six metre amplifier running 200 watts from 12 volts. While in Darwin, the locals were continuing

to work JA on two metres SSB, with VK8RH having worked over 150 JA stations. Rex also monitors 52.525 FM and this later resulted in Andrew V85DA working him on returning to Brunei.

At the end of October Andrew attended a SEANET Convention in Singapore where the attendance was about 150 amateurs plus families. He met a number of JAs he had worked, plus many of the 9V1s, 9M2s and 4S7PB.

While in Singapore he operated on 50 MHz as 9V1ES and during the week of operation worked about 700 contacts, all JAs except four to VK8. The station was sponsored by JA1UT.

Finally, Andrew asks the question — what propagation path is being used for the VK to Europe contacts ie direct, short or long path, or backscatter? As far as I can determine, the signals have been mostly direct and on the short path but occasionally a few weird paths have been involved, such as 45 to 90 degrees from an apparent direct path.

Melbourne News

John, VK3ZJC, says he has spent a few hours sorting out the beacon and repeater listings in the new WIA Call Book and has so far found 32 mistakes! He also reports that increasing packet activity on 144.800, the Adelaide VK5VF beacon frequency, virtually precludes any reception of the beacon in Melbourne. That being so, it seems inevitable a frequency change will be necessary.

On 20/10 there was an auroral opening to VK7 on six and two metres. On 22/10 it was reported that VK5NC in Mount Gambier had worked VK1BG, VK2ZRE and VK3XRS all with their beams pointing south.

John reported that activity on 1296 was low during the winter months. He maintains regular propagation checks with Roger VK3XRS in Bairnsdale. Signals are subject to some slow QSB and vary from 6 to 10dB above the noise. When Roger leaves his Keyer on for extended periods, John has noted peaks around 0100 and 0700, very poor from 0730 to 1000. In the evening there is a further peak around 1030 followed by a steady decline extending at times to a further peak around 1500.

A letter to John from Ross VK2ZRU indicates there are about five SSB stations on 1296 MHz in Sydney and none in country areas. They are also starting to have problems with FM-only stations on 1296.100. Ross runs a water cooled 2C39 linear on 1296 with 250 watts input, with four 28 element loop yagis and a GaAsFET preamp.

In Melbourne recently, a group of FM-only and multimode stations discussed the problem of FM on 1296.100 and came to an agreement to keep that frequency clear and use 1298.100 MHz for FM. The reason for this choice is that most of the SSB stations also use FM for ragchewing and crossbanding, some have transverters from two metres which can cover only 1296 to 1300, so 1298.100 has become an unofficial net. When the new band

plan is finally promulgated, the FM-only stations will be able to use any frequency within their range but using 1298.100 for an unofficial natter and liaison frequency and leaving 1296.100 for narrow band modes.

In VK3 there appear to be about 34 stations with 1296 MHz capability, 16 are using SSB and horizontal beams and 6 are located outside of Melbourne.

The World Above 50 MHz

Congratulations to QST magazine which in December 1989 celebrated 50 years of presenting the segment "The World Above 50 MHz." At present the columns are prepared by Bill Tynan W3XO, with whom I exchange monthly information. In December 1939 Ed Tilton, W1HDQ, presented the three pages with the title "On the Ultra Highs." The band was then called five metres and consisted of 56 to 60 MHz with the record trop distance being 450 miles. W9ZJB of Kansas City, Missouri, was the first amateur to work all nine call areas of the US. His equipment consisted of a pair of T-20s running 120 watts and the receiver used was a Hallicrafters S-10.

The columns also included information on the use of 112-116 MHz where W1KH used a Western Electric 316A "door-knob" tube capable of 8 watts. He also used a pair of RK-32s running 300 watts! In the Boston area distances of 25 miles were being covered regularly. Reports were also included for the 224-230 MHz band.

Ed Tilton now lives in Florida and has the call W1HDQ/4.

Closure

As I am slowly getting back into harness I will close the column at this point, allowing room for the Six Metres Standings information.

Two thoughts for the month: "One man cannot hold another man down in the ditch without remaining down in the ditch with him" and "If you look like your passport photo, in all probability you need the journey."

73. The Voice by the Lake

50 — 54 MHz DX Standings

DXCC Countries based on information received up to 15 Dec 1989. Cross-band totals are those not duplicated by six metre two-way contacts. Credit has not been given in columns 1 and 2 for contacts made with stations when 50 MHz was not authorised.

Column 1:	50/52 MHz two-way confirmed
Column 2:	50/52 MHz two-way worked
Column 3:	Cross-band (52 to 28 MHz) confirmed
Column 4:	Cross-band (52 to 28 MHz) worked
Column 5:	Countries heard on 50 MHz

Column 6: Countries heard on 52 MHz
 Column 7: 50 MHz two-way worked
 (1963-30/6/1989 — temporary listing)

Call Sign	1	2	3	4	5	6	7
VK8GB	42	2			13		
VK4ZJB	32	32				4	
VK2BA	31	32					18
VK2VC	27	27					
VK2QF	27	29					25
VK2DDG	25	26		2	12	3	
VK3OT	25	26			10		
VK3XQ	24	26			1	1	
VK3AWY	22	22					
VK2KAY	21	23					
VK5LP	21	22			6	3	8
VK2BNN	20	21					
VK4ALM	20	20					
VK4TL	19	19					
VK7JG	18	20				2	
VK4ZAL	18	18					
VK3AMK	17	17					
VK9XT	17	21					
VK3AUI	17	21					
VK3NM	16	17					
VK6RO	16	18	3	3	7	3	
VK4ZSH	15	16					
VK2ZRU	15	16			1	3	
VK3ZZX	12	13					
VK9YT	12	14					
VK6HK	12	18	1		1	1	9

VK4KHZ	10	10				12
VK6OX	10	10	1	1		
VK8ZLX	10	13				32
VK4BJE	7	7				3
Overseas						
JA2TTO	48	48			6	

Column 7 lists those 50 MHz contacts between 1963 and 30/6/89 which have been supplied to me and NO DISTINCTION IS PRESENTLY BEING MADE no matter from which State they have been received, or any relevant QSL information. The present separation between 50 and 52 MHz will assist me to make a decision as to credibility at the appropriate time. All Standings information (from day one) is now stored in the computer so that any adjustments should be relatively straightforward.

A minimum of five countries confirmed (including VK) is required for an operator to be listed.

The list position is determined by the number of confirmed contacts. Where two or more operators claim the same total, those first date listed with that total can only be displaced by another having a greater number of confirmed contacts.

The next list will appear in August 1990 and entries will need to be on my desk no later than 20 June 1990. Claimants are reminded that full details of all contacts are required;

viz: date of contact, time in UTC, call sign of station worked, country, mode, report sent and received, QSL sent and whether received, split frequency contacts should be indicated. Please add your own call sign, signature and date.

I reserve the right to request and examine any QSL cards which may be needed to support an application for listing. To assist your claim a useful idea is to include photocopies of the front and back of QSL cards.

PLEASE NOTE: Those operators who have already claimed 50 MHz contacts after 1963 and prior to 1 July 1989 are asked to submit a new list of countries worked between 1/7/1989 and 15/6/1990 as many possibilities exist for countries already nominated to be re-worked during the coming autumn period of peak F2 activity.

Eastern States operators who worked 50 Mhz stations last autumn and earlier should not need to be told that they should try and work all of them again this autumn, especially if contacts were made after 0000 UTC which will probably be used as a cut-off time for Six Metre Standings Listings for 50 MHz contacts made during the past few years. From an examination of photocopies of many QSLs forwarded to me by claimants it is becoming quite clear that many Eastern States 50 MHz contacts were made prior to 0000.ar

HOW'S DX

STEPHEN PALL VK2PS
 PO Box 93 DURAL 2158

Bouvet Island 3Y5X — 3Y0B

By the time you read this, the Club Bouvet DXpedition has successfully completed its task. The ship "Aurora" left Norway early in December for South America. In mid December at Montevideo, Uruguay, the amateur operating team joined the Norwegian scientific and helicopter crew on board the ship and headed to Bouvetya, as the island is called in Norwegian. The expected time of arrival at the island was Christmas day. Whilst on the high seas they used the callsign LA5X/mm to relay information about the progress of the voyage. The ship arrived at its destination on the 26th of December. No landing was possible on that day due to fog, blizzards and 24 feet high mountainous seas. Finally, they managed the lift-off by helicopters from the ship on the 27th of December 1989, and started operating on 14145 kHz transmit frequency and receive from 14200 to 14220 kHz on multihop frequency basis. This operating procedure caused some confusion, and suddenly quite a number of "weirdo" operators (among them some suspected pirates) appeared on the well publicised and pre-announced frequencies.

Australasia is one of the most difficult places on Earth from which to contact Bouvet.

The Americans and the Europeans heard them with signal strength 8-9, but the Sydney-Auckland-Norfolk Island area heard them only with a signal strength of S3 or less. The path to Bouvet is almost due South (SP) or due North (LP). The duration of the group's stay on Bouvet was 23 days. The expedition had five complete Icom stations. Up to the 3rd of December, the expedition had received 85.9% of donations towards its \$100,000 target. Operation was SSB, CW, from 160 to 6 metres, RTTY on 20, 15 and 10 metres. The best chance to contact them from VK was on 20 metres. We hope that many of you made the contact with this very rare DX country.

If you missed the 3Y5X activity, then be prepared for the Legion of Indiannapolis DXers with the callsign 3Y0B which should operate from Bouvet early or mid February. Besides Bouvet, this group hopes to go to South Sandwich Islands and activate that group under presumable VP8 callsign.

Laos XW8 And Vietnam 3WØ

January issue of "AR" gave detailed news of the re-activation of this much sought after country. Inh, the operator of XW8KPL is still active on a variety of frequencies. The station was established with the assistance of six

Japanese amateurs under the leadership of Yoshi JA1UT. The station is in Vientiane at the National News Agency of the Peoples Democratic Republic of Lao, Khaosane Pathet Lao (KPL). The operating times are around 0400 to 0700 UTC and after 0900 UTC. They were heard on 14165, 21295, and on 28 MHz. QSL only by direct mail to the address given in January 90 issue of "Amateur Radio". Please do not send "green" stamps for return postage (US dollars) — only 3 IRCs (International Reply Coupons) and self-addressed reply envelope.

The Hungarian DX group, HA5PP — Zoli and HA5WA — George, arrived in Laos in the last days of November. They had considerable difficulties getting on air. Why? Details are sketchy. At one stage we heard that they have been denied the operating licence, later we were told that they have now the licence, but the owner of the hotel where they were staying did not permit them to put up their antennas. When they became active on the 8th of December 1989 with the callsign XW8DX and XW8CW many who worked them in the beginning doubted that they were genuine. They operated on 21035 — 21235 — 28025 — 28495 and 14195 kHz. When I spoke to them for the last time on the 20th December, they had over 18000 QSOs under their belt. They participated in the ARRL 10 metres contest with more than 2000 QSOs and about 80000 points. They planned to go back to Hungary on the 27th of December. The Spratly operation of this group did not eventuate. Unconfirmed reports said that "they missed the boat". QSL to: F6HIZ.

If you missed the Hungarians, maybe you have worked the Japanese in Laos. XW8KPV was on the air on the usual DX frequencies from the 22nd of December until the end of December. QSL to: JH1AJT.

To make the DX activity on the bands more exciting, XV2A from Vietnam has appeared on 21274 kHz at 0600 on the 22nd of December, operated by a Japanese group. QSL to: JA3UB. And another group was scheduled to operate from the 31st of December to the 5th of January under the callsign: 3WØJA. QSL to: JA7JPZ, to the Callbook address direct.

Macquarie Island - VK0

John, VK0JR arrived at Macquarie Island at the very end of November and appeared on the band on the 6th of December, "Saint Nicholas" day. John originally comes from Canada, married an Australian and settled in Perth 10 years ago. QSL to: VK9NS.

Western Samoa - 5W1

Had a long QSO with Pete 5W1KT. He is on a two year contract with the Western Samoan Government, and will be in 5W1 until the middle of 1991. Pete set up his station not so long ago, and is now in the serious DX-ing stage. There is no QSL Bureau on the Island and the local Amateur Club is practically defunct. Pete came to VK6 some time ago from South Africa, and was always interested in Amateur Radio since he was a boy. He started as a novice in VK6 and now he has his home call as: VK6KT. Pete has a vertical antenna for 20-17-15 and 10 metres, but hopes to have a beam soon. Pete will do his own QSLing and his logs are computerized. QSL cards have been ordered and QSLs should be sent to: PO Box 1672 APIA, Western Samoa, South Pacific.

Rotuma 3D2

Bing VK2BHC went back to Rotuma and started operating under the call: 3D2XV. Soon afterwards he fell ill and he had to leave the Island. At the end of December he was improving but still sick. In the name of our readers we wish him a speedy and full recovery.

Rotuma, however, continued to be active. Mats, SM7PKK arrived in Rotuma mid-December using the callsign: 3D2XR. He intended to stay on the island until the third week in January. QSL to: SM7PKK.

Anguilla - VP2

Every keen VKDX-er would at some time have worked Paul VP2EXX (Ex V47NXX). He is a first class operator in every sense and is

often in demand for DXpeditions and multi-operator Contests. Earlier in the year he was on Desecheo KP5 with KP2A and more recently he was on St Lucia for the CQWW CW contest as N9AG/J6L and J6DX (QSL to: N9AG). A long term plan for Paul is to visit his friend UA9MA in Omsk in August 1990. Paul speaks good Russian, so he is very popular with the UA operators. If he does make the trip, he will be acting from several Oblasts. At the age of sixteen Paul has earned his Big Gun status. QSL for VP2EXX and V47NXX to KC8JH.

Banaba Island And Conway Reef

It is now official. The ARRL Awards Committee has accepted the 16 member DX Advisory Committees recommendation to accept the Island and the Reef as a new DXCC Country, but only contacts after the 1st of March 1990 will be valid. Previous contacts made from Ocean Island (Banabas former name) will count, provided that the operator and his station was physically on the island when the contact was made.

At the same time, applications for Frederick Reef, Merquesas Islands, Tatoosh Island and Guemes Islands were not recommended for DXCC Status.

The only application for a separate country status is now Walvis Bay; the South African enclave in Namibia according to several sources. Walvis Bay, known until now as ZS1, has changed prefix. Ian ZS1IS is now signing ZS9A. The Walvis Bay application will be considered by the DX Advisory Committee in mid-January 1990.

Interesting QSOs And QSL Information

WA3ZXX/KP4 — Jeff — 14226 kHz at 1150 UTC. QSL to: KP4GY.

KH0AC — Len — 14226 kHz at 1222 UTC — QSL direct to K7ZA.

ZS500A — Special event station — 14220 kHz — QSL to: W3HUP.

OD5KB — Sami — 14220 kHz at 0612 UTC. Sami is employed at Beirut Airport — QSL to callbook address.

V73AT — Ted — 14165 kHz at 1115 UTC. Ted's former callsign is KX6HE. QSL to: K2CL.

5W1HM — Kiyoko (yl) 21250 kHz 1045 UTC. QSL to: JH1IFF.

NH6RT/P/KH8 — Kiyoko's other callsign (details above).

VE3DJ/V2A — Jock — 21248 kHz at 0326 UTC. QSL to: homecall.

KG4DD — Doug — 14235 kHz — 0637 UTC. QSL to Box 692 FPO NY. Zip: 09593-

0055 USA.

F6IGS/FO — Gerry — 14233 kHz at 0940 UTC. QSL to the French DX Foundation: PO Box 88, BRUZ, 35170, France.

TA1AL — Mustafa — 14222 kHz at 0600 UTC. QSL to 1990 Callbook Address.

HS0E This is a Thai Club callsign and it is used by different visiting amateurs. You should ask for the home call of the operator and the QSL route. Between the 7th and 12th of December, the operator was John, K9EL (QSL to home call). On the 20th of December the operator was Sombat: HS1BV.

9M8FH — Festus — 14226 kHz at 1214 UTC. QSL via the Bureau or Callbook.

VU2GI — Govinda — 14226 kHz at 1218 UTC. QSL to: N2HOS.

IK2GNW/V73 — Andriano — 14222 kHz at 0603 UTC and T29GM on 14195 kHz. The operator was Andriano again who is on a Pacific DX tour. According to unconfirmed reports he fell ill with high fever and left for Italy via Hawaii. QSL to home call.

F6ESG/OD5 — Patrice — 14 MHz — CW — at 0430 UTC. QSL to home call.

3A2LF — Claude — 14 MHz CW at 2050 UTC. QSL to: callbook address.

PJ2/OH6XY — Carl 14 MHz CW at 2100 UTC. QSL to: home call.

9H3GQ — Werner — 21 MHz CW at 0400 UTC. QSL to: DK4SW

HB9AHA/J6L — Rene — 21 MHz CW at 2100 UTC. QSL to: home call.

ZF1HJ — Jack — 21 MHz CW — at 2200 UTC. QSL to: PO Box 1215 George town Grand Cayman Island, Carribean.

XX900 — Fred — 21 MHz CW at 0900 UTC. QSL to: F Fisher 259 W Cook Rd Mansfield — OH 44907 USA.

CN8MC 21 MHz CW — 1100 UTC. QSL to: Association de Radio Amateurs du Maroc Box 299 Rabat, Morocco, Africa.

VP2EM — Harold — 21 MHz — CW — 0100 UTC — QSL to: KV4AM

HC8/HC1LT — Luis — 21 MHz. CW 0430 UTC. QSL to: LD Troya, Box 289 QUITO ECUADOR South America.

P29VPY — Paul — 21 MHz CW at 0817 UTC. QSL to: K1XM

9K2KS QSL to: ON7LX — TZ6VV QSL to: N0BLD — TT8GA QSL to the French DX Foundation (see address above) — YI0BIF QSL to: KA1DE — V29OA QSL to: W7KNT — HP1XSO QSL to: Box 842 Clayton Rep of Panama. J88BS QSL to: WA4WID — IYØONU Special UNICEF station. QSL to: I5KKW — ZZ5UF QSL to: PP5AA — HS2ZW QSL to: IK8DOI — YJ1TRS QSL to: PO Box 217 Port Villa, Vanuatu. CO2OM QSL to: Box 4910 Havana 4, Cuba. 6W7OG QSL to: F2YT — P29CG QSL to: WB9SVK, call book address. HZ0AB QSL to: K8PYD — XX9KA QSL to: KC9V — ZF2HR, QSL to: SM5BUS KA5UWN/KH2, QSL to: WD5GIV — ZW0F QSL to: PY7ZZ.

From Here And There And Everywhere

Jean Pierre — 5T5SR (Mauritania) has been coming up on 10 metres around 28555 kHz at 2200 UTC. He has been also on 21280 kHz at 0930 UTC. QSL direct only to: PO Box 51, ATAR, Mauritania, Africa.

Jimmy, JH1MAO/JD1 (Minami Torishima) operated on 28477 kHz almost daily in November. QSL to his home call. JD1YAA, Aki, was heard also on 28581 kHz. QSL via JA1OGE or Bureau. Dimitri SV5ADM was calling CQ on 28522 kHz at 0655 UTC. The band was very quiet, and he was a good one for the log from the Dodecanese Islands. QSL to Callbook address. OD5KB says that Hany OD5KV, who was very active last year on the 21205 and 14222 nets, has moved to London, and will try to obtain a G callsign. Jorge D2/LU6ELF, on short notice, appeared on the "222" net on the 14th Dec. A few VKs managed to contact this elusive station. QSL to: N4THW: Mr Carlos A Vega PO Box 22541 Ford Lauderdale Fla, Zip: 33335 USA. Brazilian stations using the additional suffix of /PR100 are celebrating the 100th Anniversary of the Republic of Brazil. According to unconfirmed reports, Piet, a Dutch missionary will shortly commence operations from the Central African Republic under the callsign TL8PN. The Knights of Malta station, 1A0KM intended to be active for 24 hours on Christmas Eve. However the operators decided to postpone the activation of the station to a date somewhere in 1990.

Reason: There is too much DX activity at the moment, and they do not want to compete with the others.

Xenon, LU1ZA was active for one year from

South Orkney Islands situated in the Antarctic Atlantic Ocean. At the very end of his stay, with the assistance of Sergio LU1HM on the Argentinian end, and Jim VK9NS on the Australian end — under difficult propagation conditions — he came up on the "222" net. A few VKs and ZLs were successful in establishing contact. Xenon is an army officer and his tour of duty ended before Christmas. QSL to: LU2CN. Trevor, VK9TR is part of the meteorological team on Willis Island. he will be on the island for 6 months. He is very busy professionally, which leaves little time for him to enjoy amateur radio. QSL to his home call: VK5FG which used to be his late father's callsign.

Oops...Or The Mistakes Department

It had to happen, sooner or later...In the December 89 Issue of "Amateur Radio", page 37, under the item dealing with the "222" net there is a mistake which was discovered by the writer of this column as soon as I saw the printed copy of the magazine, and by Jim VK9NS and Neil VK6NE, but nobody else, which surprised me. The Heard Island Expedition by Jim and Kirsti was conducted under the callsign of VK0JS and VK0NL. The call signs VK0HI and VK0CW were operated by Dave Shaw VK3DHF and Al Fischer K8CW from the 21st of January to the 21st of February 1983. This other DXpedition was organised by the VK6 DX Chasers Club and was connected with the mountaineering group of William Blunt. The mountaineers were the second group which climbed Big Ben at the top of Mawson's Peak. The whole group travelled in the maxi-yacht Anaconda II.

Jim's expedition, VK0JS, was sponsored by the Heard Island DX Association (HIDXA) and used the British built 156 feet ex-whaler, Cheynes II which underwent a massive re-fit prior to departure to the island. The HIDXA Expedition had 18 members including several scientists, and researchers. The amateur group consisted of Jim VK9NS, his wife Kirsti VK9NL, Sjoerd (Sojo) VK0SJ, Bob WA8MOA, Walt W7SE and Werner OE1LO. The expedition made approximately 14000 plus contacts with 138 countries. The voyage to Heard Island and back to the mainland is a story for itself. Blizzards with winds gusting to 60 knots, seas with 20 to 30 foot waves, shortage of water (Cheynes II was a steamship) and shortage of fuel on the way back. This necessitated to use makeshift sails made of old lorry tarpaulins. The ship actually "sailed" 855 nautical miles in 368 hours at an average speed of 2.34 knots. The armchair DXpeditioner sitting in the shack making the short contact which gives a new, "DX country", never realises the difficulties endured by the dedicated to put a new "DX country on the air."

The Big Question

Have you given further thoughts to the series of questions posed by me in the January 1990 issue of "AR", in the "How's DX" column? Did you voice your opinion by dropping me a line to PO Box 93 Dural 2158? If the answer is: yes, I thank you for your cooperation. If the answer is: no, then please read the end of the January 1990 DX column again. I would like to publish the results as soon as possible, but I need your comments first.

Finally many thanks, for the assistance received from Pat VK2RZ, Les VK4DA, Neil VK6NE, Jim VK9NS, Yoshi JA1UT and the DX bulletin "QRZ DX".

73 and good DX to all of you. **ar**

EMC REPORT

HANS RUCKERT VK2AOU EMC-REPORTER
15 BERRILLE RD BEVERLY HILLS 2209

Several EMC Short Stories

1) Canadian Success Story:

(from Radio Communication 6/89 and CQ/DL 11/89).

Readers will remember the reported very sad story of the VE3SR — Jack Ravenscroft court decision (AR 11/1988). Raymond Perrin, the Director of the CRRL in Ontario, VE3FN, reports that a neighbour of a radio amateur had claimed that several of her technical appliances were affected by the transmission of the next-door radio amateur. At first, the court decided that the radio amateur had to stop operation. She had refused any attempts to have the susceptibility of the

equipment overcome. Mr Perrin was acting as defence expert, and he was supported by all other experts including the observer of the Department for Communication. The judgement has now been reversed, so that the owner of the appliances has to have her apparatus modified. Mr Perrin stated that:

a) A transmitter can then only cause interference if the transmitter does not meet the legal technical standards.

b) A transmitter can never cause an equipment malfunction, if the equipment is not designed to be a radio receiver.

c) If this kind of equipment is affected, then it is only caused by design faults of this equipment.

d) The claim, that the unwanted effect does disappear, when the transmitter is switched

off, is technically wrong.

Mr Perrin made the following statement:

"If rain gets through a roof, it does not mean that we have to stop the rain. We have to fix up the leaking roof, because the problem is caused by the leaking roof."

It is hoped, that this will be considered a worldwide test case; that the law-makers will place the blame where it belongs, and that the public will be educated accordingly.

2) Audio and VIDEO Plug Connections: (By DG40AA) CQ/DL 11/89). A number of widely used plugs are shown, which rarely provide shielding. Many examples had an interruption of the earth to equipment contact, or no reliable earth contacts. Pressure contacts instead of soldered contacts are often unreliable. Metal particles containing paints are often not conductive at all. Only all metal plugs and connectors and jacks should be used to avoid EMC problems even with correctly designed appliances.

3) Cable-TV and Satellite-Operation: (By DC8TS, AMSAT-DL 2/89). I experienced

during the last months interference to my 2m satellite reception, because the special channel-6 was used by the Cable-TV operation. 145.739 and 145.981 were particularly affected. There was splatter between 145.94 and 146.00 MHz, the degree of which depended on the modulation of the TV signal. The test tone was still audible after closure of the transmission. The other frequency affected especially the reception of the R-6 relay channel. This interference is totally unacceptable being caused to an amateur radio exclusive band. It is at best wishful thinking by the cable-TV firms, that their system is RF tight. The Americans found out already many years ago — and that is still so — that cable-TV transmission is not as RF tight as claimed. This system caused interference to amateur radio reception and it picked up legal transmission as well. VK3QQ reported these problems years ago. After collecting the necessary details, I wrote to the cable-TV firm, who claimed that they cannot find anything wrong with their set-up, and they know nothing about an exclusive amateur radio frequency band. They stated that they were willing to ask the Post-Office about this last point. It was between Xmas and New Year, when a

PMG testing vehicle stopped suddenly at my house. They confirmed the interference observations. With a 20 dB preamplifier working at 145.981 MHz the S-meter of my receiver deflected 60% of full scale over an azimuth range of at least 90. The officers found that an inadequately shielded cable going to the TV-set caused the leakage (this is usually the case). When the correct cable and the PMG-TV set was used, no trace of interference was observed, but who has a TV-set in a shielded metal case!/? The behaviour with my low noise preamplifier is now as it was earlier without the preamplifier. It is clear, that Cable-TV is quite unable to be sufficiently RF tight not to interfere with preamplifier receivers using the amateur radio frequency band. Cable-TV must never use amateur band frequencies, and they know that this will cause RFI. The firms who plan now to introduce Cable-TV should be told now that Amateur Band Frequencies must never be used for their service.

4) Channel S-6 in Sweden: (CQ/DL 12/89)

The Standards Commission (SIS) of Sweden laid down Standards for the Cable-TV service as reported in "QTC" 7/89. The new standard was established by the Svensks

Elektriska Commission (SEK), committee TK12X included representatives of the Swedish Amateur Radio Organization SSA. The following channels must not be used for Cable-TV to avoid possible interference to aircraft communication: S-1 to S-5 (108-139 MHz). S-12 (242-244 MHz). S-24 — S-25 (328 — 335.4 MHz). To protect emergency traffic S-33 to S34 (405 — 407 MHz). Also the following channels should be avoided to avoid interference to the Amateur Radio Service: S-6 (144-146 MHz) and S-37 (432-438 MHz). It is hoped that other countries and their Cable-TV companies learn from this Swedish understanding of the problem before they start to use certain channels.

5) Signal splitters and combiners - a risk of EMC problems: (DL7AOH CQ/DL 9/89).

This publication shows x-ray photographs of a number of signal splitters and combiners. The lack of shielding and reliable connection for the earthed wires was found to be the main fault. The technical data supplied were in some cases misleading. Only totally shielded units can be recommended. Unreliable contacts were also found in one case. Completely shielded units with soldered connections inside were found to be OK. ar

CONTESTS

FRANK BEECH VK7BC FEDERAL CONTESTS MANAGER
37 NOBELIUS DRIVE LEGANA 7277

February;

24 — 25th REF French contest, Phone section. (Rules December "AR".)

24 — 25th UBA Belgian contest, Phone section. (Rules January "AR".)

March;

10 — 11th RSGB Commonwealth contest. (Rules January "AR".)

17 — 18th NZART National field day contest

17 — 18th WIA John Moyle Memorial Contest. (Rules this issue.)

The three main contests that attract VK/ZL stations next month are listed in the above calendar. Since the publication of the rules of the RSGB Commonwealth contest in January's "AR", I have been advised that a group of amateurs in Victoria have obtained permission to run a "HQ" station in this year's event, and will compete using the callsign VK3WIA. This station, like the "HQ" stations in other Commonwealth countries will attract bonus points, so are well worth the effort of contacting.

In the John Moyle contest, which coincides with the ZL field day contest, VK amateurs are encouraged to work the ZL stations, but please note, the repeat contact rule: for all overseas contacts, ie, ZL, W, DL, etc, no repeats are allowed — just the normal one contact per mode per band, as in almost all

international HF contests.

Due to the amount of time that I have spent during the Christmas, New Year period looking out for the Bouvet DXpedition, and putting the finishing touches to the 1989 RD logs, these notes will be shorter than usual. I hope you all send in logs for the Ross Hull contest and the second trial VHF/UHF field day contest. Please do not forget.

John Moyle Contest Period

From 0100 UTC March 17th 1990, until 0800 UTC March 18th 1990.

Objects

To encourage portable operation on the amateur bands by Australian amateurs, and is intended to help amateurs become familiar with portable operations, and thus assist in training them for emergency situations. Emphasis is placed on working between portable stations.

Divisions

There will be two divisions;

Division "A" 24 hours.

Division "B" 6 hours.

In each division, the operating period must

be continuous within the time period allocated for the contest.

Sections

In each division there will be separate sections as follows;

"A" Portable field station, TX phone single operator.

"B" Portable field station, TX CW, single operator.

"C" Portable field station, TX Open, single operator.

"D" Portable field station, TX Phone, multi-operator.

"E" Portable field station, TX Open, multi-operator.

"G" Portable field station, TX VHF, multi-operator.

"H" Home station TX, emergency powered.

"I" Home station TX, mains powered.

"J" Receiving stations.

Station Definition

A portable station is one which operates from a power supply which is independent of any permanent installation, ie batteries, solar, wind, portable motor generators.

A SINGLE OPERATOR station is one where the work involved in setting up the station is carried out by the person who operates the station. No assistance can be received apart from the provision of food and security etc.

A multi-operator station is self explanatory.

No radio apparatus may be erected on the site earlier than 24 hours before the contest period commences.

Bands

All amateur bands may be used with the exception of the 10, 18, and 24 MHz bands.

Multi-Operator Stations

Such stations shall provide a separate log for each band used.

Only ONE transmitter may be used on a given band at any one time, whether operating in phone or CW mode.

ONLY ONE CALLSIGN may be used from a multi-operator station.

Contacts

Cross-band contacts are not permitted.

Cross-mode contacts are permitted. However they will count only as phone contacts for scoring purposes.

Contest Exchange

The exchange between stations will consist of a cypher comprising the RST report as applicable, followed by a serial number commencing with 001 and increasing by one for every contact. Following the serial number, a letter must be added indicating the section "A" to "J" in which the station is competing. Both cyphers sent and received must be entered into the log.

Repeaters

Operation through any terrestrial repeater is not allowed for scoring purposes. However, the use of such is allowed for the purpose of arranging contacts. Contacts made by using orbiting satellites or EME as a medium are allowed.

Modes

AM, FM, SSB, all count as phone.

RTTY and CW are both regarded as CW.

It would not be expected that the more exotic modes would be used in this contest.

Scoring

Scoring for portable field stations.

Portable/mobiles outside ones own call area 20 points
Portable/mobiles within ones own call area 15 points
Home stations in section "H" outside ones own call area 10 points
Home stations in section "H" within ones own call area 5 points

Station "I" irrespective of call area... 2 points
ZL stations who are in the NZART field day contest and are portable 20 points
Other stations who are in the NZART field day contest 10 points

Scoring for Home stations, emergency powered.

Portable/mobile stations outside ones own call area 15 points
Portable/mobile stations within ones own call area 10 points
Home stations section "H" irrespective of call area 2 points
Home stations in section "I" irrespective of call area 2 points

Scoring for home stations mains powered.

Portable/mobile stations outside ones own call area 10 points
Portable/mobile stations within entrants own call area 5 points
Home stations in section "H" irrespective of call area 2 points

IN ALL SECTIONS A STATION MAY BE WORKED ONCE ONLY PER BAND, PER MODE.

CW contacts. In all categories CW to CW contacts will earn double points.

Bonus Points

For any contact made by using a natural power source, a bonus of 10 points may be added. A natural power source is regarded as one the power for which is derived from solar cells, wind, methane gas etc, as well as from batteries which are completely charged by natural means. All power produced in this category must have been derived independently of commercial mains or the use of petroleum derivatives.

Receiving Stations

Stations in this section must record the cyphers being sent by the stations operating in the contest within sections "A to G" inclusive. QSO points will be on the same basis as for Home stations section "I".

Log Format

All logs shall be set out under the following headings;

Date, Time (UTC), Callsign of station worked. Band. Mode. RS/RST and serial number sent. RS/RST and serial number received. QSO points. Multiplier. Bonus. Total claimed.

Each log page must carry a progressive

IAN J TRUSCOTTS

ELECTRONIC WORLD

FOR ALL YOUR COMPONENT REQUIREMENTS

MAIL ORDERS WELCOME

ELECTRONIC COMPONENTS FOR THE RADIO AMATEUR

- SILVER MICA CAPS
- POLYSTYRENE CAPS
- VARIABLE CAPACITORS
- MURATA FILTERS, NPO & HIGH VOLTAGE CERAMICS
- AMIDON FERRITES (SEND S.A.S.E. FOR DATA)
- TEST EQUIPMENT
- DATA BOOKS
- ELECTRONIC KITS inc Kits by Drew Diamond
- Prewound RF CHOKES
- COAXIAL CABLE
- POLYOLEFIN HEATSHRINK
- INSTRUMENT CASES

30 LACEY STREET
CROYDON 3136

Phone: (03) 723 3860
(03) 723 3094

total points score claimed at the bottom of each sheet.

Summary Sheet

For bonus points to be claimed, suitable evidence must be provided as to the method of natural power generation employed. Such evidence should take the form of a photograph of the generating equipment used, or a signed statement by another amateur, showing his callsign, declaring that he has inspected the generating equipment referred to.

Front Sheet

Each log must be accompanied by a front sheet that provided the following information Name. Address. Callsign. Division (6 or 24 hours). Section (A to J). Station location. Number of contacts. Claimed score.

The front sheet must also indicate:

Equipment used. Power supply used, and in the case of multi-operator stations: a list of all the operators names and callsigns, together with their signatures. The front sheet must also carry a declaration signed by a licenced amateur as follows; "I hereby certify that this station was operated in accordance with the rules and spirit of this contest".

Certificate And Trophy

Certificates will be awarded to the winner in each section of each division. The 6 hour certificates cannot be won by the 24 hour entrants. The Contest Manager also reserves the right to award other certificates where the effort made by a specific station is of special worthiness. The highest CW scorer outright in the contest, irrespective of the section of the contest entered, will receive a trophy in the

form of the Presidents Cup to hold for a period of twelve months. This award is to encourage operators to utilise the CW mode whenever possible.

Disqualification

The general WIA contest disqualification criteria as published will apply to this contest.

Log Submission

Logs should be forwarded to the Federal Contests Manager.

Frank Beech VK7BC, 37 Nobelius Drive, Legana, Tasmania 7277.

The front of the envelope should be endorsed "John Moyle contest".

Closing date for entries is April 27th 1990. ar

AWARDS

KEN GOTT VK3AJU FEDERAL AWARDS MANAGER
38A LANSLOWNE RD ST KILDA 3183

WIA Awards Programme

Applications and enquiries about federal WIA awards should be addressed to Ken Gott VK3AJU, 38A Lansdowne Rd, St Kilda, Vic 3183. A SASE for reply is always appreciated when making an enquiry.

General Rules For WIA Awards

Cost: Free to WIA members. VK non-members pay \$A5 and others \$US5 or 8 IRCs. However, \$5 is payable by members for special event awards such as WIA 80 (see below).

Verifications: Applications must hold unaltered QSL cards for all QSOs claimed and these must show clearly the time, date, mode, frequency and signal report sent by the station concerned, and its location and/or address at the time. Alterations, even if made by the sender of the card, will disqualify the card.

Cards should not be sent with award applications. In their place, there should be a list of the cards in callsign order with the details set out in the previous paragraph listed in columns.

This list should be accompanied by a declaration signed by an official of a society affiliated with the WIA, or by two licensed amateurs, reading as follows: "I/we certify that

(insert name and callsign of applicant) holds QSL cards corresponding to the above list and that I/we have personally inspected these cards."

Signatories of the declaration should clearly indicate their names, addresses and callsigns.

Applications

Applicants should indicate whether they are WIA members and if so cite their membership number. Where relevant, changes in callsigns and the dates of such changes should be indicated. If the period of on-air activity covered in the application includes a change of QTH of more than 240 km, this should also be noted. If portable or mobile operations are involved, the station's locations should be indicated for each such QSO.

Crossband and mixed mode contacts are not eligible, nor are those made through terrestrial repeaters, from aircraft or sea-going vessels. Rules regarding changes of QTH during the period covered for an application vary for various awards.

Where a fee is payable, this should be sent with the award application.

In cases of dispute, the decision of the Federal Awards Manager and two officers of the WIA Federal Executive on the interpretation and application of these rules shall be final and binding. Notwithstanding anything to the contrary in these rules, the WIA Federal Council reserves the right to amend them when necessary.

Awards Available

Worked All VK Call Areas Award

Known as "WAVKCA" this large, colourful certificate is the WIA's most popular award, particularly with overseas amateurs. There are separate requirements for local and overseas amateurs.

Locals require 77 QSOs, as follows: VK0, 3 from at least 2 different areas; VK1, 5 on at least 2 different bands; VK2, VK3, VK4, VK5, VK6, VK7— ten each, involving at least 3 different bands; VK8, 5 contacts and 2 bands; VK9, 4 QSOs from at least three areas.

The usual rules (see above) regarding cross-band, mixed modes, mobile/portable, repeaters, etc, apply.

A past rule allowing VK applicants to make repeat contacts with the same station after 24 hours is hereby rescinded. No repeat contacts made after February 14, 1990, will count.

Overseas amateurs need one QSO with stations in each of VK0, VK1, VK8 and VK9, and three in each of VK2, VK3, VK4, VK5, VK6 and VK7, with no requirements as to bands or QTH.

Heard All VK Call Areas

This is a "heard only" version of the WAVKCA award, available to SWLs; on the same basis as to amateurs, ie confirm reception of 22 stations as specified if overseas, or 77 if resident in VK. The same fees and procedures apply.

WIA DXCC Award

This prestigious award is available to all amateurs who submit evidence of having worked 100 countries, and can be endorsed for various modes and bands. Holders are referred to as "members" of the DX Century Club.

Acceptable countries are determined by the Federal Awards Manager in consultation with the WIA Federal Council. In practice, the WIA list is the same as that issued by the ARRL, subject to the WIA reserving the right to make variations. Currently there are 321 countries on the list.

Having obtained the DXCC award, holders may register subsequent claims for higher totals and these will be published from time to time in Amateur Radio in the form of a ladder. No stickers to indicate these higher totals on certificates are available, however.

Having obtained the basic certificate, applications for recognition of higher totals should be made in multiples of 25 up to a total of 200 (ie at the 125, 150, 175 and 200 marks) and thereafter in multiples of 10 up to a total of 300. At that point applications for additions of single countries are in order.

Should a country be deleted from the DXCC list members and intending members of DXCC will be credited with such country if the date of contact was made before such deletion. Entries on the DXCC ladder typically show the member's tally of current countries and total of current and deleted countries, eg 200/220 — meaning 200 countries currently on the list and an extra 20 which have been deleted at some time, but which were worked before date of deletion.

Starting dates for new countries will generally be the same as those announced by the ARRL, with the WIA again reserving the right to make different decisions.

All claimed QSOs must have been made from the same DXCC country. (This permits a shift from, say VK2 to VK4 during the period covered in an application, but not from VK2 to VK9 or VK0 — see DXCC list for the various DXCC "countries" within Australia.)

WIA Antarctic Award

This is the latest WIA award to be introduced and at present is the only regional award offered by the WIA (meaning that it involves contacts with stations outside Australian jurisdiction).

Applicants must make confirmed contacts with ten amateur stations conducting valid operations in Antarctica. The ten must include stations licenced by at least six different government authorities, and one must be a VK0.

Antarctica is defined as the land mass, including islands and permanent ice shelf below latitude 60 degrees south. (This, incidentally, excludes Heard and Macquarie islands. These are sub-Antarctic, not Antarctic.)

QSOs may be on any amateur band, including the WARC bands, but the usual terms on crossband contacts etc, apply.

QSOs must have been made after 0001 UTC, February 23, 1988. This date was chosen to mark the 75th anniversary of the first two-way radio exchange between the Antarctic

continent and the world outside. On February 23, 1913, the exploration team led by the Australian geologist and explorer Douglas (later Sir Douglas) Mawson sent messages to the Australian Governor-General and to King George V from their base at Commonwealth Bay.

WIA 80 Award

This marks the 80th anniversary of the world's first and oldest national radio society, the WIA.

The award is open to all radio amateurs and shortwave listeners, and will operate from November 1st, 1989, until December 31st, 1990.

To qualify for the award those living in Australia (except VK9 and VK0) need to contact 80 members of the WIA.

All others need contact only eight WIA members.

Contacts through ground based repeaters are not permitted, although simplex contacts can be pre-arranged via repeaters.

Each WIA member worked on either the 30 metre, 17 metre and 12 metre bands will count as two contacts for the award.

For the contact to be valid, it must include the WIA membership number of the WIA member involved, and the number must be logged.

This number can either be the one which appears on the WIA membership certificate, or the six-digit number on the address label of the WIA journal, Amateur Radio magazine, sent each month to WIA members.

To claim the award, a log extract must be submitted that includes the callsigns and membership numbers of the required number of WIA member contacts.

The cost is \$A5.00 for claimants in VK, P29, ZL and Oceania. All others submit \$US5.00, or eight IRCs. (This is the only current award for which WIA members are being charged a fee.)

Endorsements are being given for "first in Canada", "first in New York" and other countries and call areas, as well as for bands and modes.

Worked All States (Australia) Award

Contacts must be made on the VHF/UHF bands, 6 m and above. One QSL from each VK area, 1-8 inclusive, making a total of eight verifications. Endorsements for various bands and modes are available.

The same rules apply irrespective of whether the applicant is a VK or overseas amateur.

VHF Century Club Award

Issued to any VK or overseas amateur who has proof of contacts with 100 different stations on the VHF bands, at least seventy of which must be VKs. Contacts must be made on or after June 1, 1948.

Crossband and mixed mode contacts are not eligible, nor are ones via terrestrial repeat-

ers. QSOs involving mobile and portable stations are eligible, providing operators of such stations make all claimed QSOs from the same call area.

If an applicant moves to another call area, new contacts must be made from within a radius of 240 km of the previous location to qualify; otherwise a separate application must be made claiming only contacts made from the new QTH.

Worked All VK Call Areas (VHF) Award

Requires 22 QSOs on VHF bands as follows: one each from VK0, VK1, VK8 and VK9; three each from VK2, VK3, VK4, VK5, VK6 and VK7.

Contacts must have been made after January 1, 1988, and rules regarding crossband, mixed mode, repeater, portable, mobile, etc, operations cited above in previous award rules apply.

In addition to the above federal WIA awards, there are scores of other awards offered by VK divisions, zones, clubs and special interest groups. These will be listed briefly in the next and following issues of AR.

New awards are constantly being launched by VK clubs and groups. These are reported regularly in the Awards Column in AR, along with news of new awards available from overseas amateur societies and groups and changes in the rules of the more popular existing overseas awards.

(To be continued in later issues.) ar

A Call to all Holders of a Novice Licence

Now you have joined the ranks of amateur radio, why not extend your activities?

The Wireless Institute of Australia (N.S.W. Division) conducts a Bridging Correspondence Course for the AOCB and LAOCB Examinations.

Throughout the Course, your papers are checked and commented upon to lead you to a successful conclusion.

For further details write to:

The Course Supervisor
WIA
PO Box 1066
Parramatta NSW 2124
(109 Wigram Street, Parramatta)
Phone: (02) 689 2417

**11am to 2pm Monday to Friday
7 to 9pm Wednesday**

REPEATERS

WILL MCGHIE VK6UU
21 WATERLOO CRESCENT LESMURDIE 6076

For years I have wanted someone to write a short column in Amateur Radio reflecting Repeater development and planning throughout Australia, but apart for a brief column written a few years ago by Ken Jewell and Peter Mill, Amateur Radio magazine has largely contained no such comment. Well, if AR will have me I am going to give it a go! I expect writing a regular column every month will be an arduous task, because to be successful it must be a long term commitment. Being involved with Repeaters for almost 20 years however I can see a lot to write about. Such a column could be the focus for communications between all Amateurs involved with Repeaters be they builders or users.

As Technical Officer for The West Australian Repeater Group input from other members within the Repeater Group would be sought along with comment from all Amateurs all round Australia. Packet Radio is a very powerful tool for input to a Repeater column and should be addressed to VK6UU@VK6BBS. Even though my main interest is in Voice Repeaters, Digital Repeaters will also be included. My phone number is (09) 291 7165.

Strong support for FTAC and the WIA in Repeater co-ordination would be my intention. This is not to say that there won't be a difference of opinion from time to time. FTAC do an enormous job, often in a vacuum of input from Amateurs. Maybe this column can provide some of that input.

Linking

Repeater Linking is the biggest change to Repeaters for many years. The technical means of achieving innovative linking must not be stifled by regulations that are insensitive to a developing technology. It is not an easy task to formulate regulations that must look into the future, but the importance of this futuristic outlook is crucial.

Off Air Linking

Using one of the Repeaters to be linked as one end of the link between the two (or more) Repeaters, must be an option available to Repeater builders. To identify this means of linking the term OFF AIR LINKING has been coined. It may not be the best term, perhaps Direct Linking would be better, but the concept and versatility is important to understand. Several different types of OFF AIR LINKING are possible. The example to follow is the most versatile and the method most used by linked systems in operation at the moment. When cross band linking two Re-

peaters, placing a Transceiver at only one end of the link so it receives and transmits to the distant Repeater on its normal input-output frequency has many advantages. It is economical in terms of spectrum usage, cost and complexity. The most important of all these factors is complexity. One of the Repeater sites requires no extra equipment at all. An extra antenna, coax run, equipment space and power supply are not always possible on sites that are shared with other services. At the time of writing, OFF AIR LINKING is to be prohibited. The thinking on this option must be reversed. When planning a new Repeater system, simplicity is your number one aim, otherwise the project can be killed because the workload is too great. OFF AIR LINKING does not suit all types of linking situations such as in band linking, but it must be reconsidered.

The recent fine applied to the West Australian Repeater Group for operating a cross-band 70cm to 2m repeater, even though DOTC license such systems in VK4, leaves you to wonder what is fundamentally wrong? After much pondering of this planning nightmare, the only conclusion I have come to is that the problem is with us, the Amateurs. We must find a better crystal ball when formulating regulations. The present regulations on repeater linking were formulated by Amateurs and by-and-large rubber stamped by DOTC. The problem is these regulations contravene the principle code of practice for the Amateur service, that is to be innovative. As charged by DOTC our 70cm to 2m link contravenes the regulations in 3 ways.

1. Link frequency is not on its licensed frequency.
2. Repeaters are cross linked contrary to licensing policy.
3. Retransmitting linked station identification contrary to licensing policy.

Number 2 is strange and must be a mistake by DOTC.

Number 1 is correct as the link is achieved by off air linking, and the sooner this becomes an option the better. The DOTC Officers I have spoken to see no problem with off air linking, particularly as it is spectrum efficient.

Number 3 is also correct as the system does not notch out the ident, but what is the problem? At times we seem to design systems for the lowest common denominator. Surely more than one ident on a repeater is not too much to handle.

The time has come to design repeater regulations that are farsighted. The Amateur at the bottom of this bureaucratic mess is the designer and builder, who often understands

the problems and solutions better than the rule makers but! and it is a big but, the bottom line is we the repeater designers and builders are to blame! It is no good blaming the WIA or DOTC. They do a very difficult job with at times little outside help. The WIA office-bearers are a group of dedicated Amateurs who have the prime responsibility of administration combined with providing a focus for discussion. When it comes to writing guidelines, input from those concerned, and someone to actually write the guidelines is required.

Be aware of how the system works because this is very important. Comments like "We don't get on too well with the local WIA division so we miss out on information" is no answer. Our communication lines must be drastically improved. A national repeater organization within the WIA must come about. Even a position of repeater co-ordinator filled by someone who knows repeaters would be a great step forward.

It does seem to me that the innovative amongst us are penalized by unnecessary restrictions, and all in a time when we are told that deregulation is the word.

Repeater Idents

Why are there Idents on Repeaters? Is it a DOTC requirement or a WIA requirement? From a repeater builder's point of view they just add a complication and an extra expense. A lot of a Repeater's control circuit is there not only to generate the Ident, but also to provide the correct timing and logic interface.

If the DOTC see Idents on Repeaters as necessary for identifying interference problems, I would like to know how often Idents help. To my knowledge, in VK6 the Ident on a Repeater has never contributed to solving interference problems. Identification is by the Amateur operators using call signs.

Don't get me wrong, Idents on Repeaters have a place. The point is it should be up to the Amateurs themselves to decide if they wish to personalize their Repeater. Situations such as two Repeaters on the same frequency that are often received due to enhanced conditions is one reason for having Idents.

Idents On Links

If Idents are to remain, and Idents are not to be retransmitted on Repeater link systems, this creates a complication on how to remove the Ident. Yes it can be done. One such way is with an audio notch filter. The point is: does it matter if Idents are retransmitted so that on a Repeater that is linked, you simply hear two Idents? These regulations have considerable effect on Repeater builders. Someone has to design and build all this circuitry.

The WIA is currently examining the question of Idents on Repeaters and link systems. My point is — leave it up to the Amateurs to decide if an Ident is required. ar

POUNDING BRASS

GILBERT GRIFFITH VK3CQ
7 CHURCH STREET BRIGHT 3741

Last month I mentioned a book called "MORSE CODE — The Essential Language" by L Peter Carron Jr, who subsequently wrote to me to say that he is planning a new edition this year. About the new book he says, "The first three chapters will remain essentially the same. Chapter 4, "Learning to Receive and Send," will be expanded to include additional methods of learning, with expanded exercises. More Morse characters will be added to make a very comprehensive list of characters (even though all will not be in the learning exercises). Chapter 5, "High Speed Operation", will include a brief discussion on a modern computer/transceiver interface unit. These were just in their infancy when the book was first written. Chapter 7, "The Future", will be changed to "Advances in Morse Technology". It will include non-technical discussions on narrow IF and audio filters and advances in other modern day Morse equipment. A new chapter will be added on good CW operating practices and an extensive "Compendium of CW-Related Articles" will be included. Also, quite a few foreign versions of the Morse code will be listed. The appendix will include many updates and will be expanded to list new organizations and new computer code teaching aids. There will be a new "Author's Note" section that will discuss the long-standing code/no-code debate and the recent filing by the ARRL of a petition with the FCC for a no-code license. In short, the book will have many changes and additions. I'm very excited about it. The current edition just went over 8000 in sales, which isn't bad for a book on a subject that's supposed to be "dead".

News From GB/ Europe

TONY SMITH G4FAI

"FOC, the First Class CW Operators' Club, has now joined the EUCW (European CW Association). All major UK and European CW clubs are now members of the association which exists to encourage and promote amateur CW operating. Nervous beginners to CW are reminded that the FISTS (?) Morse Club operates a "phone-a-sked" service for the benefit of all amateurs, not just members of the club. Those about to go on the air for the first time can obtain sympathetic help from an experienced operator who will gently steer them through their first QSO on the key. A list of these operators, with their telephone numbers, is available..."

This seems such a good idea to me that I hope to set up a similar system here in Aus-

tralia. If you wish to help other budding Morsiacs on the air please write and tell me your name, call and phone. I will set up a database, probably regionally based, and then anybody can simply send me a SAE for a print-out of possible contacts for help.

Tony also reminded me about an article in the Autumn edition of *Morsum Magnificat*; "Kitchen Table — Home Made Key" by Barrie E Brokensha, ZS6AJY. I won't print the entire article because I am not sure of the copyright but using a piece of hacksaw blade, some curtain track, perspex and self-tappers, Barrie has made large quantities of these keys with appropriate audio oscillators for his pupils learning the code. The sharp point of the self-tapper has proven a reliable contact in place of normal silver or gold. Students sit around a table and make contact with each other using their sets, with all speaking prohibited. Barrie has promised them that when they are proud holders of their tickets and call signs, he will substitute the audio oscillator with a QRP RF oscillator, plug in a simple dipole antenna and let them loose on the bands!

The following letter comes from

GARETH DAVEY, VK2ANF

"About 10 years ago I was working as a technician at OTC's Coast Radio Station at La Perouse (VIS), and under test was a new Philips SITOR unit for radiotelex contact with ships. (Back then, AMTOR was just a gleam in Syd VK2SG's eye.) Anyway tests were conducted on a variety of HF duplex frequencies, and it was not uncommon to have our shore-based receive frequencies jammed while working a ship. I don't know why they were jammed; perhaps someone out there didn't recognise the new-fangled SITOR signals and thought they were doing everyone a favour by interfering with them, or maybe they just wanted the test to fail. The Coast Station operators always blamed it on "the Russians". Russians or not, the jamming created a lot of problems for those 1st-generation SITOR signals, and it always fascinated me that Mr Philips included a switch on his unit marked TOR-CW, with a jack for a morse key on the back. One day while I passed by the SITOR console, one of the seasoned Coast Station operators was having a conversation with the morse key on the SITOR equipment. I had had an amateur licence for a few years and thought I could pick out signals from the mud, but no matter how hard I tried all I could hear on the speaker was a very loud, broad-spectrum jamming signal. This operator though could actually read CW through the interference, and was discussing with his shipboard

counterpart what frequencies they would go to to try again: an absolutely amazing demonstration of CW's maximisation of power/Hz, and the brain's ability as a bandpass filter."

By now many of you will have heard on the grape vine that we will have a new trophy for the Novice winner of the Novice Contest CW section each year. I have collected some donations toward the trophy which amount to \$100, and the WIA is going to put something toward the total so that the yearly interest will pay for a new trophy for each winner. Thanks to those who made donations, and to Bill Roper and the executive for their support of the code. The name of the trophy? "The Clive Burns Memorial".

If you wish to make a donation, please send it to Bill Roper at the federal office of the WIA. (Don't forget to tell him what it's for.)

Some months ago, George Craggs, VK2AYG, sent me his Morse learning kit for a squiz. I would have liked to follow his advice and try it on six raw beginners, but here in the sticks it was hard to find one! I listened to the tapes and read the instructions and made an effort to try it on one of my kids, who are all interested, but have trouble finding the time, (as usual). The kit consists of four cassettes and an instruction/check book (not cheque), and is excellent if you have a slight knowledge of the code, or perhaps if you have not used the code for a number of years since getting your ticket. However for learning the letters you have to drill yourself from the printed page.

George's system has an advantage in that you are not required to write anything down, but I think actually learning the code from a more basic cassette is a required first step. If you think differently, or want to re-learn your forgotten code, have a go at this kit, it is extremely good for practice as well. George's address is 56 Oatley Park Ave, Oatley, NSW 2223. Write and let me know how you get on.

73 for this month.

ar

Have you advised the
WIA
Executive
office
of your new
callsign?

Use the form on
the reverse of the Amateur
Radio address flysheet.

AMSAT

MAURIE HOOPER VK5EA
11 RICHLAND ROAD NEWTON 5074

New JARL Satellite JAS-1b

Harry Yoneda JA1ANG advises the JAS-1b Launch Window to be 01 Feb 90 0125-0200 utc.

JAS-1b was built at the same time as Fuji-Oscar-12 as a backup, and has the same communications configuration. However there are some significant differences, which should allow it to provide a more reliable service than its predecessor.

Gallium Arsenide solar cells have been fitted, and since these have a much higher energy conversion efficiency to the silicon cells used on FO-12, the spacecraft will have about 11 watts of power generating capability at the start of its life. It is expected that with this capacity the CPU and memory will be able to run continuously, even with an eclipse rate of 33 per cent.

JAS-1b will be placed into a much different orbit to FO-12. It will be launched with OS-1b which is a Maritime Observation Satellite and is expected to be inserted into a sun-synchronous orbit with an inclination of 99 degrees and a period of 103 minutes (altitude 900 km). However, this orbit is eclipsed for 33 per cent of each orbit and consideration is being given to obtaining a more favourable period by raising the apogee of JAS-1b by about 300 km. This could be achieved by

National Co-ordinator
Graham Ratchiff VK5AGR

Information Nets

AMSAT Australia
Control: VK5AGR
Amateur check in: 0945 UTC Sunday
Bulletin commences: 1000 UTC
Primary frequency: 3.685 MHz
Secondary frequency: 7.064 MHz

AMSAT SW Pacific

2200 UTC Saturday, 14.282 MHz
Participating stations and listeners are able to obtain basic orbital data including Keplerian elements from the AMSAT Australia net. This information is also included on some WIA Divisional Broadcasts.

AMSAT Australia Newsletter & Computer Software

The excellent AMSAT Australia Newsletter is published monthly by Graham VK5AGR on behalf of AMSAT Australia and now has about 270 subscribers. Should you also wish to subscribe, send a cheque for \$20 payable to AMSAT Australia addressed as follows:

AMSAT Australia, GPO Box 2141, Adelaide 5001.

The Newsletter provides the latest news items on all satellite activities and is a "must" for all those seriously interested in amateur satellites. Graham also provides a Software Service in respect to general satellite programs made available to him from various sources. To make use of this service, send Graham a blank formatted disk and a nominal donation of \$10 per item to AMSAT Australia together with sufficient funds to cover return postage. To obtain details of the programs available and other AMSAT Australia services send a SASE to Graham.

Further Note On InstantTrack

Omitted from the notes given in the last issue, the author of the program Franklin Antonio N6NKF has "donated" it to AMSAT, so that all income from it goes towards future amateur satellites. In the case of copies distributed by AMSAT-Australia, 50 per cent is forwarded to AMSAT and the remainder retained by the VK organisation.

ZRO Tests Via OSCAR 13

The ZRO Memorial Technical Achievement Award Program (ZRO test) has been reactivated in the last few months. Since the time schedules so far do not favour VK operators, please contact Graham VK5AGR if you wish to participate, so that he can negotiate with the organisers for a suitable time-slot.

This activity is a test of operating skill and equipment performance. During a typical ZRO run, a control station will send numeric code groups using CW at 10 wpm. At the beginning of the run, uplink power is set to match the general beacon downlink strength. This is level "zero". The control operator will send and repeat a random 5-digit number, then lower his uplink power by 3 dB (half power) and repeat the procedure with a new random number. This will continue to a level 27 dB below the beacon (level 9). A participating listener monitors the downlink signals until he can no longer copy the numbers. For further details of this activity, Graham can provide a brochure issued by the organisers.

OSCAR 13 News

Proposed operating schedules:

	31 Jan 90 - 21 Feb 90	22 Feb 90 - 27 Mar 90	28 Mar 90 - 09 May 90
Mode B	MA 000 to 160	MA 000 to 020	MA 000 to 160
Off	nil	MA 020 to 090	nil
Mode B		MA 090 to 160	
Mode JL	MA 160 to 190	MA 160 to 190	MA 160 to 190
Mode S	MA 190 to 200	MA 190 to 200	MA 190 to 200
Mode B	MA 200 to 255	MA 200 to 255	MA 200 to 255
Omnis	MA 235 to 75	MA 235 to 090	MA 235 to 075

Proposed attitude changes:

22 Jan 90 to 210/2
07 May 90 to 180/3

Eclipses: 27 Feb 90 to 21 Mar 90 between MA 31 and 65 from 13 to 89 minutes

OSCAR 10 Attitude Prediction

JAMES MILLER G3RUH

Estimated attitude data for AMSAT OSCAR-10, extrapolated from last known attitude late 1986.

Date	Alon	Alat	Sa	Ill(%)	Slat	Slon
1989 Dec 10	41	-18	-19	95	-32	274
1990 Jan 7	38	-17	10	99	-45	305
1990 Feb 4	35	-15	38	79	-42	343
1990 Mar 4	32	-14	66	40	-27	10
1990 Apr 1	28	-12	84	11	-6	28
1990 Apr 29	25	-10	58	53	17	43
1990 May 27	21	-8	31	86	36	63

Please note that on OSCAR-10 the linear polarised OMNI antennas are in use and best signals are to be expected if the SQUINT angle is in the area of 90 degrees.

burning fuel remaining in the second stage of the H-1 launch vehicle after separation from MOS-1b. If this is achieved, the effect would be that about 150 days from launch the eclipse rate would drop so that from day 300 to 470 there would be no eclipses.

A further change from FO-12, is that the new satellite will use a ring type turnstile antenna for uplink receiving. This is expected to result in a more stable uplink signal received from ground stations. For transmitting, the digital and analogue systems will share the same antenna. This has resulted in the addition of a hybrid circuit (HYB) and phase shifters, instead of two antenna power dividers and two sets of transmitting antennas.

The specifications for JAS-1b and a schematic diagram are reproduced below.

73s from Maurie VK5EA

Specifications of JAS-1b

Launch And Orbit

1. Launch (scheduled)

Time: February 1990, day is not fixed

Launch vehicle: H-1 (2-stage) rocket

Launch site: Tanegashima Space Centre, National Space Development Agency of Japan NASDA)

2. Orbit (planned)

slightly elliptical polar orbit, with 900 km perigee

Period: 106 minutes

Inclination: 99 degrees

Satellite Specifications

1. Dimension

Size: 26-face polyhedron measuring 440 mm across and 470 mm in height

Weight: Approx. 50 kg

2. System configuration

Analog and digital transponder in mode J (uplink: 144 MHz, downlink: 430 MHz)

3. Attitude control

Satellite attitude will be maintained by using the torque generated by interaction of two permanent magnets with the earth's magnetic field.

4. Thermal control

Passive control using paint and thermal insulation.

5. Planned service life: 3 years

System Specifications

1. Beacon and telemetry

JA beacon: 435.795 MHz nominal frequency, ca. 100 mW power, CW or PSK*

JD telemetry: 435.91 MHz nominal frequency, ca. 1 W power, packet in PSK

*Also capable of AO transmission

2. Telemetry

Satellite Activity For September/October 1989

1. Launches

The following launching announcements have been received:-

Int'l Number	Satellite	Date	Nation	Period min	Apg km	Prg km	Inc deg
1989 -							
077A	USA 46	Sep 25	USA	1413.4	35791	35774	5.0
078A	MOLNIYA 1-76	Sep 27	USSR	11h42m	38960	650	62.8
079A	COSMOS 2046	Sep 27	USSR	92.8	431	412	65.0
080A INTER-							
	COSMOS 24	Sep 28	USSR	115.9	2492	505	82.6
080B	MAGION 2	Oct 03	Czech	115.90	2494	504	82.5
081A	GORIZONT 19	Sep 28	USSR	23h54m	35753		1.3
082A	COSMOS 2047	Oct 03	USSR	89.5	357	178	67.2
083A	COSMOS 2048	Oct 17	USSR	89.4	270	248	62.8
084A	STS 34	Oct 18	USA	90.5	323	295	34.3
084B	GALILEO	Oct 18	USA	Jupiter probe			
085A	USA 47	Oct 21	USA				

2. Returns

During the period seventy six objects decayed including the following satellites:-

1982-026A	COSMOS 1345	Sep 27
1982-121A	COSMOS 1427	Oct 05
1989-012A	COSMOS 2002	Oct 15
1989-075A	COSMOS 2044	Sep 29
1989-076A	COSMOS 2045	Oct 02
1989-084A	STS 34	Oct 23

3. Notes

1989-075A COSMOS 2044 with two monkeys and other objects landed 165km south of the town of Kustanay, USSR, on September 29 1989.

1989-084B GALILEO was deployed from the orbiting STS 34 on October 18 1989.

Satellite Activity For October/November 1989

1. Launches

The following launching announcements have been received:-

Int'l Number	Satellite	Date	Nation	Period min	Apg km	Prg km	Inc deg
1989 -							
086A	METEOR 303	Oct 24	USSR	109.5	1228	1191	82.6
087A	INTELSAT 6A	Oct 27	ESA				
088A	COSMOS 2049	Nov 17	USSR				
089A	COBE	Nov 18	USA				
090A	STS 33	Nov 23	USA				

2. Returns

During the period seventy six objects decayed including the following satellites:-

1966-057A	COSMOS 122	Nov 14
1967-039A	COSMOS 156	Oct 23
1978-119A	COSMOS 1064	Nov 12
1985-050A	COSMOS 1662	Nov 16
1989-082A	COSMOS 2047	Nov 21
1989-083A	COSMOS 2048	Oct 26

BOB ARNOLD VK3ZBB

OSCAR-13 Schedule Schedule 01Feb90 to 10Mar90

Station: Adelaide

Hour - UTC

	0	1	2	3	4	5	6	7	8	9	10	11	12	13	14	15	16	17	18	19	20	21	22	23
01Feb							bb														bbbbbbbbbb			
02Feb						bbb															bbbbbbbbbb	BBBBBB		
03Feb						bb															bbbbbbbbbb	BBBBBB		
04Feb					b	bb															bbbbbbbbbb	BBBBBB		
05Feb																					bbbbbbbbbb	BBBBBB		
06Feb																					bbbbbbbbbb	BBBBBB	LL	
07Feb																					bbbbbbbbbb	BBBBBB	LL	
08Feb																					bbbbbbbbbb	BBBBBB	LL	
09Feb										bbb														
10Feb										bb													bbb	
11Feb								bb															bbbbbb	
12Feb								bbb															bbbbbb	
13Feb								bb															bbbbbb	
14Feb								bbb															bbbbbb	
15Feb								bb															bbbbbb	
16Feb																							bbbbbb	
17Feb																							bbbbbb	
18Feb																							bbbbbb	
19Feb																							bbbbbb	
20Feb										bbb														
21Feb										bb													bbb	
22Feb																							bb	
23Feb																							bb	
24Feb																							bb	
25Feb																							bb	
26Feb																							bb	
27Feb																							bb	
28Feb																							bb	
01Mar																							bb	
02Mar																							bb	
03Mar																							bb	
04Mar																							bb	
05Mar																							bb	
06Mar																							bb	
07Mar																							bb	
08Mar																							bb	
09Mar																							bb	
10Mar																							bb	

- CW telemetry: 12 analog data items
33 status items
- PSK telemetry: 29 analog data items
33 status items
- 3. Commands: Equipped with real-time program command function.

4. Transponder
Frequencies and modes (see the table below) are similar to those of FO-12. The analog system (JA) consists of an inverted heterodyne transponder, with a band width of 100 kHz operating with a mode J, of uplink 145 MHz and downlink 435 MHz.
The digital system (JD) functions as a mailbox using the AX.25, link level protocol. Stations currently using FO-12 will be able to use JAS-1b without any modifications to equipment.

- (1) Analog system transponder inversely heterodyned linear translator, Uplink pass-band: 145.9 to 146.0 MHz
Downlink pass-band: 435.9 to 435.8 MHz
Transmitter output: Approx. 1W PEP
Bandwidth: 100 kHz (3 dB bandwidth)
Uplink EIRP required: About 100 W
- (2) Digital system transponder
Store- and-forward packet communication, using AX.25 link level protocol, version 2.
Uplink frequencies:
145.85 MHz, 145.87 MHz, 145.89 MHz, 145.91 MHz

Bi-phase Manchester code, on FM signal, with a bit rate of 1200 bps.
Uplink EIRP required: About 100 W
Downlink: 435.91 MHz/NRZL/PSK, 1200 bps.
Transmitter output: About 1 W

- 5. Antennas
144 MHz receiving antenna (R-ANT): Ring turnstile antenna mounted at bottom of side panels.
435 MHz transmitting antenna (T-ANT): turnstile antenna mounted at the top of satellite (shared by analog and digital modes)

	polarization	gain
R-ANT:	circular	+0.5 dBi max.
T-ANT:	circular	+4 dBi max.

- 6. Power supply
 - (1) Solar cells (planned)
Cell: Gallium arsenide
Size and quantity: 2x2 sq-cm and 1x2 sq-cm, over 1300 cells.
Power output: More than 10 W, (BOL)
 - (2) Battery
Cell type and quantity: 11 series-connected NiCd cells (rectangular)
Capacity: 6 AH
 - (3) Voltage converter
Bus voltage: +11 to 18 V (14 V average)
Regulated voltages: +10 V, +5 V, -5 V
Efficiency: Better than 70%
 - (4) Power control functions
Bus voltage upper limit control (full-shunt), and UVC function to disconnect load when batter terminal voltage drops.

The above specifications were provided by courtesy of JARL. ar

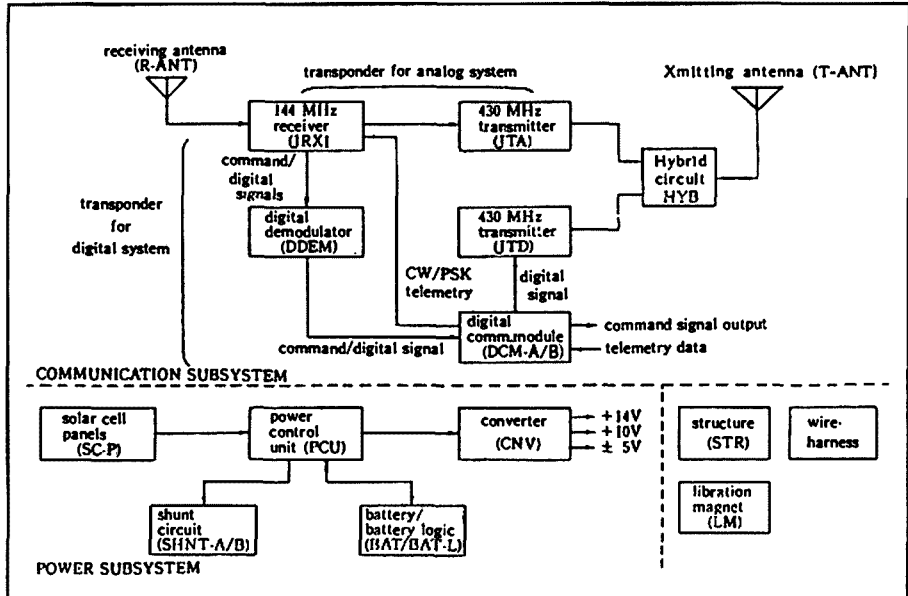

Block diagram of JAS-1b

Remember to leave a three second break between overs when using a repeater

Support the WIA in order to protect amateur radio frequencies at WARC 92.

SPOTLIGHT ON SWLING

ROBIN L HARWOOD VK7RH

52 CONNAUGHT CRES WEST LAUNCESTON 7250

Activity on HF became rather hectic in the third and fourth week of December, when two significant international events, suddenly erupted. The first one was the US invasion of Panama, in an attempt to capture military strongman, Manuel Noriega, and take him back to the States to answer drug-smuggling indictments. Relations between the US and the Panamanian military sharply deteriorated, following Noriega's annulment of the presidential election results last year, when his candidate was soundly trounced.

Noriega's thugs began harassing the substantial American population, who are mainly engaged in work around the Panama Canal Zone. There was also a sizeable US military contingent to protect the strategic gateway between the Pacific and Atlantic Oceans. The Americans acted swiftly and took most by surprise. The USAF frequencies of 8993 and 11179 kHz were carrying heavy traffic after the invasion commenced, as the transport aircraft ferried extra troops into Panama.

There are no external HF broadcasters in Panama, so I had to mainly rely on VOA and other international stations to catch up with events there. The major maritime station in Panama City — HPP did continue operating on 13.075 on ARQ, but went QRT two or three days after the invasion. The VOA in Washington came up unexpectedly in Spanish at about

the same time as the launching of the invasion, to explain why the US had intervened.

But it was the tragic events in Romania which pushed the Panamanian crisis into the background until after Christmas. The first inkling I had was a report on Radio Deutsche Welle of a massacre in a Romanian city I never knew existed, that alerted me to keep my ears tuned to news coming from the Balkans. Radio Bucharest has provided good signals to the Pacific at 0645 UTC on 15335 kHz for some time now, and I kept monitoring it. The programme output has been reflective of the personality cult that surrounded Nicolai Ceausescu and extremely boring. Yet when the revolution erupted violently, there was a swift, dramatic turn in the tone of the broadcasts. On Saturday December 22nd, the normal English output was suddenly replaced with multi-lingual appeals for help to put down resistance from the secret police. It was on a very poor-quality audio feed reflecting the uncertain situation at the time.

Several European broadcasters extended their Romanian language programming to cater for the need of listeners within that nation, as well as in the Moldavian Republic of the USSR (Moldavian and Romanian are the same language) to be kept informed of the momentous happening in Bucharest and Timisoara. The BBC came up on 15115 kHz on the

22nd at 1230 at 30 minutes notice.

Then, on the 26th of December, came the English report about the execution of Ceausescu and his wife. The tone had changed in four days from praising him to the skies, to denouncing his as a tyrant equal to Hitler. Incidentally, I have yet to receive confirmation of my report to R Bucharest in the middle of last year. I guess now with the substantial alterations within Romania, that a fresh report on signals and programming at present would be advisable.

Looking at the last quarter of 1989 in retrospect, we were witnesses to an epoch ending and a new dawn emerging as the artificial division of western and eastern Europe disintegrated. First, it was Radio Polonia, then Radio Berlin International, Radio Prague and finally Bucharest. All have altered their programming to accommodate the changed political climate. Also the World Service of Radio Moscow has brought details of the changes within the USSR over the same period. All these alterations have breathed fresh air into international radio.

I would advise that you keep an ear to the Baltic area and to the Nordic countries, for there could be significant developments over the next six months. Also, the central region of Latin America is likely to be the next flashpoint, with scheduled elections this month in Nicaragua. Managua has been heard in English floating around 6 MHz exactly around 0500 UTC. Well, that is all for February. Next month, I hope to be reviewing the 1990 World Radio TV Handbook. Until then, the very best of listening and 73. ar

Prefix Changes

New prefixes are being used by some radio amateurs operating from within the USSR.

Estonia (UR) can use ES, Latvia (UQ) has been heard under YL, and Lithuania (UP) may now use LY.

ar

DON'T BUY STOLEN EQUIPMENT

CHECK THE SERIAL NUMBER AGAINST THE WIA STOLEN EQUIPMENT REGISTER FIRST.

ALARA

JOY COLLIS VK2EBX
PO Box 22 YEOVAL 2868

This year, for the first time, a DX-YL is winner of the ALARA Contest. Congratulations to Aimee FK8FA for a great achievement. Congratulations also to the runner-up Bev VK6DE, and not least of all to our Florence McKenzie Trophy winner, Marjorie VK2VME.

Our thanks to all who participated and helped to make the 1989 Contest so enjoyable.

At the time of writing Marilyn VK3DMS is very busy preparing certificates for those who have won them. These will be despatched as soon as possible.

ALARAMEET September 1990

With the holiday period behind us and most kids back at school (to the relief of their mums, who can now actually enjoy a quiet "cuppa") 1990 is well under way. Certainly not too soon to start planning for the ALARAMEET in Dubbo on September 29/30th. Or-

ganisation for this event is well in hand, and it promises to be a very enjoyable weekend. If you are considering joining us drop Maria VK5BMT a line for details.

BYLARA

BYLARA have a new Secretary, Sandie G1LXM and Newsletter Editor Kay GOKTC. They are interested in receiving any news items from overseas YLs for inclusion in the Newsletter.

BYLARA Contest

This will be held on:
Thursday 22nd February, 1900 to 2200 UTC and Saturday 24th February, 1000 to 1300 UTC.

Reminder: YL-OM Contest

Phone: 10.2.90 — 1400 UTC to 12.2.90 — 0200 UTC.
CW: 24.2.90 — 1400 UTC to 26.2.90 — 0200 UTC.

Alara Contest November 1989 Results

No	Callsign	Name	Points	Certificate
1	FK8FA	Aimee	964	Top overall & FK ALARA member.
2	VK6DE	Bev	705	Top Phone, VK ALARA member & VK6 ALARA member.
3	VK3CYL	Kim	682	VK3 ALARA member.
4	VK3KS	Mavis	673	
5	KB5HTH	Sue	371	USA non-member.
6	VE7YL	Elizabeth	339	VE ALARA member.
7	G4EZI	Diana	315	G ALARA member.
8	VK2EBX	Joy	262	VK2 ALARA member.
9	WA3HUP	Mary Ann	240	USA member.
10	VK6YF	Poppy	237	
	VK3DYL	Gwen	237	Tied Score.
11	VK7HD	Helene	231	VK7 ALARA member.
12	VK3DML	Margaret	222	
13	WB3CN	Ruthanna	154	
14	VK5BMT	Maria	152	VK5 ALARA member.
15	VK5CTY	Christine	149	
16	VK5YL	Denise	140	
17	DJ6US	Walli	131	European ALARA member.
18	VK4AOE	Margaret	129	VK4 ALARA member.
19	VK3DVT	Valda	119	
20	VK2VME	Marjorie	116	Top Novice YL, VK Notice & Florence McKenzie Trophy.
21	VK3XF	Les	112	VK — OM.
22	ZL1BIZ	Elva	107	ZL ALARA member.
23	VK5ANW	Jenny	106	
24	VK4VR	Val	104	
25	G0EIX	Rita	97	
26	ZM2AGX	Dawn	96	
27	DF2SL	Anny	90	
28	L40018	Charles	84	Top SWL.
29	G4RFR	Jo	62	G non-member.
30	VK7RY	Edgar	54	
31	VK3DYF	Bron	43	
32	YU7LF	San	28	European OM.
33	ZS2AA	Iris	25	ZS Non-member.
	VK3ALD	Len	25	Tied Score
Check logs received from:				
	VK3XB	Ivor.		
	VK3DMS	Marilyn.		

CLUB CORNER

MEG BOX VK5AOV SECRETARY
BOX 401 BLACKWOOD 5051

On Saturday 25 November, 1989, the Adelaide Hills Amateur Radio Society conducted the first amateur radio examinations to be held by a body other than the Department of Transport and Communications.

The following examinations were taken

- 6 Full Theory
- 3 Novice Theory
- 3 Regs
- 2 Receiving at 10 wpm
- 2 Receiving at 5 wpm
- 1 Sending at 10 wpm
- 1 Sending at 5 wpm

The club wishes to congratulate the 2 persons who gained their full theory — the only successful candidates on this occasion.

These examinations were authorised for trial purposes under the new syllabus, which is not "official" until 21st February, 1990, and the Department will not issue a certificate or licence before that date.

Examinations Officer, Marshall Emm, reports that he was pleased with the way the examinations went and at this stage proposes that the next examination will be held on the first Saturday in March, 1990. Application forms may be obtained from the Secretary, AHARS Inc, Box 401 Blackwood 5051 and should be returned no later than 2 weeks before the examination date. The fee is \$10 for non-members (no matter how many exams sat for on the day), and free for members. Note: Membership of AHARS is \$10 pa at present.

Monty Nell And VK2JQ Remembered

D S THOMPSON VK2BDT

Members of Goulburn Amateur Radio Society were delighted when advice was received from the Department of Transport and Communications that they had been authorised to use the call sign VK2JQ for their Club station. The call sign is of great significance as it was the one used by the late Monty Nell who was the Patron of the Society for many years before he became a "silent key" in mid 1989. The Society thought that it would be a fitting manner in which to preserve the memory of Monty and his contribution to the hobby of "ham radio".

Monty Nell was a very keen amateur operator, he was first licenced in the early 1920's, when his call sign was OA2JQ, Australian "hams" later had VK as the prefix to their call signs denoting that they were Australian stations. VK2JQ has been held continuously

Here And There

Nancy VK2NPG and OM Dale, currently touring Australia, attended the VK5 Division Christmas Party while in Adelaide. They were late arriving due to car trouble, but had a great time once they finally arrived.

Val VK4VR represented ALARA at the Gold Coast Hamfest late last year.

Errata from last month's ALARA News: Clarrie VK3UE has been an amateur radio operator for 41 years, and Joyce VK2MI for 42 years, not 40.

Until next month,
73/33.

ar

Help
stamp out stolen
equipment -

Always include
the serial number
of your equipment
in your Hamad

elled in more than 100 countries and worked amateurs throughout the entire world. The date of this QSL was November 1967 when the country was still called Dahomey. It resulted from a QSO by the late Alex Swinton, VK2AAK (VK3AAP) whose widow, Mona, VK3BRE kindly donated Alex's QSLs to the collection. The QTH of the Dahomey station was Cotonou. This city, situated only about twenty kilometres from the capital, is the country's largest and also its chief port.

TYØLC

The special prefix TY0 is a comparatively new one. This QSL dated May 1988, resulted from a QSO between DX-er Jim Smith VK9NS (on Norfolk Is) and Jean-Louis Pipien. It is an especial, assigned call since the suffix LC stands for "Lions Club". The Lions International was holding at this time their VIIth Congress under the patronage of the President of the Republic. Their thanks to both the President and the Beninese authorities are expressed (in French) on the front of the QSL card. French (the country's official language) is almost the only European language spoken these days, English being quite uncommon. Even today, the country is very dependent upon the investment of French capital into the economy.

TY9ER

This QSL also resulted from a DXpedition, this time by Ed Richmond W4MGN. The station situated also in Cotonou, was on the air from 10-13 July 1980. Ed mentions that the pile-ups were horrendous and we can appreciate the reason why. Over 2000 contacts were made on 10, 15, and 20 metres during that short period. The QSL recipient was another top DXer, Barry VK5BS whilst operating mobile in Queensland.

If you like to play a part in building up the WIA QSL collection and to save something for the future, would you please send a half-dozen (more if you can spare them) QSLs which you feel would really help the collection along.

All cards are appreciated, but we especially need commemorative QSLs, special event stations QSLs, especially assigned call QSLs (eg VK4RAN), pre-war QSLs, unusual prefixes, rare DX and pictorial QSLs of not so common countries. Could you help? Send to PO Box 1, Seville 3199, or phone (059) 643721 for card pick-up or consignment arrangements for large quantities of cards.

Thanks

The WIA would like to thank the following for the kind donation of QSL cards (Supplementary List):

Vic VK5AGX	Arthur VK3VQ
Frank VK2QL	Bruce VK3BM
Jim VK9NS	Jack VK3JA

Greetings from **BENIN** ZONE 35
AFRICA



TY9ER

DX-PEDITION

QSO WITH <i>VK5BS/MOE/VK4</i>	DATE JULY 13 1980	GMT 0740	MHz. 14	RST 53	2-WAY SSB
----------------------------------	----------------------	-------------	------------	-----------	--------------



Guest Operator:
ED RICHMOND, W4MGN

QSL Manager for this operation only:
BOB SCHENCK, N200
P. O. BOX 345
TUCKERTON, NEW JERSEY 08087, USA

Regular QSL Manager — DLBDC

QSL assistance by



Bob Schenck
(verified by)

"Ike" VK3OW Stan VK3TE
Also the South African Radio League (SARL)

Congratulations

The Wireless Institute of Australia congratulates well-known DX-er Robin Lyon, VK6LK of Margaret River, WA as the winner of the 1989 DX QSL Contributors' competition. We feel he deserves this praise since he has remained at the top of the list for most of 1989 with some very generous (and rare) QSL contributions. Robin is to be awarded a suitable inscribed memento by the WIA in appreciation of his find effort.

DX QSL Contributors' ladder

(See "Amateur Radio" March 1989, page 55 for details.)

As stated in the December issue of "Amateur Radio", we have started a "new" ladder from Jan 1990. Those top DXers Jim Smith, VK9NS and Frank VK2QL have shot to the front of the field in no mean way with truly excellent QSLs. Despite the fact that it is becoming rather difficult to add to the WIA's prefixes, Jim sent in no fewer than 31 prefixes from quite rare DX spots together with 48 recently-issued Stateside prefixes that were new to the collection. It was a very fine effort. Old Timer, Frank VK2QL not only supplied some excellent prefixes, but also a few countries new to the collection including the rare (now deleted) country, Ifni.

Contributions

From Jim VK9NS:- AZ4F (Argentina) AZ5ZA (South Orkneys) FH4 (Mayotte) FJ (Saint Martin) FP5, FR5, FS9, FW4, S92 (St

Tome), WH8, V3, TY0, J39, J37, J27 (Djoubouti), IY4, I04, HT5, NH4 (Midway), RD7, 4V2 (Haiti), 3G87PAX (Chile), RX4, P36, (Cyprus), 8P9, 802, 6W6, 6V6, 6V2 (Senegal) 6F2 (Mexico) 5T0, together with no fewer than 48 newly-issued (one letter suffix) Stateside call signs.

From Frank, VK2QL:- Geysler Reef, Ifni and Bouvet Island (LH4C) JX2, 9V0, NG0, KF3AB (Fletcher Ice Island), KG61, PJ6, PZ3, YR4, YQ4, UY4, WS3SKY (Skylab), SW0, XL1, WI6ITU, 4C5 (Mexico), 4U2ITU, XE4, KL6ITU, 8SM0, XJ2, Special Calls include: LZ5A, N6V, 8J1ITU, 8J1AD (Antarctica), R0C, U0Y, 3Z50PZK, 4N2BR, YU7LAA, HB1KU/HE, W05ITU.

From Bruce, VK3BM:- YN8, 4A0, 3C8, HC3, CW0, Special Calls: I1IIC, DL0WU, WS0SUB/0 (Submarine Call).

From Vic; VK5AGX:- NR1, WG8, NC8, Special Calls: JA7RL (JARL), GB75LOA.

Present State Of The Ladder

Jim	VK9NS	158 points
Frank	VK2QL	149
Ray	VK3RF	24
Bruce	VK3BM	13
Barry	VK5BS	10
Vic	VK5AGX	8

This must be regarded as a pretty good effort when one considers that the WIA Collection must be one of the largest collection of prefixes in the world. It is no easy task to add to it.

Please do not forget that information on QSLs, DXpeditions and the like is available upon request from the curator. Also photostat copies of both pre-war and modern QSLs are available free of charge to any writer on the history of amateur radio. ar

In the January 1990 issue, Murphy decided that it was time to give Ken Matchett VK3TL some attention — by eliminating the entire illustrations from his QSL article! (Which, believe it or not, survived three proof-reading sessions!) Our apologies to Ken. The missing illustrations are shown below.

**ITALIAN STATION
IN
SOMALILAND**

MS4A

To Radio VK3QK
QSO on 10-5-49
SS No Phone
R 5 88

Tx 80 w input
Dipola antenna
10 Tubes receiver

Many tnx for 1b QSO
cheerio 73's
Fabrizio & Adriana

Tnx
RSE QSL DIRECT - Caramelli Alula Somaliland

**ITALIAN SOMALILAND
AMATEUR RADIO STATION**

I 5 A A W
(ex - I A A W)

TO BERS-195 RST ON 24/1/56 AT 1535 GMT
M41 TNX QSL BEST 73 CUAGN *Carlo*

GRA: CARLO BORTOLONI P.B. 85 MOGADISCIO
QTH: BENDER BEILA (50° 50' E 9° 30' N)

RX 3C312 M TX 3C6ICE 600 INPUT

EDUCATION NOTES

**BRENDA EDMONDS VK3KT FEDERAL EDUCATION CO-ORDINATOR
PO Box 565 Mt WAVERLEY 3149**

Information about the exam generation system is starting to accumulate. Papers produced using the program have been successfully used as actual examinations in VK5. A few people have passed on comments on the papers produced on a trial basis, and I have used the program to generate two papers from each bank. I would appreciate any more comments or information as it becomes available. Unless anyone feels strongly against sharing their findings, I will try to pass on information as it reaches me.

The generation program at present does not seem to me to be the complete answer. (I do not think it was intended to be.) It is obvious that each paper will require some degree of editing. The diagrams are not included on the disc, so will have to be patched in. More importantly, some questions may have to be replaced either because one may inadvertently answer the other, or because there are too many from a particular subsection. No formula seems to have been applied to decide the spread of questions from within any particular section, so the distribution reflects the number of questions on each topic in the bank. As I have said before, it will be to our advantage if we can produce extra questions to be added to the bank to even out this distribution.

I have not yet had a chance to try the editing on the computer. It should not be difficult to replace an existing question with one from the bank, or to make minor alterations to a question. I hope it is also possible to

alter the order of the questions, as at present each paper is produced with the questions in the order in which they occur in the bank. I think re-arrangement might have to be done manually.

I do not recommend trying to produce papers in a hurry. I have not yet tried to measure the time it will take to produce a satisfactory paper. It will depend to some

extent on the operator's skill of course, but each Theory paper I ran took about 12 pages of printing without any spaces for diagrams. At a very rough estimate, I would expect to spend an hour reading a paper and deciding modifications needed, (there are a few typographical errors which will need to be amended), up to an hour making the modifications, and another hour putting in diagrams and photocopying.

The exams this month will be "the end of an era". For the last time I can wish a large group of candidates luck and success. Remember, **READ THE QUESTION, and ALL the answers.** I look forward to hearing you on air in the future. ar

Morseword No 35

Solution on page 61

Across

- 1 Namely
- 2 Headgear
- 3 Brand of computer
- 4 Close tightly
- 5 Picture
- 6 Chant
- 7 Cabbage
- 8 Begin
- 9 Agreements
- 10 Performance

Down

- 1 Shakespearian king
- 2 Comforts
- 3 Admonish
- 4 A small drink
- 5 Suits
- 6 Carried
- 7 Arid
- 8 Abbot
- 9 Succeeds
- 10 Sprinkle

	1	2	3	4	5	6	7	8	9	10
1										
2										
3										
4										
5										
6										
7										
8										
9										
10										

Audrey Ryan © 1989

DIVISIONAL NOTES

VK2 NOTES

TIM MILLS VK2ZTM

Newcastle Earthquake

Just before 10.30 on Thursday 28th December, much of VK2 felt the shake. Much of Newcastle, in particular the Central Business District and surrounding suburbs bore the worst of it. Large areas lost power or had it turned off, and most communications went out. Within a few minutes the local Amateurs were activated. Links out of the area were established. Within a couple of days additional personnel were brought in from outside the Newcastle region to relieve the locals as well as provide additional facilities. The Amateur operation was maintained for almost a week.

A more detailed report will appear in later issues of "Amateur Radio", but at this stage thanks must go to the Amateurs and WICEN personnel who were involved.

1990 Annual General Meeting

It is getting round to that time again for the annual election of Council and the Annual General Meeting. Reports should be submitted to the Secretary by mid February, and those interested in serving on Council should obtain a nomination form for the office.

Field Days

You are reminded that the Central Coast ARC field day will be held at the Gosford Showground on Sunday 18th February. Details of the program may be heard on the Divisional broadcasts. Please note there is no morning broadcast on the 18th. Instead it will be held on Saturday evening the 17th. The Sunday evening will be held as usual.

The Urunga Convention will be held over the Easter weekend in April, and details should appear in Club Corner in a future issue. The Oxley Region Field Day is over the long weekend in June.

Joint Meeting

A joint meeting of the Presidents of VK2, 3 and 4 was held in Sydney in the break between Christmas and New Year. Many subjects were covered and it is hoped that they may become a regular feature. While there are the inter Divisional meetings at the Federal level, the discussions are more often

national rather than State matters.

Club Members should be aware of proposed changes in regional representation via the affiliated club structure. If not, ask to see the recent QST postings if a copy has not been included in your local club newsletter.

Divisional Office Fax

A dedicated line has been installed for the fax in the office. (02) 633 1525. It is on line at all times. Why not use it for general inquiries, broadcast items, bookshop inquiries etc.

ATV Meeting

You may have noted the report from the Sydney ATV Group in last months "AR". There are a lot of pockets of ATV interest in VK2. Several groups have had repeater licences, including, Taree, Newcastle, Central Coast, Gladesville, Sydney and Wagga. It has been suggested that a meeting be convened for all interested parties to get together and discuss and plan future activities, including the best utilization of available frequencies. An error in the callbook left out details of most of the ATV repeaters which may lead some to think there is little or no VK2 activity. This meeting is expected during February.

February Exam

The best of luck and good wishes to all who will be sitting the last DOTC exam on February the 20th. After that date all (except certain special) exams will be conducted by the Amateur Radio Service. For details within VK2 contact Terry VK2UX, the Divisional Education Officer, via the office for details of groups conducting exams or to tell him if your group will be conducting them.

Technical Tapes

Before each Sunday broadcast there is a quarter hour technical segment. Requests are received from time to time for copies or transcripts. Copies of the tapes are available if requested through the office. There is a small charge to cover tape and delivery costs. While on the subject of technical matters? or how not to use 3 pin plugs and sockets for extra low voltage, there is a 2 pin system made by the various companies in the electrical field. It is the "T" plug, designed for "extra low voltage". Many of you will know it and several use them. The question I wish to put to you is the following. "What is the correct or preferred polarity to wire it?" There is no standard set

out as far as I am aware, but because there are two ways (or is it more?) of wiring it up, there are often problems of reversed polarities, which has about the same effect on a rig as 240, if there is no reverse polarity protection. So which of the layouts below is the preferred or more common? Written replies to "Plug Polarity" PO Box 1066 Parramatta NSW 2124.

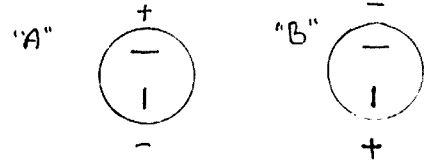

New Members

The December intake of new members was the largest for some time and a warm welcome is extended to all:

R W Allsopp	Assoc	Balgowah
D S Bird	Assoc	Terry Hills
M J Blackmore	VK2XOF	Baulkham Hills
G R Brice	VK2GRB	Thornleigh
W F Brittain	Assoc	Wahroonga
S J Burgess	Assoc	Cherrybrook
G Cotterell	Assoc	Gordon
G R Dalglish	Assoc	Picton
G B Dent	Assoc	Tamworth
T Floro	Assoc	Macquarie Centre
C H Gibbons	VK2MHR	Austinmer
J A Green	VK2PJJ	Bray Park
P J Hollis-Watts	VK2YJW	Raymond Terrace
R Harrison	VK2ZTB	Balmain
A K Hore	VK2TQB	Goonellabah
E Horman	VK2KEL	Auburn
S J Jacobs	Assoc	Narrabeen
W R Knowles	VK2DJE	Gulburra Beach
L H Kocken	Assoc	Castle Hill
A Luckman	Assoc	Ryde
R J McKosker	VK2DOT	Niagara Park
R P Obra	Assoc	Parramatta
C Pradier	Assoc	Albury
W Rannard	VK2YKZ	Georges Hall
R Raven	Assoc	Tathra
C E Rowell	Assoc	Cremorne
A Runiewicz	Assoc	Auburn
S Scott	VK2FUB	Morisset Park
L Seidl	Assoc	Carlton
B B Singh	Assoc	Herbersham
R K Sommerville	VK2URK	Woodburn
J D Stewart	VK2MHU	Wagga Wagga
N J Stewart	VK2GS	Lindfield
D M Stocks	VK2ZDS	Toongabbie
J Szowski	VK2XJJ	Kingswood
S Szybowski	VK2KEU	St Marys
J Wallace	Assoc	Caringbah
M J Walton	Assoc	Hornsby
O Zacovich	VK2DKR	Tempe

ar

VK2 WICEN NEWS

MORTON WILLIAMS VK2DEX

Bungonia Exercise

WICEN (NSW) Inc wishes to advise that the simulated cave rescue exercise for 1990, will be held as usual at the Bungonia caves on the second weekend in March, which, this year, is the 10 — 11 March.

Wicen's primary role in this exercise is to provide a safety net during the simulated cave rescue operations.

All meals are provided for a modest cost to operators to provide an enjoyable weekend, free from camp cooking.

If you are interested, contact Morton Williams, VK2DEX QTHR, or on the Sydney Wicen net on Thursday nights at 2100 local time on channel 7150 or 8275, before 1st March, as numbers must be known by then for catering purposes. ar

VK3 NOTES

JIM LINTON VK3PC

VK3BWI Weekly Broadcast

The aim of the broadcast, which starts at 10.30am each Sunday, (see WIA directory page 3 for frequencies) is to inform listeners of events, happenings and issues affecting our hobby. It has hundreds of regular listeners and is one of the media used by the WIA Victorian Division to communicate with its members. The broadcast has news items, editorial comment, reports of events and issues. Regular listeners will be aware it also has occasional items of a controversial nature, and a sprinkling of humour, trivia, and amusement.

The forward looking broadcast team late last year gave thought to how the broadcast could be improved on its already successful format. Two new segments were chosen and expected to begin this month. The first is a report on Amateur Television activity to be supplied by Melbourne ATVer Doug White VK3BOW. The other innovation for the broadcast is plain-language ionospheric predictions which will be of use to the casual or ardent user of the amateur HF bands.

Reference Library

After considerable effort, the Division's library has now been placed in new bookshelves. It is not a borrowing library, but

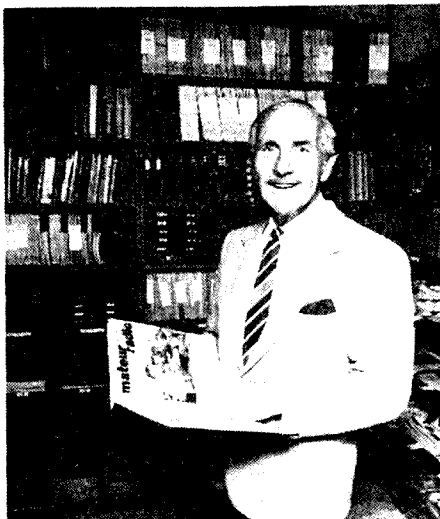

Amidst the neat bookshelves in the WIA Vic Div reference library is Ken Matchett VK3TL showing obvious and deserved pride in re-establishing the library.

exists as a reference library and membership service.

Among the periodicals held by the library is a complete set of Amateur Radio magazine from 1933. Other magazines include QST from 1926, CQ from 1950, RSGB Radio Communication, Electronics Australia (formerly Radio and Hobbies), 73 Magazine, Amateur Radio Action, Wireless World, Ham Radio, and NZART Break In. Also held is an incomplete set of ARRL Handbooks over the past 60 years, and the RSGB Handbooks. Those wishing to trace old callsigns will find the callbook collection a help. Several historical textbooks — Admiralty Handbooks, and Yearbooks of Wireless Telegraphy — give a glimpse into the early days of wireless. Members are most welcome to use the library for research, and a photocopying service is available at a nominal charge. The WIA Victorian Division Council expresses its appreciation to Ken Matchett VK3TL for his efforts in re-establishing the library. ar

5/8 WAVE

JENNIFER WARRINGTON VK5ANW

Last month, you may remember, I gave you some of the history of VK5WI and the Sunday morning Broadcasts, 40 metres in particular. I suppose that it goes without saying that without volunteers there would be no Sunday morning Broadcasts. Chris VK5PN who coordinates the volunteers roster informs me that things are getting pretty desperate on some frequencies. On 20m in particular, there could be some weeks when there is no relay, simply because of the lack of volunteers. If we could get 4 operators on each frequency each would only have to do it once a month — is

that such a great hardship? I believe that Jack VK5AHI has been a great help this year helping out on various HF bands, when needed.

6m (53.1 AM) has just lost two of its long time stalwarts. Lance VK5ZBC has done 165 relays since he started in 1981; and I don't know how many Andrew VK5AAS has done, but I know that he also has been doing it for many years. Our grateful thanks go to both of you for all the time and effort you have put in. I understand that we have one replacement on that band, our thanks to Bob VK5KZZ who has volunteered.

10m is looking "healthier" than it has for sometime thanks to Reg VK5RR who has volunteered to help VK5s UH, AH, and BAR. You might remember that last month I mentioned that Reg VK5RR was doing the Sunday morning B/Cast in March 1947! (Perhaps this will give some other former operators the incentive to return.)

Perhaps you would prefer to put on the originating Broadcasts from the BGB. There are currently six operators who do this, but as Clarry VK5KL said on the 160m report this year, some of the are not as young as they were and it would be nice to get some "new blood" on the team. 80m would also like to see some new faces but if you would like to volunteer for ANY band, please let Chris VK5PN or a member of Council know — you will be welcomed with open arms!

To those volunteers who are already doing a great job, there isn't room to mention you all, but we thank you sincerely none-the-less.

One volunteer who always seems to be there when help is needed is John VK5NX. Here are just a few of the jobs John does. He is a B/Cast Relay Operator on 80m, he is one of our Auctioneers at Buy and Sell nights, and he is "Technician in Charge" of the radios and tape recorder for the broadcasts, in the transmitter room. For many years John has organised the drinks for the Picnic and Christmas Social, and has helped organise the races for the kids etc. Four times a year he makes sure that we receive the ICS Award at the right time, and has at times been Guest Speaker, and Judge of homebrew gear when we have needed one. This doesn't include his time on Council when he was Treasurer for several years.

John will be retiring later this year, so he may not always be around when we need him, with this in mind, we felt that it was a good time to say "thank you" to John by awarding him the ICS Award at the December meeting. Thanks John, it's not going to be easy to fill your shoes!

Diary Dates

Feb 27th Ian Hunt VK5QX will speak on "Mobile Installations"

16 - 18 March Clubs' Convention at Ridgehaven Primary School. (Hopefully by now we have all your Agenda Items and names of delegates!) ar

VK6 NOTES

JOHN HOWLETT VK6ATA

Club Conference has been arranged by the Peel AR group and is destined to take place on the 17th February at a site some 30 km South of Mandurah. It has been a few years since the last meeting and should be an interesting weekend. Some WIA council members will attend so get ready with suggestions and questions you always wanted to ask.

Equipment Bank is being set up as a service to all WIA members and will come on stream soon. A secure cabinet has been built by Doug VK6ASM at NCRG Club shack, and is being stocked up with common pieces of test gear to start the project moving. Equipment can be borrowed before and after the Sunday morning news relay, or at NCRG Club meeting held on the 2nd and 4th Tuesday of each month. Commencement of the service will be announced on the news broadcast and represents another tangible reason to renew your WIA membership and support those who support you.

Intruder Watch Graham VK6RO recently became WA Co-ordinator and deserves our congratulations but even more, Graham needs information on intruders. A cassette tape is available to help you identify the many strange sounds heard on the bands, some of which are not intruders but amateur computer driven modes. Learn the difference and expand your knowledge of the hobby. SWLs are most welcome, contact Graham on (09) 451 3561 for the full story.

Under 21 Club: rumour has it that a net is being organised by some of the younger operators and sounds like a great idea. We look forward to more news on this in the near future.

New Year Resolution: why not try a new aspect of the hobby this year? Perhaps fox hunting, send some CW, join 10-10, work towards DXCC or chase an award. Learn about packet, AMTOR or Satellite Communications. Work a contest, build a kit or homebrew a project. Above all, be active on air and occupy the valuable air space we all take for granted. 73.

Notice of AGM

It is hereby notified that the Annual General Meeting of the Western Australian Division of the Wireless Institute of Australia will be held on the 17th April 1990 following the General Meeting which commences at 8pm. The Meeting will be held at the Westrail Centre, East Perth.

Agenda

1. Consideration of the Council's Annual Report
2. Consideration of the Financial Report

3. Consideration of other Reports
4. Election of Office Bearers, viz. President and Vice President of the Division and seven other Councillors.
5. Election of two Auditors.
6. Appointment of a Patron
7. General Business which has been duly notified.

Notices of motion for the AGM must be received by the Secretary not less than 42 days prior to the meeting and must be signed by at least three members.

Nomination of a candidate for election to Council must be received by the Secretary in writing not less than 42 days prior to the meeting with an intimation that such candidates are willing to act. A candidate may submit a statement not exceeding two hundred words outlining his or her case for election and experience. Each nomination shall be signed by two members proposing the candidate. Candidates must possess a current amateur licence.

Proxies

Any financial member entitled to vote may appoint a proxy, who must also be a financial member entitled to vote, to speak and vote on his/her behalf. Each such proxy must be in the hands of the Secretary prior to the meeting and be in the following form:-

I a member of the Institute hereby appoint also a member of the Institute to act for me as my proxy and in my name to do all things which I myself being present could do at the meeting of the Institute held on

Signed

Witness

Date ar

VK7 AGM

J A ROGERS VK7JK

The Annual General Meeting of the Tasmanian Division of the Wireless Institute of Australia will take place on March 24th 1990 at a venue to be notified later on the Divisional Broadcast. In order to ensure circulation of Notices of Motion to all members, these must be in the hands of the Divisional Secretary at PO Box 1010, Launceston, 7250 by the 9th February, 1990. Nomination Forms for Council must be submitted to the same address by the 3rd March.

Both Nominations and Notices of Motion must be in writing.

Proxy Forms should be in the hands of the Secretary prior to the commencement of the meeting.

Northern Branch Annual General Meeting is to be held on the 14th March 1990. The venue for this meeting is also to be advised later.

Nominations for Branch positions close the day before the meeting, ie the 13th March.

The Annual General Meeting of the Southern Branch of the Tasmanian Division of the Wireless Institute of Australia will take place on the first Wednesday in February — that is, the 7th at 105, Newtown Road, Hobart at 8.15 pm.

The Annual General Meeting of the North Western Branch of the Tasmanian Division of the Wireless Institute of Australia will be held on 13th February.

The venue will be the Penguin Hotel and the time, 7.30 pm. ar

INTRUDER WATCH

GORDON LOVEDAY VK4KAL FEDERAL INTRUDER WATCH CO-ORDINATOR
AVIEMORE RUBYVALE 4702

So to the second instalment of the Monitoring Lessons...

All modulated or keyed signals occupy a finite bandwidth, some choice is offered in designating the frequency of emission. In some cases the choice is obvious, in others it is more arbitrary. Reference should be made to the following table to ensure uniformity in Monitoring System reports. I will take the most encountered signals first...

1. NON Measure freq @ zero beat in CW or SSB mode.
2. PON Measure Centre frequency of the Emission.
3. A1A Zero beat in CW or SSB Mode.
4. A2A Zero beat of Carrier in CW or SSB Mode.
5. F1B Centre freq of Emission ie half between the zero beat of the two Carriers.
6. F7B Centre freq of 4 carriers, sounds like 2 equally strong

RTTY signals close together.

7. J3E Resolution frequency of the modulation.

These modes are featured on the monitoring service tape available from your National Co-ord at NO charge — a C60 cassette is sufficient. Many other modes will be included on the tape. More modes will be described next month, with explanations. It is not appropriate to dictate absolute standards here, because the equipment in use by monitoring stations varies. Recommendation 7 (D) of an IARU Region 1 Div Conference states "For frequency measurement made solely to investigate the occupancy of frequency channels, the permissible error as applied to exclusive Amateur Bands be +/-210Hz @ 7 MHz; +/-420Hz @ 14MHz +/-630HZ @ 21MHz & +/-840HZ @ 28MHZ". These remarks should be kept in mind when making frequency measurements. Extracts used are by permission of IARU monitoring system. ar

SILENT KEYS

We regret to announce the recent passing of:

Mr J F Magee	VK1FM
Mr E H Cox	VK1GU
Mr A T W Griffiths	VK2FO
Mr P C Smith	VK2DNE
Mr A D Costello	VK3YT
Mrs J L Sutherland	VK3NLO
Mr Jonathan Marshall	VK3KPQ
Mr I C Truelove	VK8AP

Jonathan Marshall VK3KPQ

Jonathan (19) was driving home on Thursday 7th December, when his car left the Hume Highway and struck a tree. He had been playing his part over the previous four days with WICEN providing communications for the Great Victorian Bike Ride.

Jonathan was a likeable, enthusiastic teenager whose love of amateur radio was contagious; it was part of his life. Over the last few years he did his best to enthuse other youngsters with his involvement in the Jam-boree On The Air.

He was conscientious and honourable; once he had committed himself he could be depended upon, and he was generous to a fault with both his time and equipment.

Last year Jonathan spent a year in Israel on a scholarship for leadership training. Since his return he has been deeply involved in helping to bring the best out in other young people, as well as continuing with his studies.

We grieve with his mother, father and two sisters, and all those who knew him, at his most untimely death.

ALAN WEEKS, VK3CAW

VK3SCM, MALVERN DISTRICT SCOUTS

REPEATERS

- ADDITIONS,
- DELETIONS,
- ALTERATIONS.

HAVE YOU ADVISED
THE WIA OF
CHANGES NEEDED
TO THE REPEATER LIST?

OVER TO YOU

ALL LETTERS FROM MEMBERS WILL BE CONSIDERED FOR PUBLICATION AND SHOULD BE LESS THAN 200 WORDS.

THE WIA ACCEPTS NO RESPONSIBILITY FOR OPINIONS EXPRESSED BY CORRESPONDENTS.

Membership In The "Nineties" "To Be or Not To Be ..."

I have read with interest and some degree of consternation over the past twelve months or so, the various letters concerning the continuing increase in the cost of WIA membership.

I had no intention of taking part in the discussion, but the introduction of the WIA 80 Competition, "I am a member of the WIA because", has prompted me to consider and evaluate my own reasons for being a WIA member. All too often writers have taken a negative stance, being "concerned" with the cost while high-lighting how few benefits are available to them. Very rarely do these writers contribute anything worthwhile and any positive aspects seem to be deliberately overlooked.

The only negative aspect I wish to bring forward is to comment on how pathetic the afore-said arguments are when held up to honest scrutiny. Even the current cost of \$65 is really miniscule when compared with the benefits available to members. I say available because they are there, whether or not we need to use them. \$65 equals \$1.25 per week! Peanuts, surely! Most of those who criticize the fees and who are smokers or drinkers will gladly spend \$20 per week on their habit but to ask for \$1.25 to protect and improve their hobby is "daylight robbery". What hypocrites!

The stark reality of the situation is that one cannot expect 1990's services and benefits at 1970's prices! After all, the same standard of car which cost me \$4000 in 1975 now costs \$25000! So because cars are now so costly will I give them up and walk? Of course not!

And for any amateur who has anything from \$1000 to \$10000 worth of equipment in his shack and who can't honestly afford \$1.25 per week to be a WIA member, I'm sorry to say, it is time for him or her to sell up and take up picking up sea shells for a hobby.

On a more positive note, I, personally, would like to see WIA membership fees as an automatic part of annual licence fees. Thus every licensed amateur would be a WIA member. All would enjoy the many benefits, assistance and protection, legal and otherwise, necessary in this time of over-zealous Councils and regulating bodies. With such a system and the subsequent increase in membership numbers, the per member cost would be

significantly reduced, possibly to the \$40 area. This, plus the annual licence fee could still be below \$65, our magical \$1.25 per week, a sum which, to my mind, is readily affordable by anyone. I fully appreciate the possible complications of this idea but I am sure that such complications are not insurmountable. Such a system would produce a stronger liaison with DOTC and a much healthier radio communications system overall.

To "Amateur Radio" readers, this epistle may well be wasted as most are already WIA members. Maybe these points could be conveyed to all those amateurs who are not as yet members. I hope that common decency, the Aussie spirit of a "fair go", and the manly (person-ly?) trait of shouldering one's responsibilities will see a huge increase in membership and genuine sharing of the load into the 1990's.

In conclusion, it will be very apparent that WIA membership means enough to me to put apathy aside and take up my pen in support of an excellent organization, the sole concern of which is the protection and improvement of the marvellous hobby which we all hold so dear.

DONALD A THORNLEY VK5NOD

MEMBERSHIP NO 232394

14 ANTHONY STREET MOUNT GAMBIER
5290

Packet Comment

I read with interest the contribution by Peter Broughton in the December issue of Amateur Radio, "An Introduction to Packet Radio". The Packet Radio mode is increasingly popular with amateurs both in Australia and overseas. Australian amateurs are well versed in the latest technology and in some cases advancing it. So it is appropriate that more information should be published to keep amateurs informed as to the latest developments.

However I would like to make one comment on Peter's article. He says that an IBM compatible computer is essential to use the system "to present day standards". That is not strictly correct. If he is referring to the fact that Yapp software will only run on an IBM compatible, I can tell your readers that an even more advanced program — GEEPAK Ver 1.30- will do all that the IBM compact/Yapp/TNC combination will do and more. It is designed to run with a Microbee disc-based computer including the "Computer in a Book"

and requires only a simple Beepak Modem to generate and demodulate the packet tones; it has dual port VHF/HF capability and all for less than half the cost of the IBM compact/YAPP/TNC set-up.

I agree with Peter that it is most desirable to join a user group to get a proper introduction to Packet and to keep in touch with all the latest developments. In this regard I would mention the Australian Amateur Packet Radio Association (AAPRA), an entirely voluntary association which has pioneered many of the Packet Radio developments in Australia. AAPRA introduced the popular C=PAK modems with software TNC-emulation for the Commodore family of PC's and the BEEPAK package for the Microbees. It is a convenient source of imported TNC's. Any surplus from these transactions is used to purchase equipment for supply...without cost...to Radio Clubs to establish digipeaters on strategic mountain tops and in metropolitan areas.

AAPRA has about 400 active members in all Australian states as well as oversea; it publishes an information sheet, DIGIPEAT, to keep members informed of the latest developments in packet radio world wide, including equipment mods. It does not operate any BBS or mailboxes — there are more than enough of those already — but in introducing data highways on UHF, and the ROSE networks, it will hopefully make life easier for the average packet operator.

So if you are interested in the broader picture and latest in Packet, contact AAPRA at the address below.

JOHN JEFFERYS VK2CFJ
HON SEC AAPRA
59 WESTBROOK AVE WAHROONGA
2076

CB, Amateur, "Ham" and PR

It was gratifying to note the quick response by the WIA and many amateurs to the erroneous statements made on a recent "Investigators" programme on ABC TV (7/11/89).

However, while the media and the general public still remain confused by the difference between Amateur Radio and Citizen's Band radio, may I offer the following considerations:-

As Amateur Radio operators we must first put our own house in order if we are to clear up this confusion.

This could be best done by more energetic publicity from the WIA through Divisions and Clubs to the individual amateur, explaining the differences between the two services to the media and the public.

Another point of confusion exists with the use of the ridiculous appellation, "HAM"!

Since very few of us wish to be classified as a "Lump of Pork" or a "Mug Actor", it should

be completely eradicated!

Likewise, "HAM Radio" sounds like a pig farmer's communication network!

A standard R/T voice procedure for amateurs has been in existence for many years. We should use it, NOT the "long winded" and often incorrect CB jargon. The "Q" code was intended for CW NOT phone; in any case some newcomers misuse it — QRX does NOT mean wait and the proword ROGER should be used instead of QSL (no thanks, I don't want a card!).

Clubs should appoint a publicity officer to keep the local media informed of the club's aims and activities, and this will assist in attracting new members.

When amateurs assist in civil emergency operations, these events must be publicised, BUT ONLY responsible WICEN officers should deal with the media and then in the form of press release statements which are NOT to be altered (blue pencils banned!).

As licensed radio operators we should operate our stations according to the Regulations and above all with a friendly and courteous regard for the rights of others.

TED GABRIEL VK4YG
PO Box 245 RAVENSHOE 4872

VCR TVI

I am experiencing a serious TVI problem concerning VCR's, and I wonder if a reader of AR may be able to help me.

The situation is as follows;

A. My transmitter has a maximum CW output of 100 watts. My antenna is a five-band trap vertical in ground-plane configuration. SWR no greater than 2:1 on bands on which I operate.

B. I cause no TVI whatsoever on any TV channel/Ham band combination, when receiving TV direct or when using my VCR as the TV tuner.

C. Nor do I create TVI problems when recording on the VCR (ie, the VCR recording is "clean").

D. However, when playing back any tape through the VCR I cause TVI at TX output levels as low as 5 to 10 watts. 10 metres is clear of the problem, but the situation worsens with TVI on 80 metres being the worst.

I have tried two low-pass filters in the TX coax with absolutely no reduction of the problem. (I did not believe it would anyway.) I have tried high-pass filters at the TV antenna input. Still no change. Also wrapping the TV coax several times through a large ferrite core achieved nothing. Neighbours' VCRs are also affected. I hope this is a common problem and someone out there has the cure. If so, please let me know the antidote.

RAY TURNER VK2COX
6/276 BUNNERONG RD
HILLSDALE 2036

Result Of Theft

In September I was unfortunate enough to have my rig and computer (Commodore 128D) stolen. I thus have a problem in that I have on disk all my contacts (about 250) and cannot access them.

If there is some kind person out there who owns a "128" and a printer, who would be willing to print out the list of contacts, I would be happy to pay the kind Samaritan or donate some 128 software and other goodies.

BOB ROSS-WILSON VK2FIT
111 JAMES ST LEICHHARDT 2040
PHONE 02 339 8111 (W)
02 550 0130 (H)

QSL Cards

In reply to Neil Penfold's letter in AR of Nov 1989, you are not the only one Neil, I have sent out cards direct with SAE and ample return postage and have had the cards returned via the buro or not at all.

I just don't collect cards to put them in a shoe box. If I need a card for a particular prefix, zone or country be it for WAZ, DXCC or some other award, whenever possible or convenient I ask if the station QSLs and if the answer is yes, I mail a card direct with SAE and return postage, and that in some cases is the last I hear or see of it.

It is becoming very obvious that some stations are only interested in green stamps and IRCs and once received the card and SAE finish up in the WPB. I chased zone 23 for nine years and finally worked 3 stations. I was lucky to receive a card back from a young lad (17 years old) who was working the club station (JT1KAA) after 4 months, the other 2 have been outstanding for 9 months now (just as well I did not hold my breath) and still not received. One had IRCs and a green stamp for return postage.

There are several Russian states as well as a few others where QSLing is a big disappointment. So much for the well used phrase of 100% QSL. Also a kingsize brickbat to operators who take between 9 and 12 months to send their logs to their managers.

I won't worry about going for awards any more and I will still QSL but it will be on RECEIPT only unless it is for a DXpedition or a new country, and by the way I too am a little pistol.

BILL VOGEL VK5NVW
16 WANDILLA STREET LARGS NORTH
5016

VNG Replies . . .

DH Watkins VK2DDR (AR Jan 1990, page 60) said that he has not seen a single benefit detailed which supports the reintroduction of VNG. In my VNG update, I did outline the sort of people who use VNG, but maybe I

should go through the exercise again.

First however, let's examine its worth in true government fashion by counting the number of contributors who were prepared to dip into their own pockets to resuscitate VNG and to keep it running. Since the VNG Users Consortium came into being in late February 1988, a total of seventy different contributors (organisations, clubs, societies and private individuals) have given the sum of \$12586 altogether. They include a number of radio amateurs and short wave listeners, and I don't think I need to spell out the use to these groups of standard frequency and time signal services!

Another very important use of VNG is in earthquake seismology. Over 40 seismographs (earthquake recorders) in Australia rely on it to keep their clocks accurately on time so that we can determine the locations of earthquakes. The recent Newcastle earthquake demonstrates to eastern Australians the relevance of this occupation. Western Australians have already had two towns wrecked by earthquakes. We need earthquake assessments so that we can build safer buildings. The assessments must be based on good data.

Astronomers are also major users of VNG

for timing occultations and for telescope pointing calculations. About 80 Australian amateur astronomers use it for their unpaid work which contributes to international science.

Other users include some radio stations, surveyors, navigators, geophysicists studying the earth's magnetic field, and electric power networks.

AUSLIG informs me that \$12000 has also been pledged or contributed to it since its letter went out last June.

By the way, it is also relevant that VNG only broadcasts for nine out of 24 hours on 10 and 15 MHz. This gives people a clear run of 15 hours each day to glean whatever information they want from WWV/WWVH.

**MARION LEIBA (DR) VK1VNG,
VK1KNG
HONORARY SECRETARY
VNG USERS CONSORTIUM**

2m Intruders In SE Asia

Re Ian Berwick's (VK3ALZ) item in "Over to You" in Dec AR, I wish to point out the

following. Having been to Indonesia 5 times in the last 15 months, I have observed that the use of Icom 2 metre hand helds by all types of authorities, including the Police is prolific. Literally millions of 2 metre hand helds are in use there by non-amateurs.

As for HF, they use any frequency they like, especially the international amateur bands. South East Asia is and always will be South East Asia, and despite assurances by their governments, they will do nothing about it. I'm afraid, old man, we are going to have to live with the interference, and there is nothing we can do about it. As for use of 2 metre hand helds, I'm sure we can say it won't affect us, but what about 10 million hand helds on 2 m jamming the satellites? When I was in Singapore once, many shops had literally hundreds of Icom IC2A hand helds, selling them as walkie talkies to parents for use by their kids.

I think Intruder Watch has a problem as big as someone trying to stop the waves in the ocean.

**BARRY MCNEIL VK2FP
3 BELLA VISTA ST
HEATHCOTE 2233**

HF PREDICTIONS

**ROGER HARRISON VK2ZTB
THE APOGEE GROUP**

Welcome to AR's new HF Predictions column! I trust readers find the information presented here not only useful, but interesting, too.

For ease of use and to accommodate space restrictions in the magazine, I have provided predictions applicable for three major regions of Australia:

VK EAST. Covers the major part of NSW and Queensland.

VK SOUTH. Covers southern-NSW, VK3, VK5 and VK7.

VK WEST. Covers the south-west of West Australia.

For each of these regions I have selected six "terminals" to major continental regions of the world, or regions of particular interest, such as Australian Antarctica (VK ANTARTIC). From time to time, I will include predictions to cover particular DXpeditions or other activities of special interest. This month, as there is to be a DXpedition to Bouvet Island in the south Atlantic during the early part of the month, I have included predictions for Bouvet.

Feedback from readers and users would be most appreciated - let me know what you feel is wrong, and what's right, about the paths,

presentation or any other aspect.

THE CHARTS

These charts are different from those you see published elsewhere, and arguably more useful to the amateur fraternity as they give, effectively, the predicted signal/noise ratio for each hour and for selected bands.

The charts are organised in 24 rows, one for each hour UTC (first column on the left). Don't forget to add the appropriate number of hours for your time zone, including daylight saving where it applies. The next column give the MUF (maximum usable frequency) for each hour, followed by the field strength at the MUF, in decibels referred to 1 uV/metre (dBu). The column marked FOT gives the "optimum" frequency - the most reliable frequency for the path.

Then come five columns, one for each of five selected HF bands.

The numbers in the column represent predicted field strength at each hour in decibels referred to 1 uV/metre. Here it represents "raw" signal to noise ratio as urban noise levels are typically 1-2 uV/metre, but does not take into account the advantage offered by particular transmission modes. The results are based on a transmitter power of

**This space could
be earning you money!**

**Advertising rates
available from
PO Box 300
Caulfield South 3162.**

100 W output, the use of modest 3-element beams or similar, and for "median" conditions. Where the results fall below -40 dB, no output is printed.

Enhanced conditions may improve S/N ratios by 9-15 dB. The use of CW or digital transmission modes show better results than SSB. If you've got 400 W output, you get a 6 dB improvements. Where conditions warrant it, I have deleted 28.5 MHz predictions and included 10.1 MHz. In general, providing predictions for the bands below 10 MHz is futile during this part of the solar cycle, except perhaps where DXpeditions are concerned.

The Bouvet Island predictions are different, being based on dipole antenna systems and they cover the bands scheduled to be activated. The predictions are calculated using a program known as "FTZ", for IBMs and compatibles, distributed by FT Promotions. (02) 818-4838.

Please turn over for charts.

HAMADS

TRADE ADS

SATFAX: weather satellite picture receiving program for IBM XT/AT. Displays in 64 colours. Needs EGA colour monitor & card, AM demodulator & ADC interface. \$45 + \$3 postage ***
RADFAX2: HF weather fax, morse & RTTY receiving program for IBM XT/AT. Needs CGA, SSBHF, FSK/Tone decoder. Also "RF2HERC" & "RF2EGA", same as RADFAX2 but suitable for Hercules & EGA cards respectively. \$35 + \$3 postage *** All programs are on 5.25", 360k floppy + full documentation. ONLY from M.Delahanty, 42 Villiers St. New Farm 4005 QLD. Ph (07) 358 2785

AMIDON FERROMAGNETIC CORES: For all receiver and transmitter applications. Send large SASE for data and price to RJ & US Imports, Box 157, Mortdale NSW 2223. (No enquires at office please...11 Macken St. (Oatley). Agencies at: Geoff Wood Electronics, Lane Cove; Webb Electronics, Albury; Electronic Components ACT; Truscott Electronics Vic; Willis Trading Co WA; Associated TV Service Hobart.

FOR SALE — NSW

AS NEW 15m-10m yagi \$100. DAIWA ATU 500W pep 1.9-28 MHz \$50. Tel (02) 661 3129 (H) (02) 389 5199 (B).

ICOM ICPS-15 power supply \$300 spectrum analyzer PT-EI TECHNICAL MATERIAL CORP & master oscillator + 2 tone generator \$400 + freight. (02) 918 3835.

HEWLETT PACKARD UHF sig. gen. 3.8-7.6 GHz (uses klystron) \$200. MUIRHEAD facsimile recorder and transmitter K4OID, K4OOD models \$150 each. PAL RGB video to 35mm film converter \$300 VK2FHF QTHR.

YAESU FT102 desk mike and manual. FT7 hand mike power supply mobile bracket all vgc. Ring Keith VK2PPI QTHR (02) 85 3716.

EMTRON EAT-300 antenna tuner. Like new, never used. \$190 also ICOM R71A communications receiver, excellent condition like new, \$930. Kirt VK2DOJ (02) 436 2618.

REDUCTION SALE. Includes TEN-TEC transceivers 580 DELTA 509 ARGONAUT TRIO-KENWOOD R599S RX T599D TX vibroplex keyer antenna traps etc. Write for list VK2AKE QTHR (048) 71 2113.

BRAND NEW 2001D portable SONY world range receiver with instruction book. AM150 KHZ to 30MHz CW & SSB FM 76 to 108 MHz air band 116 to 138 MHz. VK2AXR AI in Sydney. PH (02) 477 6275.

TS520S exc. cond. \$500 TH3JR ant. \$150, KR-400 rotator \$150, CWR 610 Codemaster & B & W monitor \$200. VK2BAC QTHR Fred, (047) 29 0677 evenings.

KENWOOD TS120V vgc with manual, original packing \$450. SONY 8mm video camera model CCD-AU200 vgc with acc \$1,000. Peter VK2PSW (060) 21 8177 (B/H)

FOR SALE — VIC

KENWOOD TS120S \$500. TEN TEC ARGONAUT 509 TCVR \$350 both in good order with mics and handbooks also 2el 15metre beam \$45. Mike VK3KTO (03) 557 5475.

YAESU FC102 antenna coupler with pep/rms power and SWR meters, A&B input and outputs, WARC bands, good condition \$300 ono, Geoff VK3DMN (054) 72 1455.

ALL HF BANDS VERTICAL 1.8-30 MHz CTW includes 12 meters aluminium 40 mil tube brand new \$180 ono Ted VK3TG (052) 59 3225.

YAESU FL2100Z, as new condition, with pair of matched brand new 572Bs, both ex HENRY RADIO. Also included is spare 572B still in carton, never used. \$1300, firm. Roth VK3BG (03) 725 3550.

YAESU FRG-8800 RXVR 150 KHZ to 30 MHz has FRV-8800 extends 118-174 MHz also preamp and ant. tuners \$875. VK3DSP (059) 85 2170.

KENWOOD TH-45A 70cm hand-held FM txvr with Nicad batt & charger new, boxed \$400. Helmut VK3CHN QTHR (03) 744 2064 AH (03) 339 5532 BH.

PR EIMAC SK610A sockets c/w SK606 chimneys \$75 pr RCA 813 new \$60. HI MOUND MK-701 paddle as new \$80. JENNINGS 1000 PF SKV glass vac cap new \$150. 4CX 1500B new, SK800B, associated high power components. COLLINS KWM2 round emblem, 32S-3, both with 240V 516F2. Prefer to swap or trade for other Collins Gear. VK3GY QTHR (03) 789 4363.

EIMAC 3-500Z power triode new \$125. KYORITSU clamp meter ac volt amperes p.c. \$40. HP 41C/CV wand new \$40. PH (055) 62 6016 VK3BRE QTHR.

FLOPPY DISK library case, stores 10 5.25 inch disks in a hard plastic foldout case, 20 cases \$40.00 the lot. (B) (03) 563 1299.

OSBOURNE portable computer (cpm) with some software \$400. Ring Jock (03) 762 6733 BH or (03) 726 5603 AH QTHR.

YAESU LINEAR FL2100B full power 5 band excel cond. Stan VK3SZ QTHR (03) 560 4305.

SSTV converter 8 frames and B & W. A copy of the ROBOT 400. \$200. PHILLIPS colour camera CC350N \$200. Neil VK3AQD (03) 459 6445.

KENWOOD TS520S transceiver EC \$500.

Kenwood TH45 70 cm handheld with charger in box, used once still under warranty \$400. VK3TK Steve (03) 741 0594 AH (03) 353 2460 BH.

KENWOOD TR-7400A 2 FM transceiver 144.00 to 147.995 MHz in 5 kHz steps repeater off-set PLL freq synthesizer and digital display, 25 and 5 watts output mobile cradle and handbook \$375. YAESU FT221 all mode 2m transceiver, Mutek front end, YC221 digital display and handbooks. \$500. (03) 478 9265 VK3AWB QTHR.

TOWER 2X3m sections gc \$225 (03) 726 7700 VK3EHZ QTHR.

KENPRO KR1000S KR800S full English instruction manual \$20 Box 566 PO Morphett Vale SA 5162.

ICOM IC-745 HF xcvr general coverage rx ec handbook bur less mic \$1,200 VK3OM QTHR PH (059) 44 3019.

FOR SALE — QLD

HAM PACK III plug-in RTTY/CW/ ASCII card for Apple 2 plus all speeds & shifts software manual & cables perfect \$200. (071) 28 4110.

TRIO SG-402 100 KHZ-30 MHz signal generator good condition \$160 QTHR VK4DY (071) 96 1186.

YAESU FL2100B \$900. DICK SMITH HF transceiver. 80 metres assembled & working \$275. 80 metre mobile antenna \$35. SEQTG RTTY mod/demod with built in 3" CRO \$100. VK4WA QTHR (07) 814 2480 AH.

ROCKWELL COLLINS HF trx, model KWM 380 in perf condition, plus semi prof. astatic mic and p/t foot switch also comprehensive workshop manual. A bargain at \$2400. VK4KCF QTHR.

FOR SALE — SA

TELCON semi air spaced twin coax 2kW to 2m, transmitting tubes 4-65A; 4E27(813) Grundig reel-to-reel recorder two sets tubes KW2000; Portable Diathermy 600 watts 7 metres; Post-war receiving tubes new ribbon micro — VK5LC QTHR (08) 271 6841.

KENWOOD TH-45A 70 cm. H/held brand new \$495. Ph (088) 42 2085 or write to Jeff VK5BJF QTHR.

KENWOOD TS700A with VOX3 S350 KENWOOD TR9130 2M all mode \$499 IC02A. Handheld spare battery \$250 KENWOOD MC50 with adaptor \$50. DAIWA ant tuner (CNW217) \$95. VK5AUS QTHR (08) 344 5011.

ANTENNA tower Hills 40ft windup. Hidachi 3-element tribander. CDE HAM-4 rotator. Wall bracket and all erection gear. \$550 ONO VK5JI QTHR (08) 295 8094.

BACK issues QST 1925-1939 G B Ragless 42

Grove Street, Unley Park South Aust 5061 PH
(08) 271 2935.

FOR SALE — WA

COLLINS ROUND 32S3 75S3B KWM2A with manuals complete sets spare tubes, power supplies all in excellent condition. Write VK6IK Box 515 Kalamunda 6076.

YAESU MOBILE ANTENNAS for 3.5 MHz (RSL 3.5) and 28 MHZ (RSL 28). Bill VK6LT QTHR (09) 457 1080.

FOR SALE — TAS

ICOM IC-R71A comm rx as new little use \$900. IC-505 6m all-mode trxr \$600. Lunar 6m 50W amp \$150. Damien Vale VK7CDI (003) 26 0400 (W) (003) 26 3772 (AH).

FOR SALE — NT

SHACK SELL-OUT. YAESU 'BRAINS & BRAWN" pair. FT767GX & FL7000 including 6M2M 70CM modules, CTCSS option, SP767P external speaker/phone-patch, MD-1 desk mic, VIBROPLEX keyer paddle, FIF232C computer interface and comprehensive software, FAS-1-4R remote automatic antenna selector, gc-mod, service manual, original cartons, all connecting cables. Original price \$8800. Asking \$7500. ICOM IC-751 with extra if crystal filters, PS-35 internal-mounted power supply, SP-751 ext speaker, SM-6 scanning fist mic, SM-10 graphic-equalizer/scanning/compressor desk mic, HEIL "CONTESTER" headset/foot-switch, gc-mod, service manual. Asking \$2200. MIZUHO MX-15 15M CW/SSB hand-held .5w transceiver plus

matching 5-w linear-amp(?) and schematics, asking \$250 (works great!!). Antennas: HYGAIN 11-element 6M log-yagi, W.WOLF custom-built 7-element 10M yagi, CREATE 48-1000 MHZ log periodic, BUTTERNUT HF-2V vertical with 160M kit. \$250 each or the lot for \$800, including heaps of RG213 RG8 coax. Misc: MFJ-989B 3-KW antenna tuner/swr bridge/ant. selector \$495, KENWOOD AT-230 antenna tuner/selector \$250, MFJ-931 artificial earth \$120, MFJ-1701 antenna switch \$50, HEATHKIT programmable electronic keyer \$150 (includes manual), MFJ -1278 multi-mode controller/modem with MFJ-1282 software (latest version) as new original packing/manual \$495 or \$11,500 the lot!! Looking for small modern hf mobile transceiver, 3 to 5 element triband yagi and a pc (-286/-386) at-clone with at least EGA 2X-FDD 20MB-HDD, EGA or multi-sync monitor, modem. Eddie VK8XX call (089) BH 51 3138, AH 52 7560, Fax 52 6893. Transmitting equipment sold only to licenced amateurs.

WANTED — NSW

RESONATORS for SCALAR "PITCHFORK" mobile antennas 80 and 10 MX but will take others. VK2DBA QTHR (048) 32 1705 AH.

YAESU FT680 6M multimod or FTV650B 6m transverter price for good condition. PH (02) 487 2764 AH.

FRG-7 FRG 7000 or similar comms. receiver to approx. \$500. Arthur, VK2DKF Ph (047) 39 6297 or (02) 218 7458.

POWER TRANSFORMER 1000v ct 1000v 500ma also two 813 valves as new VK2DX (065) 59 8096 QTHR.

UART S1883 or ay-5-1012 or mms5303n used in rtty regen EIA 1977 John VK2XXK QTHR (066) 21 2933.

KEYBOARD 7 bit parallel ASCII suit Xitex RTTY decoder. Receiver 136-138 for weather satellite reception. Paul VK2AHB ph (02) 449 9212.

WANTED — VIC

CIRCUIT DIAGRAM or manual for RACAL RA17L for copying pay costs. G.Himolij 118 Wilsons Rd, Newcomb Vic 3219. Ph (052) 48 1410.

TRAYS and HARNESS for: ex-Army C11/R210 complete wireless set WS19MKII vibrator model. John Bennett VK3ZA QTHR (054) 55 1234.

FM UNIT for TS-430S with connecting leads etc. Reasonable price paid. Contact Phil VK3KMZ on (059) 64 7486.

YAESU FT-7 transceiver prefer in very good order. Ron VK3OM QTHR (059) 44 3019.

WANTED — QLD

COMPONENT VALUES for 1946 Army 128 set by WWII signaller VK4EF 97 Jubilee Tce, Barndon QLD 4065 ph (07) 366 1803 AH Please.

INFORMATION copy of circuit diagrams for PLESSEY TS6802 also TSG402 cro. R.Male 13 Henzell St, Redcliffe 4020 (07) 284 6432.



Please Note: If you are advertising items For Sale and Wanted please use a separate form for each. Include all details; eg Name, Address, Telephone Number (and STD code), on both forms. Please print copy for your Hamad as clearly as possible.

*Eight lines free to all WIA members, ninth line for name and address Commercial rates apply for non-members. Please enclosed a mailing label from this magazine with your Hamad.

*Deceased Estates: The full Hamad will appear in AR, even if the ad is not fully radio equipment.

*Copy typed or in block letters to PO Box 300, Caulfield South, Vic 3162, by the deadline as indicated on page 1 of each issue.

- Miscellaneous
- For Sale
- Wanted

Name:

Call Sign:

Address:

*QTHR means address is correct as set out in the WIA current Call Book.

*A courtesy note will be forwarded to acknowledge that the ad has been received.

Ordinary Hamads submitted from members who are deemed to be in general electronics retail and wholesale distributive trades should be certified as referring only to private articles not being re-sold for merchandising purposes.

Conditions for commercial advertising are as follows: \$22.50 for four lines, plus \$2.00 per line (or part thereof) Minimum charge — \$22.50 pre—payable.

State:

VZ-300 disk drive, & VZ-300 disk controller.
Eddy VK4-AVG QTHR (070) 61 4517.

WANTED — SA

SIX METER conversion details for bushranger
CB or similar unit any help appreciated Alan
VK5BWG PO Box 1337 STIRLING NORTH
5710 STH AUST.

WANTED — WA

EIMAC 4CX1000A tube unused (098) 44 1169
or VK6MK QTHR.

ZLILH SSTV system or ROBOT 400 — Brian
VK6ZD (09) 445 1412 B/H (09) 439 9030.

YAESU MOBILE ANTENNA for 14 MHz (RSL
14). VK6LT QTHR. Bill (09) 457 1080.

WANTED intruder watch observers in VK6 free
tapes logs and assistance available contact
VK6RO Graham on (097) 451 3561 or QTHR.

DON'T

**buy stolen equipment -
check the serial number
against the WIA stolen
equipment register first.**

TRADE PRACTICES ACT
It is impossible for us to ensure the advertisements submitted for publication comply with the Trade Practices Act 1974. Therefore advertisers and advertising agents will appreciate the absolute need for themselves to ensure that, the provisions of the Act are complied with strictly.

VICTORIAN CONSUMER AFFAIRS ACT
All advertisers are advised that advertisements containing only a PO Box number as the address cannot be accepted without the addition of the business address of the boxholder or seller of the goods.

TYPESETTING : Redfords Media
25 Glenferrie Rd
Malvern 3144
Tel: (03) 500 0377

PRINTING: Industrial Printing
Richmond

MAIL DISTRIBUTION: Polk Mailing Co.
PO Box 140,
Collingwood,
Vic. 3066
Tel:(03) 417 5161

The opinions expressed in this publication do not necessarily reflect the official view of the WIA, and the WIA cannot be held responsible for incorrect information published.

ADVERTISER'S INDEX

ATN Antennas 15
Dick Smith Electronics 11
Electronics Australia 7
Engineering Design Systems Pty 16
Ian J Truscott's Electronic World 41
Icom Australia OBC, 32,33
Kenwood Electronics Aust. IFC
Magpubs 19
Stewart Electronic Components .. 13
VHF Magazine 15
WIA NSW Division 43

TRADE ADS

M Delahunty 62
RJ & US Imports 62

HOW TO JOIN THE WIA

Fill out the following form and send to:

The Membership Secretary
Wireless Institute of Australia
PO Box 300
Caulfield South, Vic 3162

I wish to obtain further information about the WIA.

Mr, Mrs, Miss, Ms:

Call Sign (if applicable):

Address:

.....

State and Postcode:

FT-736R High Performance VHF/UHF Base Station Transceiver



The sky's not even the limit for the FT-736R! This base station rig is the most complete, feature packed radio ever designed for the serious VHF/UHF operator, whether your interest is talking through the local repeater or working the world via satellite. As standard, it provides 25 watts output on the 2 metre and 70cm bands in SSB, CW, or FM modes, and can be expanded to also cover the 6 metre and 23cm bands by installing optional modules as required. Some of its many features include . . .

- Flexible frequency control, with keyboard frequency entry, 115 general purpose memories, 10 full-duplex crossband memories, 2 independent VFO's per band, band/memory/mode selective/limited-band scanning functions, as well as 2 full-duplex VFO's which can have their transmit and receive frequencies (and modes) tuned independently or tuned synchronously for satellite operation.
- IF shift and IF notch filters, noise blanker, all-mode VOX, 3 speed AGC, Speech processor, GaAs Fet front-ends on 430 and 1200MHz, high stability (+/- 1ppm) reference oscillator, VFO or selectable channel steps on FM, narrow FM mode, inbuilt AC power supply, as well as a large fluorescent digital display
- 2 Year Warranty D-2920



Limited stocks!

\$2695

or \$2995 with 2m/70cm/6m modules (D-2925 only)

Bonus MD-1 Desk Mic!

Optional 6m module \$475
Optional 23cm module \$899

Save \$169

FT-4700RH Dualband Mobile Transceiver

Continuing the tradition started by Yaesu with the FT-2700RH, the new FT-4700RH dualband 2M/70cm FM transceiver now provides higher levels of performance, while offering even better value for money!

Features include 50 watts output on 2 metres (144-148MHz), and 40 watts output on 70cm (430-450MHz), with an inbuilt coding fan for long term reliability. True full-duplex crossband operation is supplemented by dual band simultaneous reception or auto-muting reception (with independant squelch and mixing balance), so you can listen for calls on both bands simultaneously, or work someone on one band while also listening on the other band. The Bonus YSK-4700 controller cable allows the main body of the transceiver to be installed under a seat, while the front panel/controller mounts conveniently on the dashboard. On the control panel, the bright amber back-lit LCD shows both VHF and UHF frequencies and signal strengths, and all controls have back-lit labels for clear readability, with a dimmer switch for nighttime viewing. A total of 20 memories and 5 selectable tuning steps make frequency selection easy, while the advanced scanning features allow quick detection of signals on either, or both bands. And all this is backed up by our exclusive 2 year warranty, the longest in the industry.

D-3300

\$1195

With Bonus

- D-4207 2m 5/8λ antenna
- D-4030 70cm Co-linear antenna
- D-4516 Antenna Bases x 2
- D-3301 YSK-4700 Extension Cable

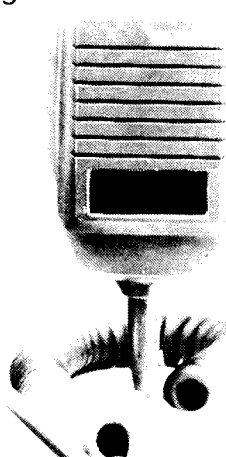

Save \$195



WITH ALL THE FEATURES IN ICOM'S NEW MOBILE TRANSCEIVERS, IT'S A WONDER THEY'RE STILL MOBILE.

ICOM have packed so many functions into the IC228A and IC2400A mobile transceivers, you'd think there was no way you could still make them so compact. (It might explain why nobody else has made a transceiver with so many features).

One of the features both transceivers share is back lit control knobs for visibility in bad lighting conditions.

There are various power outputs across the range, from 25W to 45W.

For novices, the 228A can be reduced to 10W.

The programmed Scan function scans all frequencies between two programmable set frequencies, while the Memory Scan function scans all memory channels except, of course, those you lock out.

Thanks to the pocket beep, you'll never miss a call. By installing a UT-40 Tone Squelch Unit (this is sold separately) the transceiver functions as a pager. When the frequency of a received tone equals the tone frequency you set, a thirty second alarm is emitted over the speaker.

As for monitoring the input frequency when you work a repeater, that's as simple as pushing the Monitor Switch on the front panel to open the squelch and check the frequency.

Every five seconds, Priority Watch in the IC2400A monitors the operating Channel, and one or all memory channels in succession. And that's while you operate! No longer do you have to flip back and forth between frequencies.

While the IC228A has 20 memory channels the more advanced IC2400A has 40, plus two call channels. Each channel stores all the information required to work a repeater.

With the IC2400A there are 20 double-spaced memory channels for 2 metres and 70 cm.

What's more, the IC2400A offers full duplex facility. Which means you can now simultaneously transmit on one band and receive on the other. You never have to wait for a long "over". You have full "break in". In fact, you can talk as easily as talking over the phone.

With all these functions in one small compact mobile, it really is a wonder they're still so compact and mobile.

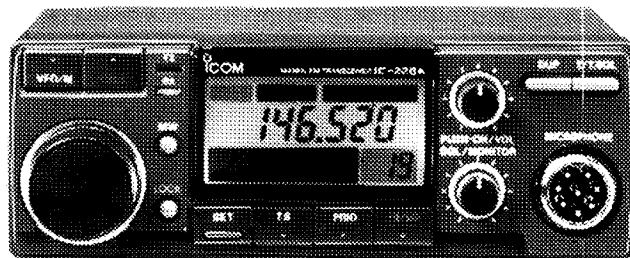

IC228A



IC2400A

Call ICOM on (008) 338 915 for details on ICOM products and your nearest stockist.
Melbourne callers (03) 529 7582. ICOM Australia Pty. Ltd., 7 Duke Street, Windsor, 3181.

ICOM

AMATEUR

RADIO



MARCH 1990

RRP \$3



THE WIA RADIO AMATEUR'S JOURNAL

KENWOOD



This is DX-clusive

Kenwood engineering pushes the outer edge of the high technology envelope of digital techniques, Digital Signal Processor, high-voltage power amplifiers, and advanced receiver design allows the all-new competition-class TS-950SD HF transceiver to deliver DX-clusive performance second to none.

The TS-950SD is designed for critical applications in SSB, CW, AM, FM, and FSK on all HF Amateur bands, including the new bands.

Features

- Dual Frequency Receive Function
- Built-in Digital Signal Processor
- Outstanding Receive and Transmit Performance
- 150W High Power and Heavy-Duty Cycle Design
- Built-In Automatic Antenna Tuner
- Superior Interference Reduction



KENWOOD ELECTRONICS AUSTRALIA PTY. LTD.
(INCORPORATED IN N.S.W.)
4E Woodcock Place, Lane Cove, N.S.W. 2066, Australia
Ph. (02) 428 4222, (02) 428 1455, Fax (02) 427 6869
Call now for further information and the name of your nearest authorised Kenwood dealer.

Please phone, mail or fax for information

Name

Address

Postcode

Publication..... Issue

Model



Amateur Radio is published by the Wireless Institute of Australia, as its Official Journal on the last Friday of the previous month.

EXECUTIVE EDITOR

Bill Rice VK3ABP

MANAGING EDITOR

Graham Thornton VK3IY

NEWS EDITOR

Jim Linton VK3PC

SENIOR TECHNICAL EDITOR

Peter Gibson VK3AZL

TECHNICAL EDITORS

David Brownsey	VK4AFA
Don Graham	VK6HK
Evan Jarman	VK3ANI
Peter O'Connor	VK4KIP
Gil Sones	VK3AUI
Phil Steen	VK4APA
Roy Watkins	VK6XV

DRAFTING

Vicki Griffin VK3BNK

ADVERTISING

Ann McCurdy

All contributions and correspondence concerning the content of Amateur Radio should be forwarded to: -

The Editor
Amateur Radio
PO Box 300
Caulfield South
VIC 3162

Registered Office

3/105 Hawthorn Road
Caulfield North VIC 3161

Telephone: (03) 528 5962
(03) 523 8191

Fax: (03) 523 8191
(Non dedicated line)

Deadlines

	Editorial	Hamads
April	5/3/90	7/3/90
May	9/4/90	11/4/90
June	7/5/90	9/5/90

© Wireless Institute of Australia 1989

CONTENTS

Technical

My Antenna Farm	8
<i>Brian Warman VK5BI</i>	
Stop the Packet Racket on HF	11
<i>Colin Richards 9M2CR</i>	
The Kenwood TS-950SD Transceiver (Equipment Review)	13
<i>Ron Fisher VK30M</i>	
The Ladder Filter Revived	16
<i>Lloyd Butler VK5BR</i>	
The 'Rononymous' 'Z' Match	45
<i>Ron Cook VK3AFW and Ron Fisher VK30M - See Random Radiators</i>	

General

Mt Minto-Antarctic Bicentennial Expedition	20
<i>Don Richards VK2BXM</i>	
JOTA 1989 - North Solomon Province	30
<i>Eric Shaw P29KES</i>	
Our Intruder Watch Co-ordinator	29
<i>Mervyn Eunson VK4SO</i>	
Pitcairn Island Bicentennial 1790-1990	26
<i>Dr G O'Toole KB6ISL</i>	
VNG's Code and the Leap Second	25
<i>Marion Leiba VK1VNG/VK1KNG</i>	

Operating

Awards	43
Contests, Calendar, 1989 RD Results	39
Commonwealth Contact Call Areas	42

Columns

Advertisers Index	64	Intruder Watch	54
ALARA	50	Morseword No 36	59
AMSAT	46	Over to you - Members' Comments	57
Divisional Notes		Pounding Brass	4
VK2, VK3 Notes	52	Random Radiations	44
VK4 Notes, 5/8 Wave	53	Silent Keys — Obituaries	55
VK6 Notes	54	Spotlight on SWLing	49
Education Notes	51	Stolen Equipment	26
Editor's Comments	2	VHF/UHF An Expanding World	36
Hamads	62	WIA Directory	3
HF Predictions	59	WIA News	3
How's DX	34		

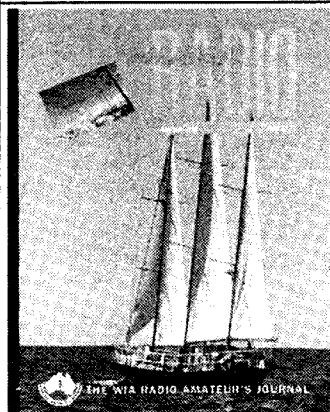

Cover

The Allan and VI Thistlethwayte under full sail on the port tack. Inset shows six metre Yagi on the wheelhouse roof. For story see article by Don Richards VK2BXM, "Mt Minto - Antarctic Bicentennial Expedition" on page 20.

Discrimination Within Our Ranks

The hobby of amateur radio is a pursuit shared by people from all walks of life and socio-economic status.

We have a long tradition of not discriminating against our fellow radio amateurs on the basis of the country in which they live, their political ideology, color, race, or religion.

Our call signs are passports into most countries via the airwaves which can't be stopped crossing national boundaries.

Throughout the world radio amateurs are men, women and teenagers, the able and disabled, from all occupations.

Governments in Australia have imposed laws banning the practice of discrimination against anyone on a number of grounds.

These include discrimination on the basis of a person's race, sex, marital status, religious beliefs, and more recently AIDS sufferers can take action for claimed discrimination.

To discriminate against someone on the basis of their race means you support the theory that human abilities are

NEWS EDITOR'S COMMENT

JIM LINTON VK3PC

produced by race. You are a racist!

Racism is an unfortunate part of our society. It can on occasion be heard perpetrated by anonymous voices on the CB bands to "stir up" an operator who has an accent—but it has no place in amateur radio.

Sexism is another form of discrimination which does not belong to amateur radio—the hobby for everyone.

However, it appears Ageism, or discrimination on the basis of a person's age and/or the length of time they've held a call sign, is being practised within our ranks.

As the WIA Federal President, Peter Gamble VK3YRP, rightly pointed out in his Editorial which appeared in December, the WIA and member's clubs are in need of volunteers.

There's a desperate shortage of suitable and willing people to perform a range of vital voluntary tasks.

However there's evidence that some volunteers, including

those elected to office or committees are suffering discrimination on the basis of their age or amateur qualifications.

An elected club official recently claimed that within his club existed a clique of old-timers acting like a "secret society".

He and his fellow senior club official were both enthusiastic radio amateurs doing their bit to further the aims of the club and amateur radio.

However in the eyes of some this pair had a serious failing—they have only been licensed in the past ten years.

They volunteered and were duly elected and should be given the fullest support and chance to contribute to our hobby.

This form of discrimination could be called "reverse ageism", or perhaps more correctly described as "elitism".

It is the practice of regarding those who have been in the hobby a long time, or having a certain class call sign, as being

superior in some way to other radio amateurs.

Discrimination is not wanted in our hobby. Let all radio amateurs be treated equally as human beings, their voluntary contributions welcomed and their merits accepted. ar

DON'T
buy stolen
equipment
- check the
serial
number
against the
WIA stolen
equipment
register
first.

Wireless Institute of Australia

The world's first and oldest National Radio Society - Founded 1910
Representing Australian Radio Amateurs - Member of the International Amateur Radio Union
Registered Executive Office of the WIA: 3/105 Hawthorn Road, Caulfield North, Vic, 3161
All mail to: PO Box 300, Caulfield South, Vic, 3162 Telephone: (03) 528 5962 (03) 523 8191
Fax: (03) 523 8191 (Non-dedicated line)

General Manager and Secretary: Bill Roper VK3ARZ

EXECUTIVE

President:	Peter Gamble	VK3YRP	VK1 Federal Councillor:	Kevin Olds	VK1OK
Vice Chairman:	Ron Henderson	VK1RH	VK2 Federal Councillor:	Peter Jeremy	VK2PJ
	George Brzostowski	VK1GB	VK3 Federal Councillor:	Peter Maclellan	VK3BWD
	Brenda Edmonds	VK3KT	VK4 Federal Councillor:	David Jerome	VK4YAN
	Bill Rice	VK3ABP	VK5 Federal Councillor:	Bill Wardrop	VK5AWM
Immediate Past President:	David Wardlaw	VK3ADW	VK6 Federal Councillor:	Neil Penfold	VK6NE
			VK7 Federal Councillor:	Joe Gelston	VK7JG

FEDERAL CO-ORDINATORS

Amsat:	Graham Ratcliff	VK5AGR	Int'l Travel Host Exch:	Ash Nallawalla	VK3CIT
Awards Manager:	Ken Gott	VK3AJU	QSL Manager (VK9, VKØ)	Neil Penfold	VK6NE
Contest Manager:	Frank Beech	VK7BC	Standards & FTAC:	Rob Milliken	VK1KRM
Education:	Brenda Edmonds	VK3KT	Tapes (Federal News):	Bill Roper	VK3ARZ
EMC:	Hans Ruckert	VK2AOU		Ron Fisher	VK3OM
Historian:	John Edmonds	VK3AFU	Videotape:	John Ingham	VK5KG
Intruder Watch:	Gordon Loveday	VK4KAL	WICEN:	Bill Wardrop	VK5AWM

1989 Ron Wilkinson Award

Ron Wilkinson, VK3AKC, was a well known amateur on the VHF and UHF bands, and had been a notable pioneer in moonbounce experiments. In 1977, after Ron's untimely death, his widow, Mrs. Mary Wilkinson, gave the WIA a sum of money to be used to provide an annual award in memory of her husband.

This award, to be announced in the month of March, the month of Ron's birthday, is awarded for special achievement in any aspect of amateur radio.

Submissions relating to four amateurs were made to Executive by Divisional Councils for consideration for the 1989 Ron Wilkinson Achievement Award.

After much deliberation, the

WIA NEWS

BILL ROPER VK3ARZ GENERAL MANAGER & SECRETARY

Executive has unanimously agreed with the VK5 Divisional Council that the winner of the 1989 Award is Graham Ratcliff, VK5AGR, for his outstanding contribution to amateur satellite communications in Australia and worldwide.

Besides the honour of being chosen as the recipient of this prestigious award, Graham receives an award certificate, and the sum of \$200.00, which includes a free WIA membership subscription for one year.

WIA 80 Competition Winner

There is no doubt that the

WIA 80 Competition, which ran in Amateur Radio magazine from November 1989 through to the January 1990 issues, was a great success. Such a success that the Executive Office was inundated with thousands of entries. The prize of an ICOM IC-900A multi-bander system, valued at \$2,000, and donated for the competition by ICOM Australia Pty Ltd, was obviously a very attractive "bait".

Most of the entries were written about a common theme that clearly shows in the examples quoted below. This common theme was interesting and reassuring for the WIA, but made the task of selecting a winner that much more difficult.

However, after much deliberation, one of the entries submitted by Mr D F Dawson, VK5KD, of Goolwa, South Australia was selected as the winner. Now VK5KD has the task of selecting whether he wants either the optional six metre or ten metre module with his ICOM IC-900A prize.

VK5KD's Winning Entry was

I am a member of the WIA because... the Wireless Institute Recognises Effective Liaison Ensures Some Stability In Negotiating Standards That Improve The United Technical Efforts Of Far-seeing Amateurs. Unity Stands Triumphant. Radio Amateur Longevity Implies Association.

As you can see, the high-

WIA DIVISIONS

The WIA consists of seven autonomous State Divisions. Each member of the WIA is a member of a Division, usually their residential State or Territory, and each Division looks after amateur radio affairs within their State.

Division	Address	Officers	Weekly News Broadcasts	1990 Fees	
VK1	ACT Division GPO Box 600 Canberra ACT 2601	President Secretary Treasurer	Ted Pearce Jan Burrell Ken Ray	VK1AOP 3.570 MHz VK1BR 2m ch 6950 VK1KEN 70cm ch 8525 2000 hrs Sun	(F) \$65.00 (G) (S) \$52.00 (X) \$39.00
VK2	NSW Division 109 Wigram St Parramatta NSW (PO Box 1066 Parramatta) 2124 Phone (02) 689 2417 Fax (02) 633 1525	President Secretary Treasurer (Office hours	Roger Henley Peter Balnaves David Horstall Mon-Fri 11.00 - 14.00 Wed 19.00 - 21.00	VK2ZIG 1.845 MHz AM, 3.595 SSB (1915 only), 7.146 AM (1045 only) VK2CZX 10.125 SSB (1045 only), 28.320 SSB, 52.120 SSB 52.525 FM 144.12 (SSB), 147.000 FM(R) 438.525 FM(R) VK2KFU 584.750 (ATV Sound) 1281.75 FM (R) Relays also conducted via many repeaters throughout NSW.	(F) \$59.00 (G) (S) \$47.00 (X) \$33.00
VK3	Victorian Division 38 Taylor St Ashburton Vic 3147 Phone (03) 885 9261	President Secretary Treasurer	Jim Linton Barry Wilton Rob Hailey	VK3PC 1.840 MHz AM, 3.615 SSB, 7.085 SSB, 147.250 FM(R) Mt Macedon, VK3XV 147.225 FM(R) Mt Baw Baw VK3XLZ 146.800 FM(R) Mildura, 438.075 FM(R) Mt St Leonard 1030 hrs on Sunday	(F) \$65.00 (G) (S) \$52.00 (X) \$39.00
VK4	Queensland Division GPO Box 638 Brisbane Qld 4001 Phone (07) 284 9075	President Secretary Treasurer	David Jones John Aarsee Eric Fittock	VK4NLV 1.825, 3.605, 7.118, 14.342, 18.132, 21.175, 28.400, MHz VK4QA 52.525 regional 2m repeaters and 1296.100 0900 hrs Sunday VK4NEF Repeated on 3.605 & 147.150 MHz, 1930 Monday	(F) \$65.00 (G) (S) \$52.00 (X) \$39.00
VK5	South Australian Division 34 West Thebarton Rd Thebarton SA 5031 (GPO Box 1234 Adelaide SA 5001) Phone (08) 352 3428	President Secretary Treasurer	Don McDonald Hans van der Zaaij Bill Wardrop	VK5ADD 1820 kHz 3.550 MHz, 7.095, 14.175, 28.470, 53.100, 145.000, VK5KHZ 147.000 FM(R) Adelaide, 146.700 FM(R) Mid North, 146.900 FM(R) VK5AWM South East, ATV Ch 34 579.00 Adelaide, ATV 444.250 Mid North (NT)3.555, 146.500, 0900 hrs Sunday	(F) \$65.00 (G) (S) \$52.00 (X) \$38.00
VK6	West Australian Division PO Box 10 West Perth WA 6005 Phone (09) 474 2626	President Secretary Treasurer	Alyn Maschette Bruce Hedland - Thomas	VK6KWN 146.700 FM(R) Perth, at 0930 hrs Sunday, relayed on 3.560, 7.075, 14.115, 14.175, 21.185, 28.345, 50.150, 438.525 MHz Country re- lays 3582, 147.350(R) Busselton 146.900(R) Mt William VK6OO (Bunbury)147.225(R) 147.250 (R) Mt Saddleback 146.725(R) Al- bany 146.825(R) Mt Barker Broadcast repeated on 3.560 at 1930 hrs.	(F) \$56.00 (G) (S) \$45.00 (X) \$30.00
VK7	Tasmanian Division PO Box 1010 Launceston TAS 7250	President Secretary Treasurer	Mike Wilson Bob Richards Peter King	VK7ZWM 146.700 MHz FM (VK7RHT) at 0930 hrs Sunday relayed on 147.000 VK7NRR (VK7RAA), 146.750 (VK7RNW), 3.570, 7.090, 14.130, 52.100, VK7ZPK 144.100 (Hobart) Repeated Tues 3.590 at 1930 hrs	(F) \$63.00 (G) (S) \$50.00 (X) \$38.00
VK8	(Northern Territory) is part of the VK5 Division and relays broadcasts from VK5 as shown (received on 14 or 28 MHz).				Membership Grades Full (F) Pension (G) Needy (G) Student (S) Non receipt of AR (X)

Note: All times are local. All frequencies MHz.

Three year membership available to (F) (G) (X) grades at fee x 3 times

lighted letters spell out "Wireless Institute of Australia".

The seven other finalists entries are as follows. The three runners-up, who receive prizes of free 1990 membership of the WIA are:-

VK1DE

I am a member of the WIA because... The Institute, its Executive and Divisional personnel have, over the years, fought for or negotiated the privileges that I now enjoy. Therefore the Institute deserves my support.

VK2BHS

I am a member of the WIA because... it is solely dedicated to the benefit of the Amateur Service and has been proved singularly effective in this task for nearly 80 years. It makes good sense to belong.

VK6LT

I am a member of the WIA because the WIA is the "linear amplifier" I need to ensure my voice is heard when my hobby is under threat.

The remaining finalists are:-

VK3BAY

I am a member of the WIA because... the mechanisms and experience to deal with government to ensure that Amateur Radio survives as a hobby is not available through any other organisation.

VK4BIB

I am a member of the WIA because... I believe that all "amateurs" should share the load of the cost of protecting our bands, not only for our use and enjoyment, but for future generations also.

VK5ZQ

I am a member of the WIA because... it is an organisation of amateurs safeguarding the interests of all Australian amateurs at all levels of government, nationally and internationally.

VK6JX

I am a member of the WIA because... it is the only institution in Australia fighting for my rights and privileges as a radio amateur against commercial pressure and non-member indifference.

A very big thank you to all those WIA members who submitted entries in this competition. May the WIA 80 year bring you everything that you want.

Also, a big thank you to ICOM Australia Pty Ltd for so positively supporting WIA 80. And congratulations to the winner of the competition, VK5KD.

WIA Member Numbers

Although the WIA introduced cyclic billing for membership subscriptions some years ago, most members (73%) are still on the January to December membership cycle. When you consider that the new annual fees come into force as from 1st January each year, the membership renewals for that cycle are generally considered a good indicator of the success of the WIA.

In recent years, about 5 to 6% of members have not renewed at the January renewal time. However, most of those losses were recouped during the year with the recruitment of new members. This year some "prophets of doom" forecast that, because of the necessary, but substantial, increase in membership fees, and the protracted public agonising over this fee increase, more than 20% of members would not renew.

Although it is still too early for final figures, with more renewals arriving in the post each day, all indications are that the net decrease in membership for 1990 will be less than 10%. This is a clear vote of support for the WIA by its members.

The challenge is for the WIA to live up to this vote of confidence, and a challenge for its members to recruit more members.

Remember, WARC 92 is just around the corner, and the radio

amateurs of Australia need the biggest voice possible in order to protect our frequencies.

Non-AR Members

It is customary for national amateur radio societies to insist that receipt of their magazine be a compulsory part of membership. Some years ago the WIA introduced a "family" grade membership whereby, if a member lived at the same address as another member, they could have a "non-receipt of Amateur Radio magazine" membership at a reduced fee.

As a result of many requests, the WIA introduced a non-AR grade of membership as from January 1990, regardless whether the member is a "family" member or not. This innovative step is a first for any national amateur radio society.

Again, some "prophets of doom", with little faith in Amateur Radio magazine, forecast dramatic increases in the number of members who would want this new grade of membership.

It will be some time yet before final figures are available. However, indications are that the 2.4% of membership who had the "family" grade of membership in 1989, will only increase by about 1%.

Also, it seems that the increase in the "concessional" grades of membership will only be about 1%. This is, no doubt, a reflection of the steadily increasing average age of radio amateurs.

Member Details

During the hectic processing of membership renewals in the Executive Office during the month of January, it was found that more than 20 members sent in a renewal cheque when their current membership did not expire for several months. They had heard all the discussions on air about payment of renewal subscriptions, assumed that their renewal notice had gone astray in the post, looked up page 3 of Amateur Radio magazine for details of the fee, and sent in their remittance.

If you are unsure about your membership details, the best place to look is on the flysheet that comes with your copy of Amateur Radio magazine each month. Not only does this flysheet have a convenient change of name/address/callsign advice slip, and a membership application form for you to sign up a new member, on the reverse side, but it also has on it your address label that contains useful information about your membership of the WIA in the top row of figures and letters.

The first two figures show the first month of your current membership of the WIA, for example "03" shows that your membership commences as from 1st March. The next numeral shows the Division of the WIA of which you are a member, for example "4" would mean the VK4, or Queensland Division. The letter immediately after this indicates your grade of membership, for example "G" means the concessional (pensioner) grade.

If you are a member of the VK3 Division, there may be two characters before your callsign or listener number, which indicate your Divisional Zone. For example, "NE" shows you are a member of the North East Zone.

After your callsign or listener number, is your database computer membership number. Please note that this is not the same number as appears on your WIA membership certificate.

Finally, at the end of the top row of your address label, is the date of the issue of Amateur Radio magazine that was posted to you with that address label. For example "0190" would indicate that the address label accompanied the January 1990 issue of the magazine.

FTAC

The Federal Technical Advisory Committee is a specialist WIA committee. It consists of a Chairman and various expert members, and advises the Executive on all technical matters appertaining to amateur radio, as well as managing the

RF spectrum as directed by Executive.

Liaison takes place between FTAC and various state Technical Advisory Committees, and matters are considered in conjunction with appropriate specialist user groups.

FTAC has an onerous task, particularly with the increasing complexity of modes and frequency usage by the amateur service.

Rob Milliken, VK1KRM, was elected as Chairman of FTAC at the 1989 Federal Convention, and has had a very busy time with many projects, including cross-linking of repeaters.

Unfortunately, Rob's work commitments have escalated to the stage that, although he would like to continue in the position, he realised that he does not have the time available to do the job justice.

Therefore, at the last Executive meeting on 23rd January 1990, John Martin, VK3ZJC, was elected as Acting Chairman of FTAC, with a view to him being appointed as Chairman at the 1990 Federal Convention.

John is not a newcomer to FTAC, having served as a committee member some years ago. He will need the support of the state Technical Advisory Committees, the specialist user groups, and he will need your support in this difficult task.

Amateur Radio Rescue

Ever since its beginnings, amateur radio has played a vital part in rescue and safety. Why don't we more actively publicise this important community aspect of our hobby? Why is the Australian news media not interested?

The following rescue due to amateur radio appeared on the Adelaide Channel 10 TV news, but probably only because their helicopter was involved. Certainly, the print media in Adelaide was not interested!

On the morning of 4th January 1990, Charlie Branch, VK5YC, who is a pensioner due to his being legally blind, was monitoring the Adelaide re-

peater 7000, as is his usual practice, when he received a call from VK5KJJ. VK5KJJ, who was mobile/portable on the shore of Lake Alexandrina, the outlet of the River Murray, had seen a boat capsize on the lake.

This lake can be treacherous, and has claimed lives in boating accidents over the years. Charlie rang the Adelaide police, who instigated rescue action involving the Channel 10 helicopter.

Another boat picked up the seven people from the capsized boat seen by VK5KJJ but, with fourteen people on board, was soon in difficulty itself. All fourteen were eventually brought to shore. A salutary lesson was that, despite the sailors having been advised not to go out on the lake that day due to adverse conditions, only one of the fourteen was wearing a life-jacket.

Rowland Bruce, VK5OU, supplied the above information, and commented that, although the newspapers acknowledged his report, they did not consider it newsworthy enough to use as no one died!

EMI Standards

During October 1989, the Community Policy Development and Planning Branch of DoTC issued a draft paper on "The Need for Electromagnetic Interference Standards" for comment.

The WIA received a copy that was examined by our past Standards Australia representative, Alan Foxcroft, VK3AE, the Federal EMC Co-ordinator, Hans Ruckert, VK2AOU, and Ron Henderson, VK1RH, from FTAC. The paper was substantial, containing 29 pages including tables and annexes.

The WIA was a little unclear as to whom the draft paper was directed, for it was general in nature and context. We presumed that it was aimed at middle and senior management, possibly for ministerial advice, and we said so in our response.

Alan Foxcroft noted that the paper included some contributions he had made at an earlier time. These related to the po-

tential for dumping of products with poor EMC/EMI performance, that would not be allowed to be imported into nations conscious of interference issues, onto the Australian market.

In this regard, Hans Ruckert commented that the German authorities took a very strong line on EMC and devoted effort to testing of consumer products such as TVs, VCRs, computers and the like.

The following comments were included in the WIA response to this DoTC paper.

"The WIA gives full support to the need for EMI legislation and standards as proposed in the paper's conclusions. As observed in the paper, the Australian radio amateur has to operate at very close proximity to many electronic devices that may suffer malfunction when subjected to high ambient RF fields.

"The WIA has been active in Standards Australia deliberations on appropriate standards. However, we note the less than enthusiastic involvement by industry which, coupled with government resource restraints, have unfortunately severely drawn out Standards Australia deliberations.

"Of great concern to the WIA is the minimal coverage in the paper afforded to power line interference. By that, we mean RFI generated by power distribution system "furniture", ie. poles, cross arms, insulator strings and clamps. Your statistics show this source contributes almost one third of interference reports, yet receives only cursory mention in the draft paper.

"The paper's conclusions correctly identify the economic considerations when introducing standards. However, the WIA feels the inter-related social issues are equally important, as the Department's field staff have observed earlier in the paper.

"Finally, the WIA supports the introduction of Australian standards based upon, or closely coupled to, international standards, ie CISPR.

"We advise our availability for involvement in the subse-

quent study proposed by the Department."

Intruder Watch Survey

Are you concerned about the future of the amateur service frequencies? Well, you should be! And here is an opportunity for you to play an important role in the fight to retain our bands.

As most amateurs will know, the next World Administrative Radio Conference (WARC) will be held in Spain in 1992. Among the many things to be considered at this WARC are the frequency allocations in the 3 to 30 MHz bands.

In order to assist the Administrative Council of the IARU to formulate policies with regard to the amateur radio stance to be taken concerning our frequencies at WARC 1992, the IARU has requested that certain bands of frequencies be studied for band occupancy and related matters.

The IARU Monitoring System has been charged with organising this survey and collating the results. The one year survey commences on 4th March 1990 at 0100 UTC, and continues until 3rd March 1991. The survey period is divided into four time periods coinciding with the HF Broadcasting schedules.

To provide useful results with the limited personnel available, the minimum number of operators required for each monitoring team will be eight. These teams of eight operators are scheduled to monitor the frequencies of interest for a two hour period each eight days. The days of the week and the scheduled time for each operator both increment throughout the year.

In other words, operator "A" will commence on 4th March 1990 at 0100 UTC, and monitor until 0300. Eight days later, 12th March, he will commence monitoring at 0400 and conclude at 0600, and so on throughout the length of the survey.

Operator "B" will commence on the same day, but at 0400

UTC. He will then go to the 12th March where he will commence at 0600 UTC. The team of eight operators will continue in this fashion for the duration of the survey.

Every monitor will be listening on the same days, which are progressively eight days apart, and each is starting on each successive monitoring day two hours later than previously. In this manner, the whole 24 hour period will be covered each eight days.

The IARU would like to see as many amateurs and SWL's as possible participating in this survey. An invitation is extended to everyone to assist, WIA member or not. This is an important activity in the preparation for the fight to protect our frequencies at WARC 92, and is of vital importance to all radio amateurs.

The operators involved will need receivers capable of tuning outside the amateur bands, but will not need to have specialised knowledge of signal types, as this is a band occupancy study only.

The frequencies of interest will be:

5.005 - 5.060 MHz
10.150 - 10.350 MHz
14.350 - 14.400 MHz
18.168 - 18.318 MHz
24.740 - 24.890 MHz

It will be very interesting to find out what goes on these particular non-amateur frequencies.

To participate in this important survey, which will only involve two hours per week, please immediately get in contact with either:

Gordon Loveday, VK4KAL,
"Aviomore",
Rubyvale, 4702,
QUEENSLAND
or

Bill Martin, VK2COP,
33 Somerville Road,
Hornsby Heights, 2077
NSW

Advice of this survey was received late, so contact either of these Monitoring System coordinators without delay.

Amateur Numbers in VK

You may recall the concern expressed in WIANEWS in December 1989 issue of Amateur Radio magazine about the lack of growth in the number of radio amateurs in Australia during the 12 month period to 30th September 1989.

However, the official DoTC statistics for Radiocommunications' licences as at 31st December 1989 are now to hand, and it seems that things are looking up a little. During 1989 there was an increase from 17898 as at 1st January 1989 to 18372 as at 31st December 1989, an increase of 474 (excluding beacon and repeater stations) or 2.65%.

As at that date, there were 3,336 Limited, 1,444 Combined, 2,878 Novice, and 10,714 Unrestricted amateur stations licensed in Australia. In addition, there were 34 beacon and 262 repeater licences in existence.

Just by way of comparison, the CB service had 304 repeaters licensed as at 31st December 1989.

Small Print in February

As you will have noticed in last month's issue of Amateur Radio, it was jam packed with information. The Managing Editor, Graham Thornton, was heard to be muttering to himself, or to anyone else who would listen, phrases like "it won't fit", "it can't be done", and "you can't fit a quart into a pint pot".

Well, as you saw, Graham did it, with only very little information having to be left out. One of the reasons so much was able to be fitted into this special data reference issue was the reduction in size of the print throughout the magazine.

However, there is no cause for alarm. As you can see from this issue of your magazine, print size is back to "normal" again.

Graham has asked me to apologise to any readers who

were concerned about this "once only" reversion to small print. He assures me that he hopes he does not have to use it again.

MagPubs Bookshops

Each month a MagPubs' advertisement appears in Amateur Radio magazine. These advertisements publicise some of the latest and most popular books available to members of the WIA at a discount from their local Divisional Bookshop.

However, each month we receive cheques and orders from members who apparently believe that these MagPubs' publications are available from the Executive Office. This is not so. We do not stock any of the current MagPubs' overseas publications in this office. As it states in the advertisements, these books are only available "from your WIA Divisional Bookshop".

Occasionally members contact the Executive Office complaining that the MagPubs' advertisement does not tell them how to contact their Divisional Bookshop. The answer to this, of course, is that a WIA Divisional directory appears on page three of Amateur Radio each month. If you do not know how to contact your Divisional Bookshop officer direct, then write or telephone to your Division as indicated in this directory.

MagPubs Sale

Having stated that MagPubs overseas publications are not available from the Executive Office, let me now state the one exception to "prove the rule".

As a result of an order placed just before the changeover of the old "centralised" MagPubs' system last year to the current decentralised MagPubs operation, the Executive Office still has several current RSGB publications sitting in stock.

These must be cleared out so that we can close the books on the previous style of MagPubs' operation. A clearance sale advertisement ap-

pears elsewhere in this issue of Amateur Radio. As you can see, only limited numbers of these books remain in stock, and they are available to you at bargain prices. First in first served! Be quick with your order.

Marlon Brando WA6BRU

An interesting item of news has come to hand from Ken Gott, VK3AJU. The well known Hollywood film star, Marlon Brando, is a radio amateur. He once held the callsign WA6BRU, and also worked as FO0GJ, and is believed to have used several other callsigns during his travels and vacations.

Peter Manso, a best-selling writer in the USA is preparing a book on Brando and would like to hear from anybody who contacted him on air and who has a "vivid recollection" of the QSO.

Peter Manso can be contacted at PO Box 668, Truro, MA 02666, USA.

Field Day Catapults

Last year the Victorian Government banned the sale and use of catapults (better known to the older generation as "shanghai", or to the Americans as "slingshots").

On learning this Ken Gott, VK3AJU, wrote to the Minister for Police and Emergency Services pointing out that radio amateurs engaged in field and similar portable operations would be seriously affected by this prohibition.

Ken's gear for portable operations includes a fisherman's hand-caster and monofilament line with sinker attached, and a catapult. Ken uses this gear to get a line over a suitable tree branch and then to draw an antenna wire over the limb.

Naturally, Ken emphasised the role of the John Moyle and other field day events as training for WICEN operations and the contributions of WICEN itself to emergency services.

Ken received a response from the Ministry, dated 29th

December 1989, which reads:

Dear Mr Gott,

PRESCRIBED WEAPONS REGULATIONS 1989

I refer to your letter requesting an exemption from the above Regulations to enable the use of slingshots in the pursuit of your hobby as an amateur radio operator.

I am pleased to be able to tell you that the following exemption was recently approved by the Governor in Council:

'Sections 4(j) and (k) [which relate to slingshots] do not apply to amateur radio operators where the articles are used in pursuit of that hobby.'

Yours sincerely,

**MONIKA HENDERSON
DIRECTOR, CRIMINAL
JUSTICE**

Please note that this is not the April issue of Amateur Radio magazine.

WIA 80 AR For Non Members

One of many initiatives that the WIA is offering during 1990 to celebrate its 80th Birthday, is a limited, once only offer of a four month subscription to Amateur Radio magazine for non-members of the WIA.

This four month subscription to AR will be for the May to August 1990 issues of the magazine and will cost just \$12.00. The subscription includes the cost of postal delivery of the magazine, and must be received in the Executive Office no later than 30th April 1990 in order to qualify for this offer.

If you know of someone who

should be a member of the WIA, here is a chance to introduce them to our magazine on a trial basis.

WIA 80 Award

The Awards Manager tells me that applications for the WIA 80 Award are starting to increase. At this time, overseas recipients of the Award number in the low twenties, and the recipients of the much harder Australian Award now number half a dozen.

The first CW Award, either for an overseas or Australian applicant, has been won by Ivor Stafford, VK3XB.

In order to qualify for the award, amateurs living in Australia need to contact (log) 80 members of the WIA. For the contact to be valid, it must include the WIA membership number of the WIA member involved. This number can either be the number on the member's membership certificate, or the six-digit number appearing on the address label of his Amateur Radio magazine.

Full rules of this interesting and challenging award appeared on page 4 of the September 1989 issue of Amateur Radio magazine.

WIA 80 Events Coordinator

As all WIA members know, Australia's national radio society is celebrating its 80th anniversary this year.

Working behind the scenes since early 1989 on the planning of many of the WIA 80 activities has been Jim Linton, VK3PC, already well known to

WIA members for his involvement with the WIA Victorian Division and as the News Editor for Amateur Radio magazine.

Jim's appointment as WIA 80 Events Co-ordinator was effectively made at the 1989 WIA Federal Convention where he convincingly proposed that the WIA's 80th birthday should not pass unheralded.

He was heavily involved with the highly successful WIA 75 Award, and was a member of the WIA 75th Anniversary Committee, taking on the job of publicity. Jim has used this experience to ensure the WIA's 80th anniversary is one of celebration.

His view was that it should not be on the scale of WIA 75. However, there were appropriate events to recognise the world's first and oldest national radio society in its 80th year.

Hence, events such as the WIA 80 logo competition, the WIA 80 Award, the WIA 80 Competition, and the WIA 80 Amateur Radio for non-WIA members scheme.

Well done, Jim.

Special June Issue

As mentioned previously, the June 1990 issue of Amateur Radio magazine will be a special "Test Equipment" issue. The Editors are seeking articles on construction of test equipment, modification of test equipment, and test procedures for this special issue.

Several authors have already submitted articles for this special issue of your magazine. However, time is running out if you want your test equipment article to be included.

Please note that articles need to be received at this office no later than the middle of March so that the articles can be prepared for publication in the June issue.

A prize will be awarded to the author of the test equipment article that is judged to be the best of those published in this special issue of Amateur Radio magazine. After much deliberation, and considering the limited finances of Amateur Radio, it has been decided that this prize will be a year's free membership of the WIA.

New ICOM Dealer in Melbourne

A late trade news item just to hand is that Stewart Electronic Components has become the latest ICOM Australia Pty Ltd dealer in Melbourne.

Stewart Day, from Stewart Electronic Components, tells me that he will be stocking a full range of ICOM transceivers and accessories. Stewart shortly expects to have a fully operating amateur station in his showrooms where intending purchasers will be able to try out the ICOM range of equipment.

ar

**Help stamp out
stolen equipment**

**Keep a record of
all your equipment
serial numbers in
a safe place**

ANTENNAS & ACCESSORIES

We manufacture a comprehensive range of HF, VHF and UHF antennas, baluns, power dividers etc to suit your application. Three of our log periodics provide continuous coverage from 13-30 MHz including WARC frequencies, and replace outdated tri-banders. Now in use in 24 overseas countries and 6 continents.

- CREATE ROTATORS, COAX CABLES & NON-CONDUCTING GUY HALYARD MATERIALS
- COMPLETE RANGE MIRAGE (USA) 5-YR WARRANTY 6M, 2M, 70CM AMPS & WATT SWR METERS
- HARD-DRAWN ANTENNA WIRE
- AUST/NZ DISTRIBUTOR FOR CREATE ANTENNAS/ROTATORS & PHYLSTRAN (KEVLAR) NON-CONDUCTING GUYING

- MATERIALS
- HIGH GAIN VHF & UHF AMATEUR, SCANNING & TV ANTENNAS
- BUTT SECTION TRIANGULAR ALUMINIUM TOWERS FOR FIXED OR TILT-OVER APPLICATIONS (REFER MARCH/APRIL 1987 AR)
- SELECTION OF POWER CHIPS AT FRIENDLY PRICES
- VSWR/PWR METERS TO 1300MHZ

Write or phone for free catalogue

ATN ANTENNAS

56 Campbell Street
Birchip Vic 3483
Phone: (054) 92 2224
Fax: (054) 92 2666

MY ANTENNA FARM

BRIAN WARMAN VK5BI
Box 677 WHYALLA 5600

As an Old Timer I am frequently asked about the most effective antenna layout to adopt for the average QTH.

When I started, in the pre-TV, pre-SSB era, I lived on a very large block in a country town. The antenna I chose was a long-wire; 8 wavelengths on 20m and slanting downhill to the USA. Power was 100 watts input on AM.

I worked a lot of DX.

Then came TV. Very primitive sets to be sure; but TV was King in those days: I did not feel competent to explain to the proud owner of a 21" Admiral that she should not be attempting to watch TV in a fringe area when I wanted to work DX! Something had to be done.

My very good friend VK5DS (an ex GM) had encountered the problem many years previously (the Gs got television in 1936) and suggested I put in resonant antennas. This advice proved to be the best I have ever received.

I was recently involved in "proving in" a site for a HF base.

I used a mobile radio with a trapped whip to assess the suitability of the location: The usual parameters dear to an amateur of course were assessed. The signal was adequate, noise not a problem. The final installation was a disaster. What went wrong?

It was my old problem. Wideband antennas! The antenna installed for this base station was the famous Australian Dipole. This antenna is installed all around Australia from Bourke to Burketown, and it works very well. But in a city it collects and radiates all RF, good and bad.

So back to my 1950's problem with the TV.

This of course was due to a wideband antenna. Namely the "Long Wire".

My solution to the TVI problem was a multiple dipole. This was (even at the bottom of the sunspot cycle) 3 dipoles on a common coaxial feedline: The dipoles were cut for 20, 40, and 80 metres.

I used this arrangement for a number of years until the lure of a beam became irresistible. I then constructed a Cubical Quad. This served me for many years as the sunspot cycle peaked and the 10 and 15 metre bands became interesting again. But then, about 10 years ago, I moved to the city and decided to give my quad to an SWL friend. (That thing would be a mis-

take in the city — too visible.) I put in a commercial Yagi antenna and 10, 15, and 20 were catered for. What about the WARC bands we had recently gained? Plus 40 and 80?

In a city-sized block there are not too many choices for an amateur who wants to use most of the bands. In my case, the new house presented as a double edged sword. On one hand, I have an excellent 20m tower which supports a television antenna system. A tower of that height is a magnet for any red-blooded Ham. Having said that, with an antenna booster at the top, what chance has the tower as a support for WARC + 40 and 80? The simple answer to that question is; pretty good, but watch out for the VCR. On 40/80, plus WARC, using a straight transceiver, there is no problem with television; the VCR changes everything!

My response to the tower was to make a trapped antenna and haul it to the top with a halyard. This antenna (which I have described in Electronics Australia and Break In) is very easy to duplicate. It covers the 80/40/30/17 and 12 metre bands.

	*Coax length (cm)	Form length (cm)
40m	180	11
30m	133	9
17m	83	7
12m	71	7

*Wound on 3.2cm poly pipe

Element Dimensions

12m	2 x 260 cm
17m	2 x 22 cm
30m	2 x 244 cm
40m	2 x 144 cm
80m	2 x 545 cm

A favourite band of mine has always been 1.8 MHz (160 metres). I have been active on this band since it again became available to Australian Amateurs in 1962.

When I lived in a mangrove swamp I used a top-loaded 50 foot (15 metre) vertical. This was supported by venetian blind cord and worked pretty well. But one of these antennas at my new QTH would have been too much. An alternative was obviously needed.

I studied the ARRL Antenna Book and was persuaded that loading the tower would solve all my problems. The 20m television tower was anchored to the ground; properly earthed, it should have

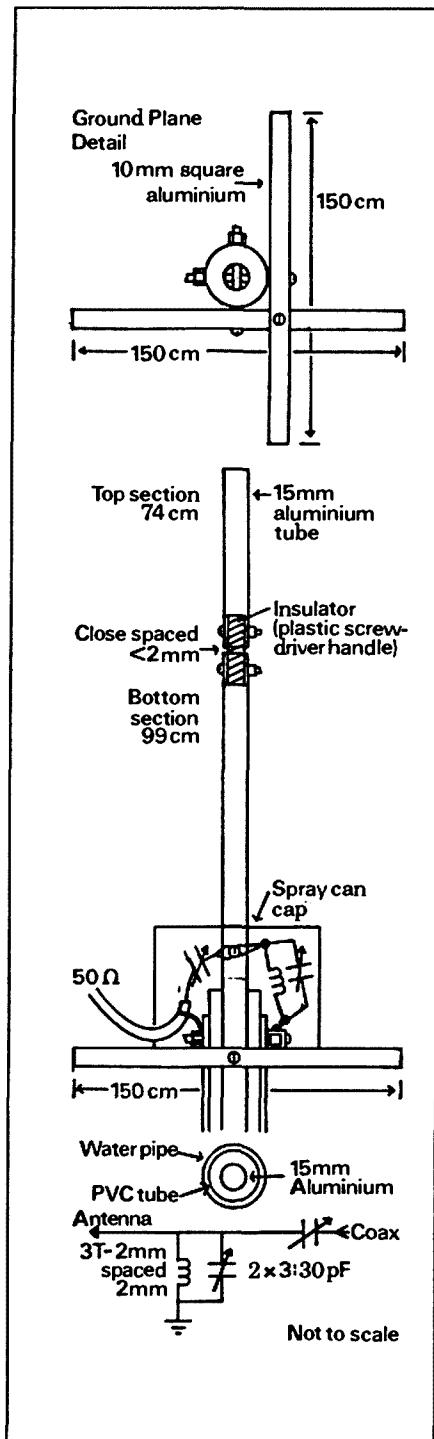

Construction details for 718 wave 2m antenna

Radio Amateurs: Have you checked out EA lately?

No doubt most radio amateurs are aware that *Electronics Australia* is by far this country's largest-selling electronics magazine, as well as being its oldest (we began way back in 1922, as *Wireless Weekly*). But have you looked inside the magazine lately?

Remember Jim Rowe, VK2ZLO? Jim used to be Technical Editor, and then Editor – back in the late 1960's and 1970's. You may recall some of the amateur radio and test equipment projects he developed, which proved to be extremely popular. Well, Jim is back at the helm of the magazine, and has been busy giving it a new lease of life.

You'll now find lots of new 'departments' in the magazine, including Solid State Update (with news of new semiconductor devices), Silicon Valley Update (news from the USA) and What's New in Entertainment Electronics. Plus all of your old favourites like Forum, The Serviceman, Circuit and Design Ideas and so on. And of course plenty of 'meaty' technical articles and construction projects.

What about *amateur radio* projects? Well, as you can see there are more of these than before – but we're very interested in publishing more. So if YOU have developed an exciting amateur radio project, please contact Jim Rowe by writing to him at EA, 180 Bourke Road, Alexandria 2015. Or phone him on (02) 693 6620, to discuss the possibility of publishing it as a contributed article. As well as earning a fee, you'll also be helping to boost interest in amateur radio!

Take a look at the new, rejuvenated *Electronics Australia* – on sale at your newsagent at the beginning of every month. Or subscribe now, by phoning (02) 693 9517 or 693 9515.

Electronics Australia

Australia's Top Selling Electronics Magazine

FEATURES IN OUR MARCH ISSUE:

ICOM'S IC-R9000 'SUPER RECEIVER'

The incredible new IC-R9000 tunes from 100kHz to 2000MHz, and has almost every conceivable feature including a built-in spectrum scope and scanner. Jim Rowe tried it out, and here's his report.

LOW COST CRYSTAL FREQUENCY CALIBRATOR

A really compact little unit, which generates any of 11 different frequencies from 10MHz down to 5kHz. Use it to check your scope timebase or receiver dial!

SIMPLE GM-NBFM RECEIVER – 2

Here's the second article describing our new easy-to-build NBFM receiver, which can also form a tuneable IF for VHF and UHF converters.

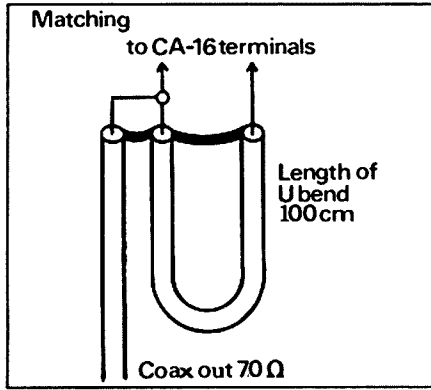

Matching arrangement for 16 element collinear antenna

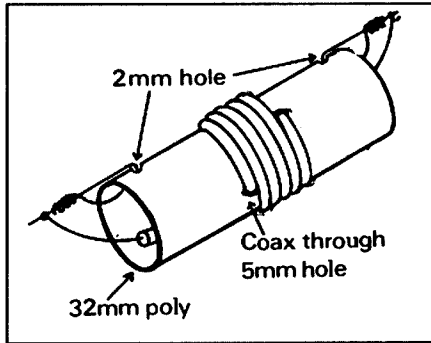

Trap construction details

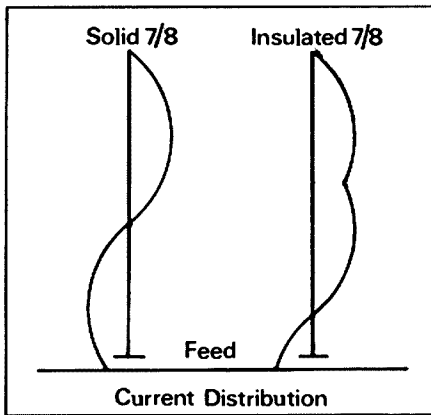

Current Distributions for 7/8 antenna

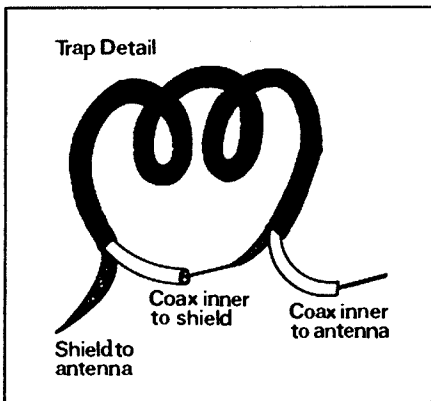

Connections for the traps

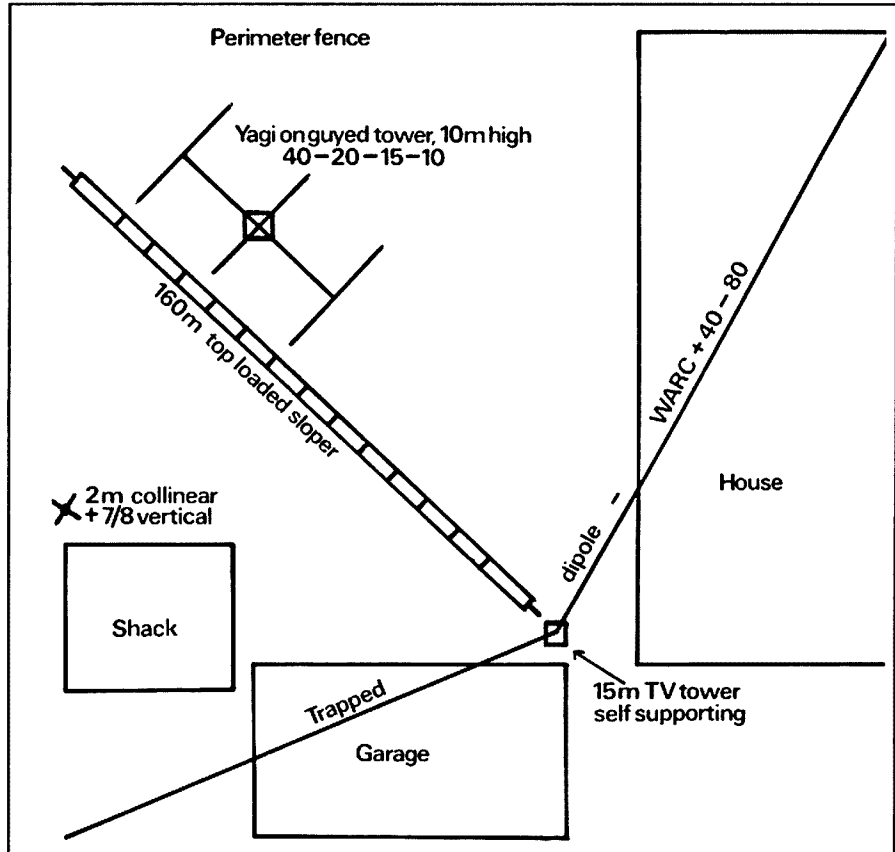

Layout for antenna farm

been the answer to an amateur's prayer. It didn't turn out that way! I tried gamma matches, as detailed in the "Book", but as the tower was a little short they did not work as well as expected: Even at 20m it was too short. The gamma capacitor had to be very large.

I still needed a 160m antenna. I tried running a random length "long wire" around the yard; it picked up a lot of QRM, not too much signal, and radiated badly. Back to top loading.

I mentioned earlier that I had used a 50 ft top loaded antenna for 160, (and as an end-fed 1/2 wave on 40), at my previous QTH. This antenna comprised one of those "pop-up" tubular TV masts surmounted by a loading coil and a circular top hat in the shape of a spoked wheel. This antenna had been successful for a couple of reasons. It was reasonably broad because of the bulk presented by the tubular mast, and it radiated well since the top loading ensured there was current right to the top.

With the aid of Pythagoras, I calculated a 20m length was available sloping from the top of the TV tower to the bottom of the back fence. This antenna was built in the form of a two wire radiator (for wider bandwidth) using 20mm poly pipe for spacers. The loading coil (also on 20mm

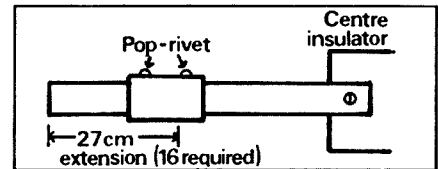

Modifications to Hills CA-16 antenna for 144 MHz

poly) is 2m from the top of the antenna; and a wire from the loading coil continues to the support, then folds back in two wires to the level of the loading coil.

The antenna base is matched to 50 ohms with an autotransformer of 50 turns to ground and tapped approx 5 turns from ground for co-ax feed to the shack. This way there are no problems with RF at the operating position.

The multi-band Yagi selected to replace the Quad was a TET HB433. This excellent 3 element beam covers the 40, 20, 15 and 10m bands. I installed a 10m crank-up tower for its support.

Whyalla is about 200km North West from Adelaide. I needed a low profile antenna for 2m SSB back to that centre. It may surprise many readers, but the path to Adelaide is always open on 2m SSB. It is a very reliable band for rag-chewing: I frequently work duplex 2m and 160. The antenna for 2m SSB is a 16

STOP THE PACKET RACKET ON HF!

COLIN RICHARDS 9M2CR
73 JALAN PANTAI 71000 PORT DICKSON MALAYSIA

Right at the outset, we should bear in mind that Amateur Packet AX.25 is a straight steal from Telecoms X.25 landline Packet — a system designed to operate on quiet and clean Telecom channels — not on radio links. Amateur Radio VHF/UHF paths offer a reasonable facsimile of a clean landline channel — hence the success and attraction of AX.25. Early kit-built TNCs were primarily aimed at users on VHF/UHF links and the modifications to run 300 bauds with 200 Hz shift were by way of an experiment by TAPR to see how Packet worked on HF. When ready-made TNCs appeared on sale — each one boasted HF facilities, as if this were automatically assured. Those who expected more microprocessor magic were soon disappointed to find that Packet Radio performed badly on the HF bands. You don't have to look far for the reasons.

Even the very shortest AX.25 packet frame is 152 bits long — leading flag (8 bits) + destination call (56 bits) + source call sign (56 bits) + control field (8 bits) + frame check sequence (16 bits) + trailing flag (8 bits) — more if bit stuffing takes place — and more again if you wish to digipeat. We haven't added a single word of communication or data yet — so that 19 bytes (152 bits) is a fixed overhead charge for each packet sent. The PACLEN command allows the user to set an upper limit to the number of data bytes in each packet. The default value of PACLEN is sometimes 128, sometimes 80 — depending on the TNC being used. 80 bytes

represents a single line of type, which seems a reasonable sort of target to aim at. This adds 640 bits to the 152 bits (minimum) overhead charge — giving a packet of at least 792 bits long. It needs just ONE of these bits to be corrupted for the whole frame to be discarded. At the HF packet speed of 300 bps this packet will take 2640 milliseconds to send. This means we need 2.64 seconds of perfect propagation to get the packet through unimpaired — no fading, no QRM, no static. What a hope! The result can be seen when you watch the struggling traffic on 14 MHz — retry after retry after retry.

In contrast, an AMTOR data block is only three characters (21 bits) long. At 100 bps it takes only 210 ms to send the block — against the 2640 ms required by our packet frame. In other words, the AMTOR block gets through in just one twelfth of the time taken by the Packet frame and the chances of interference are thus greatly reduced. Even if the Packet station tries to improve the odds by setting PACLEN to 40 (half a line of type) this shorter packet will still take 1573 milliseconds to send — 7 times as long as an AMTOR block. Remember, too, that AMTOR retries are much quicker and very much shorter than Packet.

The Packet user starts his first HF QSO and is delighted to see how quickly he gets connected. At this stage he probably doesn't know that the CONNECT packet is one of the shortest and therefore one of the easiest to send. The trouble

starts when he tries to send a message.

The first rude shock is to see that even when he gets a packet through, it will perhaps be only a short piece of a sentence. He may have to send 3 packets to complete the message before it makes sense to the station at the distant end. In the meantime, the distant station gets restless, wondering whether it is HIS turn to transmit, so he starts sending. In comes a piece of his opening sentence and Station 1 is surprised to see this jumbled in with the message HE is trying to send.

They pause and consult the 275-plus pages of the TNC manual and decide to send the command LC OFF. Incoming messages are now displayed in upper case, while outgoing messages are in lower case. Great — until they realise that at one command they have destroyed one of Packet's claims to fame — the ability to send both upper and lower case.

In an effort to tidy up the situation, Packet stations resort to sending >> at the end of each short message — like an old-fashioned "over to you". It's only a hint, so the other fellow may not notice it or may not even know what it means. No such nonsense with AMTOR, where +? passes over the transmission with precision. What's more, an AMTOR receiving station can "break-in" at any time, enabling real conversation to take place, in a logical fashion. No long wait for an ACK signal, no confusion at the sending end where the AMTOR TU is promptly switched from transmit to receive.

Continued page 12

element broadside collinear mounted at about 5m above ground. The reader may question mounting this antenna so low when it is intended for such long distance communication. But remember the propagation on this route is Tropospheric Scatter, and if the antenna is high enough to clear forward obstacles its height above ground is unimportant.

Collinear antennas are superior to Yagis for troposcatter work. This is because of their large capture area. If Yagis are to be used for such work they must be stacked. If you doubt the efficacy of this design see what fringe area antennas are used for tropo TV in Australia.

This antenna looks very good, indistinguishable from the Hills CA-16 fringe

area TV antenna it's made from. In fact the driven-element to reflector spacing of these antennas is just right for 2m. The antenna is modified for 2m simply by pop-riveting an extension to each element. (See Diagram.)

For 2m FM I use a 7/8 vertical. This excellent antenna, although used extensively in the USA, is not well known in Australia. A few people have tried extending a 5/8 vertical as an extra quarter wave does not give that antenna an unmanageable length; however, the results have been disappointing. My design gives a significant improvement over the 5/8, since it uses a phasing capacitor in order to phase out the current "null". I made mine out of surplus aluminium

tubing and incorporated a ground plane so that it could be mounted above the horizontal collinear. With this antenna I can work the Adelaide 2m repeater which is more than 200km from the QTH. It makes a great mobile antenna if you're looking for maximum range.

So there you are. Mine is an ordinary suburban back yard but I am still able to use all HF bands effectively. The design for the WARC/40/80 trapped dipole is especially effective for smaller blocks.

For further details, a SASE will bring a prompt response.

Refs. "An antenna for those other bands", Electronics Australia June 1985 "160-meter Shortie", QST November 1966 ar

Let's face it — Packet on any band is NOT a conversation mode. If you're a one-way talker or simply want to send messages, good enough. Packet is a bit like Dorothy Parker's famous dance style — "a stumble, a slip, and a 20-yard dash". AMTOR on the other hand is a "human-dimension" mode with its 66 wpm maximum speed neatly matching that of a reasonable competent keyboard operator. It is robust and friendly — with the sender seeing exactly and immediately what the distant station receives. No irritating chore of watching for an ACK signal on a jumble of TNC LEDs.

What about Packet's other major claim to fame? In the magic jargon — "time-domain-multiplexed carrier-sensed multiple-access digital communication". In other words, several QSOs simultaneously on a single channel. Monitor any 20m Packet channel and take a real look at what is happening.

Certainly there are call signs galore — many appearing at odd and distant intervals — much noise — scrappy bits of sentences, mostly repeated again and again because the other fellow didn't get it — earlier call signs vanish as they timeout in exasperation — endless rubbish scrolls up the screen — there's even a bit of a beacon message from someone crazy enough to load the channel with more garbage.

The Packet solution on 20m has been to give up overcrowded 14103 and start another channel 2 kHz up, and then another and another. Bang goes the second claim to fame — the single channel where everyone can be found. And, of course, the inevitable is happening; packet QRM is spreading down, too.

Enter the PBBS — easy because the system is portable — an XT clone and few dollars for the diskette. The PBBS is a sure-fire guarantee of bedlam because the operator is rarely in the shack to monitor its antics. Pity the poor fellow who used to run an SSB Net at the lower end of 20. There is no way in which he can eliminate the racket because the PR black boxes thrive on QRM as they continue their demented retries.

HF Packet chaos is compounded by the fact that many PR stations have only the flimsiest of notions about the frequencies they are transmitting or receiving. Thanks to the magic of NRZI they can send on either USB or LSB — who cares about Mark and Space? Few are able to tune accurately, even when they have tuning indicators on their TNCs. TNC indicators in any case are primitive devices, woefully ineffective on Packet bursts.

Milki Nakayama JR1SWB (JAMSAT design team) says that even if HF Packet

were run at 100 bps the 5 dB increase in power-per-bit would produce no significant improvement because noise on HF bands is not gaussian in nature. Current HDLC coding (ie AX.25), he says, can never be supported on a link with an error-rate between $10e-2$ and $10e-3$ (typical of HF) since there would be one bit error in even the shortest frame which would kill the packet immediately. The only solution, says Miki, would be to employ redundant coding (or error-correction coding) such as that used for the emergency communications link for Phase 3 satellites. Remember that Packet, and AMTOR for that matter, is an "error-detection" system only.

Karl Meinzer DJ4ZC (DARC Phase 3 design team) agrees that current modulation methods for Packet Radio are inefficient. He suggests that much of the attraction of Packet stems from the link-up of radio with computers, via the black-box magic of the TNC. In a way, he says, amateur radio has been led up a blind alley with AX.25, which does not lend itself to redundant coding.

There is now a vested interest, he says, in sticking to a dubious performer, since there is precious little chance of another TAPR/Vancouver-type campaign being mounted to design a better system.

The lesson to be learned from all this is that Packet Radio may be fascinating and fun for sending messages on VHF/UHF. It is NOT a real QSO mode and is grimly inefficient on HF, where AMTOR is ten times faster at getting messages through. Packet stations have now grudgingly agreed that AMTOR is the only way to send messages long-distance — hence the emergence of Packet/AMTOR Gateways.

What is disturbing to regular AMTOR users is that Gateway systems such as +APLINK+ are trampling on accepted AMTOR protocol by using mongrel packet-type commands and a CR/LF handover in place of the normal (and official) +? This is the result of trying to impose a Packet solution on an already-established AMTOR mode — the Packet tail trying to wag the AMTOR dog! A genuine AMTOR answer to the problem was set out with customary clarity and thoroughness by Peter in his description of the G3PLX AMTOR Gateway Mailbox in the Autumn '89 issue of DATACOM. Let's hope that +APLINK+ and others follow this good example.

Finally, a word of advice to newcomers to AMTOR. Since +APLINK+ is a cheap-and-easy Packet/AMTOR Mailbox and therefore commonly encountered, you may be misled into thinking that its user-unfriendly commands work also on genuine AMTOR Mailboxes. They don't! CR/

LF will NOT get your command through — so don't sit stupified at the keyboard-send +? and the world of AMTOR is open to you. You will find most AMTOR Mailboxes have friendly, conversational commands bearing little resemblance to Packet's esoteric mumbo-jumbo. And when in doubt, HELP+? will soon put you right!

Profile Colin Richards 9M2CR/GW3JET

Before retiring and settling in Malaysia, Colin was an engineer with British Telecom for 40 years. Of these, 26 were spent on secondment to ITU for work in developing countries in Africa and Asia. His task was to plan, build and sometimes run training centres for national telecoms administrations. He has worked in Kenya, Tanzania, Pakistan, Burma, Libya, Zambia, Nepal, Singapore, Bangladesh, Kuwait, Saudi Arabia, Iraq, Mozambique and Malaysia — collecting several exotic call signs on the way. As AP2CR in 1953 he was the first SSB station in Asia — using home-built gear. He is keen on AMTOR, tennis, classical music and reading. He says he is a squash player and a violinist with a promising past. His AMTOR Mailbox (selcal NMCR) has been in operation at 14078 (MARK) for the past 5 years and is well-known to VK callers. ar

Back issues of AR available to WIA members

Jan 1969 to Dec 1987
\$2.50 each

Jan 1988 to current issue
\$4.00 each

(Some issues out of stock)

Prices include postage

AR BACK ISSUES
PO Box 300 Caulfield
South
Vic 3162

THE KENWOOD TS-950SD HF TRANSCEIVER

EQUIPMENT REVIEW BY RON FISHER VK3OM
"GAALANUNGAH" 24 SUGARLOAF RD BEACONSFIELD UPPER 3808

Kenwood's new super rig has arrived at last. I say that because it was confidently expected to be on show at the Dayton Hamvention that I attended in 1988. No doubt the same expectation was there in 1989. Well at least we picked the right type number. The TS-950SD has quite a reputation to live up to. Its predecessors the TS-930S and TS-940S have not only set standards of performance but also standards of desirability. Ask any amateur which rig he would most like to own and chances are the answer would be a TS-940S. Add to this the superb transmitted and received audio quality that these rigs can produce and you certainly have the formula for success.

The overall design and concept of the new TS-950SD is of course based on the earlier TS-930S and TS-940S. With the advent of the TS-940S, there were many new features added over the TS-930S, but I cannot think of anything that was left out. The TS-950SD however does not follow this principle entirely; you certainly get more features but some of the excellent operating aids of the TS-940S have been dropped.

The TS-950SD Features And Functions

First impression of the TS-950SD is its size and weight. Just as the TS-940S was larger than the TS-930S, the TS-950SD is bigger again. Let's look at the overall dimensions. When I carried the box out to the car, I thought that I was puffing somewhat more than I should. After all it's only a transceiver. I later discovered that the packed weight is close to 30kg. The transceiver alone weighs in at 23kg. Over-all size is 409mm wide, 154 high and 446 deep. This last measurement is a whopping 96mm greater than the TS-940S. By the way, the overall weight is up 3kg. Before you buy a new TS-950SD, check the size of your desk.

The TS-950SD receives from 100 kHz to 30 MHz and tunes this range in 10 Hz steps. The large main tuning knob is weighted and has a good fly wheel effect but, as with the TS440/140/680 transceivers, the tension on the knob is now adjustable by holding the flange and rotating the control until the desired "feel"

is obtained. In addition to the main tuning control, a "VFO Channel" knob has been provided. Again this has the same function as the equivalent control on the TS-140/680, and allows the frequency to be stepped up or down in 10 kHz steps. This is a very handy feature to go from one end of the band to the other.

This control also acts as the memory channel selector when in the memory mode. Of course, it's also possible to select a frequency via the direct entry key board. The RIT/XIT has a range of +/- 9.99 kHz and the offset can now be preset before it is actually switched in — a very handy feature. Of course, there are two VFOs and a new form of VFO switching has been incorporated. Amateur band selection has been greatly improved. Direct access to each of the bands has as usual been provided via the keyboard, but now the last used frequency on each band remains, so that a sked set up on a particular frequency is not lost when another band is selected. However, the one feature that really sets the TS-950SD apart from its predecessors is the dual receive capability. The "Sub VFO" as it is called enables you to listen on any other frequency within plus or minus 500 kHz of the main receiver. The sub receiver shares the front end of the main receiver but has entirely separate IF and audio channels. It also has a separate frequency

read out and, of course, its own tuning control.

The TS-950SD sports 100 memory channels and these are all accessible from the front panel. It's no longer necessary to open the hatch on the top to select the various "banks" of memory channels. The memories are now capable of storing all sorts of information in addition to the required frequency. All 100 channels can store frequency, mode and required IF filter combination. Channels 0 to 89 can also store tone frequency data and tone on/off data. Channels 90 to 99 can be set up as tunable VFOs with the band limits programmed. Many of these features have of course been carried on from those first featured in the TS-140/680 transceivers.

A new feature is the selection of the IF filters in both the 455 kHz and 8.83 MHz IFs from a front panel control. A total of nine filters can be fitted, and our review transceiver had a full complement. They are as follows; At 8.83 MHz bandwidths of 6k, 2.7k, 500 Hz and an LC filter (wide band). At 455 kHz the choice is 12k (FM only), 6k, 2.7k, 500 Hz and 250 Hz. As there are independent controls for each IF frequency, any combination of filters can be selected. Of course, with two filters of the same bandwidth selected, the actual selectivity will be less than either. Just how this works out in practice will be discussed later.

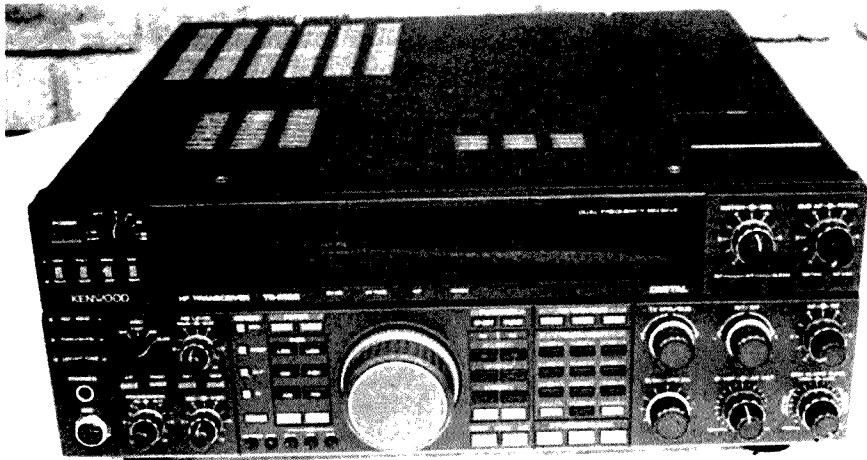

Here it is - the new Kenwood TS-950SD Digital

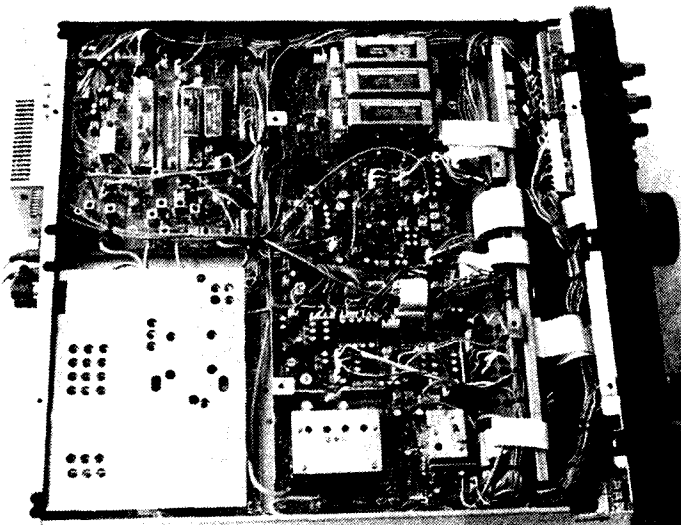

Bottom view of TS-950SD Digital. Note filter bank at top

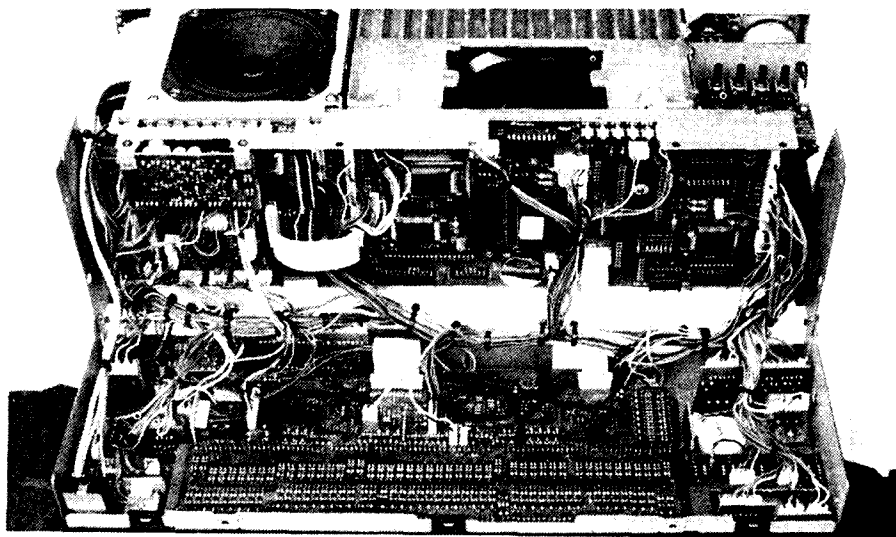

Front panel drops down for easy access

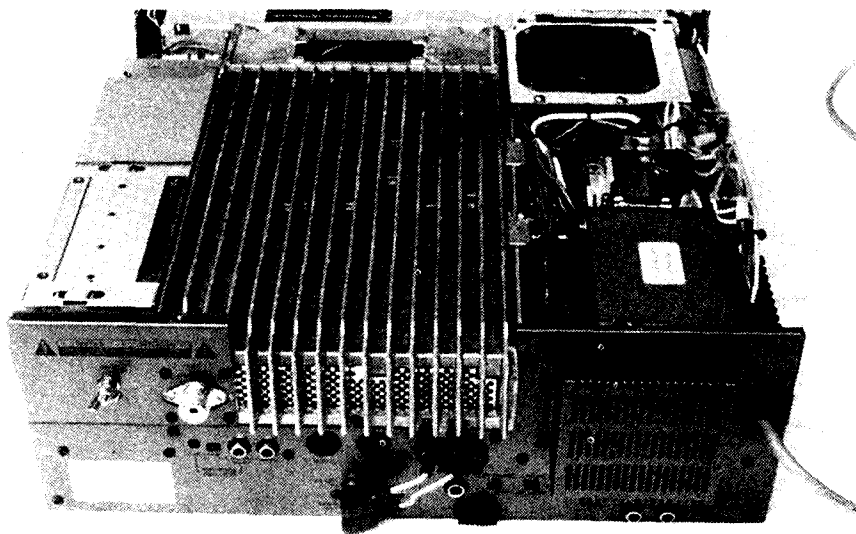

Note the extra large final heat sink. Power supply cooling fan is on the left

Another new feature is the meter, (or should I say meters?) The old analog moving coil meter is gone, and in its place is a multifunction fluorescent display meter. Now, before you start thinking of the LED type meters on VHF and UHF transceivers and that particular one on a certain HF transceiver of several years ago, let me explain. This is about the closest approximation to a real moving coil meter that you could imagine. It has all the advantages of an analog meter plus the instantaneous action of an electronic display. In addition, when in the transmit mode, up to three functions can be metered at the same time. The metering functions are; "S" meter, compression with speech processor operation, SWR with no forward setting required, ALC and Ic (transmitter final amplifier collector current). In the transmit mode, metering of RF power output is always on plus a choice of SWR and ALC, or compression and ALC, or Ic and either SWR or compression. The scales are very bright and easy to read. I can see that this is the way that future transceivers will be going. AGC selection now offers a medium delay position in addition to the normal slow, fast and off.

All the usual, and excellent, selectivity aids are included. These include the SSB slope tuning. This is a dual concentric 32 position stepped rotary switch providing adjustment of the lower and upper skirt positions in the SSB mode. The CW VBT is used for controlling the selectivity in the CW and RTTY modes, and a notch filter allows rejection of single frequency heterodynes.

The main digital frequency display is a good sized fluorescent type and is very easy to read. The 10 Hz readout is now normal and doesn't require connecting, snipping or switching to enable it. However it can be disabled if necessary. The digital/analog display under the main frequency readout can be set to give a full scale of either 1 MHz or 100 kHz.

There are three other frequency displays. Firstly there is the RIT/XIT. This is now capable of 10 Hz resolution as against 100 Hz on the TS930/940S. The two other frequency readouts to the right of the display area are the sub receiver readout and the transmit frequency display. (If split operation is taking place.) In between these and the RIT readout is the memory channel indicator. Also included in the main display area is the filter selection indicator, the VFO A/B indicator and the memory channel selection indicator. All in all, there is an indicator to tell you everything — except when it's time to eat.

Now what's missing compared with the TS-940S. That wonderful sub-dis-

play that actually told you what was happening with such varied things as the automatic antenna tuner. It contained a clock which could switch the transceiver on and off at selected times, and it gave a visual indication of the SSB slope tuning controls. These are all gone in the face of progress.

The increased size of the transceiver seems to be taken up by the extra large heat sink for the final amplifier. This is a large diecast panel than runs almost the entire depth of the rig. The cooling fan is now placed at the front — just behind the front panel. Air intake is through two small grills in the cabinet top panel. The cooling fan for the power supply is mounted at the rear, where its associated heatsink appears to be somewhat smaller than usual.

A speaker of reasonable size is mounted under the cabinet top cover, just behind the front panel on the right hand side.

Subjective Tests On The TS-950SD

Our review transceiver was the fully-optioned TS-950SD or Digital model. This included a full array of filters, the high stability master oscillator and the highly rated DSP-10 digital signal processor.

Initial setting-up of the transceiver is very easy. The only problem was getting it onto my desk. I certainly could not fit it where I have my TS-930S. It didn't take long to realise that the overall performance is very similar to my old TS-930S. However a few things stood out. The tuning knob on the TS-950SD actually spins a little easier than the TS-930S but I found that there was a small amount of horizontal slop in the control bearing. Hitting the edge of the knob to keep it spinning produced a disconcerting knock. I quickly checked the calibration accuracy on the BBC and Radio Australia on 21.7 MHz and found them spot on. Perhaps it's a good time to describe how this is done. I tune the station in the SSB mode, either upper or lower sideband until music sounds right. Note that speech will not do as 10 or 20 Hz variation will not be always evident, whereas this much error will be very noticeable on music. Now note the readout frequency, then change to the other sideband. If things don't sound quite the same you are off frequency. Of course, I am assuming that the BBC and RA are on the correct frequency. I think they are. Enough to say that the TS-950SD thinks that they are too. By the way, this test needs to be done at the highest possible frequency.

Tuning around, I got the impression that the received audio quality on SSB was not quite as good as my old TS-930S.

So, I set up the two transceivers side-by-side through a coax change over switch for some comparative tests. On a direct comparison, the received audio from the TS-950SD sounded rather muffled and no combination of IF filters changed the situation. I then decided to put the TS-950SD on to my noise and distortion meter and see what the story was. First the product detector distortion measured lower than any transceiver that I have yet tested at only .3%. Both the TS-930S and TS-940S measured around .6%. My guess is that the audio channel of the TS-950SD is tailored to cut off rather well down the high frequency end. This effect was also noticeable on AM where the response sounded very dull compared to the TS-930S.

It was now time to test the dual receive function. Firstly let's look at the two receivers. The main receiver is the one that has all the facilities like slope tune for SSB, filter selection etc. The "Sub" receiver has only one QRM reducing device, a noise blanker. It is a straight receiver with fixed SSB selectivity. However, for the purpose it's intended to fill, this is an excellent compromise. As it is controlled by the main synthesizer, the frequency stability and read-out accuracy is the same as the main receiver. The audio gain of both receivers is controlled by independent controls. I am not sure that this is an ideal system. Perhaps one audio gain plus a balance control might have been a better choice. As mentioned earlier, the "Sub" receiver only works over a +/- 500 kHz range of the main receiver. In other words, you are confined to the same band. I note with interest that at least one other make of transceiver is claiming full general coverage with their sub receiver — however this does introduce problems with antennas. If you have mono-band antennas which don't work very well on other frequencies, the actual sensitivity would be a long way down. If you are looking for dual band capability, a second transceiver might well be the easiest way around the problem (and cheapest). Having said all of that, the TS-950SD sub receiver works very well. I found that it was great for checking clear channels on 20 metres. I found it more satisfactory to listen to a clear channel than to try to listen to two conversations. However, it would be a great way to exercise your party ability to check the conversation next to you.

The most off-putting feature of the sub receiver is however the tuning control. The knob used is the same size and type as the RIT/XIT control and is just too small and fiddly to encourage much use. I forecast that, when the 960 is released (don't ask me when), this control will be

at least double the diameter, and hopefully also have some fly wheel effect.

Next, I tried out the transmit capability on both local and DX contacts. Kenwood make some interesting claims for their digital signal processor, and as it was installed in our review transceiver, it was a good opportunity to see how well it performed. It is claimed that the DSP-10 produces SSB signals of higher quality than normal through "modulation by the 10th phase shift network that digitally treats signals".

In the CW mode, "excellent characteristics are obtained through digital form-restoration of the wave shape".

Similar claims are made for AM, FM and FSK operation. The frequency response of the transmitted signal is adjustable via two rotary switches and four DIP switches in the DSP-10 unit, which is mounted in the bottom panel of the transceiver cabinet. These are really set and forget functions, as they are not readily accessible with the transceiver in normal use. For the purpose, I reasoned that if set to the widest response this would produce the best results. In the SSB mode, the High end can be set at 2600, 2750, 2900 or 3100 Hz. The low end at 400, 300, 200 or 110 Hz. In the AM mode it's interesting to note that the high end response is actually lower than SSB at 2900 Hz, but the bottom end can be extended down to 75 Hz. The response curves published in the manual show very sharp cutoff beyond these points. As I do not have access to a spectrum analyser, I cannot tell what effect the digital modulator has on the overall width or distortion of the transmitted signal. Certainly up to now, most distortion on SSB signals has been produced in various linear amplifiers in the form of 3rd, 5th and higher order intermodulation distortion. This could well be one area in which the TS-950SD excels with its new 50 volt operated final amplifier. However back to the test. I tried the TS-950SD and TS-930S in turn for comparative tests on dozens of contacts using my MC-60 microphone. The results are most interesting. 50% of the stations contacted stated that they could pick no difference between the two transceivers, and the other 50% said that the TS-930S sounded slightly better!

The manual also infers that the digital signal processor is also used on receive. I quote from the manual; "SSB Mode (received) AF slope tuning is provided by the digital filter, to suit the slope of this transceiver". If you know what this means please let me know.

I look forward to seeing an analysis of the digital signal unit taken on appropriate equipment in the future.

THE LADDER FILTER REVIVED

LLOYD BUTLER VK5BR
18 OTTAWA AVENUE PANORAMA 5041

In home-brewing a single sideband (SSB) transmitter, an essential requirement is a suitable intermediate frequency filter. Such a filter must have sufficient bandwidth to pass one sideband whilst having response shaped to attenuate the other. The ladder filter, using a number of crystal elements of the same frequency, has been popular in home-brew equipment as a means of achieving the required response.

Several articles in recent issues of Amateur Radio have dealt with these filters. Harold Hepburn (VK3AFQ) made use of such a filter in his building blocks and discussed their performance in the August 1987 issue. Rob Gurr (VK5RG) is

The CW operator has been very well catered for on the TS-950SD. Let's run through the facilities. Firstly you have a variety of optional CW filters, but even if you don't feel inclined to purchase any of these, the IF VBT control is able to narrow the receiver to a degree that will satisfy all but the most ardent of CW operators. To back this up, the AF VBT adjusts the audio selectivity. There is also a CW pitch control which allows adjustment of the CW note without actually shifting the received or transmitted frequency. Semi or full break-in keying is available. An electronic keyer is built in and both manual and automatic weight adjustment is provided. In the auto position, either a longer dash for a slower keying speed or a shorter dash for a faster keying speed is selectable. If you are a keen CW operator then the TS-950SD has been built with you in mind. Talking about morse code, all mode selections are accompanied with the appropriate morse identification.

An improved automatic antenna tuner is built into the TS-950SD. This is capable of matching a load of about 20 to 150 ohms, or in other words an SWR of about 3 : 1 maximum. While tuning, the power output of the transceiver is set to about 10 watts to protect the final amplifier (and I suspect the ATU as well) while the system is unmatched.

The ATU now has a memory function that retains the setting for each band and it automatically retunes as the band is changed. I found that a match was obtained within about three or four seconds. Note that this ATU like many other

well known in our region for his experimentation with home-brew circuits. In the November 1982 and January 1984 issues of the journal, Rob described experiments he had carried out on these filters.

Both Harold and Rob have referred to articles prepared by J A Hardcastle (G2JIR). The most useful of these is one published in the February 1979 issue of Radio Communication. In this article, a method is described by which the precise components can be selected for a given set of crystals to give a required bandwidth. The method initially entails setting up a test circuit with two of the crystals to measure a sample bandwidth.

contemporary units is designed to feed an unbalanced load only. It is not designed to couple into a balanced feeder system.

Again, like the TS-140/680S, many functions can be modified as the transceiver is first switched on. Just to run through a few of them, VFO channel 10 or 5 kHz stepping, meter peak hold on/off, 1 MHz up/down changed to 500 kHz, beep tones on/off, program scan hold on/off. In all there are 17 different changeable functions that can be preset in this way.

Of course the TS-950SD is fully computer compatible. All that is required is the optional IF-232C interface. Most of the transceiver's functions can be controlled from your computer.

I note in the Kenwood advertisements that a new line of matching accessories have been released. A matching loudspeaker unit and a new matching monitor scope are included. I look forward to seeing each of these in due course. The existing range of Kenwood microphones are recommended for use with the TS-950SD and a standard MC-43S hand microphone is supplied as standard equipment.

One final point. I was surprised to find that the AC power cord now goes directly into the transceiver through a grommet in the rear panel. The handy IEC power connector has disappeared.

The TS-950SD Instruction Manual

The instruction manual deserves high marks. Not 100% mind you. I still think

Using this measurement as a reference, the circuit component values are then calculated to give the required bandwidth in the complete ladder filter. Coefficients are given which enable calculation of component values for filters containing three, four, six, or eight crystal elements.

The G3JIR article covers quite a bit of ground, but for those who might be interested I thought I would set out the G3JIR procedure in a simplified form and then follow up with some results of its application using sample batches of crystals. All in all, the procedure works very well, but to carry it out test equipment is needed to plot spectral response so that bandwidth
Continued page 18

most manuals don't contain enough technical information these days, and this one is no exception. Operating instructions are in general well covered. There are 88 controls on the front panel which all require individual explanation, and this is done in a clear and concise manner. At the start of the front panel explanation section, a diagram of the front panel is shown divided into seven segments. Each of these segments is labelled with the page number where the explanation can be found. There is even a short (page and a third) technical description of the transceiver. There is information on the installation of the optional filters (950S) and a few basic adjustments.

The TS-950SD Conclusions

I have to say that the new TS-950SD is not up to what I thought it might be. A few things didn't turn me on. I didn't like the very sombre black cabinet and front panel. (Very much a matter of opinion I agree.)

However, having said that, I am sure that this will again be a top seller for Kenwood. There is no doubt about it, this transceiver has the capability of giving excellent results in all modes, and for the keen operator it offers facilities not currently available in any other transceiver. Our thanks to Kenwood Electronics Australia Pty Ltd for the loan of our review transceiver. ar

Amateur Radio
Helping our community

The Ultimate 2 Metre Hand-held Transceiver



The FT-411 is a top-of-the-line ultra compact 2 metre handheld offering an incredible array of features without the size and weight of previous sets. Expanding on the microprocessor controlled features of previous models, the front panel multi-function back-lit keypad allows easy frequency entry, selection of the 49 tunable memories (which store repeater shifts, or separate Tx/Rx frequencies), setting of the programmable-interval 'power-saver' system, as well as a host of other convenience features. CPU control also offers 2 VFO's, rotary dial tuning with 5 selectable tuning steps, a multi-function back-lit 6 digit LCD screen with bargraph Signal/P.O. meter, and a range of scanning options. Even VOX (voice-activated transmit) circuitry is provided, allowing hands-free operation with the optional YH-2 headset.

Yaesu have also recognised that a hand-held radio must be ruggedly constructed, and yet be small enough and light enough to carry around all day. Through the extensive use of surface-mounted components, a heavy duty die-cast rear panel, rubber gasket seals around all external controls and connectors, and a carry case supplied as standard, the FT-411 will provide reliable operation even in dusty or humid environments while measuring only 55 (W) x 155 (H) x 32mm (D), and weighting less than 550 grams (including a high capacity 1000mAh FNB-14 NiCd battery giving 2.5W output). A range of inexpensive optional accessories are also available to provide flexibility for users differing requirements. See ARA review Vol 12 Issue 3.

Complete Package: FT-411, FNB-14 7.2V NiCd, Carry Case, Antenna, Belt Clip, Approved AC Charger, **BONUS** PA-6 DC Adaptor.

SAVE \$39⁹⁵

\$469

Optional Accessories

FNB-11 600mAh NiCd Battery (5W output)
 MH-12A2B Speaker/Microphone
 YH-2 Mic/Earphone Headset

D-3350

D-3496 \$99.00
 D-2115 \$49.95
 D-2200 \$49.95

**EXCLUSIVE
2 YEAR WARRANTY**

YAESU STOCKS NOT HELD AT ALL STORES. PLEASE CONTACT YOUR LOCAL STORE FOR STOCK AVAILABILITY. OR ORDER BY PHONE...



N.S.W.: ARMIDALE: New England Electronics 711655 BALLINA: Ballina Electronics 867022 BOWRAL: F.R.H. Electrical 611861 BROKEN HILL: Hobbies & Electronics 884098 COFFS HARBOUR: Coffs Harbour Electronics 525684 DENILIQUIN: Deni Electronics 813672 DUBBO: Chris & F. 828711 FORSTER: Foster Village Electronics 545006 GLENINNES: Conn Somersdale Electronics 323661 GRAFTON: Repairs and Spares 421911 GRIFFITH: Matronics 624534 INVERELL: Inverell Electronics 221821 LEETON: Leeton Electronics 532800 LISMORE: Decro Electronic Services 214137 MOREE: Moree Electronics 523458 MUDGEE: Headware 723895 NARRABRI: Name Computer Service 923274 NOWRA: Nowra Electronics 210722 ORANGE: Central West Electronics 626491 PARKES: Strad Music Centre 623366 PORT MACQUARIE: Comdex 834574 TAREE: Brad's Electronics 526603 WAGGA WAGGA: Philips Electronics 216558 YASS: Warmington Electrical 2261116 VIC: BAINSDALE: LH & MCrawford 525677 MILDURA: P. J. Jiman Auto Pro 232882 MORWELL: Maxwell Electronics 346133 SHEPPARTON: Andrew G. Wyatt Electronics 219497 WARRNAMBOOL: Martronics 629870 QLD: AYR: Delta Electric 831566 BUNDABERG: Bob Ekin Electronics 721785 MACKAY: Stevens Electronics 511723 MARYBOROUGH: Keller Electronics 214559 PIALBA: Keller Electronics 283749 TAS: BURNIE: Electronic City 314760 DEVONPORT: A.J. Electronics 248322 SA: LOXTON: G & S Electrical 847495 MT GAMBIER: Hutcheson's Communication Centre 250400 PORT LINCOLN: Bassham's TV & Computer World 822788 WHYALLA: Eyre Electronics 454764 WA: ALBANY: Micro Electronics 412077 BUNBURY: Micro Electronics 216222 GERALDTON: Balavia Lighting & Electrical 211966 KARRATHA: Daves Oscillon c 854636 MANDURAH: Micro Electronics 412077

can be resolved. Access to a spectrum analyser or some form of sweep generator makes measurement simple but such devices are not usually available to the radio amateur. The minimum requirement is a stable signal generator and a frequency counter to set accurately closely spaced spot frequencies. Some form of device which can measure signal amplitude at the frequencies concerned, such as a calibrated CRO or a VTVM is also needed.

The G3JIR Procedure

The first operation is to connect up the test circuit with two of the crystals as shown in figure 1. Capacitors (C1) are set to an arbitrary value, suggested as 33 pF. The source resistance and load resistance are set to a value R which is calculated as follows:

$$R = \frac{0.613 \times 10^6}{2 \pi f C1} \quad \text{----- (1)}$$

where f - the crystal frequency in MHz
& C1 - capacitance in pF

The source resistance is made up of the output resistance of the sweep generator, or the signal generator and an additional resistance to make up the total value of R. The output is terminated in a resistance, also equal to R, across which is connected the input the spectrum analyser, CRO or VTVM via a high impedance probe. The high impedance probe is needed to prevent detuning of the circuit.

A spectral response curve is plotted and the 3 dB bandwidth (or bandwidth of signal within 0.707 of the level at centre frequency) is scaled off.

Filter bandwidth is approximately inversely proportional to the square root of coupling capacitance and from this relationship, a new value of capacitance (C2) is calculated for the required bandwidth (say 2.5 kHz) as follows:

$$C2 = C1 (BW1/BW2)^2 \quad \text{----- (2)}$$

where BW1 = Bandwidth previously measured
& BW2 = The new bandwidth required

A new value of R is then calculated as follows:

$$R = \frac{0.613 \times 10^6}{2 \pi f C2} \quad \text{----- (3)}$$

Refer now to figure 2 and select the form of filter suited to the number of crystal elements it is proposed to use. (The higher the number, the sharper the filter but selection might depend on how many crystals one happens to have.) Apply the following formula to each ca-

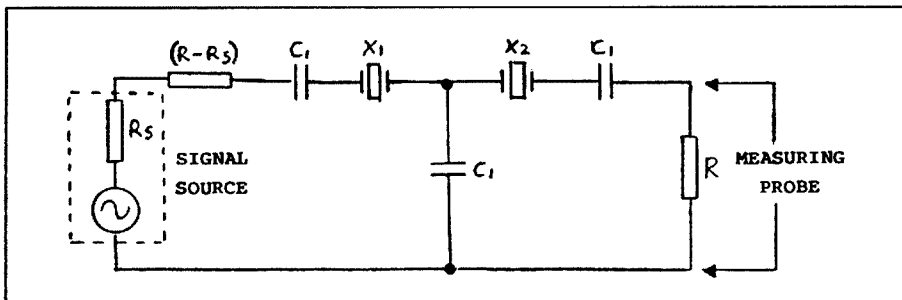

Figure 1 Test arrangement using two crystals

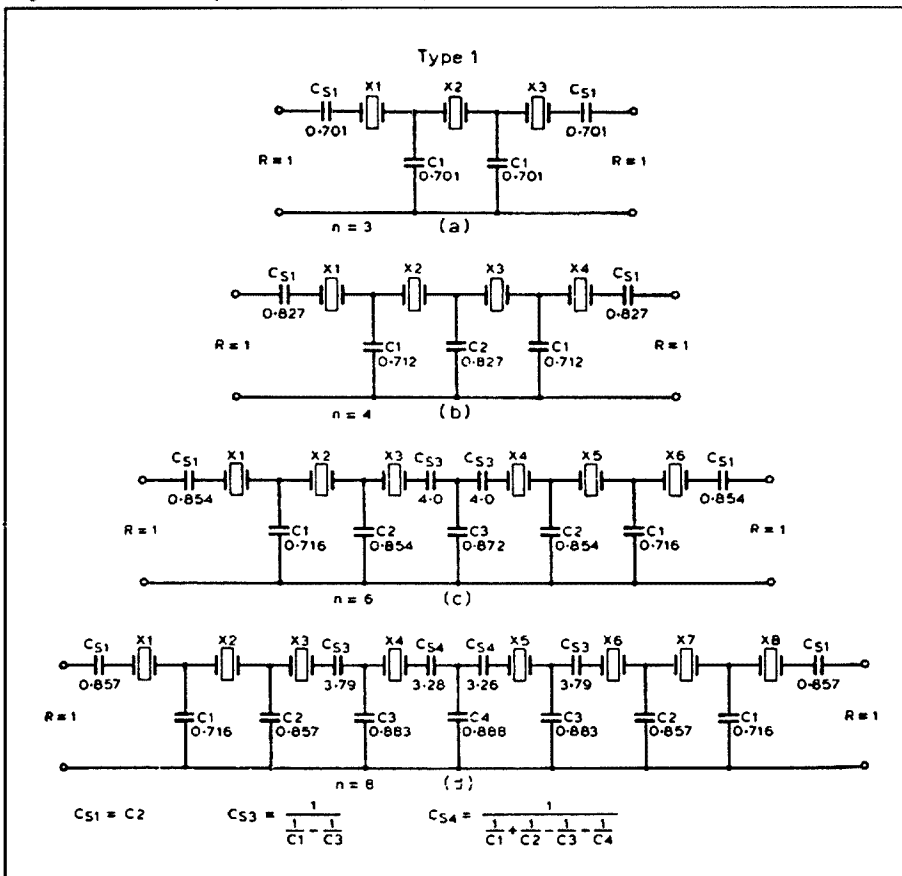

Figure 2 Capacitor coefficients for 3, 4, 6 & 8 crystal assemblies

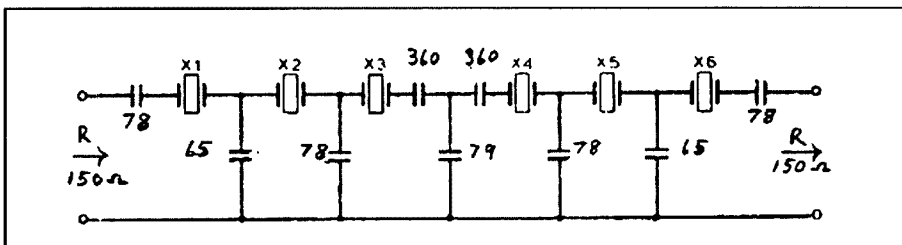

Figure 3 11.5 MHz Ladder filter - circuit diagram. Capacitor values in pF.

pacitor element in the circuit selected:
 $C(\text{pF}) = \frac{K \times 10^6}{2 \pi f R} \quad \text{----- (4)}$

where K = The capacitor coefficient shown in the circuit (fig 2)

f = Frequency in MHz

R = Source & load resistance derived in (3)

Wire up the filter using the capacitance values calculated. It might be necessary to parallel some preferred values of capacitors to obtain values close to those calculated.

The test circuit is again connected up but with the completely wired-up filter and with the new value of source resis-

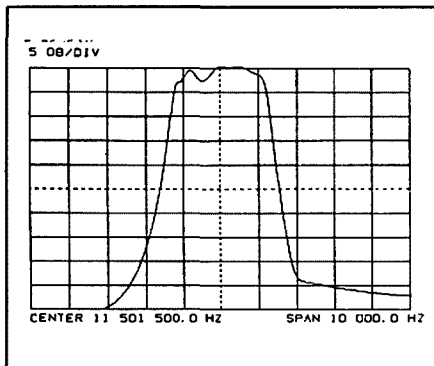

Figure 4 11.5 MHz Ladder filter unit 1 - Response

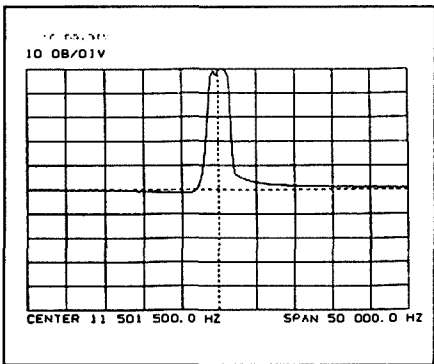

Figure 5 11.5 MHz ladder Filter unit 1 - Response (scales expanded)

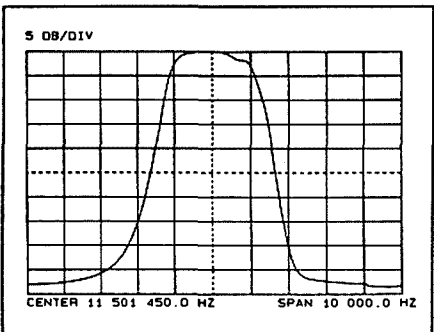

Figure 6 11.5 MHz ladder filter unit 2 - Response (same scales as Figure 4)

tance and load resistance (R) calculated from (3). The response curve is now checked and hopefully it should have the bandwidth required, with nice steep sides and high out of band attenuation.

Choice of Crystals

The choice of crystal frequency is largely dependent on what crystals one can get at the right price. Frequencies within the range of 8 to 10 MHz seem to be the popular choice for amateur radio SSB use. The idea is to build the filter first and then design the transmitter around an intermediate frequency set by the filter. Crystals should be closely matched in their characteristics to ob-

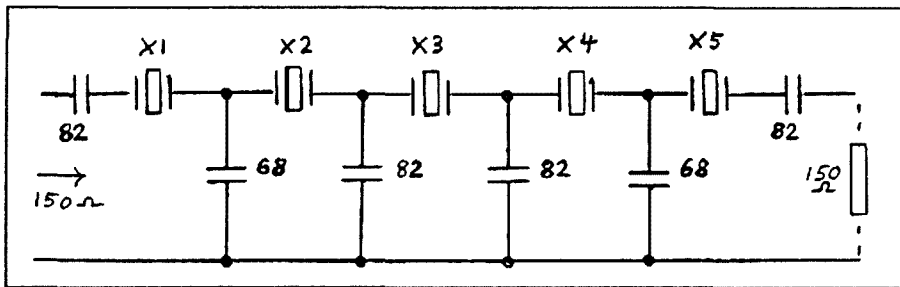

Figure 7 9 MHz (CB Crystal) ladder filter - circuit diagram. Capacitor values in pF.

tain good results. The best one can do is to select a number of them from the same manufacturing batch. Some cheaply available crystals are those made in bulk for computers and CB radio. The CB crystals are used on third overtone at 27 MHz and have a fundamental frequency around 9 MHz. Batches of crystals often come up at amateur radio buy and sell marts and are worth watching out for at those sales. Some of the crystals discussed in this article came from such a source.

Not all crystals have characteristics which enable a suitable bandwidth to be obtained for SSB. Tests were carried out on one batch of FT243 style crystals, with a frequency around 5 MHz. Using these, the capacitance values calculated for 2.5 kHz bandwidth proved to be unachievably small. The widest bandwidth achievable in practice proved to be around 1 kHz using capacitance values in the order of 15 pF.

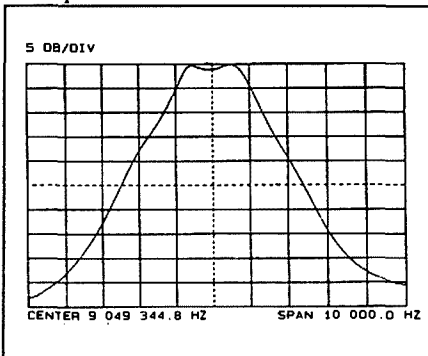

Figure 8 9 MHz ladder filter - response

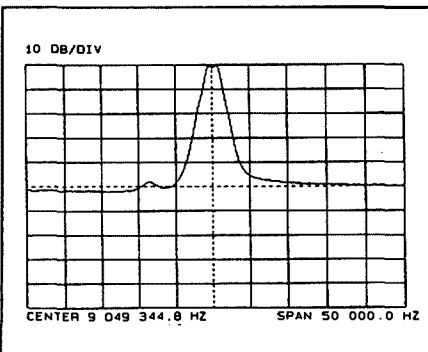

Figure 9 9 MHz ladder filter - response (scales expanded)

Some Practical Results

Two sets of 11.5 MHz filters, each with 6 crystal units, were made up using the G3JIR procedure. A further 9.05 MHz filter using five 27 MHz third-overtone crystals was assembled. The G3JIR procedure was also used for this filter except that a little guess work was applied in selecting the K coefficients. This was because no reference could be found for the use of five crystals in a filter but five was the total on hand. All the articles referred to four crystals or six crystals but not five. In applying expression (2), a value of $BW2 = 2.5$ kHz was used in each filter calculation.

The capacitance values calculated for the 11.5 MHz units are shown in figure 3. The performance achieved using capacitors trimmed to near these values are listed as follows:

Unit 1

Centre Frequency:	11.501500 MHz
3 dB bandwidth:	2.18 kHz
6 dB bandwidth:	2.49 kHz
Bandwidth of 45 dB down:	4.9 kHz
Out of band rejection:	52 dB
Passband ripple:	Refer figure 4

Unit 2

Centre Frequency:	11.501450 MHz
3 dB bandwidth:	2.01 kHz
6 dB bandwidth:	2.33 kHz
Bandwidth 45 dB down:	4.9 kHz
Out of band rejection:	48.5 dB
Passband ripple:	Refer figure 6.

Figures 4 and 5 show the spectral response of No 1 unit 11.5 MHz filter. Figure 4 has scales of 1 kHz per division and 5 dB per division whereas figure 5 has scales expanded to 5 kHz per division and 10 dB per division. Figure 6 shows the response of No 2 filter with the first scales.

The passband ripple is more pronounced in No 1 unit than in No 2 unit. They were all the same type of crystal but perhaps the No 2 batch were a little better matched than No 1 batch.

Figure 7 shows the capacitance values selected for the 9 MHz filter. This produced the following performance figures:

MOUNT MINTO - ANTARCTIC BICENTENNIAL EXPEDITION

DON RICHARDS VK2BXM/VKØAT
THE SKI INN SACKVILLE ROAD EBENEZER 2756

Inland from the coast of the Ross Sea, Antarctica, Mount Minto has long been a challenge to mountain climbers. Some of the features that make it attractive to people who enjoy adventure are these: At 4,300m, it is one of the tallest peaks on the continent, the period of time during which it can be approached is limited to a few weeks each year and approach and access are difficult and dangerous. Assuming a climbing party can get ashore, and there are only one or two suitable landing spots, the climbers then have to get up on to the ice shelf and find their way along the maze of glaciers leading towards the summit. They may have to travel 300km to reach the mountain and return, so food, tents, and equipment to see them over that distance, plus whatever is necessary for a margin of safety have to be taken.

There have been two unsuccessful attempts on Mount Minto in recent years, each by a group of climbers from Austria. Their first attempt, in 1986, ended in disaster when the ship carrying them, the Southern Quest, was caught in the ice in the Ross Sea and sank. No lives were lost and they tried again the following year. This time they were delayed by the late arrival of their charter ship at Christchurch and missed the short summer period when there is some chance of making a landing on the coast of the Ross Sea. So they never left Christchurch for

the south and returned home, disappointed but anxious to try again.

In 1984 a group of Australian climbers made an ascent of Mt Everest, the first by an Australian expedition and the first ever without oxygen. A leader in that group was Greg Mortimer and he had been discussing a plan to climb Mount Minto with the Directors of the Oceanic Research Foundation for several years.

The ORF owns the steel schooner, the *Dick Smith Explorer* and in her had already made three successful voyages to the Antarctic. It seemed that if there was to be a first for Australia in the Bicentennial year, now was the time for the Mount Minto Expedition to get going.

So on the last day of 1987 a tiny red schooner cleared Sydney Heads and set course for the Ross Sea, Antarctica, about



Another view of the *Allan and Vi Thistlethwayte*. Note 6m vertical mounted on handrail

Centre Frequency: 9.049345 MHz
3 dB bandwidth: 1.94 kHz
6 dB bandwidth: 2.3 kHz
Bandwidth 45 dB down: 9 kHz
Out of band rejection: 50 dB
Passband ripple: Refer figure 8

Figures 8 and 9 show the spectral response of the 9 MHz filter using the same scales as those used for the 11.5 MHz filter in figures 4 and 5.

Both the 11.5 MHz units and 9 MHz units were operated with a source resistance and load resistance of 150 ohms. It was coincidence that the calculation of R in both filters worked out to near this value.

Referring to each of the response curves, the side slopes of the 11.5 MHz units are seen to be much steeper than those of the 9 MHz unit and hence the 11.5 units would make better SSB filters

to reject the adjacent sideband. One could offer conjecture as to why the 9 MHz unit did not perform quite as well as the others. Perhaps the crystal Q factors were lower or perhaps the choice of K coefficients was not quite correct. Apart from that, there was one extra crystal in the 11 MHz units to improve the shape.

One observation is that each of the filters produced a 3 dB bandwidth of near 2 kHz for a value of BW2 selected as 2.5 kHz in expression (2). Bandwidth BW2 applies to the two crystal test filter of figure 1 and based on the results achieved, one must conclude that this bandwidth value should be selected around 25% greater than that required for the complete filter with five or six crystals.

Summary

Because of the spread of characteris-

tics in different batches of crystals, one cannot connect up a number of given crystals in a ladder circuit with a pre-allocated set of capacitance values and expect to obtain a specific pre-determined performance. Capacitance values must be selected to suit the particular crystals used and the G3JIR procedure outlined is a reliable method of determining these values. The procedure involves the use of some measuring techniques but these are well within capacity of the experimental radio amateur who has access to suitable test equipment.

Providing a cheap source of closely matched crystals can be obtained, construction of the ladder filter is an economical way of obtaining a wide band but selective filter for such applications as SSB. ar



Held by pack ice near the entrance to the Ross Sea. Don VK2BXM contemplates the situation

2,500 nautical miles away. On board were 11 people, together forming a mountaineering group of six and a ship's crew of five. They carried provisions for 12 months and equipment for a 300 km ice-traverse, including a motorised sledge. The ship, originally the *Dick Smith Explorer*, had been renamed the *Allan and Vi Thistlethwayte*, in honour of a generous sponsor and his wife.

The Plan . . .

There are two possible approaches to Mount Minto from the sea. One is to land on the western side of Cape Adare and for a mountain party, by a route not yet discovered, to make their way to the ice-cap and then to follow glaciers to the foot of the summit. To reach the ice-cap would be difficult, if not impossible as the rock is sheer and the ice-cliffs almost vertical. However, there is a reasonable possibility of the shore-line being accessible, so the mountain party could at least get ashore, although they could then be confronted with a major problem.

The preferred approach is from Cape Hallett, further south and in the Ross Sea proper. Cape Hallett is the site of an abandoned joint USA/NZ base. Most of the buildings have been removed and the penguins have regained their rookery. It lies on Adisto Inlet, in Moubay Bay and at the head of the inlet is Football saddle. Over the saddle is the Tucker glacier, leading towards Mount Minto, fed by other glaciers leading to the foot of the summit. Cape Hallett could be frozen-in and unapproachable, but was the first place to have a look at, Cape Adare being a bad second.

The plan was for the mountaineers to set off from the ship as soon as possible

after landing, reach the foot of the summit, establish a base camp, make the climb and return. The ship would wait at the landing spot, weather and ice permitting, or else put to sea and hope to get back in again when the party returned. All this could take 3-4 weeks, leading to the time when the ice was growing out from the shore-line into the freezing ocean, trapping the ship if she stayed in or preventing her from getting back if it were necessary to put to sea whilst the mountaineers were away.

So, that was the plan, and for it to succeed in the light of all the things that could go wrong, good radio communication was essential. As skipper of the ship and also radio operator, I had a deep interest in making sure that we were able to maintain good communication with both the outside world and the mountain climbers once they were ashore.

Radio Communication . . .

For a ship of her size (20m overall), the vessel is fairly well equipped. The normal ship's radio consists of two crystal controlled Stingray transceivers, installed in 1981, feeding a wire antenna through an EAT300 manual ATU. This all works quite well, the EAT300 giving a match from 2MHz through to 15MHz, but of course we are limited by the frequencies of the crystals fitted. On our last four or five voyages, including the last two voyages to Antarctica I have used on the amateur bands a Kenwood TS-430S and this was installed for the trip. We carried in addition a Kenwood TS-680S, a TR-751A for 2m, a 6m linear, and Harbour Control VHF gear; the lot in-

A Call to all Holders of a Novice Licence

Now you have joined the ranks of amateur radio, why not extend your activities?

The Wireless Institute of Australia (N.S.W. Division) conducts a Bridging Correspondence Course for the AOCF and LAOCF Examinations.

Throughout the Course, your papers are checked and commented upon to lead you to a successful conclusion.

For further details write to:

The Course Supervisor
WIA

PO Box 1066
Parramatta NSW 2124
(109 Wigram Street, Parramatta)
Phone: (02) 689 2417

11am to 2pm Monday to Friday
7 to 9pm Wednesday

AR 20 YEAR INDEX

IBM format 5 1/4 inch floppy disk dBase 111

Plus

.DBF file \$10.00

ASCII \$10.00

Compiled

.EXE file \$10.00

36 page printout \$5.00

Prices include disk (where applicable) and postage.

AR 20 Year Index
PO Box 300
Caulfield South
Vic 3162

stalled and ready to go!

For this expedition I put up an additional long wire antenna, a trapped wire for 80m for use until we were well away, a 20m dipole and a 6m vertical. Stowed in the engine room was a 6m Yagi for use on arrival. For work on shore were numerous hand-helds and light-weight equipment loaned by Codan and the Australian Antarctic Division. Everything was checked and tested before we left.

During an expedition to Commonwealth Bay, Antarctica, in the summer of 1984/85 I had tried to make contact with Australian amateurs on 2m sideband using about 100w and a beam set up on the after-deck whilst the ship was moored in Mawson's Boat Harbour, almost alongside his huts. This had not resulted in any contacts so Roger Harrison suggested that this time I should give 6m a try.

An amateur on Macquarie Island, which is about the half-way mark between Sydney and the Ross Sea, had already established contact with Australia on 6m during, I think, the previous year, but operation on that frequency had since been discontinued. Hence, the TS-680S (with its 6m facility) and the linear, with attendant antennas. The TS-680S would also be back-up for the TS-430S on the HF amateur bands, although that unit had not missed a beat (and hardly a sked) in the past. The 6m vertical was for use at sea, the 6m Yagi to be assembled and set up on shore or on the ship when we arrived.

Based on my previous experience, I did not expect to be able to pass traffic to Australian Coastal Radio stations once we were well away from the coast and I was relying on daily contact with Les, VK2LW, to pass position reports, news and family messages. The IPS in Sydney had given me frequency predictions for the voyage south, for the period when we were likely to be at anchor and for the return voyage. I had information on frequencies normally used by the Australian, New Zealand, USA, Italian, French and Russian Antarctic bases, the ship *Greenpeace* and the *Greenpeace* base. I had made arrangements to contact Sojo, ZL5BA, who was travelling on the ship *Greenpeace*, making for their base in the Ross Sea, where he would be radio operator for the coming 12 months.

The Voyage South

... went well. Departure from Sydney was somewhat later than originally planned which meant that the expedition time frame was compressed as we had to be out of the Ross Sea on the way

home before it started to freeze with the coming of winter.

At sea on 8 January 1988 on 52.050 MHz I worked two NZ stations, ZL3THM and ZL3TOT at position 43deg 41m S, 152deg 26m E, and on 11 January 1988 I worked VK2XJ and VK2VC on the same frequency at position 48deg 24m S, 153deg 50m E. On these contacts we were about 900 nautical miles from Christchurch and 800 nautical miles from Sydney. Contact was made each night with VK2LW to pass a position and situation report. If conditions were reasonable people on board would pass messages back to family and friends and talk with them if they visited VK2LW or a neighbouring amateur. As time went on Les gathered quite a group of interested amateurs around our frequency and I had contacts with many Australian and European amateurs. This was a pattern that continued throughout the expedition.

Communication was established with Macquarie Island on the commercial band as we sailed south. I had originally planned that our course would be to the west of Macquarie but as we approached the island gales from the west looked like forcing us dangerously close to its coast so a course change was made to take us north of the island and south along its east coast. Communication was good with Macquarie, the operators helpful and friendly and we were able to hold contact until our final approach to the Antarctic continent. They passed a daily weather forecast to us and the fact that it usually accurately predicted strong winds and rain from the west was not their fault.

About one day's sail from landfall at Cape Adare, we got stuck in a band of ice lying across the entrance to the Ross Sea. Colin Putt, my mate and ship's engineer, had often talked about what we would do if confronted by pack ice and we had decided "keep out of it". The ship, although stoutly built, is not ice-strengthened and to damage or lose her in dangerous conditions in a remote area could mean the end of the expedition and those on board. The sinking of the *Southern Quest* in the Ross Sea was still fresh in our minds. However, when we were confronted by ice, so close to landfall after almost four weeks at sea and pack that held some promise of leads to the south, we entered it and tried to push and shove our way through. Twelve hours later and a lot of red paint on the ice from our hull, we could go no further. Open water was visible to the south less than a kilometre away, but we were held firmly by pack that was starting to freeze together as the night temperatures fell. To help

things along it started snowing.

I reported our position and situation to Les, to the ship *Greenpeace*, to the Italian base at Terra Nova Bay, to the USA icebreaker *Polar Star* and to the USA base at McMurdo. In fact, to just about everyone I could contact. So there we sat, the weather worsening, the crew stretching their legs on the ice, penguins and seals looking on and everyone wondering how it would all end up.

It ended about 36 hours later, with the ice parting to the south and a lead opening that allowed us to push our way through into calm, open water. Then I got back on the radio to tell everyone that we were out of the ice and to stop worrying.

On Monday February 2nd, 31 days after leaving Sydney, our ship was moored to the ice-edge inside a rocky spit at Cape Hallett and goods were being unloaded in preparation for the climb of Mount Minto.

The Approach

... to Mount Minto from our anchorage in Edisto Inlet was across the sea-ice to the head of the inlet, over a saddle and on to the Tucker glacier, then along the glacier to its intersection with the Man-of-war glacier, and along that glacier to the foot of Minto. The plan was to use a motorised sledge, called a skidoo, to haul smaller sledges carrying the expedition's supplies.

The mountaineers carried two radios, one a portable of about 10 watts output and the other a hand-held of less than 1 watt. Skeds were set up for each evening, with various other times and frequencies nominated in the event of being unable to make contact.

In making the hard haul over the saddle to the glacier, the skidoo used much more fuel than anticipated, so two climbers returned to the ship in the skidoo for further supplies. They left the skidoo at the head of the inlet and we were able to pick them up in the inflatable boats, as the ice was starting to move out of the inlet. Overnight, it cleared completely and when they returned next day to where they had left the skidoo, there was open water. Either the skidoo had floated out to sea on a floe or it had fallen through the ice to the bottom of the inlet. During this time the ship was in good communication with the climbers and the returning party, so everyone knew what was happening as it happened. This enabled the leader of the party, Greg Mortimer, to change the programme and prepare for a man-haul to the foot of the summit. Again, we were trying to cram more into the time frame as it would obviously take longer to reach the foot of the mount and the ship still had to be out of the Ross Sea before

the ice came in again.

Each night we spoke to the mountain party from the ship and plotted their position as they moved slowly up the Tucker glacier. We gave them weather forecasts and messages from home; they gave us their position and plans for the next day. Two weeks after leaving the ship they were camped at the foot of Mount Minto waiting for the weather to clear for the final climb. Meanwhile the ship *Greenpeace* was making for Cape Hallett to carry out an inspection of the site of the abandoned USA/NZ base there. Radio contact had been established with *Greenpeace* several weeks previously and they had been following our activities closely, sometimes joining in the evening skeds with the mountain party. They were the main source of our weather and ice reports and we were looking forward to meeting them and directly thanking them for their help. We were to owe them more before leaving Cape Hallett.

During Thursday February 18 the mountaineers made the ascent of Mount Minto and when we spoke on the night of the 19th they were back at the camp on Man-o-war glacier. They did not carry a radio on the last part of the climb and carried only enough food to allow themselves one day's delay in the event of foul weather.

Time was now pressing us as sea-ice was starting to form and we had moved out of our secure anchorage as it was freezing over and the ship would be trapped. A gale had been blowing for several days and we had been motoring around the inlet trying to get the anchor to hold on the rocky bottom without success. We found the best way to shelter from the wind was to get in the lee of a berg or ice cliff, put the bow of the ship into it and keep the engine running slowly in gear. In view of all the circumstances and the fact that the climb was over, I asked *Greenpeace* if they would bring the climbers and gear back to the ship by helicopter. This they agreed to do without hesitation and prepared the larger of their two helicopters for flight as soon as the weather cleared. This plan, together with instructions for preparing a landing pad and wind indicator for the helicopter was communicated to the mountain party, who were moving slowly down the glacier, with the prospect of a long cold walk ahead.

During the morning of February 23rd the climbers and their gear were ferried in several loads to *Greenpeace*, where they had their first hot shower in months and then back to our ship. We prepared to leave immediately and by that afternoon were out of the inlet and into the Ross Sea.

Throughout the three-week period that the climbers were on shore we had been in communication almost every day by radio and at all times knew where they were and what their plan was. We passed personal messages back and forth and made the arrangements for their quick and safe return to the ship after the climb.

The Voyage Home

... started off in near disaster. Within hours of leaving Cape Hallett the ship was in a full gale from the south. The climbers were weary and short of sleep but rest was not possible. Twice the ship was laid on her beam-ends, masts in the water and a terrible mess inside. The storm sails were torn and frozen stiff and the motor could not keep our head to the wind. So for three days we hove-to, being slowly pushed north, with little control over the situation. At one time we were in danger of being forced down on to a huge iceberg and I was reluctant to engage the engine to take us clear as a broken halyard had wrapped itself around the propeller shaft and we had not had the chance to free it. The storm sails were frozen and tore as they were hoisted. So it was the motor or crash on the iceberg. When Colin Putt engaged the motor, the broken halyard wound itself around the propeller shaft and the free end, which was up the mast, became jammed behind the radar dome, whipped it from the mast and shot it into the Ross Sea!

Radar was a critical part of the watch-keeping at that time as there were several hours of darkness each day and we were still in iceberg country, so without it we had to heave-to during hours of darkness and make north as quickly as possible during hours of light.

The gale lasted five days and we emerged with sails that had to be mended, mess to be cleaned up and no radar.

As we slowly progressed north we moved out of iceberg territory which meant that we could sail during the lengthening hours of darkness. I re-established contact with Macquarie Island and the nightly skeds with VK2LW continued. I kept in contact with *Greenpeace* although our paths had now diverged and she was moving west towards the French base Dumont d'Urville.

The return voyage was to include a stop at Macquarie Island which most on board were looking forward to. There were letters to be posted, friends to meet up with and a second hot shower in three months. Colin and I were not keen on stopping at the island as there are no mooring facilities and the loss of the *Nella Dan* was still fresh in our minds.

MFJ Multi-mode



9 modes for only . . . \$595

Using the latest advances, MFJ brings you 9 exciting digital modes and keeps on bringing you state-of-the-art advances.

You get tons of features other multi-modes just don't have.

Only MFJ gives you all 9 modes

You get 9 fun modes -- Packet, AMTOR, RTTY, ASCII, CW, WeFAX, SSTV, Navtex and Contest Memory Keyer.

You can't get all 9 modes in any other multi-mode at any price. Nobody gives you modes the MFJ-1278 doesn't have.

New Easy Mail™ Personal Mailbox

You get MFJ's new Easy Mail™ Mailbox with soft-partitioned memory so you and your buddies can leave messages for each other 24 hours a day.

20 LED Precision Tuning Indicator

MFJ's unequalled tuning indicator makes it easy to work HF packet stations.

You use it the same way for all modes -- not different for each mode.

Multi-Gray Level FAX/SSTV Modem

You'll enjoy natural looking pictures that multiple gray levels can give you.

New Anti-collision technology

MFJ's new Anti-collision technology gets packets through faster, more reliably.

How? Automatic random transmit delays prevent packet collisions.

Plus more . . .

Plus you get . . . 32K RAM, free AC power supply, KISS, true DCD, free eeprom upgrade, random code generator, independent printer port, lithium battery backup, RS-232 and TTL serial ports, standard 850 Hz RTTY shift, socketed ICs, tune command, automatic serial numbering, programmable message memories, dual radio ports and more -- all in a sleek 9 1/2 x 9 1/2 x 1 1/2 inch cabinet.

MFJ Packet Radio

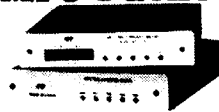

MFJ-1274
\$349
MFJ-1270B
\$299

MFJ-1270B super clone of TAPR's TNC-2 give you more features than any other packet controller -- for \$139.95.

You can operate both VHF and HF packet because you get high performance switchable VHF/HF modems.

You get Easy Mail™ Personal Mailbox, FAX reception, KISS, Net Rom compatibility, 32K RAM, AC power supply, one year unconditional guarantee and more.

For dependable HF packet tuning, the MFJ-1274 gives you a tuning indicator that's accurate to within 10 Hz -- and it's only \$50 more add \$10 shipping /all prices

Stewart

ELECTRONIC COMPONENTS

44 Stafford St. Huntingdale 3166 Victoria

Phone: (03) 543 3733

FAX: (03) 543 7238

AMATEUR RADIO, March 1990 --- Page 23

However, as we continued north it became apparent that Macquarie Island was going to be a very difficult place to reach. The ship was unable to make headway due to gales and high winds that blew directly from where we were trying to go. We would make some progress in the right direction, then a gale would blow for several days and we would be back where we started a couple of days before. This was a most unusual weather pattern for that time of year, when you would normally expect strong winds from the south-west. Later analysis shows that we were probably experiencing a weather pattern influenced by a cyclone off the east coast of New Zealand.

Macquarie Island lay on the track to Sydney, so we were simply making no progress in the direction of home. To add to our worries the fresh water tanks were not so full as expected. One of the three tanks had been discharging through a leaky valve into a tank from which we had been drawing and therefore, we found it empty when the time came to switch to it. With care there was sufficient water to reach Sydney under normal circumstances, but circumstances were anything but normal; the sails needed constant repairing, the winds were contrary, water was running low and I was wary about making an approach to any other islands, such as Auckland or Campbell, even if we could reach them.

We carried no detailed charts of New Zealand so I asked *Greenpeace* for the Pilot instructions for entering Bluff, a port on the southern tip of New Zealand. The skipper of *Greenpeace*, Jim Cottier, read these back to me and it sounded a difficult and dangerous procedure. So the decision was made to make for Lyttleton, the port for Christchurch on the east coast of the south island of New Zealand, which was further away than Bluff but well marked by lights and straightforward to enter.

Greenpeace, Les and Macquarie Island were told of the change of plans and away for Lyttleton we went, caught in a weather pattern of fair winds that carried us over the 600 nautical miles in just over five days.

For reasons that I don't understand I was unable to make contact with New Zealand coastal stations via ship-to-shore radio. Also for reasons I don't understand, I found difficulty in making contact with NZ amateurs. Even when I did, I was told that the amateur with whom I was in contact could make one contact only with me, answer three questions and accept no third party traffic. However, on the last days of the approach to Lyttleton I was able to advise Harbour Control, through a very effective VHF

repeater about 100 nm south of Lyttleton, of our plans and ask for berthing space and other facilities. The welcome and cooperation that we got on arrival, after 27 days at sea, made up for the somewhat chilly interchange on the air-waves. As soon as I could get into Christchurch I got a temporary amateur licence for a few dollars, which apparently legalised our amateur station in New Zealand, and kept up the evening skeds with VK2LW.

The 6m Project

... suggested by Roger Harrison was aimed basically at establishing contact between the continents of Australia and Antarctica. Any other contact from Cape Hallett would have been welcome, but an amateur group had been alerted by Vince Angus, VK2VC and it was towards the east coast that I aimed the Yagi.

Each day (there was no night) at 2100hrs K, all through the month of February, whilst the ship was moored alongside the ice at Cape Hallett, I called and listened on 52.050 MHz, the linear feeding the Yagi, which was set up on the wheelhouse roof and pointing at the east coast of Australia. I called on phone and slow CW, and kept it up for at least 15 minutes. I would also listen and call at odd times during the day, when I was passing the transceiver on the way down to the galley or working at the chart table. I would listen on beacon frequencies at various times in case the band was opening. At times I thought I could hear something; at other times I knew that I was imagining it. No contacts resulted,

but for the record, below are dates when there were recognisable but very weak signals:

Thursday,	11/2/88, 2100hrs	Slow Morse
Saturday,	13/2/88, 2100hrs	Slow Morse
Tuesday,	16/2/88, 1300hrs	Possible Phone

One of the major disadvantages I suffered was being unable to mount the Yagi clear of metal spars and rigging. It had to be mounted on the ship as it would not have lasted more than a few minutes mounted on the ice due to high winds. It had to be strongly and frequently guyed and no doubt was not able to give of its best due to the surrounding metal. If I ever repeat this experiment I think I would use a beam constructed for the conditions and use "dead men" or some kind of anchor to lock the guy points into the ice.

The Part Played by Radio

... in the expedition was critical. To safeguard against the various calamities that could befall us, to guard against one group taking an action that could be misinterpreted by the other, to get regular weather and ice information, meant clear and reliable lines of communication. This we achieved using quite standard equipment and skilled and patient operators.

For further information, particularly a map of the route taken by the expedition, see "Manhaul to Mt Minto" by Lincoln Hall, Australian Geographic No 12 Oct - Dec 1988. ar

Cosmonaut Hooked On Amateur Radio

JIM LINTON VK3PC

The MIR space station cosmonaut Musa Manarov, who delighted the amateur radio fraternity with his contacts using the callsign U2MIR while in orbit during November 1988, is eager to continue his amateur radio activity. He entered more than one thousand callsigns in his log book. Musa, a then raw beginner to the ways of amateur radio, found himself the most sought after contact throughout the world.

In an interview for Radio magazine in the Soviet Union, he said: "Once I nearly got a fever from the exhaustion and stress of picking calls through the QRM." His mission on the space station lasted 366 consecutive days and achieved a world record stay in orbit. Musa was really hooked on amateur radio and trained his fellow crew members Vladimir Titov U1MIR and Valery Polyakov U3MIR.

There had been some reports of activity from U1MIR and U3MIR, and indications that cosmonauts Aleksandr Volkov U4MIR, and Sergey Krikalev U5MIR may also have been on air. There was nothing confirmed about any Australian radio amateur having worked these other cosmonauts. They were mainly Russian-speaking — unlike Musa whose English was quite good.

Since coming back to earth, Musa has had very little leisure time, but intends to continue his amateur radio involvement. He hopes to be granted U2MIR as his personal callsign — don't be surprised if it appears on the HF bands soon. Simply on the basis of his excellent job of being an ambassador in space for our hobby, and the MIR operation which achieved widespread media publicity, Musa deserves to hold the callsign. He also hopes one day to be back in space as part of a future MIR crew. ar

VNG'S CODE AND THE LEAP SECOND

MARION LEIBA VK1VNG VK1KNG
HONORARY SECRETARY VNG USERS CONSORTIUM
26 FIMISTER CIRCUIT KAMBAH ACT 2902

Prologue

We entered the front door of the ABC studios in Northbourne Avenue, Canberra and people greeted him from all sides. Graham Conolly VK2BL was back in one of his old stamping grounds. It was 11 am on 6th December 1989. We were ushered into Studio 101.

Graham's assignment was not to read the news but to record the leap second voice announcement for VNG. Harvey Conroy VK1HC, also a WIA member, was at the controls in the annex to the studio. His duties included monitoring the level and driving the reel-to-reel tape recorder. All three of us were pleased to be participating in this next step in VNG's history.

Two practice runs and the tape was ready to roll.

"Three, two, one, _____. This is VNG, Llandilo, New South Wales, Australia on 5, 10 or 15 Megahertz. VNG is an Australian standard frequency and time signal service. Your attention, please! In accordance with international agreement, VNG time signals will be retarded by precisely one second on the First of January at zero hours Coordinated Universal Time."

Graham worked hard. Six readings of the same announcement while timing himself strictly with a sweep second hand so that the announcement would not be too long and get clipped.

Finally, he put the script down. "Is it alright?"

"Ooh, yeah!" Then in an aside to his colleagues, another Graham, who was going for his full call in February and had a WIA membership application paper in his bag (I asked), Harvey remarked: "I am just saying to Graham, the future ham here, that this is the clearest reception of this VNG that we are ever going to have." Finally he said to me: "I hope this gets into the WIA magazine!"

So this prologue is a tribute to VK1HC, VK2BL and the future VK1! But what was the purpose of the exercise?

The Leap Second and DUT1

Coordinated Universal Time (UTC) is the time scale used for VNG and is the basis of civil time. Its time intervals are



Graham Conolly VK2BL at the ABC studios, Canberra, recording the leap second voice announcement for VNG.

kept constant by reference to atomic (caesium beam) standards.

Astronomically-derived Universal Time (UT1), or Greenwich Mean Time (GMT) is tied to the Earth's rotation, the rate of which is not constant. In recent years it has been slowing down. Because

of this, occasional step adjustments of precisely one second, known as leap second adjustments, are made to UTC so that it does not differ too widely from UT1. This is why the last minute of 1989 was 61 seconds long.

DUT1 is UT1-UTC. The DUT1 code on VNG (January AR, page 61) gives the value of DUT1 to the nearest 0.1 second. You can work out its value by counting the number of seconds markers which have a double tone (sound like "bleeop"). If, for example, three consecutive seconds markers are bleeops, the value of DUT1 is 0.3 second. If six have a double tone, DUT1 is 0.6 second.

The sign of DUT1 is given by which seconds markers have the double tone. If they start with seconds marker one, then DUT1 is positive, meaning that UT1 is ahead of UTC. This happens after a leap second has been inserted into UTC. The sign of DUT1 is negative when the first double tone seconds marker is seconds marker nine. Because of the present slowing down of the Earth's rate of rotation, DUT1 becomes progressively more negative until a leap second adjustment is made.



Harvey Conroy VK1HC at the controls during the recording of the VNG announcement.

PITCAIRN ISLAND BICENTENNIAL 1790 — 1990

BY DR G O'TOOLE KB6ISL QSL MANAGER
AND SUZANNE MORELL

"Ahoj Captain!! Land ho — ten degrees starboard". Ah, those words that me good friend uttered 200 years ago on one of the most famous and historical ships ever to set sail. Hello mates, me name is Fletcher Christian, and I've come to tell you's all of the beauty of one certain island. Me and me band of mutineers, numbering nine, seized the HMS Bounty, previously known as the HMS Bethia. Yes, we seized that there ship from Captain LT. William Bligh in 1789.

Later, on 15 January 1790, me nine mighty mutineers, along with twelve Polynesian women and six Polynesian men, sailed onto the shores of Pitcairn Island weighed anchor. Incidentally, that there spot is now known as Bounty Bay. On 23 January, just eight short days

later, me men set fire to our beloved Bounty. While I, napping on an island's grassy knoll suspected nothing.

Me men are God-fearing men you see, who are loyal through and through. I've taught them always to follow their hearts, the ever possible idea of voyaging back to England to once again face the tyrannous, cruel wrath that me Captain's hand possessed. It also represented, their newly found and cherished freedom.

As for me, I tried to salvage the wreckage, but the roaring flames that soared from the deck to the upper masts were colossal! I tried to save the ship that still held me pride and love for it captive in its planks, but me trials were in despair amid this new yellow light. This light, that greedily consumed everything within

its reach, and hungrily devoured more and more. At least, me Church of England Bible was saved, for me people to use in later years.

As the ship sunk deeper into the sea, the idea of leaving this uninhabited island sunk with it. Little did I, or me men know what importance our landing would bring.

That there night, me mates, when my body was badly burnt, I fell deeper and deeper into a sleep, I knew I'd never wake from. But don't fret, my friends, for me spirit lived on in the mind and soul of every being on that there island. Me spirit still lives there among the hearts of me people, and it lives on today as I tell you this here tale.

The common belief surrounding our burning the Bounty was rumored as so as

Custodians of Coordinated Universal Time

The Bureau Central de l'IERS in Paris has the responsibility of deciding when a leap second adjustment should be made. It is always done at the end of a month. First preference is given to the end of December and June; second preference to the end of March and September. The previous leap second was inserted at the end of 1987 (UTC).

AUSLIG's Orroral Geodetic Observatory in the ACT is the custodian of UTC in Australia. It is also the organisation which is officially responsible for the funding and monitoring of VNG.

Using VNG's Time Code

VNG's time code was published on page 61 of January AR. The BCD time code gives the day number of the year, the hour and the next minute. If you do not want to go to the trouble of deciphering it, you may find the following information useful for working out of the time. All you need, apart from your radio receiver, is a watch accurate to two minutes.

The minute is marked by a long beep. Most of the seconds markers sound like shorter beeps. The marker of the second immediately preceding the minute is

missing. The markers of the four or nine seconds preceding this are clipped and sound like "tock" instead of "beep". For most of the time there are only four tocks near the end of the minute but during the fifth, tenth, fifteenth, etc minutes, there are nine tocks preceding the minute marker. So, when you hear a minute marker preceding by nine tocks instead of four, you know that it is minute number five, ten, fifteen, etc. Provided that your watch is accurate to two minutes, you'll know which one of these it is. To double-check, listen for the VNG station identification announcement as this is given during the fifteenth, thirtieth, forty-fifth and sixtieth minutes.

I hope you'll find this information helpful. As an earthquake seismologist, I have successfully used this technique for years to set the clocks in field seismographs (earthquake recorders) in out-of-the-way paddocks, meatsheds, shearing sheds, etc, even though I cannot guarantee the accuracy of my ageing, analogue wrist watch to any better than two minutes. With VNG, I have not needed to buy a better one!

Reference

VNG. Standard frequency and time signal service. Reference Measurements Section, Telecom Australia Research Laboratories. December 1981.

Stolen Equipment

Stolen from the home of D Canning VK3JDO 32 Beaconsfield Rd Briar Hill 3088 on 17/11/89.

ICOM IC-2GAT handheld
TX/RX with BP-70 S/N 08616.
ICOM BC-36 battery charger
ICOM BP-SAx2 battery pack
GCOL GV-16 2m handheld TX/RX with antenna

Anyone finding this equipment please contact owner or local police.

IC 560 6m TRANSCIVER

Serial No 01153

From RMIT — TAFE College Cnr Lygon & Queensberry Sts RMIT Station — VK3MT

Engraved with internal security no — T-00510 and engraved also with either RMIT School of Applied Electronics & Communications or RMIT School of Telecommunications. 7 years old — in good order.

Contact VK3CMC QTHR.

ar

ar

not to be detected from passing ships, or of the vindictive vengeance of Captain Bligh. Although, the possible real reason of my men may have been to permanently station themselves on our newly found paradise-like island, which they had no intention of ever leaving.

Ten years later, me good friend John Adams was the only mutineer left on Pitcairn. The rest, like me, had perished one by one. John Adams was a mere seaman who was almost at the point of illiteracy, but he was a good, humble, and honest man who had been loyal to me for years, always showing that he had a heart of gold for all to see and feel. John Adams showed his good, hidden wisdom as being the first true leader of Pitcairn.

In those early years, where one could have easily lost all morals, principles, or manners, and be simply satisfied just to lead the easy life of eating, sleeping, and bearing children, my men chose to follow a more productive way of life. As united villagers, they organized a respectable village square that is now known as Adamstown, and is where today, the majority of their population lives.

The men never lost their love for God, for they always looked onto their trusty Church of England Bible for consolation. In those early days when the island schooling was premature, the first island natives were taught from me good Bible. After all, what's an education, if you don't know the words of God? Me men made me proud when I seen me own children learning from that there Bible, I salvaged with me own scorched hands. Even today, that same Bible is on Pitcairn Island. Loved today, as it was loved in its yesteryears. As a reminiscence of those days, the Bible is taken out of its glass showcase, with its two padlocks guarding its safety, and is read twice a year. Yes, those there people make me darn proud!

As time passed, Captain Elliott arrived on the HMS Fly. It was in that year 1838, that Pitcairn Island became English ruled. Although they were governed by the English, my Pitcairners behaved as their own people.

It were these same Pitcairners, that for as much isolation, as they had to bear with, in their one by two mile paradise, and for as young as their homeland was, my people were extremely advanced for their times. Much more advanced in a couple of ways, than such great lands as America, Spain, or the United Kingdom. For one thing, schooling for the first time ever, was mandated. For another, a native island born magistrate would be elected annually by one of their early laws which stated: "By the free vote of every native born on the island, male or female, who shall have attained the age of eight-

een years, or of persons who shall have resided five years on the island." Notice the word "female". Although we are frequently taught in school that Australia was the first place to let women vote, this is not so. Pitcairn Island was the first to allow female suffrage in the world in 1838. Fifty-seven years before Australia, and eighty-one years before America.

Yes mates, me people have always been very promising. They still prove it, day by day. Remember, my friends, my spirit will always live on in the hearts of my people...

When one refers to life as being too tiresome, when work is too great, and stress too unbearable, doesn't one usually dream of a hideaway? An escape from daily chores and responsibilities, where sleep takes over and conquers any thought not relating to relaxation. A place where no person is under pressure. Where congested freeways, polluted air, and busy streets simply do not exist. A haven as we know not, where only friends are your neighbors, and only a seabreeze will refresh your body. A living where solitude and serenity reigns, and only beauty surrounds you. This paradise we often refer to as a tropical island where you are master of your everyday, and rule only it as you wish.

Well, Pitcairn Island 25° — 04'S, by 130° — 06'W is such an island, with just one exception. The islanders work continually, only stopping to rest on their day of Sabbath, Saturday. Life on Pitcairn is indeed very strenuous. Their days are constantly filled with work for their forty-five inhabitants.

Gardening is one of their tasks which takes up much time when the season arrives. The gardening is done on a sunny plateau where later their dark, rich, soil bears them luscious edibles such as sugar cane, papayas, yams, and bread-fruit.

How ironic that Captain Bligh left Portsmouth, England on 23 December 1787 in route for Tahiti, to acquire food. This food would later feed the bondmen of Jamaica. Their quest was to fulfill the King's request of finding breadfruit and nurturing these plants to feed many, for the cost of a few. When Fletcher Christian mutinied against his Captain and sailed back to Tahiti, and later to Pitcairn, the men found themselves with an evergrowing abundance of breadfruit: enough breadfruit for many, many slaves to have been fed from. If only Captain Bligh would have altered his course and destination, to find Pitcairn Island before his crew mutinied, he would have been held in high esteem by his peers, for accomplishing the mighty task of feeding the slaves.

Some of the other jobs that the island-

ALTRON

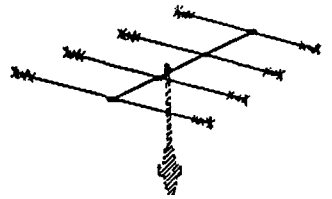

THE CITY DWELLER COMPACT 4 BANDER 2, 3 or 4 Elements

Turning Radius
2el 1.52M
3el 1.88M

C & S ELECTRONICS
4A WHITING ST
ARTARMON
NSW 2065

Tel: (02) 437 4199
Fax: (02) 438 3752

WIA 80TH Anniversary Edition of the 1990 Call Book Be quick

buy your copy
now from your
WIA Divisional
Bookshop

Special Price to WIA
members of

\$8.50

Plus Postage and
Handling

\$1.50 approx.
depending on Division

ers do are fishing, weaving, and carving. The ladies present their talent in the intricate designs and patterns that they weave. The ladies weave such things as baskets of all sizes, and colorfully designed purses that have the embroidered name of their beloved homeland.

As for the men, they have a unique craftsmen ability. They will carve anything from sharks, dolphins, or whales, to even Bounty replicas that are carved in great detail, and possess many of the characteristics of the original Bounty. These hand autographed carvings are truly works of art.

As the ladies weave and the gentlemen carve, they are assembled in what is similar to a picnic. They do their work in beautiful locations overlooking the sea, or they sit on their mountaintop, or they work on flat land.

They are often found working on the grass chatting, while watching their children jumping on the trampoline or rooting them on as they partake in a healthy game of softball.

At the time when the community is found together working, a pleasant portrait is portrayed as the workers gossip and laugh at the stories that they share. This is the time when they are brought up to date on what is happening either there on the island or around the world. The Hams join in on the conversation when they tell of the weather of a distant land, the United State's Presidential elections, what the Queen of England and her family are doing for the weekend, or what new Hollywood gossip has arisen!

But when the islanders are through with learning of current events, they ease into a pleasant evening of listening to the tunes of their most beloved and idolized singer: Elvis Presley. It was once said by one of the islanders that the spirit and memory of Elvis Presley will never die on their island...Alive or not, Elvis Presley is their hero.

A past necessity of Pitcairn has now slowly evolved into history. The necessity: the wooden longboat. Since 4 September 1928 when the first wooden longboat was launched, until December 1987, longboats have been a much needed and much loved essential of the island. Recently the second from last wooden longboat was put to rest and has now become an island museum piece. Although the modern aluminum longboat has replaced the older one, the wooden longboat will always be remembered for its heroic exploits upon the rough seas.

Items that the island would need but not be able to resource, are all brought in by regular supply ships. Interim the arrival times of these supply ships, the Pitcairners have to depend solely on the

PITCAIRN ISLAND

"BICENTENNIAL"

Please check the appropriate box:
 Amateur Radio Maritime License International

PLEASE PRINT: NAME _____
 CALL _____
 HOME _____
 ADDRESS _____
 CITY _____ STATE _____ ZIP CODE _____

PITCAIRN ISLAND
 For international operators, and
 Q or R station operators
 Q How do you call M SIC?

For amateurs, and
 Q or R station and QRP
 Q How do you call M SIC
 and M SIC



NOTE:

- The authorization period for applying for the "BICENTENNIAL" is from 1991 to 1 July 1992 or 31 Dec. 1992. All applications must be made during this period.
- The need to send both an Amateur Radio application for the "BICENTENNIAL" and a Maritime License application for the call "PITCAIRN" and the last two letters of their registration call for the vessel must be paid separate individual checks.
- You may wish a visa, also with a BICENTENNIAL application of a future date for the independent station.
- An acceptable signature on any date on application of the "BICENTENNIAL" authorization.
- Amateur Radio and Maritime License's must complete the forms provided in this application to qualify.
- No fee is charged. However, attention seeking correspondence should be made from islanders.
- Send application to Pitcairn Island 1 month of the date of the "BICENTENNIAL" day.

"BICENTENNIAL" MARK NUMBER
 DR. C. D. FOLEY - F2ALB
 3001 SAN GABRIEL ST.
 SO. GAITHER, CA. 90260 U.S.A.

Complete form section:
 Amateur Radio/Maritime License

I hereby affirm that I did not/never/yes or NO/NO/YES on this date _____
 1990, on form _____ and have a report of _____ and received a report of _____ in the _____ I further certify that the information contained in this application is true and correct in every respect as copied from my station log and that I did establish a two-way communication as stated above.

SIGNATURE _____ DATE _____ 19____

* * * CONFIDENTIAL * * *

voluntary assistance of passing vessels. Remember that Pitcairn has much of the ocean all to themselves! These much appreciated bearers of joy bring such items as fuel, food, school and mechanical supplies, building materials and mail.

Pitcairn's main source of communication to distant lands, is through Amateur Radio, which has been a part of the island for many years.

This cherished pastime of the island has expanded through the years with the dedication of its operators. One such operator was Andrew Young who communicated to faraway places using a spark gap generator in 1937.

Andrew Young's charisma and vitality was heard on airways around the world. His energy was taken as an example, and thus motivated his neighbors to share in on the fun. Soon after, the island was but a chorus of reed whistles playing the tunes of the Morse Code.

In 1937, Andrew Young was able to communicate with his simple crystal receiver to a radius of 1,000 miles. But on one extraordinary day, he was able to listen to KFI in Los Angeles 3,500 miles away. With his aged 12-volt spark gap generator he was helping to make history.

A short time later, this Ham's paradise was in threat of closing down, due to the antiquity of the station. But their luck prevailed with the more common usage of the A1 tube transmitter.

Since then, the island's progress in communication has vastly improved. Today, all Amateur Radio stations on the island, use all solid state equipment, including RTTY.

With all these modern installations situated on the island, the islanders may stay in touch with the world that their

forefathers fled from.

Today there is a continual growing number of Amateur Radio operators on the island. They assist in the operation of the commercial radio station, and newly installed satellite communications system. Amateur Radio enables them to communicate with the other far and distant lands.

Beginning on 1 January 1990, through 31 December 1990, The Pitcairn islanders will celebrate their 200th anniversary, commemorating the arrival of Fletcher Christian and his mutineers. To commemorate this splendid occasion, Pitcairn Island will hold a special event via Amateur Radio. For the entire year, nine Amateur Radio operators on Pitcairn will be making glorious contacts around the world, with other Amateur Radio stations, and for SWLs to hear. These operators will use a special call sign: VR200PI???

To make contact with only one operator on the island, will enable you to obtain a handsome multicoloured 11" x 14" document, that you will no doubt always cherish.

So mark those calendars of this historic bicentennial, and join the fun of speaking to direct descendants, of heroes you've always heard mentioned! Help yourself to a memory you'll never forget!

Try This

Recently while perusing OZ magazine November 1989 edition I found a simple solution to temperature drift in Zener diodes, as follows:-

Temperature drift in Zener diodes can be almost eliminated by connecting a silicon diode (as shown) in series with the Zener. The PTC of the Zener is counteracted by the NTC of the silicon diode but of course the 0.6v drop across the silicon diode should be allowed for in the final circuit.

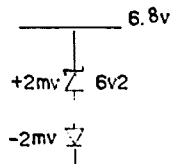

Perhaps the readers may find this useful in their experimentation as several uses spring readily to mind. The original article has been condensed somewhat to eliminate unnecessary waffle as the principle is well known.

ALLAN JOHANSEN VK4KAJ
 PO Box 373 PIALBO 4655

PITCAIRN ISLAND "BICENTENNIAL"

Please check the appropriate box;

amateur radio shortwave listener enthusiast

PLEASE PRINT:

CALL _____ NAME _____

ADDRESS _____

CITY _____

STATE _____ ZIP CODE _____

POSTAGE/HANDLING

For initial applications, send

- \$5 US cash/check enclosed
 Non-US pay send 14 DDCs

For endorsements, send

- \$1 US cash/check and SASE
 Non-US pay send 3 DDCs and SASE

RULES:

- The anniversary period to qualify for the "BICENTENNIAL" is from 0001 UTC, 1 JAN. 1990 to 2359 UTC, 31 DEC. 1990. All contacts must be made during this period.
- You need to work only one Pitcairn Island station for the basic "BICENTENNIAL" award.
- You may work a "BICENTENNIAL" station using the call VR200PI/ and the last two letters of their regular call for the award with a gold engraved endorsement sticker.
- You may work a VR6, then work a BICENTENNIAL station at a later date for the endorsement sticker.
- No membership required in any club or organization to participate in the "BICENTENNIAL" celebration.
- Amateur radio and shortwave listener's must complete the lower portion of this application to qualify.
- No QSL cards required. However, stations seeking confirmation should request QSL route from station worked.
- Send completed application within 3 months of the close of the "BICENTENNIAL" to:



"BICENTENNIAL" AWARD MANAGER
Dr. G. O'TOOLE - KB6ISL
9605 SAN GABRIEL AVE.
SO. GATE, CA. 90280 U.S.A.

Complete lower section:
amateur radio/shortwave listener

I hereby affirm that I did work/hear VR6____ or VR200PI/____ on this date _____
1990, on Freq. _____ at _____ UTC and sent a report of R__S__T__, and received a
report of R__S__T__, in the _____ mode. I further certify that the information contained
in this application is true and correct in every respect as copied from my station log and
that I did establish a two-way communication as stated above.

SIGNATURE _____ DATE _____ 19 _____

• • CONGRATULATION • •

OUR INTRUDER WATCH CO-ORDINATOR

MERVYN EUNSON VK4SO
GPO Box 1513 BRISBANE 4001

This is the stalwart who does the most to preserve our amateur bands from marauders. The same indispensable fellow whose efforts are strangely shunned by 99% of amateur operators. A peculiar state of affairs!

The vital task falls to an old-timer and avid homebrewer in Gordon Loveday VK4KAL from an unusual location at Rubyvale in Central Queensland. Ten years' previous experience as Divisional Co-ordinator fits him admirably for the position.

Not to be found in your average atlas, Rubyvale is a delightful hamlet devoid of city drawbacks. Right on the Tropic of Capricorn, it's somewhat this side of the famed Black Stump (that's at Blackall and used as the surveyors' marker to align the State's boundaries in 1886). Not exactly a bustling town, it forms along with nearby Sapphire the hub of our gemfields, a few thousand hectares of crystalline aluminium-oxide called corundum (emery to you) the second hardest of all minerals. Coloured varieties of this constitute the gemstones named sapphire, ruby, emerald, amethyst, beryl, topaz, and spinel.

A hundred years of small-claim mining has not dented demand, for due to higher specific-gravity a good sapphire carat-for-carat can be more valuable than diamond. It's also superior to galena as the detector in crystal sets (for the ham who has everything).

Otherwise Rubyvale is pinpointed as being at the junction of two of ten vast Jurassic hydrocarbon deposits, the prime coal-producing Bowen and Galilee Basins. All around is being changed into a deep pit as the ancient vegetation that aeons past grazed dinosaur, diprotodon, ornithopod and other megafauna — the bunyips of folklore — is stripped for shipment to Japan (to pay for our fancy rigs and electronic gee-gaws).

It's in the dry inland — and dry it is, there's no pub! No butcher or baker. Neither is there a convenient surgery. This is Flying Doctor country, the Beechcraft Kingair "Alf Traeger" making a routine clinic run from Charleville Base VJJ, 250 nautical miles away (no metrics in aviation). Other amenities and things like photocopiers means a 140 km round trip to "town" (that's Emerald to the east).

Tanks collect "aqua pluvius" off the



Gordon VK4KAL in the cluttered shack

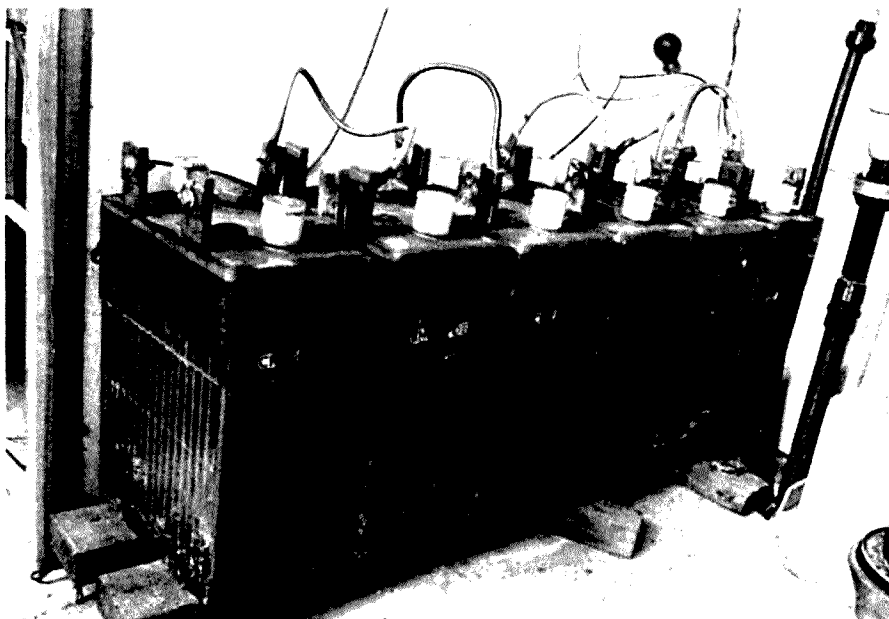

Six Kilowatt-hours reserve of solar energy roof for household use, supplemented by mineral-laden water from the underlying table. No, its casing is useless as an earth return, for a sub-strata of dolomite and basalt is notoriously non-conductive.

But it's a superb position for radio activity, unmarred by obstructions or high-rise. Power-line noise is completely absent, the supply for radio/lights/television stemming from solar panels feeding
Continued page 31

JOTA 1989

NORTH SOLOMONS PROVINCE

ERIC SHAW P29KES
PO Box 265 PANGUNA PNG

The NSP Guides, Senior, Junior and Scouts as well as Brownies again joined forces to create a most interesting weekend at Loloho Beach. My station, P29KES, was operating through a vertical ground plane supported by a beach shower stand an inverted vee strung from a high coconut tree. The climbing abilities of Henry Baraka ensured achievement of a great height for this inverted vee. Paul Weldon, P29PT was operating through a dipole.

Set-up direct at the Loloho beach provided a scenery few other Scouts would be able to enjoy for their JOTA.

JOTA call signs P29GNS (Guides North Solomons) and P29SNS (Scouts North Solomons) were activated as required, when other JOTA stations were contacted.

Operators Eric and Paul were very patient with the Girls and Boys attending. Eric was talking about JOTA 1990 already.

Having missed the official opening, the Chief talking to the Scouts was

warmly welcomed, especially by the two "Woodhouse Scouts" left in the troop.

Contact was established mainly with Australian and PNG Stations:

P29CEH, JOA. VK2AFY, KLQ. VK4AFY, ANR, GGA, KLQ, SAA, SCC, SML.

But the highlight probably was making contact with a Japanese station, prepared to have a long conversion. Koji, the operator, JE2JWE was not a JOTA station, but enjoyed talking to the boys and Annette Emberry (Acting Chief Guides Comm) was able to check her knowledge of Japanese. Paul Weldon gave the Scouts and Guides a Demo, talking to a station in Warsaw, in Morse code, at a "Mind boggling" speed.

Between conversations, the participants were entertained through games, organised by the Brownie leaders, and an Electronics Workshop organised by the one Scout patrol left in the Group, Gume patrol. No doubt the highlight for five of the new Junior Scouts was their investiture — making this day extra special.

One Scout, Nicholas Pion, completed his Special Skills badge, "Electronics", prior to JOTA, by building a Morse key Training board and numerous "little fingers" passed his project, by operating it all afternoon.

Actual conversations over the radio were carried out by:

- 3 Senior Scouts
- 9 Scouts
- 12 Junior Scouts
- 12 Girl Guides
- 15 Brownies
- 7 Leaders
- 58 Total JOTA badges
- 1 Special Skills badge "Electronics"

Was JOTA a success? Henry Baraka summed it up in six words "This was the best JOTA ever!"

Many parents attended and assisted with the cooking of a BBQ; and to close JOTA 89 the Scouts had organised a Camp fire (including a "Ghost" to light the fire) songs and sketches. ar

March Sale To WIA Members Only

Surplus Magpubs Stock Available At Heavily Discounted Prices

			Current Stock
RSGB	Operating Manual	\$20.25	6
RSGB	Radio Data Reference Book	\$23.75	10
RSGB	Buyers Guide To Amateur Radio	\$23.50	2
RSGB	Radio Communications Handbook	\$55.75	13
RSGB	Television Interference Manual	\$7.00	3
WIA	Log Book Covers	\$16.00	23
	Novice Study Guide	\$2.00	500
	WIA Book Vol 1	\$2.00	70

All prices include Postage

Send your order with payment to Executive Office of WIA
PO Box 300 South Caulfield 3162

from page 29

large glass-case 500 Ah stationary cells with thick plates of solid lead (the original Plante design). The Gemfields' expert in such things, Gordon among other pursuits manufactures a superior range of automotive batteries.

Not only excellent for HF operation, the city dweller will be amazed (and envious) at the extent and coverage of VHF and UHF traffic — an enormous area clear to the coast is embraced by four linked FM repeaters (yes, they know that's quite impossible!) engineered by the genius of Richie VK4RR.

All four 25W repeaters are solar-powered. VK4RHR on 146.925 and 438.5 is near Dysart, VK4RRR (146.975) near Sarina — both serviced by helicopter — with the "local" re-

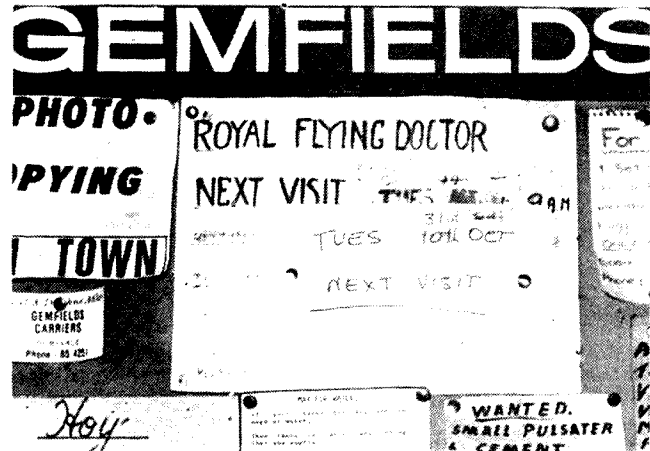

Flying Medical visit

peater on 146.950 near Blackwater. The central link site is at Middle Mountain with three remote control 828 MK2 transceivers on reverse frequencies.

Maybe the locals are prescient and preparing for the day when we DX on the bands 70 cm and above. For our HF allocations are congested with unchallenged commercial trespassers. Once it was actually necessary to maintain a watch for stray intruders, today the problem is to avoid the increasing proliferation.

Why doesn't somebody do something about it? Surprise, surprise, that's YOU! Not just the same few faithful fellows who presently send off reports.

Much, but obviously not enough, has been said on the necessity for all to participate in Intruder Watch. The machinery exists to clear our bands, but won't function unless reports increase many fold to prove our objection. Bureaucracy, with no great brief for our pursuit, calmly takes the view that complacency constitutes acquiescence.

Gordon revels in his peaceful domain and has no wish to retire to a dreadful existence in the hurly-burly of the Coast. His one complaint is that precious few reports are received to assist in his task.

A few thousand intruder lgs each month will leave him content.

This space could be earning you
MONEY

Advertising rates available from
PO Box 300 Caulfield South 3162

MAGPUBS

A Special Service of the Wireless Institute of Australia

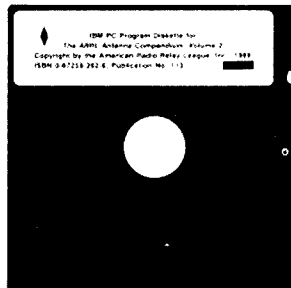
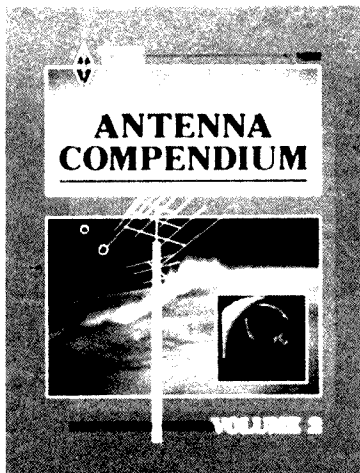

Book Only Stock # WIA292 \$24.00
Book and 5 1/4" disk
Stock # WIA294 \$34.00
Both Prices less 10% for WIA
Members

In 1985 the ARRL The ARRL Antenna Compendium, Volume 1 to its library of publications. That book contains 176 pages of previously unpublished material, covering a wide range of antenna types and related topics. The forward to Volume 1 suggests that Volume 2 might logically follow.

Like its predecessor, Volume 2 contains all brand-new material, because antennas are a topic of great interest among radio amateurs, ARRL Headquarters continues to receive many more papers on the subject than can possibly be published as articles in the League's journal, QST. So again, as with Volume 1, those papers have been collected here and combined with solicited material. None of this material has appeared in print before. Whether you have only a casual interest in antenna construction or a serious interest in understanding fundamental theory, you'll most likely find something to stimulate your thinking.

Six papers in this book contain listings of BASIC programs suitable for use with an IBM compatible computer. Some papers include more than one program listing. The programs aid in performing various design tasks associated with antennas, as described in those six papers. We offer a 5 1/4" (360K) diskette as an optional supplement to this volume. The disk contains 11 BASIC programs in ASCII text format and one compiled Pascal corresponding BASIC counterpart.

23rd CENTRALSTATES VHF CONFERENCE

1989

This collection of technical papers presented at the 23rd annual Central States VHF Conference, held in Rolling Meadows, Illinois in July 1989. This book contains many interesting papers covering topics of interest to amateurs operating at 50MHz and above. Whether-or-not you were able to attend the conference, these papers are *must* reading for every VHF-and-up enthusiast. All papers contained in this publication are unedited and are just as presented at the conference in full.

167 pages 8" x 11"

Stock # WIA286 \$24.00 less 10% to WIA Members

When it comes to
**AMATEUR
RADIO QSL's...**

1990 callbooks



Here they are! The latest editions 1990 World-famous Radio Amateur Callbooks, the most respected and complete listing of radio amateurs. Lists calls, license classes, address information. Loaded with special features such as call changes, prefixes of the world, standard time charts, world QSL bureaus and more.

The North American Callbook lists the calls, names and address information for over 500,000 licensed Radio Amateurs in all countries of North America from Canada to Panama, including Greenland, Bermuda and the Caribbean Islands plus Hawaii and US possessions.

The International Callbook lists over 500,000 licensed amateurs in countries outside North America. Its coverage includes South America, Europe, Africa, Asia, Australia and the Pacific area (exclusive of Hawaii and the US possessions). Order both Callbooks now and save at these special prices.

it's the
ONLY BOOK!

US or DX Listings

WIA289 1990 North American Callbook \$58.50 less 10% for WIA Members

WIA288 1990 International Callbook \$62.50 less 10% for WIA members

WIA 005 The two Callbook set \$109.95 less 10% to WIA members

The above books, plus many more, are available from your WIA Divisional Bookshop.

All items are plus postage and handling where applicable if not in stock at your Divisional Bookshop, order will be taken and filled promptly

THE GEORGE BUSH, MA MIKHAIL GORBACHE

What has made Icom's range of transceivers world leaders in their class? Could it be the uncompromising standards of a George Bush? Is it the durability of a Maggie (Iron Lady) Thatcher? Or the innovative thinking of a Mikhail Gorbachev?

It is, in fact, a combination of all three.

Which has led millions of radio users around the world to choose Icom. Their vote has made Icom the world leader of transceivers.



Announcing the IC-726. An advanced, HF/50MHz transceiver that combines VHF technology with the latest in sophistication. Designed for amateurs or veterans, and ideal for mobile users. 26 programmable memory channels, multi-mode transmitting and receiving and a host of other features and options.

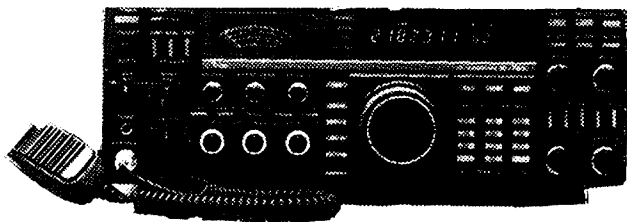

The Icom IC-765 IIF transceiver features DDS synthesiser, high speed auto tuner, built-in AC power supply, 99 programmable memories, keyboard frequency entry, band stacking register, general coverage receiver 100KHz-30MHz, CI-V system for PC control and rack mounting dimensions.

The IC-24 AT is one of Icom's newest super-compact handhelds. A remarkable dual-band transceiver with crossband, full duplex capability easily operated via a convenient keyboard. With 40 independent memory and 2 call channels, it features direct 12v operation (5W output), a clock with timer and auto-power-off functions and an excellent range of scan functions in a light-weight 340gm (with battery pack).

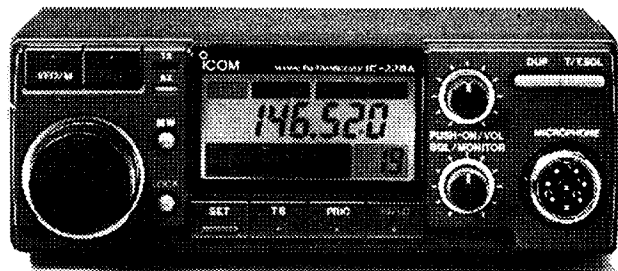

The Icom IC-228A (25W) and IC-228H (45W) mobile FM 144MHz transceivers are compact and easy to operate with 20 memory channels, multi-colour LCD programmed and memory scans, variable tuning steps, priority watch, main controls lit for night operation.

REGRET THATCHER AND V OF TRANSCEIVERS.



The Icom IC-475A (25W) and IC-47511 (75W) 450 MHz All Mode transceivers are designed for packet mode with direct digital synthesizer (DDS), 99 memory channels, USB, LSB, CW, FM, passband tuning and adjustable 1F notch filter.

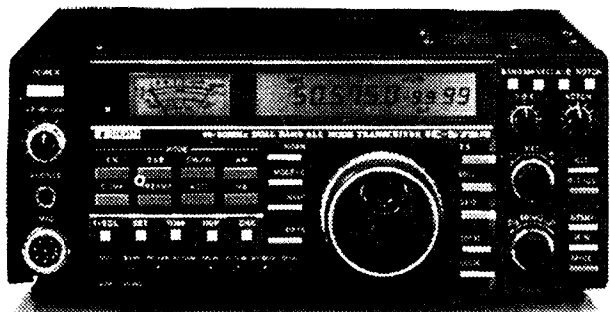

The Icom IC-575A (10W) and IC-57511 (100W) 28/50 MHz All Mode transceivers have a receiver coverage of 26-56 MHz and are equipped with direct digital synthesizer (DDS), 99 memory channels, and passband tuning.

The ICOM IC-4SA an amazing 70cm midget hand held. Comprising 48 memories plus 1 call channel, operating from batteries with 5 watts output at 13.8v

or an external 12v DC supply. Auto power off function, scanning, scan skip, clock and time function, an optional pager and more.

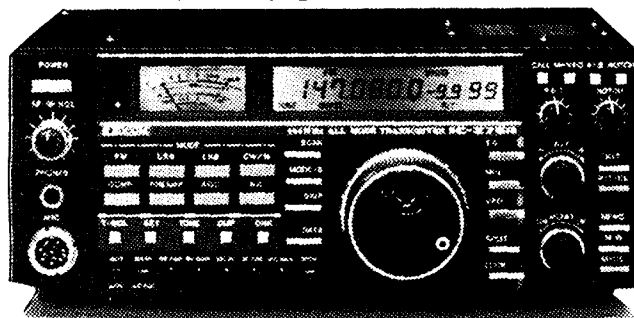

The Icom IC-275A (25W) and IC-275H (100W) All Mode 144MHz transceivers are designed for packet mode and feature direct digital synthesizer (DDS), 99 memory channels, USB, LSB, CW, FM, and passband tuning.

The remarkable IC-2SAT is the ultimate in mini handheld high performance 2M FM transceivers. With convenient keyboard, rechargeable batteries, 5W output (opt. with a 13.2v battery pack), 48 memories, a call channel and a variety of other sophisticated super multi functions. Plus 18 optional extras. Another marvellous breakthrough in miniaturized hand helds.

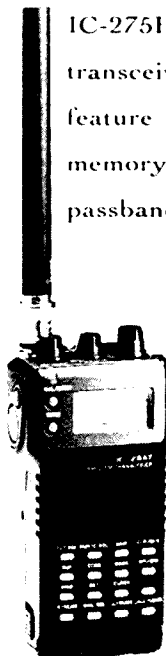

Call Melbourne on (03) 529 7582 or interstate on (008) 338 915 for your nearest Icom stockist.

ICOM

ICD 0017 R

HOW'S DX

STEPHEN PALL VK2PS
PO Box 93 DURAL 2158

Bouvet 3Y5X Last Comments

I indicated in my February column, that if you missed the Norwegian DX operation, you might be fortunate to work the next Bouvet activity which was to start mid-February. I am sorry to say, no such luck. The second expedition, which would have included activity also from South Sandwich Island, has been cancelled due to lack of shipping space. More than one month's diligent search by the would-be expedition could not find an alternative ship, which would have satisfied the requirements. The time originally booked for the first ship expired on the 15th of February, and the expanded timetable could not be fitted-in with the commercial operation of the charterboat company.

It is estimated that approximately 100 VKs and possibly 50 ZLs have worked 3Y5X. According to Japanese sources, the Bouvet group made approx 45000 QSOs. So for all those who missed out — including the writer of this column — there is a long wait, possibly 10 years or more, before the next DX group ventures to the island. QSL for Bouvet to: LA6VM direct with the usual IRCs and self addressed reply envelope.

Southern Sudan ST0/6U0

This is also one spot in Africa which is very much sought after as a DXCC country. John PA3CXC has now announced that, from mid-March, the stations 6U0DX (on SSB) and 6U0CW (on cw) will be active for a period of about two weeks. The tentative list of operators are: Jacky F2CW (who was also in the Bouvet operation), Hans PA3DFT and John PA3CXC. It is rumoured that this expedition is in conjunction with a fund-raising project for Sudanese relief.

However, if you were on the bands on the 8th of January, and you had propagation at 0415 on 14 MHz — which I did not have — you could have worked Eric WZ6C/ST4. Scores of Ws worked him. QSL to: W4FRU.

Future DXpeditions?

After many years of negotiations, Jim VK9NS hopes to receive an individual entry visa and an amateur licence to go to Bhutan A5. If all is well, he will be transmitting in two months time.

Unconfirmed reports say that, in early March or April, there will be a DXpedition to Aves Island under the callsign YV0DX. Aves Island is a separate DXCC country belonging to Venezuela and is situated near Curacao

(PJ) in South America. As propagation is usually good in the direction of the Caribbean, it should not be difficult to work it from VK.

Again he prepared for another DXpedition in October 1990, under the callsign HK0TU. This group will go to Malpelo Island — again a separate DXCC country — which belongs to Colombia and is situated hundreds of miles west of the city of Buenaventura.

Richard AH610 (ex T3210) is trying or organise a DXpedition to Palmyra Is. (KH5) and Christmas (T32) for mid March 1990. The proposed activity is designed around the "CQ" contest on 23-24 March.

It is also rumoured that FJ/N01MH will be active from FJ (St Bartholomy Island in the Caribbean), in the second part of March.

Commonwealth Games - ZM

Some of the ZL amateurs used the ZM prefix in celebrating the Games in Auckland. "Dusty" was active in the second part of January from Chatham Island signing as ZM7VS. QSL to his home address (ZL2VS): H R Miller 41 Alexandra St Marton 5151 NZ. The official amateur station of the games, operated under the callsign ZM14CG from Auckland. QSLs direct to: ZL1ALE A B Johnson, PO Box 397 Papakura 1703 NZ.

VR200 Pitcairn Island Bicentenary

From the 1st of January this year until the 31st of December, the Pitcairn Islanders will celebrate the 200 anniversary of the Bounty Mutineers landing on the island. The operators on the island (plus one guest operator with 6m gear) will sign with a special prefix VR200 PI/adding their own suffix at the end. Kari VR6KY was active on the 11th January as VRE200PI/KY on 1422 at around 0600. A special award can be obtained for one such contact. Refer to "Amateur Radio" December 89 issue, page 43 for details. (See *Pitcairn Is Bicentennial 1790-1990 P26 - Ed*)

Wallis Island - FW

Worked Mats SM7PKK when he arrived at Wallis Island from Rotuma. Mats was using the call FW/P/SM7PKK and came over with a signal strength of S9. He said "Life on the island is very expensive and if you do not speak French you might have some difficulty". Mats, the "travelling Swede" was active on several bands. He intends to go later to Nauru, Western Samoa and hopefully Tokelau Islands. QSLs to his home address: Mats Persson, Betesv 22 S-24010, Dalby, Sweden.

The Colvins W6QL & W6KG

Iris and Lloyd Colvin are well known DXers from way back. After Niger (5U7QL) and Burkina Faso (XT2KG) they were heard in Bahrain (A92QL) and arrived in Sydney late January. They were active under the call-signs VK2GDD and VK2GDE. After a few days of operation they were well on their way to work DXCC from VK. (A minimum total of 100 DXCC countries) QSLs to YASME: PO Box 2025 Castro Valley CA 94546 USA. (See detailed report about the Colvins at the end of these notes.)

Western Samoa 5W1 and DX QSLing

Received a beautiful QSL card and a long letter from Pete 5W1KT. Here are some interesting comments from his letter: "...Without a beam it is a bit hard for me to work a lot of DX but I have worked about 130 countries in 3 months. There is no local amateur radio activity on these islands. There used to be a ham radio club here and QSL bureau, but neither exist now. No local person holds a licence. The ones who operate, are mostly expatriates, holiday visitors or people in contract jobs, like me. Anyone with a valid ham licence can get a full amateur licence here.

I am amazed by the number of VKs, ZLs, VEs and JAs that QSL direct but do not include return postage. I try to do the right thing by everyone, but it is getting expensive. One IRC costs \$2.00 here and can be exchanged for only 40c. It costs 45c for surface mail. I am keeping some cards until my return to VK, to try to send them via the Bureau..."

I am ending the quotation from Pete's letter. Were you one of the VKs who did not include return postage with your QSL card? Or do you not know how to QSL with a DX station? I am sure that this subject was discussed in this and other similar publications several times, but here are a few basic rules:

a. Unless the DX station categorically states that the QSL is OK via the Bureau, do not assume that your card sent via the Bureau gets an answer. Think: no bureau which is run by voluntary labour is equipped to handle a sudden influx of 20000 or 30000 cards for one DX station, neither time-wise or cost-wise. Not all the DX stations are members of the national associations or bureaux.

b. If the DX station says QSL to his home call, or indicates that it is OK in the callbook (meaning the international listings or the USA listings of the "Callbook") it means QSL direct to the home call.

c. If there is a QSL Manager indicated, send the card direct to the QSL manager.

d. Enclose with your card a large airmail self-addressed envelope and sufficient return postage. On the average, the return postage should be either 2 IRCs (International Reply

Coupon, obtainable from your post office) or one US \$1.00 bank note. Very often called by its nickname "green stamp". Buy it from your local bank.) Be warned: In some countries it is illegal to send any currency in the mail, so find out first whether it is possible and/or legal. IRCs are always a safe bet.

e. If the QSL manager is handling cards for several DX stations, do not send more than one card per return envelope. If you still want to send more than one card to the same manager, enclose separate self-addressed return envelopes for each card, and also enclose adequate return postage for all the envelopes, otherwise the reply to you will be very much delayed.

f. Never show the addressee's call sign or your own call sign on any of the envelopes. Never use the description "amateur radio station" or similar wordings.

g. If possibly, use a typewriter to address all the envelopes. The more "non amateur" appearance of the envelopes, the less the chance that it will be lost along the postal routes in various countries where the temptation to remove the IRCs or the "green stamp" from an envelope is too great. What do you think happens in such a case to your QSL card? It will be destroyed on the spot by the offending employee!

h. Never use the small size airmail envelopes, use the larger size, at least 100mm x 230mm. Make it look like a commercial-business envelope from the outside. Do not stuff too many things into it, or if you wish, send it by registered mail (very expensive in VK). If you do not know the surname of the DX station, address it to "Mr O M Jones". The same advice applies to the return address. Some amateurs constantly use the word "Mr & Mrs" on the return envelopes. Use envelopes which have an opaque lining or coloring inside to prevent anyone from seeing the money when the envelope is held up to a light.

Interesting QSOs And QSL Information

YL1WC Serge 14180 kHz at 1231 UTC. QSL to: PO Box 6, Riga 226037 Latvia.

S79SC Simon 14140 kHz at 1900 UTC. QSL to: Box 234, Seychelles, Indian Ocean.

VR6KY Kari Young 14222 kHz at 0639. QSL to: Mrs Kari Young Pitcairn Island SPO via New Zealand.

LU6DG John in Punta Alto Radio Club 14200 kHz at 0724. QSL: via Bureau.

A43XA Khalfan 17th Anniversary of the Royal Oman ARS. QSL to: Box 981 Muscat, Oman. N5GMQ/DU1 Karl in Manila 14202 kHz at 0915. QSL to: DF9RB via the Bureau.

5U7NU Alain 14222 kHz at 0659. QSL to: F6FNU: Antoine Baldeck BP 14 F-91291 Arpajon Cedex France.

T16RLI Dave 14226 kHz at 1231 QSL to: N2AU: Arthur Hubert 436 North Geneva St, Ithaca New York 14850 USA.

FO0IGS Gerry 14217 kHz at 0924. QSL to: French DX Foundation PO Box 88, Bruz, France.

JW6WDA Arvid 14195 kHz at 0942. QSL to: LA5NM: M Bjerrang Box 210 N-9401 Harstad Norway.

3D2WZ Ray 21 MHz - CW - at 0430. QSL to: G3WZ.

HS0E John 21 MHz - CW - at 0300. QSL to: K9EL John E Sweeney 707 Venice Ct Schaumburg 11 60193 USA.

TL8CM Harry 14 MHz - CW - 0700. QSL to DL8CM: Harry Jacob, Pfarrer Theistr D-6605, Friedrichstahl 2 FRG.

JP1DMX/HI8 Hysaya 14 MHz - CW - 0600 QSL via JARL Bureau.

VP6P Mike - on Provo Island, - 14 MHz - CW. QSL to WN5A: Jack T Van Demark Jr 7514 Winter Glen, Houston TX 77072 USA.

ZC4CZ Glen 14 MHz - CW - 0700. QSL to G4SSH: Clayton, 9 Green Island, Irton, Scarborough N York YO12 4RN England.

Z21CA James 14 MHz - CW - 0500 QSL to: Mr J Smiles 13/23rd Ave, Fomona, Bulawayo, Zimbabwe, Africa.

6Z4FN Don 14 MHz - CW - 0530. QSL to: Don PO Box 45681 Nairobi, Kenya.

N6TRE/HZ 14295 kHz 1948. QSL to US Embassy PO Box 9041 Riyadh, Saudi Arabia. 9X5NH 14240 kHz 0705. QSL to: DJ6EA Udo Weber Sternbergstr 54 D 7406 Moessingen 5 FRG.

UI8QU 28495 kHz at 0632. QSL to: K9FD: Mervic D Schweigert, Rt 2, Box 138-A, Red Bud 11 62278 USA.

8P9EM 28520 kHz 1132. QSL to: G3VBL Chris Pedder, 5 Royalty Lane, New Longton Preston, Lancs PR4 4JD, England.

VQ9DX 14190 kHz 1139. QSL to: K7PQS Gary L Storm 786 Samish Island Rd, Bow WA 98232 USA.

LQ2DX 14182 at 0719. QSL to: GADX See notes below.

6W7OG Daniel 14222 kHz. QSL to: F2YT (Paul Joel Herbet, 9 Rue de L, Allouette F-62690 Estree Cauchy, France.

JT2AB Ban - Box 119 Choybalsan, Mongolia 14004 - CW -

SV8YM Taseo 14150 kHz 1831 UTC. QSL to Bureau.

From Here and there and Everywhere

Larry UT4U0 is QSL Manager for 9N1RN and has all the logs for the year 1986-87-88- and 89. QSL to: Mr V Hoyko, PO Box 9 KIEV 262200 USSR.

Frank VK2QL says that after 55 years of DX activity he finally managed to have a QSO with 3C0GD a few months ago.

The acceptance of contacts and QSLs regarding Banaba and Conway Reef have been clarified. Previous contacts count, but QSL cards will be accepted only after the 1st March 1990.

In the January issue of "AR" I drew your

attention to the usefulness of the WARC bands, for DX work. Graham VK6R0 now advises that these new bands are exciting. He worked 132 countries on 24 MHz since Dec 1982. During 1989 he worked 97 countries on 24 MHz. On the 18 MHz band, he is very close of working 100 countries. (Has anybody else a better record? What about 10 MHz? Send details to me.)

The Lithuanian Amateur Radio Society (LRMD), which functioned in 1938-1940, was reconstituted and the Lithuanian National QSL Bureau is part of LRMD. Any cards to Lithuanian stations (LY, RP, UP) should be sent to LRMD QSL Bureau, PO Box 1000, Vilnius, Lithuania 232001.

Larry TZ6VV is usually on 21272 or 28472 between 2100-2300 UTC, on 40 metres or 14175 between 0600-0800 UTC, and on 15-12 or 10 metres between 1700-1800 UTC on most days. QSL to: NOBLD Marshall P Rieck 5831 SE 63rd Street, Tecumseh, KS 66542. Heard an interesting QSO between VK0CH — Craig — (QSL direct to Box 52 GPO Canberra 2601) and Gery AL7BL. Craig is on Mawson Station in the Antarctic station which still uses huskies for local transport. Wind gusts up to 200 kms. There are 70 people on the station during summer time, but only 24 during the winter. AL7BL, on the other hand, was at the other extreme of the Earth — on the most northern part of Alaska in Prudhoe Bay. He works on the oil-fields in temperatures well below zero. One week on, one week off is his work schedule. He flies home near Anchorage, 1200 km away, each alternative weeks. I had a short contact on cw with 3W3RR on 14009 at 1829. The operator is Roman, UB5JRR. He appeared at the end of January on Porcy's "ANZA" net (21205) — HL5BDS left the South Shetland Islands in January. He will be replaced by HL8KSJ. Try to work any of the Argentine DX Group (GADX) celebrating stations with a specific LQ prefix. LQ1DX, LQ2DX, LQ3DX — LQ6DX. The celebration (1st anniversary of the group's existence) will last until the 31st of March. QSL to GADX PO Box 36 1834 Temperley — Buenos Aires — Argentina. There is an unconfirmed report that Eric, WZ6C will go to North Yemen, 4W, in March 1990. Do not be too excited about it. We will see. Jorge D2/LU6ELF is back from his vacation and is active again from Angola. His documentation with the DXCC committee is still in progress. The ARRL DX Advisory Committee has recommended Walvis Bay (ZS9) by overwhelming majority to be accepted as a separate DX country. Final decision will be known next month. T30AC will be absent from Kiribati for a year, whilst studying at the University of South Pacific in Suva Fiji. Bjarn TF3BM, using a vertical antenna was S6 at my QTH on 14185 at 1318 UTC, asking for takers without much success. He just casually mentioned that he has constant hot water in his house, generated from one of the geysers near

Reykjavik. QSL via the Bureau. Due to freak propagation conditions, TR8JLD—Jean Louie appeared on the band — 14222 kHz — at a signal strength of S9 with 10 watts and a dipole antenna 0620 UTC. QSL to AK1E: Dan Morehouse, 618 Leander St, Shelby NC 28150 USA. DL2GAC, Gernhard started a multi-country trip mid-January. Expect to hear from his with the following callsigns: 8Q7CQ, VU2BMS, 9M2QR/P P29VMS, YJOABS and H44/DL2GAC. He will be active on the following frequencies: 14260 — 21260 — 28460 kHz. QSL to: DL2GAC Bernhardt Stefan, Aacht Str 25, D7772, Uhdlingen 1 FRG. It appears that XW8CW and XW8DX has been accepted for DXCC purposes.

Interesting QSLs Received

Direct QSLs: KN0E/KH3 — CM2ED — D44BS — ZK1CQ — FO0BEF — ZK1CQ Penrhyn Is ZK1RS — TY88YL — P29KN — OY9JD — EL2WK — 6ZSWK — EL2DK — 6Z2DK — 3D2XX VU7JX — A15AA/MM — 3D2WV — 3D2VT — 5U7QL — TJ1BW — D68CY — ZS1IS — VK9TR — VKOMP — VQ9MC — T28RW — FK8FU — VP9AD — VP5JM — VK0CH — KG4DD — 3D6AK — XW8KLP — KH6JEB/KH7 — 9Q5XX — 5W1KT. Bureau QSLs: GJ2LU — VX5RA/VX6 — KH0/JA1QGG — CP6IH — OA4BJ — HK1AMW — EA9PY — HK6GLR — KC6MH — HK7AAG

The Big Question!

By the end of January 1990, more than 20 VK amateurs went to the trouble to send me letters, notes, QSL cards with comments — and others over the air — to encourage me to

stay on the job as the DX Editor of this column. I have thanked you already individually in a circular letter. But I will prepare a summary of your observations, comments, and suggestions for the next issue of "AR". Again, many thanks.

And finally the credits, where credit is due. Many thanks for the assistance received from: VK2QL, VK2DLB, VK4DA, VK4OH, VK5BAS, VK6NE, VK6RO, the Lithuanian QSL Bureau, and the "QRZ DX" Bulletin. Please keep up the information rolling in.

Good DX and 73.

Stop Press - Late News

XW8CW, XW8DX, XW8KPL, XW8KPV have been accepted by the DX Accreditation Committee of the ARLI as legitimate DXCC operations. ar

Latest News - The Colvins In Australia

The world famous husband wife DX-team, Lloyd Colvin W6KG and Iris Colvin W6QL have spent a few weeks in Sydney and became operational after arrival under the callsigns: VK2GDE and VK2GDD.

The Colvins are well known around the world as the "super DX-ers" of the DX-ers. Since 1965 they are spending at least six months each year on DX-peditions in various parts of the world.

As of October 1989 Lloyd and Iris Colvin have worked half of the active amateurs of the world, travelled in 181 countries, made over

1,040,000 QSOs, worked amateurs in 356 DX countries, received and filed alphabetically 570,000 QSL cards, (the largest such collection of QSLs in the world), held more than 140 different callsigns, worked DXCC under 100 different calls, earned more than 60 awards, and received more than 400 certificates.

In Sydney the Colvins were hosted by Harry, VK2BJL both with accommodation and station facilities. John VK2DEJ hosted in their honour a barbecue get-together which was attended by several Sydney amateurs, including the President of the VK2 Division, Roger Henley VK2ZIG and by Stephen VK2PS, the special events liaison officer of the VK2 Division. Bjorn SM7ED and his wife Alva, who were visiting at that time in Sydney, were also present at the barbecue.

On Sunday, the 28th of January 1990, the Colvins and the Swedish guests travelled to the VK2 Division's transmitting site at Dural, to see the transmitting facilities provided by the VK2 Division for its members. During the usual Sunday morning broadcast, the Colvins were interviewed on the air by Stephen, VK2PS. They spoke about their DX activities, in various parts of the world, including the well-known visit a few months ago to the Soviet Union visiting all 16 republics. They also transmitted as DX from the Club stations in the many cities and town in the Soviet Union.

A seminar was planned by the VK2 Division to take place on the 7th of February. The guest speakers were the Colvins, who spoke about HF DX-ing. We expect to bring you a detailed report about the Colvin's Sunday Broadcast interview, and the HF Seminar in the next issue of Amateur Radio. ar

VHF/UHF AN EXPANDING WORLD

ERIC JAMIESON VK5LP
9 WEST TERRACE MENINGIE 5264

All times are Universal Time Co-ordinated indicated as UTC

Beacons on Six Metres

Freq.	Call Sign	Location	Grid Square
50.000	GB3BUX	England	1073
50.005	H44HIR	Honiara	Q100
50.005	HL9TG	Korea	
50.005	ZS2SIX	South Africa	KF25
50.011	JA2IGY	Japan	PM84
50.015	SZ2DH	Greece	KM18
50.017	JA6ZIH	Japan	PM51
50.020	GB3SIX	England	1073
50.020	CX1CCC	Uruguay	
50.025	6Y5RC	Jamacia	FK17
50.025	OH1VR	Finland	KP12
50.028	JA7ZMA	Japan	QM07
50.029	CT0WW	Portugal	IN61
50.032	ZD8VHF	Ascension Is	II22
50.032	ZS5SDX	South Africa	KG50

50.035	ZB2VHF	Gibraltar	IM76
50.035	ZS3VHF	South Africa	JG87
50.039	FY7THF	French Guyana	GJ35
50.045	OX3VHF	Greenhald	GP60
50.048	TG4BFBK	Guatemala	
50.050	GB3NHQ	England	I091
50.050	ZS6DN	South Africa	KG44
50.056	VK8VF	Darwin	PH57
50.057	TF3SIX	Iceland	HP94
50.062	PY2AA	Brazil	GG66
50.064	WD7Z	Arizona	EL59
50.065	GJ4HXJ	England	IN89
50.065	NB30/1	Rhode Is	FN41
50.066	VK6RPR	Perth	OF78
50.063	KH6HI	Hawaii	BL01
50.075	VS6SDX	Hong Kong	OL72
50.078	TI2NA	Costa Rica	EK70
50.080	KH6JJK	Hawaii	BL11
50.080	HC8SDX	Galapagos Is	EI59
50.085	9H1SDX	Malta	JM75
50.086	VP2MO	Montserrat	FK86
50.088	VEISIX	Canada	FN65

50.090	KJ6BZ	Johnston Is	AK56
50.092	W5GTP	Louisiana USA	EM40
50.099	KP4EKG	Puerto Rico	FK68
50.100	HC2FG	Ecuador	F107
50.100	5H1HK	Tanzania	
50.100	KG6DX	Guam	QK23
50.110	A61XL	United Arab Emir	LL74
50.120	4S7EA	Sir Lanka	MJ97
50.321	ZS5SDX	South Africa	KG50
50.490	JG1ZGW	Tokyo	PM95
50.499	5B4CY	Cyprus	KM54
52.100	ZK2SIX	Niue	AH50
52.200	VK8VF	Darwin	PH57
52.310	ZL3MHF	Christchurch	RE66
52.320	VK6RTT	Wickham	OG89
52.325	VK2RHV	Newcastle	QF57
52.330	VK3RGG	Geelong	QF21
52.345	VK4ABP	Longreach	QG26
52.370	VK7RST	Hobart	QE37
52.420	VK2RSY	Sydney	QF56
52.425	VK2RGB	Gunnedah	QF59
52.435	VK3RMV	Hamilton	QF12
52.440	VK4TL	Townsville	QH30
52.445	VK4RIK	Cairns	QH23
52.440	VK5VF	Mount Lofty	PF95
52.460	VK6RPH	Perth	OF78
52.465	VK6RTW	Albany	OF84

52.470	VK7RNT	Launceston	QE38
52.485	VK8RAS	Alice Springs	PG66
52.510	ZL2MHF	Moutn Climie	RE78

1. This is an addition to the beacon list. Peter, VK8ZLX in Alice Springs, said HL9TG would be operating using MCW while H44HIR on the same frequency uses FSK, so there should be no problems with identification.

Readers' attention is drawn to a statement under WIA News on page 4 of January 1990 AR regarding beacons in the 50 MHz segment of six metres. Executive resolved that there be no beacons in this segment for those States with restrictions, ie VK1, 2, 3, 4 and 7. Executive agreed to a beacon in VK8 on 50.056 and agreement with the already operating beacon in Perth on 50.066. Any future beacons will be on a time sharing basis using either of the above two frequencies.

This arrangement should appease those people afraid of the implications of QRM involved with the establishment of any further beacons in the segment 50.050 to 50.200.

The eastern States of Australia should be adequately served by the two major Channel 0 TV stations in VK2 and VK4 acting as high powered "beacons". There is a proven track record of TV stations being indicators of band openings through the reception of Asian stations on 49.750 and European stations around 48.240 MHz. Their high power often indicates well in advance that an amateur band opening is possible, and no doubt more use of this facility will be made in the future.

Six Metres

With my problems making a slow recovery I have been able to spend a little time at the operating desk during the past month. Observations were that, unfortunately, there appeared little interest in the Ross Hull Memorial Contest, as few numbers were noted being exchanged. This may have been aggravated to some extent by the absence of Es on many days.

At the end of the month the VHF/UHF Field Day appeared to receive greater support, with a number of portable stations operating in South Australia and Victoria. For some of the time conditions were reasonable on 50, 144 and 432 MHz, allowing contacts between VK5 and VK3 to be established. It is of interest to note the improved signals which can be received from stations operating portable from high terrain. Trying 100 mW on 432 MHz, I had no trouble working VK5ZUC/P near Mount Magnificent, about 100 km distant.

While it is probably true to say that Es has not provided a mass of signals at any one time, nevertheless, there have been few days during January when VK4s on 50 MHz have not been heard here at Meningie. There have also been at least seven openings to Japan, mostly around the middle of the day, and VK7s have

also been prominent, some remarking they had worked 14 ZLs. On 10/1 HL9TG, while not strong here, was observed working VK4ZJB, VK4ZAZ and others around 0330.

On 11/1, Mick, VK5ZDR, worked Gary, HL9TG and JAs at 0819. Mick said Gary uses an antenna fixed on the long path to Europe via the USA. Earlier, from 0400, VK4KU, VK4ZNC, VK4YVM and others were S9 and had been working VK2, 3, 5 and 7. VK2ZGB observed calling JAs at 0411. On 13/1 at 0123, VK4ZDK was 5x9 and at 0225 VK4XD worked VK3KAY and others. On 14/1, 16/1 and 17/1 there were more JAs, some around 0400. On 20/1 the band seemed to be open to VK7 from 0040 for most of the day and they were working VK2, 3, 4, 5 and 6. At 0330 VK6AOM and VK6YBI were strong. ZL9TPY was heard around 0800.

21/1 was another good day with VK3 and VK7 from 0030, then around to VK6YU at 0104. Pagers were heard on 42 and 43 MHz. VK2s and VK4s from 0350. On 25/1 more JAs and VK5OH from Smoky Bay in the west of South Australia to VK5ZDR, also Kerry, ZL9TPY worked by many stations in VK3, 5 and 7.

On 23/1 Ed Roach VK4KAA, from Longreach, phoned to say he had been working JAs and hearing the HL9TG and KH6HI beacons. He runs 60 watts on six metres, monitors 52.525 FM and Ch 50 FM looking for visitors to the town. He runs packet radio on 144.900 with horizontal polarisation and looking south most of the time. He has 70 cm equipment. Lyle VK4KXM is also in Longreach. He confirms the VK4ABP beacon is operational on 52.345 MHz running 14 watts to a quarter wave vertical antenna.

26/1 good signals all day from VK4. At 0728 John VK4ZJB, worked Henri FK8EB/M, on his way home from work. Henri was S3 in Meningie. At 0741 from his home station he was worked by VK5LP at 5x5. At 0826 VK5LP worked Kerry ZL9TPY, at 5x5. Kerry was manning a DXpedition from Auckland Island south of the South Island of New Zealand. His signals had fallen to S2 at 0855 but there were no takers for his CQ calls. VK2, 3 and 7 were also available. On 27/1 some good signals observed from VK3 and VK7. JAs at 0200.

On 28/1 Roger VK5NY, reported TV signals were audible for most of the day on 49.750 MHz. Roger also reported that on 24/1 he had been receiving what seemed to be TV signals at 1140 from Germany on 48.239 MHz and Norway at 1152 on 48.246 MHz. Subsequently, these signals were replaced by 49.750 again and he queries whether the 240 kW station at Leningrad was involved, in addition to the 50 kW station at Vladivostok.

29/1, 30/1 and 31/1 provided Es openings to VK2 and VK4.

New Zealand Operation

It is pleasing to learn that the New Zealand

authorities have granted limited 24 hours use of the segment 50.000 to 50.150 to specific amateurs operating from a fixed location which is not closer than a 50 km radius of the service area of any Channel 1 TV station. As the service area of a TV station is usually considered to be around 120 km this means only those stations outside a radius of 170 km could operate. This will effectively restrict their numbers, particularly as the restrictions also apply to translator stations having a Channel 1 input.

Therefore, it seems likely that the bulk of New Zealand operating will still take place just above 51 MHz as the 170 km radius will probably exclude most of the large populated areas from using the lower segment. Their Channel 1 TV station sound on 50.750 MHz is a useful "beacon" for band openings.

Six Metres From Hamilton

Steve, VK3OT, has written enclosing an interesting run-down of European stations he has worked since October 1989. Steve is to be congratulated on his perseverance and thus reaping so many rewards. However, he has said the contacts were the result of long hours spent trying to raise the stations and many would not have been made without the use of CW due to language problems. Hence, at times there is still a good case for CW — please note you CW "knockers!"

The contacts open on 9/10/1989 at 0900 with PA3BFM, 0903 PA0HIP also heard by PA3EUI and G5KW. On 11/10/89 a poor QSO at 0932 to G5KW during the good opening to Alice Springs. On 19/10 SSB at 1045 to FC1BUU and at 1046 to FC1JG. On CW at 1050 to F6HWM; 1052 to F6EPE and 1053 to F9DI. 30/10: At 1116 SSB to FE6HIW; this was a cross-band contact to 10 metres.

23/11: On CW at 0858 to G3WOS; 0900 G3JVL; 0901 G4JCC; 0904 heard W6JKV/CT3 working DU3; 0912 PA0HIP; 0922 PA3ECU; heard at 0927 by G3RFS, an SWL; 0933 PA3BFM. 25/11: CW 0850 OH1ZAA; 0855 SM7BAE cross-band; 0900 G3RFS, SWL.

26/11: CW at 0814 to OH1ZAA; 0815 OH2BR. At 0820 VK3AMZ worked OH2TI, OH2KK and OH1YP. Signals extended into Melbourne with VK3AZY working two and VK3XQ one.

7/12: CW at 0840 to PE1LCH; 0844 PA0RDY; 0849 G3RFS, 0854 PA0HIP, 0855 PA4EUI, 0900 G3RFS, all SWLs. 9/12: CW at 0800 OH1YP; 0803 OH2HK; 0804 OH2BUW. 11/12: SWLs LA9BM, FD1GTR and FE6HSW report Steve's cross-band contacts.

Steve said the SWL reports were from amateurs, who, for various reasons, did not initiate contacts. The QSO between VK3OT and F6HWM on 29/10 is claimed as a new distance record from VK3 at almost 17,000 kms.

Steve included copies of QSL cards from OH2BR, F1JG, G5KW, G3JVL, PA3EUI,

G4JCC, PA0HIP, G3WOS, F6HWM, PA3BFM, FE6HSW and OH2HK. Also included was a copy of pictures from Chinese television, obtained when using his large M squared six metre antenna system. At other times, he uses a 5 element Channel 0 yagi for receiving video signals between 45 and 50 MHz.

Pacific Area Contacts

Again from Steve VK3OT. 5/12/89: 0240 KL7CDG; 0255 KL7NO; 0300 AL7C; 0302 NL7OW; 0328 KL7NO on CW; 0329 KL7HBK on CW; 0345 KL7NO SSB at S9 plus. 8/12: 0150 KL7NO 5x3. 9/12: 0150 3D2SO 539; JA8s 0100 to 0200. 10/12: 0200 ZL1AXB on F2 backscatter; HL9TG, VK8RH, VK8ZWM, VK8AH and P29KK.

11/12: 0030 AL7C 539; 0035 KL7IKV 529; JA4s with JA7 on B/S; VK6YU, VK6HK and a CQ to VK6JJ. 12/12: 0113 KL7NO; VK6AKT, VK6AOM, VK6ANR. 14/12: 0300 to 0800 JA7 and JA8. 16/12: YBOARA, XU2A (Vietnam); Alaska Ch. 2 TV on 55.250. 28/12: VK8ZCU, YJ8GP, JA8RC, JA8OMB, H44HIR beacon.

Lord Howe Island

This is advance information and subject to alterations, but Steve VK3OT will be mounting a DXpedition to Lord Howe Island. Steve said early April in his letter, but later information from Peter VK8ZLX says Steve will be operating as VK9LE from 25/3 to 8/4. On 7/4 Joel N6AMG, will join him and will operate for one or two weeks from the same location. This will present a good opportunity for those requiring LHI for a new country and we hope Steve is rewarded with conditions good enough to provide many contacts. I would imagine the US and Caribbean area stations will be seeking him.

Incidentally, Peter VK8ZLX from Alice Springs will be writing Steve's Six Metre columns for the time being — I wish him well. Peter is currently heading towards working 100 grid squares on six metres, using his 12 metres long 7 element beam at a height of 15 metres.

Bolivia

The Japanese "CQ ham radio" magazine (courtesy VK6RO) shows a QSL obtained by JH3LBD from CP8AZ in Bolivia, South America. This is a little-mentioned country with six metre operating. CP8AZ uses an IC502 and a 50 watt amplifier to a 5 element beam at 10 metres.

From the same source; a few QSL routes: FK1TK — Henri Rainer, PO Box 4608, Noumea, New Caledonia; ZK1RS — via ZL4DO, Robert J Sutton, Woodhill Forest, RD3, Waimauku, New Zealand; 3D2PO — Andrew C J Woolfield, AWA Ltd, Suva, Fiji; 4F1JZ — via DU1JZ, Evaristo "Sonny" Leviste, 27 New Delhi, BF Homes, Las Pinas, Metro Manila, Philippines.

Two Metres And Above

Mick VK5ZDR, reports a few very good periods for two metres. One surprising contact was on 10/12/89 with VK7JAD on King Island, which would be somewhat rare. 1990 started off well at 0001 on 1/1 with a good opening to VK3 on 144 and 432 MHz with many stations being worked. The opening extended to 2/1.

On 26/1 an excellent opening to VK3 and VK7 from VK5 on both bands. The good conditions continued the next day to provide opportunities for portable stations in the Field Day Contest to grab some contacts.

DX Contacts

March and April, and possibly through to May, should be a prime time for long distance contacts via F2 and TEP. The majority of the F2 contacts from the east will probably appear between 2030 and 0000 so early rising will be necessary. JAs are more likely to be prominent around 0100 to 0300. From 0600 to 0800 it will pay to look towards South Africa and from 0800 to 1000 the right time for possible European contacts. After 1000 there remains the possibility of late night contacts to Japan and other northern areas. As you can see, you will find little trouble in spending most of your waking hours in front of the rig looking for those elusive contacts. Traditionally, for a greater range of contacts, our autumn seems to favour the Southern Hemisphere rather than the spring period.

It is good to see that, at least during off-peak periods, most stations move off 50.110 after establishing a contact, and this is a wise thing to do. There are some who continue to blatantly use the call frequency for long QSOs. During peak periods, it is inevitable that some DX stations will continue to operate on 50.110, and this will be the only way you will have your contact. However, providing you are hearing the station at reasonable level, there seems little need for a contact to take

much longer than 30 seconds, at the most one minute, thus allowing waiting stations to have their contact. All that needs to be exchanged are call signs, signal reports and possibly your name — descriptions of your gear, antenna system and the weather are quite unnecessary for important contacts.

For those who say that they must stay on 50.110 for local QSOs because they can hear no other signals, may I quote you an instance during the past week when two VK4s were heard by me chatting on 50.110 after making the statement that the band was dead. On the contrary, I could hear both the VK4s and also Kerry ZL9TPY who was working VK3s. Had I not already worked Kerry I would have been annoyed that my chances would have been spoiled by chit-chat from cross town working by the VK4s.

With so many rigs now having two VFOs, it is so easy to set one VFO on 50.110 whilst you move around with the other VFO. Thus, you can have a local or Es QSO on another frequency and from time to time check the call frequency during such a contact. All it requires is a little thought for others on the band.

Closure

Unless something dramatic happens to upset the hoped-for propagation of the next few months of Cycle 22, six metre amateurs should work many countries. I would appreciate hearing from many of you so that some idea of areas worked can be summarised. You may care to list your efforts in a form which would be suitable for inclusion in the Six Metre Standings Box. Details required are shown in the February issue of AR.

Closing with two thoughts for the month: "The ultimate sin of the mind is the failure to pay enough attention" and "You can tell that a child is growing up when he stops asking where he came from and starts refusing to say where he is going."

73. The Voice by the Lake

ar

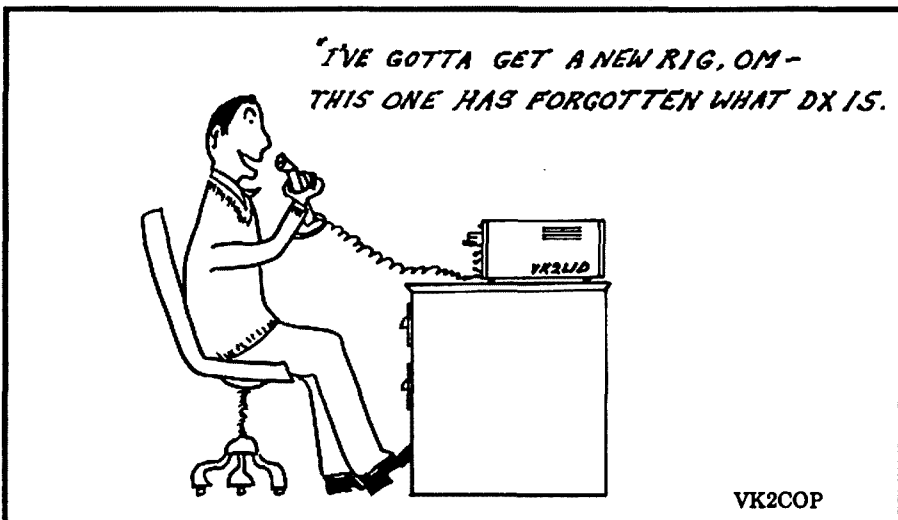

VK2COP

CONTESTS

FEDERAL CONTESTS MANAGER FRANK BEECH VK7BC
37 NOBELIUS DRIVE LEGANA TASMANIA 7277

Contest Calendar

March

- 10 — 11th RSGB Commonwealth contest (rules in January AR)
- 17 — 18th NZART National field day contest
- 17 — 18th WIA JOHN MOYLE MEMORIAL CONTEST (rules February AR)
- 3 — 4th ARRL International DX contest (late news).

April

- 20 — 21st ARI. "ARI international DX contest (rules this issue).

July

- 14 — 15th IARU HF World Championship (tentative date only).

Associazione Radioamatori Italiani have sent a set of rules for the ARI International DX contest for distribution. They have called it a "New" contest, because of the large number of changes that have been made to the rules this year. Whilst on the international theme, the ARRL has sent me a tentative list for the 1990 calendar year. 13 of the contests are either VHF or UHF Sprints or Field day contests, the other 10 are HF only, quite a work load for the contest committee! The contests that will interest our readers are the November CW sweepstakes (3-5th Nov). Sweepstakes Phone (Nov 17-19). This is followed by the 160 contest from Nov 30 till Dec 2nd. The final HF contest of the ARRL year will be the 10 metre contest that is held between Dec 8 and 9th.

The results of the 1989/1990 Ross Hull contest, and 1990 second trial VHF field day contests will be published next month. So far the number of Ross Hull logs received is up on last year, and a few VHF field day logs have already been sighted.

Good luck to you all in the John Moyle contest. PLEASE READ THE RULES, and take care with the cover sheet details. I do not like disqualifying entries. Take care to have ALL operators who man club stations SIGN the cover sheet. In the RD contest of 1989 I had thirteen stations with only the signature of one person on the lot.

The 1990 ARI International DX Contest

1. Aim

It's a world wide competition: everybody can work everybody.

2. Date and time

Every third week end of April from 2000z Saturday till 2000z Sunday. In 1990 it will be on April 20/21.

3. Classes

1. Single Operator — CW

2. Single Operator - SSB
3. Single Operator - Mixed
4. Multi Operators - Single TX - Mixed
5. SWL - Single Operator - Mixed

4. Bands

10m through 160m (except WARC bands) are allowed according to IARU Band Plans. Band can be changed only after using one for at least 10 minutes

5. Exchange

Italian stations will send RST plus two letters to identify their province. Other stations will send RST plus a serial number from 001.

6. QSO/Points

- a) QSO/HRD with own country counts 0 point but is good for multipliers' credit.
- b) QSO/HRD with own continent counts 1 point.
- c) QSO/HRD with different continent counts 3 points.
- d) QSO/HRD with any Italian (I & ISO) station counts 10 points.

The same station can be contacted on the same band once on SSB and once on CW but only the first QSO is good for multipliers' credit.

7. Multipliers

- a) all Italian provinces (95) count 1 multiplier
- b) all DXCC countries (except I & ISO) count 1 multiplier

8. Final Score

The sum of QSO/points from all bands times the sum of multipliers from all bands.

9. SWL

SWL have the same rules as OM. The same station cannot appear more than 3 times on every band as a correspondent.

10. Logs and summary sheet

Logs must contain no more than 50 QSOs on each page, separate logs are necessary for each band. Logs must show all the QSOs' data (date, GMT, callsign, complete sent and received exchanges, new multipliers and points).

Duplicate contacts must be enclosed in the log, marked and with points = 0.

A summary sheet is required showing all the scoring details on each band, class of entry, name, callsign, full address of the applicant, callsign of other operators and a signed declaration. A dupe sheet is required for entries with more than 100 QSOs on one band.

Logs must be mailed within 30 days from the end of the contest and addressed to: ARI Contest, Via Scarlatti 31, 20124 MILANO, Italy.

Please enclose your station's description and your comments. A picture will be much appreciated.

11. Penalties and disqualification

Disqualification applies for:

- a) excessive number of unmarked duplicates (more than 2%)
- b) excessive declared score (more than 5%)
- c) violation of the "10 minutes rule"
- d) log without the summary sheet

Penalties:

- e) each duplicate contact removed by the Contest Committee means a penalty of 3 QSOs
- f) each multiplier counted twice or more on the same band means a penalty of 2 multipliers

12. Awards

A plaque with a certificate will be awarded to the top scoring station in each class. A certificate will be awarded to No. 2,3,4,5 top scoring stations in each class as well as to the top scoring stations in each country in each class.

13. Italian certificates

The QSOs done during this contest can substitute the necessary QSL cards for the ARI certificates WAIP, CdM and IIA.

Enclose an award application, a list of the QSOs good for the award and 10 IRCs for each award.

Results Of The 1989 Remembrance Day Contest

QUEENSLAND AGAIN

Logs received (state and section)

Area HF HF Open HF CW VHF SWL TOTAL

VK1	18	1	2	13	34
VK2	43	6	12	3	64
VK3	21	5	7	8	42
VK4	50	5	9	23	88
VK5	31	5	6	24	68
VK6	32	1	7	48	88
VK7	13	0	3	17	33
VK8	1	0	1	0	2
Over-seas	8	0	0		8
Total Entries =	427				
Total valid logs	427				
Points Awarded					
VK1	2307	419	216	677	5149
VK2	5240	1527	1497	62	8326
VK3	2794	916	750	451	4911
VK4	5304	1213	1278	2207	10002
VK5	4761	1019	882	2310	8972
VK6	2677	442	812	5303	9234
VK7	1462	0	234	1531	3227
VK8	70	0	210	0	280
ZL	1153				
P2	63				

The formula for determination of results for each division is;

Number of logs/Number of licensees (Participation) X Total Points X Weighting factor (average of last four weighting factors).

Weighting factor to be applied for 1989 contest is;

VK1 — 1.055. VK2 — 7.084. VK3 — 5.582.
 VK4 — 5.05. VK5 — 1.43. VK6 — 1.615. VK7 — 2.375. VK8 — 10.00.
 VK1 — 34/400 x 5149 x 1.055 = 461.736
 VK2 — 64/5373 x 8326 x 7.084 = 702.550
 VK3 — 42/5064 x 4911 x 5.582 = 227.359
 VK4 — 88/3075 x 10002 x 5.05 = 1445.487
 VK5 — 68/2077 x 8972 x 1.43 = 420.046
 VK6 — 88/1682 x 9234 x 1.615 = 780.222
 VK7 — 33/643 x 3227 x 2.375 = 393.337
 VK8 — 2/205 x 280 x 10.00 = 27.316

The Queensland division is therefore winner of the 1989 Remembrance day contest.

VK4 — 1st
 VK6 — 2nd
 VK2 — 3rd
 VK1 — 4th
 VK5 — 5th
 VK7 — 6th
 VK3 — 7th
 VK8 — 8th

Certificates will be issued to the winning stations in each section, contestants comments will be published in next month's "AR".

1989 Remembrance Day Results - State Scores

HF Phone		
VK1PJ P Rayner	711	1st
VK1RJ Ron Johns	374	2nd
VK1BR	189	
VK1RH	156	
VK1BAT	152	
VK1LF	121	
VK1TD	180	3rd
VK1DW	100	
VK1DF	76	
VK1AK	60	
VK1MX	43	
VK1IF	34	
VK1ZL	29	
VK1AOP	19	
VK1BBA	17	
VK1PC	18	
VK1BEB	14	
VK1SB	14	

VK2DVU Ross Piatt	445	1st
VK2DCL Bathurst ARC	436	2nd
VK2ANO	390	3rd
VK2BTP/P Aviat NSW RC	378	
VK2ZL Westlakes ARC	334	
VK2AYK	308	
VK2NW	280	
VK2CHF	200	
VK2PS	197	
VK2CKW	190	
VK2RE	187	
VK2BUI	151	
VK2WI WIA	144	
VK2KSC	115	
VK2LEE	105	
VK2SA	104	
VK2PUP	73	
VK2GV	73	
VK2EXA	70	
VK2IV	68	

VK2ETK	67
VK2XT	64
VK2BVH	62
VK2PN	62
VK2SRM	60
VK2BHS	57
VK2BQS	56
VK2CZZ	56
VK2PD	55
VK2VR	54
VK2RX	50
VK2PY	50
VK2DDW	50
VK2EGI	35
VK2EMU	30
VK2AWT	30
VK2GJS	29
VK2AL	26
VK2ADR	25
VK2OH	22
VK2UM	20
VK2BDT	19
VK2BTZ	12
VK2PJT Log format.	0.

VK3YH S Jenkinson	517
VK3ZI Kevin White	320
VK3DMN	272
VK3CRA	210
VK3ADW	197
VK3DNC	192
VK3CDH	153
VK3ABP	121
VK3AVB	114
VK3QP	114
VK3DKT	102
VK3KTO	76
VK3DVT	74
VK3MBU	68
VK3AOE	60
VK3AMW	50
VK3CVH	41\
VK3CLS	39
VK3ALD	31
VK3ATJ	29
VK3AL	14

VK4YB Roger Crofts	536
VK4BTB Disabled ARC	336
VK4BB	308
VK4BAY	302
VK4AEV	268
VK4DO	250
VK4WIZ Rad Am Group	201
VK4BTW	189
VK4KEL	184
VK4IS	179
VK4AGL	178
VK4ASF	160
VK4CEM	159
VK4YZ	159
VK4AEM	139
VK4ACW	123
VK4BSH	109
VK4PS	105
VK4BRG	102
VK4AQD	81
VK4KWD	76
VK4WEM	72
VK4OY	72
VK4AVR	70
VK4SJP	68
VK4BNL	63
VK4KIT	62
VK4AIX	51

VK4IZ	50
VK4AAK	50
VK4NFE	50
VK4PJ	44
VK4ALM	44
VK4BIF	41
VK4WIG Gold Coast ARS	38
VK4KGE	36
VK4NDK	36
VK4AOR	34
VK4AVC	31
VK4MWZ	25
VK4FX	25
VK4BG	22
VK4CHS	20
VK4EV	19
VK4ADY	16
VK4XZ	15
VK4VAW	14
VK4IY	12
VK3DS/4	15

VK5ADD Don Macdonald	616
VK5AYD Don Young	554
VK5BI	493
VK5ARN Naracoorte ARC	486
VK5APJ	419
VK5XY	404
VK5BMT	289
VK5GN/P	213
VK5LL	152
VK5PC	108
VK5ATN	104
VK5RV	87
VK5UE	85
VK5BWA	82
VK5OV	76
VK5BVJ	67
VK5KCX	56
VK5OR	56
VK5AIM	53
VK5AQ	47
VK5ANW	43
VK5IT	36
VK5RK	35
VK5TW	35
VK5YX	26
VK5MX	25
VK5KJT	20
VK5NVW	15
VK5LC	14
VK5KX	12
VK5DH	10
VK5NEI Rule 1	43

VK6GS Gary Smith	300
VK6ATZ T Zaremba	276
VK6LD	262
VK6NHX	246
VK6SZ Kalgoorlie Scouts	221
VK6RG	205
VK6AMB	155
VK6TO	90
VK6AP	84
VK6JP	84
VK6RU	76
VK6FC/P	62
VK6SH	62
VK6KWN	62
VK6CR	60
VK6YF	57
VK6KH	48
VK6GGD	43
VK6QB	34

VK6DYL	32		VK5ST	98		VK1RH	36	
VK6AO	32		VK5WO	61		VK1WI Club	33	
VK6HQ	26		VK6ED E Davies	442	1st	VK1ZQR	30	
VK5HT	22		-----			VK1LF	26	
VK6NRN	19		HF CW Section			VK1BAT	18	
VK6XE	18		VK1DID S Wardle	118	1st	VK1PC	12	
VK6KY	16		VK1CC R Cook	98	2nd	VK1GD	11	
VK6ABR	16		VK2TR R Taylor	232	1st	VK1PJ	19	
VK6RZ	16		VK2AQF E Carruthers	196	2nd	-----		
VK6AD	15		VK2DQP	186		VK2BDT D Thompson	33	1st
VK6WZ	15		VK2BHO	176		VK2BTZ Goulbourn ARC	19	2nd
VK6YJ	12		VK2CX	154		VK2XIJ	10	
VK6WU	11		VK2GT	140		VK3EHF R Killeen	168	1st
-----			VK2AZR	140		VK3AVV M Subocz	62	2nd
VK7KZ R Geeves	506	1st	VK2EL	100		VK3BGS	51	
VK7CK Frank Clarke	216	2nd	VK2II	72		VK3CRA	46	
VK7HW	212	3rd	VK2ED	52		VK3CLS	42	
VK7KC	154		VK2FPA	28		VK3KT	35	
VK7NWR	88		VK2CDG	21		VK3DKT	30	
VK7NGC	59		VK3DVW D Harris	186	1st	VK3XH	17	
VK7BJ	53		VK3XB I Stafford	184	2nd	-----		
VK7NBF	45		VK3KS	112		VK4WIZ Radio Amat Group	229	1st
VK7RM	327		VK3BDH	92		VK4ANN Anne Minter	176	2nd
VK7KDV	27		VK3AMD	76		VK4ZDV	173	
VK7SRS Club	25		VK3DID	62		VK4YPB	162	
VK7FD	21		VK3CFI	38		VK4AHO	143	
VK7DJ	19		VK4XA Russ Colston	344	1st	VK4ZXZ	141	
-----				Top CW overall		VK4BAW	139	
VK8NCH	70		VK4XW G Harmer	244	2nd	VK4AG	137	
-----			VK4JH	240		VK4GUY	129	
Overseas Stations:			VK4CAG	188		VK4ZBV	127	
ZL1BVK Alex Learmond	447	1st	VK4GD	64		VK4KAC	126	
ZM2GJ R Pearce	221	2nd	VK4BRZ	60		VK4KZA	121	
ZL2ADN	180		VK4DXD	60		VK4VR	100	
ZL4GB	114		VK4XJ	50		VK4TDK	85	
ZL3TX	75		VK4SF	28		VK4CHS	44	
ZM1IM	63		VK5AGX Vic Noble	306	1st	VK4BNL	38	
P29NJS John Stratton	53	1st	VK5AO M Lane	198	2nd	VK4AVR	30	
ZL1CDP	53		VK5MN	138		VK4RX	28	
VK9, VK0 No entries			VK5KL	130		VK4IY	25	
VK6GGA	No log		VK5TL	56		VK4ZBD	17	
VK6GGN	Rule 7 & 12		VK5JG	54		VK4BB	14	
VK6SAA	Rule 7		VK6HQ John Hawkins	264	1st	VK4CMH	13	
VK6SH	Rule 7		VK6AJ J Jeffrey	198	2nd	VK4EV	10	
VK6GGD	Rule 7		VK6HG	164		VK4GT Rule 5e		
-----			VK6RF	72		-----		
HF Open Section			VK6WT	48		VK5AKK P Helbig	365	1st
VK1DO C Davies	419	1st	VK6RU	34		VK5ZBK S Ruediger	327	2nd
VK2BO Jim Andrews	500	1st	VK6SM	32		VK5NVF	182	
VK2DM D Macaskill	438	2nd	VK7RY E Nicholls	130	1st	VK5KCX	149	
VK2EJW	292		VK7GB E Burne	60		VK5RV	135	
VK2AIC	159		VK7RK	44		VK5BMT	135	
VK2RJ	88		VK8HA H Anderson	210	1st	VK5PC	110	
VK2HQ	50		-----			VK5OR	110	
VK3ALZ I Berwick	431	1st	HF Receiving Section			VK5OZ	102	
VK3CX J Milway	265	2nd	Ms Norah Bock SA	696	1st	VK5AIM	95	
VK3XF	177		Craig Edwards SA	355	2nd	VK5ANN	91	
VK3XH	28		P Kenyon L30037	238		VK5XY	74	
VK3DFI	15		Lance Noll QLD	260		VK5RR	70	
VK4LT Al Carter	423	1st	-----			VK5MD	62	
VK4WID Darling Downs ARC316		2nd	VHF Phone Section			VK5NVW	50	
VK4OD	249		VK1TD T Donohoe	141	1st	VK5ZKK	49	
VK4YG	173		VK1ZAR J Roberts	115	2nd	VK5ZHV	39	
VK4RM	52		VK1ACA	114		VK5ZWK	32	
VK5ATU R Moon	429	1st	VK1MX	53		VK5MX	32	
VK5GZ L Collins	289	2nd	VK1DW	50		VK5TC	30	
VK5PF	142		VK1AOP	38		VK5AVQ	21	

VK5DH	19		VK6BWI/P	84	VK6RZ	12	
VK5KX	16		VK6JMP	82	VK6GGN Rule 7		
VK5GN	15		VK6HU	100	VK6GGD Rule 7		

VK6CX B Williams	428	1st	VK6ZSE	73	VK6SH Rule 7		
VK6WIA Club	346	2nd	VK6SAN	69	VK6GGA Rule 7		
VK6ZLC	317		VK6DC	65	VK6SAA Rule 7		
VK6JMB	247		VK6ZTJ	60	-----		
VK6ZPP	240		VK6XE	60	VK7ZIF Ian Filby	338	1st
VK6JK	232		VK6RO	53	VK7KDV D Pitt	178	2nd
VK6ABR	205		VK6AN	51	VK7ZAJ	154	
VK6TO	200		VK6IY	50	VK7NWR	150	
VK6YGH	189		VK6KY	49	VK7EB	119	
VK6YF	173		VK6AMB	45	VK7AL	109	
VK6RG	172		VK6HQ	44	VK7ZJG	79	
VK6AD	166		VK6AP	36	VK7FR	69	
VK6XPS	155		VK6RGG	36	VK7ZJH	55	
VK6LZ	152		VK6ZIC	35	VK7ZBW	53	
VK6AR	144		VK6ZGM	35	VK7DJ	52	
VK6YL	144		VK6EB	34	VK7JP	40	
VK6KWN	137		VK6GA	25	VK7KZ	37	
VK6ZGT	136		VK6ALZ	24	VK7RM	28	
VK6ZGN	123		VK6NRN	17	VK7RY	28	
VK6JP	104		VK6KBL	16	VK7NBL	20	
VK6SAN	100		VK6FC/P	14	VK7HW	22	
			VK6YJ	12	No entries from VK9, 0, or 8. ar		
			VK6NE	12			

Commonwealth Contest

Following the outstanding success of the Auckland Commonwealth Games, it is to be hoped that some of the enthusiasm shown in both VK and ZL will spill over into the world of Amateur Radio for the Commonwealth Contest on 10/11 March, the rules for which were in January AR.

For the benefit of new licensees, the areas for which bonus points are awarded (maximum of 3 per area) are listed below:-

Commonwealth Contest 1990 Call Areas

The following call areas are recognised for the purpose of scoring in the Commonwealth Contest 1990.

A2	Botswana
A3	Kingdom of Tonga
C2	Nauru
C5	Gambia
C6	Bahamas
G, GB, GD, GI, GJ, GM, GU, G	United Kingdom (all one area)
H4	Solomon Ia.
J3	Grenada
J6	St. Lucia
J7	Dominica
J8	St. Vincent
P2	Papua New Guinea
S7	Seychelles
T2	Tuvalu
T30	W Kiribati
T31	C Kiribati
T32	E Kiribati
V2	Antigua, Barbuda
V3	Belize
V8	Brunei
VE1	Maritime Provinces
VE1	Sable Is
VE1	St. Paul Ia.
VE2	Province of Quebec
VE3	Province of Ontario
VE4	Province of Manitoba
VE5	Province of Saskatchewan
VE6	Province of Alberta

VE7	Province of British Columbia
VE8	North West Territories
VK1	Australian Capital Territory
VK2	New South Wales
VK3	Victoria
VK4	Queensland
VK5	South Australia
VK6	Western Australia
VK7	Tasmania
VK8	Northern Territory
VK9L	Lord Howe Is
VK9M	Mellish Reef
VK9N	Norfolk Is
VK9X	Christmas Is
VK9Y	Cocos (Keeling) Is.
VK9Z	Willis Is
VK0	Heard Is
VK0	Macquarie Is
VK0	Antarctica
V01	Newfoundland
V02	Labrador
VP2E	Anguilla
VP2K	St. Kitts, Nevis (Kitta)
VP2M	Montserrat
VP2V	British Virgin Is
VP5	Turks & Caicos
VP8	Falkland Is
VP8	S. Georgia
VP8	S. Orkneys
VP8	S. Sandwich Is
VP8	S. Shetland Is
VP8	Antarctica
VP9	Bermuda
VQ9	Chagos
VR6	Pitcairn
VS6	Hong Kong
VY1	Yukon
VU	India
VU	Laccadive Is
VU7	Andaman & Nicobar Is
YJ	Vanuatu
Z2	Zimbabwe
ZB2	Gibraltar
ZC4	Cyprus (UK bases)
ZD7	St. Helena
ZD8	Ascension Is
ZD9	Tristan d Cunha, Gough Is.
ZF	Cayman Is
ZK1	Cook Is
ZK1	Manihiki
ZK2	Niue Is
ZK3	Tokelau

ZL0	New Zealand
ZL1	New Zealand
ZL3	New Zealand
ZL4	New Zealand
ZL5	Antarctica
ZL7	Chatham Ia
ZL8	Kermadec Is
ZL9	Auckland & Campbell Is
3B8	Mauritius
3B9	Rodriguez Is
3D2	Fiji
3D6	Swaziland
4S	Sri Lanka
5B4	Cyprus
5H	Tanzania
5N	Nigeria
5W	Western Samoa
5X	Uganda
5Z	Kenya
6Y	Jamaica
7P	Lesotho
7Q	Malawi
8P	Barbados
8Q	Maldives
8R	Guyana
9G	Ghana
9H	Malta
9J	Zambia
9L	Sierra Leone
9M2	W. Malaysia
9M6/9M8	E. Malaysia
9V	Singapore
9Y	Trinidad & Tobago
GB5CC	RSGB HQ station
VK3WIA	WIA HQ station
Various	Other Commonwealth HQ

Since the RSGB notified this year's rules, there have been a couple of additions in the Maritime Provinces of Canada, VY2 and VY3, now used by former VE1s, so watch out for them — they may be eligible as bonus areas.

VK3WIA will be activated as the HQ station for Australia — it is workable by all VKs, including VK3s. GB5CC will be active in the UK and it is hoped that ZL may come up with a ZL6.

Maybe we can get back to the top VK entry of 66 logs submitted in 1984!

John Tutton VK3ZC ar

AWARDS

KEN GOTT VK3AJU FEDERAL AWARDS MANAGER
38A LANSDOWNE RD ST KILDA 3183

Details Of More VK Awards

Last month's AR gave a run-down on the awards issued by the Federal WIA. Below is the first part of a listing of awards believed to be currently on offer from WIA Divisions, and from various zones, clubs, and special interest groups.

For editorial reasons it has been necessary to keep details of these awards very brief. If further data is needed, it is suggested that you write to the addresses given. Please do not direct enquiries to me unless all other avenues fail. I can supply further information on Federal WIA awards and on some popular overseas ones, but not on the myriad awards offered throughout VK-land.

One other area has yet to be covered in this round-up of VK awards, namely the framework of the "10-10" awards and the various separate awards within it. Details will be published in an early issue of AR.

VK1 Award

VKs contact 20 VK1s for basic award (upgrades available) and DX contact ten. \$3 or 5 IRCs. Net on 3.570 MHz each Sunday following divisional broadcast at 1030 UTC. Further details from Manager, VK1 Award PO Box 600, Canberra 2601.

VK2 Awards

The VK2 Division launched its first awards in 1988. They include a Worked All NSW Award via contacts with stations in various cities, municipalities and shires, and others covering National Parks, recreation areas, and historical sites.

For further details contact Awards Manager, WIA (NSW Division), PO Box 1066, Parammatta, NSW 2150. Please enclose 2 x 41¢ stamps to cover mailing and production costs.

The following awards are issued by various clubs and groups in VK2.

Central Coast Award: Details obtainable from Award Manager, PO Box 238, Gosford NSW 2250. Club net (VK2AFY) on 3.5 MHz band, 1930 UTC, Tuesdays.

Land of the Beardies Award: Contact stations in Glen Innes area. \$3 details from Glen Innes and District ARC, PO Box 26, Glen Innes NSW 2370. Net (VK2DOQ) on 3.580 MHz at 8.00 PM local time Sundays.

Lawrence Hargrave Award: Locals contact ten members of Illawarra ARS, DX contact five. Alternatively, one contact with club

station VK2AMW. \$2 further information from Award Manager, Illawarra ARS, PO Box 1838, Wollongong NSW 2500. Net (VK2AMW) on 3.562 MHz at 1000 UTC Sundays.

Fisher's Ghost Award: Contact stations in Cambden area or existing holders of award. \$3 to VK and ZL, \$4 to others. Details from Manager, Fisher's Ghost Award, PO Box 249 Cambden, NSW 2570. Net (VK2FFG) on 3.580 MHz 8.00 PM local on Fridays.

St George Award: Contact members of St George ARS. \$2. Details from Secretary, St George ARS, PO Box 530, Engadine NSW 2230. Club stations are VK2LE and VK2ALE, but club net controller may use his/her own callsign. Club conducts an 80 m. contest every July, partly as warm-up for August Remembrance Day contest, but also to help amateurs qualify for its award.

VK3 Awards

City by the Bay Award: Contact stations in Geelong area. \$3. Details from Award Manager, Geelong Radio and Electronics Society, PO Box 962, Geelong, Vic 3220. Net (VK3ANR) on 3.56 MHz 1000 UTC on Mondays.

City of Melbourne Award: \$3. Details from Award Manager, PO Box 242, Sunshine, Vic 3020. Net (VK3CBS) 28.485 MHz 2230 UTC Sundays.

Western District Award: \$2. Details from M A Batt VK3XEX, Manager, PO Rokewood Junction, Vic 3351. \$2. Net (VK3BAML) on 3.610 MHz 1000 UTC Thursdays.

Gold Rush Award: Same cost, manager, and net as Western District Award above.

Southern Cross Award: \$2 or 5 IRC. Details from Eastern and Mountains District RC, PO Box 87, Mitcham Vic 3132. Net (VK3BNW/VK3ER) on 28.340 MHz 2330 UTC Sundays, and 3.572 MHz 1000 UTC daily.

Moorabbin Award: \$5. Contact members of Moorabbin and District Radio Club. Details from Award Manager, PO Box 88, East Bentleigh 3165. Net (VK3APC or VK3CCY) on 3.567 MHz 8pm local.

Brief details of more VK awards will appear in the next issue of AR.

Victory-45 Award

This award is offered by the Krenkel Central Radio Club of the USSR to mark the 45th anniversary of the Allied victory in the Euro-

pean theatre of World War II. It requires QSOs with USSR World War II veterans or with special memorial stations. QSOs must be between 1/1/1990 and 9/5/1990 or during the CQ-M contest on May 12-13. No cards required and the award is free.

This award should be very easy for VK and ZL stations, who only need two QSOs. Space limitations prevent me from giving details on how to identify call signs of veteran and memorial stations and other details, but anybody interested can get them by sending me a SASE.

Awards Issued Recently

WAVKCA

1800 Richard Collins	NT6V
1801 Luis P Caamano	HI8LC
1802 O Prostaks	UQ2GJN
1803 Paul Pogrebnyak	RB5MF
1804 Anvar Z Mujdinov	UI8FM
1805 K W Zuikov	UI8ZAC
1806 Sportclub, Tashkent	UI9AWX
1807 Serge Grigorev	UA6LMW
1808 Vladimir Dergabousov	UA3PDW
1809 Oleg N Viculov	UA0ABB
1810 V I Fedenko	UA3UHA
1811 Club Station, Kharkov	UB4LWA
1812 Club Station, Dnepropetrowsk	UB4EYJ
1813 Igor Anatolyevich	RB5BE
1814 Wayne M Sutherland	NQ7Q
1815 Paul Meecham	YP2EXX
1816 Michael Klengel	Y78SL
1817 E Buchmann	HB9BEG

WAVKCA (VHF)

38 Tsunehiro Douichi JO1HQQ
(6m.)

HAVKCA

155 Allajarow Shirali	U78-040-244
156 Serge Pigarev	UA1-113-455
157 Sergio Y Tevenev	UA6-102-164
158 Andy Lomovskoy	UA9-099-770
159 Kenichi Ogawa	JA1-24770

ar

REPEATERS

- additions
- deletions
- alterations

Have you advised
the WIA of changes
needed to the repeater list?

POUNDING BRASS

GIL GRIFFITH VK3CQ
7 CHURCH ST BRIGHT 3741

Publicity, A Good Idea...

Morse Seminar

"A Morse seminar was held on 27th May, 1989, at Arnold and Carlton College of Further Education, Nottingham, arranged by the College Amateur Radio Society. Some 60 visitors attended and clearly enjoyed "having a go" at the various activities, and listening to the main talks by G2CVV on "The Early Days" and G4FAI on "The Origins of Morse" plus a shorter talk on "How to operate a key".

Of considerable interest was a computer program which displayed the length of one's dits and dahs — to the dismay of many attempting to beat the computer using a pump key. Not many achieved perfect Morse! It is hoped to develop this program in time for next year to provide fingerprinting of an individual's sending.

The speed tests proved popular, though surprisingly no-one wanted the certificates offered! A well experienced gent requested numbers at 50 wpm, and to cheers from the assembled room achieved perfect copy.

Six straight keys, loaned by SMC, took some hammering — especially the gleaming brass one costing over 100 pounds — as did the keyers and paddles from Dewsbury Electronics, with even their Morse keyboard having its share of interest. It was nice to be able to sit down and try them all relatively undisturbed.

From the "sign-in" lists it appeared that about a quarter of the visitors were class B licensees, which was most encouraging, and about 12 of them took the mock tests to help them prepare for the real thing.

For a "first-time" event there were a number of things which were not quite right but I

was much encouraged by the number of folk who sought me out at the end and made very nice comments such as "The best publicity you could have was today — the word will spread!"

I must thank all the helpers. The event could not have taken place without their much appreciated assistance. One visitor asked where all the Nottingham folk were and was surprised to hear they were all helping!

Visitors completed questionnaires and made a goodly number of suggestions for the next seminar which nearly all said "had" to take place! I believe we shall be able to provide an even better 'show' next year".

RON WILSON, G4NZU MM 13 P34

Uses Of American Morse

I had numerous questions about what code to use for certain characters, and where the various codes come from, for instance the abbreviation we all use for "and" comes from the American Morse ampersand, dit-dididit, but as with other space-letters such as "o", dit-dit, the space is truncated to avoid forming the discrete letters "e-s". Users of the International code, being unused to internal — spaced characters hear it as "e-s" which is how it is usually written when copying.

CW traffic handlers in the US have long used the American Morse comma (didahdidah) instead of the much clumsier International Morse (dahdahdidahdidah). This character MIM used to be the exclamation mark until it was dropped completely, and now most operators have reverted to the American Morse exclamation mark which is dahdahdidit.

You might hear operators send OK as dit-

dit dahdidah, and they are merely using the American "o" instead of the longer International one.

The end-of-message signal AR, is actually the American Morse letters FN, which meant "finish", and the sign-off signal SK is simply the landline 30, which meant half-past the hour, and thus the end of the operator's shift.

If you have any further information on these or any other Morse characters or their history, do please let me know.

73's Gil.

ar

INTERNATIONAL MORSE	AMERICAN MORSE
A	A
B	B
C	C
D	D
E	E
F	F
G	G
H	H
I	I
J	J
K	K
L	L
M	M
N	N
O	O
P	P
Q	Q
R	R
S	S
T	T
U	U
V	V
W	W
X	X
Y	Y
Z	Z
1	1
2	2
3	3
4	4
5	5
6	6
7	7
8	8
9	9
0	0
Period (.)	Period (.)
Comma (,)	Comma (,)
Interrogation (?)	Interrogation (?)
Colon (:)	Colon (:)
Semicolon (;)	Semicolon (;)
Hyphen (-)	Hyphen (-)
Slash (/)	Slash (/)
Question marks (?)	Question marks (?)

RANDOM RADIATORS

RON COOK VK3AFW AND
RON FISHER VK3OM

Here We Are Back Again

We hope that you found something of interest in the first edition of Random Radiators that found its way into the January issue. We finished up by saying that we would be back with more aerial ideas. However, this month it's down to the other end of the feeder with a bit of information on antenna tuners.

It seems that amateurs are always looking for the perfect approach to a multi-band antenna. It's the opinion of at least one of the

authors (we don't always agree) that the ideal approach is a dipole centre fed with open wire feeder. Let's look at the two important factors mentioned. First let us consider the dipole. For operation on the 80 to 10 metre bands, a minimum length of about 20 metres will give excellent results on all bands. Who says you need a half wave dipole for 80 metres? For the feeder, an ideal approach is 300 Ohm open wire feeder that is often used as low loss TV feeder in country areas. It's a bit hard to find these days, but well worth finding. Another approach is the 450 Ohm transmitting feeder

available from at least one "AR" advertiser. This works very well but has one disadvantage. The conductors are copper plated steel and have an annoying habit of breaking off at the antenna end, after a year or so of flexing about in the wind. And the last option is to use 300 Ohm TV feeder. The loading (and the losses) will vary with the weather, but if you can find some of the slotted variety these effects will be minimised.

Now To The Nitty Gritty

Of course, to make an antenna of this type work an antenna tuner is required, and this is where many amateurs run into trouble. The problem is that an antenna tuner with a balanced output is essential. Most commer-

cial antenna tuners are designed for unbalanced output; that is they are designed to match an unmatched coax line or perhaps feed a long random wire. So this is where the subject of this month's episode comes in.

Enter the 'Ronymous' 'Z' Match

This is of course is not the first time the Z match has featured in AR. Dean VK5LB described a Z match (AR May '89) Rob VK5RG (AR Sept '84) also extolled its virtue. However during the last few years, a Melbourne amateur (who wishes to remain anonymous) has

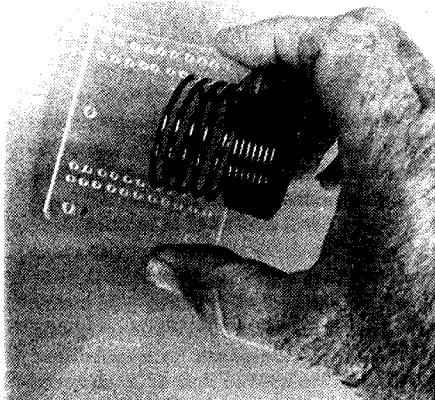

Method of winding coils

improved and perfected the Z match, and it is with pleasure we present what we consider is the definitive method to construct one yourself.

You will need the following bits which will be available at your next radio club buy-and-sell night for around two dollars the lot. One two-gang broadcast capacitor circa 1950. These were commonly called an "H" gang and must have been produced by the million up to about 1960. One single-gang variable capacitor. A broadcast type is fine but anything with about 250 pF capacitance is quite useable. Several metres of 18 SWG enamelled copper wire, a few scraps of acrylic, polystyrene or similar sheet about 2 or 3mm thick. Also required are a couple of vernier dial drives (H-3900 in the Dick Smith catalogue) and a suitable box (not entirely essential) into which the whole thing may be mounted. Our Z match

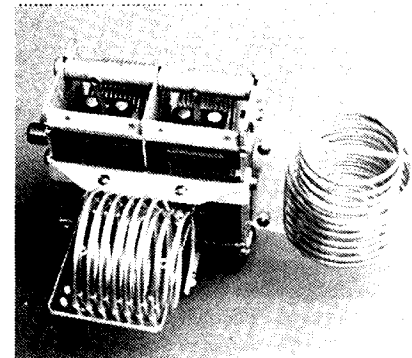

Coils assembled on two-gang capacitor

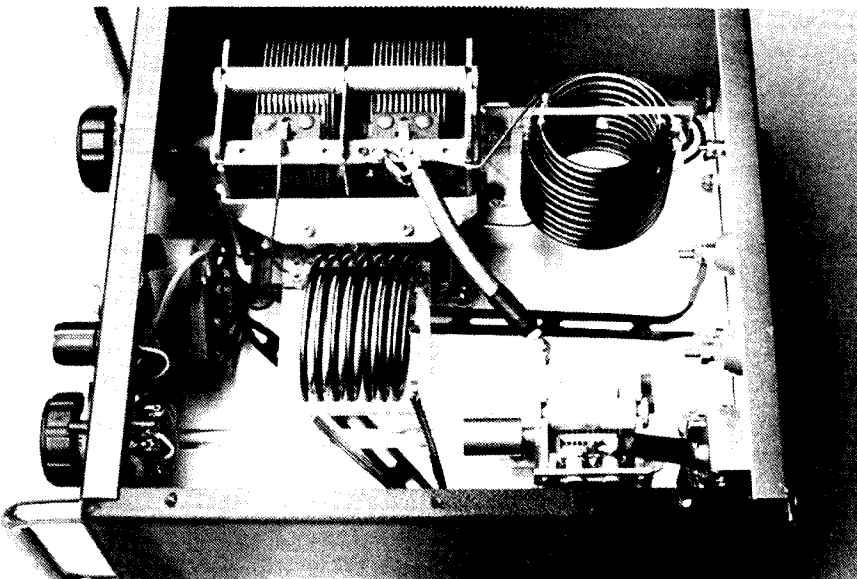

Layout of the Z match in its box

has a big advantage over most of the others — size. The coils to be described are much smaller, so you can get things into a box that is more appropriate for a modern transceiver.

How To Do It

First of all, have a good look at the photos and the diagram.

L1 is 7 turns when finished. Using 142cm of wire, wind 8 turns onto a 34mm former. When threaded into the holes spaced at 40mm on the smaller plate, this will become 7 turns.

L2 is 6 turns when finished (using 102cm of wire). Wind 7 turns onto a 42mm former. When threaded into the holes spaced at 50mm on the smaller plate, this will give a final result of 6 turns.

L3 is 10 turns when finished using 142cm of wire. Wind on 11 turns to the 34mm former.

L4 is 7 turns when finished. use 117cm of wire and wind 8 turns on to a 40mm former.

Now a few pointers for the construction of the Z match:

Firstly, layout is very important. The inductors L1/L2 and L3/L4 should be orientated so as to be at right angles to each other. See photo.

They should be located to facilitate short direct connections to both capacitors and the antenna input leads.

The layout shown in the photos has been proven and is recommended. It is very desirable to use vernier calibrated tuning controls on both capacitors.

Rob Gurr VK5RG in his article pointed out

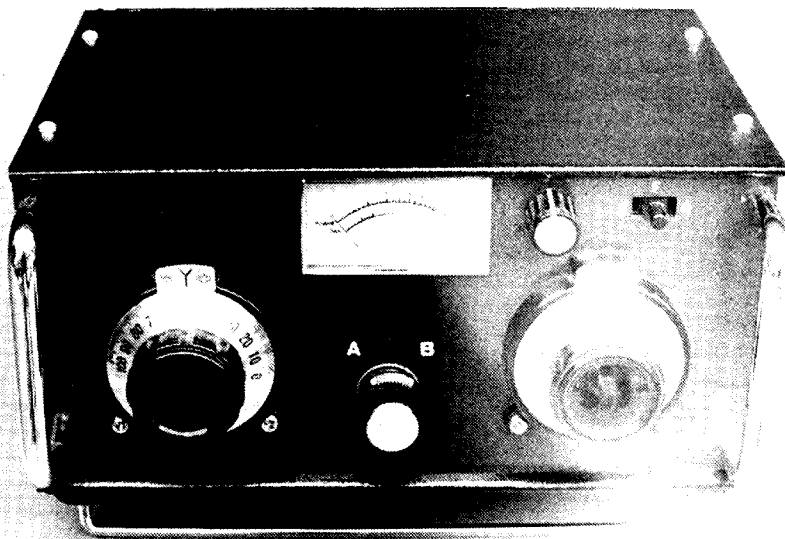

The finished Z match in its box (The meter and switch belong to a power SWR meter not described.)

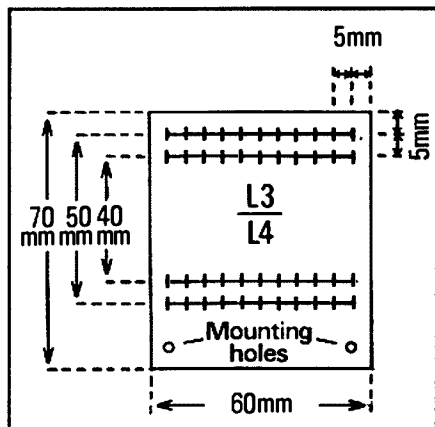

Figure 1

that many authors had recommended labeling of the links as 3.5/7MHz or 14/21/28MHz. This has caused difficulty for some constructors, as some feed line lengths may be better matched by connecting to the opposite output. This problem is solved by fitting a 2 position switch to enable the antennas to be switched as required from L2 to L4.

The Last Word On Winding The Coils

These smaller-than-usual coils are wound on acrylic plates measuring 60 by 70mm for L3/L4 and 45 by 70mm for L1/L2. As mentioned earlier, the plastic stock should be about 3mm thick.

These plates should be drilled in accordance with the diagrams figs 1 and 2. These plates can be mounted directly to the frame of the two-gang capacitor as shown in the photo-

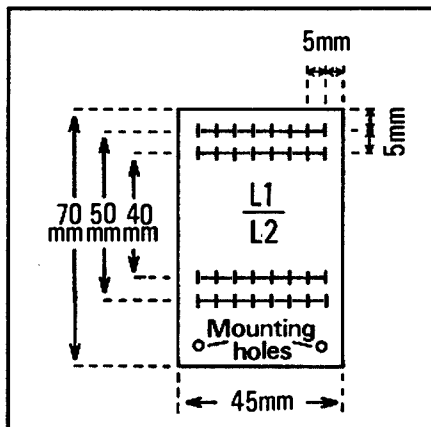

Figure 2

graph. This allows for short direct leads.

The coils can be wound with either enamelled or tinned copper wire of about 16 or 18 gauge. It should be mentioned that the Z match as described will easily handle 100 watts of RF, and in fact, under matched conditions will take close to 200 watts. Of course always tune up using low power (around 25 watts maximum).

A final construction point; the holes in the acrylic plates into which the wire is to be spirally wound should be .2mm larger than the diameter of the wire used. Fractional sized metric drills are available from professional tool suppliers.

The input capacitor "C1" needs to have a maximum capacity of about 300 pF. Again, a normal single gang broadcast capacitor is ideal but the spacing need not be as wide as "C2" as the voltage across it is fairly low.

As can be seen from the circuit, "C1" needs

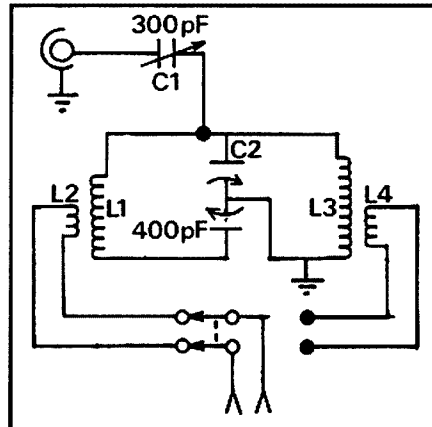

Figure 3

to be insulated from the chassis and this was achieved by mounting the capacitor on an acrylic block of suitable size and then bolting this slightly above the chassis on short spacers. The shaft will also need insulating from the slow motion drive and an extension made from a 6.5 mm plastic knitting needle is ideal.

As a final point, the Z match is by no means confined to balanced feeders. While away with Hon Ed recently on his Lake Eyre expedition, the Z match was used to load up a variety of wires of indeterminate length, with excellent results.

So there it is. Build one up and join the happy Z match users group (no subscription cost). If you feel you might need more details, feel free to call either Ron or Ron when you hear us on the air. We will be back in two months with more antenna ideas, and so for now it's 73 from me and 73 from him — the two Rons. ar

AMSAT AUSTRALIA

MAURIE HOOPER VK5EA
11 RICHLAND ROAD NEWTON SA 5074

National Co-ordinator
Graham Ratcliff VK5AGR

Information Nets
AMSAT Australia
Control: VK5AGR

Amateur check in: 0945 UTC Sunday
Bulletin commences: 1000 UTC
Primary frequency: 3.685 MHz
Secondary frequency: 7.064 MHz

AMSAT SW Pacific
2200 UTC Saturday, 14.282 MHz

Participating stations and listeners are able to obtain basic orbital data including Keplerian elements from the AMSAT Australia net. This information is also included on some WIA Divisional Broadcasts.

Successful Launch!

HR AMSAT News Service Bulletin 023.01
From AMSAT HQ Silver Spring, MD
January 23, 1990 To All Radio Amateurs BT

After nearly three years of hard work by scores of dedicated AMSAT volunteers, there are finally six new amateur satellites in orbit. At 01:35:31 UTC on January 22, 1990, ESA successfully launched its V35 mission, an Ariane 4 booster, from its launch facility in Kourou, French Guiana. On board were six amateur radio satellites, two built by the University of Surrey, UO14 and UO15 and four microsats built by AMSAT-NA, AO16, AO17, AO18, AO19. An errant tape recorder on the primary payload, SPOT-2 delayed the launch from January 9th and bad weather in the area brought about a scrub of the launch

on January 21. However, the picture perfect launch occurred at the beginning of the ten minute launch window Sunday evening local time.

Ancillary Experiments On Webersat

The following article has been condensed from "A Brief User's Manual for Webersat's Ancillary Experiments" prepared by Chris Williams, WA3PSD, Center for AeroSpace Technology, Weber State College, Ogden, Utah 84408-1805.

Once you have configured your receive station for non-DOVE microsats, i.e., UHF RCVR -> PSK modem -> TNC -> Computer (running telecommunications software) you are ready to receive WEBERSAT data. WEBERSAT's downlink frequency is 435.075 MHz for the straight BPSK XMTR and 435.100 MHz for the raised cosine XMTR. The 435.075 MHz frequency is the planned primary transmitter.

Impact Sensor

Let's talk first about the impact sensor. About one day a week we will be activating software that samples the impact sensor data and transmits it. This transmission will be 7 bit "pure" ASCII and will appear like so:

```
WEBER-n: IMPACT-n>
Impact Counter Data:
01/05/90 01:15:20 UTC 96
01/05/90 01:15:25 UTC 112
01/05/90 01:15:30 UTC 112
etc
with a data line added each 5 seconds.
```

The above format is simply date (month/day/year), time (hours: minutes:seconds) in UTC and the decimal value of the sensor. The value is interpreted as an 8-bit A/D measurement of a voltage accumulated by the sensor circuitry. Let me explain that. The piezoelectric sensor on the side of the spacecraft (it measures 6" X 1.25") pulses a voltage to the sensor circuitry when a microparticle impact occurs. The circuitry is designed to accumulate up to 16 impacts before it rolls over, ie, cycles back to zero to then continue counting. This impact count is transmitted as a value between 0 and 255 (consistent with 8-bit A/D) with the increment being approximately 16 per impact. In the numbers presented above the first sample line represents 6 (6 X 16 = 96) impacts since the last roll over. The next line, 5 seconds later, shows 7 impacts (7 X 16 = 112) — which means one occurred in that 5 second period. Please note that the format above has not been designed to squeeze transmit time down to a bare minimum. We chose not to enter any sort of efficiency contest in this regard. We preferred maximum intelligibility as the data appeared on the screen. This is true of the data format chosen for all of our ancillary experiments. Contrary to some published reports, there is no measurement attempted of impact magnitude. The strength of the piezoelectric pulse is not recorded. However, there is some information possible from which someone clever might be able to deduce something. It derives from the sensor design. Within the spacecraft, there is a second piezoelectric sensor which has been mounted on a structural spar of the top module at right angles to the external sensor. This feeds the circuitry in such a manner as to inhibit the impact count being incremented when both sensors pulse. When the entire structure flexes due to thermal effects, both sensors theoretically will pulse and without this inhibition, a count would have erroneously been recorded. The same feature should also inhibit counts of hard impacts that flex the structure. At a magnitude less than this, though, there is a behaviour we have observed which may prove interesting. When the external sensor is hit, the structure "rings". This manifests itself as an impact count increment of numbers greater than one. I have personally seen increments of as much as 8

take place from what I'll call a single medium-hard finger tap on the sensor. When hit harder, the internal sensor triggers and count inhibition takes place. Please do not ask for a more quantitative description that "medium-hard finger tap". It doesn't exist. When combined with variable sample periods, this behaviour may yield some interesting data. A large impact count accumulated over a relatively long period of time says nothing specific about the increment cause. If, however, a large count is present after a fractional second's sample accumulation time, then a "medium-hard finger tap" probably just took place. Should an observer notice an orbital position/geometry dependence of such events, things become that much more interesting. Please understand that we are talking about micro impacts here. Obviously, any object larger than microscopic specks would damage solar panels or destroy the spacecraft in an impact. So, it should now be clear that a tremendous amount of experimental potential exists in this feature of the spacecraft. Physics and Science classes worldwide should be able to do many interesting things with it and the group here at CAST would be delighted to work with any educational institution that would like some particular experiment programmed.

Horizon Sensor

The horizon intercept sensor aboard WEBERSAT is composed of two visible light sensing photocells aimed through two holes

in a field-of-view defining device. The specs. are as follows:

The conical FOV per photocell is 10 degrees. The two FOVs both point out of the same face of the spacecraft, which is the same face as the camera. They are not pointed at right angles to the face. They are angled towards each other and 11 degrees from the face's perpendicular. Sensor 1 is closest to the outside edge of the face and points slightly inwards towards the centre of the face. Sensor 2 is closest to the camera lens and points slightly outwards towards the outside edge of the face. The FOVs therefore cross a foot or so from the spacecraft, but they do not overlap at infinity. Illumination of a photocell yields a decreased reading of voltage on that A/D channel. The motivation behind the design of this sensor was simply to provide a way to tell when the face of the spacecraft out of which the camera's lens pointed was oriented towards the earth and not towards the sun. The methodology is straightforward. Because the sensors' FOVs do not overlap at distance and point 22 degrees apart, the only object which could equally illuminate both simultaneously is the Earth. The sun subtends too small an angle to be within both FOVs at the same time. At the planned orbital altitude, the Earth subtends over 100 degrees conical. The camera's programming will be arranged to wait for this situation before taking pictures, unless something dramatic at the horizon is desired. It may also turn out that interesting work can be done by math students in analy-

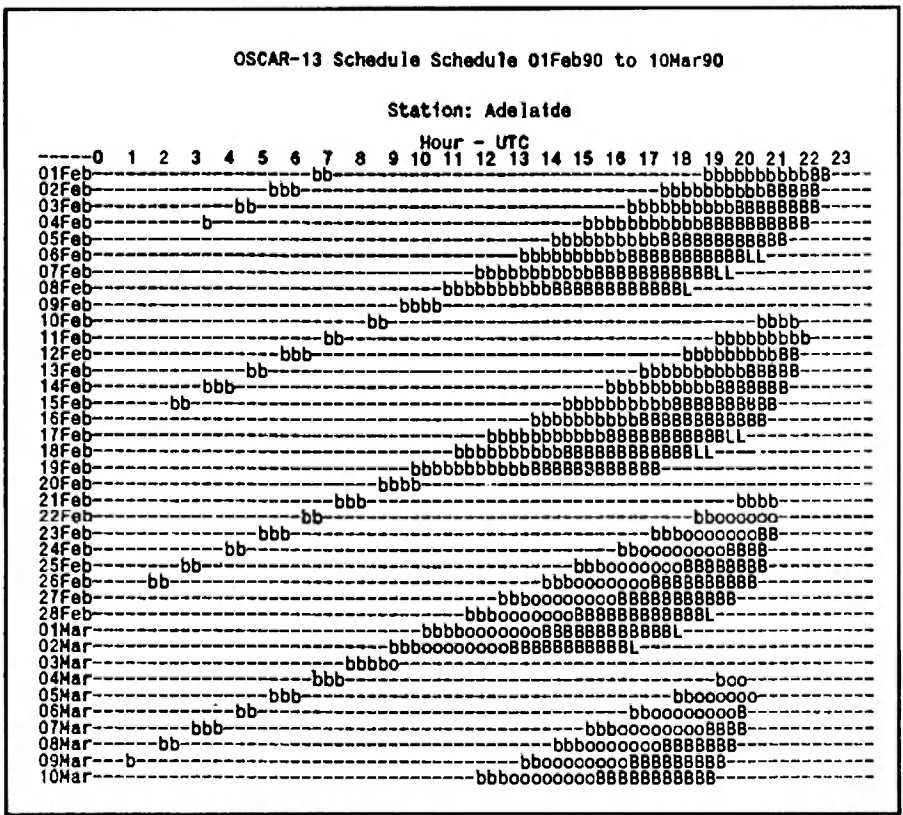

ing times of illumination and rates of change of illumination of these two sensors to investigate rotation rates of the spacecraft. At this writing, no one has any particularly firm idea of what the specific rotational behaviour of any of the microsats will be so some valuable information could evolve from student projects using this data. The two photocells are Siemens products. Their product number is BPW21. For those interested in doing some study of horizon intercept times and the effect of atmospheric versus surface illumination at the horizon, information about sensor spectral response is available from CAST or the manufacturer. The circuit diagram for the amplification network is also available. The data format for downlinked information from this experiment is similar to that of the impact sensor, specifically:

WEBER-n: HORIZN-n>
 Horizon Sensor Data:
 01/30/90 01:30:01 UTC 255 255
 01/30/90 01:35:01 UTC 255 255
 01/30/90 01:37:12 UTC 255 254
 01/30/90 01:37:13 UTC 255 253
 etc

The date and time are identical to the impact sensor format. The following two numbers are the A/D reading of sensor 1 and sensor 2. Reading left to right, the first number following the time is sensor 1 and the next, sensor 2. The timing of downlinked samples is determined by an on-board algorithm. The samples are taken each second by the software. When the sensors are clearly not illuminated (max value), samples are discarded and not entered in the print (downlink) queue — except for one every five minutes. When a change in value is detected, samples are entered and transmitted yielding data about sensor behaviour at a 1 second resolution. When both sensors' values again climb to darkness, the five minute resolution resumes and data density again becomes low. The exact value of the sensor in darkness is assumed in the above discussion to be 255, ie, maximum. This may not be true in space. We will check this out and adjust the algorithms accordingly so if you see in the data a constant value of, say, 242 plus or minus noise, then investigation will have shown us that 242 is a reasonable darkness value. Also, noise fluctuations may cause too fine an algorithm to perceive the beginning of illumination so we will be correcting for that as well. Consequently, the example shown above, which suggests the high resolution downlink becomes active when only one bit of change takes place in a stable value, may not prove correct. A change of several bits may be necessary to unambiguously identify the start of illumination. Digital filtering may be employed to explore this behaviour and is yet another area in which students from universities and secondary schools around the world may wish to define/propose experiments for upload to the spacecraft.

The Gizmo

Let's next examine an experiment that has been called a number of different things. Call it Turbo Download, Quick Video or No Phono-me Digitalker, the feature employs a D/A converter mounted on the flash digitizer board in the upper module. The way it works is straightforward. The same memory counter circuits which loaded picture memory with digitized NTSC video waveform from the camera can be used to count through that same memory and instead of writing to it, READ from it. The read values from memory are then sent to the D/A which then produces an analog waveform that is, essentially, the original picture. A difference between the original and the new signal, however, is the fact that the clocking for reading the memory will be done much slower than the 10.7 MHz digitization rate. Indeed, clocking and D/A conversion will take place at a rate of only a few kHz. This newly produced waveform then leaves the upper module on a wire within the cable that is the spacecraft intermodule bus. It is fed down the stack and into the communications XMTR. When the proper mode is selected, it is then applied to the oscillator of the XMTR thereby FM modulating the signal downlinking to the ground. The magnitude of the frequency shift of the XMTR carrier is consequently precisely related to the magnitude of the value stored in the memory location currently being clocked out and read. On the ground, a circuit tied into a receiver's discriminator could A/D the frequency shifts received and write the digitized value into a memory area of a PC. Presto, received picture — at a rate potentially much faster than the standard 1200 baud packet downlink. It should also be noted that digitized voice uplinked to the spacecraft by packet, or digitized on board through the 1.2 GHz uplink, could be clocked out to the XMTR in this manner to thereby produce FM voice. Interesting filtering algorithms could then be used to produce sound qualities desired. This is yet another opportunity for students to get involved defining experiments for this spacecraft. There is a caveat of which the reader should be aware. This feature has been tested on the ground in only a limited fashion. Commands to clock out memory values have been programmed into the digitizer board and the output of the D/A has been verified as varying according to the value within memory. Additionally, the XMTR has had its FM line varied in voltage and the carrier's frequency shift measured. However, a complete end-to-end test of the concept with ground hardware measuring ground receiver frequency shifts and all channel bandwidth limitations present has never been done. It might work. We'll see. For those interested in using this experiment, we will investigate performance in the following manner. First, we will prompt the ground users with the following message:

WEBER-n:ANALOG-n>

FM TX modulation about to begin. Numbers modulated will be 0, 16, 32, 48, 64, 80, 96,

112, ... 255, 0, 16, 32, ... repeating 50 times. Then this message reappears. Each number lasts XXX seconds on the modulation. The test begins in 8 seconds.

And eight seconds later, the downlink XMTR will change its sound from the packet buzz to a rapidly warbling tone. The expected frequency deviation range for values 0 — 255 is about 0 to +3 KHz. We will vary the XXX mentioned above as we explore what is possible with this thing. Once we have confidence in this feature, we will be using it to send pictures and other bank-switched memory data. I can't tell you about data rates or hardware design for the ground because I don't know the answers yet. This is another opportunity for schools to get involved. In this case, the projects would be somewhat more ambitious because not much is known about how this will work in a dopplered, bandwidth-limited environment.

Magnetic Field Sensors

There are two orthogonal magnetometers aboard WEBERSAT. They have been biased by a small permanent magnet glued (space-rated epoxy) near the sensor to cancel the effects of the powerful attitude control bar magnets at the four longitudinal corners of the spacecraft. These two sensors will fluctuate as the spacecraft rotates within the Earth's magnetic field. The downlink format for this data will be:

WEBER-n:MAGNET-n>
 Magnetometer Data:
 01/15/90 01:30:15 UTC 45 67
 01/15/90 01:30:20 UTC 47 82
 01/15/90 01:30:25 UTC 49 98
 etc

Again, the format is similar to the other experiments. The two numbers following the time of day are for Magnetometers 1 and 2 respectively. Magnetometer 1 is oriented to measure flux lines in the YZ plane of the spacecraft (standard microsat axis definition -> X axis camera lens points out, Z axis receiver antenna (top) and Magnetometer 2 is measuring flux lines in the XY plane. The numbers have no meaningful units. Their significance will only manifest itself when compared to previous values of the sensor and correlated with an Earth magnetic field map. Fluctuations in the Earth's field and anomalies in its conformance to simple mathematical predictive algorithms have been documented. Measurement of these fluctuations should be possible and the data downlinked from these measurements will be yet another rich source of Earth science projects for students.

Light Spectrometer

The light spectrometer aboard WEBERSAT is designed to provide data about the spectral content of light entering a slit in the

-Y face of the spacecraft. This light is focused by a lens, reflected from a diffraction grating and the resultant spectrum is shined on a 2K x 1 byte CCD sensor. This sensor then converts its data to an analog waveform for flash conversion by the same circuitry that "takes" pictures with the camera. The sensor is spectrally responsive throughout the visible light wavelengths with some extension of sensitivity beyond both high and low ends of the visible region. The format for this data will be 8 bits, unlike the data formats discussed up to now which will be 7 bit pure ASCII. It will appear like so:

WEBER-n:SPECT0-n>

Spectrometer data follows. The data was taken starting on 01:03:90 at 01:15:35 UTC with 5 seconds between looks and ending on 01:30:90 at 01:15:55 UTC. Looks are separated by text saying "Look nn begins".

Look 01 begins

WEBER-n:SPECT-n>

& * a j a j b k b k c k c l e m e m e n e o f g p g p g p o g o g p g o e m c k a . . .

and so on for 5K of data. The gibberish above represents the transmitted stream of

bytes which appear as above because of ASCII equivalence. After every packet, the WEBER-n:SPECT-n> header appears so it will be intermixed with the gibberish. There is an additional bit of information embedded in the data shown above. The first byte after the carriage return after the packet header (WEBER-n:SPECT-n>) is meant to be meaningful. It will position the received packet to follow within a look for those occasions when the satellite emerges over the horizon with a look in the middle of its transmission. Within 5K of look data, only about 20 packets of data fit and therefore that first character's value need be specific only up to 20. The letter S in the word Spectrometer in the text header above has an ASCII value well beyond 20 which identifies it as the first character of the text header rather than spectrum data. The & in the gibberish represents a byte with an ASCII value less than 20 which positions that packet precisely within the look. The text header will appear no less frequently than once every seven looks. When 5K is transmitted, the next look then begins. A look, incidentally, is simply a spectrometer snapshot. The

bytes represent the magnitude of the illumination of each cell of the CCD. Because this illumination results from the different spectrum colours from the grating, we have a measurement of the light characteristics entering the sensor at that point in time. The design philosophy is simply to observe the spectrum of reflected sunlight off the Earth's atmosphere and surface. The different atmosphere components may be measurable from this data at different latitudes and longitudes. As with all the other experiments aboard, we encourage universities and secondary schools throughout the world to contact us so that we may cooperate in defining activities.

This document is a first attempt at getting some worthwhile information to users of this spacecraft. These things evolving as they do, it will most likely be replaced with some sort of rev 1.0 soon after launch as experience teaches us superior techniques. For the time being, however, I can assure the reader that our first efforts at monitoring the sensors will employ the data formats I've specified.

ar

SPOTLIGHT ON SWLING

ROBIN L HARWOOD VK7RH

52 CONNAUGHT CRES WEST LAUNCESTON 7250

Just a few weeks ago, I received my copy of the 1990 edition of the World Radio TV Handbook, and I'm pleased to see that the editors and publishers have made the release much earlier, so as to make the most from the current schedules. In days gone by, the WRTVH sometimes did not arrive until March, when most broadcasters altered their frequencies and times to take account of seasonal fluctuation. However, the publishers have also issued supplements during the year, allowing the listener to keep abreast with the latest changes.

This edition is no different, and has all the usual features as in past issues and is easy to use. An addition this year is the inclusion of World Satellite Broadcasts together with frequency information and format eg NTSC PAL or SECAM, whether they are encoded etc. Satellite transponders have, up till now, mainly been PTP and not for general broadcast, but over the past three years, several direct broadcasting satellites (DBS) are now operational. This is particularly the situation within Europe, where the "Astra" satellite carries several channels such as Rupert Murdoch's "Sky Channel". Another British DBS is expected to commence shortly with Robert Maxwell's "BBS Channel", yet many are already questioning the financial viability of DSB, as the cost of hardware has escalated; as these operators are reliant on subscription, the public are rather wary of invest-

ing in hardware, when the cost of receiving terrestrial programmes is much cheaper.

Here in Australia, there has been DSB from AUSSAT with the ABC and SBC. The commercial networks mainly use the transponders for linking up studios etc. There is an aboriginal-owned broadcaster in Alice Springs "IMPAAJA" that was (or maybe still is) using AUSSAT to broadcast programming into the remoter regions of this vast nation. I know that originally there were plans for broadcasters to have footprints into specific regions, but I believe that these have largely been abandoned because of the economics.

Nevertheless, the information contained in the current edition re World Satellite Broadcasts is very revealing and informative. Perhaps in the future, we will see this develop as the costs of hardware will drop and DSB come into vogue. The edition has reviews on ICOM's latest R9000 receiver. This goes from 100 kHz to 1999 MHz. It has an inbuilt spectrum analyser and has 1000 multi-function memories. It caters for all modes (except TV) although RTTY, SITOR and Packet require an external terminal.

However, the cost is prohibitive for the average monitor. One AD in the Handbook quoted \$US4995. "Media Network" says that Japanese executives are presented with a R9000 as a retirement present! It also says in the review that ICOM can't keep up with the demand for the R9000. I also note that there

is also a Sony CRF-V21 at around \$US6500 with inbuilt spectrum analysis and fax decoder. It seems that the two Japanese firms are engaged in rivalry in producing similar types of receivers.

Elsewhere, you will probably read about a letter from the IARU Monitoring Service for monitors to conduct a survey of various non-amateur allocations. They are as follows:-

5.005 to 5.060 MHz
7.100 to 7.300 MHz
10.150 to 10.350 MHz
14.350 to 14.400
18.168 to 18.318
24.740 to 24.890

They are interested in occupancy of these frequencies over a 24 hour period. The period shall commence from 4th March until 24th February 1991. If you are interested in participating, please contact Gordon Loveday VK4KAL, Rubyvale QLD 4702, and he will furnish details to you.

Well, that is all for this month, and until next time the very best of listening and best 73.

ar

**WHEN YOU BUY
SOMETHING FROM ONE
OF OUR ADVERTISERS,
TELL THEM YOU READ
ABOUT IT IN THE WIA
AMATEUR RADIO
MAGAZINE.**

ALARA

JOY COLLIS VK2EBX
PO Box 22 YEOVAL 2868



Mina De Young (VK8MM) in shack - Alice Springs June 1989. Previous callsigns C2IYL, 3D2MM.

At the time of writing we are all still preoccupied with slip-slop-slapping, and even the mad dogs and Englishmen are trying to avoid the mid-day sun! However, picking up a microphone is not too much of an effort, and it's still nice to talk to a friend, work some DX or whatever our inclination may be.

One lady who has been kept very busy is Joan VK3BJB. When she first started to learn Japanese some years ago via amateur radio, she never realised what it would eventually lead to.

Condensed from the "Sunraysia Daily" 28.11.89.

"Whenever the telephone rings these days in the Mildura home of Mrs Joan Beevers, the family never knows what part of the world the call is coming from.

It could be any one of hundreds of contacts the housewife and mother of two has met or spoken to in 20 years as an amateur radio enthusiast.

And chances are the calls will be more frequent in future.

Mrs Beevers has recently taken over the job of controller, or key station, of a Japanese amateur radio maritime mobile network, despite her location in a remote section of one of the world's most isolated countries.

Every afternoon she has been checking in amateur radio operators on all kinds of ships and fishing boats going to and from Japan, taking down their positions, weather conditions and their arrival and departure times from the various ports around the world, to

pass on to other net members and to their wives or friends who check into the net, if they can't make direct contact with each other.

If any of the members are busy with their commercial work at net time, they make sure she is kept informed of their ship's whereabouts, either by direct contact or their friends relay information at net time. At the present time, she is checking ships into the network from as far away as the Panama Canal, Ireland and the northern part of the Atlantic Ocean between Europe and the USA...

As the only foreign amateur radio operator to check into the Japanese Maritime net, in June 1988 Mrs Beevers became the first ever female net controller in the net's history, and is the only foreign amateur radio operator in the world who has mastered, and uses daily when talking with other friends, the special vocabulary used by all maritime mobile operators to relay their positions, weather conditions, and entry and departure times to and from various ports.

She can also use the special phonetics necessary for the correct pronunciation of foreign port names, which are often totally different to the English spelling and pronunciation.

From the middle of April 1989, she was the only foreign station to support the history-making 137 day voyage, made by the famous Japanese yachting adventurer Kenichi Horie, who crossed the Pacific Ocean between San Francisco USA and Nishinomiya near Osaka Japan in the smallest ever yacht — the 2.8

metre yacht "Mermaid"...

As a support station, she was able to make direct contact with the yachting adventurer himself on many occasions.

Like everyone else concerned, Mrs Beevers breathed a sign of relief when the yacht arrived safely in Japan.

During her three years as support station for the Japanese amateur radio yacht network, she has been involved in several air/sea rescues for yachts in trouble, both in Australian waters and waters close to Japan. In April 1989, because of poor conditions between the yacht and Japan, she was the last person to make contact with the Japanese yacht "Meguro", which went "missing" between New Caledonia and Vanuatu in the southern Pacific area on its way from the Solomon Islands to Auckland, New Zealand for the start of the Auckland to Fukuoka, Japan yacht race...

Mrs Beevers admits that her poor attempts at the Japanese pronunciation, along with her Australian accent, for some of the difficult European and foreign port names, provides the many listeners to the maritime mobile net with great entertainment.

For many Japanese maritime mobile amateur radio operators on their long voyages, Mrs Beevers has become an important link for them in the world outside their normal daily work routine, miles away from anywhere in all types of weather conditions...

Sometimes she has to translate messages received from the various coast stations for friends on fishing boats, if they can't understand any "difficult" English vocabulary. Her service to her maritime mobile radio friends is a way of utilising the language they have taught her, and helps to make their long voyages seem to go much quicker for them."

As Joan says:

"Many people don't realise amateur radio operators can meet interesting people and travel the world without even leaving home."

YL Contests

EAST MEETS WEST SSB CONTEST.

Sponsored by YLRL.

March 17th 1990. 1800-2200 UTC.

Call "CQ YL East." All HF bands.

Logs must be received by 17th April 1990.

Address:

YLRL Vice President, Dana Tramba, C/o Dandy's, 120, North Washington, Wellington Ks 67152, USA.

DX YL To North American YL Contest. Sponsored by YLRL.

CW: Wednesday 11th April 1990 1400 UTC to Friday 13th April 1990 0200 UTC.

Phone: Wednesday 18th April 1990 1400 UTC to Friday 20th April 1990 0200 UTC.

Logs: To above address by 5th May 1990.

THELMA SOUPER MEMORIAL CONTEST 1990: Saturday and Sunday, 7/8th April 1990.

0700-1000 UTC each day.

All contacts to be on 80 metres, phone and/or CW.

YLs contact YLs and OMs. OMs contact YLs only.

One contact with each station permitted in each half hour period.

Call "CQ WARO Contest". Exchange report, Serial no (commencing with 001) and name. To qualify as a multiplier, WARO stations must have contacts with at least 20 different stations.

Bonus station ZL2YL will count as a multiplier once on each night of the Contest, if worked.

Score: one point for each contact, multiplied by the number of WARO MEMBERS worked, and bonus station if worked.

In recognition of New Zealand's 150th Anniversary, a special condition will apply to scoring this year only:

If contact number 150, 300 or 450 is with ZL2YL it will qualify as an extra multiplier. Each contact claimed as a multiplier to be underlined.

Log requirements: Include your callsign, name and address, number of contacts, number of WARO members worked, score and declaration that all radio regulations have been observed. Logs not complying with these requirements will be disqualified.

AWARDS: Highest scoring WARO member and OM operator will each be awarded a trophy to be held for one year. Certificates to first three WARO members, first three OMs and highest scoring VK-YL operator.

LOGS: to Contest Manager, Jeanne Gilchrist ZL2BOD, PO Box 651, Hawera, New Zealand: By 7th May 1990.

(From "WARO" Magazine Oct 89.)

While on the subject of contests:

Check ALARA Contest logs to see if you have

10 ALARA contacts from 5 VK call areas, or DX 5 from 4 areas, and apply for the ALARA AWARD to: The Awards Manager, Mavis Stafford VK3KS, 16 Byron Street, Box Hill South, Victoria 3128. Fee: 3 Australian dollars (or equivalent) or 7 IRCs.



Jennifer VK3MDR

Award Update

Nov	Date	Recipient	Callsign
152	16.10.89	Sergei S Khvostov	UB5-0775-529 First USSR.
153	8.12.89	Christine Taylor	VK5KTY.
154	8.12.89	Christine Taylor	VK5CTY 1 Sticker

ALARAMEET Dubbo 29/30th September 1990

It is now necessary to consider accommodation bookings for Dubbo. Maria VK5BMT has all the necessary information regarding caravan parks, hotels/motels etc, which she will be only too happy to supply to anyone requiring it.

As the ALARAMEET will be held during school holiday time, it is necessary to book well in advance, so please DON'T DELAY. Address enquiries to:

Maria McLeod VK5BMT, 1 Hawkins Avenue, Flinders Park 5025.

Souvenirs

Due to the increased cost of further orders and a slow demand, sugar spoons and charms have been removed from the souvenir list, and will no longer be stocked.

New Members

A warm welcome is extended to:

Allura KAOVWP and Michelle VK5ZYL.

Michelle is new to amateur radio, and is to be congratulated on passing her limited AOCOP on the first attempt.

Until next month,
73/33

ar

Have you advised the
Dotc of your new
address?

EDUCATION NOTES

BRENDA M EDMONDS VK3KT
PO Box 565 Mt WAVERLEY 3149

It has been very pleasing to hear from some divisions that they are moving well along the path to devolvement, and that there is a degree of co-ordination and co-operation developing. I hope this attitude continues and grows still further. It was, however, disappointing to hear recently that the Department has seen fit to terminate the appointment of the Examinations Officer on the grounds that his work is now complete. Keith Carr-Glyn, who held the position, is moving to another Authority.

Keith took on the devolvement confusion at a time when many of us had almost lost interest because of the delays and lack of co-ordination. It is a tribute to his effort, enthusiasm and attitude that he leaves behind a list

of some 70 potential examiners, a vast number of accredited papers, and established procedures for the future. Many of us would have preferred to have him remain in the position at least until the new system was fully functional and the teething troubles were over, but we can only thank him for his past work and wish him well for the future.

I have been assured that the machinery is in place for future accreditation, monitoring of examinations and collection of Pass/Fail statistics. There still remains an urgent need for extension of all the question banks, especially the Regulations, and for a scheme for evaluating individual papers, questions and the system as a whole. As I have said previously, we should be prepared to carry out an

extensive review somewhere about the end of next year. But that time all the major problems should have shown up, and any necessary modifications be apparent.

I would be very pleased to start logging any of these problems, so please forward any comments, ideas or new questions as they occur to you. I would also be pleased to collect feedback from candidates, especially any who have also sat DOTC-run exams.

I would also appreciate being kept informed of the activities of clubs and Divisions with respect to examinations. I will be getting in touch with those on the list of examiners fairly soon to request information about times and venues of exams. Please, if you are preparing papers for accreditation and intend to administer examinations, notify both your own Division and the WIA Executive office of the arrangements, so that we can answer queries about nearest or next exams. We must make it as easy as possible for potential recruits to have access to exams, even if they are not enrolled in course, and we have many

who are not attached to specific groups.

The new system will allow the WIA much better access to candidates than was previously available. This will be a great opportunity to tell candidates of the function and role of the Institute, and the importance of belonging to the oldest Amateur Radio society in the world. Promotional pamphlets which have been prepared by the VK4 Division could be used for this, or if any groups have prepared their own material we would be interested to see copies of it.

I look forward to hearing that the new system is working well. If there is any way I can help, please let me know.

ar

DIVISIONAL NOTES

VK2 NOTES

TIM MILLS VK2ZTM

Annual General Meeting

Members of the NSW Division are advised that the 1989/90 AGM is scheduled for Saturday afternoon the 28th April 1990. The agenda and reports for this meeting will be sent to Members in April. Annual reports from office bearers must be in the hands of the Secretary by the 2nd March. Notices of Motions and Nominations for Council for the forthcoming year must be delivered to and received at the Registered Office of the NSW Division, 109 Wigram Street, Parramatta NSW by 2pm on Friday 16th March 1990. Nomination forms for intending Council Members together with a leaflet listing the duties of Council may be obtained from the Admin Secretary at the office.

Divisional Fax

A reminder that the Division has a Fax machine available on its own line 02 633 1525. Clubs and members are starting to use this method for submitting news items for the broadcast. It helps to cut down on the deadline, if you rely on mail delivery. The cut off time is 6pm on Friday. Where practical, submit your item in a ready to use format — typed within A4, double spaced with a 5cm left hand margin. The same applied to posted items. Hand written items have to be retyped in many cases and this adds extra work to the broadcast officer. Keep him happy by reducing his work load.

WICEN (NSW) Inc

A reminder that the annual Cave Rescue exercise weekend will be held at Bungonia 10 — 11th March. Co-ordinator is Morton VK2DEX. Contact on the Thursday night net

on repeater VK2RWS 7150 at 9pm or a message via the Divisional office. A newsletter was despatched to WICEN members during last month.

TV Groups' Meeting

The Division, at the request of interested parties, has arranged a forum discussion meeting to be held at Amateur Radio House, 109 Wigram Street, Parramatta. These groups feel that with increasing activity in ATV that it is time for guidelines to be formulated to assist all users. The meeting is on the 4th March 1990, at 1pm.

Daylight Saving Change

A reminder that VK2 changes back on the first Sunday in March and becomes out of step with other States for two weeks. The VK2WI broadcasts follow local time 10.45am and 7.15pm. The slow morse session from VK2BWI maintains UTC time and will change on 18th March to the 7.30pm local slot.

The following are recent new members of the VK2 Division and a warm welcome is extended to them.

G F English	VK2JPR	St Ives
J O Farmer	Assoc	Ryde
J W Gill	Assoc	Willoughby
P R Guyer	Assoc	Moree
P J Kerley	Assoc	Abbotsford
S J McDonald	VK2YSM	Sandy Beach
R B Mackie	VK2EJU	Tinonee
A V Pearce	VK2KNK	Wollstonecraft
R F Peirson	Assoc	Chatswood
N C Weissflog	Assoc	Faulconbridge

members, particularly those who had let their membership lapse, took the opportunity to visit the office and renew their support for the Division by re-joining.

An important role of the office is to be the contact point for those wanting to know more about the hobby of amateur radio, and how to get the licence. We have been able to encourage quite a number to make the effort needed to join the hobby, and directed them to classes or local clubs.

Improvements in the delivery of membership services has occurred as a direct result of the new office. For example, our Book Shop service offering direct or mail order sales in the past year has been extremely popular. The quick service provided has even attracted sales from members of most other WIA divisions.

The Council promised to introduce new services and the first of these gives WIA members high quality coaxial cable, and connectors, at an extremely competitive price. We are currently looking at other possible new membership services. As mentioned in these notes last month the Reference Library is now fully operational. And the office is also an Inwards QSL Bureau distribution point.

Tax Exemption

The Australian Taxation Office has advised that income earned by the WIA Victorian Division is exempt from income tax. It has always been considered our organisation was exempt from paying income tax since being incorporated in the 1920s and from its foundation nearly 80 years ago. However there was a nagging thought about taxation liability, and no documentation confirming the tax status could be found.

Late in 1988 at the time when it was decided to improve the financial affairs of the Division it became clear a number of corporate matters needed attention. Acting on advice from our solicitors, A B Natoli, the Division's General Secretary/Manager, Barry Wilton VK3XV prepared a detailed submission to the Australian Taxation Office. This process took a year and has concluded with written confirmation from the Tax Office that subject to certain conditions, under section 23 (g) (ii) of the Income Tax Assessment Act 1936 the Division is exempt from income taxation.

Council Nominations

Nominations for the 1990/91 Victorian Division Council will close on Thursday, March 30, 1990. All nominations should be on a prescribed pro forma available from the Divisional Secretary and posted or delivered to reach the Division office not later than 3.30pm on the above date.

VK3 NOTES

JIM LINTON VK3PC

Divisional Office

It is just over a year since the WIA Vic Div moved its registered office to Ashburton, and the move has seen considerable improvements in the way the Division functions.

At first there was a settling-in period with the doors closed while painting and carpeting were fixed, and furniture and office supplies obtained. A major task was to computerise office records including all correspondence. Members who visited the office mostly expressed their approval of the new location, and were complimentary of the way it was operating. Those who needed to telephone or write to the office also found they received a prompt, courteous, knowledgeable and helpful response.

Throughout the year a number of non-

Balance Sheet The 1990 AGM

The Balance Sheet for 1989 and Auditors Report together with a report from Council will be published as an insert in May edition of AR magazine. Both will be mailed directly to members who have opted to take the non-AR magazine membership subscription. A notice advising of the 1990 Annual General Meeting will be included. It is anticipated the AGM will be held on Wednesday, May 30; however members will be formally advised of the date and venue.

Moondarra Convention

The Eastern Zone is holding a convention at Moondarra on the weekend of 4-6th May 1990. It will be similar to the very successful convention at Moondarra in 1988, with the emphasis being on a family weekend. Moondarra is situated in scenic country about 20 minutes drive north of Moe.

Accommodation will be available for nearly 100 people at the camp and meals will be available from Saturday breakfast through until Sunday lunch.

A large range of activities is planned so that there will be something for everybody. Some of the activities are fox hunts (junior and senior), CW contest, radio throwing competition (for XYLE), trade displays, white elephant stall, raffle, children's games, and a home brew competition.

Persons wishing to set up a trade display should direct their enquiry to Colin, VK3ELJ on phone 056 299 453 (BH) or 056 23 4926 (AH).

SECRETARY

EASTERN ZONE VIC DIVISION

VK4 NOTES

BILL HORNER VK4MWZ

Welcome to 1990

This year will prove to be a very busy one. Extensive communications will have to take place if the Education Devolvement is to be fully successful and run smoothly from the outset.

New Members

At the January 10 council meeting the following new members were welcomed to our division.

I H Campbell	VK4TK	Brisbane
G K Martin		Biloela
E V Parker	VK4FQT	Yeppoon
G F Featherstone	VK4WF	Brisbane
N Budgen	VK3BNR	Esk

R J Sieber	VK4KN	Birkdale
K McCosker	VK4CCJ	Toowoomba
J H Bartlett	VK4AUS	Brisbane
S Grattidge	VK4MDG	Townsville
R P F Muller	VK4SRP	Bray Park
G W Mackay	VK4CAS	Townsville
S M Hudson	VK4FEA	Brisbane
N T Mills	VK4KOP	Bray Park
R F Beets	VK4YV	Maroochydore

G T Malcolm	VK4NAE	Minden
P Antuar	VK4NCY	Brisbane
P Olivieri	VK4PO	Brisbane
G McCabe	VK4NGL	Brisbane
T E J Birch	VK4GC	Brisbane
R E Lees	VK4ER	Brisbane
N V Coveney	VK4YNC	Rockhampton
D J Reedman	VK4ADI	Gympie
J A Lee	VK4AJO	Chinchilla
J S Biddle	VK4QC	Warwick
W J Berry	VK4WB	Brisbane
R Yeats	VK4CRY	Childers
L B Zuch	VK4VFZ	Brisbane
R L Thompson	VK4NRT	Innes Park
M Dwyer	VK4AFM	Brisbane
D K Saxelby	VK4ADS	Brisbane
A Bean	VK4ABI	Sorrento
D V Redmond	VK4NRH	Mt Isa
A F Wrembeck	VK4VO	Toowoomba
C B Munchon	VK4TTT	Birkdale

G E Hawgood	VK4KE	Brisbane
I Smith	VK4NTP	Yeppoon
A N H Phillips	VK4FVA	Mysterton
P C Uzzell	VK4NAK	Cambooya
J S Strudwick	VK4FPA	Brisbane
H G Cause	VK4VKA	Brisbane
S M Harris	VK4AOZ	Caboolture
A R Hartkopf	VK4VKP	Parkhurst
P Jones	VK4YAC	Brisbane
J Elliott	VK4KIN	Broadway
Bayside Amateur Radio Society	VK4BAR	Brisbane
QLD International College of Technology	VK4CIO	Brisbane

Welcome one and all.

Good luck to those who are sitting the 1st non-DOTC administered exam. CU next month. ar

5/8 WAVE

JENNIFER WARRINGTON VK5ANW

It Pays To Make Mistakes!

Well, perhaps that isn't quite accurate, but an omission or two on my part in the Jan column has gleaned quite a bit more information. In the article on VK5WI I mentioned Cliff Moule for whom I could find no callsign. No sooner had AR hit the street (so to speak) than Gordon Ragless, the former VK5GR, rang me to say that Cliff certainly did have a

callsign, VK5CX, which he still held despite being fairly inactive these days. I subsequently rang Cliff to apologise and he has furnished me with some information both on himself and 5WI. (I quote)...

"Licence 274 issued to CE Moule with callsign VK5CX on 28.3.30 worked on 7 MHz band 29.4.30 to 31.5.31, and on 1.4 MHz (old 200m) 8.5.32 to 13.8.33 with occasional music (live and recorded) and rebroadcasts of 5DC, 5DX & 5WB (all on 200m band). Changed to 3.5 MHz from 27.8.33 with music still permitted. As in AR (Jan 1990) offer to rebroadcast WIA sessions accepted but log book only shows 2 sessions, 10.9.33 from 10.15 pm to 10.45 pm direct from VK5CX, and 24.9.33 from 10.30 pm to midnight rebroadcast VK5WB. That was H B Wilson who had VK5JM, Wayville Radio Club at his home, but used his own callsign and the WIA program continued for some months with the session originating on 1.4 MHz and rebroadcast on 3.5 MHz.

Transmissions on 200m were banned about the end of 1933, but I believe 5WI had its own transmitter on 7 MHz soon after and located in a Savings Bank building in Rundle St East (about the eastern end of the present Myer building). This could be the entry for 5.12.34 when a change was made to 80m."

Thanks Cliff for sending the above information, I'm intrigued to know what the "live" music consisted of.

Next month I'll continue with some more information which was sent by Reg Harris VK5RR.

New Members

The following are new members since June 1989, we trust that your association with the VK5 Div will be a long and happy one. Have you considered nominating for a position on Council? We need some new faces, so please think about it.

New Members From June

VK5KAQ	Mr BF Vaughan
VK5ZCI	Mr DW Bosanko
VK5ZMM	Mr MJ Mackintosh
VK5VYW	Mr TJ Wilson
VK5BRH	Mr RH Whellum
VK5YC	Mr CA Branch
VK5QB	Mr DJ Tanner
VK5NEH	Mr EG Jennings
VK5ZIP	Mr JG Rowley
Assoc	Mr RG Mayfield
Assoc	Mr P Mudge
Assoc	Mr I Marinkovic
Assoc	Mr L Vette
VK5BEB	Mr MM Telford
VK5KYM	Mr KM Oates
VK5YL	Mrs DA Robertson
	Riverland ARC
Assoc	Mr J Boardman
VK5GAS	Moomba ARC

VK5ARA Mr F Reiter
 VK5AKM Mr KG Minchin
 VK5NMD Mrs A Dawkins
 Assoc Mr BT Armstrong
 VK5MD Mr W Waldegrave
 VK5KDK Mr CW McEarchern
 Assoc Mr MP McRitchie
 Assoc Mr EG Hayman
 Assoc Mr W Hoakins
 Assoc Mr FJ Thyssen
 VK5CM Mr CW Monger
 VK5ZDR Mr MJ McMahon
 Assoc Mr PJ Koen
 VK5BP SA Scouts Ass of Aus

Diary Dates

March 16 — 18 Clubs Convention Ridgehaven Primary School.
 March 27 General Meeting BGB 7.45 pm.
 April 24 Annual General Meeting 7.45pm

Can you identify these VK5 past Presidents? For answers, see Page 56.



President 1



President 2

Sins Of Omission!

My humble apologies to Tom Sears VK5NJJ — I forgot to put him on the Christmas card list this year, as a new position, so he didn't get thanked in the usual way, as the rest of our volunteers did. I felt dreadful when I was told what I had done, as Tom has worked very hard this year helping to keep "ESC" moving especially with the mail orders.

Tom will continue to help the new ESC team of Mark VK5ZVQ and David VK5KK — our thanks to all of them for taking on the positions. ar

VK6 NOTES

JOHN HOWLETT VK6ATA

Disposals

Roy VK6XV does a good job with the buy and sell department, but did you know he also keeps a list of stolen equipment and the serial numbers? If you are buying second hand equipment, give Roy a ring on 447 7000 and check out the serial number. In a recent episode, a VK5 checked out a piece of equipment

INTRUDER WATCH

GORDON LOVEDAY VK4KAL FEDERAL INTRUDER WATCH CO-ORDINATOR
 AVIEMORE RUBYVALE 4702

Before I continue our excursion into monitoring — I'm sure all readers will applaud the move by our Region 3 Co-ord, to get a three region move, albeit originating from discussions between co-ords, to target the biggest offenders, for an ALL OUT PUSH to get them bodily removed...I hope the respective Governments react favourably. Now to continue from Feb issue:

(9) J8E Resolution freq of 2 indep sidebands.

(10) PON Centre freq of emission, this applies also to M7B

(11) R3C centre freq of emission (Fax, SSB reduced carrier)

for sale, only to find it was on the hot list! It is now with its rightful owner. Make a note of your serial numbers — just in case.

Wanneroo And Masts

For those who still think they are safe because they don't live in Wanneroo, consider this: amendment 454, once accepted by Town Planning, can be adopted by other councils. The fight continues.

Monthly Meeting

When did you last attend a WIA meeting? Many of you are missing some good lectures, which is a pity. The effort of getting along to meetings can be worthwhile — check out the QSL Bureau, perhaps there are some cards for you. How about the bookshop? There are new titles in stock. If you need new or more QSL cards, ask John VK5GU about our printing service — and save. After the meeting or lecture, relax with a cup of tea or coffee and biscuits, and chat to old friends, or make new ones. Make a note on the calendar now, and go along to the West Rail Centre on the 20th of March at 7.30 pm. Parking is free. ar

(12) R3E SSB read carrier zero beat of carrier in SSB/CW where carrier can be heard, otherwise at resolution freq of modulation.

(13) R7B Centre of freq of transmission.

Allowances should be made, where applicable for any inbuilt freq offset that results in erroneous dial readings of measured freq. FSK Morse — This method of sending morse code often produces confusion to monitoring stations. It is difficult to receive when listening to both carrier & shifted carrier. To read correctly, simply switch in a narrow filter (if available) and listen to the shifted carrier only. ar

DON'T

BUY STOLEN EQUIPMENT
 - CHECK THE SERIAL NUMBER AGAINST
 THE WIA STOLEN EQUIPMENT
 REGISTER FIRST.

SILENT KEYS

We regret to announce the recent passing of:

Mr E H Cox	VK1GU
Mr G R Pearson	VK2BDT
Mr John Zwart	VK2FCZ
Mr G B Isaacs	VK2PZK
Mr Alan Williams	VK2ZAL
Mr W L Stevens	VK4YN
Mr R W Sterrett	VK4BOZ
Mr K Span	VK4NKS
Mr John Edward de Cure	VK5KO
Mr Lance Catford	VK5XL
Mr M H Fuller	VK5AMF
Mr Harry Brown	VK6AP

Alan Williams VK2ZAL

I wish to advise his friends and fellow amateurs of the recent passing of Alan Arthur Williams VK2ZAL. Alan was 66 years old when he became a silent key on 1st December 1989. He had held this call sign since 1958 and had been very active on VHF during the 1960's.

In association with myself, VK2BDN, his brother-in-law, Alan explored the VHF and microwave regions. As a team we competed successfully in the numerous field days, "fox hunts", scrambles and "treasure hunts" which made the "sixties" so exciting.

Alan is survived by two sons, Alan and Bruce and will be sadly missed by his many friends

DICK NORMAN VK2BDN

John Edward de Cure VK3WL — VK5KO

Jack de Cure was born in Adelaide on 16th July 1899 and became a "Silent Key" on the 19th August 1989 in his 91st year. He moved to Melbourne with his family in 1902. In the early 1920s he became a telegraphist with the PMG Dept and at the same time acquired an interest in radio. He obtained his Amateur License in 1929 with the call sign VK3WL.

During this period in Melbourne his sporting activities included competitive cycling. In this field he had considerable success when taking part in interstate road racing championships.

It was due to his experience and interest in radio that he was transferred to the Radio Branch and in 1935 he was posted to the Radio Inspectors Office in Adelaide. Initially for 3 months to assist in getting the office established; eventually the posting became permanent.

Rob (VK5RG) volunteered the following:-

"I worked with Jack in the post-war period as a cadet radio inspector, he being the Chief RI for SA/NT. He helped me extensively in my

early studies and morse training. He was known and respected throughout the broadcasting and radio communication fields, where his main activities were station measurements. I was pleased to carry his bag on these occasions. Jack was an amateur sought by many overseas stations for their 160 and 80 meter VK contacts during the late 1940 and early 1950 period. His work in this field provided valuable data for the Ionospheric Prediction Service. In retirement, he continued with his only mode, CW. I don't think he ever had a phone contact. The inability to erect an 80 meter end-fed Zepp in a restricted area never daunted Jack — he let the last 35 feet hang vertically from the far mast. Details were published in AR under the heading "Inverted Bathtub Antenna".

During late 1939, I together with a group of radio amateurs who were employed in the radio industry, set out to obtain the First Class Commercial Radio Operators Certificate of Proficiency. Jack, then No2 in the Radio Branch, volunteered to coach us. Most were successful and were for ever grateful for the evenings he devoted to helping us. Many others had good reason to be grateful for his help.

Promotion took Jack to Sydney and, finally to the top job in Victoria from where he retired as Superintendent — Radio Branch — in 1960.

To the surviving members of his family we extend our sympathy.

JOHN ALLAN VK5UL

Lance Catford VK5XL

Lance was born in 1913 in Auburn, the family being farmers in the Mid North. He first built a receiver in 1924, aged 11; an interest that he was to enjoy for the rest of his life. He worked on wheat graders in Victoria (Hanafords) until health problems became evident due to the dust and chemicals used to pickle the wheat.

Lance obtained the call VK5XL in 1939. When war broke out, he was unfit for Active Service, but joined the Railways' essential service operations.

All the Amateur Radio equipment was confiscated of course for the duration of the War. After the War he became active again, using ex RAAF AR8 and AT5 equipment from aircraft at Mt Gambier. This gear is still on hand and appears to be operational. Lance used this equipment until SSB signalled the demise of AM, when eventually he proudly purchased a Collins KWM2 transceiver, which he used as the main station transceiver till the end. He had an active involvement in the Mid North Amateur Group, who met occasionally for a picnic and much face to face

communication.

Lance's interest in mechanics (he ran a successful agricultural/engineering business till retirement), and his lifelong interest in radio and electronics had a very strong influence on the lives and careers of his two sons Layton and Adrian. Both have held Amateur licenses. Adrian VK5ZAJ has hopes of obtaining the CW, and would like to pick up the 5XL call which Lance held for 50 years.

Lance passed away December 19th 1989, aged 76 years, and his XYL Vera died 12 weeks prior on the 22nd of September.

ADRIAN CATFORD VK5ZAJ

John Zwart VK2FCZ

Born on the 26th March 1932 in Holland, he travelled through Occupied Europe through the turbulent years of the Second World War, living for a time with foster parents, not knowing where his parents were or even whether they were alive until after the war. He spent two years in the Dutch Air Force where he attended the Radar and Radio School, and this gave him the qualifications of a Fine Instrument Maker and Electrical Technician.

John met Eliza, eventually marrying her at the age of 24, one week before sailing for Australia. Upon arriving in Australia he lived in Double Bay, and got a job with Burroughs where he worked for a number of years. He next worked for H G Palmer, gaining knowledge in the Television field. When that company went bust he switched to Eric Anderson, doing the same type of work. By this time he and Eliza had bought a house in Paddington which they set about "renovating".

John fell in love with the Australian bush, as did his whole family. They spent much time going bush and camping, eventually buying a caravan to go bush "in style".

In March 1964 their first son Gerard VK2XEA was born. The family moved to Clovelly, where they still live. Later he shifted jobs again, commencing a career spanning 12 years with General Electric, where he became head of the fleet of Television Service Technicians. His second son Robert was born in April 1968. His sons became involved with Scouting, where the troop often enjoyed the yarns John would spin around the campfire. John took on the job of Group Treasurer for a number of years. The family's involvement with Scouting spanned about 13 years, with Eliza becoming a Cub Leader for a time.

General Electric sold out, so John decided to seek out an alternative career. He worked for four years at Olivetti, but finding no satisfaction there he decided to put his artistic talents to use, taking a job with Ainsworth Industries as a Technical Author, producing their technical bulletins and manuals. He had been with them for 9 years at the time of his passing.



Harry Brown VK6AP. Photo supplied by courtesy of West Australian Newspapers Ltd.

His interest in radio started when he met some of the old Waverley Club during the mid 1970's. John became ill earlier this year, and was diagnosed as having cancer. He recovered sufficiently with treatment to leave hospital for a few months and enjoy some time with his family and friends. The support he received from his friends and fellow workers was enormous, and this meant a lot to him and to his family.

John will be sadly missed by all of his many friends, and he was a great driving force within the Waverley Amateur Radio Society where he was Treasurer. John passed away in the early hours of Friday morning, December 22nd, at the Sacred Heart Hospice, with his family members present.

Harry Brown VK6AP

Harry became a silent key on November 23rd, 1989 at the age of 65 years.

His passing leaves a noticeable gap among many amateur operators and friends. A very close family man, he will be sadly missed by his wife Anne, their children and families.

Harry was born in Mackay, Queensland. He joined the RAAF and later saw active service in Britain and Europe. From 1942 to 1946 Harry was based at Leicester, England, as a Warrant Officer Rear Gunner with the 227 Squadron. Harry married Anne in Scotland and returned to Queensland in 1946.

After retiring from the RAAF Harry became an adult apprentice carpenter, qualifying as a Master Builder. At one time he was a keen instructor scuba diver and a member of the Underwater Explorers Club of WA.

In 1980 Harry was introduced to Citizens Band radio by an ex-servicemen's group, the Wild Geese International Association. He interest grew quickly and he gained the novice call VK6NGB in 1984, then his full call, VK6AP, in 1985.

Harry's technical radio interests were building antennas, winding transformers, designing printed circuit boards and constructing power supplies for friends.

Harry was very fond of CW, (a skill gained in the RAAF), and produced practice morse text tapes for the VK6WIA Division tape library. On SSB he took pleasure participating in and receiving Amateur Awards. Later, he became very interested in the Amateur Radio Australian traffic network operations, (ATN), spending most of his time helping and conveying family messages to relatives both in and out of disaster areas. Special citation certificates were presented to Harry for his active on-air services in the 1985 Mexico earthquake, 1987 Vanuatu cyclone and the recent 1989 San Francisco earthquake. Harry was an active member of the WIA, attending meetings and reporting on ATN matters.

On behalf of the Wireless Institute of Australia and Amateur friends, I wish to offer thanks for his friendship.

MALCOLM K JOHNSON VK6LC
VK6WIA PRACTICE MORSE
CO-ORDINATOR

E H (Arch) Cox VK1GU

formerly VK3BD and VK2GU

The death occurred in Canberra on 11 December 1989 of E H (Arch) Cox, VK1GU. Arch, who hailed from Victoria, was a true old timer. He held certificate number VO90 and was first licensed as VK3BD in his home state of Victoria well before World War II.

Arch was active on air and in Institute affairs in Victoria prior to his transfer to Canberra in the mid 1930s. He was a reporter with the Herald in Melbourne and was assigned to the Press Gallery of the Federal Parliament as head of the Melbourne Herald Bureau. With the passage of time he became

the senior staff correspondent in the Press Gallery and confidant of many wartime Government ministers and politicians.

Re-licensed as VK2GU, Arch's name appears in the minutes of the formation of the Canberra Radio Club, later renamed Canberra Radio Society, which founded the VK1 Division.

The Club's papers and Amateur Radio magazine columns record the first Canberra to Sydney contact on 144 MHz on 5 Dec 51 between VK2GU and VK2ANF. Elsewhere his crystal locked frequency is noted as 144.1 MHz.

In 1956 as a culmination of the efforts of Arch and the late Les Pitts, VK1PI (formerly VK2PI), the ACT was assigned the amateur call prefix VK1, which up until then had been used in Antarctica. No doubt Arch's contacts in the House with the PMG and his staff assisted this re-allocation of callsigns.

For his contributions to amateur radio, and in particular his efforts with Les in achieving the VK1 prefix for the ACT, the Canberra Radio Society proposed Arch for life membership of their division, the VK2 Division. That life membership was conferred on Arch at the 1969 WIA Federal Convention which was held in Canberra that Easter. The honour was conferred by Pierce Healey, VK2APQ, the NSW Division Federal Councillor at the convention Dinner in the presence of the Federal Council, delegates, CRS members and their ladies.

With the creation of the VK1 Division in 1974, Arch automatically transferred to become the new division's first life member.

Arch is remembered by senior VK1's as a person who would not suffer fools gladly, yet was approachable to discuss a point of interest concerning amateur radio. Anecdotal evidence suggests he was equally afraid of visits by the radio inspectors as the inspectors were afraid to make their formal calls. Perhaps his reported ability to increase power to achieve difficult HF contacts was not entirely irrelevant in this context!

With the passing of VK1GU we see the loss of yet another elder statesman of amateur radio in Australia.

RON HENDERSON VK1RH
FOR VK1 DIVISION
 ar

Answers

to Jenny's question from page 54 .

President 1 John Allan VK5UL
 1970 - 1972

President 2 Geoff Taylor VK5TY
 1972 - 1974

**Sign up a new
 WIA member today**

OVER TO YOU

ALL LETTERS FROM MEMBERS WILL BE CONSIDERED FOR PUBLICATION AND SHOULD BE LESS THAN 200 WORDS.
THE WIA ACCEPTS NO RESPONSIBILITY FOR OPINIONS EXPRESSED BY CORRESPONDENTS.

Someone Likes Us!

Having been a member of the WIA for the last two years, I have read with interest the many letters published under "Over to You" columns and it occurred to me that the "pats" on the back are rather few and far between.

I was prompted to write because of some rather interesting remarks passed by my brother when he recently came to Australia from Canada to visit us.

He is an amateur in Victoria BC with the callsign VE7DIF and became very engrossed with my copies of "AR" and expressed the opinion that our magazine was outstanding in every way — he could not get over the coverage of the many topics, the technical articles and value for money which AR offers.

Another thing which impressed him was the range of parts available in Australia for the home brew enthusiasts — yes there are still quite a number of us left!

The equipment supply committee and publications committee were another surprise to him.

Perhaps we don't realise how well off we are in Australia as apparently other countries including the USA do not offer anything like the standards we enjoy here when it comes to our publications and gear in general. It is surprising what can be found in the way of

"hard to get" bits when one is prepared to search out some of the smaller suppliers in this field.

As a brand new ham and an avid "home brewer" I felt my brother Seth's comments were worth a few lines and a compliment to all who try so hard to do the best possible for our fraternity.

PETER SPENCER VK5KKB
PO BOX 147 CLARE 5453

The Man Behind The News

One sees the announcement that James A Wyatt VK4ZDJ duly won the "WIA 80" Logo Competition.

No surprise at all — knowing this OM (and his old man before him too) as I do!

Jim hails from my Central Queensland hometown of Mount Morgan with the fabulous gold-mine that has produced 8-million oz of gold (and vast quantities of silver and copper). He is by profession a senior draughtsman at the works.

Here's a photograph of Jim with one of his submitted designs (I made a special trip back to secure this!). I am pleased to be able to provide this additional background to Jim's efforts.

Shortly I'll follow up with a screed on

amateur activity at Mount Morgan, which has an unusually high concentration of radio operators too.

In passing, it was Jim's father, then my boss, who first encouraged and assisted me in studying for the ticket: in younger days I was Assayer at the mine.

MERVYN EUNSON VK4SO

GPO Box 1513

BRISBANE 4001

PHOTO: MERVYN VK4SO

Ross Hull Rethink?

It was a pretty picture of the Ross Hull Memorial Trophy on the front of January AR. Unfortunately it takes more than a polished trophy to make a good competition. The Ross Hull is not a good competition, which is sad because it could be and should be one.

To my mind the Ross Hull should be the absolute apex of VHF/UHF competition and it should follow that the winner would automatically become the absolute top dog VHF/UHF man for that year. It follows from this that the competition must be such that it can only be won by a person who has put together a VHF/UHF station which enables contacts to be made under circumstances which would not allow those contacts to be made by a lesser station.

One might think that this was ridiculously obvious but successive contest managers have been unable to put together a contest which embraces this principle. All we seem to hear is that there is little interest because few logs are received. Given the structure of the Ross Hull the really surprising thing is that they seem to expect it to be otherwise! Perhaps THIS TIME it may be possible to get some common sense into the discussion when the inevitable "lack of interest" manifests itself again.

There are two simple rules which MUST be applied if the Ross Hull is ever going to attain the status which I think it should have. It is only by attaining that status that the competition is ever going to attract interest!

Here are the rules:

1. Contacts must attract points in direct proportion to the degree of difficulty involved in making them!

2. Contacts which are not due to the technical excellence of the station and/or its operator must, as far as possible, be eliminated!

The ramifications of these rules are numerous and space does not allow that I go into them now. Nevertheless here are some examples to go on with:

a. Points must be directly proportional to distance and frequency. This is simple enough. All you have to do is to allocate points in direct proportion to the path loss in dB.

b. Luck must be eliminated as far as pos-



Jim VK4ZDJ of Mount Morgan shows one of his logo designs.

sible and this means that the contest must be held at that time of the year when it is least likely that anyone can benefit from the "being at the right place at the right time" factor caused by excess probability of anomalous propagation. The duration must also be short. One weekend in about the middle of May is my suggestion.

c. A contact is only a contact if a message is passed from one operator to the other. The message should be unique and impossible to journalise, ie not like Maidenhead locator numbers. The message should also take time, say at least five words and it should NOT indicate the score of the participants. After all who wants to submit a log when it is perfectly obvious who has the highest score already?

Is there anyone who would like to discuss the matter further? If so over to you.

73,

GORDON McDONALD VK2ZAB
59 WIDEVIEW RD
BEROWRA HEIGHTS 2082

Packet Racket A Tropic Topic?

1. Packet is alive and well in Far Nth Queensland, Cairns area, with about 6 operators so far and more to come. In the Cairns region we have Willie VK4AAC, Pete VK4DFR, Bob VK4ZZB, Gordon VK4AGZ, Ian VK4KOR, Dale VK4DMC and Mike VK4AMO. Our local repeater atop Mt Haren, Kuranda, on 144.900 is working very well and has its own BBS mailbox built in. A link to Townsville is projected for the near future.

2. One advantage of living in the tropics is the prolific insect life, in the rainforest/jungle. A night spent at home can be very revealing, after the neighbours have turned their stereos off, and especially after rain. For every insect and small animal is out for a chat, and believe it or not...they use packet!

This was brought to me not long ago, on a hot and steamy night, when the XYL rolled over in bed and remarked, "do you have to leave all those noisy radios on?" I assumed she meant my VHF and HF packet systems, which I often leave running all night. I got up to turn them off.

To my surprise everything was already off...the breaker had blown with the recent tropical storm. But the packet sounds were still there!

A quick listen out the window revealed all. It was not Willie on 2 metres, but a large insect calling CQ. A bit further down the garden, was a female of the same species, giving either Acks or UAs, I'm not sure, but she wasn't getting any closer. Maybe he was too DX...A Gecko lizard on the ceiling gave a chirp. Another, in the corner, replied at once, obviously digipeating to the Gecko family in the roof!

A Bombay Canary, our local brand of cock-

roach, came chirping over the sill, at about 300 baud, I'd guess. The lizards were well over 1200. A fruit bat chattered, as slow as RTTY!

I've spent quite a few nights in the garden now, to the chagrin of the XYL. She claims I've gone troppo, but, armed with a microphone, modem and laptop, some of these sounds are beginning to make sense. Trouble is, are they FSK or PSK? What baud rate? Parity or non parity? How far is DX?

Don't forget, I discovered this first, I'll let you know of my first QSO?

PETE ROBINSON VK4DFR
23 MASON ST
STRATFORD 4870

More About VNG

Knocking VNG seems a bit like knocking Mom and apple pie, and that's why I've hesitated from doing it.

So I was pleased and gratified when someone else suggested that VNG was more trouble than it was worth.

WVW and WVH have provided a splendid service for over 30 years. They are almost continuously audible in this country, and their spoken announcements are a great help.

VNG has one unique advantage in that its encoded pips convey the time in digital format, and it is ideally suited to EDP processing for that reason.

But VNG is essentially a time service, its role as a frequency standard is secondary, in fact, largely irrelevant.

Thus VNG should be positioned on any available frequency, and should certainly be moved off the WVW frequencies, where it causes unnecessary interference.

AL RECHNER VK5EK
PO Box 566
MORPHETT VALE 5162

(By now you have seen Marion Leiba's letter in defence of VNG in the Feb issue. One more point is that VNG is not on 15 MHz by choice, but by DOTC direction, and efforts are still being made to change to another frequency such as 16 MHz. Ed.)

Subsidies Etc

In his January "AR" letter, Graham, VK4WEM, raises a very valid point in reference to a government subsidy. If our Institute has not previously applied for a subsidy, there should be a number of red faces among the Executive members!

Considering the proven, and potential value of the Amateur Service, such a subsidy should be quite substantial, and no doubt would greatly assist in keeping the WIA "afloat".

As for VK2DDL under the heading "Smug

and Pompous" (in the same issue) I would have to go part of the way with the fellow. My main interest in "AR" is technical information. What happened to "Novice Notes"? There must be hundreds of novices joining our fraternity, and thirsting for the right information.

Recently, prior to constructing a delta-loop antenna for ten metres, I surrounded myself with text books. However, when delving through a pile of "AR" issues, I found that it had little interest in delta loops.

Nevertheless, I shall be forwarding my 1990 subscription, and would have the temerity to suggest that Mr Ellis apply for an executive position!

MAURIE DEWHIRST VK5PMD
4 HAWKE ST
LINDEN PARK 5065

(Over the years, several applications have been made by the WIA for subsidies, both State and Federal. Some have been successful. But even when granted, automatic renewal does not apply, and criteria for eligibility also change. "Novice Notes" is continuing at irregular intervals, but needs additional authors. Did you see March 88 p6 and Dec 88 p23 re delta loops? Ed)

Blatant Greed

It takes a lot to make me put pen to paper, but recent happenings that have left me feeling ripped off have made me do just that.

It all started after a recent trip to the USA, where I bought a new MFJ 1278 Terminal Node Controller, the cost US\$229 (A\$289) which I thought was a fair and reasonable price. Arriving back in good old Oz I happened to see this self same article advertised locally for \$595. I considered that I was very fortunate but couldn't understand how a figure twice as much as I paid in the States could be arrived at, especially considering that I paid retail price which obviously would have had mark-up added etc.

The second part of my story started when I unfortunately blew a 572B tube in an FL2100Z amplifier. I say unfortunately because I had the same misfortune about 7 months previously, then I found that only two companies stocked these tubes. With freight, there was not a lot of difference in price between them, in fact I paid just over \$200 each. Imagine my disgust when 7 months later I found that one of the stores had no stock and when I approached a local branch of the other supplier I was informed that the price was now \$395 each. I could not believe this so I called up a VK2 friend who obligingly called the supplier's head office and it was confirmed that the price was \$350 (I imagine post packing etc took care of \$45!)

These self same tubes are advertising in the AES (USA) catalogue for US\$95 each.

I know there will be replies mentioning "duty" "tax" "insurance" "freight" "etc etc" but 2-300%?

Will someone please tell me what is going on? Are our suppliers trying to emulate the banks' huge profits? I honestly feel that it is a blatant case of utter and unashamed greed.

ANYONE GOT A CHEAP SPARE 572B?

JOHN WOODINGS VK6AJW
9 KURRAJONG ST
ROLEYSTONE 6111

Asterisks, Intruders, Membership And VNG

I would like to comment on the following:

1. A few years back an asterisk or similar mark was used in the Callbook to indicate a WIA member. Regrettably this was dropped I am told, because of complaints by a few non-members of discrimination. I for one, maybe others, would like an indication of membership, among other things to show that QSLs may be sent via the WIA.

2. The letters by Ian Berwick-VK3ALZ and Gordon Loveday-VK4KAL (Letters Dec 1989), which referred to 10 metre intruders. In many cases, if not all, the Australian amateurs can only blame themselves. Tune across the 10 metre band — the whole 1.7 MHz of it to see what use, or should I say lack of use, is made of it. One can call "CQ" all day on 10 with zero results. A case of use it or lose it.

3. Well Mr Lawless I think you will find that non-members will be the first to whinge, and whinge the most if any bands or privileges are lost, or they find that some greenie inspired council will not permit them to put up a tower or antenna.

4. Cost of membership Ray Hinks - VK4LU (Letter January 1990). I agree those that are "bitching" about the fees charged by the WIA should take a good look at what other clubs (social and sporting) charge — especially pistol shooting, and see the fees and conditions here. I have no doubt that many would spend much more on a Saturday at the local pub.

5. VNG (DH Watkins — VK2DDR). I agree with most of your comments and I fail to see why VNG could not go back to their original frequencies of 7.5 and 12 MHz. WWV/WWVH and JJY give voice announcements making their time signals of far greater use to most users. Just imagine the confusion if one had WWV/H and JJY coming in at or near the strength of VNG

GRAHAM J MUIRHEAD VK4WEM
23 CUNNINGHAM ST
WARWICK 4370

(We produce the Callbook for DOTC by contract. The asterisks were deleted at DOTC request. VNG is not on the WWV frequencies by choice, nor for the full 24 hours. Ed) ar

Morseword No 36

Solution on page 64

Across

- 1 Strong wind
- 2 Narrow opening
- 3 Regrets
- 4 Top
- 5 Lie
- 6 Cut
- 7 Conditions
- 8 Used to curdle milk
- 9 Keep
- 10 Male deer

Down

- 1 Lowers the light
- 2 Concern
- 3 Satisfies
- 4 Under
- 5 Move quickly
- 6 Correct
- 7 Magistrate of Venice
- 8 Road
- 9 Retinue
- 10 Division

	1	2	3	4	5	6	7	8	9	10
1										
2										
3										
4										
5										
6										
7										
8										
9										
10										

Audrey Ryan © 1989

HF PREDICTIONS

ROGER HARRISON VK2ZTB
THE APOGEE GROUP

Background

For ease of use and to accommodate space restrictions in the magazine, I have provided predictions applicable for three major regions of Australia:

VK EAST Covers the major part of NSW and Queensland.

VK SOUTH Covers southern-NSW, VK3, VK5 and VK7.

VK WEST. Covers the south-west of West Australia.

For each of these regions I have selected six "terminals" to major continental regions of the world, or regions of particular interest. From time to time, I will include predictions to cover particular DXpeditions or other activities of special interest.

This month I have provided charts for South Sudan, in lieu of Africa, and for Palmyra Atoll. Information to hand, courtesy of Stephen Pall VK2PS, indicates there will be activity from these two regions during March, hence the change in the charts this month.

Feedback from readers and users would be most appreciated - let me know what you feel is wrong, and what's right, about the paths, presentation or any other aspect.

The charts

These charts are different from those you see published elsewhere, and arguably more useful to the amateur fraternity as they give,

effectively, the predicted signal/noise ratio for each hour and for selected bands.

The charts are organised in 24 rows, one for each hour UTC (first column on the left). Don't forget to add the appropriate number of hours for your time zone, including daylight saving where it applies. The next column give the MUF (maximum usable frequency) for each hour, followed by the field strength at the MUF, in decibels referred to 1 uV/metre (dBU). The column marked FOT gives the "optimum" frequency - the most reliable frequency for the path.

Then come five columns, one for each of five selected HF bands.

The numbers in the column represent predicted field strength at each hour in decibels referred to 1 uV/metre. Here it represents "raw" signal to noise ratio as urban noise levels are typically 1-2 uV/metre, but does not take into account the advantage offered by particular transmission modes. The results are based on a transmitter power of 100 W output, the use of modest 3-element beams or similar, and for "median" conditions. Where the results fall below -40 dB, no output is printed.

Enhanced conditions may improve S/N ratios by 9-15 dB. The use of CW or digital transmission modes show better results than SSB. If you've got 400 W output, you get a 6 dB improvements. Where conditions warrant it, I have deleted 28.5 MHz predictions and included 10.1 MHz. In general, providing predictions for the bands below 10 MHz is futile

HAMADS

TRADE ADS

DECODE FAX & RTTY: Listening Post software for Apple II, MICROBEE, C64/128. Decode FAX and RTTY on shortwave (Morse too, with Apple & dBee). Print pix and text on common dot matrix printers. Apple & Commodore put fax on-screen. Full documentation. \$32 post free anywhere in VK. FT Promotions, PO Box 547 Rozelle NSW 2039. PH: (02) 818 4838. Fax: (02) 818 2949.

AEM BACK ISSUES & ARTICLE COPIES: \$5 post-free anywhere in VK. Just ask for back issue, article or project you want and we'll send back issue if available, or copy of article. Send SAE for back issue list. FT Promotions, PO Box 547 Rozelle NSW 2039. PH: (02) 818 4838. Fax: (02) 818 2949.

AMIDON FERROMAGNETIC CORES: For all receiver and transmitter applications. Send large SASE for data and price to RJ & US Imports, Box 157, Mortdale NSW 2223. (No enquiries at office please... 11 Macken St, Oatley.) Agencies at: Geoff Wood Electronics, Lane Cove; Webb Electronics, Albury; Electronic Components ACT; Truscott Electronics Vic; Willis Trading Co WA; Associated TV Service Hobart.

SATFAX: NOAA, Meteor, GMS weather satellite picture receiving program for IBM XT/AT. Displays in 64 colours. Needs EGA colour monitor & card, and "Weather Fax" PC card. \$45 + \$3 postage *** RADFAX2: HF weather fax, morse & RTTY receiving program for IBM XT/AT. Needs CGA, SSBHF, FSK/Tone decoder. Also "RF2HERC" & "RF2EGA", same as RADFAX2 but suitable for Hercules & EGA cards respectively. \$35 + \$3 postage *** All programs are on 5.25" OR 3.5" Disk + full documentation. ONLY from M. Delahunty, 42 Villiers St, New Farm 4005 OLD. Ph. (07) 358 2785.

FOR SALE — ACT

YAESU FT-470 dual band handheld 2m + 70cm 5w: extra coverage VHF UHF RX. Many features incl. dual RX, APO, save DTMF, tone, tone sq, full key pad & light small size with 5w dry cell & 12v batt and charger: mint cond. \$650. Contact Tom VKIVST PH: (062) 81 5079.

FOR SALE — NSW

YAESU FT-480R 2 metre all mode transceiver, 2.5 w & 10 w, with manual. Licenced amateurs only. \$500. Mark VK2EMG QTHR (02) 85 6870.

TENTEC PARAGON allmode trans. \$2,150. **ELECTRONIC** morse key (2) \$90. Paddle \$45. (047) 54 2299 after 6pm.

THREE ELEMENT YAGI antenna; 'TET' HB33SP. VGC. \$200 MIKE (043) 67 7499 VK2IHF QTHR.

LOG PERIODIC HF antenna. Model 20-30-6S made by ATN antennas. Six elements four metre boom length. Deceased estate \$225. Ex-Springwood. PH: (047) 51 4257 VK2VJD QTHR.

FOR SALE — VIC

FT707 HF transceiver \$750, FP757HD 20 amp power supply \$500, FC700 ATU \$250. All in good condition also FT290R 2m all mode portable plus usual bits. \$500. VK3ECG DAVID (03) 648 4305 BH (03) 862 3315 AH, QTHR.

YAESU FT480R 2 metre FM/SSB/CW xcvr very good order. Complete \$475. VK3OM QTHR (059) 44 3019.

YAESU FT-209RH 2m hand held, FNB4 and FBA5 batteries including home brew constant current charger \$400. BERT VK3TU (03) 607 7760 BH (052) 78 2374 AH QTHR.

DICK SMITH 2M linear 100w as new \$240. 6M linear as above \$250. ICOM IC202 with beacon and satellite freqs. \$200. HIMOUND morse key \$30. ROGER VK3XRS (051) 56 8291.

YAESU FL2100Z linear amp as new in orig box manual 1200 watt PEP hardly used. Best offer. PH: (051) 99 2811.

CICADIA 300 DATAPHONE MODEM. \$150 in VGC ono must sell. **RADIO SHACK DMP100** dot matrix printer with serial and parallel connections plus ribbon and manual \$170 ono VGC must sell. ARTHUR VK3CUA QTHR PH:(054) 43 7425.

YAESU FT-101E HF transceiver in excellent condition. Includes inverter and manuals \$460 or will exchange for a quality scanning receiver HF to UHF. QTHR PH: (054) 61 4001.

DRAKE TR-7 txvr gen-cov rx. AM, RTTY, CW & SSB. \$1,200. **SCANNER** regency M-100. Covers UHF & VHF hambands \$180. FRANZ VK3DVD PH: (03) 726 7137.

KENWOOD TS440S HF transceiver with narrow SSB filter, little used, in original carton with handbook and microphone, suit new transceiver buyer, \$1950 ono. VK3ARZ QTHR (03) 584 9512.

FOR SALE — QLD

KENWOOD TS440S incl h/h mic, ATU SSB-N & CW-N filters, IR tuning upgrader and service manual. VGC \$2,000 DOUG VK4AIZ QTHR (07) 391 5526.

SCREEN BASED TELEPRINTER with word processing replaced by fax. Model telex 2000. Cost \$6500 any offers over \$100? VK4TO PETER on (077) 72 4400 QTHR.

YAESU FT707 mint condition \$700. Will deliver anywhere free phone after 6pm (071) 85 1240

PAT VK4WHO.

SM-100 10HZ — 150 MHZ frequency counter 6-9vdc 8 digit gate times 0-01S to 10S hold reset. \$150 with cable excellent condition. VK4KAL QTHR (079) 85 4168.

YAESU FT7 HF Transceiver mike manual good condition \$500 John VK4ET QTHR (07) 269 3942.

FOR SALE — SA

KENWOOD TS130S pwr 100 watt out mobile rig MA5 HF 5 band hel/whip ant SP40 mob/spk bumper ball antenna mount. Perfect cond. Hardly used everything \$780. QTHR PH: (083) 344 5011.

EIMAC 3-400Z new and boxed with chimney and base. Base installed in metal work and cabinet for 6MX linear as per ARRL handbook. Mobile mount for TS120. Reasonable offers considered. (086) 25 7084 QTHR 1989 onwards GEOFF VK5OH.

TELCON semi air spaced twin coax 2kW to 2m, transmitting tubes 4-65A; 4E27(813) Grundig reel-to-reel recorder two sets tubes KW2000; Portable Diathermy 600 watts 7 metres; Post-war receiving tubes new ribbon micro — VK5LC QTHR (08) 271 6841.

TONO 9000E mint plus monitor \$700 offers CRED 444 \$50 M100 \$50 PH: (086) 45 0023.

FOR SALE — WA

YAESU FT-757GX transceiver FP-757GX power supply MD-1 microphone as new \$1,500. **KENWOOD TM-2570A** 2m rig as new \$450. All with books ANDREW VK6WB (09) 447 1213.

FOR SALE — TAS

ICOM IC-R71A comm rcvr as new little use \$900 ono. **YAESU FRT-7700** rx ATU also top cond. \$80 DAMIEN VK7CDI (003) 26 3772.

THREE ELEMENT three band beam 20-15-10 CE-33 \$200 FRED VK7FD (004) 31 51 73 QTHR.

WANTED — NSW

VALVES URGENT 7360 12BY7 6U8 types please help keep my FT200 alive MAX VK2GE (065) 85 5732 QTHR.

BOOKS ARTICLES and papers on oscilloscope design also plug ins for TEKTRONIC 540 series state price. DAVID KIDD 8 GOSSE Ave DUBBO 2830 (068) 81 8906.

TET EMTRON HB33DX antenna 3 element tribander 10/15/20 metre cost \$650 sell \$225 STAN VK2DUI (02) 349 3741.

WANTED — VIC

YAESU digital display FT 101Z/B. ROB VK3VOS
(03) 364 0078.

RECEIVER (vfo must be 5-5.5 MHz) valve type
any condition also power transformer for HAL-
LICRAFTERS transmitter HT37. VK3CUP (054)
22 2786.

WANTED — QLD

CHEAP 6 metre all mode transceiver any con-
dition also 1296 MHz SSB transverter or 1240-
1300 FM transceiver. PH (07) 800 6798.

WANTED — SA

SIX METER conversion details for bushranger
CB or similar unit any help appreciated Alan
VK5BWG PO Box 1337 STIRLING NORTH
5710 STH AUST.

TRI-BAND YAGI three or four elements must be
in good condition. (086) 25 7084 QTHR 1989
onwards. GEOFF VK5OH.

WANTED — WA

DIGITAL frequency counter for FRG7 FARMER
15 WEDGEWOOD drive EDGEWATER 6027.

WANTED Intruder watch observers in VK6 free
tapes logs and assistance available contact
VK6RO Graham on (097) 451 3561 or QTHR.

WANTED — NT

KENWOOD RZ-1 mobile receiver. EDDIE
VK8XX (089) 51 3138 BH, (089) 53 4056 AH,
(089) 52 6893 FAX. Box 912 ALICE SPRINGS
0871.

**PHOTOCOPIES
of
any article
published
in a back issue
of AR
available to
members
at
\$2.50 each**

plus \$2.00 for each
additional issue in which
the article appears

AR ARTICLES
PO BOX 300
CAULFIELD SOUTH
VIC 3162

HAMADS

Please Note: If you are advertising items For Sale and Wanted please use a separate form for each. Include all details; eg Name, Address, Telephone Number (and STD code), on both forms. Please print copy for your Hamad as clearly as possible.

*Eight lines free to all WIA members, ninth line for name and address Commercial rates apply for non-members. Please enclose a mailing label from this magazine with your Hamad.

*Deceased Estates: The full Hamad will appear in AR, even if the ad is not fully radio equipment.

*Copy typed or in block letters to PO Box 300, Caulfield South, Vic 3162, by the deadline as indicated on page 1 of each issue.

*QTHR means address is correct as set out in the WIA current Call Book.

*A courtesy note will be forwarded to acknowledge that the ad has been received.

Ordinary Hamads submitted from members who are deemed to be in general electronics retail and wholesale distributive trades should be certified as referring only to private articles not being re-sold for merchandising purposes.

Conditions for commercial advertising are as follows: \$22.50 for four lines, plus \$2.00 per line (or part thereof) Minimum charge — \$22.50 pre-payable.

State:

- Miscellaneous
- For Sale
- Wanted

Name:

Call Sign:

Address:

Solution to Morseword No 36

	1	2	3	4	5	6	7	8	9	10
1	-	-	.	.	-	.	-	.	.	.
2	.	.	.	-	-	-	-	.	.	-
3	.	-	.	.	.	-	-	.	.	.
4	-	-	.	.
5	.	.	-	.	.	.	-	.	.	.
6	-	-	-	-	.	.	-	-	.	.
7	-	.	.	-	.	-	-	.	.	.
8	.	-	.	.	-	.	-	.	.	-
9	-	.	.	.	-	.
10	-	.	-	.	-	-

Across: 1 gale 2 slit 3 rues 4 head 5 fib
6 mown 7 terms 8 rennet 9 save 10 hart

Down: 1 dime 2 care 3 sates 4 sub 5 zap
6 fix 7 doge 8 street 9 suite 10 rift

**Have you advised
DoTC of your new
address?**

TRADE PRACTICES ACT

It is impossible for us to ensure the advertisements submitted for publication comply with the Trade Practices Act 1974. Therefore advertisers and advertising agents will appreciate the absolute need for themselves to ensure that, the provisions of the Act are complied with strictly.

VICTORIAN CONSUMER AFFAIRS ACT

All advertisers are advised that advertisements containing only a PO Box number as the address cannot be accepted without the addition of the business address of the box-holder or seller of the goods.

TYPESETTING : Redfords Media
25 Glenferrie Rd
Malvern 3144
Tel: (03) 500 0377

PRINTING: Industrial Printing
Richmond

MAIL DISTRIBUTION: Polk Mailing Co.
PO Box 140,
Collingwood,
Vic. 3066
Tel:(03) 417 5161

The opinions expressed in this publication do not necessarily reflect the official view of the WIA, and the WIA cannot be held responsible for incorrect information published.

ADVERTISER'S INDEX

ATN Antennas	7
C & S Electronics	27
Call Book	27
Dick Smith Electronics	IBC, 17
Electronics Australia	9
Icom Australia	OBC, 32,33
Kenwood Electronics Aust.	IFC
Magpubs	31
Stewart Electronic Components ..	23
WIA NSW Division	21

TRADE ADS

FT Promotions	62
M R Delahunty	62
RJ & US Imports	62

HOW TO JOIN THE WIA

Fill out the following form and send to:

The Membership Secretary
Wireless Institute of Australia
PO Box 300
Caulfield South, Vic 3162

I wish to obtain further information about the WIA.

Mr, Mrs, Miss, Ms:

Call Sign (if applicable):

Address:

.....

State and Postcode:

SCOOP PURCHASE

Huge Savings on the

FT-767GX All Mode Transceiver!



HF, 2m, 6m and 70cm

The FT-767GX is the **only** transceiver that offers such a high level of performance on all the H.F. bands, as well as on the 6M, 2M, and 70cm bands! A vast array of both 'operator convenience' and 'DX improving' controls are provided by the 2 microprocessors, while attention to detail in the RF circuitry provides up to 104dB receiver dynamic range (in CW-narrow mode), and transmitter 3rd order I.M.D. of -35dB (at 100W output, 14MHz). Compare the following features with any other radio.

- All band coverage from 1.8 to 440MHz (100W max H.F., 10W max VHF/UHF)
- All modes - SSB, CW, FM, AM, FSK (on HF, VHF, and UHF)
- Upconverting triple conversion H.F. receiver covering 100kHz to 30MHz, with choice of RF amplification or direct mixer feed.
- Heavily optioned - inbuilt 600Hz CW filter, inbuilt 6kHz AM filter, RF speech processor, I.F. notch and I.F. shift filters, inbuilt heavy duty AC power supply, inbuilt automatic H.F. antenna tuner, high stability PLL (+/- 3ppm), data IN/OUT sockets for packet T.N.C. connection, all mode squelch.

- Revolutionary facilities include a digital wattmeter and auto calculating SWR meter (for HF, VHF, and UHF!), programmable tuning steps for each mode (from 10Hz to 99.9kHz!), and a front panel TX shift control which allows the operator to adjust the carrier point of the SSB transmit signal to suit his voice characteristics! A large digital display, and keyboard frequency entry are, of course, standard features.

- **2 Year Warranty**, the longest in the industry!
- **BONUS MH-1 hand mic**

See ARA reviews,
Vol. 12 issues 6
and 7.
D-2935

\$3495

SAVE \$500!

Limited stocks!

YAESU STOCKS NOT HELD AT ALL STORES. PLEASE CONTACT YOUR LOCAL STORE FOR STOCK AVAILABILITY. OR ORDER BY PHONE...



• NSW • Albury 21 6399 • Bankstown Square 707 4888 • Blacktown 671 7722 • Brookvale 905 0441 • Campbelltown 27 2199 • Chaswood Chase 411 1955 • Chulibra 642 8922 • Gore Hill 439 5311 • Gosford 25 0235 • Hornsby 477 6633
 • Hurstville 580 8422 • Kaitera 56 2092 • Liverpool 600 9886 • Maitland 33 7868 • Miranda 525 2722 • Newcastle 61 1896
 • North Ryde 878 3855 • Paramatta 685 2188 • Penryn 32 3400 • Railway Square 211 3777 • Sydney City 267 9111
 • Tarnworth 66 1711 • Wollongong 28 3800 • ACT • Fyshwick 80 4944 • VIC • Ballarat 31 5433 • Belmont 43 8522
 • Bendigo 43 0388 • Box Hill 890 0699 • Coburg 383 4455 • Dandenong 794 9377 • East Brighton 592 2366
 • Essendon 379 7444 • Footscray 689 2055 • Frankston 783 9144 • Geelong 232 7111 • Melbourne City 399 Elizabeth St
 328 8088 and 248 Bourke St 629 0396 • Richmond 428 1614 • Ringwood 879 5336 • Springvale 547 0522 • D.L.O.
 • Brisbane City 229 9377 • Buranda 391 6233 • Cairns 311 515 • Cherriside 359 8255 • Redbank 288 5599
 • Rockhampton 27 9644 • Southport 32 9033 • Toowoomba 38 4300 • Townsville 72 9722 • Underwood 341 0844 • BA
 • Adelaide City 223 4122 • Beverley 347 1900 • Elizabeth 255 6099 • Enfield 260 6088 • St. Marys 277 8977 • WA
 • Cannington 451 8666 • Fremantle 335 9733 • Raine Sq 481 3281 • Midland 250 1460 • Perth City 328 6944 • TA
 • Hobart 31 0800 • NT • Stuart Park 81 1977

ORDER BY PHONE OUTSIDE SYDNEY (008) 226610 Free Call Sydney Area 888 2105



DICK SMITH

ELECTRONICS

LISTEN TO THE WORLD

Greetings How Are You

祝賀你好嗎?

こんにちは！お元気ですか？

Привет Как Вы
поживаете

Herzliche GrüÙe Wie geht's

سلام كيف حالكم

Χαίρετε τι κάνετε

Saludos Como esta Usted

WITH ICOM RECEIVERS

There's a world full of information out there and more people are using ICOM's outstanding range of receivers to gain access. ICOM will expand your horizons to include new dimensions in transglobal communications both public and private. For local news, weather and emergency services transmissions or a wealth of international knowledge – listen to the world with ICOM receivers.



IC-R9000

The first receiver to give you all communications from 0.1 MHz to 2GHz. That's space age technology applied to literally space communications.

Every receiver and scanner on the market is in this amazing unit.

FEATURES:

- AFC, for FM Modes.
- USB, LSB, CW, FSK, FM, FM-narrow, AM.
- 1000 Programmable Memories.
- 10 groups of Scan ranges.
- Multiple tuning steps.
- Direct Digital synthesizer.
- Dual clocks and timer functions.
- Super high frequency stability.
- Spectrum Scope included in Multifunctional, CRT display.
- Computer Controllable (optional CT17).

IC-R71A

Pick up long wave, medium wave and short wave bands around the world. Set your favourite frequencies and sit back with your remote control (optional) to enjoy amateur to national radio broadcasts.

FEATURES:

- USB, LSB, AM, FM, CW, R-TTY (FM Mode is optional)
- 32 Memory Channels.
- Infrared remote control (optional).
- Programmed memory and mode scans.
- Adjustable If Notch Filter.
- Noise Blanker.
- 12V DC Kit for portable operation (optional).
- Voice Synthesizer (optional).



IC-R7000

Every UHF/VHF message is within ear-shot. Listen in on weather, fire emergency services, TV and many more local communications with total convenience. Program your interests, scan for news, its all neatly packaged.

FEATURES:

- USB, LSB, FM, FM-narrow, AM.
- 99 Memory channels.
- Infrared remote control (optional).
- Variable scan speed and delay.
- Noise blanker.
- 12V DC Kit for portable operation (optional).
- Voice Synthesizer (optional).
- 6 scanning functions.

Call ICOM on (008) 338 915 for details on ICOM products and your nearest stockist. Melbourne callers (03) 529 7582. ICOM Australia Pty. Ltd., 7 Duke Street, Windsor, 3181.

ICOM Australia's warranty is only applicable to products purchased from their authorised Australian Dealers

NOTE: Handles optional on all models.

ICOM

I.CAA 4614

AMATEUR RADIO

APRIL 1990

RRP \$3



**75TH
ANZAC
ANNIVERSARY**



THE WIA **RADIO AMATEUR'S JOURNAL**

KENWOOD



This is DX-clusive

Kenwood engineering pushes the outer edge of the high technology envelope of digital techniques, Digital Signal Processor, high-voltage power amplifiers, and advanced receiver design allows the all-new competition-class TS-950SD HF transceiver to deliver DX-clusive performance second to none.

The TS-950SD is designed for critical applications in SSB, CW, AM, FM, and FSK on all HF Amateur bands, including the new bands.

Features

- Dual Frequency Receive Function
- Built-in Digital Signal Processor
- Outstanding Receive and Transmit Performance
- 150W High Power and Heavy-Duty Cycle Design
- Built-In Automatic Antenna Tuner
- Superior Interference Reduction



KENWOOD ELECTRONICS AUSTRALIA PTY. LTD.
(INCORPORATED IN N.S.W.)
4E Woodcock Place, Lane Cove, N.S.W. 2066, Australia
Ph. (02) 428 4222, (02) 428 1455, Fax (02) 427 6869
Call now for further information and the name of your nearest authorised Kenwood dealer

Please phone, mail or fax for information

Name

Address

..... Postcode

Publication..... Issue

Model



Amateur Radio is published by the Wireless Institute of Australia, as its Official Journal on the last Friday of the previous month.

EXECUTIVE EDITOR
Bill Rice VK3ABP

MANAGING EDITOR
Graham Thornton VK3IY

NEWS EDITOR
Jim Linton VK3PC

SENIOR TECHNICAL EDITOR
Peter Gibson VK3AZL

TECHNICAL EDITORS
David Brownsey VK4AFA
Don Graham VK6HK
Evan Jarman VK3ANI
Peter O'Connor VK4KIP
Gil Sones VK3AUI
Phil Steen VK4APA
Roy Watkins VK6XV

DRAFTING
Vicki Griffin VK3BNK

MARKETING
Bruce Kendall VK3WL
Norm Eyles VK3ZEP

ADVERTISING

Ann McCurdy

All contributions and correspondence concerning the content of Amateur Radio should be forwarded to: -

The Editor
Amateur Radio
PO Box 300
Caulfield South
VIC 3162

Registered Office
3/105 Hawthorn Road
Caulfield North VIC 3161

Telephone: (03) 528 5962
(03) 523 8191

Fax: (03) 523 8191
(Non dedicated line)

Business hours: 0930 to 1500

Deadlines

	Editorial	Hamads
May	9/4/90	11/4/90
June	7/5/90	9/5/90
July	8/6/90	11/6/90

Delivery of AR: If this magazine is not received by the 15th of the month of issue, and you are a financial member of the WIA, please check with the Post Office before contacting the registered office of the WIA.

© Wireless Institute of Australia 1990

CONTENTS

Technical

Do You Suffer From Til?22
Des Greenham VK3CO

Measurements on Large Electrolytic Capacitors 18
Reg Fookes VK2AKY

Modifications to Dick Smith Explorer 430 MHz Transceiver 16
Allen Crewther VK3SM

The Kenwood TM-231A 2m FM Transceiver . . . Equipment Review 13
Ron Fisher VK3OM

The TNC-220+ Operating Factors and Modifications when used in a Digi-peater 20
John Drew VK5DJ

The Transistor as a Voltage Amplifier 8
Lloyd Butler VK5BR

General

The Last Wireless Anzac 32
Jim Linton VK3PC

Wireless in the 1914/18 War 34
The Late Arnold Holst VK3OH

Annual Reports 22-31

US Disposal Reference - Ian O'Toole VK2ZIO 36
Book Reviewed by Evan Jarman VK3ANI

Columns

Advertisers' Index 64	Intruder Watch 51
ALARA 44	Morseword No 37 55
AMSAT 42	Over To You - Members' Opinions 56
Club Corner 49	Pounding Brass 41
Divisional Notes	QSLs from the WIA Collection 50
Forward Bias, VK2 Notes 47	Repeater Link 46
VK3 Notes, 5/8 Wave 48	Silent Keys - Obituaries 53
VK6 Notes 49	Spotlight on WSLing 44
Editor's Comments 2	Stolen Equipment 46
FTAC Report 59	VHF/UHF An Expanding World 40
Hamads 62	WARC 92 Update 52
HF Predictions 59	WIA Directory 2, 3
How's DX 38	WIA News 3

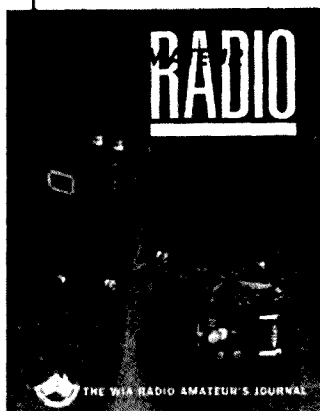

Cover

Two examples of Sterling Mark 1 spark transmitter, from the collection of Bill Babb VK3AQB, featured to mark the 75th anniversary of ANZAC day. Transmitters of this type were used, and maintained, by Bert Billings, who is the subject of Jim Linton's article "The Last Wireless ANZAC" on page 32. The Sterling Mark 1 transmitted artillery information from observing aircraft. It used an induction coil, condenser and spark gap supplied

Continued on page 33

Back in the Chair

The moment of truth has once again arrived, and a further editorial is called for! It was a pleasant respite last month to hand over the space to Jim Linton but, for the time being, the supply of guest editorialists seems to have dried up! I have just finished writing the Publications Committee Annual Report, which you will find elsewhere in this issue, so the type-writer is running hot! Time I traded it in on a word processor perhaps?

If you look back through past issues, you will see that at this time every year I have been

NEWS EDITOR'S COMMENT

BILL RICE VK3ABP EXECUTIVE EDITOR

preoccupied with preparations for the annual Marlay Point Overnight Sailing Race. This year is no exception, but it may well be the last in which we attempt to make our sow's ear of a slow catamaran into the silk purse of a racing thoroughbred! Oh, well, back to Lake Eyre in another month or two, if there's enough water; but, on that score, the hoped-for summer rains seem not to have been too generous.

Regarding lake trips, I was

asked recently how the special QSLs were coming along for those who worked us while on Lake Eyre South or Lake Torrens last October. The answer is, far too slowly! The printing of a small number (probably under 100) of special photographic cards is not without problems, but I do hope to have time to attend to it before long.

This issue does not carry an Awards column by Ken Gott VK3AJU. Ken had done an excellent job as Federal Awards

Manager for several years, but had suffered serious heart trouble in recent months. Even so, we were all shocked to hear of his sudden death early in March. *Le roi est mort, vive le roi!* Who will be the next Awards Manager? And Ken will be sorely missed at our monthly proof-reading sessions also, at which he invariably checked his own column very thoroughly, as well as proofing a good deal of other material.

On that sad note, it would seem that anything further would be inappropriate. Perhaps there will be more and more pleasant things to write about next month.

Phone Patch Warning

Articles on phone patch appearing in various magazines have featured Line Isolation Units (LIU) and given advice on the subject of interconnection between Telecom's switched network and radio equipment.

Intending constructors are advised that modifications to any authorised LIU are generally not permitted without them having been submitted to Austel for approval. Caution should be taken not to alter the LIU as approved, in any manner, including the use of alternative or substitute components, or different wiring or construction techniques.

The WIA LIU published in Amateur Radio magazine, September 1987, is authorised for use on the Telecom switched network. This article gives full details on how to build the WIA LIU and have it approved.

ar

**Support
the WIA in
order to protect
Amateur Radio
frequencies at
WARC 92**

Wireless Institute of Australia

The world's first and oldest National Radio Society - Founded 1910
Representing Australian Radio Amateurs - Member of the International Amateur Radio Union
Registered Executive Office of the WIA: 3/105 Hawthorn Road, Caulfield North, Vic, 3161
All mail to: **PO Box 300, Caulfield South, Vic, 3162** Telephone: (03) 528 5962 (03) 523 8191
Fax: (03) 523 8191 (Non-dedicated line)
Business Hours: 9.30 am to 3.00 pm on Weekdays

General Manager and Secretary: Bill Roper VK3ARZ

EXECUTIVE

President:	Peter Gamble	VK3YRP	VK1 Federal Councillor:	Kevin Olds	VK1OK
Vice Chairman:	Ron Henderson	VK1RH	VK2 Federal Councillor:	Peter Jeremy	VK2PJ
	George Brzostowski	VK1GB	VK3 Federal Councillor:	Peter Maclellan	VK3BWD
	Brenda Edmonds	VK3KT	VK4 Federal Councillor:	David Jerome	VK4YAN
	Bill Rice	VK3ABP	VK5 Federal Councillor:	Bill Wardrop	VK5AWM
Immediate Past President:	David Wardlaw	VK3ADW	VK6 Federal Councillor:	Neil Penfold	VK6NE
			VK7 Federal Councillor:	Joe Gelston	VK7JG

FEDERAL CO-ORDINATORS

Amsat:	Graham Ratcliff	VK5AGR	QSL Manager (VK9, VK0):	Neil Penfold	VK6NE
Contest Manager:	Frank Beech	VK7BC	FTAC:	John Martin	VK3ZJC
Education:	Brenda Edmonds	VK3KT	Tapes (Federal News):	Bill Roper	VK3ARZ
EMC:	Hans Ruckert	VK2AOU		Ron Fisher	VK3OM
Historian:	John Edmonds	VK3AFU	Videotape:	John Ingham	VK5KG
Intruder Watch:	Gordon Loveday	VK4KAL	WICEN:	Bill Wardrop	VK5AWM
Int'l Travel Host Exch:	Ash Nallawalla	VK3CIT			

RF Tag Ident System

On page 4 of the November 1989 issue of Amateur Radio magazine, it was reported the WIA had been asked by DoTC to comment on a proposal to permit RF identification devices to be used in Australia without being individually licensed.

The proposal covered VLF, HF, VHF/UHF and microwave bands. The proposed frequency band that was of immediate concern to the WIA was 3.5 to 3.95 MHz. As reported in November 1989, the proposed field strength limits in the 80 metre band would lead to noise powers well in excess of the CCIR man made noise predictions. This was definitely unacceptable to the Australian amateur service.

The WIA responded to DoTC and also commented that it must

WIA NEWS

BILL ROPER VK3ARZ GENERAL MANAGER & SECRETARY

gazette a standard for the RF ID system.

The response, a result of considerable work by Ron Henderson, VK1RH, achieved a good result. DoTC recently replied with a revised proposal for the HF devices that reduced the proposed field strengths from 15 microvolts per metre at 30 metres, to 1 microvolt per metre at 30 metres, explaining that this level now equated to the CCIR man made noise predictions for quiet urban areas.

The WIA has responded to this new proposal, indicating the proposed new field strength is now acceptable, but reiterating WIA concern that a DoTC

standard be gazetted before the RF tag system comes into service.

An article seen recently in an Australian computer newspaper described the application of RF ID devices to the stock taking of shipping containers in storage parks. On interrogation each container so fitted would "beep" back its' unique digital identification code for direct entry into the PC based container inventory system.

WIA and Standards Australia

A member of Executive recently heard several members

of a HF net decrying on air the apparent lack of involvement by the WIA in Standards' matters.

He knew of the considerable involvement in Standards work by the WIA, and at first could not understand why these amateurs were soundly criticising the WIA with such ill-informed and disparaging comments.

However, upon reasoned reflection, he came to the conclusion that this uninformed public comment was perhaps another instance where low profile members of the WIA, although working diligently for the betterment of the amateur service in Australia, are not having their efforts adequately publicised.

For the record, the WIA has been very actively involved on Standards Association of Aus-

WIA DIVISIONS

The WIA consists of seven autonomous State Divisions. Each member of the WIA is a member of a Division, usually their residential State or Territory, and each Division looks after amateur radio affairs within their State.

Division	Address	Officers	Weekly News Broadcasts	1990 Fees
VK1	ACT Division GPO Box 600 Canberra ACT 2601	President Ted Pearce Secretary Jan Burrell Treasurer Ken Ray	VK1AOP 3.570 MHz VK1BR 2m ch 6950 VK1KEN 70cm ch 8525 2000 hrs Sun	(F) \$65.00 (G) (S) \$52.00 (X) \$39.00
VK2	NSW Division 109 Wigram St Parramatta NSW (PO Box 1066 Parramatta) 2124 Phone (02) 689 2417 Fax (02) 633 1525	President Roger Henley Secretary Peter Balnaves Treasurer David Horsfall (Office hours Mon-Fri 1100 - 1400 Wed 1900 - 2100)	VK2ZIG 1.845 MHz AM, 3.595 SSB (1915 only), 7.146 AM (1045 only) VK2CZX 10.125 SSB (1045 only), 28.320 SSB, 52.120 SSB 52.525 FM 144.12 (SSB), 147.000 FM(R) 438.525 FM(R) VK2KFU 584.750 (ATV Sound) 1281.75FM (R) Relays also conducted via many repeaters throughout NSW.	(F) \$59.00 (G) (S) \$47.00 (X) \$33.00
VK3	Victorian Division 38 Taylor St Ashburton Vic 3147 Phone (03) 885 9261	President Jim Linton Secretary Barry Wilton Treasurer Rob Hailey Office hours 0900-1600 Tue & Thur	VK3PC 1.840 MHz AM, 3.615 SSB, 7.085 SSB, 147.250 FM(R) Mt Macedon, VK3XV 147.225 FM(R) Mt Baw Baw VK3XLZ 146.800 FM(R) Mildura, 438.075 FM(R) Mt St Leonard 1030 hrs on Sunday	(F) \$65.00 (G) (S) \$52.00 (X) \$39.00
VK4	Queensland Division GPO Box 638 Brisbane Qld 4001 Phone (07) 284 9075	President David Jones Secretary John Aarsse Treasurer Eric Fittock	VK4NLV 1.825, 3.605, 7.118, 14.342, 18.132, 21.175, 28.400, MHz VK4QA 52.525 regional 2m repeaters and 1296.100 0900 hrs Sunday VK4NEF Repeated on 3.605 & 147.150 MHz, 1930 Monday	(F) \$65.00 (G) (S) \$52.00 (X) \$39.00
VK5	South Australian Division 34 West Thebarton Rd Thebarton SA 5031 (GPO Box 1234 Adelaide SA 5001) Phone (08) 352 3428	President Don McDonald Secretary Hans van der Zalm Treasurer Bill Wardrop	VK5ADD 1820 kHz 3.550 MHz, 7.095, 14.175, 28.470, 53.100, 145.000, VK5KHZ 147.000 FM(R) Adelaide, 146.700 FM(R) Mid North, 146.900 FM(R) VK5AWM South East, ATV Ch 34 579.00 Adelaide, ATV 444.250 Mid North (NT)3.555, 146.500, 0900 hrs Sunday	(F) \$65.00 (G) (S) \$52.00 (X) \$39.00
VK6	West Australian Division PO Box 10 West Perth WA 6005 Phone (09) 474 2626	President Alyn Maschette Secretary Bruce Hedland Treasurer - Thomas	VK6KWN 146.700 FM(R) Perth, at 0930 hrs Sunday, relayed on 3.560, 7.075, 14.115, 14.175, 21.185, 28.345, 50.150, 438.525 MHz Country re- lays 3582, 147.350(R) Busselton 146.900(R) Mt William VK6OO (Bunbury)147.225(R) 147.250 (R) Mt Saddleback 146.725(R) Al- bany 146.825(R) Mt Barker Broadcast repeated on 3.560 at 1930 hrs.	(F) \$56.00 (G) (S) \$45.00 (X) \$30.00
VK7	Tasmanian Division PO Box 1010 Launceston TAS 7250	President Mike Wilson Secretary Bob Richards Treasurer Peter King	VK7ZWW 146.700 MHz FM (VK7RHT) at 0930 hrs Sunday relayed on 147.000 VK7NRR (VK7RAA), 146.750 (VK7RNW), 3.570, 7.090, 14.130, 52.100, VK7ZPK 144.100 (Hobart) Repeated Tues 3.590 at 1930 hrs	(F) \$63.00 (G) (S) \$50.00 (X) \$38.00
VK8	(Northern Territory) is part of the VK5 Division and relays broadcasts from VK5 as shown (received on 14 or 28 MHz).			Membership Grades Full (F) Pension (G) Needy (G) Student (S) Non receipt of AR (X)
Note: All times are local. All frequencies MHz.				Three year membership available to (F) (G) (X) grades at fee x 3 times

tralia committees for many years, and is a subscribing member of that association. The previous WIA Standards Co-ordinator, Alan Foxcroft, VK3AE, was, as the WIA representative, Chairman of SAA Committee TE/3, which was examining the issue of Standards on Immunity.

Representatives of the WIA have been attending meetings of SAA Subcommittee TE/14/4 - Siting of Radiocommunications Facilities for some time now. The WIA has a particular interest in this subcommittee because of repeater co-siting with commercial facilities.

Recently SAA Subcommittee TE/14/4 completed and circulated for postal vote a draft standard relating to the siting of satellite earth stations. After postal voting, the draft will be released for public comment.

Disposal News Items

During 1985 the then DOC became concerned about the increasing practice in several Divisional news broadcasts of advertising equipment for sale. Although DOC argued at the time that this was an improper, commercial use of amateur communications, nevertheless it eventually agreed to the practice continuing, on **authorised WIA news broadcasts only**, and under certain conditions.

However, for a variety of reasons, in several Divisions, the practice of including "disposals news items" in broadcasts has increased and altered to the extent that DoTC now feel it has become blatantly commercial and they must withdraw the facility.

A DoTC letter of 11th December 1989 to the WIA foreshadowed the withdrawal of the Disposal News Items facility and stated the DoTC reasoning. The WIA protested this action in the strongest possible terms, and the matter was placed on the agenda for the next Joint Meeting.

As a result of intense discussion and negotiation at this WIA/DoTC Joint Meeting held in

Canberra last Friday, 16th February 1990, DoTC agreed to withhold any action in this matter for a short time provided that:-

1. The WIA acted immediately to ensure that any disposals news items included in official WIA news broadcasts are strictly in accordance with the terms of the 1985 agreement; and

2. The WIA submits, within two months, a proposal for long term continuance of the facility, including the setting of clear parameters for news broadcasts by the WIA and others.

Work has already commenced on the proposal for long term continuance of the facility. However, it was very obvious to those representing the WIA at the 16th February 1990 Joint Meeting that the WIA has little chance of retaining this facility unless each Division of the WIA immediately "cleans up" its act and reverts strictly to the terms of the 1985 agreement.

The broad guidelines of that 1985 agreement are:

- disposal news items must only relate to amateur equipment offered for personal disposal by the amateur concerned (that is, advertisement by commercial organisations is not permitted);

- only one official WIA representative as contact officer for all disposal items is to be utilized;

- no pecuniary gain is to be received by the WIA in connection with any advertisement;

- disposal news items may include prices, at the discretion of the individual Divisions of the WIA; and

- this approval applies to authorised WIA news broadcasts only. It should not be taken as a general precedent that may be adopted for use by the whole amateur fraternity.

Stolen Equipment Register

The Stolen Equipment Register maintained by the WIA was published on pages 29, 30 and 31 of the February 1990 special data reference issue of Amateur Radio magazine. To minimise the possibility of typesetting errors, the database was provided to the printers of the magazine in ASCII on computer disk.

But the gremlins, and the proofreaders, still managed to confuse the issue.

The seventh column of data from the left hand side of the published Register, which is headed "Recovered" is incorrect, and should be crossed out. All the items listed in that published Register are still unrecovered!

The dates that were published in that column are, in fact, the dates that the stolen equipment notices were published in Amateur Radio magazine. They should not have been published in this edition of the Register.

Also, the heading of the next column, which relates to any unusual features of the stolen equipment, should simply have read "Comment".

This Register is very important, particularly if you are contemplating acquiring any second hand amateur equipment, so please ensure that you alter your copy immediately.

Anti-Social Repeater Behaviour

One of the many subjects discussed in the 16th February 1990 WIA/DoTC Joint Meeting was the problem of illegal transmissions on amateur repeaters, and the correct procedures to be followed when this occurs.

DoTC observed that, all too often, exasperated amateurs transgressed just as badly as these rather sick people in the manner in which they reacted to these illegal transmissions.

The correct procedure with

these illegal transmissions is to **totally ignore them!** Under no circumstances should you respond or comment in any way on a transmission that is not identified by a legal call sign.

The psychologists tell us that if you respond in any way to such anti-social behaviour, the perpetrator has achieved what his warped mind seeks, may well believe his actions have been justified, and will be encouraged to continue his abnormal behaviour. Ignore him totally, and eventually he will go away.

"Second Operators"

Judging by the questions that come into the Executive Office from time to time, there seems to be some confusion about the operation of amateur stations by non-licensed people.

"Can the unlicensed person operate the station equipment as long as the licensee is in the general vicinity, or should the licensee be with the equipment at all times?" "Is it legal for an unlicensed person to announce the call sign on a club station?" "What is a "second operator"?"

Basically, clause 17 on page 6 of DOC 71:-

"The licensee, if permitting an unqualified person to transmit by voice from the station, shall be physically present to supervise and control all operations."

and clause 25 on page 8 of DOC 71 :-

"Where a person who does not hold an appropriate certificate is transmitting from the station, in accordance with paragraph 17, the licensee shall signify his/her presence and control by announcing call signs in the prescribed manner."

say it all.

The unqualified person may manipulate the equipment and make contacts, **provided** the licensed operator is physically present to announce call signs, etc.. That is, he/she is close enough to see and hear everything that is happening, and be in a position to be able to assume immediate control of the station and the contact if warranted.

There is no such thing as a "second operator". That is just a bit of amateur "folk lore".

Revised Spectrum Plan

A revised radio frequency Spectrum Plan was published in the Commonwealth of Australia Government Notices Gazette On 28th February 1990, and radiocommunications users were invited to comment.

This draft Spectrum Plan sets out the broad allocations for all radio frequencies in Australia.

The Spectrum Plan in current use was produced in 1982, and DoTC maintains that it needed updating because of:

1. international radio frequency allocations made by ITU world conferences from 1983 to 1988 in regard to short wave broadcasting, maritime, aeronautical, land mobile and satellite services; and

2. developments in Australian communications to meet the needs of aviation, defence, business and private users that continue to evolve with the introduction of new services.

The WIA has received three copies of the 602 page draft Spectrum Plan and is currently examining it closely to see if there are any proposed changes that may impinge on the Amateur Service in any way.

Should it be necessary for the WIA to make a submission, we have until 31st May 1990 to put our views to DoTC.

Awards Manager Needed

As a result of the untimely death of Ken Gott, VK3AJU, the WIA has a vacancy for the position of Federal Awards Manager. If you are interested in certificate hunting and awards, and can spare a few hours a week, this could be an opportunity for you to help your fellow amateurs, and the WIA.

In the first instance, it is probably desirable that the Federal Awards Manager be located in Melbourne, and be able to call at the Executive Office in North Caulfield from

time to time. However, this is not essential, and the position could be filled by a person located anywhere in Australia.

If you are interested in helping out with Federal Awards, and you would like to know more about the vacant position, please contact me at the Executive Office, during the office business hours, by telephoning (03) 528 5962.

In the meantime, if you have applied for an award, please be patient until a new Federal Awards Manager has been appointed and settled into the job.

WIA 80 AR For Non Members

One of many initiatives that the WIA is offering during 1990 to celebrate its 80th Birthday, is a limited, once only offer of a four month subscription to Amateur Radio magazine for non-members of the WIA.

This four month subscription to AR will be for the May to August 1990 issues of the magazine and will cost just \$12.00. The subscription includes the cost of postal delivery of the magazine, and must be received in the Executive Office no later than 30th April 1990 in order to qualify for this offer.

If you have a friend, or know of someone who should be a member of the WIA, here is a chance to introduce them to our magazine and the WIA on a trial basis.

1990 Federal Convention

The 1990 Federal Convention of the WIA will be held at Normanby House in Melbourne on the weekend of 21st and 22nd April 1990. Normanby House is a facility, associated with Monash University, which provides conference and dining facilities together with residential accommodation.

Elsewhere in this issue of Amateur Radio magazine the WIA has published those annual reports that were received on or before 5th March 1990.

MAGPUBS

A Special Service of the Wireless Institute of Australia

1990 callbooks

Here they are! The latest editions 1990. World-famous Radio Amateur Callbooks, the most respected and complete listing of radio amateurs. Lists calls, license classes, address information. Loaded with special features such as call changes, prefixes of the world, standard time charts, world QSL bureaus and more.

The **North American Callbook** lists the calls, names and address information for over 500,000 licensed Radio Amateurs in all countries of North America from Canada to Panama, including Greenland, Bermuda and the Caribbean Islands plus Hawaii and US possessions.

The **International Callbook** lists over 500,000 licensed amateurs in countries outside North America. Its coverage includes South America, Europe, Africa, Asia, Australia and the Pacific area (exclusive of Hawaii and the US possessions). Order both Callbooks now and save at these special prices.

WIA288 1990 North American Callbook \$58.50 less 10% for WIA Members
WIA289 1990 International Callbook \$62.50 less 10% for WIA members
WIA 005 The two Callbook set \$109.95 less 10% to WIA members

When it comes to **AMATEUR RADIO QSL's...**



it's the **ONLY BOOK!**
 US or DX Listings

Practical Wire Antennas Effective HF Designs for the Radio Amateur

Practical Wire Antennas is a new book from the RSGB by John D Heys, G3BDQ published in 1989. This book has been written for the non-mathematician whose knowledge of this subject has never extended beyond the high school syllabus. It is aimed towards anyone who is capable of passing the Radio Amateurs examination, and the range of antennas described and illustrated are easy to set up and use successfully. There is additional data which will allow experiments and tests with versions that are cut for other bands or designed to fit into difficult locations. The simplified and, it is hoped, easily understood antenna theory is an attempt to allow the newest recruit to amateur radio to learn something about how simple wire radiators work at HF.

7" x 10" Stock # WIA296 \$28.00

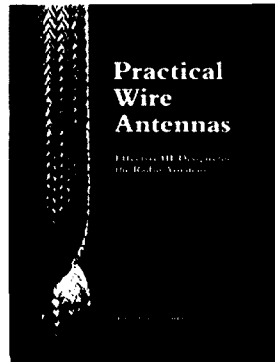

8th Computer Networking Conference 1989
 Colorado Springs, Colorado Oct 7 1989
 222 Pages 8" x 11" Stock # WIA295 \$24.00

SPACE ALMANAC

A galaxy of information! The new **Space Almanac** written by Anthony R. Curtis, K3RXX, editor of Space Today, is an extraordinary book that captures the breathtaking recent news from space, freshly compiled and written. It includes approximately 40 pages on Amateur Radio satellites. The **Space Almanac** is a major handbook featuring most anything you might want to know about Man's trip to the stars. Here's what you get:

- 500,000 words
- 960 pages
- Ten of thousands of facts
- Hundreds of stories, reports and descriptions
- Comprehensive Space history calendar
- Lists of future Space plans from around the world
- Scores of tables, charts, maps diagrams, histograms, drawings, photos, callenders, timetables
- Covers Space from Earth to the edge of the Universe in seven major sections: astronauts, space stations, shuttles, rockets, satellites, solar system and deep space

Stock Number **BX299** \$40.00

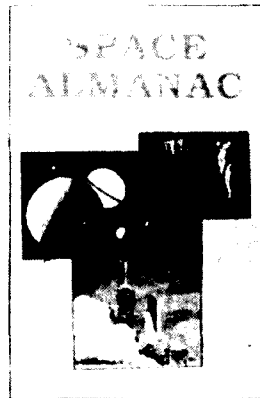

The above books, plus many more, are available from your **WIA Divisional Bookshop**. All items are less 10% discount for **WIA Members** and are plus postage and handling where applicable.

If not in stock at your Divisional Bookshop, your order will be taken and filled promptly. Not all publications are available from all Divisions.

Make sure you read them. All parties involved were advised of this closing date for publication, even though the legal closing date for these items to be included in the 1990 Federal Convention is 23rd March 1990.

At the closing date for copy, no agenda items had been received from the Divisions.

What is a "Federal Convention"?

"Federal Convention" is just another name, enshrined in the Articles of Association, for the Annual General Meeting of the Federal Body of the WIA.

Each Division of the WIA is a separate body, with its own constitution. The Federal Body of the WIA only has seven members, the seven Divisions. The nearly 8000 members of the WIA are not members of the Federal WIA, but are members of one or other of the various state Divisions.

The Federal Body consists of the Federal Council (a representative appointed from each of the seven Divisions, who are known as **Federal Councillors**), the general management group known as the **Executive** who are appointed by the seven Divisional representatives on Federal Council, and the **Executive Office** that carries out the day to day work of the Federal Body under the control of the Executive.

Currently, Executive consists of the seven Federal Councillors plus five others.

It could be accurately said that the Federal Body of the WIA solely exists as a vehicle created by the Divisions to bring about some unification of the seven Divisions of the WIA, by determining policy in those areas that affect the whole of Australia and not just one state, by liaising on behalf of the Divisions as one voice with Government, and by providing those member services, such as publishing of Amateur Radio magazine and membership fee processing, which can be most cost efficiently carried out on behalf of the Divisions by a central body.

Under the present structure of the WIA, the Divisional appointees to the Federal Body meet three times a year in

addition to the Federal Convention/Annual General Meeting.

From this rather basic explanation of the structure of the WIA I trust you now realise that, as a member of the WIA, you and your views are to be represented at this 1990 Federal Convention. And that the person acting on your behalf is your Divisional Federal Councillor.

Do you know who your Federal Councillor is?

If not, have a look at the WIA Directory on page 3 of this magazine.

Do you feel strongly about the WIA and the future of amateur radio as a hobby? Do you want your views represented at the 1990 Annual General Meeting of the WIA?

Then make sure you contact your Federal Councillor and let him know your point of view.

Video Tape Library

Complete details of the WIA Videotape Library were included on pages 31 to 33 of the February 1990 Special Data Reference Issue of Amateur Radio magazine. Everything, that is, except the address at which to contact the Federal Videotape Co-ordinator.

John Ingham, VK5KG, is the WIA Federal Videotape Co-ordinator, and can be contacted by writing to 37 Second Avenue, Sefton Park, South Australia, 5083.

Repeater Cross Linking

Members will remember the uproar late last year relating to the cross linking of repeaters. Following consideration of the ruling from DoTC of 10th October 1989, and submissions from a number of amateurs, repeater groups, and WIA Divisions, it quickly became clear that there are several difficulties with the Department's response on the use of tone access for repeater linking.

Here, in some detail, is the proposal put to DoTC by the WIA at the 16th February 1990

WIA/DoTC Joint Meeting.

The aim of this paper was to present the WIA's position on access control for amateur radio repeater links, and to recommend a course of action.

Traditionally, amateurs have been able to determine their own standards and the marketplace has often dictated which ones become popular and which ones fall by the wayside. Further, the trend in the hobby of amateur radio is towards deregulation.

Nevertheless, the WIA acknowledges that within the broad DoTC regulatory constraints there is the need for agreed amateur operating standards. The WIA, as the representative national body carries out consultation to develop these guideline standards.

In the case of amateur radio repeaters, there is a need for a number of access and control mechanisms. Some, which have been in service for many years, include:

- time out timers,
- control of repeater functions, including remote shut-down,
- extension of time out and initiation of specific linking for WIA broadcasts and WICEN,
- miscellaneous repeater housekeeping, including change of antennae, power sources etc.

Discussion has already taken place on the possibilities of using sub-audible tones to minimise the effects of co-site interference.

These controls have been generally implemented by the use of audio frequency tones superimposed on the transmitted signal. Several techniques are available and employed internationally by the amateur community. These include:

- audio tone burst,
- continuous tone carrier sub-audible squelch (CTCSS)
- dual tone multi frequency (DTMF)

Each of these existing techniques has particular merits and associated disadvantages, depending on the purpose for which they are employed.

The WIA has noted the DoTC concern over the possibility of linked repeaters allowing an amateur station's transmissions to be re-radiated on frequencies for which that station is not licensed. The WIA fully supports these concerns and accordingly has spent considerable time analysing the issues.

The WIA agrees with the DoTC viewpoint that an amateur operator should not be inadvertently re-transmitted beyond the terms of his licence. This leads to the WIA position, which we believe is supported by the Department, that an amateur operator must take a conscious and deliberate action to invoke a facility that would not be permissible for some grades of licensee.

Further, the WIA supports the DoTC position that control means must be open and achievable by all suitably licensed amateurs. To this end the WIA believes that appropriate published standards are adequate for our needs and that these should be promulgated as appropriate in amateur literature.

The WIA believes that linking control is only necessary where the potential exists for an amateur to breach the terms of his/her licence. Consequently, the WIA would see access controls only being implemented on those repeaters which have this potential. The WIA observes that there will be many situations where out-of-licence transmissions cannot occur and access control is not necessary.

Potential exists through access control of repeater links for selective routing and potentially sophisticated networkings. Further, extended repeater control and housekeeping functions also fall within this category. We believe that these controls remain the prerogative of the repeater licensee and provided that they work within the regulatory requirements, the techniques used are of no great concern to the regulatory authority.

DoTC is aware of the experimental nature of the Amateur Radio Service. In keeping with that tradition, and observing a

wide variety of equipment exists capable of being utilised for access control, the WIA would not support mandatory adoption of any particular technique. Rather, repeater operators and users should be free to choose from available techniques the means which best meets their requirements while complying with all of the regulatory constraints.

Any proposals adopted and implemented now should not lock the amateur service into techniques that become obsolete in just a few short years. Traditionally, amateur equipment has a cycle life of five and fifteen years between major updates.

The WIA recommends that:

1. Repeater link access controls only be required when access to that link may lead to a breach of regulations by the operator, due to frequency limitations of the class of license held.
2. Such links be controlled by the use of a tone access signal on the originating transmission.
3. The mode and frequency of such tone access signal conform to current guidelines established by the WIA.
4. These guidelines, see below, be reviewed from time to time to take into account advances in technology.
5. Current practices and DoTC co-ordination requirements continue, such that tone access signals conform to current WIA guidelines and be approved by the appropriate Technical Advisory Committee prior to licensing by the DoTC.

Tone Access Control Guidelines

1. Repeater link control will only be necessary where activation of a linked repeater may lead to a breach of licence conditions by a user (eg AOLCP using a 2m repeater linked to 10m).
2. Where control of a repeater link is required, the method of access to the link is by the application of audio frequency tone(s).
3. CTCSS is the preferred means of access control.
4. DTMF is the preferred means for repeater control functions, such as repeater house keeping and technical management and is not recom-

mended for access control of repeater links.

5. The sense of the access control is such that application of tone(s) is necessary to activate any link.
6. Three modes of tone access are currently available:
 - i) Tone Burst
 - ii) CTCSS
 - iii) DTMF
7. Preferred frequencies for these modes are:
 - i) Tone Burst: 1750Hz - established European tone.
 - ii) CTCSS: EIA standard tones (Hz)

67.0	94.8	141.3
69.3	100.0	146.2
71.9	103.5	151.4
74.4	107.2	156.7
77.0	110.9	162.2
79.7	114.8	167.9
82.5	118.8	173.8
85.4	123.0	179.9
88.5	131.8	186.2
91.5	136.5	192.8
 - iii) DTMF: Bell standard

	High	Tone	(Hz)
	1209	1336	1477
Low	697	1	2
Tone	770	4	5
(Hz)	852	7	8
	941	*	0
			#

DoTC is presently considering this submission from the WIA, and a response is expected shortly. ar

Jindalee Radar For QLD

Australia's northern defence will get a boost with the siting of a Jindalee over-the-horizon radar station in central Queensland.

A station requiring two sites, one for the transmitter and the other for the receiver, will be in the Longreach area, 1000 km north west of Brisbane. It will be part of a network of three stations to provide for the first time the detection of all ship and aircraft movements in Australia's northern approaches.

The Australian-developed Jindalee radar uses HF radio signals refracted by the ionosphere to detect moving objects beyond the horizon. ar

A Call to all Holders of a Novice Licence

Now you have joined the ranks of amateur radio, why not extend your activities?

The Wireless Institute of Australia (N.S.W. Division) conducts a Bridging Correspondence Course for the AOCP and LAOCP Examinations.

Throughout the Course, your papers are checked and commented upon to lead you to a successful conclusion.

For further details write to:

The Course Supervisor
WIA
PO Box 1066
Parramatta NSW 2124
(109 Wigram Street, Parramatta)
Phone: (02) 689 2417

**11am to 2pm Monday to Friday
7 to 9pm Wednesday**

**WIA 80th Anniversary
Edition of the**

1990 Call Book

Be Quick
buy your copy
now from your
WIA Divisional
Bookshop

Special Price to WIA
members of

\$8.50

Plus Postage and
Handling

\$1.50 approx.
depending on Division

THE TRANSISTOR AS A VOLTAGE AMPLIFIER

LLOYD BUTLER VK5BR
18 OTTAWA AVE PANORAMA 5041

Introduction

With today's state of the art, the operational amplifier package is well established as a means of obtaining voltage amplification and knowledge of how to design discrete transistor amplifiers for this purpose might seem unnecessary. Notwithstanding this, discrete transistor circuits are still needed at frequencies above the range of the operational amplifier and for certain special applications such as low noise amplification where a discrete transistor can often be made to perform better than the amplifier package.

In the paragraphs which follow, we will discuss factors which determine the gain of the transistor voltage amplifier and we will discuss an established method of determining the component values in the transistor circuit. The discussion will concentrate on the usual resistance capacity (RC) method of coupling and include such effects as loading by the following stage. The discussion essentially concerns the bipolar transistor but it will also extend to a problem in RC coupling the field effect transistor.

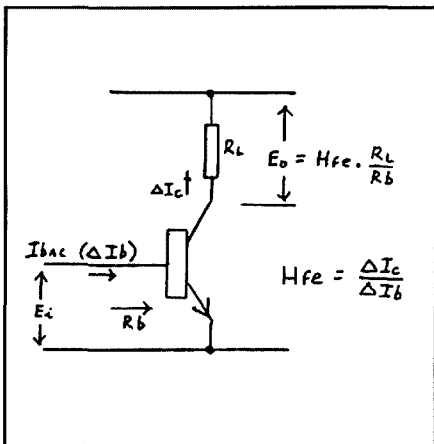

Figure 1. Transistor as voltage amplifier

Current Transfer Ratio Hfe And Stage Gain

If you were to select a bipolar transistor for an amplifier to obtain maximum voltage gain, you might be tempted to select one with the highest current transfer ratio Hfe. In fact, this would be of no avail as voltage gain is essentially de-

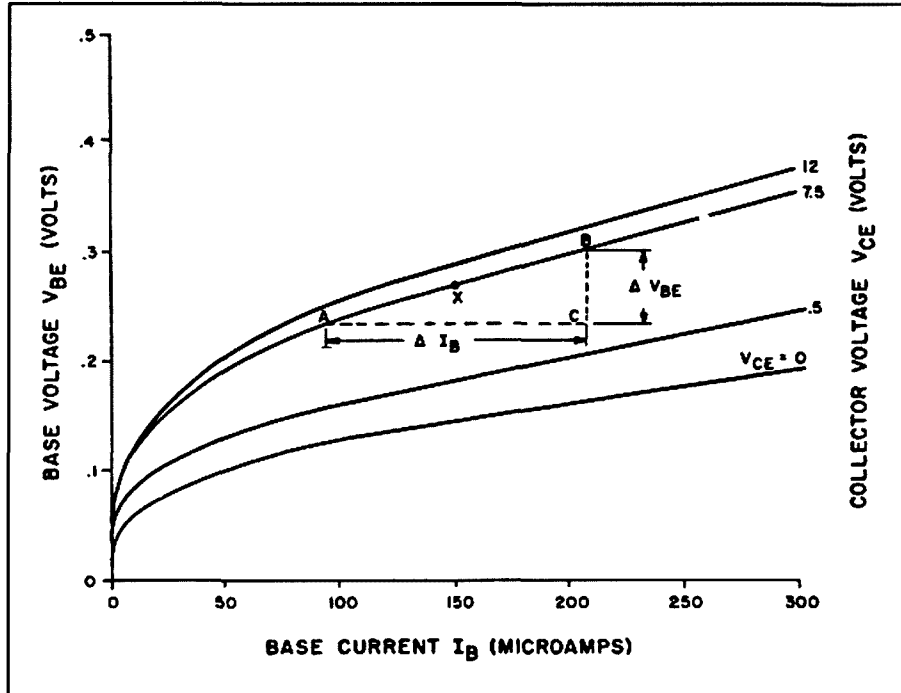

Figure 2. Base voltage V_{BE} as a function of base current I_B for a germanium transistor

pendent on two factors, namely the emitter current (I_e) and the output load resistance (R_L), but not H_{fe} . On the other hand, a high H_{fe} could increase the voltage gain of the previous stage. If these statements have astounded you, then just read on.

Figure 1 is a representation of the transistor operating as a voltage amplifier. The AC output voltage (E_o) is equal to the AC current at the collector multiplied by the load resistance (R_L) and the AC current at the collector is equal to the AC current at the base (I_{bac}) multiplied by H_{fe} , ie:

$$E_o = I_{bac} \cdot H_{fe} \cdot R_L \dots\dots\dots (1)$$

The AC current at the base is equal to the AC input voltage (E_i) divided by the transistor input resistance (R_b), ie:

$$I_{bac} = E_i / R_b \dots\dots\dots (2)$$

Substituting (2) in (1) we get:

$$E_o = (E_i \cdot H_{fe} \cdot R_L) / R_b$$

$$\& \text{ voltage gain } A_v = E_o / E_i = (H_{fe} \cdot R_L) / R_b \dots\dots\dots (3)$$

Based on expression (3), voltage gain is clearly dependent on H_{fe} , but let us now examine R_b . According to theoretical text books, the input resistance (R_e)

of a common base connected transistor is derived as follows:

$$R_e = (K \cdot T) / Q \cdot I_e$$

where K = Boltzmann's Constant

T = Absolute Temperature

Q = Charge of an Electron

I_e = Emitter Current in mA

At room temperature this works out to R_e equal to about 25/ I_e .

For common emitter connection, input is to the base and input resistance is R_b . Base current equals collector current (or emitter current) divided by H_{fe} and hence, with near constant voltage across the base/emitter forward biased junction, input resistance (R_b) is multiplied by H_{fe} . Thus we get:

$$R_b = (25 \cdot H_{fe}) / I_e \dots\dots\dots (4)$$

To illustrate the variation of AC base resistance with variation in base current ($I_b = I_e / H_{fe}$), figure 2 is shown. Observe how the slope of the curves (and hence the value of R_b) decreases as the base current is increased. R_b is given by the ratio of change of voltage base/emitter (V_{be}) to change in base current (I_b).

If we now substitute expression (4) for R_b in expression (3), we get a further

Radio Amateurs: Have you checked out EA lately?

No doubt most radio amateurs are aware that *Electronics Australia* is by far this country's largest-selling electronics magazine, as well as being its oldest (we began way back in 1922, as *Wireless Weekly*). But have you looked inside the magazine lately?

Remember Jim Rowe, VK2ZLO? Jim used to be Technical Editor, and then Editor – back in the late 1960's and 1970's. You may recall some of the amateur radio and test equipment projects he developed, which proved to be extremely popular. Well, Jim is back at the helm of the magazine, and has been busy giving it a new lease of life.

You'll now find lots of new 'departments' in the magazine, including Solid State Update (with news of new semiconductor devices), Silicon Valley Update (news from the USA) and What's New in Entertainment Electronics. Plus all of your old favourites like Forum, The Serviceman, Circuit and Design Ideas and so on. And of course plenty of 'meaty' technical articles and construction projects.

What about *amateur radio* projects? Well, as you can see there are more of these than before – but we're very interested in publishing more. So if YOU have developed an exciting amateur radio project, please contact Jim Rowe by writing to him at EA, 180 Bourke Road, Alexandria 2015. Or phone him on (02) 693 6620, to discuss the possibility of publishing it as a contributed article. As well as earning a fee, you'll also be helping to boost interest in amateur radio!

Take a look at the new, rejuvenated *Electronics Australia* – on sale at your newsagent at the beginning of every month. Or subscribe now, by phoning (02) 693 9517 or 693 9515.

Electronics Australia

Australia's Top Selling Electronics Magazine

INCLUDED IN OUR APRIL ISSUE:

WAS AMBROSE FLEMING THE INVENTOR OF VALVES?

John Ambrose Fleming may, or may not have been the true inventor of the thermionic diode valve. But as Neville Williams explains, he contributed a lot – including design of the first transAtlantic wireless transmitter.

SURROUND SOUND IN THE MOVIES

Surround sound is back in vogue – again. Did you know that it began in the movies, and back in the 1920's? Charles Slater explains its evolution over the years.

REPAIRING VALVES

It's often possible to make repairs to valves, to keep that old valve radio going. Peter Lankshear explains how it's done...

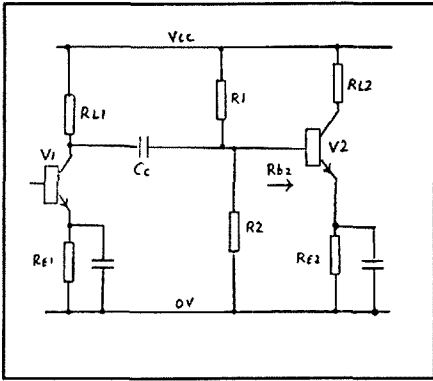

Figure 3. Effective load resistance of stage V1 is the parallel result of RL, R1, R2 and the base resistance of V2 (Rb2).

expression for voltage gain:

$$\text{Voltage gain } A_v = (H_{fe} \cdot R_L \cdot I_e) / (25 \cdot H_{fe})$$

Hfe is cancelled out so that:

$$\text{Voltage Gain } A_v = (R_L \cdot I_e) / 25 \dots\dots\dots (5)$$

Observe that calculation of voltage gain now only involves the values of RL and Ie and not Hfe, so that our first point has been proved.

The Previous Stage

As a further exercise, let us examine the amplifier stage shown as V2 in figure 3. Referring to previous paragraphs, we have seen that its voltage gain is independent of Hfe but we have also seen in expression (4) that Rb is directly related to Hfe and a low Hfe means a low value of Rb.

We now examine the gain of the previous stage V1. The collector load resistance of this stage is the parallel result of collector resistor RL1, the V2 stage base bias resistors R1-R2 and the input resistance Rb of V2. Rb is normally the lowest value making it the main factor in setting the load resistance of V1. Referring back to expression (5), we see that, for a given value of Ie in V1, the voltage gain of V1 is controlled by its load resistance which is essentially the value of Rb in V2. A high value of Hfe in V2 gives a high value of Rb in V2 and this is reflected as high gain in V1. This confirms the second point which was made earlier.

Circuit Design

Design of a transistor voltage amplifier stage, as shown in figure 4, is really quite simple. Resistors R1 and R2 form a voltage divider which sets the base reference voltage. Resistor Re provides DC feedback to stabilise the emitter current and hence the operating point of the transistor. Resistor RL is the collector load resistor.

The first thing is to decide on what emitter current should be used. A current of around 1 mA is usually quite satisfactory for audio amplification un-

less there is some special reason for selecting otherwise. If a low noise level stage is required, such as that following a low level high impedance microphone, a lower current might be desirable. On this subject, the reader is referred to an article by the writer entitled "Amplifier Noise" published in Amateur Radio, November 1985. On the other hand, a higher current is often required at higher frequencies and this will be discussed later.

The next decision is to select an emitter voltage (Ve). The higher this voltage, the greater is the emitter current stability in the presence of temperature variation and for variation in the value of Hfe. A value of Ve around 1 to 2 volts is normally satisfactory. If the supply voltage (Vcc) is around 12 volts, one might select Ve = 2V. For Vcc = 6V, a value of Ve = 1V might be as high as one can go. Calculate resistor Re as follows:

$$R_e = V_e / I_e$$

Now work out the voltage at the base. For a germanium transistor, this is close to 0.2 V higher than that at the emitter. For a silicon transistor, this is close to 0.7 volt higher than that at the emitter. Of course, this differential is simply the forward voltage drop across the base to emitter diode junction.

The base current is equal to the collector current (or emitter current) divided by Hfe. (Note that collector current is nearly equal to emitter current.) The idea is then to bleed a current through the R1-R2 divider about 10 times the base current so that the base voltage is held constant, almost independent of the base current. We calculate the resistance values as follows:

$$\begin{aligned} R_1 &= (V_{cc} - V_b) / (10 \cdot I_b) \\ &= H_{fe} \cdot (V_{cc} - V_b) / (10 \cdot I_e) \\ R_2 &= V_b / (9 \cdot I_b) \\ &= (H_{fe} \cdot V_b) / (9 \cdot I_e) \end{aligned}$$

The reason why R2 calculation is divided by 9.Ib and not 10.Ib is that one

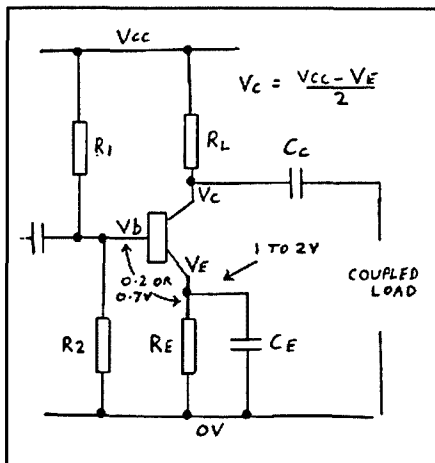

Figure 4. Stabilised amplifier stage.

tenth of the current is passed into the base itself.

All we have to do now is to work out a value for RL so that the operating point is set correctly. As far as the signal is concerned, the available supply voltage is (Vcc - Ve) and to make use of equal voltage swing either side of the operating point, the collector voltage Vc is set half way between Vcc and Ve. For RL, we calculate as follows:

$$R_L = (V_{cc} - V_e) / (2 \cdot I_e)$$

Operation is illustrated in figure 5 by the load line A for RL. Observe that the operating point is set at half the available supply volts.

Effect Of Coupled Load

As discussed previously, one effect of a coupled load, such as a following transistor, is to lower the effective load resistance and lower the gain of the stage. Another effect is to lower the maximum signal voltage swing which can be achieved. This is demonstrated in figure 5 by load line B for the total parallel load.

One way to increase the maximum signal voltage swing is to lower the value of RL. This of course means a circuit design around a higher value of collector current.

Another way to increase the maximum signal voltage swing is to reduce the signal loading by coupling via an emitter follower stage as shown in figure 6. The follower is characterised by high input resistance which reduces the signal loading. It also provides a low resistance signal source to drive an output circuit or another stage.

The Field Effect Transistor And RC Coupling

From our previous discussion, the operational collector voltage is correctly set by selecting the collector load resistance RL for a voltage loss equal to half the available supply voltage. In the circuit of figure 4, the collector current is precisely set by the values of R1, R2 and Re and virtually unaffected by any spread in the bipolar transistor characteristics. With the field effect transistor (FET), the use of RC coupling can present quite a problem when a load resistance is placed in the drain circuit. Drain current is set by the bias voltage applied to the gate of the FET and unfortunately the drain current versus gate voltage characteristic of the FET varies from sample to sample of the same transistor type. If a resistance loaded drain is used, gate bias must be set to suit the individual transistor.

At radio frequencies, the drain resistor can be avoided by coupling via an RF choke, transformer primary or tuned circuit in series with the drain.

The Capacitors

To complete our discussion on the design of the basic circuit (figure 4) we still have to select the capacitors. Resistor R_e is used to provide DC feedback for stabilisation of the operating point but this must be by-passed by capacitor C_e to prevent negative feedback at signal frequency. A good rule is to select the value of C_e such that its reactance is not greater than one tenth of the value of R_e at the lowest frequency of operation.

Capacitor C_c provides DC isolation between the collector circuit and the following load circuit or following stage. Its capacitance value is selected such that its reactance is not greater than the reflected load resistance (perhaps the base resistance of the following stage), at the lowest frequency of operation. If equal to that resistance, it will give 3 dB loss at that frequency to form the low frequency pole.

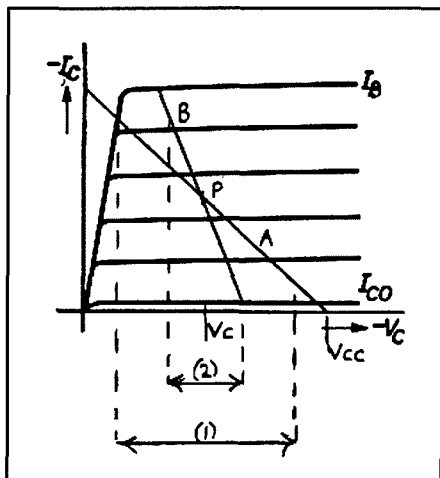

Figure 5. Load lines for amplifier stage. A = Load line for collector resistor (R_L) only — (Maximum signal voltage swing (1) approaches half supply voltage.) B = Load line with coupled load — (Maximum signal voltage swing (2) is reduced.)

High Frequency Operation

It was stated earlier that a collector (and emitter) current of around 1 mA was generally suitable for audio frequency voltage amplifiers. At higher frequencies, collector current has to be increased. The reason for this is that the value of load resistance R_L must be lowered to make it low relative to the shunt capacitive reactance, inherent at the transistor

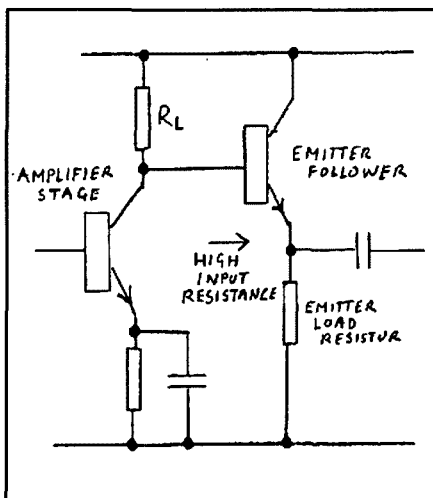

Figure 6. Emitter follower reduces signal loading.

output and at the following stage input. As frequency is increased, the shunt reactance becomes lower and hence R_L must also be made lower. To maintain collector voltage at half the available supply voltage, collector current must be increased with proportional decrease in the values of R_1 , R_2 and R_e . Referring back to expression (5), gain is lost by the lower value of R_L but this is compensated by the increase in I_e .

In the previous paragraph, we have been specifically discussing RC coupled stages with an implication of wideband operation. At radio frequencies, we might choose to tune the amplifier and incorporate the shunt capacitance as part of the tuned circuit so that a high load impedance is formed to provide higher gain. As our subject is essentially about RC coupled stages, we will not dwell further on that particular application.

The Emitter Follower

The emitter follower is a very useful special form of voltage amplifier. It has high input resistance, low output resistance and a gain just less than one. Its input resistance is approximately equal to the load resistance at its output circuit multiplied by H_{fe} . If base stabilising resistors are used as shown by R_1 and R_2 in figure 7, these must also be considered as part of the input resistance in parallel and in fact when used, are usually the main input resistance determining factor.

Output source resistance is approximately equal to the resistance of the source driving the follower stage divided by H_{fe} . In calculating the output source resistance, resistors R_1 and R_2 must also be taken into account as being in parallel with the input source. If the follower stage is RC coupled from a previous col-

AR 20 YEAR INDEX

IBM format 5 1/4 inch floppy disk dBase 111

Plus	
.DBF file	\$10.00
ASCII	\$10.00
Compiled	
.EXE file	\$10.00
36 page printout	\$5.00

Prices include disk (where applicable) and postage.

AR 20 Year Index
PO Box 300
Caulfield South
Vic 3162

Back issues of AR available to WIA members

Jan 1969 to Dec 1987
\$2.50 each

Jan 1988 to current issue
\$4.00 each

(Some issues out of stock)

Prices include postage

AR BACK ISSUES
PO Box 300 Caulfield South
Vic 3162

Continued from page 11

The Transistor As A Voltage Amplifier

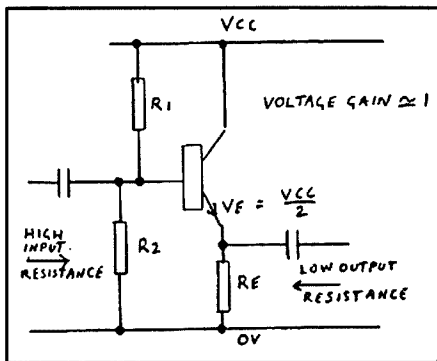

Figure 7. Emitter follower

In an emitter follower circuit, the collector load resistor can be taken to be the source resistance as the inherent output resistance of a common emitter stage is very high by comparison to the value of that resistor.

Calculation of R1 and R2 is the same as described previously for the common emitter amplifier except that base voltage Vb is made equal to half the supply voltage (Vcc) plus the base to emitter diode voltage (0.2V for germanium and 0.7V for silicon). Emitter voltage is then equal to half Vcc to enable equal signal voltage swing either side of the operating point and $Re = Vcc/2Ie$.

The problem of the coupled load limiting the signal voltage swing still applies to the emitter follower stage and the choice of emitter current (Ie) depends on just what value of coupled load resistance must be driven and how much signal voltage is required across that resistance. For low resistance coupled loads, quite a high emitter current is often required with low values of Re, R1 and R2 and consequently a high power dissipation transistor.

Defining A Fixed Stage Gain

Negative feedback can be used on any amplifier to achieve a defined stage gain. Providing the gain with feedback is a low value compared with that without feed-

back, the gain is set purely by the components which determine the proportion of feedback. This principle is well established in the application of operational amplifiers. In the case of the single transistor stage, the feedback can be achieved by removing the emitter bypass capacitor or dividing the emitter resistor into two separate components, only one of which is bypassed as shown in figure 8.

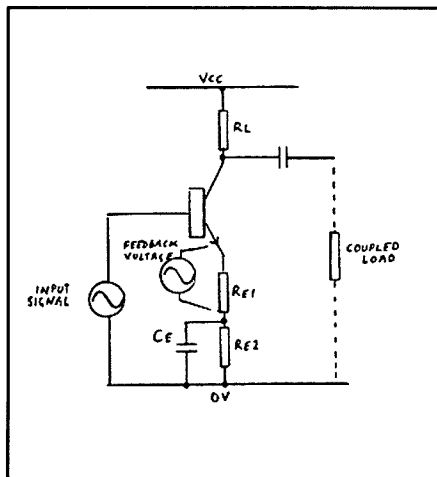

Figure 8. Amplifier with defined stage gain.

Providing the resultant gain is small compared to that without feedback, voltage gain is equal to the ratio $(Re1 + RLt)/Re1$. The value RLt is the effective load and the parallel result of RL and the coupled reflected load. To determine the values of Re1 and Re2, calculate as follows:

$$Re1 = RLt/(Af - 1)$$

where Af is the desired gain

$$Re2 = Re - Re1$$

where Re is the value calculated to set the emitter current to the desired figure.

Stable voltage gains, defined by Re and RLt are achievable up to a value of around 10. Above that, transistor gain within the amplifier loop is insufficient to maintain dependence only on the feedback factor and the gain with feedback is then also a function of the amplifier gain without feedback, ie

$$Af = A/(1 + B.A)$$

Where A = gain without feedback
and B = the feedback factor or proportion of feedback.

Voltage & Power Amplification

The definitions of voltage amplification and power amplification go back to the days of valve amplifiers. The basis of these definitions is that in class A operation, the valve does not consume power at its control grid and the requirement is to supply signal voltage rather than signal power to its grid. The last stage is a power amplifier because it must supply power to the loudspeaker or other load. All the previous driver stages are voltage amplifiers, their function being to raise the signal level sufficiently to drive the power amplifier. Field effect transistor amplifiers, with their high input resistance, can be considered in the same light but the writer could well be taken to task in defining the bipolar transistor stage as a voltage amplifier when it is required to drive another bipolar transistor stage. The transistor is driven by signal current and hence the following stage consumes power. If one must be pedantic, the previous stage could well be considered as a power amplifier. Notwithstanding this, the circuit analysis discussed has been carried out on the basis of stage voltage gain and as such, the coupled stages have been considered as voltage amplifiers. This analysis concept then makes it compatible with analysis for the FET amplifier, the valve amplifier and operational amplifier circuitry.

Summary

A short discussion has been presented on the transistor voltage amplifier with particular reference to resistance capacity coupling. Included in the discussion is the calculation of stage gain and a method of deriving component values in the amplifier circuit. Also included are the effects of a coupled load on gain and maximum signal voltage swing and an introduction to the emitter follower and stabilised gain amplifiers. ar

T Plug Connection Convention

In answer to the question posed by Tim Mills VK2ZTM on P54 of AR Feb 90. Rotate plug or socket until pins or receptacles resemble an upper-case letter "T". The horizontal connector resembles a minus sign, and is indeed the negative terminal.

CONTRIBUTED BY LAY CRANCH VK3CF
ar

Prevent pirates - make sure you sell your transmitter to a licensed amateur.

EQUIPMENT REVIEW - THE KENWOOD TM-231A 2m FM TRANSCEIVER

RON FISHER VK3OM

"GAALANUNGAH" 24 SUGARLOAF RD BEACONSFIELD UPPER

It's been quite a while since we reviewed a full-featured two-metre mobile transceiver, and it seems that there is always something of a shock when they arrive. The first impression is that they just cannot put out the amount of power that they do for the amount of space they take up. The 50-Watt output transceivers are now smaller than the 25-Watt rigs of only a few years ago.

Having said that, let's look more closely at the transceiver in question. The TM231A is an FM only transceiver, which covers the two-metre band from 144 to 148 MHz. Maximum power output is rated at 50 Watts, with selectable lower power of either 10 or 5 Watts. The overall size is 140mm wide, 40mm high and 160mm deep. Overall weight is just 1.2kg. The transceiver is supplied with a mobile mounting bracket, a DC power cable a little over two metres in length, and fitted with a two-pin automotive connector and three fuses. Yes, you did read that correctly, there are two in the positive lead and one in the negative lead. The supplied microphone has, in addition to the now usual up/down buttons, four buttons on the front to select the call channel, VFO operation, memory operation and a programmable function key which I cover later in the review. There is also the usual PTT button on the side and a lock switch on the rear. All in all, the microphone is a rather unusual looking device; however, it does perform its primary function very well.

The rather small front panel contains a total of 14 controls, many of which have two selectable functions, but most of the area is taken up with a very clear LCD multi-purpose display. This shows fre-

quency, memory channel, offset, relative power output, receive "S" meter, on-air indicator, control lock, reverse operation, priority alert function, low or medium power selection, plus several other status indications. Most of these are of reasonable size for fixed station operation, but you might have trouble picking them up while mobile. The display is well illuminated in a cream colour, as are the three control knobs and the three buttons above the VFO/memory selector knob. The six small buttons under the main display have a tiny illuminated dot on them to give you a better chance of hitting them at night. The whole effect is quite attractive.

As the photos show, most of the overall size is taken up with the heat sink, and, as we will later see, this is all needed. In order to provide more heat sink area, the SO-239 RF output connector is on a flying lead about 20cm long. Apart from the DC power cord, the only other connector on the back panel is for an external speaker. The built-in speaker is mounted inside the top cover of the transceiver, which might be either good or bad depending on how you wish to mount the rig in the car. Perhaps it might have been better if Kenwood had stuck to the earlier idea of not putting a speaker into the rig, but providing an external unit instead. I would suggest that in most mobile situations an external speaker would be very worthwhile.

The mobile mounting bracket is of a new simplified design and allows for three different mounting angles. Special screws clamp the transceiver to the bracket, and a wrench is supplied to tighten them.

As might be expected, memory and

scanning facilities are included. There are 20 memory channels.

When in the VFO mode, tuning steps are selectable. You can set up 5, 10, 12.5, 15, 20 or 25 kHz steps, and, of course, the 25kHz is ideal for our band plan, and allows easy stepping up and down the FM portion of the band.

The TM231A on the Air

At the outset, I would suggest that if the transceiver is to be used primarily for mobile operation, you will save a lot of time and confusion by programming up the memories you need and sticking to them. A quick glance at the display to determine the operating frequency is probably about all the time you can safely take your eyes off the road. However, for base station use, you can let your head go and push the buttons to your heart's content.

Right, back to the beginning. First thing I did was to program the VFO for 25kHz steps. This makes it easy to zip up and down the band and also saves the embarrassment of landing on a non-standard channel and perhaps causing interference. But again, I am getting ahead of things. One of the nice features is the power on/off switch. No more turning up and down the audio volume control, there is a separate push button right in the top right-hand corner — very easy to find. This is one of the best I have seen and, of course, allows the audio to be preset at the right volume.

Talking about the volume, audio output appeared to be reasonable using the internal speaker, but again I would like

ANTENNAS & ACCESSORIES

We manufacture a comprehensive range of HF, VHF and UHF antennas, baluns, power dividers etc to suit your application. Three of our log periodics provide continuous coverage from 13-30 MHz including WARC frequencies, and replace outdated tri-banders. Now in use in 24 overseas countries and 6 continents.

- CREATE ROTATORS, COAX CABLES & NON-CONDUCTING GUY HALLYARD MATERIALS
- COMPLETE RANGE MIRAGE (USA) 5-YR WARRANTY 6M, 2M, 70CM AMPS & WATT SWR METERS
- HARD-DRAWN ANTENNA WIRE
- AUST/NZ DISTRIBUTOR FOR CREATE ANTENNAS/ROTATORS & PHYLSTRAN (KEVLAR) NON-CONDUCTING GUYING

- MATERIALS
- HIGH GAIN VHF & UHF AMATEUR, SCANNING & TV ANTENNAS
- BUTT SECTION TRIANGULAR ALUMIN IUM TOWERS FOR FIXED OR TILT-OVER APPLICATIONS (REFER MARCH/APRIL 1987 AR)
- SELECTION OF POWER CHIPS AT FRIENDLY PRICES
- VSWR/PWR METERS TO 1300MHZ

Write or phone for free catalogue

ATN ANTENNAS

56 Campbell Street
Birchip Vic 3483
Phone: (054) 92 2224
Fax: (054) 92 2666

to make a point. If it's easy to provide 50 Watts of RF output, why is it so hard to provide more than a couple of Watts audio output? I think the time has come when we should have at least 10 Watts of UNDISTORTED output. WHY NOT! By the way, this also applies to base station transceivers. Received audio quality was also acceptable, but a good sized external speaker is really required to make the most of the very good audio that the rig can produce.

I set the transceiver up on the desk alongside my old Kenwood TR-7950, both coupled to my antenna through a two-position coax switch. Both of these transceivers have roughly the same specifications, but are about six years apart in manufacture. The most noticeable difference is that the TM231A is about half the overall size. One wonders what might happen over the next six years. Actually, I couldn't pick much difference between the two. The sensitivity of the new TM231A measured just one dB better.

Transmitted audio from the TM231A was rated as excellent with the supplied microphone and broadcast quality when I connected my MC-60A desk mic.

Getting on top of the operating procedures might take you a while, but the instruction book describes everything very well. Let's go through some of the excellent facilities.

The 20 memory channels are arranged so they can be programmed in a variety of ways. First, channel one can be used to store the frequency for the priority alert function.

Channels 15 and 16 can be used to store the lower and upper limit frequencies for the programmable band scan function, and channels 17 to 20 can be used to store repeater frequencies with odd splits. I don't know of any of these, mind you, but if you do come across any you won't be left out in the cold.

Scanning of the memory channels is available in several modes. Firstly, the scan may be carrier operated, or you can set up a time-operated scan. Let me explain the difference. If you just want to check for activity around either programmed memories or the whole band, the timed scan will stop for about five seconds then carry on to the next busy channel. With the carrier-operated scan, the transceiver will pause until the station you are listening to actually stops transmitting. Next, if one of the local repeaters is full of rubbish (and that's a likely situation), it's possible to lock that channel out of the scan and then quickly re-instate it later if required.

Several interesting options are offered with the TM231A. Unfortunately, none

was included with our review transceiver. However, let's run through them, and hope that one day we might be able to obtain some from Kenwood and review them separately. Unfortunately, not a lot of information is supplied about them in the instruction book.

First, three external loudspeakers are available. Two, the SP-41 and the SP-

50B, are for mobile use, and the SP-430 for base station use. The SP-430 is, of course, the matching speaker for the TS-430/440 HF transceivers. A total of six different microphones is available for either mobile or base station use, plus RC-10 remote controller. This intriguing device allows full remote control of the TM231A with the rig placed perhaps



The Kenwood TM 231 A – Although not normally a "hand held" transceiver, this shows how compact the unit really is.



TM 231 A Microphone – Note remote control button and 'Mic' input hole above.



The TM 231 A – Note the large LCD multi purpose read out.

under the seat or in the glove box.

Another option I would like to try out is the DRU-1 digital recording unit. This enables you to pre-record and then re-play up to eight short calls. It also is capable of recording incoming messages, and if used in conjunction with CTCSS (also an option), you could arrange for a friend to leave a short message even if you are not in the shack.

The TM231A on Test

First of all, the transceiver was connected to a 13.8-Volt DC power supply, and tests for power output and current drain were carried out. The following results were obtained.

	Power Output	Current Drain	% Efficiency
High	52 (Watts)	9.1 (Amps)	41
Medium	10 (Watts)	4.3 (Amps)	16.9
Low	5 (Watts)	3.1 (Amps)	11.8

Clearly, modern high-powered transceivers show greatest efficiency at high power output. If current drain is an important consideration, then you might be better off to look at one of the older transceivers that could typically put out 10 Watts at about two Amps drain, which offers over double the efficiency at 10 Watts.

Receiver current drain was 300MA with no audio output, peaking to 500MA at full audio output. I imagine that most of this was caused by the dial lights.

With this sort of power input and output on transmit, you might imagine that the heat sink gets rather hot after a long over. It does!

Next, I checked out the receiver. First audio power output and distortion. The receiver output was terminated with both four Ohms and the specified eight Ohms. At eight Ohms, the maximum was 3.6 Watts with just on 12 per cent distortion. At 4 Ohms, the maximum output improved to 4.6 Watts with distortion at 10 per cent. The actual discriminator distortion is very good at only one per cent measured at 1kHz with 3kHz deviation.

Receiver sensitivity was next checked and found to be somewhat better than specification. SINAD was measured at 12dB for an input of .12uV, specified at 12dB for .16uV.

Lastly, the "S" meter calibration was checked. The "S" meter consists of a series of bars on the LCD display. There are 10 up to the S9 mark and four slightly larger bars for S9+. Overall, the bars are slightly larger than many current transceivers and, therefore, easier to read at a reasonable distance.

The "S" meter calibration is as follows

(in Microvolts):				
S3	S5	S7	S9	S9+
0.56	1.6	2.2	3.2	5.7

The TM231A Instruction Manual.

Well, at least you can brush up on your Spanish, French, German, Dutch and sundry other European languages while you study the English section. Two hundred and twentyseven pages of instruction manual actually finish up with

about 43 pages of readable material. What there is, is well written, with clear instructions on how to master the operating system. As is, unfortunately, the norm these days, there is no technical information included, apart from two circuit diagrams. There is one for the TM231A/E and one for the TM531A/E, which is the 1200MHz version.

I find it unfortunate that not even basic adjustment information on, say, the microphone gain or deviation setting is included. After all, we don't all speak at the same level. Actually, as far as I can see, there is no microphone gain control, only a deviation preset.

However, I imagine that Kenwood will have a service manual available, and I would suggest that new owners might consider purchasing one.

The TM231A Conclusions

There is no doubt that the TM231A is an excellent little transceiver. It does everything that can be expected of it and does it very well. And, of course, it has that extra that comes with all Kenwood transceivers — Kenwood audio quality on both transmit and receive. At its present price, the TM-231A is one of the best-value two-metre transceivers on the market. My thanks to Kenwood Electronics Australia for the loan of the review transceiver. ar

COPIES OF AR ARTICLES

Photocopies of any article published in a back issue of AR available to members at

\$2.50 each

(plus \$2.00 for each additional issue in which the article appears).

AR Articles
PO Box 300
Caulfield South
Vic 3162.

MODIFICATIONS TO DICK SMITH EXPLORER 430 MHz TRANSCEIVER

ALLEN CREWTER VK3SM
28 REYNOLDS PDE PASCOE VALE STH 3044

If, after having assembled the Explorer kit, the transmitter section won't function, here are a few ideas that I have used to put some units on the air.

1. Make sure that all the capacitors, transistors and coils are hard down on the board. A very short length of lead is a lot of inductive reactance at these frequencies.
2. Capacitors C103, 163, 164 & 166 must be small NPO type (ie have a black dot on the top). They were not supplied in some kits. (NPOs are also called for in the VCO circuit.)
3. All coils must be correctly wound as per the instruction book and the height of the hairpin coils must be as shown, a suitable drill bit under the loop when soldering will check for you.
4. The voltage at the collector of Q1 should be $+10 \pm 0.1V$. It can be adjusted by changing R4 and R5. A low voltage here can be a problem in getting the crystal oscillator to work.
5. The 8.5333 MHz crystal is generally high in frequency. Add up to 10 pF to C144 to correct it.
6. When adjusting the transmitter section, do NOT hold the PTT button for MORE THAN A FEW SECONDS at a

time as Q25 may fail.

7. Up to TP4 no trouble should be encountered and the correct levels should be obtained but often no reading can be seen at TP5. If this is the case, try items 8, 9 and 10.
8. REMOVE R99 from across C108.
9. REMOVE C104 (39 pF). (These mods will cause Q14 to operate in the correct tripler mode.)
10. Return to TP4 and readjust, then move to TP5. Now, there should be sufficient drive to permit lining up the rest of the transmitter section.
11. A good point to check the frequency with a counter is at C57, position F10. The operating frequency will be:-
— Receive $F(\text{counted}) \times 3 + 10.7$ MHz.
— Transmit $F(\text{counted}) \times 3$ MHz.

Once it is on the air, you will (or may) get reports that it is off frequency. This is not the trouble; it is the microphone sup-

plied. Get a better one or do the following modification.

Fit a 10 k 1/4 W resistor from the 10V TX link near the microphone socket to the spare contact on the socket. In the microphone disconnect the microphone element and fit an electret element snuggled in a piece of foam. Rearrange the wires to follow the circuit shown in Fig 1. Across the microphone socket bypass the 10k resistor with a 10 μF electrolytic capacitor.

This mod will improve your audio and hopefully eliminate the "off frequency" reports.

On one unit here the audio amplifier on the receiver failed. In this case, I adopted the easy way out and pulled out all the amplifier components and replaced them with an LM 380 on a small matrix board. The circuit and layout is shown in Fig 2.

Good luck and see you on 430. ar

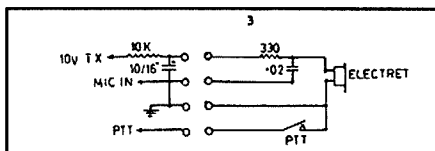

Fig 1. Microphone rewiring.

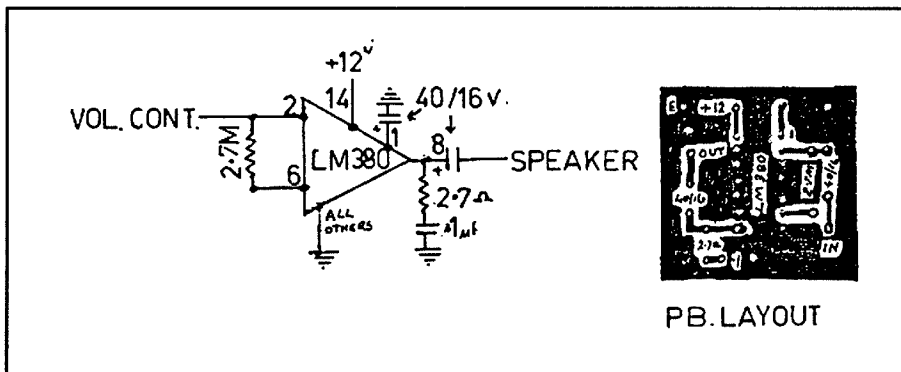

Fig 2. Audio amplifier.

Try This Ribbon Revival

I read with interest the paragraph in Bits "N" Bytes concerning the aerosol cans of ribbon reviver. I too had seen advertisements for this product and was considering buying some as I get through a large number of ribbons on my printers.

A few months ago one of my two printers packed up so I summoned a repairman. After he had repaired the printer I asked him for his opinion on

this reviver. After a chuckle he said that this was rather expensive in his opinion. The trick he and many others in the trade use is the ubiquitous WD40 lubricating fluid at £1.89 a can. The method he gave is as follows:-

1. Remove the lid of the ribbon cartridge and from about 12 inches lightly spray the ribbon in the box. Also wind in the portion of ribbon outside the box and spray that.
2. Leave the lid off overnight and replace the following morning.

I have tried this and it works very well

indeed, allowing about 5 doses before the ribbon is finally exhausted.

He also stated that no harm would be done to the printer or print head and in fact the WD40 lubricated the pins in the print head.

For information, the gentleman concerned was, before retirement, an engineer for Epson (UK).

BRIAN LONNON G3ZUM

(RP7 seems to work too - Ed.)

Reproduced by kind permission of the Author from "Mercury" Nov 1989 - the Journal of the Royal Signals Amateur Radio Society.

EXTRA-HIGH PERFORMANCE— All Mode Transportable Transceivers

You can guarantee yourself a spectacular season with these all mode, multi—purpose transportable transceivers for either the 6M or 2M bands!

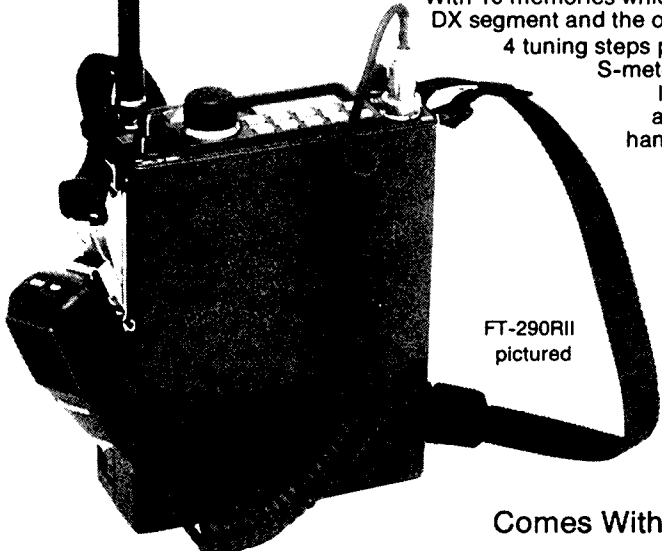

FT-290R II
pictured

With 10 memories which store mode and repeater offset, 2 independent VFO's (set one on DX segment and the other on FM segment), all mode squelch, noise blanker on SSB/CW, 4 tuning steps per mode, 2.5 watt output power (plus selectable 250mW), analogue S-meter and PO meter, and full functions for operation through repeaters.

It's easy to operate with just three knobs and 10 buttons which allow access to all functions quickly and easily. The units are supplied with hand microphone and antenna. PLUS — they now come complete with FBA-8 (9x'C' size) battery holder for shoulder-carried portable operation at no extra charge!

See A.R.A. review Vol. 12, Issue 5

6 Metre — FT-690R II Covers 50-54MHz. Channels steps SSB/CW-25/100/2500Hz. With telescopic whip antenna and microphone Cat D-2874

2 Metre — FT-290R II Covers 144-148MHz and comes with rubber duck antenna and microphone. Cat D-2875

\$799 ea

Either version

Comes With Bonus Battery Holder (Cat D-2876) **Save \$49.95**

KIT CLEARANCE

We have a limited number of these super-value kits! But hurry, they're only available at these stores— York St, Gore Hill, North Ryde, Wollongong, Newcastle, Melbourne City, Bourke St, Springvale, Adelaide City, Beverley, Perth City, Brisbane City, Chermside, Darwin.

2 Metre Linear Amp Kit

— Increase your operating range with this high power amp kit. Nominally rated for 10 watts in with 100 watts output, it still provides around 40 watts output with only 2.5 watts in (ideal for use with the FT-290R II listed below). The kit is supplied complete with all hardware, components, etc. and uses high quality coax relays for maximum performance. Requires 13.8V DC at 15 amps.

Cat K-6313

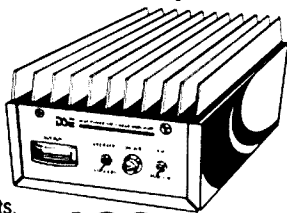

\$199

Morse/RTTY Decoder Kit

— This kit can be hooked-up between the audio output of a receiver and a dot matrix printer, and will decode and print out most Morse or RTTY transmissions without using your computer. Features both narrow and wide filters for RTTY, a digital section based on a Z80 microprocessor running at 4MHz, and a Morse decoding program which self-tracks from around 5WPM to 40WPM. Kit includes AC plugpack and a pre-punched/screened front panel.

Cat K-6339

\$99



6 Metre Linear Amp Kit

— Similar to our K-6313 2M kit, except covers 50-54MHz. Provides approx. 120 watts output with 10 watts in, and is very straight forward to assemble and align. Features include a carrier operated relay, over-voltage protection, switchable delay for SSB, and relative output power metering. Ideal for FT-690R II listed above (gives around 40 watts out with 2.5 watts in). Complete kit including pre-drilled heatsink and case.

Cat K-6349

\$199

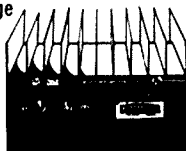

H.F. Transceiver Kit

— Save a fortune and polish up your construction skills with this mono-band H.F. Transceiver Kit. It provides around 30W P.E.P./15W C.W. on the 80 metre band, with a digital frequency display and easy to use VFO tuning. The kit comes complete with case, silk screened front panel, all components, and even a microphone. **BONUS** - while stocks last you will also receive the 40m, 20m, 15m, and 10m (bottom 500kHz) upgrade kits at no extra cost, allowing you to choose which H.F. band you want.

Cat K-6330 (Very limited stocks)

\$249

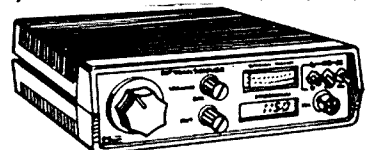

• NSW • Albany 21 6399 • Bankstown Square 707 4688 • Blacktown 671 7722 • Brookvale 905 044 1 • Bondi 387 1444 • Campbelltown 27 2199 • Chatswood Chase 411 1955 • Chullora 842 6922 • Gore Hill 439 5311 • Gosford 25 0235 • Hornsby 477 8633 • Hurstville 580 8622 • Kcane 58 2092 • Liverpool 600 9868 • Marrand 33 7688 • Miranda 525 2722 • Newcastle 81 1696 • North Ryde 878 3855 • Parramatta 889 2186 • Penrith 32 3400 • Railway Square 211 3777 • Sydney City 267 9111 • Tamworth 88 1711 • Wollongong 268 3800 • ACT • Fyshwick 80 4944 • VIC • Baratarat 31 5433 • Belmont 43 8522 • Bendigo 43 0386 • Box Hill 890 0699 • Coburg 383 4455 • Dandenong 794 9377 • East Brighton 592 2388 • Essendon 379 7444 • Footscray 869 2055 • Frankston 783 9144 • Geelong 232 711 • Melbourne City 393 Elizabeth St 328 6088 and 246 Bourke St 639 0398 • Richmond 428 1614 • Ringwood 879 5338 • Springvale 547 0522 • QLD • Brisbane City 229 9377 • Buranda 391 6233 • Cairns 311 515 • Chermside 359 6255 • Redbank 268 5599 • Rockhampton 27 9644 • Southport 32 9033 • Toowoomba 38 4300 • Townsville 72 5722 • Underwood 341 0644 • WA • Adelaide City 223 4122 • Beverley 347 1900 • Elizabeth 255 8099 • Enfield 260 6088 • St. Marys 277 8977 • WA • Cannington 451 8668 • Fremantle 335 9733 • Perth City 481 3281 • Midland 250 1480 • Northbridge 328 6944 • TAB • Hobart 31 0800 • NT • Stuart Park 81 1977

ORDER BY PHONE OUTSIDE SYDNEY (008) 226810 Free Call Sydney Area 888 2105

**DICK SMITH
ELECTRONICS**

MEASUREMENTS ON LARGE ELECTROLYTIC CAPACITORS

REG FOOKES VK2AKY
19 DELAGOA PLACE CARINGBAH 2229

Introduction

The advent of fully solid-state transceivers and power amplifiers has brought the need for high-current, low-voltage regulated power supplies. Purchasing one ready-made off the shelf can severely deflate the bank account, so many amateurs elect to build their own. After the transformer, the most expensive component is the reservoir capacitor. Surplus computer power supplies are a common source of supply, and although normally of premium quality, it would be re-assuring to be able to check the basic parameters of capacitance and DC leakage current. DC leakage current is accepted as an indicator of the condition of an electrolytic capacitor; when the rated maximum value is exceeded the capacitor is assumed to be "outside limits" and un-serviceable. The extra internal heating caused by the high current can create a thermal runaway situation, leading to physical, explosive destruction of the unit. Although not a comprehensive check-out, these two measurements should suffice for power supply components.

Measurement of the leakage current is relatively simple, but the capacitance is a little more difficult. The average digital capacitance meter or bridge stops at about 100 μF , while the values used in the power supplies are normally tens of thousands of μF , and even up to 100000 μF .

The unit to be described will measure capacitance values of these magnitudes as well as the DC leakage current. It will also re-form the dielectric film of electrolytic capacitors which have been idle for long periods. The techniques used are about as close to first principles as one is likely to get.

Principles Involved

Consider Figure 1. When the capacitor, C, is fully charged the voltmeter will register the full supply voltage, V_0 . If the switch, S, is moved from position 1 to 2, C will commence to discharge through R and the voltmeter will indicate the falling voltage. If a stop watch is started as S is changed and simultaneous values of voltage (v) and time (t) recorded, and these plotted on linear graph paper a curve of the form shown in Figure 2 will result.

The curve has several interesting features. The maximum slope is at $t = 0$, and although the slope always decreases as t increases, it never reaches zero, and while the curve approaches closer and closer to the horizontal axis it never reaches it. In other words, the graph goes on for ever.

The general equation for curves of this form is:

$$y = ae^{-bx}$$

where e is the base of natural logarithms (2.71828...) and a and b are constants. It is commonly called an exponential equation and qualitatively describes many natural phenomena, including radioactive decay, the temperature of a cooling object and the intensity of a beam of radiation traversing an absorbing medium.

In the case of Figure 1 the equation is:

$$V = V_0 e^{-t/RC}$$

V and V_0 are expressed in volts, t in seconds, R in ohms and C in farads.

This expression has the useful feature that at the instant when $V = 0.368 V_0$, t is numerically equal to RC. (A justification for this statement is offered in the Appendix). Hence, by knowing R and measuring the time for V to decrease to 36.8% of its initial value, C is readily calculated.

As a point of interest, the current through R follows the same form of curve as the voltage across it, the equation being:

$$I = I_0 e^{-t/RC} \text{ where } I_0 = V_0/R$$

So the timed decay of I could also be used to measure C. Disadvantages of this method include the measurement of small currents (down to a few microamps), and it will not be taken further.

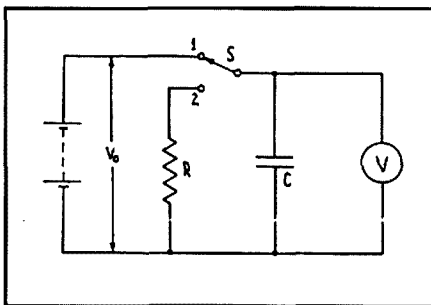

Figure 1

Returning to the first method, a few minutes with a calculator will show that the technique is not really practical for values of C in the pF and nF ranges, but if R is 1M Ω and C is a few tens of μF the situation changes — each second represents 1 μF , and intervals of 20 or 30 seconds are easily timed to $\pm 5\%$. At the other end of the capacitance range, say 100000 μF , the decay time with R = 1M Ω would be 100000 seconds, or nearly 28 hours. Clearly, a range of values of R is necessary.

To accommodate different capacitor voltage ratings a variable voltage power supply is required for V_0 , and to measure the DC leakage current a suitable meter needs to be inserted between the power supply and the switch, S.

To complete the set-up, a stop watch is required to perform the timing operation.

The Real World

The preceding discussion assumed all the circuit elements to be perfect, ie C was pure capacitance — neither series nor shunt resistance — and in the case of electrolytic capacitors this is never the case. There is not much we can do about series resistance, except to hope that it is not large enough to be significant. Except for very old specimens this is usually a valid assumption. The shunt resistance will produce a current which continues to flow after the capacitor is fully charged, and because it is in parallel with the measuring resistor R, will result in a lowered measured value of C. Normally the error will be negligible, and in any case, if the leakage current is excessive the capacitor should be discarded.

The voltmeter should ideally have infinite input resistance, but this also is impractical. The voltmeter resistance, being in parallel with the capacitor shunt resistance, will increase the indicated leakage current and also reduce the measured value of capacitance. However, since it is usually known, allowance can be made for it. A problem noticed with DVM's when indicating a changing voltage is the display time lag. With a "Fluke 75" DVM I have found that the timed interval should not be less than about 70 seconds.

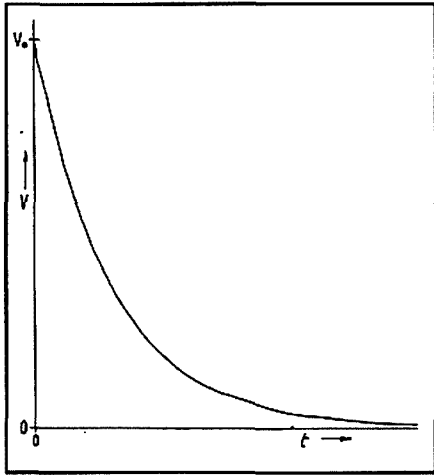

Figure 2

The voltmeter input resistance should be constant for all ranges. VTVM's, FET-input voltmeters and DVM's usually fulfil this requirement. In addition their resistance is normally 10 MΩ, an acceptably high value.

Ordinary multimeters are unsuitable.

The Circuit

Figure 3 is the circuit diagram of the device. This is a project that certainly can be assembled from junk box components — as mine was.

The power supply section need only be capable of a few milliamps. Its voltage will depend on the maximum capacitor working voltage decided upon. One hundred Volts seemed a reasonable choice and allowed the use of a gaseous voltage stabiliser. Although not strictly necessary, stabilisation permits a steady DC leakage current reading.

VR1 and VR2 should be 2W wirewound units. Although not common these days they can still be found, especially in junk boxes.

The voltage applied to Cx, the capacitor under test is set by VR1, while VR2 limits the current during the re-forming and charging operations.

The charging and leaking currents are measured by the current meter, M1, with its associated shunts and range switch. The SC (short circuit) position is a safety feature to protect the meter during repeat capacitance measurements, as described in the Operation section. The diode D1 across the meter provides back-up protection in case of operator forgetfulness. The current range switch is a 2-pole, 5-position rotary wafer type, with the two sets of contacts paralleled to reduce contact resistance.

An external analogue multimeter with suitable current ranges would be quite

suitable here instead of a built-in meter.

The CHARGE-MEASURE SWITCH, S is a SPDT toggle with a fast snap action.

Any one of the four test resistors, R, is selected by a suitable rotary switch. Assuming that the voltmeter input resistance is 10MΩ, only the 1MΩ range will be significantly affected by it. This is compensated by increasing the 1MΩ resistor to 1.1MΩ.

Good insulation in the whole measuring circuit is necessary.

Operation

As well as the basic circuitry of Figure 3, one will need a suitable voltmeter, as previously discussed (DVM, VTVM etc.), a stopwatch and preferably a pocket calculator.

With VR1 at minimum voltage, VR2 at minimum current (maximum resistance) and M1 set to a suitable range (see later) connect the voltmeter and Cx, the capacitor to be tested.

Slowly advance the voltage and current controls so that Cx voltage rating is not exceeded and the current is within the limits specified later. As Cx approaches the fully-charged condition the current should fall to a low value and the applied voltage will probably have to be reduced to avoid exceeding its voltage rating.

If Cx has been discharged for a long period — as long as two years for good computer grade units, as short as three months for some older types — manufacturers recommend that the dielectric film be reformed by slowly increasing the applied voltage so that the charging current never exceeds twice the rated maximum DC leakage value. The voltage should be held at the rated level for four hours (Philips 1962), if your patience

allows. During this time the current should fall to a constant level — the DC leakage current. The rated maximum value is quoted (Philips 1962) as:

$I = 0.08 CV \mu A$ at 20° C, (C expressed in μF .)

For a capacitor in good condition a value of about 20% of this would be expected.

A leakage current greater than the rated maximum indicates that the capacitor is unserviceable.

Improved manufacturing techniques have reduced the leakage current, and the quoted maximum limits were halved in 1963, and then halved again in 1965 (quoting from Philips literature). So a knowledge of the capacitor's age is desirable.

For low values of leakage current remember to subtract the current flowing through the voltmeter, or temporarily disconnect it.

Assuming Cx has passed the DC leakage test, its capacitance may now be measured.

Note the (steady) voltmeter reading and calculate 0.368 of it. To save time and effort a table or graph giving 0.368 V₀ against V₀ can be made.

Select a value of R to give an expected decay time of about 100 seconds. For R=1MΩ each 1 μF represents one second, for R = 100kΩ each 1 μF equals 0.1 seconds, etc.

When all is ready simultaneously flip S from CHARGE to MEASURE and start the stopwatch. Watch the voltmeter and as its reading passes through the calculated value stop the watch.

The capacitance of Cx in μF is found by multiplying the stopwatch time in seconds by the multiplier corresponding to the selected value of R — 1 for 1MΩ, 10 for 100kΩ, 100 for 10kΩ and 1000 for 1kΩ.

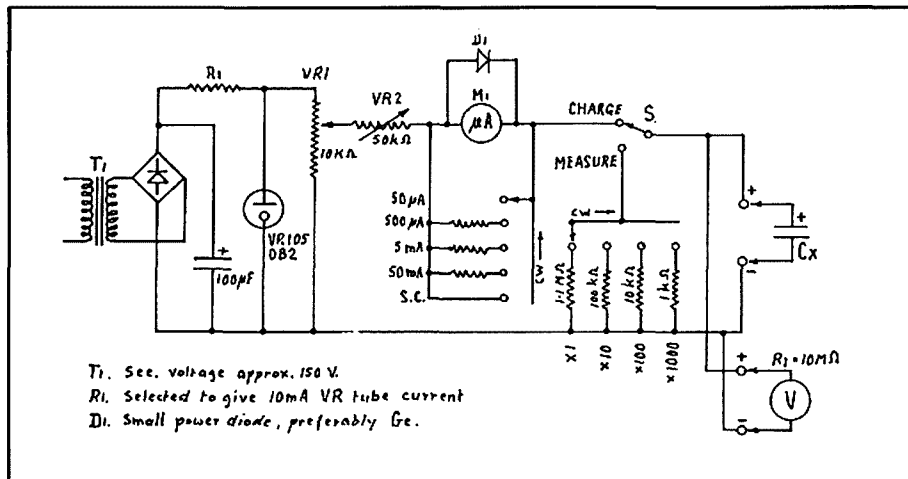

Figure 3

T₁. Sec. voltage approx. 150 V.
R₁. Selected to give 10mA VR tube current
D₁. Small power diode, preferably Ge.

Continued on page 20

THE TNC-220+ OPERATING FACTORS AND MODIFICATIONS WHEN USED IN A DIGI-PEATER

BY JOHN F DREW VK5DJ
34 AITKEN ST MILLICENT 5280

The TNC220+ is an Australian version of the TNC220. It has been put out by the Melbourne Packet Radio Group in kit form and as ready built boards. At the time it was an excellent and economical way of getting on packet, the boards are of good quality and the kit is easy to build with an excellent construction manual that contains clear building and setup instructions.

The unit makes use of the PacCom program in ROM and because this is used in at least two other designs, owners are not likely to be left with an obsolete unit. In fact, since buying my kit there have been two program updates which are compatible with the 220+. The second and third versions (1.1.6 & 1.1.6a) offer personal message systems which, al-

though not able to forward mail like the MBL program, do offer a very useful message system. Such a system satisfies 90% of amateurs' needs and doesn't clog up the full blown BBSs.

A number of digi-peater operators are either using or have used the TNC220+ as the TNC in a digipeater. The unit is a fine piece of equipment for use at home, but unfortunately some problems have arisen.

The first thing to remember is that the TNC was designed for home use where it is expected that all the input and output lines will be tied to the proper places.

Firstly, pin 4 of the TNC220+'s output connect must be tied high or tied to pin 5 so that the receive buffer does not overflow. Later versions of the manual pointed

this out.

Secondly, some operators have left the receive data, pin 2, floating. No input should ever be left floating. When connected to a computer terminal in normal use, this pin is held low. The simplest fix is to wire a 6k8 resistor between the negative 10V available on pin 5 of U2 (the 7662 is a voltage inverter) and pin 2 trace of the RS232 connector on the board. This holds the input pin in the case of VK5RPM at -3.7V. Ideally the voltage should be a bit more negative than this and a 4k7 may be better. In our case the modification was done on site and the digi had to be re-installed in order to try it. It was too much bother to take it all out to get to the section in order to try different values!

Continued on Page 21

Measurements On Capacitors

Continued from page 19

The capacitance tolerance on electrolytic capacitors can be as wide as +100%, -20%, but is usually stated on the capacitor. Any measured value within these limits would be acceptable. A significantly low value indicates rejection.

A repeat measurement, perhaps with a more appropriate value of R, can be made by returning S to the CHARGE position after reducing the applied voltage to a low level and selecting the S C position for the current meter. The voltage is then raised to the rated value as before and the measurement procedure repeated.

The foregoing discussion has concentrated on the electrolytic capacitor as it is the most common type for capacitances greater than 100µF, but the theory and techniques are applicable to other types.

For anyone interested in quite comprehensive information on electrolytic capacitors, from the Philips organisation's point of view, there were a number of articles in the "Miniwatt Digest" series. These are listed in the References. Similar data would also be available

from other manufacturers, and from technical literature.

Other Uses

Although designed to measure large values of capacitance this device has other uses, such as a low-current power supply and a test set for zener diodes.

To do this connect the diode to the Cx terminals, observing polarity, adjust the voltage and current controls, as for a capacitance measurement, so that the specified test current flows through the diode, and the zener voltage will be displayed by the voltmeter.

The dynamic resistance can be determined by taking current and voltage measurements at several points on the voltage plateau, plotting the results and drawing the straight line of best fit. The dynamic resistance is then given by:

$$R_d = \frac{\Delta V}{\Delta I}$$

Conclusion

Unlike a sophisticated black-box type instrument, where one connects the item under test, maybe sets a range switch, and then reads the required parameter

on a digital display, this piece of gear has to be "driven", rather like an old fashioned bridge, with due regard for what is going on. The two danger areas are "twanging" the current meter and exceeding the voltage rating of the capacitor.

On the credit side it is simple, versatile and capable of very good results.

Appendix

Since the equation $V/V_0 = e^{-t/RC}$ is of exponential form, t/RC will have all values from zero to infinity (t, R and C all being positive, real numbers).

Therefore at some instant t/RC will be numerically equal to unity.

For this to be so t must equal RC.

At the same instant V/V_0 will equal e^{-1} , which is 0.36788...

References:

Miniwatt Digest articles.

Vol	No	Date	Page
1	7	Apr 1962	110
2	11	Aug 1963	169
3	3	Dec 1963	45
5	1	Oct 1965	10
5	3	Dec 1965	43
6	10	Oct 1967	156

ar

The reasons for using a resistor rather than hard wiring is so that a computer will still work the RS232 without any switching. Most computer outputs will probably drive lower impedances but you'd have to experiment. As it is, the impedance is about 3 kohms (the 6k8 resistor and the 7k drive impedance of the interface chip are in parallel) and it works fine.

This latter fix is necessary because, when the input floats, I suspect RF is detected and somehow jams up the Z8530 SCC.

I'm not convinced that it is just a case of receive buffer overflow although it may be. Anyway, this simple installation step is the most essential of the steps to stop the TNC220+ crashing in digi operation.

One modification that it is a design error (and to my knowledge the only one) is in the software watch dog timer.

Back in May, when especially annoyed by the crashes, a search with the CRO found that the waveform on the A0 address line was really poor. The strong rounding which was observed was traced to the fact that the software watchdog timer U4 was loading this line with a 3k9 resistor and a 0.1 ufd cap. No wonder the waveform was bad and it certainly wouldn't have been doing the program much good if there was an occasional mis-read because of the distortion on that line.

Shortly afterwards I circulated on the packet network a mod which successfully overcame that problem.

It was —

Remove R27, it's a 3k9 located between U19 and U8, one end goes to the +ve 5 volt line and the other to the A0 address line.

U19 has a spare NAND date which can be accessed through pins 4, 5 and 6. This gate is wired as an inverter when one of its input pins is held high. use wire jumpers to join pin4 (U19) to one of the holes vacated by R27 and pin 5 (U19) to the other hole. It doesn't matter which.

At the edge of the board near C12 there is a short, 3-5 mm, trace on the underside. (It connects two small plated through holes and C12 solders to one of these.) Cut this trace.

Use a jumper wire to connect pin 6 (U19) to the now isolated end of C12. The effect of this mod is to put a buffer inverting gate between the A0 line and the watch dog timer.

Since then I noticed that a VK2... (sorry but I can't recall his name) suggested that it is better to run the watch dog timer off the interrupt line coming from the Z8530. It makes sense as it seems to be the Z8530 locking up anyway. In which case you would change the above mod by

removing my suggested jumper from U19 to the A0 end of where R27 was located and take it from U19 to either pin 5 of the Z8530 or pin 16 of the Z80.

The VK2 suggested an increase in the delay for the watch dog timer. That shouldn't be necessary but if the watch dog timer doesn't start up properly it may be worth trying.

The last steps are also important and involve setting the parameters to minimise data problems on the outputs and inputs.

Set: Xflow OFF
Monitor OFF
Flow OFF
AX25 ON

Other default settings are fine although operators will want to fine tune many parameters to suit local needs. The above, however, are quite important to minimise lock up problems as they permit free

180 and operates on the dot, every 30 minutes on the hour and half hour.

Because CLKADJ varies from unit to unit depending on the crystal the following simple program will help you set the CLKADJ figure in your TNC220+.

The program was written in BASIC with simple variable names and little screen formatting to cater for as many computers as possible. When you have typed it in to your computer you may like to dress it up a bit.

Since writing the above article, John reports that the above modifications provided only temporary respite from the crashes. After some twelve weeks the problems recurred. This coincided with the arrival of summer activity. Clearly the article does not provide a complete solution but it may serve to encourage others to experiment and find the ultimate cure. **ar**

```

5 REM Written by John Drew (VK5DJ) on 30/7/89
10 CLS: GOTO 1000
97 REM
98 REM ***** this routine for the first time adjustment *****
99 REM
100 INPUT "Enter the gain in secs ";S1
110 S1 = S1 / D1
120 C2 = 7920 / S1
130 PRINT "The CLKADJ is ";INT(C2+.5);
140 RETURN
497 REM
498 REM ***** this routine is used for fine adjustment *****
499 REM
500 INPUT "How many secs lost or gained (minus sign for gain) ";S3
510 S2 = 7920 / C1 : S2 = S2 * (86400 + S2)/86400
520 S3 = S3 / D1
530 S4 = S2 + S3
540 C2 = 7920 / S4
550 PRINT "The new CLKADJ should be ";INT(C2+.5);
560 RETURN
997 REM
998 REM ***** Main loop *****
999 REM
1000 PRINT:PRINT "To calculate the CLKADJ for the TNC220+": PRINT
1010 PRINT "For best results, you will need to have noted the time drift"
1020 PRINT "in the beacon over a period of a number of days."
1030 PRINT "e.g. If CLKADJ is 0 and a drift of 102 secs over 3 days ";
1035 PRINT "then CLKADJ = 233"
1040 PRINT
1050 INPUT "Enter the current CLKADJ in the TNC ";C1
1060 INPUT "Over how many days was the time change measured ";D1
1070 IF C1<1 THEN GOSUB 100 ELSE GOSUB 500
1075 IF C2<0 OR C2>65535 THEN PRINT " which is illegal, check figures"
1077 PRINT
1080 PRINT "Do you want more? (Y/N) ";
1090 A$=INKEY$: IF A$="" THEN 1090
1100 IF A$="Y" OR A$="y" THEN PRINT A$: GOTO 1040
1110 PRINT A$: PRINT"Good clocking"
1120 END

```

flow of data.

Currently VK5RPM has run 10 weeks without a crash. It is starting to look hopeful that the problems are fixed.

Lastly, many operators have battled with the clock settings. VK5RPM is currently running with 238 as the CLKADJ and is keeping time closer than 1 sec per week.

The beacon on VK5RPM is set on B E

**When you buy something
from one of our
advertisers,
tell them you read
about it in the**

**WIA AMATEUR
RADIO MAGAZINE**

DO YOU SUFFER FROM TII?

DES GREENHAM VK3CO
16 CLYDESDALE CRT MOOROPNA 3629

No, "TII" is not some new, exotic disease. It is, in fact, yet another form of radio interference! We have all heard and read about TVI (Television interference) and BCI (Broadcast interference). There have been many stories and articles on how to diagnose and correct these particular forms of interference that have plagued amateur operators for decades.

A new form of interference that has just appeared in recent times is TII. What is "TII", you may ask? This is "Turning Indicator Interference" — a recent problem experienced in modern cars.

Turning indicators have been installed in cars for around 30 years and have always consisted of some form of bi-metallic strip and relay to produce the required rate of flashing.

This type of unit is virtually immune to RF interference. To keep abreast with progress, vehicles now use a "chip" to produce the pulses which activate the vehicle turning lights. Of course, along with most chips they are susceptible to RF interference.

The effect is to render the turning indicator almost totally ineffective when

transmitting in a mobile situation, particularly on the 2 metre band. The indicator, which normally "clicks" when operating, will produce a loud raucous noise and render the turning lights useless.

In some less affected vehicles the interruption rate is speeded up and the turning lights are also useless.

The author has experienced this phenomenon personally on three Holden "Commodores" and understands it does also occur on other makes and models. Thankfully, the solution is quite easy and does not involve any modification or work on the vehicle itself.

Step one is to locate the flashing unit, this can be done by switching on the vehicle ignition and operating the turning indicators — a steady "clicking" will be heard under the instrument panel. By removing a plastic panel, the "flasher" unit can be found and unplugged. The majority of vehicles use a three terminal unit which plugs into a socket hanging out of the main wiring loom. The solution is to simply solder 3 capacitors on the base of the pins of the unit and re-install it. Quite an easy operation.

The capacitor value is not critical,

however, 0.047 μ F, 50 volt minicaps are quite small and will fit around the unit easily — (see sketch). The bypassed unit is then re-installed. This procedure has cured the problem in all cases and you will find that you can turn corners and transmit simultaneously without problems. ar

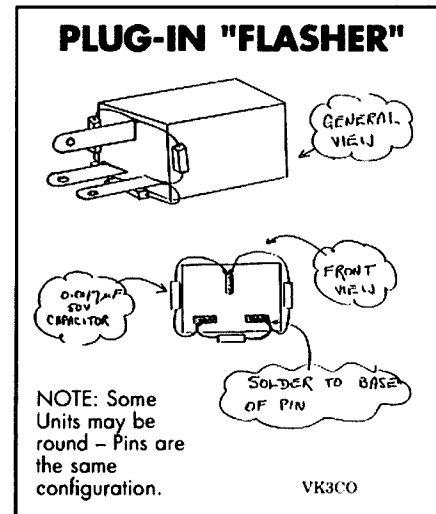

1990 FEDERAL CONVENTION REPORTS

At an earlier Federal Convention it was agreed that the annual reports by the various Federal Co-ordinators should be published in the issue of Amateur Radio magazine immediately prior to each Convention.

The statutory closing date for receipt of these reports this year is 23rd March. However, because of printing deadlines, the latest date for publication in this issue of Amateur Radio magazine was 5th March. Here are all the reports received by that date.

90.04.01 ANNUAL REPORT OF THE FEDERAL PRESIDENT FOR YEAR ENDING 31ST DECEMBER 1989

This past year has been a period of consolidation within the Federal sphere of the WIA. There have been some small changes as ideas

and procedures put in place last year have been improved.

Executive Matters Executive Office

Bill Roper, as Secretary and General Manager, has brought stability to the office after a number of years of change. Ross Burstall found he was unable to continue in the role of Assistant General Manager and Ann McCurdy has now taken on that role. Further details of the staffing of the Executive Office are provided in the General Manager's Report.

It should be noted that Bill Roper is still providing a considerable voluntary contribution to the work of the Executive Office, with the occasional assistance of the Melbourne based Executive. This practice is necessary to cover the shortfall in staffing which currently exists and involves considerable work on weekends and public holidays. The latest

cutbacks in expenditure have exacerbated this situation further.

Bill Roper has continued his review of office practices and procedures. The WIA is firmly committed to the philosophy that it is a "Service Organisation" and should appear that way to the members. Towards the end of 1989, a new computer system for the membership records was purchased. The faster response time of the new system has enabled the office to more efficiently answer the very popular question "Am I still a member?", as well as printing the address labels for AR in a much shorter time. This is not surprising when you compare the technology of the old Cromemco computer (using the CP/M operating system) with the newer, IBM compatible computer with a 286 processor and a 80M hard disk drive.

Federal Executive

Following the appointment in 1988 of a number of interstate members to the Execu-

tive, a further step was taken in 1989 when, in addition to a number of Melbourne based members, a representative from each Division was nominated to the Executive. The members of the Executive elected at that time were George Brzostowski, VK1GB; Brenda Edmonds, VK3KT; Joe Gelston, VK7JG; Kathy Gluyas, VK3XBA; Ron Henderson, VK1RH (Vice Chairman); Peter Jeremy, VK2PJ; David Jerome, VK4YAN; Peter Mill, VK3ZPP; Kevin Olds, VK1OK; Neil Penfold, VK6NE; Bill Rice, VK3ABP and Bill Wardrop, VK5AWM. David Wardlaw, VK3ADW, was co-opted onto Executive as Immediate Past President. Kathy Gluyas resigned in July and the vacancy remained unfilled. Peter Mill recently tendered his resignation and has been replaced by Peter Maclellan, VK3BWD.

During the year the Executive met on 12 occasions, with three of these meetings being two-day Saturday and Sunday meetings. These two-day meetings have allowed many items to be considered in detail, particularly items relating to the financial, budget and performance aspects of the WIA.

This initiative has definitely been worthwhile, as a wider group of people are now more aware of what is involved in running the WIA on a daily basis. It has also furthered a better understanding between the Divisions and provided a good opportunity for the exchange of ideas. Although there have been some teething problems, this has been a successful arrangement and should be continued.

Corporate Planning

Following a detailed presentation to the 1989 Federal Convention, the Corporate Plan was adopted. Since then it has been reviewed on a regular basis and changes incorporated as issues were considered by the Executive. This document should not be thought of as something which is "set in concrete", but rather as a document which can be regularly updated to take into account the changing needs of the WIA. As expected, progress on some objectives is excellent, while work on other objectives still await the necessary resources.

Amateur Radio Magazine

Our magazine has undergone a program of steady improvement over the past year. This has included a new look front cover, new layout, WIANEWS and WIA information pages in each issue. Feedback from members on these changes has been very positive. Congratulations to all of those involved!

International Matters

The anticipated World Administrative Radio Conference (WARC) is to be held in Spain in 1992. Preparation for that Confer-

ence is already well under way. David Wardlaw and other members of the Executive are monitoring the flow of paper (which is well under way!) and are attending meetings with other interested delegates from the communication industry.

DoTC Matters

The greatest success in our dealings with DoTC over the past year must surely be the updating of the conditions of use of the six metre band. This has resulted in a much better operating arrangement for the majority of six metre enthusiasts. A great deal of the tribute for this goes to Peter Stackpole, VK1RX who, with the assistance and encouragement of a number of other six metre operators, prepared a very detailed paper for consideration by the DoTC.

One of the most contentious issues involving DoTC was that of Cross Linked Repeaters. The progress on this matter was well reported in the WIANEWS column of Amateur Radio and I do not propose to repeat it here, except to note that with the co-operation and good will of many members, Divisions and the Executive, a difficult problem is well on the way to being resolved in a way which is consistent with the "deregulated" approach which is the hallmark of current DoTC policy.

The Devolvement of Examinations issue proceeded at a modest pace following the appointment of Keith Carr-Glynn to the Radio Frequency Management Division. He has now completed his work and exams are now being handled by various groups around Australia. The WIA is concerned, however, that in some parts of this vast country, potential amateurs may find it difficult to locate and attend an examination. This matter will continue to be monitored.

The negotiations and debate on the issue of Third Party Traffic are still continuing! A submission has recently been made by the WIA pointing out the "deregulated" approaches currently being taken in a number of overseas countries. The Department is still considering this matter.

Divisional Visits

The difficulties in the airline industry have curtailed the usual travel itineraries of a number of members of Executive. In spite of this, I have been able to meet with members of the Divisional Councils of VK1, 2, and 4. I would like to thank the Divisional Councillors for their hospitality on these occasions. Other members of the Executive have also visited a number of Divisions. Field days and club activities have also featured on various travel itineraries. Members of the Executive appreciate these opportunities to make contact with the many and varied people who make up the hobby of amateur radio.

Thanks

There are many volunteer co-ordinators who contribute to the activities of the WIA on behalf of the Executive. On behalf of all members of the WIA, I would like to thank the following people for their efforts:

Graham Ratcliff	Amsat
Ken Gott	Awards Manager
Frank Beech	Contest Manager
Brenda Edmonds	Education
Hans Ruckert	EMC
John Edmonds	Historian
Bill Horner and Gordon Loveday	Intruder Watch
Ash Nallawalla	International Travel
	Host Exchange
Neil Penfold	QSL Manager
	(VK9, VK0)
	Standards and FTAC
Rob Milliken	Tapes (Federal News)
Bill Roper and Ron Fisher	Tapes (Video)
John Ingham	WICEN
Bill Wardrop	

Unfortunately, Ken Gott recently passed away.

I would also like to thank the members of the Executive, particularly Ron Henderson, and the Office Staff, especially Bill Roper, for their support and encouragement during what has been a very busy year for me.

PETER GAMBLE VK3YRP
FEDERAL PRESIDENT

90.04.02 REPORT OF IARU REGION 3 LIAISON OFFICER FOR YEAR ENDED 31ST DECEMBER 1989

Strong points

The year 1989 was one of consolidation following the triennial IARU Region 3 conference in Seoul in 1988. Arising from that conference the WIA representatives identified some 25 actions.

To date 18 of those have been completed, 4 are long term and ongoing whilst 1 requires initiation by another nation.

Consequently we are fairly well up to date with our international liaison.

During the year the WIA voted on a number of IARU matters concerned with election of officers and constitution updates.

As we reported last Convention, Michael Owen, VK3KI, is now IARU Vice President, the first non-American to hold this high office.

The WIA wrote to the Region 3 Association on two matters during the year, the Associations management structure and suggesting IARU set up a satellite fund. Both matters were referred to the Directors meeting for consideration.

A plaque was received from the IARU

Monitoring System International Coordinator, Bob Knowles, ZL1BAD and presented to Bill Martin, VK2COP by the President to acknowledge his IW efforts.

Last Convention the Council, in planning the budget, identified International Representation as a separate component and set it at \$2 per member per year. I commend them for this action as we now have a firm planning basis for our international relations funding. This fund will finance all WARC and IARU activities, such as the Australian Preparatory Group (APG) meetings in the country between now and WARC92, amateur representation on the official Australian Delegation to WARC92 in Spain, and the Australian delegation to IARU Region 3 conferences, the next being in Indonesia in 1991. Incidentally our WIA representation in Indonesia should be a minimum of three in order to cover all working party activities and allow new people to gain exposure in the international arena.

With the next Region 3 conference in 1991, we should be starting now, in 1990, to identify issues which need to be on the agenda for that conference. We can take it for granted band-plans will be discussed as will WARC92 attitudes and aspirations of the amateur community.

Problems

Two matters from the Seoul conference, which have not progressed as fast as we would have liked are, obtaining from DoTC agreement that amateur to amateur through amateur communications are not third party traffic, and the use of the national prefix VKx/ before home calls for visiting amateurs as is done in much of the remainder of the world. Both issues continue to be pressed with DoTC.

RON HENDERSON VK1RH
WIA IARU LIAISON OFFICER

90.04.03 FEDERAL FINANCIAL REPORT FOR THE YEAR ENDED 31ST DECEMBER 1989

The full financial statements of the Federal Body of the WIA for 1989, audited by Harmon Partners, will be submitted to the 1990 Federal Convention.

Complete publication of those statements in Amateur Radio would not only take up a lot of space, but would also be boring to most members.

Therefore, the following is a precis of the Financial Report being submitted to the 1990 Federal Convention, together with a chart of the Income and Expenditure, both budgeted and actual, for 1989, and the budget for 1990. If you would like to see a copy of the complete financial statements, then contact your Divisional Federal Councillor who will only be too

pleased to arrange for you to see a copy. If this is not practicable, then copies may be available by contacting the Executive Office.

For the second year in succession I have been acting in the dual role of WIA accountant/book-keeper and Treasurer. I do not believe this is a situation that should be allowed to continue, and I am concerned that the WIA seems unable to find a competent volunteer to take on the important position of Treasurer!

The final budget for 1989 is shown in the left hand column of figures in the chart of Income and Expenditure, and the actual figures are shown in the centre column.

A non-profit organisation such as the WIA should **NEVER** budget for a loss! A non-profit body can only make capital expenditure for fixed assets, such as equipment and furniture, from Accumulated Profits!

However, because of the urgent requirement to continue upgrading the efficiency of operations of the Federal Body of the WIA during 1989, and realising that, because of the cumbersome hierarchical structure of the WIA, increased membership fees to cover the costs could not be put in place before 1990, the Federal Body accepted a 1989 projected loss of \$34,500.

Based on this budget, the Federal Body incurred a net loss on operations for the year of \$36,450, which was \$1,950 more than expected.

Some of the more significant aspects of the audited 1989 financial statements include the following:-

AR Advertising, a major source of income, was \$3,250 under budget after allowing for the \$9,337 book entry relating to the contra advertising arrangements with three commercial electronics magazines. Again in 1989 the Executive Office received no help from any of the Divisions in obtaining advertising for Amateur Radio magazine!

The 1990 Australian Radio Amateur **Call Book** produced a profit of just \$5,000 after deducting the commission payable to the Australian Government Publishing Service for the "privilege" of publishing the Call Book, and the Executive Office overheads. The quality of the amateur radio station call sign information supplied from DoTC again resulted in many hours of unnecessary work by the WIA.

Income from **Members Subscriptions** was well down on budget because, instead of the forecast increase in membership, the membership actually decreased to 7619 as at 31st December 1989.

Convention Expenses were \$9,090 over projections because of the two unbudgeted Extra-ordinary Federal Conventions held during June and November. In future, the costs of the additional three Conventions each year should be offset by the reduced cost of the Annual Federal Convention.

Executive Travel was \$1,210 under budget only because the Federal President and Vice President were able to visit Divisions as part of their employment travels around Australia.

Salaries & Secretarial costs were kept down to \$14,545 under budget for the year, by decreasing the number of staff, and reducing the working hours of several others.

Amateur Radio magazine, the publishing of which involves at least half of the workload of the Executive Office, cost \$550 less than budgeted. This is a pleasing result considering the substantial improvements made in presentation of the magazine during 1989.

1990 Budget

The budget for 1990, which is shown in the right hand column of the chart of Income and Expenditure, was arrived at after much deliberation. In approving the budget at the full meeting of Executive on 10th and 11th February 1990, the following motion was passed:

900201

It was **RESOLVED** that this Executive,

- noting the terms of the Budget as proposed by the General Manager and Secretary;
- noting it is based upon the best available projections for membership of the WIA;
- noting that it is prepared on an assumption that membership will be increased by 380 new members;
- recognising a need to increase the budgeted surplus from \$10,000 to a figure approaching 5% of income, that is of the order of \$20,000;

RESOLVES to accept the budget for 1990 as promulgated by the General Manager and Secretary with the following provisos:

- that the Divisions accept a recruiting target of an additional 430 new members in addition to the assumed 380, thus setting the recruiting target to 825 new members;
- that the Executive may take whatever steps may be necessary to achieve the budget surplus, including:-
 - the adjustment of the number of pages of AR;
 - review of the number of Extraordinary Conventions to less than four per year;
 - an adjustment in salary liabilities by adjusting working hours of staff;
 - devolution or shedding of functions.

If any member has any questions about the finances of the Federal Body of the WIA, they should be addressed in the first instance to the Federal Councillor of their local Division.

BILL ROPER VK3ARZ
GENERAL MANAGER & SECRETARY

CHART OF INCOME AND EXPENDITURE

INCOME	BUDGET 1989	ACTUAL 1989	BUDGET 1990
ADVERTISING (incl. HAMADS) - AR	51000	47750	37600
CALL BOOK	26000	32621	28000
DONATIONS	350	142	150
INSERTS - AR	600	646	600
INTEREST RECEIVED	18000	17436	11500
MAGPUBS	0	10782	7500
MEMBERS SUBSCRIPTIONS	257000	239306	310500
SUBSCRIPTIONS (O/SEAS DIRECT) - AR	5000	4339	4000
SUNDRY INCOME	50	1529	750
TEAC FEE INCOME	3875	6485	4650
TOTAL - INCOME	361875	365374	405250
LESS EXPENDITURE			
AMSAT	1500	463	1500
AUDIT FEE	2000	1900	2000
AWARDS - AR	700	315	500
AWARDS & SPECIAL PROJECTS	1200	1558	750
BAD DEBTS WRITTEN OFF	250	69	500
BANK CHARGES	1250	1273	1300
BULK POSTS - AR	33000	37270	36700
CALL BOOK EXPENSES	12000	13619	14750
COMMITTEE/COORDINATOR EXPENSES	750	919	1000
CONVENTION EXPENSES	14000	23090	19000
DEPRECIATION	10000	10102	6800
DRAFTING - AR	1500	662	1000
ELECTRICITY	1500	1398	1500
GENERAL EXPENSES/SUNDRIES - AR	250	0	0
GENERAL EXPENSES/SUNDRIES	1500	1784	1500
I.A.R.U. DUES	4400	4347	5175
INSURANCE/WORKCARE LEVY	3000	3135	3100
INTERNATIONAL REPRESENTATION PROVISION	0	0	11120
LONG SERVICE LEAVE PROVISION	3250	764	620
MAGPUBS EXPENSES	0	7666	4800
POSTAGES & FREIGHT	7500	9046	9500
PRINTING - AR	72000	74561	78850
PRINTING/STATIONERY/OFFICE SUPPLIES	6000	5567	9000
PRODUCTION EXPENSES - AR	1700	1338	0
PROMOTION/ADVERTISING/RECRUITING	11000	9972	4500
RENT & CLEANING	7000	7575	8300
REPAIRS & MAINTENANCE (OFFICE)	3500	3910	2000
SALARIES & SECRETARIAL	148000	133455	125000
TEAC EXPENSES	2000	3030	2400
TELEMEMO - KEYLINK	2120	2118	0
TELEPHONE	2500	2480	2600
TRAVEL - AR	1000	972	0
TRAVEL (EXECUTIVE)	2500	1290	2000
TRAVEL (OFFICE)	1000	1112	750
TYPESETTING - AR	25000	24849	26110
WRAPPING & ADDRESSING - AR	11500	10219	10500
TOTAL - EXPENSES	396370	401826	395125
SURPLUS/DEFICIT	-34495	-36452	10125
NETT AMATEUR RADIO COST	196395	195845	198945

90.04.04 ANNUAL REPORT OF THE PUBLICATIONS COMMITTEE FOR THE YEAR ENDED 31ST DECEMBER 1989

Each year this Committee's report has referred to its affairs over the year as having been anything but dull and uneventful. Yet compared with 1989 previous years were relatively dull!

To begin with, as foreshadowed last year, Betken Productions had given notice in November 1988 that they could not continue with AR beyond the January 1989 issue. This meant that new producers, typesetters and printers had to be found very rapidly, a process made more difficult by the Christmas holidays during which most similar organisations close their doors for two or three weeks.

To cut a long story short, a new firm of typesetters was found very rapidly, located only a few minutes drive from the Executive office. It is only fair to give all the credit for these negotiations to the General Manager, Bill Roper, who not only made initial contact with Redfords, but also gave them a good idea of our requirements and arranged a provisional contract.

Central to their activities is a Macintosh computer, not only for typesetting but also for the so-called "paste-up" phase, ie the actual physical arrangement of the material on each page. It rapidly became apparent that although this process was a good deal faster than the earlier methods it placed more load on the Editor and his helpers. Total responsibility for material selection and rough placement now became vested in the Editor, who in effect now became the producer as well. This added responsibility extended to proof-reading and corrections after typesetting. The first issue under the new arrangements (Feb 1989) also included some 27 pages of technical data, mostly in tabular form, which it had been decided not to publish in the Callbook. The result of this was ten full days of voluntary and unpaid work by the Editor, who as a member of Executive could not accept paid employment by the WIA. Obviously such a situation could not continue.

Fortunately the solution to the problem lay within it. Now that production had become an "in-house" job it was no longer costing us money. In fact we were saving nearly \$1000 a month compared to 1988 costs. Obviously this was sufficient to attract a part-time Managing Editor who would become largely responsible for production. Such people do not "grow on trees" and we were very fortunate, resulting from an appeal in the March editorial, to obtain the services of Graham Thornton, VK3IY, as Managing Editor. Others did in fact apply (one from Sydney and one from Hobart) but having so recently regained

direct "hands-on" control of production we were reluctant to experiment with detail management by remote control. I think the results since Graham's appointment speak for themselves.

I have mentioned proof-reading. I think the statistics are worth making known. On the third Thursday of every month the two Editors plus at least two other people put in a whole day on proof-reading. The number of errors discovered usually lies between 500 and 1000! At the second reading, only a day or two later, this has usually been reduced to about 50. At the third and final reading these have all (hopefully!) been removed. Some nearly always elude us, but we try every month to achieve that elusive target of zero errors.

As mentioned last year, we were looking forward to the first DX column by Pat Kelly, VK2RZ. This appeared in April, and Pat continued to provide a well-written "How's DX?" page or two until the September issue, when he had to relinquish the task for health reasons. Fortunately at about this time Stephen Pall, VK2PS, who had been a prolific source of DX information to successive columnists for many years, was able to take over the actual writing of the column. All of us, particularly the DX enthusiasts, are greatly indebted to Stephen for the many hours each month it must take him to collect and collate all the information.

We have had problems for several years in the reliable reproduction in black and white of photographs supplied as colour prints. Pictures which looked good in colour often turned out, after half-tone dot screening, either lacking contrast or, more frequently, far too dark. One of Graham Thornton's major contributions, soon after he joined us, was to establish why this trouble occurred. Until then enquiries always seemed to conclude in a "vicious circle" in which the photographer, plate-maker and printer each blamed the other two for some alleged shortcoming, but no-one could offer an effective solution. The problem turned out to be one of colour balance. The dot-screening process uses blue light, so areas which do not reflect blue are reproduced as black. Graham devised a simple way of checking in advance how a print would reproduce, so that those which were unsuitable could be discarded in advance. He also located a specialist photographer able to re-process prints to change their colour balance favourably if the subject was vital to the article. The results have been excellent, as will be seen by comparing recent issues of AR with those early in 1989. Many thanks, Graham!

Advertising still remains a problem area, and frequently a whole issue contains advertisements only from Victoria and New South Wales. I repeat what seems an annual appeal

for the other Divisions to try persuading local dealers or sales people that there is a market accessible through advertising in AR.

Perhaps the market is not confined to amateur radio equipment. Now that the detailed results of last year's survey of members have been issued, perhaps we may hope wider markets may be indicated in that data. One development this year has been the introduction of corporate style advertising on the front cover of the October and November issues, but the market here is very limited, and frequently the cover is needed in support of an article or a topical theme. Still it is pleasing to have an occasional cover which pays rather than costing money.

As regards money, it is a pleasure to report that the advance and un-audited figures for 1989 show that the magazine costs were almost exactly on the Budget target. There was a surplus of a few hundred dollars in fact, in a total approaching \$200,000.

For this excellent result, the General Manager deserves enthusiastic congratulations, since it has been achieved only by his unremitting attention to every detail of AR finances.

Other items deserving mention are the Callbook (edited by Bruce Kendall) which returned a useful profit, the 20 year index in either disk or hard copy format (many hours of keyboard work by Ron Fisher) which is selling well, the further-improved layout style from October (again largely under Bill Roper's guidance) and the appointment of John Friend, VK3ZAB, as our official photographer. Many thanks to all concerned for a job well done!

BILL RICE VK3ABP
EXECUTIVE EDITOR

90.04.05 REPORT OF FEDERAL TECHNICAL ADVISORY COMMITTEE FOR YEAR ENDING 31ST DECEMBER 1989

Strong points

On the digital front FTAC has been involved in advising on packet network negotiations with DoTC.

Repeater activity has been concerned with site EMC/EMI at three sites, leading to the need to reverse the repeater input and output frequencies in the 147 - 148 MHz segment to achieve compatibility. Advice was given on repeater linking negotiations with DoTC.

Beacon activities have been related to the change of the 28 MHz beacon service to time sharing in accordance with the revised IARU

band plan, a review of the need for beacons in the 50.05 - 50.2 MHz segment (two specific frequencies were recommended, and both were allocated for use - as demand increases time sharing is to be adopted). It is noted with regret some beacons are still not to band plan despite the lapse of several years.

Bandplans have been reviewed and the results of the last Federal Convention are being published now the 1296 MHz plan has been cleared with the CAA. Negotiations with DoTC concerning exclusive Australian UHF and microwave segments has been suspended pending the first meeting of the APG for WARC92. Some 1296 MHz repeaters are not to band plan.

Several VHF/UHF record claims were evaluated during the year and the current list published in Feb 90 AR. The listing is over-complicated by including all state records for all bands and several modes. It is recommended that in the future only national records be kept, and for a lesser number of modes/circumstances. Attached is the latest status in the recommended format.

During the year comment was provided on two significant DoTC papers relating to EMC/EMI. One was concerned with the introduction of a RF Tag Identification system and the second was a position paper on Electromagnetic Compatibility.

In summary, useful progress has been made on a number of issues dragging over from past years.

The WIA has continued to be active in Standards Australia affairs. Progress is evidenced by the recent postal vote (the WIA voted in the affirmative) on a draft standard by Committee TE/14/4 Siting of Radiocommunication Facilities, Part 3, Satellite Earth Stations. Part 4, Broadcasting & Mobile Services (VHF & UHF), is still being considered.

Weak Points

Once again there has been a pronounced lack of input from Divisions and the amateur body generally, with one obvious exception. Advice provided by FTAC on means of repeater linking came in for considerable and vocal criticism. Approximately 3 months after that advice was given a number of well reasoned papers were received and the situation retrieved.

It is a pity it took so long to obtain those views and well illustrates the difficulty in communicating with the practising amateur out there in the Divisions. FTAC must use AR magazine and Federal tapes more to overcome these communications barriers. But how do we inform the non-member?

Unfortunately the pressure of work precluded my giving anywhere near the attention to FTAC that it deserved and it was with real regret that I had to tender my resignation

as Chairman of FTAC to the January 1990 Executive meeting. Whilst I cannot be an active member in the coming year, I am more than willing to assist where required on any repeater EMC/EMI issues which may arise.

Recommendations

Following WIA tradition, and in compliance with Federal Council resolution 85.09.13, it is RECOMMENDED all microwave band plans from 1296 MHz upwards be reviewed to

ensure they reflect Australian amateur practice. The review results should be PUBLISHED in AR magazine and presented to Council for consideration in October/November 1990.

It is RECOMMENDED the Australian VHF/UHF records be simplified to show only those categories shown in the statement attached.

R. MILLIKEN VK1KRM
RETIRING CHAIRMAN FTAC

A few statistics:

VK1	NIL	observers		
VK2	4	"	32	logs
VK3	4	"	27	"
VK4	16	"	342	"
VK5	3	"	27	"
VK6	7	"	44	"
VK7	1	"	(SWL)3	"
VK8	3	"	25	"
			38	498

Intrusions	
B/cast mode	566
A1A/F1B	2854
RTTY	534
Other	1617
CB intrusions from our near North	19372
	23943

What other reason need I stress for the majority of amateurs to throw their weight and reports behind the 38 observers who are doing a fine job and getting NO immediate reward for their efforts?

Merit Certificate Still being checked.

Was Intruder Watching part of your New Year resolution?

GORDON LOVEDAY VK4KAL
FEDERAL INTRUDER WATCH
CO-ORDINATOR

90.04.09 REPORT OF THE FEDERAL CONTEST MANAGER FOR THE YEAR ENDED 31ST DECEMBER 1989

The 1989 John Moyle Memorial and Remembrance Day Contests both enjoyed wide support with a healthy mix of HF and VHF entries received. Unfortunately, the same cannot be said of the Ross Hull and Novice Contests which continue to receive little support.

Perusal of the VHF/UHF entries in the Remembrance Day Contest will reveal the almost complete lack of entries in certain states, i.e. from VK2, only 3 entries, and from VK3 only 8, whilst the VK6 area produced 48, this from a total Remembrance Day Contest that produced 136 VHF logs.

Of the 22 entries received for the latest Ross Hull Memorial Contest, 15 came from Victoria and no entries came from New South Wales. This lack of VHF/UHF activity during the contests period has been evident for a number of years and in my opinion should be reason enough to cease holding VHF/UHF Contests in this country.

AUSTRALIAN VHF, UHF and SHF RECORDS

CORRECT AS AT 3RD MARCH 1990.

LEGEND

* - Australian record

- New record since last publication in Feb 90 AR.

1. HOME/PORTABLE CATEGORY.

52 MHz	VK8GB	to	9Y4LL	10/04/82	18,665.4 km.
144 MHz	VK4ZSH/4	to	JA7OXL	24/04/83	6,616.9 km.
432 MHz	VK3ZBJ	to	VK6KZ/6	23/01/80	2,715.9 km.
576 MHz	VK3KAJ/5	to	VK3ZBJ	25/ 2/89	382.9 km.
1,296 MHz	VK3ZBJ	to	VK6WG	18/03/88	2,449.3 km.
2,300 MHz	VK5QR	to	VK6WG	17/02/78	1,885.5 km.
3,300 MHz	VK5QR	to	VK6WG	25/01/86	1,885.5 km.
5,650 MHz	VK5NT	to	VK5ZO/P	12/11/89	176.4 km.
10,000 MHz	VK3KAJ/3	to	VK3ZBJ/3	8/02/86	252.1 km.

2. EME CATEGORY.

144 MHz	VK3ATN	to	K2MWA/2	28/11/66	16,761 km.
432 MHz	VK6ZT	to	K2UYH	29/01/83	18,726.4 km.
1,296 MHz	VK3AKC	to	W2NFA	6/10/73	16,713 km.

3. ATV CATEGORY.

432 MHz	VK7EM/T	to	VK3ZPA/T	13/12/72	413 km.
---------	---------	----	----------	----------	---------

4. MOBILE CATEGORY.

144 MHz	VK3KAJ/M	to	VK6BE	25/ 1/86	2,224.5 km.
432 MHz	VK3KAJ/M	to	VK6BE	25/ 1/86	2,224.5 km.
576 MHz	VK3KAJ/M	to	VK3ZBJ	26/ 2/89	122.5 km.
1296 MHz	VK3ZJC/M	to	VK3KKW/M	16/ 9/89	137.6 km.

5. DIGITAL MODES CATEGORY.

52 MHz	VK3ZJC	to	VK8ZLX	26/12/88	1,906.3 km.
--------	--------	----	--------	----------	-------------

RAY ROCHE VK1ZJR
FOR FTAC

90.04.08 REPORT OF FEDERAL INTRUDER WATCH CO-ORDINATOR FOR YEAR ENDED 31ST DECEMBER 1989.

1989 was a disturbed year. Two changes of Federal Co-ordinator have not made this report easy to compile. Maybe 1990 will be more satisfactory?

VK4 still has the most observers and hence

most reports. Unfortunately amateurs in most other states seem to believe the situation is not serious. Whatever happened to all the other observers in those states? Did they run out of patience or lack of interest in their fellow amateur? Do not start blaming the WIA when the band cuts occur, or the "heavies" close the bands to you.

Relations with DoTC are cordial, with several new ideas being tried to improve our presentation to their Monitoring Service, so that action can take place at Government level.

The Contest Manager held a second trial VHF/UHF contest this summer to test the need for and acceptance of the concept of a VHF/UHF one day field day Contest similar to those enjoyed by amateurs overseas. The results are again most disappointing with only 10 entries being received.

Contest Reports

Ross Hull Memorial Contest

Support for this Contest remains almost static with the 1989/90 Contest attracting only 3 more entries than in 1988/9. The addition and attraction of bonus points for contacts up into the UHF regions provided little attraction and participation remains very poor. Band conditions were erratic during the contest period and this could have had some bearing on the numbers participating.

John Moyle Memorial Contest

Run in conjunction with the New Zealand Field Day Contest, this Contest remains quite popular. The repeat contact rule remained a problem with large areas of the country having quite limited band openings across the Tasman. As this contest is open to all call areas, and is primarily a HF Contest, this year I returned to the widely accepted contest rule of "One contact per mode per band" for all stations. This should solve the problems that arose from allowing repeat contacts after a few hours.

Novice Contest

This Contest seems to be in decline with Novice stations sending in fewer and fewer logs each year. This year, the leading Novice stations in each state received contest certificates and I hope that this will encourage more activity in future Novice Contests.

Remembrance Day Contest

Remains our most popular contest, with a good mix of entries in all sections. The 1989 Contest attracted 427 entries overall, 136 of these being in the VHF section. Looking back over the years, participation remains very good and most agree on it being "the friendly contest" and long may it remain so.

Contest Publicity

Advance publicity for our contests is a problem in Australia and, whereas advance publicity is provided freely through our associated societies and magazines in other countries, the same cannot be said about a commercial amateur radio magazine which is printed in Australia. I have forwarded copies of all our contests to this particular magazine and have as yet to see anything in print. As a number of the active amateurs who are not

WIA members read this magazine, I believe that the use of "paid for" column space should be investigated.

In conclusion, I wish to thank all those amateurs who have sent logs to me for adjudication. Standards of log keeping have remained very good, although some mistakes have occurred whilst I have tried to read signatures and call signs written in longhand. A small number of entrants have been disqualified for omitting or refusing to provide information required in the rules.

FRANK BEECH VK7BC
FEDERAL CONTEST MANAGER

90.04.12 ANNUAL REPORT OF THE FEDERAL QSL MANAGER FOR YEAR ENDING 31ST DECEMBER, 1989

Operation of the bureau continued through 1989, with more QSL cards being sent to ANARE in Tasmania. This is because the bureau has no forwarding address or home call sign of the operators who are stationed in the Antarctic. ANARE have not told the bureau what is done with the cards after they receive them. No replies to any correspondence included with the cards have ever been received from ANARE.

The geographical mess of the VK9 and VK0 prefixes is now being felt by the sorting officers of the bureaux. Direct mail has been received for call signs: VK9TAX, 9TR, 9TC, 9DX, 9AMY, 9DH, etc. and of course the VK9Y..s stationed on Macquarie with a Limited licence.

In consultation with the VK2 Bureau Manager a real problem exists to which no practical solution could be found that would find favour with all amateurs. The VK2 Bureau holds cards for many operators who have been and are presently operating from the off-shore islands. These members and non-members do not want cards via the bureau, having made no attempt to have them forwarded on to themselves. VK2, after holding them for some considerable time, has no option but to destroy the cards. It is far too costly to return them to the sender.

Having only two operators advise the Federal Bureau of where to send their cards, the rest are usually now despatched to ANARE and VK2. Once the home call sign of a VK9/VK0 operator is "discovered", a suitable size packet of cards is made up and sent to the home call sign address (e.g. VK9TAX = ZL2TAX) at the WIA's expense. Is this fair?

Norfolk Island (post code 2899) costs \$8.10 per packet (parcel) up to 2kg. Hardly a month

passes without an accumulation of 2kg of cards. For VK9YH/F6GVD, VK9YD/OH5VD for example, it costs the WIA \$3 for a 500gram packet. VK9YG has accumulated another 1kg of cards in the Federal bureau which will cost \$8.60 to forward on to G land.

Another factor is that the bureaux managers don't send cards to the operators who themselves have a manager. For example, VK9YV has (had) G3AAG, as a manager (actually his home call) and many cards are marked "Via G3AAG". But the bureaux still send them to the Federal Bureau of the WIA. It's easier.

In these days of rising postal charges there appears to be one solution before destroying the incoming cards. Where the home call sign or address of the VK9/0 operator is known, a letter of enquiry be sent requesting an answer as to what to do with that operator's cards. No answer in reply or a "destroy" answer be carried out. Also a "donation to assist with onforwarding costs" could be asked for explaining the reasons why it was asked for.

Recommendations:

1. Unless advised beforehand, a letter be sent to the VK9/VK0 operator requesting a direction be given as to disposal of QSL cards:
 - (a) Onforward, or
 - (b) Destroy.
2. If onforward request received, a postal cost be levied sufficient to cover the cost of mailing. Postal charges to be given in original letter.
3. Overseas Magazines and Bureaux be advised that the operator has chosen 1(b).

NEIL PENFOLD VK6NE
FEDERAL QSL BUREAU MANAGER

90.04.13 REPORT OF FEDERAL EDUCATION CO-ORDINATOR FOR THE YEAR ENDING 31ST DECEMBER, 1989

The year 1989 will be remembered as the year in which examination devolvement finally became a reality.

After over two years of discussion and consultation with the WIA and a number of other bodies, DoTC appointed an Examinations Officer to oversee the devolvement process.

Keith Carr-Glynn did an excellent job, moving swiftly and efficiently, and keeping us informed of progress throughout.

Consequently this has been a very busy year in the Education field. Liaison with

DoTC has been close and continuous and, I believe, mutually beneficial.

We were very pleased that DoTC acceded to our request for access to the examination Question Banks before their distribution. I received the draft copies in May, whereupon I convened a meeting of education representatives from the Divisions for mid-June to review the questions. Unfortunately only VKs 3, 4 and 7 were able to attend the week-end meeting, but some input was received from the other Divisions in response to my circulation of a number of the questions to them. It was not possible to review the whole of the two banks in the time available, but full comments were eventually sent to DoTC. Most of our requests for amendments to the Novice bank were granted, but a significant number of which we did not approve were allowed to remain in the AOCF bank.

The second half of the year saw the release, in stages, of the revised banks, both in printed version and on computer disk, the Regulations bank, the CW program on disk, the procedures volume and the exam generation program. The Examinations Officer then stated that he was ready to receive question papers for accreditation.

It is pleasing to note that when the Examinations Officer relinquished his position at the end of January 1990, there were 70 names on the examinations mailing list, and over 200 papers had been accredited. It is also pleasing that a degree of co-operation is developing between the Divisions with regard to examinations. Some feedback is reaching me about the Divisional planning for examinations and the preparation of papers. I have also received a number of comments about the banks and the generating program.

I have prepared two papers from each bank which will be made available as sample papers, and expect to have a stock of accredited papers available shortly. I am not entirely happy with the generating program, but I believe that the main problem lies in the uneven distribution of questions in the banks. There is an urgent need for more questions to be added in some sections.

The low points in the year are the old ones of lack of information input from members. I have asked for listings of clubs in each Division, but so far only VK4 has responded.

I have also had little response to my requests for information on classes, on-air CW training sessions or schools with active amateur stations. There is a great need for a central register of this type of information.

In summary, most of the year has been taken up with activities related to devolvement. I have had the usual range of requests for information, sample examination papers or CW tapes. I have attended Executive meetings, Joint DoTC/WIA meetings, some club meetings and several club or zone conventions.

Future activities which I see as important are:-

- a. continued liaison with DoTC about examinations;
- b. establishment of links with all other examining bodies;
- c. setting up a register of times and venues of examinations;
- d. collection of examination statistics and information;
- e. preparation or collection of new questions to be added to the banks;
- f. preparation for evaluation of the devolved system after about two years.

Recommendations

Now that devolvement has taken place, it is time to review some of our earlier ideas. Since we have a great number of examiners, there does not seem to be any need for the employment of a Federal Examinations Co-ordinator, as was recommended in 1987. This recommendation should be rescinded.

A similar recommendation that provision of examination materials be on a cost recovery basis should be reaffirmed.

It is also recommended that all examination materials produced by WIA agencies carry appropriate identification to ensure that candidates are introduced to the WIA at the earliest opportunity. The change in the examination system gives us the best opportunity for years to recruit new members.

I would like to thank all those who have helped me this year, whether by providing information, criticising questions or discussing ideas. They have made my work easier and more enjoyable, thus making it more valuable to members and the WIA.

BRENDA EDMONDS VK3KT
FEDERAL EDUCATION CO-ORDINATOR

90.04.14. REPORT OF FEDERAL HISTORIAN FOR YEAR ENDING 31ST DECEMBER 1989

Most of the material held by the WIA is now stored by the Federal Historian. The radio journals are accessible for research, but need further cataloguing. However any additions can be readily coped with and would be gratefully accepted, particularly journals issued before 1940 except perhaps QST. It has been difficult to respond to some specific detailed requests simply because of the difficulty in locating a specific item in a large amount of uncatalogued material.

It has not been possible to accept offers of historic hardware because of the difficulty of collection and storage, but I have suggested

that offers should be made to Divisions or to amateur collectors. Should the WIA have a new policy on the possibility of a museum or do we depend on the enthusiasm of Divisions and individuals?.

It is essential that we continue to sort and catalogue the present documentary material. Much of the valuable work done by previous historians has not been fully used because of the lack of continuity resulting from the inevitably intermittent cataloguing. The present system would not meet the standards of a professional archive, but it will allow easy and not-too-slow access to the material as required.

J W EDMONDS VK3AFU/ATG
FEDERAL HISTORIAN

90.04.15 REPORT OF AMSAT-AUSTRALIA COORDINATOR FOR YEAR ENDING 31ST DECEMBER 1989

1989 has been yet another busy year as many more Amateurs look towards the Amateur Satellite Service with an eye to using one or more of the 7 new satellites due for launch in the first 2 months of 1990.

The first 6 will be launched aboard an European Space Agencies Ariane 4 launcher. Two satellites (UoSAT-D and UoSAT-E) were built by the University of Surrey group and are similar to the previous UoSATs namely scientific and educational satellites with the exception of UoSAT-D which has a general-access Amateur Packet Radio store-and-forward package similar to FUJI-OSCAR-12 but using 9600 baud AFSK. The other 4 satellites are known as MICROSATS (because of their size - 9" cubes). Two of the Microsats i.e. PACSAT (AMSAT-NA) and LUSAT (AMSAT-Argentina) will have general-access Amateur Packet Radio store-and-forward packages, another Microsat known as WEBERSAT (Weber State College in Utah) will carry a video camera imaging system and the fourth DOVE will be an educational satellite with a Digital Voice synthesizer speaking messages and satellite telemetry in a number of different languages. The 7th satellite due to be launched in February 1990 by the Japanese Space Agency NASDA will be an 'enhanced' replacement for FUJI-OSCAR-12 which was decommissioned in late 1989 due to insufficient power budget. This new Japanese Amateur Satellite will be put into a much more favourable orbit and therefore should be able to support much more store-and-forward packet radio bulletin board service (PRBBS) and it also has a Mode J voice transponder.

Other events that occurred during 1989 that have seen an upsurge of interest in the

Amateur Satellite Service have been the Amateur Radio operations conducted by the Russian Cosmonauts on the Soviet Space Station MIR on 145.550 MHz FM simplex with hundreds of contacts being made by Australian Amateurs with modest 2 metre equipment. The lead up to the decay of UoSAT-OSCAR-9 on the 13th of October 1989 also generated a significant amount of interest as many Amateurs and school children monitored the 2 metre beacon telemetry of a dying spacecraft that had given 'virtually' continuous service since its launch on 6th October 1981. AMSAT-OSCAR-13, the Amateur Satellite which allows world-wide communications on 145, 435, 1269 and 2304 MHz bands completed its first year of service on the 15th June 1989. The use of the Mode S transponder began in April 1989 which meant that many more Amateur signals are now appearing on the 2304 MHz band. On a slightly low note the computer software on OSCAR-13 failed 3 times during the last 3 months of 1989 due to extreme high energy particle bombardment caused by the high solar activity but Ground Command Stations in Germany and Australia reloaded the software and had the satellite functioning again within (on at least 2 occasions) 24 hours.

To give the Federal Councillors some appreciation of the interest in the Amateur Satellite Service during 1989 AMSAT-Australia received just over 1200 items (compared to 1000 in 1988) of correspondence requesting information on hardware, literature and of course tracking and telemetry decoding software from Amateurs and non-Amateurs. AMSAT-Australia also produces an 8 page monthly NEWSLETTER which has now had over 500 subscribers since it started production in April of 1985. Also since April 1987 I have 'manually' uploaded and downloaded Packet Radio messages from the Digital Communications Experiment (DCE) on UoSAT-OSCAR-11 to and from Australian Amateurs to Amateurs throughout the world. The majority of messages have been between Amateurs in Australia and the UK on the basis that as GB2UP is a special event station the DCE traffic does not constitute 'third party traffic'. I am still awaiting feedback from the WIA and DoTC negotiations on this subject since November 1988.

Finally, I would like to thank the WIA for its continued support of the Amateur Satellite Service via the activities of AMSAT-Australia and ask the 1990 Federal Convention to recommend that the WIA strongly support the formation of an IARU Satellite Fund by whatever means are at its disposal and that the financial support for AMSAT-Australia be continued at the present level.

GRAHAM RATCLIF, VK5AGR
AMSAT-AUSTRALIA NATIONAL
COORDINATOR

90.04.17 REPORT OF FEDERAL TAPE CO-ORDINATORS FOR YEAR ENDED 31ST DECEMBER 1989

During 1989 both Ron and I worked hard to meet the aim of the Federal Tapes in providing high quality news and comments from the Executive Office of the WIA for dissemination on weekly Divisional News broadcasts.

The tapes were recorded fortnightly in the Executive Office with two news segments on each tape.

Preparation of the news material for a two news segment tape averages five man-hours; the recording a total of another man-hour; and duplication of the tapes and despatch another two man-hours..

Again this year, several constructive comments were received from Divisions which helped us to even further improve the presentation of the news.

Unfortunately, on several occasions during the year, the Federal Tape segment was not included in a particular Divisional broadcast without explanation to the listeners.

Spot checking of the Divisional news broadcasts by both Ron and me again showed a marked difference in quality of replay of the Federal Tape from Division to Division. Apparently this is a result of the different equipment used for replay in the various Divisions, as the tapes are checked for consistent quality before being despatched from the Executive Office.

Both Ron and I would like to thank those volunteer Divisional broadcast announcers and engineers who helped us so ably in presenting news from the Executive Office of the WIA to the amateurs of Australia. The comprehensiveness of the Divisional news broadcasts gives Australian amateurs a news service which is unequalled in coverage anywhere else in the world.

If invited, both Ron and I are prepared to continue as the Federal Tape Co-ordinators for the next 12 months.

BILL ROPER VK3ARZ
ON BEHALF OF THE FEDERAL TAPE
CO-ORDINATORS
RON FISHER VK3OM AND
BILL ROPER VK3ARZ

**Have you
 advised DoTC
 of your new
 address?**

90.04.18 ANNUAL REPORT OF THE GENERAL MANAGER & SECRETARY FOR YEAR ENDING 31ST DECEMBER 1989

The Executive Office exists mainly as a vehicle created by the Divisions to provide those member services, such as Amateur Radio magazine, the Call Book, membership fee processing, Customs certification, etc., which can be most cost efficiently carried out on behalf of the Divisions by a central body.

1989 was a year of consolidation of staffing, hours and procedures in the Executive Office.

Despite a lack of adequate resources, the outstanding backlog of work from previous years was almost brought completely up-to-date. With the completion of the clean-out of years of accumulated rubbish, re-arrangement of office furniture to maximise usage of the inadequate space available, finalisation of the filing systems, and rationalisation of the tasks performed, the office is now running much more efficiently than in previous years.

Some of the major achievements of the Executive Office during the year include:-

Installation and use of a facsimile machine.

Installation and programming of the new membership database computer.

Sorting out and transferring of the remnants of the Federal MagPubs operation back to this office.

Publishing of the 1990 Call Book.

Eradication of the five year backlog of contest trophies.

Commencement of compilation of instruction manuals for office tasks.

Placing of VHF Communications magazine operation onto computer, and making it commercially viable for the first time for many years.

Staffing of the Executive Office, which varied during the year because of ill health, and lack of adequate financial resources, currently consists of:

Full time paid employees

General Manager - Bill Roper 70-80 hrs pw

Part time paid employees

Assistant General Manager	
Ann McCurdy	21 hrs pw
Membership Secretary	
Helen Wageningen	18 hrs pw
Accounts/Mail Clerk	
June Fox	20 hrs pw
Clerical	
Chris Russell	18 hrs pw
Computer Maintenance	
Earl Russell	6 hrs pw

Volunteer workers

Librarian - Ron Fisher 5 hrs pw

Major problems in the Executive Office during 1989 continued to include:-

Lack of a Federal Treasurer.

Insufficient human and financial resources to handle the present work load on behalf of Divisions.

Inadequacy of the office itself (eg poor lighting, inefficient airconditioning, lack of space).

I enjoyed the seemingly impossible challenges of the position of General Manager during 1989. However, I do not believe that it is reasonable for the WIA to expect me to continue working 70 to 80 hours a week, and seven day weeks, as I have done for the past 22 months.

Either additional assistance must be provided in the Office, or work currently handled by the Executive Office must be devolved to the Divisions.

I would like to thank the Executive Office staff, those Divisional office bearers with whom I am in regular contact, the many members from all Divisions who have given me encouragement, and particularly the Federal President, Peter Gamble, for the support given to me during my time in this position.

BILL ROPER VK3ARZ

GENERAL MANAGER & SECRETARY

90.04.19 REPORT OF FEDERAL COORDINATOR INTERNATIONAL TRAVEL HOST EXCHANGE FOR THE YEAR ENDING 31 DECEMBER 1989

The International Travel Host Exchange (ITHE) is a voluntary scheme administered by the American Radio Relay League (ARRL) wherein interested radio amateurs are able to meet or host fellow operators from other countries.

Your name does not have to be on the list for you to take advantage of such hospitality, and you can do so when travelling around our own country. This is another free service from the WIA.

Send a SASE to the Federal Coordinator if you have an enquiry.

I personally hosted two visitors from USA and India during 1989 and I am aware of several contacts by other Australian ITHE participants. One American visitor visited an ITHE participant in nearly every Australian city! After a promising start in 1987, there was no net gain of VK members in 1989. The total Australian membership is still 25, and continued publicity at suitable intervals should improve the situation.

ASH NALLAWALLA ZL4LM/VK3CIT
FEDERAL ITHE CO-ORDINATOR

90.04.20 REPORT OF FEDERAL EMC (ELECTRO MAGNETIC COMPATIBILITY) CO-ORDINATOR FOR YEAR ENDING 31ST DECEMBER 1989

"Amateur Radio" published during the 1989 year EMC Reports in February, July, September and October. One more report has been sent to the Editor entitled "Several EMC Short Stories".

Several OMs expressed in letters and during phone calls their appreciation for the work done.

I pointed out in a letter (dated 17-4-1989) to the Editor, that we should make a definite distinction between the term "Interference" (to be used only for illegal radiation), and the term "Disturbance" (to be used when insufficient RF immunity of an appliance causes the collision). This is necessary for any legal argument, in order to show from the start who is to be blamed (see West Germany).

The document titled "THE NEED FOR ELECTROMAGNETIC INTERFERENCE STANDARDS" from the Department of Transport and Communication was received and studied. I was pleased to see that the WIA had a chance to point out what our position was as far as EMC is concerned. The reader could also see that the Department now had a correct understanding of the problem.

The European Common Market EMC Standards will force manufacturers world wide to design their products accordingly, if they wish to export appliances to this large market. This development should help Australia as well.

The WIA should perhaps now point out to the Department that, based on overseas experience, Australia should never allow Cable TV Companies to use frequencies which are exclusive international amateur radio frequency bands. Australia should follow the Swedish example. The claim of the cable TV operators, that their system is RF tight, is simply not true. We deal with signals of -144 dBm strength for satellite communication. The worst offenders of the cable TV system are the low quality cables branching off to the user and the coaxial connectors. It is important that cable TV companies know from the start that exclusive amateur radio bands will not be made available for their service. Shifting them later would be far too complicated and costly.

HANS F RUCKERT VK2AOU
EMC CO-ORDINATOR

ar

Soviets & China Learn About Emergency Communications

When natural disasters occur in Australasia, North America, or Britain, radio amateurs are trained and prepared to provide emergency communications. Their contributions are recognised by local authorities and appreciated by the general community in disaster affected areas.

Restrictions on the handling of Third Party Traffic imposed by many government radio administrations have prevented the greater use of amateur radio to provide communications during disasters. The lack of organised emergency communications was highlighted when a devastating earthquake hit Armenia late in 1988, and a group of eager United States radio amateurs offered their services. This sparked interest among Soviet authorities who saw how amateur radio can make a valuable contribution in times of emergency. Earlier this year with assistance from the USSR Radio Sports Federation, and the Red Cross, a new independent organisation called the Soviet Amateur Radio Emergency Service (SARES) was formed.

The SARES has appointed 25 regional co-ordinators to take control of training and disaster preparedness. The International Amateur Radio Network (IARN) has supplied SARES with a portable repeater and HF transceiver for use during training exercises and disasters.

China also is keen to learn all it can about amateur radio emergency communications. IARN Australian director, Sam Voron VK2BVS, has been invited by the China Welfare Institute to address radio amateurs in Shanghai. "They have no first hand knowledge of the use of amateur radio during disasters. The Chinese are very interested in what they've read in magazines and heard about disaster communications provided by radio amateurs in other countries," Sam said. He has played a role in international emergency communications for a number of years including those after numerous earthquakes, hurricanes and tropical cyclones. Sam will explain how radio amateurs can organise themselves in preparation for disasters, when he's the guest of the China Welfare Institute in Shanghai during the middle of May.

JIM LINTON VK3PC

ar

THE LAST WIRELESS ANZAC

JIM LINTON VK3PC

This month marks the 75th anniversary of the landing on Gallipoli of the ANZACs, when the combined Australian and New Zealand Army Corps did battle during World War I. A group of ANZACs will make a commemorative pilgrimage to Gallipoli on ANZAC Day this year.

A little known aspect about Australia's involvement in WWI is the role wireless played, and how a small group of Australians took wireless to the battlefield and were attached to the British forces at Gallipoli.

ANZAC veteran Hubert (Bert) D Billings, 95, of Glen Iris, Melbourne, tells a vivid story of his pre-war training and role in WWI, which included being a member of the 1st Signal Troop, Australian Engineers. This incredible character was in the 1st Light Horse Brigade, and later joined the Australian Flying Corps, the forerunner of the Royal Australian Air Force. Mr Billings was in the 68th (Australian) Squadron, Royal Flying Corps in England and France. During this later involvement, he was a member of the escort march for Baron (The Red Baron) von Richthofen's funeral in France, on April 21, 1918.

Before WWI, Bert Billings was a Victorian Railways clerk and a qualified telegraph operator. In 1910, the Australian Government passed the "Universal Training Act" which required every youth at the age of 18 to register for military training. It was a part-time three-year training scheme for home defence, and those called up could not be sent overseas unless they volunteered.

Mr Billings said: "I was also one of the first amateur wireless experimenters, with my own call sign, XJP, since 1912, and therefore had no hesitation in selecting army signals to serve in, and was duly posted to the 21st Signal Engineers."

Signalling in those days was mostly by hand-held flags; night-time signalling by a large oil-burning signalling lamp and, in sunlight, by heliograph using Morse Code, he explained. "In 1913, the Government bought the first wireless sets ever in use in the Australian Army. They were known as "500-Watt Marconi Wireless PACK sets" — six were obtained — one to Queensland, two each for NSW and Victoria, and one for South Australia," Mr Billings recalls. (See picture on opposite page.) The wireless sets had more than 250kg of gear. In the field they were carried on four pack horses, and needed six men to set up.



Bert Billings Circa 1917

Two 10-metre-tall steel antenna masts were erected 100 metres apart, plus guy wires and earth mats. The PACK sets had a nominal range of 30 miles but, under good conditions, this was exceeded.

Power for the set came from a 500-Watt alternator driven by a petrol engine. These two units were fixed permanently on a steel frame to form a pack saddle to be carried by horses. The receiver used a carborundum crystal detector with battery excitation and, with its massive transformer, was also carried by a pack horse.

Being a young amateur wireless experimenter, Bert was eager to get the first set in Victoria on-air. He said: "We unpacked the set for our unit, and assembled it on the road outside the Drill Hall by referring to the book of instructions supplied by the Marconi Company. No-one knew anything about it, but as I was the only one who had experimented with wireless, I was made senior operator. We erected the station, started the engine, and I called VIM, the Melbourne wireless station then situated in the Domain near where the Shrine now stands, and was very pleased when I got an immediate reply. This was the first time a wireless message was sent by the Army in Victoria, and I am proud to have been the first operator." The instruction book said a station could be set up in 15 minutes but, after plenty of practice, Bert and his colleagues were doing it in five minutes.

During peace time and in the early days of WWI, the 1st Signal Troop was

able to go into its training camp as a fully equipped unit with two mobile wireless stations. The camps were held at Broadmeadows, then an undeveloped area on Melbourne's northern outskirts, and the Troop would travel by horse from the signals depot in South Melbourne.

At noon on August 3, 1914, Australians were told: "England has declared war on Germany." The Australian Government later offered a fully equipped and trained force of 20,000 men to serve anywhere in aid of Great Britain. A similar offer by New Zealand, with a commitment of 10,000, came at the same time. About 20 members of the 21st Signal Engineers applied and were accepted for overseas service. Mr Billings recalls that early on August 19, they were sworn into their new unit — the 1st Signal Troop, Australian Engineers, 1st Light Horse Brigade, 1st AIF. Then followed training around Australia and, by October 20, the full AIF was ready, and so were 28 troop ships for them and their horses, and another 10 ships for the New Zealanders. The convoy was guarded by four warships in a trip which took six weeks travelling at 12 knots across the Indian Ocean.

On the night of November 8, the convoy heard that a German submarine sank three warships off the African coast, and sent one of its escorts to assist. Early next morning, an SOS was received from Cocos Island advising that a strange warship was approaching — and the signals then ceased.

The convoy was fearful it could be attacked. The cruiser "Sydney" was sent to Cocos Island to tackle the German raider Emden. Listening to the wireless traffic during all this drama was Bert, and his fellow signaller Orm Metcher. "It was with intense interest that we listened to progress reports and movements. Finally, we heard the historic message "Emden beached and done for", Bert noted in his diary.

The troops arrived safely in Egypt and underwent desert training. On April 1, 1915, the two wireless sections of the 1st Light Horse, and two from the 2nd Light Horse — 30 men and 40 horses — were placed on a ship. It was later explained to them they were on loan to the British Army for wireless communication and would be specially trained by the Royal Navy. This was in preparation for setting up wireless stations to help artillery observers pinpoint attacks on Gallipoli. The station with Bert Billings was attached to the Essex Regiment of the British 29th



This is the only known photograph of the wireless station and three who first operated it on landing at Gallipoli, April 25, 1915. Seated is Bert Billings taking a message from Sgt Orm Metcher, with Bill Dobbysns the engineer tending the petrol generator. Photo - State Library of Victoria.

Division, and followed the first landing party at Cape Helles on April 25. In research based on the British War Office records, Mr Billings has found the British simply omitted to bring any wireless stations with them — and the only mobile wireless stations in the whole of the Middle East were those with the 1st AIF. After shelling the Turkish forts on the high cliff shoreline, the troops landed with heavy losses. Sapper Wireless Operator/Mechanic Bert Billings transmitted the first artillery control message to a Royal Navy warship — HMS “Euryalus” — on April 27, 1915. Mr Billings said: “It has always been regretted by me this extra service by Australian soldiers was not recognised by some way, or at least recorded in British and Australian official histories.”

On May 25, the Australians got word they were to return to the 1st Signal Troop at ANZAC. The plan to capture Gallipoli and force the Turks back was a failure. In a cleverly planned evacuation over four weeks, the Turks did not have an inkling the army attacking them had been slowly going away. Mr Billings left on the last night, December 19, 1915. The battle of Gallipoli was lost, but the war continued and he found himself in the battle of Romani in the Sinai Desert.

In early October, 1916, he transferred out of the Light Horse to the Australian Flying Corps as an Air Mechanic, with

the rest of his service in England and France. The sense of balance which Light Horsemen had helped them easily to adapt to the flimsy aircraft of WWI. The spark wireless sets on the aircraft fed about 20 Watts into trailing aerals which had to be recovered before landing. By the time he was discharged, on March 28, 1919, Mr Billings had served 1682 days, of which 1559 were overseas.

After the war, he studied to become an accountant, and when WWII broke out again, served, this time in the Army as a Captain Auditor. Mr Billings was a cohesive influence which kept together the veterans of the 1st Signals Troop. He

proudly held the Troop's banner in the ANZAC Day parades in Melbourne. Although not continuing his amateur wireless activities after WWI, he frequently kept his fist in on a Morse key at his home. The last wireless operator from Gallipoli recently suffered a stroke, some two days before his name was published as being a member of the Gallipoli 75th commemorative party. Ill-health makes his joining the return to Gallipoli very doubtful. Through the eyes of his grandson, Malcolm Crook, a tour guide, he has been able to pictorially revisit the area.

ar

Cover Story continued from page 1

by a 6 Volt accumulator producing 35 Watts of power. The helical coil, shown in the photo, was used for antenna reactance compensation. The aircraft trailed 180 feet of wire as an antenna. The wavelength used was between 120 and 300 metres. The DC power circuit was keyed to produce morse signals. The quality of the spark was

observed through the window shown. Removal of this cover allowed adjustment of the spark gap. The operating range was about 15 miles to a crystal receiver on the ground.

We thank Bill Babb for arranging the photo, and Jim Davis VK7OW for the technical information. Photograph — Ashton Grave, Strathmore.

WIRELESS IN THE 1914/18 WAR

THE LATE ARNOLD HOLST MID
VK3OH (EX 3DB)
(SILENT KEY 1975)

Although we have already published extracts from this article — "A Little About Wireless In The First World War" AR p18 August 1985, we thought it appropriate to reproduce it in full, in view of the 75th anniversary of ANZAC. We are grateful to Jim Davis VK7OW for supplying this copy. The above reference contains pictures of the Marconi 500 Watt spark transmitter used both at Gallipoli and in Mesopotamia — Ed.

In December, 1915, urgent cables from India were received in Australia and New Zealand asking for the loan of men to help out the scanty communications of her Expeditionary Force "D" operating in Mesopotamia.

Both countries responded to this request and offered to supply and maintain complete wireless units in the field.

So the 1st Pack Wireless Signal Troop was formed. One officer and 54 other ranks from NSW and Victoria. This Pack Troop arrived in Mesopotamia on March 19th, 1916. On April 18th a troop from New Zealand arrived, and both were camped at Makina a few miles from Basra. Each troop supplied 4 pack wireless stations. April 25th saw the first Australian station go up river and attach itself to the 15th Div at Khamisiyah on the Euphrates. On its way it sent and received the first wireless messages handled by the Australians for Expeditionary Force "D".

In March 1916, the Imperial Authorities asked the Commonwealth to increase the wireless establishment in Mesopotamia, so the 1st Australian Wireless Signal Squadron was formed and arrived in Mesopotamia on July 6th, 1916. The writer was member of this squadron.

Those already in Mesopotamia, including the New Zealand troop, were absorbed into the Squadron. It camped at Margil near Basra, and was fitted out with its wireless equipment, horses, etc. It soon became officially known as "The Anzac Wireless".

Meanwhile, by arrangement with the Second (British) Squadron, it had been decided that the Anzac Squadron take over the advanced wireless work and leave the 2nd Squadron any work at the base. As it turned out, the Anzac Squadron did the lot. As the Army moved up the Tigris and the Euphrates, so did the

wireless, divided into many stations, waggon sets and pack sets, attached to Army HQ, Div HQ, Brigade HQ, Battalion HQ even to half platoons.

We had three pack sets with the Cavalry Division, and maintained continuous contact with HQ while the cavalry was on the move. This meant that one station at a time halted and erected its two masts, cleared its traffic, and dismantled, packed up and galloped with the cavalry rear-guard, who had waited for it, to catch up with the main body of the column.

So as the Army advance continued to Baghdad and beyond and into Persia with Dunster force, so our wireless stations moved with them and became separated by hundreds of miles.

Now a word about our equipment. This consisted in the main of two sets, one rated at 500W and one at 1 1/2 kW. These were made by the Marconi Co in the UK and were very good, reliable and robust. The 500 W set was divided into five separate loads carried as packs on horses or mules.

No 1 load consisted of an air-cooled petrol engine of 2-3/4 HP built by Douglas & Co (the same engine that Douglas used in their motor bike), evenly balanced by an alternator on the opposite side of the saddle. The connecting shaft was detachable. This ran at 1800 revs per minute. Attached to the generator was the rotary spark gap, so designed to produce a

Continued on page 36



Reinforcements for the ANZAC Wireless Section.

Back Row: Sapr MW Wraxall (NSW) Sapr CS Howitt (Qld), Sapr H O'Hagan (NSW), Sapr CV Sior (Vic), Dvr AD Eves (NSW), Dvr EW Williams (NSW), Dvr AE Short (NSW).

Third Row: Sapr HA Hill (NSW), Sapr AW Paul (Vic), Sapr AP Watson (Vic), Sapr RF Dodds (Vic), Sapr JAM Tait (WA), Sapr RH Treganowan (Vic), Sapr WJ Morris (NSW), Sapr TP Maher (NSW).

Second Row: Dvr R Crawford (NZ), Sapr AM Mitchell (NSW), Sgt RW Parsons (SA), Lieut JD Crawford (Vic), L'cpl Whitehall (NSW), L'cpl JG Bennett (NSW), Sapr HW Stewart (NSW).

Front Row: Sapr WD Tomlins (NSW), Sapr RF Clarke (WA). Photo from the archives of the Museum of Victoria.

THE RFM

NED STOUT VK6**

I suppose that if you were to read this account without knowing how it all came about, you could be forgiven for wondering if it is really true.

First off, I think you should know a bit about me and how I happened to be involved with this particular investigation. I'm not a young fellow anymore, and my education in electronics was obtained in the "old school" and most of what I know has come from reading books and magazines about ham radio. My interest in radio dates from before World War II; my experience began in the old crystal set era and, of course, went through the "valve age" and I'm into the solid-state era now. Well...kinda into it, anyway.

I guess you should know something about my employer, too. He is a wealthy industrialist and has very little understanding of technology, but he sure knows how to make money! I think the reason he likes me is because I am about the same age as he is — and I am self-taught. (Someone not having a technical background often feels it is easier to learn from someone like me, who is self-taught.) Oh yes, we call him The Boss, and he is working hard trying to get a Novice ticket at present.

The other bloke who works with me in the Lab is a young Novice who comes from a farming background. Besides being tall, he is young and healthy and is a genuine "bushie". The Boss and I call him Slim; his surname is Verdigal or something like that, anyway. Slim has a great imagination and is really good at improvising things that the Boss and I dream up...but I'll tell you more about that later.

I guess the only other piece of information you need to know is about the Lab. Well, the Boss doesn't want anyone to know its actual location but I can tell you that it is fully equipped with all the latest and best test equipment. Slim and I have never been refused any new piece of gear that we wanted, or a new ham rig to try out. (The Boss is especially keen on trying out new antennas...)

We have a fully air-conditioned four-wheel drive vehicle and often tow a trailer which contains a ten-kilowatt AC generator to power our ham gear when we work in the outback.

Well, now, having gone through all that I can get on with telling you about the RFM.

One day earlier in this year Slim and I loaded the 4-wheel with all the camping gear we thought we'd need for a little jaunt into the bush. We loaded plenty of

tucker, put water in the Jerry cans, and loaded up with seven-strand copper wire, insulators, rope, collapsible poles, etc, and headed up the coast towards Broome. Our task was to set up some place in the desert and make comparisons with the sorts of results we normally got on our home base which was similarly equipped. We had a transceiver (and a spare) and intended using dipole antennas. The main thing we were checking on was to see if any difference exists between using similar antennas over greatly different levels of water table. We know that the water table around the Lab is only 6 or 8 feet (usually) and that the desert has virtually no water table at all (we think).

On our third day out, we were heading generally northeast and were listening to the mobile rig. When we were listening to a QSO between a W7 and a JA2, we gradually noticed a rise in signal strength from both stations. At first, Slim and I didn't say anything to each other about this peculiar rise in signal strength, thinking it was due to QSB. However, as we drove along, the signal strength kept increasing and soon began actually blocking the receiver. I figured that something had gone wrong with either the AGC or the S-meter amplifier circuit. Although we had been quite thorough in checking out our gear before leaving on this jaunt, and had made sure that the mobile antennas were securely fastened, I have to admit that it had been a pretty rough ride, over several rocky outcrops and down along some dried-up streams. In fact, it was only a half-hour or so after I first noticed those extra-strong signals that we stopped for a short break in the bed of one of those dry rivers. When we turned off the ignition, and without any of the road noise being present, the signals were louder than ever. When the dust had settled a bit, I glanced at Slim and found that he was looking at me, too. We both shrugged and rather sheepishly started talking about the strange way the receiver had been acting, but that we hadn't wanted to mention to the other because we were both concerned that the other would think that something was wrong, personally, that is. We had a good laugh about that, but then we settled down and became serious and started to think of ways to investigate the strange signal strengths.

By this time the receiver was practically useless because of front-end overload, so we decided to disconnect the coax feedline at the base of the whip. The

signal strength dropped to about 25 db over S9, but there were so many signals on the band (we had tuned up on 15 metres) that we couldn't separate them. The signals were coming from all over the globe without any regard to skip conditions or area of origin. Occasionally we could copy a call sign. I remember hearing an A6X and a C31 and, later, a KH. Then we QSYed up to 10 metres, but had the same sort of results even with the antenna disconnected, so we dropped down to 80 metres CW. That band was completely loaded with signals from all over the world! Then we disconnected the feedline directly at the receiver, with the same sort of bedlam continuing, although at a slightly lower signal strength. There seemed to be a heck of a lot of American novices on the band, but we could copy other stations as well; one of them was signing 3V8 — and another was signing 8Q7; there were loads of other call signs.

By this time Slim and I both realized that we were onto something truly out of the ordinary. We decided to pitch camp right then and there and to sort ourselves out. I figured a scheme to check out the situation; the first thing seemed to me to be the requirement for an orderly system, so I made a check list:

- a. Try receiving on each of the bands, one at a time.
- b. Re-connect the antenna and try transmitting.
- c. Move the vehicle away from the river bed in various directions and repeat a, and b, above.
- d. Record all results for analysis.

It was while we were going through these procedures that, very hazily at first, I began to recall a story that an old Navy operator had once told me about his experiences during World War II. Although he, himself, had not actually experienced it, a similar extra-strength signal area had apparently been observed by an American aircraft crew flying over northern China. They reported the strange condition through regular military channels but, as the war was soon to end, there was not a great deal of interest or follow-up to the report. Later, after all the records had been security de-classified, the world political situation changed, and the subject was dropped.

After we got back to civilisation (some two weeks later) we told The Boss about our experience. He made us write it up and made copies of our logs and sent all this away somewhere (I don't know where) and that was all there was to it.

I haven't forgotten our little caper, I can assure you. As I thought about it more I recalled little snippets of information that I dredged up from the murky depths of my mind; I recalled that the Chinese were supposed to have given a descriptive name to their particular strong signal area; I think that, translated into English, it was something like Radio Frequency Magnet and I have always thought of it as The RFM. The Boss has said that Slim and I can go back into that river bed again, but he wants to come along! (He probably thinks that I made all this up.) ar

Wireless in the War

From page 34

synchronous gap with the alternator frequency. There were 24 studs on the disc and this gave six sparks a half cycle of the alternator (50 - 60 cycle), so this produced a very good note easy to read through the static noises.

No 2 load — two boxes containing the transmitting and receiving gear. When in use, one box was placed on top of the other. The top box contained the receiver, the key and portion of the transmitter. The bottom box contained a closed iron core transformer, the HF closed circuit, Leyden jar type tubular condensers and RF chokes.

No 3 load. Two valises containing rope guys for two masts, aerial gear and copper earth mats.

No 4 load. Sixteen sections of tubular steel masts when jointed to each other made two masts each 30 ft high.

No 5 load. Spare parts, stocks of petrol and oil.

The personnel of a Pack Station were one NCO in charge, a corporal in charge of transport, six operators and five drivers — all mounted. Each driver had a pack horse to lead and look after. Each operator had a number of duties in erecting and operating the station, long hours on watch and needed considerable skill in Morse. For all this extra, the Army paid him 1/- a day less than a driver. A pack set took about 7 minutes to erect, when the lads got a move on.

The receiver employed a Carborundum Crystal detector with bias provided by a couple of dry cells through a potentiometer. The circuit was very simple: A tuned aerial inductance and condenser, a tuned closed circuit parallel tuned with a small condenser, crystal detector and high impedance head phones. The frequency range was 300 metres to 1000 metres. We used 700 metres throughout the war. All messages were in 5 letter cypher. We were not permitted to use plain English. We used the "V" sign for "from" not "DE".

BOOK REVIEW

"US DISPOSAL REFERENCE"

IAN O'TOOLE VK2ZIO

REVIEWED BY EVAN JARMAN VK3ANI

In many an amateur shack lies a pile of military surplus equipment. For many, this equipment was the vehicle into the hobby, but has not been used since acquiring the S-line from Collins. Now its sole function, if any, is to keep the door open.

Occasionally it gets passed on at radio club auction nights, or conventions, to a novice trying to get on the air and not go broke! Alternatively, a nostalgia buff or collector acquires the equipment.

What usually happens is that some piece of equipment is lying around with just a number and you cannot be sure of what it is or its capacities.

Ian O'Toole (VK2ZIO) has come to the rescue. He has compiled a disposal reference guide. There are two volumes, British and American, with a third on Australian made gear in preparation. They are a montage of original advertisements for the equipment sorted by numeric/alphabetic order. Just browsing through the American manual (Volume 2) brought back so many memories.

The equipment is basically World War II surplus, although names like Hallicrafters and Hammarlund appear with gear aimed specifically at the amateur market. The old favourites are there, AR88, BC348 etc, along with the more obscure; more than 700 items.

The 500W pack sets had a guaranteed daylight range of 35 miles but we worked 2 to 3 times that in daylight, and at night time up to 200 or 300 miles.

Our other type of set was a 1.5 kW Wagon set and consisted of two limbered wagons, each drawn by teams of six horses driven postillion fashion. Two masts, 70 ft high when erected, were carried in sections. The receiver was similar to the 500W set, but the transmitter had a 7 HP water cooled engine made by Douglas. The alternator was larger than the 500W set as were also the components of the transmitter. The low voltage supply from the alternator to the transformer primary was broken by the operating key in both types of sets.

Throughout our service in Mesopotamia and Persia of more than 3 years, we transmitted and received countless thousands of messages of vital importance to the Army operations without delay or error. In this we were greatly helped, because a large proportion of our operators were ex Post Office or Railway Telegraph operators. A few, such as the writer, were "Wireless Hams" or in today's language "Radio Hams".

I include extracts from letters to our

One of the more novel specifications shown is the price: from 98 cents upwards for complete equipment.

The RCA AR88N is \$49.50, a price that won't be seen on communications receivers these days. Alternatively, some of the uses that various advertisers say their products can be put to are at least novel: A Sonobuoy that converts easily "for quick and easy two-metre FM fun", for example. Another is the multiplicity of parts or uses for a B-29 bomb sight described as "an invaluable machine for experiments, laboratories, physicists, tech institutes, schools, engineers, research men, repair men, mechanics, manufacturers, opticians and electricians", and goes on to list the types and number of parts that it contains. About the only use they left off was for dropping bombs — its originally designed function.

The ultimate for appliance operators is the trader who offers a complete station on HF, all bands with full power. Included is the shack, fully constructed, with 10kW generator. A deal that no one has yet matched. For those with an interest in identifying war surplus, or the nostalgia buff, this manual is a good source of information or memories. Full details are available from Ian O'Toole, 222 Old Northern Rd, Castle Hill, 2154. Phone (02) 680 2112.

unit received after the War: from HR Hopwood (CGS to Sir Stanley Maude)

"...The work of the Anzac Squadron was beyond praise. I believe that I am absolutely correct in stating that no single instance occurred in which there was failure to transmit, without loss of time, any message entrusted for despatch. Especially was this the case early in 1917 during the operations which preceded General Maude's final advance on Baghdad in March of that year, while the work of the unit during the actual advance was admirable."

From General Wm Raine Marshall:

"...It was, therefore, a special source of pride to have under my command in Mesopotamia an Australian & New Zealand Wireless Unit. During their four years service with the Mesopotamian Expeditionary Force they were distinguished by efficiency in the technical part of their work and by the grit and unflinching cheerfulness which were characteristic of all ranks in carrying out their duties. I know what a high opinion my distinguished predecessor (Sir Stanley Maude) entertained of this unit, and I am proud to endorse the opinion of that great soldier."

ar

TECHNICAL CORRESPONDENCE

VCR Interference Solutions

I read Ray Turner's letter in February AR, concerning his VCRTVI problem. Instead of writing to Ray I felt it may be desirable to write in a general way about the problems that he is experiencing and perhaps a number of other people with the same troubles may be helped to find ways to overcome the insidious problems that VCRs experience.

Firstly, as observed, putting low-pass filters in the transmitter output did not help since it would appear the transmitter was clean as no TV sets experienced the problem. Second no observable improvement was achieved through using a high pass filter on the VCRs. The question has now to be asked, what quality were the high pass filters? There have been a lot of high pass filters on the market over the years but only in more recent years have good homegrown Australian filters been available — admittedly at higher prices compared to imported junk. You can expect to pay between \$20 and \$55 for good quality filters. The preferred type is a combined high pass filter with a 1:1 ferrite cored RF transformer which acts as a braid breaker. This combination works well in most cases, and is to be preferred to filters that are either a

high pass or a braid breaker but do not combine the two. You may need one of these but I suspect that it will not completely cure the trouble.

The next step, having fitted one of these combination filters is to go and buy yourself a ferrite rod about 20cm x 9.5mm from Jaycar or Dick Smith or whoever is your favourite supplier, and wind the power cord over the ferrite core starting at one end and finishing at the other. Wind it tightly and tape it in position. You may need also to wind the power lead of the TV set onto a ferrite rod too. Wind the filter up close to the VCR so only a small amount of lead hangs out the back of the VCR.

This combination has now filtered both the TV antenna coax lead and the power lead and hopefully removed most if not all the troublesome RF out of the VCR.

If this combination has achieved some improvement, make sure that there are no extension leads on the TV to extension speakers etc, as they will pick up the TX RF quite well.

If you still have trouble I would suggest that you are getting to the stage of having to shield the VCR. This becomes more difficult involving bonding of various panels, putting aluminium cooking foil over some areas of the VCR and earthing them to some frame metal. However, many VCRs have mostly plastic cases and good earthing spots are

hard to find. Keep in mind that double insulated devices should not have exposed metal, so the shields will have to be inside the unit, but make sure nothing will short out the works, as if it does you won't have to worry about interference/lack of RF immunity in the VCR. Sometimes even just wrapping the VCR in foil over the outside and not even earthing it has been known to succeed.

80 metres is a bad band for RF immunity problems with VCRs as much of the video signal from the heads is low level RF in the general range 500 kHz to 4 MHz or thereabouts so no wonder 80 metres gives it a caning. It is not an impossible task to overcome the interference/immunity problem as TVs, audio equipment, and VCRs are regularly made to work successfully almost beneath Radio Australia's antennas at Shepparton where the ERP is of the order of 2,000,000 watts on 6 megahertz.

Good luck with it Ray, suggest you endeavour to get your antenna as far away as possible from other TV/VCR combinations, although this may be difficult as you appear to live in a batch of flats. I would appreciate knowing how you go with it.

RODNEY CHAMPNESS VK3UG
17 HELMS COURT BENALLA 3672
ar

Scout Radio & Electronics Service Unit (Victorian Branch)

During Easter 1990 many of the Venturers in Victoria will be taking part in the 1990 Hoadley Hide. As a part of the support services for this large event, the Scout Radio & Electronics Service Unit will be providing radio communications in the forest area involved.

To the un-initiated, the Hoadley Hide is a Venturer Hiking/Activity competition camp, conducted during Easter each year. Venturers are the section of the Scout Movement consisting of young people aged from 14 — 18 years.

The object of the weekend depends on your point of view.

To the Venturers the object may be to cover the maximum number of activity sites in the shortest distance, meet new friends and have fun. This must be achieved while keeping the team fit and healthy.

To the Leaders the object is to provide the means for the above not forgetting

safe, healthy, secure camping sites and keeping track of around 900 Venturers in the forest. This also includes co-ordinating the movement of over 1500 people into and out of the forest; this number includes Venturers and their parents transporting them, Rovers (the 18 — 26 age group that provide many of the activities), Leaders and families.

To the Radio & Electronics Service Unit the object is to provide the radio comms to support the leaders in the above. It doesn't end there however, the comms team are often called upon to fix all sorts of other radio and electronic related problems, the help is provided when possible.

To provide the support required, an army of radio operators and equipment is moved in to the forest and set up. The bands used are 80m HF to provide comms over distance and mountainous terrain; 11m (27 MHz CB) to provide for comms to leaders with existing CBs in their cars; 2m VHF FM to provide high quality comms over the local area. To assist

the 2m operation this year's Hoadley Hide should see the first airing of the new Scout portable repeater VK3RSR.

The five base stations are generally staffed by 3 operators each. The operators roster themselves so-to ease the work load and to eat, sleep etc. Normally the bases operate for around 16 hours per day with the HQ base maintaining a 24 hour watch.

The Radio & Electronics Service Unit would like to hear from any interested people whether in the Scout movement, or just believing in the ideals of Scouting, who are interested in assisting with this activity or other service unit activities. The Scout Radio & Electronics Service Unit (SR & ESU) aims are to provide communications, training and advice to the Victorian Branch of Scout Association, on radio and electronics related matters.

For further information please contact Philip VK3JNI Home Phone (03) 438 3013.

ar

HOW'S DX

STEPHEN PALL VK2PS
PO Box 93 DURAL 2158

Sprately Islands 1S

It has been reported from several amateur sources and DX bulletins, that activity from this group of territorially disputed islands will take place in the second part of March. RL8PYL was organising the group of four USSR, two Japanese and four Vietnamese amateurs to travel to an abandoned Vietnamese military base aboard two helicopters with 10 soldiers and a doctor. When you read this, the event has either taken place or not. Propagation-wise there should be no difficulty working them, provided you are able to overcome the QRM in the dog-pile.

International Marconi Day

April 21 has been designated as International Marconi Day, and it will be celebrated from 0001 to 2359 UTC by activating at least 14 special-event stations in the world, working from various places which have special significance in Marconi's wireless activities. The stations are K1VV/IMD, VE1IMD, VO1IMD, EI2IMD, IY4FGM, GB0IMD, GB2IMD, GB4IMD, IY0TCI, IT1TMM, ZS6RSA, DA0IMD, GB2MDI, F7IMD. There is a special award if you work at least 10 of the above stations. Apply for the award with a GCR list and \$US5.00 or 10 IRCs to CRAC, PO Box 100, Truro, TR1 1RX, England.

Bouvet . . . Again

If you worked them, send your card with the necessary SAE+IRCs to: Club Bouvet, Box 88, N-1361 Billingstadsletta, Norway. Those who listened on the expeditions' frequencies will remember the bedlam, QRM and jamming. Because of the split frequency, many stations transmitted on the wrong (listening) frequency, not knowing the correct method to use two VFOs. As a result, the FCC — the equivalent of our DOTC — has issued 240 written warnings to US amateurs for out-of-band activity. It looks like authorities in some countries do monitor the amateur frequencies.

Crozet Is FT-W and Kerguelen Is FT-X

New operators are now active from these islands. FT4WB Jean Louis is on Crozet, FT4XA is on Kerguelen. QSL card for both of them to: FD6ITD: Jean-Pierre Berthomieux, 29 rue du Cammas, F-31650 Orens de Gameville, France. FT5XH — FT4XG and FT4XI go to also on the island. QSLs for FT5XH to go to Jacky Calvo F2CW, Le Bois de L'essard, Nercillac, F-16200 Jarnac, France.

DX QSLing

In the last issue of "AR" I gave you some hints what to do to make sure that your QSL card gets safely to its destination. Here is another tip: Your innocent-looking envelope, on which you have affixed a nice variety of colourful Australian stamps, can become the prey of a fanatical stamp collector. (Yes, besides amateur radio, there are also other fanatical hobbyists . . .) Advice: Some of our post offices can issue you with a franking machine sticker instead of stamps. Stamp vending machines at bigger post offices will issue you similar stickers. By franking your overseas letters in this fashion, you have removed an additional temptation at the other end.

WARC bands

Graham VK6RO reports a hive of activity, both CW and SSB, between 24890 kHz and 24990 kHz. The following countries were worked recently in a short space of time: C31, JR7, ZK2, UL7, UD6, XW8, UQ1, G0, UF6, UW9, SV5, S79, XV2, DU3, 9V1, LY2, HL1, RA2, J37, UH8, LZ1, UO5, UG6. Please note that the ARRL Board has accepted the recommendation of the DX Advisory Committee that the 5BDXCC can now officially be endorsed for 12 and 17 metres (7 band DXCC). The 30-metres endorsement is still pending.

Future DXpeditions

It appears that the abandoned DXpedition to South Sandwich Island and South Georgia Island, which was to have taken place with the second Bouvet operation, is now scheduled between November 15 and December 15, 1990. Please note in advance in your DX diary, if you have one.

Bangladesh - S2

Jim VK9NS, who is still prepared to go to Buthan provided he gets the necessary visas etc, is very hopeful that in the meantime he will be able to operate for a short period from Bangladesh in the near future.

Juan Fernandez Island - CEO

Look out for some activity from the island of Robinson Crusoe. A group of operators from Chile intends to activate the callsigns CEOZZ and XQOZ during late March and/or early April. QSL to: CE3BFZ: Pedro Barroso, PO Box 13312, Santiago 1, Chile.

Interesting QSOs and QSL information

To save space, I have omitted the repetition of kHz after the frequency, and UTC after the time. All frequencies are in kHz, and the time is in UTC, unless otherwise indicated.

FY4FC Aimee (yl exFK8FA) 14MHZ SSB at 1025. QSL to: Box 447 Mont Dore, F98607, French Caledonia. AP2TN Tariq-14022 CW at 2110. QSL: Tariq Nasseer Khilji, F-289 Rehman Pura, Lahore 16, Pakistan. A92EV 28490 SSB at 0605. QSL: PO Box 833 Bahrain, Middle East. TA5L 28495 SSB at 0548. QSL: GAR 54 Adana, Turkey. P4/N4NXX Danny 28MHZ SSB at 0330. QSL: PO Box 2209, San Nicolas, Aruba.

JP1DMX/H18 Saya 21205 SSB at 0505. QSL: via JA1ELY via Bureau. PJ2HB Hank 14151 SSB at 0654. QSL: WA2YMX, Mark S Horowitz, 3465 Carrolton Av, Wantagh NY 11793. 9H1HV Silvio 14156 SSB at 0730. QSL: Bureau. 3W3RR Roman 14165 SSB at 1212. QSL: Bra Ven Kong, Box 308, Moscow, 103009, USSR. Send two IRCs. VP2VE Lee 14111 SSB at 0940. QSL to: WA2NHA: Howard Messing, 90 Nellis Drive, Wayne, NJ 07470. YJ0ABF Berthold 28006 CW at 0224. QSL: via DF5WA via Bureau. AP2ASA Asim 14228 SSB at 1237. QSL: via Bureau or direct. YJ0AHM Hilde(yl) 14200 SSB at 1317. QSL: via DL5UF via Bureau. VR6JR Jim 14222 SSB at 0651. QSL: via G3OKQ: J Russel, Greenfingers, Oyster Lane, Byfleet, Weybridge, Surrey, England. VR200PI/JR Jim 14222 SSB at 0650. QSL: via KB6ISL. Dr G O'Toole, 9605, San Gabriel Ave, South Gate, CA 90280 USA. LQ9DX Ser 14204 SSB at 0704. QSL: PO Box 36, Buenos Aires, Zip 1834 Argentina. A35KB Kevin 14222 SSB at 0606. QSL: PO Box 1, Nuku-Alofa, Tonga. WZ6C/ST4 Erik 14222 SSB at 0501. QSL: W4FRU: John H Parrott Jr, PO Box 5127, Suffolk, Virginia 23435 USA. C21DD Dumas 21205 SSB at 0512. QSL: PO Box 177, Nauru. 9H1EU Tony 14243 SSB at 0707. QSL: WA4JTK: Alan E Strauss, 17401 NW 47th Ave, Carol City, FL 33055 USA. 5W1AU Phillip 14222 SSB at 0511. QSL: W6KNH, Clyde J Schoenfield Jr, 42 Donald Drive, Orinda, CA 94563 USA. 5B4SA Lawrence 14222 SSB at 0627. QSL: Lawrence Kymisis, Box 1531 Nicosia, Cyprus. VY1FF Gerard 21205 SSB at 0544. QSL: VY1AU: William Champagne, 12 Tamarack Dr, Whitehorse, YT-Y1A 4W2 Canada. DK1CE/H44 Ulmar 21191 SSB at 0515. QSL: via DJ9ZB: Franz Langner, PO Box 150 D-7637 Ettenheim, West Germany. V29C Bruce 14227 SSB at 1211. QSL: W2GBX, Bruce Siff, 2069 NE Collins Cir, Jensen Beach, FLA 34957, USA. OD5FK 14222 SSB at 0634. QSL: PO Box 16-5443 Beirut, Lebanon. JT1BY Tom 14222 SSB at 0625. QSL: PO Box 470 Ulan Bator, Mongolia. YJ8M Marek 14222 SSB at 0615. QSL: PO Box 217 Port Vila, Vanuatu. SV9AHZ John 14243 SSB at 0802. QSL: PO Box 92 Hania, 73100 Crete, Greece.

4UVIC 21028 CW at 1226. QSL: via Bureau (OE) HL9HH Harry Herr, PO Box 3695 APO San Francisco 96366 USA. JT1BC Lham 14048 CW at 0940. QSL: via Bureau. CN8ST Tariq 14021 CW at 2030. QSL: F2CW (see address in this issue). EA8AB Paco 21014 CW at 2000. QSL: via Bureau. PJ2AM Art 14005 CW at 2300. QSL: via Bureau.

RTTY News

Some of you asked me to provide interesting RTTY information. As I do not operate in this mode, I asked the doyen of the RTTY enthusiasts, Syd Molen VK2SG, to assist me, and he agreed. Here is a brief picture of Syd: Started amateur radio in 1947 and became an HF DXer. Late in the 1960s, RTTY started to become a new mode of DXing. Syd, together with another RTTY enthusiast well known in VK2, Bill Storer VK2EG, founded ANARTS —The Australian National Amateur Radio Teleprinter Society, which is the national body of RTTY, Amtor and a mixture of Amtor/ Packet data modes. Packet later developed its own national society. Syd started to send out DX notes on RTTY around 1972. His transmission is now a regular weekly news bulletin on each Friday on the RTTY frequencies, usually on 14 MHz, and reaches every RTTY mode operator around the world. Here is a sample of rare DX in the RTTY mode as published by Syd: 4K2OIL 14094 at 0015. QSL: Box 341 Omsk, 644099 USSR. ZP6EM 14091 at 0110. V5MAH 14085 at 0148. VP8BFH 14093 at 2040. QSL: Box 60, Port Stanley, Falkland Is. TZ6VV 21093 at 2040. JW7SP 14082 at 0149. QSL to: LA3T. HR2JAE 21090 at 0021. QSL: Box 2020 San Pedro, Sulva, Honduras. J28TY on 28097 at 1147. EL2MR 28087 at 1627. QSL to: WA8LKS ZD8BOB 21088 at 0838. QSL: Box 2, Ascension Is, South Atlantic. D2ALA is now QRV on RTTY. JX9CAA will be on Jan Mayen until October. Kergulen and Crozet should be active now: all bands and all modes. Question: RTTY and DX enthusiasts! Is this what you want? Shall we continue? Drop me a line.

From Here and There and Everywhere

Bing VK2BCH is on the mend. He put in a brief appearance on one of the nets early in February, but it will take some time before he is fully fit. IAØPS was an Italian station on the "Terra Nova" Antarctic Italian Research Base. RI1OA was a very strong signal from Uzbekistan on 14226 at 1240. Please note: The Indian QSL Bureau is not functioning. All QSLs to Indian stations to be sent direct, or to QSL managers, otherwise no QSL from VU. D2/LU6ELF and ZS9 (Walvis Bay) have now been accepted by the ARRL DXCC committee as a DX country. Walvis Bay cards as far back as 1977 are in order but will be

accepted only after June 1. YS1MAE was heard on 14222 at 0537. Pete KN0E/KH3 has changed his callsign to AH3C. AP2UR was heard in a CW QSO on 14005 at 1157. Shanti 4S7WP wants his cards to be sent to Box 80, Colombo, Sri Lanka. The "TADZHIK DX Club" was formed recently. President is Alex UJ8JJ. Secretary is Alex UJ8JV, and vice president is Alex Rubstov, UJ8JCQ. His address is PO Box 1102, Dushanbe 734032 Tadzhikistan USSR. The object of the club is to activate rare oblasts in a number of southern republics, ie UI, UM, UJ. They want to introduce suitable awards and are looking for small donations in the form of IRCs and small green stamps. In return they promise you a numbered certificate. The address of the VQ9 QSL Bureau is Diego Garcia ARC, Box 15, NSF, FPO San Francisco, 96685 USA. Received a letter-type QSL from Simon Chan S79SC with lots of technical information on FEBA radio, a Christian broadcasting station with programmes in 29 languages to many countries around the Indian Ocean. Incidentally, despite the modern up-to-date broadcasting equipment, Simon's amateur equipment is a 1969 KW2000A.

The international DX Conference of the Spanish LYNX DX Group will be on April 28-30 in the Mediterranean town of Benidorm. KX6DC has had his callsign changed to V73AZ. Frank Hine, VK2QL, one of the big DXers of the past (mostly on CW) said in his notes, which he sent to me, that it was he, as VK4QL in Townsville, who originated this DX column in the early 1950s, when still on active service with the RAAF. W9GW was active for one week as T32BN. UR2QD changed its callsign to ES1QD. Matts SM7PKK is now in American Samoa as KH8/SM7PKK. He survived Wallis Island, where he ran out of money. He hopes to go to Niue ZK2 before attempting the voyage to Tokelau. Tony VK9LA wants his QSLs to be sent to DJ5CQ. One-line info: ET3PG is on the air, no further details. JD1YAA was active in the CW mode on 10 MHz. VK5NVW advises that he and VK6JS are checkpoints for the "CQ" Magazine, and can check QSL cards for most "CQ" awards. For further info, send a large SASE to any of these two stations.

Interesting QSLs Received

Direct QSLs: 3D2PL, JY5FA, KHOAC, 3B8FV, YK1AA (return from operator in three weeks) BZ4RCC (return from operator in seven weeks) YB1BGD (return from operator SAAD in four weeks) KH6JEB/KH7 (return from operator in two weeks)

Bureau QSLs: FY5AN (sent direct, received through the Bureau, seven months). 9H1GY, 9H4R, H44/DL2GAC, CE6EDZ, HC8DX (two years and three months), 5W1HV.

Route unknown: FR4FD, JW1MFA, PJ1B, 8P9EM, 9X5NH.

Answer to the Big Question

Following my appeal to the readers of this column in the January 1990 issue of "Amateur Radio" to make comments and voice opinions about the usefulness of this column, I received many more letters, notes, QSL cards with comments, than I expected. Instead of a dozen or so, I received 37 replies from the following: VK2: DLB, QL, DID, CWS, DEJ, BHS, FNJ, DTH, DOJ, APD, VFT, RZ. VK3: DVT, ZJ, AJU, EBP, VQ, LDT, JI, AQZ. VK4: DA, TT, OD, OH. VK5: BAS, LB, NVW, RK, KL, WO. VK6: AMK, NV, NE, RO, AGH. VK7: CV, YP. No comment from other call areas, nor (to my surprise) from any SWL reader. Here is a sample of what the readers say about the column: "I read the column before the ham ads." "The column is up to date with news that a DXer needs." "For me the DX column is the only worthwhile part of AR." . . .

Not one of you said that I should change the format, but many suggested good ideas for improvement. All of you said, in quite definite terms, that I should continue as editor of the DX column. Here is a summary of the suggested improvements:

1. You want early DX news on upcoming DXpeditions. This is difficult because of the lead time of "AR" (average four weeks) and because this news appears on the bands only about two-three weeks before it happens, unless it is planned in all detail, like the one for Bouvet, which expedition was planned for more than six months.
2. You want full QSL information with complete postal address. This takes up space and will cut down the number of QSL infos published per month.
3. You want more DX information on 160-80-40 and WARC bands.
4. Some of you want RTTY news.
5. List of QSL managers' names and addresses with regular updates.
6. QSL cards received to be grouped into direct and Bureau QSLs.

To achieve all this, I need your assistance, which will shorten my time in monitoring the bands. Please send me detailed information of your rare DX QSOs and QSL addresses, and any other DX news which you think should be shared with the other DXers. I thank you again for your splendid effort in sending your replies to me.

Many thanks for the assistance received from VK2SG, VK2FNJ, VK2QL, VK4DA, VK4OH, VK5BAS, VK5KL, VK5BS and VK5NVW, and the DX bulletins: "QRZ DX" and "The DX Bulletin". Please keep the information rolling in.

Late news: Jim VK9NS has received permission to travel to Bhutan and hopes to operate from A5 at the beginning of April.

Good DX and 73.

VHF/UHF AN EXPANDING WORLD

ERIC JAMIESON VK5LP
9 WEST TERRACE MENINGIE 5264

All times are Universal Time Co-ordinated indicated as UTC

Australian Amateur Bands Beacons

Freq	Callsign	Location	Grid square
50.056	VK8VF	Darwin	PH57
50.066	VK6RPH	Perth	OF78
52.200	VK8VF	Darwin	PH57
52.320	VK6RTT	Wickham	OG89
52.325	VK2RHV	Newcastle	QF57
52.330	VK3RGG	Geelong	QF21
52.345	VK4ABP	Longreach	QG26
52.370	VK7RST	Hobart	QE37
52.420	VK2RSY	Sydney	QF56
52.425	VK2RGB	Gunnedah	QF59
52.435	VK3RMV	Hamilton	QF12
52.440	VK4RTL	Townsville	QH30
52.445	VK4RIK	Cairns	QH23
52.450	VK5VF	Mount Lofty	PF95
52.460	VK6RPH	Perth	OF78
52.465	VK6RTW?	Albany	OF84
52.470	VK7RNT	Launceston	QE38
52.485	VK8RAS	Alice Springs	PG66
144.400	VK4RTT	Mount Mowbray	QG62
144.410	VK1RCC	Canberra	QF44
144.420	VK2RSY	Sydney	QF56
144.430	VK3RTG	Glen Waverley	QF22
144.445	VK4RIK	Cairns	QH23
144.445	VK4RTL	Townsville	QH30
144.465	VK6RTW	Albany	OF84
144.470	VK7RMC	Launceston	QE38
144.480	VK8VF	Darwin	PH57
144.485	VK8RAS	Alice Springs	PG66
144.530	VK3RGG	Geelong	QF22
144.550	VK5RSE	Mount Gambier	QF02
144.600	VK6RTT	Wickham	OG89
144.800	VK5VF	Mount Lofty	PF95
432.160	VK6RPR	Nedlands	QF78
432.410	VK1RBC	Canberra	QF44
432.420	VK2RSY	Sydney	QF56
432.440	VK4RSD	Brisbane	QG62
432.445	VK4RIK	Cairns	QH23
432.445	VK4RTL	Townsville	QH30
432.450	VK3RAI	MacLeod	QF22
432.535	VK3RMB	Mount Buninyong	QF12
432.540	VK4RAR	Rockhampton	OG56
1296.410	VK1RBC	Canberra	QF44
1296.420	VK2RSY	Sydney	QF56
1296.440	VK4RSD	Brisbane	OG62
1296.445	VK4RIK	Cairns	QH23
1296.480	VK6RPR	Nedlands	QF78
2304.445	VK4RIK	Cairns	QH23
2306.440	VK4RSD	Brisbane	OG62
10445.000	VK4RIK	Cairns	QH23
? operation doubtful			

SIX METRES

The six-metre band has been relatively quiet for the past month. From the VK5 viewpoint, there have been the usual VK2 and VK4 openings from time to time, and at least five observed openings to JA.

Thanks to John VK4ZJB who phoned on 7/2 to advise that he, VK4ZAL, VK4ZNC and VK4KU had been successful on that day at 0330 in working Terry V73AQ (10 Watts) from the Marshall Islands. Good work. Also pleasing to know the Marshall Islands are still active.

On 11/2 from 0100 there were wall-to-wall JAs from JA1, 2, 4, 5, 7, 9 and 0 with many signals 5x9. The dogpile on 50.110 was due to attempts to work VK9TAX who was 5x9 in Japan. The VK9 location was not known but could have been from the Cocos-Keeling group of islands in the Indian Ocean. Another station being called was VK9PN mobile, possibly from the same area. At the same time the JAs were working a few VK2s and VK5s.

East Coast of USA

With a degree of excitement in his voice, John VK4ZJB phoned on 27/2 to say that day between 0000 and 0045 Brisbane stations had worked to the eastern States of the USA with signals to 5x5. Those involved were VK4ZAA, VK4ZAL, VK5APG, VK4GC, VK4ZNC and VK4ZJB who worked WA2UFZ, N2HZW, KB2FDZ, WB2BZB, WA2BPE, WA8EON and N8JGM; in addition VK4ZNC worked W1APO while VK4ZJB excelled himself by working VE3KKL in Canada. Congratulations gentlemen, a very good effort.

I suppose it was to be expected some good contacts would eventually evolve in the light of so many strong solar flares being observed on 50 MHz during the past few days, the S meter had risen to S5 several times on solar noise at Meningie. Therefore, everything seems to be in readiness for some excellent DX on 50 MHz during March/April and possibly May.

Austria on Six Metres

Per favour of Graham Thornton, VK3IY, Managing Editor of AR, advice has been received from Dr Ronald Eisenwagner, OE4REB, that amateurs in Austria have been granted the use of 50.000 to 52.000 MHz from 1/2/90 to 31/1/91, with the following restrictions: All modes with bandwidths of 3 kHz or less; maximum power 25 Watts measured at the transmitter antenna terminal; horizontal

antenna with a beam-width of 100 degrees or less; no mobile, portable or air-mobile operating; there are area restrictions during the operating hours of TV-1 (generally 0900 to midnight local time) for most of OE3, all of OE1 and OE4 and parts of OE6. Optional extension of operating beyond 31/1/91 will depend upon the 12-months' practical experience.

Thus another European country becomes available for six-metre contacts. It is not known how many amateurs are affected by the restrictions — it seems highly likely that the unrestricted zones will be areas of low population density but there may be some stations with sufficient interest in the outer areas to make contacts to Australia possible during a European opening.

DX-pedition

In a very brief note, Steve VK3OT advises that GB4MSS will operate from UA0 in grid square NQ59CN from March 1 to April 15, 1990, operating with CW on 50.105 and SSB on 50.110. No other details.

1000 Mobile Contacts

Graham VK6RO has written to say that on 13/2/90 at 0609 he worked JA0BBE on 50 MHz CW for his 1000th contact to Japan using his mobile station with an output power of about 10 Watts from his TS680S and a vertical quarter-wave antenna!

Graham said his first QSO with Japan was on 10/10/79 with 2.5 Watts. During the 1000 mobile contacts modes used have been AM, FM, SSB and CW.

Well, what can one say? It must take a very dedicated operator to achieve that goal from the cramped conditions of a car and I am sure the VHF fraternity will say well done for that effort, Graham.

From the USA

From Bill Tynan's "World Above 50 MHz" in QST, comes advice that at last a breakthrough has occurred to the northern areas of California from Europe when K6QXY, WA6BYA, W6JKV and K6MYC all worked FC1BUU on 28/12/89.

KL7JKV from Alaska reports having more than 1900 six-metre contacts during the US autumn period. Most contacts have been with JAs, but other areas worked include VK, KH6, KG6, VS6, KHØ, DU, HL, KH4, JD, VE, W and XE. KL7JKV and AL7C have both worked all Japanese prefectures, a significant feat, indeed.

From the same source comes news that Dave W5UN worked 13 new countries in 1989 via two metres EME. They were 4J1FS, CT3M, T2ODJ, T3ODJ, HC5K, V63MB, HD8E, F6EYM/CT, ZK1RS, FK1TS, ZD8MB and HL9TG.

Bill Tynan also writes that "ever since W1HDQ and other east-coast stations made

it across the Atlantic on 50 MHz in 1947, VHFers have been speculating on the eventual achievement of six-metre DXCC. Some said it couldn't be done, and most HF DXers, when the possibility was posed to them, simply scoffed."

However, despite the many obstacles, it seems that 100 countries worked on six metres has been finally achieved. VE1YX submitted the first DXCC application to the ARRL in early December 1989 and K5FF, W5FF, K8WKZ, W4CKD/8 and K1TOL are also said to be at the 100 mark. The first 10 to qualify will receive 50 MHz DXCC plaques, and all awards will be numbered.

On behalf of Australian amateurs, I congratulate the above operators and others who will shortly follow them with 100 countries. It is a fine effort, only made possible by F2 propagation and probably one of the best solar cycles ever, plus the operators' dedication to the task in hand. The task has been made a little easier by many administrations making 50 MHz available to amateurs in countries never before to have operated on 50 MHz. Despite various restrictions in some areas, contacts have been made with rare countries.

While on the subject of Bill Tynan W3XO/5, I was most unfortunate to miss him during his recent tour of Australia. Bill called at my house on 27/2, the only day I had been absent since Christmas Day — a day when I had an appointment with a medical specialist in Adelaide. Such is the luck of life, but I was most disappointed, as Bill and I have been swapping VHF notes for years.

50MHz DX Standings

For some time now I have been contemplating the best way to handle various 50MHz contacts made during the past few years up to July 1, 1989, when the present expanded operating conditions were laid down. All

50MHz contacts have been listed separately whilst the matter was sorted out. I believe the following parameters are not unreasonable given the varying circumstances which prevailed in different Australian States.

1. Contacts made between the hours of 1500 and 0000 (midnight to 0900 EST) will be accepted from VK1, 2, 3 and 4.

Explanation: These times seem a reasonable compromise in regard to the operating hours of Channel 0 stations (suggest 0000 to 1500 daily). I have neither the time nor resources to check the operating schedule of every Channel 0 station, particularly when related to the multitude of amateur 50MHz contacts made at various times, especially in 1988/89. From my observations, it seems some stations were given a form of official/unofficial go-ahead providing no interference was caused to Channel 0 television transmissions, and this seems to have clouded the issue.

2. Listed contacts from stations in VK5, 7 and 8 will be accepted at face value.

Explanation: Although stations in these call areas were limited to a power of 25 Watts during the operating hours of Channel 0 stations, again it is impossible for me to know at what time they could legally increase their power, and I certainly have no means at my disposal to establish what power levels were actually used by any station. However, I do know from my own operating that few contacts were lost due to the use of a lower power level. (I rarely run more than 20 Watts on six metres these days because there exists a potential TVI problem if I do, so I play it safe!).

3. There are no restrictions applied to stations in VK6 or any VK9 call area.

No doubt my stated views above will not

satisfy everyone, but I believe there are enough ifs and buts which apply to 50MHz operation prior to 1/7/89 for some compromise arrangements to be made. After all, those of us who were fortunate to live in areas with none or few restrictions do not really know how WE may have operated with rare DX pouring in had we lived in one of the eastern States. It is easy to make statements from the safe side of the fence!

Equally, I don't want complaints about the 0000 cut-off from eastern States operators. Under the circumstances, I believe this is a fair and reasonable compromise; also, you will have more opportunities than VK5, 6 and 8 to again work the DX from across the Pacific in the coming months, and possibly the next two to three years, thus making up for any shortfall in your original listing.

Having said all that, I now invite operators to submit their lists before June 20 for ALL stations worked — those presently listed after 0000 can go down as "heard contacts" until finally validated by a new contact. For the sake of the record, we need to know who worked who on 50 MHz!

CLOSURE

By the time this is ready, hopefully we will be in the full swing of exotic F2 DX on 50 MHz. For some it will mean rising from bed earlier than usual, as many such contacts will commence around 2200 or earlier, and most will be finished by 2400. During March/April 1989 signal levels often peaked around 2300.

Closing with two thoughts for the month: "By the time parents are ready to enjoy the comforts of life, their children are using them", and "Rose-coloured glasses are never made in bifocals. Nobody wants to read the small print in dreams".

73 from The Voice by the Lake **ar**

POUNDING BRASS

GILBERT GRIFFITH VK3CQ
7 CHURCH ST BRIGHT 3741

If you are 'in the know' like me and read your AR each month, you will be getting a little concerned about the future of The Code. Each time I see an article or a letter advocating abolishing Morse, I say to myself, "What can I do?"

This month I have a little idea which, I assure you, is not an April fool joke. We all know the basics behind the digital keyer, and many have now built or bought electronic keyers to make our sending damn near perfect... well.

The ACCUKEYER, developed by Jim Garrett, WB4BBF, has been around in one form or another since 1973, and was featured in Electronics Australia in March 1978, by Ian Pogson, about the time that Dick Smith

started selling the kit. The article from EA was reprinted in LO-KEY in June 1989.

Recently I have received a number of enquiries about the circuit and the kit (not available) and remembered my efforts to obtain all the bits and pieces. I thought it would be a good idea to make the ACCUKEYER a little more available, because even though the Curtis 8044 makes the ACCUKEYER obsolete, it is still the only offering with the automatic letter-spacing feature, something every beginner should use. How to make them more available is to make my own offer to collect unwanted and maybe broken ACCUKEYERS and make them available to budding Morsiacs on a non-profit basis. I am not going to do repairs on your keyers —

you can do that yourself — but, if you cannot be bothered and you have one sitting in your junk box, you can send it to me and I will then make it available to newcomers to the code. All it will cost you is the postage and you will know that your keyer will be back on the air in good order. I can even keep a list of contributors and recipients, if you like. Do it now, and keep Morse Code alive.

If you, like me, thought that building QRP gear was just a matter of soldering in a few components, then you could not have been more wrong. I am presently putting together a CW transceiver using the Howes kits which I have assembled over the past year or so. You would be excused for thinking that this was just a matter of finding a suitable box and bunging everything in. Ha! I just don't know where to stop at the moment. Even considering just the receiver and transmitter modules, I need an antenna switching circuit and corresponding delay circuitry with extra override controls on the front panel; the metal-

work is already a pain. Now, if I want the extra VFO, it has to go in its own box, inside the main cabinet, with switches to swap VFOs, and more holes in the front for tuning caps and RIT. What about the audio filter? There goes another switch in the front panel. Should I install that 8044 on its little board? Or will the speed control clutter the layout? It would

make an ideal source of side-tone though, so I'd better put it in. What about the transmitter — do I want the crystal channels installed? I have a five-position switch for that. Then I can also use either VFO for a transmit frequency source . . . fine . . . no, now the cabinet is too small; I reckon I'll need one about the size of the IC751A. All this for a

'brew rig'!!! Can I fit a battery in there? It will make it handy for portable work; might as well put the paddles in the front as well. Who says home brew isn't fun? I've already drilled about 40,000 holes in the thing. What about a carry handle, antenna tuner, heeellllp!

P.S.: I'll let you know when it's finished . . .
. . . 73 Gil ar

AMSAT AUSTRALIA

MAURIE HOOPER VK5EA
11 RICHLAND ROAD NEWTON SA 5074

National Co-ordinator

Graham Ratcliff VK5AGR

Information nets

AMSAT Australia

Control: VK5AGR

Amateur check in: 0945 UTC Sunday

Bulletin commences: 1000 UTC

Primary frequency: 3.685 MHz

Secondary frequency: 7.064 MHz

AMSAT SW Pacific

2200 UTC Saturday, 14.282 MHz

Participating stations and listeners are able to obtain basic orbital data including Keplerian elements from the AMSAT Australia net. This information is also included on some WIA Divisional broadcasts.

AMSAT Australia Newsletter and Computer Software

The excellent AMSAT Australia newsletter is published monthly by Graham VK5AGR on behalf of AMSAT Australia and now has over 270 subscribers. Should you also wish to subscribe, send a cheque for \$20, payable to AMSAT Australia, addressed as follows:

AMSAT Australia, GPO Box 2141, Adelaide 5001.

The newsletter provides the latest news items on all satellite activities and is a "must" for all those seriously interested in amateur satellites. Graham also provides a software service in respect to general satellite programmes made available to him from various sources. To make use of this service, send Graham a blank formatted disk and a nominal donation of \$10 per item to AMSAT Australia, together with sufficient funds to cover return postage. To obtain details of the programmes available and other AMSAT Australia services, send a SASE to Graham.

Editorial — Are We Lucky?

You will notice from the following articles that Jas-1b was successfully launched, making seven new amateur satellites this year! On the minus side, Uosat-E (Uosat-Oscar-15) appears to have suffered a major mishap shortly after being placed in orbit — to date,

no signals have been heard from it after the first few orbits.

You will no doubt have heard that the mission 36 from Kourou in February suffered total loss shortly after launch. The Microsats/Uosats were on mission 35! Perhaps luck was on our side . . .

Another Successful Launch

HR AMSAT news service bulletin Silver Spring, MD February 12, 1990
A new Oscar is born: Fuji-Oscar-20

On Wednesday, February 7, 1990, at 01:33 UTC the National Space Development Agency of Japan (NASDA) launched an H-1 booster from its Tanegashima Space Centre. Aboard this launch vehicle were three payloads: MOS-1B, DEBUT and JAS-1B. MOS-1B is a marine observation satellite and is intended to be used for oceanographic resource studies. DEBUT is an experimental satellite which will have deployable booms and an umbrella-shaped antenna. The third payload was JAS-1B, the JARL follow-on satellite for FO-12. The three satellites were successfully injected into orbit. Separation of DEBUT and JAS-1B from the upper stage of the H-1 occurred over Santiago, Chile at 02:33 UTC February 7. At that moment the 50kg amateur radio satellite which is now known as FUJI-OSCAR-20 was born! The upper stage of the H-1 rocket at that point had successfully completed the final boosting of FO-20 to an apogee of 1700 km. At this altitude, FO-20 would be in a more favourable orbit from the standpoint of not having to experience long solar eclipse periods for the first 150 days after launch. After day 300 and until day 470 after launch, FO-20 will be in a sun-earth orientation such that it will not experience solar eclipse periods. This is expected to provide an excellent power budget for FO-20 users.

On the first orbit over Tokyo at 03:09 UTC, FO-20's CW beacon was heard at 435.795 MHz. The signal was strong and stable. The Doppler shift was estimated to be about 9 KHz. After the first orbit, many QSOs were heard on the Mode JA downlink passband between 435.800 to 435.900 MHz. For example, N9CZA and NK6K worked W6AMW

on their first pass on Mode JA. Also, on the second orbit, N5BF made CW contacts on FO-20 on Mode JA to WA4SBC, WB8ELK and KI6QE. On the third orbit, N5BF was able to even push a few packets through the Mode JA transponder using his PSK modem. Later, reports started to pour in about the excellent signals heard from FO-20. W2RS reports that he has worked G4CUO, G6HMS and G8ATE, all on SSB Mode JA on Orbit 38. On the same orbit, HB9XJ worked WA8VXH.

After the initial check-out of all the spacecraft sub-systems of FO-20 are accomplished, JARL will announce the operating schedule. Mode JD and the BBS may be released for service after the initial check-out is completed.

FO-20 Operating Hints

From Peter DB2OS

- Use shortest TXDELAY as possible (ie 30ms = T3).
- Do not use MAXFRAME greater than 2.
- Don't forget to switch the TNC to FULLDUPLEX.
- Disconnect BEFORE LOS to empty the user list.
- Make your contact as short as possible to give others a chance. (Do you really have to be connected from AOS until LOS??)
- Kill all your read messages!
- Watch 70cm clicks and QRM from your transmitter.
- Change transmit frequency for doppler (+-2kHz).

Don't forget to switch back to HALF-DUPLEX for terrestrial usage ;-)

Which UPLINK frequency?

HB9AQZ suggests the following system for selecting an uplink frequency:

Take the last letter from your callsign and select:

A . . . G -> 145.850 MHz
H . . . M -> 145.870 MHz
N . . . T -> 145.890 MHz
U . . . Z -> 145.910 MHz

example: DB2OS —> Uplink on 145.890 MHz
DL1CF —> Uplink on 145.850 MHz
any further ideas? 73 Peter DB2OS

Microsat Object Numbers Corrent

HR AMSAT news service bulletin
Silver Spring, MD February 18, 1990
NORAD/NASA gets the object numbers ordered properly for MICROSATS/UOSATS

This week, Ray Soifer (W2RS) and Dick Daniels (W4PUJ) confirmed that the North American Air Defence (NORAD) Command and NASA have finally managed to get the object numbers and catalogue numbers for the MICROSATs and UoSATs ordered correctly. After launch, the numbers were assigned based on the order in which the satellites appeared coming over tracking stations. This was definitely not the order in which the satellites were released from the third stage of the ARIANE rocket. In the weeks following launch, a great deal of time and effort were expended by W2RS, KA9Q and Max White of the Royal Greenwich Observatory figuring out who was who from the elements sets being released by NASA. Eventually, through the efforts of these individuals, the six new amateur satellites were correctly identified from the element sets being published by NASA. However, after AMSAT officials discussed the confusion caused by the random assignment of catalogue numbers with NASA officials, this problem was finally resolved. The following are the corrected object and catalogue numbers which will apply to all MICROSAT/UoSAT element sets after orbit #260:

Satellite Name	Int'l Object Number	Catalogue Number
UO-14	90-05B	20437
UO-15	90-05C	20438
AO-16	90-05D	20439
DO-17	90-05E	20440
WO-18	90-05F	20441
LU-19	90-05G	20442

WO-18 Picture Testing Continues

HR AMSAT news service bulletin
Silver Spring, MD February 18, 1990
WEBERSAT picture testing continues

It is a well-known axiom among photographers that if you want to take a picture of something, you must first point the camera lens in the right direction. However, in outer space it is sometimes impossible to know when your picture-taking satellite will be pointed down to earth. This is what the engineers of WEBERSAT-OSCAR-18 have learned this week from their recent picture-taking efforts. Chris Williams (WA3PSD) of Weber State University reported that of the six pictures taken so far this week, most did not contain anything very interesting to look at. One of the pictures appeared to have been taken of the sun and another appeared to be a picture of deep space. The others seemed to be brighter on one side than the other. Another consideration in the picture-taking process that needs to be taken into account is that the field of view of the CCD camera aboard WO-18 is about 20 deg. Anything outside of that is not seen. So, if the spacecraft, at the point when the shutter is snapped, is moving or rotating away from the earth's horizon, the earth will be missed. WA3PSD

OSCAR-13 Schedule for 01Apr90 to 09May90

Station: Adelaide

Hour - UTC

	0	1	2	3	4	5	6	7	8	9	10	11	12	13	14	15	16	17	18	19	20	21	22	23
01Apr																								
02Apr																								
03Apr																								
04Apr																								
05Apr																								
06Apr																								
07Apr																								
08Apr																								
09Apr																								
10Apr																								
11Apr																								
12Apr																								
13Apr																								
14Apr																								
15Apr																								
16Apr																								
17Apr																								
18Apr																								
19Apr																								
20Apr																								
21Apr																								
22Apr																								
23Apr																								
24Apr																								
25Apr																								
26Apr																								
27Apr																								
28Apr																								
29Apr																								
30Apr																								
01May																								
02May																								
03May																								
04May																								
05May																								
06May																								
07May																								
08May																								
09May																								

b means OSCAR-13 is in view and the Mode B transponder is ON using the Omnidirectional antennas
 B means OSCAR-13 is in view and the Mode B transponder is ON using the High Gain antennas
 L means OSCAR-13 is in view and the Mode JL transponders are ON
 - means OSCAR-13 is NOT in view

Satellite Activity for November/December 1989

1. Launches

The following launching announcements have been received"

Int'l No	Satellite	Date	Nation	Period min	Apog km	Prg km	Inc deg
1989-							
091A	COSMOS 2050	Nov 23	USSR	11h49m	39342	603	62.8
092A	COSMOS 2051	Nov 24	USSR	92.8	456	305	64.8
093A	KVANT 2	Nov 26	USSR	91.8	413	344	51.6
094A	MOLNIYA 3-36	Nov 28	USSR	156.0	40600	662	62.5
095A	COSMOS 2052	Nov 30	USSR	89.7	373	175	67.2
096A	GRANAT	Dec 01	USSR	5880	200000	2000	51.6
097A	USA 49	Dec 11	USA				
098A	RADUGA 24	Dec 15	USSR	1475	36551		1.5
099A	PROGRESS M-2	Dec 20	USSR				

2. Returns

During the period 85 objects decayed, including the following satellites:

1967-039A	COSMOS 156	Oct 23
1979-031A	MOLNIYA 1-43	Dec 09
1979-104A	ARIANE LO-1	Nov 27
1980-014A	SMM	Dec 02
1982-121A	COSMOS 1427	Oct 05
1984-104A	COSMOS 1601	Nov 29
1989-067A	COSMOS 1776	Dec 15
1989-066A	PROGRESS M	Dec 01

3. Notes

1989-093A KVANT 2 docked with the MIR manned space station on December 6, 1989. The add-on module KVANT was moved from the central docking port to a lateral port on December 8, 1989.
 1989-099A PROGRESS M-2, an automatic cargo craft, was to deliver expendable materials and various cargo to the MIR manned complex.
 1989-090A STS 33 landed at Edwards Air Base on November 28, 1989.

BOB ARNOLD VK3ZBB

wishes to emphasise that there is no evidence of anything wrong with the camera hardware or electronic circuitry aboard WO-18. Except for lack of a good picture of the earth, all the telemetry and data taken so far indicate everything is fine. Since none of the MICROSATs has an active attitude control system to keep it earth pointing, Chris indicates that more pictures will be taken at different latitudes. If you are collecting raw picture data from WO-18, Chris reports that WEBERWARE 1.0 will

be released in three weeks. This software will convert the data files into images. Computer requirements are an IBM compatible PC with an EGA or better monitor.

FLASH!

Late-breaking word is that a picture of the earth was successfully taken when WO-18 was over the Himalayas between 0500 and 0600 UTC on February 18, 1990.

73 from Maurie VK5EA ar

SPOTLIGHT ON SWling

ROBIN L HARWOOD VK7RH
52 CONNAUGHT CRES WEST LAUNCESTON 7250

There has been an addition to this shack, an Atari PC3 computer with an accompanying PCM124 monitor. This fine piece of equipment has taken much of my time over these past weeks, as I familiarise myself with the intricacies of operating it. It has taken me some time to be educated and, as a consequence, I haven't done much listening around. It is also my hope to eventually link up my Tono Theta 777 modem to this computer, so I can operate from my desk.

Also, a friend has lent me a Packet TNC to connect up on two metres with the computer but, alas, I haven't mastered that either, and do get increasingly frustrated. There is nothing wrong with it, just that yours truly is rather dense at putting information into the grey matter.

When I do at last crack it and make a connection, I will probably jump up and down with excitement.

I can readily appreciate how the addition will materially assist me in my monitoring activities, and already have started storing my loggings into the hard disc. It will also spur me onwards to sending out more frequent reports. After using this computer as a word processor, I won't be needing the old Adler to

type out reports and assignments, as previously.

When the Atari PC3 is linked up to the Tono 777, I should be better able to keep track of utility services, which are my main monitoring interest, especially with regard to the Intruder Watch.

A number of Australian metropolitan commercial outlets departed medium wave in February to populate FM. 3KZ, 5KA, 3GL have moved there with new call signs, with 4BK and 3AK to go and shortly join them. The channels are temporarily vacant, until they are required by either the RPH or PB stations, so those with loop or other MW antennas should, theoretically, be able to hear other stations there now.

On January 23, Radio New Zealand International came on-air with its new 100kW sender. It is located near Lake Taupo and, although it is not beaming to Australia, does provide excellent signals and audio. It is much more pleasant to receive now that the antique 7.5kW senders have been pensioned off.

The station no longer relays the National Programme, but concentrates mainly on Pacific/Melanesian dialects plus English. The best channel I have found is 17680 kHz from

REMEMBER
to leave a three second
break between overs
when using a
repeater

0300 to 0900 UTC.

Several international broadcasters have had to cut back programming due to budgetary restraints. The VOA is deleting Greek, Turkish, Slovenian and Laotian from the first of this month, with Uzbek and Shona from June 1. Religious broadcaster, Radio Veritas International in Manila has deleted its English releases.

The proposed VOA/RFE/Kol Israel facility in the Negev Desert of Israel is now in doubt, due to environmental and navigational concerns. As well, the changed political nature within eastern Europe and the USSR means that the facility is no longer a priority to either RFE or VOA. If the Americans do pull out, it would be left to the Israelis to pursue independently.

Radio Korea in Seoul has reached agreement with Radio Canada International to share each other's facilities, and is due to commence on April 2. RCI will be heard via R Korea from 1300 to 1325 UTC in Chinese on 6150, 1330 till 1400 in Japanese on 6095 and 1430 to 1455 in Chinese on 9700. Seoul, via the Sackville transmitters of RCI, will be heard on 11715, presumably in Spanish from 1000 to 1030 UTC — 1030 to 1100 in English. On 6145 and 9645 kHz, Korean programmes will be aired from 1100 to 1130 to North America.

Well, that is all the news for this month. Until next time, the very best of 73 and good monitoring! ar

ALARA

JOY COLLIS VK2EBX
PO Box 22 YEOVAL 2868

Women In Wireless

By Olive J Rockner VE7ERA
Condensed from the Canadian Amateur Radio Magazine

As a former seagoing brasspounder it saddened me to learn that CW is to be phased out commercially by 1991. No longer the friendly chatter of Morse around the world as ships on vast oceans reach out to other ships or to coast stations on distant shores. I would like to acquaint the reader with a relatively little-known fact — mention wireless operator to the average person and an image comes to

mind of a lone man hunched over a key. How many are aware of the part women have played in the annals of seagoing sparks, in particular, Canadian women? Records indicate the first young woman to serve at sea as a wireless operator was American, a Miss Graynella Packer, in 1910. Miss Packer remained only a few months, but by the end of the '30s at least 13 other young ladies had operated on vessels along the Atlantic and Pacific coasts and on the Great Lakes.

In 1940, the Merchant Marine began recruiting operators in Canada. Twenty-year-old Fern Blodgett had dreamed to someday become a sailor. Working days as a stenogra-

pher, she attended wireless night classes, gaining her commercial licence 18 months later only to discover there were no positions open to women. A few weeks later, however, Fern's former principal phoned and asked if she was still serious. "Yes" was the answer. Port authorities at Montreal were surprised to find that F Blodgett was a YL, but checked with the captain of the Norwegian cargo ship "Mosdale" to learn if a woman was acceptable. Captain Sunde was desperate and agreed. Fern proved to be a capable operator. Constant storms were the ship's lot and Fern witnessed many horrors of torpedoing and their attendant tragedies.

In 1942, Fern married Captain Sunde, and their honeymoon was spent at sea, in convoy. Mosdale was a lucky ship; she made 98 Atlantic crossings, of which Fern was aboard for 78. Fern retired from the sea after war's end to make her home in Norway. A book of her

adventures, "Lucky Mosdale", became a best-seller in Norway.

The second east Canadian woman to take up the sea was Esther Crichton of Halifax. She sailed aboard M/S "Narvik" in the Pacific area during the latter war years, and retired in early 1947.

The first west Canadian girl to receive her licence was Ina Waller of Kimberley BC. She did not go to sea. She served in the Marine Room at VAI, the Pt Grey Wireless Station, and as an interceptor operator there and at Victoria. A number of others earned their commercial tickets during the war years and were employed mostly as interceptor operators at various DOT stations. From Western Canada there were three who sailed in wartime. Ola McLean of Vancouver and Alice House of Port Coquitlam graduated from Sprott Shaw School of Radio in 1944, determined to ship out, and succeeded later that year in an uneventful crossing of the Pacific. A brief report appeared that Ola and Alice had arrived safely in an Australian port aboard an Allied (not Canadian) tanker after a voyage during which they were treated royally. The article stated that the two were prevented from signing on a Canadian ship by marine regulations in Canada.

Alice later served on the Norwegian tanker "Karsten Wang", and in 1947 married Captain Olaf Hansen who has been second officer of the same Norwegian tanker on which she had made her first voyage.

Ola McLean remained at sea for a number of years, her voyages taking her to most of the ports of the world. The third western YL with wartime experience was Rosemary Byrom of Victoria, who joined her first Norwegian ship in San Francisco and remained aboard for a year. Service on three more tankers followed, one of which sailed in the last convoy to cross the Atlantic before VE day. Rosemary retired about 1947.

After VJ day, women interceptor operators were released from government service and Anna Ozol secured a position aboard a Norwegian vessel and achieved the doubtful distinction of being one of the few women who had to send out an SOS; happily the vessel was able to make port without aid.

On leave in February 1947, Anna brought word a Norwegian ship in San Francisco needed an operator. Within days, Elizabeth King was fulfilling her longtime wish to ship out. Elizabeth joined her first vessel and sailed across the Pacific to the Philippines, Orient and Australia, remaining aboard just over a year, and after a lengthy holiday ashore, shipped out again in another vessel also sailing the Pacific routes. Elizabeth served until early in 1951 when she left the sea for good.

After Elizabeth, Norma Gomez and myself quickly followed. Norma was assigned to a coastal vessel with primitive conditions and she retired six months later.

I was more fortunate, replacing Esther



Merilyn Wright WA4NR



Sisters Maxine Reams N6GGR (left) and Gerry Swanson KD7RA.

Crichton, and served four years, covering much of the world.

The only other Canadian girl who went to sea in those years was Lylie Smith. She shipped out in 1946. Prior to that she had been the first girl radio operator hired by the Hudson's Bay Fur Trade Co for its northern posts. Probably the longest at sea of any of the Canadian YLs, Lylie spent five years on the Far East routes, and another five years sailing between the US, Europe and South America.

By the late '40s and early '50s, Norwegian

girls were taking over more of the positions on their country's ships. The few Canadian YLs settled ashore and no others followed in their wake. Until 1970, when Dallas Bradshaw from Victoria BC went to England for training, and became the first woman operator to sail aboard a British ship.

Predominantly, it has been Scandinavian countries which have accepted women operators, mainly Norway and Sweden, and other countries, Denmark, Finland, Germany, Russia and Great Britain. The US started is, although its numbers have not been as great

as Scandinavia. American girls have continued to serve since the latter war years in their merchant marine, Coast Guard, and on Army transport and hospital ships.

A number of YL professionals are also amateurs, with callsigns many will recognise. Elizabeth VE7YL also had the callsigns EP2ELA and YB0ADT. Kirsti VK9NL, and Kari VR6KY. Others, Sylvia LA10GA, Mikaela DK5EJ/OH2SG, Esther W6BDE and Lota AC7V.

Ship's operators may disappear, but Morse will be around for a long, long time, of that I am convinced. For many of us it is, and always will be, mysterious music that spans the globe — our other language.

Bits and Pieces

Heather VK2HD was pleased to have the opportunity of meeting Lloyd and Iris Colvin

when they took time off from being rare DX stations in remote parts of the world to visit Sydney earlier in the year.

Reminder: Thelma Souper (WARO) Contest — April 7 and 8, 1990 — 0700 to 1000 UTC each day. (Rules March AR).

We certainly have Iris Colvin to thank for activating so many new YL countries, but other YLs continue to appear on the bands from remote places. One worked recently (unfortunately not by me) was Patti N3CRH/TJ (Cameroon). Makes obtaining YL-DXCC much easier than it used to be.

It has been very pleasant recently to hear some "new voices" on the Monday night ALARA Net, and the numbers joining us on 80 metres are increasing, in spite of the band being a bit noisy at times. VK6 members have special problems in the summer, which make it very difficult for them to join the official net at that time of the year.

From the "War Widows" magazine
*Oh, give me your pity, I'm on a committee
Which means that from morning to night
We attend, and amend, and contend and defend
Without a conclusion in sight.
We confer and concur, we defer and demur
And reiterate all our thoughts
We revise the agenda with frequent addenda
And consider a load of reports.
We compose and propose, we suppose and oppose
And the points of procedure are fun!
But though various notions are brought up as motions
There's terribly little gets done.
We resolve and absolve, but we never dissolve
Since it's out of the question for us
What a shattering pity to end our committee
Where else could we make such a fuss?
Author unknown*

That's it for this month. 33/73. ar

REPEATER LINK

WILL MCGHIE VK6UU
21 WATERLOO CRES LESMURDIE 6076

Thank you to all those who wrote, telephoned or contacted me via Packet radio. The response was not in the hundreds, but it was pleasing to hear that a repeater column can contribute to better repeater management.

Desensing

If your repeater is running with no problems and has lots of technical input from experts, then skip over this paragraph. If we could go back in time and redesign the off-set on two metres for repeaters, I would not choose 600KHz. It is just too close for high performance on a consistent basis. Many amateur repeaters on two metres suffer at some time from desensing. However, it is impossible to change now. Does your repeater suffer from desensing? Maybe you think it does not but, in fact, it does — how do you tell? The simplest way you can find out is when you next visit the site, try the following test. Ask an amateur to transmit a signal that produces a slightly noisy signal into the repeater's receiver as monitored on the repeater's loudspeaker. Now turn the repeater's transmitter off and see if the noise as received from the weak signal reduces. If it has, then your

repeater is suffering from desensing. Maybe you are not going up to the site for a while, so try this second method of finding out if your repeater system is desensing. Find an amateur who can vary his power output down to almost zero. While you monitor the repeater's output, ask the other amateur to slowly reduce the power output of his/her transmitter, on the repeater's input, down to zero. If the signal you are receiving on the repeater's output slowly becomes noisy and turns the repeater's transmitter off once only without the repeater transmitter keying on and off in a regular fashion, then your repeater does not suffer from desensing. A regular on-off cycling of the repeater's transmitter means your repeater does suffer from desensing. What to do about it is another matter, but at least you will know if your repeater is as sensitive as it can be.

Autopatch

Autopatch is similar to phonepatch, but differs in two important ways. Firstly autopatch is a phone connection via your local repeater, and secondly the amateur signal can be mobile. These differences may seem

slight, but they make autopatch illegal. It may be that the first difference, connection via your local repeater, is no longer a problem. Making a phone call via a repeater implies automatic dialling and, until now, this was not allowed. If what I read lately is true, automatic dialling is now permitted. The second difference is, as I understand it, the only remaining reason for autopatch being illegal. Telecom has the monopoly on mobile phones in Australia and, as a consequence, autopatch is not allowed. I may be wrong in my assumptions of the situations, so if you know better, please let me know. It often comes as a surprise how the commercial world affects the world of amateur radio. To think that autopatch could in any way compete with Telecom is, of course, ridiculous, but it may be the foot in the door for other organisations to connect radio systems to the telephone. This may change as an investigation into Telecom's monopoly of the mobile phone service is under way.

Just maybe this outcome will bring amateur in Australia a lot closer to autopatch. If my assumption about it being illegal to operate from a mobile situation into the phone system is correct, then phonepatch cannot operate to a mobile HF radio. As you can read, I have many unanswered questions so, please, if you can explain the situation, contact me by writing or phoning on (09) 291 7165 or Packet radio VK6UU at VK6BBS. ar

Stolen Equipment

Stolen from Andrews Communications Stand at the Gosford Field Day, one standard C520 2m/70cm handheld transceiver Serial No F140829. Contact Andrews Communication Systems PO Box 33 Kensington 2033 PH (02) 349 5792.

Stolen from E Radclyffe VK1TR from Phillip College car park on 6th Feb ICOM IC-22 Serial No 1246F. Contains crystals for channels 40 and 50 and repeaters 146.9/146.3, 146.95/146.35. The dial globe is obviously not original. The power wires have no plug and the squelch circuit is intermittent. Contact VK1TR QTHR.

Stolen from vehicle of G Howard VK3XD at Diamond Creek 8th February 1989 one IC-22 VHF FM Transceiver Serial No 10918. Contact Greensborough police or VK3XD QTHR. ar

DIVISIONAL NOTES

FORWARD BIAS

PHIL CLARK VK1PC

Hi, welcome to Forward Bias again.

Well, things have been quiet in VK1 for a while, but now there is some news to report.

As you all probably know by now, we have good stocks of the smart new log books in both horizontal and vertical format, and they are very attractively priced. Have a look in the bookshop at each meeting and see what is available. If what you want is not there, ask, and we will see if we can get it.

There has been quite a stir over the charges for repeater sites under the cost recovery by some Government departments. In the ACT, the sites at Mt Majura and Mt Ginini, where our repeaters and beacons are located, are owned by the Civil Aviation Authority, and the first indication of the cost for these sites well exceeded our ENTIRE annual budget! We contacted the department and, as a result, it reviewed the charges because of the community support and the emergency communications provided by the amateur repeaters without cost to ANY users. The amateur repeaters are provided by the division's volunteers as a service to the community and any amateurs without charge. It is worth pointing out here that the repeaters are designated to be used in emergencies by WICEN and have been included in the New South Wales Government-approved disaster plan for the Queanbeyan and Molonglo rivers. The Mt Ginini site is crucial because it has a power supply independent of the power grid and is not as likely to be affected by power failure in the event of a disaster in the local area. As I said before, the department did review its charges and gave substantial reductions in the fees; however, even the reduced amount is a large part of our annual budget, and will be a serious strain on our limited resources. Naturally, we are in contact with the department with a view to maintaining the facility on Mt Ginini. In the next report I hope to have more news about this.

Classes for the NAOCP exam have started in February, and the attendance at these has been very good! We are pleased to see the interest in amateur radio as shown by the enrolments for these, and hope those attending will become new members of the division.

On the matter of exams, the last amateur exam conducted in Canberra by the Department of Transport and Communications was held in February. Future amateur exams in Canberra will be conducted by the Wireless Institute. The committee has decided initially that these will be held at monthly intervals, depending on applicants. At the time of writing, it was hoped that the first exam to be conducted by the Institute would be held in

May, but we will keep you informed of developments in the weekly broadcasts.

Recently, we have been pleased to welcome quite a few new members to the VK1 division. To welcome new members to the division in future, they will be announced on the news broadcasts. In line with the policy of announcing new members, the following were accepted as members of the ACT division at the February meeting. We welcome Iris Weigarten VK1NXV, Doron Arad VK1AB, and Rob Apathy VK1KRA to the VK1 division.

A warm welcome is extended to all visitors and prospective new members at our monthly meetings.

A contingent from VK1 joined others from Wagga, Goulburn and the surrounding area for the bus trip to the Gosford field day organised by the Goulburn club. As usual, the organisation and facilities provided were of the expected high standard and were much appreciated by all who availed themselves of the opportunity to go to Gosford.

The division has been active in providing those services that members let us know that they want. One of the more popular services is the purchase of certain equipment, when we can pass on substantial savings by making bulk buys. In the past, the division has been able to provide items such as headsets, transformers, coax and other items at very reasonable prices to members. We are making every effort to continue this service and, at the time of writing, are looking at the possibility of purchasing coax, power transistors and good quality BNC and N-type connectors.

As most of you are probably now aware, the latest ruling by the Department of Transport and Communications resulting in the strict enforcement of regulations in regard to the advertising of items on the weekly broadcast means we can no longer inform members of goods the division has for sale — including books — through this medium. This has also imposed restrictions on the information that can be given out about personal items for sale. The committee is taking steps to try to keep members informed of "for sale" and "wanted" items, both from the division and from members.

The division is also planning to restart the popular social activity of fox-hunts. Arrangements for these will be announced on the regular weekly broadcasts as details are finalised.

The annual general meeting took place on February 26. The following were elected to office:

President: Ted Pearce	VK1AOP
Vice President: Phil Clark	VK1PC
Vice President: Carl Makin	VK1KCM
Treasurer: Ken Ray	VK1KEN
Secretary: Jan Burrell	VK1BR
Fed Cr: George Brzostowski	VK1GB

Committee Members:

Neil Pickford	VK1KNP
Darryl Fallow	VK1DF
Marion Leiba	VK1VNG
Paul Tams	VK2CJ

We wish the new committee success in 1990.

VK2 NOTES

TIM MILLS VK2ZTM

Annual General Meeting

Members of the NSW Division are advised that the AGM of the Division will be held on Saturday the 28th April 1990 at 2pm at Amateur Radio House, 109 Wigram Street, Parramatta. The agenda, reports and financial statements together with any other material for the meeting is included as an insert to this issue of "Amateur Radio".

Family and non "AR" receiving members will receive a separate posting. Should you not receive this insert, please contact the office. The insert will also have your membership card for the 1990/91 year. Look carefully for it, as last year some 60 members did not find it before throwing out the report.

Contact With The Division

The Divisional office may be contacted by mail to PO Box 1066, Parramatta NSW 2124: FAX, 24 hours a day on 02 633 1525. Phone message taking answering machine is across the line. To fit in with the office arrangements, the phone is currently being manned between 12 noon and 1pm Monday to Friday and 7 to 9pm Wednesday. Office and library open 11am to 2pm Monday to Friday and 7 to 9pm Wednesday.

Silent Key

It is with regret that we have to report the passing on 1st March 1990 of Keith Howard VK2AKX. Keith founded the Westlakes Amateur Radio Club at Teralba, a Newcastle suburb, in the early 1960's. He was a Life Member of the Division. (See *Obituary on P54 Ed.*)

VK2BWI Slow Morse

We had a recent note from Ross, VK2BRC, the Co-ordinator of the Division's 80 metre slow morse session. It has been decided for the remainder of this year to commence the session at 8pm local time, and not adjust for daylight saving. The frequency is 3550 kHz. The present sun spot cycle is placing a high absorption on the 80 metre band. The IPS forecast for this month shows the ideal working frequency for the VK2WI morning broad-

cast as higher than 11 MHz. We will not be re-introducing the morning 80 metre transmission at the moment, and will continue to rely on the 40 and 30 metre transmissions — 7146 and 10125 kHz. We still seek more country clubs to consider relaying the VK2WI broadcasts to their local VHF or UHF repeaters.

Exams

Now that the exams are to be conducted by the Amateur Radio Service, various people have been approved by the Department to provide them. The Division is one of these sources, and at the time these notes were written, the exact timetable was still being worked out. It is expected that a quarterly interval will be adopted with exams at the weekend. The first exam conducted by the Division is expected in May. Listen to the broadcast, or contact the office for further details. Would others conducting exams please advise the office, so that we have the details and can advise inquirers accordingly.

QSL Bureau

Recent increases in postal charges have forced the VK2 Bureau to increase some handling charges. You should also note when sending in your OUTWARD cards that the packet should not be greater than 200 mm thick or it becomes an expensive parcel. Contact the Bureau for new rate details.

WICEN (NSW) Inc

Some new information leaflets have been printed and distributed to some clubs and groups. Check with them. Membership and general WICEN inquiries should be directed to PO Box 123 St Leonards NSW 2065.

Urunga Convention

The 42nd Urunga Convention will be held over the Easter Weekend — 14/15th April. Information from telephone (066) 52 3177; 55 115 or 53 2463. Mark up the calendar for the June holiday weekend at Port Macquarie, for the Oxley Region field day. Details from PO Box 712 Port Macquarie 2444. Phone contact (065) 83 1311. The Central Coast ARC may be conducting the 1991 field day on a Saturday, as it is unlikely that the present site will be available on a Sunday.

New Members

A warm welcome is extended to the following who became members of the NSW Division during February:

I M Boswell	Assoc	Gladesville
P R Browne	VK2XQK	Speers Point
D W Chaffey	VK2NBC	Chester Hill
M P Covi	VK2KMP	Hamilton
R E Goodwin	Assoc	Wombarra
A J Hargreaves	VK2MGL	North Lambton

K G Harriman	VK2AFH	Meerschumvale
G Herodes	VK2XQU	Moorebank
P G King	VK2GPK	Morisset
F W Lawler	VK2KMU	Warners Bay
K Tahara	VK2FCA	Sydney
H Wagner	VK2CCW	Kings Langley

Time/Date 11.00 am. Sunday 22nd April 1990.
Venue- 59 Westbrook Ave, Wahroonga NSW 2066.

Members, non-members and friends interested in Packet Radio are cordially invited to attend the AGM of the Australian Amateur Packet Radio Association.

It will be held irrespective of weather conditions. Luncheon will be provided at a cost of \$5.00 per head. BYO "beverages" if required. We need firm numbers for catering, so please notify by post to the above address if you will want to eat, and enclose payment. **The last date for acceptance must be 17th April, preferably before Easter.**

A warning is issued that absentee packet operators are at risk of being appointed as officer bearers!
de John VK2CFJ, Hon Sec AAPRA

VK3 NOTES

JIM LINTON VK3PC

WIA Examinations Service

Applications for the examinations being conducted by the WIA throughout Victoria next month close on April 30. Intending candidates have only a short time to make an application to contest the examination being held on the night of the third Tuesday in May. Applications must be made on a prescribed form available from examination supervisors who are part of the WIA Examinations Service. To find out the contact name, phone number and postal address of your nearest exam supervisor, ring the WIA Victorian Division office on either Tuesdays or Thursdays between 9am and 4pm. It is planned to have examinations in May, August, November and February each year. Applications will close on the last day of the preceding month, and must be accompanied by the examination fee(s).

Inwards QSL Bureau

All correspondence for the Inwards QSL Bureau, including registrations or changes to call signs and addresses, should be sent to the Divisional Office. We cannot accept changes over the telephone; they must be in writing from the person concerned.

The Bureau is using a computer database which holds all of the user registrations and their chosen distribution points. Information sheets on how the Inwards and Outwards QSL Bureaux work are available free on request.

Sunday Broadcast

The weekly news and information broadcast through VK3BWI on Sundays has a new outlet — the Otways two-metre repeater VK3ROW. Thanks to the efforts of the Geelong Amateur Radio Club, the broadcast is now automatically relayed through this repeater. Plans are still moving ahead to have the broadcast relayed through the Mt Wombat two-metre repeater VK3RGV to better serve north-central Victoria.

Clubs, zones, groups and other contributors to the broadcast, please note the deadline for written news items to reach the Divisional Office is 10am on Thursday each week.

5/8 WAVE

JENNIFER WARRINGTON VK5ANW

5WI - The Saga Continues

Here, as promised, is the information provided by Reg VK5RR. Reg writes... "The first VK5 News on Sunday mornings (post war) was on 26.1.47, using my own call sign. This continued weekly, up to and including 20.4.47. The frequency in use was 7081kHz for the first two Sundays and then changed to 7195kHz thereafter. Against each entry was the note "See Special Log Book" in which "callbacks" were recorded. The last such entry in my Log Book was on 20.4.47, so presumably the official 5WI call was used. I carried on for about a year when, due to business reasons, I think, I was obliged to relinquish the position (a letter of thanks from Doc Barbier VK5MD confirms that he retired on 25.3.48)... I think the 80m broadcast you refer to was more in the nature of a Morse practice session, as I remember doing this in the evenings once a week.

... Hal Austin took over from me until 1954, and then it was taken over by Charlie Othen VK5ON."

Thanks, Reg, for taking the trouble to write and fill in those gaps.

From a very early Slow Morse operator to a very new one. Nigel Hanwell VK5KAG (although I suspect that he has upgraded by now) is the latest volunteer on the Slow Morse panel. Nigel joins Trevor VK5BWF, Jack VK5AJK, Wayne VK5AC who is also the coordinator, Brenton VK5AQ, Ron VK5AAC and Emlyn VK5AEJ (who only came to help out for a couple of weeks — 13 years ago!). If you'd like to help out, I'm sure Wayne would be pleased to hear from you.

Diary Dates

Don't forget the AGM on Tuesday April 24 at 7.45pm. It would be nice to see some new 'blood' on Council. I shall be retiring after 10 years. It certainly isn't a record, but I think it's long enough! ar

VK6 NOTES

JOHN HOWLETT VK6ATA

AGM

Make sure you have your say on the 17th of April. After all you have paid for the right and it's no good complaining later. Nominations for council are:

Atkinson, Harry	VK6WZ
Bastin, Christine	VK6ZLZ
Harlock, John	VK6GU
Hedland-Thomas, Bruce	VK6OO
Howlett, John	VK6ATA
Penfold, Neil	VK6NE
Thurston, Glen	VK6ZGT
Wallace, Dave	VK6IW

The nominations were ruled by council as incorrect, and another was withdrawn before the closing date.

Exams

The WIA and DOTC are working towards accreditation for special examinations in Morse, theory and regulations. Council will keep you up-to-date as agreements are made.

Congratulations to the Peel amateur radio group for the fine social day out. The 60-70 people who turned up on Saturday 17th February enjoyed themselves, and some stayed overnight at Bunbury and made a weekend out of it. Thanks to Alex and XYL who made us welcome and hope we were all suitably well behaved to be invited back again! ar

This space could be earning you

MONEY

Advertising rates available from

PO Box 300
Caulfield South 3162

CLUB CORNER

Radio Amateurs Qld Timers Club Meeting (Qld)

The next meeting of the Radio Amateurs Qld Timers Club will be held at the Coorparoo RSL Club, 45 Holdsworth St, Coorparoo, Brisbane on April 29, 1990. All old timers having been licensed over 25 years or nearing 25 years are more than welcome to come along to the luncheon. For further information and registration, phone Bill Bentson, VK4QF, (07) 870 8785 or Cress Everdell, VK4ZAO, (07) 208 4535. Apologies would be appreciated. This will be the 11th biennial meeting.

Bill Bentson VK4QF

Healesville Amateur Radio Group

The Healesville district and the Upper Yarra Valley has a relatively new club actively promoting the hobby. The Healesville Amateur Radio Group (HARG), while small in number compared with the larger metropolitan clubs, has all the elements to ensure its long-term success. Enthusiastic members are taking part in field-day activities and planning is well advanced for them to active a local scout callsign during this year's Jamboree on the Air.

After achieving publicity in local newspapers and other outlets, the club started classes which have seen a number of people obtain their Novice licence, and some are going on to

upgrade. HARG is supervising examinations set by the WIA Victorian Division Examinations Service and attracting candidates from the Upper Yarra valley and outer eastern Melbourne suburbs.

It has weekly meetings on Wednesday nights at the Postal Institute building behind the Healesville telephone exchange. For further information, contact the HARG President, Graeme Tremellen VK3TGP (059) 62 6098.

South East Radio Group Inc

South East Radio Group Inc is holding its annual convention over the Queen's Birthday long weekend in June this year.

The latest state-of-the-art communications equipment will be on display and no doubt there will be some hard-to-beat specials on offer. Those of you who don't fancy the most recent technology will find much pre-loved gear available.

Of course, you can always spend some time just relaxing and catching up on the events of the past year with your friends. You can do this in comfort, as there is ample space available, with tea and coffee facilities.

South East Radio Group Inc will again host the Australian Fox Hunting Championships. Participants from last year will attest to the fact that the competition was fast and furious. It will be even better this year, with the addition of a 1296 MHz Hunt. Other events will, of course, be programmed to ensure that a wide range of tastes is catered for.



HARG Vice President, Lyn Eddy VK3DKE (left) and President, Graeme Tremellen, VK3TGP, show WIA Div President Jim Linton VK3PC, seated, the club's station during the recent visit.

You are urged to come and spend an enjoyable weekend with us on the June 9 and 10, 1990. Anyone who has been before will tell you how worthwhile it will be.

Should you decide to attend, accommodation will need to be organised as quickly as possible as Mount Gambier plays host to many functions at this time. Further information

and registration forms can be obtained by writing to the Convention Co-ordinator, PO Box 1103, Mt Gambier, 5290.

See you there.

ar

QSLs FROM THE WIA COLLECTION (23)

KEN MATCHETT VK3TL HON CURATOR WIA QSL COLLECTION
PO Box 1 SEVILLE VIC 3139

"Island in the Sun" JM-2PZ

This QSL from Jamaica is one of the rarest in the WIA QSL collection. Dated December 1926, it resulted from a SWL report sent by Mr L G (Len) Simmons. On the front of the card, the Jamaican reports that "you are my first 'A' to report my signals. You are quite correct, was working Z4AC and Z2AE at the time you heard me. One hundred and twenty Watts input". It will be remembered from earlier articles that the prefixes as we now know them really started in 1927. Before this, there was an attempt to systematise callsigns by using letters which were in many cases abbreviations of the name of the country of origin. Thus the 'A' and the 'Z' calls referred to above stood for Australia and New Zealand respectively. Similarly, JM was used by Jamaican stations. On the bottom of the Jamaican QSL is printed: "Armstrong tuned plate tuned grid — one UV 203 A". The Armstrong oscillator is very similar to the well-known Hartley circuit, but instead of having the inductance between plate and cathode (as part of the tapped resonant tank inductor) the Armstrong oscillator had a separate plate inductance. The Armstrong circuit was the circuit that appeared in the first-published paper on regenerative reception (Proc IRE Sept 1915). It was the advent of regeneration, of course, that changed the nature of radio transmission and reception almost overnight.

This revolution in the use of the audion valve brought about a degree of both selectivity and sensitivity previously undreamt of. Amateurs the world over owe a great debt of gratitude to its inventor, Edwin H Armstrong, who developed the idea whilst still an undergraduate at Columbia University between the years 1913-1915.

The transmitting valve mentioned, viz UV 203A, was a general-purpose triode which was useful up to 10MHz. It took about 1000 Volts on the plate with a plate current of about 150 mA. The 'UV' was a valve base code

indication.

At the time of the QSO, Len was living at Belgrave, Vic. He was later to become VK3LV and a 'silent key' in 1987.

VP5EM

The recipient of this QSL was Bob Grundy VK5BG (he became a 'silent key' in 1988). Bob received his licence in 1937 and operated from Crystal Brook, SA. He was the radio operator with the Leichhardt Search Expedition of 1938. Bob's equipment is shown in "The Murray Bridge Story" by Lloyd Butler in 'AR' July, 1988.

In the latter part of the 1920s, the JM prefix was replaced by VP5 from the "British Colonies and Protectorates" prefix block allocation VPA-VSZ.

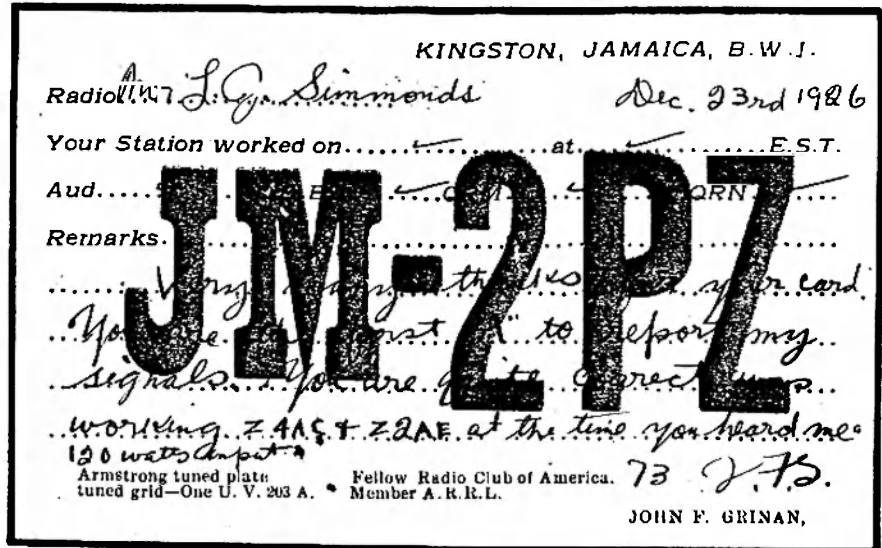

6Y5MR

Jamaica is the largest of the Commonwealth countries in the West Indies, and the third-largest island in the Caribbean. With its area of a little over 11,000 sq km, it is about one sixth the size of Tasmania.

Discovered by Christopher Columbus in May 1494 on his second voyage, the island was at first called Sant Jago, but the Indian name, Jamaica (derived from Xaymaca), survived. The name means "land of water" and refers to the numerous rivers that flow down from the island's central mountains.

Although bauxite and tourism are important revenue producers, sugar remains the main export, as it was in the days of slave labour on the sugar plantations. Sugar and its famous derivative, rum, have formed the backbone of the country's economy. The rich full-blooded Jamaican rum was once the main means of exchange during the slave trade, and was a

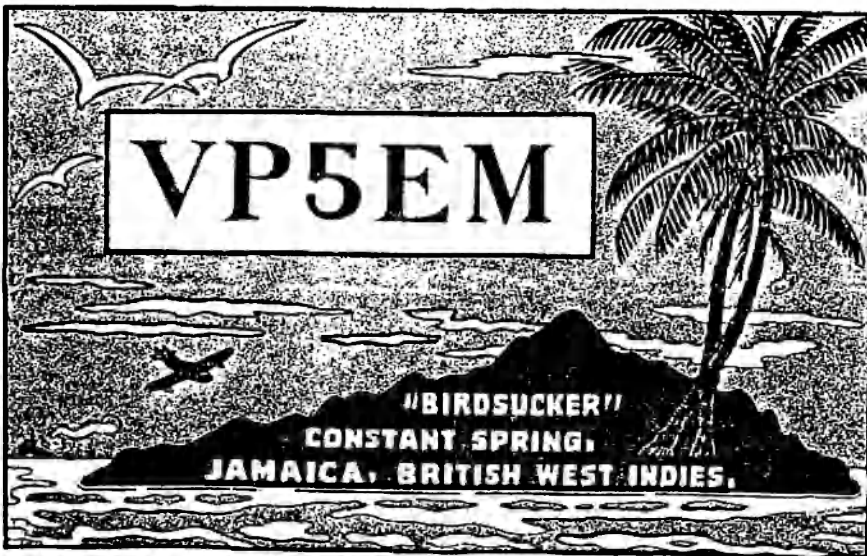

The 1990 DX QSL Contributors' Ladder:

Frank, VK2QL	161 points
Jim, VK9NS	158 points
Ray, VK3RF	24 points
Bruce, VK3BM	13 points
Barry, VK5BS	10 points

Scoring QSLs Received

Frank, 2QL: Prefix TZ2, special calls: OH0MAS, ZM0ZOU, KY6ITU, KS7ITU, KS9ITU, KN6ITU, KG6ITU, KI4ITU, KG2ITU, KJ2ITU

Lindsay, G5Z: Prefix EW3, special calls: VK2RAS/5, VK2BWI.

The task of adding to the WIA collection of prefixes, and especially allocated call signs, is becoming increasingly difficult (even for our best DX-ers) but why not give it a go? Please write for a "Wanted Prefixes" list.

Thanks to all contributors. Keep up the good work. If you would like to play a part in building up the WIA QSL collection, and to save something for the future, would you please send a half-dozen (more if you can spare them) QSLs which you feel would really help the collection along. All cards are appreciated, but we especially need commemorative QSLs, special event station QSLs, specially assigned QSLs (e.g. VK4RAN) pre-war QSLs, unusual prefixes, rare DX and pictorial QSL of not-so-common countries. Could you help? Send to PO Box 1, Seville, 3139, or phone (059) 64 3721 for card pick-up or consignment arrangements for larger quantities of cards. Thanks **ar**

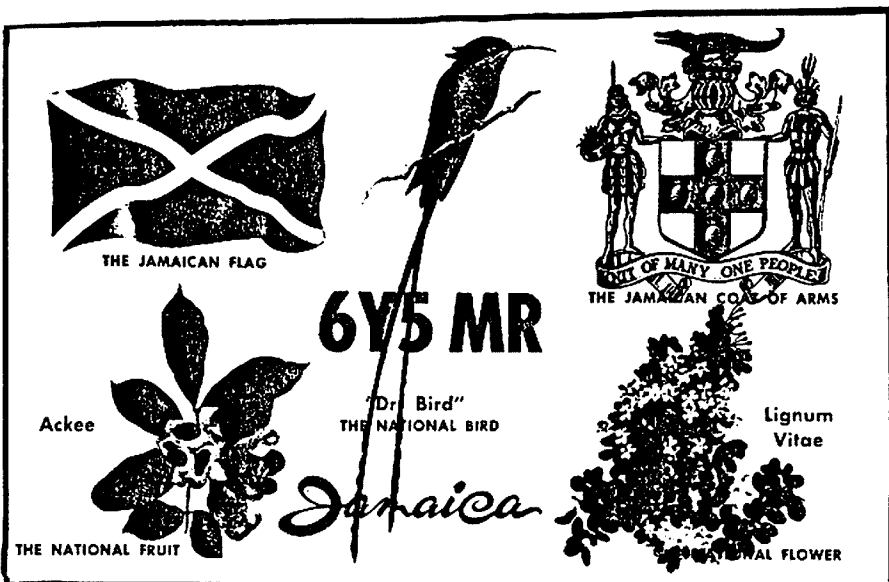

naval ration (called 'grog') from the 18th century to as late as 1970.

Three years before his death in 1506, Columbus again visited Jamaica (on his fourth and last voyage). His son Diego became the colony's first governor. In 1596, the British attacked and sacked the island's capital city Spanish Town, but, despite this, Jamaica remained in Spanish hands until 1655. A few years later, the British occupation was formally recognised by the Treaty of Madrid. This was followed by a large influx of new settlers, many of whom were undesirable. In fact, Jamaica became a refuge for pirates and buccaneers, amongst whom was the famous (or infamous) Henry Morgan. Due to his exploits against the Spaniards, he was later to be rewarded with a knighthood and the governorship of the young colony.

When Jamaica was granted independence in 1962, after being under British rule for 300 years, the new prefix 6Y5 replaced VP5, which to that time had been shared with Jamaica by the Cayman Islands and the Turks and Caicos Islands.

The 6Y5 QSL card from Kingston, the island's present-day capital, shows the national flag, fruit, bird, flower and coat of arms. The flag consists of a gold cross (representing the value of natural wealth) together with the colours green (symbol of hope and agriculture) and black (symbol of the past and the hardships facing the country).

The QSL card was received by Roy Jonasson (now an 'SK') VK4NE who held several calls between 1928 and 1989. It is one of many QSLs kindly donated to the WIA by his son, Neil.

Thanks

The Wireless Institute of Australia would like to express its thanks to the following for their

contribution of QSL cards towards the Collection:

(Supplementary List)

John,	VK3ZA
Roy,	VK2TR (ex VK9AU)
Frank,	VK2QL
Roland,	VK2GAL
Lindsay,	VK5GZ
Neville,	VK7NC
Jim,	VL6RU
"Snow",	VK3MR

Also to the friends and families of the following 'silent keys' (Supplementary List)

Jim Porter,	VK2AXP
Jack de Cure,	VK5KO

INTRUDER WATCH

GORDON LOVEDAY VK4KAL FEDERAL INTRUDER WATCH CO-ORDINATOR
AVIEMORE RUBYVALE 4702

This month, I thought readers may be interested in some doings from Region 1. John VK4QA has been spending some time in the Netherlands and other places.

"It is interesting to read about Region 1. Veron is a consistent contributor to IARUMS, as are the following: Fed Rep of Germany, Finland, Sweden, the RSGB has been revitalised with a new co-ord in 1989, G5XB." Also a Report of the IARUMS Co-ordinator, covering '87/'88 and '89. "Gradually, the "picture of intruders" on several amateur bands is changing. In particular, the 7MHz band has become much more usable by the disappearance of practically all broadcasting stations. The Chinese and Albanian BC stations went QRT. Occasionally, new BC stations came up, but went off air again after some time. In these cases, IARUMS has been very active with complaints and requests to shut down the

transmissions. The problem of non-amateur RTTY transmissions is growing steadily. Many of these occupy amateur frequencies for many hours or whole days, with usually only idling signals. A lot of time has been spent trying to identify these RTTY signals. Knowledge of the origin of these signals is growing. Means to attain this: take bearings and measure shift/ baud rate, where and when suitable equipment is available. It is clear that the big majority of these signals originate from Eastern Europe and, more especially, the Soviet Union. However, we have NO access to most administrations responsible for these transmissions. It is the opinion of your Co-ordinator that it is essential to seek ways to change this. Assistance from the EC and/or AC is needed. Maybe "glasnost" can open some closed doors in the future? IARU Region 1 Division Conference 1-6 April 1990 ... Spain." **ar**

WARC 92 UPDATE

DAVID WARDLAW VK3ADW
WIA WARC-92 TEAM LEADER

In order to prepare for Australian participation in WARC-92, the Department of Transport and Communications has formed the Australian Preparatory Group for the WARC-92 (APG WARC-92)

The first meeting of this group was held in Canberra on February 8.

The attendance of 50 was drawn from the following organisations: AUSSAT, AUSTEL, ABC, AWA, CAA, CSIRO, Department of Administrative Services (IPS), Department of Defence, Department of Foreign Affairs and Trade, DOTC, FACTS, Philips RCS, Public Broadcasting Association of Australia, Telecom and WIA, together with a number of individual consultants.

The WIA was represented Ron Henderson VK1RH and myself.

Major allocation topics were identified as:

1. Additional spectrum for HF-BC.
2. Additional spectrum for mobile and mobile-satellite services in the 1-3 GHz band.
3. Spectrum for high definition television (HDTV).
4. Spectrum for the sound broadcasting satellite service (SBSS).
5. Review of radio determination satellite service (RDSS) sharing criteria.
6. 20 GHz and up spectrum for new space services.

Broadcasting interests reported that there was significant overseas pressure for additional spectrum for international HF broadcasting and that a number of administrations wished to further extend national broadcasting on HF. Australia uses HF national broadcasting in its tropical zone in accordance with ITU regulations.

At present, HFBC planning is incomplete, and some consider that no more spectrum should be allocated for broadcasting until the planners indicate that it is required.

It was claimed that international HF broadcasting was popular and had a significant audience.

UHF Bands and Up

The following requirements for additional frequencies in the UHF and up section of the spectrum were indicated:

Mobile Sat	2-3 MHz
HDTV	500 MHz
SBSS	2 MHz

The amateur bands involved are 1240-1300 MHz and 2300-2450 MHz. The danger is a change in sharing arrangements which could be disadvantageous to the Amateur and Amateur Satellite Service Above 20 GHz. We will need to retain our existing Exclusive

Allocations and maintain our wider sharing arrangements. There could be some difficulties in this part of the spectrum which may not seem important at the present time but could be very much so in the future.

HF bands

The major problems on the HF Amateur Allocations will most likely be on the 7MHz band. On this band the amateurs in Region 2 share 7100-7300 kHz with broadcasting in Regions 1 and 3. At present in Australia we have an extended 7MHz band on a non-interference basis.

It is also possible that there will be pressure on the top end of the 3.5MHz band. This pressure already happened at WARC-79, although at that stage it did not affect Region 3. However, we must be prepared.

Committee Structure

Four committees were set up to examine and develop draft Australian inputs and delegation briefs for the JIWP (WARC-1992) and also for the WARC-92 conference relating to:

- F. Frequency Allocation matters
- T. Technical matters
- R. Regulator matters
- A. Administrative and policy matters plus overview

A fifth committee, H, was set up to examine and develop a draft Australian input and delegation brief for the WARC HFBC-93. This committee relates to broadcasting planning issues only and excludes frequency allocation issues.

The WIA will be represented on committees F and T. At present there are no regulatory matters concerning the amateur service on the agenda, so representation on committee R is unnecessary. Committee H is only for HF broadcasters.

In the frequency range 960 MHz - 3.4 GHz DOTC are developing a paper which will be available for comment in March. There will be a draft spectrum plan in March also. (Not available at time of writing).

The following is the initial Amateur and Amateur Satellite Service submission to the APG.

(The WIA, together with the IARU, considers the Amateur and Amateur Satellite Service as one).

The Amateur and Amateur Satellite Service

Amateur Service: a radio-communications service for the purpose of self-training, inter-communication and technical investigations

carried on by amateurs, that is, by duly authorised persons interested in radio technique solely with a personal aim and without pecuniary interest.

Amateur-Satellite Service: a radio-communications service using space stations on earth satellites for the same purpose as those of the Amateur Service.

The above are nos 3.34 and 3.35 of the definitions in article 1 of the Radio Regulations of the International Telecommunication Union.

The Amateur Service world-wide, uses, or experiments with, virtually every aspect of the art of radio communication, from the most simple to the most sophisticated.

It is the urge of the amateur to experiment and to communicate that is expressed in different countries in different ways. The self-education of individuals or the establishment of classes for those who desire to qualify as radio amateurs provides a basic education for many who would not otherwise acquire that knowledge.

Whether it is a simple telegraphy transmitter for the novice or the satellite for the advanced amateur, both are learning. The amateur is restricted in the matters that may be the subject of his communication. His common interest with all other amateurs in the world is his interest in the radio art, and by that inter-communication knowledge is exchanged and expanded.

The knowledge and experience of communications, and the existence of the equipment that the amateur uses, provide a valuable resource that in many countries cannot be found in any other service.

The most important features of the Amateur Service are:

- (1) It makes unique provision for advancing an individual's skills in both the technical and operating phases of the art, thus helping to provide a reservoir of trained operators, technicians and electronics experts. It also provides an avenue for further investigation for those already involved in this field.
- (2) It has a unique ability to enhance international goodwill.
- (3) It is a voluntary, non-commercial service.

The interests of radio amateurs are as diverse as the number of countries and regions in which they are located.

The basic desire to study radio communications with the opportunity for practical application leads to:

- (i) The acquisition of experience and skill in communication techniques and operating;
- (ii) contact and interchange of information with others having similar interests;
- (iii) furtherance of the unique ability of the radio amateur to promote international goodwill;

- (iv) contribution to scientific research by participation in a programme organised on a national or international basis; and
- (v) participation in communication systems including emergency communication by both training and assistance, when required.

Reference has been made to the urge to communicate. The Amateur Service provides a trained, regulated and disciplined outlet for that desire. Otherwise, that urge, and the desire to experiment with communications, might find its outlet in undisciplined, illegal and perhaps potentially dangerous transmissions.

An important aspect of the Amateur Service is that because the amateur must be qualified and then licensed by his administration he is known and recognised. The amateur zealously guards his spectrum allocations and rejects the improper use of the frequencies allocated for his use. Such improper use cannot go unnoticed, nor can unauthorised users hope to remain undetected. It would be a foolish act to operate a clandestine transmitter in an amateur service allocation.

Many administrations rely heavily on the fact that the Amateur Service is a safeguard against unauthorised use of radio communications.

Issues of Concern to the Amateur Service

1 HF

While realising that the decisions of WARC79 did not satisfy a number of countries with regard to the amount of spectrum allocated to the HF Broadcasting Service, and that Recommendation 511 of HFBC-87 suggests the possibility of extending the frequencies allocated exclusively to HF broadcasting, the Amateur Service feels that it would not be desirable, bearing in mind the time constraints of the WARC, to review the whole of the HF spectrum.

2. UHF

The Amateur and Amateur Satellite Service only has shared access to its family of frequencies in this part of the spectrum; currently satisfactory in the 1240-1300MHz band, but difficult in the 2300-2450MHz band.

The Amateur and Amateur Satellite Service would hope that consideration would be given to the peculiarities of amateur usage of these bands.

3. Above 20 GHz

The Amateur Service has a family of small exclusive bands, all contiguous with larger shared bands where amateurs are secondary.

This was felt to be the most satisfactory way to make provision for future usage with the least difficulties.

Conclusion

As can be seen from this report, a number of amateur bands will be threatened at this limited-allocation WARC.

As with the WARC's in 1959 and 1979, the WIA is actively looking after the interests of the Amateur and Amateur Satellite Service for all Australian amateurs. As the President of the IARU said, the best way you can support the Amateur Service is to belong to your national society.

A great deal of energy was exerted at and before WARC79 to preserve your 50MHz band, the top two MHz of the 144MHz band, and the 20 MHz of the 430MHz band that most of the rest of the world lost. We gained three new HF amateur bands, 12 new amateur satellite allocations and five new bands above 20 GHz.

It is somewhat disappointing to note the large number of amateurs who are non-members of the WIA and are prepared to accept the privileges obtained by the WIA effort and finance without accepting the responsibility of membership. Thank you WIA members. ar

SILENT KEYS

We regret to announce the recent passing of:-

Mr Keith Howard	VK2AKX
Mr Arnold Cresswell	VK2DLK
Mr K A Robson	VK2PLJ
Mr Harrison Chapman	VK3GU
Mr Rob Jennings	VK3AF
Mr Ken Gott	VK3AJU
Mr Vic Gay	VK3EVG
Mr Jack Lester	VK5LR
Mr Joe Burns	VK5UJ
Mr B P Williams	L50496
Mr M R Pitman	VK6SN
Mr Doug Watson	VK7DW
Mr C K Perry	VK8KP

Vic Gay VK3EVG

Sadly I report that Vic Gay VK3EVG passed away on the 7th February this year aged 80 years. Vic gained his NAOCP when he was in his seventies through sheer diligence and perseverance. Some time later, he got his AACP and became VK3EVG.

Vic was a self-effacing dedicated amateur, ever ready to help anyone with gear, manuals etc.

He was a member of the Moorabbin Radio Club and was always the first to volunteer to build cupboards, tables etc, and he assisted in the re-vamping of the Club station. He never broadcasted such activities.



The late Vic Gay VK3EVG

He was the founder, together with Colin Cole VK3DEG, of the Early Birds' Morse Net. This was a Morse training net for Novices wishing to upgrade to the AACP. It is now in its sixth year and still going strongly. Vic attended each session, practically every morning, and was always happy to send a Morse Test when required in his easily recognisable,

copper-plate fist. No computers or bugs for Vic — just the old PMG key.

Vic and his wife Ivy loved Australia, and travelled in their sweet-running EH Holden all over Australia. He used his HF and 2 metre gear during these trips, and what Vic didn't know about such transmissions was of no consequence.

On the morning of the 7th February, the listeners on the Net heard Vic make a mistake while sending a Morse piece but no correction signal was sent, a few blips followed, then silence. It was all over, another dedicated amateur had left our ranks.

Vic Gay was a gentle man with a gentle touch.

Q FOSTER (Ex VK6QF)

Rob Jennings VK3AVJ

Rob drowned at Lake Glenmaggie on November 7, 1989 whilst on holidays with his family over the long weekend. Rob was an extremely active person who excelled at everything he undertook, achieving great success academically and athletically. He had the ability to apply his knowledge in a practical manner, which was demonstrated by the number and diversity of projects he undertook.

He will be sadly missed by all his friends, who extend deepest sympathy to his wife Jill and sons Christopher, Luke and Matthew.

GEOFF ELEY VK3KAS

Jack Lester VK5LR

I have been in constant contact with Jack for some 32 years — right up to his death on 9th February 1990, in his 88th year.

Jack had a varied career. He obtained his Industrial Engine Driver's Certificate on 3/4/1929: Amateur Radiotelegraphy 1930: Full Amateur Licence, Radiotelephony July 1935: Broadcast Operator's Certificate, March 1941.

He was employed at Renmark Power Station, SA, in his early years. After leaving Renmark he conducted an electrical business in Berri, SA.

He later joined Radio Station 5RM where he stayed until transferring to 5DN in Adelaide.

He left 5DN to join the Radio Branch of the PMG (as it was known then) in the workshop and later at the Transmitter Site at Mt Bonython.

I am sure the VK's 5ON, 5FJ, 5ASW, 5AVR, 5BOL and many other "Hams" will join me in saying we shall sadly miss a sincere and genuine friend of long standing.

BILL CRAWFORD VK5XB

Joe Burns VK5UJ

It is with deep sorrow that I announce the passing away of my father Joseph Stewart Burns (VK5UJ) on October 30th 1989, aged 76 years.

"Uncle Joe" as he was fondly known by his many amateur friends, had his QTH in Napierby near Port Pirie, where he retired after finishing his working career in the State Government in Whyalla South Australia.

It is difficult for me to write this letter to Amateur Radio, as I not only lost a great father, but a true mate. It was his influence

and guidance that led me into a successful career in Radio Communications in the Public Service.

Joe was a Marine Engineer by trade, but developed an interest in Radio when I was a teenager. Dad had a shed down the back yard, where he spent hours tinkering with valve radios and amplifiers, and this is where I whetted my appetite and took radio on as a hobby.

In 1955 I joined the then PMG Dept as a Technician-in-Training, and we both got heavily involved in radio projects, especially the 1 metre "Pirate Days" as some of the old timers will remember.

In 1958, my father and I sat for our "Limited Certificate" and were both successful.

Dad's call sign was then VK5ZCP and mine VK5ZDI.

In late 1962, I was transferred to Darwin, and we decided to concentrate on our morse (then 14 wpm) to obtain the full licence so we could keep in contact on the HF bands.

"Uncle Joe" beat me on this, when he passed his in mid 1964 and I got mine in mid 1965.

From then on, we kept regular skeds twice a week on 20 metres, and progressed over the years through various modes from AM to SSB to RTTY.

These sessions over the past 25 years became very familiar to many amateurs and short wave listeners. Dad's life revolved around his family, the local community and amateur radio, and he gained the love and respect from people in all these areas as he was always there to give help and guidance when needed. His departure has left a big gap in our lives.

Dad had known of his illness and the inevitable outcome for some time, but kept it a secret from his family and friends so as not to distress them, until it became obvious in the last few weeks.

To our many amateur friends who sent condolences to our family, I thank you sincerely, and know the memory of VK5UJ will remain in our hearts for eternity.

**FIRST HARMONIC
BARRIE BURNS VK8DI**

Keith Harris Howard VK2AKX

Keith Harris Howard VK2AKX passed away suddenly on Thursday 1 March 1990.

A devoted family man, Keith was a natural educator and a mentor to many. He lived and breathed Amateur Radio.

Born 30 October 1930 in Cessnock 30 km west of the City of Newcastle, he was educated at West Cessnock Primary, Cessnock High School and then the Armidale Teachers College. After graduation in 1950, Keith's first teaching position was in the north-west NSW town of Gwabegar.

In 1954 Keith made the first of four visits to England and Europe. Whilst on his first



The late Keith Howard VK2AKX

visit to England he gained his Certificate of Engineering.

He returned to Australia in 1959 and taught at Blackalls School before joining the staff of the Booragall High School. Not only a trained teacher, Keith was a born educator and specialised in teaching learning-impaired students. He worried about each of his students and gave them his all until having to take early retirement from teaching.

In 1970 he visited the Osaka World Fair and continued on to Europe via the Trans-Siberian Railway. It was on this trip that he met Etsuko, and they were later married in London. He returned to England in 1972, then taught for a time as a specialist maths teacher in Saudi Arabia, before returning to Australia in 1974. He had a rare ability to master numerous languages, speaking Russian and Japanese fluently. For a number of years he taught English to the many migrants who were located at the large transitional migrant camp in the northern Newcastle suburb of Mayfield. A language he could never master was Finnish.

During his lunch hours at high school Keith listened to DX on a 40m receiver. His maths master Jack VK2ADT was an amateur radio operator and advised Keith to join the WIA. Thus at the age of fourteen began his life long love of the hobby. Strangely, it wasn't till Keith was in England in the early fifties that he first became licenced as a radio amateur, receiving the call sign G3NDH. It was on his return to Australia that Frank Hinks, the District Radio Inspector in Newcastle granted Keith a reciprocal call of VK2AKX. Keith must surely have been one of the few Australian-born amateurs who had never sat for his amateur exams in their own country.

Keith lived and breathed both Amateur Radio and teaching; it was logical that he

should combine both talents. he believed the future of any organisation lay with the youth of the land. As a teacher, he understood the need to instil knowledge effectively in the young. He gave his whole hearted support to the new Youth Radio Scheme, becoming one of the program's examiners.

In 1960 at the instigation of Rex Black VK2YA, one of the founders of the Youth Radio Scheme, Keith established the Booragul High School Radio Club, one of the first such school clubs in Australia. Five of his pupils gained their amateur radio licences. One of them was Susan Brown VK2BSB who was the first-ever school girl to become a radio amateur in Australia. Susan went on to become President of the NSW Division of the WIA.

Keith joined forces with Rex Black and others to promote the concept of the Novice Licence. Never afraid of fighting the establishment, he was intolerant of elitism and needless conservatism. The Novice proposal shocked the Amateur Radio and PMG establishments to the very foundations. Keith and others travelled to WIA headquarters in Melbourne to argue for such a scheme. The opposition was enormous but Keith never relented. Yet a decade was to pass before the then PMG relented and introduced the Novice grade licence.

It is a tribute to Keith that so many of his school and later Westlakes Radio Club pupils went on to achieve success in the electronics and electrical areas both at degree and technician levels. Over fifteen of his pupils went to become electronic, electrical or computer engineers. He had the rare ability to make electronic theory seem simple and logical.

An accomplished writer, he wrote a number of books amongst which was a treatise on map reading. Few are aware that Keith was fellow of the Royal Geographical Society. Undoubtedly his crowning glory was his Manual of Questions & Answers for the Novice Licence. It has sold over 30,000 copies becoming one of the all-time best selling books in Australian history, and the definitive text for use in Australian schools, radio clubs and correspondence courses. A whole generation of VK novices studied that book in order to pass their exams.

From his licensing as a VK he was involved with the Hunter Branch of the WIA VK2 Division, compiling and reading the branch's weekly news each Monday night using the branch call sign of VK2AWX. He transmitted these broadcasts from the basement of his mother's Bolton Point home. For a number of years he wrote a weekly bulletin that was published in the *Newcastle Morning Herald* and *Amateur Radio*.

In 1964 Keith fell foul of educational bureaucracy when a school's inspector was horrified to hear he was running an Amateur radio club at Booragul High School. The inspector was convinced Keith must have been

causing interference to any aircraft passing overhead and that he should be stopped immediately. Thus ended a successful experiment at the school.

Undaunted, Keith along with some amateur friends then founded Westlakes Radio Club in a little church hall at Teralba so as to continue training his school students. Little did he realise the club, later to become the Westlakes Amateur Radio Club would one day be arguably the largest in Australia. Under Keith's tutorage hundreds of students successfully went through his classes and thousands more studied his text books on their way to success.

One of his innovations was to institute an on-air basic electronics course called "Electronics by Radio". Such a course was strictly illegal, but Keith soon found the flaw in the regulations. There was no reason why two amateurs could not hold a conversation, one asking questions, the other answering them. Keith used his own call sign whilst John Bedford used the club's call sign of VK2ATZ. Strangely, there was only one signal. Keith and John were in the same room! John would ask a question and pass the mike to Keith for the answer.

Assisted by Bruce Morley VK2ZNB, Keith was the first VK on 160m after the band was opened up to Australian amateurs. Using an AT7 with homebrew modulator, the pair was still frantically wiring with just ten minutes to go. Somehow, the job was completed in time and at exactly one second past midnight, the call sign VK2AKX was heard loud and clear on 160m AM.

At Keith's instigation, the Westlake's Novice Contest commenced in 1977. Three years later when the WIA took the contest over it became the Australian Novice Contest

and the perpetual trophy was named the "Keith Howard VK2AKX Trophy".

Keith's work for amateur radio was recognised in the late seventies, when he was elevated to life membership of the Wireless Institute of Australia.

Keith's ability with the pen, his articulate speech and his brilliantly sharp and analytical mind made him a fearsome opponent whether defending a colleague, amateur radio or himself against the injustices of bureaucracy. Never afraid of authority at any level, he would challenge without hesitation if he thought a wrong had been committed. Woe betide the clerk or official at the PMG or its successor the Department of Communications, when Keith was in full flight against bureaucratic inertia or ineptness. Keith's onslaughts were always logical, accurate and to-the-point. He was a brilliant tactician.

He was the driving force behind the VK2 QSL bureau which has been run by the Westlakes ARC for a number of years.

Keith was a man of honour, integrity and high principle. He was a father figure to both the many students who passed through his hands and the many Westlakes club members. Our grieving is not just for the loss of a great man, but for the loss of part of our lives. Keith was a friend, a confidant and a father figure to so many.

The tradition lives on in part for his fourteen year old son Minoru who is VK2MIN.

To his wife Etsuko, his two sons Minoru and Satoru and his family, we grieve with you and to Keith we say thank you for the honour of having known you.

Seven three Keith, your memorial is a generation of amateur radio operators who got there because of you.

WESTLAKES AMATEUR RADIO CLUB ar

Morseword No 37

Solution on page 61

Across

- 1 Quality of sounds
- 2 Take the top off
- 3 Be fond of
- 4 Willingly (archaic)
- 5 Two dozen
- 6 Minerals
- 7 Pen
- 8 Sheep
- 9 5 x 8 - 6
- 10 Competes

Down

- 1 Young Elizabeth
- 2 Prison
- 3 Not the dashes
- 4 Increased
- 5 Swamp
- 6 Whole
- 7 Secondhand
- 8 Egyptian goddess
- 9 Consent to
- 10 Be enthusiastic

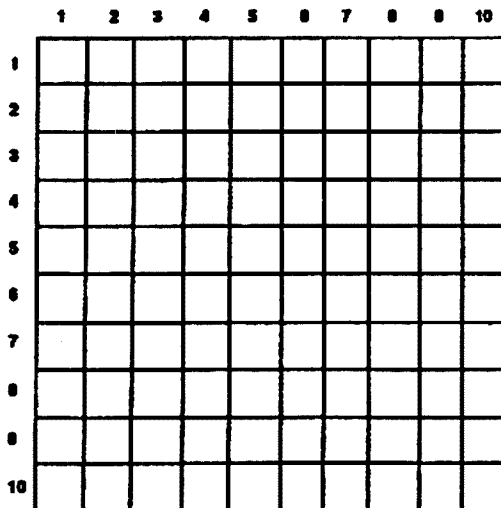

Audrey Ryan © 1989

OVER TO YOU

ALL LETTERS FROM MEMBERS WILL BE CONSIDERED FOR PUBLICATION AND SHOULD BE LESS THAN 200 WORDS.

THE WIA ACCEPTS NO RESPONSIBILITY FOR OPINIONS EXPRESSED BY CORRESPONDENTS.

In Defence of Importers

(In the March issue we published a letter from John Woodings VK6AJW entitled "Blatant Greed". This was the writer's own title for the letter, and was not chosen by us. However, it had been intended to follow the title with a question mark. This was inadvertently omitted. The letter was published purely as an expression of the author's opinions, with no intention of implying support or otherwise of these opinions. The following letter has now been received in rebuttal of the claims by 6AJW and is published in its entirety as a very cogent defence of importers' pricing practices. Ed)

As always, as a member of the Wireless Institute, I eagerly await the arrival of my Amateur Radio magazine each month. Unfortunately, this month I had to swallow a lump when I got to the letters. Not only do I find that you have permitted one of your advertisers and long-time supporters to be maligned without any option of early reply which you have extended in the past, but to find that your own choice of headline for this letter would seem to indicate that you agree with the remarks which were made!

In relation to the letter from John Woodings, VK6AJW, I would like to make a few points:

1. We would dearly love to be able to sell the MFJ-1278 for the US advertised price of \$279.95 (MFJ Catalogue of January 1990) but we can't because, unlike Mr Woodings, we have to pay freight, exchange cost, import duty of 21 per cent and sales tax of 20 per cent, which he has avoided by bringing in the goods personally when he returned from overseas.
2. If Mr Woodings expects to be supported by local suppliers then he must offer some loyalty in return. I assume he was supplied with an Australian type approved plug pack and that he doesn't mind sending the unit to the USA for warranty service!
3. If Mr Woodings is prepared to take the risk of quality on vacuum tubes of unknown origin then don't complain about the fact that sellers in this country always insist on NEW product from known and reputable sources.
4. The 572B is available from my stock in

Melbourne at \$175.93 plus the ubiquitous sales tax, making it \$211.12 for brand-new prime-quality product. I hate to think of someone paying \$395 for it.

Let's look at the example of the MFJ-1278 which your writer has used and see how the selling price of \$A595 is reached. Let's take a shipment of 10 units and use my actual costs: 10 MFJ1278s, my cost \$US223.96

	\$US2239.60
Freight from factory to airport in USA	\$US80.00
Manufacturer's export fees	\$US78.50
Total for goods	\$US2398.10
Converted to \$A at 0.75	\$A3197.47
Import duty at 21%	\$671.47
Air freight from USA	\$430.35
Airline document fees	\$5.00
International terminal fee	\$20.00
Delivery to our store	\$17.00
Financial Institutions Duty	.75
Customs Agent's fees	\$83.00
Total cost in my store for 10 units	\$4425.04

Which equates to a cost of \$442.50 each. Now the price of \$595 at which I advertise the MFJ-1278 includes the final insult from Mr Keating of 20 per cent sales tax, so the price before tax is \$A495.83, which leaves me \$53.33 each in profit, or less than 10 per cent with which to pay my staff, pay the rent, pay the gas and light and power, support the WIA with advertising, answer queries and look after all the after-sales support, warranty service, storage and the like. What a joke!

When you look at it that way, the greed is on the part of those who bemoan the lack of a local industry, and when somebody does try to do something for them they get it thrown back in their faces. Not very encouraging, is it? We can save some costs by bringing in larger shipments, but it doesn't make more than a \$20 per unit difference what we do.

You might well ask why we do it? Well, in this company we took a conscious decision that we should support the amateur fraternity by supplying good quality products at REASONABLE prices. So we do it because we are amateurs (VK2ESD and VK3ZJF) and because we believe that most people support what we try to do.

That then brings us to the point as to why we should support the Wireless Institute and its magazine. Not only do we have to compete with other commercial organisations, such as Emtronics, Andrews, Captain Communications and the rest, which we do willingly on a sensible commercial basis, and rightly so. But, now we find that we are forced to com-

pete with the Institute itself! We see ads for the VK2 division selling radios; now we hear that the VK3 division is starting to sell connectors and cable, the Melbourne Packet Radio Group, the advisory body on packet radio, is acting as a commercial body, selling packet gear, as is the Australian Amateur Packet Radio Association in Sydney!

These bodies are supposedly non-profit, non-commercial bodies established to serve the interests of the amateur community. Maybe they should get their own houses in order by providing the services and impartial forum they are supposed to provide, but on the whole don't. What is even worse, is that now they have a commercial imperative which means they can no longer fulfil that role.

If any or all of these bodies expect any support at all from the amateur equipment industry, then maybe the amateurs and the organisations should take stock of what they do, how they operate and what they say. After all, nobody could reasonably expect us to offer financial support to our competitors, would they?

Would Mr Woodings please accept my order for 100 MFJ-1278s at \$A289. I need some profit to pay for the paper to deal with that sort of totally unwarranted and uninformed criticism. Yours sincerely,

JOHN DAY VK3ZJF

TECHNICAL DIRECTOR

STEWART ELECTRONIC COMP PTY LTD
44 STAFFORD ST HUNTINGDALE 3166

In Further Defence . .

In response to John Woodings VK6AJW letter in "Over to You", March 1990.

Firstly, I would like to illustrate the costings on a typical spare part from an overseas supplier. Let's take a USA - sourced product:

— Nett price ex works	\$US100.00
— Exchange rate	\$US0.75 = \$A1.00
— Import duty	21%
— Overseas freight	Sea = 10%. Air = 12%
— Inland freight	4%
— Packing	2%
— Clearance, local delivery etc charges	6%
— Factors: Sea = 1.43	Air = 1.45
	0.75 0.75
	1.906 1.933

Small parcels, etc tend to be sent air freight from the USA.

Therefore: 1.933 x \$US100.00 = \$A193.30 landed cost

Once having received the stock into the warehouse or store, one has to handle it, store it, pay staff to sell it, fixed and variable overheads need to be paid (eg: rent, telephone, salaries, worker's compensation, payroll tax, superannuation, etc, etc, etc).

And then, finally, return a worthwhile profit to the vendor.

Unless one turns his stock over rapidly, there is also a 20 per cent interest factor which has to be applied to the landed cost for bank charges on overdrafts etc.

Bearing all this in mind, a 100 per cent mark-up is not unreasonable and, as a minimum, I would suggest a 70 per cent mark-up, returning a gross margin to the vendor of 50 per cent and 41.18 per cent respectively.

\$A193.30 x 2 + \$A386.60 retail, plus sales tax

or \$A193.30 x 1.7 = \$A328.61 retail, plus sales tax

The above example is fairly typical of what actually occurs in the real commercial world.

Having got the mathematics out of the way, the other factor to be considered is good old market forces.

A supplier will, if he's marketing oriented, obtain the maximum price, and therefore profit, for goods and services he sells.

This is entirely a product of free market forces.

Basically, if a supplier tries to sell left-handed widgets at \$50.00 each, but most other suppliers sell them for \$25.00 each, he's not going to sell very many. And, he will probably go out of business eventually.

Of course, other factors beside price also play a part in the market force equation, eg: service, delivery, availability, etc.

And, last of all, and this is purely a personal observation, having been in a business some years ago that sold amateur, CB and commercial communications products, amateurs and CBers would be some of the most difficult people to deal with; and dare I say, in many cases with little commercial experience or exposure to make objective judgments about such matters.

In closing, has anyone ever wondered why we see only a small percentage of the equipment available on the US market here in Australia?

All other considerations aside, the main reason I would suggest is simply that we have a population of 15-16 million, with an amateur population of 18,372 (ref p6, AR March '90 WIA News), 0.118 per cent of the national population (approx)!

The short answer is that it is not commercial viable.

BRUCE R KENDALL VK3WL
8 WALWA PLACE
WERRIBEE 3030

Import Costs Again

Like John Woodings (Over to You, AR March) it takes a lot for me to bother finding the time to write any more than I have to, but 'Blatant Greed', I ask you, is this fair to your advertisers, and to Australian business?

John fails to mention the costs of a multitude of other goods as compared with their costs overseas, especially from countries with the broad consumer base they have in Amer-

ica. Did he say how much cars cost there? Or mowers?

Importers have many additional costs such as sales tax, duty, freight, exchange rate differences, insurance, advertising, and even dockers' strikes to consider when pricing their goods for retail sale. Fixed costs must be shared by the very few customers serviced; this is a price we must all pay because there are so few of us. Consider the WIA membership debate if you will.

John is one of the few amateurs who are affluent enough to actually go to America, but the cost of his ticket there should also be added to the price of the goods he bought; the prospective importer often has to make the same trip for business purposes.

Rather than whinge about supposed rip-offs, why don't all those whingers try getting into business for themselves, or shutting up about that which they know little, and supporting Australian business. If everyone went overseas to buy amateur (or anything) there would be no local market at all.

Oh yes, I nearly missed mentioning one of the most important aspects of buying foreign goods. If it goes wrong, who is going to fix it? Where will the spare parts come from?

Honest John might 'honestly feel that it is a blatant case of utter and unashamed greed' and, in some cases, that might indeed be so, but it is only dumb, dumb, dumb to let yourself be 'ripped off'.

In my own business I meet the occasional customer who remarks that a certain price is a 'rip off'. I then either point out that he can look elsewhere (at his own expense) for a better price, or he can go without. No retailer can force a customer to pay, so if you pay what you think is an exorbitant price, then you have only yourself to blame.

I can see that sitting back and complaining about all and sundry is going to make this country great . . . yeah, a great flop.

GILBERT GRIFFITH VK3CQ
7 CHURCH ST
BRIGHT 3741

More VNG Feedback

The list of the sort of people who use VNG which M Leiba details in the February issue of "AR" is very interesting.

It seems to me that they could derive the information they require from WWV anyway, but if they must use VNG then the DOTC should authorise its operation elsewhere in the spectrum where it will not interfere with the acknowledged international time and frequency standard.

I believe that it may be indicative of the VNG users consortium's breadth of concern for equity of all that caused M Leiba to include, as an apparent afterthought to the list, "other users" which include surveyors and navigators.

The consortium should be aware that these people, particularly the latter, have used WWV as a source of standard time for decades. As well, they benefit from WWV's weather warnings, a service VNG does not provide.

These facilities are used by people all around the world, and I doubt they really want to wait or, indeed, are able to wait, for VNG to cease transmission so they may "glean" this information from WWV.

The points that need to be made are:

- VNG is an authorised intruder
- It should be allocated other frequencies
- The WIA should act responsibly as it does with all known intruders and actively seek to have interfering transmissions stopped.

D H WATKINS VK2DDR

9 WILLAWA ST

BALGOWLAH HEIGHTS 2093

(Comments need to be made on your three points. VNG is authorised by the relevant authority (DOTC) and is on frequencies allocated to its type of service, thus it is not an intruder. Its operators would prefer other frequencies, and are still negotiating. The WIA has no Intruder Watch jurisdiction over non-Amateur frequencies. Ed.)

VNG Defence

Knocking VNG seems to be becoming a popular pastime in recent months, but one writer seemed to have the uneasy feeling that he was being rather disloyal. Maybe it is worth considering that VNG is an Australian product! It was developed with dedication over more than two decades, and revived by the grass-roots efforts of a number of Australians who believed we should have our own standard frequency and time-signal service, rather than relying on those from overseas.

However, what really gives me the pip (excuse the pun) is that these people do not bother to check all their facts before they blossom into print. This applies particularly to points 1 and 2 below.

1. VNG's role as a frequency standard.

VNG is now operating at Llandilo in the same manner it did at Lyndhurst, so the transmitted carrier frequencies are such that average daily deviations do not exceed +/-1 part in 10¹¹. Enough said?

2. Frequency allocation.

VNG's frequency allocation problems were discussed initially in March 1989 AR, pages 16-17, and then in November AR, page 40. A welcome piece of news is that DOTC has advised that it is working on allocating 16 instead of 15 MHz. Our users hope this comes about, as they find the interference to VNG by WWVH/WWH and other time services annoying, too! By the way, do not forget there are several others, including BPM (China), BSF (Taiwan) and JJY

(Japan) on the same frequencies. BPM sounds like VNG and sometimes comes in very strongly. I wonder whether some of the interference blamed on VNG is in fact BPM.

3. Telling the time with VNG.

It is true that VNG does not have voice time announcements each minute, but it does have a BCD time code which is the CCIR-recommended method of transmitting this information. Also, in last month's AR, page 26, I explained how to use VNG to tell the time without deciphering the BCD time code. I am sure this method will not be beyond the intelligence of my fellow amateurs!

4. Is VNG more trouble than it is worth?

While WWV and WWVH may be almost continuously audible if you have a good antenna, we found their signals not continuously sufficiently strong for scientific field work and even at many base stations. Also, users were concerned about figuring out the correct propagation delay. They preferred to support the revival of VNG. Believe me, this resuscitation effort has cost us a lot of energy, expense and (dare I say it?) sacrifice, and we would not have undertaken it if we hadn't considered it worth the effort. We are not masochists! Just a reminder that we do have amateur radio supporters as well. They do not write to AR because they don't have anything to complain about. They contribute to the Consortium to help keep VNG on air instead!

**MARION LEIBA (DR) VK1VNG/
VK1BNG**

**HONORARY SECRETARY
VNG USERS CONSORTIUM**

VNG and Economics

Two subjects —

A. Let me add my voice to those objecting to VNG on 5, 10 and 15 MHz. When I read some time ago that VNG was to return to the air, I thought "beauty". When I found that it was to occupy some of the frequencies used by JKY and WWV, I thought "what . . . dreamed that up?" Now we learn that it's the DOTC to blame. One might have hoped it had more sense. Please use the good offices of the WIA to ask DOTC to allow VNG to move to 4.5, 7.5 and 12 MHz (or 16 MHz).

B. I do not agree that WIA membership fees are too high, but the argument that the VK4 fee is \$1.25 per week is spurious. The reality of the matter is that the fee is \$65.00 and payable RIGHT NOW, and just after Christmas, too! I have seen too many wives of co-workers lined up outside the office door on pay-day to have many illusions about disposable incomes.

Many amateurs may have equipment worth several hundred or a few thousand dollars in

the shack. How many of the new rigs are on the never-never, and how many of the other, older rigs are five, 10, 15, 20 and more years old? My shack is fairly well equipped. I have a CRO and a signal generator. Both are well over 30 years old. Hey — anyone got a schematic and component values for an R A Ratcliffe model 200 signal generator? It features three 6V6GT and one 6X5GT valves, plus a power rectifier I can't identify. Help!

K G ENGLAND VK4JPE

31 MORGAN ST

ROCKHAMPTON 4700

Service Recognised

On January 16, 1990, I was awarded the National Medal and Clasp for 25 years community service by the Queensland State Emergency Service.

In the citation for the award were included the following:

Service in:

- 1) Civil Defence Organisation — 2 years
- 2) State Emergency Service — 15 years
- 3) RAAF Reserve
- 4) WICEN — 25 years +

In acknowledging the assistance to the SES and the community by WICEN, the SES has honoured not only me, but all amateur radio operators of North Queensland, both past and present, who have participated in WICEN operations.

This WICEN activity stretches back past the national net for Darwin following Cyclone 'Tracey', right through many more emergency operations such as Cyclone 'Winifred' up to the present day.

I am proud to have led this group of dedicated amateurs, and humbled by this award, which has only been made possible by their efforts as well as mine.

TED GABRIEL VK4YG

PO BOX 245

RAVENSHOE 4872

Aussie Tolerance?

Our persuaders are making much of some emotive Ockerisms lately — "the fair go" is a favourite; "dinkum" is not getting a fair go.

Many of the persuaders are not dinkum members of the ARS and would be more convincing if they were. So how about it, get fair dinkum, don't be content to hang around at Limited or Novice level; "there are 'igher things fer blokes ter do". Have a go at becoming dinkum, complete with an unrestricted licence and lots of operating time on CW.

Fair crack of the whip, "use it or lose it" they say, so do yer bit and help those internationals at the CW end of the HF bands cryin' out for a natter with a dinkum Aussie brass pounder.

Don't be left fer dead; if you won't make it to full call yer should be barred.

Note — correspondence coaching for Novice and AOCIP theory is available from address below. The cost — 100 x 230 SAE.

By the way, for Ted Gabriel's information, the "proword" ROGER has been superseded for several years by ROMEO.

LINDSAY LAWLESS VK3ANJ

Box 112

LAKES ENTRANCE 3909

(I guess, by "persuaders" you mean WIA office-bearers, Lindsay. Some who have Limited or Novice calls find that these permit as much activity as they have time to enjoy. Not everyone thinks CW DX is the pinnacle of radio achievement. Ed).

RAAF History

I was a member of the RAAF during World War II and served as a Wireless Maintenance Mechanic. I am documenting the history of the training and working of this trade group which was trained in Melbourne at No 1 STT (Exhibition Building) and the Melbourne Technical College from late 1941 onwards.

I would like to hear from any ex-members who trained as Wireless Maintenance Mechanics who may be able to add to my information.

DON BROWN

EX 50021 RAAF

158 MAJURA AVE

AINSLIE ACT 2602

Pecking order?

I write this in early February, and it is over three months since I last heard the woodpecker.

Is it a miracle, or have the little boys found a new toy to play with?

LES HAWKINS VK4DA

15 COOMBER ST

BUNDEBERG 4670

(As described in the article by VK5PU in AR May 1986, the Soviet OTHR was even then obsolescent. Maybe it has now been retired! Ed)

**Have you
advised the
WIA Executive office
of your new callsign?**

**Use the form on the
reverse of the Amateur
Radio address flysheet.**

FTAC NEWS

JOHN MARTIN VK3ZJC
ACTING CHAIRMAN, FTAC

Data Base

The beacon and repeater Data Base published in February "AR" is being revised at present. Please notify FTAC of any additions or corrections to the list.

New 5650 MHz Record

FTAC has verified the claim of Nick Tebneff

VK5NT and Des Clift VK5ZO for a new record on the 5650 MHz band. On November 12, 1989, Des operated portable with a 40 mW Gunn oscillator and a 600 mm dish, while Nick used a 140 mW klystron and an identical dish. The mode was wide band FM using a 30 MHz IF. This contact is a new national record for the 5650 MHz band, the distance covered being 176.4 Km.

HF PREDICTIONS

ROGER HARRISON VK2ZTB
THE APOGEE GROUP

April Charts

For ease of use and to accommodate space restrictions in the magazine, I have provided predictions applicable for three major regions of Australia:

VK EAST Covers the major part of NSW and Queensland.

VK SOUTH Covers southern-NSW, VK3, VK5 and VK7.

VK WEST.Covers the south-west of West Australia.

For each of these regions I have selected six "terminals" to major continental regions of the world, or regions of particular interest, such as Australian Antarctica (VK ANTARCTIC). From time to time, I will include predictions to cover particular expeditions or other activities of special interest. This month, I've included predictions for the long path to Europe.

Feedback from readers and users would be most appreciated - let me know what you feel

is wrong, and what's right, about the paths, presentation or any other aspect.

The Charts

These charts are different from those you see published elsewhere, and arguably more useful to the amateur fraternity as they give, effectively, the predicted signal/noise ratio for each hour and for selected bands. The charts are organised in 24 rows, one for each hour UTC (first column on the left). Don't forget to add the appropriate number of hours for your time zone, including daylight saving where it applies. The next column give the MUF (maximum usable frequency) for each hour, followed by the field strength at the MUF, in decibels referred to 1 uV/metre (dBU). The column marked FOT gives the "optimum" frequency - the most reliable frequency for the path. Then come five columns, one for each of five selected HF bands. The numbers in the column represent predicted field strength at

Don't buy stolen equipment

Check the serial
number against the
WIA stolen equipment
register first.

New 23 cm Band Plan

Details of the new plan were published in the 1990 Call Book and on page 13 of February "AR". Any comments on this plan would be most welcome. ar

each hour in decibels referred to 1 uV/metre. Here it represents "raw" signal to noise ratio as urban noise levels are typically 1-2 uV/metre, but does not take into account the advantage offered by particular transmission modes. The results are based on a transmitter power of 100 W output, the use of modest 3-element beams or similar, and for "median" conditions. Where the results fall below -40 dB, no output is printed.

Enhanced conditions may improve S/N ratios by 9-15 dB. The use of CW or digital transmission modes show better results than SSB. If you've got 400 W output, you get a 6 dB improvements. Where conditions warrant it, I have deleted 28.5 MHz predictions and included 10.1 MHz. In general, providing predictions for the band below 10 MHz is futile during this part of the solar cycle, except perhaps where DXpeditions are concerned.

The Bouvet Island predictions are different, being based on dipole antenna systems and they cover the bands scheduled to be activated. The predictions are calculated using a program known as "FTZ", for IBMs and compatibles, distributed by FT Promotions. If you want to know more about this program, call (02)818-4838. ar

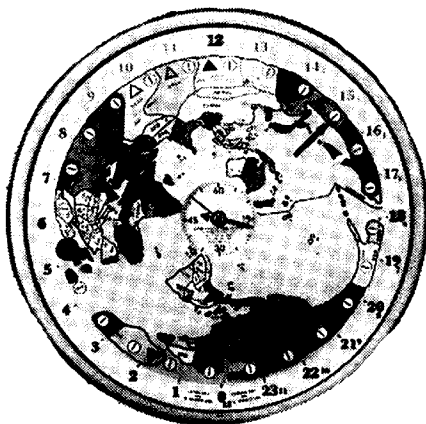

Ever baffled by World Clocks?

There is no need to be confused by a maze of foreign city names which cannot relate to their times.

The ZONE VIEW GLOBAL CLOCK* provides pictorial views of 30 Time Zones, differentiated by colour, clearly shows the time and day in each zone.

Amateurs! Now you can know at a glance who's in bed, who's having lunch, and who might be on the air.

*25cm diameter quartz movement.

For details or orders contact:
RESEARCH ENGINEERING CO.
1319 Main Road, Eltham, Vic. | Australia 3095.
Phone: (03) 439 5825

Rec. Ret. \$82 plus P&P.

HAMADS

TRADE ADS

AMIDON FERROMAGNETIC CORES: For all transmitter and receiver applications. Send DL size SASE for data/price to RJ & US Imports, Box 157, Mortdale NSW 2223. (No enquiries at office please...11 Macken St (Oatley). Agencies at: Geoff Wood Electronics, Sydney; Webb Electronics, Albury; Electronic Components, ACT; Truscott's Electronics, Melb; S Willis, Perth; Assoc TV Service, Hobart. Closed first 2 weeks May.

SATFAX: NOAA, Meteor, GMS weather satellite picture receiving program for IBM XT/AT. Displays in 64 colours. Needs EGA colour monitor & card, and "Weather Fax" PC card. \$45 + \$3 postage *** RADFAX2: HF weather fax, morse & RTTY receiving program for IBM XT/AT. Needs CGA, SSBHF, FSK/Tone decoder. Also "RF2HERC" & "RF2EGA", same as RADFAX2 but suitable for Hercules & EGA cards respectively. \$35 + \$3 postage *** All programs are on 5.25" OR 3.5" Disk + full documentation. ONLY from M. Delahunty, 42 Villiers St New Farm 4005 QLD. Ph (07) 358 2785.

FOR SALE — NSW

KENWOOD 711 as new \$1200. KENWOOD 811 as new \$1300. BWD 511 scope A1 with probe \$250. COSSOR CME 110A cable reflectometer working no book SINGER spectrum analyser input attn missing working ok. 1 MHz to 40 GHz \$1500. ERIC VK2WH (02) 519 7007 Bus (02) 958 1985 AH.

HOMEMADE oscilloscope (DG7-6), circuit \$120 pick up. High-low pass split filter 5000 Watt HARO-ELECTRONIC/Germany — 70 dB gold terminals, silver tub coils ceramic capacitors. \$50. VK2AOU QTHR (02) 53 9789.

KENWOOD TL-922 linear amplifier HF, new in box with new EIMAC 3-500Z tubes never installed \$2500 WILSON M420 14 MHz 4 element yagi, gamma matched, assembled, as new, with instruction sheet, made USA \$360 70 foot galvanised free standing tower, ex RAAF, as new \$1850 Manfred VK2RV (02) 371 8854 QTHR.

YAESU FTONE vgc full manuals filters \$1750 also EMTRON tuner EAT300A vgc \$250 George VK2EHN QTHR (043) 69 2896.

STANDARD C146A 2 metre 5 channel FM handheld TXVR including nicads, leather carry-case, technical manual, full circuit diagram. Excellent condition. \$250 ono. VK2DEQ QTHR (063) 62 8703.

KENWOOD TS940 S mint condition integrated antenna tuner and power supply memories manuals original packings low hours owner purchased TS950 S \$4000 Jim VK2FIA (049) 46 7533 all hours.

DRAKE TR7A transceiver 250 w HF 1.5 — 30 MHz with aux 7 marine mint condition manuals carton \$1500 Max VK2TX (043) 62 1919 QTHR.

LOG periodic ATN 8 elem exc. cond. 10-30 MHz \$500 must sell Jose VK2FNJ (047) 30 3910 AH (02) 925 8607 BH.

COMPLETE RTTY station INFO TECH 200E demodulator 300C keyboard high resolution monitor SIEMENS printer many spares all handbooks \$600 KENWOOD 811B uhf all mode transceiver hardly used \$800 ICOM 211 2mx all mode transceiver \$400. Both c/w mics and handbooks VK2BDT QTHR (048) 21 5036.

VIDEO RECORDERS, 2 x National NV 3020E 1 x Sony AV3600CE, 30+ Hrs of tape in 1/2 and 1 hr reels. Copy of technical manuals for Sony only. \$150 the lot. Geoff VK2DYS QTHR (02) 744 8307.

FOR SALE — VIC

YAESU FT101E HF transceiver includes manuals and inverter. Excellent condition. \$450. Ph (054) 61 4001. QTHR VK3KQI.

YAESU FT102 with AM/FM module, desk mike & hand mike. EC \$1100. KENWOOD TM-221A 2 metre set with mobile ant. EC \$525. D S COMMANDER 2 metre set, requires tuning \$130. DS 100 watt 2 metre linear amp \$175. DS HF 80 metre set EC \$210. FARNELL lab std dual circuit power supply 0-30 volt \$215. DAIWA mike compressor MC-22 \$40. JOHNSON VIKING converted to 10 metre band \$100. TRANSWEST 13.8 volt/6 amp power supply \$60. MASTER DM-6022A digital multimeter new \$75. AVTEK MODEM 300, 1200/75, 1200, 2400 baud modem \$295. VK 3NIV c/o VK3EFK (058) 21 2393.

YAESU FL-2100B still in carton never used \$900. Ken VK3ASN QTHR (03) 842 5905.

KENWOOD PS50 20 amps power supply as new \$485. Jim VK3NR (03) 367 6920.

STANDARD handheld 500E. Dual band transceiver with two nicad batteries plus charger hardly used manuals etc. Best offer Ph (051) 99 2811.

KENWOOD TM2570A 2m FM mobile TXVR with DTMF, up to 70 w output. 23 memories. \$620 neg. Fab VK3FAB. (050) 23 4920 after school hours.

AZDEN PCS 4000 2 metre mobile transceiver 5 or 25 w 16 memories reverse backlit dial no mods new condition instruction book carton \$400. Alf VK3EJ (03) 877 2983.

COMMUNICATIONS RX LAFAYETTE HA 800 80 through 6 metre amateur bands \$100. Leo VK3YX QTHR (03) 232 9422.

FT7 \$370 FL110 \$220 FRG7 \$220. (Manuals included.) Buyer to collect from Bendigo or Melbourne. Max VK3ATK (054) 41 2158 or (03) 563 3080.

YAESU FT757GX ex-cond \$1300. YAESU FP757HD power supply \$450. PLESSEY FOSTER hand held power mikes (2) brand new \$60 each. Kevin VK3CKL (03) 792 9503.

WESTON milliamp DC meter, model 430, resist 10 ohms, zero corrector \$95. WESTON current transformer, model 539, cap 2v amps, freq 25-150, line-volts 750. Ranges 20, 10, 5, 2, higher ranges \$150 ono. (055) 62 6016.

TRAP dipole 40 80 meters "RAKE" \$25 Ted VK3TG (052) 59 3225.

YAESU FT-48OR 2m all-mode transceiver with four memories and scan functions. Complete with owners manual, service manual and accessories \$495. Adrian VK3DAW Ph (03) 720 6451.

YAESU FT-209RH 2m hand held and accessories \$350. Bert VK3TU Ph (052) 78 2374 QTHR.

ICOM auto antenna tuner AT500 \$1000 John (03) 232 6587 AH (03) 794 8077 Bus.

YAESU FTV-650B 6m SSB transverter. Matches FT-101 series transceivers \$150. VK3BRZ (AH) (052) 82 3167.

ARON 200 MHz dual trace oscilloscope model BS-601 used twice, extra lead \$500 ono with manual Sam (03) 330 2557.

1 YAESU FT200 SSB transceiver. 1 ICOM 2m all mode transceiver IC 211. 1 KENWOOD SSB transceiver TS520S. 1 DRAKE microphone stand type. As new condition. Nearest offer. All offers in writing please. Contact: Robert Stewart, Northern Metro College of TAFE, Television Training Unit, 20 Otter Street, Collingwood, 3066. Ph 419 6666 ext 230.

IC32AT 2m/70cm 5 Watt handheld. BP70, charger ant h'book carton. Perfect cond \$650 Andy (03) 735 3335.

DRAKE TR7 TXCVR 10 kHz — 30 MHz AM/SSB/CW/RTTY exc cond AM filter fitted. Recently checked by agents workshop manual included \$1200. Wandel and Golterman level test set PSM-5 10 kHz to 36 MHz laboratory instrument. Superb AM/SSB/CW RCVR external audio and AGC module incl plus workshop manual has separate sig gen and spectrum analyser \$1500. H L Hepburn VK3AFQ (03) 596 2414 QTHR.

FOR SALE — QLD

ICOM R7IA receiver \$800. As new Ph (07) 390 7762.

UNUSED 6883 O/P valves \$5 ea. Also unused driver and other valves incl 12BY7 6BY7 6Y9 6AK6 6AQ5 6BX6 6EA8 etc 75¢ ea. Unused 14 core H/duty PVC cable suit beam control 90c/metre. Unused SIEMENS cradle relays 12v PCB mounting \$1.50 ea. Sid VK4SG QTHR (07) 268 2414.

ICOM IC-2A portables two transceivers excellent condition plus two battery packs best offer ph (075) 31 3124 evening.

REVEX W570 SWR/PWR meter in perfect cond \$320 covers 1.8-1300 MHz. YAESU FBA-8 battery pack \$30 for FT-2/690 TXVRS. Glen VK4VGC (075) 35 0919.

YAESU FT221 with desk mic \$250 KENWOOD TH215A must sell make offer both top condition QTHR Ph (075) 39 1252 Neville VK4AEV.

KENWOOD TS830 TXVR and remote VFO230 vgc with manual and cartons overhauled by Kenwood dealer \$950. Ron VK4MBJ QTHR (070) 92 1181 AH.

COMMODORE C64 B/W monitor tape recorder joystick lots of books etc computer desk lot \$500. (075) 33 8249 lan.

FOR SALE — SA

YAESU FT690R Mk1 w/case, HB 25w 6m linear, 6m VK5 preamp \$600 the lot. KARINNA 40 CH CB conv to 10m \$240. KENWOOD TH21A 2m micro H H charger spr Nicad \$280. Terry, VK5ATN QTHR Ph (088) 63 1268.

AUSTRALIAN VOICE REPEATER map and

repeater LIST with place names arranged in state and alphabetical order for easy mobile reference. Send \$2 plus SSAE (9"x4") to ADELAIDE HILLS A R SOC (VK5BAR) BOX 401 BLACKWOOD SA 5051.

KENWOOD ATUAT230 \$310. KENWOOD ATU AT250 \$500. Peter VK5BWH QTHR (086) 42 2363.

KENWOOD TH-45A 70cm. H/held brand new with charger etc \$380 (088) 42 2085 Jeff VK5BJF QTHR.

FOR SALE — TAS

DATONG morse tutor D-70 as new \$200. Collection of WIA morse cassette tapes up to 12 wpm \$12. VK7KFM 20 Lions' Cres, "Urnina Park" BURNIE 7320.

MARCONI sig gen TF995B-5 200 kHz 220 MHz \$500 transmitter KW VICEROY 10-80m 100w SSB-AM \$150 AWA test-set A412 low high band modules \$450. HENRY RADIO amplifiers 145 180 MHz 50 w cont FM 13.8 VDC \$100. Col VK7KW QTHR (003) 44 2761 AH.

JRC - JST 125 T/CEIVER- As new 160 - 10mtr Inc. WARC & General cov. rec., 77 memories. Boxes \$2200 ono.

TANDY HTX 100 10m. SSB/CW mobile new \$475 25W output See AR review VK7AN (003) 317914

WANTED — NSW

CIRCUIT DIAGRAM (or copy) for four valve Kriesler mantel radio model no 11-20 costs reimbursed — David VK2ZTH. Ph (02) 627 1111 BH (047) 51 3837 AH.

VOLTOHMIST probe set, will accept individual probes. Model number 2A56074 please advise cost David Kidd 8 Gosse Ave Dubbo East (068) 81 8906.

FT107DM must be in top cond will pay top price. VK2UH Smithy QTHR or (048) 40 2228.

YAESU mobile ant RSL 3.5 whip only will pay anything (well almost) for good unit Ph George VK2EHN (043) 69 2896 QTHR.

KENWOOD speaker model SP820 Maurie (02) 627 1434.

QTH comfortable rural or semi-rural with or without external plant 2/3 bedrooms VK2BOG QTHR (047) 58 8164.

WANTED — VIC

FOR COLLINS 51S-1 recvr, audio output trans (T8), AGC/IF trans (T7), meter, handbook, 6DC6 valves, any other parts. David, VK3BFB (03) 587 1593.

HELP required. How to use an Apple IIc computer on packet software required — system used and cost please send information to: Alan Foulstone VK3ECZ C/- PO Box 161 Laverton 3028.

ICOM22S, manual & modifications for copying. Pay costs. David Aston VK3THY. Ph (03) 434



Please Note: If you are advertising items For Sale and Wanted please use a separate form for each. Include all details; eg Name, Address, Telephone Number (and STD code), on both forms. Please print copy for your Hamad as clearly as possible.

*Eight lines free to all WIA members, ninth line for name and address Commercial rates apply for non—members. Please enclosed a mailing label from this magazine with your Hamad.

*Deceased Estates: The full Hamad will appear in AR, even if the ad is not fully radio equipment.

*Copy typed or in block letters to PO Box 300, Caulfield South, Vic 3162, by the deadline as indicated on page 1 of each issue.

*QTHR means address is correct as set out in the WIA current Call Book.

*Please enclose a self addressed stamped envelope for acknowledgement that the Hamad has been received. Ordinary Hamads submitted from members who are deemed to be in general electronics retail and wholesale distributive trades should be certified as referring only to private articles not being re—sold for merchandising purposes.

Conditions for commercial advertising are as follows: \$22.50 for four lines, plus \$2.00 per line (or part thereof) Minimum charge — \$22.50 pre—payable.

State:

- Miscellaneous
- For Sale
- Wanted

Name:

Call Sign:

Address:

.....

7152 AH (03) 646 1500 BH.

VARIAC or similar 150 watts or any bench type unit. Ron VK3BRC QTHR (03) 819 3568.

YAESU FL110 solid state amplifier. Bill VK3ARZ QTHR (03) 584 9512.

9 MHz SSB xtal filters. Preferably replacement unit for YAESU FT301, FT7, or FT7B, but will consider others. Bill VK3ARZ QTHR (03) 584 9512.

WANTED — QLD

TUBES 6L7 6K7 6J7 6SJ7 for Super Pro receiver. Ph (07) 390 7762.

HELP wanted schematic and component values RATCLIFFE model 200 signal generator Ken VK4JPE (079) 22 4985 will send SASE if needed.

9 MHz crystal filter with data, AKG K50 headphones, screw type feed — through capacitors, VK4JZ QTHR (07) 398 2002.

WANTED — WA

FT200 FT250 TX-RX radios & any parts going or not esp, No. 335001 models. Revs accep. (09) 419 2951.

WANTED — NT

ANTENNA 2 to 4 element triband quad or 3 to 7 element triband yagi or 8 to 9 element 13-30 MHz log periodic. Must be in very good condition; fairly priced; ready for shipping. Eddie VK8XX, (089) BH 51 3138, AH 53 4056, FAX 52 6893.

TRADE PRACTICES ACT

It is impossible for us to ensure the advertisements submitted for publication comply with the Trade Practices Act 1974. Therefore advertisers and advertising agents will appreciate the absolute need for themselves to ensure that, the provisions of the Act are complied with strictly.

VICTORIAN CONSUMER AFFAIRS ACT

All advertisers are advised that advertisements containing only a PO Box number as the address cannot be accepted without the addition of the business address of the box-holder or seller of the goods.

TYPESETTING : Redfords Media
25 Glenferrie Rd
Malvern 3144
Tel: (03) 500 0377

PRINTING: Industrial Printing
Richmond

MAIL DISTRIBUTION: Polk Mailing Co.
PO Box 140,
Collingwood,
Vic. 3066
Tel:(03) 417 5161

The opinions expressed in this publication do not necessarily reflect the official view of the WIA, and the WIA cannot be held responsible for incorrect information published.

ADVERTISER'S INDEX

ATN Antennas	13
Call Book	7
Dick Smith Electronics	IBC, 17
Electronics Australia	9
Icom Australia	OBC,
Kenwood Electronics Aust.	IFC
Magpubs	5
Research Engineering Co.	59
WIA NSW Division	7

TRADE ADS

M R Delahunty	62
RJ & US Imports	62

HOW TO JOIN THE WIA

Fill out the following form and send to:

The Membership Secretary
Wireless Institute of Australia
PO Box 300
Caulfield South, Vic 3162

I wish to obtain further information about the WIA.

Mr, Mrs, Miss, Ms:

Call Sign (if applicable):

Address:

State and Postcode:

FT-736R HIGH PERFORMANCE VHF/UHF BASE STATION TRANSCEIVER

The sky's not even the limit for the FT-736R! This base station rig is the most complete, feature packed radio ever designed for the serious VHF/UHF operator, whether your interest is talking through the local repeater or working the world via satellite. As standard, it provides 25 watts output on the 2 metre and 70cm bands in SSB, CW, or FM modes, and can be expanded to also cover the 6 metre and 23cm bands by installing optional modules as required. Some of its many features include . . .

- Flexible frequency control, with keyboard frequency entry, 115 general purpose memories, 10 full-duplex crossband memories, 2 independent VFO's per band, band/memory/mode selective/limited-band scanning functions, as well as 2 full-duplex VFO's which can have their transmit and receive frequencies (and modes) tuned independantly or tuned synchronously for satellite operation.
- IF shift and IF notch filters, noise blanker, all-mode VOX, 3 speed AGC, Speech processor, GaAs Fet front-ends on 430 and 1200MHz, high stability (+/- 1ppm) reference oscillator, VFO or selectable channel steps on FM, narrow FM mode, inbuilt AC power supply, as well as a large fluorescent digital display • **2 Year Warranty**



BONUS MD-1 Desk Mic!



D-2920

\$2695

or **\$2995** with 2m/70cm/6m modules D-2925

Optional 6m module **\$475**

Optional 23cm module **\$899**

Limited Stocks! SAVE \$169

ONE PLACE TO SHOP FOR ALL YOUR ACCESSORIES!

1990 ARRL Handbook

Just released, this quality hard cover edition of the ARRL handbook is a MUST for every Ham shack. It covers all aspects of Amateur operations, including up-to-date information on Satellite and digital mode techniques, as well as many chapters of constructional projects for the home-brew enthusiast.

Cat B-2223

\$49⁹⁵

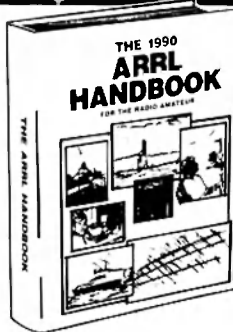

High Quality 2-Way Coax

You can tell by the way it feels that this ultra high quality 2 position coax switch will give you years of trouble free operation. Suitable for HF, VHF and UHF 1000MHz use. Gives superb isolation, lower insertion loss (<0.1dB) and better performance. Anything less just isn't worth it! Cat D-5208

\$69⁹⁵



Rak BL-50A Balun

Designed for use as a centre support for dipoles or yagi antenna. Input is 52 ohms unbalanced with output 52 ohms balanced. The RF input power is 1kW with an insertion loss of less than 1dB. Frequency range covers the entire HF band (3 to 30MHz). Cat D-5310

SAVE \$10!

\$49⁹⁵

3 Element Yagi

This Australian made Yagi was originally designed for 27MHz, but is easily adaptable to 28MHz operation. It uses a Gamma-match for easy coax feed (no balun required), is very simple to construct, and only requires the use of a light-duty rotator. Cat D-4428

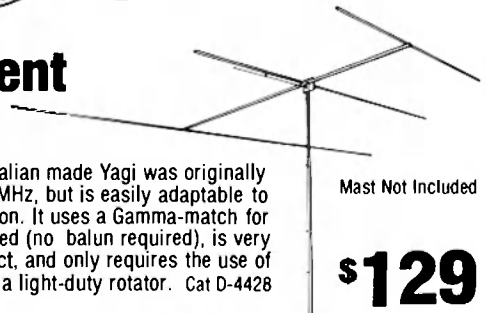

Mast Not Included

\$129

• NSW • A burry 21 8399 • Bankstown Square 707 4888 • Blacktown 871 7722 • Brookvale 905 0441 • Bondi 387 1444 • Campbelltown 27 2199 • Cheshwood Chase 411 1955 • Chullora 642 8922 • Gore Hill 439 5311 • Gosford 25 0235 • Hornsby 477 6633 • Hurstville 580 8622 • Kogarah 56 2092 • Liverpool 800 9888 • Marand 33 7888 • Miranda 525 2722 • Newcastle 61 1896 • North Ryde 878 3855 • Parramatta 689 2188 • Penrith 32 3400 • Railway Square 211 3777 • Sydney City 267 9111 • Tamworth 66 1711 • Wollongong 28 3800 • ACT • Fyshwick 80 4944 • VIC • Ballarat 31 5433 • Belmont 43 8522 • Berdigoy 43 0388 • Box Hill 890 0699 • Coburg 383 4455 • Dandenong 794 9377 • East Brighton 592 2386 • Essendon 379 7444 • Footscray 689 2055 • Frankston 783 9144 • Geelong 232 711 • Melbourne City 399 Elizabeth St 328 6088 and 246 Bourke St 839 0396 • Richmond 428 1614 • Ringwood 879 5338 • Springvale 547 0522 • QLD • Brisbane City 229 9377 • Buranda 391 8233 • Cairns 311 5151 • Chermiside 359 8255 • Redbank 288 5599 • Rockhampton 27 3644 • Southport 32 9033 • Toowoomba 38 4300 • Townsville 72 5722 • Underwood 341 0844 • WA • Adelaide City 223 4122 • Beverley 347 1900 • Elizabeth 255 8099 • Enfield 280 8088 • St. Marys 277 8977 • WA • Cannington 451 8666 • Fremantle 335 9733 • Perth City 481 3261 • Midland 250 1480 • Northbridge 328 6944 • TAFE • Hobart 31 0800 • NT • Stuart Park 81 1977

ORDER BY PHONE OUTSIDE SYDNEY (008) 226610 Free Call Sydney Area 888 2105



WITH ALL THE FEATURES IN ICOM'S NEW MOBILE TRANSCEIVERS, IT'S A WONDER THEY'RE STILL MOBILE.

ICOM have packed so many functions into the IC228A and IC2400A mobile transceivers, you'd think there was no way you could still make them so compact. (It might explain why nobody else has made a transceiver with so many features).

One of the features both transceivers share is back lit control knobs for visibility in bad lighting conditions.

There are various power outputs across the range, from 25W to 45W.

For novices, the 228A can be reduced to 10W.

The programmed Scan function scans all frequencies between two programmable set frequencies, while the Memory Scan function scans all memory channels except, of course, those you lock out.

Thanks to the pocket beep, you'll never miss a call. By installing a UT-40 Tone Squelch Unit (this is sold separately) the transceiver functions as a pager. When the frequency of a received tone equals the tone frequency you set, a thirty second alarm is emitted over the speaker.

As for monitoring the input frequency when you work a repeater, that's as simple as pushing the Monitor Switch on the front panel to open the squelch and check the frequency.

Every five seconds, Priority Watch in the IC2400A monitors the operating Channel, and one or all memory channels in succession. And that's while you operate! No longer do you have to flip back and forth between frequencies.

While the IC228A has 20 memory channels the more advanced IC2400A has 40, plus two call channels. Each channel stores all the information required to work a repeater.

With the IC2400A there are 20 double-spaced memory channels for 2 metres and 70 cm.

What's more, the IC2400A offers full duplex facility. Which means you can now simultaneously transmit on one band and receive on the other. You never have to wait for a long "over". You have full "break in". In fact, you can talk as easily as talking over the phone.

With all these functions in one small compact mobile, it really is a wonder they're still so compact and mobile.

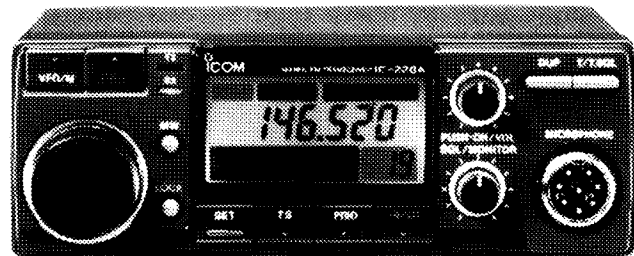

IC228A

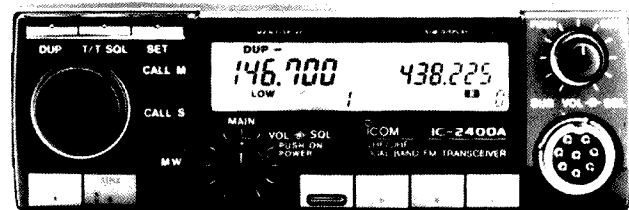

IC2400A

Call ICOM on (008) 338 915 for details on ICOM products and your nearest stockist.
Melbourne callers (03) 529 7582. ICOM Australia Pty. Ltd., 7 Duke Street, Windsor, 3181.

ICOM

AMATEUR RADIO

MAY 1990

RRP \$3

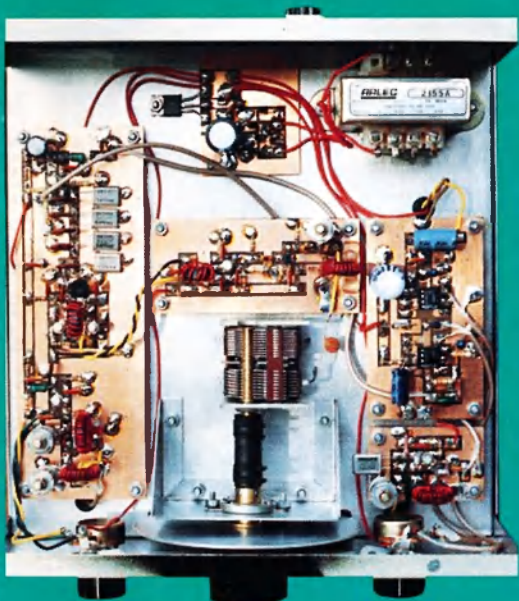

SUPERHET DC RECEIVER



THE WIA RADIO AMATEUR'S JOURNAL

KENWOOD



This is DX-clusive

Kenwood engineering pushes the outer edge of the high technology envelope of digital techniques, Digital Signal Processor, high-voltage power amplifiers, and advanced receiver design allows the all-new competition-class TS-950SD HF transceiver to deliver DX-clusive performance second to none.

The TS-950SD is designed for critical applications in SSB, CW, AM, FM, and FSK on all HF Amateur bands, including the new bands.

Features

- Dual Frequency Receive Function
- Built-in Digital Signal Processor
- Outstanding Receive and Transmit Performance
- 150W High Power and Heavy-Duty Cycle Design
- Built-In Automatic Antenna Tuner
- Superior Interference Reduction



KENWOOD ELECTRONICS AUSTRALIA PTY. LTD.
(INCORPORATED IN N.S.W.)
4E Woodcock Place, Lane Cove, N.S.W. 2066, Australia
Ph. (02) 428 4222, (02) 428 1455, Fax (02) 427 6869
Call now for further information and the name of your nearest authorised Kenwood dealer.

Please phone, mail or fax for information

Name

Address

..... Postcode

Publication..... Issue

Model



Amateur Radio is published by the Wireless Institute of Australia, as its Official Journal on the last Friday of the previous month.

EXECUTIVE EDITOR
Bill Rice VK3ABP

MANAGING EDITOR
Graham Thornton VK3IY

NEWS EDITOR
Jim Linton VK3PC

SENIOR TECHNICAL EDITOR
Peter Gibson VK3AZL

TECHNICAL EDITORS
David Brownsey VK4AFA
Don Graham VK6HK
Evan Jarman VK3ANI
Peter O'Connor VK4KIP
Gil Sones VK3AUI
Phil Steen VK4APA
Roy Watkins VK6XV

DRAFTING
Vicki Griffin VK3BNK

MARKETING
Bruce Kendall VK3WL
Norm Eyres VK3ZEP

ADVERTISING
Ann McCurdy

All contributions and correspondence concerning the content of Amateur Radio should be forwarded to: -

The Editor
Amateur Radio
PO Box 300
Caulfield South
VIC 3162

Registered Office
3/105 Hawthorn Road
Caulfield North VIC 3161

Telephone: (03) 528 5962
(03) 523 8191

Fax: (03) 523 8191
(Non dedicated line)

Business hours: 9am to 3pm weekdays

Deadlines

	Editorial	Hamads
June	7/5/90	9/5/90
July	8/6/90	11/6/90
Aug	9/7/90	11/7/90

Delivery of AR: If this magazine is not received by the 15th of the month of issue, and you are a financial member of the WIA, please check with the Post Office before contacting the registered office of the WIA.

© Wireless Institute of Australia 1990

CONTENTS

Technical

A Morse Oscillator	20
<i>Mervyn Eunson VK4SO</i>	
Coming Up from Down-under on the Diamond Dilly	16
<i>Don P Wood W7YSO/VK2DSO</i>	
<i>(Evaluation by Reg Hardman VK4XH)</i>	
Morse - The Phillips Code	18
<i>Lloyd Butler VK5BR</i>	
Superhet-DC Receiver for 3.5-4.0 MHz	8
<i>Drew Diamond VK3XU</i>	

General

NCRG JMFD 1989	24
<i>John Sparkes VK6JX</i>	

Book and Product Reviews

Hints and Kinks for the Radio Amateur - ARRL	23
<i>Jim Linton VK3PC</i>	
The Bencher Iambic Paddle	22
<i>Graham Thornton VK3IY</i>	

Operating

Contests	
Calendar, Ross Hull Results, 1990 Trial VHF/UHF FD, Contest, VK Novice 1990 Rules	26
Australasian Sprints 1990 Rules	27

Columns

Advertisers' Index	56	How's DX	28
ALARA	38	Intruder Watch	38
AMSAT	34	Morseword No 38	43
Club Corner	45	Over To You - Members' Opinions	49
Divisional Notes		Pounding Brass	32
Forward Bias,	41	QSLs from the WIA Collection	46
VK2 Notes, VK3 Notes,	43	Random Radiators	40
VK4 Notes, 5/8 Wave	44	Repeater Link	39
VK6 Notes	45	Silent Keys - Obituaries	48
Editor's Comments	2	Spotlight on SWLing	38
Education Notes	37	Stolen Equipment	36
EMC Report	33	VHF/UHF An Expanding World	31
FTAC Report	37	WIA Directory	2, 3
Hamads	54	WIA News	3
HF Predictions	52	WICEN	41



Cover

A homebrew project for those winter evenings. Drew Diamond VK3XU has combined the best of both worlds with his unique Direct Conversion Superheterodyne combination. See article on page 8 for full details.

Why Join The WIA?

This may be the first copy of Amateur Radio you have seen. If so, we're pleased to be with you, and we'd like you to stay! We know a bit about you: do you know who we are? What do we know about you? One thing is that you have some interest in radio communication and you have an amateur licence or are probably studying to get one. You are probably male, but one in ten of you may be a young lady (irrespective of age). You may have once belonged to the WIA, and decided for various reasons not to continue. You may have considered joining but never actually "got around to it". You may even have a violent aversion to us! We have been called ignorant, smug, pompous, biased, parochial, paranoid and out-of-touch, but also aware, informative, interesting, wide-ranging, essential, internationalist and on-the ball! We have been so described by some of our members (or ex-members). But who are we? **WE ARE OUR MEMBERS!** And so also are most of you.

You may, as members, change us into a different or-

EDITOR'S COMMENT

BILL RICE VK3ABP EXECUTIVE EDITOR

ganisation altogether; if there are enough of you who want to do it. Some of us, those who comprise Executive and its various sub-committees, have been described as an entrenched minority of minders and persuaders, either brain-washed or brain-washing! But we are simply amateurs who have seen (or been shown) a job to do and accepted the challenge to do it. You, and you, and you (yes, and you too!) are free to take our places. We are only "entrenched" because new volunteers are conspicuously absent. We need you, whether you have been a member for years, just joined, or still thinking about it, because from you must come those who will replace us. And if you do not replace us, what then? Fairly obviously, we will slowly fade away. So what?

Here is where about half Australia's radio amateurs differ quite strongly from the rest. The

pro-WIA group are aware that without strong national organisations amateur radio might only have evolved into a pale shadow of what it is. It might well by now have ceased to be, or, less drastically, have become no more than the Citizen's Bands today, restricted to short range and low power with only one or two bands instead of 15 from MF to microwaves, and more still at even higher frequencies. Admittedly there are many more CB operators than amateurs, but this is for the dual reasons that no examination is needed for a CB licence and it may be used for a number of commercial purposes. Many CBers "step up" to amateur radio after acquiring a taste for radio on CB, and we welcome them to our wider fields.

The others, mostly not WIA members, represent several viewpoints. Some, of course, as in most human activities,

just don't care. They, the apathetic ones, are probably a very small minority, since the effort of studying for and passing the amateur licence exams implies a certain amount of energy and enthusiasm. Some of the non-members have a strong aversion to anything that sounds like compulsory unionism, and we must admit there are some parallels. Unions achieved working conditions which individual workers could not, and they achieved their aims by their bargaining power, which was simply weight of numbers. Not all Australian unions have enforced compulsory membership, but many have. "No ticket, no job"! There was then no question of non-members enjoying conditions to which they had not made a contribution. Membership of the WIA has never been compulsory, and non-members may enjoy conditions which WIA negotiation with Government has produced, or WIA funds have paid for. Whether this is fair to all may be debated at length, but not here and now!

Probably most of those who

Wireless Institute of Australia

The world's first and oldest National Radio Society - Founded 1910
 Representing Australian Radio Amateurs - Member of the International Amateur Radio Union
 Registered Executive Office of the WIA: 3/105 Hawthorn Road, Caulfield North, Vic. 3161
 All mail to: **PO Box 300, Caulfield South, Vic, 3162** Telephone: (03) 528 5962 (03) 523 8191
 Fax: (03) 523 8191 (Non-dedicated line)

Business Hours: 9.30 am to 3.00 pm on Weekdays

General Manager and Secretary: Bill Roper VK3ARZ

EXECUTIVE

President:	Peter Gamble	VK3YRP	VK1 Federal Councillor:	George Brzostowski	VK1GB
Vice Chairman:	Ron Henderson	VK1RH	VK2 Federal Councillor:	Terry Ryeland	VK2UX
	Kevin Olds	VK1OK	VK3 Federal Councillor:	Peter Maclellan	VK3BWD
	Brenda Edmonds	VK3KT	VK4 Federal Councillor:	David Jerome	VK4YAN
	Bill Rice	VK3ABP	VK5 Federal Councillor:	Bill Wardrop	VK5AWM
Immediate Past President:	David Wardlaw	VK3ADW	VK6 Federal Councillor:	Neil Penfold	VK6NE
			VK7 Federal Councillor:	Joe Gelston	VK7JG

FEDERAL CO-ORDINATORS

Amsat:	Graham Ratcliff	VK5AGR	QSL Manager (VK9, VKØ)	Neil Penfold	VK6NE
Contest Manager:	Frank Beech	VK7BC	FTAC:	John Martin	VK3ZJC
Education:	Brenda Edmonds	VK3KT	Tapes (Federal News):	Bill Roper	VK3ARZ
EMC:	Hans Ruckert	VK2AOU		Ron Fisher	VK3OM
Historian:	John Edmonds	VK3AFU	Videotape:	John Ingham	VK5KG
Intruder Watch:	Gordon Loveday	VK4KAL	WICEN:	Bill Wardrop	VK5AWM
Int'l Travel Host Exch:	Ash Nallawalla	VK3CIT			

WIA NEWS

BILL ROPER VK3ARZ GENERAL MANAGER & SECRETARY

Trophy

As the result of a submission from Gil Griffith, VK3CQ, supported by a group of CW enthusiasts in Australia and New Zealand, the WIA has now added another contest trophy to those already available.

The "Clive Burns Memorial Trophy", to be inaugurated in 1990, will be awarded each year to the Novice, or NAOCP holder, who achieves the highest score in the CW section of the annual VK Novice Contest.

The late Clive Burns, VK3CQL, who died in 1987, gave unstintingly of his time and expertise, throughout his years as a radio amateur, to

encourage newcomers into the fascinating hobby of amateur radio. He particularly promoted interest in high quality CW operation.

In 1983 Clive established the daily "Earbashers" net on 80 metres through which he, and a number of other radio amateurs, helped listeners and participants to improve their CW skills or upgrade their qualifications.

Many radio amateurs, whether dedicated CW operators or not, both in Australia and elsewhere, acknowledge their debt to Clive.

This trophy has been established as a memorial to Clive and, in continuation of his years of effort, as an encouragement

an inadequate pension or other benefit; but anyone who can afford the cost of a licence and still keep the wolf from the door should not find the WIA subscription prohibitive. Consider the cost of other things and compare in value for money. Perhaps some other items are less necessary?

To look on the bright side, if more of you join us we will be able to look after your needs even better. "Economies of scale" is not just a catch phrase. Future subscription rises may not be so necessary. More of you will become available to fill positions on your Divisional Council, or on Executive and/or the various sub-committees. We need new blood. Some of us may even then be able, finally, to leave our trench and let you jump in!

were, but are not now, WIA members, have left us because we wrote, said or did something at which they took umbrage. The last time I quoted an American President I named the wrong man, but I think it was Lincoln who made the well-known comment about pleasing some of the people all the time, all of the people some of the time, but never all the people all the time. He wasn't wrong! Some of those who have been displeased by WIA actions have very long memories. I think Bill Roper has a comment on this in WIA News.

And then there are those who say they cannot afford the subscription. We know the economic state of the nation could be better, and is probably getting worse. We know there are amateurs whose only income is

WIA DIVISIONS

The WIA consists of seven autonomous State Divisions. Each member of the WIA is a member of a Division, usually their residential State or Territory, and each Division looks after amateur radio affairs within their State.

Division	Address	Officers	Weekly News Broadcasts	1990 Fees
VK1	ACT Division GPO Box 600 Canberra ACT 2601	President Ted Pearce Secretary Jan Burrell Treasurer Ken Ray	VK1AOP 3.570 MHz VK1BR 2m ch 6950 VK1KEN 70cm ch 8525 2000 hrs Sun	(F) \$65.00 (G) (S) \$52.00 (X) \$39.00
VK2	NSW Division 109 Wigram St Parramatta NSW (PO Box 1066 Parramatta) 2124 Phone (02) 689 2417 Fax (02) 633 1525	President Roger Henley Secretary Peter Balnaves Treasurer David Horstall (Office hours Mon-Fri 1100 - 1400 Wed 1900 - 2100)	VK2ZIG 1.845 MHz AM, 3.595 SSB (1915 only), 7.146 AM (1045 only) VK2CZX 10.125 SSB (1045 only), 28.320 SSB, 52.120 SSB 52.525 FM 144.12 VK2KFU (SSB), 147.000 FM(R) 438.525 FM(R) 584.750 (ATV Sound) 1281.75FM (R) Relays also conducted via many repeaters throughout NSW.	(F) \$59.00 (G) (S) \$47.00 (X) \$33.00
VK3	Victorian Division 38 Taylor St Ashburton Vic 3147 Phone (03) 885 9261	President Jim Linton Secretary Barry Wilton Treasurer Rob Hailey Office hours 0900-1600 Tue & Thur	VK3PC 1.840 MHz AM, 3.615 SSB, 7.085 SSB, 147.250 FM(R) Mt Macedon, VK3XV 147.225 FM(R) Mt Baw Baw VK3XLZ 146.800 FM(R) Mildura, 438.075 FM(R) Mt St Leonard 1030 hrs on Sunday	(F) \$65.00 (G) (S) \$52.00 (X) \$39.00
VK4	Queensland Division GPO Box 638 Brisbane Qld 4001 Phone (07) 284 9075	President David Jones Secretary John Aarsse Treasurer Eric Fittock	VK4NLV 1.825, 3.605, 7.118, 14.342, 18.132, 21.175, 28.400, MHz VK4QA 52.525 regional 2m repeaters and 1296.100 0900 hrs Sunday VK4NEF Repeated on 3.605 & 147.150 MHz, 1930 Monday	(F) \$65.00 (G) (S) \$52.00 (X) \$39.00
VK5	South Australian Division 34 West Thebarton Rd Thebarton SA 5031 (GPO Box 1234 Adelaide SA 5001) Phone (08) 352 3428	President Don McDonald Secretary Hans van der Zalm Treasurer Bill Wardrop	VK5ADD 1820 kHz 3.550 MHz, 7.095, 14.175, 28.470, 53.100, 145.000, VK5KHZ 147.000 FM(R) Adelaide, 146.700 FM(R) Mid North, 146.900 FM(R) VK5AWM South East, ATV Ch 34 579.00 Adelaide, ATV 444.250 Mid North (NT)3.555, 146.500, 0900 hrs Sunday	(F) \$65.00 (G) (S) \$52.00 (X) \$39.00
VK6	West Australian Division PO Box 10 West Perth WA 6005 Phone (09) 474 2626	President Alyn Maschette Secretary Bruce Hedland Treasurer Thomas	VK6KWN 146.700 FM(R) Perth, at 0930 hrs Sunday, relayed on 3.560, 7.075, 14.115, 14.175, 21.185, 28.345, 50.150, 438.525 MHz Country re- lays 3582, 147.350(R) Busselton 146.900(R) Mt William VK6OO (Bunbury)147.225(R) 147.250 (R) Mt Saddleback 146.725(R) Al- bany 146.825(R) Mt Barker Broadcast repeated on 3.560 at 1930 hrs.	(F) \$56.00 (G) (S) \$45.00 (X) \$30.00
VK7	Tasmanian Division PO Box 1010 Launceston TAS 7250	President Mike Wilson Secretary Bob Richards Treasurer Peter King	VK7ZWW 146.700 MHz FM (VK7RHT) at 0930 hrs Sunday relayed on 147.000 VK7NRR (VK7RAA), 146.750 (VK7RNW), 3.570, 7.090, 14.130, 52.100, VK7ZPK 144.100 (Hobart) Repeated Tues 3.590 at 1930 hrs	(F) \$63.00 (G) (S) \$50.00 (X) \$38.00
VK8	(Northern Territory) is part of the VK5 Division and relays broadcasts from VK5 as shown (received on 14 or 28 MHz).			

Note: All times are local. All frequencies MHz.

Membership Grades Full (F) Pension (G) Needy (G) Student (S) Non receipt of AR (X)
Three year membership available to (F) (G) (X) grades at fee x 3 times

to the promulgation of CW activity in amateur radio in Australia.

The winner of the "Clive Burns Memorial Trophy" each year will receive a suitably engraved, unique wall plaque to be retained permanently.

Postage

The cost of postage alone for sending mail from the Executive Office to members and prospective members during the 1989 calendar year was \$9045.69. In addition, the total postage costs for mailing Amateur Radio to members each month totalled \$37,269.92. That's a lot of stamps!

Noticing similar trends with some overseas amateur radio societies, the WIA has decided to encourage members to enclose a "self addressed, stamped envelope" when writing to the Executive Office and requiring a reply. Typical examples of this are when you forward a HAMAD for publication in Amateur Radio magazine, or are requesting member service information.

If every member did this, it would certainly help the finances of the WIA. However, remember that this is only a request and is not compulsory. You will still receive an acknowledgment of your HAMAD, or a reply to your enquiry, whether you forward a "self addressed, stamped envelope" or not.

June Issue of AR

As mentioned previously, the June 1990 issue of Amateur Radio magazine will be a special "Test Equipment" issue. The Editors are seeking articles on construction of test equipment, modification of test equipment, and test procedures for this special issue.

Several authors have already submitted articles for this special issue of your magazine. However, time is fast running out if you want your test equipment article to be included.

A prize of a year's free membership of the WIA will be awarded to the author of the test equipment article that is judged to be the best of those

published in this special issue of Amateur Radio magazine.

Intruder Watch

At the WIA/DoTC Joint Meeting held in Canberra in February 1990, DoTC agreed to regularly supply to the WIA details of intruders removed from the amateur bands. DoTC also requested that the "WIA Intruder Watch reports, instead of interspersing full details of problems that are insurmountable at this time (such as Indonesians on 10 metres), should prioritise the reports so that important problems stand out."

Subsequent to these discussions, the WIA has received a letter from Mr R Wyeth of the Radiocommunication Operations Branch of DoTC. Amongst other things, Mr Wyeth says:-

"I would like to express the Department's appreciation for the efforts and interest by your members in providing the (Intruder Watch) information. I can assure you that you are providing a valuable service in that part of the spectrum which is regarded as self-regulating.

Presently, because of limited resources, monitoring programs are undertaken on a demand basis. The Department sees the amateur bands as generally well behaved and free of problems that exist in other parts of the spectrum. Consequently, the need to spend valuable time in these bands is minimal. It is on the basis of your reports that monitoring is initiated.

Any instances of intrusion by Australian stations notified are immediately investigated.

The Thai fishing boats in Darwin harbour allegedly using 28 MHz were inspected, however no evidence of use of amateur frequencies could be established. Monitoring however has disclosed numerous Asian non amateur transmissions exist and that they originate as one would expect from outside Australia's sphere of responsibility.

Complaints have been received directly from amateurs concerning unlicensed commercial operators using amateur bands especially the 2

metre band. These have been investigated and have resulted in several prosecutions.

As you are aware, the Intruder Watch Report focuses on the HF spectrum and nearly all the intrusions are by overseas operators. Before any breaches are brought to the attention of the responsible administration, the Department must positively identify the country of the offending station. This is not an easy matter as the callsigns are generally illegal and extensive monitoring must be undertaken. To complicate the situation further, the intruders frequently only appear after hours or at irregular intervals. This situation should improve markedly when the HF Direction Finding equipment on order becomes operational later this year. The Department will be in a better position to identify the intruders once the equipment is installed.

Notwithstanding these limitations, the Department endeavours to identify all intruders so corrective action can be implemented."

Are you an active member of the WIA Intruder Watch team?

WICEN and Newcastle Earthquake

Amateur radio operators and the Wireless Institute Civil Emergency Network (WICEN) did a tremendous job during the recent Newcastle earthquake disaster. All too often in Australia the valuable assistance and contribution by radio amateurs in times of emergency is overlooked in the post disaster publicity. Cyclone Tracy in Darwin is perhaps the most notorious example of this.

Therefore, it is gratifying to the amateur radio service in Australia that official recognition has been given to the Newcastle and Lake Macquarie WICEN group for their invaluable assistance in the Newcastle earthquake disaster.

In a letter dated 15th March 1990, addressed to Philip Greentree, VK2IW, the Secretary and Operations officer of the Newcastle and Lake Macquarie WICEN, the Lord Mayor

of Newcastle, Alderman John McNaughton, wrote the following:-

"I acknowledge receipt of your report on the activities of WICEN during the December 28 earthquake.

The report has been noted with interest and forwarded to the consultant preparing the official record of the disaster.

I would also like to take this opportunity to thank you and the members of your organisation for your immediate response to assist the City during the difficult days immediately following the devastation.

Your support is gratefully acknowledged and appreciated."

Philip, VK2IW, told the Executive Office that a full story on the amateur radio involvement during the earthquake, complete with photographs, will shortly be submitted to Amateur Radio magazine for publication.

In another recognition of the magnificent work performed by WICEN during the Newcastle earthquake, the local WICEN was invited to take part in the first ever national radiothon. This event occurred on Sunday 18th March when Newcastle ABC radio broadcast for 22 hours through 142 AM, FM and shortwave stations across Australia to raise money for the Newcastle Earthquake Appeal.

A full HF and VHF station was established by WICEN and many stations were worked. All stations contacted qualified for the Newcastle Brick Award, to help rebuild Newcastle with amateur radio bricks.

Amateur stations, as well as SWL's, can write to Newcastle-Lake Macquarie WICEN, C/o ABC Radio, Newcastle, NSW 2300, in order to obtain the award.

Amateur Exams

As everybody should know by now, the last radio amateur examinations conducted by DoTC took place in February, and all future amateur examinations will be conducted by DoTC approved external agencies.

Although the devolvement of amateur examinations has the potential to provide considerable benefits to the amateur service in Australia, such as after hours and weekend examinations, and more frequent examinations, nevertheless there are some early problems.

In letters forwarded to a number of approved examiners during March 1990, DoTC have said:-

"...these benefits (of devolved examinations) will only fully accrue when potential Amateurs have reasonable access to an examinations centre providing the full range of examination opportunities. This is not yet the case.

...presently there are places where candidates appear to be poorly served, both in the availability of examination centres and with some examination centres not offering the full range of examinations. Candidates wishing to be examined in Morse Code appear to be particularly disadvantaged."

Have you, or your local radio club, considered the service to amateur radio you could be performing if you conducted amateur examinations locally? Are you aware of potential amateur examination candidates who are severely disadvantaged because there is no examination facility reasonably available to them?

Please contact your local Division of the WIA to find out what you can do to help more potential amateurs join our ranks!

Amateur Call Book

Supplies of the 1990 Australian Radio Amateur Call Book are almost completely sold out from the Executive Office. Although most WIA Divisions still have some available, you should move quickly if you want a copy of this invaluable reference book.

The next edition of the Australian Call Book is not due to be published until September of this year. Now is perhaps an appropriate time for members to check that the information in the Call Book is accurate, and

to notify the Executive Office of any changes to be made in the 1991 Call Book.

WIA Logbooks

The WIA recently made arrangements for the production of a new supply of professional quality logbooks for members. These are now available in an attractive A4 format with spiral plastic binding so that the book will open out and lie flat on the bench.

Vertical or horizontal column layout is optional, with the traditional column headings. These logbooks are available from Divisional Offices at a cost of \$5.00 each, plus post and packing where applicable.

Comments coming into the WIA indicate that a number of members are now starting to keep a logbook again, after not bothering for a while when the compulsory logkeeping regulation was axed some time ago.

For all those members who find a logbook and record keeping an important part of operating an amateur station, these new WIA logbooks will become a welcome addition to the shack.

Joint WIA/DoTC Meeting

Several agenda items discussed at the WIA/DoTC Joint Meeting held on 16th February were reported on last month. Other matters which were discussed at the meeting included Third Party Traffic, Examination Devolvement, Reciprocal Licensing, Intruder Watch, CB pirates, Digitised Voice Bulletin Boards, 576 MHz ATV Repeaters, and Callsign Allocations.

These Joint Meetings have been a feature of the WIA's relationship with DoTC for many years. Traditionally they have been held on a quarterly basis, but with the dates set by mutual agreement. It is at these meetings that policy is discussed, and agreements formalised. Items may remain on the agenda for several meetings as negotiation continues and each or either body prepares position papers. In some cases

MAGPUBS

A Special Service of the Wireless Institute of Australia

1990 callbooks

Here they are! The latest editions 1990. World-famous Radio Amateur Callbooks, the most respected and complete listing of radio amateurs. Lists calls, license classes, address information. Loaded with special features such as call changes, prefixes of the world, standard time charts, world QSL bureaus and more.

The North American Callbook lists the calls, names and address information for over 500,000 licensed Radio Amateurs in all countries of North America from Canada to Panama, including Greenland, Bermuda and the Caribbean Islands plus Hawaii and US possessions.

The International Callbook lists over 500,000 licensed amateurs in countries outside North America. Its coverage includes South America, Europe, Africa, Asia, Australia and the Pacific area (exclusive of Hawaii and the US possessions)

Order both Callbooks now and save at these special prices.

When it comes to
**AMATEUR
RADIO QSL's...**

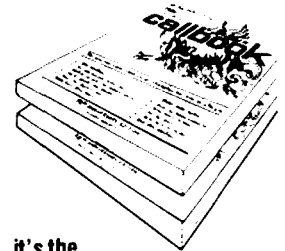

it's the
ONLY BOOK!
US or DX Listings

WIA288 1990 North American Callbook \$58.50 less 10% for WIA Members
WIA289 1990 International Callbook \$62.50 less 10% for WIA members

Practical Wire Antennas Effective HF Designs for the Radio Amateur

Practical Wire Antennas is a new book from the RSGB by John D Heys, G3BDQ published in 1989. This book has been written for the non-mathematician whose knowledge of this subject has never extended beyond the high school syllabus. It is aimed towards anyone who is capable of passing the Radio Amateurs examination, and the range of antennas described and illustrated are easy to set up and use successfully. There is additional data which will allow experiments and tests with versions that are cut for other bands or designed to fit into difficult locations. The simplified and, it is hoped, easily understood antenna theory is an attempt to allow the newest recruit to amateur radio to learn something about how simple wire radiators work at HF.

7" x 10" Stock # WIA298 \$28.00

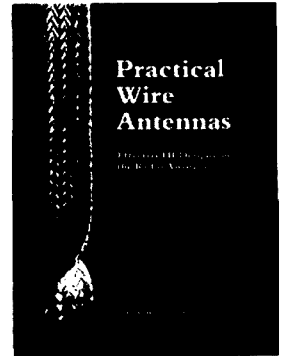

8th Computer Networking Conference 1989

Colorado Springs, Colorado Oct 7 1989

222 Pages 8" x 11" Stock # WIA295 \$24.00

SPACE ALMANAC

A galaxy of information! The new Space Almanac written by Anthony R. Curtis, K3RXX, editor of Space Today, is an extraordinary book that captures the breathtaking recent news from space, freshly compiled and written. It includes approximately 40 pages on Amateur Radio satellites. The Space Almanac is a major handbook featuring most anything you might want to know about Man's trip to the stars. Here's what you get:

- 500,000 words
- 960 pages
- Ten of thousands of facts
- Hundreds of stories, reports and descriptions
- Comprehensive Space history calendar
- Lists of future Space plans from around the world
- Scores of tables, charts, maps diagrams, histograms, drawings, photos, callenders, timetables
- Covers Space from Earth to the edge of the Universe in seven major sections: astronauts, space stations, shuttles, rockets, satellites, solar system and deep space

Stock Number BX299 \$40.00

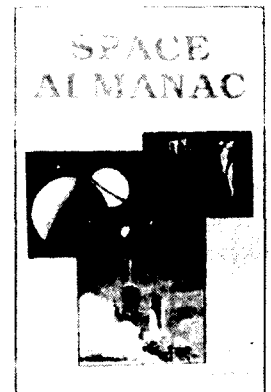

The above books, plus many more, are available from your WIA Divisional Bookshop. All items are less 10% discount for WIA Members and are plus postage and handling where applicable.

If not in stock at your Divisional Bookshop, your order will be taken and filled promptly. Not all publications are available from all Divisions.

it is necessary for the WIA to canvass members about proposed agreements, or for DoTC to research opinions of other departments.

Microwave Users

The WIA's WARC 92 team of David Wardlaw, Ron Henderson and Peter Gamble is seeking information on the use of the microwave bands by Australian amateurs. By microwaves we mean the amateur bands from 1296 MHz upwards.

In order to state the WIA case on behalf of Australian radio amateurs to the authorities, the team needs information on the occupation of the microwave bands. They are aware of the beacons from the beacon listing and presume they are operational most of the time.

John Martin, VK3ZJC, the Chairman of FTAC has been collecting this band use information and would appreciate your assistance. Send your list of microwave users to Chairman FTAC, PO Box 300, South Caulfield Vic., 3162.

Are Amateurs Elephants?

A recent letter from a member commented that his local radio club has only about 50 % of members who are also WIA members. He further commented that "the non-members are mostly people with elephantine memories who can't forget some personal clashes with Divisional or Executive office-bearers in the dim past". It made us wonder to what extent this situation applies throughout Australia.

The WIA, like any similar organisation, must accept that, if the administrators blunder or treat the members poorly, the members have a right to consider renouncing their membership if they feel strongly about it. But, in the WIA, as in many other organisations where the main work load and decision making are carried by a very few people who are mostly volunteers, opinions, attitudes and policies change from time

to time as the management changes.

Perhaps those with long memories of offence given could be persuaded to note the changes and growth that has occurred in the WIA in recent years. Those who originally gave offence, whether intentionally or not, have probably now retired from office, and the disliked policies may have been reversed.

Alternatively, those who feel they have valid criticism are welcome to voice their opinions to the management, or even come and help the management consider their ideas.

It seems to us to be invalid to criticise the current administration for the perceived mistakes of their predecessors.

Amateur Licence Statistics

Figures to the end of 1989 show a total of 18372 radio amateur licences issued in Australia by DoTC (which total includes multiple licences, clubs, and licences held by the WIA). WIA membership at the same date was 7619, of whom 7278 were licensed.

A set of statistics, recently received from the IARU, listing numbers of operators and society membership for countries by region, makes for some interesting comparisons.

Indonesia, with 60,000 radio amateurs, has 72,000 society members of whom 60,000 are licensed. Apparently society membership is compulsory in that country.

Netherlands, with 15,321 operators, has 11,100 society members, of whom 8,300 are licensed.

Corresponding figures for several other countries are:-

France:	14,134,	9,527 and	7,685.
Italy:	28,000,	17,109 and	11,900.
USSR:	64,002,	142,978 and	11,761.
UK:	54,000,	36,971 and	30,115.

While the figures alone cannot prove much, as they reflect licensing policy and availability of moderately priced equipment

as much as dedication to the society cause, they do suggest that in some countries the non-licensed members play a very significant part in the organisation. Perhaps this is an area where the WIA has not given as much attention to recruiting as it might have done.

The SWLs and electronics enthusiasts have much to offer to our hobby. At times they have carried a large part of the workload but, apart from access to classes and Amateur Radio magazine, they perhaps have gained little else from their membership. It was even pointed out to the WIA recently by a correspondent that Amateur Radio magazine has little to offer the unlicensed member or the potential Novice.

We need to be aware of the importance to the WIA of these members, and provide services for them.

Service Area Maps

A recent news release from DoTC announced the publication of "Commercial Television and Radio Service Area Maps". This book contains maps and descriptions of the service areas of Australian commercial television and radio stations.

The service area is the geographic area containing the communities which the station is licensed to serve. The book is available from Commonwealth Government Bookshops and by mail and telephone order for \$34.95.

Late Member Payments

Judging from queries received, some WIA members have missed previous explanations as to why, when they renew their membership more than three months after the due date, they do not receive some copies of Amateur Radio magazine.

This situation occurs because, when a member pays his renewal fee more than three months after the due date, the member then goes onto a new

subscription cycle beginning in the month in which the late payment is received. As a result, the following year's membership subscription for that member will become due in that new month in the following year.

Current policy is for members to receive only one magazine after failing to renew, and unfinancial members are removed from the mailing lists each month.

Despatch of Amateur Radio begins again in the month of renewal. Copies of the missed Amateur Radio magazines may be available from the Executive Office at a cost of \$4.00 posted. However, the WIA cannot guarantee that back copies will always be on hand to be sent. Incidentally, just in case your membership renewal notice goes astray in the post, you can check the month when your membership is due for renewal by looking at the top left corner of your Amateur Radio address label.

QSL Bureau Survey

Stephen Pall, VK2PS, has completed and presented to the Executive a comprehensive document reviewing the current operations of the various WIA QSL Bureaux. This report will be discussed in detail at the 1990 Federal Convention, and a summary of findings will be published in Amateur Radio magazine afterwards.

For the present, sincere thanks are due to Stephen for completion of a mammoth task, and thanks to the Divisions who co-operated by providing him with the information. **ar**

**Support the WIA
in order to protect
Amateur Radio
frequencies
at WARC 92**

TECHNICAL CORRESPONDENCE

Temperature Coefficient Correction in Zener Diodes

In the March 1990 issue of Amateur Radio, Allan Johansen VK4KAJ told us how the positive temperature coefficient of a zener diode can be compensated by the negative temperature coefficient of a series silicon diode. We can add a little more concerning this subject.

The zener effect, which we are told is a quantum mechanical effect in which electron pairs are generated directly from the energy of electric fields (if you can understand all that), is only responsible for breakdown in diodes designed to have a breakdown voltage less than about 5 volts. Such a mechanism produces a negative temperature coefficient.

The general name given to a zener diode is somewhat of a misnomer because for diodes with breakdown volt-

age greater than 7 volts, the breakdown is caused by the avalanche effect. This produces a positive temperature coefficient.

For diodes between 5 and 7 volts, both mechanisms occur and hence the temperature coefficients tend to cancel and such diodes have a very low temperature coefficient.

To obtain a low temperature coefficient for higher regulated voltages, a number of zener diodes can be connected in series, either a combination of several diodes each around 5 to 7 volts, or one or a number below 5 volts with one or a number above 7 volts.

The idea submitted by Allan, using the series silicon diode, would of course only be feasible for zener diodes above 7 volts.

REFERENCE:

"Miniwatt" Zener diodes and their application. - Miniwatt Digest July 1966.

LLOYD BUTLER VK5BR
18 OTTAWA AVENUE, PANORAMA 5041

A Call to all Holders of a Novice Licence

Now you have joined the ranks of amateur radio, why not extend your activities?

The Wireless Institute of Australia (N.S.W. Division) conducts a Bridging Correspondence Course for the AOCP and LAOCP Examinations.

Throughout the Course, your papers are checked and commented upon to lead you to a successful conclusion.

For further details write to:

The Course Supervisor

WIA

PO Box 1066

Parramatta NSW 2124

(109 Wigram Street, Parramatta)

Phone: (02) 689 2417

11am to 2pm Monday to Friday
7 to 9pm Wednesday

AR 20 YEAR INDEX

IBM format 5 1/4 inch floppy disk dBase 111

Plus

.DBF file \$10.00

ASCII \$10.00

Compiled

.EXE file \$10.00

36 page printout \$5.00

Prices include disk (where applicable) and postage.

AR 20 Year Index
PO Box 300
Caulfield South
Vic 3162

Back issues of AR available to WIA members

Jan 1969 to Dec 1987
\$2.50 each

Jan 1988 to current issue
\$4.00 each

(Some issues out of stock)

Prices include postage

AR BACK ISSUES
PO Box 300 Caulfield
South
Vic 3162

This space
could be
earning you
money!

Advertising
rates available
from
PO Box 300,
Caulfield South,
3162

SUPERHET-DC RECEIVER FOR 3.5 TO 4.0 MHz

DREW DIAMOND VK3XU
 "NAR MEIAN" GATTERS RD, WONGA PARK 3115

Experimental amateurs will be aware of the relative advantages and disadvantages of direct conversion (DC) and superheterodyne receivers. The popularity of DC being due to the relatively good performance obtainable with fairly simple circuitry, and the absolute absence of spurious responses (apart from the "audio image"). This latter is really the only disadvantage with DC, in that true single-signal reception cannot easily be achieved. Direct conversion receivers with this capability have been made and details published, but they are so complex as to negate the whole idea of DC receivers; that of simple design consistent with acceptable performance.

The superhet provides single-signal reception, but alignment of the IF amplifier can be tricky, and instability can be a problem if high IF gain is attempted. Care must be exercised in choice of oscillator and IF frequencies to avoid spurious signal responses.

With the appearance of crystal ladder filters, along with an abundance of practical design data in recent years, plus experiences gained in both superhet and DC designs, it has become practicable to make a receiver (similar to the "super-gainer") which combines some of the best features of both schemes whilst retaining relative circuit simplicity.

The main idea behind this implementation is that the incoming signal is converted to an IF, filtered for selectivity, detected, then passed on to a high-gain audio amplifier which provides the bulk of the receiver gain, there being little or

no gain at IF.

With the availability of low-cost TV/clock crystals for our ladder filter, and low-noise op amps for the AF amplifier, the parts may be readily obtained for a receiver of more than adequate performance.

Performance

This receiver was empirically designed using the "bread-board" technique by employing circuit ideas from many sources. The prototype has the following characteristics:

- Frequency Range: 3.5 to 4.0 MHz.
- Reception Modes: SSB, CW, RTTY, DSB and AM (as SSB).
- Sensitivity: 0.5 μ V for 10 dB S + N : N.
- IF Rejection: 60 dB.
- Image Rejection: 72 dB.
- IF Filter Pass-band: Nominally 1.8 kHz.
- Supply Voltage: 9 to 14V @ about 300 mA.

Signal handling characteristics are very good, and the receiver is pleasant to operate. No strong-signal intermodulation effects have been observed at this location, even with a full-sized dipole connected.

Circuit Description

In essence we have a DC receiver tuned to about 4.433 MHz, with a crystal filter at its input. Frequencies in the range 3.5 to 4.0 MHz are converted to this frequency by the action of the balanced

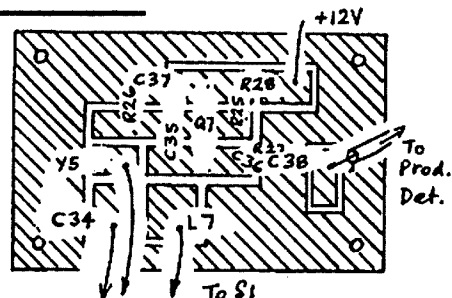

Component Locations BFO 80m Receiver VK3XU

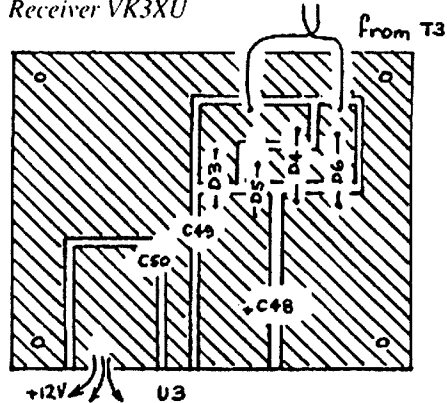

Component Locations Power Supply 3.5-4.0 MHz Receiver

mixer and local oscillator adjustable from about 7.930 to 8.450 MHz (signal + IF). In order to keep things uncomplicated, frills such as AGC and S meter have been omitted.

The input band-pass filter offers little attenuation to signals in the 3.5 to 4.0 MHz range. Signals at broadcast, IF (4.433 MHz) and image (about 12 MHz) are rejected so only the band of interest is delivered to the input of the RF amplifier. Q1, an MFE131 or 40673 dual-gate FET provides about 15 dB gain and improves the sensitivity without substantially compromising the large signal handling capability. The potentiometer adjustable voltage on gate 2 of this FET permits the operator to vary the RF gain from about 0 to 15 dB which allows the receiver to handle all signal strengths likely to be experienced.

A Hartley oscillator maintained by Q5 supplies the VFO signal nominally from 7.930 to 8.450 MHz. Amplifier Q6 buffers the VFO and delivers a push-pull signal to the mixer.

A balanced mixer is necessary in order

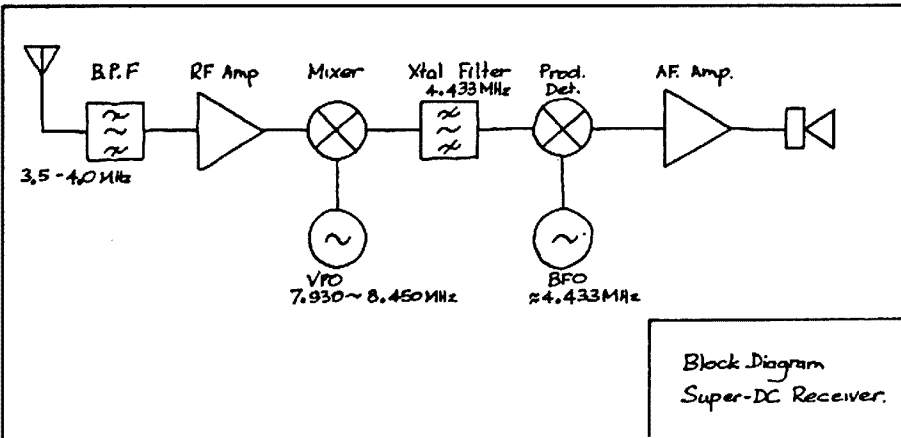
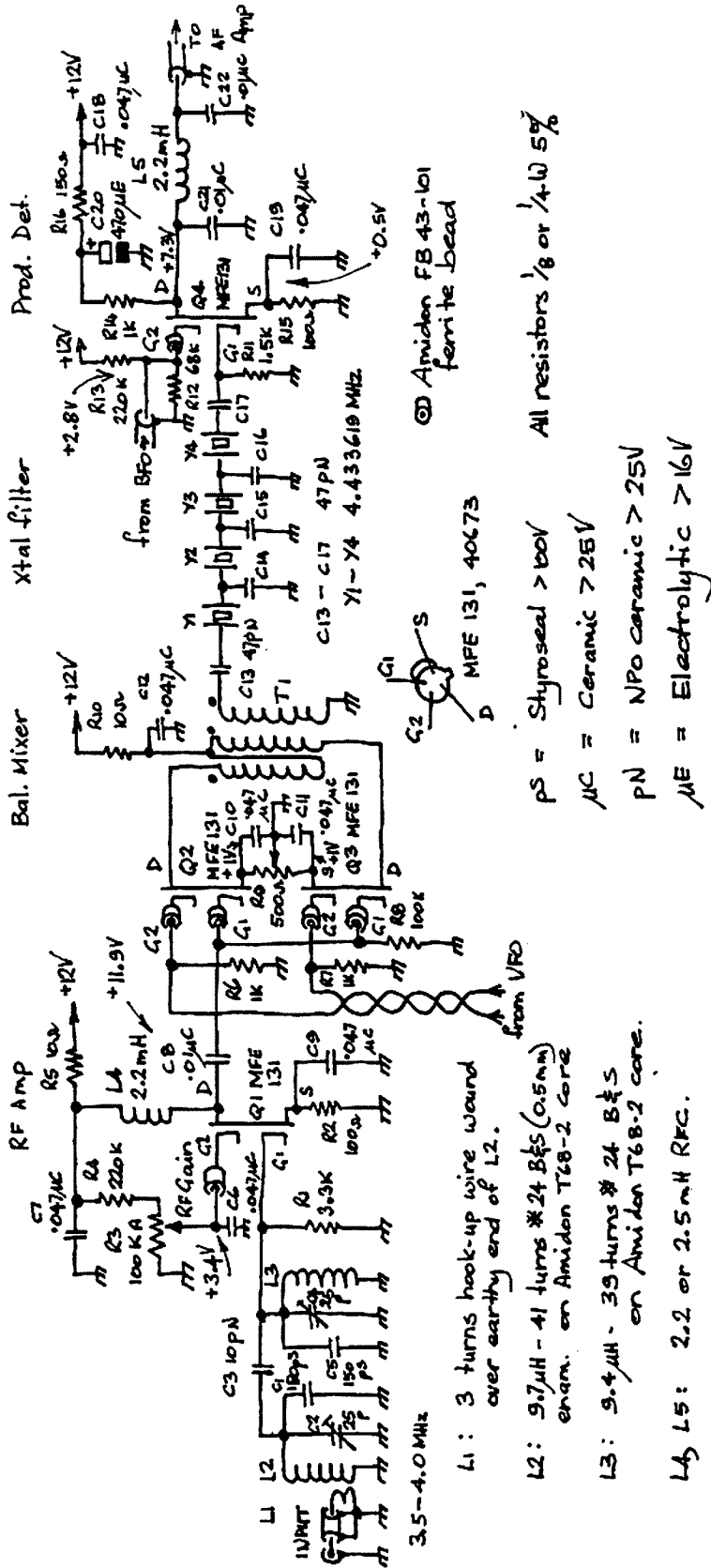

Figure 1



- L1 : 3 turns hook-up wire wound over earthy end of L2.
- L2 : 9.7µH - 41 turns #24 B&S enam. on Amidon T68-2 core.
- L3 : 9.4µH - 39 turns #24 B&S on Amidon T68-2 core.
- L4 L5 : 2.2 or 2.5 mH RFC.

T1 : ~ 11 loops trifilar #24 B&S enam on Amidon FT50-43 core

PS = Styrofoam > 100V
 µC = Ceramic > 25V
 PN = NPO ceramic > 25V
 µE = Electrolytic > 16V

Ⓞ Amidon FB 43-101 ferrite bead

fig 2

RF Amp, Balanced Mixer,
 Crystal Filter, Product Detector
 (RF Board)
 Super-DC Receiver
 Drawn DCD Nov 89.

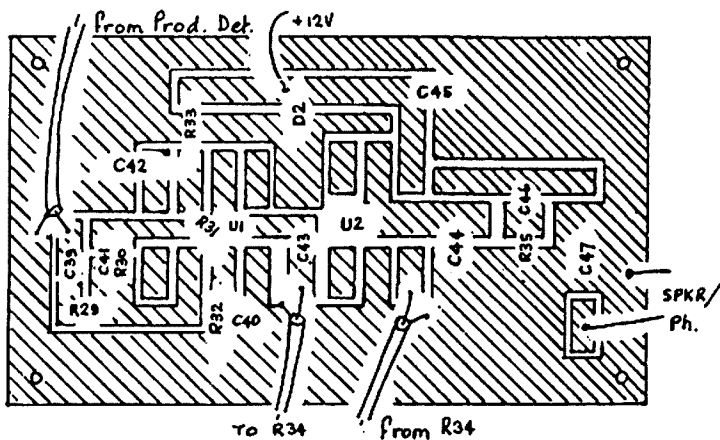

Component Locations AF Amplifier 80m Receiver VK3XU

to prevent any signals at IF (4.433 MHz) from reaching the output of the mixer and masquerading as a real signal. By applying input signals to gate 1 of Q2 and Q3 in parallel, and extracting the IF from the drains in push-pull, any IF energy at this input is "phased out". A doubly balanced mixer would of course have been the ideal choice here, but in this instance the increased complexity was not justified.

The crystal ladder filter is based upon ideas published recently in QST, AR and Rad Comm (see bibliography). TV colour burst crystals at 4.433 MHz (4.433619 actually) were chosen for their availability and suitability of frequency. The coupling capacitors shown for C13 through C17; 47 pF, yield a 6 dB band-

pass of about 1.8 kHz, which probably represents a fair compromise for CW and SSB reception. For CW only work, these could be 68 or 100 pF (increasing C of the coupling capacitors decreases the bandwidth). Different makes of crystals will

probably require different values of coupling capacitors. M-Tron crystals were also tried, and these required 27 pF coupling capacitors for 1.8 kHz bandwidth. The Colpitts crystal oscillator maintained by Q7 supplies BFO frequency, nominally at 4.433 MHz. The oscillating frequency of the crystal is "pulled" from one end of the filter band-pass to the other to allow USB or LSB reception. A nice refinement here would be a capacitor variable from about 10 to 100 pF in series with the earthy end of the crystal so that the BFO frequency could be placed at any desired point from one end of the filter band-pass to the other, and so improve the QRM handling capacity of the receiver. As variable capacitors are now fairly scarce, the values of C and L

shown will allow switched USB and LSB reception.

The product detector at Q4 has the IF signal applied to gate 1, and BFO frequency to gate 2. The wanted product of these; audio, is developed at the drain. Significant RF voltages will exist at this point, and these are removed by RF filter C21, L5, C22, allowing audio frequencies only to pass through to the AF amplifier.

An LF356 at U1 is set to provide about 40 dB of AF gain, and this is followed by an LM386 with about 30 dB gain to adequately power speaker or headphones. To prevent instability, liberal decoupling is used throughout the set.

Construction

As previously mentioned, this receiver was first bread-boarded using the usual "ugly" method upon scraps of circuit board material, and these were thumb tacked onto my experimental "chassis"—a piece of oregon timber wrapped with aluminium foil. Except for VFO wobblers due to long leaded components, the final lash-up worked well. It can therefore be fairly safely assumed that just about any well known construction method will work, provided that signal carrying connections and by-pass leads are kept as short as practicable, and the general layout is followed.

The components for the final prototype are accommodated upon five home made double-sided circuit boards, one for the RF amp/mixer/crystal filter/product de-

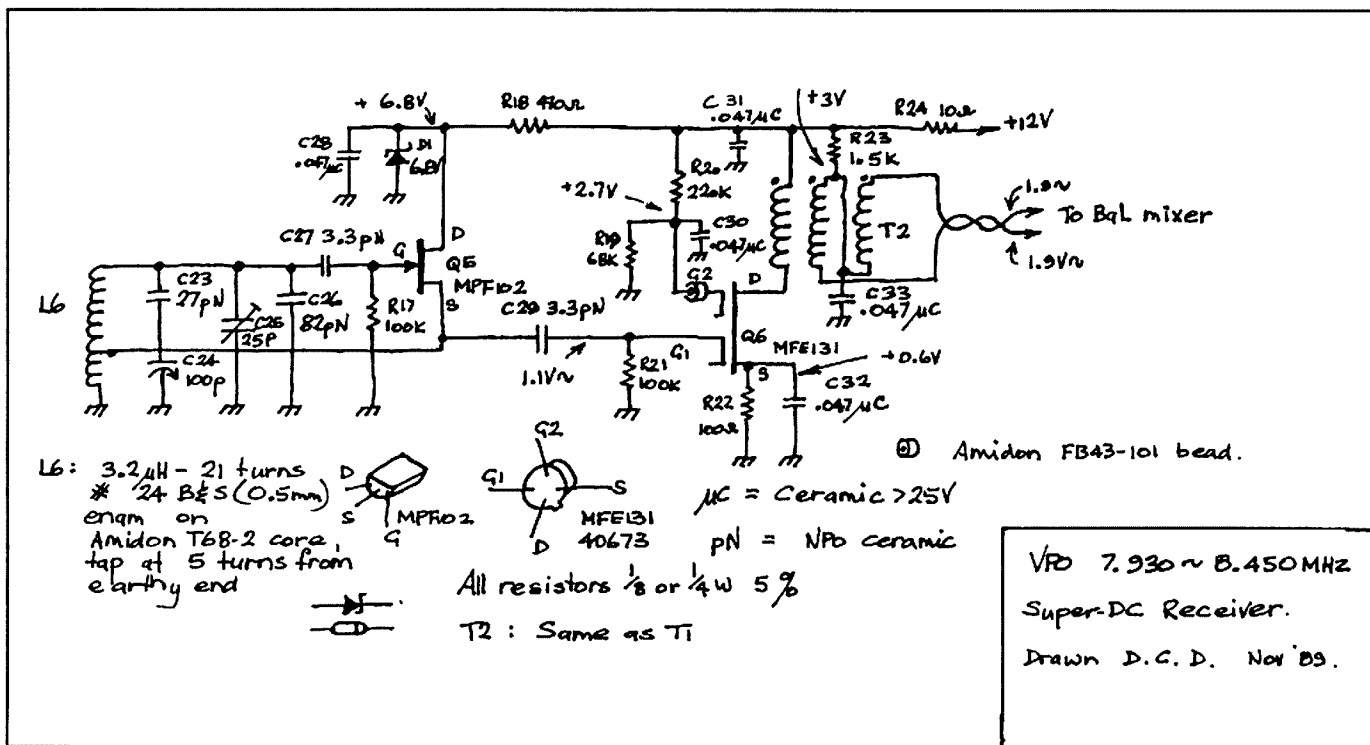

Figure 3

MORE FEATURES FOR YOUR MONEY!



FT-411 2M HAND-HELD

Superb performance on the 2M band with all of the 'top-of-the-line' features and reliability you know you can expect from Yaesu! Don't be fooled by unknown brands which can only offer some of these features...

- 144 to 148MHz transceive operation (optional 140-174MHz Rx)
- Long life 1000mAh NiCd battery pack
- 2.5 watts RF output as standard, up to 5 watts with 12V DC
- Better than 0.16uV (12dB SINAD) sensitivity
- Programmable power saver for extended operating periods
- Keypad or dial frequency entry, with 5 selectable tuning rates
- 49 tunable memories which store repeater offsets
- Band, memory, priority, or limited-band scanning
- Carry case, belt clip, approved AC charger
- **2 Year Warranty!**

Cat D-3350

\$449

YAESU STOCKS NOT HELD AT ALL STORES. PLEASE CONTACT YOUR LOCAL STORE FOR STOCK AVAILABILITY. OR ORDER BY PHONE...

FT-4700RH DUALBAND MOBILE TRANSCIEVER

Continuing the tradition started by Yaesu with the FT-2700RH, the new FT-4700RH dualband 2M/70cm FM transceiver now provides higher levels of performance, while offering even better value for money!

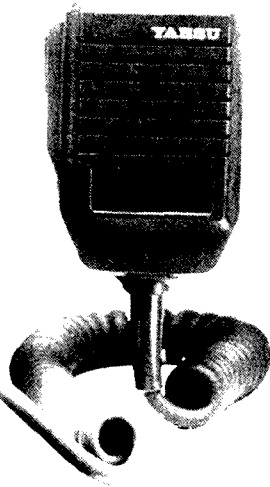
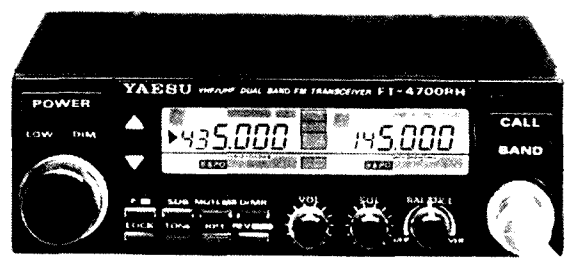

Features include 50 watts output on 2 metres (144-148MHz), and 40 watts output on 70cm (430-450MHz), with an inbuilt cooling fan for long term reliability. True full-duplex crossband operation is supplemented by dual band simultaneous reception or auto-muting reception (with independent squelch and mixing balance), so you can listen for calls on both bands simultaneously, or work someone on one band while also listening on the other band. The **BONUS** YSK-4700 controller cable allows the main body of the transceiver to be installed under a seat, while the front panel/controller mounts conveniently on the dashboard. On the control panel, the bright amber back-lit LCD shows both VHF and UHF frequencies and signal strengths, and all controls have back-lit labels for clear readability, with a dimmer switch for nighttime viewing. A total of 20 memories and 5 selectable tuning steps make frequency selection easy, while the advanced scanning features allow quick detection of signals on either, or both bands. And all this is backed up by our exclusive 2 year warranty, the longest in the industry

D-3300



With Bonus

- D-4207 2m 5/8 antenna
- D-4030 70cm Co-linear antenna
- D-4516 Antenna Bases x 2
- D-3301 YSK-4700 Extension Cable

2 YEAR WARRANTY

\$1095

BFO 4.433 MHz
 Super-DC Receiver
 Drawn D. C. D Nov '89.

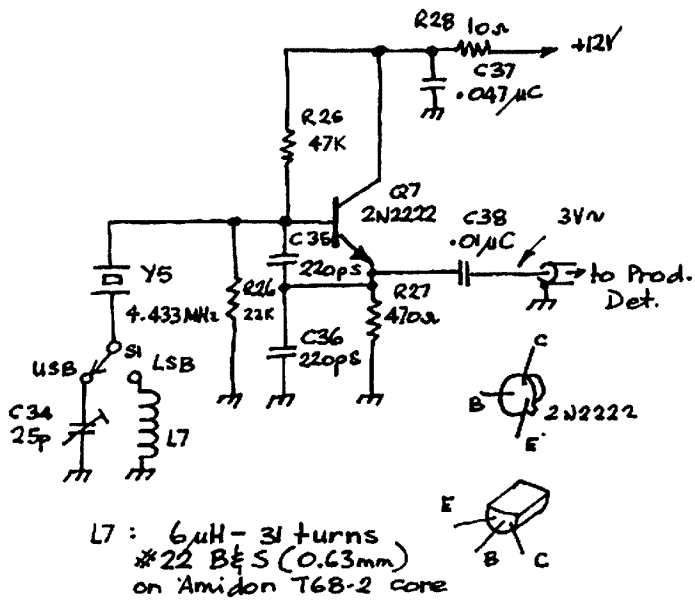

Figure 4

Draw a cloth through the group to remove any wrinkles, then twist the free ends together and fix these in the chuck of a hand drill. Whilst keeping the wires taut, turn the drill until you have about three twists per cm. A smooth twist is required, with no transpositions or bumps. Tug the drill to set the twists, then remove the group. Carefully wind the triplet onto an Amidon FT50-43 toroidal core (about 11 loops should fit nicely). Leave about 2cm lead length. Remove about 1cm of enamel from each wire. With your multimeter set to ohms X1; locate the start and end of one "winding". Push these to one side out of the way. These will form the "secondary" of T1, and "primary" of T2 respectively (starts are shown schematically with a dot). Now, for each transformer, locate the other two windings. Connect the end of one to the start of the other to form the centre tap.

The set should be accommodated in a metal case. It would be a good plan to allow room for expansion, and it is suggested that a form of construction similar to that used for the prototype is adopted; a pan type chassis with front and back panels, the main receiver components on the top side, leaving room for any future converters underneath. The case measures 250 mmL x 250 mmW x 125 mmH.

ductor, one for the VFO/buffer, one for the BFO, one for the AF amp, and another for the power supply circuit. The un-etched reverse side of each board provides a ground plane to aid circuit stability. Apart from a mounting hole at each corner, no drilling is necessary. The components are mounted "VHF fashion" directly onto the etched copper side of the boards as shown. As the artwork for the audio ICs would have been very fiddly, this problem has been dodged by using wire wrap sockets for these chips. By spreading the socket leads out, then cutting them to length, it is easy to mount these devices

to the board with plenty of elbow room to work. Note that one resistor; R31 is under U1.

It is suggested that the boards may be made and tested in the following sequence; power supply (if required), AF, BFO, VFO, RF board. It would be prudent, if you have a FET checker, to go through your five MFE131s and select two for the balanced mixer which match as closely as possible. Check the transconductance with the two gates tied together.

Broadband transformers T1 and T2 could be a bit difficult if these have not been tackled before. Proceed as follows; Take three 300 mm lengths of #24 B&S (0.5mm) enameled wire, lay them parallel to one another then twist together at one end. Clamp that end in a vice.

The type of dial for the frequency read-out must be left to individual resources and taste. To my knowledge, there are no really satisfactory ready-made dials presently available. You could use one of those verniers calibrated 0-100 available from Dick Smiths, but a graph or table will be necessary. The same company can supply the Jackson planetary reduction drive shown.

The photo shows a suggested approach; an 11cm dia aluminium disc painted flat white and attached to the boss of the drive. An arc shaped aperture is cut out in the front panel and a perspex window made to suit. Press-on letters may be applied later at (say) 50 kHz points for frequency calibration, then the window fitted into place. The dial may be illuminated by fitting 12V/100mA lamps each side of the perspex so that light is launched into the window to illuminate the scribed cursor line and calibrations.

A flexible coupler should be interposed between the drive and capacitor shaft to take up any small mis-alignment. Couplers have all but vanished from the shelves. Illustrated is one approach; a length of 0.25" rubber tube, such as fuel line is attached to the capacitor shaft and drive, where one of the pot shaft off-cuts is fitted. The tube is fixed there with fuel filter clips. It will be found that after a short time the rubber will vulcanize onto the shafts and will not easily slip.

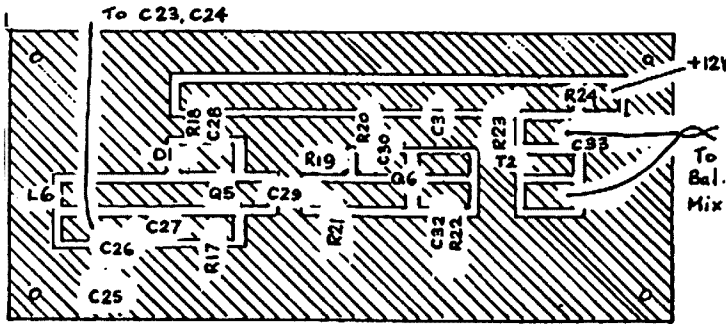

Component Locations VFO 80m Receiver VK3XU

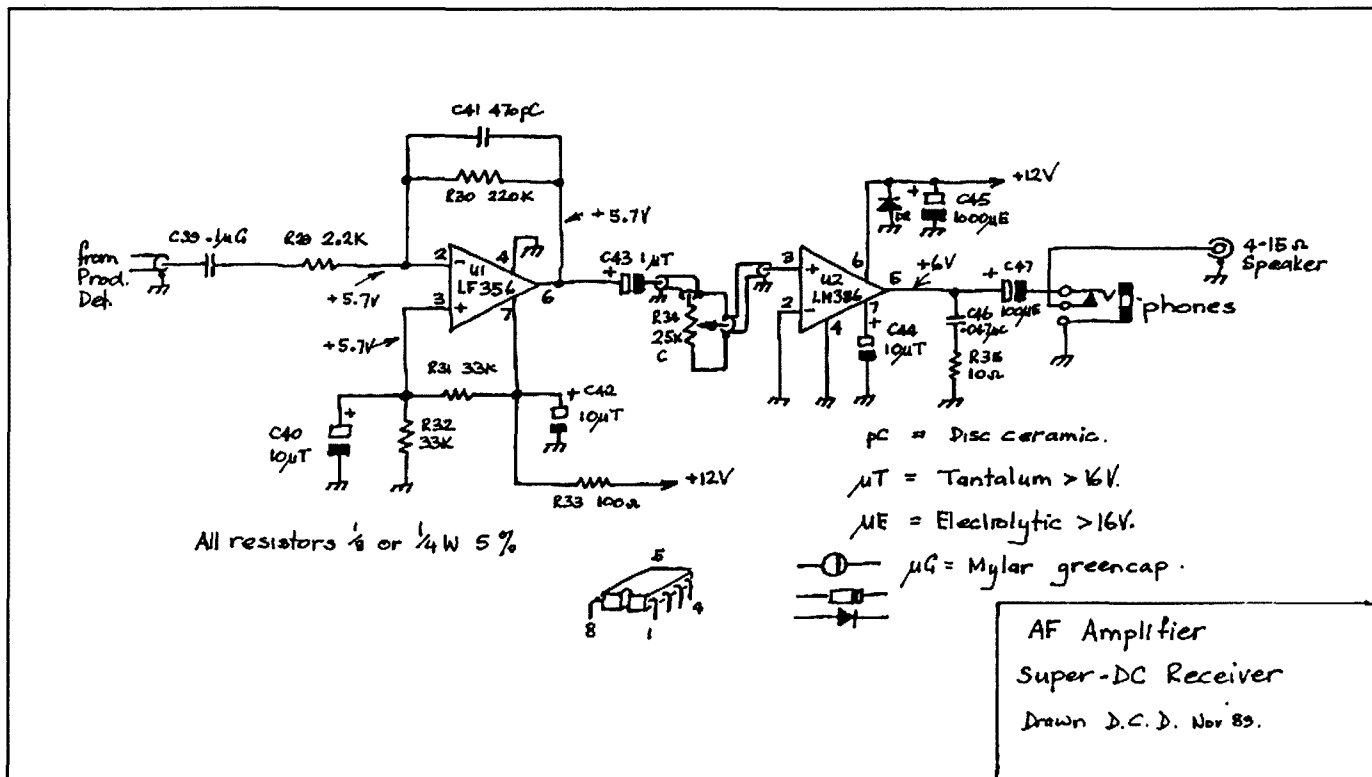

Figure 5

Alignment

The VFO frequency range should first be established. If a digital frequency meter is available; connect this to either side of the secondary of T2. Sweep the VFO through its range, checking for a little more than 500 kHz swing. With C24 at full mesh, adjust C25 so that about 7.930 MHz is generated. Now with C24 fully unmeshed, the frequency should rise to about 8.450 MHz. In the absence of a counter, another receiver which can be tuned to the VFO frequency will also serve. Set this to 7.930 MHz, and swing the VFO through its range. The VFO

should radiate enough signal to be heard on the other receiver. Adjust C25 so that the VFO generates 7.930 MHz with C24 at full mesh. Check that the VFO generates about 8.450 at minimum C. The tuning range will now be established. Oscillator coil L6 should then be fixed onto the circuit board with epoxy cement spaced off with a small rectangle of perspex or similar.

If a signal generator is available; set this to 3.6 MHz at about 10μ V, and see if the signal can be tuned in. Adjust C2 for loudest signal. Now set the generator to 3.9 MHz and peak C4 for strongest signal. There will be some inter-reaction

between these, and some juggling may be needed to obtain best flatness from 3.5 to 4.0 MHz. Keep the generator output level just sufficient to provide a useable signal. After this adjustment, it should be possible to detect a signal well below 0.5 microvolt across the band.

If a generator is not available; connect an antenna to the input and adjust C2 and C4 for best sensitivity consistent with best flatness. Some compromise may be necessary. Keep in mind any tuning effects that the antenna may have.

R9 sets the exact balance of the mixer. If a generator is available; sweep it carefully around 4.433 MHz at about 100μ V and see if the signal can be heard. Adjust R9 for a null. This should occur near the mid travel of this pot.

If no generator is available, set R9 to mid-travel (perhaps later you can borrow a generator and perform the above adjustment). Meantime, rejection of the IF will be entirely adequate for most locations.

The BFO crystal Y5 is pulled onto the low side of the filter pass band to provide LSB reception, and no adjustment is provided for this. It should be found that the value of inductance used (6μ H) will place the BFO frequency in just the right spot for LSB signals.

Capacitor C34 is adjusted to place the BFO frequency on the high side of the filter for USB signals. This is a subjective adjustment. You should find that the

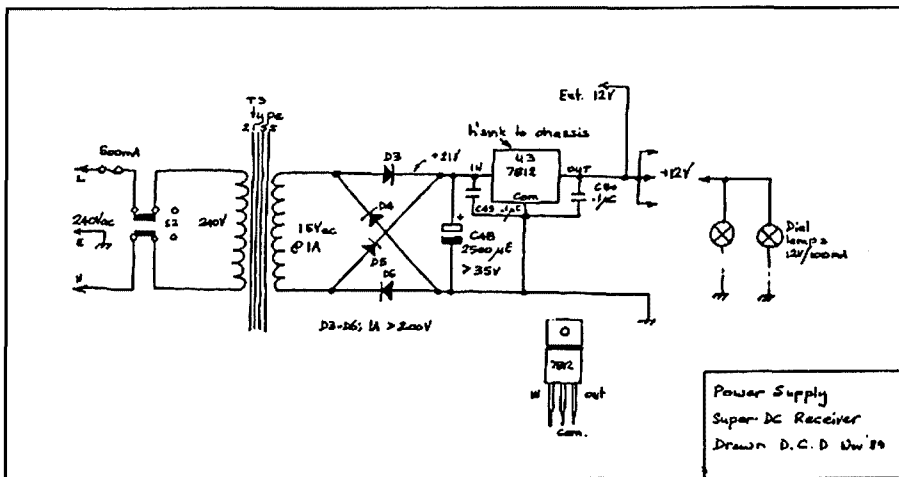
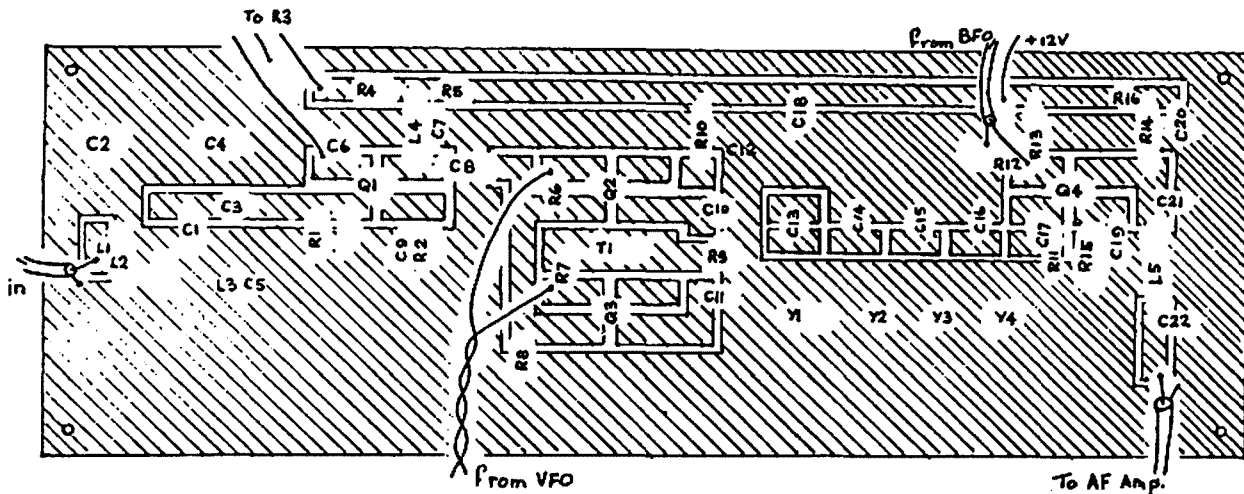

Figure 6



Component Locations RF Amp, Mixer, Filter, Prod Det 80m Receiver VK3XU

pitch of the BFO hiss shifts in character as the BFO frequency is changed in response to C34 variations. Set C34 so that as a carrier is tuned in, a strong beat is heard on one side of the signal, and a much weaker beat is heard on the other — about 10 pF worth of the 25 pF available.

Troubleshooting

There are no perceived pitfalls for the typical builder. Some key dc and rf voltages are indicated as a troubleshooting aid should this be necessary. Use a high impedance meter (eg a DMM) for these readings. The ordinary ARRL Handbook RF probe was used for the RF voltages.

The phasing and connections for the broadband transformers must be strictly observed, and past experience indicates that this is a common area of difficulty for some beginners.

During development it was found that the MFE131s would oscillate at VHF fairly easily. To tame these it was found necessary to add a "Q killer" to gate 2 of each device, and also gate 1 of the mixer devices. These beads must be fitted to the gate leads in such a manner that the bead cannot contact other leads or components, as they can cause some strange effects if allowed to flop about. Some PVC stripped from hook-up wire is placed on the lead each side of the bead.

If, after unsuccessful attempts you cannot get your set to work satisfactorily, write to me about it and I shall extend any reasonable amount of help necessary. An SASE would be appreciated.

Parts

All the parts used in this project are readily available at present, except perhaps for the 100 pF variable capacitor. Let me know if this is a problem, as I still have a few spare (at time of writing) available to enthusiasts for just the cost of postage. See advertisements in this journal for suppliers of Amidon cores. All other components should be readily available from the usual electronics suppliers. Remember to shop around for the best price on crystals, as they vary widely from place to place. When buying, make sure they are all of the same type and make.

References And Further Reading

1. DeMaw & Collins — Modern Receiver Mixers; QST Jan '81.
2. Hayward & DeMaw — Solid State Design; ARRL.
3. Hayward — Designing & Building Crystal Ladder Filters; QST July '87.
4. Gurr, VK5RG — Ladder Crystal Filters; AR Jan '84.

5. DeMaw — Practical RF Design manual; Prentice-Hall Inc.

6. Converter Circuits — any recent ARRL H'book eg 1988 edition p30.9.

Inductive Components

Amidon T68-2 toroidal core
L1/2, L3, L6, L7

Amidon FT50-43 toroidal core
T1, T2

Amidon FB43-101 ferrite bead
For Q1, Q2, Q3, Q4, Q6 (7)

2.2 or 2.5 mH R F C

Type 2155 transformer, 15V/1A T3

Miscellaneous

4.4336...MHz crystals (eg Philips 04042.945 or M-Tron MP-1), X5 vernier reduction drive, flexible coupler (see text), printed circuit material, antenna connector, speaker connector, ext 12V connector, fuse holder, 500 mA fuse, power lead, grommets, SPDT switch (S1), DPDT switch (S2), knobs, headphones connector, 12V/100 mA lamps and holders, screws, nuts, spacers, #22 and #24 enam. wire, hook-up wire, miniature coax, multipole bandswitch (if converters are planned), case to suit or material for same, perspex for dial window and VFO coil, epoxy glue, 8-pin DIL wire wrap sockets X2.

ANTENNAS & ACCESSORIES

We manufacture a comprehensive range of HF, VHF and UHF antennas, baluns, power dividers etc to suit your application. Three of our log perennics provide continuous coverage from 13-30 MHz including WARC frequencies, and replace outdated tri-banders. Now in use in 24 overseas countries and 6 continents.

- CREATE ROTATORS, COAX CABLES & NON-CONDUCTING GUY HALYARD MATERIALS
- COMPLETE RANGE MIRAGE (USA) 5-YR WARRANTY 6M, 2M, 70CM AMPS & WATT SWR METERS
- HARD-DRAWN ANTENNA WIRE
- AUST/NZ DISTRIBUTOR FOR CREATE ANTENNAS/ROTATORS & PHYLSTRAN (KEVLAR) NON-CONDUCTING GUYING

- MATERIALS
- HIGH GAIN VHF & UHF AMATEUR, SCANNING & TV ANTENNAS
- BUTT SECTION TRIANGULAR ALUMIN IUM TOWERS FOR FIXED OR TILT-OVER APPLICATIONS (REFER MARCH/APRIL 1987 AR)
- SELECTION OF POWER CHIPS AT FRIENDLY PRICES
- VSWR/PWR METERS TO 1300MHZ

Write or phone for free catalogue

ATN ANTENNAS

56 Campbell Street
Birchip Vic 3483
Phone: (054) 92 2224
Fax: (054) 92 2666

VK3XU Printed Circuit Boards for 80m Receiver

(Reproduced full size)

*AF Amplifier
55mm x 96mm
(below top)*

*RF Amp. Mixer Filter,
Product Detector
63mm x 180mm
(below)*

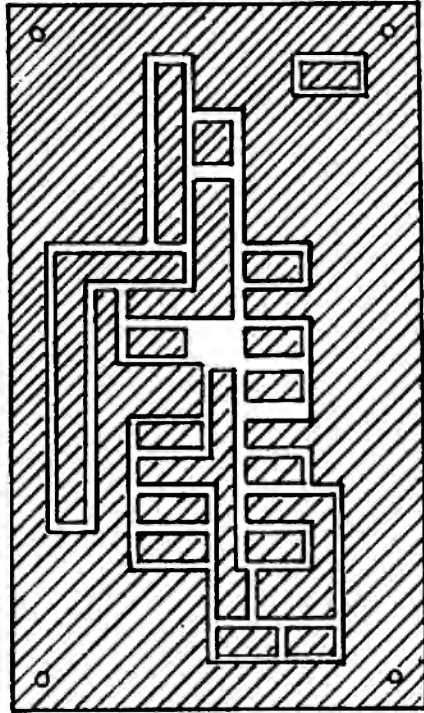
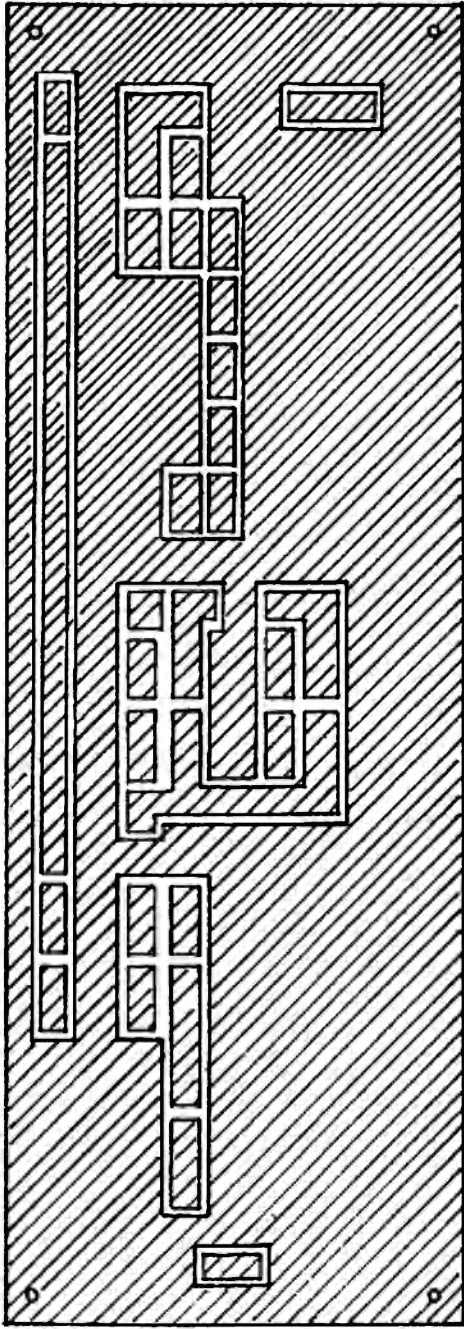

*VFO
45mm x 100mm
(Centre Bottom)*

*BFO
36mm x 55mm
(below top)*

*Power Supply
48mm x 60mm
(below bottom)*

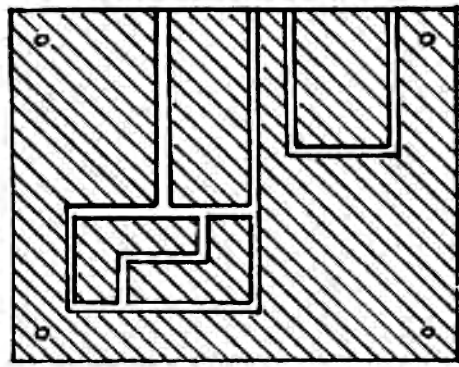
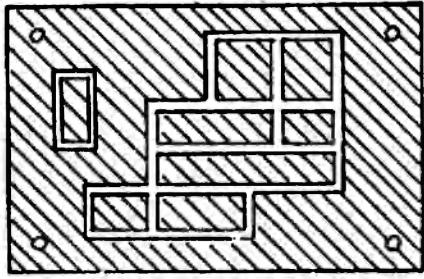
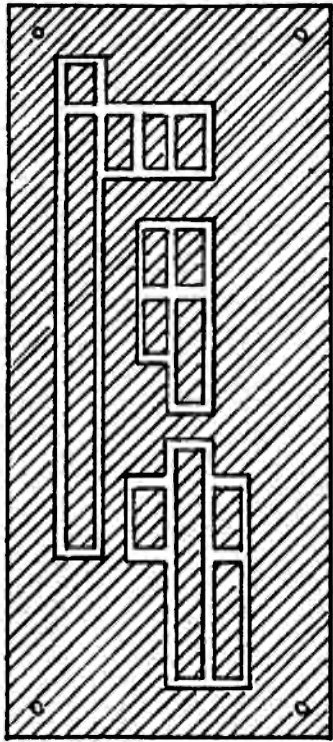

Continued on Page 23

COMING UP FROM DOWN UNDER ON THE DIAMOND DILLY

DON P WOOD W7YSO/VK2DSO
SUBMITTED BY REG HARDMAN VK4XH

Eighteen months 1986-7 in Carlingford (Sydney) Australia at the bottom of the sun spot cycle VK2DSO (W7YSO) maintained communications with home.

Armed only with my old Kenwood TS-120-S transceiver, MFJ-941-D tuner, telegraph key, a 1 lb spool of # 22 bare hookup wire in my carry on flight case and my first wife by my side, I was ready to brave Australia and the ozone layer.

I told Dodie (Flora) she could remain number 1 wife as long as she continued to put up with my radio hobby. As counselled by my elders, I should set little things like this straight at the onset, and as we were just recently married (just six kids and 21 grandkids ago), I felt the matter should not be left unattended.

After scrounging a car battery for power, stuff for a charger and picking up my new VK2 licence, we were ready for project "SKYWIRE".

The endurance test and antennas came the hard way. First a full length of 1/2" galv water pipe from the BBC Hardware store just short of a 1/2 mile up the hill from our flat ... she on one end and me on the other. Next was a length of 3/4" water pipe. It came down the hill attended by considerable muttering and obvious indications of an undesirable task as we again shared the load down the hill to the flat, thus completing phase one of the acquisition of antenna support masts.

The large back yard with its 5 to 6 ft wooden fence was well suited for our project. The pipes were stood on end and secured with coat hanger wire to the wooden fence. With nylon cord as the insulator, the spool of #22 bare hookup wire was strung out in long wire fashion, about 105 ft long.

The first contact with W7AOE (my bro-in-law back home) was on 20 m and of Q2-3 level. This prompted our son Don (WA7GWD) to air freight a triband Butternut Bowtie beam to us.

As always, one thing calls for another. Most beams, you know, work best if not left lying on the ground, and seem to have an efficiency factor somewhat relative to their height above the earth.

Without a question, the 1/2" & 3/4" pipe would not support the beam, so with

the greatest of apprehension I approached my bride. This time not with the bargain of lets do or be replaced format, but with the dream of being able to hear and talk to our families, grandkids and her mom and dad.

Like time erasing the memories of the last painful child birth, a couple of lapsed weeks and a brief and noisy contact with home, had but almost, totally, kind of, removed the distasteful memories of carting the pipes down the hill.

With the dream and high hopes of bettering our contacts with home, we once again trudged up the hill to the BBC Hardware store for more pipe.

This time was the test of all times! The first pipe was a full length of 1" galvanized water pipe. The second was 1 1/4" or 1 1/2" (whatever slips over the 1 in size) pipe. MAN! WAS IT HEAVY!

By this time in our stay in Australia, it

was very apparent to me that my style of living could be in jeopardy for an unknown period of time if indeed Dodie were to renounce her #1 position.

Being aware of the laundry, cooking, etc, I did my best to ease the load at her end of that big heavy pipe by moving back and forth toward the centre of the pipe as the threats and cries of anguish demanded. And, of course, extra rest stops were awarded this trip as an added incentive.

The 1/2" and 3/4" pipes were positioned to support a 40 m dipole fed with home brew ladder line and broad side to the USA. The two larger pipes were telescoped together along with a short piece of 3/4" pipe to form a mast approximately 32 ft long to support the newly acquired beam.

With a rope-pulley arrangement and a home brew winch fashioned from pipe

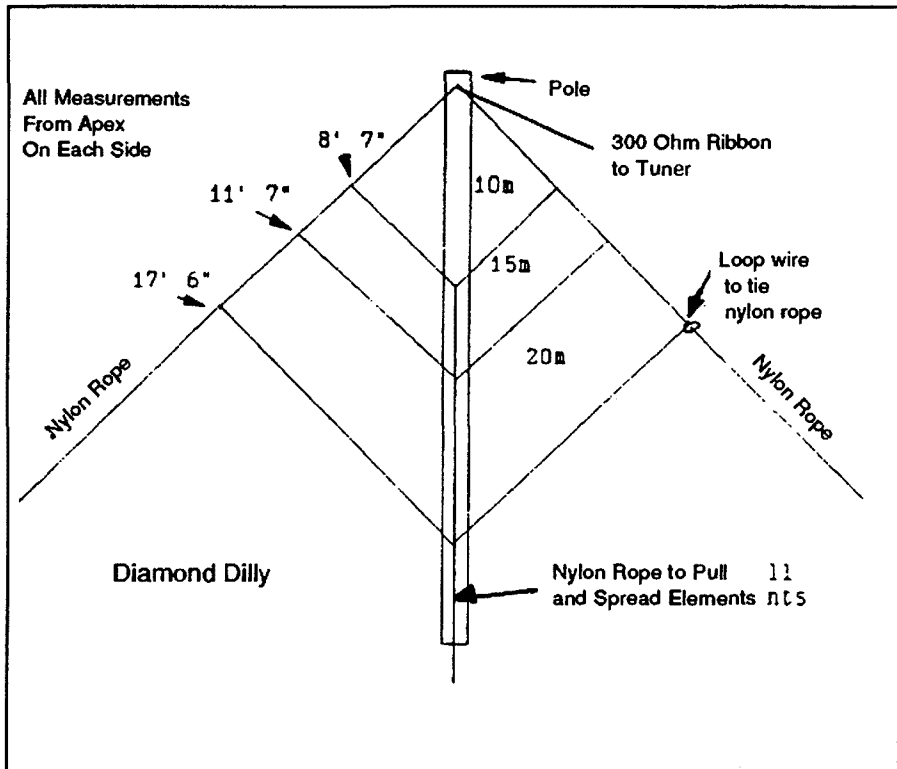

Diamond Dilly Antenna

and stuff, I was able to raise and lower the mast without Dodie's assistance. This was no small thing, and gained me that one look from her!

Some months later, I acquired some sections of aluminium antenna mast allowing an additional 16 ft in height. As hoped, this increase in height was most rewarding.

Operations continued for about four months; then we almost lost the lot in a freak wind storm. Reluctantly I lowered it 10 ft or so. Realizing that height above ground was a must, and was not going to be possible due to cost and other factors, my mind went back to the mental drawing board.

There had to be something easy to support, that I could build out of nothing, and that would work at lower altitudes.

CUBICAL QUAD!! I had used one for 10-12 years, with good results on a 40-ft tower. That was it! One element in a diamond configuration, fed at the top with the home brew ladder line.

Even with the added wire I had managed to scrounge, I would still fall short of having enough to make it multiband, and besides, the lower freq loops would be at the highest point on the mast where the most used 15 m loop should be. There had to be a way, and I had to find more wire. After careful study of a triband Quad driven element section, the extra wire would be found, and the 15 m loop would be at the highest point! Gee, what a guy won't do for his Dodie!

The 40 m dipole wire and ladder line were salvaged and the 1/2 and 3/4" pipes were left standing for side supports. For test purposes, I used a length of 300 ohm TV twinlead for the feed line, and the test was on!

The beam was left in place, then the 15 and 20 m loops were slung (diamond, top fed configuration) under it. Results were very gratifying. Being able to switch from beam to loop and back at will on the MFJ tuner, left no doubt as to test results. Generally, the beam and loop were about the same, with the loop holding the upperhand.

Knowing the day was forthcoming when the need to ship home or dispose of the beam would be upon us, I removed the beam and went for it. With the beam gone, I was able to extend the pipes again and add another 10 ft of "BBC" PVC pipe to the top. This provided a 55 ft support for the loop, getting it up there where more of the good stuff is.

The mast now resembled a wet noodle stood on end, but with the antenna serving as guying for the mast, it did the job. The single mast support was ideal, with the corner of the diamond loop being at the most desirable point of feed.

It was a grungy bunch of wire I had to work with and didn't make life too easy. The large diameter pieces were soldered together and used for feedline and the top sloping section of the loops in an effort to keep losses down.

With the added mast height, I was able to include 40 m and then the 80 m band in a screwy inverted V, dipole arrangement. Unable to continue straight out with the 80 m dipole legs because of space limitations, I tied them off with nylon cords to the tops of the 1/2 and 3/4" pipes secured to the wooden fence, then ran the remainder sloping down in line with and onto the wooden fence.

The common top half on each quad loop idea is fine for a single or driven element, but due to different spacing requirements for each band, full loops would still be required for the reflector and director element arrangement.

Many enjoyable contacts are logged in my Aussie log book, reflecting the worth of this all band "DIAMOND DILLY" antenna fed with open wire feedline.

Diamond Dilly Antenna Evaluation

REG HARDMAN, VK4XH

16 Sunningdale Av, Rochedale 4123

I have the following additions, comments, and changes to make as a result of my recent building of the "Diamond Dilly". Let me say first that the nylon rope legs of the Diamond so indicated can/should be the inverted Vee section of the 40 metre dipole, rather than the separate dipole so indicated. It is quite possible for the unit to have a 40 metre quad element (as well as the other three) if the height of the mast is around 45 feet or more. If this is the case then the dipole section will be the 80 metres 1/2 wave component so indicated in the text.

The unit I constructed utilized only the 10-15-20 metre quad elements. The results of the tests are as follows: The three band antenna was constructed out of the green insulated earthing wire normally used in house wiring and raised to a level of approximately 35 feet. The apex was spread to an angle of approximately 90 degrees and in my case I used 450 ohm ladder line rather than the 300 ohm TV ribbon. The Diamond Dilly was purposely raised to 35 feet, the same height as my 3 element Wilson beam and positioned some 15 feet away from the same beam. I ran the ladder line to an EAT-300 tuner and then to a coaxial switch before the transceiver so that I could switch backwards and forwards from the multi band single element quad to the beam for comparison purposes.

On April 22 my first contacts were

with VK5QX (Ian in Adelaide) and WL7BOR (Ed in Anchorage, Alaska) on 15 metres at 0700Z. The SWR on both antennas was almost 1:1.

Running barefoot on the transceiver, Ed could hardly tell the difference in signals (around 5 & 5) between the beam and the single element quad (he thought there was about 1 1/2 S points different), while Ian could not tell the difference at all. On "receive" in copying Ed and Ian there was very little difference; possibly one "S" point in favour of the beam, which was very surprising to me.

We then moved to 20 metres where a similar condition existed (as with 15) in comparing signal strengths with Ed in Alaska. The results were particularly gratifying to me in that the single element quad could achieve rather spectacular results for just a few dollars worth of wire materials. In the case of 20 metres I got the SWR down to about 1:2. I think perhaps the element length was a little too long.

Switching the transceiver to 18.114 MHz I was also able to load up on this frequency via the tuner and worked ZL2APW, Ron in New Zealand and W2NTU Ed in Cotton Valley, Louisiana, USA with good results and a flat SWR.

Although not made up for 40 metres I was also able to load up on the tuner with about a 1:2 SWR and worked VK1KM Kevin and VK2FLG Ron. Although the results were not spectacular I was able to break in with about 40 watts of power and carry on an effective QSO.

The next morning I worked Don, W7YSO, on 15 metres and 10 metres again reflecting very little difference between the single element quad and the 3 element beam. There was in this case of 15 metres a little more favour towards the beam but this was barely distinguishable on ten metres.

In addition to the above, I was able to successfully tune to the 10 MHz and 24 MHz bands and work a number of stations on these bands on 25/4/89. Therefore with the above configuration I was able to successfully operate on the 7 MHz, 10 MHz, 14 MHz, 18 MHz, 21 MHz, 24 MHz and 28 MHz bands.

In summing up, I believe this single element multi-band antenna is ideal for emergency operation, being able to provide better than dipole results for about the same amount of money. However, it can also be very effective in a permanent installation where only a low budget is permissible.

With emergency operation, throwing a rope over a tree and tying off both legs is all that is required for multi band "gain plus" operations.

ar

MORSE — THE PHILLIPS CODE

BY LLOYD BUTLER VK5BR
18 OTTAWA AVE PANORAMA 5041

In my article "Early Background of Telegraph Codes" (Amateur Radio Sept 1989), I made a brief reference to the Phillips Code. Subsequent to the publication, I have received a letter from Tony Smith G4FAI giving us further detail on this code. Apart from many other contributions Tony makes to various radio and electronics journals, he is the editor of "Morsum Magnificat", a publication devoted to the historic aspects of telegraphy and available through a small subscription via Tony.

Tony also refers to an article in "Morsum Magnificat", concerning the Phillips code and written by Kaye Weedon of Norway. Kaye Weedon is an electrical communications engineer who worked for Kodak for 43 years and who is very interested in researching early communications history.

In this article, Kaye refers to another article on telegraphy which he had published in "Volund 1985", a journal of the Norsk Teknisk Museum. Further information on the Phillips code can be gleaned from the Volund article.

I have had further letters from both Tony and Kaye and a copy, from Kaye, of the Volund article. With their kind permission, we reprint Tony's original letter, Kaye's article from "Morsum Magnificat" and a section relevant to the Phillips code from the English summary of Kaye's article in Volund 1985.

Morsum Magnificat

Tony Smith, G4FAI,
1, Tash Place,
London, N11 1PA,
England.
17.11.89.

Mr Lloyd Butler, VK5BR,
18, Ottawa Avenue,
Panorama 5041,
South Australia.
Dear Lloyd,

I was most interested in your article about early telegraph codes in "Amateur Radio", September 1989, and was pleased to see that you found information from some of my PW articles to be of use.

However, I think you may have misunderstood the nature of the Phillips code which, as you say was used for press work in the USA. This was basically a system of word or phrase abbreviations used to speed up the transmission of press copy and intended to be sent by normal (American) Morse. As you noted, the

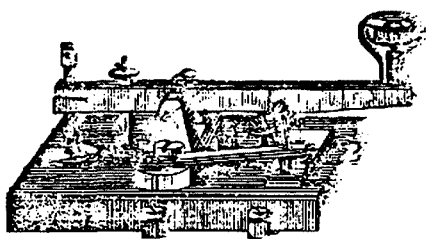

punctuation signs are the same as the normal American code apart from a few symbols which were presumably worked out to be more efficient in transmission bearing in mind the purpose of the code.

I enclose for your information a copy of an article referring to the Phillips code which is in the winter issue of Morsum Magnificat and which gives an example of the use of the code.

I'm also enclosing details of MM. There's no obligation, of course, but if you are interested in the historical aspects of telegraphy you may find a subscription worthwhile.

Incidentally, you mention the US Navy code. You may be interested to know that that had a fore-runner, the Army General Purpose or "Wig-wag" code which was sent either by flag or by conventional Morse instruments.

Yours sincerely,
Tony Smith

Phillips Code Reborn

Sooner or later the venerable Phillips code had to be revived. The following appeared in a "New Products" notice in "Newsweek", May 9, 1988.

"... the Panasonic Industrial Co ... has developed a new software program for certain Panasonic electric typewriters that could increase the speed and accuracy of typists. The program, called FasType, automatically converts Gregg shorthand abbreviations ... into full typed text. If, for example, a secretary types the abbreviation "asap" on the keyboard, the system will automatically type out the words "as soon as possible" ... Panasonic claim the program increases office productivity in two ways: by reducing the number of keystrokes needed for data entry, and by eliminating some potential spelling errors.

FasType ... has a 1,400-word standard glossary that includes days of the week, months, salutations, common nouns and standard business terms. A separate "user glossary" allows operators to store abbreviation unique to their job ..."

It is interesting to quote an example (ref.1) of the abbreviations used in the Phillips code era which lasted, in the US, c1879-1919. The Phillips code was only used by commercial high-speed operators and almost entirely for press work. Speed of message handling was their bread and butter — unlike Europe where bonus pay was unknown, telegraphists were offered no incentives and, in the German Post Office, higher speed was seen as a possibility of reducing staff.

Phillips code enabled US operators to send for hours at 45-50 wpm, at times even more, but it also transferred a burden to the receiving operator.

Example: "Mems o cx Cgs rptg und cv cmns o eno cap wo krp xgn ifo thr adhts w cmb aga ay emt to crpns, bt cujx es dtmd efo qpt peo f sq stas wi efy dmz ay osn."

Which "translates" as:

"Members of Congress representing under cover combinations of enormous capital who corrupt legislation in favour of their adherents will combine against any embarrassment to the corporations, but courageous and determined effort on the part of the people of the separate states will effectually demoralize any opposition."

In the Phillips code the computer was the human brain on the telegraph operator whose functions are described thus (refs. 2, 3, 4):

"Working Phillips involved very remarkable brain work. First, both operators had to know the Phillips code by heart. The sender would automatically encode his abbreviated message in Morse, (American Morse, ie Vail's code). The receiving operator performed the almost incredible task of hearing the sounder in a noisy room, immediately decoding the message from "Phillips" into the readable language of the original message which his pen recorded on paper. (Later written by typewriter.)

In press work, the use of the Phillips code ... materially lightened the burden of the telegraph operators, some of whom could now handle 50 to 55 wpm. for hours. Around 1907, such operators augmented their annual pay of 400-500 dollars by a bonus of 25-50 percent using their privately owned typewriters."

The burden is now taken over by the computer and its software but the "operator", now the "FasType" secretary, has to master the Gregg shorthand ab-

abbreviations, duplicating the Morse operator's initial learning process of 109 years ago.

Where the old-time operators stored the abbreviations in their minds but could look them up in the Phillips code book, the modern secretary has them stored in the computer program for instant reference if the human memory is not adequate.

References

1. Weedon: "Sounder, skrivemaskin, bonus, Phillips-Kode og "Vibroplex", VOLUND 1985, Norsk Teknisk Museum, p.67
2. Weedon: *ibid*, p.72.
3. Weedon: "Faster Manual Morse", *Morsum Magnificat* Nr 11 Spring 1989, p.45.
4. Murray, Donald: "The Typewriter and Piecework in Telegraphy". *Post Office Electrical Engineer's Journal*, Vol 1, 1908, pp 18-21.

Extract On The Phillips Code

KAYE WEEDON

From Reference 1, Above.

The introduction 1879, by Walter Phillips, of the PHILLIPS CODE BOOK marked another advance in faster message handling. Essentially, this code substituted "words" of 2 to 4 letters for those of 5 or more. This gave savings of 30 to over 50 per cent of actual signals transmitted. The Phillips Code was used almost only for press matter intended for the large number of newspaper over the US continent and was not permitted for ordinary telegrams.

At one time c1907, before the general introduction of the "Vibroplex" key, two U.S. operators on one, rare, occasion netted 50 wpm over 8 hours, using reception by sounder, typewriter, and Phillips code. **ar**

ST KILDA ACCESS TELEVISION — HELP NEEDED

St Kilda Access Television (SKA TV) is a community television organisation. SKA TV is working towards the establishment of a permanent community access TV station to serve the inner south eastern suburbs of Melbourne.

SKA TV was incorporated in October 1988. Since that date SKA TV has run two test transmissions in the St Kilda area using 10 and 20 watt transmitters.

Membership of SKA TV is open to all stands at 350, as of April 1990.

SKA TV would welcome the participation of radio and TV amateurs in our activities. Within the next 12 months SKA TV must determine the site, trans-

mitter and antenna required to service the inner south east of Melbourne.

As is typical of community volunteer organisations, money is lacking. The purchase of new transmitting equipment is not currently an option for us. Anyone who knows of the availability of second hand transmitting equipment, or the designs for such equipment could assist us greatly. Our most pressing requirement is a UHF linear amplifier of 100 watts or more capacity.

Anyone wishing to join SKA TV or assist in any way should contact Steven Armstrong, Technical Co-ordinator, on BH: (03) 525 3551 or AH: (03) 529 8468. **ar**

Back issues of AR available to WIA members
10 randomly selected back issues of our choice,
between Jan 1969 to Dec 1987,
available for \$17.50

Price includes postage.

AR Back Issues

PO Box 300

Caulfield South Vic 3162

WORKING H.F. MOBILE? NEED A COMPACT H.F. BASE ANTENNA MOONRAKER AUTO-TUNE ANTENNA SYSTEM

- Originally developed for long haul commercial mobile services the MOONRAKER AM318 Auto-Tune antenna puts the ATU components up in the air where they belong so that they become an integral part of the radiating system instead of being coiled up in a 'black box' somewhere.
- The 2.7M whip is 1/4 wave centre loaded at all frequencies with no base loading and no sliding contacts. It automatically retunes to the best SWR for any frequency in the range 3 to 18 MHz (other bands to order).
- The compact antenna control (interface) unit gives visual and audible tuning status and is suited to manual/automatic operation or located up to 20 metres away for base station use if desired. Just select the frequency and press the tune button, retuning time is typically less than 3 seconds.
- Impedance 50 OHMS (Nom).
- VSWR 1.8:1 Typical 1.3:1
- Power rating SSB-140W.PEP, CW 70W.
- Mounting - Anti shock mount with 12.7mm mounting stud.
- Construction - Anodised aluminium with a removable fibre glass top.
- Options - Scan, activates a wide band amplifier in the AE for receive scanning; H/D anti-vibration mount for rough roads; Top whip section spring for off road.
- Price - Complete system with 4M control cable only \$749:00 plus sales tax 20%, if applicable. Air freight \$23:00.
- Cheque, Bankcard and Mastercard welcome.

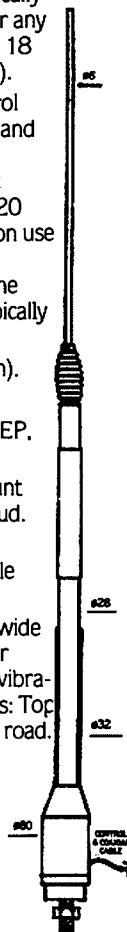

**PHONE (002) 73 1533
or FAX (002) 73 1749
FOR SPECIFICATION SHEET
MOONRAKER AUSTRALIA
PTY. LTD.
TASMANIA TECHNOPARK
DOWSING POINT, 7010**

A MORSE OSCILLATOR

BY MERVYN EUNSON VK4SO
Box 1513 GPO BRISBANE 4001

Restoring Traeger "pedal wireless" morse sets to working condition brought surprises. For one, there was no sidetone facility to monitor transmissions!

Determined types, these pioneer bush folk — some scored brief tuition in the art of sending morse and a pat on the back. Then they were ready for outside contact in any emergency, with at best a watt or so of CW to span hundreds of miles to Base. They could monitor their transmissions, recounts Rev Fred McKay (one of the early "patrol padres"), by the blinking of the tuning indicator (a torch globe in series with the aerial output coil).

Not this op though, audio sidetone was needed to demonstrate the old sets. The oscillator evolved for the purpose also functions well with the Traeger Morse Typewriter in public displays of early Flying Doctor relics. Here all are invited to try their hand at morse, either through the keyboard or on a straight hand key, to be copied by the duty radio officer (an amateur volunteer).

The circuit is simple and effective. A NE555 IC timer chip as an astable multivibrator generates audio tone and is keyed in the supply line. Its output alone is sufficient for close listening. For a higher level of audio, a LM386 amplifier will add ample gain.

The illustrations may mislead with a false impression of complexity. Actually, a number of options, some pure gimmicks, were added for versatility, and the device, like Topsy, just grew.

For use by different volunteer operators in various surroundings, often

crowded and noisy, the expanded version has both adjustable pitch and gain, multiple switched inputs, a relay to trigger transmitters if needed, and flashing LED indicators to impress small boys and confuse know-alls.

The circuit diagram shows the basic essentials, and a little explanation may be warranted. Frequency of operation is determined by the R-C divider at the NE555 timer input. Most operators prefer a tone around 800 Hz, best achieved by making Rx a fixed value 3.9k resistor and omitting Rv. If semi-fixed adjustment over a wide range is preferred, substitute a 3.3k resistor in series with Rv a 1k trimpot, and select your own note.

Variable pitch control with a pot on the front panel, as depicted, is largely a gimmick, but with justification. Apart from preferences of different duty operators, slow morse from the Morse Typewriter (loaded down to about 10 wpm) sounds best at low pitch. A higher pitch is more suitable for faster morse from the hand key. For personal use the complication is superfluous.

As a trainer to practise the code, merely construct the oscillator section with the NE555 (in a socket) and its resistors and capacitors. A PCB is not warranted, for the few components mount conveniently on a scrap of plated stripboard (Veroboard or similar). The output from pin 3 is fed to a miniature speaker, behind which will fit the whole works, including a 9V battery. A switch is not necessary as there is no drain unless the key is operated.

For higher output level than the oscillator alone provides, a LM386 chip may be added as a non-critical amplifier. This will effect a gain of 20, normally quite ample with the relatively high input. A gain control is not necessary.

Where considered necessary, gain of the amplifier may be increased to 200 by adding a 10 μ F capacitor across pins 1 and 8 (marked with an asterisk). In this case it is advisable to decouple the supply line with a 100 μ F capacitor. The piercing tone now will be excessive for close listening, necessitating a cut-throat gain control. Here this simply became a surplus 200-ohm pot (as a variable load) in series with the speaker — a cheaper carbon 500-ohm item will be equally effective.

Supply voltage is not critical, any range between 6V to 12V will do, for both active devices will function, without alteration of tone, down to about 4V or so. A small 9V battery will do fine here, particularly if the non-essential LEDs are omitted to limit drain.

The version depicted is not so restricted, being supplied by a hefty 12V power pack or else a car battery in situations without mains.

If it is required to trigger a transmitter, a small relay and line socket are added. These need not be elaborate, a single set of low-rated contacts will suffice.

And there it is, a budding homebrewer's ideal. Completely uncritical in all ways, requiring a most determined effort to produce a dud. It may be as stark and basic as wished. With a full display of ingenuity it can become versatile and complicated. **ar**

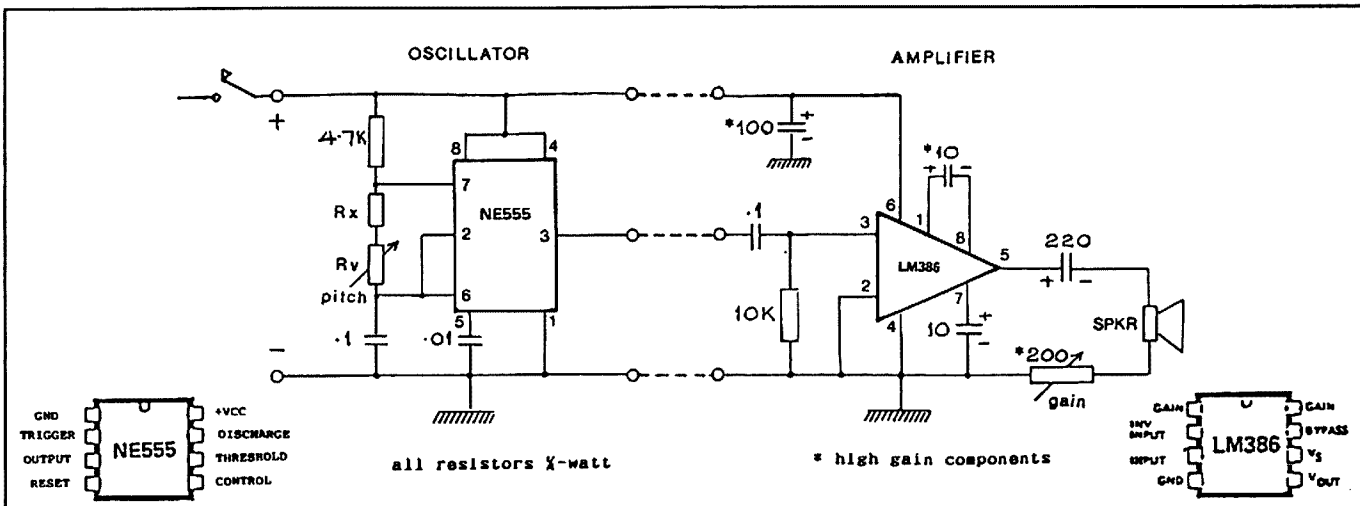

A Morse Oscillator Circuit Diagram

Radio Amateurs: Have you checked out EA lately?

No doubt most radio amateurs are aware that *Electronics Australia* is by far this country's largest-selling electronics magazine, as well as being its oldest (we began way back in 1922, as *Wireless Weekly*). But have you looked inside the magazine lately?

Remember Jim Rowe, VK2ZLO? Jim used to be Technical Editor, and then Editor – back in the late 1960's and 1970's. You may recall some of the amateur radio and test equipment projects he developed, which proved to be extremely popular. Well, Jim is back at the helm of the magazine, and has been busy giving it a new lease of life.

You'll now find lots of new 'departments' in the magazine, including Solid State Update (with news of new semiconductor devices), Silicon Valley Update (news from the USA) and What's New in Entertainment Electronics. Plus all of your old favourites like Forum, The Serviceman, Circuit and Design Ideas and so on. And of course plenty of 'meaty' technical articles and construction projects.

What about *amateur radio* projects? Well, as you can see there are more of these than before – but we're very interested in publishing more. So if YOU have developed an exciting amateur radio project, contact Jim Rowe by writing to him at EA, 180 Bourke Road, Alexandria 2015. Or phone him on (02) 693 6620, to discuss the possibility of publishing it as a contributed article. As well as earning a fee, you'll also be helping to boost interest in amateur radio!

Take a look at the new, rejuvenated *Electronics Australia* – on sale at your newsagent at the beginning of every month. Or subscribe now, by phoning (02) 693 9517 or 693 9515.

Electronics Australia

Australia's Top Selling Electronics Magazine

INCLUDED IN OUR MAY ISSUE:

AMATEUR RADIO TO THE 'RESCUE'

WICEN/SES emergency training exercises aren't all hard slogging and deadly serious, as Tom Moffat VK7TM relates. On occasions, they can be quite enjoyable – even good fun!

THE RISE & FALL OF THERMIONIC VALVES - 1

Many of today's younger amateurs and electronics enthusiasts have never seen a valve. EA's former Editor in Chief Neville Williams describes the role of valves in building the radio and electronics industries.

CONVERTER FOR THE 144MHZ BAND

Add 2m reception to our recently described 6m NBFM receiver, with this low cost converter. Easy to build, it uses a flexible PLL system for the local oscillator.

PRODUCT REVIEW

GRAHAM THORNTON VK3IY

The Bencher Iambic Paddle

An electronic keyer is an achievable project for the average home-brewer; however, the construction of a mechanical paddle to operate it presents difficulties to most amateurs. The Bencher Iambic Paddle is designed to meet this need.

For the uninitiated, a definition of 'iambic' is in order. If the dot and dash paddles of such a keyer are actuated simultaneously, a series of alternating dits and dahs results. This closely resembles the sound of iambic pentameters beloved by poetry teachers. Hence the name. Such keyers are characterised by dot memory - a following dot may be initiated during the transmission of a dash. This has the advantage of economy of motion.

The Bencher Paddle is mounted on a solid steel base 1.5 cm thick. The base is 10 cm wide by 9.4 cm deep. The total weight of the instrument is 1.25 kg. Three finish options are available: black, chrome or gold. The instrument has mirror symmetry about a vertical plane mid-way between the two clear-plastic paddles.

A bracket connects each paddle to a movable, gold plated, solid silver contact. Seen from above, the face of this contact is at an angle of 135 deg to the paddle. A similar but stationary contact opposes frontwards. This latter contact is mounted on the end of an Allen-keyed grub screw, which is threaded into a split stud projecting vertically from the base. A further screw compresses the 'split', firmly locking the adjustment screw.

The contact-paddle bracket connects to a front-facing outward-curving semi-annulus, at the axis of symmetry of the latter. Two nylon bushes are vertically opposed near the inner extremity of the semi-annulus. Horizontal steel spindles with tapered ends, project forward from the flat face of an immovable short cylinder mounted to the rear. These spindles fit neatly into the nylon bushes, forming needle bearings which together act as the fulcrum of the rotary system. The tension spring mounts onto a radially directed set screw, projecting inside the semi-annulus. The entire rotor system is held in place on the spindles exclusively by this tension spring. Rotation of the set screw alters the point of application of

the spring tension, thus varying its moment about the fulcrum.

Three solder lugs are fitted underneath the base, together with a cable clamp to protect the connections. The Allen key, supplied with the equipment, fits neatly under the base in a special battery - connector type clip. Three rubber feet ensure a firm grip on the operating table.

I found the instrument very pleasing indeed to use. A magazine review cannot really do justice to the device. A hands-on (and eyes-on) appraisal is really necessary for an individual to appreciate its quality. I could detect no tendency whatever for the instrument to slide when one paddle only was used; a variety of surfaces was tested. With the particular tension setting on the model supplied for review, only one or two grams of thrust was necessary to actuate the contact. 200 grams of thrust (the limit of the spring balance) did not produce any sliding whatever. There was a tendency for the feet to lean somewhat when keying; however this resilience gave a pleasant cushioning effect.

This device cannot be described as an 'el cheapo'. It is perhaps not appropriate for the occasional CW user. However, for dedicated morsiacs (such as this review author!) it is an investment which deserves honoured place in the shack. From the quality of its design, materials and workmanship, it can be relied on to give a lifetime of faithful service. It should also maintain a high resale value. You can see your face in the chrome plated version - perhaps this might be an added incentive for the YLs! The instrument almost justifies a place as a piece of purely decorative art! The gold plated option, at more than twice the price of the chrome equivalent, would be the exclusive preserve of the wealthy connoisseur! Seriously though, it is not a toy, but a precision instrument. It is a tribute to the watch-maker's art, from which it is obviously derived. If I am permitted one criticism, such a magnificent device should have a permanent dust cover - using a plastic bag as temporary protection between uses seems like sacrilege! (It seems that the Editors of QST share this view. Page 3-9 of the latest 'Hints & Kinks' shows a design for a plastic cover for the Bencher paddle.) The final price is not clear at the time of writing, but after the

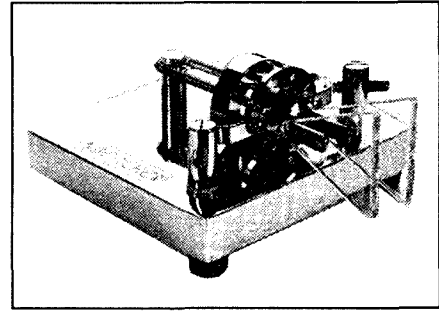

The Bencher Iambic Paddle

sales tax people and the Post Office are satisfied, there will not be too much change from \$200 for the chrome model, delivered by post. Thanks to Leigh Campbell of Pro-Foto Industries, Canberra for supplying the evaluation model. Sales enquiries should be directed to his firm whose address is: P O Box 501, Fyshwick ACT 2609.

Further Reference - Pounding Brass, Gil Griffith VK3CQ AR Jan '89.

ar

BENCHER IAMBIC PADDLE

THE ULTIMATE KEYER!

AS REVIEWED IN THIS
ISSUE

THREE MODELS TO
CHOOSE FROM:
BLACK; CHROME &
GOLD

AVAILABLE FROM:

PRO-FOTO
INDUSTRIES

PO BOX 501, FYSHWICK
ACT. 2601.
PHONE 062-807168

BOOK REVIEW

HINTS AND KINKS FOR THE RADIO AMATEUR

JIM LINTON 4 ANSETT CRES, FOREST HILL 3131

HINTS AND KINKS for the RADIO AMATEUR

A collection of practical ideas gleaned from the pages of QST

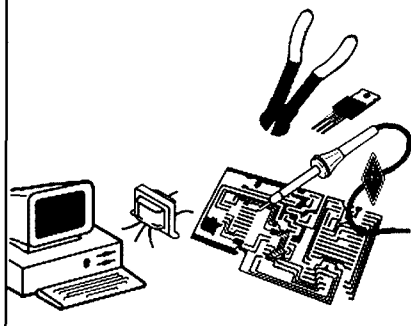

The 12th edition of this publication is like its previous editions a collection of practical ideas gleaned from the pages of the ARRL journal QST. In its 12 chapters you will find a wide range of innovations and wizardry, and the book is fully indexed. It shares the hands-on experience of QST contributors in virtually every aspect of amateur radio. Since 1933 "H and K", with its fixes, tidbits, updates, projects and practical tips, has become an established part of the amateur radio publication scene.

This updated version replaces the previ-

ous edition released seven years ago and is sure to take pride of place in many a radio shack bookshelf. It offers a range of useful ideas for both the old hand at amateur radio and the newcomer. Chapter 1 contains ideas for the radio shack including safety aspects, operating comforts, and techniques to make QSOs more pleasurable. Chapter deals with many hints for receivers and transmitters with some modifications for specific commercial rigs. Chapters 3 and 4 are devoted to CW devotees and digital modes respectively, with ideas for using computers in the shack. Chapter 5 concerns antennas, feed lines and things which go between or are appended to these two. Chapter 6 is entitled Shop Secrets and has tricks of the trade. Testing and test gear are covered in the 11 pages of Chapter 7. The next chapter is full of items for mobile operators and guidelines for installations in modern cars with their complex state of the art auto-electronics.

In the remaining chapters are to be found ideas and practical applications for VHF and UHF antennas, amplifiers, tone generators, power supplies, taming interference, a world time finder slide rule. The 160 page 12th edition lives up to its name and upholds the reputation it has earned since first delighting radio amateurs in 1933. Hints and Kinks available through WIA Divisional Book Shops is highly recommended for those who like to get involved in some practical work or a weekend project.

PIRATES JAM POLICE

A gang of pirate radio operators had jammed and engaged in harassment on police frequencies in Adelaide for several months, according to the Department of Transport and Communications.

The illegal activity also occurred on radio channels used by other essential services and private radio networks. DOTC state manager, John Wilson said the pirate operators targeted a number of essential services, including the police, by interrupting their radio broadcasts.

Mr. Wilson said pirate operators had conducted a campaign of illegal activities, including jamming transmissions and harassing legitimate operators. Using sophisticated mobile

and portable transceivers the pirates operated at random by day and night. He said the illegal transmissions were quite hard to track down and radio inspectors monitored them for several weeks.

After a while a pattern to the transmissions emerged and gradually the RIs pieced together snippets of information about the pirates. In a series of raids on several Adelaide houses the RIs and South Australian Police CIB detectives seized radio communications equipment, including scanners, CB radios and illegally modified transceivers. DOTC said charges under the Radiocommunications Act were expected to be laid against seven people.

Contributed by Jim Linton VK3PC

Superhet - DC Receiver for 3.5 - 4.0 MHz
From page 15

Parts List for the Super-DC Receiver

Capacitors

3.3pF	NPO ceramic	C27, C29
10pF	NPO ceramic	C3
25pF	air trimmer	C2, C4, C25, C34
27pF	NPO ceramic	C23
47pF	NPO ceramic (see text)	C13, C14, C15, C16, C17
82pF	NPO ceramic	C26
100pF	air variable	C24
150pF	styroseal	C5
180pF	styroseal	C1
220pF	styroseal	C35, C36
470pF	disc ceramic	C41
0.01uF	disc ceramic	C8, C21, C22, C38
0.47uF (or 0.1)	disc ceramic	C6, C7, C9, C10, C11, C12, C18, C19, C28, C30, C31, C32, C33, C37, C46
0.1uF	disc ceramic	C49, C50
0.1uF	mylar (greencap)	C39
1uF	tantalum >16V	C43
10uF	tantalum >16V	C40, C44
100uF	electrolytic >16V	C47
220uF	electrolytic >16V	C42
470uF	electrolytic >16V	C20
1000uF	electrolytic >16V	C45
2500uF	electrolytic >35V	C48

Resistors

10 Ohm 1/4W 5%	R5, R10, R24, R28, R35
100 Ohm 1/4W 5%	R2, R15, R22, R33
150 Ohm 1/4W 5%	R16
470 Ohm 1/4W 5%	R18, R27
500 Ohm TRIMPOT	R9
1 kOhm 1/4W 5%	R6, R7, R14
1.5 kOhm 1/4W 5%	R11, R23
3.3 kOhm 1/4W 5%	R1
2.2 kOhm 1/4W 5%	R29
20 or 25 kOhm log pot	R34
22 kOhm 1/4W 5%	R26
33 kOhm 1/4W 5%	R31, R32
47 kOhm 1/4W 5%	R25
68 kOhm 1/4W 5%	R12, R19
100 kOhm 1/4W 5%	R8, R17, R21
100 kOhm lin pot	R3
220 kOhm 1/4W 5%	R4, R13, R20, R30

Semiconductors

MPF102, 2N5457 etc	Q5
MFE131, 40673	Q1, Q2, Q3, Q4, Q6
2N2222, 2N3904 etc	Q7
LF356 8-pin DIL IC	U1
LM386 8-pin DIL IC	U2
7812 +12V regulator IC	U3
6.8V/400mW zener	D1
200V/1A diode	D2, D3, D4, D5, D6

ar

NCRG JMFD 1989

JOHN SPARKES VK6JX
83 ANEMONE WAY MULLALOO 6025

Or How to plan and work very hard, set up the biggest and best multiband portable field station in Australia, have a fantastic time, and STILL lose!

1988 — "I don't believe it..." This phrase echoed through our otherwise silent clubroom at the first Northern Corridor Radio Group meeting after the 1988 JMFD results were published in AR.

Even 1000 contacts — all on natural power (and I mean honestly natural!) was nowhere near enough to clinch the open section for our team in 1988 — even while sporting this VI88WA callsign.

"Something has to be done about this..." No one in Australia seems to realize that VK6 is like another country on 80 and 40 metres — and coming in on the side of triband yagis on 20, 15 and 10 metres isn't easy either!

The contest manager understands our problem but his hands are tied — changing the points scoring system to put VK6 on a par with the eastern states would make his letter box bulge and his job unbearable.

Still, what the heck — the important thing is to have fun ... right? ...

"We're gonna get our revenge this year! We'll even go in the phone only section so everyone will want to operate! 8dB+ gain antennas on all bands except 80 — this'll shake 'em up!" Thus spoke our president — we all agreed but deep down the words had a hollow sound.

Friday afternoon (T — 18 hrs) rolled around too slowly. Knock off early — wait at home for Phil 6ZPP to turn up. When he arrives he welcomes my extra ballast — the roof rack looks like OTC fell on it.

Meet up with John 6ATA, Jack 6KDX, Alek 6APK and John 1NCO/P and take off. Destination — Tandara Wilderness Camp, about 60 km North of Perth and out in the Marri tree, black sand boondocks NE of Yancheep. Everyone else to come up later, or early tomorrow morning.

At the gate, Dennis 6ZN and Syd are already waiting — "Sorry, we're late ...". The site is great. Toilet block, running water from bore and windmill, lots of big trees with large clear areas in between. Not too hot as a VHF/UHF location — but local apathy precludes any expectations of a big score from these bands anyway.

Tents or antennas — what first? Let's



Breakfast L to R Ray VK6JRD, Son Nick VK6JMS, John VK6ATA, Phil VK6ZPP and John V6INCO/P

have another tinny and plan this out ... Antennas! 40 Metres goes up with the aid of a few good throws over 36 foot high branches. Three 1/4 wave verticals in phase (3 element curtain array to the plebs) — BEWDIFUL!

As the evening closes in, the VHF/UHF station is erected. 13 elements on 70cm, 14 element slot on 2m and 6 elements on 6m — all up at about 25 feet. 100 watts on all bands, 9913 and N connectors — loss is not a problem. Loud Russian TV carriers below 6 metres bode well for some TEP in the contest. The rest of the highly tuned operating team arrive gradually as a gibbous moon glints off all the hardware now in the air.

Last on the list for Friday night is 20 metres — a 2 element delta loop (Old Faithful!). A quick tweak on the gamma match, and 100W into a 1:1 SWR brings in plenty DX. Things are looking great.

And now, what everyone has been waiting for — tinny time, chew the fat then bed by midnight (T — 9 hrs).

First light is about 5am, (T — 4 hrs). Everyone is up, cuppas are passed around, breakfasts are gobbled up.

10 metres, another 2 element delta loop is installed and tested. 15 metres, a 2 element V-beam is stood up on a lattice mast at about 30 feet.

Since first light most of our naturally charged batteries have been lugged to the operating positions, each of which is equipped with at least 2 borrowed solar panels. The spares are placed in a central sunny spot and the rest of the solar panels are connected up to them. The sky is cloudless, and natural power is no problem. 10 and 20 metres are open but 15 is still waking up. By now, everyone who's anyone is on site! (T — 1hr) A quick operating schedule is posted, log sheets and pencils are distributed and the presi-

dent gives all a pep talk. Not really necessary as everyone is rarin' to go!

(T — 10 secs...) Local time 0900 hrs — Go!!

10 metres is working the world, as well as the odd VK and ZL station! 15 gets off to a slow start, but by 1100 hr local is going well. 20 is universally good.

While the contest operators are sweating it the 40 metre radial system is laid down, and the tuning unit tweaked up for 0% reflected power. On 80

metres, a full size folded dipole is pulled up to about 50 feet. (A 12 foot fishing rod got the line over the high branch — well done Alek!) But Murphy has fouled up the 4:1 balun connections, so after much cursing and testing, a pre-tuned G5RV (standby) antenna is pulled up instead — works great. Roll on Saturday night! Lunch is generally a "grab what you can when you can affair!!"

At 1300 hrs, 3 Weber BBQs are stoked up to cook dinner. The Club has provided 11 kg of prime beef with jacket potatoes and onions for all participants to enjoy. The aroma around the central cooking area is heavenly.

At about 1600 hrs under a veil of secrecy, our secret weapon is deployed for immediate action. A 6 foot diameter balloon is inflated with Hydrogen gas. This beautiful orb then pulls up a 5/8 wave vertical on 80 metres! A comprehensive radial system is laid down, and a tuner at the base zeroes it in. How will it compare to a G5RV? Only the night knows! The sea breeze has now come in strongly and keeps turning our 5/8 vertical into a sloper — doesn't matter!

I mentioned VHF apathy before — but this incident takes the cake. A local station was contacted on 2m, and asked very nicely for a number. The reply — a sneer, then "73". This operator will be dealt with summarily at this years NCRG HAMFEST!!!

1800 hrs local — all operating ceases as dinner is served. All operators, SWL's and family members are all seated around the cooking area and a hearty meal is washed down with plenty of Western Australian beer!

After dinner, operating commences in earnest. 80 metres is fired up — but very few contacts result as no one can hear us (or they don't want to hear us!?) Lots of

eastern states and ZL stations can be heard — but we might as well be on the moon — very few came back. What happened to the 5/8 vertical? The G5RV soundly thrashed it! Most stations on 80 metres are obviously coming in at very high angles. The vertical was too good for its own good! What a shame there was no DX to experiment with!

40 metres is slightly better but it's a bit disheartening when you've worked hard for 2 hours and have 15 contacts, and VK4 and VK5 and ZL stations have 150 contacts. Again, 40 metres is another world from this side of the continent. 10 metres is pumping. Lots of DX is rolling in on 10, 15 and 20. 6m comes and goes with JA's being worked occasionally.

The evening passes quickly, and by 1am Sunday morning, all are fast asleep building up some strength for the final mad dash starting at first light. All except Tony who is still flogging the 20 m horse, which hasn't died yet!

First light Sunday morning. No time for breakfast — quick cuppa and into it. 10 minutes later 40 m is stymied again as all the stations who can hear us are worked for the last time this year.

Operators try frantically to get those last few contacts ... QRZ doggy x-ray!!

0900 hrs local — pencils and mikes down!

A mad scramble now ensues as the VK6 divisional broadcast is going to be relayed on 40 m and 6 m from the field day site. Talk about dedication! Still, it was worth it, as a total of 12 stations



Jack VK6KDX and son Hamish operate the VHF/UHF station. Note solar-panel-destroying trailer in background

come in on the callback.

Wearily, with the hot sun on our backs, all antennas are dismantled, tents are taken down and we sadly prepare to leave our best Field Day site yet.

Murphy strikes for the second time (I suppose that only twice on a Field Day weekend must be some sort of record!) on the limestone road out of the camp. A trailer tyre blows and dumps a Weber BBQ on to a solar panel. Whoops — well, that's one we can't borrow next year...

A fantastic time was had by all at the Field Day. I don't believe it would be very probable that a better, more dedicated group of people has ever fired up on JMFd from a portable field location. Do we have a chance of winning with the current scoring system? We don't think so.

Will VK6ANC be back, regardless, bigger and better next year? Believe it!!!
ar

FIRST HAM CONTACT BETWEEN BV AND BY

(Originally published in a CRSA newsletter. Report by BZ4RC. Translation by Edward Teo. Ed)

On the 12th December 1989, Mr Yang Leong Yong BV2LB had a QSO with Mr Chan Foong at BY4RSA for the first time.

Mr Yang, an influential man in the amateur radio affairs helped to introduce ham radio activities into Taiwan. He told Mr Chan that in 1985 twenty-five students passed the amateur Radio Examination and since then fourteen stations have been set up within Taiwan.

In April 1989 a further seventy-nine students passed, out of a total of one hundred and eighty-three who sat the second examination.

Mr Chan at BY4RSA had also helped to introduce amateur radio activities into China.

BV2LB had put a lot of effort into convincing the Taiwanese authorities to allow amateur radio communication between China and Taiwan and he hopes this will become easy reality in March/April of 1990.

CONTRIBUTED BY
DAVID RANKIN 9V1RH

THE GREAT 1990 APRIL FOOLS' DAY JOKE (S)

By JIM LINTON VK3PC

On one particular day each year practical jokers come to the fore and play tricks on others, who are then described as April Fools. Sunday, April 1, 1990, had plenty of April Fools among the ranks of radio amateurs throughout Australia.

On the VK2WI broadcast an item discussed future developments of amateur devolution following on from the devolution of examinations. It said the natural consequences were that all Amateur Radio Service matters would be handled by the representative body, the WIA. The VK2WI broadcast said this would include licensing, issuing of callsign, and imposing on-the-spot fines for offences against the Radiocommunications Act. The WIA New South Wales Division told listeners it was considering the installation of a special computer to handle the allocation of callsigns. The item caused something of a stir.

Harry Atkinson VK6WZ, who runs the VK6 broadcast, was determined not to

have an April Fools Day joke as part of his broadcast. So having completed the "joke-free" broadcast, Harry began conducting the 2-metre callback in Perth after the broadcast and asked for any stations visiting Western Australia to call in. A distorted signal from JA1APR was heard, and duly acknowledged. Later in the callback Norm Schroeder VK6NS had some QSP from the JA. "I've just had a telephone call from that JA, he says to add the letters India Lima to his callsign," Norm said. Harry admits he got caught and became an April Fool.

In Victoria the VK3BWI broadcast had an April Fools Day joke which caught hundreds of radio amateurs. A report on the broadcast announced the release of unique and prestigious callsigns which had single letter suffixes in the block VK3A to VK3Z.

It attracted a lot of response and had some 327 radio amateurs of all grades of licence from throughout Victoria, and

even interstate, seeking to enter a ballot for the callsigns. There was virtual hysteria created, with hundreds of radio amateurs eager to get one of these special callsigns.

The item on the broadcast mentioned twice that entries to the ballot closed at midday — considered by the perpetrator to be an obvious clue to the validity of the item. A so-called "callsign telephone hotline" fitted with an answering machine was kept busy ... (which was actually the WIA executive office). As a matter of interest the callsign block VK3A to VK3Z had traditionally been allocated to experimental stations.

(It was perhaps unfortunate that the VK3 April Fool joke was not kept "in house" by quoting the VK3 phone, instead of inflicting unnecessary extra work on the Executive Office. One gentleman, at least, who drove a considerable distance to the VK3 Ashburton office, was reported as being distinctly "not amused" — Ed)

ar

CONTESTS

FEDERAL CONTEST MANAGER FRANK BEECH VK7BC
37 NOBELIUS DRIVE LEGANA TASMANIA 7277

Calendar

June

16 — 17th WIA Novice contest. (Rules this issue)

July

14 — 15th IARU HF World championship (Tentative dates)

Information regarding the results of the French "Championnat de France 1989" included the Australian results;

1st VK8XX with 33756 points

2nd VK2BQQ with 297 points

3rd VK4TT with 270 points

Please note that in the rules for the 1990 Novice contest that are included in this issue, the address to which the new Contest Manager wishes contest logs to be forwarded will be advised.

Ross Hull Memorial Contest 1989 Results

Callsign:	Contact	Bonus	Total
	Points:	Points:	Score
VK3XRS R Steedman	1593	3500	5093
VK3DLM L Mostert	1355	2650	4005
VK3ZJC J Martin	1406	1250	2656
VK5NC T Niven	569	1600	2169
VK3AUG N Sallman	1003	1000	2003
VK3BBB B Young	556	1300	1856
VK3AUI G Sones	523	900	1423
VK3CY D Clark	664	750	1414
VK3ELS I Morris	572	750	1322
VK3TDV M Binz	455	800	1255
VK3AOS R Blake	106	950	1056
VK3VF B McKenzie	290	500	790
VK1ZAR J Roberts	36	700	736
VK3BMV E Templeton	154	500	654
VK4AIZ D Friend	40	600	640
VK4XA S Coleston	34	450	484
VK5VB N Harwell	18	450	468
VK7ZAP A Perkins	54	300	354
VK3ZXY T Leith	75	250	325
VK3KTR R Rode	52	250	302
VK3ANP D Waring	20	250	270
VK5AFO D Cavies	4	100	104

Congratulations to VK3XRS, with the highest score. Roger will receive the winner's certificate and his name will be engraved on the perpetual trophy that will be held by the Victorian division until the next winner is announced in 1991. Certificates will also be given to the highest scoring stations in each locator field.

Certificates for the top scoring stations in each locator field are as follows;

Maidenhead locator field QE ... VK7ZAP
Maidenhead locator field QF ... VK3XRS
Maidenhead locator field QG ... VK4AIZ

Maidenhead locator field PF ... VK5VB

Comments on the contest have been favourable, those stations who made the effort to work the higher contest bands and looked for the DX stations reaped the rewards. Certificates will be made up in the near future and posted out ASAP.

To clear the decks, please note the following and correct your copies of "AR" accordingly. In the lists announcing the results of the 1989 RD contest please note that John VK5NJV (now VK5PO), was incorrectly listed in the VHF section as VK5NVF.

VK2DID was listed as VK1DID in the HF CW section.

VK1CC R Cook was the top scoring VK1 station in the HF CW section.

In the results of the 1989 Novice contest, Ray VK3MBU was listed as VK3BMU.

In the February issue of "AR" page 40, the printers missed out section "F" in the rules for the John Moyle contest, I hope that you all realised that this section would not have been dropped from this contest.

Results Of The 1990 Trial VHF/UHF Field Day Contest

Section "B" 24hr All band; Single op
VK3BBB/P B Young 566 points 30 squares
16980 total.

Section "B" Cat "C" Multi op
VK3ATL/P Geelong ARC. 596 points 40 squares
23840 total.

VK5ZUC/P VK5ZUC & VK5AJQ 296 points
24 squares 7104 total.

Section "B" Cat "D" Home Stn
VK5NC T Niven 101 points 35 squares
3535 total

VK3XRS R Steedman 42 points 17 squares
714 total

VK5LP E Jamieson 17 points 7 squares
119 total.

Section "A" 12hrs Cat "A" single op single band.

VK4NEF E Fittock 186 points 6 squares
1116 total.

Section "A" sec "B" All band single op
VK3DLM L Mostert 340 points 26 squares
8840 total

VK3XEX M Batt 142 points 17 squares
2414 total

VK4IY R Mutzelburg 16 points 3 squares
48 total

Section "A" cat "D" Home stn
VK7JG J Gelston 16 points 8 squares
128 total

Certificates to the top station in each category should have arrived by the time you read the results. Comments received with your

entries will be passed on to the Federal contest co-ordinator VK6NE with the hope that the contest can be improved upon and kept going. Lack of propagation seems to have been the main factor in the low participation this year, as was the case with the Ross Hull memorial contest, perhaps changing the dates of the VHF contests would help.

Your helpful comments on this and the Ross Hull contests will be passed on to the incoming contest organisers. As this will be my final column in "AR" may I wish you all GOOD CONTESTING. I will now get my station handbooks out and refresh myself on how to turn my rig "on". 73 ... Frank Beech VK7BC.

VK Novice Contest 1990 Rules

Contest Period

From 0800 UTC June 16th 1989 until 0800 UTC June 17th 1989.

Objects Of The Contest

To encourage operation of amateur radio stations in Australia, New Zealand and Papua New Guinea, with special emphasis on contacts with Novice and radio club stations.

Stations Eligible

Only stations in VK, ZL and P2 call areas may enter. No stations outside these call areas are permitted to be worked or entered in a log for the purpose of this contest. Except for club stations, no multi-operator working is allowed. Stations in the same call area may contact each other as well as stations in other call areas.

Contest Bands

All operations must be confined to within the Novice frequency sub-band allocations in the 10, 15 and 80 metre bands. No cross-band operation is permitted. Novice allocations VK HF; 3.525-3.625 MHz, 21.125-21.200 MHz, and 28.100-28.600 MHz.

Modes Of Operation

Only phone or CW may be used. In the CW mode, operation must not exceed 15 words per minute.

Contest Sections

Section (a) Phone — Novice/Full call.

Section (b) CW — Novice/Full call.

Section (c) SWL.

Scoring

For contacts with a novice station — Five points.

For contact with a club station — Ten points.

For contacts with a Full call station — Two points.

Listener section;

For Novice to Novice contacts — Five points.

For Novice to Full call stations — Two points.

For Full call to Full Call stations — Two points.

For any contact with a radio club — Ten points.

For phone stations, call CQ NOVICE CONTEST.

For CW stations, call CQ N.

Contacts

Any station may be contacted TWICE per band, provided a period of at least 12 hours has passed after the first contact.

Number Exchange

Section (a), On phone. Stations must exchange a serial number comprising an RS report followed by three figures. The figures must commence at 001 for the first contact and increase by "one" for each further contact.

Section (b), For CW stations. As for phone, but the report is an RST followed by the serial number.

Log Entries

Each log should be laid out so as to provide columns in the order given as follows;

Date/time UTC. Band. Mode. Station contacted. Report and serial number sent.

Report and serial number received. Claimed score. Each log sheet must be endorsed at the top "VK Novice Contest 1989".

Total claimed score for each page must be shown at the bottom of the page.

Front Sheet

A front sheet must be attached to the contest log and must carry the following information:

Name and address of operator. Call sign. Station location. Section entered. Score. Declaration; The front sheet must also carry a

declaration which states. I hereby certify that I have operated within the terms of my licence, and the rules and spirit of the contest ... This declaration must be followed by the signature of the operator ... with date.

In the case of a club station, the entry must be signed by a responsible officer of the club committee, or a licensed operator delegated by the committee to do so. In the case of multi-operator stations, the call signs of participating operators must also be shown on the front sheet.

Regulations

All stations participating in the contest must be operated within the terms of the station licence and applicable regulations.

Entries To

Logs are to be forwarded to: The Federal Contests Manager. Entries must be posted so as to reach the Contest Manager no later than July 20th 1989. The address for entries is: Federal Contests Manager, Neil Penfold VK6NE. Envelopes are to be endorsed "Novice contest".

Certificates

Certificates will be awarded to the top scoring stations in each section at the discretion of the Federal Contest Manager.

Certificates will also be awarded to the top scoring Novice station in each call area.

And to any other entrant where meritorious operation has been carried out in the

opinion of the Contest Manager.

Trophies

The Keith Howard VK2AKX Trophy for the Novice entrant with the highest aggregate (phone and CW) score, and the Clive Burns Memorial Trophy for the Novice entrant with the highest CW score (see WIA news this issue) are perpetual trophies on permanent display at the Executive office. In each case the annual winner will receive a suitably inscribed wall plaque as permanent recognition.

Certificates may be awarded at the discretion of the Federal Contest Manager. Provision is made for adjudication in the case of a tie.

Operator

A person may only submit one contest log per mode.

Logs for entries where an operator uses more than one call sign whilst operating in this contest will not be accepted.

Disqualification

The contest disqualification criteria as published annually in "Amateur Radio" will apply. Any station observed during the contest as constantly departing from the generally accepted code of operating ethics, may also be disqualified.

Note: see August issue of "Amateur Radio" for the disqualification criteria.

Note also "Contacts" now twice per band.

Australasian Sprints CW And Phone July 1990

The Adelaide Hills Amateur Radio Society Inc is pleased to announce that the fifth series of the annual Australasian Sprints will be held during July 1990.

Both of these contests, which are for CW and Phone operators respectively and are of one hour duration on 80 metres, are open to all appropriately licensed amateurs in VK, ZL and P2 call areas. As in past contests, a section is provided for SWLs.

The Australasian Sprints are endorsed and co-sponsored by the South Australian/Northern Territory Division of the Wireless Institute of Australia and the Adelaide Hills Amateur Radio Society, and Certificates and Trophies will be awarded to call area winners and overall winners.

The reasoning behind the concept of the Australasian Sprints is simple. Most contests are long with fairly complex rules, and participation, except by serious contesters, is tending to diminish. The Australasian Sprints, being of only one hour duration, are quick and simple, providing a busy hour of frantic (hopefully) or frustrating (possibly) operation. They are challenging but fun.

Object Of The Sprints

The Operator's basic goal in the Sprints is to make (and SWLs to hear and log) as many contacts as possible, without duplication, during an hour of operation on a single band. Any contact with a VK, ZL or P2 station on 80 metres during the contest period can be

counted, but a station may be claimed only once.

Eligibility

The Australasian Sprints are open to all licensed amateurs, or groups of amateurs using a single call sign, eg club stations, anywhere in the VK, ZL and P2 call areas.

Contest period

1200 to 1300 UTC, July 7, 1990 (CW only)

1200 to 1300 UTC, July 14, 1990 (phone only, any legal mode)

Frequencies

For the CW Sprint, frequencies between 3.500 and 3.700 MHz may be used.

For the Phone Sprint, frequencies between 3.535 and 3.700 MHz may be used.

Contest Call

CQ Sprint or CQ Test or CQ Contest

Exchanges

Minimum exchange for a valid contact will consist of a signal report and a three digit serial number. The serial number may start at any number between 001 and 999 but will revert to 001 if 999 has been reached.

Logs

Contest logs must show for each contact the time (UTC), call sign of station worked (both call signs for SWLs), report/serial number given and report/serial number received. Each log must be accompanied by a cover sheet showing the name and date of the Sprint (CW or Phone), the total number of contacts claimed and a statement that the Operator(s) has abided by the rules and spirit of the contest. This cover sheet is to be signed by the operator(s) and personal call signs added where multi-operators enter using a club call sign. Any special conditions such as QRP or mobile

operation should be mentioned in the statement. Any comments you wish to make will be welcomed by the Sponsors.

Logs are to be in the hands of the AHARS PO Box 401 Blackwood SA 5051. Attention Contest Manager, no later than Friday August 17th and the envelope is to be endorsed CW, Phone, or SWL Sprint.

Awards

Certificates will be awarded to the highest score in each VK, ZL and P2 call area for both the CW and Phone Sprints. Trophies will be awarded to the outright winners of both. Certificates may be awarded to other operators whose performance was, in the opinion of the Sponsors, exemplary.

SWLs

Certificates will be awarded to the highest scoring listener log in the VK, ZL and P2 call areas for both the CW and Phone Sprints.

Any entry which is clearly in violation of the rules or spirit of this Contest or which contains an excessive number of claimed duplicate contacts (this does not refer to duplicates which have been indicated as such and are not claimed), may be disqualified. The decision of the interpretation of these rules, the granting of awards and disqualification will be final.

These Contests are recommended as a good Saturday evening entertainment. If you have never entered a Contest before, here is a good, friendly time to start. Join in and enjoy the fun. Those operators who have competed previously can hardly wait for July.

DAVID BOX
VK5OV CONTEST MANAGER

HOW'S DX

STEPHEN PALL VK2PS
PO Box 93 DURAL 2158

Bhutan-A5

As I write these lines in the first days of April, listening to my transceiver, there is quite a pile-up around 14200 kHz. The northern American continent is determined to work Jim, VK9NS who is on a DXpedition in Bhutan.

Jim has been working on this project, on and off, for the past 3 years. His aim is not only a simple DXpedition. Through this amateur radio activity, personal contact and co-operation, he wants to establish a situation which might convince the Bhutan Authorities that continuous amateur radio activity is good for that country.

I had to turn to various encyclopedias to find out more about this mysterious country.

Bhutan lies in the Eastern Himalaya between India and Tibet. It is a small mountainous country, of about 47,000 km² area, with approx 1.5 million population. The greatest distance from South to North is 177 km and from the West to the East 322 km. In the north and north-west, several mountain peaks are over 7000 m. The capital of this hereditary kingdom is Thimphu with a population of about 12,000. The official language of the country is Druk-ke, a Tibetan dialect. The country has a population density of 28 persons per km². Beside agriculture and animal husbandry, there are some small industrial undertakings and some coal mining. The climate of the country is extreme: it is very hot in the lowlying foothill regions, but extremely cold in the Great Himalayas. I heard Jim saying in one of his skeds, that snow was falling and the room temperature, even after heating, was hovering around 12°C. Bhutan had little contact with the outside world until the late 1950s. The Kingdom is governed by a hereditary King since 1907. The present King, Jigme Syngie Wang Chuck, came to the throne in 1972 after the death of his father.

It was in early March when Jim received a telex advising him that permission was granted to enter the country, and that he could operate amateur radio whilst in Bhutan. Among many conditions of the entry was one which is quite common in undeveloped countries and in some eastern block European countries, the exchange of hard currency into the local one. In Jim's case this was set around US\$200 per day. Jim's trip has been sponsored by the Heard/Island DX Association (HIDXA). Jim arrived at Bhutan on the 21st of March, and intends to stay until the 10th April. I leave the mathematical calculation of the total expenses to you and the idea of donations to HIDXA, to your good DX sense. QSL address is:

P O Box 90 Norfolk Island 2899 South

Pacific.

Jim does not operate nets and has no fixed time of operation.

Everybody is welcome to contact him. He was heard around 1100 UTC transmitting on 14142 and listening around 14200. He was also heard on 28 MHz, on 21295 and on CW at the lower end of that band, and he has operated RTTY. Jim used a vertical antenna and the callsign of A51JS. QSL to: VK9NS, and his address is correct in the Australian Callbook.

Bangladesh - S2

Jim planned that on his way back he will stop in Bangladesh. He has a visa to enter. However, at the time of writing this, he has no permission to operate. It is interesting to note that there was no amateur radio activity from Bangladesh since 1981. However there was a surprise 24 hours "pilot" operation from this country on the 15/16th of March by various Japanese operators, with JA1UT as leader. The short operation was preliminary research into the possibility of resuming amateur activity in Bangladesh. About 1000 QSOs were made with 21 countries. According to other unconfirmed reports, three Japanese operators went to Bangladesh on the 2nd of April for a short operation. It looks like things are changing for the better in these countries as far as amateur radio is concerned. Other sources are quoting Vince, K5VT, that he will be active from S2 as from the 6th of April for 10 days.

Spratly Islands - 1S

No sign or rather "no signal" yet on the bands from this proposed activity. Rumours are flying around as usual. The expedition allegedly needs \$40,000 and there is no helicopter or doctor yet. Other sources say that the JAs decided in the last minute not to take part. Yet another source quotes the "Voice of Free China" (Taiwan), which allegedly said that the island will go under Taiwanese administration as from the 1st of August next. But delicate expeditions, like this, with political power-play backgrounds, are always surrounded by a secrecy "curtain". They suddenly appear and then disappear. It is quite possible that by the time you read this in May, the whole activity is already over, if it will happen at all.

Jarvis Island - KH1J?

A long detailed leaflet hit my desk in the last days of March about this proposed DXpedition. Seven experienced amateurs, Peter AH3C, Eric K2NA, Martti OH2BH, Wayne

N7NG, Jim WA6AUE, Masahiro JG2BRI, and Toni KN3T will take part. The expedition is scheduled to arrive at the Island, which is a Wildlife Refuge under US Administration, around the 13th of April for a ten day activity. The callsign to be used is planned to be AH3C/KH1J. Representatives of this group have prepared a submission to the DX Advisory Committee of the ARRL, for a separate country status. Stay tuned for further news of what really happened, in the next issue of "AR".

Abu Ail Islands - A15

This island group is situated in the southern part of the Red Sea, near the Republic of Yemen. One of the islands - Quoin - has a lighthouse on its highest peak, which until now was under the control of the Red Sea Lights of London. This organization is relinquishing the control of the lighthouse, and on the 1st of April 1990 the Republic of Yemen will take over the lights. Out of the blue (as usual) came the German DX Group: Baldur DJ6SI, in CW mode and signing A15AA, DJ6JC on RTTY signing as A15AC and Carl DK2WV signing as A15AW on SSB. The short operation was from the 23rd of March to the 31st of March. I was lucky to work Carl on the last day on 14199 on the longpath with S5. QSL to each operators home address.

Namibia - V51

After many years of turmoil and civil war, on the 21st of March 1990 Namibia became Africa's latest independent nation. The old ZS3 prefix has disappeared and a new one -V51 was born. To celebrate the occasion, a commemorative station was activated with the callsign V51NAM, which was very active on all bands for several days and with different operators. QSL to: P O Box 1100, Windhoek 9000, Republic of Namibia, Africa. Please indicate on your card the operator's name. A few days later, I worked Gerd V51GB ex ZS2GB. QSL to Box 1165, Tsumeb 9000, Republic of Namibia, Africa.

QSLing To The Soviet Union

Since the arrival of "glasnost" more and more Soviet amateurs are asking for direct QSL. In the last two issues of "AR" I have discussed how to QSL to foreign countries and how to avoid the loss of your card through the mail system on the "other side". Ed, NT2X, who has extensive correspondence with the Soviet amateurs, has given some interesting pointers in the "DX Magazine" April issue, under the title "Mail to the USSR". Here are some of his thoughts quoted verbatim: - "Put no callsigns on the outside of the envelope. Do not mail SAEs to the USSR. They are a waste since the envelopes are standard USSR size, and they attract attention, due to the thickness of the incoming mail, and due to their

foreign appearance in the outgoing mail. Conceal your IRCs or US\$1 between the QSL card and another piece of paper. Avoid flashy stamps. Under no circumstances send your QSL cards with IRCs or \$US1 via Box 88 Moscow. Everything else will be removed, and only the QSL card will be forwarded to the recipient. These are the thoughts of Ed, NT2X. We have reprinted them without any comment.

Novice VK Net

Rob, VK3VOS asked me to publicise the emergence of a "VK" Novice Net on 21 MHz. It operates for the time being on Fridays, Saturdays, Sundays and Mondays, on 21192 and it is aimed at novice stations in VK and ZL, but anyone may join in. This net is the "younger brother" of the ANZA net which operates on 21205 kHz.

The net starts at 0530 UTC. So all you novices (and many years ago I was one of you) who until now only "listened" to the "juicy DX" a little further up, please participate in the doings of this net. Rob VK3VOS is waiting for you.

Chatham Island - ZL7

Dusty ZL2VS, who during January 1990 operated as ZM7VS, has sent me a short note describing some events from his operation. Chatham Island is the main island of a group which lies about 800 km South East of the capital city of Wellington New Zealand. The Islands are fairly bleak, being exposed in all directions to the winds of the South Pacific. Gale force winds are quite common. The population is around 850, and the main industry is fishing with a little wool production, but the islanders are dependent on mainland New Zealand for all supplies. A supply boat calls once a month and the old Argosy aircraft call in twice a week, weather permitting.

The equipment used was a TS430S running "barefoot" to a 3 element Yagi up about 7 metres fixed on a heading over the North Pole. The station operated every day from the 15th of January to the 31st January with breaks from about 2000 to 0400 UTC due to poor propagation during that period. The total QSOs of 5923 could have been better, if openings on 10 and 15 metres had been better from the Chathams. A single dipole was used on 80/40 metres with an ATU. Dusty goes on to say that at one stage his station lost all the incoming and outgoing signals. Reason: 300 sheep broke loose and trampled down the fence at ZL7TZ's QTH, from where Dusty was operating, and broke the coax feedline. QSL to ZL2VS.

Expedition to South Sandwich and South Georgia Islands

Watch this space. This activity will take place late November to early December this year. In our next issue we will give you all the details.

South Yemen - 70 and North Yemen - 4W

According to unconfirmed reports, 9K2DR intends to activate in the company of three other 9K amateurs both South Yemen and North Yemen for a period of one week each, on the 20-15- and 10 m bands. No call sign has been allocated and they expect to receive their permits early in April. The operation is planned at the end of April or early May.

Interesting QSOs and QSL Information

To save space I have omitted the repetition of kHz after the frequency and UTC after the time.

- 9M8MKS Chan - 14230-SSB at 1535. This is a club station in Kuching, Sarawak. The operator should give you the QSL route. One operator on the 2nd of April was Bong, and QSL via 9M2FH via the Bureau. Serge - 14007 - CW at 1047. QSL via UA9MA via the Bureau.
- 4K2OIL Serge - 14007 - CW at 1047. QSL via UA9MA via the Bureau.
- S01EA - 21295 - SSB at 0555. QSL to Jose, EA2JG : Arseli Echeguren Bardeci Las Vegas 69, 01479 Luyando, Alava, Spain.
- 7X3DA - Hamid - 14041 - CW QSL to: Box 1033, LM, 9300 Laghouat, Algeria.
- CU2DG - Orlando - 21243 - SSB at 1045. QSL to: Orlando Resendes Silva, Rua Coronel Chaves 70, R9500, Ponta Delgada, Sao Miguel, Azores Isl. Portugal.
- 9Q5DX - 14 MHz - CW - QSL to: KQ3SF: Henry J Kessler 8 Preakness Way, West Barnstable, MA 02668 USA
- 9N90ILY 21MHz - CW - QSL to: JN1XWO via Bureau.
- 4K2OT - Franz Josef Land - 21287 SSB at 0959. QSL to: UB5KW via the Bureau
- 9J2AL A1 - 14222 - SSB at 0636. QSL to: P O Box 32481 Lusaka, Zambia or via Bureau to WD0HHM
- RB3MR/JT 21MHz - SSB at 1034. QSL to Box 639 Ulan Bator, Mongolia.
- 9K2HA Faisal - 14190 - SSB at 2205. QSL to: PO Box 58158, Rabiiah, 85351 Kuwait.
- 4K2BPU Franz Josef Land - Vlad - 14020 CW at 1036. QSL via UA9MA via the Bureau.
- 5B4ZL John - 21205 - SSB - QSL via: ZC4EPI via the Bureau.
- CP1JX Wolf - 14250 - SSB at 0953. QSL via the Bureau.
- J88BS Len - 21205 - SSB at 0611. QSL via WA4WIP : Richard G Tesar, 3093 Linwood St Sarasota, - FL34232 USA
- FM5WD Lucien 21205 at 0535 SSB. QSL via: W3HNK: Josef L Arcure Jr, P O Box 73, Edgemont PA 19028

- USA
- ZP5ZR Gabriel - 14222 SSB at 0622. QSL via the Bureau.
- V47KTG Toby - 14222 - SSB at 0648. QSL to A16M : Barry D Friedmann 6933 Mammoth Ave Van Nuys, - CA 91405 USA
- CN8GI - Ahmed, - 14250 SSB at 0610. QSL to: DK2WV: Carl Heinz Ilg, Max Loewe Str 15 D-8014, Neubiberg, West Germany.
- PZ1EL Ramon - 21205 - SSB at 0611. QSL to: Box 9931, Paramaribo Surinam.
- 5W1AT Marty - 14222 - SSB at 0524. QSL to P O Box 2015, Apia Western Samoa, Pacific.
- HK0TCN Vic - 14226 - SSB at 1327. QSL To: P O Box 464 St Andres Island, Caribbean.
- 4F3BAA Jun - 28021 - CW. QSL to Box SM217 Manila Philippines.
- ZC4RF 14243 - SSB at 0600. QSL to G0IAS: A R Hickmann, Conifers, High St, Elkesley, Retford, Nottingham, Notts, DN 22 8AJ.

RTTY News

- Here is some choice DX as supplied by Syd VK2SG.
- A51JS - 14087 at 1339. QSL via VK9NS.
- FM5WD 14086 at 2309.
- FR5ZD - 14075 at 1333 ARQ.
- KH8/SM7PKK - 14081 at 0605, QSL to: SM7PKK.
- 9X5/G0LIZ - 14085 at 16272. QSL via: Box 81, Kagale, Rwanda, Africa.
- AP2NK - 14068 at 1159. QSL to: Nasir Hkhan, Box 1944, Islamabad 4400, Pakistan.
- 3X1SG - 14084 - at 2113. QSL to ON7GV.
- V31HQ - 14094 - at 2055. QSL to DL1ZBP.
- GJ4YMX - 14090 at 0001. QSL to: Box 437 St Helier, Jersey, CI.

From Here And There And Everywhere

Manfred Gronak Y21RO, will be in the cold literally for one year, starting in April. He will operate Y90ANT from the East German Antarctic Research Base "Georg Forster". Location: 70° 46' S, and 11° 51' E. Look out for him on CW: 3503-7003-14010-21010- and 28010. On SSB: 7045-1419-14290-21190-21290- and 28490. QSL to home address: Koellnische Str 22, Berlin 1190 GDR or via the Y2 QSL Bureau.VK2RZ reported that Rod 5Z4BH was active as J28TY at the end of February. His XYL is an Australian and they visit Sydney regularly each year Many DX-ers were shocked to hear that "Droshn" HK3HFQ became a silent key on the 3rd February after a short illness. He was well known on the 14MHz SSB band, both in the afternoons and late nights EST. He obtained his licence some years ago at the age of 70, and enjoyed every

minute of his hobby. His son John operates under the call HK6HFY ... VK5WO advises that PS7KM from Natal Brazil, told him that the Natal DX Group will be going to Trinidad Island off the Brazilian coast in the Atlantic Ocean. Location: 20° S and 30°W. It will be an 8 weeks operation between visits of the Brazilian Navy supply ship. They will be active on all bands incl 6 metres, on SSB and CW. This will be a good opportunity for the VKs to work this rare DX country. Further news as it comes to hand: callsigns, QSL info etc. The prefix 4U has been allocated to the United Nations. At this stage there are four calls in use: 4U1UN and 4U1WB in the USA, 4U1ITU in Switzerland, and 4U1VIC in Austria. All these are amateur club stations connected with various United Nations Agencies. Maybe it is not well known that any licensed amateur (you must have your original licence with your or a certified copy of the licence) whose country has subscribed to the charter of the UN, can operate from any of these Club stations with the permission of the respective officials. These Clubs usually do not QSL, but the operators do. Therefore, it is essential that you find out the individual operators call sign and the QSL route, otherwise it will be difficult to obtain a card. There was some activity from 4U1UN in February 1990. One of the operators was NA2K. If you worked 4U0UN, then please check your log again. You either made a mistake, or you worked a pirate.

VK2DID worked XE/AA7AF early in March. The operator was Ken, in Acapulco. Ken and some friends of his are in Acapulco fitting out a yacht, and they will sail it to the South Seas, South Pacific, then on to ZL and finally to Sydney. Departure time from Acapulco tentatively is in April. Enroute they will operate as AA7AF/MM on 21 MHz CW and 28 MHz CW. On nearing land, they will endeavour to use 6 m and 2 m. They would appreciate calls from anyone hearing their signals..... Walvis Bay: On the 19th of February the operator of ZS9/DK7PE was Rudi. QSL to his home address: Rudolf Klos, Kleine Unter-gasse 25, D-6501, Nieder Ulm, West Germany.S0 Western Sahara was very active in the second part of March. The Spanish Lynx DX Group has activated S01EA, -S04EA, - and S01LYNX. QSL to EA2JG. (address above). Expect to hear many more Taiwanese amateurs on the air. Shane BV2FA says, as

reported by VK2LEE, that the Taiwanese authorities have issued 40 new calls recently. ZL7NAB Warren, works at the Radio Station on Chatham Island and he can be worked on 21MHz. He wants his QSL to be sent c/- Radio Station Chatham Island, New Zealand. During the CQ WW WPX (the "CQ" magazine sponsored World Wide World Prefix Contest) on the 24/25th of March, a number of exotic prefixes were flying around. CZ, XM, CI, CF were Canadians, TM France, PI for Holland, OG2AI was Eric OH2BBF, OH0AM was OH7JT, QSL to OH2QV. PJ9V was OH3VV, ZX5C was PY5CC, PT5T was N5FA and ZW5B was PY5EG. The proposed Southern Sudan - ST0 activity has been re-scheduled to mid or late April. John PA3CXC was in Southern Sudan for a few days in February, but the activity was very limited and restricted to the local evening hours on a local battery operated equipment running about 40 watts. The callsign to be used will be probably : PA3CXC/ST, instead of the planned 6U0DX. The estimated cost of the operation is around US \$5000 - but as at the 9th of March a large proportion of that amount has not yet been donated. ZL0AKH and FO0XXL was Iris, W6QL from New Zealand and Tahiti. Iris and Lloyd W6KG ended their DXpedition and left for the States on the 29th March 1990. 3D2PO is Ian in Suva. He used to sign under the call: KX6PO. FW/YJ8M was Marek on Wallis Island. QSL to : Box 217 P O Port Vila Vanuatu. Pitcairn Island was first sighted on 2nd of July 1776 by a man named Pitcairn, and the island was named after him. Thanks to Irma, VR6ID. 3W5JA was JA7JPZ: M Sato 23 Tenzindo, Mikawa, Higa Shitagawa Yamagata, Japan. If you are interested in Middle East QSOs do not forget to check into the "Arabian Nights Net" on Fridays at 0500 UTC on 14250 kHz. JY5HH Mohamed is the net controller. On the 2nd of March the following stations were working DX: YK1AO, OD5AS, A61AC, 9K2YA, OD5HA, 9K2GM, A41JV and HZ1FM. Sometimes those who are beginners on DX-ing, or old-timers whose interest is again re-kindled in DX-ing, are asking the question : which are the usual DX bands, or rather band-segments? Here are some guidelines: In CW operation usually the very low end of the band e.g.: 28002 to 28025, 21002 to 21030, 14001 to 14035, 7002 to 7020 and 3501 to 3510. In SSB:28400 to 28550 but more around 28480, 21180 to 21210, 21275 to 21310,

14150 to 14210 but mainly around 14180 to 14205., 14250 to 14300, 7060 to 7095 and 3794 to 3800. There are also nets lasting from 1 to 2 hours at various frequencies on the band, which appear regularly at a certain time on certain days. Please avoid them, unless you want to participate. So, if you wish to have a long leisurely "rag chew" with your friend across the town or across the ocean, please try to avoid these band segments. The best spot for ragchewing is the lower end and the upper end of the SSB band segment. Yes I know, there are no reserved frequencies, and we all have the right to be at any part of the band, provided we act within the terms of our licence, which also implies that we will not QRM the station which is already on that frequency. Please be considerate to your fellow amateur, and please listen for a minute or so before you ask the courtesy question : "Is this frequency occupied?"

Interesting QSL's received:

Direct QSLs AP2IN 23 days, .TI100D 2 months, BZ1FB 3 weeks from Mgr, V290A 3 weeks from Mgr. TT8GA 4 weeks from Mgr. VP2V/KG6WI 8 weeks from Mgrs. OD5KB 3 months from op. VP2VE 4 weeks from Mgr. VK2GDD 7 weeks from Mgr. FO0IGS 6 weeks from Mgr. XT2KG 10 weeks from Mgr. Via the Bureau: JT1KAA 4 months.

Thanks To You

To all of you who sent further letters, notes of encouragement - many thanks. If you want a written reply, please always enclose a self-addressed stamped envelope when you are enquiring about QSL addresses, or sending in QSL/QSO reports. I would like to stress again, when sending reports, it is very important that you indicate mode (CW,SSB) full frequency in kHz. (eg : 21215) and time in UTC. A description of say : 20-15 m is not usable. Why? All amateurs are creatures of habit and they usually operate in the same time slot each day, and on their "favourite" frequencies. This is why full information is necessary, so that you can find the DX easier on the bands.

And again, many thanks for the assistance received from : HK6HFY, VK4OD, VK2LEE, VK2CWS, VK2QL, VK2DID, VK2RZ, VK3XB, VK3KS, VK5WO, VK2SG, VK3DD, VK2APD, VK4UA, ZL2VS, VK3VOS, OH2BN, and the bulletins "QRZ DX" and "The DX bulletin".

GOOD DX AND 73.

RADIO AUSTRALIA RELAY PLAN

A relay station might be set up in Thailand for Radio Australia so it can better serve north Asia. The Australian Broadcasting Corporation's overseas service does not have a station offshore unlike those of other national broadcasters including the BBC

and VOA.

Radio Australia General Manager, and former career diplomat with postings in the Asian region, Richard Broinowski met recently with Thai Government officials to discuss the possibility of setting up a relay station. Mr Broinowski said

after the meeting the low quality of Radio Australia's signal in Asia was a national disgrace. A seven month review of Radio Australia's operations last year found that the service's transmitters had inadequate capacity, reliability and range. It was hoped to place up to two 500 kilowatt transmitters in Thailand at a cost of \$20 million to relay Radio Australia.

VHF/UHF AN EXPANDING WORLD

ERIC JAMIESON VK5LP
9 WEST TERRACE MENINGIE 5264

The Beacon List

As is usual for May, only alterations to the beacon list are published. First, correct the call sign of JA6ZIH on 50.017 to JA6YBR. The beacon apparently has three different message styles and varies power between 50 watts and 0.1 watts.

I have been thrown into utter confusion after reading the list of beacons in February 1990 AR! It would seem to me that the call signs and frequencies listed are for those allocated to the various States, but there is no indication which beacons are operational. For beacons which are operational, it may be better to use my listings in AR and even these may be subject to some inaccuracies.

Six Metres

From the VK5 viewpoint, the March DX openings have been disappointing, and nothing like that hoped for following the experiences of March 1989.

However, there certainly have been many good catches in the Eastern States. John VK4ZJB, amongst others, has been doing rather well. John reports as follows: 12/3: 0255 V73AQ, 0315 3D2PO, 0345 V63AO; 15/3: 0405 T20AA; 17/3: 1143 HL5BBK 5x9; 18/3: 0A8ABT called VK4KU on CW; 19/3: 0020 HK1JXV (LK20 square) (Columbia) 5x9, 0A8ABT (Peru), TI (Costa Rica) also 5x9. At 1000 VK4ZJB had a 5x9 contact with V73AQ and at 1058 JD1BFI on Ogasakawi; 22/3: 2055 V31PC, 2153 FO5DR, 2247 N6AMG/KH8; 23/3: at 0705 VK4ZJB observed KH6JEB/KH8 and VK9LE in contact with one another; 24/3: 0120 HL1ST, 0130 ZK1WL, 0615 KH6JEB/KH7 (Kure Is), 0650 NI6E/KH6, 0705 WA6EMV/KH6, 2120 6Y5FS, 2127 HH7PV, 2130 6Y5IC, 2150 N6AMG/KH8, 2200 ZK1WL. (Seven countries in one day — good effort.) 25/3: 2321 N6AMG/KH8; 26/3: 0140 N6XQ, 0215 V73AQ. Later W6JKV/FW and V31PC — this brings John's country tally to 62 worked and 56 confirmed. Good work John — that's the highest score I have heard so far.

John VK4ZJB further advises the receipt of his SSB verification from VE3KKL for the 5x5 contact both ways at 0016 on 27/2/90. That's rather a notable contact. John also received a listener's report of 5x2 from DC6KI from the Federal Republic of Germany, who heard John working PAORDY on 12/10/89.

Eddie VK4KAA from Longreach in square QG26 advises a return to six metre activity after a break of more than four years, and has worked KH8, KH7, T20, V73, FO8, FK8, KH6 and many JAs. In addition he has been able to work Townsville on backscatter. He also re-

ports their VK4ABP beacon, running 15 watts to a groundplane antenna, is heard well throughout the Pacific area.

Graham VK6RO sends a brief report on the opening to Europe on 28/2 when between 0914 and 1055 he worked PA, G18 and G. He was also called by GW and GJ but no contacts completed. Don VK6HK worked a GM in Scotland during the opening. Has anyone else worked a GM?

From the South Australian viewpoint Hugh VK5BC in the Riverland reports on 22/3 working KG6DX and hearing the H44HIR beacon. On 24/3 at 2143 he worked N6AMG/KH8 at 5x9, 2210 T20AA and 0247 KG6DX 5x9. The best day was 25/3 when he worked N6AMG/KH8, ZK1WL, ZF1RC, VK9LE and VK9ZLX at 0024, HL1ST, HLIIF, W6JKV/FW (Wallis Island) and then JAs. On 2/4 Hugh nearly made it to 5W1JP. At 0005 he worked JR6KJL who mentioned he had been hearing 9H1 (Malta) about half an hour earlier.

Roger VK5NY on 25/3 at 2343 worked ZF1RC at the odd angle of 30 degrees which seemed to indicate some scatter effect was involved, he then worked ZK1WL and HL1ST. On 26/3 it was V73AQ.

At Meningie, I noted JAs on 3/3/ 5/3, 6/3 and 9/3 this being the best day. They were working VK2,3,4 and 5 with signals to S9 plus. Some were heard calling LU during the morning. At 0200 video was strong on 49.750. On 20/3 from 0000 there were strong FM signals, paging signals, a news service in English from China on 44.5 (probably a short-wave station harmonic) and many others, in fact there were 23 signals between 38.5 and 45.6 MHz, but they were gone soon after 0100, at which time the JAs came in again. On 24/3 there were 14 stations between 38.5 and 46 MHz with the Chinese harmonic very strong. Often there is a strong tone signal on 43.9 MHz when nothing else is apparent.

The UTC morning of 2/4 was better than usual. John VK4ZJB phoned to say W6JKV/FW and 5W1JP were making it to Melbourne and the signals may reach South Australia, which they did with Hugh VK5BC working W6JKV/FW, T20AA, 5W1JP and at 2318 V31PC. All four stations were audible at Meningie but too weak to work — it wasn't my morning! Col VK5RO earlier at 2200 worked K6MYC at 339, also 5W1JP.

Neville VK2QF also reports poorer than expected conditions with his main contacts being to KH6JEB/KH7 and V31PC on 23/3 and a P32 on Christmas Island on 31/3. David VK2BA was a little more fortunate and on 25/3 chatted up 6Y5, HI8, HH7PV, V31PC and ZF1RC.

My friend of long standing, Robert VK2BBR, writes that he has worked the UK on six metres and two contacts so far have been confirmed, namely G3OIL and G3JVL. On 24/3 Robert worked at 0119 HL1ST, 0125 ZK1WL, 0643 NI6E/KH6. On 25/3 he worked at 2128 6Y5FS, 2133 ZF1RC, 2135 HH7PV, 2138 N6AMG/KH8, 2241 6Y5IC, 2250 ZK1WL, 0711 KH6SB, 0720 KH6RS and 0741 KH6JEB/KH7 — that's six countries making a good effort. I wonder if Robert worked all these stations with the antenna in the same general direction? If so, the 6Y5 stations would surely be by the long path. Robert hopes to erect his second six metre yagi very shortly and looking for improved results.

As has often been discussed in South Australia, those amateurs living in latitudes nearer the equator than we do, have more consistent paths of activity over long distances than we can ever hope to share in. We certainly do get some good contacts, but the time between is often considerable. Perhaps I should move to Byron Bay!

DX-Peditions

Reports filtering back from the Pacific appear to indicate Steve VK9LE (VK3OT) and Peter VK9ZLX (VK8ZLX) have not exactly been flooded with contacts. No doubt we shall hear more as time progresses but if that is so it is most unfortunate as one would have had reason to expect a rather good autumn period for our hemisphere. It will be ironic if Joel N6AMG has better conditions after joining the party early in April for a week or so.

A report from Japan indicates that a YL six metre operator will tour the Pacific areas between March and December, with about 13 island nations on her stopping list. This expedition may provide some of those elusive areas I need, such as 5W1 and ZK3. More information later, but keep listening.

From QST and World Above 50 MHz, N4HSM reports having 774 contacts in 35 countries from his November 1989 DXpedition to St Kitts. While most contacts were to the USA, there were 44 to VE, 11 Caribbeans, 3 South Americans, 3 Africans and 241 Europeans.

From the same source, a group of Japanese operators worked 1155 stations from XV2A in Vietnam between 23/12 and 28/12/89. They left the Icom IC-726 and two element Yagi there, in the hope it may be operated by some Vietnamese.

Europe

Again from QST, Bill Tynan reports that G4UPS in his notes says more European countries are obtaining six metre privileges. Belgium is now allowed 30 watts between 50.0 and 50.45 MHz with ON4PS being the first Belgian station to receive a six metre permit. Three Swiss stations, HB9XAJ, HB9CRQ and HB9QQ are authorised to oper-

ate. In the case of Denmark and the Faroe Islands, all licence classes of OZ and OY have been granted 50 to 52 MHz with powers of 100-500 watts with no antenna restrictions but operating on a non-interference basis. I previously reported on the Austrian stations.

The French situation is clarified in the same columns via the Northeast VHF News that 252 French stations are holding permits commencing from 50.200 MHz. They all have distinctive prefixes such as FC, FD or FE. In addition there appear to be 100 experimental stations limited to specific segments of 50.086 to 50.089, 50.111 to 50.114 and 50.135 to 50.139 MHz.

The Solar Peak

Bill Tynan in his QST notes also says that the January/February SWOT Bulletin includes KH6BZF's propagation report which quotes Dr Andre Koeckelenbergh, Director of the SIDC Royal Observatory in Belgium as stating that the peak of Sunspot Cycle 22 may have occurred in September 1989. There is, however, other speculation that the peak may have been in November. Due to the method used to determine average solar activity, the time of the peak will not be known until six months after it has occurred.

However, despite what seems for some people a fall-off in contacts so far this equinox, April may be better. Also, following past experiences, we most likely can expect a variety of good contacts for at least another three years.

Higher Than 50 MHz

With most activity presently situated on six metres one could be forgiven for thinking all other bands have closed down. This is not the case. Thanks to considerable help from

David VK5KK, Keith VK5AKM and on another occasion Mark VK5AVQ, the antenna system at VK5LP has once again been improved. The missing half element was refitted to the six metre beam, a new K1FO type 22 element yagi has replaced the original 16 element KLM on 70 cm and a new 27 element loop yagi (made by Des VK5ZO) installed for 23 cm. This antenna is assisted by a masthead pre-amplifier and a length of one inch heliax cable.

Throughout the week commencing 25/3 extensive testing over the 160 km path to Wasleys (the home of Keith VK5AKM) showed all was working well. An attempt with Trevor VK5NC at Mount Gambier failed to produce a 1296 MHz contact due to poor conditions associated with the hot weather. However, on 1/4 Wally VK6WG from Albany sent out a CQ call on 70 cm around 0130 and was answered by David VK5KK who was at the Wasleys residence. David followed this with a 1296 MHz contact to Wally. A phone call brought me on the band and I worked Wally on 70 cm but my 1 watt on 1296 MHz was insufficient to make it both ways but Wally was 5x1 at Meningie. It seems I will need to unpack my 100 watt 1296 MHz linear for better results! Col VK5RO also worked VK6WG and VK6YAU on 70 cm.

Contests

The Federal Contest Manager's report on VHF/UHF contests as published on pages 27 and 28 of April AR makes depressing reading. It seems the amateur fraternity is unable to adequately support such contests, despite many attempts by a number of people to promote them. Thus it seems there is little hope of saving the Ross Hull Memorial Contest or the later inaugurated VHF/UHF Field

Day Contest.

Without going into a great discourse on the pros and cons of such contests, suffice to say that it would appear one of the main reasons for their demise is the vastness of our country, and therefore the difficulty of providing scoring tables which are equally satisfactory and fair for operators in the eastern States and those with smaller populations in the more remote regions such as VK6 and VK8 and possibly VK5. If the VHF and UHF bands had the same sustainable operating characteristics as are enjoyed on the HF bands rather than often relying almost solely on the vagaries of enhanced propagation for contacts over considerable distances, then such contests may have continued.

Mount Gambier Convention

In case you missed the item on page 49 of April AR, the South East Radio Group Inc will hold their annual convention at Mount Gambier over the Queen's Holiday weekend of 9 and 10 June. No doubt there will be the usual rivalry between the VK5 and VK3 amateurs, but all this leads to an enjoyable weekend. Why not attend?

Closure

As I await the signals to appear on six metres, I will close these notes with two thoughts for the month: "When science finishes getting man up to the moon and beyond, maybe it can have another try at getting pigeons down from public buildings" and "The barbarism of our time is the more appalling because so many people are not really appalled by it."

73 from The Voice by the Lake

POUNDING BRASS

GILBERT GRIFFITH VK3CQ
7 CHURCH ST BRIGHT 3741

My much publicised Howes kits transceiver finally made it to air in March, and what was Peter VK2PA using? The same set of kits he had just finished assembling himself! I could only give him RST259 but he gave me 559, but there was a lot of QRN about at the time, and the SEC has still not fixed the noisy poles near my home, (they were reported by the RI over 5 years ago!). A third contact a few days later was with Marlene VK3FML who, although not using it at the time, said she had the Howes transmitter kit sitting amongst the junk on the bench. Marlene also said that a couple of her friends had worked Peter and like the cut of his kits too. It certainly is a small world in CW, my only previous contact was back in November with Bill ZL4QY... so I have been out of touch for a while, the effect of which was my receiving speed was down to

about 15 wpm, so I was having more than a little trouble copying Pete, especially with no AGC on the rig. Sending has not suffered much with the layoff, thank goodness. I am not sure whether the new Kent paddle was the cause, but sending was easy and didn't require a lot of thought, as the paddle seemed to drive itself with exactly the words I wanted to send.

Stewart Electronics sent me the Kent paddle to try out, instead of the Bencher I ordered, and it is a joy to use. I will be keeping it for sure. It features a heavy steel base which is coated in black plastic, with a large brass block holding two sets of bearing races which support the paddles. Tension is achieved with two separate springs and their adjusting nuts so you can set it up however you like. Mine came in kit form and took about 20 minutes to

assemble, it should prove no problem for anyone to assemble, and you will then be confident in setting it up to suit your individual taste.

In regard to setting up the transceiver, this is something it pays to think about, how about sending me details of how you have set your kits out to make a transceiver? At this stage I have used an antenna relay operated by a switch for TX/RX. The separate VFO's RIT is disabled, and the transmitter power is enabled via the same switch. A separate switch disables the RIT for netting with the TX off. Another switch disables the (external) VFO entirely, while yet another switch controls whether the external VFO or the RX board's VFO drives the receiver. The next switch gives either narrow or not-so-narrow audio filtering. The power switch gives either OFF, Batt, or external power. The internal 1.2AH, 12V gel battery should give at least an evening of use before recharging, which is automatic whenever the external power is connected. All this fits, not very nicely, in a cabinet 100H by 300W by 150D, and there is

still room for a keyer board and a QSK board if desired.

You will remember that last month I suggested an idea to further our favourite mode, and I have received a letter from Bob, VK2YRX who is looking for a Curtis chip, board and circuit. If you have one, his number is (02)-813300, and Bob you can also get the chip (8044B or 8044ABM) from Curtis Electro Devices Inc Box 4090, Mountain View, CA 94040, using a Visa card to order.

Bob also says "I wonder if your readers might like the use of a 24 hour Morse practice station on 80 metres? There is one such station, VK2RCW, on about 3.698 MHz (and 144.950 MHz) which is operated by the Hornsby and District Radio Club. The contact person and station "sysop" is Barry, VK2AAB. I am not sure of the station's present output power, but it probably wouldn't exceed 20-30 watts and is more likely to be in the region of about 10 watts to the antenna. It sends at about 12wpm, and it simply outputs the con-

tents of a local packet radio bulletin board, but in somewhat edited form. It is also intended as a CW beacon. It is readable from almost anywhere in Australia on a mobile helical whip fitted to the front of my vehicle...."

Morsum Magnificat Important Information.

New Address: Morsum Magnificat
8A Corfe View Road
Corfe Mullen,
Wimborne,
Dorset BH21 3LZ
England.

Rates: Surface....US\$14, Airmail....US\$17.
Now payable by Access/Eurocard/Mastercard or Visa.

Cheques should be payable to "GC Arnold Partners."

I have been informed that there is not a lot of support for Morsum Magnificat from Australia, so how about it Morsiacs.

More on American Morse from Duane,

VK2VE.

"The 'American Morse' is actually the old railway morse, which surprisingly enough will still be used, not for telegraphic messages, but between the railway train dispatchers and the railway station operators at single man stations. The station operators were train message handlers, ticket sellers etc etc. The railway morse is sent using bugs and sounders, a quite distinct sound system, actually faster to recognise than international tone morse...All my techs had to know the railway morse so we could communicate when no phone circuits were available. Try as I might, I could not get used to the different morse characters, so I always sent international and received railway morse; my troops got used to me, after all I was the boss!! A lot of the troops, and the railway operators, generally passed messages at a rate of 45 to 50 wpm! True!! They had to drop to about 25 wpm for the boss!.."

'till next month....Gil

ELECTRO-MAGNETIC COMPATIBILITY REPORT

HANS RUCKERT VK2AOU EMC-REPORTER
25 BERRILLE RD BEVERLY HILLS 2209

A number of phone calls were recently received from amateurs who had EMC-problems with electronic appliances of their neighbours. I recommended in September 1986 "AR" page 53, that amateurs should keep the EMC-Reports in a folder, in order that they can be consulted when EMC collisions arise. We never know, when a neighbour (or we too) may purchase an appliance, which may be disturbed by our transmitter signal. With so many EMC-Reports published in "AR" in recent years (see "AR" February 1989: EMC-Report list, and later) there is a good chance that the OM with an EMC-Problem will find the answer/remedy to his or her neighbours' problem.

Step 1) Keep the "AR" EMC-Reports for reference.

Step 2) In any case get your own set-up in order first.

This step will teach you what is required to cure your TV-set, VCR and/or Hi-Fi gear. We can now demonstrate to our neighbour (and to the Radio Inspector) what is wrong with the design of his/her appliance, and what will have to be done to avoid the TV, VCR and Hi-Fi appliances being also receivers of unwanted signals from other legal transmitter services.

Proposed methods:

a) Earth the braid of the TV feeder coaxial cable close to the TV-set, and earth any metal case of the appliance (if available). It is unfortunate that the two 470 pF capacitors separate the feeder braid from the TV chassis, which reduces the immunity by about 20 dB.

b) Our house can be considered as a wire cage of mains wires, connected to the outside mains supply wires, which go along the street, and to the appliances inside the house. The outside mains wires pick up RF from our antennas, being often at a similar height, and often running parallel to the antenna dipoles. Now the unwanted RF is distributed via the mains wires (of the cage) to any appliance connected to the 240V mains, causing overloading of the amplifiers' frontend and so generating harmonics.

c) A low-pass filter at the transmitter antenna terminal may not be enough, if the power supply cable of the transmitter is not free of RF. A ferrite (low Q, high permeability) choke core (ex TV line oscillator ferrite core) and 10 or more cable turns of the power supply mains cable are usually effective.

d) An omnidirectional vertical antenna near a community roof-TV-antenna of a home-unit, using a flat response TV mast-head preamplifier (5...900 MHz) is of course asking for trouble. The radio amateur should use a highly directional beam antenna as high as, and as far away as possible from the TV antenna. Unselective preamplifiers should be illegal (as in Germany).

e) DL6DBC (Dortmund) was surprised when recently a PMG EMC-Test minibus stopped at his place. The Radio Inspector stated that the masthead preamplifier at the TV community antenna, which was approved years ago, no longer meets the present immunity requirements and has to be replaced by a more channel selective unit. The RI will come again when the new amplifier has been in-

stalled to test the effectiveness. One pays for the TV licence in Germany, and gets in return effective service - protecting the radio amateur - from the post office. See also "AR" June 1987 page 58-59.

f) There is a drawing error (not by me) "AR" December 1987 page 50 on the circuit of the "Effective High-Pass Filter". The 22 pF capacitor should be a 220 pF capacitor, as on the left half of the circuit. The most effective place to install the filter is by attaching the filter case to the lid of the TV-tuner. Unselective amplifiers can be improved by following them with this high-pass filter.

g) A number of useful ways to solve EMC problems will be found in "AR" September 1988 page 46-47.

h) The 2nd International Congress on EMC and a technical exhibition was held at Karlsruhe (Germany) from the 13th to 15th of March 1990. The DARC EMC-Reporter DJIZC was attending the conference. EMC has become an EEC and beyond problem.

i) Cable-TV operation on the exclusive radio amateur 2m band has become a major problem in over 200 West-German towns ("CQ-DL" 3/1990, page 172). The branch cables and coaxial connectors near the customers house are not as RF tight as claimed by the TV-cable companies, causing interference to the 144-148 MHz reception of radio amateurs. These installations are, in return, also often disturbed by legal 2m amateur radio transmissions picked up by insufficiently shielded cable installations. The Americans already had this problem many years ago - and still experience it now. So far (2.2.1990) 2449 interference reports have been received by the DARC administration. 1990 reports were received from 2m mobile stations.

j) the inadequate shielding of VCRs and the resulting lack of immunity to unwanted but legal transmissions, was dealt with in "AR"

June 1988. The wideband high gain amplifiers of VCRs are operating on the 3.5..4 and 7..7.3 MHz amateur bands, requiring effective shielding, which is often missing. The EMC report of September 1988 "AR" describes on page 47-48 the often only effective cure of the VCRs susceptibility. One has to place the VCR in a metal box which is open at the front

(front tape loader), with enough room for cooling air circulation, and a row of 6-10 mm diameter holes for ventilation should be provided near the bottom and the top. All in and out-going cables should be wound on ferrite core chokes (10 or more turns) near the shielding box. It may be necessary to attach a high-pass filter to the VCR antenna terminal.

k) It was reported that, in locations near radio - or TV transmitters, digital telephones had to be replaced by older models to avoid disturbances by the transmitter RF radiation. One would expect that telephone designers would check the apparatus prior to installation for RF immunity (EMC).

AMSAT AUSTRALIA

MAURIE HOOPER VK5EA
11 RICHLAND ROAD NEWTON SA 5074

Satellite Activity For December 1989/January 1990

1. Launches

The following launching announcements have been received:

Int'l No	Satellite	Date	Nation	Period min	Apog km	Prg km	Inc deg	
1989 —								
100A	COSMOS 2053	Dec 27	USSR	95.2	548	527	73.6	
101A	COSMOS 2054	Dec 27	USSR	24h29m	36436	1.5		
1990 —								
001A	SKYNET 4A	Jan 01	UK	1382.5	33782	33685	3.4	
001B	JCSAT 2	Jan 01	Japan	180.1	7191	821	0.3	
002A	STS 32	Jan 09	USA	90.8	342	316	24.4	
002B	LEASAT 5	Jan 09	USA	1427.1	36363	34858	1.4	
003A	COSMOS 2055	Jan 17	USSR	89.6	280	251	62.8	
004A	COSMOS 2056	Jan 18	USSR	100.8	819	779	74.0	
005A	SPOT 2	Jan 22	ESA	100.9	831	802	98.7	
005B	UOSAT-D	Jan 22	Amateur Satellites with initial parameters:-					
005C	UOSAT-E	Jan 22						
005D	MICROSAT 1	Jan 22						
005E	MICROSAT 2	Jan 22						
005F	MICROSAT 3	Jan 22		100.8	821	791	98.7	
005G	MICROSAT 4	Jan 22						
006A	MOLNIYA-3	Jan 23	USSR	11h41m	38892	642	63.0	
007A	MUSES-A	Jan 24	Japan	400.6h	538870	208	30.7	

2. Returns

During the December period twenty six objects decayed and in the January period sixty five objects decayed including the following satellites: -

1965-021A	OPS 7353	Dec 31
1988-101A	COSMOS 1979	Dec 25
1965-112A	COSMOS 103	Jan 02
1984-034B	LDEF	Jan 20
1989-095A	COSMOS 2052	Jan 24
1990-002A	STS 32	Jan 20

Notes

The amateur satellites of the 1990-005 series were launched with SPOT 2 as the primary payload from the Kourou Space Centre. French Guiana.

After launch the satellites were named:-

1990-005B	UOSAT 14
1990-005D	OSCAR 16
1990-005F	WEBERSAT 19
1990-005C	UOSAT 15
1990-005E	DOVE 17
1990-005G	LUSAT 19

1990-007A MUSES-A was launched from Kagoshima, Japan. The purpose of the mission is to verify the swingby technology of modulating the course and speed of the probe by utilizing the gravity of the moon, and to deploy a subsatellite (weight 13 kg) into moon orbit.

BOB ARNOLD VK3ZBB

National Co-ordinator
Graham Ratchiff VK5AGR

Information Nets
AMSAT Australia

Control: VK5AGR
Amateur check in: 0945 UTC Sunday
Bulletin commences: 1000 UTC
Primary frequency: 3.685 MHz
Secondary frequency: 7.064 MHz

AMSAT SW Pacific

2200 UTC Saturday, 14.282 MHz

Participating stations and listeners are able to obtain basic orbital data including Keplerian elements from the AMSAT Australia net. This information is also included on some WIA Divisional Broadcasts.

AMSAT Australia Newsletter And Computer Software

The excellent AMSAT Australia Newsletter is published monthly by Graham VK5AGR on behalf of AMSAT Australia and now has over 270 subscribers. Should you also wish to subscribe, send a cheque for \$20 payable to AMSAT Australia addressed as follows:

AMSAT Australia, GPO Box 2141, Adelaide 5001.

The Newsletter provides the latest news items on all satellite activities and is a "must" for all those seriously interested in amateur satellites. Graham also provides a Software Service in respect to general satellite programs made available to him from various sources. To make use of this service, send Graham a blank formatted disk and a nominal donation of \$10 per item to AMSAT Australia together with sufficient funds to cover return postage. To obtain details of the programs available and other AMSAT Australia services send a SASE to Graham.

Operating Hints Updated To Include Pacsat And Lusat

FO-20 (PACSAT-1 & LUSAT-1) Operating Hints — Freddy ON6UG via FO-20 BBS

- Use shortest TXDELAY as possible (ie 30ms = T3).
- Do not use MAXFRAME greater than 2.
- Don't forget to switch the TNC to

FULLDUPLEX.

- d) Disconnect BEFORE LOS to empty the user list.
- e) Make your contact as short as possible to give others a chance. (Do you really have to be connected from AOS until LOS??)
- f) Kill all your read messages!
- g) Watch 70 cm clicks and QRM from your transmitter.
- h) Change transmit frequency for doppler (\pm 2kHz).

Don't forget to switch back to HALF-DUPLEX for terrestrial usage!!

Which UPLINK frequency?

HB9AQZ suggests the following system for selecting an uplink frequency — take the last letter from your call sign and select:

FO-20 LUSAT-1 PACSAT-1

A...G-> 145.850 145.840 145.900 MHz
 H...M-> 145.870 145.860 145.920 MHz
 N...T-> 145.890 145.880 145.940 MHz
 U...Z-> 145.910 145.900 145.960 MHz

Of course if you hear someone else in your local area using a particular frequency then I suggest you try another ie VK5ZTS and VK5AGR using the above system on FO-20 would both be trying to use 145.890 with VK5ZWA on 145.850 and VK5ZK on 145.910 therefore either VK5ZTS or VK5AGR should switch to the unused frequency of 145.870 to minimise interference to each other.

Packet On Fuji-Oscar-20

A Typical Session of Fuji-Oscar-20's Mailbox — Graham VK5AGR

By way of explanation — all the text appended by <Enter> below is what I typed on my keyboard — the remainder is what I received from FO-20. The second to last frame is a typical FO-20 telemetry frame which consists of 27 (00 to 26) analogue telemetry channels with values from 000 to 999, 9 system status channels (27a to 29c) with hex values of 0 to F and 30 status points (30a to 39c) with values of binary 0 or 1. Data on decoding this information is available in the AMSAT-UK FUJI-OSCAR-12 Handbook which are currently available from AMSAT-Australia for a \$15 donation (only 3 left) but they are also available from AMSAT-UK.

Connect 8J1JBS <Enter>
 ***Connected to 8J1JBS
 FO-20/JAS1b Mailbox ver. 2.00
 commands (B/F/H/M/R/U/W)
 Use H command for Help
 JAS>
 H <Enter>
 ++ Available commands ++

B: List file headers addressed to ALL
 F: List latest 15 file headers
 F*: List latest 50 file headers

OSCAR-13 Schedule for 01May90 to 10Jun90
 Station: Adelaide
 Hour - UTC

	0	1	2	3	4	5	6	7	8	9	10	11	12	13	14	15	16	17	18	19	20	21	22	23	
01May																									bbb
02May																									bb
03May																									
04May																									
05May																									
06May																									
07May																									
08May																									
09May																									
10May		bb																							b
11May	b																								bb
12May																									bb
13May																									bb
14May																									
15May																									
16May																									
17May																									
18May																									
19May																									
20May																									
21May	bbb																								bb
22May																									bb
23May																									bb
24May																									bb
25May																									b
26May																									
27May																									
28May																									
29May																									
30May																									
31May		bb																							bb
01Jun																									bb
02Jun																									bb
03Jun																									bb
04Jun																									bb
05Jun																									bb
06Jun																									
07Jun																									
08Jun																									
09Jun																									
10Jun																									

LEGEND:
 b : AO-13 1s in view and the Mode B transponder is ON (Omnidirectional antennas)
 B : AO-13 1s in view and the Mode B transponder is ON (High Gain antennas)
 L : AO-13 1s in view and the Mode JL transponders are ON
 S : AO-13 1s in view and the Mode S transponders is ON
 - : AO-13 1s NOT in view

Please note the AO-13 transponder schedule given below as the resolution of the barchart does not totally indicate all the options due to the rather complex nature of the Mode-S transponder operations in conjunction with either the Mode-L or Mode-B transponders.

AMSAT-OSCAR-13 Transponder Schedule from 09May90

Mode-B : MA 000 to MA 110	Note:- from 07May90 until magnetorquer
Mode-JL : MA 110 to MA 135	of AO-13 to LON/LAT of 180/0 has been
Mode-L : MA 135 to MA 140	completed ALL transponders will be
Mode-S : MA 140 to MA 145	OFF from MA 200 through perigee to
Mode-BS : MA 145 to MA 150	MA 060. The next eclipses affecting
Mode-B : MA 150 to MA 256	AO-13 begin on 11Jul90.
Omnis : MA 215 to MA 045	

F<d>: List file headers posted on day <d>
 H: Show this message
 K<n>: Kill a file numbered <n>
 M: List file headers addressed to current user
 R<n>: Read a file numbered <n>
 U: List current user (s)
 W: Write a file
 JAS>
 M <Enter>
 NO DATE UTC FROM TO SUBJECT
 0196 03/02 21:41 ON6UG VK5AGR Tnx info
 JAS>
 R196 <Enter>
 NO DATE UTC FROM TO SUBJECT
 0196 03/02 21:41 ON6UG VK5AGR Tnx info.

Hello Graham, I have put your info in the file, if it is not correct please let me know. Do you have enough fingers to operate all those digital satellites?
 73's Freddy
 JAS>
 K196 <Enter>
 Killed!
 JAS>
 W <Enter>
 TO? ON6UG <Enter>
 SUBJECT? Reply <Enter>
 Enter text, <CR>. <CR> to end.
 Freddy, OK on the info in the file. <Enter>
 No — I do not have enough fingers <Enter>
 to work all the digital satellites but have <Enter>

been using the digipeaters on PASCAT-1 and LUSAT-1 <Enter>

<Enter>

End

JAS>

F <Enter>

NO DATE UTC FROM TO SUBJECT

```

0207 03/03 00:30 VK5AGR IOLYL Reply
0206 03/03 00:26 VK5AGR ON6UG Reply
0205 03/02 23:59 JR1EDE DL1CF Hello Heinz
0204 03/02 23:53 AL7IH 1K1COA my setup
0203 03/02 23:51 AL7IH ON6UG info
0202 03/02 22:37 ZL1WN N5BF microsats
0201 03/02 22:00 AL7IH ON6UG setup
0199 03/02 21:44 DLICR DLICF auch da
0198 03/02 21:44 I6CGE 1K1COA SALUTI
0195 03/02 21:40 ON6UG HB9AQZ Mode S
0194 03/02 21:39 ON6UG ALL JD-USERS (2)
0193 03/02 21:38 1K1COA G2BFO Hello
                                     Dividde
                                     Alfred

```

JAS>

cmd: DISCONNECT <Enter>

***DISCONNECTED: 8J1JBS

8J1JBS*>BEACON:

JAS1b RA 90/03/03 00:38:58

```

712 376 673 679 728 837 846 830471 651
618 001 491 512 513 510 512 509655 001
699 680 700 695 999 644 877 17608A 000
110 111 000 000 111 100 001 111111 000

```

8J1JBS*>BEACON:

JAS1b MO 90/03/03 00:34:00

Mailbox is at your service from 90/03/01 12:00:00

The JD Transmitter is available in all orbits during JD mode. ar

KEPLERIAN ELEMENTS - THE "NASA 2-LINE FORMAT" EXPLAINED

This is the format used by NASA to distribute satellite elements in their "NASA Prediction Bulletin". The origin of the format is unknown. Some old NORAD reports refer to this as T-card format. NASA documents often call it the "2-line" format.

Each number is in a specified fixed column. Spaces are significant. The last digit on each line is a mod-10 check digit. Data for each satellite consists of three lines in the following format:

AAAAAAAAAA

```

1 NNNNU NNNNAAA NNNNN.NNNNNNNN +.NNNNNNNN +NNNNN-N +NNNNN-N N NNNNN
2 NNNNN NNN.NNNNN NNN.NNNNN NNN.NNNNN NNN.NNNNN NN.NNNNNNNNNNNNNNN

```

Line 1 is a eleven-character name.

Line 2

Column	Description
01-01	Line Number of Element Data
03-07	Satellite Number
10-11	International Designator (Last two digits of launch year)
12-14	International Designator (Launch number of the year)
15-17	International Designator (Piece of launch)
19-20	Epoch Year (Last two digits of year)
21-32	Epoch (Julian Day and fractional portion of the day)
34-43	First Time Derivative of the Mean Motion divided by 2. or Ballistic Coefficient (Depending of ephemeris type)
45-52	Second Time Derivative of Mean Motion divided by 6. (Blank if N/A)
54-61	BSTAR drag term if GP4 general perturbation theory was used. Otherwise, radiation pressure coefficient.
63-63	Ephemeris type
65-68	Element number
69-69	Check Sum (Modulo 10) (Letters, blanks, periods = 0; minus sign = 1; plus sign = 2)

Line 3

Column	Description
01-01	Line Number of Element Data
03-07	Satellite Number
09-16	Inclination [Degrees]
18-25	Right Ascension of the Ascending Node [Degrees]
27-33	Eccentricity (decimal point assumed)
35-42	Argument of Perigee [Degrees]
44-51	Mean Anomaly [Degrees]
53-63	Mean Motion [Revs per day]
64-68	Revolution number at epoch [Revs]
69-69	Check Sum (Modulo 10)

All other columns are blank or fixed.

Note that the International Designator fields are usually blank, as issued in the NASA Prediction Bulletins.

The following set of elements was posted on the packet network by Graham VK5AGR on 25th March.

UO-11

```

1 14781U 84 21 B 90 80.60976102 .00001635 00000-0 31350-3 0 6339
2 14781 97.9615 135.9978 0012504 159.5868 200.5860 14.65023709323147
MIR

```

```

1 16609U 86 17 A 90 75.35661081 -.00084508 00000-0 -10421-2 0 4706
2 16609 51.6184 78.1725 0015148 279.7370 80.0397 15.59871900233609
RS-10/11

```

```

1 18129U 87 54 A 90 79.93062365 .00000222 00000-0 23389-3 0 742
2 18129 82.9277 33.7239 0012337 11.4575 348.6905 13.72068564137349
AO-13

```

```

1 19216U 88 51 B 90 76.23511618 -.00000102 00000-0 99999-4 0 815
2 19216 57.0320 164.1337 6913866 223.1742 55.0039 2.09702208 13447
UO-14

```

```

1 20437U 90 5 B 90 78.24586989 .00000498 00000-0 21448-3 0 348
2 20437 98.6996 154.6013 0012407 56.9858 303.2476 14.28516088 8028
UO-15

```

```

1 20438U 90 5 C 90 78.25456188 .00000230 00000-0 10823-3 0 302
2 20438 98.7040 154.6070 0011380 58.0678 302.1593 14.28292322 8025
AO-16

```

```

1 20439U 90 5 D 90 80.27336346 .00000433 00000-0 18842-3 0 305
2 20439 98.7127 156.6667 0012698 51.9222 308.3115 14.28617359 8317
DO-17

```

```

1 20440U 90 5 E 90 80.06189741 .00000466 00000-0 20175-3 0 217
2 20440 98.7134 156.4601 0012820 52.6944 307.5414 14.28653096 8286
WO-18

```

```

1 20441U 90 5 F 90 79.07690227 .00000425 00000-0 18473-3 0 193
2 20441 98.7101 155.4814 0013305 55.9153 304.3282 14.28761841 8144

```

Stolen Equipment

Stolen from G J Brown VK5ZGB 20 Lambert Ave, Holden Hill 5088 on 16 December 1989.

ICOM IC-02A 2m handheld SerNo 29906240, ICOM IC-044 70 cm handheld, ICOM HM46 speaker mic. Contact owner QTHR or local Police.

ar

AMATEUR RADIO HELPING OUR COMMUNITY.

EDUCATION NOTES

BRENDA EDMONDS VK3KT
EDUCATION COORDINATOR

The devolvement saga continues. Many potential examiners have been somewhat surprised and disappointed to be notified by DoTC that for an examination to be accredited there must be a complete package ie there must be Theory and Regulation question papers and CW sending and receiving examinations. This does not tally with the information previously received, and will make the preparation and administration of the examinations much more difficult. The WIA will be

approaching the Department in an attempt to negotiate a more satisfactory arrangement.

Many groups are apparently intending to provide an examination in May on the traditional third Tuesday. Our congratulations to those organisers on their initiative, and our best wishes to the candidates.

However, I have heard from various sources that there is still a vocal minority opposing the devolved system. The fact that they are opposing the system does not bother me. But

I do object to destructive criticism of those who are making a genuine attempt to make the system work, and loud-mouthed derision of their efforts.

There is no way we will be able to reverse the situation. It is up to all of us to 'give it a go' and do the best we can to produce functional and efficient procedures to help newcomers into a hobby which has so much to offer. We have here a chance to provide a service which will, if properly handled, be the most 'candidate friendly' of any examination system so far established. If we wish to continue to enjoy our present privileges, or to be in a position to lobby for increased privileges, we must take every opportunity to both increase the amateur population and boost the WIA membership. If we let this chance slip, we may not get another. ar

FTAC NEWS

JOHN MARTIN VK3ZJC
3 VERNAL AVE MITCHAM 3132

Feedback: Information for the Data Base update has been received from VK2, VK3 and VK6. A list of corrections is to be published in "AR".

6 Metre Beacons: FTAC has approved a frequency change for the VK8RAS beacon to 50.043 MHz. It is proposed to set up a 50 kHz wide beacon segment for VK5/6/8/9 within the range 50.200 — 50.500 MHz. It should be noted that the WIA beacon policy still permits beacons on discrete frequencies outside the DX window in VK5/6/8/9.

6 Metre Band Plan: Several changes have been proposed to the 6 metre band plan. The first is to add two channels to the repeater segment: 52.550/53.550 and 52.575/53.575 MHz. These frequencies are already used by repeaters in VK3, but at present they are officially simplex channels. It is also proposed to allot 5 channels at 53MHz for packet radio, and possibly also some channels for other special purposes such as RTTY, WICEN etc.

Packet Radio Channels: A proposal has been made to increase the number of packet radio channels on the 2 metre band, by adding 144.925 MHz and moving the lower limit of the segment down to 144.700 MHz. A downward extension is suggested because it is less likely to cause any clashes with existing club nets above 145 MHz.

FTAC Mail: Mail to FTAC can be addressed to the Federal Executive office, to VK3ZJC (QTHR), or via packet radio to VK3ZJC via VK3RPA. ar

**Have you advised
 DoTC of your
 new address?**

CORRECTIONS TO BEACON AND REPEATER DATA BASE

The following corrections should be made to the lists published in February "A.R."

Duplex Repeaters

53.800 / 52.800	VK6RTH	Perth	Note correct input freq.
53.825 / 52.825	VK7RMD	Mt Duncan	Service area NW Tas.
53.900 / 52.900	VK3RMS	Mt Dandenong	Add to list
146.625 / 146.025	VK7RAD	Mt Duncan	Service area NW Tas.
146.700 / 146.100	VK3RML	Mt Dandenong	Add to list
146.900 / 146.300	VK3REB	Nungumer	Note correct location
147.050 / 147.650	VK3RSD	Omeo	Not yet on air

Simplex Repeaters

Delete the following - they are actually beacons:

144.435 VK3RNV	432.435 VK3RNV	432.450 VK3RAI	432.545 VK4RAP
144.550 VK3RSE	144.800 VK3VF	52.320 VK6RTT	52.460 VK6RPH
144.600 VK6RTT	52.470 VK7RNT		

Delete 144.575 VK3RYC: closed down.

Beacons

Discard the list published in the February "A.R." Reference Section. The list published in April "A.R." page 40 is correct, with the addition of the CW practice beacons VK2RDW and VK3RDW, both on 144.950.

ATV Repeaters

Replace the list published in February "A.R." with the following:

<u>Output</u>	<u>Input</u>	<u>Call</u>	<u>Site</u>	<u>Service Area</u>	<u>Status</u>
426.250	444.250	VK2RTW	Willans Hill	Wagga	0
579.250	426.250	VK2RPM	Middle Brother	Pt Macquarie	0
579.250	426.250	VK2RTN		Newcastle	0
579.250	426.250	VK2RTS	Springwood	Sydney area	0
579.250	444.250	VK2RTV	Gladesville	Sydney	0
579.250	444.250	VK2RTG	Kariong	Gosford/Wyong	0
579.250	426.250	VK3RMZ		Bendigo	0
579.250	426.250	VK3REX		Swan Hill	?
579.250	444.250	VK3RTV	Mt Dandenong	Melbourne	0
579.250	444.250	VK6RAP		Perth	T
426.250	444.250	VK7RTV	Mt Duncan	NW Tasmania	0
579.250	444.250	VK7RAE	Devonport	NE Tasmania	?

Status: 0 = operating T = testing ? = unknown

John Martin VK3ZJC
 Acting Chairman, FTAC

SPOTLIGHT ON SWling

ROBIN L HARWOOD VK7RH
52 CONNAUGHT CRES WEST LAUNCESTON 7250

Personnel at HCJB's transmitting site were surprised on Wednesday morning, February 21st, when some armed men broke into the facility, tied up the duty operators and stole about 50 circuit boards which, among other things, control the antenna switching operation, the audio processing system and the 500 kW sender. They also stole a mission vehicle. They left behind a note demanding \$US250,000 and threatened additional damage to other HCJB facilities and to staff if any one of them were apprehended.

The dazed staff had HCJB back on-air by mid-morning with all but the 500 kW sender. Pre-established contingency plans were immediately implemented. The Ecuadorian authorities were informed and were very helpful as also were the US Embassy in Quito.

This action has had its effect on HCJB's output, particularly with the 500 KW sender, which was out of action for several weeks while the engineers made new circuit boards to operate it. Both HCJB and the authorities

now believe that it was a criminal activity rather than a terrorist action. Additional security has been added to all HCJB facilities.

In last month's column, I referred to the VOA cutting language services due to budgetary limitations. Well, the VOA management have now changed their minds and will continue all existing language services. Radio Canada International has also decided to continue their Mid-East service in English via the transmitters of Radio Austria International in Moosbrun. They have decided, however, that RCI will continue in German for the time being, as the plans were to discontinue it, yet the momentum of German re-unification and its ramifications within Europe, has altered that.

In March, Radio Australia really stepped out, making several significant alterations to their frequency database. They now are operating on the 22 metre band on 13700 kHz from 0600 UTC. Other new channels are 17630, 15560 and 15465 kHz. The BBC reportedly have come on to the 22 metre band with

Russian broadcasts.

Radio Vilnius in Lithuania has been having its problems with transmitters as well lately, but in this case, it involves the senders elsewhere within the USSR. As no doubt you're aware, the Lithuanian parliament unilaterally declared its independence of Soviet control. Radio Vilnius has some senders within Lithuania, yet relied mainly on other geographical sites within the USSR to get out its programming. The Soviets were displeased with Vilnius and temporarily terminated these relays. At deadline time, the situation has not been resolved, so it would be good to keep an ear on Vilnius at 2230 UTC on 15105 kHz in English. Other Soviet programming has been heard on that channel at times.

This year it will also be interesting noting the output of several eastern European broadcasters, on the first of May, since the momentous events towards the end of 1989, when the Iron Curtain came down. I won't be surprised if May Day is not celebrated in Czechoslovakia, East Germany or Poland any more. Even Radio Moscow has changed their emphasis with the May Day "live" broadcasts from Red Square.

Well, that is all for this month. Until next time, the very best of 73 and good listening!

ar

INTRUDER WATCH

GORDON LOVEDAY VK4KAL FEDERAL INTRUDER WATCH CO-ORDINATOR
AVIEMORE RUBYVALE 4702

"Intruder VCN has ceased (?) using this call since 11/01/90. Did Bill VK2COP cause the Canadians to act promptly?? All traffic is now under the call of VRQ where all others originate anyway. PKJ & VBXX were only copied by VK6XW, Karl, on 25/01/90. Some other observers have reports dating to 19/02/90, in Eastern States. There is still a proliferation of callsigns, eg UWX2, RMAJ, RBPP, L3T etc, churning out 5 letter groups for hours on end, taking up valuable band space....have they used up all their "usable

freq" of 14250-14350kHz? The "RTTY" wheel on 14058.5 on a heading of 350 deg from VK6XW, same direction as VRQ, could come from another area...China has started using 14058+. Uses A1A marker pulse at abt 3pps. Data burst with 250Hz shift in very short bursts, usually less than 1 second. Heard after 0100 in NW USA. QTH was TSINGTAO in previous observations will require new bearings. More info needed here also. 1ARU REG 2 has had no loggings of "Woodpecker", has it disappeared? Also from Reg 2 UHF3

(from FCC) on 7047.9 cross bearings place it as being located in KOMANDORSIKYE ISLAND just NE of PETROPAVLOVSK on KAMCHATKA PENN (53 N x 170E). Now an action case. What will happen now depends on USSR. I have received quite a few observations of Australian stations using a portion of the 10 MHz band. Call signs are generally given, eg VL3974 on 10.139.7 USB. At the present time these are quite legal. Radio Branch advises it is not granting any more licences to the LANDMOBILE SERVICE operating on these frequencies. But I do not know, when or if, the operators will be asked to vacate. Watch these notes.

The first reports in the Special Survey, show plenty of activity on some of the bands, depending on propagation.

ar

ALARA

JOY COLLIS VK2EBX
PO Box 22 YEOVAL 2868

YLs who can celebrate their "Diamond Jubilee" as amateur radio operators are rare indeed, but such a one is Austine Henry VK3YL. ALARA is very pleased to extend warmest congratulations to Austine, and wish her many more years of activity in the hobby of amateur radio.

"HOW ABOUT SIXTY YEARS?"

ALARA is fortunate in having "long time" operators amongst its membership. This article tells the story of one - Austine Henry

VK3YL, who, on 13th May this year will have been licensed for sixty years.

Austine's interest in radio began when, as a youngster convalescing after an operation, she was given a "cat's whisker type" crystal set. With this she experimented. Amateur operators were permitted on the broadcast band in those days. Austine discovered them and decided that she would like to join them. Encouraged and assisted by Will (who later became her husband) she studied for the

necessary examinations. Having gained her Experimental Licence, she built a one watt transmitter using crystals ground from rejected lenses that were, after much searching, often found available from opticians in those days.

CW was the mode, and one noteworthy contact made in September 1930 was with Baron de la Rouche ON4HM, her first QSO with Belgium. At an Amateur Radio Exhibition in the Melbourne Town Hall in 1932 Austine's rack and panel home brew rig was displayed. Her mast in the front garden with "3YL" thereon was a landmark on Dandenong Road.

By 1933 Austine's proficiency in CW was such that she was admitted to the Royal

Australian Air Force Wireless Reserve, a group of amateurs who regularly visited Point Cook for training. Imagine the surprise of RAAF officers when a woman appeared in the group. Training included operating from a sturdy Wapiti plane.

When war broke out, Austine found herself debarred from active service (the WAAF had not been formed then) but she nevertheless exploited her talent as a Morse operator by taking the WIA classes that were set up to train service personnel.

After the war, like most amateurs, Austine found that modifying the surplus equipment then readily available was the effective way of returning to the air. In due course, commercial equipment took over the shack. A high-light contact in 1957 was that with FO8AP/MM on the ill-fated Tahiti Nui raft on which the operator was attempting to float to Chile.

Today 3YL's equipment includes the Drake line and a three element Yagi. CW DX has always been Austine's favourite activity, and a grand total of DX was amassed on "Zepps" and dipoles even before the beam appeared.

CW gave Austine a place on the ARRL

DXCC Honour Roll as the first and only VK YL to achieve that distinction. She also is currently placed second on the Australian DXCC ladder. Other awards include Worked All States YL and the Canadian YL DXCC. She was the first VK YL to gain the ALARA Award. Austine is not only a very long time member of the RSGB and a foundation member of YASME, but also is an Assistant Director of the Old Old Timers' Club which has a membership of some 2000, and she is a member of YLRL, YLISSB and RAOTC.

Radio is not Austine's only interest. She is also a philatelist and an enthusiastic golfer. Illness of her husband has, however, restricted her time spent on the greens and fairways.

Congratulations on your sixty years as a licensed amateur, Austine, and our best wishes to you for the future.

(Mavis VK3KS and Bron VK3DYF)

Reminder:

ALARA AGM MONDAY 28TH MAY
3.580+/-QRM 1030 UTC

33/73

JOY

ar



Austine VK3YL

REPEATER LINK

WILL MCGHIE VK6UU
21 WATERLOO CRES LESMURDIE 6076

Repeater Linking

The February AMATEUR RADIO is interesting reading on page 12 and 13 under band plans for the Amateur Radio Service. To quote 'A pair of frequencies are to be used for repeater linking. Maximum power for inter-repeater linking is 5 Watts. Now there are two points about this regulation that I do not understand. Firstly, why, in order to link two repeaters together, must a pair of frequencies be used? If to link two 2 metre repeaters, the link between the repeaters must be on 420MHz in one direction and 440 MHz in the other, what a technically difficult way of going about it. The UHF link antenna has to have a wide bandwidth. The link equipment may not operate at its best performance by having 20MHz between receive and transmit. A cavity filter cannot be placed between the link transceiver and the antenna to solve any intermod or interference problems. The two sub-bands at 420 and 440 MHz are a good idea, but why it is necessary to use a pair of frequencies for each link is beyond me. If any one knows please let me know. The second part to this regulation is the limiting of the maximum power to 5 Watts. I also do not understand this. Supposing, in order to link two repeaters, 20 Watts is required to provide a noise free link? When this regulation was first drafted, the West Australian Repeater Group opposed it in writing. Why paint our-

selves into a corner? Likewise, if any one knows why the 5 Watt limit on link transmitters, please let me know.

CTCSS Encoding

Solving the problem of future restrictions to be placed on repeater systems that are linked, is a complex and difficult problem. These restrictions come about, due to the decision taken that Amateurs can not be retransmitted to a band on which they are not licensed to operate. One solution is to nominate a separate CTCSS tone for each grade of licence, to be used when the extra linking facilities are available. It is important to note that, with no CTCSS tone fitted, the repeater system operates as it did before. CTCSS is only required if you want to gain access to a link to another repeater. As linking systems become more complex, the various grades of licence will have various degrees of access. The CTCSS tone will tell the repeater what grade of licence is requesting a link connection. The repeater will decide if the connection request is valid. With the present number of licence grades, a total of 4 CTCSS decoders would be required to identify the grade of Amateur licence. This may seem complex and a lot of work for the repeater builder, but it is not easy to overcome the problem. There are however some short cuts. For example, the difference between the Z call and K call on VHF and UHF is slight, so the

K call could use the Z call CTCSS tone. There is only one example where separate tones are required, and that is where a 70cm or 2m repeater is linked to a frequency in the 28 to 28.6MHz band. A higher grade of licence can use a lower grade of CTCSS tone in a given situation. In fact, in order to place in operation a cross band 70cm to 2M system, the full call, K call and X call could all use the Z call CTCSS tone, until a more complex repeater link situation evolves requiring the use of more than one tone. This simplification is only to reduce the extra circuitry required in the repeater. In the long term, each grade of licence with its own identifying CTCSS tone is the way to go. Do not forget this system could be with us for a long time, and it is easier to do it right in the first place. One other situation needs to be looked at: case where a repeater requires CTCSS tone is used to identify the grade of licence and interference protection to the repeater. The linking request is achieved by DTMF tones. All this may seem very over-designed, but the more you look at the solution to the problem the more the complexity increases. This brief outline is the submission to the WIA. What was yours? By the way, it took a couple of hundred person hours to come up with a solution and to fine tune it. The top priority was to foresee all the possible ways linking may develop. The single CTCSS tone for each grade of licence will make it easier to install a CTCSS encoder in equipment not fitted. I look forward to the conclusion to the cross band link problem, so we can get on with linking some of our repeater systems in the West. All such planning and construction has ceased in VK6. ar

RANDOM RADIATORS

RON FISHER VK3OM
RON COOK VK3AFW

Another All-Band Dipole

Continuing on with the theme of multi-band wire antenna we present extracts from an article that appeared in Ham Radio Today, May 1984. In this Brian, G2WI, describes his "Dexterous Dipole" which was used on all the non-WARC bands from 160 m to 10 m. He used two 30 feet high masts to support his system which initially was a commercial KW five band trapped dipole. The SWR was up to 2.5:1 on some bands so an ATU was necessary. The antenna worked well but did not provide for 160 m. Strapping the feeders and feeding it against ground produced indifferent results. Brian then decided to add two more traps to allow operation as a dipole on 160 m.

"The traps were obtained from Wight Traps (G3IMX) along with some suggestions for their installation. After some digestion of these ideas, the 80 m traps were attached some 6 feet up from the bottoms of the vertical sections, the requisite extra 20 feet of wire was attached to the other side of these traps."

The general arrangement is shown in Fig 1. It should be noted that the main current carrying section is at the highest part of the antenna and is not bent. The 80 m tails are run in a straight line parallel to the masts. By placing the 80 m traps 6 feet from the ends the bandwidth is claimed to be better. Certainly placing the 160 m tails 9 feet or so above the ground allows complete access under the antenna. It is a simple scheme and Brian reports working plenty of DX and no TVI.

For the home brewer it is suggested that the 7 MHz traps be made with 60 pF capacitors and coils of about 8.2 uH for resonance at 7.2 MHz. These are the values used in the W3DZZ version of the five band dipole. A suitable high voltage capacitor can be made from a short length of coax or a piece of double-sided fibreglass printed circuit board.

No information on the 80 m traps is available but doubling both the capacitance and inductance values given above is as good a place to start as any. The 160 m tails might need to be adjusted for resonance. If they come out to be less than 10 feet then use more C and less L in the 80 m traps. Conversely if more than 30 feet is required, try increasing L and reducing C.

A final word from Brian. "It is hoped that this article will give heart to those struggling in awkward locations. It's amazing what a little ingenuity can do — go, give it a try!!"

More On The Wonderful Windom

John, VK5JG, writes describing his experiences with a Windom. He used 300 ohm ribbon feeder connected to a point 1/3 of the total

length along from one end. The overall length is a half-wave on 80 m. For John's particular QTH this was more convenient than centre feed. On 80, 40 and 20 m it has performed "very well" but "results have not been good" on 10 m. Mike, VK3BDL once reported an improvement in operation of a G5RV on 10 m when he swapped an ordinary 300 ohm ribbon feeder for 300 ohm ladder line. Ladder line now appears to be unobtainable, but if some can be found or you are prepared to roll your own then it is worth considering.

John uses a simple ATU consisting of a 25 turn coil on a 2 inch diameter former resonated with an old broadcast receiver two gang capacitor. The feeder is tapped in a symmetric manner onto this coil. The 50 ohm coax is coupled via a 4 turn coil. Although not mentioned by John, we suggest that the rotor of the capacitor be grounded. This ATU tunes 80, 40 and 20 m without changing the coil. A separate ATU was used for 10 m.

The Windom is not intended for operation on 15 m or the WARC bands as it provides a match (nominally) only on the frequency at which it is a half wave long and on even harmonics of this frequency. John points out that further information on the Windom is given in the ARRL Antenna Book. (pp364,365 of the 1958 edition).

Peter, VK3BWD, has drawn our attention to the fact that a number of multiband and broadband antennas use the 1/3, 2/3 dimensions. More of this later.

And More On Baluns

Last time we made some cautionary comments about baluns when used on un-matched lines. Because of some questions raised we address this subject again. There is much good information on the topic, particularly in the ARRL publication "Transmission Line Transformers" by Jerry Sevick. (Available from Stewart Electronics and Magpubs.) Articles have also appeared from time to time in many journals, such as in Pat Hawker's Technical Topics column published in Radio Communication (February 1984 for example) and a letter by Wade Blocker in Proc IEEE, Vol 65 No 9 Sept 1977 pp 1045, 1046. What follows is a summary of some of the more important points.

There are two types of broad-band impedance matching transformer, namely a conventional transformer of careful design, and a transmission line transformer. Both may be used as baluns as well as impedance matchers.

Conventional Transformers

These can be made to cover the range from sub-audio to VHF, but not in the same device. They can offer dc isolation but suffer from the well known limitations of conventional transformers, namely increased core losses at higher frequencies, core saturation at high voltages or low frequencies (relative to the design parameters) and resonances between leakage reactances, winding inductances and stray and inter-winding capacitances.

Matching ratios

A significant advantage is the ability to select virtually any transformation ratio,

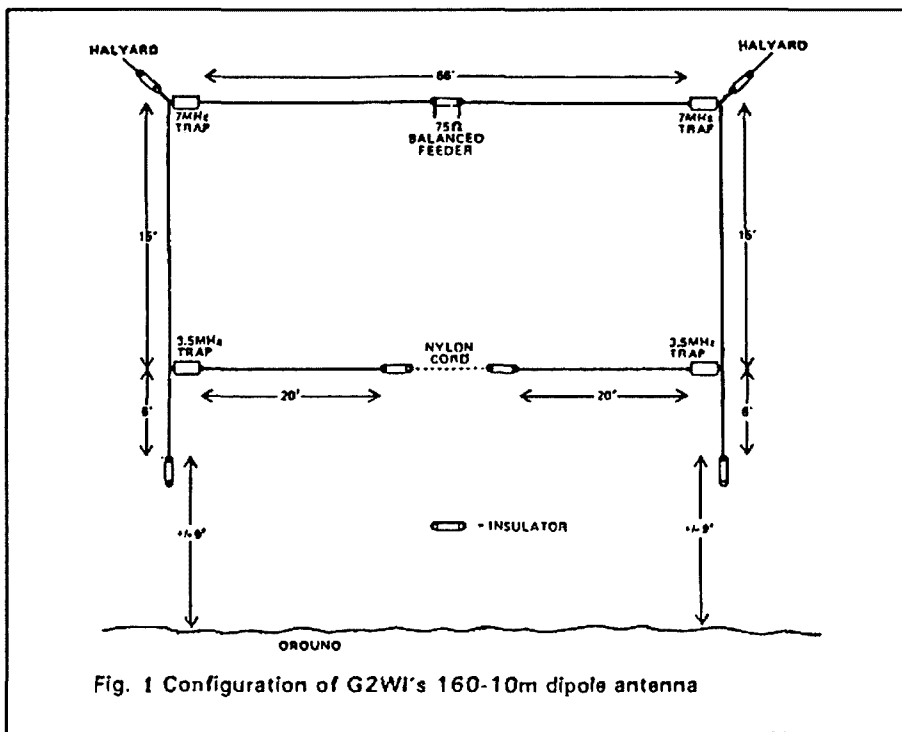

Fig. 1 Configuration of G2WI's 160-10m dipole antenna

indeed many matching transformers have a range of taps to allow a wide range of matching ratios.

Power Rating

Their power rating is determined by the core size as the flux is determined by the power being transmitted and core saturation must be avoided otherwise coupling drops and harmonics are generated, to say nothing of the increased core losses.

Using a rod instead of a toroidal core reduces the saturation problem but replaces it with a reduced bandwidth and reduced coupling as well.

Frequency Response

The high frequency cutoff is determined by the combined effect of resonance and the shunt impedance of stray capacitance. Some high performance transformers use overwound windings to produce tight coupling but incorporate a Faraday screen to minimise capacitive coupling. The low frequency cutoff is determined by the inductance of the windings.

Transmission Line Devices

Construction

The simplest form of balun, which provides a 1:1 match, is produced by winding the transmission line into a coil, which can be either a multi-layer or single layer solenoid. The currents flowing in the transmission line are not affected by the inductance so formed if the currents are balanced. An unbalanced current has to flow through the inductance. This is best understood if the case of a coiled coaxial cable is considered, but the same applies for a two wire balanced line.

If a ferrite core is used then a significant increase in the inductance is obtained, in-

creasing the bandwidth at both the low and high frequency ends due to the presence of the core. As explained later other parameters also affect the bandwidth.

Instead of winding the cable through the core, several small cores can be slipped over the cable, six cores being equal to six turns through the core. This has the advantage of simple construction and allows the use of smaller cores for any given power level.

Typical construction is of a twin pair of twisted wires, representing a transmission line of specific impedance, wound in a single layer on a toroidal core.

Operation

As only the common mode or residual unbalanced current produces a net current, the flux in the core is low, hence small cores can handle very high powers and the core losses are low. For a given length of wire, the ferrite toroid gives a higher inductance than a ferrite rod core which is superior to an air core. All three are used at times, but the ferrite toroid is most used at HF.

Bandwidth

At the low frequency end the device behaves in a similar manner to an auto-transformer and has the same limitations as a conventional transformer. As a minimum recommended limit the primary inductive reactance should be 75 ohms and preferably 250 ohms for a 50 ohm primary load. It seems advantageous to design the device with a lower frequency limit than is actually needed.

At the high frequency end the loss increases as the line length approaches 1/4 wavelength. At lengths of 1/2 wavelength negligible power may be transferred. Using a high permeability core allows a shorter length of wire to be used for a given low frequency limit and hence gives an extended high frequency limit, that is a high permeability core

gives greater bandwidths. Ferrite has been found to be better than powdered iron.

Losses

The principal losses in transmission line matching devices are:

- (i) copper loss
- (ii) dielectric loss, including that of the core
- (iii) mismatch loss, arising from the load deviating from the nominal value

Maximum efficiency occurs when the characteristic impedance of the line used in the transformer, Z_0 is given by:

$$Z_0 = \sqrt{Z_L Z_g}$$

where Z_L is the load impedance and Z_g is the generator impedance.

The load or generator can both be balanced, unbalanced or any combination of these.

Rods vs Toroids

Rods give a simpler construction than toroids but will have an inferior low frequency response for a given length of wire, so the choice involves a compromise.

Range Of Impedance Ratios

Transmission line transformers excel in transferring 50 ohm impedances to ones in the region of 10 to 200 ohms. Extension of operation beyond these limits can be done, but usually the bandwidth or efficiency is reduced. Multiple wire transmission lines must be used for cases where ratios other than the simple 1;1, 4:1 or 1:4 are required.

Acknowledgements

The feedback from readers, and in particular the contributions from John, VK5JG and Peter, VK3BWD is gratefully acknowledged. Contributions from other readers on antenna topics will be appreciated.

ar

WICEN

LEIGH BAKER VK3TP
WICEN CO-ORDINATOR VK3 1986-89

The ability of the amateur service to provide emergency communications has been demonstrated many times, most recently perhaps on the occasion of the Newcastle earthquake. This event showed to all involved the competence and versatility of a WICEN group. A full report of the operation will be published shortly.

The potential value of the amateur service in national emergencies has been used as justification for our existence, and an argument for the retention or expansion of our privileges. But for much of the time, the value has been potential rather than actual. The ability has always been there and operators respond when the emergency occurs, but organisation, training and liaison with other authorities have been erratic and lacking in continuity.

This article has been written to summarise the present WICEN situation in Victoria, not

because it is particularly good or because it is better than in other states, but as a starting point for useful interchange of ideas between Divisions and in the hope of stimulating similar summaries from other Divisions.

As in many other aspects of amateur radio, there is far too little lateral communication, and too little communication overall. Many amateurs who are fully aware of how their own Division handles WICEN (or exams, or tower applications, or repeaters) have little idea of what happens over the border. This is a plea for better communications, for finding out what others have done, and sharing ideas and success/failure stories so that we can all benefit. In an organisation that runs almost completely on volunteer time and effort, it makes sense to avoid repeating other people's mistakes.

In Victoria, WICEN has been active for nearly 50 years. In the early years, it ap-

peared when the emergency (usually a major bushfire) arose, went through a brief period of activity afterwards when the administration was reviewed, then quietly faded out until the next big blow-up. As major fires tend to be 10-15 years apart, when the next event occurred, those who had gone through the reviewing and organising during and after the last event had lost interest or were retired or dead. Official bodies, which recognised WICEN as an element of their Disaster Plan, frequently had very outdated personnel lists. In addition, most of the training took place in the actual emergency situation, although the Murray River Canoe Marathon regularly provided some training, and small groups of enthusiasts ran some exercises.

However, the last decade has seen very considerable development. At the time of the 1983 fires, the Victorian State Disaster plan (Displan) recognised WICEN as an entity, but had not specified its role. After the fires, steps were taken to define this role, to make the Displan authorities and others aware of WICEN's potential, and to increase the number and quality of available operators. As a result, we now have a large pool of compe-

tent operators, a well defined place in the Displan, and a good working relationship with disaster and relief agencies in almost all districts.

The role of WICEN in Victoria is seen as being to co-ordinate the response of the amateur service to an emergency situation. Under the State Disaster Plan, the responsibility for management of a disaster is vested in the Police Force, the Chief Commissioner of Police being the State Disaster Co-ordinator. In the current Displan, WICEN ranks as an organisation of equal standing with the Country Fire Authority, the State Emergency Service, or Department of Community Services. WICEN may be called on to provide communications for the Police, combatting agencies, support agencies, or even the public, if conventional services are not available.

The organisation of WICEN in Victoria follows the pattern of the State Disaster Plan. The State is divided into 26 Regions which coincide with the Country Fire Authority Regions. Unfortunately, these do not coincide with WIA zones, but it was seen as more important to match with the other Disaster organisations that to adhere strictly to the Zones. Overall management is vested in the WICEN State Co-ordinator, who is elected by the VK3 membership, with the appointment then ratified by the WIA Victorian Division. Each Region has a Regional Co-ordinator and a Deputy, who are responsible for the groups and teams in the Region. A Regional Co-ordinator is responsible for any disaster activity and training exercises in his/her own Region, but can ask for help in an emergency from a neighbouring Region or the State Co-ordinator.

Since 1983, there has been a deliberate policy of liaison with the Police and other authorities, so that, at the present time in most Regions, WICEN is represented on all Displan committees. This means that it has been possible to negotiate with all other authorities, and the WICEN operators as registered emergency workers have all the insurance and compensation provisions provided under the Emergency Management Act.

There has also been a concerted training program, so that there are now more than 400 trained and available operators. Training has been largely by means of exercises — the traditional Murray River Canoe Marathon still runs every year, but in addition WICEN teams provide safety and results communications for car rallies, horse endurance rides, bike rides, fun runs, and events such as an Open Day at Tullamarine Airport, and the International Equestrian Competition at Werribee last year. Overall, in 1989, VK3 WICEN operators attended over 70 events, in some of which interstate operators also participated. In fact, it has become necessary of late to keep a fairly low profile, to avoid over-committing the members. To reduce the load on the leaders, and as a further training exercise, the events are co-ordinated by different operators.

One major initiative has been the production of two Handbooks. The "Regional Co-ordinators Manual" contains the administrative material — paperwork for formal exercises, registration forms, call-out procedures and contacts, both amateur and inter-service. The "Procedures and Techniques Manual" is the guide to the field operator, covering operating procedures and conventions,

message handling, duties of WICEN officers and equipment standards. Both these volumes have been endorsed by both the Victorian Police and the SES. Other initiatives include the establishment of a phone BBS for information dispersal, (03) 232 0913, construction of several portable repeaters and involvement in many club projects.

So WICEN Victoria is now a functioning, well used and efficient organisation, in good standing with the local Disaster authorities. Some of the bodies for which WICEN provides services as exercises pay some compensation for costs. Training exercises are frequent and often enjoyable. There is a place for all interested persons — even the unlicensed can participate as log-keepers, or drivers.

But there is an urgent need for more liaison between Divisions. At present, Victorian amateurs lose their insurance cover once they cross a State border in an emergency operation. Obviously, this is a case for discussion and negotiation between the State Disaster organisations, but perhaps some pressure can come from WICEN in other States, too.

If there are ideas or resources mentioned here that you feel could be used in WICEN in other Divisions, please let us know and VK3 will be happy to share. If you have some good ideas to share, we would certainly like to hear them.

As a start to more lateral communication, it is intended to hold a telephone meeting of all WICEN State Co-ordinators in early June, with the Federal WICEN Co-ordinator, Bill Wardrop, VK5AWM, as moderator, when some of the procedural differences can be resolved, and plans made for closer co-operation. A report of this will be published as soon as possible thereafter. **ar**

DIVISIONAL NOTES

FORWARD BIAS

PHIL CLARK VK1PC

The first meeting of the 1990 committee was held on Tuesday 13th March 1990. New committee members Darryl, VK1DF and Marion, VK1BNG were made welcome.

As this was the first meeting of a new committee, there was quite a full agenda to be discussed. Some of the items were: how to keep members informed of the educational publications available through the bookshop, more about examination devolvement, recruitment, new members, promoting amateur radio and the WIA, charges for repeater sites, self regulation of amateur bands, and the allocation of portfolios was made. Reports were received from the Treasurer, the outgoing Federal Councillor and the Field day co-ordinator. Kevin VK10K, the retiring Federal Councillor, was given a vote of thanks for his work on behalf of the division as he handed over this task to the capable hands of George, VK1GB.

Four new members were accepted at this meeting. We welcome to the division: Mal Cooper, VK1MC with congratulations on upgrading recently to the full call! Gordon Brown, VK1AD and Doug Jackson, VK1ZDJ who have returned to the fold, Russel Thompson, VK1NRT with congratulations on that vital first novice step!

The division is very pleased to see the membership growing, as a lot of the work now is with DOTC and international bodies due to the pressure the bands for our hobby are under from other interests. As the only national body representing amateurs to our government agencies, the more members we have the better we are able to represent amateur radio when things are proposed. All members are asked to encourage non-members to join for the protection of the bands and privileges that they enjoy.

The matter of charges for the repeater and beacon sites has been a difficult one for the division. Being a small division, the charges are a significant part of our budget, even after the reductions that have been made. Because of the cost of sites, we may reluctantly have to

relinquish the Mt Majura site for beacons, however at this stage we will still maintain the facility on Mt Ginini. Another location is now being sought for the equipment that may be removed from Mt Majura.

Here are just some of the portfolios for the 1990 committee that were allocated:

Book sales and Forward Bias	VK1PC
Broadcast manager(s)	VK1KNP and VK1DF with VK1BNG
Federal Councillor	VK1GB
FTAC	VK1DF and VK1KCM
President	VK1AOP
Treasurer and Membership	VK1KEN
Secretary	VK1BR
Senior Vice President	VK1KCM
Vice President	VK1PC
WICEN Co-ordinator and Liaison	VK1KEN and VK1BNG
QSL Inwards	VK1KEN
QSL Outwards	VK1AOP

Of course these are just a few, and if you want to know who is doing what, ask at any of the meetings or contact a committee member.

The bookshop has been active in obtaining stocks of the popular technical books as well

as those that members order for themselves, so have a look at the books at each monthly meeting. As part of the effort to provide information to members on this educational service, we were going to try to give several short reviews of books on the weekly broadcasts, however the current interpretation of the DOTC ruling on the content of WIA amateur news broadcasts seems to prevent us from doing this at the present time.

The division set up a station for the John Moyle Memorial Field Day at the Kowen forest fire tower. I will have more about this next time. **ar**

VK2 NOTES

TIM MILLS VK2ZTM

Annual General Meeting

This was held at the end of April for the year of 1989. Members should have received the annual report as an insert to April "Amateur Radio". Remember to cut your membership card for this year from the back page of the report. At the time nominations for Council closed in March, only seven members had been proposed and a ballot was not required. Details of the new office bearers and meeting report will be given over the VK2WI broadcast and included in a future "AR".

Video Tapes

Many clubs and groups have made use of the Federal video tape library and obtained copies of what John VK5KG has available. A reminder that the VK2 Division has copies of most of what is available in the VHS format at the Parramatta office. Recent titles at the VK2 office are "How to Survive in a Dog Pile" by John VK2DEJ; and "HF DX Seminar" with Iris and Lloyd Colvin. Some more material next month.

Coming Events

With winter approaching, it is expected that the VK2WI 80 metre morning AM transmission will be re-introduced. Most likely without callbacks, since good coverage is being obtained on both 40 metres (7146) and 30 metres (10125). While on the subject of 80 metres, the evening slow morse session from VK2BWI has now been standardised to start at 8 pm local time, regardless of time changes. It will be followed an hour later by VK5AWI. It is hoped that this will overcome the confusion resulting from the annual daylight saving changes.

The next Trash & Treasure will be held at VK2WI Dural, weather permitting. Sunday the 27th May. Why not come up and have a barbecue first. Listen to the morning broadcast on the 27th for the weather details and if it is on. Saturday the 2nd June will be the annual fireworks display at VK2WI Dural, again weather permitting. On the June long

weekend 9 - 10th, the annual Oxley Region field day will be held at Port Macquarie.

QSL Bureau

Just a reminder to keep in touch with the VK2 Bureau at PO Box 73, Teralba, 2284 for the handling of your cards. Advise them just what you require, and hence keep the volume of uncollected cards down. Watch the size of your packet of outwards cards sent to the bureau. Changes in postal regulations impose a thickness limit of 20 mm on large letters. Above that, your packet becomes a parcel. The Bureau reports that they have been receiving cards produced on computer paper. While this approach may cut the weight, they are almost impossible to sort, so please do not use this format. The same type of problem occurs with non-standard cards. They will not fit into postings without having to be folded. They also alter the weight and in turn the operating cost of the Bureau. If in doubt about the operating requirements of the VK2 Bureau, collect a copy from the Parramatta office or send a stamped, self addressed envelope to the Bureau at PO Box 73, Teralba, 2284.

WICEN (NSW) Inc

This month there are two small exercises on the 20th. The first is communications at Amaroo with cars. Peter VK2EMU is looking after this event. The other is at Bungonia Caves with a public open day. Details from Morton VK2DEX.

Local WICEN Co-ordinators — for Orange, Robert VK2ZRJ; Central Coast, Ray VK2TV; Newcastle area, Philip VK2IW. During April details about WICEN were sent to some 40 clubs and groups in the State. Included were application forms. The annual WICEN dues are \$5.00. Check with your Local Co-ordinator, your club or the State WICEN Committee

at PO Box 123 St Leonards NSW 2065.

An audio cassette on WICEN Voice Procedure was recently produced and sent to WICEN members.

T Plugs

Several interesting replies were received to the question posed in the February notes. While there does appear to be a preferred format, there has been no indication if a formal method has even been adopted. Most replies express personal preference. A summary will follow later.

New Members

The following became members of the VK2 Division during March and a warm welcome is extended to them.

J T K Blade	VK2AJB	Riverwood
D P Byrnes	VK2TDB	Cullerin
C Edmondson	VK2XLK	Port Macquarie
J T Hefferan	Assoc	Ambervale
B L Wilkinson	VK2XMU	Hillsdale

ATV Forum

A well attended forum on ATV operation was held at Amateur Radio House in early March. Minutes were sent to those groups who submitted agenda items, and copies are available from the Parramatta office. A sub-committee, chaired by Peter VK2ABH, has been set up to assist with ATV in VK2. **ar**

VK3 NOTES

JIM LINTON VK3PC

Busy Month of May

This month sees the planned start of WIA

Morseword No 38

Solution on page 56

Across

- 1 Pulls
- 2 Trick
- 3 Seep out
- 4 Chooks
- 5 In what way?
- 6 French military cap
- 7 Rice wine
- 8 Graber
- 9 Marries
- 10 Upper House

Down

- 1 Cubes
- 2 Fruit
- 3 Russian name
- 4 Unopened flower
- 5 Brought out
- 6 Clotted blood
- 7 God of love
- 8 Part of the eye
- 9 Turn outwards
- 10 Fluids

	1	2	3	4	5	6	7	8	9	10
1										
2										
3										
4										
5										
6										
7										
8										
9										
10										

Audrey Ryan © 1989

Victorian Division Examinations Service, the election of the 1990-91 Divisional Council, and the Vic Div Annual General Meeting. Members have been advised about the AGM and supplied with the customary reports and financial statements. Considerable work is required at this time each year to meet all Corporate Affairs Commission requirements, and the exhaustive but necessary probe of our financial affairs by the auditors. The results are to be seen when members read the director's report, financial statement and balance sheet. The provision of a statewide examinations service due to begin this month is a milestone which followed a lot of preparation work over the past year. Examinations are now more widely available than ever before which should help those wanting to qualify or upgrade a presently held amateur qualification.

Check Out Rumours If You're Concerned

A member became concerned when he heard others on air bemoaning the WIA Victorian Division QSL Bureau policy of charging non-members of the Division for use of the outwards Bureau facility. Those voicing criticism were not members of the WIA who obviously spoke out of ignorance. The WIA member noted their concerns and personally undertook to check on the policy and the reasons for it, and advise them what he had found out.

The member was told by the WIA Victorian Division secretary Barry Wilton VK3XV that the Division has a policy of not using membership funds to provide services to non-members. Those who choose not to join and support the WIA through membership are currently charged on a per-card basis for cards sent overseas. But the current practice of including non-WIA members QSL cards with those sent overseas is being phased out. The Division is under no obligation to provide this service to non-members.

The broad issue highlighted by the inquiring actions by the WIA member in this instance is that rumours and criticism of the WIA can be checked out. The WIA Victorian Division is the authoritative source available to any member concerned about anything they hear others claiming the WIA is allegedly doing or not doing.

Weekly Broadcast

Let us have your news. Often the activities of a radio club, group or zone, or even an individual, could be of interest to others, but we don't hear about it. On some occasions the VK3BWI broadcast team has heard about an interesting activity and chased the details suitable for broadcast. The broadcast team will continue to hunt out and report news -- they take pride in striving to maintain the high standard achieved by the broadcast. But ours is a communicating hobby and why can't those involved in events and activities put ink

to paper, and ensure it reaches the broadcast via the Divisional Office by the 2pm Thursday deadline?

The First Examinations

A small number of candidates sat for a special examination session held last month at the WIA Victorian Division Office.

A few lessons were learnt in the conducting of examinations during this session which was really a trial run for the statewide examinations scheduled for May 15. The devolution of examinations has definite benefits for candidates and in Victoria one of these is the increased number of examination centres. It is expected about 100 candidates will be sitting the WIA Victorian Division Examinations Service exams at 15 centres around Victoria and in Albury. **ar**

VK4 NOTES

DAVID JONES VK4NLV

The 1990 VK4 Radio Club Conference, Annual General Meeting and dinner were held over the weekend of the seventh and eighth of April, at the Bardon Professional Development Centre in Brisbane.

The RCC was attended by twenty-seven voting club delegates, plus all Councillors (including the 1990 nominees), most of our ex-officio officers, and two very thoughtful and experienced guests in Ron Henderson VK1RH, Vice-Chairman of FE, and Reg Brooke VK2AI, Affiliated Clubs Officer for VK2.

The Conference was well-chaired by the old quiet joker himself, Cliff Jenkins VK4QJ, with the Club Conference taking up most of the two days of sessions. The only "time-off" was for the AGM of the Division which commenced at 1630K on Saturday 7th. This was attended by some sixty members of the Division, plus the Member Clubs, and it concluded some two hours later. The main items of business were the presentation of a proposed new Articles of Association, including the adopting of a new Memorandum of Association. We didn't get through the Articles, as there were fifty-one clauses; however, twenty-six were approved, so we're well on the way, and not before time too. It's taken a lot to get this far, but now it's happening, and importantly, this Division can now complete its application for tax exemption. Congratulations to the constitution Sub-committee.

Election Of The Council

The following were elected to the Divisional Council for 1990, with office bearers to be elected by the Council itself.

Bill Dalglish VK4UB, Eric Fittock VK4NEF, Eddie Fisher VK4ABX, John Bews VK4KJB, David Jerome VK4YAN, Harry Standfast VK4ASF, Neville Mills VK4KOP, Don Thomson VK4YI, Ross Mutzelburg VK4IY, Bill Sebbens VK4XZ, Doug Inall VK4XX and David Jones VK4NLV.

For the first time in many years, we now have a Council of twelve. Congratulations to

all those elected.

And finally, it was with great pleasure that President, David VK4NLV, was able to present Merit Badge No 30 to Theo Marks VK4MU, for his fifty-plus years of service to the ARS and for his exemplary service to this Division. Well done, Theo. You are a wonderful example to us all.

After the AGM, we all retired to the dining room for a very well prepared dinner, which was followed by a laugh-a-minute after-dinner address by Terry Hammond VK4TH talking about radio and yachts. Terry was thanked by Brian VK4RX, who had no trouble convincing us to stay land-lubbers. This was followed by the presentation of a beautiful floral arrangement to Jan Jones, David's wife, for all the typing and preparation she has done for the WIAQ during David's two years of involvement. Thank you Jan, from all of us.

All-in-all, a great weekend of Amateur Radio. **ar**

5/8 WAVE

JENNIFER WARRINGTON VK5ANW

Club's Convention 1990

Once again a very successful Clubs' Convention was held at Ridgehaven Primary School over the 17/18 March.

Clubs Represented were, Lower Eyre Peninsula, ACBRO (Assoc of Citizens and Band Radio Ops), Lower Murray, 2nd Adelaide Scouts, Darwin, Alice Springs, Barossa, Elizabeth, Port Adelaide, South Coast, Adelaide Hills and SA ATV Grp. Apologies were received from Moonta Scouts, Riverland, and various individuals.

As there were not the number of Federal Agenda Items that had been discussed in former years, the discussion was of a more general nature, but never-the-less created a great deal of input.

It was especially pleasing that we managed to get delegates from Darwin and Alice Springs this year. Although we wouldn't have wished on "Spud" VK8ZWM the sad circumstances of his father's death, which was the reason he was in Adelaide, we were however pleased to have him with us. Darwin must have been a very dull and quiet place that month! Likewise it was good to meet a new face from Alice Springs, Murray Collings VK8NUE.

Besides our Guest Speaker on the Sat evening, Geoff Stephens from DOTC, there were several "mini" Guest Speakers, who addressed the gathering from time to time. These included, Kevin May VK5IV — our Broadcast Producer; Peter Koen the new Commissioner for Scout Radio in SA; Barry Chammen VK5KCX our Disposals Officer; Neil Abraham VK5ZJA & Craig Maitland VK5ZAW our Repeater Committee; John Ingham VK5KG our Federal Video Tape Co-ordinator; and Mark Spooner VK5AVQ & Dave Minchin VK5KK our new ESC manag-

ers. Various other people like the QSL manager, WICEN Director, Federal Councillor etc also spoke. We would like to thank all these people and all the delegates and Council Members who gave up their weekend or part thereof, for the sole purpose of trying to improve the hobby of Amateur Radio, in one way or another. Of course, one of the most important parts of the weekend is the food! and once again we weren't disappointed. Our Special Thanks go to Pam Bruce (who did all the buying and co-ordinating), Gill Wardrop, who never lets us down, even when she had something else on that weekend which she would have liked to have attended. Also, thanks to Marnie Allan and Margaret McDonald who helped on Sunday. It was all very much appreciated.

Photos Of Past Presidents

The collection of the photos of Past Presidents is going very well as I have found a number of them in the photo albums in the Historians Cabinet. It has now got to the stage where I can give a "short list" of those we are still looking for, (I am talking about the early ones, the more recent ones will hear from me in due course!) If you have photos of any of the following I would be very pleased to hear from you.

A Mather (Provisional President 10.9.1919)
R B Caldwell (1923-25 & 1927-31)
Jack M Honner (1925-27)
Joe Kilgariff VK5JT (1937-39)
Ivor Thomas VK5IT (1945-47)

I have photos of R D Elliot VK5RD, Ozzie Richardson & Marshall Hider but they are not very good quality for enlarging so a second source of these would be appreciated.

Diary Dates

Tues May 22nd Buy and Sell night
(don't forget it's the FOURTH Tues NOT the fifth!) **ar**

VK6 NOTES

JOHN HOWLETT VK6ATA

Exams

A meeting between WIA, DOTC and TAFE has seen the future of AR exams settled. TAFE in WA will carry out all aspects of the exams and a TAFE certificate will be issued to the successful candidates. A list of certificate recipients will be sent to the DOTC to provide a check list for those applying for a licence. Expertise with exams is TAFE business and security is assured. Some 52 exam centres will be available with exams being held 4 times a year as normal. As an experiment 2

exams will be held during the day and 2 in the evening. "ON DEMAND" exams will also be part of the new service at extra cost. Morse exams will also be available at language teaching centres, as cassette and headphone equipment is already in place. Enquiries for exam information centre should be now directed to TAFE Information Centre, 401 Hay Street, Perth Phone 325 3544. Remember the arrangement is new, have patience while TAFE staff finalise every aspect. Don't ring DOTC or WIA with exam enquiries — however you may ring with praise for a job well done!

21 Net

Licensed operators about 21 years old are invited to call into a net taking place at 2030 local time on the first Sunday of the month. Check in on CH2|146.700| or 3.580 MHz and take part. Operators to listen for are: James VK6FJA and Peter VK6BWI.

Membership

The good work started by Fred Page is still bringing in new members. Unconfirmed reports give membership as 70% of active amateurs, remember that is active operators not just licence holders. We still have a lot to do to convince more out there to join. **ar**

CLUB CORNER

WIA Western Zone

Annual meeting of the Western Zone WIA Victorian Division to be held at the Lake Bolac Hotel, Lake Bolac.

At 1330 hours on May 26 1990

All amateurs welcome.

Bob Pitcher Sec VK3NBV
Box 539 Hamilton 3300
(055) 72 1788

International Amateur Radio Club

The first regular privately conducted amateur radio licence exam in Australia was held on Sunday 4th March 1990 at the International Amateur Radio Club (IARC) in Sydney. (AHARS would seem to have prior claim to this distinction, Sam, See AR Feb 1990 p50 - Ed)

Every 4 weeks all grades of amateur exams are conducted by IARC compared to the one exam every 3 months previously conducted by the government.

Sam VK2BVS says that this should help to motivate people to try again for the next exam instead of thinking why wait 3 months - I'll get involved in some other more accessible interest.

Even though candidates risk being turned away because of lack of space or materials, they were allowed to sign up for the IARC

conducted exam on the day. Previously people had to apply one month prior to a government exam date.

Sam says this gets rid of an unnecessary restriction and makes the exam more accessible for people in today's dynamic lifestyle. 14 people attended the IARC examination and got their results same day; and the next day, a Monday, those who were successful were able to show their exam result and

obtain their amateur licence at a DOTC office.

Who will be second?, third?, fourth? to organise regular private amateur radio licence examinations in Australia?

Sam says now that anyone can apply to conduct amateur radio licensing examinations. The training, examining and promoting of our hobby is in the hands of all 18,000 Australian amateurs. Does this mean we could have 18000 exam centres in Australia? Well Sam says probably not. However because the means of motivating people and directly experiencing the satisfaction of the results is now



First happy band of candidates for IARC privately conducted AOCP exam. (We wonder if the hand-held helped to provide answers? Ed)

all in the hands of every radio amateur, rather than the government, the effect must be to motivate amateurs to fill their exam rooms or experience dropping numbers of candidates. - This means promoting amateur radio in the general community, wherever you live.

Sam says dropping numbers of candidates in Government exams previously had little effect on amateurs, because what was out of sight was out of mind. Now the situation has changed.

To enrol in the next IARC amateur radio licence exam, telephone Sam on (02) 407 1066. If you are holding exams, write in and let us know, so it can appear in this journal.

Moorabbin & District Radio Club

**Combined Trade Day And White Elephant Day
Big Event Planned For June**

Trade days and white elephant days at the Moorabbin and District Radio Club have always been well attended and voted very successful by all concerned.

This year, the club has decided to combine the two events into the one big event.

Additional accommodation is being arranged, and adequate free parking is avail-

able around the club rooms, which are located in the Turner Road Reserve in Turner Road McKinnon Melway Map Reference 77 G 9.

Most important of all is the date Saturday June 16th 10 am to 4 pm. Doors will open at 8.30 am to allow traders and others involved to set up their stands.

Intending participants or visitors requiring further information should contact the Club's hard working Secretary Doug Richards VK3CCY, who is QTHR or telephone (03) 583 4462.

Allan Doble VK3AMD
Publicity Officer
(03) 570 4610

ar

QSLs FROM THE WIA COLLECTION (23)

**KEN MATCHETT VK3TL HON CURATOR WIA QSL COLLECTION
PO Box 1 SEVILLE VIC 3139**

Nauru — Phosphate Island C21NI

On most atlases the island of Nauru appears as a small dot just south of the equator. It is one of the smallest nations on earth being about 20 km around its perimeter. The C21NI QSL is that of the Nauru Amateur Radio Club, and it shows the island's location. It will be seen that the island is south of the Marshall Islands, just west of its nearest neighbour Ocean Island (Western Kiribati) and north east of the Solomons.

Around the island is a coral reef which is exposed at low tide. This necessitates the construction of a huge cantilever bridge jutting out into the sea from which the island's only export, rock phosphate, is loaded into ships. By the shore is a strip of fertile land on which most of the vegetation and houses are found. On the inner side of this fertile strip rises a plateau approximately 70 metres high from which the phosphate is extracted by machinery leaving a moonscape-like pattern of high pinnacles of hard limestone.

A few years ago Nauru was widely regarded as the world's richest nation per capita. However, losses by Air Nauru, the Nauru Pacific Shipping Line and sundry debt problems threaten to change the picture. Supplies of phosphate are rapidly diminishing. It is hoped that a solution will be found through profitable investments for these islanders.

Being an island only one degree south of the equator, the humidity is very high and special precautions have to be taken to prevent mould on clothing and furniture, not to mention electrical equipment. All the Government buildings and the homes of expatriates are air-conditioned. Rainfall is very variable and can be as high as 180 inches (about 5,000 mm) annually. Temperatures are fairly high (about 30 deg C) with little difference between day and night temperatures.

Prior to 1914 Nauru was part of the Protectorate of German New Guinea, but upon the outbreak of World War 1, the island was occupied by Australian forces. After the war, Nauru was jointly administered by Australia, Great Britain and New Zealand. An Aus-

tralian Administrator was appointed. After a period of Japanese occupation (from 1942 to 1945) an Administrator was again appointed, but the island finally gained its independence on 31st January 1968. It became a Republic under a President, the first one being Hammer DeRoburt (who, incidentally gained much of his schooling at Geelong, Victoria).

The population of Nauru is about 8,000 some 5000 being native Nauruans, the remainder being made up of other Pacific Islanders (who provide much of the work force), Chinese (who are important traders) and others. There are also a few hundred Australians and New Zealanders who provide much of the work force in administration and education.

This QSL, dated October, 1977 was sent by the Nauru Radio Club to Old Timer, Des Butler VK1DL of Hughes, ACT. Des became a Silent Key in 1986, his QSL collection being donated to the WIA by his widow, Jean.

C29ED

This QSL shows the national flag of the young nation. The colour is deep blue (representing the ocean) and the flag is traversed by a central yellow band that represents the position of the equator relative to the island (represented by a 12 pointed star). This indicates the number of native tribes on the island. The call C29ED was a special issue call, the suffix standing for the Education Department (The writer at the time was the Director of Education on the Island.) The individual call of C21TL was also used. The many thousands of contacts made over nearly two years on Nauru gave many radio amateurs from nearly 200 countries their first CW or SSB contact with the island.

The QSL shown and dated January 1973 was sent to that most successful DX'er Morrie Morris, VK3BZ of Parkdale, Victoria. It was part of several thousand excellent QSL cards donated by his widow, Mary.

VK9RJ

In 1956 the island of Nauru shared the VK9 prefix with three other VK9s (Norfolk Island, Papua and the Territory of New Guinea) although most of the ARRL country

C29ED

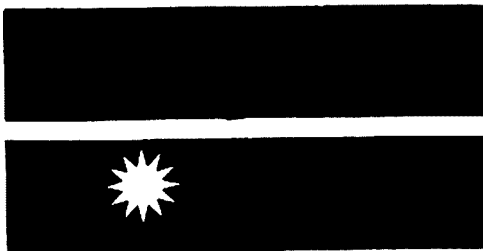

REPUBLIC OF NAURU

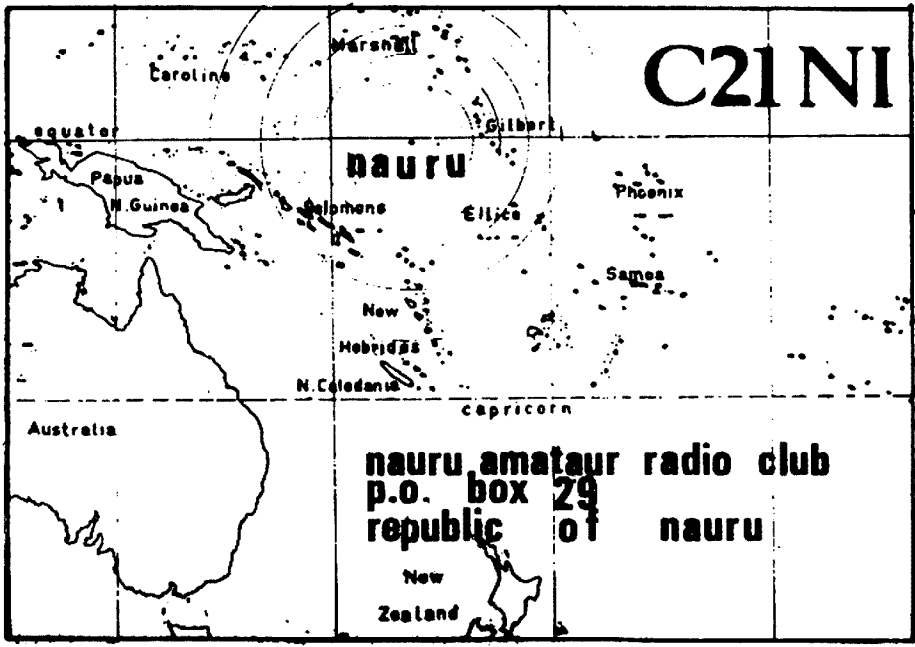
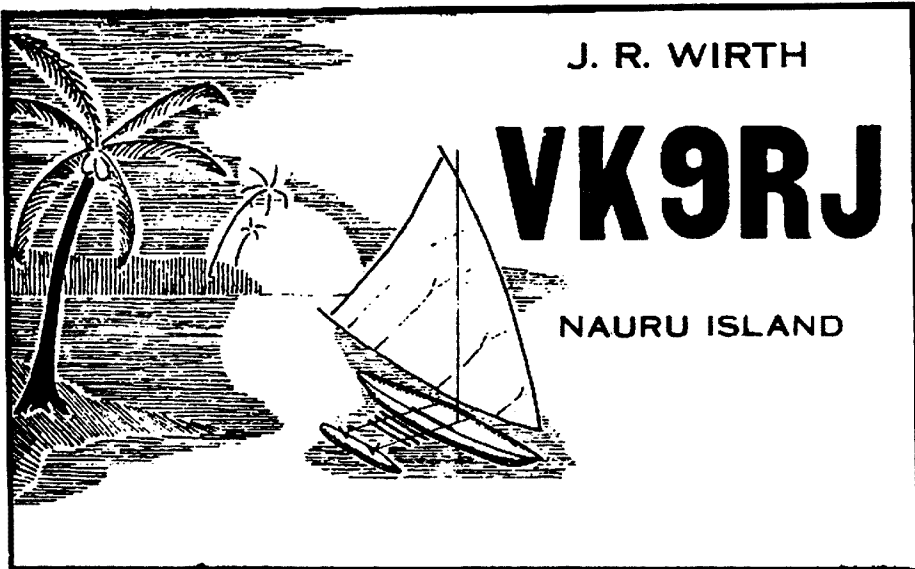

station after independence using the new call C21JW. This really caused some excitement on the bands. he returned to NSW in 1970. The WIA collection also contains QSLs from Danny Weil's DX-pedition around the world. When on the sloop "Yasme" he came ashore on Nauru in 1956, operating with the call VK9TW. This operation was only a few weeks before the Yasme sank under him after hitting a reef 150 miles from Port Moresby. Danny was the sole mariner on board at the time and was rescued by a Catalina flying boat. Bill Hempel, then VK3AHO (now VK4LC) operated as VK9BH (1963) and Laurie McInnes as VK9AM (1962), but despite these activities VK9 QSLs remained fairly scarce items. Nowadays and particularly since the formation of the Club station C21NI, several native Nauruans have qualified for their amateur licence, thus reducing to a considerable extent the degree of rarity of Nauru in DX circles.

If you would like to play a part in building up the WIA QSL collection and to save something for the future, would you please send a half-dozen (more if you can spare them) QSLs which you feel would really help the collection along.

All cards are appreciated but we especially need commemorative QSLs, special event station QSLs, especially assigned call QSLs (eg VK4RAN), pre-war QSLs, unusual prefixes, rare dx and pictorial QSLs of not so common countries. Could you help? Send to PO Box 1, Seville 3139 or phone (059) 643 721 for card pick-up or consignment arrangements for larger quantities of cards.

Thanks

The Wireless Institute of Australia would like to express its thanks to the following for their contribution of QSL cards towards the Collection:

- (Supplementary List)
- Albert VK6UA
- Frank VK2QL
- Austin VK5WO
- Brian VK3BBB
- Bill VK3AQB

Also the friends and families of the following "silent keys" (Supplementary List).

- Alan Costello VK3YT
- Ron Hooper VK5NL
- John Rankine VK5JF

ar

listings of the period were dated January 1957.

The actual announcement of the addition of Nauru to the ARRL countries list was made in the July 1956 issue of QST. The announcement followed as a result of the operation from Nauru by G2RO and the subsequent submission of a confirmation by a DXCC member. DXCC credit was given starting September 1st, 1956 for creditable confirmations dated on or after November 15th, 1945.

It was not until after independence came in 1968 that the numeral prefix C2 was allocated from the prefix block, C2A-C2Z. In fact, the new prefix was quite late in getting on the air as evidenced by the date of the QSL shown. The VK9RJ QSL resulted from a QSO in December, 1968 with Les Catford of Malvern, SA despite the fact that independence had

been granted in January of that year. QSL cards with the VK9 prefix were not all that common. Well known was the call VK9RJ used by John Wirth. Jack, as he was generally known, was the wireless operator in charge of Radio Nauru for a few years. He continued on as operator in charge of Radio Nauru for a few years. He continued on as operator of the

WIA slow morse transmissions

VK2BWI Nightly at 2000 local on 3550 kHz	VK5AWI Nightly at 1030 UTC on 3550 kHz
VK2RCW Continuous on 144.950 MHz 5 wpm, 8 wpm, 12 wpm	VK6RAP Nightly at 2000 local on 146.700 MHz
VK3RCW Continuous on 144.950 MHz 5 wpm, 10 wpm	VK6WIA Nightly (except Saturday) at 1200 UTC on 3.555 MHz

SILENT KEYS

We regret to announce the recent passing of:-

Mr D R Gill	VK2SH
Mr David Priday	VK2CDZ
Mr R S Fenn	VK3
Mr Eric Cagney	VK4EC
Mr Neil White	VK5WN
Mr F L Brady	VK5AFL

Dudley Ross Gill VK2SH

I regret to announce the passing of Dudley Ross Gill (Doug), late of Port Macquarie and Tamworth.

Doug held the call sign VK2SH for many years and was very active on the bands during the immediate post war period. An ex-Wireless Mechanic in the RAAF 1941/1945, he obtained his AOPC in 1947.

Doug will be well remembered in the Radio Sales and Service Industry going back to pre-war days in the Manning River District (Gills' Radio Service) and later in Port Macquarie in partnership with Pete Alexander (Gill and Alexander). He retired about 12 years ago and resided in Port Macquarie. He was 79 years old.

PETER ALEXANDER VK2PA

Eric Cagney VK4EC

On the morning of 1st March 1990 Amateur Radio in Australia lost another true Old Timer and I lost a friend of 40 years, when Eric Cagney passed away quite suddenly. He was first licensed in 1935 and would have been 81 in May.

We met quite by chance at the Rockhampton Showground in 1949. I had been interested in radio since 1932 when, at the age of 11, I built my first crystal set, but Eric said a man was not really "into" radio until he had acquired his ham licence. Before long I was invited to his shack in Bracker Street where he operated a home-brew AM rig running 30 watts to a single 807 feeding a three-element Yagi (also home-brew) on a windmill tower. With this relatively simple equipment (and later with an SSB "grey box" Eric worked the world and won many overseas DX awards. Under his gentle persuasion I finally went for my ticket, home-brewed my equipment and hit the air as VK4FU in November 1953. The late Harold Hobler (VK4DO), the late Bob Greenwood (VK4NG), Bill Dodd (VK4WD), Eric and I formed a group which later led to the foundation of the Rockhampton Radio Club, which used to meet at Rockhampton Airport where Bob Greenwood was employed.

I learnt a great deal from Eric: not so much the technical stuff (which is available from books), but he demonstrated to me the technique of good operating, courteous conduct on

air, the importance of a clean signal and the tremendous sense of fellowship which exists among hams worldwide. It must also be recorded that our friendship extended to our wives and families and our homes were always open to each other. Eric's wife, Thelma, died some years ago and he never quite became reconciled to his loss.

I left Rockhampton in 1955 moving first to NSW and then back to my home state, Victoria, in 1960. Since 1955, on almost every Sunday morning at 0800 local time, Eric and I with, in more recent years, another Old Timer, Bill Beaney VK4BN, have maintained a sked on 20 metres, the last being only five days before Eric's passing.

My wife and I offer our condolences to Eric's son Noel VK4VIS, and to other members of the family.

Vale, old friend and quiet gentleman. I shall miss you more than I can say.

JOHN FULLAGAR VK3AVY

Neil Cameron White VK5WN

Neil was born in Adelaide on 7th May 1917 and lived in the Prospect area until he joined the RAAF in 1941. He had started employment in the State Government — Architect-in-Chief's Department as an apprentice electrician, and was able to continue in the RAAF as a maintenance electrician, seeing service in the Northern Territory and New Guinea.

After the war, he returned to the Architect-in-Chief's Dept and for a while was transferred to the Dept of Labour and Industry, maintaining lifts. Sometime after his return to his former Dept, there was a name change to the Public Buildings Dept, in which he was finally in charge of all State Government lift maintenance, as a Senior Engineering Assistant.

By the time that Neil retired, about 10 years ago, he had developed three major interests: - football from way back — he was a very keen follower of North Adelaide, Amateur Radio and his attachment to his 7 grandchildren — he told many people that he was a lucky man, to have their affection.

Like many other amateurs, his first equipment was all "home brew", but later he was able to acquire some of the commercial gear. He covered most of the bands, and when the VHF group formed, he was their first Chairman, and was very keen on 6 metre contacts. Later he built his own 160 metre transmitter, and used that band for the Sunday morning broadcasts.

A lot of time was spent in helping with the setting-up of the Burley Griffin building.

Neil played bowls for Hawthorn Bowling Club for about 6 years, until a stroke took him "out of action" and, unfortunately, he had

numerous sessions in hospital over the last few years, but he always looked forward to the Sunday morning contacts with Ossie Scott and Alan Haines.

He died suddenly on reaching his younger daughters' home at Tecoma in the Dandenongs on 24th February 1990. To Joan, his widow, and the family we extend our sincere sympathy.

CLIFF MOULE VK5CX

Kenneth Davidson Gott VK3AJU

Ken was born at Moreland, Victoria in 1923. He never knew his father, who was reported "killed at sea" soon after Ken's birth. "I didn't mind not having a father, other kids' fathers beat them".

As a schoolboy at Stewart St State School and Northcote High, he set up a telephone link with his mates along the back fences of Blyth St, East Brunswick. He built crystal sets and simple radio sets.

At Melbourne Boy's High (1939-40) his talents for writing and debating came to the fore, although a continuing interest in fire-works led him to organise an explosion while on a geology excursion to Lilydale.

At the University of Melbourne (1941-7) he edited the weekly newspaper, Farrago, and the Melbourne University Magazine. He was active in many student activities — debating, the Labor Club, the Fine Arts Society, the Free Thought Society. His poor eyesight resulted in his rejection from the Army, but he helped to organise student war-work, and himself worked in the Ardmona cannery during vacations. He also worked as the Herald University correspondent. "If there's no news around, a good journalist will go out and make some".

He graduated BA Hons in Economics in 1947, and later took out a Diploma of Journal-

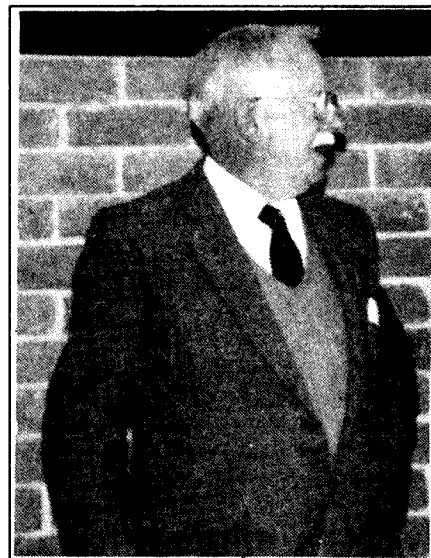

Kenneth Gott

ism, then worked as a journalist and economic consultant until 1965.

He spent 1948-9 in London, where he married a fellow student, Beth Noye, who was studying at London University for a PhD in Botany. Worked in the BBC newsroom, then went to Prague as editor for the International Union of Students, until 1952. Returning to Australia, he worked in the Melbourne bureau of West Australian Newspapers, as a National feature writer for "The Australian", and contributed regularly to "The Bulletin", "Nation", "Straits Times" (Singapore) and

others. He also published a number of books.

During these years their three children — Margaret, Jim and Miranda were born.

In 1965, he went to New York as Editor for Business International Corporation, a research and publishing company servicing international business, and in 1970 to Hong Kong to set up their Asia-Pacific office, returning to New York in 1976.

He returned to Australia in 1978 as a policy analyst for Conzinc Riotinto Australia, retiring in 1983, but continuing to work as a

consultant for various companies and organisations, and only now found time to return to his interest in amateur radio.

At the time of his death he was looking forward to once again taking a leading part in the John Moyle contest from his base near Kinglake, and was hoping to repeat his success of 1989.

He is survived by his wife Beth, three children and three grandchildren.

Whatever he did in life, work, politics or hobbies, he entered into with his whole being.

BETH GOTT

OVER TO YOU

ALL LETTERS FROM MEMBERS WILL BE CONSIDERED FOR PUBLICATION AND SHOULD BE LESS THAN 200 WORDS.

THE WIA ACCEPTS NO RESPONSIBILITY FOR OPINIONS EXPRESSED BY CORRESPONDENTS.

Import Costs Again

After reading the story in our journal (Over to You) about "Mr Blatant Greed", I thought you had better show your readers the other side of the coin.

Last year I decided I needed a new ATU so after reading all the HAM journals I could find, to see what was the best ATU around, I found one MFJ 789C V tuner and the price was \$339.00 US. One phone call and a Visa number, it was on its way.

It arrived via customs on 9/8/89; letter in mail to say collect your ATU from Tradex, at the airport. I arrived the next day at Tradex, collected the ATU, and went next door to Customs. This was the cost.

Customs value	\$450.32
Duty 21%	\$94.57
Freight	\$69.00
Storage	\$25.00
Sales tax 20%	\$130.77
	<u>\$769.66</u>

The above price does not included going to the airport or having a day off work to collect it. Why a day off work, you ask? Well, Tradex the custom agent, charges \$25.00 per day storage. I've enclosed all receipts of the above for 100% proof to the editor. The MFJ789C is advertised in Australia now for \$756.00 so sending overseas for ham gear is now out of the question.

JOHN FLEMING VK3CJF

71 NORMA CRES, KNOXFIELD, 3180.

VNG & CB Amateur Ham Etc — Feb 90

No doubts Dr Leiba is good at her chosen profession, but understandably biased in regards to the benefits of VNG frequencies. I and many others consider it only causes interference to the well tried WWV, with all the associated information. It does not even give you the "simple time" when you want it —

unlike WWV, and useless as regards checking radio propagation. The need for accurate time keeping has been covered by WWV for years. In my experience WWV was first on any check list to be used for Time Signals or Navigation, both ground and Astro. I was never out of communication and never lost, and now retired gracefully in one piece—so it must have worked. The time signal concept is OK — perhaps back on 7.5 MHz. At present it is only interference to something which is very useful to Radio.

To Ted VK4YG (same issue page 58) I am a "HAM" and have a "HAM" Licence, and am as good or better than most "HAMS" depending on which mode you mention. Only ex CB operators QSL on phone Ted, but I QSL on CW. I "ROGER" but never "ROMEO" (CB AGAIN), and have never been out of communication. We all have our problems Ted — some, bad phonetics, some, bad CW — and some when mobile, calling on the wrong frequency (?) Let it lie Ted, and concentrate on WICEN.

G. W LANYON VK2AGL

16 HILTON AVE, ROSELANDS 2196

Knockers

How many members are there in the VNGKO which seems to have now surfaced in Australia after a long period of residence in New Zealand? January 29th saw the demise of a sheet of Teletext which had been running for nearly three months. Facts were presented which gave the non-Amateur a distorted view of the issues involved with shared frequencies. This I take was the birth of the VNG Knockers Organization.

Now to my amazement AR Jan 90 carried a letter from an overseas member of VNGKO. D H Watkins VK2DDR must have impaired vision not to have seen the excellent articles in AR for March '89 and November '89. All the questions were answered and I am very sure that a letter to Honorary Secretary of the

VNG Users Consortium would have been answered with great clarity almost by return mail. The letter in AR Feb '90 from the Hon Secretary enlarges on earlier articles so I would expect all to be clear by now. Page 61 Jan '90 had further information on the coding of the signal of VNG which with a one chip demodulator would enable a simple computer (Vic20) to display on screen the seconds, minutes, hour of day, as well as the day number in the year. Now what else could be wanted — oh yes a signal could be sent to other equipment to use the information thus decoded.

R IAN HENRY ZL1BKZ-VK4BKO

27 McRAE RD, MT WELLINGTON,

AUCKLAND 1106 NZ

Field Day Rules (1)

I was disappointed to read of the removal of periodic reworking of FD stations from the John Moyle Field Day. For years we have requested the Federal Contest Manage to bring VK rules into line with ZL rules in this respect; to reduce the confusion caused, and to increase the enjoyment for all taking part.

These requests, among others, were obviously ignored. This FCM has chosen instead to change the rules without any prior warning or consultation to participants; to remove the VHF distance multipliers; to restrict operation to "local" stations only; to further reduce participation in the John Moyle by setting up his own VHF Field Day; and finally, to permit only one contact (per band) with each station taking part.

I have been an active participant in the JMFD for many years. It was one of the most enjoyable and challenging contests in the VK contesting year... much of the thrill is in planning and establishing a competitive effort; or in pulling a long-distance VHF contact out of the noise. Frank is obviously not aware of how little activity there is in this contest. As an experienced contester he should know the frustration of calling into a dead band!

I do recognise that it is never possible to please everybody. Does it seem unreasonable to circulate ideas for rule changes via the Contest column for comment first? (and to amend rules only after due consideration is given to the responses). Finally, contesting in

VK already suffers from much confusion and too many rule changes. For heaven's sake, when we do finally come up with a common sense set of rules, leave them alone!

GEOFF HUDSON VK3CGH

16 FOWLER ST, BOX HILL STH 3128

Field Day Rules (2)

The unimaginable has occurred, it would appear that the very successful North East Radio Group, (the NERGs) — VK3CNE will not be participating in the John Moyle Field Day this year. This will be the first time since the inception of the group that this activity will be missed, and the reason? Another rule change! And what a change.

This year there will be no repeat contacts allowed with other field stations, why not? From discussions with the contest manager it would appear that as he was instructed to allow overseas QSOs by the Federal Convention he decided that this should be like other overseas contests and only allow one QSO per station per band.

Two issues come to mind; one is the effect on this contest, the other is the method used to change contest rules. Operators will sit around for hours searching for QSOs in the field day. Last year there was such low activity that operators were falling asleep! With this reduction in possible QSOs there will be no point in setting up a station. This will become another WIA contest killed off by rule changes.

You may think that a strong statement but it is true. Look at the participation rates in all the WIA sponsored contests over the last few years. Included are the RD, VK/ZL/O, Novice and John Moyle. Falling activity is not being experienced by other contests, the CQ Worldwide for example is continually growing. WHY?

The answer is, not just that the rules don't change much, but that the contest is fun and a challenge and any rule changes are made to improve these elements of the contest. When is a contest fun and a challenge? When there are more QSOs possible than you can make, so improvements in your operating style, equipment and technique will net more QSOs. I can give an example of what I mean, some years ago the RD contest had an open section which meant just that — all bands all modes, along with a one hour rework period on VHF. This meant that an operator would decide on an HF band and "run" QSOs there, but he would have to keep an ear on VHF as well and every hour or so run through all the repeat QSOs on VHF. This required skill and was a real challenge, therefore that year many operators stayed up for the full 24 hours and were rewarded with over 2000 QSOs. Then the rule changes came, with no real explanations.

- No combining HF and VHF — now 2 separate categories.
- Rework time out to 3 hours.

Result? Less activity! What were the rule changes aimed at? There was talk of the inequity of country versus city operators as

there was little VHF activity in the country, no mention of lower HF noise in country, or relative average size of land or height above sea level, relative income and family tolerance levels. Let's face it, some have good contest locations and some don't and we will never achieve a truly equitable contest. But changing the rules so that there are less possible QSOs means that there is no incentive to improve, thus no challenge and activity drops off, just as in the RD contest.

Changes in rules for other contests have also seen a drop in activity, so what to do? Have a set procedure for changing rules. Simple, but it is not done currently. I have been a contest manager and to change a rule all I had to do was submit the altered copy for publication in AR — that was it! No discussion, no consideration of the operators, just change it. Rules for WIA contests are usually published the month before, thus there is no chance to debate changes or have points clarified. There should be a fixed method for changes to WIA contest rules. This should be a two step approach, firstly to get the rules back on track and then to make sure they stay there. The following is offered as suggestion.

1. The WIA establish a committee of actual WIA contest operators and have them review the current rules of all WIA contests.
2. The committee identify changes to the rules to steer the contests back to their original courses.
3. The proposed changes be widely publicized in AR and copies sent to past and present participants calling for comments.
4. Clubs be requested to conduct "contest forums" where the new rules are discussed.
5. The information gained from 3 and 4 be digested by the committee and altered rules again produced for comment.
6. After a suitable period final rules are produced and published for all WIA contests, perhaps in a special document along with sample log sheets, dupe sheets and cover-sheets.

That would perhaps help to get participation back. Any further rule changes would have to go through a similar process which may take twelve months but the changes may then be for the better and not just because a small vocal group perceived some inequity.

A set of evaluation criteria should be established to help determine if the changes are valid and desirable. The first criterion for any change must be, "Does it improve the contest for the majority of operators?" The change to the JMFD which removes repeat QSOs for field stations loses on this test!

Well, contestants, x-contestants and would be contestants, what do you think? Are you sick of the continuous changes to the rules? Let your division and the executive know of your concerns and let's see if we can improve the WIA sponsored contests.

GREG WILLIAMS VK3VT

**1 NOORABIL COURT, GREENSBOROUGH
3088**

Discrimination?

Having just read, and substantially agreed with, the News Editor's comment in March, I am moved to add my "two bob's" worth to what Jim, VK3PC, has to say about discrimination within our ranks.

Although now over 60, I am in no sense an "Old Timer", having only gained my Novice Licence in mid-1988 and the "Full Call" later that year.

The point I wish to make is that I think the WIA is itself culpable of practising "Ageism".

I refer to what seems to me the elitist way in which entries are listed in the Australian Radio Amateur Call Book. For each State, two letter call signs are given precedence, in their own special section, at the beginning of each State's entries.

As a matter of practical everyday use of the Call Book, this method of listing is most frustrating and time consuming because, after first deciding in which of the two lists a call sign will be, we then have to find the start of the appropriate list and then find the actual entry. A nuisance — especially in mid-QSO.

Although not limited to "Old Timers", two letter calls are mainly the privilege of those who have been licensed for a very long time and I think that, simply by the continued allocation of such a call sign, recognition rightly is given to this fact. However, providing precedence by separate entries in the Call Book, apparently because of this, is elitist in the extreme and definitely discriminates against those who are not so favoured.

This furthers an undesirable "Them" and "Us" division of the WIA membership as a whole and, as a member, I most strongly object to this. What do others think?

DENNIS G BATES VK3DGB

**9 GLENALVA PARADE,
CANNONS CREEK 3977**

(The 1985-86 Callbook was in fact listed with mixed two and three letter calls, and this is the sequence provided in most computer list-sorting programs. We received so many complaints, not all from two-letter calls, that we re-wrote the sorting program to put the two-letter call signs first. Ed)

Roger Rejoins

(Reprinted with writer's permission. Was also read on VK2 broadcast.)

OK. I give in! I'm joining the Institute again.

Federal has regained us the use of 50 MHz, my all-time favourite band. Something is being done about member services on a national basis. Amateur Radio magazine is showing signs of improvement. There's active dialogue and discussion about the future of the hobby. The NSW Division is taking a "commercially aggressive" approach to attracting members, and keeping them — with good quality, informative Sunday broadcasts, regular Institute-sponsored "events" and contests, special of-

fers for members, new beacons and UHF repeaters, etc. The Institute is showing signs of Life!

Please accept the enclosed 3-year payment for full member subscription. 73.

ROGER HARRISON VK2ZTB
347 DARLING ST BALMAIN 2041

SE Asian Piracy

I thank Barry McNeil VK2FP for providing us with some first hand information of the regulatory situation in Indonesia and Singapore.

However the 2m handhelds are not the focus of my complaint.

The bone of contention involves 10 m base stations — they have a 10 kHz spacing and a power in the range of 10 to 25 watts.

We would like to know the manufacturer and suppliers of these sets.

Regarding the laissez-faire regulatory situation which appears to apply in SE Asia, Barry takes the view that nothing can be done.

My thinking is slightly different.

Most countries, in the Pacific Basin are signatory to the ITU convention and maintain well disciplined regulatory structures. Countries such as in SE Asia who flout the convention will always be in the minority.

Legitimate users of the spectrum who are interfered with eg VK amateurs will complain. Continued pressure in the form of these complaints generally produces results in the long term.

What we are talking about here is not just a minor breach of the convention — we are talking about the flagrant disruption of a complete HF allocation — which I have not seen previously in 40 years of amateur radio.

As Barry points out, it is a massive problem — but I cannot see that we have any option but to tackle it.

If you do nothing you get precisely that.

Melbourne is within single Hop F2 distance of all the countries involved — this means all of Southern Australia is right in the firing line. It is very much a VK problem.

A concerted campaign is required by amateur societies in the region, and needs to be organised.

I am not new to this business — I spent many long hours back in 1958-59 in the fight to save 6 m from CH O. The records of my work are in the Institute files.

Nonetheless I feel it is time for the younger generation to come forward and do their bit.

IAN BERWICK VK3ALZ
107 LOONGANA AVE, GLENROY 3046

Ten Metre Activity

Recent letters lamenting the present state of the 10 metre band are interesting.

Graham Muirhead says "We VKs have only ourselves to blame", but the problem

may be a bit deeper than that.

If we use long-haul 6 metre DX as our measuring stick, then this present sunspot cycle, even if it were to stop dead tomorrow, is probably the most remarkable in the history of radio, and certainly the most remarkable since WW 2, all 4 of which (Cycles 19 through 22) I have enjoyed.

In 1968/69, during Cycle 20, the 10 metre band most mornings was packed full of K and W stations, all strength 7 to 9.

One could work almost any state of the union simply by asking for it. During a contest, Yanks could be worked at 3 or 4 a minute, up to around 200 an hour, for hours on end, as my log books testify.

But try and do that today! The silence on the band is deafening! The US beacons are often heard, and a handful of regulars front up now and then at good signal strength, but overall activity is literally not one hundredth part of what it used to be. And all of these remarks are true, perhaps to a lesser degree, of Europe in the evenings.

I can't work out why. Are TVI-RFI problems endemic? They tell me that linears sold in the States have 10 metres disconnected to foil CB operators. Is that the reason? Or is it all those Asian intruders that have so effectively revealed our Intruder Watch for the paper tiger it is?

Fellow hams! Lend me your ears? Consult your propagation predictions! Rotate your antennas! Set yourselves down in front of those rigs, and call, call, call!!

AL RECHNER VK5EK
404 ESPLANADE, MOANA 5169

Intruder Watching

I'd like to suggest an aid to Intruder Watching in VK.

It is without a doubt that we have now the most efficient and effective means of passing written information, the International Packet Radio/Amtor Network. A WIA BBS could be set up primarily for intruder reports ... Many of us will hesitate to go to the trouble of writing out a report, putting it in an envelope, and posting it, when a few strokes on the keyboard would suffice, and get the information there quicker!

I've spent the last couple of years in & out of Asia, and monitored the bands up there. Being familiar with a number of Asian languages, I'm getting fed up with rumours and hearsay mainly from people who want to do in their favorite 'scapegoats'. Let's get to the truth of the matter, and find out who and when and where and why!

Comments, please!

PETER ROBINSON VK4DFR
23 MASON ST, STRATFORD 4870

Blatant Greed Again?

I refer to John Wooding's letter on the above subject in your March issue of AR.

I wholly support his views and comments

concerning the prices quoted by Australian dealers in respect of 572G radio tubes.

My FL2100Z amplifier has been out of action for months due to the want of two such tubes. My last quote from an interstate city dealer, about six months ago, was \$239 each, to which I commented — "You're joking".

At about the same time, the purchase price in the US was given as \$US95 each, and in England as £60 (about \$A120). So, now they cost \$395 each (in Australia)!

At this rate of increasing cost they should retail at around \$700 each, in about twelve months time!

Does any keen ham want a FL2100Z amplifier in excellent working order — going very cheap? (Purchaser to supply own tubes of course.)

(By now you have seen the letter from VK3ZJF in April, quoting \$211 approx for a 572B. Not quite so bad!! Ed)

V H A McBRATNEY VK5YD
PO BOX 151, BLACKWOOD 5051

VCR TVI — Possible Solutions

VK2COX asked in the February issue of AR for solutions to tape playback related TVI. It seems to be the transmitted RF getting somehow to the very low-level video tape playback preamplifier, which causes his troubles. The VCR records video on tape using a kind of FM covering frequencies from a few kilohertz up to about 7 MHz. Signal levels are some tens of millivolts.

The coupling in his case seems to be via power lines. Thus a good RF choke in his transmitter power leads and in each recorder's power leads and in any other leads coupled to the VCRs should help. The power or signal lead wrapped about ten turns around a good ferrite bar or two U-shaped cores together should be enough. The transmitter should be grounded separately from main power to cold water metal pipes or to some similar good ground. Main point is not to let the RF to go to the power lines in any form, neither conducted or coupled.

SAKARI MATTILA OH2AZG & VK3TJE

LAAJALAHDENTIE 26B25
SF-00330 HELSINKI FINLAND

Roger Romeo

Lindsay Lawless VK3ANJ states that ROGER has been superseded for several years by ROMEO (AR, April). I was aware that the NATO phonetic alphabet was amended to delete Roger and substitute Romeo. However, that does not necessarily mean that there is an automatic alteration to any "prowords". To settle a bet and possibly improve my operating skill, please tell us Lindsay, your authority for this statement.

BOB JACKSON VK7NBF
FALMOUTH HOUSE, FALMOUTH 7215

HF PREDICTIONS

ROGER HARRISON VK2ZTB

May Charts

For ease of use and to accommodate space restrictions in the magazine, I have provided predictions applicable for three major regions of Australia:

VK EAST. Covers the major part of NSW and Queensland.

VK SOUTH. Covers southern-NSW, VK3, VK5 and VK7.

VK WEST. Covers the south-west of West Australia.

For each of these regions I have selected six "terminals" to major continental regions of the world, or regions of particular interest, such as Australian Antarctica (VK ANTARCTIC). From time to time, I will include predictions to cover particular DXpeditions or other activities of special interest. This month, following a number of requests, I've included predictions for the long path to Europe, first introduced last month.

Feedback from readers and users would be most appreciated - let me know what you feel is wrong, and what's right, about the paths, presentation or any other aspect.

The charts

These charts are different from those you see published elsewhere, and arguably more useful to the amateur fraternity as they give, effectively, the predicted signal/noise ratio for each hour and for selected bands.

The charts are organised in 24 rows, one for each hour UTC (first column on the left). Don't forget to add the appropriate number of hours for your time zone, including daylight saving where it applies. The next column give the MUF (maximum usable frequency) for each hour, followed by the field strength at the MUF, in decibels referred to 1 uV/metre (dBU). The column marked FOT gives the "optimum" frequency - the most reliable frequency for the path.

Then come five columns, one for each of five selected HF bands. The numbers in the column represent predicted field strength at each hour in decibels referred to 1 uV/metre. Here it represents "raw" signal to noise ratio as urban noise levels are typically 1-2 uV/metre, but does not take into account the advantage offered by particular transmission modes. The results are based on a transmitter

power of 100 W output (except where noted later), the use of modest 3-element beams or similar, and for "median" conditions. Where the results fall below -40 dB, no output is printed.

Enhanced conditions may improve S/N ratios by 9-15 dB. The use of CW or digital transmission modes show better results than SSB. If you've got 400 W output, you get a 6dB improvements. Where conditions warrant it, I have include predictions for the bands below 14 MHz, deleting the upper bands.

Europe, Long Path

The long path predictions for Europe, which means you can have contacts during daylight hours here, show some interesting results for May. The charts for VK East and VK South have been calculated with the 'standard' parameters - 100 W, median conditions. However, the VK West chart has been calculated using 400 W power and assuming 'good' conditions (10 percent of the time). And the signal strengths aren't all that good even then! So, take heed. If you live in the west, you'll need maximum legal power, a beam and good prevailing conditions to get through.

The predictions are calculated using a program known as "FTZ", for IBMs and compatibles, distributed by FT Promotions. If you want to know more about this program, call (02) 818-4838. ar

UTC	MUF	DBU	FOT	7.1	10.1	14.2	18.1	21.2
1	16.0	-21	11.5	-29	-15	-12
2	15.8	-26	11.4	-35	-19	-14
3	16.2	-29	11.7	-22	-16	-16
4	17.7	-27	12.5	-25	-17	-17
5	20.0	-22	14.6	-29	-19	-19
6	22.0	-17	16.1	-31	-19	-19
7	23.6	-13	17.3	-30	-19	-19
8	24.2	-10	17.8	-26	-16	-16
9	23.9	-9	18.2	-20	-12	-12
10	21.7	-9	16.5	-33	-15	-10
11	19.4	-9	14.7	-23	-10	-8
12	17.6	-8	13.3	-15	-8	-8
13	16.3	-6	12.3	-31	-9	-6
14	15.4	-3	11.6	-19	-4	-5
15	14.8	0	11.1	-34	-7	0	-4	-11
16	14.1	5	10.7	-11	4	5	-3	-14
17	13.6	8	10.3	6	12	7	-4	-16
18	12.3	10	9.4	13	14	5	-10	-25
19	10.9	11	8.4	16	13	0	-19	-38
20	10.7	13	8.3	19	15	0	-21	...
21	13.9	13	10.8	23	21	12	-1	-15
22	18.0	9	13.0	-18	3	11	9	4
23	17.4	-2	12.3	-31	-7	-2
24	16.8	-12	12.0	-21	-10	-9

VK EAST - EUROPE S.P.

UTC	MUF	DBU	FOT	7.1	10.1	14.2	18.1	21.2
1	16.9	-10	11.9	-18	-8	-8
2	16.6	-19	11.8	-29	-15	-12
3	17.1	-23	12.1	-39	-20	-14
4	18.9	-22	13.1	-24	-16	-16
5	21.4	-18	15.3	-29	-18	-18
6	23.7	-14	16.9	-32	-20	-20
7	25.4	-11	18.2	-33	-20	-20
8	25.5	-11	18.7	-36	-17	-17
9	22.3	-13	16.7	-23	-15	-15
10	19.0	-16	14.2	-36	-18	-13
11	15.9	-19	11.9	-26	-14	-13
12	13.5	-21	10.0	-18	-13	-16
13	11.8	-19	8.8	-30	-13	-14
14	11.1	-15	8.2	-19	-11	-17
15	10.9	-8	8.2	-11	-8	-18
16	11.0	1	8.2	-11	0	-18
17	11.1	8	8.3	7	9	-18
18	10.4	10	7.9	12	11	-23
19	9.7	11	7.4	16	10	-7
20	10.0	13	7.7	18	12	-5
21	12.7	13	9.3	22	19	8
22	17.7	12	13.6	25	20	11
23	18.5	10	12.9	29	14	11
24	17.8	1	12.5	-21	-2	1

VK STH - EUROPE S.P.

UTC	MUF	DBU	FOT	14.2	18.1	21.2	24.9	28.5
1	13.8	6	11.0	5	-9	-23
2	15.8	4	12.6	6	-1	-11	-26	...
3	17.8	4	14.2	7	3	-3	-15	-28
4	19.5	4	15.6	7	6	1	-8	-19
5	20.6	4	16.6	7	7	4	-1	-14
6	21.4	5	17.2	8	9	5	-1	-11
7	21.7	6	17.5	10	10	7	0	-9
8	21.6	7	17.4	14	13	8	1	-8
9	21.2	11	17.1	22	17	11	1	-10
10	20.3	12	16.4	24	17	9	-2	-14
11	19.2	10	15.5	22	13	4	-10	-25
12	17.0	10	13.5	18	6	-6	-22	...
13	14.7	10	11.6	12	-4	-19
14	12.9	10	10.0	5	-16	-36
15	11.5	10	8.9	-3	-28
16	10.9	10	8.3	-8	-35
17	10.6	10	8.0	-10	-39
18	10.5	10	8.0	-10	-39
19	10.3	10	7.9	-12
20	9.7	10	7.5	-18
21	9.1	10	7.1	-24
22	9.3	10	7.4	-21
23	11.0	10	8.7	-7	-34
24	12.4	10	9.8	3	-17	-37

VK WEST - EUROPE S.P.

UTC	MUF	DBU	FOT	7.1	10.1	14.2	18.1	21.2
1	18.9	-1	12.9	-33	-8	-2
2	18.2	1	12.5	-23	-3	1
3	17.6	3	12.1	-12	2	3
4	16.7	5	11.6	-9	4	5
5	16.5	7	11.5	-18	2	8
6	16.9	9	11.8	-8	7	11
7	18.6	8	13.1	-16	4	11
8	19.8	3	14.8	-12	2	4
9	16.6	-5	12.3	-28	-8	-5
10	14.1	-17	10.4	-17	-11	-14
11	12.3	-30	9.1	-21	-15	-16
12	11.4	...	8.4	-23	-16	-17
13	11.2	...	8.4	-36	-25	-25
14	11.2	...	8.3	-32	-31	-31
15	11.2	...	8.4	-38	-36	-36
16	10.5	...	7.9
17	9.8	...	7.4
18	10.1	...	7.8
19	12.8	...	9.3	-25	-22	-22
20	17.8	-22	13.7	-40	-21	-15
21	22.5	-11	15.6	-20	-12	-12
22	21.3	-7	14.7	-29	-13	-7
23	20.5	-4	14.1	-19	-7	-4
24	19.6	-3	13.4	-13	-4	-3

VK EAST - EUROPE L.P.

UTC	MUF	DBU	FOT	7.1	10.1	14.2	18.1	21.2
1	17.7	-5	12.3	-37	-11	-4
2	17.1	-1	11.9	-22	-4	-1
3	16.6	3	11.6	-39	-10	2
4	15.8	5	11.1	-27	-6	3
5	15.6	7	11.2	-14	3	7
6	16.0	8	11.4	-7	10	5
7	17.4	8	12.5	-14	4	10
8	19.4	2	14.0	-10	3	4
9	16.3	-4	12.7	-23	-6	-5
10	14.0	-14	10.8	-34	-13	-11
11	12.4	-25	9.5	-18	-14	-18
12	11.6	-34	8.8	-20	-15	-18
13	11.3	...	8.9	-29	-22	-23
14	11.2	...	8.6	-32	-32	-32
15	11.0	...	8.5
16	10.4	...	8.1
17	9.7	...	7.6
18	10.0	...	7.9
19	12.0	...	9.2
20	16.0	-30	12.7	-22	-16	-16
21	20.9	-18	14.9	-25	-17	-17
22	20.1	-17	14.1	-23	-15	-15
23	19.2	-14	13.4	-34	-16	-11
24	18.4	-9	12.8	-21	-9	-7

VK STH - EUROPE L.P.

UTC	MUF	DBU	FOT	14.2	18.1	21.2	24.9	28.5
1	12.4	...	10.0	-36	-17	-15	-17	-23
2	12.1	...	9.7	-37	-19	-17	-19	-26
3	12.4	...	9.8	-36	-17	-15	-17	-23
4	13.3	-38	11.0	-29	-9	-6	-9	-13
5	15.0	-21	11.8	-26	-3	2	-1	-5
6	15.8	-18	11.3	-22	-2	1	1	-3
7	15.5	-15	11.2	-22	-1	3	1	-4
8	14.9	-11	10.8	-15	3	5	0	-8
9	14.9	-2	10.9	-5	8	7	0	-8
10	15.1	-2	11.1	-5	8	8	1	-7
11	16.0	-12	11.4	-22	-2	4	3	-3
12	17.6	-13	13.0	-34	-11	1	4	-1
13	18.6	-13	13.8	-40	-15	-3	2	2
14	17.8	-17	13.5	...	-15	-2	2	0
15	17.0	-21	12.8	...	-14	-2	2	-1
16	16.3	-23	12.2	...	-39	-12	-1	-2
17	15.5	-26	11.7	...	-36	-9	-1	-3
18	14.9	-29	11.3	...	-35	-8	-2	-5
19	15.5	-40	10.3	...	-32	-9	-6	-11
20	11.8	...	9.1	-29	-14	-13	-15	-21
21	11.6	...	9.0	-22	-9	-9	-12	-19
22	13.2	-38	10.8	-19	-2	-1	-4	-10
23	13.0	-28	10.7	-27	-8	-6	-9	-14
24	12.7	...	10.4	-32	-13	-11	-13	-19

VK WEST - EUROPE L.P.

UTC	MUF	DBU	FOT	14.2	18.1	21.2	24.9	28.5
1	12.2	-9	9.7	-7	-12	-20	-34	...
2	12.6	-14	9.6	-10	-11	-17	-28	...
3	12.2	-22	9.4	-16	-14	-18	-28	...
4	15.9	-15	12.4	-21	-12	-12	-17	-25
5	23.4	-7	18.1	-30	-13	-8	-7	-9
6	30.0	-4	23.0	-35	-14	-7	-3	-3
7	28.9	-4	21.6	-34	-14	-7	-3	-4
8	26.4	-4	19.9	-28	-11	-5	-4	-5
9	23.2	-2	17.8	-20	-8	-5	-9	-9
10	19.8	-5	14.8	-15	-6	-5	-9	-15
11	16.6	-6	12.4	-10	-6	-8	-15	-25
12	14.1	-6	10.5	-6	-7	-13	-24	-38
13	12.4	-3	9.2	-3	-9	-19	-34	...
14	11.6	4	8.5	1	-11	-24
15	11.4	10	8.4	4	-11	-25
16	11.5	12	8.5	5	-10	-25
17	11.4	14	8.5	6	-10	-26
18	10.7	15	8.1	4	-14	-32
19	10.0	15	7.6	0	-19	-38
20	10.3	15	7.9	2	-17	-35
21	11.2	15	8.6	5	-12	-28
22	10.5	11	8.1	1	-16	-33
23	9.9	1	7.7	-5	-20	-37
24	10.1	-8	8.0	-8	-19	-32

VK EAST — AFRICA

UTC	MUF	DBU	FOT	7.1	10.1	14.2	18.1	21.2
1	11.7	-3	8.9	-23	-5	-4	-14	-27
2	12.1	-6	9.3	-38	-12	-5	-12	-21
3	11.8	-14	9.1	...	-22	-10	-14	-22
4	15.4	-10	11.9	...	-35	-12	-9	-12
5	22.6	-5	17.5	-21	-8	-5
6	28.3	-3	22.3	-26	-9	-4
7	26.7	-4	21.3	-26	-10	-5
8	24.5	-5	19.4	-22	-8	-4
9	21.7	-5	17.7	-17	-7	-5
10	18.8	-6	14.7	...	-40	-13	-6	-7
11	15.9	-8	12.3	...	-31	-10	-8	-12
12	13.7	-8	10.6	...	-20	-8	-10	-17
13	12.2	-5	9.4	-34	-10	-5	-13	-24
14	11.5	2	8.8	-10	2	-2	-15	-29
15	11.2	8	8.8	8	10	0	-16	-33
16	11.1	10	8.5	14	13	1	-16	-34
17	10.9	12	8.4	17	14	1	-18	-37
18	10.2	13	8.0	19	14	-2	-23	...
19	9.7	14	7.6	19	12	-5	-28	...
20	9.9	14	7.8	19	13	-4	-26	...
21	10.8	14	8.4	21	16	1	-18	-37
22	10.2	14	7.9	20	14	-2	-23	...
23	9.6	9	7.5	10	8	-6	-27	...
24	9.8	1	7.8	-6	1	-7	-25	...

VK STH — AFRICA

UTC	MUF	DBU	FOT	14.2	18.1	21.2	24.9	28.5
1	10.5	5	8.1	-2	-17	-33
2	12.7	1	9.8	0	-7	-17	-33	...
3	16.5	-1	12.4	-3	-2	-6	-15	-26
4	24.3	0	18.8	-9	0	2	0	-5
5	30.3	-1	23.1	-20	-4	1	2	1
6	32.5	-1	24.4	-26	-8	-1	2	1
7	32.1	-2	24.0	-29	-9	-3	1	0
8	31.0	-2	23.2	-28	-9	-3	0	-1
9	29.1	-2	21.8	-25	-8	-2	-1	-2
10	26.6	-2	19.9	-17	-4	-1	-1	-4
11	23.2	-1	17.4	-10	-1	0	-3	-8
12	19.8	0	14.8	-3	0	-2	-8	-16
13	16.7	2	12.4	2	0	-6	-16	-28
14	14.1	5	10.5	5	-3	-13	-28	...
15	12.4	10	9.2	6	-7	-21
16	11.6	12	8.6	5	-11	-27
17	11.4	14	8.6	5	-12	-28
18	11.5	15	8.5	6	-11	-28
19	11.5	15	8.6	6	-11	-28
20	10.8	16	8.2	3	-15	-34
21	10.1	16	7.7	0	-21
22	10.4	16	8.0	2	-18
23	11.0	16	8.3	5	-13	-31
24	10.2	13	7.8	0	-19	-38

VK WEST — AFRICA

UTC	MUF	DBU	FOT	14.2	18.1	21.2	24.9	28.5
1	28.4	-1	21.6	-22	-5	0	1	-1
2	28.0	-1	22.0	-24	-7	-1	0	-2
3	28.2	-2	21.2	-25	-7	-2	0	-2
4	27.7	-2	21.0	-23	-7	-2	0	-2
5	27.3	-1	20.8	-20	-5	-1	0	-2
6	26.4	-1	20.1	-15	-2	1	0	-3
7	24.8	0	18.9	-8	1	0	0	-5
8	22.8	2	17.3	4	7	4	-1	-9
9	20.8	6	15.9	15	11	5	-4	-16
10	18.8	8	14.3	17	9	1	-12	-27
11	17.2	8	13.0	16	5	-6	-21	-39
12	16.0	9	12.1	14	1	-12	-30	...
13	15.2	9	11.5	13	-2	-16	-37	...
14	14.5	10	11.1	11	-5	-21
15	13.7	10	10.4	8	-10	-28
16	13.2	10	10.0	5	-14	-33
17	11.9	10	9.1	-1	-25
18	10.4	10	8.0	-12
19	10.2	10	7.9	-13
20	13.2	10	9.9	5	-14	-33
21	19.1	5	14.8	12	7	0	-12	-25
22	24.5	1	18.9	-2	5	4	1	-5
23	27.4	1	21.1	-11	1	4	3	0
24	28.1	0	21.5	-17	-3	1	2	0

VK EAST — ASIA

UTC	MUF	DBU	FOT	14.2	18.1	21.2	24.9	28.5
1	30.0	-1	22.8	-25	-7	-1	1	0
2	30.8	-1	23.3	-28	-9	-2	1	1
3	31.1	-1	23.4	-29	-9	-2	1	1
4	30.8	-1	23.2	-28	-9	-2	1	1
5	30.3	-1	22.8	-25	-7	-1	1	1
6	29.3	0	22.1	-20	-4	1	2	0
7	27.6	0	20.9	-12	0	3	2	-1
8	25.4	2	19.2	1	6	6	3	-3
9	22.3	5	16.9	14	12	7	-1	-11
10	19.3	6	14.5	16	9	1	-12	-26
11	16.5	6	12.4	12	1	-11	-28	...
12	14.2	7	10.6	7	-10	-26
13	12.6	7	9.4	0	-21
14	11.8	8	8.8	-4	-28
15	11.5	8	8.6	-6	-31
16	11.5	8	8.6	-6	-31
17	11.5	8	8.7	-6	-31
18	10.7	8	8.1	-12
19	9.8	8	7.5	-20
20	10.0	8	7.7	-18
21	12.9	8	10.1	2	-18	-38
22	18.4	-3	14.3	-3	-8	-17	-29	...
23	24.3	-2	18.7	-12	-2	0	-3	-8
24	28.2	-1	21.5	-19	-4	0	1	-1

VK STH — ASIA

UTC	MUF	DBU	FOT	14.2	18.1	21.2	24.9	28.5
1	26.1	-1	20.1	-15	-3	1	0	-4
2	27.2	-1	21.0	-20	-5	0	0	-2
3	27.6	-1	21.8	-22	-6	-1	0	-2
4	27.6	-1	21.5	-23	-7	-1	0	-2
5	27.4	-1	21.0	-22	-6	-1	0	-2
6	27.1	-1	20.5	-20	-5	0	0	-3
7	26.5	-1	20.1	-15	-2	1	1	-3
8	25.3	0	19.2	-8	1	3	1	-4
9	23.6	2	17.9	2	6	5	0	-7
10	21.2	8	16.1	22	15	8	-2	-15
11	19.0	8	14.4	20	11	1	-13	-28
12	16.7	8	12.7	16	3	-9	-27	...
13	14.9	8	11.3	11	-5	-21
14	13.7	8	10.3	6	-14	-32
15	12.9	8	9.7	2	-19	-40
16	12.5	8	9.5	0	-23
17	12.1	8	9.1	-3	-27
18	11.8	8	9.0	-5	-30
19	10.8	7	8.3	-13
20	9.6	7	7.4	-24
21	9.6	7	7.5	-24
22	12.4	0	9.3	-6	-24
23	17.8	-4	13.8	-3	-4	-9	-20	-33
24	23.0	-2	17.7	-10	-1	-1	-4	-11

VK WEST — ASIA

UTC	MUF	DBU	FOT	7.1	10.1	14.2	21.2	28.5
1	17.9	3	14.2	-36	-7	4	-3	-24
2	19.8	3	15.7	...	-12	3	1	-16
3	21.3	3	17.0	...	-14	3	4	-10
4	22.3	4	17.9	...	-13	4	6	-7
5	23.0	5	18.4	...	-11	6	7	-4
6	23.2	7	18.6	-35	-4	10	9	-3
7	23.2	10	18.6	-4	13	18	13	-2
8	22.8	10	18.3	14	22	23	14	-4
9	21.3	9	17.2	20	25	22	9	-12
10	18.9	10	15.0	24	31	29	3	-9
11	16.4	10	13.0	25	24	16	-7	...
12	14.4	11	11.1	26	23	11	-19	...
13	12.8	11	9.8	25	19	5	-32	...
14	11.9	11	9.1	24	17	1	-40	...
15	11.6	11	8.8	23	16	0
16	11.6	11	8.8	23	16	-1
17	11.4	11	8.7	23	16	-2
18	10.7	11	8.3	22	13	-6
19	10.0	11	7.8	20	11	-10
20	10.3	11	8.1	21	12	-8
21	12.4	11	9.8	24	18	4	-35	...
22	13.8	9	10.9	12	15	8	-19	...
23	14.6	5	11.5	-9	5	5	-14	...
24	16.0	3	12.7	-20	0	5	-8	-37

VK EAST — VK ANTARCTIC

HAMADS

TRADE ADS

• **AMIDON FERROMAGNETIC CORES:** For all transmitter and receiver applications. Send DL size SASE for data/price to RJ & US Imports, Box 157, Mortdale NSW 2223. (No enquires at office please... 11 Macken St (Oatley). Agencies at: Geoff Wood Electronics, Sydney; Webb Electronics, Albury; Electronic Components, ACT; Truscott's Electronics, Melb; S Willis, Perth; Assoc TV Service, Hobart. Closed first 2 weeks May.

FOR SALE — ACT

• Deceased estate. FT-one TXCVR. C/W CW/AM/SSB filters FM board. \$1500 SG402 RF-sig gen SG402A audio sig gen \$150 each. 3 EL 15 M monoband Yagi \$150 Eric VK1EP (06) 249 6437.

FOR SALE — NSW

• **KENWOOD TH215A** 2 metre handheld CTSS encode. DTMF. Program battery saver. 10 memories. Scanning brand new, with box, manual, aerial & battery pack. \$450 o.n.o. Tony VK2JTS (042) 71 6811 after 6pm.

• 5 only UHF valves, 3CPN10A5/7815, 10 watt plate dissipation, 3000 MHz, & data sheet. (Add plate heat sink to obtain 100 watts) plate dissipation similar to 2C39 valve & 3CX100A5 \$40 each. 2 valves "807" each \$30. QTHR VK2AOU ph (02) 53 9789.

• **LINEAR amplifier parts plate & loading capacitors** air-var or vacuum var. socket tube chimney 4CX 1000 A or 4CX 1500B tank coils etc. (02) 918 3835 VK2DTR.

• **LINEAR amplifier HF bands.** Similar to 30-S1 COLLINS 4CX 1000A \$2400 R1000 KENWOOD manual & packing \$450 & cartage VK2DTR. (02) 918 3835.

• **YAESU FL2100Z** linear amplifier hardly used, manual, carton, two new spare 572B finals. \$1400 negotiable. Please ring Ron VK2BW (02) 542 1514.

• **YAESU FLDX400 TX** \$180.00 LAFAYETTE ham band only receiver model HA350 \$150.00 TX sold to licensed amateurs only. VK2BPM (02) 623 3606 QTHR.

• **ICOM IC202** 2 metre SSB TXVR with linear satellite xtals \$175 YAESU YC-221 digital display \$45 KENWOOD TR2200 2 metre TXVR \$80 Terry VK2XAS (02) 726 5652.

• **FTDX 400** transceiver in working order. Valves ok \$200.00 plus cartage Laurie Lawson VK2IX Rosewood

PO NSW 2652. PH (069) 48 8321.

• **YAESU transverter FTV700 VHF/UHF 144 MHz plus 430 MHz** recently overhauled by agent \$500 VK2IS QTHR (066) 52 3376.

• **HF transceiver, Kenwood TS130S, 200W pep 80-10m.** Faultless performer, WARC bands, mobile compact, 13.8v DC, \$700, Ted VK2EZQ QTHR (02) 477.7834.

• **DAIWA CNW518 2.5 kW pep antenna tuner** cross needles never used \$350 Lawrie VK2FIF QTHR (066) 28 0418.

• **REDUCTION sale Kenwood TL922 linear HF-AMP** as new \$2100 plus freight insurance Lawrie VK2FIF QTHR (066) 28 0418.

• **IC215 IC202 \$130 ea.** Courier CB, Ferris 5000 modified for 10 mtrs 40 chn \$170 ea. Multi quarts 16 \$130 all in good order with hand books DX100 RX \$80. VK2AJY QTHR (043) 96 4553.

• **AX 190 communications receiver \$100 VIC-20 computer with CN2 cassette.** 1515 printer. Disk drive 1541. 16k ram plus many extras. Complete \$500 VKK2BKN QTHR (069) 72 2021.

• **EC64, energy control Apple IIe compatible,** 64k ram, one floppy disk drive Z80 card inbuilt, no software, \$650 ono (02) 670 4422 (bus) (02) 670 4003 (ah) 1800-1900 hrs.

FOR SALE — VIC

• **TOWER-13** metre self supporting galvanised steel. Currently on ground ready for transport to your QTHR (03) 435 7870 ah Greg Williams VK3VT.

• **TEKTRONIX type 533A** dual beam cro. Large lab instrument with handbook \$190 H-P mod 608D sig gen. 10 to 420 MHz \$175. CODAN mod 7113 power supply 240/12v 20A fully reg. \$250. VK3ZJS QTHR ph (054) 28 6309.

• **ANTENNA, TET443DX,** four element quad band, 7/14/21/28 MHz, in fair condition but fault in 20 metre traps. \$250 ono. Ernie VK3CEW, (03) 467 1503 or QTHR.

• **UNIQUE opportunity to purchase house** with approved tower permit five brooms ensuite lounge/din kit/family rumpus near sch/shops transport. Approx 25 sq. \$260,000 enquiries (03) 842 5214.

• **ICOM IC27A** 2 metre FM transceiver c/w mobile

bracket and instruction manual, dual VFOs, 9 memories and priority facility \$375.00 firm VK3CCE QTHR ph (03) 509 1720.

• **FT ONE Yaesu FM board fitted service manual** operating manual. Looks good goes well. \$1400. Ron VK3IW QTHR (054) 63 2227.

• **ANTENNA W Wulf duo band Yagi** ten and fifteen metres assembly and tuning details good condition \$150. Vic VK3ABX QTHR (052) 59 2944.

NALLY tower self supporting wind up tilt over. Extensible to 14m. EC. \$750 purchaser to arrange dismantle and transfer. Vic VK3ABX QTHR (052) 59 2944.

• **YAESU FT-620 50 MHz transceiver.** Good condition. No power supply required. \$350 Martin VK3TGF (03) 589 5014.

• **YAESU FT-107m HF transceiver** including operator and service manuals and DMS option. Excellent condition \$800 Emotator 502 CXX antenna rotator GC \$150. Steve (03) 391 2346.

DECEASED estate, VK3VM. YAESU FT-2B 10 w VHF FM transceiver simplex and repeater crystals with matching Yaesu model FP-2 two way power supply, \$150. YAESU Memorizer 10 w VHF FM synthesized transceiver, 1 memory, \$200. KEN model KP202 hand held VHF FM transceiver, full set of crystals, with charger. \$115. YAESU model FL2100 HF linear amplifier, with manual, \$800. Satellite Tracking Antenna system two yagi (146/435 MHz), two rotators, with controllers, \$500. Tech model TE22D audio generator, \$50. Model CO-50 audio oscilloscope, \$50. Micronta 12 v regulator, \$40. All items in good working order. Enquiries to Ron, VK3AFW (03) 579 5600 AH, QTHR.

• **COMPLETE DX station** or of appeal to serious antique collector. Heathkit HW32 transceiver 20 metres only, 200 watt pep, one knob tune up, good vox, with h.d. p/s and manual. Excellent performer. 9 spare valves.

heathkit HA14 linear amplifier 1000 watt pep. 2-USA 572B valves. H.D. P/S switched 800 to 2000 volts and metered 1 amp. Heathkit monitorscope SB610 like new. To watch what's going on. Heathkit 100 K/c crystal calibrator. Plug in. Suits most heath models. Total Price complete \$1270. Johnson Matchbox (aerial tuner) 10 to 80m. External directional coupler (SWR)

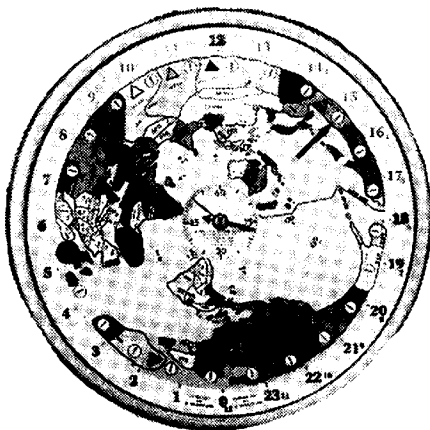

Ever baffled by World Clocks?

There is no need to be confused by a maze of foreign city names which cannot relate to their times.

The **ZONE VIEW GLOBAL CLOCK*** provides pictorial views of 30 Time Zones, differentiated by colour, clearly shows the time and day in each zone.

Amateurs! Now you can know at a glance who's in bed, who's having lunch, and who might be on the air.

*25cm diameter quartz movement.

For details or orders contact:
RESEARCH ENGINEERING CO.
 1319 Main Road, Eltham, Vic. Australia 3095.
 Phone: (03) 439 5825

Rec. Ret. \$82 plus P&P.

metered. Excellent \$300. TV system complete new and unused. Made in Japan. Camera F1.6, monitor 5 inch, intercom. All cables and manual. Made firstly for door watching with audio \$350. Sony B and W-5 inch portable TV excellent. Real collectors item \$100. Philips combined cassette and hi-fi amplifier. Good \$50 VK3DS QTHR (053) 32 3226.

• GECOL two metre hand held, ICOM clone. Thumb wheel frequency change. Extra 500 mA battery, speaker mike, vinyl case, wall charger as new QTHR (059) 96 33580 \$300 ono.

• COMM C64 PC, & power supply & 1541 disk drive joystick & printer & monitor & all cables & 7910 VH & VHF modem complete PC & PKT station many program/software \$750.

• YAESU type F SSB generator used in the FL50 transmitter complete with valves xtal etc \$25. Ph (03) 32 9422

• APPLE 2+ compatible with floppy, Ham Pack III RTTY/CW/ASCII on board modem, software and manuals monitor, heaps of original software. Perfect condition. Bargain \$350. Alan VK3BYG QTHR (03) 890 3894.

• ICOM 2A with 12 volt adapter and Nicads \$290. ICOM 215 8 repeater and 2 simplex fitted \$140. YAESU 708 hand held new nicads \$290. PYE bantam one repeater fitted with case \$50. Len VK3AQJ (03) 762 3522 QTHR.

• TELEPRINTER Creed model 7 dual speed, with manual free to a good home. Len VK3AQJ (03) 762 3522 QTHR.

FOR SALE — OLD

• FT-726R satellite tcvr works perfectly recent re-alignment with 2M, 70CM & satellite modules \$1950. SX-200 scanner good cond. Covers 26-512 MHz \$300 Lee VK4CXX QTHR ph (07) 375 5688.

• YAESU FL2100B HF linear \$850 ono. Homebrew HF linear, pair 2 x 813s including power supply \$500 ono. VK4WA QTHR ph (07) 814 2480.

• YAESU FT707 transceiver vgc \$700 ph (071) 85 1240

after 6pm Pat VK4WHO.

• HL-35 144 MHz amplifier 32-30w gasfet preamp \$150 David VK4ADF (07) 800 1406.

• FT290R as new \$500. TS520S good condition \$500 5 band SAGA DENSHI MT-240X antenna new \$700 SEIMENS 100 teleprinter and SEQTGP modem \$150 5FP7 SSV tubes. David VK4ADP QTHR.

• YAESU FRG 7700 perf cond. \$450. DRAKE SSR1 fair cond. \$100 SAIKOSCR 7000 scanner \$250. QTHR. (076) 27 3384 a/h or (076) 27 3323 b/h.

• YAESU FL-2100B linear amplifier 80, 40, 20, 15, 10 m-bands, perfect working order. 2 near new 572B finals, \$950. Bernhard VK4EBV (07) 354 3779 after 6pm.

FOR SALE — SA

• YAESU FL2100B little used excel cond \$900. Jim VK5UJ (08) 295 8094.

FOR SALE — WA

• HEAVY duty cyclonic butt section mast with tilt base. 3 section, 14m, with guys \$250. Alek VK6APK (09) 448 5810.

FOR SALE — TAS

• SIG-GEN wayne kerr 10 kHz 10 MHz output + 10dBm \$120 2m antenna CUSH CRAFT RINGO \$50 TE15 grid dip meter \$75. Wagner 24v to 12v DC converter 20 amp \$60 sailor 24v to 12v DC converter 8 amp \$40 4 of valves 6KD6 \$20 ea heath sig gen 310 kHz 220 MHz \$110 valves QB3-300 \$25 ea. Col VK7KW QTHR (003) 442761.AH

WANTED — NSW

• NEW member undertaking WIA course requires good comm receiver and morse key E Byrne "Elsinore" Goulburn 2580..

• CAN anyone loan catalogue or photocopy details of Telecom Coaxial Connectors expenses reimbursed. Art VK2AS QTHR (02) 416 7784.

• VALVE tester for mini series valves. Pay postage Laurie Lawson, VK2IX PO Box Rosewood NSW 2652 ph (069) 48 8321.

• URGENT valve type 6JH8 either new or working VK2APL QTHR ph (02) 457 9157.

• HITACHI WM.800.S tuning gang 3 band "car/port" Tr.radio (1970's) in cube abt. 35mm easily damaged removing INTACT. Possibly leave in set. "US" set ok. VK2AFU QTHR (02) 53 5774 or (047) 82 1617.

• PROP PITCH motor. Details to VK2OE PO Box 1914 Wollongong 2500, NSW.

• ALL mode 52 MHz 432 MHz T/Rs prefer old models let me know what you have. VK2AJY QTHR (043) 96 4553.

WANTED — VIC

• DEFUNCT YAESU FT7 for spares in particular front panel in good condition VK3CCE QTHR ph (03) 509 1720.

• KENWOOD TS-130S or TS120S xcvr prefer in excellent order. Ron VK3OM QTHR ph (059) 44 3019.

VK & ZL novice Dxers Dx net 21.192 Friday thru Mondays 05:30Z onwards all welcome. Rob VK3VOS.

• CIRCUIT diagram and component list for iambic keyer to suit Bencher paddle. Will cover all costs Goff VK3BGC (03) 49 2719 ah.

WANTED — OLD

• HI-TECH CW decoder module for a Vic 20 computer. Write (or phone 378 8148 if local) stating price to L40228 P E Kelly, 96 Taringa Pde, Indooroopilly QLD 4068.

WANTED — WA

• REQUIRE copy of circuit/manual for AWA VOL TOHMYST Mod 56010 (1953?), and KYORITSU CR bridge analyser mod K.129. Reimbursement paid. Ilmar VK6AIB QTHR or (09) 276 6637.

• HEWLETT PACKARD signal generator HP606A also rf vvm HP410 B both immaculate unmodified complete with manuals VKK6MK (098) 44 1169 QTHR.

WANTED — TAS

• 2m all mode transceiver suitable base station must be good condition not h/held Ray VK7RK QTHR (003) 44 1849.

HAMADS

Please Note: If you are advertising items For Sale and Wanted please use a separate form for each. Include all details: eg Name, Address, Telephone Number (and STD code), on both forms. Please print copy for your Hamad as clearly as possible.

*Eight lines free to all WIA members, ninth line for name and address Commercial rates apply for non-members. Please enclosed a mailing label from this magazine with your Hamad.

*Deceased Estates: The full Hamad will appear in AR, even if the ad is not fully radio equipment.

*Copy typed or in block letters to PO Box 300, Caulfield South, Vic 3162, by the deadline as indicated on page 1 of each issue.

Miscellaneous

For Sale

Wanted

Name:

Call Sign:

Address:

.....

*QTHR means address is correct as set out in the WIA current Call Book.

*Please enclose a self addressed stamped envelope for acknowledgement that the Hamad has been received. Ordinary Hamads submitted from members who are deemed to be in general electronics retail and wholesale distributive trades should be certified as referring only to private articles not being re-sold for merchandising purposes.

Conditions for commercial advertising are as follows: \$22.50 for four lines, plus \$2.00 per line (or part thereof) Minimum charge — \$22.50 pre-payable.

State:

Solution to Morseword No 38

	1	2	3	4	5	6	7	8	9	10
1	-	.	.	-	-	-	.	.	-	.
2	.	-	-	.	.	.
3	.	-	-	-	.	-
4	-	.	.	.
5	-	-	.	-	-	-
6	-	.	-	.	.	.	-	.	.	.
7	.	-	.	-	.	.	-	-	-	-
8	-	.	-	-	-	.
9	.	-	-	.	-
10	-	.	-	-	.	.

Across: 1 tugs 2 ruse 3 leak 4 hens 5 how
6 kepi 7 arak 8 taker 9 weds 10 Senate

Down: 1 dice 2 pear 3 Ivan 4 bud 5 drew
6 gore 7 Eros 8 uvea 9 evert 10 inks

TRADE PRACTICES ACT

It is impossible for us to ensure the advertisements submitted for publication comply with the Trade Practices Act 1974. Therefore advertisers and advertising agents will appreciate the absolute need for themselves to ensure that, the provisions of the Act are complied with strictly.

VICTORIAN CONSUMER AFFAIRS ACT

All advertisers are advised that advertisements containing only a PO Box number as the address cannot be accepted without the addition of the business address of the boxholder or seller of the goods.

TYPESETTING : Redfords Media
25 Glenferrie Rd
Malvern 3144
Tel: (03) 500 0377

PRINTING: Industrial Printing
Richmond

MAIL DISTRIBUTION: Polk Mailing Co.
PO Box 140,
Collingwood,
Vic. 3066
Tel:(03) 417 5161

The opinions expressed in this publication do not necessarily reflect the official view of the WIA, and the WIA cannot be held responsible for incorrect information published.

ADVERTISER'S INDEX

ATN Antennas	14
Dick Smith Electronics	IBC, 11
Electronics Australia	21
Icom Australia	OBC,
Kenwood Electronics Aust.	IFC
Magpubs	5
Moonraker Australia	19
Profoto	22
Research Engineering Co.	54
WIA NSW Division	7

HOW TO JOIN THE WIA

Fill out the following form and send to:

The Membership Secretary
Wireless Institute of Australia
PO Box 300
Caulfield South, Vic 3162

I wish to obtain further information about the WIA.

Mr, Mrs, Miss, Ms:

Call Sign (if applicable):

Address:

State and Postcode:

EXTRA-HIGH PERFORMANCE— All Mode Transportable Transceivers

You can guarantee yourself a spectacular season with these all mode, multi—purpose transportable transceivers for either the 6M or 2M bands!

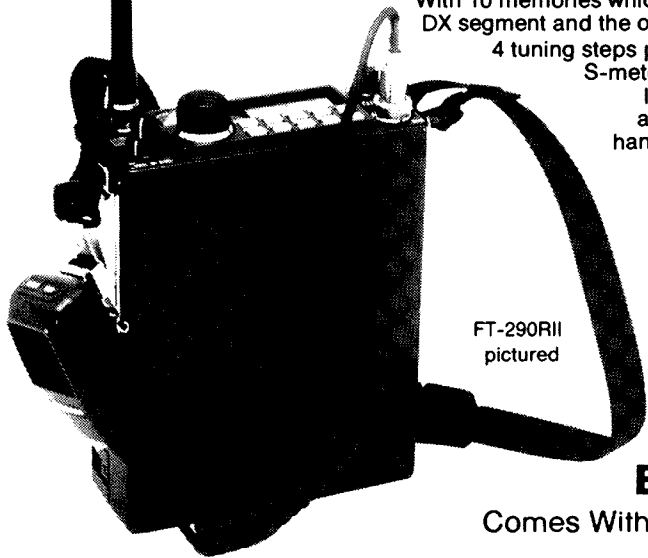

With 10 memories which store mode and repeater offset, 2 independent VFO's (set one on DX segment and the other on FM segment), all mode squelch, noise blanker on SSB/CW, 4 tuning steps per mode, 2.5 watt output power (plus selectable 250mW), analogue S-meter and PO meter, and full functions for operation through repeaters.

It's easy to operate with just three knobs and 10 buttons which allow access to all functions quickly and easily. The units are supplied with hand microphone and antenna. PLUS — they now come complete with FBA-8 (9x'C' size) battery holder for shoulder-carried portable operation at no extra charge!

See A.R.A. review Vol. 12, issue 5

6 Metre — FT-690R II Covers 50-54MHz. Channels steps SSB/CW-25/100/2500Hz. With telescopic whip antenna and microphone Cat D-2874

2 Metre — FT-290R II Covers 144-148MHz and comes with rubber duck antenna and microphone. Cat D-2875

\$799 ea

Either version

Comes With Bonus Battery Holder (Cat D-2876)

YAESU'S MICROSIZED HANDHELD

Ultra Compact - Rugged Construction - Superb Performance! The Yaesu FT-23R 2M Transceiver

Superb performance on the 2m band with all the reliability you know you can expect from Yaesu. The FT-23R is tiny in size, only 55mm x 32mm x 139mm, yet this handheld packs more punch than you'd believe possible.

It's fully micro-processor controlled with 10 memories (7 memories can even be programmed for non-standard repeater shifts), repeater splits, pushbutton or manual scanning (busy/memory/priority), 1MHz up/down stepping, up to 5 watts output (with 12V DC) and more.

You get full 144 to 148MHz band coverage in the palm of your hand. Supplied with high capacity, 600mAh FNB-10 NiCad battery giving 2.5W output, AC charger, mini rubber-duckie antenna and carry case.

Cat D-3490

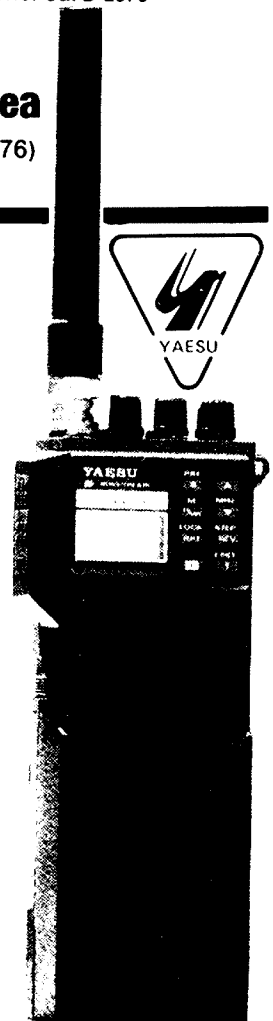

WITH FULL 2 YEAR WARRANTY

Limited
Stocks!

Now Only
\$349

DICK SMITH
ELECTRONICS

Optional Accessories:

PA-6	DC Adaptor/Charger suit FNB9/10/14	D-3498	\$39.95
FNB-11	600mAh NiCd Battery (5W output)	D-3496	\$99.00
MH-12A2B	Speaker/Microphone	D-2115	\$49.95



The smaller we get, the better we get!

ICOM's amazing new mini FM Handhelds

The minute you see and hold one of the Icom "S Series" mini handhelds you'll agree with our thought that "bigger is not always better and smaller is not always less".

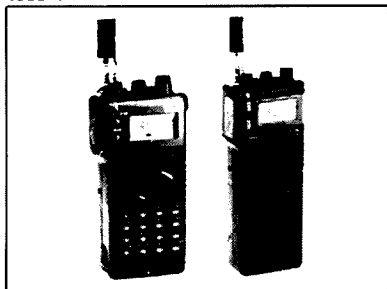

By reducing the size of our product, maintaining high standards of quality and production and constantly improving our range, Icom's business continues to grow. So, the smaller we get, the better we get.

4 DTMF code memory channels for auto dialing.

IC-2SAT, IC-4SAT, IC-24AT
Overall, Icom's family of tiny miracles, the 2SAT, 4SAT and 24AT give the Handheld enthusiast ease of operation through the convenient, multi-function keyboard. Delivering a full 5W output (at 12V) they feature clear, backlit function displays, splash resistant design and durable construction for outdoor use. One of these models is bound to suit your application, camping, skiing, in the field or vehicle. Use with built-in, rechargeable NiCd batteries (IC-2SAT, IC-4SAT only) or external power supply without having to use

DC-DC converters, just the optional cigarette lighter cable or mini power cable.

IC-2SA

A super multi-function hand held with strong appeal for veterans, the 2SA is also the perfect way for newly licenced Amateurs to get started. This 144 MHz FM transceiver delivers 5W output (at 12V) with the optional BP-85 battery-pack, 40 memory channels, automatic power saver, LCD readout, operation from battery or external 12 volt DC supply. A PTT lockout switch is provided to prevent accidental transmissions. Amazingly its tremendous versatility and wide variety of functions are simply controlled by just six switches and three controls. An interesting and detailed colour brochure will be sent to you on request - call now for the name of your nearest stockist.



DC socket for charging and external DC power entry.

24 hour clock with timer.

40 memories.

Dual band display.

Optional battery packs, various sizes, power output.

IC-24AT

Two Radios in one?

Would you believe a full dual-bander in the palm of your hand? Yes, full crossband duplex with 40 independent (simplex, 20 duplex) memory and 2 call channels, 5 watts out put from 12 volts direct power!

With all its features, you'd think the 24-AT would be quite a handful - and it is - almost. Even with its battery pack it only weighs 340gm but still gives you 6 scan functions, priority watch and built-in clock with a timer function.

We know you can't wait to find out more about our latest triumph in design and miniaturisation, so call us now for a free colour brochure giving full details on the 24AT and ask for the name of your nearest stockist.

For further information call Icom free on 008 338 915

Melbourne callers (03) 529 7582 Icom Australia Pty. Ltd., 7 Duke Street, Windsor 3181.

Icom Australia's warranty is only applicable to products purchased from their authonsed Australian Dealers.

■ AMATEUR ■ MARINE ■ LAND-MOBILE ■ AVIATION ■ CB ■ AMATEUR ■ MARINE ■ LAND-MOBILE ■ AVIATION ■ CB ■ AMATEUR ■ MARINE ■ LAND-MOBILE ■

Please rush to me your brochure on the 2SA 2SAT 4SAT 24AT and the name of my nearest Icom stockist.

SEND TO: Freepost 15, Icom Australia Pty Ltd, Windsor, 3181 (no stamp required).

Mr., Mrs., Ms. Company Title

Address Suburb

City Post Code Phone No.

NCAA 4641 AR

■ AMATEUR ■ MARINE ■ LAND-MOBILE ■ AVIATION ■ CB ■ AMATEUR ■ MARINE ■ LAND-MOBILE ■ AVIATION ■ CB ■ AMATEUR ■ MARINE ■ LAND-MOBILE ■



AMATEUR RADIO

JUNE 1990

RRP \$3

SPECIAL
TEST
EQUIPMENT
ISSUE



THE WIA RADIO AMATEUR'S JOURNAL

KENWOOD

KNOCKOUT DUAL-BAND DUO!

TM-731A

The Kenwood TM-731A redefines the original Kenwood term "dual bander". The wide range of innovative features include a dual watch function, selectable full duplex operation, automatic band change, 30 memory channels, large dual LCD displays, programmable scanning, and 50 watts of output on 144 MHz and 35 watts on 430 MHz.

The optional RC-10 multi-function handset remote controller is also available, making the TM-731A even more enjoyable to operate.

Features:

- Ultra Compact design with easy to install mount.
- Multi function microphone with programmable function key.
- High sensitivity receiver and an improved antenna switching circuit for wide dynamic range.
- Hi/Lo power switch for power reduction to 5 watts when high power not needed.
- Dual watch function to receive both 144 MHz and 430 MHz bands at the same time.
- 30 Memory channels with Lithium battery backup.
- Various scan modes are provided including band scan, programmable band scan, memory and dual scans.
- Frequency lock function prevents accidental loss of selected frequency.
- Dual frequency selector may operate independently of each other for main and sub-bands.
- Sliding balance controls audio output between main and sub-bands.
- Easily selectable dual and single band operations.
- Large amber multi-function LCD display for best visibility in sunlight or after dark.
- Built-in selectable CTCSS Tone Encoder

Features:

- Dual watch function allows you to receive both VHF and UHF bands at the same time.
- Built in 2 VFOs for main and sub-bands.
- Large multi-function LCD display provides excellent visibility.
- Tone Alert System for both bands causing a beeper tone to signal the presence of an incoming signal.
- Automatic band change function changes between main and sub-bands when a signal is present.
- Selectable dual and single band operations.
- Five watts RF output is available when operated with 13.8 VDC.
- Balance control for main and sub-band audio output.
- 10 Multi-function memory channels plus call channel for each band, with lithium battery backup.
- Various scan modes are provided including band scan, programmable scan, memory and dual scan.
- Auto battery saving circuit increases battery life.
- Auto-power off function.

TH-75A

The TH-75A combines the 2m and 70cm bands together into one compact, feature-filled hand-held package. Large dual LCD displays, dual watch, selectable full duplex operation, tone alert and many additional features make this dual band HT different from the rest.



KENWOOD ELECTRONICS AUSTRALIA PTY. LTD.

(INCORPORATED IN N.S.W.)

4E Woodcock Place, Lane Cove, N.S.W. 2066, Australia

Ph. (02) 428 4222, (02) 428 1455, Fax (02) 427 6869

Call now for further information and the name of your nearest authorised Kenwood dealer.

Please phone, mail or fax for information

Name

Address

Postcode

Publication Issue

Model



Amateur Radio is published by the Wireless Institute of Australia, as its Official Journal on the last Friday of the previous month.

EXECUTIVE EDITOR
Bill Rice VK3ABP

MANAGING EDITOR
Graham Thornton VK3IY

NEWS EDITOR
Jim Linton VK3PC

SENIOR TECHNICAL EDITOR
Peter Gibson VK3AZL

TECHNICAL EDITORS
David Brownsey VK4AFA
Don Graham VK6HK
Evan Jarman VK3ANI
Peter O'Connor VK4KIP
Gil Sones VK3AUI
Phil Steen VK4APA
Roy Watkins VK6XV

DRAFTING
Vicki Griffin VK3BNK

MARKETING
Bruce Kendall VK3WL
Norm Eyres VK3ZEP

ADVERTISING
Ann McCurdy
All contributions and correspondence concerning the content of Amateur Radio should be forwarded to: -

The Editor
Amateur Radio
PO Box 300
Caulfield South
VIC 3162

Registered Office
3/105 Hawthorn Road
Caulfield North VIC 3161

Telephone: (03) 528 5962
(03) 523 8191
Fax: (03) 523 8191
(Non dedicated line)

Business hours: 9.30am to 3pm
weekdays

Deadlines

	Editorial	Hamads
July	8/6/90	11/6/90
Aug	9/7/90	11/7/90
Sept	6/8/90	8/8/90

Delivery of AR: If this magazine is not received by the 15th of the month of issue, and you are a financial member of the WIA, please check with the Post Office before contacting the registered office of the WIA.

© Wireless Institute of Australia 1990

CONTENTS

Technical

A Microwatt RF Power Meter	8
<i>Ron Cook VK3AFW</i>	
A Simple Inexpensive RC Bridge	16
<i>J A Gazard VK5JG</i>	
Getting more from your Oscilloscope	10
<i>Ivan Huser VK5QV</i>	
Novel Polarity Tester	9
<i>Trevor Sherrard VK4ATS</i>	
A Simple Dip Meter	12
<i>Drew Diamond VK3XU</i>	
Level and Frequency on one Meter	17
<i>Ken Kimberley VK2PY</i>	
Recycled Connector Current Tester	20
<i>Steve Mahony VK5AIM</i>	

General

Introducing the New Minister	27
<i>Jim Linton VK3PC</i>	
Newcastle Earthquake Disaster	22
<i>Peter Greenwood VK2IW</i>	
Not More of the Use It or Lose It Syndrome	20
<i>Peter McAdam VK2EVB</i>	
Twenty-Five JOTA Badges that Otherwise Would not have Been Gained	18
<i>Ken Westerman VK5AGW</i>	

Book Review

All About VHF Amateur Radio	27
<i>Jim Linton VK3PC</i>	

Operating

Contests	
Sunshine State Jack Files Memorial Contest rules	30
Seant World Wide DX Contest 1990 rules	31

Columns

Advertisers' Index	56	How's DX	32
ALARA	41	Intruder Watch	40
AMSAT	36	Morseword No 39	46
Club Corner	46	Over To You - Members' Opinions ..	49
Divisional Notes		Pounding Brass	36
Forward Bias. VK2 Notes	44	QSLs from the WIA Collection	47
5/8 Wave	45	Silent Keys - Obituaries	48
Editor's Comments	2	Spotlight on SWLing	39
FTAC News	39	VHF/UHF An Expanding World	34
Hamads	54	WARC 92 Update	43
HF Predictions	52	WIA Directory	2, 3
		WIA News	3

Cover

For most of us, the prospect of owning our own Spectrum Analyser is a wild pipe-dream. Now, the VOS-107 Spectrum Probe opens up an entirely new concept. This simple-to-use high input impedance probe, combined with a CRO of at least 1MHz bandwidth, performs as a Spectrum Analyser over the frequency range of 1-100 MHz.

The Probe is priced at \$345 excluding sales tax, or \$399 including tax. Sales enquiries may be made to Emona Instruments, 86 Parramatta Road, Camperdown (PO Box 15, Camperdown NSW 2050) phone (02) 519 3933 fax (02) 550 1378

Why are we Radio Amateurs?

This is a question I am sure we have all been asked many times. Each time we have probably been able to find a number of reasons, but have we ever tried to analyse in depth what really "makes us tick"? Perhaps this is not the place to try — I have only half a page at the most, and the more I think about it the more I think a book could be written on the theme. But a number of you who read this are perhaps still thinking of becoming amateurs, or you have friends who are interested but would like to know more before they commit themselves to this unique and demanding activity. I prefer not to use the word "hobby", because I feel amateur radio is far more than "just a hobby". Often enough, the word "amateur" also gives the general public a wrong impression, as many of us are quite professional in our abilities but exercise them without expecting to be paid. We are driven by love, not money; the word "amateur" of course literally means "lover".

Imagine then that one of

EDITOR'S COMMENT

BILL RICE VK3ABP EXECUTIVE EDITOR

us, visited by a non-technical member of that "general public" is trying to explain our fascination.

"What's that box there? Is it some kind of radio?"

"Yes, it's an amateur radio transceiver."

"Is it two-way, then? Can you talk to people on it? Who?"

"Yes, I can talk to other amateurs." (Across town, around the country, all over the world, depending on the many factors which determine the station capability, and which we then try to explain).

"It all sounds awfully technical. Why can't you talk to them on the phone? It wouldn't cost any more, would it? What do you talk about?"

Further explanation, about relative costs, 10-second DX versus rag-chew contacts, restriction to "unimportant" conversation. If you operate CW, satellites, moonbounce, RTTY or packet, the explanation starts to become really difficult at this stage, and the

onset of the proverbial glazed eyeballs and hunted expression is very near! But can we really explain to ourselves what it is that drives us on?

The more I think about all the other areas of amateur activity yet unmentioned (mobile, hand-held, television (fast or slow-scan) computer applications, antennas, design, construction, maintenance, serious DX, VHF, UHF, microwaves; the list goes on and on) the more obvious it becomes that there are probably no two amateurs with exactly the same collection of motivations. Another big area is that of community service (WICEN, ATN etc), and then, of course, all the work involved in running an organisation like the WIA and producing a magazine like this. A complex collection of interests and duties, driven by a mixture of curiosity and obligation, aided at times by determination (or is it pig-headed stubbornness?). Amateur Radio is a

challenge, a whole constellation of challenges to do more and better than before. We are radio amateurs because we have accepted those challenges. One is to share our enjoyment by inviting others to join us. You won't regret it!

ar

COPIES OF ARTICLES

Photocopies of any article published in a back issue of AR available to members at \$2.50 each (plus \$2.00 for each additional issue in which the article appears)

AR ARTICLES
PO Box 300
Caulfield South
Vic 3162

Wireless Institute of Australia

The world's first and oldest National Radio Society - Founded 1910
 Representing Australian Radio Amateurs - Member of the International Amateur Radio Union
 Registered Executive Office of the WIA: 3/105 Hawthorn Road, Caulfield North, Vic, 3161
 All mail to: **PO Box 300, Caulfield South, Vic, 3162** Telephone: (03) 528 5962 (03) 523 8191
 Fax: (03) 523 8191 (Non-dedicated line)
 Business Hours: 9.30 am to 3.00 pm on Weekdays

General Manager and Secretary: Bill Roper VK3ARZ

EXECUTIVE

President:	Peter Gamble	VK3YRP	VK1 Federal Councillor:	George Brzostowski	VK1GB
Vice Chairman:	Ron Henderson	VK1RH	VK2 Federal Councillor:	Terry Ryeland	VK2UX
	Kevin Olds	VK1OK	VK3 Federal Councillor:	Peter Maclellan	VK3BWD
	Brenda Edmonds	VK3KT	VK4 Federal Councillor:	David Jerome	VK4YAN
	Bill Rice	VK3ABP	VK5 Federal Councillor:	Bill Wardrop	VK5AWM
Immediate Past President:	David Wardlaw	VK3ADW	VK6 Federal Councillor:	Neil Penfold	VK6NE
			VK7 Federal Councillor:	Joe Gelston	VK7JG

FEDERAL CO-ORDINATORS

Amsat:	Graham Ratcliff	VK5AGR	Int'l Travel Host Exch:	Ash Nallawalla	VK3CIT
Awards:	Phil Hardstaff	VK3JFE	QSL Manager (VK9, VK0)	Neil Penfold	VK6NE
Contest Manager:	Frank Beech	VK7BC	FTAC:	John Martin	VK3ZJC
Education:	Brenda Edmonds	VK3KT	Federal Tapes:	Ron Fisher	VK3OM
EMC:	Hans Ruckert	VK2AOU	Videotape:	John Ingham	VK5KG
Historian:	John Edmonds	VK3AFU	WICEN:	Bill Wardrop	VK5AWM
Intruder Watch:	Gordon Loveday	VK4KAL			

WIA NEWS

EXECUTIVE

54th Federal Convention

This year's Federal Convention differed in two ways from previous years. The location was no longer the Brighton Savoy but, mainly to reduce costs, was at Normanby House, Clayton. And, for the first time, this was not a once-per-year opportunity for inter-Divisional discussion of WIA affairs, but was one of a quarterly series, beginning last year, in which the Divisional Federal Councillors participated as members of an expanded Executive.

Under the new system each

quarterly meeting has some of the characteristics of a traditional Convention. This has enabled problems to be dealt with much sooner, and understanding between Divisions to be enhanced. In effect, each meeting has only three months' business to discuss, but the April meeting serves also as the Annual General Meeting which is required by Corporate Affairs legislation.

As has been the custom this Convention began with an informal "rag-chew" session on the Friday evening, which also served as a welcome to our New Zealand observers, Cathy and Brian Purdie, ZL2ADK

and ZL2TPS, and Jim Meachen, ZL2BHF.

The formal Convention session began on Saturday morning, after accepting the 1989 minutes, with the presentation of the financial reports, followed by reports from Federal Office Bearers. Most reports, including those published in April Amateur Radio magazine, were accepted with minimal comment.

Those reports which led to discussion were:-

The President's report...

Some items of interest were the current situation regarding disposal items being advertised on Divisional broadcasts, and progress on a reciprocal licensing agreement with Italy.

Region 3 liaison...

This was mainly in connection with preparation for WARC 92, regional policy as regards possible changes to band allocations, and progress of funding to support amateur representation at the WARC.

FTAC...

The only point of contention here was a recommendation by the retiring Chairman, Rob Milliken, VK1KRM, that the number of Australian VHF/UHF record categories be reduced. The report as a whole was accepted, but the recommendation was unanimously rejected. It is understood the new chairman of the Federal Technical Advisory Committee, John Martin, VK3ZJC also prefers to retain

WIA DIVISIONS

The WIA consists of seven autonomous State Divisions. Each member of the WIA is a member of a Division, usually their residential State or Territory, and each Division looks after amateur radio affairs within their State.

Division	Address	Officers	Weekly News Broadcasts	1990 Fees
VK1	ACT Division GPO Box 600 Canberra ACT 2601	President Ted Pearce Secretary Jan Burrell Treasurer Ken Ray	VK1AOP 3.570 MHz VK1BR 2m ch 6950 VK1KEN 70cm ch 8525 2000 hrs Sun	(F) \$65.00 (G) (S) \$52.00 (X) \$39.00
VK2	NSW Division 109 Wigram St Parramatta NSW (PO Box 1066 Parramatta) 2124 Phone (02) 689 2417 Fax (02) 633 1525	President Roger Henley Secretary Peter Balnaves Treasurer David Horsfall (Office hours Mon-Fri 1100 - 1400 Wed 1900 - 2100)	VK2ZIG 1.845 MHz AM, 3.595 SSB (1915 only), 7.146 AM (1045 only) VK2CZX 10.125 SSB (1045 only), 28.320 SSB, 52.120 SSB 52.525 FM 144.12 VK2KFU (SSB), 147.000 FM(R) 438.525 FM(R) 584.750 (ATV Sound) 1281.75FM (R) Relays also conducted via many repeaters throughout NSW.	(F) \$59.00 (G) (S) \$47.00 (X) \$33.00
VK3	Victorian Division 38 Taylor St Ashburton Vic 3147 Phone (03) 885 9261	President Jim Linton Secretary Barry Wilton Treasurer Rob Hailey Office hours 0900-1600 Tue & Thur	VK3PC 1.840 MHz AM, 3.615 SSB, 7.085 SSB, 147.250 FM(R) Mt Macedon, VK3XV 147.225 FM(R) Mt Baw Baw VK3XLZ 146.800 FM(R) Mildura, 438.075 FM(R) Mt St Leonard 1030 hrs on Sunday	(F) \$65.00 (G) (S) \$52.00 (X) \$39.00
VK4	Queensland Division GPO Box 638 Brisbane Qld 4001 Phone (07) 284 9075	President Ross Mutzelburg Secretary Eddie Fisher Treasurer Eric Fittock	VK4IY 1.825, 3.605, 7.118, 14.342, 18.132, 21.175, 28.400, MHz VK4ABX 52.525 regional 2m repeaters and 1296.100 0900 hrs Sunday VK4NEF Repeated on 3.605 & 147.150 MHz, 1930 Monday	(F) \$65.00 (G) (S) \$52.00 (X) \$39.00
VK5	South Australian Division 34 West Thebarton Rd Thebarton SA 5031 (GPO Box 1234 Adelaide SA 5001) Phone (08) 352 3428	President Rowland Bruce Secretary John McKellar Treasurer Bill Wardrop	VK5OU 1820 kHz 3.550 MHz, 7.095, 14.175, 28.470, 53.100, 145.000, (F) VK5BJM 147.000 FM(R) Adelaide, 146.700 FM(R) Mid North, 146.900 FM(R) (G) (S) VK5AWM South East, ATV Ch 34 579.00 Adelaide, ATV 444.250 Mid North (X) \$39.00 (NT) 3.555, 146.500, 0900 hrs Sunday	
VK6	West Australian Division PO Box 10 West Perth WA 6005 Phone (09) 474 2626	President Alyn Maschette Secretary Bruce Hedland Treasurer - Thomas	VK6KWN 146.700 FM(R) Perth, at 0930 hrs Sunday, relayed on 3.560, 7.075, 14.115, 14.175, 21.185, 28.345, 50.150, 438.525 MHz Country re- lays 3582, 147.350(R) Busselton 146.900(R) MI William (X) \$30.00 VK6OO (Bunbury) 147.225(R) 147.250 (R) Mt Saddleback 146.725(R) Al- bany 146.825(R) Mt Barker Broadcast repeated on 3.560 at 1930 hrs.	(F) \$56.00 (G) (S) \$45.00 (X) \$30.00
VK7	Tasmanian Division PO Box 1010 Launceston TAS 7250	President Tom Allen Secretary Ted Beard Treasurer Peter King	VK7AL 146.700 MHz FM (VK7RHT) at 0930 hrs Sunday relayed on 147.000 (F) VK7EB (VK7RAA), 146.750 (VK7RNW), 3.570, 7.090, 14.130, 52.100, (G) (S) \$50.00 VK7ZPK 144.100 (Hobart) Repeated Tues 3.590 at 1930 hrs (X) \$38.00	
VK8	(Northern Territory) is part of the VK5 Division and relays broadcasts from VK5 as shown (received on 14 or 28 MHz).			
Note: All times are local. All frequencies MHz.			Membership Grades Full (F) Pension (G) Needy (G) Student (S) Non receipt of AR (X)	Three year membership available to (F) (G) (X) grades at fee x 3 times

the full range of categories.

Federal Contest Manager...

It is intended to divide up what has so far been a very onerous task for one person into a five person scheme, each having responsibility for one major contest. Neil Penfold, VK6NE, is still co-ordinating the new arrangements but hopes ultimately to devolve the task completely. The retiring Federal Contest Manager, Frank Beech, VK7BC, will still retain management of the VK-ZL-O Contest. Contest participation seems to be falling in Australia, although rising in the USA. Perhaps the new scheme may restore interest.

Education...

Now that devolvement of examinations is almost complete there was considerable interest in the report by the Federal Education Co-ordinator, Brenda Edmonds, VK3KT. At the 1987 Convention a motion was carried to appoint a paid examination co-ordinator, when it appeared that the WIA might be wholly responsible for the devolved examinations. Now there are many examining organisations, including several of the Divisions, a full-time co-ordinator is no longer needed. One of Brenda's recommendations was to rescind the 1987 motion, and this was unanimously agreed. Brenda's achievements in liaison with DoTC were recognised with acclamation on a motion by Peter Maclellan, VK3BWD.

AMSAT...

Graham Ratchiff, VK5AGR, was not personally present, but his report was accepted enthusiastically. Graham plans to visit West Germany on AMSAT business later this year, partly at his own expense. The possibility of further subsidising his trip from funds intended for IARU travel is to be investigated.

General Manager and Secretary...

Among the points made by Bill Roper, VK3ARZ, in his report was the continued inability of the WIA to fill the vacant position of Federal Treasurer. This problem was discussed briefly, but with the intention of going into more detail later. Stephen Pall, VK2PS, moved that appreciation be shown of Bill's efficiency in managing the WIA's affairs under adverse conditions. This was carried with acclamation.

Following the reports, the Convention was addressed by Alan Jordan, Manager Regulatory, Radio Communications Operations, DoTC, on many items of interest to the Amateur Service. Alan's address included interference investigations, examination devolvement, penalties for infringement of regulations, visitor licensing, spectrum pressures, third party traffic, advertising and updating of regulatory brochures. He answered many questions on these and other topics, informally over lunch as well as in the conference hall.

After Alan Jordan departed in mid-afternoon, the Divisional reports were presented, and there was some discussion arising from the financial and WICEN reports.

Attention was then turned to the previously notified agenda items, of which there were only four this year, due to so much more business being dealt with at the quarterly meetings.

One of these items was simply to formalise the expansion of Executive to 12 members and remove the previous time limits after the Federal Convention on the holding of the first meeting of the new Executive, but the others were more contentious.

90.09.01, proposed by VK4, was aimed at more flexibility in application of State boundaries to Divisional operating areas. Some states saw no problems, others were strongly opposed. In view of the need for thorough investigation it was agreed to defer

final consideration until the next full Executive meeting.

90.09.02, proposed by Executive, was to conduct a co-ordinated special recruiting campaign in all Divisions later in 1990. Although there was much discussion, this was eventually carried unanimously.

90.09.03, proposed by Executive, required the Divisions to seek agreement on uniform membership procedures, which again provoked much discussion. Eventually, with minor amendment, this motion was also carried unanimously, although the vote was postponed until Sunday so that delegates could read and discuss Bill Roper's draft document on membership procedures.

The remainder of Saturday afternoon was spent reviewing progress on previous Council resolutions still uncompleted, plus a review by David Wardlaw, VK3ADW, of some aspects of planning for WARC 92.

After dinner there was an informal assessment of progress by the WIA over the last twelve months.

Sunday morning was largely devoted to 90.09.03 as mentioned before, but this was preceded by brief discussion of Divisional trading activities, repercussions on advertising in Amateur Radio and further aspects of examinations of licence candidates in remote areas.

Election of the new Executive brought about few changes. By call signs, with Federal Councillors first, the list is:-

VKs 1GB, 2UX, 3BWD, 4YAN, 5AWM, 6NE, 7JG, 1OK, 1RH, 3KT, and 3ABP, with 3ADW immediate Past President and 3YRP President. There is one vacancy, for which it is hoped a Melbourne-based treasurer may be co-opted soon.

Presentations were made to the visitors from our sister society in New Zealand, the NZART, who responded in kind, and the Remembrance Day trophy for the 1989 contest was formally presented

to VK4NEF representing the Queensland Division.

Following the close of the Convention, a meeting of the new Executive was held, discussing the Treasurer vacancy, office work load, Contests and Awards Co-ordinators, WARC 92 preparation, recruiting programs and terms of reference for a review of Divisional and Federal WICEN.

Full minutes of both the Convention and the Executive meeting have been circulated to all Divisions.

Repeater Cross Linking

Members will recall the furore relating to tone access systems for control of cross linked repeaters which erupted late last year. The latest WIA submission on this matter, which was lodged with DoTC on 16th February 1990, was detailed on page 6 of the April 1990 issue of Amateur Radio magazine.

A response to that submission has now been received from Alan Jordan, Manager Regulatory, Radiocommunications Branch, DoTC, and reads as follows:

"I refer to discussions at the last joint Department/Institute executive meeting and to my letter of 10 October 1989 advising of the introduction of a new requirement for the fitment of a tone access system to amateur repeater stations which are cross-linked.

As you will recall, following consultations, the Department accepted the Institute's indicated preference for use of an audible tone burst access system in such situations. At the time it was also agreed that to ensure ready access a single uniform Australian standard should be adopted.

Since promulgation of the new provisions it has become apparent that some concerns exist within the amateur community that more than one form of tone access should be permitted. I also understand that, as a result of further internal consultation, the

Institute has revised its initial position on this aspect.

Accordingly, the Department has reviewed the access arrangements previously announced and I am pleased to advise that the following amended provisions will now apply:-

- (i) Fitment of a tone access system shall only be mandatory where an amateur repeater operating in the 146 to 148 MHz repeater band is cross-linked to a repeater operating in another amateur band.
- (ii) Only the following internationally recognised tone systems shall be employed for tone access:
 - (a) Continuous Tone Coded Squelch (CTCSS);
 - (b) Audible Tone Burst; or
 - (c) Dual Tone Multi Frequency (DTMF)

The system utilised shall conform to the standard tone frequencies for the relevant system specified in attachment (A) (this table is the same as published on page 8 of April 1990 issue of Amateur Radio magazine).

- (iii) Where a tone access system is fitted, it shall be installed such that the cross-link is only activated where the transmission of the relevant tone(s) is detected and only remain active while the originating transmission is present.

Selection of which of the three tone access systems is utilised will be the responsibility of each repeater group concerned. However, information on the type of link access tone system adopted must be made freely available to the amateur community.

The licensee of existing links will be given until 30th July 1990 to comply with the new requirements.

It is recognised that the use of tone access to provide interference protection and/or facilitate control of other special repeater features also offers distinct advantages. The Department has no objections to use of the three tone systems specified for these purposes.

Notwithstanding the flexibility in choice of the tone system to be employed, the Department suggests that to provide a co-ordinated approach, the Institute may care to develop guidelines for standard usage of the new access arrangements.

The relevant paragraphs in Departmental brochure DOC71 will be amended to reflect the revised conditions at the earliest opportunity."

A draft policy setting out WIA guidelines for "standard" usage of the new tone access facilities is in course of preparation, and it is expected to be released for members comment and input in the near future.

Contest Championship Co-incident

Although the participation in the major WIA HF contests has fallen in recent times, never-the-less contests are still an important and exciting part of the activity of amateur radio, and have been so since the earliest days of organised amateur radio communication.

The WIA sponsors four major HF contests each year: John Moyle Memorial Field Day Contest
Remembrance Day Contest
VK Novice Contest
VK/ZL/Oceania Contest.

In 1984 an HF Contest Championship competition was introduced on an annual basis. To be eligible for this competition entrants must participate in at least three of the four HF contests sponsored by the WIA. Points are allocated for the top 10 scorers in each State in each of the contests, with 10 points being for the highest score, down to one point for the tenth position. Points are allocated on a State basis to overcome any unfairness due to geographic or propagation advantages which may exist.

There are a number of other rules, some of which overcome the problem where only one 'token' entry appears for a particular category or section

M A G P U B S

A Special Service of the Wireless Institute of Australia

1990 callbooks

Here they are! The latest editions 1990. World-famous Radio Amateur Callbooks, the most respected and complete listing of radio amateurs. Lists calls, license classes, address information. Loaded with special features such as call changes, prefixes of the world, standard time charts, world QSL bureaus and more.

The North American Callbook lists the calls, names and address information for over 500,000 licensed Radio Amateurs in all countries of North America from Canada to Panama, including Greenland, Bermuda and the Caribbean Islands plus Hawaii and US possessions.

The International Callbook lists over 500,000 licensed amateurs in countries outside North America. Its coverage includes South America, Europe, Africa, Asia, Australia and the Pacific area (exclusive of Hawaii and the US possessions). Order both Callbooks now and save at these special prices.

When it comes to
**AMATEUR
RADIO QSL's...**



it's the
ONLY BOOK!
US or DX Listings

WIA288 1990 North American Callbook \$58.50 less 10% for WIA Members
WIA289 1990 International Callbook \$62.50 less 10% for WIA members

Practical Wire Antennas Effective HF Designs for the Radio Amateur

Practical Wire Antennas is a new book from the RSGB by John D Heys, G3BDQ published in 1989. This book has been written for the non-mathematician whose knowledge of this subject has never extended beyond the high school syllabus. It is aimed towards anyone who is capable of passing the Radio Amateurs examination, and the range of antennas described and illustrated are easy to set up and use successfully. There is additional data which will allow experiments and tests with versions that are cut for other bands or designed to fit into difficult locations. The simplified and, it is hoped, easily understood antenna theory is an attempt to allow the newest recruit to amateur radio to learn something about how simple wire radiators work at HF.

7" x 10" Stock # WIA296 \$28.00

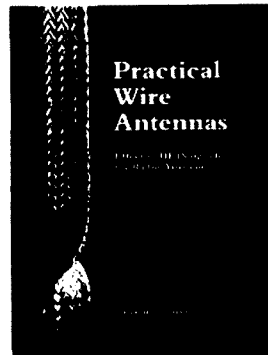

8th Computer Networking Conference 1989
Colorado Springs, Colorado Oct 7 1989
222 Pages 8" x 11" Stock # WIA295 \$24.00

SPACE ALMANAC

A galaxy of information! The new Space Almanac written by Anthony R. Curtis, K3RXX, editor of Space Today, is an extraordinary book that captures the breathtaking recent news from space, freshly compiled and written. It includes approximately 40 pages on Amateur Radio satellites. The Space Almanac is a major handbook featuring most anything you might want to know about Man's trip to the stars. Here's what you get:

- 500,000 words
- 960 pages
- Ten of thousands of facts
- Hundreds of stories, reports and descriptions
- Comprehensive Space history calendar
- Lists of future Space plans from around the world
- Scores of tables, charts, maps diagrams, histograms, drawings, photos, callenders, timetables
- Covers Space from Earth to the edge of the Universe in seven major sections: astronauts, space stations, shuttles, rockets, satellites, solar system and deep space

Stock Number BX299 \$40.00

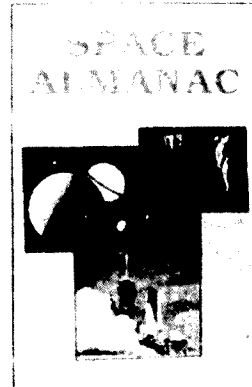

The above books, plus many more, are available from your WIA Divisional Bookshop. All items are less 10% discount for WIA Members and are plus postage and handling where applicable.

If not in stock at your Divisional Bookshop, your order will be taken and filled promptly. Not all publications are available from all Divisions.

from any State.

In 1988, for the first time in the history of the HF Contest Championship, there was a tie for first place in the Phone section. Ken, VK3AJU, with a score of 39 out of a possible 40, and Ian, VK5QX, also with a score of 39 out of a possible 40, were the joint winners.

Guess what? The 1989 HF Contest Championship has produced another draw, and to make the co-incidence even more unusual, the same two amateurs were the tied winners!

Frank Beech, VK7BC, the immediate past Federal Contest Manager, tells me that Ken, VK3AJU, and Ian, VK5QX, both scored 28 points out of a possible 40.

The sad part of this remarkable co-incidence is that Ken, VK3AJU, a keen contester, has now become a Silent Key.

World ITU Day

Did you take the opportunity on 17th May to celebrate the 125th anniversary of the signing of the International Telegraph Convention, the treaty which created the International Telegraph Union, later the International Telecommunication Union (ITU) and the world's oldest inter-government organisation?

If so you may have contacted stations using the special call sign VK(n)ITU. For some years now DoTC has granted permission for the use of this call sign by WIA Divisions on World ITU Day.

As part of this year's celebrations, the ITU headquarters in Geneva held its first Open Day on Sunday 13 May to show "how the Union's work affects the development of everyday telecommunication facilities such as the telephone, new telematic services and television".

Items in the extensive display included historic telegraph, telephone and radio devices, as well as demonstrations of modern telecommunications and data equipment, and future television systems.

Assistance with the display was provided by a number of European organisations as well as nearby amateurs.

Radiation Standards

The April edition of "The Australian Standard", the journal of the Standards Association of Australia, lists its recent publications of standards for a range of equipment and processes. One of the items noted supersedes a 1985 publication on Radiofrequency radiation, specifying limits of exposure of the human body to frequencies in the 100 kHz to 300 GHz range if hazardous biological effects are to be avoided.

This Standard, subtitled "Part 1 -1990", applies to occupational exposure of radiation workers and incidental exposure of the general public. No information is given as to the content of Part 2.

Obituaries

Comparison with other national amateur radio society journals shows that the WIA's journal, Amateur Radio, is the only one which regularly publishes obituaries. The WIA sees these items both as a tribute to those members who have been active in the Amateur Service and as information to other amateurs. These articles contribute to the history and tradition of the both the WIA and the hobby of amateur radio as a whole.

However, with the ever-increasing production costs of Amateur Radio magazine, and the constraints of space availability, the WIA has reluctantly accepted the need to place some limits on this facility.

The present intention is to continue to publish obituaries relating to members, and past members, but only if they are kept to a maximum length of 200 words.

Rather than impose impersonal editing on obituaries submitted for publication which are in excess of this 200 word limit, and so perhaps lose some of the writer's nu-

ances or emphases, it is proposed that these items will be returned to the contributors for reworking to the maximum acceptable length.

It is of course possible that a biography of a noted deceased amateur could become the basis for a short or feature length article for Amateur Radio magazine, a local newspaper or a technical journal.

End of an Era?

Two of the best-known voices in Australian amateur radio, those of Ron Fisher, VK3OM, and Bill Roper, VK3ARZ, are about to disappear from the Divisional news broadcast scene. For over fifteen years these two enthusiasts have produced the "Federal Tapes" which have been a consistent feature of most Divisions' broadcasts.

This system has been used over the years as a way of keeping members up-to-date with news and views from the Federal Body of the WIA. However, with the move towards more direct Divisional involvement and commitment in Executive activities, and not least because of the continual criticism of the "Federal Tapes" in recent years by one or more of the Divisions, the time is seen as appropriate for each Divisional Federal Councillor/Executive member now to be responsible for distributing Federal information within his Division.

Scripts for the Federal news segments in Divisional broadcasts will be provided to each Division from the Executive Office, and it will be the responsibility of the Divisional Federal Councillor to provide this news, plus any further Federal news or comments he may have, to his Divisional broadcast.

However, "Federal Tapes" will not disappear altogether. It is planned that a different type of "Federal Tape" will be produced on an irregular basis in the future to cater for items of special interest, inter-

views with amateur radio personalities, or reports of special events.

Federal Awards Manager

Recent appeals for a volunteer for the position of Federal Awards Manager, following the untimely death of Ken Gott, have at last paid off. Our thanks go to the six amateurs who offered their services.

After consideration, the position has been awarded to Phil Hardstaff, VK3JFE, who is able to take on all aspects of the position, and is conveniently located to enable close liaison with the Executive Office.

We extend our thanks to Phil, and good wishes for the future with this onerous task.

Members will realise that Awards mail has accumulated unanswered since Ken Gott's death. Please be patient a little longer until Phil can assume complete control and bring all outstanding Awards matters up-to-date.

Please note that all correspondence relating to Federal WIA Awards should be sent to:

The Awards Manager,
WIA Executive Office,
PO Box 300,
Caulfield South,
VICTORIA, 3162.

WIA 80 Award

Although the mail for this award has been accumulating as just mentioned, we understand that activity continues.

Have you made any progress towards gaining your WIA 80 award?

In case you have forgotten, to be eligible, VK amateurs (excluding VK9 and VK0) have to contact or log 80 members of the WIA. A valid contact must include the WIA member's membership number, either that on the membership certificate or the six-digit number on the AR address

label. The time period for the award is from November 1st, 1989 to December 31st, 1990.

For further information on this award, see Page 4 of Amateur Radio magazine for September 1989. Please note, however, that all claims for this award should now be sent to The Awards Manager, c/o WIA Executive Office.

Disaster Communications

A recent "ARRL Letter" describes the activities of the Jamaica Amateur Radio Association during two recent hurricanes, and explains the disaster communications planning in the area. Items noted in the report include the use of the amateur network to provide intercommunication between the various agencies involved, the effectiveness of short written messages rather than wordy verbal reports, a 72 hour moratorium on incoming health and welfare traffic to allow the local networks to concentrate on local needs, and the role of "jump teams".

The "jump team" in this case comprised two amateurs who travelled throughout the disaster area providing technical support for the re-establishment of communications.

Two points were stressed:-

Control of the communications situation belongs with amateurs in the affected area; and

No-one should send teams to an affected area until they are invited by the appropriate authorities.

The "ARRL Letter" also notes moves by the US National Disaster Medical Service to formalise its arrangements with the amateur service.

DOVE OSCAR-17

News reached the Executive Office recently about the breakdown of an On-Board Computer on DOVE-1, and the attempts to reset it.

Eventually, after several days of transmitting the reset sequence through the world's largest privately owned 2 metre antenna, with 32.5 dBi gain and nearly 2 megawatts EIRP, the attempt was successful and testing and commissioning were able to proceed.

Coincidentally, this enormous antenna, belonging to W5UN and used mainly for EME moonbounce, was unfor-

tunately destroyed in a tornado shortly after its use in the AMSAT operation.

Further details about this interesting amateur satellite can be found on page 34 of the October 1989 issue of Amateur Radio magazine.

DoTC Interference Booklet

One of the topics discussed by Alan Jordan, Manager Regulatory, Radiocommunications Branch, DoTC, at the 1990 WIA Federal Convention was the role of DoTC in interference investigations.

Alan commented on the release last year of the booklet "BETTER TELEVISION AND RADIO RECEPTION, YOUR SELF HELP GUIDE", which has been produced by DoTC in an attempt to reduce the number of interference investigations required. The booklet is attractively presented and written in plain English with simple technical terms. Over half of its 55 pages address problems affecting the quality of television reception. Good quality colour photographs make for fairly simple identification of the problem, and the importance of quality equipment, correct usage and an efficient antenna system are stressed.

Other sections deal with interference to AM and FM broadcasts and household electrical appliances, possible cures, and how to ask the Department for help if all else fails. A lift out questionnaire can be used as a check list or completed and forwarded to the Department if necessary. A directory of Departmental addresses is also included.

This booklet is forwarded as a first response to people who contact the Department over reception difficulties, and has been distributed to television/radio technicians and antenna installers throughout Australia.

It may now be purchased for \$7.50 from the Australian Government Publishing Service, and would be a very useful addition to every radio amateur's library.

Good Wishes

It has been brought to our notice that Pat, VK2RZ, the immediate past Amateur Radio magazine's "How's DX" column editor, is having a spell in hospital. Pat, best wishes for a speedy recovery from everyone at the WIA. **ar**

A Call to all Holders of a Novice Licence

Now you have joined the ranks of amateur radio, why not extend your activities?

The Wireless Institute of Australia (N.S.W. Division) conducts a Bridging Correspondence Course for the AOCF and LAOCF Examinations.

Throughout the Course, your papers are checked and commented upon to lead you to a successful conclusion.

For further details write to:

The Course Supervisor
WIA

PO Box 1066
Parramatta NSW 2124
(109 Wigram Street, Parramatta)
Phone: (02) 689 2417

**11am to 2pm Monday to Friday
7 to 9pm Wednesday**

Back issues of AR available to WIA members

Jan 1969 to Dec 1987
\$2.50 each

Jan 1988 to current issue
\$4.00 each

(Some issues out of stock)

Prices include postage

**AR BACK ISSUES
PO Box 300 Caulfield
South
Vic 3162**

**AMATEUR RADIO
HELPING OUR COMMUNITY**

MICROWATT RF POWER METER

RON COOK VK3AFW 7 DALLAS AVE OAKLEIGH 3166

Low-level RF measurements are difficult for most radio amateurs to make. This article describes a simple meter capable of measuring RF power from one Watt down to less than $10 \mu\text{W}$ with good accuracy (from audio frequencies to beyond 150 MHz).

Introduction

The measurement of power at levels of around one Watt and higher is readily done using commercial equipment or by constructing the circuit shown in Figure 1. This is a terminating power meter, that is it terminates a line and absorbs the incident power. Another family of power meters is known as a through-line meter and absorbs very little of the power being measured. My application was the measurement of power from an exciter to be used for VHF transverters and measurement of the output from the oscillator and low-level stages of those transverters, thus a terminating meter was suitable but, because of the lower power levels involved, a more sophisticated circuit was required. This article describes the design and development of the meter.

The Circuit

The basic limitation of the circuit in Figure 1 is due to the finite turn-on volt-

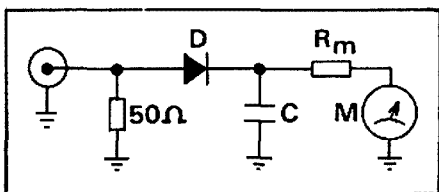

Figure 1

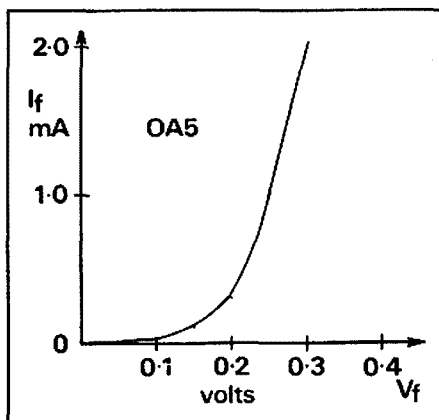

Figure 2

age of the diode D. For germanium diodes this is about 0.25 V, 0.4 V for hot carrier diodes and 0.6 V for silicon diodes. Figure 2 shows a curve for a typical diode. If we have a two-Watt transmitter connected to the circuit in Figure 1, a voltage of 10 V rms will be applied across the 50 Ohm resistor. If the meter M draws 1 mA at full scale, a value of R_m can be found to limit the current to this value for 10 Watts input. The voltage across C will be 1.414 times the rms voltage, so R_m will be $14.14/1 = 14.14 \text{ k Ohm}$. We need to allow for the meter resistance which will be about 100 Ohms. Also, examination of Figure 2 shows that there will be a small volt drop across D, about 0.25 V at 1 mA, so this needs to be allowed for. A resistance of 13.8k Ohm would be suitable for Rm.

Now if the power level were reduced to one milliwatt, the peak RF voltage is 0.316 V. After allowing for the diode drop we have 66 mV to drive the 1 mA through the meter. Unfortunately this will not happen, as the meter has a 100 mV drop across it at one mA. Indeed, long before the power levels have been reduced to that level, we will have had problems of non-linearity with our simple instrument. Selecting a more sensitive meter will alleviate the problem to a degree, but it is difficult to buy a meter requiring less than $50 \mu\text{A}$, and even with this improvement, eventually the diode volt drop will defeat us.

If we could make the meter load very large, say 1M Ohm, then the power level could be reduced a very long way before the diode volt drop caught up with us. An obvious solution is to use an op amp as a meter amplifier. Figure 3 shows the circuit I selected. The diode load is 1M Ohm, which is roughly equivalent to having a meter of sensitivity $0.1 \mu\text{A}$, the difference being that there is no requirement for the diode to supply 100 mV to drive the meter, the op amp looks after that. The rectified voltage is filtered by a 1000 pF capacitor and applied to the high-resistance input of the op amp. The amplifier supplies enough current to produce an equal voltage across the range resistor, which is selected to suit the meter. The meter resistance is not important; I chose a 1mA movement because it was readily available.

Scales and Ranges

The instrument is really an rf voltme-

ter with a 50 ohm input resistance. Indeed, in some applications it may be preferable to calibrate it in volts. The power reading is obtained by squaring the meter reading and multiplying by the full-scale value. For example, the indication of power at half deflection is actually $0.5 \times 0.5 = 0.25$ full scale. Thus, on the 10mW range, the meter indication of 0.5 represents 2.5 mW, and an indication of 0.1 represents 0.1 mW or $100 \mu\text{W}$.

While I chose to use a 1, 5, 10 sequence for the ratio between ranges, a 1, 10, 100 sequence would be suitable for powered meter applications. With such an arrangement, the meter need not be used below about one-third scale except on the most sensitive range where powers as low as $2.5 \mu\text{W}$ can be measured at five per cent deflection. This is sufficiently sensitive to get a reading from local TV and broadcast stations using the station antenna.

It may be convenient to make up a chart to allow quick conversion of a meter reading to power level. The chart could be stuck onto the top of the meter case so it can be readily found when required!

Limitations

Because it is a simple circuit it has some limitations. Firstly the op amp must be carefully chosen to have very low bias current and low offset voltage. The offset voltage must be negligible compared to the rectified voltage at the lowest power levels, and the bias current must be negligible compared to the current in the 1M ohm resistor at the lowest power levels. I found that an LM308AN was suitable. The 741 series and the lower performance versions of 308 series were inadequate.

Of course the basic limitations of the diode rectifier still exist, but for the accuracy class involved I found the limitation negligible in this instrument. Initially I tried to use a germanium diode because of its low forward drop, but the reverse resistance was about 1M ohm and so the rectification efficiency was very poor. A hot carrier diode was substituted with excellent results.

The parasitic impedances in the 50ohm load also cause errors as the frequency is increased. Tests carried out using equipment at the QTH of Harold, VK3AFQ, indicated satisfactory performance up to about 200 MHz. A better quality load would extend the range. As it is it can be used for initial tune-up of low-power

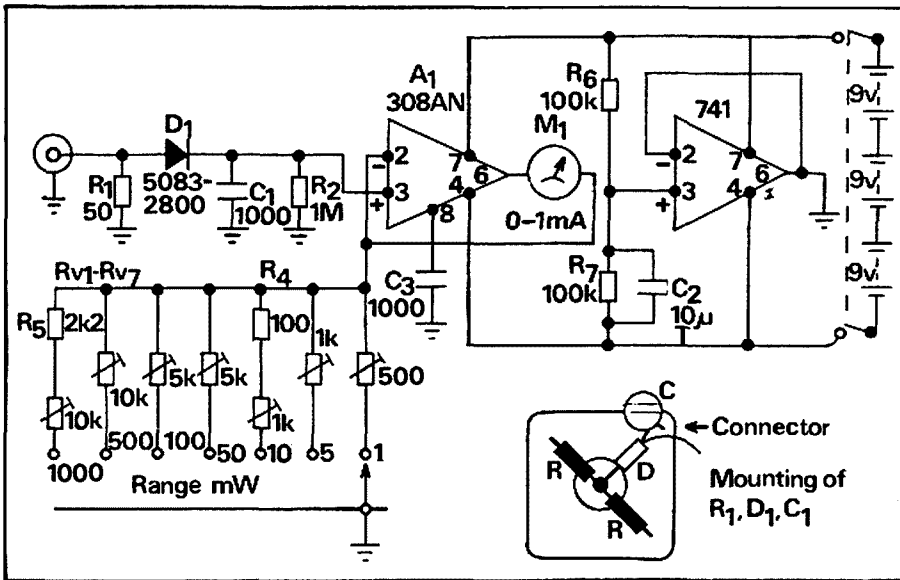

Figure 3

equipment at 450 MHz but the VSWR is probably greater than 2:1 and final tune-up needs to be done into the actual load.

Power Supply

Because the op amp requires a balanced positive and negative supply, it is tempting to use two 9V batteries in series with the common point earthed. Unfortunately for a one-Watt range, the op amp needs a +/-12V supply or more to ensure "headroom" for the amp above the 10 volts from the rectifier. Four 9V batteries could be used, but this is pushing the op amp a bit hard, so three 9V batteries were selected to keep the instrument small and portable. A 741 op amp is used to synthesise an earth point for the system.

Calibration Table

Meter Reading	RF Power Level						
	1W	500mW	100mW	50mW	10mW	5mW	1mW
0.0	0	0	0	0	0	0	0
0.1	0.010	5.0	1.0	0.50	100 μ W	50 μ W	10 μ W
0.2	0.040	20.0	4.0	2.0	400 μ W	200 μ W	40 μ W
0.3	0.090	45.0	9.0	4.5	900 μ W	450 μ W	90 μ W
0.4	0.160	80.0	16.0	8.0	1.60 mW	800 μ W	160 μ W
0.5	0.250	125	25.0	12.5	2.50	1.25 mW	250 μ W
0.6	0.360	180	36.0	18.0	3.60	1.80	360 μ W
0.7	0.490	245	49.0	24.5	4.90	2.45	490 μ W
0.8	0.640	320	64.0	32.0	6.40	3.20	640 μ W
0.9	0.810	405	81.0	40.5	8.10	4.05	810 μ W
1.0	1.000	500	100.0	50.0	10.0	5.00	1.00 mW

The above table shows the power level for various meter indications on seven ranges. The square law response is clearly evident. The 500mW, 500mW and 5mW ranges could be omitted as there is sufficient overlap on decade ranges alone.

Calibration

To calibrate the instrument, a DC source and DC voltmeter are required. Select a range and apply a voltage equal to the peak RF voltage for full scale on the range. For example, this is 0.3162V for 1mW, 1.000V for 10mW, 3.162V for 100mW and 10.00V for 1 watt. Make sure you apply the correct polarity, otherwise you will not get a reading. If you wish to check the linearity of the meter you can do so by measuring the voltage to obtain indications at the main scale markings. Remember, most moving pointer meters are only intended to be accurate to about three per cent above 1/3 full scale, and the cheaper ones will be worse than this. Also, such meters can suffer from stiction, and a gentle tap on the meter face

before reading is good practice.

Concluding Remarks

Whilst other meters using thermistors, filament lamps and diode compensation circuits have been used successfully for μ W power measurement, the best going into the 40 GHz region, they are more complex and require special machined parts for the microwave region. For my application the complexity did not seem warranted.

The meter has proved very useful to me and I hope that those of you who make this instrument enjoy similar success.

References

- 1 Grebenkemper, J, KA3BLO, The Tandem Match — An Accurate Directional Wattmeter, QST, Jan 1987, pp 18-26.
- 2 Braithwaite, I, G4COL, Simplified RF Power Meter, Technical Topics, Radio Communication, May 1986, p342.
- 3 Gibson, H L, Test Equipment for the Radio Amateur, Second Ed, Chapter 4, RSGB.
- 4 Braithwaite, I, G4COL, An RF Voltmeter, Ham Radio, November 1987, pp 65-75.
- 5 Pivnichy, J, N2DCH, A Sensitive RF Voltmeter, Ham Radio, July 1989, pp 62-67.

ar

NOVEL POLARITY TESTER

TREVOR SHERRARD VK4ATS
38 HALSMERE ST
GEEBUNG 4034

Equipment Required (i) DC source
(ii) Test probes (copper)
(iii) Slice of potato (raw)

Method (i) Connect leads to source
(ii) Insert into potato (about 2mm spacing)

Result: One probe shows green. This is the positive pole.

So the humble spud joins the ranks of Hewlett Packard, Tektronix, Fluke etc.

"Don't leave home without one".

GETTING MORE FROM YOUR OSCILLOSCOPE

IVAN HÜSER VK5QV 7 BOND ST MOUNT GAMBIER 5290

Next to the multimeter, the cathode-ray-oscilloscope is, arguably, the most useful piece of electronic test equipment available to the radio amateur. As well as allowing the wave-shape of a voltage to be displayed, the modern calibrated oscilloscope allows the user to determine such things as the peak-to-peak value of a waveform, the period of the waveform from which the frequency can be determined, phase shift and whether the waveform is AC, DC or a complex waveform of AC superimposed on DC.

A cathode-ray-oscilloscope is also necessary when checking the linearity of RF power amplifiers.

The most common oscilloscope used by amateurs is perhaps the dual-trace oscilloscope with a frequency response of DC to 20MHz¹. These are available at reasonable cost through the normal commercial channels and represent good value for money.

The aim of this article is to discuss some relative points that may help you effectively set up your cathode-ray-oscilloscope, recognise some of the problems encountered and generally improve the usefulness of the instrument.

Initial Setup

There are four important adjustments necessary when initially setting up a cathode-ray-oscilloscope and these adjustments will need to be checked from time to time during operation. They are **focus**, **astigmatism**, **trace rotation** and **probe compensation**, and are generally completed in that order.

All of these adjustments have some bearing on the resolution and accuracy of the traces and so should be effected with care. Some of the controls need only infrequent adjustment and hence these controls may be located inside the oscilloscope. Consult your manual before attempting any adjustment.

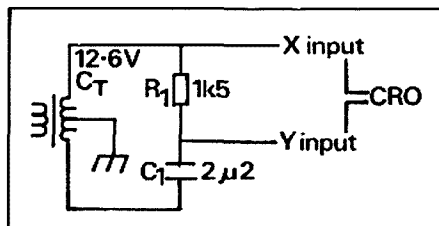

Figure 1

Focus — Astigmatism

These two adjustments should be done concurrently and are best accomplished using a circular trace. Figure 1 shows a 90° phase-shift network which, when connected to the oscilloscope operating in the X-Y mode, will give an approximate circle on the screen. A variable resistor may be used in place of R₁ to “tweak” the circle if so desired.

Adjust the X and Y gain controls and the vertical and horizontal shift controls until the circle takes up about 60 to 80 per cent of the screen. Adjust the focus using the sides of the circle and the astigmatism using the top and bottom of the circle, repeating the adjustments until the sharpest overall pattern is achieved. These adjustments should be carried out with the intensity set to “normal” brilliance, bearing in mind that a sharper trace will be obtained if a low intensity is used.

Alternatively, the focus can be adjusted on the slope of a sine-wave and the astigmatism on the flat top of a square-wave. This is, in fact, how I complete the adjustments, using waveforms obtained from an audio signal generator. If a signal generator is not available, the sine-wave can be obtained from the secondary of a low-voltage transformer and the square-wave from the calibration output of the oscilloscope.

Trace Rotation

It is impossible to manufacture a cathode-ray-tube having perfect geometry. This, together with external influences such as stray magnetic fields, including the earth’s magnetic field and fields produced by surrounding wiring, can cause the trace to tilt. In modern oscilloscopes, a trace rotation control is provided to counter the problem.

With the input to the Y amplifier grounded, obtain a sharp horizontal line on the screen and adjust the trace rotation control until the trace is aligned with the horizontal graticule lines.

Probe Compensation

One of the most important, yet often the most overlooked considerations when using an oscilloscope, is how to connect the oscilloscope to the circuit under test.

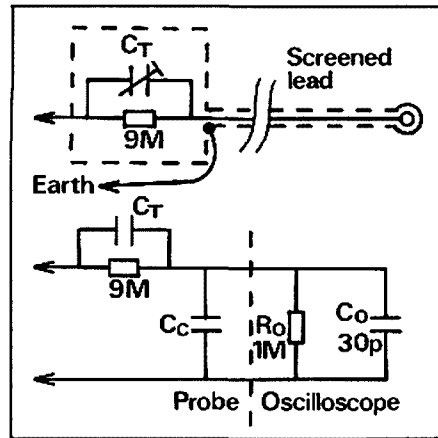

Figure 2a and 2b

Experience has shown that it is best to use a commercial probe with your oscilloscope rather than a home-brewed lead using a random length of RG58 coax or whatever.

The input impedance of a cathode-ray-oscilloscope is typically 1MΩ shunted by about 30pF of stray capacitance. Another 60pF or so can be added for the capacity of the lead. When connected to a circuit, this combination can cause distortion of the waveshape and errors of measurement. In some cases it can cause the circuit to malfunction.

On DC and low-frequency AC, the input impedance can be considered to be 1MΩ resistive and may have negligible loading effect on the circuit, although even 1MΩ can cause problems in some circuits, as will be seen later.

As the signal frequency increases, the reactance of the effective shunt capacitance decreases and, at 10MHz, 100pF presents a reactance of only 160Ω — far less than the 1MΩ impedance quoted in the specifications.

With a X10 probe, the DC-input impedance will be raised to 10MΩ and, at the same time, the shunt capacitance will be effectively reduced to around 10pF. This represents a useful improvement in input impedance.

The circuit of a typical X10 probe is shown in Figure 2(a), while Figure 2(b) shows the equivalent circuit. The trimmer capacitance (C_T) together with the cable capacitance (C_C) in parallel with the input capacitance to the oscilloscope (C_O) form part of an AC voltage divider.

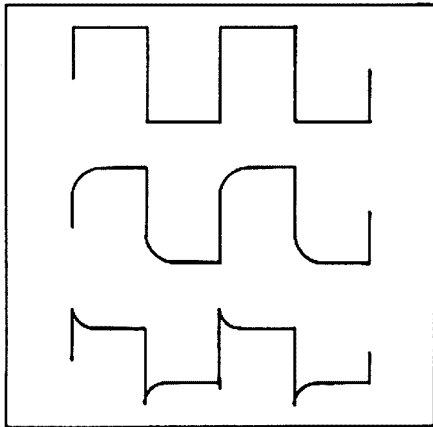

Figure 3a, 3b and 3c

When correctly adjusted, the reactance ratio will be the same as that of the resistive divider, and the circuit becomes frequency independent.

With the probe set to X10, C_T should be adjusted to give the "best" waveshape using the square-wave calibration output of the oscilloscope or a square-wave from a signal generator. Figure 3(a) shows a square-wave viewed on an oscilloscope using a correctly compensated probe, while figure 3(b) shows the effect of an under-compensated probe and Figure 3(c) an over-compensated probe.

Probe Applications

Perhaps the best way to illustrate the use of a probe is by way of practical examples.

The effect of stray capacitance can be demonstrated by viewing a square-wave, first with a correctly compensated probe set to X1, and then with the probe set to X10. On X1 a distinct integration of the waveshape should be seen as shown in Figure 4(a). This is caused by the stray capacitance being charged and discharged via the internal resistance of the square-wave source and is typical of a charge/discharge time constant curve for a resistor and capacitor in series. On X10 the effective stray capacitance will be less, hence the effect on the waveform will also be less. This is shown in Figure 4(b).

It can be seen that waveforms having fast rise and fall times such as a square-

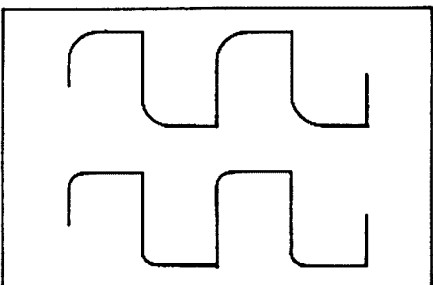

Figure 4a and 4b

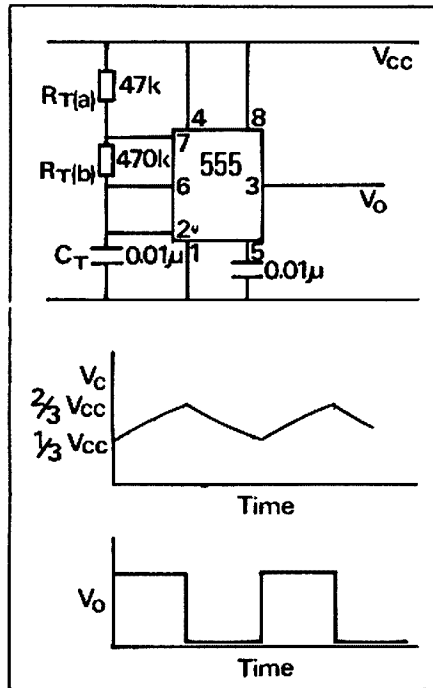

Figure 5a and 5b

wave, may be distorted by the capacitance of the lead and that the longer the lead the greater will be the capacitance and, hence the greater the distortion of the waveform.

Perhaps one of the most subtle effects of lead capacitance is that it can produce a phase-shift, which in turn may cause an otherwise stable circuit to oscillate. Using a X10 probe will generally correct the problem.

A X10 probe may also be used to reduce the DC loading on a circuit. Consider the 555 astable multi-vibrator circuit shown in Figure 5(a).

A change in state of the output occurs when the timing capacitor (C_T) charges to 2/3 of the supply voltage and again when it discharges to 1/3 of the supply voltage, producing the waveforms shown in Figure 5(b).

With the X1 probe connected across the capacitor, the $1M\Omega$ internal resistance of the oscilloscope, together with

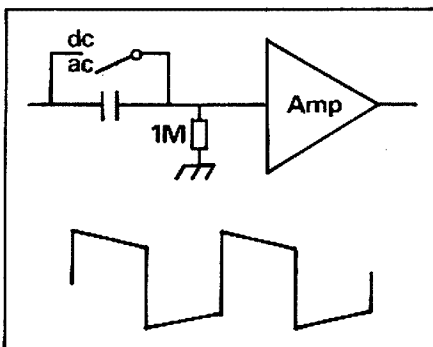

Figure 6

the two charging resistors $R_T(a)$ and $R_T(b)$, form a voltage divider. A simple calculation will show that with the oscilloscope connected, the maximum voltage to which the capacitor can charge will be less than 2/3 of the supply voltage and the circuit will cease to operate.

If a X10 probe is used, the $10M\Omega$ impedance will have little effect on the operation of the circuit.

Standing Waves

As the frequency increases, the length of the probe lead may become an appreciable fraction² of a wavelength, particularly if a long home-brewed lead is used. Since the cable is not terminated in its characteristic impedance, standing waves can occur.

When monitoring the RF output from a transmitter, the standing waves can result in a high voltage point at the input of the oscilloscope. This has a nasty habit of destroying the front end of oscilloscopes.

The AC-DC Switch

Distortion of a waveform can sometimes be attributed to the incorrect use of the AC-DC switch. Figure 6(a) shows the basic connection of the switch.

If a square-wave is viewed on an oscilloscope with the AC-DC switch in the AC position, partial differentiation of the waveform can occur due to the input coupling capacitor and the $1M\Omega$ input resistance of the oscilloscope. This effect is shown in Figure 6(b).

Summary

When using an oscilloscope:

1. A compensated probe should be used with the switch in the X10 position for most applications. The X1 position should only be used when viewing very low-voltage waveforms (in a low-impedance circuit).
2. Always start with the AC-DC switch in the DC position and, if possible, leave it in that position while viewing waveforms.
3. Rather than extend the length of an oscilloscope lead, move the oscilloscope closer to the circuit under test.
4. Read your manual.

Notes

1. Note that a 20MHz oscilloscope can be used to display a 30MHz waveform, but the calibration of the vertical amplifier will no longer be valid.
2. On 30MHz, a 1/4 wavelength of RG58 coax measures less than two metres.

Continued on page 15

A SIMPLE DIP METER

DREW DIAMOND, VK3XU
 'NAR MEIAN' GATTERS RD
 WONGA PARK 3115

The dip meter is a very handy instrument for the radio worker. Resonant frequency of tuned circuits may be found simply by loosely coupling the dipper coil to the inductive component of the circuit under test and searching for a dip on the meter. The inductance of an unknown coil, or the capacitance of an unknown capacitor may be found by measuring the resonant frequency of a known/unknown combination and then looking up a chart (see Ref 1). The meter may also be used to check the quality of SSB, CW, RTTY or AM transmissions, and as a signal source for receiver work. Wavemeter operation is also provided, so transmitter stages may be checked for harmonics and/or spuri. This project should interest anyone with more than a passing interest in the technical aspects of radio, and offers an instrument which will find frequent application, both inside and outside the shack.

Theory of Operation

The classic Hartley configuration was found by experiment to be the simplest

circuit to provide the widest frequency coverage consistent with a satisfactorily constant output indication over each range. The 1.8MHz to 30MHz frequency range is covered with five home-made plug-in coils: L1-L5. The coils are mounted upon four of five-pin plugs so that a variable capacitance maximum of 300pF may be selected to cover the 1.8 to 17MHz ranges, and 100pF maximum for the 17 to 30MHz range.

Oscillation is maintained by Q1, an MPF102 FET. The sine voltage appearing at the source tap is detected by germanium diode D1 and C9 charges to an EMF of about 0.5V which drives meter M1. Earphones may be plugged into the circuit here so that any audio modulation upon the signal can be heard.

The 'dipping' phenomenon is produced when the coil of the dipper is coupled to the coil of the tuned circuit under test. This is what I think actually happens: "When the field from the primary coil energises the 'passive' coil, it will, if the exciting frequency is at or near the resonant frequency of the passive

circuit, set up its own field in opposition to the primary field, which tends to lower the amplitude of oscillation in the primary circuit." If the coupling is sufficiently 'tight', oscillation may actually cease. The higher the Q of the passive circuit, the sharper and deeper the dip for the same degree of coupling. This explanation is at odds with that normally given in the standard texts, which generally state that energy is "absorbed" or "sucked" from the dipper coil, but this does not explain why a higher Q circuit produces a deeper dip than a low Q one.

(This is because the coupling factor, or tightness of coupling, is defined as the product of coupling coefficient K and Q. When $KQ = 1$ coupling is said to be critical. Ed)

Wavemeter operation is obtained when the oscillator is switched off. The circuit then becomes a simple tuned circuit and diode detector tapped into the coil.

Construction

The dipper shown in the photo was built in an off-the-shelf aluminium box measuring 7.5 x 13.3 x 5.4cm. The circuit components have been mounted upon a small tag strip adjacent to the coil socket, so ensuring that signal conductors are kept short. The 200pF + 100pF variable capacitor at C6 and C7 is known to be available from two sources at present (more about parts later). These capacitors usually come with little padder capacitors fitted to the solder tags. These are not required, so remove the 8BA screws and break off the copper plates. Use a multimeter on its highest ohms range to check that the capacitor plates are not shorting or leaky (must read infinite over the entire rotation). When fitting the capacitor, make sure that the mounting screws do not touch the plates. Use spacers if this is a problem.

The photo shows a suggested dial arrangement. The scale, compassed upon thin cardboard, may be fixed onto the case with double-sided adhesive tape, capacitor shaft projecting through the centre. The cursor was made from a 72mm length of 1.5mm perspex, width to suit a largish knob of about 3cm diameter. A line should be scored down the middle of the perspex as shown, then glued to the knob. A very small hole (say 1mm) will be required in the cursor corresponding to each dial scale to facilitate

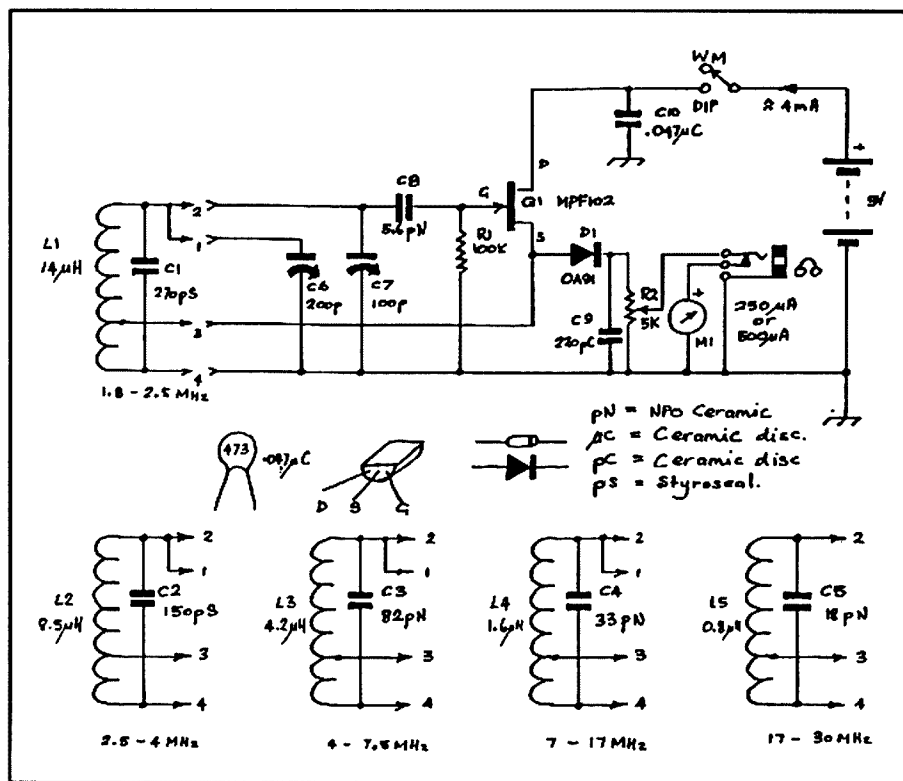

Figure 1. DIP OSCILLATOR 1.8-30MHz

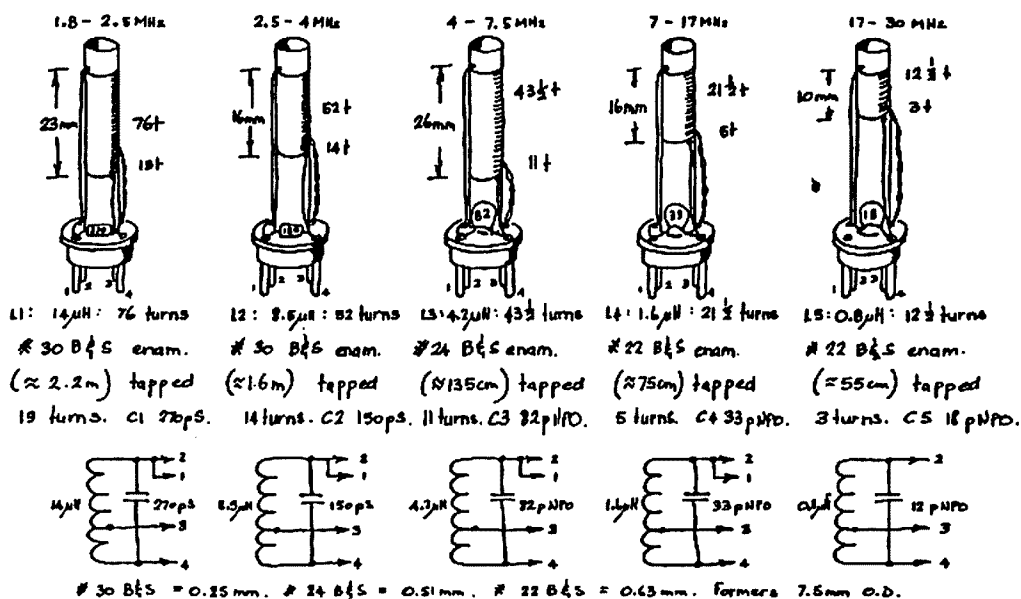

Figure 2. PLUG-IN COIL DETAILS

calibration later.

A deliberate choice was made to use small diameter coil formers so that compact circuitry may be explored with the dipper. The five coil formers should be glued with epoxy cement to the five-pin plugs preparatory to winding the coils. The 7.5mm formers shown have had their bases cut off with a junior hacksaw, leaving just the tubular parts, about 50mm long. Take care cutting the bakelite formers — they are rather brittle. Drill across the full diameter of the formers with a 1mm drill at the places indicated. These holes will provide anchor points for the coil ends.

To wind the coils L1 and L2: place one end of the wire in a vice. Thread the other end of the wire through the bottom an-

chor holes and solder it into the appropriate plug pin. Now, whilst keeping the wire taut, walk towards the vice making sure all the time that each turn lies right next to the last. At the 1/4-way mark, pull out about 5cm of wire, then twist it into a little pigtailed loop. This will form the source tap. Now carefully wind on the remaining turns. Do not let go your grip on the coil until the other end is passed through the top anchor holes, or the whole thing will uncoil. Coils L3-5 may be wound in the usual way, holding the winding onto the former between forefinger and thumb.

The coils should be checked and proven to give the correct frequency range. It may be necessary to change the value of capacitor across a coil to obtain the correct range. For example, if it is found that the nominally 4 to 7.5MHz range is a little low, then C3 could be decreased to the next lowest preferred value, ie 68pF. When all is right with the coils, it is strongly recommended that an additional fillet of epoxy be applied to the base of the coil for extra strength and to provide support for the capacitors. Later they should be coated with clear lacquer to cement and protect the winding. The coils may be colour-coded to the dial scale, or keyed alphabetically (or both) to give unambiguous ranging.

Calibration

The small 1mm holes in the cursor will allow a pin to be used to mark the calibration points, then the knob swung to one side and the actual frequency marked

upon the appropriate scale. Mark lightly with pencil first, and so obtain a 'feel' for the frequency spread, then complete later with a fine black pen.

There are a number of methods available for calibrating the dipper. The simplest and most direct way would be to loosely couple a frequency counter to the coil and read the frequencies off for each range. A one or two turn loop at the counter input should provide sufficient signal for this. If the dipper must be tightly coupled to obtain unambiguous readings, then errors will occur, so another method should be adopted.

or

Listen for the dipper signal on a calibrated general coverage receiver. Set the receiver to salient frequencies and tune

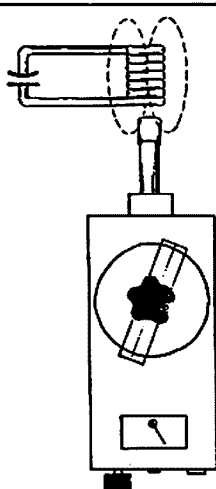

Figure 3. Inductive coupling - end on.

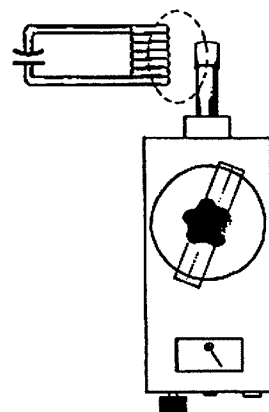

Figure 4. Inductive coupling - side on.

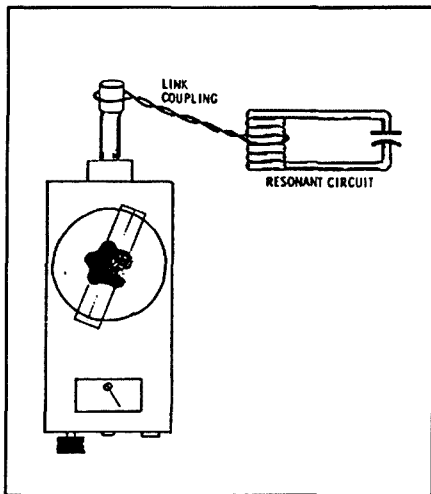

Figure 5. Link Coupling .

the dipper for a signal at each desired calibration point. Remember, as with any superhet, a strong signal may result in the reception of the 'image', so be on guard for this potential source of serious error. The stronger signal is probably the correct one.

or

If a calibrated signal generator is available, connect a three or four-turn loop to the output connector of the generator, which is adjusted to supply an appropriate frequency and a large signal. With the dipper loosely coupled to the loop, a flick in meter reading should be observed as the dipper dial is swept over the generator frequency (or listen for a beat in headphones if this is easier for you).

Uses

References 1, 2 and 3 show typical applications for this instrument. Shown in Figures 3-6 are some of the most commonly used measurement techniques available. Always use the least amount of coupling necessary to obtain a visible dip.

Parts

All the components specified in this project are readily obtainable at present. The variable capacitor may be purchased from Jaycar or Truscotts Electronic World (Croydon, Vic). Make sure the one you get is exactly as specified, complete with 1/4" shaft of adequate length. The meter, case, five or four-pin plugs (known as line or speaker plugs) and 7.5mm bakelite coil formers were obtained from Electronic World. Plugs, socket, signal meter and some other parts also available from Dick Smiths.

Problems

If your meter will not oscillate on some

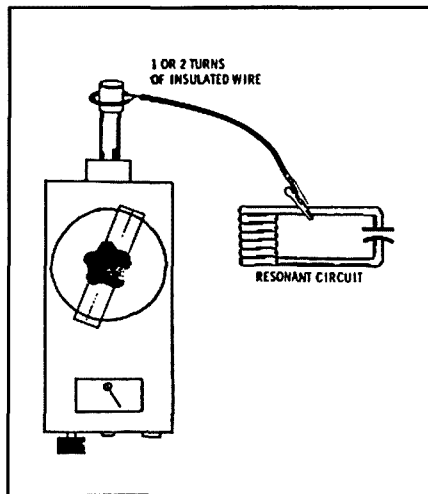
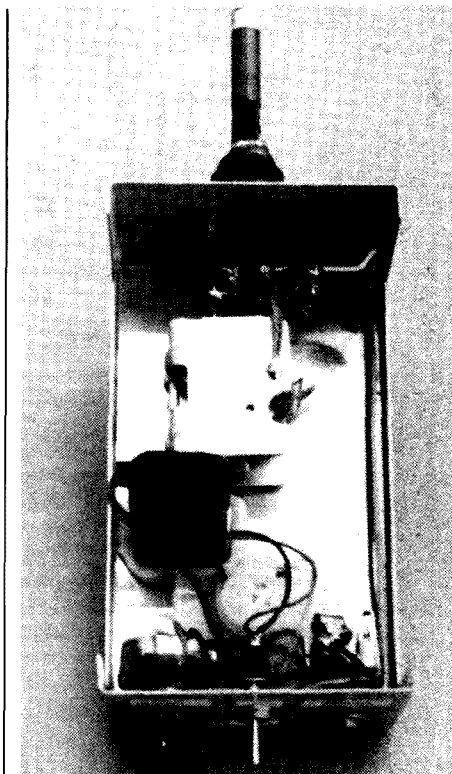

Figure 6. Capacitive coupling

ranges, you may have a low gain MPF102, so try a new one (perhaps a different brand). Avoid using ordinary disc ceramics for C3-C5, as they are rather lossy, and may cause erratic operation.

Erratic operation or false dips may also be caused by a fault in the variable capacitor. Check that the plates are not shorting, and look through the vanes to see that no foreign matter is caught there. Carefully use compressed air to remove any particles. Check also that the rotor wiper is clean and providing good contact.

If the oscillator is switched on without a coil plugged in, a meter reading will be observed. This is simply drain-source current now flowing through the diode, as the low-resistance path through the



Placement of Components - Internal View

source tap is removed. If this annoys you, reverse the direction of diode and meter. I left mine as is, because it provides a rough but quick battery check.

When monitoring signals, the meter should not have to be directly coupled to the transmitter, as enough signal will normally be found 'in the shack' to pro-

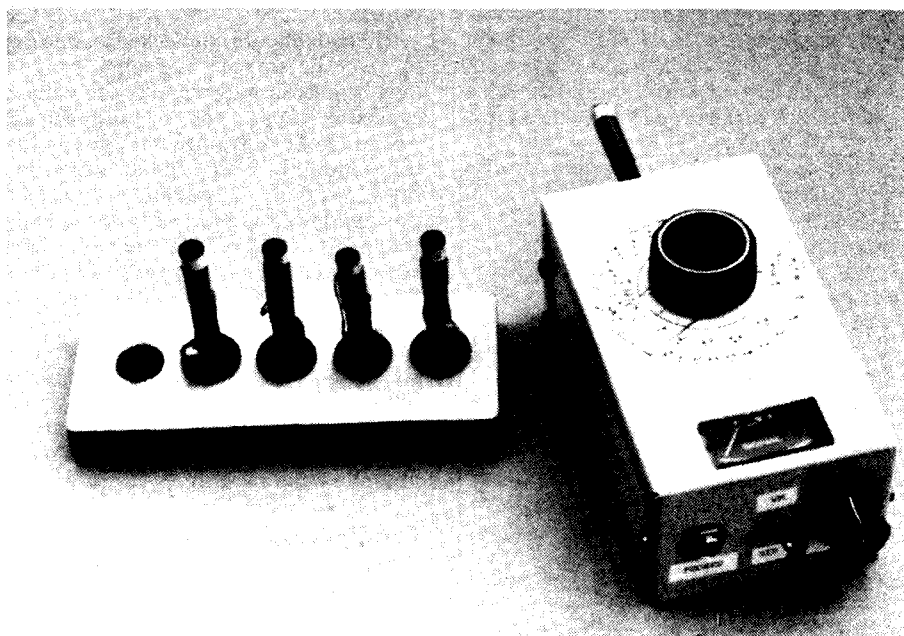

Dipper and Coil set

vide headphone operation.

Obviously, with the dial knob directly connected to the variable capacitor shaft, frequency adjustment is very coarse. A worthwhile improvement would be the addition of a 6:1 planetary drive.

If, after fruitless attempts on your part, you cannot get your dipper to work satisfactorily, please write and I shall extend any reasonable amount of help necessary (SASE please).

References and Further Reading

1. Measuring Coils and Capacitors with a Dip Meter — Novice Notes, May '88
2. Any Amateur Radio Handbook
3. Servicing with Dip Meters — Lenk, Foulsham-Sams
4. Bailey, G3WPO — FET Dip Oscillator MKII, Rad Com Apr 87.

Parts List

Capacitors	Where used
5.6pF NPO ceramic	C8

18pF (nominal) NPO ceramic	C5
33pF (nominal) NPO ceramic	C4
82pF (nominal) NPO ceramic	C3
100 + 200pF dual gang variable	C6, C7
150pF (nominal) styroseal	C2
220pF ceramic	C9
270pF (nominal) styroseal	C1
0.047uF ceramic	C10
Resistors	
5Kohm linear pot	R2
100Kohm 1/4W, 5% R1	
Semiconductors	
MPF102 FET	Q1

OA91 etc germanium diode D1

Miscellaneous

Case, 7.5mm coil formers (5), four or five-pin plugs (5), socket to suit, 250uA or 500uA meter, headphones connector, 9V/216 battery and connector, SPDT switch, pot knob, dial knob, 1.5mm perspex material, winding wire, hook-up wire, small tag strip, 4BA CSK screws for variable capacitor (3), screws, nuts, solder, epoxy cement, wet weekend (1) etc.

ar

Errata and Addenda for DC Superhet — Drew Diamond VK3XU AR May 90

- C42 is shown as 10μT. It should be 220μE (as shown correctly in the parts list).
- Parts list should indicate 0.047μF (or 0.1) disc ceramic (not 0.47). Also, a trace of 50Hz FM on the VFO (not previously noticed) has been traced

to stray flux from the power transformer. The VFO circuit board should therefore be placed so that L6 is as far from the power transformer as practicable (ie rotate the VFO board 180° from that shown in the photo).

Getting more from your Oscilloscope Continued from Page 8

Profile of the Author

Ivan was born and educated in Adelaide. He served an apprenticeship as an electrical fitter and, at the same time, completed a radio course at the School of Mines (now the SA Institute of Technology) and obtained his AOCF in 1952.

After returning from a two-year working holiday in the UK and Europe, he obtained his BOCF and found employment as a radio mechanic until joining TAFE as a lecturer in 1969.

Ivan has held the call signs of VK5QV, G3KGH and VK2ATX.

Looking forward to early retirement later this year, Ivan spends much of his spare time caretaking at Centenary Tower on top of Mount Gambier, where he wrote this article during breaks between attending to tourists.

ar



Ivan Huser VK5QV

RODRIGUES ISLAND
 (WAZ ZONE 38 UTC ZONE 151 (OTA) A1)
3B9FR
 ROBERT FELICITE PORT MATHURIN
 QSL VIA FEENIX P. O. BOX 14, P-81281 ANPAJON Cedex FRANCE

RADIO	DATE	UTC	FREQ	RST	2 WAY
VK2PS	18587	11S	14	59	55E
				59	55E
				59	55E

GREETINGS FROM SANTA CRUZ ISLAND

Galapagos Islands Lost In Time.

HC8JG

Confirming 2-WAY QSL with

Radio Station	Date	Time	Zone	Frequency	RST	Mode
VK2PS	10-8-89	20:14		7.05	56	SSB

Pse QSL Tax

JOSE LUIS GALLARDO

Santa Cruz Islands

GALAPAGOS

FRIGET DRAKE

Ant. 3-4m Yagi Beam 70°

QSL Mg WA6ZEL

More exotic DX QSL cards from stations worked by Stephen Pall VK2PS

A SIMPLE AND INEXPENSIVE RESISTANCE-CAPACITANCE BRIDGE

J GAZARD VK5JG 2 CORBIN ROAD MENINDIE GARDENS 5081

The circuit of the bridge is shown in Figure 1. An audio oscillator (Tr 1 Tr 2) generates a tone to activate the bridge and the unknown resistor or capacitor is compared with a standard. The ratio of the unknown to the standard is shown when the potentiometer finds the null point of the tone. The tone is amplified by Tr 3.

Because leakage from the oscillator to the amplifier can reduce the depth of the null, the oscillator and the amplifier are fed by separate batteries and placed as far apart as possible.

The bridge can be assembled under a piece of masonite or other hardboard

should be satisfactory for amateur use. Greencaps are suitable as standard capacitors. The minimum range of standards is 100Ω, 10000Ω and 1 Meg Ohms for resistors and 100pF, 0.01 and 1μF for capacitors, but if a 10-position switch is available, the range could be 100Ω, 1000Ω, 10000Ω, 100000Ω and 1 Meg Ohms and 100pF, 0.001, 0.01, 0.1, and 1μF. To connect the unknowns it is convenient to use miniature battery clips connected to the terminals by 50mm of flexible wire.

Calibration is done with a protractor. First the angle of the swing of the potentiometer is measured. This is the angle A in Figure 3. The scale will read the ratio

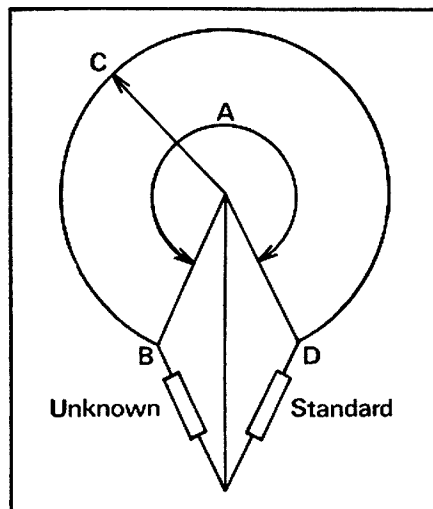

Figure 3

of the unknown to the standard, that is BC/DC . If this ratio is R , then $CD = BC/R$, $BC + CD = A$, and from these equations it can be shown that $BC = A\{R/(R+1)\}$. For example, if A is 290 degrees, for ratio 0.4, $BC = 290(0.4/1.4) = 83$ degrees. Also for ratio 6, $BC = 290(6/7) = 248$ degrees.

The angle BC can be plotted on a sheet of paper for all the ratios required, and the paper can be pasted to the top board. See Figure 2. Since the impedance of a capacitor decreases with increase in capacitance, the scale for capacity will be the reciprocal of that for resistance so that two scales will be necessary, one for R and one for C . Otherwise a switch could be used to reverse the positions of the standards and the unknown when changing from R to C .

High-resistance headphones or similar 600-Ohm types are suitable. Note that in this circuit the headphones are in the collector circuit of TR3 and should be capable of passing the collector current without ill effect.

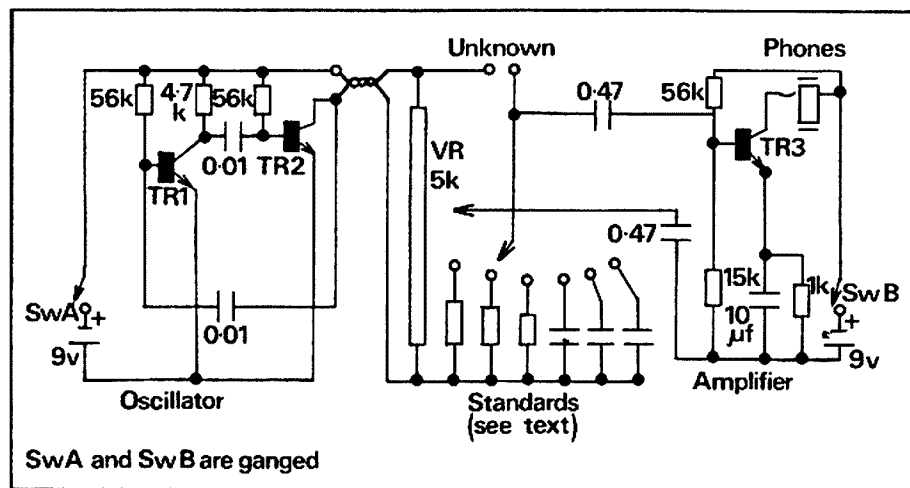

Figure 1

about 250mm square, which forms the top of a shallow box 50mm deep. See Figure 2. To improve the appearance, the hardboard can be stained with "Raven Oil" black which does not affect its insulation properties. The oscillator and amplifier can be built on separate matrix boards about 50 by 35mm and mounted under the top board.

The potentiometer should be wire-wound with a resistance of 2500 or 5000 Ohms and should be as large in diameter as possible. The three transistors are general purpose types such as BC108, BC548. The current from the batteries is 4mA for the oscillator and 2mA for the amplifier so that the 9V No 216 batteries should last for years.

For standards, one per cent resistors are obtainable, but five per cent types

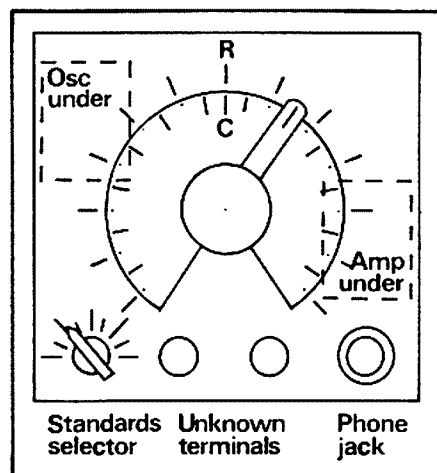

Figure 2

Support the
advertisers
who support
Amateur Radio
Magazine.

LEVEL AND FREQUENCY ON ONE METER

KEN KIMBERLEY VK2PY 21 NICOLL ST ROSELANDS 2196

Editor's note: This is part of a much larger article on the development of a square-wave signal generator by the author. Publication of the full article has been delayed by lack of space among other things, but we thought the following brief extract might be of interest to those who like to build their own test equipment.

The purpose of the level meter is simply to permit setting the output of the generator to a known level. It was intended to show full-scale at the maximum output of the generator plus gain-controlled amplifier which was about five volts peak (10V peak to peak). This was found to produce about 3V DC across C_2 and varied little over the frequency range up to about 4MHz.

Germanium diodes are used in preference to silicon because they have a much lower "turn-on" voltage (approx 200 vs 600 mV) so give better meter linearity over the lower part of the scale.

Frequency control of the oscillator is by a variable potentiometer (100k) and this introduces mechanical problems in coupling to a suitable dial (a rare item itself). The thought occurred that it might be possible to use the level meter as a frequency readout, thus avoiding mechanical dial problems. A changeover switch was installed to select one or the other.

The reader is referred to the author's previous articles in AR (June 1988 et seq) which dealt with capacitance meters. These were based on the principle that the current through a capacitor (at constant voltage and frequency) is directly proportional to the capacitance, thus the capacitance may be read as a current.

Reversing the procedure, if the capacitance is fixed, the current will be directly proportional to frequency. The voltage was fixed by deriving it from the output of a 4049 CMOS buffer (operating on regulated 12 volts) which is driven by the oscillator. Referring to the circuit, the frequency range is set by capacitor C_1 which is selected in decade steps by a switch, ganged to the oscillator range switch, also in decade steps.

The values involved are as follows:

Frequency range	Value for C_1
0-200 Hz	0.56 μ F
0-2 kHz	0.056
0-20 kHz	5600 pF
0-200 kHz	560
0-2 MHz	56 pF (fixed & trimmer)
0-4 MHz (max)	27 pF (trimmer)

Thus the same 1mA meter, depending on the position of the changeover switch, reads either the generator output level or its frequency. The larger the meter dial the better the resolution, but in appearance it is probably better than most home-made dials. **ar**

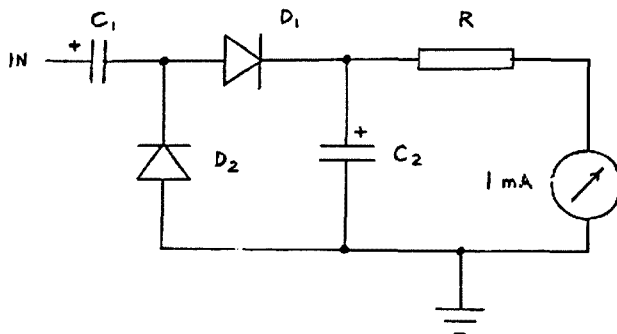

Item	Level meter	Frequency meter
C1	47 μ F 35V Ta	See text
D1, D2	Germanium	Germanium
C2	22 μ F 10V	100 μ F
R	1000 Ω variable + 2700 Ω fixed	120 Ω (500 Ω variable across meter)

WORKING H.F. MOBILE? NEED A COMPACT H.F. BASE ANTENNA MOONRAKER AUTO-TUNE ANTENNA SYSTEM

- Originally developed for long haul commercial mobile services the MOONRAKER AM318 Auto-Tune antenna puts the ATU components up in the air where they belong so that they become an integral part of the radiating system instead of being coiled up in a 'black box' somewhere.
- The 2.7M whip is 1/4 wave centre loaded at all frequencies with no base loading and no sliding contacts. It automatically retunes to the best SWR for any frequency in the range 3 to 18 MHz (other bands to order).
- The compact antenna control (interface) unit gives visual and audible tuning status and is suited to manual/automatic operation or located up to 20 metres away for base station use if desired. Just select the frequency and press the tune button, retuning time is typically less than 3 seconds.
- Impedance 50 OHMS (Nom).
- VSWR 1.8:1 Typical 1.3:1
- Power rating SSB-140W.PEP, CW 70W.
- Mounting - Anti shock mount with 12.7mm mounting stud.
- Construction - Anodised aluminium with a removable fibre glass top.
- Options - Scan, activates a wide band amplifier in the AE for receive scanning; H/D anti-vibration mount for rough roads; Top whip section spring for off road.
- Price - Complete system with 4M control cable only \$749:00 plus sales tax 20%, if applicable. Air freight \$23:00.
- Cheque, Bankcard and Mastercard welcome.

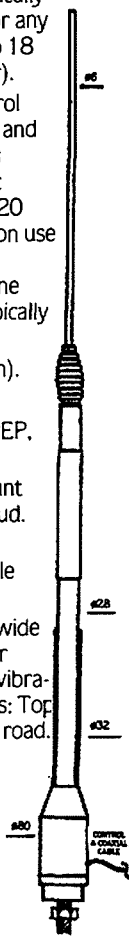

**PHONE (002) 73 1533
or FAX (002) 73 1749
FOR SPECIFICATION SHEET
MOONRAKER AUSTRALIA
PTY. LTD.
TASMANIA TECHNOPARK
DOWSING POINT, 7010**

TWENTY-FIVE JOTA BADGES THAT OTHERWISE WOULD NOT HAVE BEEN GAINED

KEN WESTERMAN VK5AGW RAILWAY VIEW BIRRIWA 2844

Whilst travelling around Australia last year I helped the Guides and Scouts with Jamboree on the Air in Derby WA. While I was performing this task one of the Guide leaders asked me would it be possible for the Brownies of the Air in the Kimberleys to join in. I then made enquiries with the local RFDS Base and was informed that it would bring up the Radphones Service free of charge for the next JOTA, if it was allowable to interconnect by telephone and a telephone patch.

Upon arriving back in Adelaide, I asked the SA WIA Council to back me in this task, which it did. I also asked for Federal backing at the Federal Convention in April. This was also given.

I commenced in February by approaching DOTC, Telecom, The Royal Flying Doctor Service in Adelaide and the 12 Schools of the Air. I also commenced to make a phone patch and the WIA-approved Line Isolation Unit.

The answers from the Schools of the

Air mainly said they had had Brownies or Cubs of the Air, but they have folded as leaders are unprocurable. However, four centres, Derby, Carnarvon, Port Augusta and Broken Hill, still have groups that meet on the School of the Air frequencies.

The Department of Transport and Communication said it had no objection to the interlinking of the telephone service connected to Radphones to the Amateur Service for Jamboree on the Air.

Telecom connected two telephones to the WIA Headquarters at the Burley Griffin Building in Adelaide and made no charges for connection or the calls made (which included about 12 hours of STD calls).

The Royal Flying Doctor Base at Derby was the first base interconnected, and the Radphone service was voluntarily brought up for one hour.

Contacts were also made with Carnarvon, Broken Hill, and some children in remote areas of South Australia by telephone and patching to the Amateur Sta-

tion in Adelaide.

Radphone in Port Augusta was brought up and we were interspersed with its telephone traffic as it is a 24-hour station.

Twenty-five children and three leaders of the Brownies, Guides and Cubs of the Air were thus brought into this year's JOTA for the first time.

It seemed to take a while to work through the members at a conventional JOTA station as the children all seemed eager to talk to Outback members.

The operating abilities of the children from the Outback were first class; no shyness at all. Their poor town and city counterparts, at double their age, on some occasions appeared to be faltering and possibly mike shy as well.

I found out you never say the word "over" without addressing it to the next operator by name, or you will find yourself listening to an Outback child and a townie talking at the same time.

Having a double radio link caused

Jamboree of the Air via RFDS and DRCS Saturday 21st October 1989. VK5WI Adelaide using phone patch to Radphones and DRCS* to lone Scouts, Guides, Cubs and Brownies of the Air. Operator Ken Westerman VK5AGW

001	0527	0600	14MHz	SSB	5/5	VK2BKU	Alison Tania Brett Naomi Kurt Judy	Beverley Springs Mt Elizabeth Mt Elizabeth Gibb River Mowla Bluff Brown Owl	RFDS Derby RFDS Derby RFDS Derby RFDS Derby RFDS Derby RFDS Derby
002	0732	0850	14MHz	SSB	5/6	VK2BPA	Kate Jenelle Matthew Bridgette	Wahroonga Ullawarra Umbertana Umbertana	DRCS Carnarvon DRCS Carnarvon DRCS Copley DRCS Copley
003	0850	0930	7MHz	SSB	5/6	VK5TV	Julie-Anne Suzanne Elizabeth Mandy Clare Penny Judy	Glenburgh Glenburgh Edmund Edmund Weedarra Weedarra Tawny Owl	DRCS Carnarvon DRCS Carnarvon DRCS Carnarvon DRCS Carnarvon DRCS Carnarvon DRCS Carnarvon Carnarvon
004	0931	0950	7MHz	SSB	5/5	VK5ABS	Judy	Tawny Owl	Carnarvon

*Telecom's Digital Radio Concentrator System

Jamboree of the Air RFDS and DRCS Sunday 22nd October 1989. VK5WI Adelaide using phone patch to Radphones & DRCS to lone Scouts, Guides, Cubs & Brownies of the Air. Operator Ken Westerman VK5AGW

005	0035	0040	14MHz	SSB	5/7	VK4SRC	Glenn	Nr Copley	RFDS Port Augusta
006	0145	0205	14MHz	SSB	5/6	VK4GCR	Lynnette Kathy Lill	Mutooroo Mutooroo Brown Owl	DRCS Broken Hill DRCS Broken Hill Port Augusta
007	0247	0340	14MHz	SSB	5/6	VK5TP	Colby Kirsty Francie Emma	Mutooroo Mutooroo Murtie Glenara	DRCS Broken Hill DRCS Broken Hill DRCS Broken Hill DRCS Broken Hill
008	0345	0405	14MHz	SSB	5/7	VK6AGN	Craig Nicole Jillyann	Minnipa Minnipa Camerons Cnr	Phone Minnipa Phone Minnipa RFDS Port Augusta

problems on a couple of occasions due to fading at one or both ends. The Outback children reacted well, by reducing their speech speed and were not frightened to ask for a repeat. This would be due to their schooling by radio.

The statistics of the weekend:

Five children from the Derby area through Derby Radphones.

Eight children from Carnarvon area by telephone.

Two children from Port Augusta area through Port Augusta Radphones.

Four children from remote South Australia by telephone.

Six children from Broken Hill area by telephone.

Eight Amateur JOTA stations worked.

The numbers were down in the Port Augusta and Broken Hill areas due to races being held in Broken Hill and a gathering at one station to celebrate the flowing of the Cooper over the Birdsville Track.

A meeting using the Telecom conference facility for the remote parents in the Carnarvon area was postponed so their children could take part in JOTA.

For the next JOTA it would probably be better done in the same town as the School of the Air (local calls only involved). Some Schools of the Air appear to have phone patches and others do not. This would not cause a great problem as phone patches can easily be put together.

I found having all of one group on Radphones and making contact with a conventional unit was the more efficient way rather than using the telephone with only one child at a time being connected. However, most Outback stations do have the DRCS telephone connected, and it could be used as a last resort if propagation was not good.

A telephone hooked in parallel with the phone patch was an advantage as prompting of the child if needed was relatively easy. A foot switch for press to talk was employed. VOX was not used as

Jamboree of the Air via RFDS and DRCS Sunday 22nd October, 1989. Guiding & Scout leaders involved

Mrs Judy Barrett
Brown Owl
Beverley Springs Station
via Derby WA 6728
091 91 4646

Mrs Peta Smallshaw
Akela
Smally's Cafe
Derby WA 6728
091 9 1550

Mrs Judy Smith
Tawny Owl
c/- School of the Air
Carnarvon WA 6701
099 41 2237

Mrs Lil Martin
Brown Owl
5A Forster St
Port Augusta SA 5700
086 41 4290

Mr David Fitzsimmons
Akela
14/42 Forster St
Port Augusta SA 5700
086 41 0602

Mrs Sue Andrews
Brown Owl
Avondale Station
via Broken Hill NSW 2880
080 91 9412

Mrs Sue Allen
Guide Leader
Box 34
Broken Hill NSW 2880
080 2195

Mr Greg Warnes
District Commissioner
(Lones)
10 Fairbrother Drive
Happy Valley SA 5159
08 381 7766

Mr Peter Koen
SA Commissioner Scout
Radio
27 Hoskin Ave
Kidman Park SA 5025
08 356 6990

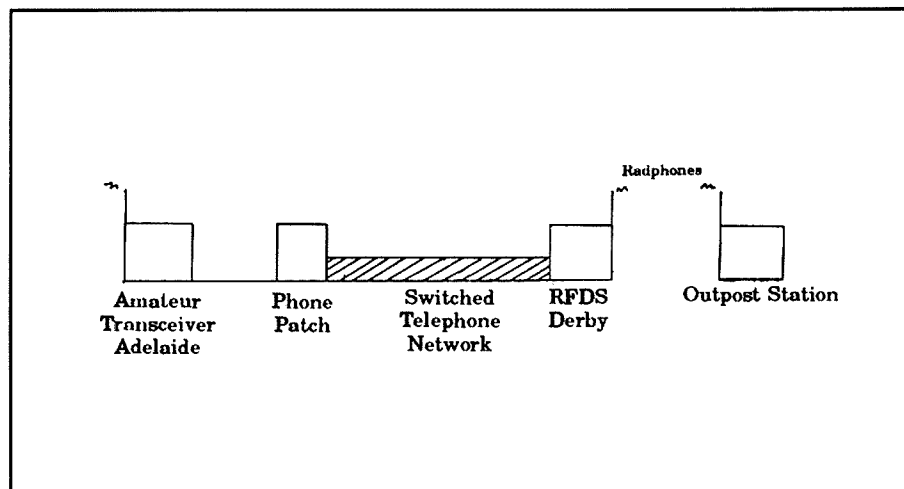

unwanted triggering was possible.

For this service to take place it was understood that there would be no expense to The Royal Flying Doctor Service, The Guiding and Scouting movements or the Wireless Institute. This was actu-

ally the case.

Without the tremendous help given by Telecom and the Royal Flying Doctor Service in Adelaide, Derby and Port August, the Outback JOTA section would not have been possible. ar

RECYCLED CONNECTOR CURRENT TESTER

STEVE MAHONY VK5AIM 19 KENTISH ROAD ELIZABETH DOWNS 5113

You have all at some time wanted to measure the current drawn by a piece of equipment from a 9V battery. This little device allow you to do it easily.

You recycle the connectors of two old/flat 9V batteries, about an inch (25mm) of 16 gauge tinned copper wire, and a high value 1/2W resistor eg 100k - 1M.

As per diagram you link two different contacts (cup and stud) with the inch of TCW. The other two contacts are joined by the high value resistor.

To check the current you remove the battery clip from the battery, clip the "Tester" on to the battery and then clip the battery on to the other side of the "Tester". A multimeter can then be clipped on to the resistor the correct way around

and used to measure the current drawn by the equipment.

The high value resistor simply acts as an insulator and the current flows through the multimeter. Most pieces of equipment running on a 9V battery only draw 10-20 mA, and very little current flows through the resistor.

On one model I bent hairpin loops in the resistor leads to facilitate meter connections. The units I have made are all popular, especially when connecting up prototype equipment or faulty gear.

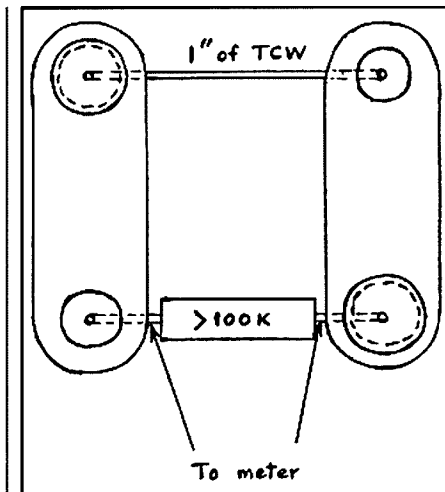

NOT MORE OF THE USE IT OR LOSE IT SYNDROME!! HERE WE GO AGAIN!!!

PETER McADAM VK2EVB 14 GRANT CLOSE COFFS HARBOUR 2450

The subject, "Are we (the amateurs) losing the 10-metre band?"

This is becoming so serious it's not funny anymore and the author thinks all amateurs should take a good look at this topic and their individual operating practices.

Have you used 10 metres lately? Does the propagation favour 10 metres at this time of the sunspot cycle? Why not, have you checked? Have you ever worked DARE I SAY IT . . . CW on 10 at all? What about the FM or SSB sections? Have you ever, ever used 10 at all since gaining your amateur licence?

If you can only answer NO to the above questions, are you one of the ever-increasing number of amateurs who couldn't care less about the illegal encroachments into our band space or are you prepared to do something about

it? The sad thing is that many amateurs can answer yes to many of the above questions, but still only use 10 metres occasionally when reports of real DX are heard. In between times 10 metres is left to the devices of mostly novice licensees who watch the band very keenly for openings.

It seems to me that an increasing number of VK amateurs don't seem to care what happens as long as nothing interferes with the 20-metre and the two-metre amateur bands. (Now that the novices on two metres dispute has settled). "Who cares about the 576 MHz band, we weren't interested in ATV anyway," some say. Others reply with, "So what if 70cm is likely to come under threat, we don't have any gear for that band anyway." Comments of, "23cm (expletive deleted) equipment would be too touchy at that

frequency" are sometimes heard. And even the "No-one uses 160 metres now, that's old hat" line is dragged out. Packet's only for computer freaks and CW is for old timers and so it goes on.

Could it be that Bluey, the average VK amateur, is becoming too lazy or too complacent for his own good? Does he have it too good? Is Bluey suffering from living in an insulated world, shut up in his shack, only working the same contacts year in, year out, and having a point of view no larger than this seemingly closed environment will allow? Yes, I believe so, and, what's more, it will be the downfall of our hobby.

"What is this author leading up to?" you will be thinking by now. Well, here is a history of what is now a well developed problem. Of recent times, with the increase of propagation on 10 metres, an

alarmingly large number of AM signals has been observed. These appear quite regularly every 10 kHz from below 28 MHz right up to 29.7 MHz, if not higher. There are also many SSB and FM signals as well as suspect RTTY and data signals. While many of the speech transmissions, judging by the direction of propagation and language used, seem to emanate from Asia, Indonesia and the Pacific islands, an alarming number with Australian and New Zealand accents has appeared.

"They have only just started to appear!" some amateurs exclaim. But is that really the case? Of course not; this growing army of illegal operators has been at it for years. Disguised under the cloak of poor radio conditions, they have moved into the 10-metre amateur band unchallenged, and now are staking a claim. Many appear to have quite sophisticated equipment, too, not just your ordinary garden variety modified CB radio.

The general apathy amongst a large proportion of amateurs is not helping either. Many of you will say, "Can't do much about it" or "What can I do by myself" when approached about the problem. Many more just throw their hands in the air, turn a blind eye and use other bands as if the pirates have rights there on 10. Others say let's do something, but what? And so it goes on and very little is stopping the pirates from taking over.

Just to make it clear, 10 metres is a PRIMARY amateur band. That means nobody but amateurs may use it but, if we keep going the same way, the commercial sector may think it can move in on other primary amateur bands. Then what would we do? The commercial sector has the finance to go to the high courts and probably win. "More doomsday predictions" I can hear many amateurs say, but are they really?

Let's look at some of the causes.

1. Obviously the ease of obtaining suitable equipment must be looked at. Sure every electronics and motor accessory shop, as well as many large chain stores, sells cheap CB radio equipment, but how many of these buyers really know much about performing modifications to this gear? Not many, it seems, but they can soon find someone who does.

2. There are certain books on the markets that explain to you (with the aid

of diagrams) how to modify existing CB equipment to gain more channels or to install VXOs (sliders etc) to enable access in between channels.

3. By far the biggest problem has been the easy access that the non-amateur has had in the past, not only to second-hand amateur gear, but also the newest and latest equipment.

4. It seems that some people, no matter what the cost, are able to buy and use what equipment they want to.

5. But the biggest part of the blame lies with us amateurs. "Explain yourself" you say, or "This bloke is nuts", and similar statements to the same end.

Well, to deal with the last of these statements first, we the amateurs of, not only Australia, but the world, are to blame. "Why?" you say. Well, just to start with, who could have the most say (through amateur bodies like the WIA and ARRL etc) about government legislation designed to limit the sale of both new and used amateur equipment to unlicensed persons? The author has never once had to produce proof of licensing when buying new or used equipment to start with, so how many non-amateurs have bought the same way? If we amateurs had to notify the DOTC or appropriate government body, to whom we sold our second-hand equipment and when, it would possibly go a long way toward limiting access to non-amateurs. This would also remove the temptation from amateurs like you and me to sell to non-amateurs because the price was right (which, I believe, is getting pretty common).

If the government can censor the contents of movies and books available to the public, why not limit the sale of books of CB modifications to licensed amateurs only, to allow us and only us to use ex-CB equipment on our bands. Also, perhaps the limiting of the sale of amateur books in general to licensed amateurs may be possible but would undoubtedly upset SWLs. If this was done, some allowance for prospective amateurs would have to be made to allow them to study for their examinations. Suitable laws could be proposed and passed to prosecute shop owners proven to be selling these publications and equipment to non-licensees.

All this may help prevent further attacks on our bandspace, but the biggest impact of this situation could be made by

every amateur, whether novice, combined limited/novice or full call by actually using the 10-metre band (according to licence provisions only) and, by doing so, declaring our territory. It's very simple really, and it works like this: instead of clogging up 80 metres or a two-metre repeater, chatting to a local group of friends, and possibly creating QRM to others engaged in DX or interstate contacts, why not consider using 10 metres where you can have the convenience of virtually no static, a lack of QRM and plenty of bandspace with which to experiment? Why not hold a weekly club net on 10 metres, perhaps a CW practice session, and other activities, but mainly just use the band?

That doesn't mean you have to have contacts all the time, even just monitoring and logging details of suspicious stations can be helpful. These details can then be forwarded to the WIA Intruder Watch Co-ordinator in your state and the DOTC which will assist them to make use of existing local laws and/or the necessary political overtures to whichever country the interference is emanating from. If two amateurs, while communicating on another band, can by using beams get a map reference, and take a recording of the transmissions, these could be submitted to the DOTC and evidence accrued. Of course, it is a very difficult problem for the DOTC to handle with its limited manpower and the low priority rating of this matter, but priorities can always be changed depending how much mail, publicity and exposure is given to the particular subject in question.

Be careful though, the author is not advocating direct actions or radio contacts with these pirates as it could lead to verbal abuse and ensuing litigation from said pirates or DOTC, as one could easily be in contravention of the Radiocommunications Act. So the message is to "tread lightly, listen quietly and arm the authorities to swing the big stick", rather than going it alone. If every amateur in Australia, or even the world, was able to agree on this one point, imagine the power we would hold and the good we could do for our hobby.

So, keep your ear to the ground, or rather speakers, and help preserve our hobby for the years to come, by reporting intruders. A little work now could save much frustration in the future. **ar**

**REMEMBER TO LEAVE A THREE SECOND BREAK BETWEEN OVERS
WHEN USING A REPEATER**

THE NEWCASTLE EARTHQUAKE DISASTER

BY PHILIP GREENTREE VK2IW

Australia's first fatal earthquake occurred at 1027 hours on 28 December 1989. It was a disaster for which there was no warning in a land that is the World's oldest continent and presumably the most stable. Although only at 5.5 on the Richter scale, the earthquake had devastating effects on the City of Newcastle, the sixth largest in Australia. The effects were made worse by the many inner city buildings that were up to one hundred years old, and constructed from single and double cavity brick. Twelve lives were lost and the damage bill exceeds 600 million dollars. Yet that is not the end of the damage. Many hundreds of people are still returning from summer vacation only to find their homes although still standing, are destroyed internally.

Amateur Radio Operators as part of WICEN...the Wireless Institute Civil Emergency Network... played an important part in supporting the disaster recovery efforts of the recent earthquake that destroyed much of the inner City of Newcastle in Australia.

Thursday 28 December 1989 was like any other summer day in Newcastle; a beautiful start to the day, fine and heading for a temperature in the high twenties centigrade. Small groups of post Christmas shoppers were taking their time since there was no need for rush at this time of the year.

Many were at the beach, surfing, sun bathing; others of an older age were at the Newcastle Workers Club for the weekly Bingo game, a mecca for the City's senior citizens. Starting at 1030 AM, the Bingo had for the first time in years been moved from the main auditorium to an ancillary room because numbers were down due to holidays.

The housie game never started, the shopping was not completed; at 1027 AM, an earthquake of strength 5.5 on the Richter scale struck the Newcastle region. Centred 13 kilometres beneath the Newcastle Western suburb of Cardiff, the earthquake, not large by world standards, changed the lives of Novocastrians for ever. The devastation caused by the tremor was made worse by the age and brick construction of buildings in the inner city areas. Worse again by the fact that much of the area was built on low lying former swamp lands that don't provide for solid foundations.

Foundations had never been a problem in the past, Newcastle wasn't in an earthquake zone was it?

In an instant, twelve people were dead or dying from horrific injuries, more than 150 more were suffering varying levels of injuries.

The main shopping street of the inner suburb of Hamilton was a disaster area. Shop front awnings had collapsed onto shoppers inflicting dreadful injuries. News was spreading rapidly that something was dreadfully wrong at the huge Newcastle Workers Club; the club's top level concrete floor had crashed on to the floor below, crushing to death nine people. Four large hotels were destroyed, schools collapsed, many fine historical buildings wrecked and hundreds of homes smashed beyond repair, thousands more suffering all levels of damage.

Thank goodness it was the Christmas-New Year holiday period and so very many were away on holidays. Thank goodness all the schools and colleges were closed for vacation.

As soon as local operators arrived at SES HQ they were assigned to one or other of the many rescue crews being dispatched as soon as they were formed. Many of these crews were volunteers that just "walked" in off the street. There were no radios in their trucks and WICEN was able to step in to the breach. The 146.775 MHz 2m repeater had been formally commandeered under Dennis' call sign VK2XDW. This was done since his call was familiar to all Newcastle operators and it was not till late on Friday that the call sign VK2WIH was used.

The scenes of devastation were heart breaking. The author was despatched with a crew to the Cooks Hill-Junction area, and the sights that confronted him were beyond belief. Broken home after broken home, neighbours asking for help

because they thought someone was trapped next door. All around were people who just couldn't come to grips with what had happened.

Floods and bush fires give warning, there is time to prepare, but an earthquake just happens, no warning, just the whole world shaking as your life's labour, your home, your work, your reason falls down round you. After it's over, all that remains is the devastation, the dust and the cries of the shocked and injured. Australians are a resourceful people, and soon people were moving their possessions out using their own vehicles, friends and rented trucks. **Yet no looting...**what a godsend. But this was Newcastle, and Novocastrians don't loot, it's not in their or any other Australian's nature. There was a job to be done, and it was. Amazingly there was no real panic, other than in the isolated individual. To a man, three hundred thousand Novocastrians pulled together and worked as one.

At this stage it must be pointed out that WICEN's presence was only a token one. VKs 2XDW, 2HT and 2KEI were the only local members, the rest of the operators were all volunteers who were demonstrating just how well trained and self disciplined the amateur radio community is in Newcastle.

Geoff VK2GL was despatched with a structural engineer from the NSW Electricity Commission, and they worked as a team all through the night.

VKs 2CD, 2CRR, and 2AVO were amongst the early arrivals that WICEN coordinator Dennis VK2XDW immediately despatched to the field with SES rescue crews. The family team of Keith VK2AKH and son Alan VK2MGL weren't far behind, Keith spending his time in the field, whilst Alan spent many long hours doing the paper work by assisting the net controller.

That night it became obvious that the SES controller was in need of a contact person between him and the public and media. The amateur radio operators set up a health and welfare unit in an adjacent SES building. This team, led so ably by Keith VK2AKX, took over responsibility for welfare enquiries from the public, and handled all press releases on behalf of the SES Controller. Keith made an

excellent media officer and was very ably supported by VKs 2CRR and the husband and wife team of 2AVO and 2DBL. Denis VK2XDW was able to locate a FAX machine and the team was on the air.

As it eventuated, the choice of Keith for this job was providential since the world-wide media tried to turn the show into a zoo. Calls came in from all over the world and every one wanted details of the massive looting they claimed was happening. There was no better person to take on the media tigers and Keith put them straight from the start. There just was not any such thing happening and Keith literally had to battle caller after caller who tried to put the words into his mouth. In Keith they had met their match and he told it exactly as it was.

One thing that impressed international experts in earthquake recovery was the way the authorities so rapidly blocked off the Central Business District and inner suburban areas, thus keeping sightseers out, making the job so much easier for rescue teams. With so many streets into the city, and so many barricades needed, there were just not enough police to go round until reinforcements were rushed in from Sydney and other parts of the state. Amateur radio operators manned a number of the barricades providing a radio link as required. Many police were walking round with mobile phones, but the telephone system was so congested that they were basically useless. As army and police reinforcements arrived, the several Amateur radio operators involved were taken off barricades and re-assigned to rescue teams.

A city unused to earthquakes results in considerable confusion, many unbelieving; what was it really? Local Amateur Radio Operators switched on their 2m HTs or mobiles and compared notes. It was an earthquake, yes there had been considerable damage, people had been killed, many of the amateur's own homes damaged, but just how bad was it?

Dennis VK2XDW the local coordinator for the Wireless Institute Civil Emergency Network (WICEN) lives in Mayfield, a couple of kilometres from the city centre. He was quickly mobile and stunned by what he saw. The huge Newcastle Technical College where he is a teacher was a wreck. The nearby Parkview Hotel was collapsing and all around were people milling in a state of confusion. Just down the road was Hamilton — shattered. Dennis was stunned but realised that a major emergency had started. With all power and telephones out of action, it was obvious that Amateur Radio would be needed.

He proceeded to the State Emergency Services headquarters at the other end of



Newcastle Workers Club

the inner city and found emergency workers were assembling for duty. Alderman Don Geddes, the area controller of SES, immediately informed Dennis that WICEN had been activated and that every available radio amateur was needed.

Only when Dennis announced on the 2m repeater frequency 146.775 MHz that WICEN was activated and that every assistance was needed, did the reality of the situation dawn on us all.

Thus began the largest disaster relief action ever undertaken by the volunteer State Emergency Services, WICEN and amateur radio. It was one of the largest emergency activations of amateur radio in Australian history. This wasn't an exercise, it was the real thing. Immediately, local amateurs responded and raced towards SES headquarters. The majority of the sixty-three that responded were untrained and not members of WICEN, but in a manner that is so typical of the great, proud City of Newcastle, there was a job to be done. No time for questions, are you a member? are you trained? did you bring the paper work? No time, just go to work.

And go to work they did.

Ray VK2TV from the City of Gosford, seventy kilometres to the south, and a radio controller for the Volunteer Rescue Authority was sent by the VRA directly to the Newcastle Workers Club to set up a direct link with their HQ in Sydney.

Dennis VK2XDW dispatched Graham VK2FA to the Newcastle Workers Club to provide a direct HF link from his mobile to the WICEN station at Police Rescue HQ in the Sydney suburb of Marrickville.

Thursday evening saw Brian VK2YBC

take over net control and quickly establish himself as a true professional on the microphone. All through the evening and into the long hours of the night, Brian's crisp, clear and authoritative voice dominated the air waves. It was a tribute to Brian that only rarely did messages need repeating, and even then only because field personnel using HTs were in a shadow area.

Hamilton Telephone Exchange had taken a battering and had been cleared, staff unable to return to the building for several hours. During that time local telephone links were out of action. When the telephones were restored, the congestion was so great the public phone system was next to useless for a long time.

Amateur radio was for a time the only link between the Royal Newcastle Hospital and the outside world. That hospital had taken a battering, two main wings being damaged so badly they will never be used for hospital work again. Faced with a loss of 250 beds as a result, and with the Mater Hospital ten kilometres west suffering damage also, things for a while were very grim as casualties continued to pour in. For a time WICEN was passing emergency messages from that hospital to Sydney.

By Friday it was obvious there were just not enough local amateurs since many were away on holidays, so when WICEN Sydney asked if help was needed, the answer was an emphatic yes. In no time, VKs 2DLY, 2CKD and 2EMU were on their way, others following over the next few days.

Still more Amateur Radio volunteers were coming from Sydney and the Central Coast areas to the South, the Hunter



Beaumont Street Hamilton. First aid just after the earthquake.

Valley to the West and Port Stephens to the North. Newcastle hams who had been away on holidays were returning to lend assistance.

The workload was enormous. In the six days from the time of the earthquake, the State Emergency Services handled more than 4000 individual calls for help, hundreds of these being passed in by Amateur Radio Operators attached to SES teams in the field. It wasn't that the telephone system, one of the World's most modern, couldn't handle the work load, there just weren't enough lines into SES headquarters.

As if all concerned were not working at top capacity on Thursday night, an urgent message was received from the Newcastle police. Despite all the excellent work carried out by the police, it had been discovered that there was no list of victims and their injuries etc. Six competent people were required immediately for the task of registering all the disaster victims. Six amateur radio operators immediately volunteered for the job and led by Dave VK2DFL, they worked into the early hours and registered every earthquake victim, in all the region's hospitals.

When that job was complete, they came back and went out on further emergency work.

With responsibilities for radio net control of a considerable proportion of the SES rescue effort, media relations and welfare, Disaster Victim Registration, and every available operator in the field, the WICEN group was doing fine. In fact, if we had known that the region's ambulance service had lost its central communications room, we could have

placed a great number of operators in individual ambulances until an emergency communications unit arrived from Sydney later in the day.

Mobile cranes and "cherry picker" lift devices were rushed into the rescue efforts but their commercial radios being on different frequencies to emergency services posed a potential nightmare. WICEN immediately despatched operators to each of the vehicles involved and was responsible for their control for the remainder of the emergency.

By the following day (Friday), tiredness was starting to show as a problem, but there was no respite. New operators arrived only to be immediately assigned to the field with rescue crews. Brian VK2YBC was falling asleep at the microphone, and Greg VK2GJS very capably relieved him for many hours, whilst Brian found a stretcher somewhere to have a sleep.

Already there were stories developing that would become news worthy. A short time after the quake, two nondescript characters arrived at SES HQ in a battered, old Ford van and said they had picks, shovels and themselves, and wanted to help. The SES controller promptly called them the "Argy Mob", after the Western suburb of Argenton where they came from, asked if WICEN control could assign a radio operator, which was done, and sent them into the field.

"Tas", "Darren" and WICEN operator Kevin VK2CKD from Sydney came back four days later, the stuff of legends. Stopping only for a bit of sleep when they really needed it, they worked on. As they finished allocated jobs, in would come a

call via 2 metres for a list of more jobs. They demolished dangerous chimneys, covered up shattered roofs, propped up shop awnings about to fall and worked, and worked and worked.

The Australian military forces were activated on Friday with the 14 Field Squadron of the Royal Australian Regiment moving into the disaster area. Whilst the army has tremendous communication capabilities, all their frequencies are incompatible with civilian services. Within a short time, a group of Radio Amateurs had been dispatched to link the army with SES HQ. With so many army teams in action, they themselves experienced communications problems, and the need for a radio link between 14 Field Squadron HQ and the many field units resulted in further Radio Amateurs being dispatched to form a separate 2m network.

The army group's commanding officer was amazed and deeply impressed at the level of communications mounted by these civilians. He was equally surprised at the level of sophistication of the equipment in use and the professional standard of supposedly amateur operators.

Whilst Geoff VK2GL was providing radio support for council engineers in the damaged Cooks Hill area, he was approached by local residents who reported their fears for an elderly man trapped in a local terrace house. The front door had to be broken down to gain entry, and the inside of the house was found to be a shattered mess, destroyed beyond repair. Only then did they hear the faint sounds of sobbing. A frantic search found the elderly gentleman, fully dressed, two bags packed with clothes, sitting on the toilet seat, the only part of the house that had remained intact. He had survived the collapse of his house the day before, packed his bags, sat down for a rest, and at that point went into shock. There he had sat, through the night and into the next day, uncomprehending of the disaster that had struck Newcastle and himself. A radio call from VK2GL to WICEN control soon had the Salvation Army social workers on their way to help the man.

The backbone of the Amateur Radio operations were 2m hand helds and it was quickly becoming clear that the old basic HTs were superior to some of the newer Microprocessor controlled devices. Digital paging systems located on 149 MHz were severely interfering with many of the HTs, but not so a group of fifteen year old Icom HTs.

Running on dry cells the Icom HTs worked perfectly. Others using nicad batteries quickly showed their uselessness in a disaster situation. When nicads die there is no warning, and when they



What used to be the Newcastle RSL Club Perkins St Newcastle

do, how does one recharge them when in the field during an earthquake disaster? There is no doubt that dry cells are the recommended way to go in a disaster.

Through Friday night the recovery continued and Saturday saw the urgency of the rescue efforts slowing down a little as all living persons trapped in the wreckage were believed to have been found.

By Saturday the WICEN team was nearing exhaustion. Coordinator Dennis VK2XDW was stood down with others for rest. The author, who had at last got some sleep during the night, spent the next twelve hours on the control mike, giving VK2YBC a much earned break.

Other net control operators particularly those who worked the night shift, included Dave VK2DFL, Andy VK2MHO and Neville VK2HT.

As if WICEN didn't have a full enough slate, news arrived that engineers were being flown in from all over Australia, to assist the Newcastle City Council in assessment of damage. There were not enough council radio cars to go round, so WICEN was requested to supply a team of operators to go with these out of town engineers.

Another repeater was needed to run the engineer network, so the other Newcastle 2m repeater on 146.900MHz was commandeered for the duration and the call sign VK2WNC used.

The team of amateur radio operators sent out with the council engineers proved invaluable. One visiting New Zealand born earthquake consultant could not believe there were no radios in the various cars used. He was not only greatly relieved but when a team of amateur radio operators arrived, but full of praise

for their performance, as was the Newcastle City Council. A very dangerous situation developed at one demolition site and only the presence of an amateur radio operator allowed the engineers to pass the details back to the City Council HQ.

WICEN and its volunteer amateur radio operators had established quite a reputation, to the extent that operators were being sent by SES on reconnaissance to report on damage to determine what action and what type of disaster teams should be sent. Tony VK2BOA, a local dentist, was in the thick of it in the suburb of Stockton as he reported on damage. He soon linked up with some

council engineers who had been dispatched without radios.

Back at SES HQ, various problems had developed. All existing report forms were in foolscap format whilst the paper in the photo-copier was the new Australian standard A4 size. No worries, WICEN redesigned the forms on the run and produced hundreds more copies.

During Saturday, Dennis noticed that the SES data base operator was falling asleep at his PC. It eventuated that he had been at his station, non stop, since Thursday. Added to that, the data base was giving problems and the operator was too tired to solve them. VKs 2XDW and 2IW quickly arranged for D-Base III experts to come in at short notice from the University of Newcastle and the Newcastle Technical College. Within hours, there was a team of over twenty-five IBM PC experts at work.

All those operators on one PC? Not for long since Phil VK2EPB, the Newcastle manager for Wang Computers promptly obtained a quantity of IBM AT compatibles from his office and the team went to work with gusto.

SES night shift radio operators were rather thin on the ground by that night also. As a result, WICEN operators manned both group's radios during the long hours for the next four nights.

Most WICEN personnel gained some sleep at last on Saturday, but it wasn't long enough. All too soon it was Sunday and a New Year's Eve like none before in this city. No one had ever experienced such a concentrated fifty-six hours of non-stop work. The SES crews like so many aspects of Australian life were all volunteers, their wives running the ca-



The George Hotel, or rather, what was left of it. Cnr Hunter and Watt Sts Newcastle

tering team that fed the "troops" so well.

The SES welfare teams were near exhaustion by Sunday, so a very early morning wake up call had Ruth, VK2IW's wife, out of bed. Ruth, who works in the therapeutic diets department at the Royal Newcastle Hospital had been on holidays and was now needed to help feed several hundred tired and hungry volunteers. She quickly arranged for her daughter Betina and a friend to go with her. They were joined by VK2CRR's wife Joan who had commercial cooking experience herself. What a team, what a performance, it must have been the first time any disaster team had been treated to haute cuisine. The four of them prepared an estimated eight hundred meals that day and had the troops lining up for more.

Those that couldn't make it in from the field, had hot meals taken to them.

Monday saw a repeat performance to the great delight of the SES and WICEN workers.

It was announced on Sunday afternoon that the following day, Police would be setting up a special centre outside the main disaster area for the issuing of passes enabling residents and businesses limited entry to the disaster area. Entry was to be permitted only if the relevant building was safe. This meant a radio link with City Hall was required, since that was where all required information such as ownership and damage status was obtainable.

WICEN was called on to perform the communications task and a third repeater was needed. A new unit for 147.100MHz which had been on trial with radio engineer Peter VK2ZRT prior to installation was pressed into use in Peter's workshop that had survived the earthquake. Using the call sign VK2WSC hundreds of messages were passed to and fro throughout Sunday and Monday by VKs 2EMU, 2DLY and 2BOA.

The city council end of the link involved a base station being set up on the top floor of the council HQ building, the other end of the link being situated in the police control caravan located at the International Sports Centre. The following day, the caravan was moved to the Broadmeadow Race Track, the WICEN team going with it. Later that day, Telecom established a direct computer link with council HQ and the radio amateurs were no longer needed, returning to SES HQ for re-assignment to other work.

Peter VK2ZRT did a tremendous job as he repaired equipment that had failed in the field. Loan equipment enabled much needed operators to stay in the field with borrowed equipment.

By Tuesday it was becoming obvious that the dust was settling, all bodies had

been recovered, and the disaster rescue emergency was over. It was time to go, and leave the situation to the mop crews, so WICEN and its volunteer team of sixty Amateur Radio Operators were stood down on Wednesday 3 January 1990 after seven non-stop days of plain hard work.

Several people in particular stand out for the incredible job they did. Dennis VK2XDW as WICEN Coordinator showed his ability as a "fire fight" commander. Brian VK2YBC shone as WICEN's top line net controller working tirelessly and Geoff VK2GL did wonderful work liaising with the City Council, Police, Army and establishing the two secondary repeater nets. Keith VK2AKX was the ideal person for his job as media liaison controller, in fact, he was brilliant. It is sad to record that Keith has since become a silent key (see obituary in April AR p54).

That leaves a further sixty or so VKs plus several of their wives who worked non stop throughout the emergency. For seven days the author was proud to be an Australian radio amateur and there is no doubt that an example of selflessness and organisation has been set for amateur radio in Australia.

It was interesting to note the extraordinarily high level of good behaviour shown by the amateur community. At no stage was there anything other than exemplary self discipline demonstrated on the repeaters and various nets used.

Since the earthquake, Hunter WICEN has been reformed and is now a vibrant group recognised by the local authorities. WICEN (NSW) has been formally accredited as a specialist rescue support group, as part of the NSW emergency services plan.

The only recognition that WICEN and the sixty Radio Amateurs whose communications skills had held a good deal of the rescue effort together for so many days have received, is a single letter from the Lord Mayor of Newcastle. No other official recognition for the work performed by amateur radio has been received. Despite the extraordinary role Amateur Radio Operators played in the disaster recovery efforts, there has been NO other mention of recognition for the work done on behalf of the SES, the police and other services etc.

Australia must be the only country that doesn't realise what amateur radio involves. Could it be many Australians don't understand the difference between the HIGHLY QUALIFIED, FEDERAL GOVERNMENT EXAMINED Radio Amateurs and the technically UNQUALIFIED CB radio fraternity?

Is the word amateur a misnomer? In the context of amateur radio, "amateur" means the operator does not receive

payment as distinct from a commercial broadcaster. Yet Amateur Radio operators form the largest group of TECHNICALLY QUALIFIED radio operators with a LEGAL allocation of radio frequencies second only to the Australian Army. Few realise that Radio Amateurs are licensed to not only transmit Television, Voice, Teletype, Computerised digital data etc, but to BUILD their own equipment as well.

They provide the community with an emergency service (WICEN) that has immediate access to over a hundred million dollars worth of communications equipment.

In the USA, the Soviet Union and a great many other countries, amateur radio is a breeding ground of future Electronic and Electrical Engineers. Why the difference in Australia?

Whilst not complete, the following is a fairly comprehensive list of amateurs known to have worked with the emergency team.

2AAB, 2AAM, 2AGB, 2AGS, 2AKH, 2AKX, 2APE, 2AVO, 2BFE, 2BOA, 2BQY, 2BZD, 2CD, 2CKD, 2CRR, 2DBL, 2DFL, 2DLY, 2DPY, 2EBA, 2EMU, 2ENG, 2EPB, 2FA, 2FAB, 2FJS, 2GG, 2GJS, 2GL, 2GN, 2HT, 2IW, 2KAP, 2KBL, 2KFU, 2KLM, 2KLX, 2KTV, 2MHR, 2MGL, 2MHO, 2NJC, 2PFQ, 2TKW, 2UI, 2XDW, 2XJD, 2XJD, 2XJG, 2XKM, 2XQJ, 2XRS, 2YBC, 2YXM, 2ZJC, 2ZNB, 2ZPH.

ar

AR 20 Year Index

IBM Format 5 1/4 inch floppy disk

dBase III Plus .DBF file	\$10.00
ASCII	\$10.00
Compiled .EXE file	\$10.00
36 page printout	\$5.00

Prices include disk (where applicable) and postage.

AR 20 Year Index

PO Box 300

Caulfield South VIC 3162

INTRODUCING THE NEW MINISTER

BY JIM LINTON VK3PC

Kim Beazley MHR has taken over the super Ministry of Transport and Communications at a time of great change and plenty of challenges.

Mr Beazley entered Federal Parliament as the Member for Swan in 1980, and was appointed Minister for Aviation and Minister Assisting the Minister for Defence in the first Hawke Government. At the time he was the youngest member of the ministry. He also later served as Special Minister of State, and was Minister for Defence (1984-90).

In his new posting Mr Beazley has to deal with a range of developments in the area of communications. These include



*Mr Kim Beazley MHR
Minister for Transport and
Communications*

the switching by some AM broadcast stations to the FM band, expansion of the Special Broadcasting Service, and growth in the number of community broadcast stations.

Aspirants for community TV licences were certain to try their luck with the new Minister after having been put on hold by his predecessor, Ralph Willis, as high priority matters in communications were addressed.

The momentum for deregulation of telecommunications is speeding up with vested interests pushing for greater relaxation. The independent telecommunications regulatory body, Austel, recently

BOOK REVIEW

ALL ABOUT VHF AMATEUR RADIO

JIM LINTON VK3PC

This publication, written by Bill Orr W6SAI, is sure to be a good seller because of the information it contains and the author's proven simple writing style.

Bill is well known for the other books he has written, co-authored or edited about antennas of all types. His newest book covers six metres, two metres, 70cm, the USA 33cm (902MHz) band and 23cm.

Rather than being dedicated to the construction of receivers and transmitters, it deals with the principles of operation, propagation and effective antenna systems. The text is aided by useful drawings or pictures which appear on nearly every page.

There are 10 chapters providing information on important aspects of VHF radio and references to other publications for additional information outside the scope of this book. The chapter titles are: VHF Propagation; The VHF Bands — an Overview; the VHF Repeater and How it Works for You; VHF Moonbounce Communication; and Amateur Satellite Communication. Other chapters are: Al-

came out in support of new players in the field of cellular mobile phone services to operate in competition to Telecom's monopoly.

The Federal Government's embargo on pay television is due to end in September, thus leaving the way open for cable TV or radiated subscription TV. And the possible introduction of high definition television (HDTV) also has to be considered. The second generation of satellites for the financially ailing domestic satellite company, Aussat, is an important issue sure to attract a lot of attention in coming months.

The Department of Transport and Communications is busy dealing with an ever-increasing demand for new uses of the radio frequency spectrum. It also has

ALL ABOUT VHF AMATEUR RADIO

50 • 144 • 220 • 420 • 560 • 1290 • MHz

by WILLIAM ORR, W6SAI

DX Propagation
VHF Yagi beam antennas
VHF Quad beams
Mobile antennas that work
Repeaters and how they work
All about Moonbounce — DX
OSCAR satellites — how to use them
How to cure television & stereo interference
All about the SWR meter for VHF
How to protect your mobile equipment from theft

6 • 2 • 1 • Meters • 70 • 33 • 25 • CM

most Everything about Coaxial Lines; VHF Vertical and Mobile Antennas You can Build; and VHF Interference and How You Can Suppress It. The final chapter, VHF Roundup, deals with sundry matters including SWR antenna checks, the care of Nicad batteries, and how to protect your mobile gear from theft.

The book includes a brief history on the VHF spectrum from the earliest experiments of Hertz and

Marconi, through to the post-WWII boom in its use. The chapter on OSCAR satellites and how to use them also gives an historical perspective on this aspect of our hobby.

The use of imperial measurements in the book should not cause Australian readers too many metric conversion headaches.

All About VHF Amateur Radio is suited to the newcomer wanting to dose up on easily consumed encapsulated information, the established hobbyist seeking to expand or update knowledge, and is a comfortable, interesting read for those not technically inclined.

It can now be obtained through the WIA Divisional Bookshops. **ar**

to continue its progress towards setting standards aimed at alleviating potential electro-magnetic compatibility (EMC) problems. The department is also preparing for its participation in the World Administrative Radio Conference in 1992. **ar**

**SUPPORT THE
ADVERTISERS WHO
SUPPORT AMATEUR
RADIO MAGAZINE**

FT-1000 HF ALL MODE TRANSCEIVER



THE BEST OF THE BEST

Attention all serious HF operators! To be a truly WORLD CLASS operator during these times of crowded band conditions, you've got to have a truly WORLD CLASS rig...and the rig you need is arriving in Australia very soon. Of course we're referring to the versatile new YAESU FT-1000.

The FT-1000 is the product of 3 years intensive research and development at YAESU, resulting in a highly reliable, fully featured, yet easy to use HF transceiver. It's bound to blow away your competition with its spectacular combination of power and operational flexibility. Compare!

Direct Digital Synthesis (DDS)- Two 10 bit DDS plus three 8 bit DDS provide fast lock-up times and lower synthesizer noise than traditional PLL systems. Using DSS's means a cleaner transmitted signal and improved receiver performance.

High RF Output Power- Continuously adjustable output from 20 watts to a mighty 200 watts is under your control. A built-in blower sees that high duty cycle transmissions take place quietly and efficiently.

Dual Channel Reception- Utilising independent VFOs and digital displays, reception can be in different modes, on different frequencies, with different IF bandwidths. An optional Bandpass Filter Module (BPF-1), will allow cross-band dual-receive using two antennas.

Ultra-High Performance Receiver- it provides all-mode coverage from 100kHz to 30MHz with a dynamic range of up to 108dB. Selectable filters for the following frequencies are fitted as standard: 6kHz, 2.2kHz, 1.8kHz, 500Hz, 240Hz. The QRM rejection systems include cascaded IF filters, IF width and shift controls, IF notch filter, a variable noise blanker, and CW audio peaking filters.

For the full story on the incomparable YAESU FT-1000, contact your local Dick Smith Electronics store for your copy of YAESU's 12 page full colour booklet.

Sneak Preview!

To celebrate the opening of the expanded Ham Shack at our Bourke Street store (Shop 20, Midtown Plaza, 246 Bourke St., Melbourne), we will be holding an FT-1000 'Demo-Day' on Saturday, 16th of June 1990. Drop in any time from 9am till 4pm and enjoy tea or coffee while we demonstrate all the marvellous features of the new FT-1000.



THE ULTIMATE 2 METRE HAND-HELD TRANSCEIVER



**EXCLUSIVE
2 YEAR WARRANTY**

The FT-411 is a top-of-the-line ultra compact 2 metre handheld offering an incredible array of features without the size and weight of previous sets. Expanding on the microprocessor controlled features of previous models, the front panel multi-function back-lit keypad allows easy frequency entry, selection of the 49 tunable memories (which store repeater shifts, or separate Tx/Rx frequencies), setting of the programmable-interval 'power-saver' system, as well as a host of other convenience features. CPU control also offers 2 VFO's, rotary dial tuning with 5 selectable tuning steps, a multi-function back-lit 6 digit LCD screen with bargraph Signal/P.O. meter, and a range of scanning options. Even VOX (voice-activated transmit) circuitry is provided, allowing hands-free operation with the optional YH-2 headset.

Yaesu have also recognised that a hand-held radio must be ruggedly constructed, and yet be small enough and light enough to carry around all day. Through the extensive use of surface-mounted components, a heavy duty die-cast rear panel, rubber gasket seals around all external controls and connectors, and a carry case supplied as standard, the FT-411 will provide reliable operation even in dusty or humid environments while measuring only 55 (W) x 155 (H) x 32mm (D), and weighting less than 550 grams (including a high capacity 1000mAh FNB-14 NiCd battery giving 2.5W output). A range of inexpensive optional accessories are also available to provide flexibility for users differing requirements. See ARA review Vol 12 Issue 3, and AR review January 1990 issue.

Complete Package:

FT-411, FNB-14 7.2V NiCad, Carry Case, Antenna, Belt Clip. Approved AC Charger, **BONUS** PA-6 DC Adaptor. (Provides 5 watts output with 12V DC, while charging the FNB-14)

SAVE \$39.95

\$449

Optional Accessories

FNB-11	12V 600mAh NiCd Battery (5W out)	D-3496	\$99.00
MH-12A2B	Speaker/Microphone	D-2115	\$49.95
YH-2	Mic/Earphone Headset	D-2200	\$49.95

YAESU STOCKS NOT HELD AT ALL STORES. PLEASE CONTACT YOUR LOCAL STORE FOR STOCK AVAILABILITY. OR ORDER BY PHONE...



DICK SMITH ELECTRONICS

• NSW • Albury 21 8399 • Bankstown Square 707 4888 • Belconnen (06) 253 1785 • Blacktown 671 7722 • Brookvale 905 0441 • Bondi 387 1444 • Campbelltown 27 2199 • Chatswood Chase 411 1955 • Chullora 642 8922 • Gore Hill 439 5311 • Gosford 25 0235 • Hornsby 477 6633 • Hurstville 580 8622 • Kotara 56 2092 • Liverpool 600 9888 • Maitland 33 7866 • Miranda 525 2722 • Newcastle 61 1896 • North Ryde 878 3855 • Parramatta 689 2188 • Penrith 32 3400 • Railway Square 211 3777 • Sydney City 267 9111 • Tamworth 66 1711 • Wollongong 28 3800 • ACT • Fyshwick 80 4944 • VIC • Ballarat 31 5433 • Belmont 43 8522 • Bendigo 43 0388 • Box Hill 890 0699 • Coburg 383 4455 • Dandenong 794 9377 • East Brighton 592 2366 • Essendon 379 7444 • Footscray 689 2055 • Frankston 783 9144 • Geelong 232 711 • Melbourne City 399 Elizabeth St 326 6088 and 246 Bourke St 639 0396 • Richmond 428 1614 • Ringwood 879 5338 • Springvale 547 0522 • OLD • Brisbane City 229 9377 • Buranda 391 6233 • Cairns 311 515 • Cherrmside 359 6255 • Redbank 288 5599 • Rockhampton 27 9644 • Southport 32 9033 • Toowoomba 38 4300 • Townsville 72 5722 • Underwood 341 0844 • SA • Adelaide City 223 4122 • Beverley 347 1900 • Elizabeth 255 6099 • Enfield 260 6088 • St. Marys 277 8977 • WA • Cannington 451 8666 • Fremantle 335 9733 • Perth City 481 3261 • Midland 250 1460 • Northbridge 328 6944 • TAS • Hobart 31 0800 • NT • Stuart Park 81 1977
ORDER BY PHONE OUTSIDE SYDNEY (008) 228610 Free Call Sydney Area 888 2105

CONTESTS

The Sunshine State Jack Files Memorial Contest 1990

All licensed amateur radio operators are invited to participate in the **Sunshine State Jack Files Memorial Contest for 1990**.

Objects

- The objects of the contest are to:
 - perpetuate the memory of the late Jack Files, who was a long-time member of the council of the Queensland Division of the Wireless Institute of Australia;
 - enable amateur radio operators to work Queensland stations for the "Worked all Queensland Award" and other awards issued by amateur radio clubs in Queensland;
 - encourage mobile/portable operation from the lesser populated towns and shires of Queensland;
 - provide a 'warm up run' for the Remembrance Day Contest.

Period

- The contest will be run in one time period, on Saturday 14th July 1990, from 1500 hours EST (0500 hours UTC) to 2100 hours EST (1100 hours UTC).

Sections

- Stations within VK4:
 - Tx all band. 20% of contacts claimed must have been made on the V/UHF bands;
 - Tx HF phone;
 - Tx HF CW;
 - Tx V/UHF only;
 - Club stations in a to d above, single transmitter.
- Stations outside VK4:
 - Tx all band phone;
 - Tx all band CW.

Preferred contest frequencies

Phone	CW
1.820-1.840 MHz	1.805-1.815 MHz
3.570-3.590 MHz	3.525-3.535 MHz
7.100-7.120 MHz	7.010-7.020 MHz
14.180-14.200 MHz	14.050-14.060 MHz
21.170-21.195 MHz	21.125-21.150 MHz
28.480-28.520 MHz	28.125-28.150 MHz

Operation

- The WARC bands may not be used in this contest. Cross-band operation is permitted only via a satellite repeater; contacts made via a net are not admissible; cross-mode operation is allowed.
- The contest is primarily for single-operator stations, but log keepers are allowed. Where two licensees use a single station, each is to submit a separate log.
- Club stations may use multiple operators,

provided that there is only one transmitter in use at any one time.

- Home-based stations may be worked again after an elapsed time of one (1) hour.
- Mobile or portable stations are not subject to the one-hour rule when operating from a different city/town/shire. When operating within one hour from that of previous operations, they are regarded as "new" stations for their own and the contacted stations scoring purposes. (Different is not to be taken as alternating, e.g., operations from Area A for 50 minutes, then move to Area B, operate for 50 minutes and return to Area A, would be regarded as alternating, not different). Operations from the same city/town/shire after one hour, regardless of movement within that area, are regarded as home station operations.

Calling procedure

- Phone: CQ Jack Files Contest
CW: CQ Test Jack Files

Exchanges

- Each exchange is to contain the following elements:
 - the location designator, N or S, see Scoring;
 - the serial number beginning with 001 and continuing in sequence throughout the contest and on all bands worked;
 - the "code letters" of the designated city/town/shire, as set out in the attached "designated areas and code letters".

Scoring

- For scoring purposes, Queensland is divided into two zones by the Tropic of Capricorn. Stations in designated areas north of the Tropic are to use the letter "N" as the first element of contact exchange. Those in designated areas south of the Tropic are to use "S" similarly.

Example: A valid exchange for scoring purposes might be:

S	001	MH
Zone	Contact	City/town/shire
N	132	RH

- Stations within VK4, phone contacts:
 - HF/V/UHF within the same zone ...3 points
 - HF/V/UHF with the opposite zone ...5 points
 - HF/V/UHF outside VK4...2 points
 - All CW contacts score double points, ie, 6, 10 or 4.
- Stations outside VK4, ALL phone contacts, 2 points, ALL CW contacts, 4 points.

Bonus points applicable to all stations

- A bonus of ten (10) points may be claimed

for the **first** contact with a city/town/shire, other than the one from which the claimant is operating, over the whole contest.

- A further bonus of ten (10) points may be claimed for each club station on **each occasion** it is worked (one-hour rule still applies).

Examples: Phone: A VK4 station in S zone, first contact with VK4000 in Cairns, which is the club station of the Green Isld ARC Inc, scores 5 points for across zone, 10 points for first contact Cairns City, 10 points for club station, total 25 points.

CW: For the same contact, score 10, 10, 10, total 30 points.

Stations outside VK4 would score 2, 10, 10, or 4, 10, 10, for phone or CW respectively.

NB: No further bonus may be claimed for Cairns City.

Logs

- Logs must show the full name, address and callsign of the operator(s), the section entered, points claimed for each contact and the total points claimed, a signed and dated statement that the rules have been followed, and the appropriate licence conditions observed. A recommended form of log is:

Date Time	Band	Mode	Call	No Sent	No Rec'd	Points Club Total
15						
7						
89						
0834	7.0MHz	Phone	VK4000 S001BE N00CS	5	10	21
0837	7.0MHz	Phone	VK4SSS S002BE S001BE	3		3

(Assumes VK4SSS is not a club station)

- Logs are to arrive at:
VK4 Contest Manager
T Mulholland VK4AEM
PO Box 35
Caloundra City Q 4551
ON or BEFORE 10th August, 1990.

Awards

- Trophies will be awarded by the WIA (Q) Awards Manager to the highest scorer in each section, provided that there is a minimum of five entries in that section.

Code to define cities, towns and shires for the Jack Files contest

Cities/Towns			
Brisbane	BN	Ipswich	IP
Bundaberg	BU	Logan City	LC
Cairns	CS	Mackay	MC
Caloundra	CA	Maryborough	MB
Charters Towers	CT	Mount Isa	MI
Dalby	DY	Redcliff	RC
Gladstone	GD	Rockhampton	RH
Gold Coast	GC	Roma	RM
Goondiwindi	GI	Toowoomba	TO
Gympie	GY	Townsville	TV
Hervey Bay	HB	Thuringowa	TH
		Warwick	WA

Shires			
Albert	AL	Jericho	JE
Allora	AA	Johnstone	JO
Aramac	AC	Jondaryan	JY
Arakun*	AN	Kilcoy	KY
Atherton	AT	Kilkivan	KK
Burdekin	BK	Kingaroy	KG
Balonne	BL	Kolan	KO
Banana	BA	Laidley	LA
Barcaldine	BC	Livingston	LV
Barcoo	BO	Longreach	LO
Bauhinnia	BH	McKinlay	MK
Beaudesert	BT	Mareeba	MA
Belyando	BY	Maroochy	MO
Benedmere	BD	Milmeran	ML
Biggenden	BG	Mirani	MN
Blackall	BX	Miriam Vale	MV
Boonah	BV	Monto	MT
Booringah	BQ	Moreton	MR
Boulia	BZ	Mornington*	MZ
Bowen	BW	Mount Morgan	MM
Broadsound	BS	Mulgrave	MG
Bulloo	BP	Mundubbera	MU
Bungil	BI	Murgon	MY
Burke	BR	Murella	MX
Caboolture	CB	Murweh	MH
Calliope	CL	Nanango	NN
Cambooya	CM	Nebo	NE
Cardwell	CD	Noosa	NO
Carpentaria	CP	Paroo	PO
Chinchilla	CH	Peak Downs	PD
Clifton	CF	Perry	PY
Cloncurry	CY	Pine Rivers	PR
Cook	CK	Pioneer	PI
Crows Nest	CN	Pittsworth	PT
Croydon	CR	Proserpine	PP
Dalrymple	DL	Quilpie	QL
Diamantina	DI	Redland	RD
Douglas	DG	Richmond	RI
Duaringa	DU	Rosalie	RO
Eacham	EA	Rosenthal	RL
Eidsvoll	ED	Sarina	SA
Emerald	EM	Stanthorpe	ST
Esk	EK	Tambo	TB
Etheridge	ET	Tara	TA
Fitzroy	FZ	Taroom	TM
Flinders	FL	Tiaro	TI
Gatton	GT	Torres	TE
Gayndah	GH	Waggamba	WG
Glengallan	GL	Wambo	WO
Gooboorum	GM	Warroo	WR
Herberton	HT	Widgee	WE
Hinchinbrook	HK	Winton	WI
Ilfracombe	IL	Wondai	WD
Inglewood	IW	Woocoo	WC
Isis	IS	Woongarra	WN
Isisford	IF		

*Permission to operate in these shires is required.

SEANET World Wide DX Contest 1990

Contest Dates & Times

CW contest: 0001z Saturday 21 July '90 to 2359z Sunday 22 July '90

Fone contest: 0001z Saturday 18 Aug '90 to 2359z Sunday 19 Aug '90

Bands:

160, 80, 40, 20, 15, 10 metres

Entry Classification

1. Single band - single operator
2. Multi band - single operator
3. Multi band — multi operator

Power Input

As stipulated in the regulations governing the licence of the operator.

Contest Call

- "CQ SEA" for CW contest
- "CQ SEATEST" for FONE contest

Reporting

RS/RST report plus serial numbers starting with 001 and increasing by one for each successive contact. See also rule 3(d).

Scoring Rules

1. For stations OUTSIDE SEAnet area
 - (a) Contact with stations within SEAnet area of the following prefixes: DU/DV/DX, HS, YB/YC/YE, 9M2, 9M6, 9M8, 9V, V85.
 - 20 points on 160 metres
 - 10 points on 80 and 40 metres
 - 4 points on 20, 15 and 10 metres
 - (b) Contacts with other stations within SEAnet area not listed above in 1(a):
 - 10 points on 160 metres
 - 5 points on 80 and 40 metres
 - 2 points on 20, 15 and 10 metres
 - (c) Contacts between stations outside SEAnet area will not be counted.
 - (d) Multipliers will be three points for each country worked, ie for countries within SEAnet area only.
2. For stations in the SEAnet area
 - (a) Contacts with stations outside SEAnet area
 - 10 points on 160 metres
 - 5 points on 80 and 40 metres
 - 2 points on 20, 15 and 10 metres
 - (b) Contacts with other stations within SEAnet area not listed above in 1(a):
 - 10 points on 160 metres
 - 5 points on 80 and 40 metres
 - 2 points on 20, 15 and 10 metres
 - (c) Contacts between stations in own country

will not be counted either for QSO points or multiplier purposes.

(d) Multipliers

Contacts with countries within SEAnet area Count 2 points for each country worked
 Contacts with countries outside SEAnet area Count 3 points for each country worked

3. The final score will be the sum of the points multiplied by the sum of the country multipliers.

List of SEAnet area prefixes

A4, A5, A6, A7, A9, AP, BV, BY/BZ, DU/DV/DX, EP, HL, HS, JA/JE/JF/JG/JH/JI/JJ/JR etc, JD1, JY, KH2, P29, S79, VK1/.../VK9, VQ9, VS6, VU, V85, XU, XV/3W, XW, XX9, YB/YC/YE, ZK, ZL1/ZM1.../ZL4/ZM4, ZL6/ZM6, ZL9, 3B6/3B7, 3B8, 3B9, 4S7, 4X/4Z, 8Q7, 9K2, 9M2, 9M6, 9M8, 9N1 and 9V.

Restrictions

- (a) Contacts on cross-mode or cross-bands or mixed CW-FONE logs will be disqualified.
- (b) Operators are not allowed to transmit two or more signals at the same time on the same band.
- (c) Only one contact per band with the same station will be counted.
- (d) Contest numbers should begin with 001 on each different band.
- (e) All entries in violation of the contest rules, incorrect statements in the submitted reports, taking points from duplicate contacts, and practices against the brotherhood of amateur radio will be disqualified.
- (f) The decision of the SEAnet contest committee shall be final.

Entries, Log(s) and Summary Sheet(s)

All entries must be in the form of log(s). Summary sheet(s) showing claimed scored band-by-band plus total score claimed must be attached to the log(s). The summary sheet(s) must be signed by the operator(s) and include the following statement:

"I/we certify that the station has been operated within the spirit of the contest and the terms of the station licence."

Please do not forget to clearly mark your name, call and mailing QTH on the summary sheet(s) and log(s).

All times must be in UTC. Entries must be received by the Contest Manager, Yathe 9V1JY, PO Box 2728, Singapore 9047, not later than 31st October 1990. Results will be announced at the Seanet '90 Convention. If you require a results slip to be sent to you, please enclose three IRCs together with your entry.

HAVE YOU ADVISED DOTC OF YOUR NEW ADDRESS?

HOW'S DX

STEPHEN PALL VK2PS
PO Box 93 DURAL 2158

Exciting DX in April

As I write these lines very early in May — the month of April filled with an abundance of DX, just passed. What a month it was!

Jim VK9NS has completed his successful Bhutan (A51JS) activity with approximately 15,000 QSOs. He decided not to go to Bangladesh, where Vince K5VT was active on CW as S20VT (QSL to home call). Almost at the same time, the Japanese group led by JH1AJT made a return visit and operated for two weeks on SSB under the callsign S21U. QSL to JH1AJT: Yausuo "Zorro" Miyazawa, PO Box 8, Asahi, Yokohama 241 Japan. The Jarvis DXpedition had a successful and well-disciplined activity from the Island as AH3C/KH5J. They came up on the designated frequencies, announced their callsign and QSL information frequently and, at some stages, were actively looking for VK-ZLs. After 52,000 QSOs, the seven operators returned to their respective countries (W-OH-JA) via the Dayton, Ohio, Hamvention at the end of April. QSL for the Jarvis operation to be sent to OH2BN: Jarmo J Jaakola, Kiilletie 5C 30, 00710 Helsinki, Finland. John, PA3CXC kept his promise and activated Southern Sudan with the call: PA3CXC/ST0. QSL via the Bureau, or to: John H Fung Loy, Straussin 4, NL-2551, NMS Gravenhage, The Netherlands. At the end of the month of April came 1A0KM — The Knights of Malta. Booming signal on the longpath to VK. QSL to: IO1J: Antonio Privitera, via Ceresia 34, I-00199, Rome, Italy. After many months of rumours, Spratly Island was activated by the Russian team. The operation was intermittent due to generator and fuel supply problems, but many DXers were able to make contact with them. The call was: 1S0XC. QSL to: Roman Stapanenko, PO Box 208, Moscow, 102009, USSR. Keep in mind the earlier published suggestions how to QSL direct with the Soviet Union. The Hungarian DXpedition could not operate from Burma, so it decided to activate XU8CW and XU8DX from Kampuchea. QSL to: Mr Jacques Pecourt, PO Box 1384, Millbrook, NY 12545, USA.

What an exciting month! Seven very rare DX countries in one month. One well known VK2 DXer wrote to me: "Working S2,ST0 and 1S in 24 hours is a bit hard to top, so I might retire, hi."

Future DX?

Whilst the propagation is still at acceptable levels, do what you can, as the bottom of the "22" sunspot cycle is not as far away as you might think. Some experts say that we have already reached the peak of the cycle. There

was a major solar storm mid-April. The solar flux peaked around 250, but it is quite possible that it will drop down around 150 by mid-May.

Trindade Island DXpedition

This activity will be in full swing in June and July. The correct callsign will be announced on the first day of operation, to stop pirates using the call before.

All bands, including WARC bands will be used, both SSB and CW, with two stations operating. Sorry, no RTTY. QSLs via the Bureau, or for direct reply with SASE for the SSB operation to: PS7KM, Karl Mesquita Leite, Box 385, 59000 Natal, R N Brazil. For CW operation to: PT7AA, Pergentina I de Andrade, Rua Osorio de Paiva 25, 60000 Fortaleza, CE, Brazil. The cost of the expedition is over US\$2000 and the NatalDX Group, Caixa Postal 597, 59021, Natal R N Brazil, South America, is seeking donations by registered air mail to defray costs.

South Sandwich and South Georgia Islands — VP8

This activity will start on 26th November 1990 on the South Georgia Island Group, and on 1st December at the South Sandwich Island. The planned stay on South Sandwich is

seven days. Both locations will operate SSB, CW, RTTY, Satellite, UHF, VHF, HF, 10 through 160 metres. All 22 operators are experienced in DX work. QSL via the Bureau or direct to: AA6BB/7 or KA6V/7, J & J Branson, 93787 Dorset Lane, Junction City, OR, 97448, USA. The total cost of expedition is estimated around US\$215,000. Here are some interesting figures which will make you think: Ship charter from the Falklands and return 20 days, including fuel and meals: \$175,000. Generator and fuel: \$12,000. Foul weather gear \$9000. Air transportation (to Falklands) \$15,000 etc, etc. Jerry Branson (above) is the treasurer of the operation, and donations are actively sought from the DXing fraternity.

Minami Torishima — JD1

Kiyo, JA9IAX, will begin a three-month stay on the island beginning 17th May. He will be very active, specially on CW. QSL to JJ1TBB.

Jan Mayen-JX

LA7DFA: Per is scheduled to be on the island from 1st April to 27th July, and will operate as JX7DFA. Look out for him on: 3501, 7005, 14010, 21010 and 28010. All those who need practice with the key, better start again. QSL to: Per Dahlen, Myrvangsvingen, 21,7026, Trondheim, Norway.

Market Reef OH0M

A number of USA and Finnish operators will be active from this tiny rocky island, located between Åland (OH0) and Sweden (SM). The maximum elevation is one metre

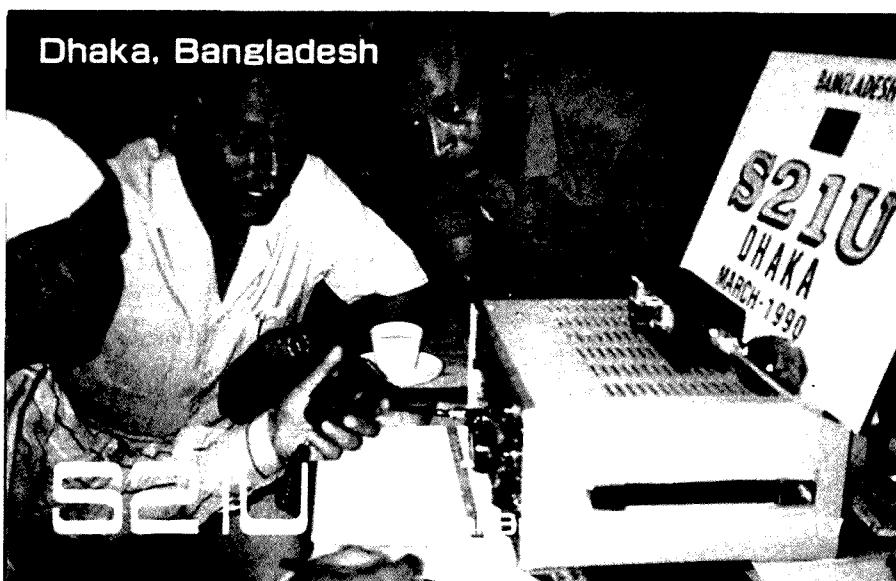

S21U was established in March 1990 in the office of the Bangladesh (Dhaka) National Broadcasting Authority with the goodwill and co-operation of Japanese operators. It was granted a licence for preliminary research into amateur radio activity in Bangladesh. Card by courtesy of JA1UT.

above sea level. The island is uninhabited, except for a few birds which rest there. The only buildings are an automated, unattended lighthouse and weather station. The activity is planned from 28th July to 4th August.

Cocos Keeling Islands — VK9

If you worked VK9EW and VK9WB between 19th and 26th May on CW and SSB you have contacted Ray W5EW and Barry WC5N who spent one week on the island. QSL for both stations to W5EW, Ray Husher, PO Box 73, Bernice, LA 71222, USA.

Oman-Kuria Muria Island — A43

The DX group of the Royal Omani Amateur Radio Society has activated this island. Many years ago, in 1967 to be exact, this was a separate country using the prefix VQ9S. The present special call was used as A43KM/0. They were active from 17th to 24th May. Both SSB and CW from 10 to 160 metres. There is some hint that the society might press for a separate country status with the DXCC. QSL via the Bureau.

Conway Reef — 3D

At the time of writing this article, it was planned that part of the Jarvis DXpedition team and well-known DXers VE7SW, SM7PKK and Ron ZL1AMO will visit Conway Reef between 16th and 23rd May. This will be the first DX operation since the reef was added to the official DX countries list.

Interesting QSOs and QSL information

Note the following abbreviations: Callsign name of operator — frequency — (kHz), mode UTC time. ADAR means = QSL info in previous AR issues.

YJ8NAC — MODREA-(YL)-28170-CW-0108. Novice, licensed three weeks, QSL to F6FNU — ADAR.

A61AD — 14200-SSB-2210-QSL to: WB2DND: Donald Greenbaum, 250 Standish St, Duxbury, MA, 02332 USA.

3D2QB — Allan-21010-CW. QSL to: SM5BQB: Alland Ostermann, Haro, S-10005, Stockholm 1 Sweden.

HK0BXX — Francisco-14014-CW-1200. QSL to: WB9NUL: Joyce Boothe, RT 6, Box 748A, Harlingen, TX, 78552 USA.

6W6JX — 14 MHz-CW-0700. QSL to: J Pipien, PO Box 200, Kaolack, Senegal, Africa.

VQ9LW — 14 MHz-CW-0400. QSL to: WA2ALY, L A Wolff, 624 East Dr, Paramus, NJ, 07652, USA.

V31BB — 14 MHz-CW-0740. QSL to: K3FEN, T Bell, 747 Sunblest Blvd, Noblesville, IN 46060, USA.

FG5XC — 14 MHz-CW-2200. QSL to: Pierre Habazac, F-97113, Gourbeyre, Guadeloupe.

XZ2TH — 21 MHz-CW-0130. QSL to: W6EXP, Ralph Blake, 1002 Modoc St, Susanville, CA, 96130, USA.

ZK2KY — Kiyoko-28475-SSB-0322. QSL to: PO Box 3 Tokaimura, Japan.

A92FB — Bernie-21247-SSB-1225. QSL to: B Donders, PO Box 22394, Bahrain.

V31PC — Don-21292-SSB-0645. QSL to: D Owen Lewis, Box 7 Punta Gorda, Toledo, Belize.

TA2L-Ustun-21155-SSB-0655. QSL to: Ustun Arik, Platin Sok 11 3 Box 430, Kizilay, Ankara, Turkey.

EK0DR-21015-CW at Cape Schmidt on the way to Wrangel Island. QSL via Bureau via UA0KBZ.

C21DX-21014-CW-0955. QSL to: Nauru Central Radio Club, Nauru.

CU2GE-Joseph-14188-SSB-1100. QSL via the Bureau.

JY5IN-Ibrahim-14243-SSB-0622. QSL to: Box 925677, Amman, Jordan.

8J90XPO-28018-CW-0708. QSL via Bureau.

ZF1RC-Roger-21205-SSB-0515. QSL to: PO Box 1549, Cayman Island.

JA7FTJ/JD1-14226-SSB-1308. QSL to: JA7BIJ, Hirokatsu Tsukidate, 1-3 Tainaka, Nukazuka, Hachinohe, Aomori 031 Japan.

ZV7XW-Eli-Club Station-14222-SSB-0616. QSL via Bureau. (Brazil)

H44MS-Bernhard-14222-SSB-0637-OP. DL2GAC. QSL: ADAR.

T30NAD-Bob-28480-SSB-2356. QSL via JO1CRA via Bureau.

CO8MA-Raf-21280-SSB-0336. QSL to: PO Box 144 CP, 75100, Las Tunas, Cuba.

Z24JS-George-21205-SSB-0539. QSL to W3HNNK: ADAR.

ZL0AIC-Marcus with "Greenpeace" in the Antarctic-14222-SSB-0705. QSL to: HB9AAA: via the Bureau.

T77C-Tony-14145-SSB-0810. QSL to: Tony Ceccoli, via Delle Carrare 67, RSM-47031, Murata, San Marino.

FT5XA-Rafique-14226-SSB-1158. QSL to: F61TD: Jean Pierre Berthomieux, 29 rue de Cammas, F31650, Daint Orens De Gameville, France.

RTTY News

Here are some choice DX as supplied by Syd VK2SG.

TR8JLD-14089-2245. QSL via AK1E.

ZK2RW-21087-0337. QSL via Ron, ZL1AMO. OY9JD-21097-1825.

FM5WU-14082-2220. QSL to F6FNU-ADAR. KP2BH-14087-1300

HV3SJ-21083-1800

S92LB-14087-0445

YV0AA-14088-0320. QSL via YV5AJ, Radio Club, Caracas, Venezuela.

SU1HN-14085-0046. QSL to: Ahmed Hassar, Box 1578, Alf Naskah, Cairo, Egypt.

PZ1BS-14090-2124. QSL to Box 83, Paramaribo, Surinam.

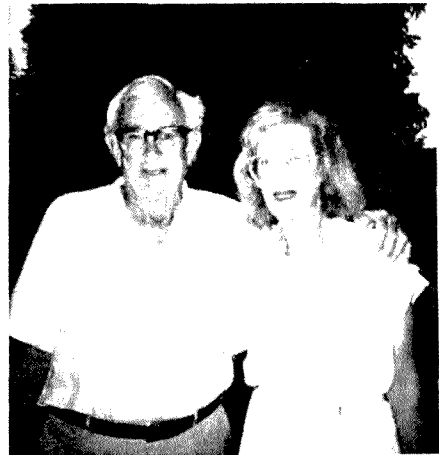

Nancy VK2PNG pictured with Dale Baker at the VK5 WIA Christmas party Dec 1989.

From Here and There and Everywhere

VERON, the Dutch Amateur Radio Society, advises us that the World Championships and Games for the Disabled will take place in Assen, Holland, from 14th to 26th July. A special amateur radio station will be operational with the callsigns PI4ASN and PA6WGD. A QSO with the latter station will qualify you for an award. Send your QSL card and US\$5 (or equivalent) to the Award Manager, PA3FFX, PO Box 407, 9400, A K Assen, The Netherlands. All proceeds from this award will be for the development of sporting facilities for the disabled.

VK2DID reports that he had a CW contact with Carlos KP4EJ. The interesting part of the QSO was when Carlos reported that his aerial was a full wave, and it was 20 feet underground. QSL to: Box 978 Salinas, Puerto Rico. The QSL address of 3W3RR and 1S0XV is the same. Graham VK6RO claims that he is the first VK to work "100 countries" on the 18MHz band. He started on the 17th December 1982 and had reached the magical number on 12th March 1990. Zbig "Frank" VK2EKY sent a picture card to the VK2 Division from American Samoa, where he started his recent Pacific DX journey as KH8/VK2EKY. He was later heard as 5W1KY from Western Samoa. Depending on personal circumstances, he might go to ZK1, ZK3 (?) or Rotuma Island. Later on in the year, he intends to travel to Japan where he will stay six months with his Japanese wife. He intends to be active from Japan with a 7J6 prefix from Beppo. QSL for KH8/VK2EKY or 5W1KY goes via WA3HUP, ADAR. However, VKs might QSL via the VK2 Bureau.

"Dusty" ZL2VS, who operated at the beginning of the year as VM7VS, is waiting on his new QSL cards from the printer. He hopes to complete his QSLing duties soon. "Bing", VK2BCH has recovered from his illness, and intends to go back to Rotuma to reactivate his

3D2XV callsign, and then proceed to A35. Matts, SM7PKK is still in the Pacific area. He was heard from Wallis Island as FW/P/SM7PKK. Later he visited American Samoa as KH8P/SM7PKK, then Niue Island as ZK2KK. He will be one of the operators who will go to Conway Reef middle of May. All QSLs to his homecall - ADAR. Ken, VK5QW is not the QSL Manager for UQ1GWC or YL1WC. Recently he received a number of QSL cards for these stations, as QSL manager, which he is not, and has difficulty redirecting them. There is an unconfirmed rumour that the Japanese amateurs will return to Bangladesh for 30 days activity in September. ZS8MI will be active again with ZS5AEN as the new operator. IJ5ONU was a special call for the "UNICEF" activity. QSL to I5KKW via the Bureau. EK0KBZ and EK0DR were special-event stations with the joint US/USSR sled-dog expedition in the Arctic to Wrangel Island. QSL to UA0KBZ via the Bureau, or direct to Sergey UA0KBZ, PO Box 485, Cape

Schmidt, Magadan Oblast, 686830, USSR. 4K3ODX is on Novaya Zemlya Island. QSL to RAI0A. CT0B was a special-event station activating Berlenga Island in the Atlantic Ocean off the Portuguese coast. QSL via CT1CWT. Instead of helicopters, the Spratly DXpedition used boats to get to the island. It was said that a Soviet sponsor has arranged a loan of \$25,000 to finance the expedition, and the loan must be repaid. GC45LD was a special callsign on Jersey Island to commemorate the 45th anniversary of the liberation of the Channel Islands.

EM/EO/ER/EU/EV/EW are special USSR prefixes to celebrate the victory of the USSR in World War II.

Interesting QSLs Received

Note: W = weeks; MO = months; FM = from; MGR = manager; OP = operator.

Direct QSLs received: 9K2KS 11W FM MGR - ST4/WZ6G 8W FM MGR - VK9LA 2W

FM OP - VK9TR 4W FM OP - FM5WD 4W FM MGR - XW8KPV 15W FM MGF - 9H1EU 2W FM MGR - J88BS 3W FM MGR - XW8DX 5W FM MGR - C06CD 2W FM MGR - ZB2FX 7MO FM OP - EA6SX 3W FM OP - XX9SW 4W - ZB2AZ 3W - Z21AA 3W - Others direct: A41KJ, ZB2GR, A92EV, VR200PI/JR, OH0XX.

Bureau QSLs received: LX2KQ - EA6MQ - JW1CY - ZS5XA - LX9CFL - ZP5PX - HB0CZS - VK0JV - OH2AP/OH0M - T32JA - ZF2NV/ ZF8 - 5W1YL - T22VU - VK 9NKG - GD4PTV - EA6VQ - YS1MAE - FM5CL.

Thanks To You

Encouraging notes were received from VK3CTM and VK3N/XPL. Information received from VK2DOJ, VK2DID, VK2RZ, VK2APD, VK3DD, VK4DA, VK4OH, 4K4OD, VK5WO, VK5QW, VK5NVW, VK5BAS, VK6NE and the "QRZ DX" and "The DX Bulletin". To all of you thanks for your assistance and cooperation.

Good DX AND 73.

VHF/UHF AN EXPANDING WORLD

ERIC JAMIESON VK5LP
9 WEST TERRACE MENINGIE 5264

All times are Universal Time Co-ordinated indicated as UTC

Beacons on six metres

Freq	Call sign	Location	Grid square
50.000	GB3BUX	England	IO73
50.005	H44HIR	Honiara	QI00
50.005	HL9TG	Korea	
50.005	ZS2SIX	South Africa	KF25
50.011	JA2IGY	Japan	PM84
50.015	SZ2DH	Greece	KM18
50.017	JA6YBR	Japan	PM51
50.020	GB3SIX	England	IO73
50.020	CX1CCC	Uruguay	
50.025	6Y5RC	Jamaica	FK17
50.025	OH1VR	Finland	KP12
50.028	JA7ZMA	Japan	QM07
50.029	CT0WW	Portugal	IN61
50.032	ZD8VHF	Ascension Island	II22
50.032	ZS5SIX	South Africa	KG50
50.035	ZB2VHF	Gibraltar	IM76
50.035	ZS3VHF	South Africa	JG87
50.039	FY7THF	French Guyana	GJ35
50.045	OX3VHF	Greenland	GP60
50.048	TG4BFK	Guatemala	
50.050	GB3NHQ	England	IO91
50.050	ZS6DN	South Africa	KG44
50.056	VK8VF	Darwin	PH57
50.057	TF3SIX	Iceland	HP94
50.062	PY2AA	Brazil	GG66
50.064	WD7Z	Arizona	EL59
50.065	GJ4HXJ	England	IN89
50.065	NB30/1	Rhode Island	FN41
50.066	VK6RPR	Perth	OF78
50.063	KH6HI	Hawaii	BL01
50.075	VS6SIX	Hong Kong	OL72
50.078	TI2NA	Costa Rica	EK70
50.080	KH6JJK	Hawaii	BL11

50.080	HC8SIX	Galapagos Is	EI59
50.085	9H1SIX	Malta	JM75
50.086	VP2MO	Montserrat	FK86
50.088	VE1SIX	Canada	FN65
50.090	KJ6BZ	Johnston Is	AK56
50.092	W5GTP	Louisiana USA	EM40
50.099	KP4EKG	Puerto Rico	FK68
50.100	HC2FG	Ecuador	FI07
50.100	5H1HK	Tanzania	
50.110	KG6DX	Guam	QK23
50.110	A61XL	United Arab Emir	LL74
50.120	4S7EA	Sri Lanka	MJ97
50.321	ZS5SIX	South Africa	KG50
50.490	JG1ZGW	Tokyo	PM95
50.499	5B4CY	Cyprus	KM54
52.100	ZK2SIX	Niue	AH50
52.200	VK8VF	Darwin	PH57
52.310	ZL3MHF	Christchurch	RE66
52.320	VK6RTT	Wickham	OG89
52.325	VK2RHV	Newcastle	QF57
52.330	VK3RGG	Geelong	QF21
52.345	VK4ABP	Longreach	QG26
52.370	VK7RST	Hobart	QE37
52.420	VK2RSY	Sydney	QF56
52.425	VK2RGB	Gunnedah	QF59
52.435	VK3RMV	Hamilton	QF12
52.440	VK4RTL	Townsville	QH30
52.445	VK4RIK	Cairns	QH23
52.450	VK5VF	Mount Lofty	PF95
52.460	VK6RPH	Perth	OF78
52.465	VK6RTW	Albany	OF84
52.470	VK7RNT	Launceston	QE38
52.485	VK8RAS	Alice Springs	PG66
52.510	ZL2MHF	Mount Climie	RE78

Six Metres

From a VK5 standpoint, six metres has

been poor this autumn — the expected large influx of stations from exotic countries did not materialise, although there were a few good contacts; these included VK9LG from Lord Howe Island, W6JKV/FW Wallis Island, 5W1JP, V31PC Belize, T20AA, KG6DX, 3D2ER, 3D2CM and V73AQ Marshall Islands. Strong signals were rare and the CW signals from some other stations were too weak to work.

Roger VK5NY was observed working VK9LG on 8/4 and 10/4 around 0430 each time. On 11/4 there was an afternoon aurora which produced some raspy sounding contacts with VK3LK and VK7ZJA. The following morning UTC there were backscatter and Es signals from VK2QF, VK4BRG, VK4FNQ, peaking to 5x9 at times. At 2259 on 11/4 Roger worked XE1GRR at 4x4, 2306 3D2PO. Hugh VK5BC was amongst the DX and was heard working 3D2PO and W6JKV/FW and others. On 12/4 at 1130 Steve VK3OT was very strong on CW with my antenna at 335 degrees!

13/4 started at 0045 with VK9LG working JAs, at 0130 Joel was 5x3 rising to 5x9 on CW at 0145. At 0158 VK9LG was 5x9 on SSB and even stronger at 0205, dropping to a 5x3 CW signal at 0300. Short skip from VK3XRS who was 5x9 at 0247. At 0140 VK4DDG was heard working K6QXY. At 0426 VK2ZRZ was 5x9 and VK9LG again at 0430. There were plenty of JAs from most districts.

On 14/4 at 2310 T20AA was S2 then to KG6DX at S6 working VK2, 3, 4 and 5. On 15/4 at 2214 the usual backscatter signal from VK2QF and at 2245 VK8ZLX on backscatter. At 2300 Hugh VK5BC was observed making various contacts. On 16/4 at 0025 VK4ZAZ 5x7 while at 0820 VK5DK in Mount Gambier worked KH6IAA and NI6E/KH6 at 5x7. On 17/4 at 2323 T20AA was S1 on CW. Following the above activity the band was relatively quiet apart for JAs until this was written on 20/4.

Queensland

Although no remarkable signals in VK5, along the eastern seaboard between Sydney and Cairns, operators were being treated to some good DX, particularly those around Brisbane. John VK4ZJB reports a selection of contacts as follows: 2/4: 2205 5W1JP 5x9; 2216 W6JKV/FW 5x9. 3/4: 2132 HH7PV (Haiti) 5x1; also TI2HL, V31PC, ZK1EG, KG6DX. 5/4: 0645 JG6CVO/JD1 Ogasawari Island DXped, signals to 5x9; 8/4: 0200 YC0UVO 5x2; V73AQ. 12/4: 8P6JW Barbados, FM5WD Martinique, YV4AB Venezuela. 13/4: VK9LG, 1115 YC0UVO Indonesia, also TI5LI, ZK2KK, Niue, 5W1KT. 14/4: JJ1AEB/KH0 Marianas, AH3C/KH5 Palmyra Island. During the period several contacts were made to T20AA Tuvalu. Those making contacts from the Brisbane area included VK4s DDG, ZJB, ZNC, ZAL, ZAA, ZAZ, APG and others.

Victoria

Gil VK3AUI reports six metres DX somewhat poor this year. On 19/3 worked JA8s; 22/3 JA2s; 24/3 KG6DX and JAs. At 2348 worked ZF1RC with some difficulty due to QRM, then shortly after at 0001 25/3 Gil called CQ higher up the band to be answered by ZF1RC! He later worked JA8s. 29/3: 2307 T20AA and heard ZL3TY. On 30/3 at 0930 worked VK7JG via aurora. On 2/4 at 2250 he worked T20AA and at 0001 JI2UNR. Thanks for writing Gil, I have recorded your amended DX Standings list.

New Zealand

Kerry ZL3TPY writes with some news of his recent DXpedition at Owenga, South East Chatham Islands in AE15 grid square. He commenced operating on 19/3 with no DX! 20/3: 2016 V31PC. 21/3: 2312 heard H44HIR beacon. By this time Kerry must have been thinking had it been worth the effort, but everything changed on 22/3 when between 2052 and 2157 he worked N6XQ, K6SJI, K6HHJ, K6GMV, K6ODV, WA6BYA, K6JZK then VK2JSR on backscatter. 23/3: 1938 to 2112 — N4EJW, W400, K5LZO, K5AAD, V31PC, KP4EIT, HH7PV, K5ZMS mobile, W6UXN QRP with two Watts and others for a total of 47 contacts in W4, 5, 6 and 7. 24/3: 0345 JA8s, 2215 VK4BRG and heard P29PL. 25/3: 0206 to 0326 JA3, 8, 0 for 25 contacts,

1849 ZL1AKW F2 backscatter and at 1952 seven W5s, W7VXW and WA6BYA.

26/3: 0205 to 0751 JA1, 2, 3, 5, 6, 7, 8, 9, 0 for 137 total. Kerry remarked it was strange not to hear any JA4s. 0859 to 0936 13 VK2s and from 1929 to 2010 N5KW, W5FF, HI82, KP4ECR, WA4LOX, HH7PV and at 2318 the ZL3MHF beacon on 52.300. 27/3: 2104 to 2256 W5, 6, 7. 28/3: 2341 K6QXY. 29/3: 0056 VK4BRG, 2010 WA4LOX and K4QXX. 30/3: 2026 to 2345 W5 and W7.

Total QSOs were 270, which Kerry found disappointing. He also heard N6AMG/KH7, VK9LE, VK5s on backscatter, ZL TV on tropo for two days plus Ch 0 TV and many W6 and W7 beacons. Equipment used was an IC-575H and five-element home brew NBS Yagi up seven metres giving a clear take-off in all directions. Power was from a Honda EX350 generator plus battery.

Western Australia

In a brief report, Graham VK6RO advises that on 10/4 he just missed out on a two-way CW contact with JG6CVO/JD1, but was more fortunate on 16/4 when, at 0019, he worked AH3C/KH5J (Jarvis Island) at 5x9 and at 0121 VK9LG at 519. He did not report contacts to any other areas, so VK6 may be having a lean time, too.

The Higher Bands

Although no interstate reports are to hand, regular contacts have been occurring most evenings from around 1030 on 144, 432 and 1296 MHz between VK5KK, VK5AKM and VK5LP. The 160km path has been very reliable on all three bands even when using around three Watts.

The usual 5x9 path between VK5LP and Chris VK5MC at Hatherleigh has been used, also a contact with Colin VK5DK brought forth the information that he had moved from Yahl, a short distance from Mount Gambier, into the town itself, where he is gradually establishing his station again.

DX Standings

For those people who are working stations the second time around in order to qualify, please note that I do not need a further QSL if you obtained one previously. QSL cards are not obtained without considerable cost — all

I need is for an operator to indicate the usual parameters (call, date, time etc) and, upon comparison with your former list, the new contact will take the place of the former contact.

Closure

Unfortunately, I need to enter hospital again on 23/4 for further treatment in an effort to keep me walking, hence the short date span of these notes. Sorry about that! Closing with two thoughts for the month: "A lot of drugs are used by people who think that if you tinker with an empty head you can get it going." And: "Things turn out best for people who make the best of the way things turn out." 73 from The Voice by the Lake.

Late Items

Hugh VK5BC said April was a relatively quiet month but by persevering he was able to work as follows:

3/4: 5W1JP, W6JKV/FW, T20AA, V31PC, XE1GRR, JA and heard Ws. 4/4: JAs. 6/4: 3D2PO. 8/4: KG6DX, VK9LG. 10/4: Via aurora VK3LK, VK7ZBA, VK5NY, VK3AMZ, VK7MC, VK5RO. 11/4: JAs. 12/4: XE1GRR, W6JKV/FW, 3D2PO. 13/4: VK9LG.

16/4: T20AA, V73AQ, ZL3TY, 3D2ER, AH3C/KH5J, VK9LG, KH6IAA, NI6E/KH6, KH6SB, JAs. 17/4: T20AA. 24/4: ZK2KK, VK8GB, VK8HA, 3D2CM, XE1GRR. 26/4: 3D2PO, T32B. 27/4: V31PC, ZL7TZ. 28/4: 3D2PO. 30/4: 5W1KT, JAs. 1/5: 3D2PO, V31PC, FO5DR, F4NK. 3/5: JAs.

Most stations were worked during the morning local time and with a mixture of CW and SSB.

John VK4ZJB reports that on 24/4 between 0005 and 0045 CEODFL (Marco) on Easter Island was worked by VK4s, ZAA, ZJB, ZNC, APG, BRG and others. On 26/4 T32B was worked in Brisbane at 2301. Later FO4NK.

VK3s were reported working W9XE plus PJ, FO and YU.

Graham VK6RO reports he heard T32B (Christmas Is Pacific) on 28/4 at 0013 at 519; on 29/4 he worked ZS6XL (South Africa) at 0705 with signals 529. Also he heard V51E from Namibia at 0717. V51E was running his keyer at the time while attending church and returned after the opening.

DE VK5LP
ar

ANTENNAS & ACCESSORIES

We manufacture a comprehensive range of HF, VHF and UHF antennas, baluns, power dividers etc to suit your application. Three of our log periodics provide continuous coverage from 13-30 MHz including WARC frequencies, and replace outdated tri-banders. Now in use in 24 overseas countries and 6 continents.

- CREATE ROTATORS, COAX CABLES & NON-CONDUCTING GUY HALYARD MATERIALS
- COMPLETE RANGE MIRAGE (USA) 5-YR WARRANTY 6M, 2M, 70CM AMPS & WATT SWR METERS
- HARD-DRAWN ANTENNA WIRE
- AUST/NZ DISTRIBUTOR FOR CREATE ANTENNAS/ROTATORS & PHYLSTRAN (KEVLAR) NON-CONDUCTING GUYING

- MATERIALS
- HIGH GAIN VHF & UHF AMATEUR, SCANNING & TV ANTENNAS
- BUTT SECTION TRIANGULAR ALUMIN IUM TOWERS FOR FIXED OR TILT-OVER APPLICATIONS (REFER MARCH/APRIL 1987 AR)
- SELECTION OF POWER CHIPS AT FRIENDLY PRICES
- VSWR/PWR METERS TO 1300MHZ

Write or phone for free catalogue

ATN ANTENNAS

56 Campbell Street
Birchip Vic 3483
Phone: (054) 92 2224
Fax: (054) 92 2666

POUNDING BRASS

GILBERT GRIFFITH VK3CQ
7 CHURCH ST BRIGHT 3741

Learning Morse Code .. are we flogging a dead horse?

No! How could a Morsiac like me advocate dropping the code tests for HF? But I bet you thought that's what I meant, and I have given the subject a lot of thought over the past couple of years.

What I really am getting at is the diversity of methods of learning the code, and the way that everyone reckons "their" way is the best, or even that we must simply give it a try — which is a bit difficult when one already knows the code.

You probably already know of computer programs you can learn from; you may know someone who is "into" the psychology of learning Morse code; maybe you believe that one has to receive before one sends, or like to keep a balance. Which characters should be learned first, and what about the punctuation and figures?

Everybody seems to have their own pet theory and, probably, they are all *right!*

In all the writings and stories sent to me over the past few years, I am most impressed by those who learned Morse code in the Forces and carried their training through to their amateur career. Their superiors surely must have studied the problems involved in teaching in a hurry and then applied them. Many of the letters I receive are from just those teachers and students themselves, and funnily enough they never complain about difficulty, and simply remark that they passed their 18wpm test after three weeks' training, or whatever. I am usually surprised at the short time taken!

My own preference is to use a cassette and the broadcasts, mainly because that's the way I learned. But I *did* want to learn, and I spent many hours a week (something like 30) for a number of weeks diligently writing characters, and sending pages of text to myself. Whatever the system, the *only* ingredient that is common to *all* systems is *effort*.

We have, in most cases, been forced to make the effort, in order to achieve our goal of a ham ticket (see note). And, do you think you or anyone else will make that effort if it is no longer required?

So, what are we to do? Do we let the lazy ones dictate the abolition of Morse code? Or should we stop moaning about their efforts and each of us make our own individual efforts to keep it. Let us emphasise the good things about achieving code proficiency, and continue to introduce as many newcomers as possible. Compared with learning the theory of radio and the regulations, the code is simple. At least it looks that way to me and, once learned, it is harder to forget than either the theory or the regulations.

Try keeping a few copies of Morse teaching tapes handy in case you get an enquiry, then give a copy to anyone else who is interested. It works!

Short Record

A nondescript nonentity, a limb of the Oppressed,
I wear no badges on my arm, no medals on my chest;
But though my past is colourless, my future dim and bleak,
I cherish a distinction which is probably unique.

Of all the mass of traffic through the tortured ether hurled,

By all the busy tells of all the navies of the world,

No Morse of mine impinged upon a fellow-speaker's ear,

I never sent a signal in the whole of my career.

I used to wonder meekly when "Control" would let me in,

To add my little quota to the universal din;
Then realised my destiny, surrendered to my fate,

Eternally to sit and serve by being told to wait.

But once, and only once, I found my baser self self constrained,

To break the wireless silence I so rigidly maintained;

My weary watch was over, my relief was overdue,

I gently, briefly pressed the key to see what it would do.

I often sit and wonder where that blameless dot has gone,

If still through endless time and space it hurries bravely on;

Disowned by its creator and dismissed the parenthesis,

Unauthorised, attenuated, lonely little pip.

But though beyond our universe its travels may extend,

It still will bear my fingerprints on reaching journey's end;

And beings in some unknown world may trace it back to me,

As surely as the flagship did in 1933.

by "unknown"?

Note for this month: Everyone knows what a ham is. Why do many Australians dislike the name "ham"?

AMSAT AUSTRALIA

MAURIE HOOPER VK5EA
11 RICHLAND ROAD NEWTON SA 5074

National Co-ordinator
Graham Ratcliff VK5AGR

Information Nets
AMSAT Australia

Control:	VK5AGR
Amateur check in:	0945 UTC Sunday
Bulletin commences:	1000 UTC
Primary frequency:	3.685 MHz
Secondary frequency:	7.064 MHz

AMSAT SW Pacific
2200 UTC Saturday, 14.282 MHz

Participating stations and listeners are

able to obtain basic orbital data including Keplerian elements from the AMSAT Australia net. This information is also included on some WIA Divisional broadcasts.

AMSAT Australia newsletter and computer software

The excellent AMSAT Australia newsletter is published monthly by Graham VK5AGR on behalf of AMSAT Australia and now has over 270 subscribers.

Should you also wish to subscribe, send a cheque for \$20, payable to AMSAT Australia,

addressed as follows: AMSAT Australia, GPO Box 2141, Adelaide 5001.

The newsletter provides the latest news items on all satellite activities and is a "must" for all those seriously interested in amateur satellites. Graham also provides a software service in respect to general satellite programs made available to him from various sources. To make use of this service, send Graham a blank formatted disk and a nominal donation of \$10 per item to AMSAT Australia, together with sufficient funds to cover return postage. To obtain details of the programs available and other AMSAT Australia services, send a SASE to Graham.

Dove status report

(AMSAT news service bulletin 118.01 from AMSAT HQ, April 28, 1990)

On the AMSAT-NA Operations Net of 22 April 1990, Microsat command engineer Bob

McGwier, N4HY gave a brief rundown on the current status of the BRAMSAT Project DOVE satellite. After a DOVE CPU crash in March, the primary transmitter (on 145.825 mHz) was locked on in a condition where no data was being transmitted. Routine commanding of the spacecraft was impossible. Eventually, with the help of the moonbounce array at W5UN and fortuitous circumstances, the CPU was reset and control was regained. On the following day, the two-metre transmitter was turned off and the experimental S-band transmitter was activated as the only downlink during an interim recovery period.

A decision was made not to resume any DOVE operation on two metres until a new software load could be accomplished. This meant that return packets from the Microsat Boot Loader (running in on-board ROM) would have to be recovered from the S-band transmissions. DOVE's owner, BRAMSAT President Dr Junior DeCastro, PY2BJO, provided N4HY with an S-band receive converter and antenna system to be used in the recovery effort. When this equipment was installed at N4HY, Bob was able to verify what other S-band receiving stations around the world (including ON6UG, KORZ and KF4AU) had already discovered, that the phase shift keying modulation index on the transmitter was much lower than expected. Simply put, the binary data does not shift the S-band carrier a full plus and minus 180 degrees as it had been designed to. Listening on a sideband receiver, the signal sounds like mostly carrier with data only at a low volume. Additionally, data being sent via this transmitter is from the MBL which transmits incomplete telemetry packets, and those only infrequently. Command stations have experience with this data format, but it cannot be decoded directly by regular TNCs so it is difficult for other operators to participate in data collection through they may have S-band gear.

Since the reset, it has been determined that DOVE is in a safe and stable condition running the MBL firmware. N4HY has developed a DSP-based technique to decode with some certainty the undermodulated packets returned on DOVE S band during software uploads. He expects to be able to load and verify a new operating system on DOVE with some difficulty and then resume two-metre transmissions. A full recovery is expected.

During the time required to get the S-band receive gear and demodulation techniques developed, work has been proceeding on the first, rudimentary PBBS systems for LUSAT and PACSAT. After these systems are installed and in use, full attention will be concentrated on the DOVE recovery.

AMSAT-NA and BRAMSAT recognize the popularity of DOVE and regret the inconvenience that these startup delays have caused to educators and other amateurs worldwide who are anxious to see DOVE begin its operational mission. It is, of course, imperative that all

NASA 2-line Keplerian Elements

```

AO-10
1 14129U 83 58 B 90 84.27862046 -.00000064 00000-0 0000000 0 4622
2 14129 25.9479 212.4769 5985025 129.1636 301.2066 2.05882684 50981
UO-11
1 14781U 84 21 B 90 99.59599845 .00001872 00000-0 35652-3 0 6525
2 14781 97.9554 154.3796 0013847 103.2959 256.9785 14.65141902325925
MIR
1 16609U 86 17 A 90 99.55795904 .00027804 00000-0 31768-3 0 5237
2 16609 51.6177 316.2517 0012925 12.3047 347.8333 15.61861985237386
RS-10/11
1 18129U 87 54 A 90 99.91159827 .00000115 00000-0 11540-3 0 941
2 18129 82.9305 18.9669 0010881 315.0282 45.0035 13.72076337140087
AO-13
1 19216U 88 51 B 90 98.16789877 -.00000112 00000-0 99999-4 0 849
2 19216 57.0155 160.8093 6926959 224.6613 52.5253 2.09702913 13909
UO-14
1 20437U 90 5 B 90 98.69799047 .00000333 00000-0 14884-3 0 478
2 20437 98.6991 175.0011 0011957 1.9596 358.1640 14.28547955 10949
UO-15
1 20438U 90 5 C 90 94.22658296 .00000672 00000-0 28542-3 0 386
2 20438 98.7043 170.5385 0010972 16.8573 343.2924 14.28317844 10301
AO-16
1 20439U 90 5 D 90 97.71241468 .00000788 00000-0 32935-3 0 382
2 20439 98.7109 174.0751 0012372 4.5554 355.5683 14.28654650 10802
DO-17
1 20440U 90 5 E 90 97.71059459 .00000838 00000-0 34893-3 0 315
2 20440 98.7110 174.0777 0012473 4.5127 355.6104 14.28693461 10804
WO-18
1 20441U 90 5 F 90 99.24533202 .00000467 00000-0 20139-3 0 281
2 20441 98.7042 175.6130 0012728 1.5364 358.5853 14.28798124 11022
LO-19
1 20442U 90 5 G 90 98.12125844 .00000777 00000-0 32352-3 0 348
2 20442 98.7064 174.4989 0013204 3.7794 356.3462 14.28868160 10868
FO-20
1 20480U 90 13 C 90100.01933386 .00000074 00000-0 21628-3 0 219
2 20480 99.0470 159.3790 0540761 202.8727 154.7429 12.83125060 8008

```

OSCAR-13 SCHEDULE Station: Adelaide Hour - UTC

	0	1	2	3	4	5	6	7	8	9	10	11	12	13	14	15	16	17	18	19	20	21	22	23	
01Jun90																									bbb
02Jun90														bbbbb											bb
03Jun90														bbbbb										bbb	
04Jun90														bbbbb											bb
05Jun90														bbbbb											b
06Jun90														bbbbb											bb
07Jun90														bbbbb											bb
08Jun90														bbbbb											bb
09Jun90														bbbbb											bb
10Jun90														bbbbb											b
11Jun90														bbbbb											bb
12Jun90														bbbbb											bb
13Jun90														bbbbb											bb
14Jun90														bbbbb											bb
15Jun90														bbbbb											bb
16Jun90														bbbbb											b
17Jun90														bbbbb											bb
18Jun90														bbbbb											bb
19Jun90														bbbbb											bb
20Jun90														bbbbb											bb
21Jun90														bbbbb											bb
22Jun90														bbbbb											bb
23Jun90														bbbbb											bb
24Jun90														bbbbb											bb
25Jun90														bbbbb											bb
26Jun90														bbbbb											bb
27Jun90														bbbbb											bb
28Jun90														bbbbb											bb
29Jun90														bbbbb											bb
30Jun90														bbbbb											bb
01Jul90														bbbbb											bb
02Jul90														bbbbb											bb
03Jul90														bbbbb											bb

Schedule until 5 July 1990:
Mode-B : MA 000 to 100
Mode-JL : MA 100 to 125
Mode-LS : MA 125 to 130
Mode-S : MA 130 to 135
Mode-BS : MA 135 to 140
Mode-B : MA 140 to 256
Omnis : MA 220 to 040

facets of spacecraft checkout and operation, including this first crash recovery, be done thoroughly and with the utmost care.

Project Oscar meeting report

(AMSAT news service bulletin 118.02 from AMSAT HQ, April 28, 1990)

Future plans made during project OSCAR meeting

Project OSCAR's Executive Committee met on April 22 and has set forth on a number of new projects. Among the items covered was renewed interest to again produce the Project OSCAR Orbital Prediction Calendar Book. The purpose of the orbital prediction book is to provide simple and inexpensive tracking information to anyone interested in the low-orbiting satellites such as Microsat, UoSAT, Fuji and the Radio Sputnik series of amateur satellites.

It was determined that Project OSCAR members would like to participate in future satellite projects. Therefore, the Executive Committee will be submitting thoughts to the group meeting in Marburg, West Germany in May, discussing ideas on a Phase IIID satellite. Project OSCAR will look to develop a Mode S receive system from available (and cost effective) modules now on the market. Project OSCAR members will complete this project and write up a description of the system for publication in the amateur radio media so that anyone interested in Mode S will be able to make the move into this new area of OSCAR communication.

Finally, in response to many who have asked for information, Project OSCAR will sponsor a seminar about operating on all of the available amateur radio satellites. This seminar will take place on September 29 and 30 on the San Francisco Peninsula. In addition to a full schedule of talks aimed at the beginning and advanced satellite user, there will be demonstrations available, plus published papers provided to all in attendance. Complete details of this OSCAR seminar, along with names of the speakers scheduled to speak, will appear in the AMSAT bulletins, on Packet and phone BBS, and the usual amateur radio media.

Microsat checkout continues

(AMSAT news service bulletin 104.01 from AMSAT HQ, April 14, 1990)

Engineering team testing new software to gain operating efficiencies.

The AMSAT Satellite Factory continues to make progress in characterising the Microsats and they move closer to full commissioning. Over the past few weeks Bob McGwier, N4HY and Harold Price, NK6K, have been working on new data formats for Whole Orbit Data (WOD) dumps. These new formats present data in binary form, saving about 10,000

bytes of code in the operating system. This latest software load allows the operating system to run faster. In the WOD collection environment, every 10 seconds the on-board house-keeping computer samples several channels and continues this throughout an entire orbit. Once data for a number of orbits have been stored in on-board memory, Bob and Harold can command the microsats to downlink the information stored.

Using this technique, they have determined that AO-16 has achieved magnetic lock (with the earth). This results in the +Z surface pointing toward the earth when over the south pole and away from the earth when over the north pole. They feel that there is still some residual wobble but, for the most part, the satellite has stabilised.

As Bob and Harold continue to test this software, the digipeating function of AO-16 will be disabled. To determine if the digipeater is active, check the LSTAT telemetry line. If you see "d:0" this means the digipeater is off, "d:1" means the digipeater is on. Telemetry normally comes down once every 10 seconds. When a packet is digipeated, the time interval switches to 30 seconds.

If telemetry is coming down each 10 seconds, look at the LSTAT line. If d=0, DON'T TRANSMIT. If you see other digipeat activity, the digipeater is on, and it is OK to transmit. You must specify the spacecraft call sign as a digipeater to get digipeated, eg, PACSAT-1. This is because there are multiple spacecraft on various uplink frequencies.

Radio M1/RUDAK-2 Data Sheet update/correction

RADIO-M1/RUDAK-2 Data Sheet

AMSAT-DL/AMSAT-U joint project
AMSAT-DL Journal March 1990
(Updated document 17 April 1990)

RUDAK II (2nd generation) is part of the Russian amateur radio transponder "RADIO-M1". "M" refers to Molodechno, White Russia, USSR. RUDAK is the German abbreviation for Regenerative Transponder for Digital Amateur Radio Communications. The transponder is a joint project of AMSAT-U-ORBITA in Molodechno, the Adventure Club in Moscow and AMSAT-DL/RUDAK group in Marburg, Munich and Hanover.

Launch: June, 1990 from Plesetsk, USSR with PROTON rocket

Satellite: "Subtenant" to GEOS, a Russian geological research satellite

Orbit: Circular orbit at 1000 km altitude and 83 deg inclination.

Orbital period = 105 minutes

Amateur Radio Payload: Linear and regenerative transponders for analog and digital communications and telemetry beacons.

Linear Transponder 1:

Uplink: 435.102-435.022 MHz (80 kHz)

Downlink: 145.852-145.932 MHz (inverted)
Output power: 10 Watts maximum.

Beacon CW telemetry (8 parameters): 145.822 MHz 0.2 Watts

Beacon digital telemetry (30 parameters) 1100 bps PSK

R+Scrambler 2 kHz deviation: 145.952 MHz 0.4 Watts

Regenerative Transponder RUDAK-2:

Two on-board computers with IPS operating system for packet radio (AX.25) (Mailbox, telecommunications experiment with digital signal processing up to nearly 20 kHz, etc). 1 mByte RAM disk. four separate uplink channels.

Gain of satellite RX and TX antennas: 2.3 dBi each (dipoles)

Input sensitivity: < -125 dBm (435 MHz) for a C/N of 45 dBHz

UPLINK:

SAT-RX-1: 435.016 MHz +10 kHz 1200 bps, FSK, NRZIC/Biphase-M (JAS, PACSAT)

SAT-RX-2: 435.155 MHz +10 kHz (AFC) 2400 bps, BPSK, Biphase-S

SAT-RX-3a: 435.193 MHz +10 kHz (AFC) 4800 bps, RSM, NRZIC/Biphase-M

SAT-RX-3b: 435.193 MHz +10 kHz (AFC) 9600 bps, RSM, NRZI (NRZ-S) + Scrambler

SAT-RX-4: 435.041 MHz +10 kHz (digital AFC) RX for RTX-DSP experiments

Output signals of RX-4 are the In-phase and quadrature components, I(t) and Q(t), which are sent to the DSP RTX immediately after analog/digital conversion with eight-bit resolution. This supports various modulation modes depending on the software. All other receivers provide data (D) and clock (C) at their outputs.

DOWNLINK:

The downlink can be switched to the following operating modes:

Transmit frequency: 145.983 MHz
Output power: 2 Watts nominal (10 Watts maximum)

Mode 1: 1200 bps, BPSK, NRZI (NRZ-S) (like FO-20)

Mode 2: 400 bps, BPSK, Biphase-S (AMSAT mode for OSCAR-13 beacon)

Mode 3: 2400 bps, BPSK, Biphase-S (planned for OSCAR-13)

Mode 4: 4800 bps, RSM, NRZIC (Biphase-M) (like 4800 bps uplink)

Mode 5: 9600 bps, RSM, NRZI (NRZ-S) + Scrambler (like 9600 bps uplink)

Mode 6: CW keying (only for special events)

Mode 7: FSK (F1 or F2B), e.g. RTTY, SSTV, FAX etc (only for special events)

Mode 8: FM modulated by D/A signals from DSP-RISC processor (e.g. speech)

Power consumption: 14V @ 350 mA (max) = 4.9 W; Standby: 80 mA (RUDAK without power amplifier)

Mass: 6.2 kg
 Dimensions: 230 x 320 x 120 mm
Linear Transponder 2:
 Uplink: 435.123-435.043 MHz (80 kHz)
 Downlink: 145.866-145.946 MHz
 Output power: 10 Watts maximum
 Beacon CW telemetry (8 parameters) 145.948 MHz 0.2 Watts

Beacon digital telemetry (30 parameters) 1100 bps PSK
 R+Scrambler 2 kHz deviation 145.838 MHz
 0.4 Watts
 Beacon digital telemetry (30 parameters) 1100 bps PSK
 R+Scrambler 2 kHz deviation 145.800 MHz
 2 Watts

Total power consumption: 40 Watts (maximum)
 Total mass: 22 kg
 Total dimensions: 480 x 400 x 300 mm
 73s de Peter DB2OS
 PS: 1100 bps PSK TLM on the analog transponder is a new feature and it seems to be NOT a typing error, but I will check that.
73S FROM MAURIE VK5EA

FTAC NEWS

JOHN MARTIN VK3ZJC
 3 VERNAL AVE MITCHAM 3132

ATV REPEATERS — VK4/5

Output	Input	Call	Site	Service Area	Status
579.250	426.250	VK4RTV	Spring Hill	Brisbane	0
579.250	426.250	VK4RAT	Mt Stuart	Townsville	0
444.250	426.250	VK5RON	Barunga Ra	Clare Valley	0
579.250	426.250	VK5RTV	O'Halloran Hill	Adelaide	0

Data Base

The beacon and repeater Data Base update is nearly complete. VK2, 3 and 6 have supplied information for the update, and it is not too late for other states to provide additions or corrections.

Three More 5760 MHz Records

Following the new national 5760 MHz

record of 176.4 km - set last year by VK5NT and VK5ZO - Steve Hutcheon VK4ZSH has been travelling the country setting new state records on this band. They are: VK1 record (14.7 km) with Ed Penikis VK1VP; VK2 record (144.3 km) with Warren Bates VK4ZBW; VK4 record (173.4 km) again with VK4ZBW. Steve also visited Melbourne recently and made a 5760 MHz contact with Les Jenkins VK3ZBJ, which will no doubt result in an-

other record claim. Congratulations to all concerned.

Feedback

There has been little response to the proposals on the 50 MHz beacon segment, the 6 metre repeater and packet radio channels, and the 2 metre packet radio segment. These proposals will be put to Federal Executive in the near future, so if you have any comments or suggestions please write before the decisions are made!

Band Plan Proposals

Comments are requested on a proposal to restore a 7 MHz wide ATV channel at 1285 - 1292 MHz. This would involve shifting the digital and voice simplex segments of the 23 cm band to 1283 - 1285 MHz. At 25 KHz channel spacing, this would provide 40 voice and 40 digital simplex channels. Repeater channel allocations would not be affected. Proposed new band plans for 13 cm and above will be published soon.

ar

SPOTLIGHT ON SWLing

ROBIN L HARWOOD VK7RH
 52 CONNAUGHT CRES WEST LAUNCESTON 7250

In April, Radio Prague terminated its external broadcasting, following the "Revolution" in November of last year. The new, non-communist government closed down the external wing of Radio Prague because of its past associations with the previous regime. The idea is that they would be vetting staff at Radio Prague to see where they now lie politically, before allowing them back to the microphone. The only shortwave program emanating from Prague at present is the Inter program, which is aired in English, Czech, French, Russian and German. It can be heard on 9505 or 7345 kHz from 0600 UTC and is primarily aimed for European tourists. The "Inter" program was prepared in Radio Prague, yet by different personnel from that of other sections of Radio Prague.

As I mentioned in last month's column, the Lithuanian crisis could be very interesting, as it has been. Oddly enough, The World Service of Radio Moscow appears to be giving the most comprehensive coverage of what has been happening, both in Moscow and in Lithu-

ania itself. I do know that the BBC Monitoring Service in Caversham Park, near Reading, is keeping a close ear to transmissions coming from Vilnius, the Lithuanian capital plus other Baltic broadcasters.

I have just been notified by Bill Martin, VK2COP, the IARUMS Region 3 co-ordinator, that there have been significant alterations to the special spectrum survey over the next 12 months. Previously, the range between 7100 and 7300 kHz and 14250 and 14350 kHz was to be scanned for all non-amateur transmissions. But the IARU Monitoring Service has now decided to scan between 6765 and 7000 kHz and delete 7100 to 7300 kHz and 14250 to 14350 kHz. This has made it a little easier to concentrate on the rest of the spectrum under study, although I personally found the 7.1 to 7.3 kHz section interesting from a monitoring perspective. Although, over April, I was unable to fulfil my allotted quota of monitoring activities, due to other pressing commitments. This will be rectified in the coming months.

I am also finding the 22-metre broadcasting allocation very interesting, as more international stations are increasingly using it. As mentioned recently, Radio Australia commenced using it in March, as did the BBC World Service. Personally I find that 13 MHz is more consistent than 15 or 11 MHz here in Northern Tasmania. I was somewhat disappointed with the lack of response from international broadcasters to the 11-metre broadcasting allocation of 25600 to 26100 kHz. Only a handful of stations bothered to utilize it, and I would not be surprised if this allocation is deleted after WARC 1992. At the peak of previous sunspot cycles, I can recall excellent propagation and signal levels on this band.

Yet another international broadcaster has severely curtailed its broadcasting output. Radio RSA in Johannesburg, South Africa is to cease broadcasting to non-African target areas from May 1. Budgetary reasons have been cited as the reason. Personally I would have expected an increase in RSA's output, because of ongoing developments within that nation at present.

Well, that is all for June. Already half of 1990 has gone. I'm convinced that the years seem to be going more quickly as one gets older. Anyhow, good listening and 73 DE VK7RH.

INTRUDER WATCH

GORDON LOVEDAY VK4KAL FEDERAL INTRUDER WATCH CO-ORDINATOR
'AVIEMORE' RUBYVALE 4702

Intruder Watch Information

Why does the Intruder Watch need so many reports of Intruders observed in the Amateur bands? The authorities need to be convinced that Intruders are causing harmful interference to the Amateur service, and the occasional report is not going to impress them. Many reports on THE SAME INTRUDERS are needed to let the authorities know that we want some action taken to have them removed from the Amateur bands.

Where do you obtain Observers' Log Sheets? — From your Divisional Intruder Watch Co-ordinator.

Who is he? — Check with your Divisional Council, or look under 'Intruder Watch' in the Call-book.

Where do you send your completed Observers' Log Sheet? — Back to your Divisional Intruder Watch Co-ordinator.

Where does he send it? — To the Federal Intruder Watch Co-ordinator.

What does the Federal Intruder Watch Co-ordinator do with it? — He compiles a monthly summary, and keeps records of all the Intruders reported.

What happens to the summary? — One copy is sent to the IARU Region 3 Intruder Watch Co-ordinator in New Zealand, one copy goes to the Department of Communications in Melbourne, and one copy is retained by the Federal Co-ordinator for record purposes.

What does the IARU Region 3 Co-ordinator do with the summary? — He combines it with the summaries from other IARU Region 3 summaries, and a copy is sent to Intruder Watch HQ in the UK, where it ends up as a world summary, and the number and details of Intruders can then be compared.

Ultimate complaints can ONLY be directed to an offending administration's Intruders by the Administration of the complainant country at this stage. However, this could be changed in the near future and, hopefully, this will be a more effective way of registering complaints.

So then, it should be obvious that the Intruder Watch needs great numbers of complaints in the form of observers' reports, and the most effective manner is to have the most common and regular Intruders reported EACH MONTH, so that a legitimate case can be built up against them.

An Intruder DOES NOT, insofar as the Intruder Watch is concerned, include 'pirate' stations, or those using foul or abusive language. These should be reported directly to the DOC. The Intruders we speak of in the Intruder Watch are those transmissions

emanating from governmental, commercial or military sources. These sources are all to be heard on the HF bands. Possibly the most prevalent mode of emission used by the Intruders is that of radio-teletype (RTTY). These can be difficult to identify, but more about that later.

The submission of a written objection against Intruder stations is simply a matter of filling in an Observer's Log Sheet (OLS) and forwarding it to your Divisional Intruder Watch Co-ordinator, ideally to reach him by the end of the month. It is essential that you nominate the type of receiver(s) and antenna(s) used and, if you can, please give bearings. If you suffer harmful interference from the Intruder, say soon the sheet. This is good evidence. Please state ALL times in UTC. These sheets are obtainable from the Federal Intruder Watch Co-ordinator, or from your Divisional Office.

Intruder Modes of Emission

New designations of modes of emission came into force at the start of 1982. Here we show comparisons of the old and new designations of the more common modes.

old designation:	new:
A0	NON
A1	A1A (Aural)
A2	A2A (Aural)
A3	A3E
A3H	H3E
A3A	R3E
A3J	J3E
A3B	B8E
A4	A3C
A4A	R3C
A5C	C3F (TV)
A7A	R7B
A9B	B9W
F6	F7B
F1	F1B (RTTY)
PO (Woodpecker OHR)	PON

Some further information on modes:

Mode A1A (CW)

Intruder stations using CW are mostly using code-groups. Don't worry if the message doesn't make much sense. Just satisfy yourself that it is in fact an Intruder, but DO listen for an identifying call-sign. An example is on 21115 kHz at 0600, 0800 or 1000 hrs UTC.

Mode PON: The Infamous 'Woodpecker'

The best evidence in reporting this (and other Intruders) is to mention that the Intruder caused harmful interference to your

QSO with such-and-such a station. Quote any comments your contact may make regarding the Intruder, such as, "That woodpecker sure is strong tonight, I can hardly copy you." Measure how wide his transmission is.

Mode R7B: Amplitude-modulated, reduced-carrier, multi-channel, voice frequency telegraphy:

This one sounds for all the world like a big circular-saw, such as those found in a saw-mill. He is very common on the Amateur bands, and usually very strong. Average bandwidth around 7 kHz. Common on 20 metres.

Mode B9W: Phase-modulated pulse multi-channel transmission:

This one can sound like the R7b above, but the classical sound is that of a distant jet aero engine. Usually accompanied by two (or one) guard carriers, about 3 kHz apart. If you can't hear the carriers, it could well be an R7B signal you are hearing.

Mode A3E: AM Broadcasting:

This one is familiar to us all, and should need no explanation. Specific examples can be heard nightly on 7025, 7065 and 7095 kHz. Some of these are of obvious Asian origin, and can be heard very clearly. If you hear a carrier when you are on SSB mode, switch to AM, and often an AM broadcast station Intruder will become apparent.

Mode F1: Radio-teletype and F1 Morse:

Probably the most prevalent mode employed by Intruder stations, and a real problem on the Amateur HF bands. If you have the RTTY equipment, try for some hard copy. If not, log him as usual, and try to establish the shift of his transmission.

Wind up to the high-frequency side of the signal and zero-beat. Slowly tune down to the low side of his signal and you will hear the second frequency creep in. The difference between the two frequencies is the shift of operation, and the point midway between the two IS THE FREQUENCY OF TRANSMISSION. Common Intruder shifts employed are 250, 500, 1000 and 2000 Hz.

The usual shift employed by AMATEURS is that of 170 Hz, and Amateurs can only use shifts of up to 850 Hz.

Be sure that you are in fact monitoring a RTTY transmission. Amateur slow-scan television has a certain similarity, and also AMTOR (Amateur Microprocessor Teleprinter Over Radio) in one mode sounds like very fast RTTY. A blank C90 cassette tape sent to the Federal Intruder Watch Co-ordinator will be returned to the inquirer with all these before-mentioned modes of emission demonstrated.

RTTY transmissions come in many shapes and forms. Some of the examples appear below:

REVERSALS: Reversals, which are used for adjustment purposes or to test machines, are a series of fast dots.

BLANKS: Blanks are a series of dots for the mark, and a series of dashes for the space.

The machine is actually idling at this stage.

RYs: RYs is a series of dots at intervals, and is also used to test machines. They usually show a definite rhythm.

All these foregoing can be heard to advantage on the demonstration tape.

Don't be frightened to submit an Intruder report because you're unsure of the mode. Just describe it to the best of your ability.

Try to observe if any Intruders are coming up regularly. Some of them are as regular as clockwork, and these are the ones worth reporting.

The Intruder Watch is only as good as the help it gets from Amateurs who send in written objections to the presence of Intruders on the Amateur bands.

Please send any reports of Intruder stations to your Divisional Intruder Watch Co-ordinator, and help preserve the Amateur bands FOR Amateurs.

PLEASE HELP THE INTRUDER WATCH

Allocation of Frequency Spectrum for Purposes of the Intruder Watch

160 metres:

1800-1825 kHz —

Amateur Service is Primary Service. Exclusive to Amateur operators.

1825-1875 kHz —

Amateur Service is Secondary Service. Not exclusive to Amateur operators.

80 metres:

3500-3700 kHz and 3794-3800 kHz.

In International Amateur Radio Union, Region 3, the 80-metre band is shared with fixed Services. It is not exclusive to the Amateur service. RTTY and CW non-Amateur signals cannot be considered to be Intruders. But broadcast stations are Intruders.

40 metres:

7000-7100 kHz —

The Amateur service is the primary service, and this segment is exclusive to Amateur operators. Any non-amateur signals are those of Intruders.

7100-7300 kHz —

Is shared by international broadcasting stations ONLY. Any non-Amateur signal OTHER THAN broadcasters can be considered to be an Intruder. Non-Amateur RTTY and CW signals are Intruders.

30 metres:

10100-10150 kHz —

Shared with fixed stations. The Amateur service does not have exclusive use of these frequencies. Broadcast stations are Intruders.

20 metres:

14000-14250 kHz —

Amateur service is primary service. This segment is exclusive to the Amateur operators. Any non-amateur signals are those of Intruders.

14250-14350 kHz —

This segment is shared with Iran, the People's Republic of China and the USSR fixed services. It is NOT exclusive to the Amateur service. RTTY and CW signals which are non-Amateur cannot be considered to be Intruders. But broadcast stations are Intruders.

17 metres:

18068-18168 kHz —

The Amateur service shares this segment with fixed services. Non-Amateur RTTY and CW are not Intruders. But broadcasters are.

15 metres:

2100-21450 kHz —

The Amateur service is the primary service. This segment is exclusive to Amateur operators. Any non-Amateur signals are Intruders.

12 metres:

24890-24990 kHz —

This band is shared, and non-Amateur RTTY and CW signals are not Intruders. But broadcasters are.

10 metres:

28000-297000 kHz —

The Amateur service is the primary service. This segment is exclusive to Amateur operators. Any non-Amateur signals are Intruders.

Intruder Watch

Over the past 12 months I've had a good look at the Monitoring Service and its direction. I'm of the opinion it is too lax in its achievements. We have put into place one or two ideas suggested by DoTC to assist it in deciding which intruders it will target for possible removal (I wish them luck)... on the other hand, too much monitoring time has been wasted logging intruders that DoTC will have great difficulty in removing — because they are NOT of a commercial nature.

I refer to CB operators on the 28MHz band. Admittedly, they are a nuisance, but having ignored their country's regulations, they are most unlikely to take further notice of our government's directives. We can work over them, if we set about it. Those of us who can run the full power on these frequencies should be encouraged to do so. Our friends in the US very effectively remove these intruders with this method. I think a persistent signal alongside would eventually move them on — and if enough operators persist on 10m, we eventually would have the majority of the band unadulterated. The present sunspot cycle has a lot to do with the strength of these intruders.

It seems to me that possibly these CBers DO NOT KNOW HOW FAR THEIR SIGNALS RADIATE, and maybe we are causing untold distress to them — what a happy thought. However, DO NOT, UNDER ANY CIRCUMSTANCES, MOVE OFF FREQUENCY FOR AN INTRUDER.

ALARA

JOY COLLIS VK2EBX
PO BOX 22 YEOVAL 2868

The members of ALARA would like to express their concern for the victims of the recent widespread flooding in Queensland, New South Wales and Victoria. For anyone who has never experienced it, the total devastation is hard to imagine, and cleaning up and repairing will be a daunting task.

Intruder Watch. How can we Help?

Perhaps the prevalence of intruders on the amateur bands is something we do not pay enough attention to. The following comments from Bill Martin VK2COP point out how we

can assist:

"As the Monitoring System Co-ordinator for IARU Region 3, it occurred to me that the Monitoring System (Intruder Watch) doesn't hear from the ladies too often.

The system always needs the support of amateurs and SWLs in reporting transmissions from stations which should not be using our frequencies. We are concerned with transmissions from commercial, governmental and military stations. All these sources have their own allocated frequencies, so we should strongly object when they use ours.

Any intruder report takes the form of a log entry, including frequency, date (UTC), time

(UTC), mode of emission, bearing (if possible), call sign of unauthorised station (if obtained) and any comments.

These reports can be sent to me (Bill Martin VK2COP, 33 Somerville Road, Hornsby Heights NSW 2077) or to the Australian co-ordinator, Gordon Loveday VK4KAL, "Aviemore", Rubyvale, Queensland 4702.

This is an ongoing work, and must be maintained to try to keep the amateur bands free for amateur operation. The Monitoring System is always in need of reports on intruders.

Report forms can be obtained from VK4KAL.

Perhaps one or more of your members may be willing to spend the time to send in a report now and then."

Further information can be obtained from Bill VK2COP or Gordon VK4KAL, who would be most appreciative of any help we can give

them. So — the next time you hear an emission which appears suspect in any way, scribble down the details, and get a report off to Bill or Gordon. It is our own radio bands we are trying to save!

Alarameet 1990

The ALARA get-together is now only a few months away; most people have booked their accommodation, and our ALARAMEET co-ordinator (Maria VK5BMT) has an interesting program worked out. The previous two ALARA get-togethers in 1984, Mildura and 1987, Adelaide were very successful, and we are looking forward to an equally enjoyable time in Dubbo this year.

The 222 YL Net

Although Barry VK7GE can no longer act as controller of the YL net due to work commitments, the YLs are still very active on 14.222 on Mondays at 0600 UTC. Heather VK2HD "fills the bill" admirably on many occasions. Other controllers have been Dawn ZL2AGX, Bev VK6DE and Mavis VK3KS. Harry VK2BJL was rather surprised to find himself in that position one Monday afternoon. Our thanks for helping us out on that particular Monday, Harry.

In spite of what must be deliberate QRM at times from the few, the majority of OMs do all they can to "give us a go", assisting with DX information and keeping the frequency clear. Our thanks for their help and consideration.

Awards update

155	16.1.90	Iris Osborne	G0FIW	2stickers
156	24.1.90	Egbert Hertsen	ONL40003	All SSB
157	2.2.90	Aimee Tuband	FY4FC	4stickers

New members

A warm welcome to new members:

Dana N0FYQ, Jane VK4FVJ, Joanna G1UEQ, Marjorie VK2VME, Lyndell VK5KLO.

Congratulations on upgraded callsign to Margaret VK3END (formerly VK3MCZ).

73/33 Joy

Joy — Profile of a Correspondent

Joy was born in London and spent her childhood there, which included the years of World War II. She has many stories of her experiences of the bombing and of food rationing during those years.

She speaks highly of her father who had fought in WWI and was a member of the Home Guard in WWII. He worked in the developing section of a film company and was a 'grand and godly English gentleman'.

Her mother was ill for many years with Parkinson's disease and died when Joy was only 18.

About a year after her mother's death, in

Australian Ladies' Amateur Radio Association

List of Members as at 31st March 1990

VK2AMU Betty
 VK2BBM Beryl
 VK2DDB Dorothy
 VK2DJO Norma
 VK2EBX Joy
 VK2HD Heather
 VK2MI Joyce
 VK2NPG Nancy
 VK2PNG Margaret
 VK2PXS Bobbie
 VK2VCC Chris
 VK2VME Marjorie
 Jean Darling

VK3AEB Erika
 VK3AGO Lorrie
 VK3AYL Rae
 VK3BBL Bonnie
 VK3BIR Mavis
 VK3BJB Joan
 VK3BRE Mona
 VK3BTU Janet
 VK3BYK Barbara
 VK3CWA Margaret
 VK3CYL Kim
 VK3DML Margaret
 VK3DMS Marilyn
 VK3DVT Valda
 VK3DYF Bron
 VK3DYL Gwen
 VK3END Margaret
 VK3FML Marlene
 VK3JAW Marlene
 VK3JQ Liz
 VK3KS Mavis
 VK3MDR Jenny
 VK3PRV Patricia
 VK3PYL Phyl
 VK3UE Clarice
 VK3VAN Jessie
 VK3XBA Kathy
 VK3YL Austine
 Jean Truebridge
 Raedie Fowler
 Muriel May
 Jean Shaw

VK4BDH Dulcie
 VK4CPL Phyl
 VK4BZL Jeanette
 VK4JO Jo-Anne
 VK4IA Daphne
 VK4FVJ Jane
 VK4KCA Christine
 VK4MP Pat
 VK4MUM Ann
 VK4NAM Dorothy
 VK4NNJ Valarie
 VK4PT Pat
 VK4PZ Mary
 VK4QW Cecily
 VK4VG Josie
 VK4VR Val
 VK4YC Alma
 Bonnie Pounsett

VK5ANW Jenny
 VK5AOV Meg
 VK5BMT Maria
 VK5CTY Christine
 VK5KLO Lyndell
 VK5NEI Janet
 VK5YL Denise
 VK5ZYL Michele
 Pauline Koen
 Bev Tamblyn

VK6DE Bev
 VK6DJL Jan
 VK6JMP Joan
 VK6NKU Peggy
 VK6QM Margaret
 VK6YF Poppy
 VK6YL Gillian
 VK6ZLZ Christine
 Olive Couch
 JuneGreenaway
 Lynda Francis

VK7HD Helene
 VK7TN Grace

VK8MM Mina
 VK8NKN Maree
 VK8NXL Rae

VK9NL Kirsti

Overseas Members

CP5LE Barbara
 DJ1TE Christa
 DF2SL Anny
 DL3LG Sigrid
 DF3LX Heidi
 DK5TT Margot
 DJ6US Walli
 DL2HBM Marga
 FK8FA Aimee
 JA1AEQ Fumi
 JH1GMZ Akiyo
 JJ1CAS Hiromi
 J11VLV Nanako
 J36JQC Mizuyo
 JR5MVX Masayo
 K1IJV Jean
 WA1UVJ Karla
 W2GLB/7 Phyllis
 WB2YBA
 Christine
 KA3CEO Jeanne
 WA3HUP Mary
 Ann
 WB3CON
 Ruthanna
 WB3EFQ Lois
 WA4NRX Merilyn
 KA5ONE Betty
 KK5L Carol
 WD5FOX Darleen
 KA5WXE Karen
 K6INK Jerrie
 KA6V Joanie
 KA6NZK Eliza-
 beth
 KB6CLL Mary
 N6GGR Maxine
 N6GZW Claudia
 WA6OET Jessie
 N7KEL Jean
 KC7TE Daurel
 KD7RA Gerry
 KD7YB Joan
 KO7Q Shirlee
 WA7TLL Marion
 WB7SUQ Mary
 KB8RT Lee
 WD8MEV Shirley
 K9RXX Ann
 KA0SNF Cathy
 KA0VWP Allura
 N0FYO Dana
 G1UEQ Joanna
 G3HCQ Sheila
 G4EZI Diana
 G4KFP Jasmine
 G4KVR Cilla

G4VFC Dee
 FOCCI Angelika
 G0CTQ Audrey
 G0EIX Rita
 G0FIW Iris
 Jeanette Arter
 GM4LUX Shirley
 GM4UXX Anne
 GM6KAY Kay
 GW0ARP Jean
 IT9KXI Santina
 OH3ST Eeva
 PA3DST Paula
 PY2JY Inge
 SM5HYL Rozita
 SM0HNV Rajja
 VE6YW Hallie
 VE7YL Elizabeth
 VE7CBK Bobby
 VE7CIX Rae
 VE7DKC Margaret
 VE7LOH Muriel
 VR6YL Betty
 ZL1ALE Aola
 ZL1ALK Celia
 ZL1BBN Win
 ZL1BDZ Clarrie
 ZL1BIZ Elva
 ZL1BWQ Ethel
 ZL1BQW Christine
 ZL1CAV Phillipa
 ZL1OC Vicki
 ZL1TDB Margaret
 ZL2ADK Cathy
 ZL2AGX Dawn
 ZL2AWP Alma
 ZL2AZY Biny
 ZL2BHZ Jill
 ZL2BOA Marilyn
 ZL2BOD Jeanne
 ZL2BBOV Anne
 ZL2PQ Lynn
 ZL2QW Pauline
 ZL2QY Pearl
 ZL2TZG Gail
 ZL2UKG Gwen
 ZL2VQ Carol
 ZL2GW Val
 ZL3VR Anne
 ZL4IO Melva
 Kathy Armstrong
 ZS1YL Lee
 ZS5DC Diane
 ZS5V Mary
 ZS5YO Mimi
 ZS6GH Diana
 ZS6VC Pat

1950 Joy and her father emigrated to Australia. They started life here in Healesville, where Joy had a pen pal, but after about 18 months they set off on a motorbike and sidecar to see more of Australia.

One of their stops was in Griffith where Joy met Dan and where she was married in Au-

gust 1952.

The next 20 years were occupied with raising six children (three of each) in various parts of rural NSW and Victoria. Joy taught the children by correspondence to begin with, but eventually they were forced to move to Leeton, and later to Wellington, so they were

nearer schools.

Joy first got "hooked" on radio through CB when she had more time for herself as the children became more independent. Then, in 1978, Joy turned to amateur radio and studied first for her Novice and then for her AOCPL licence as VK2EBX. Her dedication to becoming an amateur can be judged by the fact that after doing the course by correspondence she had to travel 250 miles (400 km) to sit for each exam!! (The only female in the 40 applicants, what's more). Her previous call signs were VK2VJV and VK2KJC. Her son Will held the call sign VK2VJC before his death in 1986, so he was able to share Joy's interest, but though her husband, Dan, is interested, he has not yet found time for the study needed.

Joy is an active DX participant in amateur radio, particularly, but not only, in the field of ladies activities. She has many DX awards including the DXCC. She is an active member of ALARA and of WARO, YLRL, BYLARA and CLARA in sister countries. She is a regu-

lar member of several nets run by and for lady operators. Joy is now the ALARA publicity officer and correspondent for AR, offices she took over from Margaret VK3DML in 1985. She is also the VK2 representative on the ALARA committee.

Her interest in writing is not limited to amateur radio matters, as shown by several poems of hers that have been printed in AR and in various other magazines, worldwide. In 1983 she won the Bronze Swagman Award for bush poets in a competition run from Winton in Queensland.

As shown by the range of topics mentioned in the ALARA notes each month, Joy has an interest in many aspects of our hobby and can share that interest with others in well written prose.

Contributed by Joy's daughter, Janet, Doug Tamblin VK5PDT, Marilyn VK3DMS, Christine VK5CTY and Jenny VK5ANW.



Joy Collis VK2EBX

WARC 92 UPDATE

DAVID WARDLAW VK3ADW
WIA WARC-92 TEAM LEADER

The IARU launches WARC Countdown to aid WARC-92 preparations

A newsletter 'WARC Countdown' is being produced by the International Secretariat of the IARU at the directive of the IARU Administrative Council.

The first issue outlines the functions of WARCS and looks at the likely agenda for WARC-92. This subject has already been covered in 'Amateur Radio' April 1990:

"The IARU Administrative Council is planning to produce documentation of the value of amateur radio to the world community, including, but not necessarily limited to, the following areas:

- Amateur radio as a national resource
- Amateur radio as a vital component of community service
- The need for amateur radio in emergencies, both national and international
- The use of amateur radio as a basis for developing technology and conducting experimentation that will benefit all communications services."

Comments from members may turn up something that has been overlooked by others.

Also in 'WARC Countdown' is a section devoted to the importance of the CCIR which is of interest:

CCIR: Key to WARC Technical Preparation

The International Radio Consultative Committee, or CCIR, studies technical and operational characteristics of radio systems. Issues for study are identified as *Questions*. *Reports* are the documented results of investigations. The end product of the CCIR is an international standard, called a *Recommendation*. The main work of the CCIR is carried out by 11 study groups with responsibility for specific radio services of technical investigations, such as propagation and spectrum management. At meetings of the study groups, working groups are formed to consider input papers submitted by administrations or recognised international organisations. Interim working parties, or IWPs, may be formed within a study group, and joint interim working parties, or JIWPs, involve two or more study groups. These study groups conduct their regular work in four-year study periods, the one just concluded being 1986-1990. The output papers resulting from the 1986-1990 study period have been distributed to administrations and study group delegates, and eventually will be for sale to the public in the form of *Green Books* arranged by radio service and printed in several languages. When there is a need, the CCIR may depart from this schedule, such as to prepare technical reports for a WARC.

The Green Book technical documentation for the Amateur and Amateur-Satellite Services consists of Question 48 and Report N/8, both with the title of "Techniques and Frequency Usage in the Amateur and Amateur-

Satellite Services". Report N/8 has several appendices which detail technical characteristics, frequency usage, and operational and technical achievements of these services. The Green Book also contains Recommendations 476-4 (1986) and 625 (1986), which together define the technical standards for the error-correcting radioteletype mode used in the Maritime Mobile Service and known to amateurs as AMTOR.

Currently, nearly all study groups have IWPs, or are participating in JIWPs, doing preparatory work in anticipation of the WARC-92 agenda to be decided by the Administrative Council in June 1990. Several IWPs and JIWPs are presently scheduled to meet during July through October 1990. Three important meetings are: IWP 8/15 (October 8-19, Geneva, 0.5-3 GHz mobile and mobile-satellite frequencies, 12.7-23 GHz HDTV allocations, and new space services above 20 GHz); JIWP 10.3.6-8/1 (time and place to be announced, expansion of HF broadcasting allocations); and, JIWP WARC-92 (April 1991, place to be announced, overall preparation of the CCIR report to WARC-92)."

Since the last WARC-92 update there have been meetings of the Frequency, Technical and Regulatory committees. The WIA was represented at all these meetings. The main topic of concern being the scope of the agenda of WARC-92 which will be decided by the ITU Administrative Council which meets in June. Australia is a member of the ITU Administrative Council and will have a say in the formulation of the agenda for WARC-92.

Once the agenda is available, we will all be able to get down to more specific detail.

A number of our fellow amateur societies are very concerned about the possible effects of any expansion of HF broadcasting. As you know, this could affect the 7MHz band and will need to be watched very closely.

DIVISIONAL NOTES

FORWARD BIAS

PHIL CLARK VK1PC

We welcome two more members to the ACT division.

At the committee meeting held on 10th April, A L Cook VK1K1S and P J Weaver VK7ZPJ were accepted as members of the division.

Field Day

As mentioned last time, the divisional station for the John Moyle Memorial field day was established at the Kowen Forest fire tower site. Now the stories of that epic event are coming to light! Now the tales of individual and group heroism can be told! (Those that are printable, at least).

It was decided that the best way to get the TH6DXX beam up in the air was to use a 'cherry-picker', so one was duly borrowed (scrounged) for the weekend. It was set up on the hilltop. The beam and rotator were mounted and the cable attached to its 15-metre boom. The crowd gathered around as Chris went to start the motor. Unfortunately, the motor had decided that today was to be a 'rostered day off' and no work was to be performed. "Oh #%*.-!" (dear?) said Chris.

The group gathered around and stared with gloom at the maze of wires, buttons,

lights, hydraulic pipes and the defunct motor. There was no alternative but open-heart surgery. Sleeves were rolled up, cans of anaesthetic administered to the operating team and gallery, and the screwdrivers, pliers and tools laid out.

While the "operation" was being carried out, work went on getting the rest of the station together. Bruce, at great risk to personal beauty and fame, climbed the underside of the ladder up the fire tower to attach the rope for the dipoles.

"Look!" someone said, "There's Spiderman!"
"No it's not," said another voice, "it's Frog-man."

Meanwhile, the canvas "shacks" had been erected, the wire antennas strung and the equipment installed. The generators were positioned and fuelled ready to start. Bob considered canvas to be undignified, so he decided to operate the VHF and UHF from his ostentatious mobile home! He spent most of his time trying to find where to connect his shower outlet, and how to get the best view from the dining room window.

About this time, there was a mighty roar (well, a "put-put", anyway) and a cloud of blue smoke from the cherry-picker — surgery had been successful! A cheer went up as the beam headed skyward.

In spite of everything, VK1WI went "on the air" at 1430 on Saturday with 20 and 40

metres most active. There was a total of 1084 contacts on bands covering 80m, 40m, 20m, 15m, 10m, 2m and 70cm.

The station closed again at 1430 on Sunday, and guess what! The cherry-picker (with Ted's beam on top) refused to come down. Chris then addressed the machine with a few choice words about its ancestry and possible destination and, with some TLC, down it came, much to Ted's relief.

Paul VK2CJ did a great job of organising and co-ordinating the effort, and thanks are extended to him and all who helped or participated over the weekend.

Finally, special thanks to Ted VK1AOP, Chris VK1DO and John VK1ZX for the equipment that they lent for the operation, and the ACT Police for their support with the provision of generators for the station.

Technical Points

At the March monthly meeting of the division, Paul VK1BX, gave a very interesting talk on radio equipment installation in vehicles. The talk covered points such as alternator and ignition noise, its causes and possible cures, return current paths when the battery is charged and discharged and when the engine is started (or where NOT to connect your valuable set!), and compatibility with other electronic vehicle systems. He brought out some very interesting and educational points about alternators and the types of regulators and diodes used with them and some of the effects that can result, and showed some of the ways that noise can be introduced into antenna and microphone leads via current flowing in the screen.

On the subject of meetings, please tell us your ideas about what talks, speakers, films etc you would like. Let any committee member know and we will try to include your ideas as the subject for a presentation. Perhaps you have a subject that you would like to present yourself.

Mathematical Prefixes

For those with a mathematical mind, did you know that:

One piece of a phone smashed into a million pieces is a micro-phone? (1e-6).

That a million million (1e12) bulls is a terabull?

One tenth (1e-1) of your mate is deci-mate? or that 10 (1e1) cards are a deca-cards?

Well, now you do!

73 TILL NEXT TIME, PHIL.

VK2 NOTES

TIM MILLS VK2ZTM

Annual General Meeting

The 1990 AGM of the NSW Division was held at Amateur Radio House on Saturday afternoon, April 28th. Attendance was over 40. Merit certificates were awarded to Steve VK2PS and Alan VK2XAT for service to the



VK1WI team for the John Moyle Field Day. Back row L to R — Peter, Laurie, Paul VK2CJ, Ted VK1AOP, Lothar VK1KLS, Jim VK1JS, John VK1ZX. Front row L to R — Murray VK1ZMD, Chris VK1DO, Bob VK2YRX, Laurie VK1KLB. Mal VK1MC is missing from the photo.

Divisional Broadcasts.

The Returning Officer declared the following as the new Council for 1990/91: Reg Brook VK2AI, Glen English VK2JPR, Roger Henley VK2ZIG, Dave Horsfall VK2KUF, John Martin VK2EJM, Tim Mills VK2ZTM and Terry Ryeland VK2UX. The Returning Officer for 1990/91 is Peter O'Connell VK2EMU.

The Special Resolution to extend the number of Divisional Councillors from seven to nine, and to alter the timing for notification of the Annual General Meeting, was passed unanimously. The motions to abolish the conference of clubs and replace it with regional conferences were passed after much discussion. The motion to set associate membership fee at a discount to full membership was passed after much discussion.

Finally, there was general discussion from the floor on several topics. Following many recent changes to the Divisional Memorandum and Articles of Association, it is intended to publish an amended version of same. Stocks of the present articles (3rd edition) are low, and a general reprint will be undertaken during the coming year. The NSW WICEN co-ordinator, Steve, VK2DNN, spoke at length on the benefits of joining WICEN, with particular emphasis on personal insurance of those amateurs assisting in disaster recovery etc. There was some discussion on section 6(e) of DOC-71 and a clarification was sought. Amateur devolvement was discussed, and it was noted that over 300 on-the-spot fines were issued by DoTC in the past year, totalling over \$20,000.

After the AGM, the new council met to allocate major portfolios. These notes were prepared before the first general council meeting and the full listing of office bearers will be in next month's notes. President for this year will be Roger Henley, VK2ZIG.

Examinations

Last month (May) was when many groups, including the Division, conducted their first licence exams. Would all groups keep the Divisional office informed with their exam schedules. This, in turn, will enable the Division to direct enquiries.

Video Tape Library

New tapes have recently been added to the Division's video library at Parramatta. These may be borrowed by members and clubs. Format VHS, a Beta copy can be arranged on some titles. From last year's "Satellite Seminar" with Graham VK5AGR, three tapes (eight hours' running time). "How to Survive in a Dog Pile" by John VK2DEJ, on a single tape. "HF DX Seminar" with Iris and Lloyd Colvin, and "Making Friends on DX" by Syd VK2SG on another tape. From the Federal video library a tape on "Quartz Crystals" by Clem VK5GL and "Introducing Microwaves" by Des VK5ZO has also been added. The Division has

sent tapes of the locally produced material, as above, to the Federal Tape Library. Anybody requiring copies should check conditions and requirements detailed on page 31 of February 1990 'Amateur Radio'.

VK2WI — Dural

A separate transmission unit has been obtained and installed on our 30-metre broadcast frequency of 10125 kHz. Similar power to the previous transmitter, which has now been returned to 80-metre duty. The return of the winter months has enabled the starting up again of the morning 80-metre AM transmission. It is time to compile the roster July to September. If you can assist, contact Steve VK2KXX direct or via the office.

Oxley Region Field Day

The June holiday weekend 9/10th is the time for this annual event at Port Macquarie. Details have been on the broadcast. Contact with the club at PO Box 712, Port Macquarie, NSW 2444. (See details in Club Corner - Ed)

QSL Bureau

The VK2 Bureau, operated on behalf of the Division by the Westlakes ARC at Teralba, Newcastle, had a computer breakdown a couple of months ago, which slowed down card processing. It is hoped that the backlog has been cleared. A note on postage costs. Last January Australia Post changed a few rates, so you would be well advised to obtain a chart of charges from your local post office so you can watch both weight and thickness when sending your outwards cards.

Education

Positions vacant. Educational Liaison Officer, Terry VK2UX, advises that there are several positions vacant within the Divisional structure. Terry is now Federal Councillor and has a little less time. He requires an Education Officer, an Education Committee and a Correspondence Course Supervisor. Further details from the office.

ATV

A recent meeting of interested persons on future directions for Amateur Television within NSW resulted in an advisory committee with Peter VK2ABH as Chairman.

WICEN (NSW) Inc

A co-ordinators' conference was held at the end of April at the Central Coast VRA base at Wyong. Several co-ordinators were able to make it together with Leigh VK3TP from Vic WICEN. A detailed report in the next WICEN newsletter being sent out during this month. Recently, all WICEN members were posted an audio cassette on 'Voice Procedure' together with a multi-choice test paper. Copies of this tape may be obtained by other WICEN

groups. WICEN (NSW) Inc postal address is PO Box 123 St Leonards NSW 2065, or phone messages via the Division (02) 689 2417 or fax on (02)633 1525. A note to interstate groups that VK2 has stocks of WICEN cloth badges should they require same.

Forthcoming WICEN exercises include: Central Coast, St Albans horse ride June 24th, Upper Hunter, Scone 200 over July 4 to 6th Sydney, City to Surf Sunday 12th August.

Central West and Sydney sections were activated for 24 hours on April 24th to provide backup to police during the Nyngan flood evacuation. HF, linked VHF/UFH voice and packet nets were established.

The renewal of WICEN membership becomes due 1st July for the period to 30/6/91. Renewals and new memberships welcomed. The annual dues are \$5.00. By now, your local club should have some WICEN information, together with application forms, so perhaps enquire at your next meeting. Check with your local co-ordinator whether your groups collect due locally, and send a single cheque to the WICEN treasurer. It makes his job easier.

New Members

A warm welcome is extended to the following who became members of the VK2 Division during April.

AD Austin	VK2ADA	Woolgoolgah
A S Barr	VK2EGB	Campsie
P J Buckman	VK2FTJ	Boggabri
T J Eastley	VK2KVT	Kingswood
R J Dellosta	VK2NJD	Beacon Hill
G J French	VK2AJI	Narooma
K R Golden	VK2DGT	Coffs Harbour
J M Milson	VK2MBM	Ruse
DW Olley	3D2DW	Fiji
R E Patterson	VE1VAE	Canada
C W Perry	VK2EO	Lindfield
S J Pollard	Assoc	Granville
J J Rowe	VK2JJR	Cabramatta
M J Savins	VK2DMS	Toormina
G J Sully	Assoc	Richmond
K F Turk	VK2PKT	Lakemba
G Williams	Assoc	Epping

Your Membership Card

Did you remember to cut it from the back cover of the Annual Report???

5/8 WAVE

JENNIFER WARRINGTON VK5ANW

Now Let's Get This Right!

Just forget all the previous information I have given you about Buy and Sell nights and, after this, you will be as confused as I am! Council has had a re-think about the policy for Buy and Sell nights. From the April meeting (and I'm sorry, but the May copy had already



Peter Koen (State JOTA Co-ordinator) pictured with Don McDonald VK5ADD (the then VK5 President) at the VK5 Clubs Convention 1990.

gone in before the change-back) where there are five Tuesdays in the month, the fourth Tuesday will be a General Meeting night with a speaker, and the fifth Tuesday will again be a General Buy and Sell. When a Deceased Estate arises, it will be on a fourth Tuesday

instead of a Speaker. (And they say women change their minds!)

New Council Members for 1990

Well, there weren't any. Not only did we

not get enough volunteers to need an election, we didn't get enough to fill the vacancies left by retiring members. Those retiring, besides myself, were Alan Mallabone VK5NNM (due to work and family pressures) and Ben Broadbent VK5ABE (due to study and family commitments). Ben hopes to return in a couple of years and his talents will be put to good use when he does. Alan has made a considerable contribution during the past few years that he has been on Council, and many new members have been directly attributable to Alan. We thank them both for their contribution and hope to see both of them back again one of these days.

At the time of writing, only the following positions have been filled:

President Rowland Bruce VK5OU
 Secretary John McKellar VK5BJM
 Treasurer Bill Wardrop VK5AWM
 Past President Don McDonald VK5ADD
 WICEN Director Ian Watson VK5KIA

Other members to date are: Peter Maddern VK5PRM, Bob Allan VK5BJA and Hans Van Der Zalm VK5KHZ.

Finally, best of luck to the VK5 Foxhunters going to the SERG Convention this month. ar

CLUB CORNER

Bayside District Amateur Radio Society (VK4)

Bayside District Amateur Radio Society (Inc) meetings are held on the first Monday of each month at 1930 local time at Alexandra Hills High School library, followed by light refreshments.

Club call VK4BAR is heard on Monday at 2000 local time on the Mt Cotton repeater (147.675 MHz) and again Wednesday at 2000 local time one 28.300 MHz.

The society is also conducting amateur radio exams and beginners classes.

For further enquiries phone (07) 824 1518, Ian Campbell VK4TK.

The Society is presenting a display in the Albert Morris pavilion at the Redlands Show, Long St, Cleveland on 29th and 30th June, and 1st July 1990. Everyone is welcome to attend.

Oxley Region's Annual Field Days Weekend — Port Macquarie

It's on again for 1990! Port Macquarie, the nerve centre of the Oxley Region Amateur Radio Club, will see the annual gathering of amateurs from near and far on the Queen's Birthday weekend. The venue will be on the premises of the Tacking Point Surf Life Saving Club on Matthew Flinders Drive, Light-house Beach, Port Macquarie.

The two-day event begins with registration at 10.00am on Saturday 9th June 1990 and continues until Sunday 10th June. (Registra-

tion for Sunday's activities begins at 9.00am on Sunday for those who are attending on that day only).

There will be the usual comprehensive program of events which comprises a range of fox hunts, amateur-related contests, surplus gear sale booth, WIA bookstall, activities for the XYLs, YLs and family members.

Coffee, tea and bickies will be on tap, free! And an inexpensive hot-food smorgasbord will be a social highlight at 6.00pm on the Satur-

day evening. Snacks for other meals will be on sale at the venue at reasonable prices.

This notification missed the May issue due, unfortunately, to the injury and subsequent hospitalisation of our club's publicity officer, Lewis (VK2LS). Amateurs, their friends and interested non-amateurs who wish to have further information regarding this always-enjoyable event may direct enquiries to the secretary (Trevor, VK2TT, 065 85.2278), or the president (Allan, VK2ALI, 065. 83.3312). Written requests should be directed to The Secretary, ORARC, PO Box 712, Port Macquarie). ar

Morseword No 39

Solution on page 56

Across

- 1 Platform
- 2 Filch
- 3 Women's _____
- 4 Flame
- 5 Male deer
- 6 Holy man
- 7 Bantu Warriors
- 8 Moves
- 9 Scot's garment
- 10 Sight

Down

- 1 Joint
- 2 Skin
- 3 Small state!
- 4 Superhuman
- 5 Genuine
- 6 Blend
- 7 Cooker
- 8 Acts
- 9 Listen
- 10 Floats

	1	2	3	4	5	6	7	8	9	10
1										
2										
3										
4										
5										
6										
7										
8										
9										
10										

Audrey Ryan © 1990

QSLs FROM THE WIA COLLECTION (23)

KEN MATCHETT VK3TL HON CURATOR WIA QSL COLLECTION
PO Box 1 SEVILLE VIC 3139

Libya - North African Battleground

Because of its geographical position bordering the Mediterranean, Libya (or to give it its full name, The Libyan Arab Republic), has been the scene of battle for centuries. The name Libya was given by the early Greeks in those days to a large area of North Africa which included Egypt and even Ethiopia. Today the country has an area approximating to that of Queensland, and is bounded by Algeria and Tunisia to the west, Egypt to the east and three countries to its south namely, Niger, Tchad and Sudan.

The country originally had three provinces, two of which are associated with pre-WW 2 amateur radio. These are Tripolitania to the west and Cyrenaica to the east. The third province was Fezzan to the south.

Nearly 2500 years ago there were invasions by the Persians, followed by the Romans when Libya became a wealthy centre of Roman civilization. In later years, the Vandals, Arabs, Spaniards and Turks have all had a hand in its occupation. The modern history of Libya however, starts just before World War 1 when, in 1911, Italy declared war on the country but managed to retain it after the armistice. Even in relatively recent times, Libya has been the scene of battle, not the least memorable being the North African campaign of the early 1940s.

MD2AC

As can be seen from the QSL card, this originates from Tripoli (not to be confused with the city of the same name in Lebanon). Tripoli is both the main city and port of the western province of Tripolitania. In 1940 Italian forces under the command of Marshal Graziani had started their western march to the Egyptian border where they were opposed by the Western Desert Force (eventually to form the British Eighth Army). When in early 1941 Germany decided to come to the rescue

of its Italian ally, it was at the port of Tripoli in Libya that the German commander, General Erwin Rommel landed with his Axis forces. It was also at Tripoli that Field Marshal Montgomery finally completed the conquest of the former Italian empire in North Africa.

The years 1943-49 saw the British administration of Tripolitania and Cyrenaica. (The French administered the southern province of Fezzan). After the war, both American and English personnel activated these two provinces using prefixes commencing with the letter M. These were not quite official prefixes. They were "official" in the sense that they were allocated by MEF (Middle East Forces) authorities but were not part of the official international Telecommunications Union prefix allocation to member countries. Nevertheless, they appear in ARRL countries lists of the day. Their use gave rise to considerable confusion just after the war, so much so that QST (in its May, 1948 issue) had to say "These MEF calls are getting more complicated day by day ... We had better go down the list to straighten things out as follows: For military personnel ... Cyrenaica MD1; Tripolitania, MD2. ... Special civilian prefixes Cyrenaica MC1, Tripolitania MT2". Contacts using such prefixes were quite acceptable for DXCC purposes. Of course, Old Timers will realise that the M (military—or more precisely, occupation personnel prefixes) for Libya were amongst several used shortly after the war, especially during the period 1946-1952. Amongst others were those used in Austria (MB9) Eritrea (MD3) Egypt (MD5) Trieste (MF2) to name a few. Most were fairly quickly replaced as ITU allocations were made, but some like MP4 (Bahrein) seemed to have hung around for years.

The MD2AC card was sent through the US Army Postal Service, but the WIA QSL collection has also MD2 cards from RAF personnel (MD2GO) and other British operators

(MD2PJ, MD2KP, MD2DW).

The MD2AC card is dated July, 1949 and was for a QSO with Len Moncur, VK3LN of Ascot Vale, Victoria.

LI2JC

One has only to read the issues of QST during 1937 to see that the ARRL was having real trouble in arriving at what could be described as a "List of Countries" for DXCC purposes, admitting (in QST Jan 1937) that the task was not as simple as at first thought, and that it had to "boil the list down to a reasonable figure (a reasonable figure being about a couple of hundred)". It is quite possible that there was no amateur radio activity out of Libya before the second world war, although it must be said that the country itself was listed, albeit without any accompanying prefix. The only possibility may have been the use of the I prefix that had been allocated to Italy "and its colonies".

The first listed prefix for Libya was one that appeared early after the war. It was LI2. The choice of prefix by the occupation forces personnel probably followed the early practice of allocating country prefixes by using letter abbreviations. The LI prefix was not infrequently in parenthesis thus indicating there existed some doubt in ARRL circles that it was authentic. The LI2JC QSL shown in one of two LI cards in the Collection. It originated from the RAF base of El Adem, Tobruk. This prefix was later changed to MD1 (not MD2 as might have been expected, the reason being that these calls originated from Cyrenaica and not Tripolitania). The name Tobruk of course, will always remain in the annals of history as the scene of the heroic resistance of the Australian 9th Division against the might of the German Afrika Korps.

The QSLs of MD1A, MD1D AND MD1BA (all from Cyrenaica) are also in the Collection. As mentioned above, special prefixes for civilian use were also issued ... Cyrenaica MC1 and Tripolitania MT2. The Collection is fortunate in having the rather rare QSL MC1A (Cable and Wireless, Benghazi) and the somewhat unusual QSL (Official?) of TINS sent by a member of the MEF (RAF) in Tripoli and dated as early as Dec 1946. This is a printed

R.A.F. EL ADEM, TOBRUK, LIBYA	
LI2JC	
Rx: SX28	Tx: CO/PT/PA Input 100-wt Ant 1/2 x d
TKS RADIOBERS-195FOR 14 Mcs. CW/PONE QSO	
ON 22/3/47 AT 21-35 GMT. de REPORTS	
YOU WERE RST PSE/TKS QSL.	
see over line on. 73. Jack. J.A. CURRIE.	

Tripoli - Tripolitania Libya North Africa	
MD2AC	
Radio VK3LN	Phone CW Sigs wkd at
QSA 5 B 98%	GMT cont. 7 to 49 Coast QRO 14 M.
Transmitter: 1 KW 60-460-D Ant. Shielded	Remarks: Field Signal
Receiver: SX-28	3mi. late and minor
MILTONE E. GALLAHER	
1950-AACS APO-231 NYC-NY	STATE CALL WILCO RFD-4 Cochran, Ga.

QSL and undoubtedly one of the first to be sent out of the country after the war, probably before the MEF issue of the MD prefixes.

From the front of the LI2JC card we read that the originator, Jack Currie was using a SX28 receiver. This was probably the most famous member of the Hallicrafter SX series of receivers, and was very popular just before the war. It was a 6 band, 15 valve set covering a frequency range from 550 kHz right up to 43 MHz. In 1941 it sold for just under \$160 (US). His transmitter was in all probability, "homebrew" (as were most of the rigs at that time). The CO/FT/PA stages of the transmitter (as shown on the QSL) stood for Crystal Oscillator/Frequency Tripler/Power Amplifier.

5A2CV

After WW2 the three provinces of Libya federated and the country was declared independent by the United Nations Organization. In 1963 a unitary State was formed and the provinces as such abolished, but it was 1969 that saw the greatest political change in the country. This was Colonel Gaddafi's army coup occurring late in that year, which action led to the withdrawal of all foreign forces from the country. However before this event, and as early as 1952 the new prefix ITU allocation of 5A (from the block 5AA-5AZ) had been made, Cyrenaica using 5A2C and Tripolitania, 5A2T. (There was no allocation to Fezzan). By far the most common 5A prefix allocation is 5A2T since much of the Libyan population is centred around Tripoli. The



prefix 5A2 was the only one used for some years but now the WIA collection contains prefixes 5A1 to 5A5 inclusive and even a 5A0 (issued to a Polish visitor in 1987).

The pictorial QSL 5A2CV shown resulted from a QSO in Jan 1959 between a RAF Amateur Club member stationed in Tobruk and Gerry Butler, formerly VK3GB now residing at Redcliffe, Queensland.

Thanks

The Wireless Institute of Australia would like to express its thanks to the following for their contribution of QSL cards towards the Collection:

(Supplementary List)

Fred, VK3CFK
Harvey, VK3AHU
Frank, VK2QL
Ray, VK3RF

Also to the friends and families of the following "silent keys" (Supplementary List)
Jack Gerard, VK2ADN
Noel Ericsson, VK2MF.

If you would like to play a part in building up the WIA QSL collection and to save something for the future, would you please send a half-dozen (more if you can spare them) QSLs which you feel would really help the collection along. All cards are appreciated but we especially need commemorative QSLs, special event stations QSLs, especially assigned call QSLs (eg VK4RAN), pre-war QSLs, unusual prefixes, rare dx and pictorial QSLs of not so common countries. Could you help? Send to PO Box 1, Seville 3139 or phone (059) 643 721 for card pick-up or consignment arrangements for larger quantities of cards.

The 1990 DX QSL Contributor's Ladder:

Frank,	VK2QL	163 points
Jim,	VK9NS	158
Ray,	VK3RF	37
Austin,	VK5WO	30
Bruce,	VK3BM	13
Barry,	VK5BS	12
Snow,	VK3MR	9
Vic,	VK5AGX	8

Special QSLs received:

From VK5WO: CR8AC (Goa)
VK3RF:- Prefixes T26 (Tuvalu)
8P7, 8P8 (Barbados) P41 (Neth.Ant.)
J88 (St Vincent)
Special Calls:-
IQ8RAI, CP1AA, SP0PCL.

ar

SILENT KEYS

DUE TO INCREASING DEMANDS ON SPACE WE REGRET THAT AS FROM JULY WE MUST IMPOSE A 200 WORD LIMIT ON OBITUARIES

We regret to announce the recent passing of:-

Mr Herbert Chappel	VK2PYN
Dr WAS Butement	VK3AD
Dr AG Moritz	VK3ZHU
Mr PD Thomas	VK5ZPT
Mr Frank Anzalone	W1WY

William Butement VK3AD

William Alan Stewart Butement, Australia's first chief scientist in defence, died on January 25, aged 85, in Melbourne.

Born in New Zealand, he was educated at Scots College in Sydney and University College School at Hampstead, England. After completing a Bachelor of Science at the school, he worked in the British War Office's Signals Experimental Establishment at Woolwich, London.

Dr Butement was an early researcher in the field of radar and is credited with develop-

ing the first searchlight radar.

In 1946, Lieutenant-General Sir John Evetts recruited him as Deputy Chief Scientific Officer of a team which came to Australia to investigate a site that became the Woomera rocket range.

He was appointed the Australian Department of Supply's Chief Scientist and was responsible for the newly created Australian Defence Scientific Service. The service was later developed into the Defence Science Technology Organisation.

In 1967, he left the service to take up a five-year term as executive director of research at Plessey Pacific Pty Ltd.

He was made a Commander of the British Empire in 1959 and awarded a Doctor of Science by Adelaide University in 1961.

Reprinted from Canberra Times 28/2/90

Alan Moritz VK3ZHU

I regret to advise that Dr A.G. Moritz VK3ZHU became a Silent Key on April 4 last.

Alan was a Senior Research Scientist at

the Materials Research Laboratory, Maribyrnong where his main disciplines were Mass Spectrometry and Nuclear Magnetic Resonance Spectrometry.

He was widely known in the scientific community.

He was known by most of the radio amateurs who passed through the Laboratory over the years - also to many VHF-ers in VK3 and VK5 (which was his home state).

With VK3ATY he held the 2.3 GHz record for some years.

Alan also contributed technical particulars to AR and would have been known to the Editorial Staff.

Alan leaves a wife (Margaret), two sons (Andrew and Jonathan) and a daughter (Karen).

IAN BERWICK VK3ALZ.

Frank Anzalone W1WY

On 30 December 1989 Frank, who had just turned 87, lost his struggle with cancer after a long and arduous battle. He loved amateur radio, but would be the first to admit that contesting was his special passion. Frank was originally licensed as W2WC in Brooklyn, New York in 1922, and he enjoyed a 43-year career as Chief Radio Engineer for WHN Radio in New York City.

Frank's greatest contribution to the contest world was through his role as Director of the CQ World-Wide DX Contest, spanning a period of more than 40 years.

Ken O'Farrell VK4OF

This obituary is in remembrance of Ken O'Farrell VK4OF who passed away in June 1989 aged 64, from illness since retirement. It is with deep regret and sadness that we remember his passing.

Ken served his apprenticeship as a fitter with the Queensland Government Railways, and moved on to obtain his Marine Engineers Certificates. He served some time on tankers before joining the Main Roads Department in Townsville where he met his wife Mary. From Townsville he moved to Brisbane commencing a long and distinguished career in the electrical industry. Ken worked at New Farm, Bulimba, Swanbank and Gladstone Power Stations, with the greater part of his 30 odd years in the industry as a Shift Engineer or Shift Supervisor.

In Brisbane Ken attended Army radio theory classes in the early 1960s. He gained his licence and callsign VK4OF and became an avid DXer, using a quad antenna to work the world on HF. He became heavily involved with the WIAQ and printed QTC for some

time, at home using a Gestetner. Ken has had some fantastic contacts on HF, for example, he worked King Hussein of Jordan. During an earthquake in Alaska in the 1960s Ken relayed messages between an American warship and an amateur in Anchorage initially establishing the only communication between Alaska and the outside world. The warship was on its way to Alaska but propagation prevented direct communication so Ken did all the message relaying on CW until the warship finally established direct communication. When the La Balsa raft expedition was in progress, Ken helped relay messages from the raft crew back to Ecuador. During a later exchange on behalf of the crew, Ken received a personal thankyou over the air from the then President of Ecuador. He later received a signed thankyou certificate from the President. While convalescent after a heart attack in 1985 Ken worked the Butternut Antenna Factory in the USA. Using his Butternut antenna he worked a stateside ham, also using a Butternut. The latter telephoned Butternut, told them the situation, and the factory fired up their station for a 3 way QSO. These are just some examples of the unusual and interesting incidents which seemed follow Ken throughout his life.

He experienced many dangerous and amusing incidents over the years especially

from travels in Russia and India, but no matter how dangerous the situation, Ken could always turn it into a humorous story. Even though not heavily involved in Amateur Radio during the last few years he maintained an interest with the recent purchase of a 2 metre hand held, and a solid state HF set. He wanted to go solo sailing when he retired and these rigs were to take pride of place in the vessel.

Ken was a member of the Gladstone Amateur Radio Club from its formation in 1980. To those who knew him personally he always helped with questions on radio, of which his knowledge was extensive.

Some will remember Ken as a workmate, some will remember him as a friend, some will remember him as a good fist or strong voice on air using impeccable procedure. As well as the above I will remember Ken as a person full of life, with a lot of courage, and a person who had done almost everything and has enjoyed every minute of it. Ken is survived by his wife Mary, daughter Linda, sons Tony and Joel and grandchildren.

(Compiled by Nigel VK4AV on behalf of the members of the Gladstone Amateur Radio Club. Special thanks to Peter VK4PJ and Allan VK4SS.)

ar

OVER TO YOU

ALL LETTERS FROM MEMBERS WILL BE CONSIDERED FOR PUBLICATION AND IN FUTURE MUST BE LESS THAN 200 WORDS.
THE WIA ACCEPTS NO RESPONSIBILITY FOR OPINIONS EXPRESSED BY CORRESPONDENTS.

Packet Trading

In his response to John Woodings' letter, John Day refers to AAPRA along with other non-commercial organisations such as the WIA and the Melbourne Packet Radio Group as competition. Comments such as those reveal a lack of understanding of the situation.

When Amateur Packet Radio first appeared, there were no commercial units available. AAPRA, like SADC, imported boards and helped the amateur community make its own packet systems. We found it cheaper to buy Paccomm units than to build our own with local components. We are not and never have been interested in making money for AAPRA itself. We were and are people who are interested in packet as one medium for communication, and clearly you can't communicate unless there is someone out there with suitable equipment. So we set out to help Australian amateurs get on the air with packet. Magic is unreliable!

Essential to the use of packet is establishment of a digipeater network, for which AAPRA has more or less given the necessary equipment to interested clubs. To date we have given away well over \$6,000 of gear. This money came from our "commercial" activities.

We have imported and sold Paccomm TNCs, and were very fortunate to have a software TNC emulation program for the Commodore 64 written for us by Chris Mills. This, combined with a simple modem which has been developed into the present C=PAK and BEEPAK dual-port modems (the latter for use with Gerard Hill's Microbee software) has enabled about 360 amateurs to become involved in packet at minimal cost. Provision of these units and documentation (we have sole distribution rights for the software) and distribution of information has been done by a few volunteers, so that our overheads are very low. This enabled us to fund much of the development of packet in Australia with the help of our subscribers.

Without this effort, the demand for commercial packet gear would not have grown to its present level, and it seems that the growth will increase. We are not in competition with the trade, we are stimulating it!

At this point it is appropriate to add that AAPRA has no control over the evolution of the packet system. If, as it appears, there are some amateurs who want a network that will support 4,800 Baud or more, using TC/PIP or other protocols, there is nothing to stop them doing so if they are able to provide the equip-

ment. AAPRA is only concerned with the network we have developed, which caters for the more modest capabilities of, for example, the C-64. The ROSE network is improving rapidly as more clubs are installing nodes, and the effect in reducing traffic congestion is amazing.

Such an improvement in the amateur radio environment has been gained by the voluntary work of a very small number of hard-working enthusiasts, and it is typical of the community that those who whinge the most are the ones who do nothing. We appreciate the help the amateur community gets from various members of the trade, but wish something could be done to promote a combined effort and not the silly growth of factions within our common interests.

As for the statement that we now have a "commercial imperative" and can't fulfil our role of supplying impartial service and advice, has John Day ever asked our advice? He would even find that we have referred enquirers to his firm. We also encourage people to use 'Digicom' rather than C=PAK if they feel 'Digicom' has facilities to offer that suit them better than the different facilities we can offer. It just happens that a product that satisfies the market best is the one that is bought; many factors affect this, price is not the only one. Our existence may help keep the prices of some commercial units reasonable (our prices were deliberately placed at a level that was compatible with possible commercial exploitation) and in that sense we may be "competition". But don't you agree that we built the market in the first place? And that

we have returned all the results of our work to the community. Traders do not do that (no one expects them to). Without the efforts of AAPRA and similar groups, the trade would probably still be depending on the sales of Morse keys!

Finally, AAPRA is busy fulfilling its aim to establish packet radio in the Australian amateur community, for those who are neither rich nor geniuses. None of us intends to slave away forever. The only thing in it for us as individuals is the satisfaction of doing something worthwhile, and success in occupying our spare time! We don't want to compete . . . any takeover is welcome, as long as it preserves our members' interests.

I have no doubt that the other "competitors" will tell the same story.

JOHN JEFFERYS VK2CFJ

HON SEC

AUSTRALIA AMATEUR PACKET RADIO

ASSOCIATION

59 WESTBROOK AVE WAHROONGA 2076

Conflicting Clocks

When two measuring devices disagree, the user has to decide which one is accurate. So when the atomic clock and the dynamical clock (period of the earth's orbit) were found to differ, M Leiba, in the March 'AR' article on the Leap Second, considered that it was the dynamical clock that was varying and that the atomic clock was constant.

Gravitational processes govern dynamical time, which can only vary if energy conservation laws are violated. Electromagnetic processes govern atomic time. Norman and Setterfield of the Flinders University in South Australia showed in 1987 that the rate of atomic processes is not constant ⁽¹⁾.

Light is produced by atomic processes and its velocity, *c*, has been measured since the 17th century. During the 300 years before 1985, *c* decayed non-linearly by some 1,500 km/sec or approximately 0.5 per cent. The plotted values show an exponentially damped sinusoid. Its rate of change then approached zero, and *c* now appears to be increasing slightly, behaviour consistent with an exponentially damped decay curve.

So, whilst all atomic clocks tick in unison, their rate is not constant. Thus the Leap Second is required to correct atomic time, not dynamical time.

⁽¹⁾ The Atomic Constants, Light and Time, by T Norman and B Setterfield, published by Stanford Research Institute International, California, 1987. ISBN 0-7258-0363-0.

JIM JENNISON VK2PU

ILLOURA

EAST-WEST RD

VALLA 2448

(This may already be a cat among some of the physics pigeons! Ed)

Income and Upgrading

Permit a "Yes, but . . ." (from one whose

LAOCP is far enough to go considering available income) to the letter by Lindsay VK3ANJ, in May 'AR'.

His letter appears to presuppose that available income can finance a wide range of interests — HF, VHF, UHF, SHF.

And, having built or bought the gear, time is there to use it all!

As an invalid pensioner, demands on my time probably limit me to about eight hours a week, mostly during daylight! Mostly on weekdays!

IAN CROMPTON VK5KIC

9 CRAIG ST, RICHMOND, 5033

Wireless in the 1914/18 War

I read with much interest the articles in the April '90 issue headed "The Last Wireless ANZAC" and "Wireless in the 1914/18 War".

Of special significance to me was the discovery of my late father's photograph on page 34, shown as a member of the Wireless Squadron of the Australian Light Horse.

I recall how, in my youth, my father used to send Morse code to me at the dinner table, using the blade of a knife in the tines of a fork, brass sounder style. It is not surprising, therefore, that I also served in wireless units in AIF Signals in World War II.

As some of your members may be trying to identify other squadron members in the photograph, it appears that the third row should read from right to left, as my father is second from the right.

I look forward to further articles on the historical background and foundations of radio communication which binds so many of us together.

W J PAUL VK2EXX

12 BILLABONG AVE

TURRAMURRA 2074

Approved Procedures

Referring to recent correspondence about operating procedures, the information in DOC72 is sufficient for most amateur radiocommunications but, for those wanting to improve their vocabulary and their technique, I suggest referring to the BTI (maritime) "Handbook for Radio Operators". The library catalogue number is 623 89 32. The following extracts refer to recent debates.

Acknowledgment of receipt by the operator:

Telegraphy — the letter R sent once-K
Telephony — "Your message received" — "Over" or "ROMEO your message" — "KILO" or simply "ROMEO" — "KILO".

The abbreviation QSL is better reserved for a request for acknowledgment from the addressee — if operator acknowledgment is not sufficient.

The Q code and other telegraphy abbreviations can be used in telephony where there are

language difficulties; in other circumstances these should not be used. When used, the correct form is:

Request — QSL ROMEO QUEBEC (RQ)

Response — QSL BRAVO QUEBEC (BQ)

Some responses which could be used by amateurs are:

Where the answer is affirmative, say — "YES"

Where the answer is negative, say — "NO"

Where information is not immediately available, but soon will be, say — "STANDBY"

Where information cannot be obtained, say — "NO INFORMATION"

Where a message is not properly heard, say — "SAY AGAIN"

Where a message is not understood, say — "MESSAGE NOT UNDERSTOOD"

If any part of a message needs safeguarding, use the word "repeat", eg "Change to channel 6800, repeat 6800".

Numbers should be spoken thus — six eight zero zero for 6800.

We are not professionals, but it is worthwhile following their example, particularly when accuracy is important.

LINDSAY LAWLESS VK3ANJ

Box 112

LAKES ENTRANCE 3909

Dinkum Persuasion

Referring to my letter and your footnote in April 'AR' —

Yes, CW DX is not the only achievement pinnacle, it is one of many. CW is a pinnacle to be conquered to enable us to serve the international community which authorises our existence. One is also happier to know oneself competent to cope with any amateur communication situation, and also able to assist beginners.

One ITU objective is to make affordable telecommunications available to all, including the amateur radiocommunication service. Many amateurs out there, with simple CW rigs, look for encouraging contacts with Australian amateurs. The only excuse for incapability is total inability to master Morse. Others should be able to spare a little time to talk on CW. Rag chewing on 80 or the local repeater breeds parochialism and does nothing for international goodwill.

Regarding persuaders; aren't we all? WIA management persuades us that the institute is entitled to a fair go from non-members. I try to persuade management that we need policy changes to attract more members. The following statistics are from recent issues of AR.

There are 18,372 licensed amateurs; 7,619 (41 per cent) are WIA members; 10,714 (58 per cent) are unrestricted licensees; 10,753 licensees are not persuaded that WIA membership is worthwhile; *many doubt they will get a fair go*. We have persuaded the authorities to allow lower entry qualifications, producing an all-time low proportion of unre-

stricted licensees.

Should we concentrate less on persuasion and more on providing real needs and quality services? Persuasion will not compensate for inferior performance.

Regarding tolerance — I cannot tolerate those members who, with weak excuses, will not upgrade their qualifications, and who lobby for lower entry qualifications. WIA policy condones that; we should, instead, provide incentives and actively encourage upgrading.

The ITU is our boss; we deserve the sack if we make no effort to improve performance.

LINDSAY LAWLESS VK3ANJ
Box 112
LAKES ENTRANCE 3909

Elusive Snake

A few weeks ago I received the following

letter from a UK amateur. I can't help him, but I wonder if any AR reader may be able to help.

Greg Baker
PO Box 208
Braidwood 2622
Dear Greg,

This may sound a stupid question to ask, but have you ever come across or seen an antenna called "The Snake". It lies flat on the surface of the ground, hence its name.

When I was in Australia in 1986, touring around the Walgett, NSW, area with a sheep farmer, I accidentally came across one being used by a VK amateur for transmit and receive. When he said . . . "take a look at my snake in the paddock" I thought it was a leg pull! But when I did look, there it was lying in the sun: 2 x 145ft lengths of coaxial cable, flat on the surface of the ground! The snake's head

was in the paddock sealed in a clear plastic box, with the two tails going back to his shack, with one tail into his antenna tuning unit on TX and RX. (A sketch was supplied, but not reproduced here. Ed)

Since my return I have heard a "W" using one, but he gave no details — perhaps it was a VK import?

I have not seen anything published in Practical Wireless. Neither is there anything in my 1988 ARRL handbook or RADCOM-RSGB.

I should be grateful for any information you may have on your side.

RICHARD WILLIAMS

PS: My antenna masts came down in recent storms over here and I thought this snake idea might be better than new masts and sky wires?

Situations Vacant ARDF — Fox Hunting — Foxtearing

This is a very popular international sport. Basically it is orienteering with a radio receiving having directional capabilities.

At the JARL-sponsored foxtearing convention held in Tokyo last November there were 270 entrants, including six from China, nine from South Korea and a lone American domiciled in Japan. China won the YL and Junior classes, while Japan won the senior and old-timer classes.

ARDF is conducted on 80m and 2m. Contestants leave the start on foot at five-minute intervals. As each transmitter is found they stamp their card and move to the next. The contestant with the least overall time is the winner.

During my visit to China in March 1990 I visited a "fox hunting" school near Nanjing in Jiangsu Province, which is run by the Sports Commission. Middle-school pupils go

there for a year to learn fox hunting in the mornings and to attend their normal classes in the afternoons.

Australia has never competed internationally in ARDF competitions.

The Jiangsu Province Sports Commission has indicated it would be pleased to have an Australian group attend the school and receive instruction in international ARDF techniques. It is anticipated that this would be for about 10 days.

If there is any amateur interested in taking part in this training course (self financed) in mid-1991, more information can be obtained from VK4DO, QTHR.

It would be expected that participants take part in an international contest in 1992. Most likely to be held in China.

WALLY WATKINS, VK4DO
(079) 47 1036

WIA SLOW MORSE TRANSMISSIONS

VK2BWI	Nightly at 2000 local on 3550 kHz
VK2RCW	Continuous on 144.950 MHz 5 wpm, 8 wpm 12 wpm
VK3RCW	Continuous on 144.950 MHz 5 wpm, 10 wpm
VK5AWI	Nightly at 1030 UTC on 3550 kHz
VK6RAP	Nightly at 2000 local on 146.700 MHz
VK6WIA	Nightly (except Saturday) at 1200 UTC on 3.555 MHz



Rcc. Ret. \$82 plus P&P.

Ever baffled by World Clocks?

There is no need to be confused by a maze of foreign city names which cannot relate to their times.

The ZONE VIEW GLOBAL CLOCK* provides pictorial views of 30 Time Zones, differentiated by colour, clearly shows the time and day in each zone.

Amateurs! Now you can know at a glance who's in bed, who's having lunch, and who might be on the air.

*25cm diameter quartz movement.

For details or orders contact:
RESEARCH ENGINEERING CO.
1319 Main Road, Eltham, Vic. Australia 3095.
Phone: (03) 439 5825

UTC	MUF	DBU	FOT	14.2	18.1	21.2	24.9	28.5	UTC	MUF	DBU	FOT	14.2	18.1	21.2	24.9	28.5	UTC	MUF	DBU	FOT	14.2	18.1	21.2	24.9	28.5
1	10.2	-7	8.1	-4	-13	-26	1	9.7	4	7.4	-3	-21	-39	1	8.4	10	6.5	-5	-28
2	9.7	-17	7.5	-7	-14	-25	2	9.4	-5	7.2	-5	-19	-36	2	9.6	1	7.4	-2	-17	-34
3	9.3	-27	7.2	-9	-15	-25	3	9.0	-14	7.0	-8	-21	-36	3	14.0	3	10.5	3	-1	-8	-21	-36
4	13.5	-13	10.5	-11	-7	-10	-18	-30	4	13.1	-6	10.2	-5	-6	-13	-25	-40	4	22.7	6	17.5	1	8	7	4	-3
5	21.8	-1	16.9	-18	-5	-1	-2	-6	5	21.0	1	16.3	-9	0	1	-2	-8	5	29.9	5	22.8	-9	4	8	9	7
6	29.2	3	22.5	-23	-5	2	4	4	6	27.0	3	21.6	-14	0	4	4	1	6	32.7	5	24.6	-15	1	7	9	8
7	27.8	2	20.8	-22	-4	1	3	2	7	24.7	2	19.7	-14	-1	2	1	-2	7	32.2	4	24.1	-18	-1	5	8	7
8	24.7	2	18.5	-15	-1	2	-1		8	21.8	1	17.3	-11	-1	1	-2	-8	8	30.6	4	22.9	-18	-1	5	7	6
9	20.7	1	15.5	-10	-1	1	-2	-8	9	18.5	-3	15.2	-8	-1	-2	-8	-18	9	28.1	4	21.0	-10	0	5	6	3
10	16.8	-2	12.6	-6	-1	-3	-10	-19	10	15.3	-4	12.0	-6	-4	-8	-17	-30	10	24.9	4	18.6	-7	3	5	4	0
11	13.4	-5	10.0	-4	-4	-10	-21	-35	11	12.3	-7	9.6	-5	-9	-17	-32	...	11	20.8	4	15.6	-1	5	4	-1	-8
12	11.0	-7	8.2	-3	-9	-20	-36	...	12	10.4	-8	8.0	-6	-16	-29	12	16.9	4	12.6	3	'4	-1	-10	-22
13	9.5	-4	7.0	-4	-16	-31	13	9.3	-6	7.2	-7	-22	-39	13	13.4	6	10.0	6	-1	-41	-26	...
14	8.9	6	6.6	-3	-21	-40	14	9.1	5	7.0	-6	-26	14	11.0	11	8.2	5	-9	-25
15	9.2	15	6.8	0	-20	-40	15	9.3	13	7.3	-4	-26	15	9.5	16	7.0	1	-20
16	9.6	18	7.1	3	-17	-37	16	9.4	16	7.2	-2	-25	16	8.9	18	6.6	-2	-25
17	9.6	20	7.3	3	-18	-39	17	9.3	18	7.1	-2	-26	17	9.2	20	6.9	0	-23
18	9.2	21	6.9	1	-22	18	8.8	19	6.9	-6	-32	18	9.6	22	7.1	3	-19
19	8.5	21	6.4	-3	-28	19	8.2	19	6.4	-10	-40	19	8.8	22	6.5	-1	-25
20	8.3	21	6.4	-4	-29	20	8.0	19	6.3	-12	20	9.1	22	6.8	1	-22
21	9.8	21	7.5	5	-16	-36	21	9.5	19	7.2	-1	-25	21	8.1	22	6.5	-1	-30
22	9.1	17	7.0	0	-22	22	8.8	19	6.8	-5	-32	22	8.4	22	6.5	-5	-32
23	8.4	6	6.6	-6	-27	23	9.2	15	6.4	-10	-18	23	9.4	22	7.1	3	-20
24	8.2	-7	6.5	-8	-25	24	8.0	7	6.3	-12	-38	24	8.5	20	6.5	-3	-28

VK EAST — AFRICA

VK STH — AFRICA

VK WEST — AFRICA

UTC	MUF	DBU	FOT	14.2	18.1	21.2	24.9	28.5
1	25.8	1	20.8	-19	-4	0	1	-1
2	25.6	0	21.0	-21	-6	-1	0	-2
3	25.6	-1	19.4	-22	-6	-2	-1	-3
4	25.8	-1	20.5	-21	-6	-1	-1	-4
5	26.1	-2	20.2	-18	-4	-1	-1	-4
6	25.4	-2	19.3	-13	-2	0	-1	-6
7	23.6	-1	18.0	-6	1	1	-3	-9
8	21.1	1	16.0	4	5	1	-7	-17
9	18.7	4	14.3	12	6	-2	-15	-29
10	16.4	6	12.5	12	1	-12	-29	...
11	14.5	7	11.0	8	-8	-23
12	13.0	7	9.9	3	-17	-36
13	12.2	8	9.2	-1	-3
14	11.6	9	8.9	-4	-29
15	11.2	9	8.5	-7	-34
16	10.9	9	8.3	-9	-37
17	9.7	9	7.4	-20
18	8.2	9	6.3	-39
19	7.9	8	6.1
20	11.2	9	8.5	-7	-33
21	17.8	4	13.8	10	3	-6	-20	-36
22	22.8	2	17.5	-1	4	3	-1	-8
23	25.8	2	20.1	-9	2	4	3	-1
24	26.5	1	21.1	-15	-2	2	-1	-2

UTC	MUF	DBU	FOT	14.2	18.1	21.2	24.9	28.5
1	27.6	1	22.3	-22	-5	0	2	1
2	27.0	0	22.1	-25	-7	-1	1	-1
3	26.7	0	20.3	-26	-8	-2	0	-1
4	26.9	0	22.3	-25	-7	-2	0	-1
5	27.1	1	22.4	-22	-6	0	2	0
6	27.7	1	22.0	-17	-3	2	2	0
7	27.0	0	20.4	-9	1	3	2	-2
8	24.2	1	18.3	2	6	5	0	-7
9	20.5	3	15.5	12	8	2	-8	-20
10	16.9	5	12.7	11	1	-10	-26	...
11	13.7	5	10.3	3	-14	-31
12	11.4	5	8.5	-8	-33
13	9.7	6	7.3	-2
14	9.0	7	6.7	-30
15	9.2	7	6.8	-28
16	9.5	7	7.1	-24
17	9.8	7	7.4	-20
18	9.0	7	6.9	-29
19	8.1	7	6.2
20	8.0	7	6.2
21	11.1	7	8.6	-10	-37
22	16.8	-5	13.0	-4	-6	-13	-25	-40
23	23.3	-3	17.9	-10	-2	-1	-5	-11
24	27.9	-1	21.3	-17	-3	1	1	-2

UTC	MUF	DBU	FOT	14.2	18.1	21.2	24.9	28.5
1	25.9	-1	19.9	-13	-2	1	0	-4
2	25.7	0	20.8	-17	-3	1	1	-2
3	25.3	0	20.8	-20	-5	0	0	-2
4	25.2	0	20.6	-21	-5	-1	0	-3
5	25.5	0	20.6	-20	-5	-1	0	-3
6	25.7	0	20.3	-17	-4	0	0	-3
7	26.1	-1	19.8	-13	-1	1	0	-4
8	24.6	-1	18.7	-7	1	2	-1	-7
9	20.5	1	17.1	2	5	3	-4	-12
10	19.5	1	16.8	18	10	2	-21	-25
11	16.9	6	12.8	18	2	-10	-28	...
12	14.3	6	10.9	7	-11	-28
13	12.4	6	9.4	-3	-26
14	10.9	7	8.2	-13
15	10.2	6	7.7	-20
16	10.0	6	7.6	-21
17	9.9	6	7.5	-22
18	10.0	6	7.6	-22
19	8.9	6	6.8	-35
20	7.8	5	6.0
21	7.5	5	5.8
22	10.6	-4	8.0	-17
23	16.4	-5	12.7	-4	-7	-15	-29	...
24	22.3	-3	17.2	-8	-1	-2	-6	-14

VK EAST — ASIA

VK STH — ASIA

VK WEST — ASIA

UTC	MUF	DBU	FOT	14.2	18.1	21.2	24.9	28.5
1	15.1	1	12.0	2	-5	-14	-29	...
2	17.0	2	13.6	3	0	-7	-18	-32
3	18.8	2	15.0	4	3	-2	-11	-22
4	20.0	3	16.0	6	6	2	-6	-16
5	20.8	5	16.7	9	8	4	-3	-13
6	21.0	7	16.9	14	12	7	-1	-11
7	20.8	10	16.7	20	15	9	-1	-12
8	20.2	8	16.2	20	13	5	-6	-19
9	17.7	8	14.3	17	7	-3	-18	-35
10	15.1	9	12.0	12	-2	-16	-36	...
11	12.6	10	10.0	4	-16	-35
12	11.1	10	8.5	-5	-29
13	9.7	11	7.4	-14
14	9.4	11	7.1	-17
15	9.5	11	7.2	-15
16	9.8	11	7.4	-16
17	10.0	11	7.7	-12	-40
18	9.2	11	7.1	-18
19	8.5	11	6.7	-25
20	8.4	11	6.6	-27
21	10.2	10	7.9	-11	-39
22	11.4	9	9.0	-2	-23
23	12.0	3	9.5	-2	-18	-35
24	13.2	1	10.4	-1	-12	-25

UTC	MUF	DBU	FOT	14.2	18.1	21.2	24.9	28.5
1	13.6	6	10.8	4	-8	-22
2	13.6	5	12.0	7	-2	-13	-29	...
3	16.5	5	13.2	5	2	-7	-20	-16
4	17.4	6	13.9	10	5	-3	-15	-30
5	18.0	7	14.3	12	7	0	-12	-26
6	18.3	9	14.7	16	9	1	-11	-24
7	18.1	11	14.6	19	11	2	-11	-25
8	17.7	12	14.2	20	10	1	-13	-29
9	16.9	10	1					

HAMADS

TRADE ADS

● **SATFAX:** NOAA, Meteor, GMS weather satellite picture receiving program for IBM XT/AT. Displays in 64 colours. Needs EGA colour monitor & card, and "Weather Fax" PC card. \$45 + \$3 postage *** **RAD-FAX2:** HF weather fax, Morse & RTTY receiving program for IBM XT/AT. Needs CGA, SSBHF, FSK/Tone decoder. Also "RF2HERC", "RF2EGA" & "RF2VGA", same as RADFAX2 but suitable for Hercules, EGA & VGA cards respectively. \$35 + \$3 postage *** All programs are on 5.25" OR 3.5" disk + full documentation. ONLY from M Delahunty, 42 Villiers St, New Farm 4005 OLD. Ph (07) 358 2785.

● **AMIDON FERROMAGNETIC CORES:** For all transmitter and receiver applications. Send DL size SASE for data/price to RJ & US Imports, Box 157, Mortdale NSW 2223 (no enquiries at office please ... 11 Macken St Otley.) Agencies at: Geoff Wood Electronics, Sydney; Webb Electronics, Albany; Electronic Components, ACT; Truscott's Electronics, Melb; S Willis, Perth; Assoc TV Service, Hobart. Closed first 2 weeks May.

● Decode and print weather pictures on your computer using the Listening Post Software from FT Promotions and a suitable decoder (AEM 3500). Also decodes RTTY and Morse. Versions for Apple, Commodore 64/128 and Microbee (C64/128 no CW) — only \$36 inc p&p. Call or write to FT Promotions, PO Box 547, Rozelle NSW 2039. Ph: (02) 818 4838.

● Propagation prediction program as used by Roger Harrison in AR — two-program set provides HF propagation predictions for any two locations in the world, for any month giving freq vs time with signal strength, MUF and FOT and showing modes and elevation angles vs time. IBM and comp only — \$36 inc p&p. Call or write to FT Promotions, PO Box 547, Rozelle NSW 2039. Ph: (02) 818 4838.

FOR SALE — ACT

● **MORSE** Training program DOTC Approved, for IBM XT/AT & Clones WANG APC, SANYO 550/555, Commodore PC. Copies \$5. From VK1 Division Box 600 Canberra 2601.

FOR SALE — NSW

● ICOM IC502 50MHz 3watt Tranceiver I.G.C. 50-5MHz Coverage \$160 Three 572B Triodes. Best offer contact Scott VK2JSR Ph(066) 295-127 AH

● D.S.E. 75mm CRO in as new cond \$200 F.O.R. (06)2261001 R.Dell VK2DVG Between 8am 6pm or QTHR.

● YAESU FT-ONE top condition all options installed, including fan speed control, improved NB, manuals, service extender kit - \$1600 VK2AFR QTHR Ph.(02)6357179.

● AZDEN PCS-300 h/hold, 3watts h/power complete with charger, stand, rubber duck \$250 AEA Pakratt PK-64 v.g.cond with manual for C-64 only \$350 VK2EVD 066 527160

● WILLIS u10 70cm-fm transceiver. valves, 6U7G, 4cx5000a, 813 12 BY7A, pair 6146B's, 5Z3, 6A6, OC3, 6SK7GT, 6X5GT, 5U4GB. Bird 888 50 ohm vht dummy load 1200 watts. Ken VK2YKM QTHR, a/hrs (066)243197.

● WWII Pan adaptor, 5" crt, valves components appr good, built in p/s. pr crt's, 3BP1s best offer. Midland SWR/power meter \$25. pr 872's merc vap tubes, ceramic bases, \$20 ea. 2/pr 3e25/832a vht/uht, ceramic bases, suit linear \$20 ea. back issues AR & ARA to 10 years. min order 12 copies \$1 per copy. hb p/s on metal chassis, 350 volt 125ma. well filtered \$25. YAESU YC-601 dig disp unit. suit FDX100, FDX277 & FDX401 to FDX505 series. \$300. YAESU trcvrs. FDX400 \$300. FDX401 \$350. both sets appear-

ance & cond good. valves ok, new drivers & finals. 1 kw linear components in steel cabinet. cannot finish due to ill health. hd trani, filter, 3 meters, 2 fans, copper tubing tank coil, new tubes, 4/RCA 808's plus 5/830b's, ceramic sockets fil chokes & hd rf choke \$450 inc freight. getting started? YAESU FDX401 & FDX560. mint appr, recent alignment. instr books. valves & sets in good working order. spare valves at sensible prices. \$425 ea inc freight. VK2IX QTHR - Ph (069)488321.

FOR SALE — VIC

● **KENWOOD** TS930 transceiver complete with mic and instr book mint condition - \$1900.00. AEA computer patch model CP1 with mba-tor software for Commodore C64 computer, suitable for cw, rty, amtor and ascii, with full instr - \$250. MFJ sbb filter SBF2 - \$25. Alf Chandler - tel (03)5895344.

● **DICK SMITH** 100w 2M linear, as new condition, assembled and aligned to full specs, inc manual, \$195 posted VK. Roger VK3XRS. Phone (051)568291.

● **ICOM** IC28H 2 metre transceiver. 50 watts FM with mobile mount. microphone. 21 memory channels, manual, original carton, 18 months old mint condition, sell to licensed amateur only \$540.00. Scanner - Uniden Bearcat hand held. Model UBC 200xt. latest model. range from 66MHz to 956MHz in 10 bands, covers 2 metres and 70cm amateur bands. all vhf and uhf mobile networks, marine, air, cellular telephones etc. 200 memory channels, with charger, leather carrying case. Four months old, in mint condition, currently retailing for \$599.00, urgent sale \$450.00. Laptop Computer Amstrad ppc640 IBM compatible, current model in excellent condition, hardly used. 640k ram, v20 processor chip, two 9cm 720k floppy drives, includes external monitor, inbuilt modem (300/300, 1200/1200, 75/1200), carry case, manual, three way power, dos 3.3 and utilities. \$975.00. Hard Disk Drive. NEC for IBM XT/AT. 10 megabytes with controller and cables, little used in excellent condition, includes DOS 3.3 and utilities. \$190.00. Floppy Disk Drive 13cm for IBM etc, little used with cable. \$100. VK3UV QTHR. (03)5806424.

● Power supply 25A YAESU FP7577HD \$450. Kevin VK3CKL (03)7929503 QTHR.

● **HEATHKIT** VTVM IM-18 technical manual, full circuit diagram. in excellent condition, \$160 ono. Vince VK3AJQ QTHR (03)8723505. after 6pm week nights.

● **YAESU** FT 757 gx transceiver, full coverage receiver. scanning microphone in good condition \$1300 o.n.o. tel (051)992811.

● **TANDY** Realistic Pro 2022 200 ch. scanner as new only 20min use too complicated cost \$549.95. Sell \$400. David L30259 QTHR (03)3703589.

● **AZDEN** PCS 4000 2 meter mobile transceiver 5 or 25w 16 memories reverse back lit dial no mods new condition inst book carton \$380 Alf VK3EJ AH(03)8772983 BH (03)8733777.

● **KENWOOD** TS440S with mic, service manual, gc \$1750. YAESU FT690RMK1 with mic, carry case, mobile bracket, and matching 1OW FL6010 linear, gc \$500 Michael, VK3EMJ QTHR A/H (03)5319954.

● **EQUIPMENT** racks. fully drilled and tapped. accept standard 19inch panels. 1870mm high. military specification, fully enclosed. ventilated and shielded. superior quality. \$200 each. John VK3ZA Ph (055)772428.

FOR SALE — OLD

● **YAESU** FT7 transceiver with mike - manual and pwr cable. excellent condition. original owner. with carton and packing \$365 Chas VK4CHO (07)3417153.

● **AMIGA** amateur radio related programmes. 4 disks posted \$25 Herb VK4KM QTHR (071)644382.

● **TRAMP** 128 v1.9 terminal prog. for Commodore 128 \$5 posted. Herb VK4KM. QTHR (071)644382

● **HAMPACK** 111 plugin rty cw asc11 card for Apple 2 plus all speeds & shifts software manual & cables other discs \$200 ono (071)284110.

● **KENWOOD** TS830S txvr and remote VFO230 vgc with manuals and cartons. overhauled by accredited Kenwood dealer. \$950 Ron VK4MBJ QTHR (070)921181 a/h.

● **IC502** 6 meter SSB portable transceiver, good condition, some modifications. best offer Geoff VK4KGE QTHR (071)621499 bh (071)621499 ah.

FOR SALE — SA

● **YAESU** FT227R memorizer 2 metre transceiver with

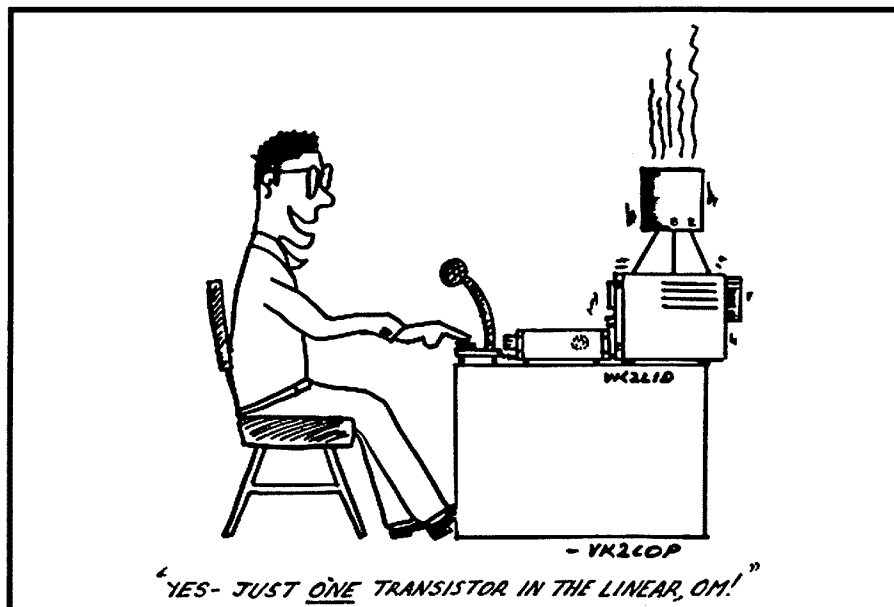

handbook mic \$230.00 VK5BVJ QTHR (087)380000.

FOR SALE — TAS

- YAESU FL2100B linear amplifier, very good condition. \$800 o.n.o. Ian VK7JY Ph (003)272011.
- JRC - JST 125 transceiver 160-10 meters inc warc, & gen.cov.rec. 77 memories commercial quality excellent condition \$1950.00 inc mic & boxes etc. JRC-NVA 88 matching ext. spkr \$145.00 new. Tandy HTX100 - 10 mtr ssb/cw 25w output mobile transceiver new, unused \$450.00. VK7AN (003)317914.

WANTED — NSW

- ICOM ICU51A uhf all mode trans in good cond. contact Scott VK2JSR Ph (066)295127 a.h.
- AWA MRT25A (or 25) low band tor spares only price etc to VK2ED QTHR (043)284106.

WANTED — VIC

- 15M YAGI monobander. must be in good condition VK3CUI Denis (03)8746517.
- CIRCUIT A.W.A. modulated oscillator type 3J6726 150 kc. - 30mc. uses 2 only IQ5-GT valves all costs reimbursed. Ken VK3ZFI QTHR (03)5805347.
- ICOM IC21A 2m, fm xcvr. also KENWOOD SP930/940 speaker. Ron VK30M QTHR Ph (059)443019.
- KENWOOD xcvr TS130V (victor) low pwr version TS130S Reg VK3CCE QTHR (03)5091720.

WANTED — QLD

- 5PIN ceramic valve sockets for 4-125 valves qty price VK4CB QTHR (07)2026566.

WANTED — WA

- HAMSOF cartridge for amtor by Kantronics, to run on a C64C or the program on disk. VK6SY QTHR.
- UNIDEN 2020 front end or complete 2020 txvr with working front end. Laurie VK6NAO (09)3872140.

**Support
the WIA in
order to
protect
Amateur
Radio
frequencies
at WARC 92**

**THIS SPACE
COULD BE
EARNING YOU
MONEY!**

**ADVERTISING RATES
AVAILABLE FROM
PO BOX 300,
CAULFIELD SOUTH,
3162**

HAMADS

Please Note: If you are advertising items For Sale and Wanted please use a separate form for each. Include all details; eg Name, Address, Telephone Number (and STD code), on both forms. Please print copy for your Hamad as clearly as possible.

*Eight lines free to all WIA members, ninth line for name and address Commercial rates apply for non—members. Please enclosed a mailing label from this magazine with your Hamad.

*Deceased Estates: The full Hamad will appear in AR, even if the ad is not fully radio equipment.

*Copy typed or in block letters to PO Box 300, Caulfield South, Vic 3162, by the deadline as indicated on page 1 of each issue.

*QTHR means address is correct as set out in the WIA current Call Book.

*Please enclose a self addressed stamped envelope if an acknowledgement is required that the Hamad has been received.

Ordinary Hamads submitted from members who are deemed to be in general electronics retail and wholesale distributive trades should be certified as referring only to private articles not being re—sold for merchandising purposes.

Conditions for commercial advertising are as follows: \$22.50 for four lines, plus \$2.00 per line (or part thereof) Minimum charge — \$22.50 pre—payable.

- Miscellaneous
- For Sale
- Wanted

Name:

Call Sign:

Address:

.....

State:

Solution to Morseword No 39

	1	2	3	4	5	6	7	8	9	10
1	.	.	.	-	.	-	-	-	.	.
2	.	-	.	-	-	-	-	.	.	.
3	.	-	-	.	.	.
4	.	.	-	-	.	.
5	-	.	-	.	.	-
6	-	.	.	-	.	-
7	.	.	-	-	.	-	-	.	.	.
8	-	-	.	-	-	-
9	-	.	-	.	.	.	-	.	.	-
10	.	.	.	-	-	.

Across: 1 stage 2 rob 3 lib 4 fire 5 hart 6 saint 7 impi 8 goes 9 kilt 10 view

Down: 1 hip 2 peel 3 Vic 4 giant 5 real 6 merge 7 oven 8 does 9 hist 10 swim

TRADE PRACTICES ACT

It is impossible for us to ensure the advertisements submitted for publication comply with the Trade Practices Act 1974. Therefore advertisers and advertising agents will appreciate the absolute need for themselves to ensure that, the provisions of the Act are complied with strictly.

VICTORIAN CONSUMER AFFAIRS ACT

All advertisers are advised that advertisements containing only a PO Box number as the address cannot be accepted without the addition of the business address of the boxholder or seller of the goods.

TYPESETTING : Redfords Media
25 Glenferrie Rd
Malvern 3144
Tel: (03) 500 0377

PRINTING: Industrial Printing
Richmond

MAIL DISTRIBUTION: Polk Mailing Co.
PO Box 140,
Collingwood,
Vic. 3066
Tel:(03) 417 5161

The opinions expressed in this publication do not necessarily reflect the official view of the WIA, and the WIA cannot be held responsible for incorrect information published.

ADVERTISER'S INDEX

ATN Antennas	35
Dick Smith Electronics	28, 29
Electronics Australia	IBC
Emona Instruments	1
Icom Australia	OBC,
Kenwood Electronics Aust.	IFC
Magpubs	5
Moonraker Australia	17
Research Engineering Co.	51
WIA NSW Division	7
TRADE ADS	
RJ & US Imports	54
M Delahunty	54
FT Promotions	54

HOW TO JOIN THE WIA

Fill out the following form and send to:

The Membership Secretary
Wireless Institute of Australia
PO Box 300
Caulfield South, Vic 3162

I wish to obtain further information about the WIA.

Mr, Mrs, Miss, Ms:

Call Sign (if applicable):

Address:

.....

State and Postcode:

Radio Amateurs: Have you checked out EA lately?

No doubt most radio amateurs are aware that *Electronics Australia* is by far this country's largest-selling electronics magazine, as well as being its oldest (we began way back in 1922, as *Wireless Weekly*). But have you looked inside the magazine lately?

Now it's bigger and better than ever, because our leading competitor *ETI* has been merged with us, to form *Electronics Australia with ETI* – the biggest, brightest and most informative electronics magazine, bar none.

You'll now find lots of new 'departments' in the magazine, including Solid State Update (with news of new semiconductor devices), Silicon Valley Update (news from the USA) and What's New in Entertainment Electronics. Plus all of your old favourites like Forum, The Serviceman, Circuit and Design Ideas and so on. And of course plenty of 'meaty' technical articles and construction projects.

What about *amateur radio* projects? Well, as you can see there are more of these than before – but we're very interested in publishing more. So if YOU have developed an exciting amateur radio project, contact Jim Rowe by writing to him at EA, 180 Bourke Road, Alexandria 2015. Or phone him on (02) 693 6620, to discuss the possibility of publishing it as a contributed article. As well as earning a fee, you'll also be helping to boost interest in amateur radio!

Take a look at the new, bigger and brighter *Electronics Australia with ETI* – on sale at your newsagent at the beginning of each month. Or subscribe now, by phoning (02) 693 9517 or 693 9515.

INCLUDED IN OIR JUNE ISSUE:

70CM CONVERTER

Here's an easy to build 70cm converter design for our 6m NBFM Receiver. It's all on one PCB, with microstriplines for straightforward front-end tuning.

THE RISE & FALL OF THERMIONIC VALVES – 2

Neville Williams concludes his look at the role of valves in building the radio and electronics industries. This month he looks at AC heating, multi-grid tubes and what it was like to work at AWA's valve factory.

CHOOSING A DMM

There are so many digital multimeters available nowadays that choosing the best one for your job can be far from easy. Jim Rowe explains how they work, and what the specs really mean.

Electronics Australia

WITH
eti

Australia's Top Selling Electronics Magazine



The smaller we get, the better we get!

ICOM's amazing new mini FM Handhelds

The minute you see and hold one of the Icom "S Series" mini handhelds you'll agree with our thought that "bigger is not always better and smaller is not always less".

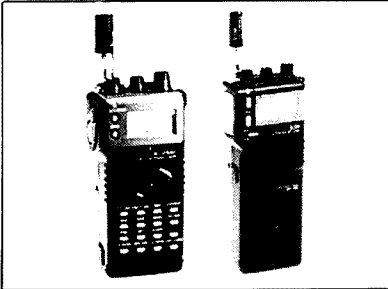

By reducing the size of our product, maintaining high standards of quality and production and constantly improving our range, Icom's business continues to grow. So, the smaller we get, the better we get.

4 DTMF code memory channels for auto dialing.

24 hour clock with timer.

IC-2SAT, IC-4SAT, IC-24AT
Overall, Icom's family of tiny miracles, the 2SAT, 4SAT and 24AT give the Handheld enthusiast ease of operation through the convenient, multi-function keyboard. Delivering a full 5W output (at 12V) they feature clear, backlit function displays, splash resistant design and durable construction for outdoor use. One of these models is bound to suit your application, camping, skiing, in the field or vehicle. Use with built-in, rechargeable NiCd batteries (IC-2SAT, IC-4SAT only) or external power supply without having to use

DC-DC converters, just the optional cigarette lighter cable or mini power cable.
IC-2SA

A super multi-function hand held with strong appeal for veterans, the 2SA is also the perfect way for newly licenced Amateurs to get started. This 144 MHz FM transceiver delivers 5W output (at 12V) with the optional BP-85 battery-pack, 40 memory channels, automatic power saver, LCD readout, operation from battery or external 12 volt DC supply. A PTT lockout switch is provided to prevent accidental transmissions. Amazingly its tremendous versatility and wide variety of functions are simply controlled by just six switches and three controls. An interesting and detailed colour brochure will be sent to you on request - call now for the name of your nearest stockist.

DC socket for charging and external DC power entry.

IC-24AT

Two Radios in one?

Would you believe a full dual-bander in the palm of your hand? Yes, full crossband duplex with 40 independent (simplex, 20 duplex) memory and 2 call channels, 5 watts out put from 12 volts direct power!

With all its features, you'd think the 24-AT would be quite a handful - and it is - almost. Even with its battery pack it only weighs 340gm but still gives you 6 scan functions, priority watch and built-in clock with a timer function.

We know you can't wait to find out more about our latest triumph in design and miniaturisation, so call us now for a free colour brochure giving full details on the 24AT and ask for the name of your nearest stockist.

40 memories.

Dual band display.

Optional battery packs, various sizes, power output.

For further information call Icom free on 008 338 915

Melbourne callers (03) 529 7582 Icom Australia Pty. Ltd., 7 Duke Street, Windsor 3181.
Icom Australia's warranty is only applicable to products purchased from their authorised Australian Dealers.



■ AMATEUR ■ MARINE ■ LAND-MOBILE ■ AVIATION ■ CB ■ AMATEUR ■ MARINE ■ LAND-MOBILE ■ AVIATION ■ CB ■ AMATEUR ■ MARINE ■ LAND-MOBILE ■

Please rush to me your brochure on the 2SA 2SAT 4SAT 24AT and the name of my nearest Icom stockist.

SEND TO: Freepost 15, Icom Australia Pty Ltd, Windsor, 3181 (no stamp required).

Mr., Mrs., Ms. Company Title

Address Suburb

City Post Code Phone No.

NCAA 4641 AR

■ AMATEUR ■ MARINE ■ LAND-MOBILE ■ AVIATION ■ CB ■ AMATEUR ■ MARINE ■ LAND-MOBILE ■ AVIATION ■ CB ■ AMATEUR ■ MARINE ■ LAND-MOBILE ■

AMATEUR RADIO

JULY 1990

RRP \$3



THE WIA RADIO AMATEUR'S JOURNAL

KENWOOD

More features than ever before!

Announcing the exciting new TH-26A and TH-46A handheld transceivers.

Your transceivers for 2 metres and 70 cm have never had so many features packed into such a convenient size!

Don't let the sleek, streamlined looks fool you. The new range of TH-26A and TH-46A transceivers are built tough to make it in Australia's harsh conditions.

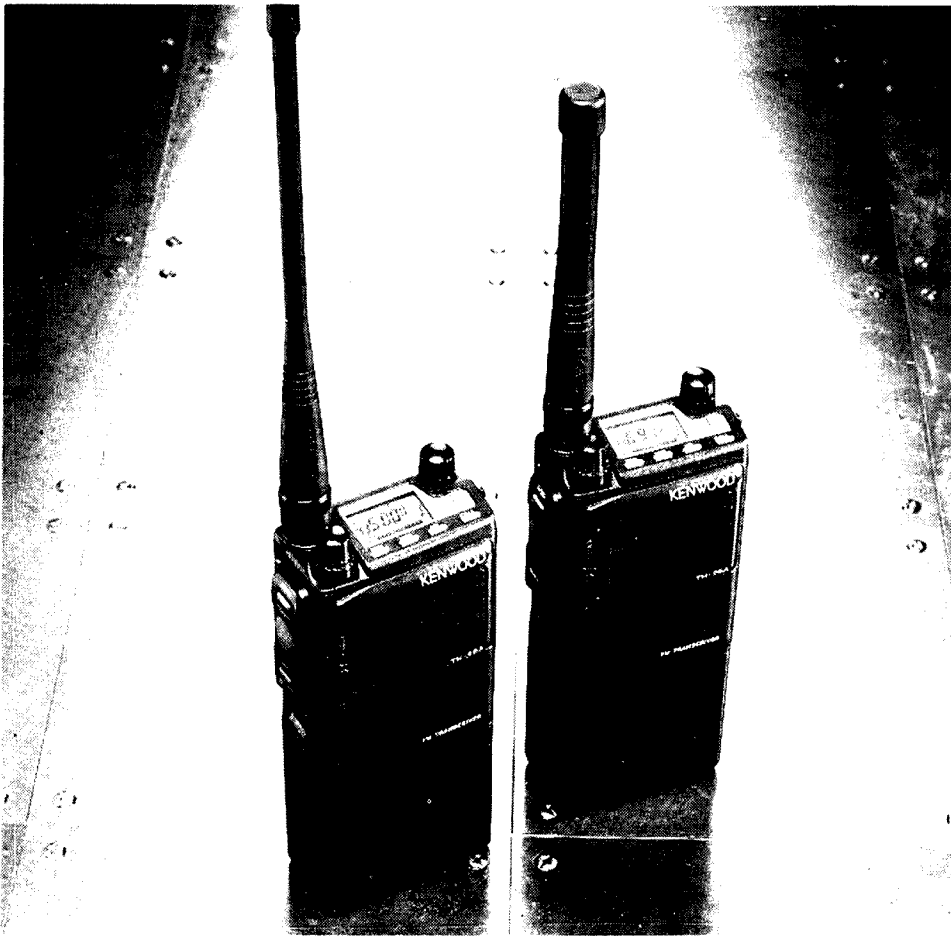

This high-performance duo is all-new from the ground up, and incorporates a number of special Kenwood features not seen before. Things like three output power levels — from a super low 'economy' setting of just 20mW which is ideal in so many applications — to a full 5 watts when powered from 12V. These rigs have all your bases covered.

A full 21 memory channels (including one special 'call' channel) can be programmed with frequency, offset and many user-defined features such as CTCSS tones for repeater access and linking functions.

While the Kenwood TH-26A and TH-46A are supplied with a very comprehensive range of features, you can also choose from a wide variety of options to specify the transceivers to meet your exact requirements.

You can experience the very latest communications technology at your local Kenwood dealer, or send the coupon below to receive an information package.

KENWOOD ELECTRONICS AUSTRALIA PTY. LTD.
(INCORPORATED IN N.S.W.)

4E Woodcock Place, Lane Cove, N.S.W. 2066, Australia
Ph. (02) 428 4222, (02) 428 1455, Fax (02) 427 6869
Call now for further information and the name of your nearest authorised Kenwood dealer.

Please phone, mail or fax for information

Name.....

Address.....

..... Postcode.....

Publication..... Issue.....

Model.....



Amateur Radio is published by the Wireless Institute of Australia, as its Official Journal on the last Friday of the previous month.

EXECUTIVE EDITOR
Bill Rice VK3ABP

MANAGING EDITOR
Graham Thornton VK3IY

NEWS EDITOR
Jim Linton VK3PC

SENIOR TECHNICAL EDITOR
Peter Gibson VK3AZL

TECHNICAL EDITORS
David Brownsey VK4AFA
Don Graham VK6HK
Evan Jarman VK3ANI
Peter O'Connor VK4KIP
Gil Sones VK3AUI
Phil Steen VK4APA
Roy Watkins VK6XV

DRAFTING
Vicki Griffin VK3BNK

MARKETING
Bruce Kendall VK3WL
Norm Eyres VK3ZEP

ADVERTISING
Ann McCurdy
All contributions and correspondence concerning the content of Amateur Radio should be forwarded to: -
The Editor
Amateur Radio
PO Box 300
Caulfield South
VIC 3162

Registered Office
3/105 Hawthorn Road
Caulfield North VIC 3161

Telephone: (03) 528 5962
(03) 523 8191
Fax: (03) 523 8191
(Non dedicated line)

Business hours: 9.30am to 3pm
weekdays

Deadlines

	Editorial	Hamads
Aug	9/7/90	11/7/90
Sept	6/8/90	8/8/90
Oct	10/9/90	12/9/90

Delivery of AR: If this magazine is not received by the 15th of the month of issue, and you are a financial member of the WIA, please check with the Post Office before contacting the registered office of the WIA.

© Wireless Institute of Australia 1990

CONTENTS

Technical

A Front End Tuner for the VLF-LF Receiver	9
<i>Lloyd Butler VK5BR</i>	
A Shack Full of Junk	12
<i>Ken England VK4JPE</i>	
QSL Card Generator	17
<i>Ron Churcher VK7RN</i>	
Signal Strength, 'S' Meters and Preamps	14
<i>Gordon McDonald VK2ZAB</i>	
Two-Metre Meteor Scatter Tests in VK4	16
<i>John Roberts VK4TL</i>	

General

Amateur Radio Long Vanuatu Tedei	21
<i>Jim Linton VK3PC</i>	

Equipment Review

The Kenwood TH-75A Dual Band Handheld Transceiver	19
<i>Ron Fisher VK3OM</i>	

Book Review

Microwave & RF Designer's Catalogue	13
<i>Ron Fisher VK3OM</i>	

Operating

Awards	26
Contests	
Calendar, 1990 RD Contest Rules	22
WA 3.5MHz Contest Rules	23
1989 VK-ZL Oceania Contest Results	25

Columns

Advertisers Index	56	Intruder Watch	38
ALARA	42	Morseword No 40	43
AMSAT	34	Over To You - Members' Opinions 49	
Club Corner	46	Pounding Brass	33
Divisional Notes		QSLs from the WIA Collection	47
VK2, VK3 Notes	44	Random Radiators	40
VK4 Notes, 5/8 Wave	45	Repeater Link	39
QRM from VK7	46	Silent Keys - Obituaries	48
Editor's Comment	2	Spotlight on SWLing	38
Education Notes	37	Stolen Equipment	17
FTAC News	37	VHF/UHF and Expanding World	31
Hamads	54	WIA Directory	2,3
HF Predictions	52	WIA News	3
How's DX	27		

Cover

Vanuatu celebrates its 10th anniversary of independence this month with the Vanuatu Amateur Radio Society setting up a commemorative station YJ10IND. It will be looking for contacts with VK. The WIA broadcasts on Sunday will be supplied further details. The first Ni Vanuatu YL operator Touasi Taiwia YJ8NTT is pictured on this month's cover at a rig with Tim Williams, also interested in the hobby, looking on. Picture taken by photographer Philippe Metois of Vanuatu. For full story, see article by Jim Linton VK3PC on page 21.

Disconnected Jottings

There have been several items this month, either presented to me or forcing themselves to my notice. Most are quite unrelated each to the other, but all deserve some comment; so, here goes!

Space Restrictions

Last month we gave notice that from now on letters to "Over to You" exceeding 200 words in length will not be published. This is due to pressure on space since we have reduced our total pages as a result of decreasing advertising income, in its turn due to the state of the national economy. A similar restriction also applies to obituaries. In either case, items significantly over the limit will be returned to their writers for condensation, and some have already been sent back. There are some though, in the order of 250 words, which have been accepted until you, the writers, become familiar with the limit. Pruning these to size has been a job for guess who? Yes, me! Believe me, it's not easy and it takes time. There is an old proverb, that a liter-

EDITOR'S COMMENT

BILL RICE VK3ABP EXECUTIVE EDITOR

ary genius can say in 200 words what any fool can say in 1000! We can't all become geniuses overnight, but please take pity on Hon Exec Ed and prune out those surplus words. Please?

Old Timers

I had a phone call recently from Jim McDonnell, VK2DJM, of Ballina. Jim is 80 years old (he sounded much younger over the phone) and has held the previous calls of VK3ZN and VK4ZN. He lives in a retirement village, and is crusading for the older, somewhat incapacitated amateurs who would love to get back on the air but are unable any longer to put up antennas. As a group, radio amateurs are slowly becoming older (like the general population, but faster) so this situation is becoming more common as time goes on. Jim would like to see radio clubs in particular taking a more active interest in running working bees to help out their older members, or po-

tential members, in these situations. How about it, folks?

Federal Tapes

As was announced last month, for reasons which would take too long to explain here, the production of weekly Federal News tapes for Divisional broadcasts has stopped for good after 15 years. That announcement was made in WIA News, which was only partly written by Bill Roper last month. But, since its inception, that column has been Bill's baby, and it was thought inappropriate to include thanks to Bill (and Ron Fisher) in the column. As Executive Editor, I am not so restricted, and I would like to acknowledge here and now the tremendous effort made by Bill and Ron over all those years. It is a great pity that the service "ground to a halt" so suddenly, but I know for sure that 3ARZ and 3OM are glad to have the extra spare time. Many, many thanks to them both for their thousands of

hours of unpaid dedication.

Lake Eyre Safari

A couple of months have gone by since my last mention of Lake Eyre, or indeed of sailing. A correspondent has meanwhile suggested that probably no-one is interested anyway! Obviously he's not, but judging by other letters, some are. The big news since then has been the record floods in outback Queensland in April. By mid-May the Cooper Creek flow at Innamincka was about 12 million cubic metres per hour, but at the time of writing was not expected to reach Lake Eyre until late July. It seems that it will not be as big a filling as in 1974, but there is no doubt that there will be sufficient depth for sailing until late next year. I am hoping to take our trailer-sailer to the Lake as soon as the depth is adequate, possibly in September, and to make it a bigger, brighter and better DXpedition than we achieved back in 1975, '76 and '77. I wonder how many of you might be interested in that, perhaps even joining us on the Lake for a few days? I await response from at least a few of you!

Wireless Institute of Australia

The world's first and oldest National Radio Society - Founded 1910
 Representing Australian Radio Amateurs - Member of the International Amateur Radio Union
 Registered Executive Office of the WIA: 3/105 Hawthorn Road, Caulfield North, Vic, 3161
 All mail to: **PO Box 300, Caulfield South, Vic, 3162** Telephone: (03) 528 5962 (03) 523 8191
 Fax: (03) 523 8191 (Non-dedicated line)

Business Hours: 9.30 am to 3.00 pm on Weekdays

General Manager and Secretary: Bill Roper VK3ARZ

EXECUTIVE

President:	Peter Gamble	VK3YRP	VK1 Federal Councillor:	George Brzostowski	VK1GB
Vice Chairman:	Ron Henderson	VK1RH	VK2 Federal Councillor:	Terry Ryeland	VK2UX
	Kevin Olds	VK1OK	VK3 Federal Councillor:	Peter Maclellan	VK3BWD
	Brenda Edmonds	VK3KT	VK4 Federal Councillor:	David Jerome	VK4YAN
	Bill Rice	VK3ABP	VK5 Federal Councillor:	Bill Wardrop	VK5AWM
Immediate Past President:	David Wardlaw	VK3ADW	VK6 Federal Councillor:	Neil Penfold	VK6NE
			VK7 Federal Councillor:	Joe Gelston	VK7JG

FEDERAL CO-ORDINATORS

Amsat:	Graham Ratcliff	VK5AGR	Int'l Travel Host Exch:	Ash Nallawalla	VK3CIT
Awards:	Phil Hardstaff	VK3JFE	QSL Manager (VK9, VK0):	Neil Penfold	VK6NE
Contest Manager:	Frank Beech	VK7BC	FTAC:	John Martin	VK3ZJC
Education:	Brenda Edmonds	VK3KT	Federal Tapes:	Ron Fisher	VK3OM
EMC:	Hans Ruckert	VK2AOU	Videotape:	John Ingham	VK5KG
Historian:	John Edmonds	VK3AFU	WICEN:	Bill Wardrop	VK5AWM
Intruder Watch:	Gordon Loveday	VK4KAL			

WIA NEWS

EXECUTIVE

Repeater Linking Policies

Recently there has been quite a bit of misinformation circulating on-air about one of the policies relating to repeater linking. In order to dispel this misunderstanding, Peter Gamble VK3YRP, the WIA Federal President, and ex-Chairman of FeTAC, explains the history and status of the repeater policies in question....

In 1985, the WIA Federal Technical Advisory Committee (FeTAC) prepared a paper on repeaters, which covered

many topics, including repeater linking. The paper was initially prepared as a response to a paper on repeaters by the then Department of Communications (DoC), now the Department of Transport and Communications (DoTC), which was proposing some quite harsh repeater licensing requirements. These included a proposal to licence a repeater only when the traffic justified it!

The FeTAC paper was prepared with inputs from the Divisions and drafts were circulated for comment. Some of the proposals were also discussed with DoC officials to

gain some insight into their approach to the subject. The paper was then presented and discussed in detail at the 1986 Federal Convention and, with modifications, was accepted as WIA policy.

Following the 1986 Convention, the paper was forwarded to DoC. The DoC response gave approval for repeater linking and also 28 MHz FM repeaters. It contained a set of conditions and policies on various repeater matters, some of which have since been included in the latest regulatory booklet (DOC 71).

Since that time, several repeaters have been successfully linked in various configurations. However, concern has been expressed recently at some of the DoC policies and conditions that apply. One policy in particular that

is causing some concern at the moment is that:

"The DoC will authorise the cross-linking of up to three repeater stations. Cross-linking of any number of repeaters for the purposes of WICEN or approved WIA broadcasts will, however, be considered."

This policy was first stated in a letter to the WIA signed by David Hunt the then Manager, Regulatory Operations Branch, Canberra, and dated 30/9/86.

At this point it is interesting to go back to the original WIA repeater paper. DoC had expressed concern that an unlimited network of linked repeaters operating in a mode where all transmitters simultaneously carried the same transmission was unduly and unnecessarily tying up the radio spectrum to the detri-

WIA DIVISIONS

The WIA consists of seven autonomous State Divisions. Each member of the WIA is a member of a Division, usually their residential State or Territory, and each Division looks after amateur radio affairs within their State.

Division	Address	Officers	Weekly News Broadcasts	1990 Fees
VK1	ACT Division GPO Box 600 Canberra ACT 2601	President Ted Pearce Secretary Jan Burrell Treasurer Ken Ray	VK1AOP 3.570 MHz VK1BR 2m ch 6950 VK1KEN 70cm ch 8525 2000 hrs Sun	(F) \$65.00 (G) (S) \$52.00 (X) \$39.00
VK2	NSW Division 109 Wigram St Parramatta NSW (PO Box 1066 Parramatta) 2124 Phone (02) 689 2417 Fax (02) 633 1525	President Roger Henley Secretary Tim Mills Treasurer David Horsfall (Office hours Mon-Fri 1100 - 1400 Wed 1900 - 2100)	VK2ZIG 1.845 MHz AM, 3.595 AM(1045) SSB (1915 only), 7.146 AM (1045 only) 10.125 SSB (1045 only), 28.320 SSB, 52 120 SSB 52.525 FM 144.12 (SSB), 147.000 FM(R) 438.525 FM(R) 584.750 (ATV Sound) 1281.75FM (R) Relays also conducted via many repeaters throughout NSW.	(F) \$59.00 (G) (S) \$47.00 (X) \$33.00
VK3	Victorian Division 38 Taylor St Ashburton Vic 3147 Phone (03) 885 9261	President Jim Linton Secretary Barry Wilton Treasurer Rob Hailey Office hours 0900-1600 Tue & Thur	VK3PC 1.840 MHz AM, 3.615 SSB, 7.085 SSB, 147.250 FM(R) Mt Macedon, 147.225 FM(R) Mt Baw Baw, 146.800 FM(R) Mildura, 438.075 FM(R) Mt St Leonard 1030 hrs on Sunday	(F) \$65.00 (G) (S) \$52.00 (X) \$39.00
VK4	Queensland Division GPO Box 638 Brisbane Old 4001 Phone (07) 284 9075	President Ross Mutzelburg Secretary Eddie Fisher Treasurer Eric Fittock	VK4IY 1.825, 3.605, 7.118, 10.135, 14.342, 18.132, 21.175, 28.400, MHz VK4ABX 52.525 regional 2m repeaters and 1296.100 0900 hrs Sunday VK4NEF Repeated on 3.605 & 147.150 MHz, 1930 Tuesday	(F) \$65.00 (G) (S) \$52.00 (X) \$39.00
VK5	South Australian Division 34 West Thebarton Rd Thebarton SA 5031 (GPO Box 1234 Adelaide SA 5001) Phone (08) 352 3428	President Rowland Bruce Secretary John McKellar Treasurer Bill Wardrop	VK5OU 1820 kHz 3.550 MHz, 7.095, 14.175, 28.470, 53.100, 145.000, 147.000 FM(R) Adelaide, 146.700 FM(R) Mid North, 146.900 FM(R) South East, ATV Ch 34 579.00 Adelaide, ATV 444.250 Mid North VK5BJM (NT) 3.555, 146.500, 0900 hrs Sunday VK5AWM	(F) \$65.00 (G) (S) \$52.00 (X) \$39.00
VK6	West Australian Division PO Box 10 West Perth WA 6005 Phone (09) 388 4388	President Alyn Maschette Secretary John Farnan Treasurer Bruce Hedland - Thomas	VK6KWN 146.700 FM(R) Perth, at 0930 hrs Sunday, relayed on 3.560, 7.075, 14.115, 14.175, 21.185, 28.345, 50.150, 438.525 MHz Country relays 3582, 147.350(R) Busselton 146.900(R) Mt William (Bunbury) 147.225(R) 147.250 (R) Mt Saddleback 146.725(R) Albany 146.825(R) Mt Barker Broadcast repeated on 3.560 at 1930 hrs.	(F) \$56.00 (G) (S) \$45.00 (X) \$30.00
VK7	Tasmanian Division 148 Derwent Ave Lindisfarne TAS 7015	President Tom Allen Secretary Ted Beard Treasurer Peter King	VK7AL 146.700 MHz FM (VK7RHT) at 0930 hrs Sunday relayed on 147.000 (VK7RAA), 146.750 (VK7RNW), 3.570, 7.090, 14.130, 52.100, 144.100 (Hobart) Repeated Tues 3.590 at 1930 hrs	(F) \$63.00 (G) (S) \$50.00 (X) \$38.00
VK8	(Northern Territory) is part of the VK5 Division and relays broadcasts from VK5 as shown (received on 14 or 28 MHz).			

Note: All times are local. All frequencies MHz.

Membership Grades
Full (F) Pension (G)
Needy (G) Student (S)
Non receipt of AR (X)

Three year membership available to (F) (G) (X) grades at fee x 3 times

ment of other amateurs. The WIA generally supported this view and, after consultation with DoC, the following guideline was formulated:

"The maximum number of repeaters to be cross-linked where simultaneous emission is used will usually be a maximum of three. Where the received transmission is stored before retransmission, for example in RTTY or packet mode operations, or where repeaters may be selectively added to the link, then this limit does not apply. This restriction does not apply to the cross-linking of repeaters for a temporary specific purpose (eg a WIA Broadcast or for WICEN activities).

Reference: Repeater Paper, Section 4.3 (f), General Guidelines for Repeater Cross-Linking."

This guideline makes an interesting number of distinctions between "hard linked" repeaters and "selectively linked" repeaters. First, all repeaters where the message is stored before retransmission, such as packet or RTTY repeaters are considered to be "selectively linked" and hence the "maximum number of three" rule does not apply to these repeaters. Indeed, the emergence of the packet networking systems follows this idea and these repeaters are not considered to be "linked" but rather "networked".

Second, special exemptions should apply for WIA Broadcasts or WICEN activities. These are clearly different circumstances from the typical amateur transmission and are specifically referred to in the DoC policy statement.

Third, the idea of "selectively adding" repeaters to the link for real time transmission foreshadows the idea of "trunking" or "networking" a group of voice repeaters. At the time the paper was written, it was envisaged that some form of tone access would be used to select a desired output repeater. This type of system was then being tested experimentally in New Zealand, where a "back bone" link was being set up between

Auckland and Wellington.

It was considered that the flexibility should be there for Australian amateurs to follow similar paths. A typical scenario envisaged a trunk link between two major cities, with perhaps several spurs to large towns along the way. Amateurs would be able to access the "network" at various points and easily select the desired output repeater by using some form of tone signalling, such as DTMF.

In discussions with the Department of Communications in 1986, these ideas were floated and no opposition was shown to the idea. The DoC suggested that it would consider each proposal on its merits.

Later discussion with DoTC, continuing up to the preparation of these comments, has confirmed that it is prepared to consider each proposal on its merits.

Thus the WIA believes that there is sufficient flexibility within the current DoTC policy to accommodate all possible arrangements for repeater networks, whatever the mode.

Crimes Act Amendment

The WIA has just become aware of an amendment to the Crimes Act 1914 that is the cause of some concern. George Brzostowski, VK1GB, advises that the terms of the new section 85ZKB of the Crimes Act 1914 of the Commonwealth, now makes it an offence for a person to manufacture, advertise, display or offer for sale, sell or possess an apparatus of device (whether in an assembled or unassembled form) that the person knows is an apparatus or device of a kind that is capable of being used to enable a person to intercept a communication in contravention of section 7(1) of the Telecommunications (Interception) Act 1979.

The critical elements are that the defendant be proved to have known that the device was capable of being used by

any person, whether the defendant or anybody else, for the purpose of interception.

That is not the end of the matter as far as radio amateurs are concerned. The Act invokes a person's skills and training as an aid in inferring that the person should have known the device's capabilities. That knowledge plus the act of possession, sale, etc, is sufficient to constitute the offence.

For instance, the terms of subsection 85ZKB(3) provide that for the purposes of establishing a contravention of subsection (1), if having regard to a person's abilities, experience, qualifications and other attributes, and all the circumstances surrounding the alleged contravention of subsection (1) the person ought reasonably to have known that an apparatus was of a kind referred to in subsection (1), the person shall be taken to have known that the apparatus was an apparatus to which subsection (1) applied.

The WIA is seeking clarification of how these provisions are likely to be policed, and whether there is a possibility of some amendments being introduced. There will be difficulties, as public policy to protect telecommunications, which now include the use of mobile telephones, is a matter of great importance to the Government.

After receiving advice and ascertaining how the Government sees the practical application of this law, the WIA will offer advice to members and radio amateurs generally.

People wishing to have an input into the WIA's efforts are invited to contact George Brzostowski VK1GB on (06) 247 3296.

Packet Networking Protocols

Since the inception of packet radio techniques into the Amateur Service there has been a rapid expansion in the use of this new mode worldwide. Many would argue that

packet is at present the most exciting aspect of our hobby.

However, the rapidly increasing interest in packet radio has caused problems with congestion on large packet networks. This problem has led to the development of several high level "networking" protocols to improve the efficiency and flow of information between packet repeaters used in a network environment. These protocols, used only at the repeater stations, are transparent to the end user and therefore require no change to the user's existing node equipment.

As a consequence, Australian amateur packeteers have looked towards using the various networking protocols available from overseas, such as NETROM, ROSE, TEXNET, etc..

And this is where a problem arises!

Back in November 1988, DoTC raised the matter with the WIA in the form of a discussion paper that included the following comments:

"Under existing Australian licence conditions each packet header is required to contain the call sign of the destination station, the originating station and, where different, the station transmitting. Both the AX25 and V3 protocols have no difficulty in meeting this minimal requirement.

While both of these packet protocols allow the interconnection of repeater stations under a digi-peater scheme, in practice they have proved inefficient where traffic levels are high. This aspect is understood to be causing packet repeater networks to be effectively limited to a maximum of about three stations.

In essence the constraint is due to each individual packet being transferred from repeater to repeater with acknowledgement from the last station in the chain. Any failure occurring between the intervening stations is not identified until the last link. As a consequence considerable delays can occur. This situation is exacerbated under heavy traffic conditions.

The virtual circuit networking protocols, on the other hand, acknowledge at each transfer of the packet, and have been streamlined so that only one "connection" is made between repeater stations. All individual user's packets destined for a repeater are handled together within this framework.

Packet transmissions occurring between stations in the network are only identified with the call sign of the transmitting and receiving repeater. However, because the protocols are transparent to the user, the up/down link packets to a repeater follow the AX25 or V3 identification format.

Except for some systems, such as NETROM, the networking protocols all meet Australian identification requirements on the up/down links. However, all FAIL to conform on transmissions occurring between repeaters. The networking protocols therefore cannot be authorised under DoTC's existing packet licensing condition."

The WIA discussed this problem at length with several people active in packet radio and, as a result, sought from DoTC the facility to transmit inter repeater packets on the user frequency. However, after much discussion at the November 1988 Joint WIA/DoTC meeting in Canberra, DoTC and the WIA eventually agreed to alteration of the existing repeater linking conditions to allow packet, and to relax identification requirements, **but only where a separate interlink frequency is used!**

This ruling was publicised in WIA news broadcasts via the Federal Tapes, but was inadvertently not published in the pages of Amateur Radio magazine. Also, DoTC made a decision at that time not to delay the publication of the long awaited DOC 71 booklet any further and, therefore, the current version of DOC 71 was issued without these packet repeater linking amendments being included.

All these events have com-

bined to bring about confusion and misunderstanding with a small group of packet users.

In order to clarify the situation, a letter was sent to the WIA by DoTC on 13th June 1990, over the signature of the Manager Regulatory, Alan Jordan.

This letter is as follows:

"It has recently come to my attention that some confusion has arisen in the Amateur community concerning the use of "Rose" and other packet networking protocols. I would therefore like to take this opportunity to clarify the actual situation.

As you will recall, when the "packet" mode of transmission was introduced into Australia the Department placed only minimal conditions on its use. The primary requirement being that each "packet" must contain the call sign of the destination station, the originating station and, where different, the station transmitting.

Both the commonly used AX25 and V3 packet protocols fully comply with these conditions, either when used for direct communication between Amateur/Repeater Stations or for "digi-peater" operation.

On the other hand, all networking protocols have difficulty conforming with the identification requirements. Except for "Netrom", the majority meet the conditions in respect to communications to/from Amateur and Repeater Stations, but all fail to comply during intercommunications which take place between Repeater Stations.

Accordingly, "Rose, "Netrom" and like networking protocols are not authorised for use in the general packet environment. Notwithstanding this constraint, in recognition of the need to improve the efficient transfer of information in networks, the Department does permit the use of these protocols where separate repeater inter-link channels are employed.

In the special case where a

MAGPUBS

A Special Service of the Wireless Institute of Australia

The Complete DX'er 2nd Edition

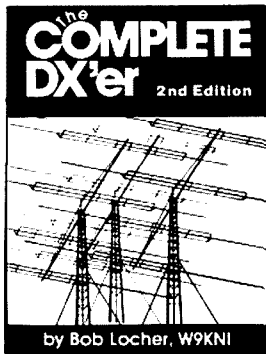

Since first publication to rave reviews in 1983, W9KNI's masterpiece, "The Complete DX'er" has become the standard text for the rising DX hunter. Now considerably revised and updated, this new 2nd edition 1988 fully retains the approach and feel of the original classic while adding two important new chapters of special interest to SSB operators. Every significant aspect of DX'ing is covered, from learning how to REALLY listen, how to snatch the rare ones out of pile-ups and how to secure that elusive QSL, plus advice on siting, equipment selection and antennas. Yet by no means is the book a series of dry lectures. Chapter after chapter of "reports from the front" detail life in the pile-ups, the excitement of landing the new one, the agony of defeat, all in a manner guaranteed to entertain and educate at the same time. This new edition is certain to retain its status as an all time classic.

204 pages 6" x 9" Stock # WIA194 ... \$20

This is the most comprehensive edition since the Handbook was first published in 1926. The sixty-seventh edition contains over 1200 pages and over 2100 tables, figures and charts. Added to this edition are new antenna projects including two high-performance Yagis for 144 and 432 MHz designed by Steve Powlishen, K1FO, Dick Jansson, WD4FAB has completely revised the space communications chapter, which includes his innovative array for AO-13 Mode L. As always the Handbook includes many chapters of construction projects, including:

- Power supplies, Keyers and Measuring Devices
- QRP transmitters and VHF/UHF preamps
- A High-performance communications receiver
- High-power HF and VHF amplifiers
- Digital audio memory keyer

The Handbook has always been known as a reference for component data. There is an entire chapter devoted to everything from tube and transistor specifications to aluminum tubing sizes. There is up-to-date information on digital techniques and operating practices ... and ... much ... much more.

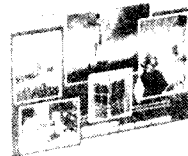

WIA 287 .. \$52.90

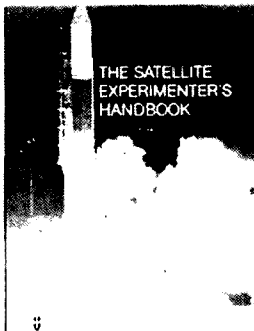

THE SATELLITE EXPERIMENTERS HANDBOOK

Martin R. Davidoff
Published by the ARRL Now under the one cover, here is the information you need to communicate through or pick up the signals from orbiting satellites. Whether your interest is in Amateur Radio, Weather, TV-Broadcast or other spacecraft, you'll find an immense store of valuable data in *The Satellite Experimenter's Handbook*. Whether you're a beginner, an experienced satellite enthusiast, a teacher or a scientist you'll find *The Satellite Experimenter's Handbook* to be indispensable.

11" x 8" 207 pages Stock WIA177 \$20.00

SATELLITE ANTHOLOGY

The second quarter-century of OSCAR satellites has begun ... We've collected the best of the Amateur Satellite News column and articles out of 31 issues of QST to better document this new era. You can use this handy volume alone or as a supplement to the previously published *Satellite Experimenter Handbook* (Stewart Stock # BX177). You'll find the latest information on OSCARs 9 through 13 as well as the RS satellites. Operation on Phase 3 satellites (Oscar 10 and Oscar 13) is covered in detail. A heretofore unpublished article gives a profile of the UoSat-Oscar 11 satellite. The popular four-part series, "Adventures In Satellite DX'ing" and "Working OSCAR—the Basics" are included. Timely information appears on the use of digital modes, tracking antennas, RUDAK, microcomputer processing of telemetry & where to find additional OSCAR information.

95 Pages 8 1/2" x 11"

Stock # WIA180 ... \$16



The above books, plus many more, are available from your WIA Divisional Bookshop. All items are less 10% discount for WIA Members and are plus postage and handling where applicable.

If not in stock at your Divisional Bookshop, your order will be taken and filled promptly. Not all publications are available from all Divisions.

network protocol is used on a dedicated repeater inter-link channel, each transmission between stations is only required to contain the call sign of the originating and destination Repeater Station. However, I would stress that all transmissions flowing to/from Repeaters in such a network and Amateur Stations must conform to the existing identification conditions."

This statement from DoTC is clear. Under the present rules governing the amateur service in Australia, networking protocols such as ROSE are constrained to interlinking situations only.

One can envisage a communication's trunk on its separate frequency with users gaining access to nodes on that trunk using different frequencies. Good communications practice would suggest the trunk on which the networking protocol operates is optimised for throughput and could well be on UHF or microwave and operated at high data rates, for example 9600 baud, or even higher. However, bearing in mind the experimental nature of amateur radio, please note that the WIA believes it is quite permissible to use interlinking frequencies in any amateur band in agreement with licensing conditions.

The WIA has long been aware that the DoTC requirements are more stringent than those applying elsewhere on the worldwide amateur scene. We have always maintained a pro-deregulation attitude in negotiation that is further witnessed by our stand in IARU circles against adopting AX25 as THE amateur packet protocol.

The WIA continues its representational and negotiating roles with DoTC and continues to press for changes to the existing conditions. However, we must know the requirements of all Australian packet users so that the WIA approaches to DoTC on behalf of Australian packet users support the use of the widest possible range of protocols.

Approaches to DoTC locally,

or at central office level in Canberra, by individuals, or representatives from local interest groups, are invariably referred to the WIA at Joint WIA/DoTC Meetings for their view.

So please make your views known to us. Address your comments to your Divisional Technical Advisory Committee, or direct to the Chairman of FeTAC, at the Executive office address, PO Box 300, Caulfield South, 3162.

1296 MHz Info Needed

Are you active on microwaves, that is 1296 MHz and above?

The WIA's WARC 92 Australian Preparatory Group representatives are urgently in need of information on the use of these bands in Australia.

Already the Chairman of FeTAC, John Martin VK3ZJC, has compiled a list of known operators. A little while ago a couple of the Divisions ran a similar plea to their members on their weekly news broadcasts.

If you are active on the microwaves, please advise details to the Chairman of FeTAC at the Executive office address, PO Box 300, Caulfield South, 3162.

John will collate the data for the WARC 92 team, and also publish a precis in Amateur Radio magazine in due course.

Australia Amateur Call Book

Is the information relating to your personal particulars correct in the WIA 80th Anniversary issue of the Australian Radio Amateur Call Book?

Now is a good time to correct your name, address and callsign details for publication in the next Australian Amateur Radio Callbook.

The 1991 Australian Amateur Radio Callbook is scheduled to be published towards the end of this year, but work on it has already commenced.

The information in any Callbook published by the WIA is only as good, and as up-to-date as the information received from DoTC, and from WIA members. WIA members keep us informed of their changes of address (otherwise Amateur Radio magazine does not arrive!), so their details published in the Call Book are taken from the WIA records and not DoTC records. However, bear in mind that these WIA records are only as accurate as we, and you the member, make them.

One of the most important priorities in the production of the Call Book is the list of suppressions. For one reason or another a few amateurs do not wish their address, and sometimes even their name, to be identified in the Call Book, but this suppression request **MUST** be on file **IN WRITING** in the Executive Office.

Please help the WIA to produce as accurate a Call Book as possible. If you want any changes made to your entry in the 1991 Australian Radio Amateur Call Book, it is not too early to advise the Executive office of the WIA at PO Box 300, Caulfield South, 3162.

Ham Radio Defunct

Hot on the heels of the announcement that the Australian electronics magazine, "Electronics Today International", has ceased publication comes the news that the June 1990 issue of the American "Ham Radio" magazine will be its last.

"Ham Radio" magazine and its associated "Ham Radio Bookstore" have been sold to the publishers of "CQ" magazine.

Existing subscriptions to "Ham Radio" will be fulfilled by "CQ".

Federal Technical Advisory Committee

The Federal Technical Advisory Committee, or

"FeTAC" as it is commonly known, has been very busy of late under the direction of the new Chairman, John Martin VK3ZJC.

Amongst many other items under current consideration, John advises that the new WIA repeater and beacon database has been completed, except for verification of information from VK1, VK5 and VK7. Copies of the relevant sections have been sent to FeTAC representatives in those Divisions. Once those checks have been made, one of the proposals the WIA is now considering is to make the new repeater/beacon database available for distribution to WIA members from the Executive office on computer disk.

John also advises that work is continuing on the UHF Band Plan revision. A set of proposed band plans has been drawn up, and these have already been passed for comment to several panel members of FeTAC. The revision is to be in two stages:

1. Minor changes to the narrow-band modes and calling frequencies on all UHF bands; and
2. Full band plans for 2300 MHz and higher bands.

Other activities include the following proposals that have been circulated to all WIA Divisions and published in Amateur Radio magazine for comment:

1. 6 metre band - new repeater and packet radio channels.
2. 6 metre band - beacon segment above 50.200 MHz.
3. 2 metre band - expansion of packet radio segment to 144.700 - 144.925 MHz.
4. 23 cm band - reinstatement of VSB ATV channel at 1285 - 1292 MHz.

Bandplans for Sale

The WIA has just published a 38 page booklet entitled "Bandplans for the Amateur Radio Service" that gives a background to bandplans and

how they are presented.

The booklet includes detailed bandplans for all Australian amateur service bandplans from 1.8 MHz to 47 GHz.

Update pages will be issued from time to time, for a small fee to cover printing costs and postage, to enable Australian amateurs to have a continually updated convenient reference to the Australian amateur service bandplans.

The cost of this invaluable publication is \$2.80, including handling and postage, and is only available from the Executive office of the WIA. Please forward your remittance, made out to "WIA", to "Bandplans, PO Box 300, Caulfield South, Victoria, 3162".

Only 400 copies of this bandplan booklet have been published so you will have to be quick to get your copy before they run out.

Cross Linking Repeater Tones

It seems from some conversations heard "on air", and some remarkably ill informed messages appearing on packet bulletin boards, that there still seems to be some misunderstanding of the WIA/DoTC agreement on the use of repeater tones. Most of these fears seem to be that Australian amateurs will be using three different tone systems on repeaters for cross-linking.

THIS IS NOT THE CASE!!

DoTC has agreed to accept all three systems, and the decision on which system to use has been left to the amateur service. It is now possible for amateurs to agree on a uniform national system that suits our needs, rather than having DoTC make the decision for us.

The WIA strongly supports a uniform national tone system, and this will be settled shortly in consultation with repeater groups throughout Australia. If the WIA has not pursued the policy of deregulation, this kind of consultation would not have been

possible.

Is it better to have a uniform tone system decided by amateurs, or a uniform system decided by DoTC regulation?

AR Special Editions

The first "Special Interest" edition of Amateur Radio magazine for several years, the June "Test Equipment" issue, has already become a collector's item.

Unfortunately, because of an error by the printers, the usual number of surplus copies was not printed, so the WIA is unable to respond to requests for individual or extra copies. Look after your valuable membership copy!

The next "Special Interest" edition of the WIA magazine will be the October 1990 issue, when the feature topic will be antennas. The Editors are already accepting articles for this issue but there is still time for a few more. Please remember that technical articles that require editing or drafting need to be submitted well before the advertised closing dates for copy. Articles which are not received by the date of the Publications Committee meeting on August 6th will be too late for the special issue.

As with the June 1990 "Test Equipment" issue, there will be a prize of one year's free membership of the WIA for the author of the article judged to be the best to be published in the October 1990 special "Antenna" issue.

Letter from IARU President

The following letter has been received from Richard Baldwin, President of the International Amateur Radio Union (IARU), and is addressed to Australian radio amateurs:

You, and the Wireless Institute of Australia.

Every decade or so amateur radio is faced with a cri-

sis.

Every decade or so the members of the International Telecommunication Union (ITU) meet for the purpose of deciding whether any changes need to be made in the allocation of frequencies to the 40-odd radio services that inhabit the spectrum. At such a conference, depending on the agenda, each service has to justify its needs and requirements, and the delegates of the administrations have to decide whether, for example, the Amateur Service and the Amateur-Satellite Service can substantiate their need for their existing allocations and whether, perchance, additional frequencies might be allocated to amateur radio at the expense of some other service. Or, and this is always a threat, whether some of the amateur frequency bands ought to be taken away from us and allocated to some other service. That's a disturbing thought, but it can happen, and it has happened.

The fundamental goal and objective of the International Amateur Radio Union (IARU) is to make sure that the Amateur Service and the Amateur-Satellite Service are adequately represented at, and between, international telecommunications conferences. Just to refresh your memory, IARU is a federation of 127 national societies, of which the Wireless Institute of Australia is one.

In preparation for any international telecommunication conference - that is, in preparation for a World Administrative Radio Conference (WARC) of the ITU - IARU, through its three regional organisations, draws up a plan to ensure that the needs of radio amateurs are properly developed and co-ordinated. Then, each member-society of IARU is responsible for making sure that its administration knows of the need of the amateur radio service and that its administration recognises the value of the amateur radio service.

And so you have many individuals involved in the work

of the IARU Administrative Council, which co-ordinates the overall WARC preparatory activity, and you have many individuals involved in the work of the three regional organisations, co-ordinating the preparation within the geographic boundaries of each region, and you have many individuals involved in the work of the member-societies, performing the necessary liaison with their telecommunications administrators.

But what about you? Where do you fit into this picture, this preparation for the next World Administrative Radio Conference, scheduled to be held in the first quarter of 1992?

You have an important role to play. You may not be a member of the Administrative Council, nor of the regional Executive Committee, nor of the WIA's cadre of leaders, but you're needed. Why? For support, that's why.

The WIA is the oldest amateur radio society in the world. It has a distinguished record of leadership in the preparation for, and participation in, ITU's WARC's. It has contributed mightily to the work of IARU. But it can continue to be successful, not only as a national society but as a participant in IARU/ITU affairs, only if it has the substantial support of radio amateurs in Australia.

If you are a member of WIA, you are helping it to play a key role in tackling the crisis that faces us in 1992. If you are not yet a member, the WIA needs your support. Whatever happens at WARC-92, good or bad, happens to all of us. With good team work, we stand a chance for success. Join the team!

**RICHARD L. BALDWIN,
WIRU,
PRESIDENT IARU.**

Historic WICEN Conference

Sunday, 3rd June, 1990 saw a memorable development in the WICEN area, with the first ever National Telephone con-

ference. After considerable behind-the-scenes organisation and planning, at 1355 hours EST all Divisions and the Federal WICEN Co-ordinator were connected through the telephone network to discuss WICEN Divisional organisation and plan further co-ordination and co-operation.

After moving quickly through the circulated motions for voting, several issues for future consideration were aired. Tasks which can be carried out on a National basis were considered, and various Divisions appointed to take further action.

A motion at the WIA Annual Convention called for a review of WICEN at National and Divisional level, so this telephone conference allowed the Terms of Reference to be discussed.

The conference concluded at 1645 hours, with the Divisions agreeing that a similar conference should be held in October 1990. A full outline of the meeting will be published in Amateur Radio magazine as soon as practicable.

Handicapped Radio Amateurs

The WIA recently received, via the IARU Region 3 Association, a booklet entitled "Information Program for Handicapped Radio Amateurs", published by IARU Region 1.

Besides an IPHA report for 1988/1990, the booklet contains "Information by Country", "Nets" and "Technical Information".

The booklet is available from the Executive Office for perusal by any handicapped amateur radio groups.

The WIA wishes to respond to IPHA with information on the Australian scene. If you are involved with amateur radio for the handicapped, please send a brief note of your activities to the Executive Office, together with a contact point.

Test Equipment Winner

After deliberation, the Publications Committee has judged the "Microwatt RF Power Meter" article by Ron Cook VK3AFW as the best of the articles published in the June 1990 "Special Test Equipment" issue of Amateur Radio magazine. As the winner, Ron is entitled to a year's free membership of the WIA. However, Ron, as with an increasing number of WIA members, is now holding a three year membership. Therefore, a cheque for the value of the current year's membership of the Victorian Division of the WIA has been presented to Ron.

When judging the qualifying articles, the Publications Committee asked that a special encouragement commendation be made to Trevor Sheppard, the author of the "Novel Polarity Tester" article on page 9.

Wanted! Contest Co-ordinator

Following the decision at the 1990 Federal Convention to appoint separate Co-ordinators for each of the major contests run by the WIA, the individual contest manager positions have been filled, and are as follows:

Ross Hull Contest

John Martin VK3ZJC

John Moyle Field Day

Phil Raynor VK1PJ

Remembrance Day

Northern Corridors Radio Club

VK Novice Contest

Westlakes Amateur Radio Club

VK/ZL/Oceania

Frank Beech VK7BC

However, no appointment has yet been made of an overall Federal Contests Co-ordinator. At present Neil Penfold VK6NE, the VK6 Federal Councillor, is carrying out the main tasks, but he would be happy to hand over and brief another qualified volunteer for the position.

If you believe you have the skills and enthusiasm to take on this most interesting task, please contact Neil Penfold VK6NE as soon as practicable.

Late Membership Renewal

A reminder to WIA members who are late in paying their subscriptions. If you are more than three months late in renewing your membership, your membership is transferred to a new membership cycle and missed back copies of Amateur Radio magazine can only be provided (if in stock) at a cost of \$4.00 each posted.

New UK Callsigns

The March 1990 issue of "Radio Communication", the monthly magazine of the Radio Society of Great Britain (RSGB), summarises planned changes to the system of callsigns in the UK, as the available callsigns in the present "G" series are running out. It seems that, shortly, new UK amateur stations may be using callsigns with prefixes in the MA to MZ range.

ar

**THIS SPACE
COULD BE
EARNING YOU
MONEY!**

**ADVERTISING RATES
AVAILABLE FROM
PO BOX 300,
CAULFIELD SOUTH,
3162**

A Call to all Holders of a Novice Licence

Now you have joined the ranks of amateur radio, why not extend your activities?

The Wireless Institute of Australia (N.S.W. Division) conducts a Bridging Correspondence Course for the AOCP and LAOCP Examinations.

Throughout the Course, your papers are checked and commented upon to lead you to a successful conclusion.

For further details write to:

The Course Supervisor

WIA

PO Box 1066

Parramatta NSW 2124

(109 Wigram Street, Parramatta)

Phone: (02) 689 2417

**11am to 2pm Monday to Friday
7 to 9pm Wednesday**

Whilst the circuit design has been based on an untuned aerial, it does not inhibit additional tuning of the aerial circuit to further improve performance. The option of doing this is dealt with in the section headed "aerials".

The Circuit

The circuit of the front end tuner is shown in figure 1. The circuit provides a tunable frequency range of 8 kHz to 600 kHz in four bands switched by SW1B. Other sections of the band switch, SW1A & SW1C provide direct coupling of the aerial to the receiver for broadband operation when the switch is set to the fifth position.

The tuning system is formed by inductors L1, L2, or L3, which are resonated with variable capacitor C4. This is a two section receiver tuning gang with a maximum capacity approaching 500 pF per section. Inductor L1 is a pot core assembly with two windings, each 130 mH. The windings are connected in series for band 1 to tune between 8 kHz and 25 kHz. One single winding is used for band 2 which tunes between 15 kHz and 40 kHz. Two 10 mH miniature chokes connected in series are used for band 3 which tunes between 35 kHz and 150 kHz. A single 1.5 mH miniature choke is used for band 4 which tunes 140 kHz to 600 kHz.

The ready wound pot core inductor is one donated by Norm Burton. The 10 mH and 1.5 mH chokes are a miniature type supplied by Dick Smith Electronics.

Resistors R1 to R4, switched by SW2, terminate the aerial and determine the loss resistance added to the tuned circuit and hence the circuit Q.

The high input impedance of voltage follower stage N1 provides coupling to the receiver input with minimal loading of the tuned circuit. This is necessary to maintain the high value of Q in the tuned circuit. For the voltage follower, one half of a JFET operational amplifier package type LF353 is used. This has good high frequency performance and was also used in the VLF-LF receiver for RF and IF amplification. (The other half of N1 package is not used. It was originally intended as an interface for the aerial but, as explained earlier, its use proved to be unsatisfactory.) As an alternative to the amplifier package, an emitter follower stage could be used. For this application, a Darlington connected transistor pair might be advisable to achieve sufficiently high input resistance.

For anyone interested in duplicating the circuit, two components specified in the circuit might not be readily available at the local electronics store. The first is the tuning gang, an item not in good

supply these days. The best bet is to recover one from a discarded broadcast receiver. Some gangs only have about 350 pF maximum capacity per section but a 3 section gang in one of these would do the job.

The second item is the pot cored inductor. This is an ideal type of inductor for the low frequency bands, if one can obtain the pot core parts assembly to wind one, or otherwise obtain one ready wound with a suitable inductance. An alternative idea was tried out with eleven of the Dick Smith 10 mH chokes connected in series to make up 110 mH. This tuned band 2 from 15.7 to 67 kHz. To lower the frequency for band 1, an 820 pF fixed capacitor was switched across the tuning gang with a fourth switch bank of SW1. This gave a tuning range for band 1 of 11.3 to 15.9 kHz. The maximum circuit Q achievable with the 10 mH chokes was around 50 to 100, not as good as the pot cored inductor, but still quite good.

Changes To Receiver

The front end tuner has been built as a stand alone unit which is simply inserted in the aerial feeder cable to the receiver. However, because of its addition, the 530 kHz trap in the receiver is no longer required and disconnection of the trap provides some improvement to the low receiver sensitivity at frequencies approaching 500 kHz.

Another change is the addition of a selective audio filter. According to Norm Burton, a good audio filter is essential for receiving VLF signals and he suggests a filter bandwidth of 100 Hz or less. Encouraged by this, a simple resonant filter was added to the audio stages of the receiver as shown in figure 2. The tuned circuit is formed by another of Norm's pot core inductors (130 mH) which is resonated with a 0.12 μ F capacitor. The circuit is driven in a series mode (much like

the front end tuner) from the low output resistance of amplifier N5B. As there is voltage gain (equal to Q) in the tuned circuit, the resistive output divider is used to prevent a steep rise in signal level when the filter is switched in.

The frequency of the filter is 1200 Hz, worked out as follows: In the narrow IF mode, the centre frequency is 457.6 kHz. The beat frequency oscillator is needed to receive the narrow band modes and this runs at 456.4 kHz, 1200 Hz lower than the intermediate centre frequency. Hence, maximum signal beat occurs at a fre-

Table 1

Band	Bandwidth (kHz)	"Q" Frequency Bandwidth (Hz)	Position 1 Q
1	10	48	208
1	15	60	250
1	20	84	238
1	25	132	189
2	16	85	188
2	25	121	207
2	35	234	150
3	40	610	66
3	70	802	87
3	120	1140	105
3	150	1360	110
4	150	1830	82
4	200	3480	57
4	300	2910	103
4	400	2300	174

Table 2

Bandwidth For Different "Q" Switch Positions

At 15 kHz On Band 1

Switch Pos	Bandwidth (Hz)	Q
1	60	250
2	83	181
3	145	103
4	226	66
5	360	42

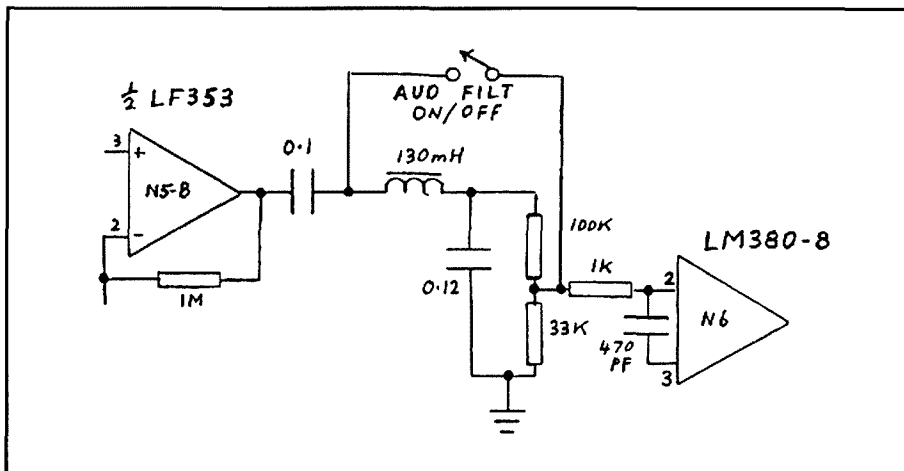

Figure 2: Addition of 1200 Hz Audio Filter to the Receiver

quency of 1200 Hz and this is the tuned frequency of the filter. The bandwidth of the filter is 100 Hz and it is very effective in reducing much of the low frequency hash which gets through in spite of the narrow RF bandwidth.

Operation

Operation of the front end tuner, in conjunction with the receiver, can be a little tricky as the front end is not ganged to the receiver tuning. One method of tuning is to set the band switch to the broadband position and first locate the station with the receiver tuning dial. The band switch is then set to the appropriate band and the tuning gang is set for maximum signal level. Care must be taken not to tune in to the frequency of a strong signal which would simply enhance cross modulation by that signal. Tuning on the lowest frequency bands is very sharp and on the unit constructed, a 2.5 to 1 reduction gear was fitted to the tuning knob to assist in adjustment. A calibrated scale marked in frequency for each band was also added to simplify setting of the front end tuning near the frequency marked on the receiver tuning dial. With this aid, the front end tuning is then simply trimmed for peak signal level with little chance of false tuning.

A problem at VLF & LF is noise from mains operated equipment in the local vicinity and particularly in one's own house. I find it necessary to turn off fluorescent lamps, triac controlled light dimmer switches and TV sets. The TV line time base at 15625 Hz, in the middle of the VLF band, is a particular nuisance. This type of noise tends to disappear after midnight when everyone has switched things off and gone to bed.

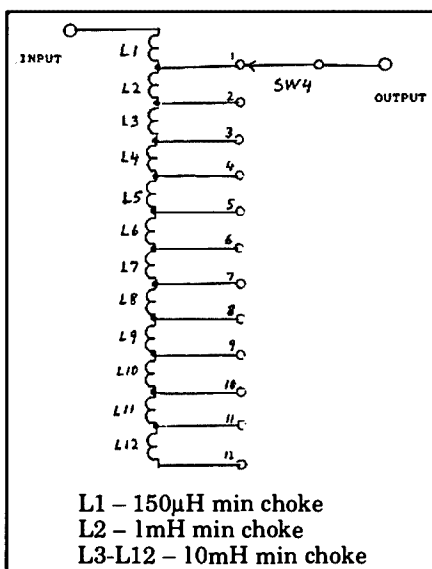

Figure 3: Aerial tuning circuit

Measured Performance

Table 1 lists measurements taken of bandwidth and Q for various frequencies in each band of the tuner and with Q set maximum. It is interesting to observe the high Q factors obtained, particularly for bands 1 & 2 which use the pot core. This is something which could not be achieved in the early days, before ferrite cores, unless regeneration was applied.

Table 2 lists measurements taken of bandwidth and Q at 15 kHz on band 1 for different settings of the Q switch. This shows that a 6 to 1 range of bandwidth and Q can be selected.

Aerials

At low frequencies the usual wire aerial is but a fraction of a wavelength long and as a general rule, the more wire put up in the air, the greater is the signal level we will capture. As one would expect, at the home location the longest of three wire aerials available gives the highest signal level. The signal level is also improved by about 6 dB when all three wires are paralleled together.

Earlier mention was made of tuning the aerial and this is an optional addition which can be made to the front end circuitry. By resonating the inherent capacitance of the aerial with series inductance and loading the output into the terminal resistance set by the Q switch, a further gain in signal level of at least 10 dB is achieved. The three paralleled wires at the home location measure a capacitance of around 1000 pF and resonance with this, over most of the VLF band, was made possible by tapping along the bank of series connected 10 mH chokes used in a test previously discussed. Resonance was found to be fairly broad and the 10 mH increments were proved to be small enough to allow peaking of the signal.

The front end unit was ultimately fitted with a further switch, connected to ten of the 10 mH chokes and two other chokes, for tuning the aerial. The circuit diagram of this is shown in figure 3 and shown as an optional block in figure 1. The 10 mH chokes provide aerial tuning adjustment in fine steps between 13 kHz and 50 kHz. As there were only two spare positions on the 12 position rotary switch for the higher frequencies, one had to be satisfied with 1.15 mH to resonate around 150 kHz and 150 µH to resonate around 400 kHz. As stated before, tuning is quite broad and even with this compromise, some gain is achieved over the whole of the higher frequency range by the addition of the inductors.

As is well known, the radiation resistance of an electrically very short aerial is but a fraction of an Ohm and at reso-

nance we see a low resistance, essentially that of the earth, in series with the loss resistance of the inductor. As it turns out, this works out quite well to match into the low terminal resistance set by the Q switch. It must be pointed out, if not obvious, that the inductance values used in figure 3 are selected for a particular aerial capacitance and might have to be varied to suit another particular aerial.

At this stage, a brief mention of Norm Burton's aerial system might also be of interest. He uses a 33 ft 6 wire cage with 42 ft of 4 wire cage down lead. The cage at the top increases the capacitance to ground and raises its effective length and hence its radiation resistance and aerial efficiency. He also uses a frame aerial which gives lower signal level but enables him to phase out some of the interference he gets from localised power lines. Norm tunes all his aerials and considers it essential for good reception at these low frequencies.

Some Final Remarks

It seems very clear that a highly selective front end is essential for good reception at VLF. A narrow bandwidth is needed to restrict the noise and this is more easily controlled in the IF stages of a superheterodyne although some form of front end tuning is clearly desirable to prevent cross modulation from strong local stations. What might seem less apparent is the fact that the noise level on this band is so high that the noise itself can cross modulate the desired signal. It seems essential to restrict the noise bandwidth as much as possible before amplification takes place and herein lies the need for the highly selective front end.

All this ties in with much of what Norm Burton has told me. He has two superheterodyne receivers and a Marconi CR200 TRF receiver which tune the VLF band. The CR200, which has two tuned RF stages before detection, outperforms the other receivers both in minimising noise and separating one station from another, not to mention the odd spurious responses the superhets happen to generate. He has also pointed out how single valve regenerative receivers were successfully used on these low frequency bands in the early years. By using regeneration, effective Q would have to be high with resultant narrow bandwidth and good selectivity. I am almost tempted to build one up to see how well it works.

Dick Hope VK4DLJ informs me that there is quite a lot of interest in ELF-VLF-LF in the USA and there is an organisation called the Longwave Club of

continued on page 25

A SHACK FULL OF JUNK

KEN ENGLAND VK4JPE
31 MORGAN ST ROCKHAMPTON 4700

Many amateur shacks boast very little in the way of test gear. Some shacks seem to contain a multimeter and a VSWR meter (left over from CB days?). Perhaps the multimeter is a "you-beaut" digital unit that scrambles every time it feels RF.

But the well equipped shack for a home brewer or avid kit builder should contain more. The other day I bought a book on the design of phase lock loop circuits. This excellent publication even included instructive experiments to be carried out using various integrated circuits. But to do the experiments in full required an "Oscilloscope. Just about any general-purpose type will do, but it must be at least a dual-trace type."

Also required were a function generator, a frequency counter and a VOM. After this list was swallowed, there were a "number of useful circuits" requiring logic switches and 7-segment displays.

Now I am sure that the experiments are most instructive. But if I felt wealthy enough to own dual trace scopes and function generators, I might have bought sufficient crystals at twenty odd dollars each and never have given the idea of replacing them with a cheaper PILL synthesiser a thought!

But this is no excuse for having no test gear. The amateur with ambitions of home brewing can set himself up with some useful units for quite a low cost.

In spite of what some amateurs with access at their workplace to the latest in multi-wobulated spectrum sweepers may tell you, there is nothing wrong with "old valve gear". A signal generator full of octal tubes may not be good to 500 MHz but it will certainly work at 455 kHz and probably at 10.7 MHz as well for alignment jobs. A CRO with a 2.5 or 5 cm tube may be no good at 15 MHz, but for IF and AF work it's worth trying. What about those off-frequency tones in the packet modem?

A Load Of Old Rubbish

Have a look around the junk shops in your area, every now and then. Not long ago I gave a few (very few) dozen dollars for a Philips CRO and an Eddystone 5-band receiver. Both units were truly filthy. On the outsides there was dirt on the cases where most things haven't even got places!

But both units had newish silicone-

rubber-insulated mains cords. This led me to believe that they might have been more or less OK. "Well, *caveat emptor*" I thought and produced my cash. I took both units out of the shop. I wiped both units on the grass to remove the loose muck. I put both units in the car boot.

Later, both units got a good dusting with a (dry) car washing brush. I pulled the case off the CRO. All of the internal wiring was silicone insulated and looked in good condition. The chassis looked like new! Two of the timebase capacitors were obviously late replacements. I plugged the CRO in. I turned it on. Nothing happened. No sparks. No smoke. No funny noises. No display on the screen either! I switched it off and turned to the Eddystone.

A Digression

The story of the Eddystone was much the same. Silicone insulation and one or two newish electrolytics inside. "Miniature" valves instead of the octal base ones in the CRO. I found a metre or so of wire and attached it to what seemed to be the medium wavelength antenna terminal. I plugged the set in and switched on. No smoke. No sparks. No station, but a gentle hum from the set. Aha! Tuned near 29 MHz eh? No wonder nothing was heard on a winter afternoon.

The other end of the band selector. Swept the broadcast band. The local ABC station on 837 kHz at 10,000 Watts and maybe 10 km away as the crow flies was just audible. The knob for the volume control pot was missing. No way was I going to touch that with the set turned on.

Over the next few weeks, I found a high resistor in the detector circuit and replaced it. I had two suitable knobs for the pots along the front panel. I twiddled the local oscillator coil until broadcast stations appeared where they should have been. I got two of the short wave bands lined up as well, courtesy of WWV. Meanwhile I resprayed the case with the remains of two cans of enamel from the back of the garage cupboard. I re-polished the aluminium panel at the front with a wire brush in a drill chuck. By this time I was well sucked in. Some old dry transfer lettering at the back of the desk got pressed into service for the newly polished panel. Soon the old Eddystone looked good and was starting to perform.

A visiting amateur spotted it in the shack one day. I told him that two bands were not working properly yet. He said "No worries", or words to that effect. "*Caveat emptor*" I thought again, and pocketed his cash.

Cost of parts put in — might have been \$5.00. Cost of paint — maybe \$5.00, but if I hadn't used it on the radio case the cans would probably have gone flat anyway. Profit on deal — probably nil, but it paid for itself, the CRO and most of the bits put into both.

Back To The CRO

The old CRO sat under the house on the bench for a few hours while I fiddled about with the Eddystone. While washing up after dinner it came to me that the CRO spot was probably off the screen. In any case the bench was brightly lit when I first tried the CRO. It was quite possible that a faint glow on the screen might not have been visible. So back down the stairs I went and on went the CRO again. Yes, there was a faint glow. I twiddled the vertical and horizontal pots. The spot appeared. A little more fiddling and there was a distorted sine wave on the screen with my finger on the vertical input. Obviously the CRO was in fair condition. I selected the next time base frequency. The distortion all but disappeared. Better and better!

Ted Roberts VK4QI was good enough to look into his files and came out with a schematic for the CRO. Some time was spent tracking down faults like a dud synchronising pot and a leaky capacitor. But I have gained some knowledge of how a basic CRO works, as well as a functional instrument, for the cost of several hours study of it, and perhaps a few dollars in parts.

The Next Heap Of Junk

That same Ted VK4QI one day sold me a huge old RA Ratcliffe Model 200 signal generator for a small consideration. It weighs a tonne, but it's almost all there. Inside were three 6V6GT valves, common enough even today. But the rubber insulated wiring was, well, how shall I put it? Working without a schematic, the old wire was replaced with new silicone insulated material, following the old routing. I replaced one capacitor and checked the old resistors. Those on which

the colour coding could be read were replaced if necessary. Those whose values were illegible were left in place. Meanwhile I sketched a schematic by following the wires and filled in component values wherever they could be read. Most of them couldn't.

Greatly daring, I switched the generator on. A short length of wire on the output terminal lay near a receiver tuned to 510 kHz, as low as it would go. I selected range "A". I turned the big, graduated brass disc. Noises came from the speaker at several distinct spots. I turned a kit-built digital frequency meter on. The generator was on 102 kHz, the shields were off and the fifth harmonic was getting out. The frequency meter showed 90 kHz near the bottom of the "A" range and over 27.5 MHz at the top of the "F" range. Nearly four volts of RF were available around 1 MHz.

Some parts of the signal generator are still missing. There used to be a "Palec" brand meter labelled "CARRIER" at the

top right. Some of the wiring around this is gone too. Perhaps a couple of the unknown resistors inside are higher than they should be. Perhaps one or two of the valves are not what they once were. But the unit still produces radio waves over a wide range of frequencies, and stays on frequency once it has warmed up for ten minutes or so. The internal modulation around 400 Hz works. That is certainly enough to align any receiver with an IF below 27 MHz. Beats trying to do it with a GDO!

Parts needed cost around \$15, including a BNC panel socket added to the output terminals for connection to coax. A 20k Ohm pot controlling the buffer amplifier was scratchy. None were stocked at the local electronics stores, but a new 50k Ohm pot with a junkbox 47k Ohm resistor in parallel does the same job. Perhaps the next step is to remove the rather sad looking case and re-spray it as well.

A signal generator or a modest CRO need not cost hundreds of dollars. What does it matter if the amplifiers and oscillators inside are solid state or vacuum tubes as long as they work properly and the unit is safe? In amateur service, signal generators and CROs are unlikely to be turned on all day, every day. Even if the valves are old and on the way out, they should last years. If you can lay your paws on spare valves the chance of a terminal failure is a slight.

Perhaps I have been lucky in coming across two instruments which have cost me considerably less than a hundred dollars. I don't know. But keep your eyes peeled. A faulty old oscilloscope may appear in a junkshop window one day. The fault might be as simple as a worn potentiometer or a leaky capacitor. A few hours work in tracking it down and a few dollars in replacement parts could see you the proud owner of a shack full of junk!

ar

BOOK REVIEW

MICROWAVE & RF DESIGNER'S CATALOGUE 1990-1991

RON FISHER VK3OM

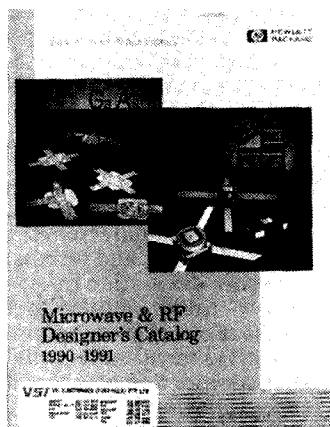

mounting types, for switching applications.

- * PIN diodes — applications.
- * Step recovery diodes, ranging from UHF to Ku band.
- * Microwave test accessories — Hewlett Packard RF coaxial components such as switches, attenuators, detectors and coaxial connectors.
- * Interface products — applications in high-speed fibre optic systems through to medical diagnostic systems.
- * Amplifiers — emphasises broadband amplifiers with exceptional gain flat-

ness and phase linearity, also variable gain amplifiers with very fast response time.

Other chapters cover such things as GaAs MMICs, switches and switch drivers, mixers, impulse generators and micro-bias networks to cover 0.1 to 18GHz. This book is an obvious necessity for anyone working in the field of RF and microwave design.

Enquiries should be directed to VSI Electronics (Aust) Pty Ltd at 16 Dickson Avenue, Artarmon, NSW, 2064.

This latest catalogue produced by Hewlett Packard is distributed in Australia by VSI Electronics (Australia) Pty Ltd.

The book is divided into 18 sections, and includes the following devices and applications:

- * High reliability — this shows how to select devices to achieve desired reliability parameters.
- * Silicon bipolar transistors — characteristics and applications.
- * Schottky barrier diodes — characteristics, including low-cost surface-

Most of us are familiar with the cheerful and friendly voice of Ron Fisher VK3OM. This seems to be as good an opportunity as any to show readers what he looks like. He is pictured here, resplendent by his rig at "Galanungah", Beaconsfield Upper. Ron is well known as Federal Tape Co-ordinator and Equipment Review Editor of AR. His untiring efforts as Executive Office Librarian continue unabated. In addition to all this, he applies his vast knowledge of amateur equipment to casting a critical editorial eye over the Hamads. The WIA and this magazine would be much the poorer without Ron's willing voluntary contributions. Good on yer Ron!



SIGNAL STRENGTH, "S" METERS AND PREAMPS

GORDON McDONALD VK2ZAB
59 WIDEVIEW ROAD, BEROWRA HEIGHTS, 2082.

Amateur Radio Dxers, particularly VHF and UHF DXers, receive some strange signal reports at times. For example, reports like: "You are S9 with the preamp in". (or out).

Well now, I don't know about you but I find such reports more than a bit annoying because I have gone to a lot of trouble with beams, linears and the like to ensure that my signal at the receive station is as good as I can make it and then this guy gives me a report which implies that I might as well have not bothered because MY best efforts are dependent on HIS receiving gear!

This is surely a strange way of looking at things. Here is another peculiar comment you may have heard: "I tried a preamp once but it brought the noise up as well as the signal so I don't use it now". Did this fellow really think that the preamp would amplify one form of input and not another?

Yet another anomaly can be found in the fact that even though manufacturers and equipment reviewers tell us that the transceivers of today are chock full of the latest "state of the art" technology, we are still unable to make an accurate, and therefore useful, assessment of the level of the signal received!

It seems to me that signal strength, S-meters and preamps are not well understood, and that we are not as well served by manufacturers as we might be if we knew a bit more about what could reasonably be expected of them.

Let's start to change this sad situation by reviewing the history of signal strength and S-meters up to now:

RST System

There was a time when amateurs didn't have meters or LEDs to show the strength of signals received, but even so they felt that the transmitting station might like to know how he was getting out, so they devised a code based on how they perceived the signal to be — more or less. This was the "S" part of the RST system. The other letters stand for Readability and Tone, but will not be part of our present discussion. Anyway the idea was to try to match the strength of the signal heard with one of the choices listed in a published table.

The table lists nine possible signal

strengths. I don't know why nine was chosen instead of say ten but the point is that the system has become firmly entrenched in amateur radio practice, and so we would be hard put to change it now even if there seemed to be a reason for doing so.

RST "S" Table

Estimate Of Signal Received	Report
Faint signals, barely perceptible	S1
Very weak signals	S2
Weak signals	S3
Fair signals	S4
Fairly good signals	S5
Good signals	S6
Moderately strong signals	S7
Strong signals	S8
Extremely strong signals	S9

S-Meters

The invention of AGC provided a voltage in the receiver which was proportional to the level of the signal received, and it was a simple step to feed this to a meter on the front panel to indicate the relative signal strength. However, it now became necessary to assign a specific level of input signal to specific S-meter readings because obviously the meter itself was in no position to know what constituted say "Good" signals. A standard was required.

The standard used by at least one receiver manufacturer during WW2 was for S9 to equal 50 microvolts and for the S points to be spaced by two to one in voltage ie 6 db.

Thus S9 = 50 microvolts, S8 = 25 microvolts, S7 = 12.5 microvolts etc.

Of course all this applied to HF receivers, and it wasn't received with universal enthusiasm because, for one thing, the sensitivity of the receiver differed from band to band, making it difficult to calibrate the meter accurately. A really accurate S-meter added complexity and cost, which could not be justified except for receivers designed specifically as signal strength measuring instruments.

What about VHF? Well you didn't need a meter at VHF because the signals were either there or they weren't. There was no in between with line of sight propaga-

tion. VHF signals hadn't learned to propagate beyond the horizon at the time.

Since that time, the situation has deteriorated to the stage where we now find receivers with meters marked in S points, which are anything from 10 dB to 1 dB apart, even on the one meter, and receivers where the S-meter remains firmly on the zero for all signals short of a whistle from the ham next door running a California kilowatt into his stack of eighty yagis turned in your direction. Then there are (yuk) LEDs.

It also seems that manufacturers think that we are gullible enough to believe that the better of two receivers tuned to the same signal is that one with the biggest S-meter reading!

Unfortunately, lack of knowledge of S-meters can also be detected among equipment reviewers, who insist on either ignoring the S-meter altogether or else treating it as an intrusion on the front panel which prevents the knob control from being raised from 497 to an even 500. The idea that a properly calibrated S-meter may be of more use than a fancy digital frequency readout or the provision of 2003 memories apparently hasn't occurred to them.

We are all to blame for this state of affairs to some extent, because we haven't explained that antenna measurements plus study of propagation and path losses make accurate signal strength measurements mandatory, and we can't see why we can't use our station receiver for this purpose — rather than try to justify the purchase of one of those special measuring receivers mentioned earlier.

Furthermore we haven't really defined a standard for our S-meter. We will correct that omission right now.

A Standard Scale For Amateur S-Meters

The S9 = 50 microvolts with points 6 dB apart introduced during WW2 is quite reasonable at HF but at VHF it is no good at all, because 50 microvolts at say 2 metres is far more than an "Extremely strong signal". Also if we count down in 6 dB steps from that point we will run out of scale when we are still umpteen dB above the noise.

At one IARU regional conference it was proposed to adopt the WW2 scale for

HF and a scale with 6 dB steps but with S9 = 5 microvolts input at VHF. This is a sensible standard and no other has ever been seriously proposed, so why not proclaim it as the S-meter standard for amateur radio right now!

The only addendum required is to state that the 5 or 50 microvolts is applied across 50 Ohms.

Better yet, let's define our S points in terms of the power output of a signal generator of 50 Ohms impedance supplying the input to our receiver. We will express the power in decibels relative to one milliwatt (dBm). Thus:

VHF/UHF Scale

Signal Report	Input dBm	Input μ V
S9+20dB	-73	50.00
S9+10dB	-83	15.81
S9	-93	5.00
S8	-99	2.50
S7	-105	1.25
S6	-111	0.63
S5	-117	0.31
S4	-123	0.16
S3	-129	0.08
S2	-135	0.04
S1	-141	0.02

HF Scale

Signal Report	Input dBm	Input μ V
S9	-73	50.00
S8	-79	25.00
S7	-85	12.50
S6	-91	6.25
S5	-97	3.12
S4	-103	1.56
S3	-109	0.78
S2	-115	0.39
S1	-121	0.20

Thermal Noise Floor

It is worth noting that the VHF/UHF S1 level is close to the level of the thermal noise floor of a telephony receiver with its antenna pointed towards the earth horizon. In this case the thermal noise POWER available to the receiver is given by:

$$P = kTB \times 10^3$$

where: P = Power in milliwatts
 k = Boltzmann's constant = 1.38×10^{-23} Joules/Kelvin
 T = 290 K. The agreed standard earth temperature
 B = Bandwidth in Hertz.
 (See Appendix 1)

This is seen to be equal to -174 dBm/Hertz, so the receiver will see that power in every Hertz of its bandwidth plus any noise it makes itself.

For example: If our receiver was noise-

less and had a bandwidth of 2000 Hertz it would have a noise floor of: $(-174 + (10 \log 2000)) = -141$ dBm. That means that the weakest signal it could detect (at the same level as the noise) would be S1! However if it had a noise figure of say 6dB, which is more likely, its noise floor would be -135 dBm and of course the weakest signal it could detect would be S2!

On HF the level of hash is much higher than this due to sources of noise other than thermal, so a higher starting point is required for our scale. ie 20 dB higher at -121 dBm.

We should note that if the antenna noise temperature is less than 290 K due to it pointing elsewhere than at the earth the theoretical minimum noise floor will be better than -174 dBm/Hertz.

S-Meter Calibration

Now that we have a standard scale for our S-meter, how do we go about calibrating the one we have or if we haven't got one what do we do about it? Obviously there are as many different circumstances as there are types of receiver so all that can be done here is to set out some general rules.

1. If your receiver has a meter and calibration pots: Take a calibrated signal generator tuned to the frequency of interest and connect its output to the input of the receiving system. Adjust the signal generator output to S1 level as given in the table and set the meter to read S1 using the minimum set pot. Then adjust the signal generator output to S9 from the table and set the meter to S9 using the maximum set pot. The two pots will almost certainly interact, so go back to S1 from the signal generator and read just that pot for S1 on the meter, then to S9 again and readjust that pot. Alternate from one end of the scale to the other until S1 output from the signal generator indicates S1 on your meter and S9 from the generator indicates S9 on your meter without further adjustment of the pots.
2. If your receiver has a meter but no means of adjustment: limited amount may be possible if it has an AGC pot but failing this the only thing to do short of modification is to feed the signal generator in as in (1) and then record the reading on the meter for each S point level set. ie make a calibration chart.
3. If your receiver has AGC but no meter: Connect a sensitive (50 microamps per volt) external meter to the AGC line. Some receivers provide access to the AGC line via an accessories socket

at the back. Check this before soldering about in the works. The meter will require a series resistance multiplier. You will have to determine its value experimentally. When you have a meter proceed as in (2).

4. If you have no meter, and you can't use the AGC for any reason, you may like to try a modification to the receiver along the lines of providing a separate IF amplifier and detector specifically for the purpose of driving the S-meter.

This approach would probably result in the best S-meter arrangement of all. What's more, there are ICs made for this purpose! Receiver designers please note! There is more about this in the appendix.

The Preamp Connection

The reason for using a preamp at VHF/UHF is illustrated under "Thermal Noise Floor". The 6 dB noise figure given for the receiver in the example is fairly typical of the better receivers around, and when we add the feeder cable and connector losses to arrive at the receiver SYSTEM noise figure, we may be lucky to make 8 dB! With a good preamp mounted right up at the antenna we should be able to reduce this to about 2 dB to bring about a 6 dB improvement in our minimum detectable signal, and our signal to noise ratio generally.

Incidentally, the weak signal performance of the average VHF/UHF receiver of today without a preamp is about the same as an average vacuum tube preamp of the late 1950s.

OK so we accept that we need a preamp. Suppose that we make a beaut GaAsFet design with less than one dB noise figure and 18 dB gain and install it up the pole.

However, on switching on in anticipation of hearing all those signals that were in the noise before, we are brought to a disappointed halt by observing that the S-meter, which was reading about S2 noise before, is now reading about S5 noise.

Still, instead of cursing the preamp as a waste of time and money, we realise that if the S-meter could "see" antenna noise before it couldn't fail to increase its indication of it now that we have put 18 dB gain in the antenna to receiver path. So what do we do now? Well we certainly don't pull out the preamp. Our noise figure has in fact improved just as the theory predicted it would. So how do we get the S-meter to read correctly?

Solutions I have heard include installing an attenuator (18 dB?) between the antenna and preamp or between the preamp and receiver! The first of these would result in the noise figure of preamp becoming $1+18 = 19$ dB. Hardly an ac-

2 METRE METEOR SCATTER TESTS IN VK4

A TEN MINUTE CW TRANSMISSION IS HEARD EVERY DAY FOR A YEAR 1350 KMS AWAY

JOHN ROBERTS VK4TL
16 KAMBARA ST WHITE ROCK 4868

The RSGB manual relates the performance of meteor scatter as "little more than occasional "pings" of signal. I am not sure the word "ping" is a good description as the signals I hear are usually vowel sounds when short such as UH! and AH! and devoid of a bell-like characteristic such as the word "ping" indicates. To set up a range, one needs a distance of 1000 to 2000 kms and a few dedicated people who will turn up for skeds. The range was conveniently Cairns to Brisbane with VK4TL in Cairns and VK4s QV and AZK in Brisbane, sometimes assisted by 4SU and 4YMR. All four Brisbane stations have been receiving the test. The time was picked to enable maximum attendance to ensure continuity of tests and not for optimum conditions. Special permission from DOTC was sought and granted for the limited high power conditions. Tests began in July 1988 and continued day by day until July 1989, and now continue weekends only.

The equipment used at VK4TL IC271/4CX50B 400 Watts/LDF5-50 to a 10 element J Beam. VK4AZK IC29 with J310 preamp LDF4-50 to 11 element ATN yagi and VK4QV TS711A Nuteked/Preamp/LDF4-50 to 16 element Tonna.

In order to reduce variables, antenna aiming was kept on target, the largest antenna being the 16 el Tonna. The distance Cairns/Brisbane at 1413 kms compares with the Melbourne/Brisbane distance of 1406 kms. Cairns/Sydney at 2000 kms would have been within the test range and it is regrettable we had no

one there. Liaison was conducted on 14.345 MHz. It is amazing how many other liaison nets were heard there from around the globe on EME or terrestrial matters.

At 6.50 am local time until 7 am the keyer sent VK4TL K with a 6 second gap for receiving. The frequency picked was 14.3 MHz and the time of operation was intended to dovetail with other VK2 operations on the frequency at the time. Recorded meteor showers in the Northern Hemisphere produce enhanced propagation. It is not a known fact whether or not their efforts are an influence south of the equator.

Some attention was paid to the correlation but only Quadrantids early January produced 6 days when complete call-signs were received on January 3-8. If other periods like this had occurred it might have appeared conclusive but it is more probable to be a period of ducting.

The results — VK4TL was heard in Brisbane every day someone was available. Absenteeism counted for less than ten days. QSOs were logged with VK4AZK and VK4QV. The difference between being heard as 400 watts PEP, and 400 watts CW was very apparent and I hope that the lesson has been well learned. This was an extra plus ensuing from the special licence conditions. Much more remains to be done in this field. We know that the time was picked for practical reasons. Tests need to be carried out at other times of the day to see if this type of propagation is still there at midday for instance. Alas my already flogged help-

ers would not turn up for skeds at midday. I stopped asking them; I need friends too!

If our efforts encourage others to become involved in tests such as this then it will have been more worthwhile. Since it uses only a tiny portion of your day (15 minutes) this cannot be a barrier. Nor is the gear needed an obstacle, as a good yagi which can be home brewed, a preamp two metre SSB rig or if that's too expensive a converter feeding an HF transceiver. The receiving end is every bit as important to the operation as the transmitting end.

The ERP was increased at VK4TL for a short period with a stack of 4 x 9 element J beam copies. VK4LC and others reported a worthwhile increase in strength. These antennas and others are now packed away pending a move to an area where I can operate 6 metres again. (Does that make any sense?)

Propagation by this mode would appear to have no practical value, as I imagine that even "packet" would require a correctional signal, which is unlikely to be coming. I will have to make do however and pretend it's a sport akin to DX on 6.

My great thanks for support in this project go to John VK4AZK and Angus VK4QV. Also supporting, Mike VK4YMR, who provided numerous reports and Arnold VK4SU, who during the year worked on his antenna system until he could hear me.

The tests have continued through 1990 on Sunday mornings at 2050Z to 2100Z but should conclude about June this year. **ar**

Signal Strength, "S" Meters and Preamps continued from page 15

ceptable solution. What about the second? Well the noise factor of networks in cascade is given by the formula:

$$F_{ab} = F_a + ((F_b - 1)/G_a)$$

Note that these are not logarithmic units. ie: Noise Factor = Antilog (Noise Figure (dB)/10.)

Substituting values of 1 dB preamp noise figure for F_a , 8 dB noise figure for receiver with cable etc losses (F_b) and 18 dB for our preamp gain we find that our system noise figure becomes a respectable 1.34 dB. However if we blow our receiver noise figure out to 8+18=26 dB by putting that attenuator between it and the preamp we find that the system noise figure is now 8.8 dB and we are worse off than we were before we put in the preamp.

Obviously the only answer is to calibrate the S meter by feeding our signal generator into the system in front of the preamp!

It is equally obvious that if the S meter is properly calibrated to the receive system an S9 signal is an S9 signal regardless of whether the system includes a preamp or not and the information in the report at beginning of this article is redundant.

Conclusion

We have explained why an S meter is an essential tool for the serious amateur and we have provided a logical standard scale. We have explained why a preamp is necessary at VHF/UHF and what has to

be done to the S meter when the preamp is connected to the receiver.

There is now no valid reason why manufacturers should fail to provide and there is certainly no excuse for equipment reviewers who fail to criticize any equipment which does not measure up.

In the meantime let's see if we can calibrate our present receivers to the standard and give some sensible reports.

Appendix

(1) The noise bandwidth is not the same as the signal bandwidth. The relationship between the two is complex and beyond the scope of this article. However for most purposes including ours the noise bandwidth can be taken to be 1.57 times the signal bandwidth. **ar**

QSL CARD GENERATOR

RON CHURCHER VK7RN
PO Box 277
DEVONPORT 7310

When deciding what their QSL card is going to look like I think everyone would like to think that it is a little different than the average style of card — perhaps with a little more personal approach in design.

When taking your requirements to a printer, you soon discover that anything “different” starts to put the cost up, so I went to my local friendly camera centre and found that, for a fairly large quantity, I could get super-size prints of my shack setup showing yours truly etc for very little more than the cost of normal printed cards.

Then came the problem — how do I print the details on the back. Normal stamp-pad ink soaks into the photographic paper so I couldn't use a rubber stamp.

My trusty Microbee came to the rescue and I set up two programs in Microsoft basic — one for posting direct and the other for use via the Buro.

As readers will see, it's a very basic program for use with a DP100 printer. It would not need much changing for use with other computers. I did not attempt to link it directly with my computer log-book as I foresaw a few problems doing so.

I've tried to make it “user friendly” and as foolproof as possible (I need it to be!!). I hope it may give someone looking for something a bit different some ideas.



VK7RN

RON CHURCHER, P.O. BOX 277
DEVONPORT, TASMANIA. 7310

To radio VE3BAY/Ray
Confirming QSO on 14.147 M/H
Date 30/7/89 Time 1100 UTC
Your signal was 5/9
Txcr is Icom 720 + IC2KL amp.
Antenna is CUE. QUAD.

MR RAY PELLOWE
7 DONCLIFFE DRIVE
TORONTO ONTARIO
C A N A D A M4N 2E5

Thanks Ray for the chat
This is being used as an example of the way my QSL
card is printed out on the computer. It allows for three lines
right across the card if required.

VK7RN

RON CHURCHER, P.O. BOX 277
DEVONPORT, TASMANIA, 7310

To radio VE3BAK/Ray
Confirming QSO on 14.147 M/H
Date 30/7/89 Time 1100 UTC
Your signal was 5/9
Txcr is Icom 720 + IC2KL amp.
Antenna is CUE. QUAD.

VE3BAK

CANADA

Thanks Ray for the chat
This is how it comes out if the card is being sent
via the QSL Buro. It just cuts out the full address
and prints call and country in top corner.

Stolen Equipment

Stolen from W Watt VK2ZQW 5 Brighton Rd, Peakhurst 2210 on 11/1/90:

BWD 804 10 MHz Scope Set 51767

Kenwood TS520 HF Transceiver Ser 010296

Kenwood TV5066m Converter Ser 720089

Kyokuto FM144 VHF FM Transceiver Ser 8296

Microwave 40 W 144 MHz Linear Amp

Yaesu YC-355D 200 MHz Frequency Counter

Stolen from Max Mondolo VK2AML 8 Seymour St, Croydon Park 2133 on 16/5/90:

Drake TR-7 transceiver serial no. 2333 inscribed with name Haagsma.

Stolen from Mike Hewitt VK3KMJ 2m Kenwood TR751A Ser 705 0512 Contact owner Ph (03) 874 6182.

```

10 REM *** PROGRAM 'QSLCARD
20 REM *** PRINTS CARDS FOR BURD
30 REM
40 REM *** TYPE IN DATA FOR PRINTING
50 INPUT "CALL";A$
60 INPUT "NAME";B$
70 INPUT "COUNTRY";C$
80 INPUT "DATE";D$
90 INPUT "TIME";E$
100 INPUT "FREQUENCY";F$
110 INPUT "SIG. STRENGTH";G$
120 INPUT "ANTENNA";H$
130 REM *** THREE LINES OF PERSONAL REMARKS
140 INPUT "REMARKS";J$
150 INPUT "REM.2";K$
160 INPUT "REM.3";L$
170 INPUT "ARE ALL DETAILS CORRECT -- Y/N";ANS$
180 IF ANS$ = "N" GOTO 50
190 REM *** PRINTER CODES
200 ESC$= CHR$(27)
210 LPRINT CHR$(27);"S"
220 LPRINT CHR$(14)TAB(3)"VK7RN"
230 LPRINT TAB(30)CHR$(14);A$
240 LPRINT CHR$(15)"RON CHURCHER, P.O.BOX 277"
250 LPRINT "DEVONPORT, TASMANIA, 7310"TAB(60);C$
260 LPRINT
270 LPRINT "To radio "A$;"/";B$
280 LPRINT "Confirming QSO on ";F$;" N/H"
290 LPRINT "Date ";D$;" ";Time ";E$;" UTC"
300 LPRINT "Your signal was ";G$
310 LPRINT "Txcr is Icom 720 + IC2KL amp.
320 LPRINT "Antenna is ";H$
330 LPRINT
340 REM *** STANDARD LINE WITH CONTACT'S NAME
350 LPRINT "Thanks ";B$;" for the chat"
360 LPRINT J$
370 LPRINT K$
380 LPRINT L$
390 LPRINT CHR$(16)
400 INPUT "ALL OK? - DO YOU WANT TO RETYPE -- Y/N";ANS$
410 IF ANS$ = "Y" GOTO 170
420 END

```

```

10 REM *** PROGRAM 'QSLPOST'
20 REM *** PRINTING CARDS FOR POSTING
30 REM *** TYPE DATA FOR PRINTING
40 REM
50 INPUT "CALL";A$
60 INPUT "NAME";B$
70 INPUT "ADDRESS 1";M$
80 INPUT "ADDRESS 2";N$
90 INPUT "ADDRESS 3";O$
100 INPUT "ADDRESS 4";P$
110 INPUT "DATE";D$
120 INPUT "TIME";E$
130 INPUT "FREQUENCY";F$
140 INPUT "SIG. STRENGTH";G$
150 INPUT "ANTENNA";H$
160 REM *** THREE LINES FOR MESSAGE
170 INPUT "REMARKS";J$
180 INPUT "REM.2";K$
190 INPUT "REM.3";L$
200 INPUT "ARE ALL DETAILS CORRECT -- Y/N";ANS$
210 IF ANS$ = "N" GOTO 50
220 REM *** SET UP PRINTER CODES
230 S0$=CHR$(14):S1$=CHR$(15):DC2$=CHR$(16):LF$=CHR$(10):ESC$=CHR$(27)
240 LPRINT CHR$(27);"S"
250 LPRINT S0$; TAB(3)"VK7RN"
260 LPRINT
270 LPRINT S1$;"RON CHURCHER, P.O.BOX 277"
280 LPRINT "DEVONPORT, TASMANIA, 7310"
290 LPRINT
300 LPRINT "To radio "A$;"/";B$
310 LPRINT "Confirming QSO on ";F$;" N/H"
320 LPRINT "Date ";D$;" ";Time ";E$;" UTC"
330 LPRINT "Your signal was ";G$;DC2$;TAB(37);M$;S1$
340 LPRINT "Txcr is Icom 720 + IC2KL amp, ";DC2$; TAB(41);N$
350 LPRINT S1$;"Antenna is ";H$;DC2$; TAB(36);O$
360 LPRINT TAB(27);P$;S1$
370 REM *** STANDARD FORMAT LINE WITH CONTACT'S NAME
380 LPRINT "Thanks ";B$;" for the chat"
390 LPRINT J$
400 LPRINT K$
410 LPRINT L$;DC2$
420 LPRINT LF$
430 INPUT "ALL OK? - DO YOU WANT TO RETYPE -- Y/N";ANS$
440 IF ANS$ = "Y" GOTO 200
450 END

```

WORKING H.F. MOBILE? NEED A COMPACT H.F. BASE ANTENNA MOONRAKER AUTO-TUNE ANTENNA SYSTEM

- Originally developed for long haul commercial mobile services the MOONRAKER AM318 Auto-Tune antenna puts the ATU components up in the air where they belong so that they become an integral part of the radiating system instead of being coiled up in a 'black box' somewhere.
- The 2.7M whip is 1/4 wave centre loaded at all frequencies with no base loading and no sliding contacts. It automatically retunes to the best SWR for any frequency in the range 3 to 18 MHz (other bands to order).
- The compact antenna control (interface) unit gives visual and audible tuning status and is suited to manual/automatic operation or located up to 20 metres away for base station use if desired. Just select the frequency and press the tune button, retuning time is typically less than 3 seconds.
- Impedance 50 OHMS (Nom).
- VSWR 1.8:1 Typical 1.3:1
- Power rating SSB-140W.PEP, CW 70W.
- Mounting - Anti shock mount with 12.7mm mounting stud.
- Construction - Anodised aluminium with a removable fibre glass top.
- Options - Scan, activates a wide band amplifier in the AE for receive scanning; H/D anti-vibration mount for rough roads; Top whip section spring for off road.
- Price - Complete system with 4M control cable only \$749.00 plus sales tax 20%, if applicable. Air freight \$23.00.
- Cheque, Bankcard and Mastercard welcome.

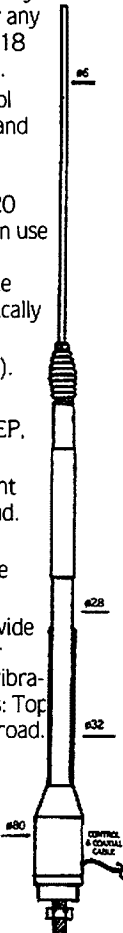

**PHONE (002) 73 1533
or FAX (002) 73 1749
FOR SPECIFICATION SHEET**

**MOONRAKER AUSTRALIA
PTY. LTD.
TASMANIA TECHNOPARK
DOWSING POINT, 7010**

EQUIPMENT REVIEW.

THE KENWOOD TH-75A DUAL BAND HANDHELD TRANSCEIVER

RON FISHER VK3OM

24 SUGARLOAF ROAD, BEACONSFIELD UPPER 3808

As I have pointed out in reviews over the last few years, handheld transceivers seem to show more advanced design features than mobile or fixed station equipment. The new KENWOOD TH-75A seems again to support this view.

The TH-75A is the latest dual band FM transceiver that covers the 2 metre and 70 cm bands. Like most of the current dual-band handhelds, the Kenwood is quite a deal larger and heavier than many of the midget single-banders that are around these days. I guess it's a matter of deciding whether you need the extra facilities or not, and if you do, whether the extra size and weight is acceptable.

Transmitter power output up to five watts is available, depending on the battery pack selected, or as an alternative, the rig can be powered from a 12 Volt car battery system. As with many dual-band transceivers, full duplex operation is possible; that is, you can transmit and receive simultaneously, but of course on separate bands. I was unable to actually check this feature out, but it seems that an ear piece or headphone set would be required at each end. I wonder if this facility is often or every used?

The four optional battery packs are as follows: PB-5 has an output of 7.2 Volts at

200 mAh. The PB-6 also has an output of 7.2 Volts, but at an increased capacity of 600mAh. The BP-7 is again 7.2 Volts, but gives the highest capacity of 1100 mAh. All of these produce the same transmitter power output. If higher output is required, then the PB-8 delivers 12 volts at 600 mAh. As with all handhelds, the battery life depends on how long you talk, as, even at the lowest voltage, the current drain exceeds one amp.

Let's look at some of the facilities offered on the TH-75A. In addition to the full duplex operation mentioned above, it is also possible to listen on both bands at the same time. Two squelch controls, one for VHF and one for UHF are provided. Only one audio volume control is available but a balance control allows the relative audio output on each band to be set. Although dual receive is possible, dual transmit is not. You can only transmit on one band at a time.

A total of twenty memory channels, ten for VHF and ten for UHF, are provided. These can be programmed with information on frequency, repeater splits, tone frequency data and call channel information. Frequency selection is via either the front panel key pad, or from the top panel rotary "tuning" control. This same control is also used to select memories when in that mode.

The liquid crystal frequency and status display is reasonably large and has good clarity. In addition to frequency, there are something like twenty other status indicators. You will need both a good memory and good eye sight to work them all out. The "S" meter is a vertical bargraph set between the main and sub-frequency displays, and indicates battery voltage while in transmit mode. The instruction book has some helpful charts to tell you what to expect from this when using the various battery packs.

Illumination is provided for the display but not the key board. This is actuated by a button near the PTT button on the side of the transceiver. It's not too easy to find.

A tone squelch and CTCSS module is available as an option and was not fitted to our review transceiver. I feel that, if manufacturers expect this to become popular, then it should be fitted as a standard feature.

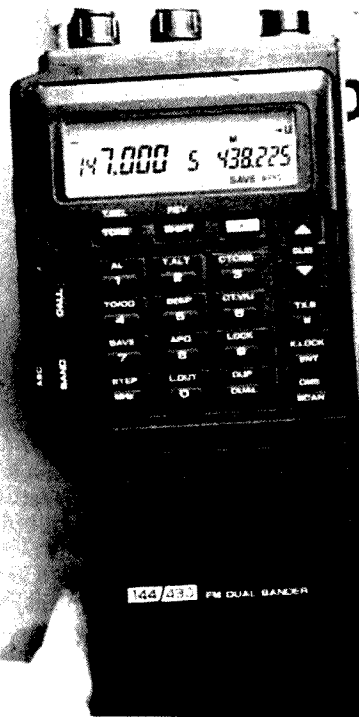

Close-up of display and key pad

The TH-75A On The Air

I am going to start this section with a grouch, which applies not only to the TH-75A, but to most of the Kenwood range of handhelds. The battery must be removed from the transceiver before it can be recharged. In addition to this, there is no indication that the recharging process is actually going on. No LED indication, just nothing. I know that the chances of putting the charge adaptor on to the battery incorrectly are remote, but it can happen. You might even forget to turn on the AC. How about it Kenwood? One little red LED would not cost much. I must admit to using my handheld (not Kenwood) on receive with the charger connected. I know it's not recommended, but it works fine and keeps you listening.

To balance this though, there are lots of very good points about the TH-75A. The transmitted audio quality was rated as very good, with just the right amount of deviation. I would like to try the exter-



Charging system with Battery connected to Adaptor



Complete view of TH-75A

nal speaker microphone some time, but would expect it to be good. Received audio quality was rated as adequate. Small speakers in small boxes always sound like small speakers in small boxes. As mentioned earlier, an external speaker would be a decided advantage for mobile use, or for just plain better quality for home station use.

One of the more tricky points of using the transceiver is the PTT switch. There are three of them! Not all PTT switches of course, but three push button switches one above the other. The top one is called the monitor switch. It opens the squelch to check if any weak signals are on the frequency. The second button down is the display light switch, which lights the display only and not very well at that. And the third button is the PTT. Believe me, it's easy to push the wrong one. Below all of these, and well out of the way, is the battery lock button. The external DC input socket is on the other side. Both memory and programmed scanning are available, as is a priority channel function. I have always preferred the Kenwood priority channel alert system to other makes. Your favourite channel is monitored every five seconds and if it becomes active, the transceiver beeps

at you. Select channel one (the priority channel) and there you are. Another nice feature is the auto band-change. This comes into effect when a station comes up on the frequency being monitored on the sub-band. Press the PTT within three seconds and you are on the sub-band. You won't miss anything while using the TH-75A. There are more chirps from this rig than from a cage full of birds.

The TH-75A On Test

All of these tests were conducted using an external regulated power supply set to simulate the various battery voltages.

Receiver current drain; Power supply, 7.2 Volts

With no receiver audio output; 105 mA

With full receiver output on one band only; 200 mA

With full receiver output on two bands; 300 mA

With battery save function in operation; 20/30 mA

Kenwood kindly supplied power output and current drain figures as measured in their lab using professional test equipment.

At 146 MHz

7.0V 2.4 Watts output 0.98 Amps

9.0V 3.8 Watts output 1.24 Amps

12.0V 6.0 Watts output 1.42 Amps

13.8V 6.0 Watts output 1.43 Amps

At 430 MHz

7.0V 1.9 Watts output 1.17 Amps

9.0V 4.0 Watts output 1.36 Amps

12.0V 4.6 Watts output 1.42 Amps

13.8V 6.0 Watts output 1.43 Amps

Low power selection produced an output of 0.4 Watts on both bands at 7.2 volts and strangely a slightly lower 0.35 Watts at 12 Volts.

The receiver audio power output was measured next. The signal generator was set for 1 kHz modulation with 3 kHz deviation. With an 8 Ohm load, a maximum power output of 520 milliwatts was produced. With a 4 Ohm load, the output was slightly higher at 625 milliwatts. The 10% distortion level was at 400 milliwatts and this dropped to 2% at 200 milliwatts.

This output, fed to an effective external speaker, produced a reasonable acoustic level. The internal speaker was able to produce a good level for normal locations, but could be lacking in noisy situations.

Receiver sensitivity was excellent, with a 12 dB signal to noise ratio at 0.15 μ V input on both bands.

The squelch opened at well below 0.1 μ V

again an excellent figure. The "S" meter, as usual, proved to be of limited use, reaching full scale at just above 1 μ V input. There are twelve segments of bar graph for the S meter, and no calibration points are provided. The receiver proved to be very free from spurious responses on both bands. I have a police UHF repeater operating in my back yard and no hint of its operation was noted.

The Instruction Book

There is no doubt about it, the TH-75A is a complicated machine. Basic operation is fairly straight forward, but if you want to make full use of the facilities that are offered, then you will need to study the book carefully. In this regard the instruction is excellent. As is unfortunately the normal situation these days, very little technical information is included. A full circuit diagram is provided, but you might be hard pressed to find the adjustments for mic gain or deviation.

Conclusion

If you are in the market for a dual-band handheld, the TH-75A must be a strong contender. As I have pointed out before, dual-band rigs of this type are bigger and heavier than their single-band cousins. Also the slightly higher output power capability must be paid for by high battery consumption. If you intend to talk a lot, a spare battery would be essential. Kenwood offers a wide range of accessories to complement the TH-75A. Here are a few to consider: three battery chargers — three optional batteries (in addition to the one supplied with the rig) — a battery case to take either AA style manganese or alkaline cells (this presumably might also take AA size nicad batteries) — a speaker microphone unit — and the TSU-6 tone squelch unit. A selection of carrying cases to fit the transceiver, with the varying size batteries, DC connecting cables and telescopic antennas, is available. The current price of the TH-75A is \$900. Our review transceiver was supplied by Kenwood Electronics Australia Pty Ltd to whom all enquiries should be addressed.

Kenwood Comment

Regarding the BC9 wall charger "The reviewer is only commenting on the BC-9 wall charger which is supplied with the TH-75A. If he had the BC-11 rapid charger or the BC-10 compact charger, he would get the results and features he is complaining the BC-9 lacks". ar

HAVE YOU ADVISED DOTC OF YOUR NEW ADDRESS?



AMATEUR RADIO LONG VANUATU TEDEI

BY JIM LINTON VK3PC

The tiny Pacific nation of Vanuatu consists of 80 islands stretching some 800 kms, and this month celebrates its 10th anniversary of gaining independence.

It had been a condominium jointly run by England and France. The influence of those two colonising nations is still evident, but it adds to the country's charm. Under the condominium it was called New Hebrides. The name Vanuatu translated means "Our Land". The title of this article includes two words from the Bislama language, the local form of Pidgin English. Interpreted it simply means **AMATEUR RADIO IN VANUATU TODAY.**

This unspoilt paradise has the character of a struggling third world country, but tourists and locals alike favour it being saved from heavy commercialisation. Holiday-makers seeking a spot to give them an immediate sense of relaxation, exposure to a different culture, and plenty of adventure, will find Vanuatu meets all those expectations. One of the first things to strike a tourist is the genuine friendliness of the indigenous Melanesian Ni-Vanuatu.

The first YL Ni-Vanuatu to obtain an amateur licence is 24 year old Touasi Taiwia YJ8NTT. Recently qualified for her Novice Licence, Touasi features on the cover of this month's Amateur Radio magazine, along with a workmate Tim Williams, who is yet to obtain his licence.

The amateur radio community consists of about 20 licensees, with about six of them really active. Keen DXpeditioner is Marek Bladowski YJ8M, who has operated from YJ1 at both the Torres Group, and Shepherd Group — the northernmost islands. The amateur radioscene is centred on Efate Island, which includes the capital of Port Vila. Apart from Touasi, the radio amateurs are expatriates now resident in Vanuatu.

The Vanuatu Amateur Radio Society (VARS) goes out of its way to help visiting

radio amateurs to make their stay as pleasant and enjoyable as possible. Up to 30 radio amateurs travel to the idyllic Pacific spot each year, and most often take out a YJ0 callsign issued as a visitor's licence. For the CQ WW contest in October in recent years, Pekka OH1RY has been a higher scorer, signing YJ0RY.

Radio amateurs from Britain, New Zealand, USA, Canada, West Germany, France, Fiji, Papua New Guinea, The Solomons and quite a few other countries can, with adequate proof of their qualification, be granted a visitor's licence. Currently there's no reciprocal licence agreement between Vanuatu and Australia, but that is likely to change soon. Vanuatu is a party to International Telecommunications Union conventions, and has adopted Australian standards for licensing.

Although the standard is the same, the old essay-style theory question papers are being used. An offer has been made to help Vanuatu convert its written examination papers to the multi-choice question style now used in Australia. Examination devolvement has existed in Vanuatu for six years. VARS appoints an examiner for the Morse examinations, and invigilates the theory and regulations examinations. Norman Shackley YJ8JS of VARS said: "Australia had offered reciprocal licensing years ago, but it was never taken up because of the bureaucracy in a new country like Vanuatu finding its way. It's simply the problem of drafting a letter and it being left on the bottom of the pile." He said this was not meant as a criticism, but just a recognition of the enormous difficulties faced by a country on gaining independence.

The issue was revived last August, when the author of this article visited the country, and the Vanuatu Amateur Radio Society immediately took the matter up with authorities. Telecom Vanuatu has since written a letter to the Australian Department of Transport and Communi-

cations seeking a reciprocal licensing agreement. The WIA fully supports the move, and has actively pursued it with DOTC. At the time this article went to print, the agreement was in the hands of DOTC for ultimate approval.

Norman YJ8JS took up the hobby of amateur radio while on secondment to Vanuatu from the public service in Britain. He successfully interested and encouraged Touasi, one of his staff, to study for her own amateur licence.

Touasi passed her Novice telegraphy tests in June 1989, and continued studies to take out a Novice callsign.

Norman said Ni-Vanuatu generally experienced difficulties when they needed to study at home. "Simple things like not having electricity in their homes. Study after 6 pm when the sun goes down is just not possible," he said. His experience with the problems was gained while being a high ranking official in the Customs Service at Port Vila.

Norman said the difficulties came to light after staff needing to improve their knowledge and skill level were unable to make the progress expected. He has since returned to Britain after being on secondment from the British Department of Customs and Excise. Language is another problem for Ni-Vanuatu to grasp concepts such as inductance, capacitance and reactance, with all student material written in English. "It's asking the impossible to expect someone to learn by themselves through reading a foreign language textbook about such concepts," Norman said. A solution could be videotapes of basic electronic concepts to help get them across, he said. Hopefully these can be supplied to VARS from Australia or elsewhere. They would certainly help Touasi spark interest in our hobby among other Ni-Vanuatu. Listen to her and the other VARS members operating YJ10IND, a commemorative station being set up in Port Vila for the 10th anniversary celebration on the last weekend this month. **ar**

CONTESTS

Calendar

August 11-12

WIA 1990 Remembrance Day Contest

October 6-7

VK/ZL Oceania DX Contest, SSB Section

October 13-14

VK/ZL Oceania DX Contest, CW Section

The rules for the RD contest of 1990 are almost identical to those of '87, which originally came into use after some years of fact finding, juggling of statistics, help from academics, studying of propagation, etc, etc.

A great effort went into discovering that to formulate a set of rules for the RD contest that would be equitable for all divisions was nearly impossible. So it was back to basics.

What was wanted? Simply, a sporting chance for all divisions to win the trophy. Immediately that brought out a few salient points:

1. A simple one point per contact; no more juggling of a scoring table to make divisions "equal".
2. Rule out the propagation problem; some bands do favour various paths during the contests.
3. Operation of club stations and, in some cases, the various callsigns assigned to a single operator.

And bring in a weighting factor! And, that's the key. Allowing all divisions to participate as they have done in the past, but should a division "lift its game", this would reward it with a great chance to win the friendly contest. But, to keep winning, it must keep on improving its score.

After the new rules were first used by VK1BR, and then the refined version by Ian VK5QX in 1987, results showed that they worked. In successive years, divisions generally agreed that at last a workable compromise had been achieved. Criticism dropped almost right away, but then some modifications were made to later contests. However, these have been shown not to have been in the best interests of the contest.

Minor changes were made, such as points per contact for some modes, operation of multi callsigns, club stations and number of operators etc. These slowly eroded away the original and refined rules of 1987 until they were "out of kilter" with the original intentions.

To explain further — 2, 3, or 6 hours between repeat contact on VHF? Just where does the repeat contact interval turn the contest into a VHF activity only? Would this distract from the HF component of the contest?

What if propagation is woeful, wouldn't VHF activity keep the contest alive?

Eastern seaboard HF sometimes doesn't seem to reach the Western seaboard — VHF

then maintains activity, and should the HF bands open, operators will not have given up altogether, and are around to keep checks on these occurrences. Amateur population centres "love" 2 hour intervals on VHF and this shifts operation of HF to VHF in many areas. Does it? Is this so wrong?

So long as there is participation, then the basic intentions have been achieved.

Signal report — why? It serves no purpose in the RD contest. If the serial number and callsign is recorded, the ubiquitous 5 and 9 serves no purpose. Should the operator wish to send or receive it, nothing prevents the exchange. (Having checked thousands and thousands of contacts as an ex FCM, almost without exception the exchange has been 5 and 9.)

Rule 7, all operators must sign the declaration, why? What does this achieve, that a callsign was used by one, two or even ten operators? It makes no difference in the contest as no multi transmissions are allowed.

As the perpetuator of the overall system of rules way back in early eighties, let me assure those who query the system, that it was working as intended before the modifications of later years.

Having only the CW and phone sections and no "open" section removes a strange way of contest operating and scoring. CW operators take pride in stating they get through when conditions are rough. Providing additional points for one mode because it takes more effort to make a contact, makes the special formula devised to make the competition between divisions off balance by such bias. The valid log requirement of 25 contacts over the previous 10, is an effort to assist in overcoming a problem of certificate issue, and should cause no distress to any RD operator.

Neil Penfold VK6NE Acting Co-ordinator

1990 Remembrance Day Contest — Rules

This contest is held to commemorate those amateurs who died during WWII, and is designed to encourage friendly participation between all amateurs and to help in the improvement of operating skills of all participants.

This contest is held annually during the weekend nearest the 15th August, the date on which hostilities ceased in the south-west Pacific area.

The contest is preceded by a short opening address by a notable personality, which is transmitted on various WIA frequencies during the 15 minutes immediately prior to the commencement time of the contest. As part of this opening ceremony, a Roll Call of the names of those amateurs who paid the Supreme Sacrifice, is read.

A perpetual trophy is awarded annually for competition between Divisions of the Wireless Institute of Australia. It is inscribed with the names of those Australian amateurs who made the Supreme Sacrifice and so perpetuate their memory throughout amateur radio in Australia.

The name of the winning Division each year is also inscribed on the trophy and in addition, the winning Division will receive a suitable certificate. The winning Division also holds the trophy for the next 12 months, after it is presented at the Annual Federal Convention.

Objectives

Amateurs in each VK call area will endeavour to contact other amateurs:

- in other VK call areas, P2 and ZL on bands 1.8 to 30 MHz, except the 10, 18 and 24 MHz bands.
- in any VK call area, including their own, P2 and ZL on bands above 52 MHz, and as indicated in Rule 5.

Contest Period

0800 UTC 11th August to 0759 UTC 12th August 1990.

All Australian amateur stations are requested, as a mark of respect, to observe 15 minutes silence prior to the commencement of the contest. It is during this period that the Opening Ceremony Broadcast, referred to above, will take place.

Rules

1. There will be two contest categories.
 - (a) High Frequency (HF) — for operation on bands below the 52 MHz band.
 - (b) Very High Frequency (VHF) — for operation on bands from 52 MHz and upwards.
2. In each category there will be three sections
 - (a) Transmitting Phone
 - (b) Transmitting CW
 - (c) ReceivingModes applicable to each section are as follows
 - (a) AM; FM; SSB; TV
 - (b) CW; RTTY
 - (c) Receive (a) or (b)
3. All Australian amateurs (VK callsign) may enter the contest, whether their stations are fixed, portable, or mobile. Members and non-members of the Wireless Institute of Australia are eligible for awards.
4. Cross Mode Operation is permitted. Cross Band Operation is not permitted excepting via a satellite repeater.
5. Scoring Contacts
 - (a) All contacts score one point.
 - (b) On all bands a station in another call area may be contacted once on each band using each mode. That is: you may work the same station on each band on Phone, CW, RTTY and TV.

(c) On the bands 52 MHz and above, the same station in any call area may be worked using any of the modes listed at intervals of not less than two hours since the previous same band/mode contact. However, the same station may be contacted repeatedly via satellite not more than once by each mode on each orbit.

(d) Acceptable logs for all entries must show a minimum of at least 10 valid contacts.

6. Multi-Operator Stations Are Not Permitted (except as in Rule 7), although log keepers are allowed. Only the licensed operator is allowed to make a contact under his/her own callsign. Should two or more operators wish to operate any particular station each will be considered as a contestant and must submit a log under the individual callsign which applies to that operator.

7. Club Stations may be operated by more than one operator, but only one operator may operate at any time; ie no multi-transmission.

8. Ciphers — for a contact to be valid, serial numbers must be exchanged between stations making the contact. The serial number will comprise three figures commencing 001 for the first contact and incremented by one for each successive contact. Should the serial number 999 be reached, the serial number will revert again to 001

9. Terrestrial Repeaters — contacts via terrestrial repeaters are not permitted for scoring purposes. Contacts may be arranged through a repeater and if successful on another frequency will count for scoring purposes. The practice of operating on repeater frequencies in simplex mode is not permitted.

10. Portable Operation — Log scores of operators located outside their allocated call district will be credited to that call area in which the operation takes place; eg VK5XY/2 — this score will be added to the VK2 Division scores.

11. Entries — a log of all contacts must be submitted. This should be in the format as shown in the example and must be on one side of the paper only

A Front Sheet must also be included showing the following information in this order:

Category (HF or VHF). Section (Phone, CW or Receiving). Call Sign, Name, Address, Total Score, Page Tally.

Declaration: "I hereby certify that I have operated in accordance with the rules and spirit of the contest."

Signed: _____ Date: _____
Logs are to be forwarded to the RD Contest Co-ordinator, 2 Moss Crt, Kingsley 6026 WA. Envelope to be endorsed Re-

membrance Day Contest on the Front outside. Entries must be forwarded in time to reach the RDCC, by 28 September 1990. Any entries received later than this day may be used as Check Logs only.

12. Disqualification — Any station observed during the contest as constantly departing from the generally accepted codes of operating ethics may be disqualified.

13. Awards — certificates will be issued in accordance with the Guidelines for Certificate Issue Remembrance Day Contest

Determination Of Winning Division

Scores by stations in VK0 are added to VK7.

Scores by VK9 stations are added to the mainland call area which is geographically nearest.

Scores claimed by P2 and ZL stations are not included in the scores of any VK call area.

The formula to be applied to determine the winning WIA Division is as follows:

Total Contacts per Division/Total Licenses per Division times the Weighting Factor.

The Weighting Factor is calculated such that should each WIA Division perform equally as well in 1990 as in the past four years (averaged) the result would be a seven-way dead-heat.

Consequently, the most improved Division will win the trophy and also earn a revised and lower weighting factor for the following year.

Receiving Section Rules

1. This section is open to all shortwave listeners in Australia, Papua New Guinea and New Zealand. No active transmitting station may enter this section.

2. Contest Times and logging of stations on each band are as for transmitting.

3. Logs should be set out as per the example. It is not permissible to log a station calling CQ. The detail shown in the example must be recorded.

4. Scoring will be as per Rule 5 for transmitting with other aspects of that same rule also applying.

5. Club Stations may enter this section.

Awards For SWLs

Certificates will be awarded to the highest scorer in each call area. Further certificates may be issued at the discretion of the Contest Manager.

Dupe Sheets

Where stations make a reasonable number of contacts it is most helpful that they use some form of checking system to ensure that they do not have invalid duplicate contacts.

Example Transmitting Log

Remembrance Day Contest 1990

Call Sign: VK1XXX Category: HF

Section: (1) Transmitting Phone

Date Time (UTC)	Band (MHz)	Mode	Call	No Snt	No Rcd	PTS
16.8.86						
0800	14	SSB	VK2QQ	001	002	1
0802	"	"	VK6LL	002	001	1
0805	"	"	VK5ANW	003	011	1
0807	"	"	ZL2AGQ	004	003	1
0809	"	"	VK4XX	005	007	1
Page 1 of 10				Page total 40		

Example Front Sheet

Remembrance Day Contest 1990

Category: HF

Section: (a) Transmitting Phone

Call Sign: VK1XXX Name: Joe Brown

Address: PO Box 123, Farm Orchard, ACT, 2611

Total Score: 1498 points

Page Tally	10 Sheets	1498 points
	Page	Score
1		40
2		39
3		40
-		-
-		-

Pages 10 Total 1498

Declaration: I hereby certify that I have operated in accordance with the rules and spirit of the contest.

Signed: J Brown Date: 20.8.90

Example Receiving Log

Remembrance Day Contest

Name/SWL NO: L30371. Category: HF

Section: (c) Receiving Phone

Date Time (UTC)	Band (MHz)	Mode	Stn Calling	Stn Called	No Snt	No RCD	PTS
16.8.86							
0800	14	SSB	VK1XXX	VK2QQ	001	002	1
0802	"	"	VK1XXX	VK6LL	002	001	1
0805	"	"	VK5ANW	VK1XXX	011	003	1
0807	"	"	ZL2AGQ	VK1XXX	003	004	1
0809	"	"	VK7AL	VK2PS	007	010	1
Page 1 of 7				Page Total 40			

The 14th West Australian Annual 3.5 MHz CW & SSB Contests Transmitting & Receiving Rules

- Duration: CW Sunday 29th July. SSB Sunday 16th September between the hours of 1030Z and 1330 Z time ie 3 operating hours for each contest.
- Frequencies: All contacts to be made in the 3.5/3.7 MHz band using frequency allocation applicable to your licence conditions.
- Calling: Stations will call CQ WAA using the three times three technique, infringe-

ment of this rule by the use of long CQ calls may entail disqualification, as will prearranging of a QSO.

4 Scoring: Points for contacts are as follows:-

Within Western Australia	5	points	per	contact.
WA to all Mainland				
Eastern States	2	"	"	"
WA to VK7	4	"	"	"
WA to VK0 & Overseas	8	"	"	"

3 points per contact with WA stations only.

5 Multipliers: A multiplier of 2 per WA Shire worked will apply to the final score. WA Stations north of the 26th Parallel only; an additional multiplier of 1.3 will apply per contact confirmed with stations south of the 26th Parallel.

6 Contacts: Stations may be worked twice on each night ie once between 1030Z to 1300Z and again between 1300Z to 1330Z these contacts will count for points. Each time the contact for WA stations will take the form of an exchange of 5 characters comprising RST/RS and Shire Letters. eg a station in NORTHAM sends 579NM or if in HARVEY 579HY this helps towards the worked all shires award.

Eastern States and Overseas stations will send RST/RS plus a running number starting at 001.

7 Logs: Contest logs to be set out on one side of a Quarto or Foolscap sheet with columns headed as below.

Date:	Call:	Operator:				
Time Z	Call	RST WKD	RST Out	Shire Letters	Shire Multiplier	Points Claimed

Column 7 to be totalled at the foot of each page and the running totals brought forward. The last page to contain the following summary: Total number points scored, Input power, Equipment and Antennas used, along with comments on the contest in general. SWL participants score as above using the outgoing TX score.

All logs to be addressed to the WAA Contest Committee, 42 Kennedy Street, Melville, WA 6156 and posted so as to reach us not later than 5th October for both contests. The results for all contests will be published in the December issue of AR.

Shire Identification Letters

1	Albany Town	AT	11	Bridgetown/
2	Albany	AL		Greenbushes
3	Armadale	AK	12	Brookton
4	Augusta/		13	Broome
	Margaret		14	Broomehill
	River	AM	15	Belmont
5	Bassendean	BA	16	Bruce Rock
6	Bayswater	BW	17	Bunbury
7	Beverley	BV	18	Busselton
8	Boddington	BO	19	Canning
9	Boulder	BD	20	Capel
10	Boyup Brook	BB	21	Carnamah

22	Carnarvon	CN	86	Mt.Magnet	MM
23	Chapman		87	Mt. Marshall	ML
	Valley	CV	88	Nannup	NP
24	Chittering	CI	89	Naremben	NN
25	Claremont	CT	90	Narrogin	NG
26	Cockburn	CR	91	Narrogin	
27	Collie	CE		Town	NT
28	Coolgardie	CG	92	Nedlands	NL
29	Coorow	CW	93	Northam	NM
30	Corrigin	CS	94	Northam	
31	Cottesloe	CO		Town	NO
32	Cranbrook	CK	95	Northampton	NH
33	Cuballing	CB	96	Nungadin	NG
34	Cue	CU	97	Peppermint	
35	Cunerdin	CD		Grove	PG
36	Dalwallinu	DU	98	Perenjori	PJ
37	Dandaragan	DN	99	Perth	PH
38	Dardanup	DP	100	Pingelly	PY
39	Denmark	DK	101	Plantagenet	PT
40	Donnybrook/		102	Port	
	Balingup	DB		Hedland	PD
41	Dowerin	DR	103	Quairading	QG
42	Dumbleyung	DG	104	Ravens-	
43	Dundas	DS		thorpe	RT
44	East		105	Rockingham	RM
	Fremantle	EF	106	Roebourne	RB
45	East Pilbara	EP	107	Sandstone	SS
46	Esperance	ES	108	Serpentine/	
47	Exmouth	EH		Jarrahdale	SJ
48	Fremantle	FM	109	Shark Bay	SB
49	Gingin	GG	110	South Perth	SP
50	Gnowan-		111	Stirling	ST
	gerup	GP	112	Subiaco	SU
51	Geraldton	GN	113	Swan	SW
52	Goomalling	GM	114	Tambellup	TP
53	Gosnells	GS	115	Tammin	TM
54	Greenough	GR	116	Three	
55	Halls Creek	HC		Springs	TS
56	Harvey	HY	117	Toodyay	TY
57	Irwin	IN	118	Trayning	TG
58	Kalamunda	KA	119	Upper	
59	Kalgoorlie	KL		Gascoyne	UG
60	Katanning	KG	120	Victoria	
61	Kellerberrin	BN		Plains	VP
62	Kent	KT	121	Wagin	WN
63	Kojonup	KP	122	Wandering	WD
64	Kondinin	KD	123	Wanneroo	WO
65	Koorda	KO	124	Warooa	WR
66	Kulin	KU	125	West Arthur	WA
67	Kwinana	KW	126	Westonia	WS
68	Lake Grace	LG	127	West Pilbara	WP
69	Laverton	LV	128	Wickepin	WI
70	Leonora	LA	129	Wiluna	WU
71	Mandurah	MB	130	Williams	WL
72	Manjimup	MP	131	Wongan/	
73	Meekatharra	MK		Ballidu	WB
74	Melville	MV	132	Woodanilling	WG
75	Menzies	MZ	133	Wyalka-	
76	Merredin	MD		tchem	WY
77	Mingenew	MW	134	Wyndham	
78	Moora	MA		East	
79	Morowa	MR		Kimberley	WE
80	Mosman	MS	135	West	
81	Mukinbudin	MU		Kimberley	WE
82	Mullewa	ME	136	Yalgoo	YO
83	Mundaring	MG	137	Yilgarn	YN
84	Murchison	MH	138	York	YK
85	Murray	MY			

WPX Contest From BY1PK

Wally Watkins VK4DO PO Box 262 Airlie Beach 4802

Being interested in contest working for many years and often having worked stations on DX-peditions, I had always dreamt of being in that position. Dreams do come true.

In conjunction with a lecture tour for amateur radio clubs in Beijing and Nanjing in China, it was possible to sandwich between cities the weekend of the 1990 CQ WPX contest.

Negotiations in January 1989 with Tong at BY1PK, during my visit to Beijing, had led to an invitation to operate in the 1990 WPX from his station. Final arrangements were made during the year.

My old friend, Huang, had retired from the Chinese Radio Sports Association, and the new interpreter was Meng Chao, BZ1FB. It was decided that we would both operate BY1PK in the multi, single transmitter section of the contest. The arrangement was for me to leave my hotel and stay at the CRSA work unit for the weekend as it was in the same building as BY1PK.

Saturday morning arrived. Meng was to meet me at the "Hao Yuan" Hotel at 0730 and go with me to BY1PK to start operating at 0800. However Meng was delayed and did not arrive until 0800. So it was a fast trip, each on a bicycle through peak traffic, complete with my suitcase and bag.

We got on air at 0819 and soon settled down to contest conditions. On Saturday 28 MHz and 21 MHz were used during daylight and 14 MHz was used at night towards North America. Sunday was a repeat performance except for a short stint on 7 MHz and 3.5 MHz in the evening.

In 34 hours of operating 2368 contacts were made giving 585 prefixes.

It should be noted that China does not permit contacts with amateur stations in South Korea, Israel or South Africa. It was difficult to explain to a persistent 4x4 that contact was not allowed. JY1 called me and after swapping numbers he asked me for the actual signal report, which was S7 not the usual S9 for contests.

On my return to Australia the work really began with the checking and scoring of the log. Just enough time was left to meet the 10 May deadline.

No prizes are expected, however the combination of being a "wanted" prefix, first class equipment and antennas, was a great experience.

My thanks to fellow operator Meng Chao BZ1FB, station managers Tong and Yu for keeping fresh log sheets at the ready as well as coffee and food and not the least the friendly cooperation of the Chinese Radio Sports Association during the weekend.

1989 VK-ZL Oceania Contest

VK And ZL CW results

F BEECH VK7BC
1989 MANAGER

VK-CW	160	80	40	20	15	10	Mult	Total
VK2DXI #15m	30	560	113	754	372	471	861,459	
VK2APK	120	100	430	188	544	276	459	761,022
VK2BBQ			345	154	370	246	359	400,285
VK2DID		90		77	256	106	194	102,626
VK2PS *160m	140	90	80	25	88	84	123	62,361
VK2CWS						140	58	8,120
VK2AIC				2	50	38	42	3,780
VK3XB #	20	10		335	194	104	293	194,259
VK3MJ	40	20		88	170	66	161	61,824
VK3MR				347			167	57,949
VK3VT				70	44	8	70	8,540
VK3KS	20	10		1			3	93
VK4XA #*10m						1054	265	27,930
VK4TT *20m				468			218	102,024
VK4OD					110	34	54	7,776
VK4XW		130	20		12	4	21	3,486
VK5ADX #40m	80	110	750	121	332	76	325	477,425
VK5AGX		90	225	210	76	104	249	175,545
VK8AV/4				72	152	58	282	40,890
ZL3GQ #*80		240	645	276	602	616	626	1,489,254
ZM1AIZ	120	150	670	70	192	110	286	375,232
ZL1HV			175	87	138	160	209	117,040
ZL2AGY						510	161	82,110
ZL3AGI				189			128	24,192
ZL1AIH		310					25	7,750

#Call area cert, *top band score.

VK and ZL Phone Results

VK-Phone	160	80	40	20	15	10	Mult	Total
VK1PJ #		470	10	71	466	932	477	929,673
VK1ZL		60	5	54	134	98	134	47,034
VK1LF		120			80		43	8,600
VK2APK #*160m	140	280		178	854	134	390	618,540
VK2DXI		130	50	61	896	160	318	412,446
VK2KM					988		261	257,868
VK2PWS					856		187	160,072
VK2BJL				129	42	326	246	122,262
VK2BAM		280		110	22	162	155	88,970
VK2PS	60	200		128	20	60	157	73,476
VK2FT						342	86	29,412
VK2CWG * 80m		570					41	23,370
VK2CJH				16	4	2	15	330
VK2PKW used as check log.								
VK3AJU S Key.		150		54	124	8	100	33,600
VK3DNC				4	70	42	54	6,264
VK4OH #		260		428	422	376	506	751,916
VK4LT *10m		190		8	404	1118	415	713,800
VK4KRP						1330	289	384,370
VK4NEF					62	468	157	83,210
VK4PJ					322		105	33,810
VK4OD					94	78	73	12,556
VK5HB #		130	40	147	358	144	310	253,890
VK5ADX		200		161	262	102	247	179,075
VK5QX *20m				510			271	138,210
VK5NVW						470	128	60,160
VK5DON	20	60		35	96	70	101	28,381
VK8XX #*15m				24	1574	504	438	920,676
VK8BE						28	13	364
ZL3GQ #*40m		100	125	248	908	594	592	1,169,200
ZL1AAS	100	170		206	168	872	459	695,844
ZL1BVK		270		134	902	64	332	454,840
ZM1IM			10	26	330	304	186	124,620
ZL2AH					314	86	132	52,800
ZL3TX	100	300	10		82	32	76	39,824
ZM4GB		230		44	74		77	26,796
ZL2GJ		240		14	62	6	60	19,320
ZL1AGO						112	50	5,600

A Front End Tuner from the VLF-LF Receiver

Continued from page 11

America. This club also distributes a magazine called "Lowdown". Perhaps, in Australia, we should be pressing for an amateur radio section of the bands at these low frequencies. Judging by the lack of signals around 40 to 100 kHz, this spectrum does not appear to be greatly utilised.

To finalise the discussion, we have described a front end tuner which improves the performance of the VLF-LF receiver immensely. In fact, it would be a useful addition to place in front of any receiver which happens to tune these bands. With separate sharp RF tuning, Q switch and possibly aerial tuning, the receiver is a little complicated to adjust, but once mastered, the results are certainly worth while. One further control to be watched is the receiver RF gain. With all the extra gain in the front end tuned circuits, it is very easy to lock up the receiver with too much signal level.

One might ask why the tuning could not be simplified by ganging the front end tuned circuits with the receiver oscillator tuning. To make a highly selective tuned circuit at 10 to 30 kHz accurately track, at 455 kHz difference, with the oscillator circuit at around 465 to 485 kHz, seems a highly difficult, if not impossible task. It seems that with the superheterodyne we must either trim the front end manually or tolerate the inferior performance of broader tuning. **ar**

#Call area certificate winner. *Top band score in call area.

Results for the overseas stations will be published next month. Comments from overseas stations suggest that activity from our call areas will need to be increased if the contest is to grow.

The 1990 contest will be run by NZART and adjudicated by John Litten ZL1AAS 146 Sandspit Road, Howick New Zealand. Please give the contest your support this coming October.

The winning stations will receive certificates in the near future.

1990 dates are; Phone Oct 6-7th. CW Oct 13-14th.

Good contesting to you all,
VK7BC

ar

AWARDS

PHILL HARDSTAFF VK3JFE
FEDERAL AWARDS MANAGER

WIA Awards Program

Applications and inquiries for Federal WIA awards should be addressed to Phill Hardstaff, Federal Awards Manager, c/o WIA, PO Box 300, South Caulfield, Vic, 3162. A SASE when making an inquiry would be appreciated.

New Awards Manager

With the formalities out of the way I would like to introduce myself. Although I would not class myself as a fanatical award hunter I have been known to chase the odd award or two. I have held the callsign of VK3XGK since around 1984 but was always an avid SWL before that. In 1986 I left Telecom, with which I had been working for 12 years, and took up employment with the South Pacific Commission in Noumea, New Caledonia, for three years. From there I was FK1TS for two years, operating mostly on six metres. My work took me around the Pacific a lot and I managed to operate at one time or another under the following calls: A35PJ, 5W1HF, 3D2TS, ZK1XT — to mention a few. I returned from New Caledonia very reluctantly last year, and now manage a national repair centre for a large computer company. I also got out the Morse key and managed 5WPM and hope to get the other five really soon. I have decided to settle here again for a while, but would love to go back and live in the Pacific somewhere, some day.

Awards Program

It is anticipated that, by the time you read this, the current backlog of awards will have been tidied up and all outstanding awards mailed out. The one area that will take a little longer to iron out is the DXCC records. I would like to get all this information on computer and in a data base, so I can write a short program to manage all this information and make updates much easier, and also help you in that I would be able to tell anyone their current status in the short time it takes to boot a computer. This may also be a way of getting around enforcing updates only in prescribed multiples. I am also keen to see endorsement stickers for DXCC and some of the other awards. I would appreciate any input from people involved in DXCC on these and any other issues they feel important.

Grid Square Award

My predecessor (the late Ken Gott) was committed to introducing a Grid Square award, which is uncanny, because it's something I also believe in very strongly, and hope

to get off the ground shortly. I can promise you it will be worth the wait. In the meantime, can I please have some input? For instance, do we have a HF and a VHF version? Do we use the same rules as the ARRL VUCC or what direction should I be heading in? I have my own ideas, but will save these for a future issue. I would also like to see an award just for six metres, with a name maybe based on the current solar maximum.

New Address

As you may have noticed, I have given the address of the WIA Federal Office as the address for the awards manager. This is to prevent a repetition of the current situation. In the past, the advertised address for the awards manager was the home address of the person doing the job at the time. The new policy will be that the address given to overseas organisations will be that of WIA Federal Office, so that if I change address or have to resign for some reason, we do not have to notify all overseas clubs etc. I have been told that mail still regularly arrives at addresses from more than 10 years ago.

Need for input

I am always open to suggestions and would welcome any ideas you may have to forward, be they changes to existing ones or new ones.

WAVKCA VHF

One thing I will be looking into is why the WAVKCA (worked all VK call areas) for HF is an oversize colour and rather good-looking certificate, but the WAVKCA VHF is a rather plain A4 sized affair? This seems to be the wrong way around. Actually, I would like to see just one certificate (the current HF one) and endorse it for 50MHz, 144MHz etc. Does anyone know how this situation arose?

WIA80 award

Applications for this award are starting to pick up, with the majority coming from overseas. It would seem that we are just beginning to see the results of publicity for this award.

Awards recently issued

The following awards have been verified

and mailed during the past month.

WIA80

No	Callsign	Name	Endorsement
29	VK6PY	Paul Yates	First VK6
30	OH6IU	Pehr Hending	First OH
31	KM4ZM	David Martin	First Alabama
32	K8CSG	Bill Gary	
33	KB7GOW	Kirk Wheeler	First Arizona
34	VK3AJO	Vincent Winterbine	
35	VK3KS	Mavis Stafford	All 2-way CW
36	ZL2AGX	Dawn Young	First ZL
37	W3KRB	W G Owen	First PA
38	HL5AP	Byong Joo Cho	First HL
39	VK4NFE	Bob Neville	First VK4
40	ZL1BJN	W K Schief	First ZL1
41	K15X/5	George Hawkins	First Mobile

HAVKCA

No 160 Gary Szucs MI USA

WAVKCA (HF)

1814	Wayne Sutherland	NQ7Q
1815	Paul Meecham	VP2EXX
1816	Michael Klengel	Y78SL
1817	E Buchman	HB9BEG

WAS (VHF)

No 178 FK1TK Henri Rainer 50MHz SSB

I must get around to claiming WAS VHF for myself as FK1TS, when I work out how to do it and who issues it! I can't understand why there are so few claims for WAS VHF, when it is relatively easy to pick up. I will try to get a bit of publicity in Japan through some of my old 6m contacts, and see if we can't get this one moving a bit.

I have deliberately not made any references to any new awards from overseas this month, as I have to check which ones have been included in these pages before and which haven't. As well, I would like to only present awards that have some merit and that are reasonably difficult to obtain, ie require some effort to qualify for them.

My apologies to Vincent Winterbine VK3AJO for mailing your award to the VK3 Division office — I wrote down the first address I saw on your letter, not realising what it was, and that it was the address you sent it to. I tried to phone you, but no luck. I hope you got your award okay.

Also, thanks to Ivor Stafford VK3XB for your phone call and nice comments about your certificate. I will be in touch soon about DXCC etc. Anyone else with any ideas about anything in the column, please feel free to contact me after 7.30pm weekdays or on weekends on (03) 434 6424.

73 TO ALL
ar

AMATEUR RADIO
HELPING OUR COMMUNITY.

HOW'S DX

STEPHEN PALL VK2PS
PO Box 93 DURAL 2158

We are approaching the half-year mark in our calendar, and with it comes the ever-changing propagation pattern. The solar flux dropped at one stage on 31st May to 120, the lowest recorded for a number of years. Several heavy disturbances occurred also this month, which made conditions quite difficult for DXers.

Studying the propagation predictions provided by Roger Harrison on the pages of "AR" will help you to use the bands at the most advantageous times.

YEMEN — 70

It was in the "wind" since early March, or in the "ether" as pre-war old-timers described the upper regions of space, that a joint 70-4W DXpedition will be activated from these much sought after countries. Little did we know at that time that a political event will make Yemen, as such, a new DXCC country, replacing the 70 and 4W prefixes with a new one.

On 23rd May, North and South Yemen told the United Nations that they had merged into a single state, the Yemen Republic. This merger will create a powerful new Arab State the size of France, with a population of about 14 million. The new capital of Yemen is: San'a and its principal port and commercial centre is Aden.

A few days later, three Kuwaiti amateurs: Yosouf 9K2CS, Mohammad 9K2MJ and Mohammad 9K2DR arrived at Aden and activated 701AA. Their equipment is a TS440S and a TL922 amplifier, a three-element beam and dipoles for 40 and 80 metres. They worked only 10-15 and 20 metres in the SSB mode. Frequencies used were 28460, 21295, and 14195, listening up five with split operation. They appeared also on the three Australian nets, to the joy of many VK, ZL, Pacific and USA amateurs.

QSLs go direct to 9K2CS, Saud Alsabah, Box 476, Kuwait, Kingdom of Kuwait, Asia.

Conway Reef — 3D2AM

This was again a well planned and precise operation organised by the Yasme Foundation, an international DX group, and supported by NCDXF, JA "CQ" Magazine and Icom America.

A number of operators from the previous Jarvis Island activity and other DXers who were in the Pacific Area took part. A 66ft schooner, bearing the name of "Yasme", took the eight DXers, representing six different countries and four continents, to Conway Reef on 18th May, for a nine-day operation. It was a five-station activity on CW and SSB and on six bands, from 1.8 to 28 MHz. I was fortunate

to work them on the last day on 80 metres. There was no pile-up, and no takers to the CQ call. The operator, Peter OH1RY, told me that they will be leaving in three-four hours, after a successful operation and about 45,000 QSOs. The same boat is scheduled to continue its journey to reach other Pacific locations later this year.

QSLs to: The Yasme Foundation, PO Box 2025, Castro Valley, CA 94546 USA.

Spratly Islands 150XV

This operation lasted almost one month, with some interruptions due to fuel and generator problems.

The Spratly Islands are located in the South China Sea. There are about 100 islands, but only 33 remain above sea level. The island group covers an area of about 180,000 square kilometres.

The expedition ended on 12th May with about 45,000 contacts. There were several Russian operators who were active previously in Vietnam prior to going to Spratly. Towards the end of May a number of them were still active under one of these callsigns: 3W1PZ, 3W6PY, 3W9CZ, XV0SU and 3W3RR.

QSL cards to all above Spratly and Vietnamese callsigns, to be sent to PO Box 308, Moscow, 103009, USSR.

Willis Island VK9

When you read these lines, Trevor VK9TR will have already left or will be in the process of leaving the island for Adelaide, after the completion of his tour of duty. Willis Island lies about 300 miles east of Cairns (16°S and 150°E). The main island is about 400 metres long, 180 metres wide and nine metres above sea level. The island is administered by the Australian Bureau of Meteorology and is manned by four officers from time to time, who spend a six-month tour of duty there. It is very likely that, in the future, remote weather facilities will be established on the island, which will curtail future amateur activity from that location. Trevor has made about 5000 contacts, and was one of the most obliging and co-operative amateurs who made himself available in his spare time for all the DXing fraternity, both on nets and outside nets.

Western Samoa Amateur Radio Club Inc

Some issues earlier (Feb and March AR) we published some comments about the Western Samoa Amateur Radio Club Inc, on a basis of a QSO and a letter received from Pete 5W1KT.

This prompted the club to write to the WIA Melbourne office with some information about the activities of that club, pointing out the correct situation. Pete 5W1KT has also written to explain that some of his comments were based on personal observation only. There was no criticism intended, and he apologises to anyone who may have been offended by his personal opinion. Here now are the basic facts based on both letters:

The Western Samoa Amateur Radio Club Inc, does exist. It is active and recently celebrated its 22nd year of existence. Members are: President, Phil 5W1AU, Secretary, Marty 5W1AT, Treasurer, Jim 5W1AC, Percy 5W1AB, Ernest 5W1AA, Clyde 5W1AI, Larry 5W1BB and Uti 5W1BC, a YL member. All except Clyde are locals. The QSL bureau postal address is PO Box 1069, Western Samoa, and is run on incoming basis only for those operators who are still on the island at the time of receipt of the card. The members of the club are active in varying degrees, depending on the amount of damage suffered by the stations in recent cyclones and the members' work schedules. Many visiting DXers are active from Western Samoa. Pete was entertained at a barbecue by President Phil. Western Samoa does not have an official reciprocal agreement with any country. However, as a courtesy, the Western Samoa Post Office, which is the local authority, will issue a licence to operate, and a callsign, which is yours for life, on a written application and the production of a valid Amateur Radio licence from a recognised ITU state, and on payment of \$15 local funds. This licence is issued as a courtesy to visiting amateurs.

We trust that these explanations have now clarified the position of the WSARC Inc.

Nauru-Kiribati-Tuvalu

Jack VK2GJH, better known as T30JH, was active during the month of June in the area. He was in Nauru as C21NI from 31st May to 5th June; as T30JH in Tarawa, Kiribati from 6th to 15th June; in Funafuti Tuvalu as T20JH from 15th to 20th June; back to T30JH from 20th to 21st June, and back to Nauru C21NI from 27th June to early July. It is interesting to note that one US station, WA6TUA/5 was waiting for 31 years to finally work C21, which he now did.

QSL direct only to: PO Box 299, Ryde, NSW, 2112 with SASE.

The ANZA Net

The ANZA net, on 21205 kHz, and its net controller, Percy VK4CPA (formerly VK3PA) celebrated the 20th anniversary of the establishment of the Australian New Zealand Africa net on 20th May, 1990. The net is now 20 years old, and is still going strong under Percy's leadership, with some assistance from

YAESU

Computer Aided All Mode Transceiver! FT-747GX Budget HF Transceiver

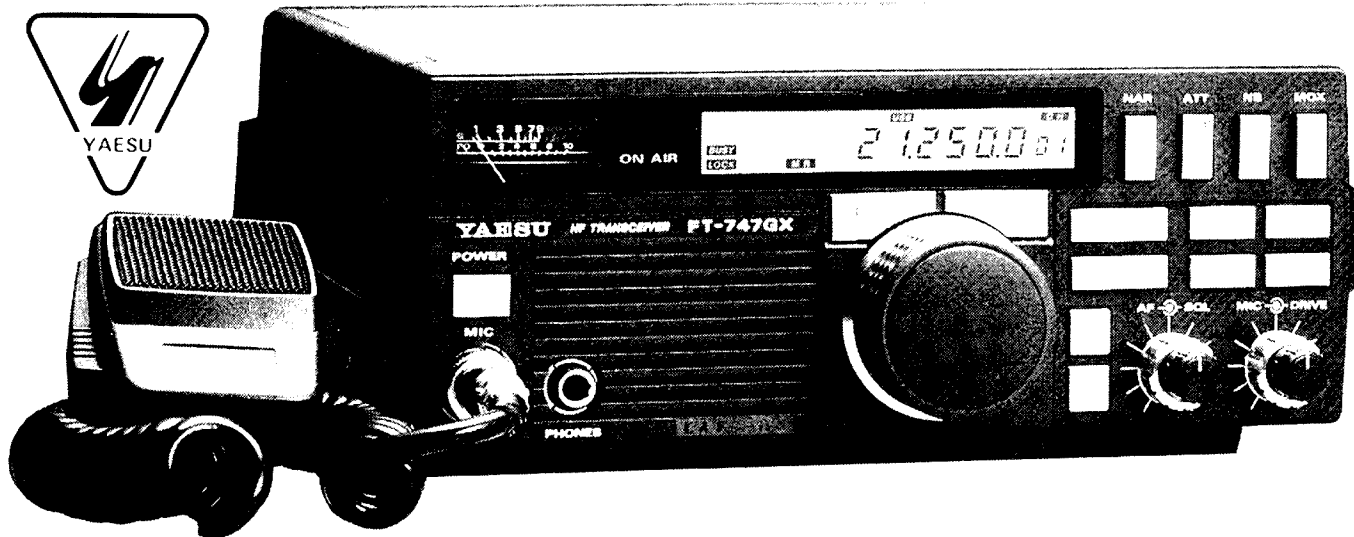

Better performance and value for your dollar is the hallmark of the FT-747GX from Yaesu. Incredibly lightweight and measuring just 238 x 93 x 238mm it takes up next to no space in the shack and is well worthy of consideration as a mobile rig.

The FT-747GX SSB/CW/AM (& optional FM) transceiver provides 100 watts PEP output on all 1.8 - 30MHz amateur bands and general coverage reception continuously from 100kHz to 30MHz.

Superb Features

You get the ultimate in convenience including front mounted speaker, a clear unobstructed display and control layout that leaves selection, via the 15 pushbutton controls and two dual pots, as easy and uncomplicated as it can be.

With operator selectable tuning steps for each mode, dual VFO's for split frequency operation and 20 memory channels -eighteen of which can store split Tx/Rx frequencies. Wideband 6kHz AM, and narrow 500Hz CW IF filters are fitted as a standard feature, as well as a clarifier, switchable 20dB receiver attenuator and noise blanker to optimize reception under varying conditions.

It's also fitted with the CAT (Computer Aided Transceiver) system for user programming for even more advanced control by an external computer.

What's more, you'll get a BONUS D-2110 hand held microphone when you purchase your new Yaesu FT-747GX from Dick Smith Electronics, your authorised Yaesu Distributors.

Cat D-2930

With 2 Year Warranty.

\$1179

*Yes, we stock a range of antennas and mounting bases for mobile use.
Ask at your nearest store!*

PHONE AND MAILORDER SERVICE
ORDER BY PHONE - 008 22 6610 (LOCAL CALL FEE)
OUTSIDE SYDNEY SYDNEY AND ENQUIRIES - 888 2105
FAX (02) 805 1986 OR Write To DS XPRESS, PO Box 321 North Ryde NSW 2113
All major credit cards accepted, O/Nite courier available.
24 HOUR DESPATCH OF ALL ORDERS

DICK SMITH
ELECTRONICS

SCOOP PURCHASE

Huge Savings on the

FT-767GX All Mode Transceiver!



HF, 2m, 6m and 70cm

The FT-767GX is the **only** transceiver that offers such a high level of performance on all the H.F. bands, as well as on the 6M, 2M, and 70cm bands! A vast array of both 'operator convenience' and 'DX improving' controls are provided by the 2 microprocessors, while attention to detail in the RF circuitry provides up to 104dB receiver dynamic range (in CW-narrow mode), and transmitter 3rd order I.M.D. of -35dB (at 100W output, 14MHz). Compare the following features with any other radio.

- All band coverage from 1.8 to 440MHz (100W max H.F., 10W max VHF/UHF)
- All modes - SSB, CW, FM, AM, FSK (on HF, VHF, and UHF)
- Upconverting triple conversion H.F. receiver covering 100kHz to 30MHz, with choice of RF amplification or direct mixer feed.
- Heavily optioned - inbuilt 600Hz CW filter, inbuilt 6kHz AM filter, RF speech processor, I.F. notch and I.F. shift filters, inbuilt heavy duty AC power supply, inbuilt automatic H.F. antenna tuner, high stability PLL (+/- 3ppm), data IN/OUT sockets for packet T.N.C. connection, all mode squelch.

- Revolutionary facilities include a digital wattmeter and auto calculating SWR meter (for HF, VHF, and UHF!), programmable tuning steps for each mode (from 10Hz to 99.9kHz!), and a front panel TX shift control which allows the operator to adjust the carrier point of the SSB transmit signal to suit his voice characteristics! A large digital display, and keyboard frequency entry are, of course, standard features.

- **2 Year Warranty**, the longest in the Industry!
- **BONUS MH-1 hand mic**

See ARA reviews,
Vol. 12 issues 6
and 7.
D-2935

\$3495

Limited stocks!



YAESU STOCKS NOT HELD AT ALL STORES. PLEASE CONTACT YOUR LOCAL STORE FOR STOCK AVAILABILITY. OR ORDER BY PHONE...

• NSW • Albury 21 8399 • Bankstown Square 707 4068 • Belconnen (062) 53 1785 • Blacktown 671 7722 • Brookvale 9050441 • Bondi 367 1444 • Campbelltown 27 2199 • Chatswood Chase 411 1955 • Chullora 642 6922 • Gore Hill 439 5311 • Gosford 25 0235 • Hornsby 477 6633 • Hurstville 560 6622 • Kotara 56 2092 • Liverpool 600 9888 • Maitland 33 7886 • Miranda 525 2722 • Newcastle 61 1896 • North Ryde 876 3855 • Parramatta 689 2188 • Penrith 32 3400
• Railway Square 211 3777 • Sydney City 267 9111 • Tamworth 66 1711 • Warrington 28 3800 • ACT • Fyshwick 80 4944 • VIC • Ballarat 31 5433 • Belmont 43 8522 • Bendigo 43 0388 • Box Hill 890 0699 • Coburg 383 4455
• Dandenong 794 9377 • East Brighton 592 2366 • Essendon 379 7444 • Footscray 689 2055 • Frankston 763 9144
• Geelong 232 711 • Melbourne City 399 Elizabeth St 326 6088 and 246 Bourke St 639 0396 • Richmond 428 1614
• Ringwood 879 5338 • Springvale 547 0522 • QLD • Brisbane City 229 9377 • Buranda 391 6233 • Cairns 311 515
• Chermside 359 8255 • Redbank 288 5599 • Rockhampton 27 9644 • Southport 32 9033 • Townsville 38 4300
• Townsville 72 5722 • Underwood 341 0844 • SA • Adelaide City 223 4122 • Beverley 347 1900 • Elizabeth 255 6099
• Enfield 260 6068 • St. Marys 277 8977 • WA • Cannington 451 8666 • Fremantle 335 9733 • Perth City 481 3261
• Midland 250 1480 • Northbridge 326 6944 • TAS • Hobart 31 0800 • NT • Stuart Park 81 1977
ORDER BY PHONE OUTSIDE SYDNEY (066) 226610 Free Call Sydney Area 688 2105

DICK SMITH

ELECTRONICS

others. Congratulations and happy DXing to all of you. A detailed report of this very rare achievement will appear in the near future in "AR".

Interesting QSOs and QSL Information

Note the following abbreviations: Callsign-name-frequency-mode-UTC-month of QSO. ADAR = means QSL info in previous "AR" issues.

HS0M Mike— 14200 — SSB — 1125 — April. QSL to: WA4BQ via Bureau.
TG9/KP2Z — Aki — 7003 — CW — 1155 — May. QSL to: JA5DQH Akito Nagi, Box 73, Ishii, Tokushima, 779-32 Japan.
4U1WB — 14206 — SSB — 1237 — May. QSL to: KK4HD Paul J van der Eijk, 7524 Dolce Dr, Annandale, VA 22003 USA.
BZ4RC — Chen — 21023 — CW — 0654 — April. QSL to: Box 538, Nanjing, PR of China.
8J7ITU — 21021 — CW — 0704 — May. QSL to: JARL via Bureau.
OY7ML — Martin — 21009 — CW — 0711 — May. QSL to: Martin Haasen, PO Box 184, Torshavn, FR100 Faroen Islands, North Atlantic.
PY0FF — Andre — 14225 — SSB — 0900 — May. QSL to: Cx Postal 1, Fernando de Noronha, PE 53990, Brazil.
YK1AO — Omar 28522 — SSB — 0603 — April. QSL to: Omar Shabsigh, PO Box 245, Damascus, Syria.
1S0XV — 28545 — SSB — 0735 — April. QSL to: Box 308, Moscow, 103009, USSR.
TL8WD — Dieter — 28456 — SSB — 0735 — May. QSL to: DL8CM, ADAR.
3B9FR — Robert — 14215 — SSB — 1130 — May. QSL to: Box 31, Rodriguez Island via Mauritius, Indian Ocean.
XF1C — Ben — 21205 — SSB — 0543 — May. QSL to: WB6JMS James L Arthur Jr, PO Box 84, Atwood, CA 92601 USA.
7X2FK — Mohammed — 14243 — SSB — 0612 — May. QSL to: PO Box 105, Rouiba, 35300 Algeria, Africa.
EL7X — Willy — 14193 — SSB — 0749 — May. QSL to: Willy Lameree, Box 538, Monrovia, Liberia, Africa.
S79FT — Frank — 21205 — SSB — 0521 — May. QSL to: DL7FT Frank Turek, Box 1421, D-1000, Berlin 19. BRD.
HC6CR — Roberto — 28539 — SSB — 2237 — May. QSL to: Roberto Camacho, PO Box 614, Ambato, Ecuador.
RZ8T/UA4 — 21205 — SSB — 1147 — May. QSL to: Box 555, Penza, 440061. USSR.
SV9AKI — George — 14243 — SSB — 0614 — May. PO Box 33, Souda, 73200, Island of Crete, Greece.
9L1US — Dave — 14201 — SSB — 0644 — May. QSL to: WA8JOC Kenneth S Scheper, 5875 Cedaridge Dr, OH 45247, USA.
FT5XH — Francois — 14226 — SSB — 1204 — May. QSL to: F6GYV Francois Treveneau, 143RuedeMalbec, F-33800, Bordeaux, France.

H44AP — Al — 14199 — SSB — 0909 — May. QSL to: Box 418, Honiara, Solomon Islands, South Pacific.
C6AFW — Farley — 14232 — SSB — 1115 — May. QSL to: PO Box N-1316, Nassau, Bahamas.
C31UA — Carles — 14118 — SSB — 0556 — May. QSL to: Carles Munoz Hilpke, Hotel Festa Brava, La Llacuna 7, Andorra la Vella, Europe.
A35KY — Zbig — 14222 — SSB — 0902 — May. QSL via WA3HUP (via Bureau for VKs only).
CN8GJ — 14243 — SSB — 0622 — May. QSL to: Box 21 Mohamedia 20900, Morocco, Africa.
3B8CA — Jacques — 14226 — SSB — 1313 — May. QSL to: Jacques Cantin, Grand Baie, Mauritius, Indian Ocean.
3W1PZ — 14003 — CW — 1256. QSL to: Box 308, Moscow 103009, USSR.
7Q7LA — Les — 21205 — SSB — 0536 — May. QSL to: G0IAS A R Hickman, Conifers, High St, Elkesley, Retford, Nottingham, Notts DN22 8Aj.
9K4KS — Kenny — 14243 — SSB — 0625 — May. QSL to: WA4JTK Alan E Strauss, 17401 NW 47th Ave, Carol City, FL 33055, USA.
3D2XV — Bing — on Rotuma — 14222 — SSB — 0445 — May. QSL to: VK2BCH, Box 344, Forster, NSW, 2428.
CE0DFL — Marco — 21 MHz — SSB — 0406 — May. QSL to: PO Box 7, Easter Island, Chile.
CP6EX — Mike — 21296 — SSB — 2230 — May. QSL to: PO Box 3478, Santa Cruz, Bolivia, South America.
3DA0BK — 28495 — SSB — 0624 — May. QSL to: PO Box 122, Eveni, Swaziland, Africa.
3W6PY — 28495 — SSB — 0725 — May. QSL to: PO Box 43, Temirtau, 472310 USSR.
A22JP — 28475 — SSB — 0710 — May. QSL to: PO Box 1022, Gaborone, Botswana, Africa.

RTTY News

Pick of the month of RTTY QSOs as supplied by Syd VK2SG

ZP2EM — 14083 — at 0030Z.
OD5SK — 14083 — at 2358Z. QSL to Box 130, Tripoli, Lebanon.
SV5TS — 21086 — at 1758Z. T32AB — 21085 at 0751 Z. QSL to: N7YL.
ZS9A — 21095 — at 1710Z. SU1HN — 14083 — at 2355Z.
FT5DX — 14081 — at 0235Z. TJ1MW — 21084 at 1529Z.
V85GA — 14072 at 1244Z. ARQ. TA3D — 14088 at 0317Z, QSL to: Box 963, Izmir, Turkey.
HH2PK — 14087 — at 0027Z. QSL via: N1DRS.
8P6QA — 21085 — at 1925Z ARQ. 7Q7LW — 14085 — at 2000Z.
P43SF — 14083 — at 2001Z.

From Here and There and Everywhere

Brian VK5BAS advises that SV9AHZ will be active as J49E from 1-15 August on a small island south of Crete on all bands. CW still has its place, especially if it comes to a challenge. Recently I worked W2PJW on 14 MHz in the CW mode. Ed is in New Jersey. He uses 5W with a loop in his attic as his antenna. A real QRP station with a QRP antenna. My report to him was 449.

Max VK2APD worked WA5MKU on 15 April. This was a special event station commemorating the 78th anniversary of the loss of the "Titanic" with 1517 lives. The historic CW message was as follows: "CQD CQD SOS SOS CQD SOS MGY (MGY the call letters of the Titanic) Come at once. We have struck a berg. CQD OM position 41° 46' N 50° 14' W Require immediate assistance, we have collided with an iceberg. Sinking. Can hear nothing for noise of steam". A handsome certificate and detailed fact sheet were sent to Max for the confirmation of the QSO.

Jose VK2FNPJ advises about two South American nets which are looking for VK participation. The Brazil DX Net is on 14236 kHz at 0900 UTC from Monday to Friday. Net controller is Daniel PT7BI. On Saturday and Sunday the same net is on 28530 at 1500 UTC. The Latin American DX net is hosted by Nathan OA4OS, and meets on 14143 KHz at 2200 UTC.

ZM6CA is a special call commemorating the NZART annual conference at Hamilton, NZ. The call was used in May and June. QSL to: ZL1HJ M Gannon, 9 Liverpool St, Te Kuiti, 2500 NZ.

IK5DNE/IA5 was a special station from Elba Island. IOTA No EU28. QSL to: IK5DNE.

The QSL info for special call IQ5AP is IK5HHA.

FO0SST Steve was on Kauehi Island IAOTA OC 66 and QSL to: AA6LF.

ET3AZ was heard on 14240 kHz at 1530 UTC early in May. The operator's name was Mike, and he gave his QSL info as: Telecom Radio Club, Addis Ababa. Does anybody else know more about this call?

On 10 May the Spratly operators were calling CQs and looking for QSOs on 28496 at 0600 UTC without takers. This gave me the opportunity to have a short chat with the operator Yuri, homecall R18FY, mentioning to him that a mysterious Spratly callsign, 1S5IJ appeared on the bands. Yuri told me that it was a pirate. Despite that he spoke Russian and gave a Russian home call as his QSL info.

If you are interested in DXing, ask your radio club to borrow the videotapes produced by the VK2 Division about the following DX topics: "HF DX Seminar" with Iris and Lloyd Colvin (1hr 14min), "Making Friends on DX" by Syd VK2SG (28min), "How to Survive in a Dogpile" by John VK2DEJ (2hrs 15min).

Please read all the rules on how to borrow from the WIA videotape library on page 31, February 1990 "Amateur Radio".

If you worked HH2YF on 14236 kHz at 0930 UTC, he was "Yves" on the Brazilian net. QSL to: PO Box 13339, Port au Prince, Haiti, Caribbean.

It was also reported on the same net that XZ1A was heard working on 21185 at 0800 UTC with a QSL address to JA1UT.

Zbig ex-VK2EKY, on his Pacific wanderings, went first to KH8 as KH8/VK2EKY, then he operated from 5W1KY, and finally he operated as A35KY. He described his A35 as the best QTH of the three. He planned to go on another island early in June.

FT4WB Crozet Island was reported to be active on 28480 kHz.

ZS8MI has a new operator: Gerard. He gave his QSL info as: PO Box 13077, Jacobs, 4026, Natal, RSA. The QSL address of 4UVIC, which was active in the second part of June, is: WB4FNH, Madagascar, 5R8J (QSL to F5IL) was supposed to appear on several nets in May but, so far, I did not hear from anyone who worked that station.

Was it a practical joker or was it real?

EP2MANIA was heard operating at 0425 UTC on one of the nets on Friday.

FJ5BL was active from St Barthelemy Island in the Caribbean. QSL to: F6AJA.

8J90XPO is a special event station at the International Garden and Greenery Exposition in Osaka, Japan, till 30 September. QSL to JARL via Bureau.

HF0POL is a Polish club station on King George Island in the South Shetlands, active on weekends on 28560 — 21260 — or 7060. QSL to: KB6GWX.

Market Reef: OH2AP/OJ0 was active between 29 May to 3 June. QSL to: OH2AP.

And, for those who are chasing DXpeditions, here are the usual DXpedition frequencies: CW — 28025, 21025, 14025, 7005 and 3505 kHz. SSB: 28495, 21295, 14195, 7045, 7080, 3795 kHz. VK6RO advised me that he has now worked 100 countries on FM, and he claims to be the first VK operator to have done it. He started FM country hunting on 20 January 1982, and the last one was Spratly Island ISOXV on 28 April on 29600 kHz. Has anyone else worked more than 100 countries on FM?

Interesting QSLs Received

Note: W=weeks, MO=months, FM=from MGR=manager OP=operator.

Direct QSLs received: JT0DX 5MO FM MGR, P43HM 4MO FM OP — TT8CW 11 MO FM MGR, 5N7NU 3MO FM MGR — VK9TR 2W FM OP — VR6KY 4MO FM OP — A92FB 2W, 5B4SA 4W — FW/YJ8M 4W, KH6JEB/KH7 4W, 9J2BO 7W, V85GA 4W — XW8DX 11W, TF3CW 9W, CO6CD 9W, 5Z4FO 3W, Z24JS, 4W FM MGR, HS0M 1MO FM MGR.

Thanks to you . . .

Many thanks for the information received from: VK2XBB, VK2APD, VK2GJH, VK2DID, VK2FNJ, VK2PRS, VK2SG, VK3DD, VK4OD, VK4OH, VK5NVW, VK5BAS, VK6RO, VK6NE, WIA Federal Office, Western Samoan Amateur Radio Club Inc, 5W1KT, "QRZ DX", "The DX Bulletin" and Sydney Morning Herald. Your support is very helpful and is always appreciated.

If you have not heard Pat VK2RZ on the bands lately, the reason is that Pat is in hospital. The DX fraternity wishes him a speedy recovery from his recent injury. ar

VHF/UHF AN EXPANDING WORLD

ERIC JAMIESON VK5LP
9 WEST TERRACE MENINGIE 5264

All times are Universal Time Co-ordinated indicated as UTC

Australian Amateur Bands Beacons

Freq	Call sign	Location	Grid square
50.056	VK8VF	Darwin	PH57
50.066	VK5RPH	Perth	OF78
52.200	VK8VF	Darwin	PH57
52.320	VK6RTT	Wickham	OG89
52.325	VK2RHV	Newcastle	QF57
52.330	VK3RGG	Geelong	QF21
52.345	VK4ABP	Longreach	QG26
52.370	VK7RST	Hobart	QE37
52.420	VK2RSY	Sydney	QF56
52.425	VK2RGB	Gunnedah	QF59
52.435	VK3RMV	Hamilton	QF12
52.440	VK4RTL	Townsville	QH30
52.445	VK4RIK	Cairns	QH23
52.450	VK5VF	Mount Lofty	PF95
52.460	VK6RPH	Perth	OF78
52.465	VK6RTW?	Albany	OF84
52.470	VK7RNT	Launceston	QE38
52.485	VK8RAS	Alice Springs	PG66
144.400	VK4RTT	Mount Mowbray	QG62
144.410	VK1RCC	Canberra	QF44
144.420	VK2RSY	Sydney	QF56
144.430	VK3RTG	Glen Waverley	QF22
144.445	VK4RIK	Cairns	QH23
144.445	VK4RTL	Townsville	QH30
144.465	VK6RTW	Albany	OF84

144.470	VK7RMC	Launceston	QE38
144.480	VK8VF	Darwin	PH57
144.485	VK8RAS	Alice Springs	PG66
144.530	VK3RGG	Geelong	QF22
144.550	VK5RSE	Mount Gambier	QF02
144.600	VK6RTT	Wickham	OG89
144.800	VK5VF	Mount Lofty	PF95
432.160	VK6RPR	Nedlands	OF78
432.410	VK1RBC	Canberra	QF44
432.420	VK2RSY	Sydney	QF56
432.440	VK4RSD	Brisbane	QG62
432.445	VK4RIK	Cairns	QH23
432.445	VK4RTL	Townsville	QH30
432.450	VK3RAI	MacLeod	QF22
432.535	VK3RMB	Mount Buninyong	QF12
432.540	VK4RAR	Rockhampton	OG56
1296.410	VK1RBC	Canberra	QF44
1296.420	VK2RSY	Sydney	QF56
1296.440	VK4RSD	Brisbane	OG62
1296.445	VK4RIK	Cairns	QH23
1296.480	VK6RPR	Nedlands	OF78
2304.445	VK4RIK	Cairns	QH23
2306.440	VK4RSD	Brisbane	OG62
10445.000	VK4RIK	Cairns	QH23

Can anyone report on the status of the Albany beacons please?

Six Metres

The six-metre DX situation has been rather quiet during the past month in VK5.

Hugh VK5BC near Berri has spent a lot of time calling CQ DX on CW, and occasionally he lands something. He recently scooped up 3D2PO, worked a few VK2s and VK4s on backscatter and then on 22/5 around 0400 he worked ZL1AXB on CW. The ZL was S5 here while in contact with Hugh but, on concluding, simply faded out so the key was put away once more! For most of the day there had been weak backscatter signals, mostly from VK2.

Col VK5RO has had a reasonable degree of success during 1990 and the following shows what has been available in VK5 starting on 11/1/90 at 0815 with HL9TG and JA2, 3, 4, 6, 9. 25/1: 0801 ZL9TPY. 11/2: all JA districts. 18/2: 1014 NI6E/KH6 then more JAs. 20/2: 1452 KJ6WD/DU3. More JAs from 27/2 until 4/3: 0500 HL1FF followed by all JA districts. JAs practically every day until 20/3 then at 0628 HL1GR and JAs. 21/3: 2205 T20AA and JAs. 24/3: 0340 KG6DX; 0400 JG3DMH/JD1; 0751 KH6JEP/KH7. 2151 N6AMG/KH8. 25/3: 0010 heard ZF1RC; 0130 HL1ST; all JA districts then at 0351 HL2IFF.

1/4: all JA districts then at 2200 K6MYC and 5W1JP heard on backscatter. 2/4: 2251 W6JKV/FW; 2254 HR1WPK; 2308 ZL2KT; 2330 5W1JP and heard HH5DK and V31PC. 5/4: 2258 3D2PO. 6/4: 2359 3D2PO. 12/4: 2230 3D2PO; 2310 XE1GRR. 13/4: 0108 VK9LG; 0214 NI6E/KH6 and at 2246 heard a T12 station. 14/4: 0038 KH0/JJ1AEB; 2310 T20AA; 2320 3D2PO; 2350 KG6DX. Between 1050 and 1103 heard the 9V2ST beacon sending 9999911317 continuously on 50.100. 15/4: 2319 3D2ER; 2336 3D2CM, JA6, 7, 8. 16/4: 0821 KH6IAA; 0823 NI6E/KH6; 0900 KH6SB. 17/4: Heard brief CQ call from ZS6XL at 0758; 2203 N6CW and heard W5FF.

18/4: 2307 3D2CM. 25/4: 2226 3D2PO and JA 3, 8. 26/4: 2345 ZL7TZ. 27/4: 0017 ZL1AXB; 2322 W4EQM; 2350 3D2PO. 28/4: all JA districts. 30/4: JA1, 2, 8, 9; 0645 3D2PO. 1/5: 0156 XE1GRR; 0323 FO5DR; 0340 FO4NK. Since then a few JAs with best on 12/5. (It is interesting to note the large number of contacts with stations in 3D2 Fiji).

Col also reported that during the auroral opening on 11/4 between 1025 and 1327 on 50 MHz he worked VK3OT, VK3AME, VK3AIG, VK3NM, VK5BC, VK7IK, VK7DC. On 144 MHz he worked VK3UM. His comment was that there were no beat notes — just like the old-time spark transmitters!

Bill VK5ACY reported working W4EQM at 2245 on 27/4 at 5x5. JAs have been fairly regular around the middle of the day with a good opening on 12/5 from 0500 to 0900. VK4FNQ was heard working 5W1KT.

In the eastern states there was more activity. Steve VK3OT has been well rewarded for his long hours of perseverance, the following being his rewards for this equinox. 22/3 2330 ZK1WL 5x9; 2335 T32VP 5x5; 0700 KH6JEB/KH7 5x4. 7/4: 0056 YC0UVO 5x3. 15/4: 2235 V73AQ 5x5. 16/4: 0015 AH3C/KH5J. 24/4: 2140 ZK2KK 5x9. 26/4: 2250 V31PC 5x5. 29/4: 0121 HH7PV 5x7. 30/4: 0020 YV4DDK 5x3; 0133 TI2KD 5x3. 1/5: 0135 PJ9EE 559. Also in 1990 he worked ZL9TPY, FO5DR, FO4NK, 4W1JP, 5W1KT, ZK1CG, T32IO, T32B, YB0ARA, ZL7OYA, ZK2KY.

That's quite a successful effort considering overall conditions were not as good as last April. These contacts give Steve a very respectable tally for the Six-Metre Standings. Steve reports the QSL route for PJ9EE is via YB3CN, whose address is available from Steve via a phone call.

New South Wales

Mike Farrell VK2FLR (formerly VK2AM) reports that between 18/2/90 and 4/5/90 he worked 17 countries outside VK and ZL. He lives at Glebe Point, which is 2km west of the centre of Sydney and is badly obstructed in all directions east of north, so he considers he has had his fair share of DX!

On 18/2 at 1000 he worked NI6E/KH6 at 5x5. 28/2 1225 JR6HI on Okinawa. 3/3: 0330 JE0GG 559; 0450 HLI1FF 539; 0750 JL1IRG 539. JA1, 2, 8 and 9 were worked between 4/3 and 17/3. 22/3: 2350 KG6DX 569. 24/3: 2145 N6AMG/KH8 5x9; 2210 T20AA 4x2; 2220 V31PC 5x7. 25/3: 0045 JA8RC 5x7; 0130 HL1ST 419; 0205 JA7CSL 559; 0250 KG6DX 5x9; 2143 N6AMG/KH6; 2220 ZK1WL 4x1 and then more JAs. Between 2040 and 2200 heard ZF1RC, 6Y5IC, 6Y5PS, HI8W and HH7PV. 29/3: 2205 K6STI 5x5; 2220 N6CA 419. 30/3 between 2200 and 2400 heard W6AMG/KH8, T20AA, K6CXY.

1/4: 0230 V73AQ 5x5. 3/4: 2210 5W1JP 5x9; 2215 W6JKV/FW 5x5. 18/4: 2130 T20AA 5x9 also heard weakly AH3C/KH5, XE1GRR and ZL3ALE. 24/4: 2130 ZK2KK 5x7. 26/4:

2345 XE1GRR 3x3; 2350 V31PC 3X2. 28/4: 0610 TO 0845 JA1, 7, 8, 9. 30/4: 2350 5W1KT 5x3; 1135 to 1320 JA1, 2, 0. 1/5: 2315 3D2PO 5x3; 2350 N6CW 5x3. 2/5: 0020 YV4DDK 5x2; 0040 PJ9EE 5x1.

It is interesting to note that whilst there were a few good strength contacts, many were marginal at 5x3 or less and is summed up by Mike's words that "in comparing this equinox with the corresponding autumn equinox of 1989, I feel that last year was better in that trans-pacific openings started earlier in the season, they were of longer duration and signals were stronger. On the other hand, the frequency of openings was about the same and there was more activity from DXpeditions in the Pacific region. I suppose it would be too much to expect a repeat of the tremendous X-class flare activity we had in early March 1989!"

Queensland

Ron VK4BRG has written from Box 323 Sarina Qld 4737 saying that for the time being he will be QSL manager for Simon YJ8GP for direct-only cards.

When Ron was in YJ8 last July he left a six-metre rig and 60-Watt amplifier with Simon to keep YJ on the air. For various reasons Simon is behind with his QSLs and Ron will help to clear his existing backlog — in other words, anyone who sent a direct QSL should not need to send a further card.

Ron reports six metres not as good as expected but in April had some interesting contacts as follows: 13/4: 0155 to 0312 K6GSS/KH6, KH6IAA, NI6E/KH6; 1129 VK9LG. 1858 to 2348: TI2KD, TI2RH, TI2HL, KG6DX, 3D2AG, T20AA, TI2NA, TI4JHQ. 14/4: 0236 KH0/J1AEB; 2039 to 2400 T20AA, TI2KD, ZK2KY, YV4AB, 3D2PO, AD6C, V73AQ, 5W1KT, KH0/J1NJC. 15/4: 0018 AH3C/KH5J. One would think Ron's hands would be trembling after writing so many elusive contacts into the log!

Six Metres DXCC

I was pleased to receive a communication from Ray Clark K5ZMS, Number 1 member and secretary of SMIRK, to the effect that the American Radio Relay League DXCC Desk has determined the first recipients of Six Metre DXCC. No 1 DXCC goes to Lee Fish, K5FF and No 2 goes to her husband Fred W5FF. No 3 goes to Bob Billings VE1YX. There are about nine or 10 others who are waiting for QSL cards and these include JA4MBM, W4CKD/W8, K1TOL, W3XO/5 and LU3EX. Both Lee and Fred now have 113 countries worked on six metres!

As a result of the ARRL declaring these three new holders of DXCC, SMIRK has declared Lee Fish K5FF the winner of the SMIRK DXCC Trophy. Because the No 2 holder is her husband, his name and callsign were added to the trophy and it was awarded jointly.

The presentations were made at the Dayton Hamvention VHF/UHF Forum in the USA

on 27/28 April 1990. International Awards of Merit were also presented as follows: For Service Achievement to Ray Clark K5ZMS; Technical Achievement to Ed Tilton W1HDQ; Operating Achievement to Bob Billings VE1YX; Special Achievement to Kazuo Ogasawara JA1RJU.

Ray K5ZMS says he has not yet been able to complete a list of all countries active on six metres but estimates that there have been in excess of 150 countries and this includes the various DXpeditions that have come and gone. VK5LP attempted to produce such a list but after 80 countries I ran out, so I do not possess precise information on the status of many small countries and islands — I am certain such information has to come from the northern hemisphere where there appears to be greater potential for establishing contact with rare countries and for dissemination of the appropriate information.

Who's on Six

Ray Clark K5ZMS and his Six Metre News lists a number of stations and areas which are likely to be activated on six metres, and the following is a precis.

V31JO is active. WA2ALY is providing the call VQ9LW. G4KLF/MM will be ZS1DD/MM and has his A45ZN call and hopes to gain permission to operate from Oman. JA8JRC/6W1 continues to be active from Senegal. Richard EL2B is back in Liberia. EL2FO should be receiving his SB110 from N2AU and be on six soon. Jose CO2JA is said to be active. Jack T30JH is on six and plans to operate from Nauru as C21JH. Andy VS5DA is on between 1300 and 1600.

West German use of six metres is expected soon. They will have 50.080 to 50.400 with 25 Watts ERP and horizontal polarisation, CW and SSB only and the permit is for one year. East Germans are seeking six-metre permits.

Monaco may be on six soon, depending on Italian/French authorities.

Jim J37AE departed Grenada in April, ending operations from there.

6Y5IC has trouble with his transverter and is trying to obtain parts to make repairs.

SMIRK has donated an antenna to allow VP8BFH and VP8BOQ from The Falklands to come on six metres.

QSL Routes

From Ray Clarke also — 6Y5FS has returned to England — QSL to N E Bethuna — G3FRS, 22 Dunbar Road, Wood Green, London N22, England.

AH3C/KH5J Jarvis Island go to JA1BK. Eric (ex FO0OQ) is now FE1JJK/FY and QSL via FD1JMH.

Matts Persson SM7PKK to Betsy 22, S-24010, Dalby, Sweden.

Mike Barry ZD8MB has returned to England — QSL as G4MAB, 'Holme Beck', Low Heskett, Carlisle, Cumbria, CA4 OEU, England.

The DX Report

The SMIRK DX Report is very comprehensive, and stations in the northern hemisphere have been involved in contacts to many we probably dream about. The following are some call signs worked by various stations during the period between 23/3 and 30/4 and are generally those not so far reported by me: 6Y5FS, CE0DFL, SV1DH, KB6SL/CE3, PY0FF, CT1DTQ, CT3DJ, PA3EUI, LA2AB, VE3KKL, LU2DEK, 8P6JW, VR6JR, TR8CA, FM5WD, 5H1HK, HC1BI, HC5K, 7P8EN, YC0IKI, ZP6XDW, 9H1BT, WH3AAD, 9Y4VU, LX1JX, A22BW, ZK1CG, LU3EX, CX8BE, 9L1US, F8SDR, YV5ZZ, 9Q5EE, V29OA, HC2GE, ZD7CW, PY2DM, ZS9A, ZS2FM, OZ4VV plus countless Ws and JAs.

Just for readers' interest, here is an abridged report from SMIRK covering one day only, which indicates the type of activity taking place across the equator: 31/3/90. Flux=172 A=7 K-2. 8P6JW reports 0130-0200 working LU, HC. 0150-0300 heard ZD8 beacon. OA, TI2. 0340 W6JKV/FW to HC1BI. So far he has worked 5H1, TI2, FO5, 3D2, VK4,

P29, KG6, FY7. 1400 8P6JW has 5H1 beacon. 1535 V51E to 9H5, ZC beacons. HC5K has LU and CX. ZS6BW has 5B4 and SV beacons. Large opening between North and South America. 1545 7P8EN DXpedition into Mediterranean area. LU to W7. 1730 to 1945 8P6JW worked YC0UVO, YC0IKI, FM5WD, 5H1HK. 1955 W7 to LU again. FY7 beacon to FW. 2000 TR8CA worked 8P6JW. 2025 3D2s to KH6JEB/KH7. 2030 ZLs to W6 and VK to V73. 2205 P29 hear 5W1. LU to W6. 2240 KH6 to LU, CX and ZP. 2305 ZP6XDW got 9H1BT. At 0300 in the morning WH3AAD on Johnston Island was working JAs!

The above paragraph was being repeated in somewhat similar fashion day after day; it all makes incredible reading. There has been so much going on despite the general acknowledgement that this year was not so good as last year!

Two Metres and Above

With most people concentrating on six metres activity on the higher bands has diminished. VK5LP maintains a nightly sked to

VK5AKM and VK5KK at Wasleys with 144 and 432 MHz receiving the greatest use. Power levels of three Watts only are required for good contacts to be maintained over the 160km path — not line of sight as the Mount Lofty Ranges intervene. Using one Watt we have been successful with two-way contacts whenever tried on 1296 MHz. With help from VK5KK we hope soon to have 10 Watts from both ends on 1296.

Closure

These notes have been concluded earlier than usual as I am due back in hospital on 30 May for further surgery. I hope to be on deck in time to write something for next month and to include the updated Six Metres Standings.

Closing with two thoughts: "Just because a rumour is idle doesn't mean it isn't working" and "Wild horses couldn't drag a secret from most women. Unfortunately, women seldom have lunch with wild horses". 73 from the Voice by the Lake.

Late item: Steve VK3OT and Arie VK3AMZ worked WS4F and A4VCC the morning of 285.

ar

POUNDING BRASS

GILBERT GRIFFITH VK3CQ
7 CHURCH ST BRIGHT 3741

This month I would like to bring you a little overseas news, something that readers of *Morsum Magnificat* will be familiar with from the number 15 Spring edition:

IARC Proposal To IARU For End Of Morse Test?

Israel's national radio society (Israel Amateur Radio Society) is submitting the following formal proposal to the International Amateur Radio Union Region 1 Conference at Torremolinos, Spain, 1-6 April 1990:

"That IARU Region I agree in principle that in view of the abolition of Morse proficiency testing for Maritime Mobile operators the CW test for amateurs be replaced by some form of operating proficiency test more suitable to the present day data operating modes of amateur radio."

Should this proposal be carried, then an additional proposal is submitted to the Conference suggesting that action be initiated with the ITU to modify Article 32 of the radio regulations to require any person seeking an amateur radio licence to prove that he has knowledge of the various data codes and operating procedures, and has demonstrated his competence in manual keyboard operation. An alternative proposal waives this requirement for those making exclusive use of frequencies above 30 MHz.

The Israeli paper recognises that even if the Conference agrees to its proposals, the

need to obtain ITU approval and subsequent adoption by individual administrations means that "nothing will happen overnight". It goes on, however, to make a further proposal, that a working group be set up to devise a practical and theoretical operating examination to "elaborate a common syllabus for Region 1" and "define the required keyboard skills, speed of data entry and acceptable number errors".

The paper is signed by Ron Roden, 4X4RR (G4GKO), IARU Liaison Officer, IARC, who comments "with great respect to the historical and traditional mode of amateur operation and the CW operators (amongst whom I am proud to count myself) I submit that we must not permit ourselves to indulge in nostalgia to the possible future detriment of the Amateur Service".

In its conclusion, the paper says, "It is felt that introduction of the measures proposed will not only prove attractive to the "Computer Generation" but will also fully satisfy the concept of self-training".

And Here Are The Results

Israeli Proposals Defeated

The voting on the proposal by the Israel Amateur Radio Club to the IARU Region 1 Conference in April, that the amateur Morse test be replaced by a test of computer skills, was 30 countries AGAINST and 9 countries in FAVOUR of the proposal.

The following is a summary of the minutes of the meeting which discussed this matter.

The IARC (Israel) delegate introducing the proposal referred to emergency communications by amateurs, saying that AMTOR surpassed CW and, that in a few years time, ships would be equipped with SPECTOR. He felt that the Morse examination was only a bench mark in order to gain access to the HF bands.

SSA (Sweden) — A meeting in Helsinki in February had voted against the Israeli paper. A letter had been received from the Scandinavian CW group protesting against the paper's conclusion.

NARS (Nigeria) — CW was considered very honourable amongst radio amateurs and was very important to African societies.

REF (France) — France's PTT had recently sought the views of REF on the need for a Morse test for amateurs. The REF board of directors had agreed that no Morse examination was necessary. The PTT were surprised by this view but had accepted it and were prepared to give access to frequencies below 30 MHz without the need for a CW test.

PAOULOU, Chairman of the IARU Region 1, said that the paper did far more than deal with the question of Morse code on the HF bands. It dealt with the very future nature of the amateur service. The proposal almost reduced the amateur service to the nature of the mobile service. More young people were needed in the amateur service but they must attain a certain level of achievement. He hoped that amateur radio would continue to provide the sort of challenges that made good radio operators rather than computer operators.

VERON (The Netherlands) — Amateur radio is all about encouraging self-training, building the equipment and technical investi-

gations. The nature of CW meant that communication could be achieved with very simple equipment, ideal for beginners. Thus a knowledge of Morse was required. In addition, CW was efficient and used the narrowest bandwidth of any mode or transmission, allowing more stations to use a given amount of spectrum space. It would be very unwise to remove the Morse examination as an amateur radio requirement, and if it was removed it would be very dangerous for the future of amateur radio.

W1RU, President of IARU, said that he was supposed to be impartial, however, 90% of his operating was on CW. He described some of the history of the amateur service and concluded by saying that the amateur service and the mobile service were not considered to be similar.

URE (Spain) — Felt that there would be no Morse test in three years time, but did not wish to discourage CW as an operational mode.

REF (France) — was not against CW but against the Morse examination. So far as

bandwidth was concerned, if the existing bands became crowded then new bands should be proposed.

The votes cast were as follows:
For the Proposal:

CARS (Cyprus), FRA (Faroe Islands), IARC (Israel), MRASZ (Hungary), REF (France), REP (Portugal), SRAL (Finland), URE (Spain), AGRA (Gabon).

Against the Proposal:

ARI (Italy), ARAS (Senegal), ARM (Monaco), DARC (FRG), EDR (Denmark), FRR (Romania), IRA (Iceland), IRTS (Ireland), LRAA (Liberia), MARL (Malta), NARS (Nigeria), NRRL (Norway), OVSV (Austria), PZK (Poland), ROARS (Oman), RSF (USSR), RSVDDR (GDR), SARL (South Africa), SLARS (Sierra Leone), SRJ (Yugoslavia), SSA (Sweden), UBA (Belgium), URA (Andorra), USKA (Switzerland), VERON (Netherlands), RSGB (UK), ZARS (Zimbabwe), BARS (Bahrain), AFVL (Liechtenstein), LARS (Lesotho).

Well, Morsiacs, our side won this bout, but

the winds of change are blowing and we will have to watch out. It seems to me that amateur radio has become more of a hobby for the reasonably well-off than ever, and if the Morse requirement is dropped new amateurs will probably not even give it a thought. The less well off will have no idea that you can build cheap equipment yourself, because CW will not be mentioned when training for the licence test. It would be a great pity if one had to buy a computer to enjoy amateur radio, and it would still be impossible for many.

The Keymen's club of Japan (KCJ) is a private club, the members of which are all very interested in Morse communications. The "KCJ single operator CW contest" will be held from 1200 UTC August 18th to 1200 UTC August 19th 1990. If you are interested in competing in this contest, perhaps in order to apply for the WAJA (worked all Japanese Prefectures award) or KCJ award, write to me enclosing a stamped addressed envelope and I will send a copy of the rules. Be quick. ar

AMSAT AUSTRALIA

MAURIE HOOPER VK5EA
11 RICHLAND ROAD NEWTON SA 5074

National Co-ordinator
Graham Ratcliff VK5AGR

Information Nets

AMSAT Australia
Control: VK5AGR
Amateur check in: 0945 UTC
Sunday Bulletin commences: 1000 UTC
Primary frequency: 3.685 MHz
Secondary frequency: 7.064 MHz

Amsat SW Pacific

2200 UTC Saturday, 14.282 MHz

Participating stations and listeners are able to obtain basic orbital data including Keplerian elements from the AMSAT Australia net. This information is also included on some WIA Divisional Broadcasts.

AMSAT Australia Newsletter And Computer Software

The excellent AMSAT Australia Newsletter is published monthly by Graham VK5AGR on behalf of AMSAT Australia and now has over 270 subscribers. Should you also wish to subscribe, send a cheque for \$20 payable to AMSAT Australia addressed as follows:

AMSAT Australia, GPO Box 2141, Adelaide 5001.

The Newsletter provides the latest news items on all satellite activities and is a "must" for all those seriously interested in amateur satellites. Graham also provides a Software Service in respect to general satellite programs made available to him from various sources. To make use of this service, send Graham a blank formatted disk and a nominal

donation of \$10 per item to AMSAT Australia together with sufficient funds to cover return postage. To obtain details of the programs available and other AMSAT Australia services send a SASE to Graham.

Webersat News

WO-18 CCD Camera Iris Settings Experiments

(From AMSAT News Service Bulletin 153.01, June 2, 1990)

For the past several weeks WEBERSAT-OSCAR-18 (WO-18) has been sending three to four pictures daily from outer-space. This continuous stream of imaging data has been part of an ongoing experiment by the students at Weber State University (WSU) to characterize the amount of natural light which enters the CCD camera for the various iris settings. The goal of this experiment is to find the proper settings for the camera iris for a particular light level. This will help considerably in improving the overall picture quality. With the integration of the on-board earth's sensors in the current software, the occurrence of over exposed pictures or totally dark pictures taken when WO-18 isn't earth pointing is no longer a problem. Chris Williams (WA3PSD) says that the painstaking task of manually setting the iris from the ground and observing the results will help software engineers in the future as they continue to understand the CCD camera operation. "The early days of random picture taking is gone," according to WA3PSD. There are 256 possible settings which ground controllers can command the camera iris to; a "zero" setting has the iris completely closed, a "255" setting has

it wide open. What will ultimately come out of this experiment is a look-up table in WO-18's software which will say "for this light level, use this iris setting".

Most Asked Questions About WeberWare 1.0

(From AMSAT News Service Bulletin 153.02, June 2, 1990)

WeberWare 1.0 is a software program for IBM PCs and clones which will take raw packets from WO-18 and turn the packets into pictures on EGA/VGA CRT screens. Recently, as more amateurs start to use WeberWare 1.0, the following questions are being asked of AMSAT Area Co-ordinators about its use:

"Does the TNC (automatically) go into KISS mode?"

The answer to this is no. You must command your TNC into KISS mode by typing: KISS ON. After this, the TNC must be RE-STARTED or turned off and back on so that it will actually start to operate in KISS mode.

"How do you store the files? As ASCII?"

The picture data from WO-18 comes down as raw binary data, that is, it is not displayable as ASCII characters. As the data is received, your communications program must store the binary packets in a file. Do not be concerned about ASCII telemetry frames which occasionally come down along with the binary packets. WeberWare 1.0 ignores the ASCII telemetry.

"How do you upload a picture to WeberWare 1.0?"

When you store the data from a WO-18 pass, name the file so that its file extension has a ".RAW" and put the file in the same directory in which WeberWare 1.0 resides. After you have invoked WeberWare 1.0 and the main menu comes up, you will see an option for "PACKETS TO PIXELS". Upon choosing that option, WeberWare will give

NASA 2-line Keplerian Elements

- Posted by VK5AGR 3 June 1990

```

AO-10                      Epoch.....Drag.....
1 14129U 83 58 B 90141.55893209 -0.00000034 00000-0 0000000 0 5259
2 14129 25.9838 203.2065 5966345 144.7263 275.5441 2.05881342 52151
UO-11
1 14781U 84 21 B 90150.60681341 .00002274 00000-0 00000-0 0 7397
2 14781 97.9502 203.7363 0012427 309.2706 50.7376 14.65386404333392
MIR
1 16609U 86 17 A 90151.89394067 .00025638 00000-0 00000-0 0 7044
2 16609 51.6144 52.9043 0010267 351.6325 8.4458 15.60876417245554
RS-10/11
1 18129U 87 54 A 90150.88464022 .00000158 00000-0 00000-0 0 2069
2 18129 82.9265 341.3123 0012162 160.4836 199.6814 13.72090897147075
AO-13
1 19216U 88 51 B 90148.23246392 .00000105 00000-0 00000-0 0 1284
2 19216 56.9522 153.1540 6957743 228.0483 47.3201 2.09698248 14951
UO-14
1 20437U 90 5 B 90151.43733054 -.00002350 00000-0 00000-0 0 1538
2 20437 98.7024 227.5906 0010468 201.5841 158.4689 14.28616292 18471
UO-15
1 20438U 90 5 C 90147.46533688 .00000564 00000-0 24154-3 0 877
2 20438 98.7008 223.6190 0009592 211.4239 148.6369 14.28369234 17907
AO-16
1 20439U 90 5 D 90142.25412747 .00000692 00000-0 29135-3 0 801
2 20439 98.7039 218.5151 0010628 229.1515 130.8783 14.28715882 17162
DO-17
1 20440U 90 5 E 90150.23446723 .00000754 00000-0 00000-0 0 830
2 20440 98.7039 226.4855 0011009 204.9054 155.1593 14.28772891 18305
WO-18
1 20441U 90 5 F 90150.64496878 .00000667 00000-0 00000-0 0 835
2 20441 98.7040 226.9105 0011547 204.2814 155.7811 14.28871939 18363
LO-19
1 20442U 90 5 G 90150.63884055 .00000694 00000-0 00000-0 0 833
2 20442 98.7046 226.9194 0011741 205.3066 154.7526 14.28941027 18363
FO-20
1 20479U 90 13 C 90144.15135168 .00000003 00000-0 00000-0 0 751
2 20479 99.0426 195.1993 0541743 102.9595 263.2557 12.83155784 13666
Inclin..RAAN.....Eccen....ArgPeri..MeanAnom..MeanMotion..Orb.
    
```

NOTE: FO-20 ident number is now 20479 (instead of 20480)

Satellite Schedule

Satellite: AO-13

Station: Adelaide

Hour - UCT

```

-----0 1 2 3 4 5 6 7 8 9 10 11 12 13 14 15 16 17 18 19 20 21 22 23
01Jul90 - bbbbbbBbbBbLLLSB-----
02Jul90 - bbbbbbBbbBb-----Bb--
03Jul90 - -----Bb-----
04Jul90 - -----Bb-----
05Jul90 - -----bbbb-----
06Jul90 - -----bbbbbbBbb-----
07Jul90 - -----bbbbbbBbbBbb-----
08Jul90 - -----bbbbbbBbbBbb-----
09Jul90 - -----bbbbbbBbbBbb-----
10Jul90 - -----obbbbbBbbBbbBbb-----
11Jul90 - -----bbbbbbBbbBbbBbb-----
12Jul90 - bbbbbbBbbBbbBbbBbb-----o
13Jul90 - bbbbbbBbbBbbBbbBbb-----obb
14Jul90 - -----ob-----
15Jul90 - -----ob-----
16Jul90 - -----ob-----
17Jul90 - -----ob-----
18Jul90 - -----ob-----
19Jul90 - -----ob-----
20Jul90 - -----ob-----
21Jul90 - -----ob-----
22Jul90 - -----ob-----
23Jul90 - -----ob-----
24Jul90 - -----ob-----
25Jul90 - -----ob-----
26Jul90 - -----ob-----
27Jul90 - -----ob-----
28Jul90 - -----ob-----
29Jul90 - -----ob-----
30Jul90 - -----ob-----
31Jul90 - -----ob-----
01Aug90 - -----ob-----
02Aug90 - -----ob-----
03Aug90 - -----ob-----
04Aug90 - -----ob-----
05Aug90 - -----ob-----
06Aug90 - -----ob-----
07Aug90 - -----ob-----
08Aug90 - -----ob-----
09Aug90 - -----ob-----
10Aug90 - -----ob-----
    
```

FLUKE 80 SERIES MULTIMETERS

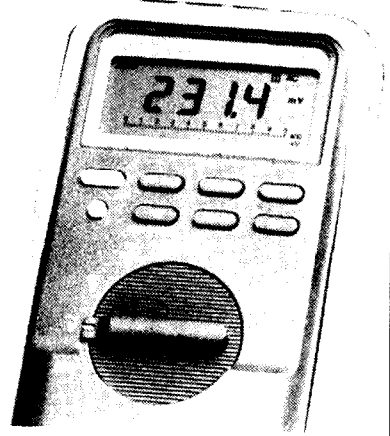

**Tough enough
to take it,
wherever you
take it**

Fluke 80 Series multimeters come in a rugged, water and dust resistant case. They can handle up to 1000 VAC (RMS)/DC on any terminal and have an "input alert"™ warning if test leads are in the current jacks and a non-current function is selected. They are shielded against electromagnetic interference and are protected against shock and vibration.

Each Fluke 80 Series multimeter comes in a rugged protective holster, with a unique "Flex-Stand"™, which bends and holds to any shape, allowing the multimeter to be stood or hung almost anywhere.

To find out just how tough a Fluke 80 Series multimeter can be... call your local Fluke distributor today.

FLUKE AND PHILIPS -- THE T & M ALLIANCE



PHILIPS

you a choice of all files that have file extensions ".RAW".

Chris Williams (WA3PSD) of Weber State University (WSU) points out that a complete picture file will take up about 156 Kbytes in a disk file. According to Chris, one can quickly start to run out of hard disk space in a HURRY!

AO-13 And AO-10 Transponder Schedules

(From AMSAT News Service Bulletin 153.07, 2, 1990)

The present transponder schedule for AO-13 (effective 5 May 90) is as follows:

Mode-B : MA 000 to MA 100
 Mode-JL : MA 100 to MA 125
 Mode-LS : MA 125 to MA 130
 (Mode S Beacon only)
 Mode-S : MA 130 to MA 135
 Mode-BS : MA 135 to MA 140
 Mode-B : MA 140- to MA 256
 Omnis : MA 220 to MA 040

The best estimate of the current attitude is: BLON = 179 and BLAT = -2.1 for 04 Jun 90
 Cross mode B and S QSOs are possible during MA 135 to 140.

AO-10's Mode-B Transponder Now Available For Use

AMSAT-OSCAR-10 appears to be receiving sufficient solar panel illumination to support Mode-B transponder operations, therefore, the transponder is available for general use whenever AO-10 is in view at your location. Please DO NOT use the transponder if the signals are FMing. The current estimate of AO-10's attitude is LON 24 deg LAT-9 deg.

FO-20 Keeps Status

The good news is that NASA is now tracking both Fuji OSCAR-20 and the DEBUT spacecraft and publishing orbital elements for the two.

The bad news is that NASA/NORAD has swapped tracking data with names. FO-20 is Catalog number 20480, Intl number 90-13C. DEBUT is Catalog number 20479, Intl number 90-13B.

** The element set distributed by AMSAT for FO-20 contains the correct elements for that satellite.**

However, if you use the NASA 2-line sets, you will need to use the numbers listed for DEBUT.

If this is confusing, just remember that FO-20 is faster than DEBUT (look at Mean motion). FL-20 rises earlier, so that should lead you to the correct element set.

These results are based on Closest Point of Approach (CPA) observations and analysis. Anyone observing any differences or corrections, please contact the AMSAT Orbital Data Manager by mail or packet.

Dick Campbell, N3FKV @ W5XO
 AMSAT Orbital Data Manager

(What this means is that FO-20 Keplerian

Satellite Activity for March/April 1990

1. Launches

The following launching announcements have been received:

Int'l No	Satellite	Date	Nation	Period min	Apog km	Prg km	Inc deg
1990 —							
025A	USA-54	Mar 26	USA	354.9	20284	169	37.6
026A	COSMOS 2063	Mar 27	USSR	11h49m	39346	602	62.9
027A	OFEQ 2	Apr 03	Israel	102.5	1577	209	143.2
028A	PEGSAT	Apr 05	USA	96.4	682	500	94.1
028B	USA-55	Apr 05	USA	96.3	673	498	94.1
029A	COSMOS 2064						
TO	TO	Apr 06	USSR	115.0	1495	1437	74.0
029H	COSMOS 2071						
030A	ASIASAT-1	Apr 07	China	1436.2	35789	35786	0.1
031A	USA-56	Apr 11	USA				
031B	USA-57	Apr 11	USA				
031C	USA-58	Apr 11	USA				
032A	FOTON 3	Apr 11	USSR	90.5	389	225	62.9
033A	COSMOS 2072	Apr 13	USSR	89.0	248	189	64.8
034A	PALAPA-B2R	Apr 13	Indonesia	1485.7	37785	35717	0.4
035A	COSMOS 2073	Apr 17	USSR	88.7	267	189	82.3
036A	COSMOS 2074	Apr 20	USSR	104.9	1016	982	83.0
037A	STS-31	Apr 24	USA				

2. Returns

During the period fifty objects decayed including the following satellites:-

1983-033A	ROHINI 3	Apr 19
1984-127A	COSMOS 1615	Apr 15
1988-045A	COSMOS 1949	Apr 23
1988-065A	COSMOS 1960	Apr 03
1990-024A	COSMOS 2062	Apr 05

3 Notes

1990-0271 OFEQ 2 was launched in Israel.

1990-028A PEGSAT was launched using the winged Pegasus rocket booster released from an airborne plane.

1990-030A ASIASAT-1, a U.S. built telecommunications satellite was launched by China for the Asia Satellite Communications Company.

BOB ARNOLD VK3ZBB

element sets will now use the number 20479, so if you use the autoloader facility in InstantTrack or similar, delete your old set containing the "old" number 20480 first — Maurie VK5EA).

Phase III-D Design Meeting

(From AMSAT News Service Bulletin 125.06, May 5, 1990)

Preliminary Design Review for New Satellite Held in Germany.

Amateurs from around the world who are involved in the Radio Amateur Satellite Service are meeting in Marburg, West Germany from May 7 through May 9 to begin work on another major amateur satellite project. The purpose of the meeting is to set specific design goals for Phase III-D. The three days of meetings will cover a wide range of topics. Areas to be discussed will include: launch opportunities, orbit choices and constraints, transponder choices, antenna design, on-board computer systems, and propulsion systems. In addition to setting hardware and software design goals, equally important discussions will focus on labour division between groups,

monetary commitment required, and development of a communication structure between groups involved in the program.

Mouse Driver Problem With InstantTrack

(From AMSAT News Service Bulletin 132.03, May 12, 1990)

Microsoft Software Found To Cause Intermittent Problems

Some InstantTrack users have recently discovered a problem where the map "goes away" or "freezes" when they use their mouse. InstantTrack's author Franklin Antonio (N6NKF) has determined that this problem is a result of a conflict with the Microsoft mouse driver (MOUSE.COM) versions 7.00, 7.01, 7.02 and 7.03. Changing to a mouse driver version earlier than 7.00 or later than 7.03 is the cure. An update of InstantTrack is not required to resolve this problem.

Microsoft is aware of the problem, as it occurs with many programs other than InstantTrack. InstantTrack users who are experiencing this problem should contact Microsoft and ask to obtain version 7.04 of MOUSE.COM.

73S FROM MAURIE VK5EA

EDUCATION NOTES

BRENDA EDMONDS VK3KT
EDUCATION COORDINATOR

I have now received some reports of examinations run under the devolved system, and am aware that there are new call signs on air as a result of some of these.

Most comments so far collected have been favourable, the examination conditions were good, the organisations were efficient and few problems were encountered.

However I do not as yet have any sort of overview of what is happening throughout Australia. I feel I need a lot more information about arrangements in all Divisions, and examinations run that have not been under WIA supervision. I will have a meeting with DoTC as soon as possible to discuss the progress of devolvement, so would greatly appreciate feedback from all sources, both examiners and candidates, so that any unforeseen problems can be aired, and further planning or refining of the existing system can occur.

I have asked each Division to collect some information for me, so that time can be allocated at the July Weekend Executive meeting to discussion and planning, and to defining more clearly the roles of the Divisions and of the Federal Co-ordinator. I intend also to request some of this information from bodies known to have conducted or planning to conduct examinations on their own behalf, and so

would obviously be pleased to hear from any examining body which does not hear from me within a few weeks. If you do not hear, that means I do not know of your existence.

Please note, I am not trying to interfere in your activities or override your authority. I am simply trying to collect items which should be raised with DoTC, and to start a central register of where information is held. I would especially like to know what records each examiner maintains about questions, papers, candidate pass/fail rates and application rates for each section of the examinations.

From some remarks I have heard, there seems to have been a bit of a communication gap between the various sections of DoTC, eg between Canberra and the State Offices, in the early stages. I think much of this has been overcome, but please tell me if this caused problems. I am assuming that each examiner has been notifying the local State Office of each intended examination, but some of the information seems to have got lost at times.

My congratulations to those bodies which have recently run successful examinations. I know it has been much work by few very dedicated persons. Tell me if there is any way in which I can help you now or in the future.

ar

FTAC NEWS

JOHN MARTIN VK3ZJC
3 VERNAL AVE MITCHAM 3132

Data Base

Thanks to the Divisions and individual amateurs who have helped with information. VK4XRL corrects the input frequency of the VK4RTV ATV repeater to 444.250 MHz.

Band Plan Changes

Comments would be appreciated on a proposal to make a slight rearrangement of the EME segment and calling frequencies on all bands from two metres up. The proposal is:

(1) 2m, 70cm, 23cm and 13cm bands:

Extend the EME allocation to 50 kHz at 144, 432, 1296 and 2304 MHz. Drop the .050 DX M/S calling frequency — it is used only on six metres. Move the CW calling frequency up to 144.05, 432.05, 1296.05 and 2304.05 MHz. Thus bisected the DX segment of each band with 50 kHz each for EME and terrestrial DX.

(2) Higher bands:

Due to doppler shift, larger EME segments are needed on these bands, and the level of activity does not justify as many calling frequencies. The proposal is to extend the EME segments on these bands to 100 kHz either side of 3456, 5760 MHz etc, and retain only two all-mode calling frequencies (3456.1, 5760.1 etc (primary) and 3456.2, 5760.2 etc (secondary).

Microwave Activity Register

Thanks to the following amateurs for supplying information: VK2DVW, VK4CAV, VK4EKA, VK4XRL, VK5KK, VK5ZEM. The register now lists the following numbers of active stations:

23 cm: VK1 7; VK2 4; VK3 38; VK4 3; VK5 10; VK6 3; VK7 5.

Higher bands, nationwide: 2300 MHz 19; 3300 MHz 9; 5350 MHz 7; 10 GHz 14.

There are obviously far more than this, and VK3 certainly needs to be pulled down from its commanding lead on 1296! So, if you are active on the higher bands or know anyone who is, please write in. If we can get a reasonably complete list it can be published to help microwave users keep in touch with each other, as well as helping the WARC '92 team in its planning.

1296 MHz FM

Some 1296MHz operators are using transverters from two metres and cannot operate outside the 1296-1300MHz range. A number of VK3 operators have adopted 1298.1 MHz as an unofficial FM net for transverter users.

ar

FLUKE 80 SERIES MULTIMETERS



On the alert, accurate and safe

Fluke 80 Series multimeters come with a large number of "alert" functions designed to ensure safe, easy use.

The "Input Alert" prevents accidental damage through wrong lead connection. An automatic power cut-off (after 30 minutes idle) extends battery life. This may be overridden in 36 hour record mode.

And the readouts couldn't be easier. Fluke's patented "Touch Hold"™ feature, when activated, captures, locks and displays each measurement, yet leaves you both hands free to position the probes. In the relative mode, measurements can be made relative to your own reference point. And there's a maximum/minimum alert, plus automatic storage of max/min readings.

And there's much more. Why not be alert to all the special features of Fluke 80 Series multimeters . . . call your local Fluke distributor today.

FLUKE AND PHILIPS - THE T & M ALLIANCE



PHILIPS

SPOTLIGHT ON SWLing

ROBIN L HARWOOD VK7RH
52 CONNAUGHT CRES WEST LAUNCESTON 7250

Well, half of 1990 has already slipped by and activity on the various bands has been hectic as the political situation, particularly within Eastern Europe, has continued to be extremely interesting. Since the revolutionary changes in that region, the different international broadcasters have made greater efforts to improve their output, particularly as the listener response has dramatically improved.

One international broadcaster that has been concentrating on the Eastern European countries exclusively has been Radio Free Europe in Munich, West Germany. Now the US Government, which has been funding its operations, is seriously re-evaluating whether it should continue to broadcast since the emergence of a strong independent broadcasting infrastructure in the region. A recent presidential commission has reported that there appears to be no need to continue Radio Free Europe, although the companion Radio Liberty could continue. Radio Liberty broadcasts to the USSR exclusively in the languages of that vast nation. Both stations share the same facilities and were subject to heavy jamming until December 1988.

In last month's column, I did mention that Radio Prague had ceased broadcasting its international service. Now the station reappeared on 7th May and, as I stated in last month's column, personnel alterations have been made, with some voices no longer heard. The station has also changed its callsign to Radio Prague International. They have made substantial alterations to their previously released schedule, concentrating on European audiences, although I have seen reports that the North American service is operational. Their Spanish service seems also to be in limbo, particularly as that seems to be the section where most changes to their staff were made.

Another station that has changed its callsign is Radio Bucharest, Romania. It is now known as Radio Romania International. There doesn't appear to be any schedule alterations, either.

As it is now mid-winter, reception is excellent in the daytime on HF circuits. I do find it much easier to tune around the various allocations without any jamming. It also seems to be better this year from last year, particularly down on the lower frequencies, with Euro-

pean signals over the polar path, around my local midday period.

I am noting on various non-amateur frequencies, packet signals, and suspect that these may be pirate operations. There is one net around 27.612 MHz in French with several stations in Europe and the Indian Ocean.

Judging by their headers, they don't appear legitimate. I have also heard packet signals around 10.3 MHz, and I don't know if they are legitimate or perhaps connected with the 27 MHz suspicious operations.

By the way, there are SWL files on your local packet BBS. There was one file on schedules of international stations, easily heard here in Australia. I was able to make use of it when I had a borrowed packet TNC. Hopefully, I will be back among the packeteers shortly.

Last year, we gained a new pastor in our congregation and it wasn't too long before we both realised we had something in common. He is an active ham, with the call of VK7BE. The perplexed members of our little flock have been hearing us discussing delta-loops, quads, DX, QSLs, FT200 etc, and have been wondering if we belong to some esoteric sect. By now, I should have in place a delta loop at this QTH, based on a successful design by my pastor.

Well, that is all for this month. All the very best of listening and good propagation.

73 DE VK7RH.

ar

INTRUDER WATCH

GORDON LOVEDAY VK4KAL FEDERAL INTRUDER WATCH CO-ORDINATOR
'AVIEMORE' RUBYVALE 4702

During the last 12 months some new ideas have been put in position to improve the input to DOTC — some have been noted by observers, as the log sheets show, eg, the number of times heard during the month, but only a few observers have bothered to include the length of time the intruder was heard. This is important also. It will give the DOTC monitor staff a chance to concentrate on those intruders they have a chance to remove from the bands. DOTC will only monitor those intruders who occupy our bands for long periods of time. It is impracticable to investigate a single logging of short duration.

It is interesting to look back (1982) and find some persistent intruders still with us. Some have left by their own accord (maybe) or by our combined efforts (?). We still have VRQ on 14075/80 kHz Vietnamese News Agency on A1A. UMS on 14141/14171/18152/21032 kHz plus a couple of newcomers, RGT77 on 14148 is also USSR Naval. The seasonal shift brings many of these into prominence. Many intruders are constantly changing their frequencies.

I must draw attention to FSK ... it is often heard as a constant NON signal, and may

break into unintelligible CW. Tune up about 500 Hz and the call should be readily identified (if it has one). Sometimes, if you tune to the lower side, you will often hear a jumble of letters. If you write these down in "dots" and "dashes" with appropriate spacing, it will decipher out, eg, VU2BNC (a beacon station) will sound like "BD DE ET VIAA"!

My final remarks are directed along the lines of Ian VK3ALZ (AR May 1990 P.51). I feel the same way. It is the younger generation who must really fight for the bands they occupy now. I also did my share of "lobbying and fighting for 6 metres back in 1958-59, then as VK4ZBI. What ails the younger generation? Are they frightened of failing, I wonder? We all started the hard way, some more so, than others; so take advantage of the experience we have to offer, NOW.

To Beth Gott, I convey my deepest sympathy. Ken was looking forward to adding his weight to the Special Survey; that was not to be.

ar

Modified Summary April 1990

Freq	UTC	Date	Logsx	EMN	ID	Comments
7002.5	1150+	2003	5	A1A	"V"	
10150	1125	2703	4	A3E	-	Chinese Lang B/cast
14023.5	0630+	2203	25	F1B	-	250 Hz 3rd register
14046	mni	mni	30	mni	-	24 hr Radio Telephone
14058+/-	daily	daily	55	"	-	24 hr op "HELSCHEIBER" China??
14071/75	mni	mni	49	A1A	VRQ	Vietnam
14211.5	"	"	24	F1B	-	250 Hz 3rd Reg shift Txt in cyph
14215	1000+	120490	7	A1A	EH6	A new one???
14217.5	mni	mni	23	F1 CW	-	& F1B 250 Hz 3rd register
21315	0500+	030490	8	A3E	-	Rad Moscow 2nd prog to Russia

3rd Harmonic of 7105 MHz
Because of good condx we have a proliferation of Radio Moscow on 21.405/450 logging 88 A3E

Also 3rd harmonic of 4.990 MHz " 24.950 possibly China
28.280 up Radio Moscow 36+ " All 3rd Harmonics

REPEATER LINK

WILL MCGHIE VK6UU
21 WATERLOO CRES LESMURDIE 6076

Repeater Audio

The retransmitted audio from a repeater can vary from repeater to repeater. It is important that audio quality through a repeater system be as good as possible for several reasons. Most important of all is listener comfort. Poor quality audio causes fatigue and loss of intelligibility. To tell how well your repeater does on audio quality compare the audio direct and as retransmitted. If there is a reduction in the quality of the audio the most likely causes are off frequency, incorrect deviation etc, or it could be that the repeater transmitter has a phase modulator. It is difficult to achieve good frequency response and low distortion with a phase modulator for the following reasons. Firstly a phase modulator has a rising frequency response. For the same input level a 2 kHz tone produces twice the deviation of a 1 kHz tone. This means that a phase modulated repeater transmitter does not reproduce the low frequency content and the audio sounds thin. You would think frequency compensation would solve the problem but the amount of low frequency boost required, about 20 dB, over drives the phase modulator and results in distortion. An understanding of how phase modulation is produced is required to understand its limitations. Distortion increases as deviation increases. Even at 5 kHz deviation on 2m distortion is as high as 15%. The distortion level is frequency dependent and can be almost 100% at low frequencies. The end result of all this is thin sounding distorted audio. The solution to this problem is to direct frequency-modulate the repeater transmitter. Frequency modulation has a flat frequency response at much lower distortion. In fact, a flat frequency response is not what is required from the repeater's transmitter. Pre-emphasis is required when direct FM is to be used. Attention to good audio through our repeater systems will become more important as repeaters are linked together because the resulting distortion can only increase as the number of systems linked together increases.

2 Metre Duplexer

In order to understand your duplexer, let's learn some of its limitations. Firstly it introduces a loss of about 2 dB into your repeater system on receive and transmit. So 10 Watts is reduced to about 6.5 Watts, or a 10 μ V signal to about 8 μ V. The very best duplexer of this type will have an insertion loss of 1 dB, but silver plating is required, so 2 dB is a realistic loss.

The duplexer will not improve your repeater if the best of the previous two aerials is

used. It can't even equal it because of the 2 dB loss. The duplexer will only improve your repeater system if previously it was being de-sensed due to aerial placement.

Reject attenuation is about 100 dB and that's a lot of dBs! — So isolation between the repeater's receiver and transmitter must be very good. To test if there is enough RX-TX isolation, connect a well shielded dummy load to the TX and a slightly noisy signal from a shielded signal generator, and key the transmitter on and off. There should be no change in the noise level of the receiver. If the noise level increases, your duplexer will not fix it.

The coax used to connect the duplexer to the receiver and transmitter should be double screened, or one with a good quality braid. (Remember the better than 100 dB isolation). The coax from the duplexer to the aerial does not need to be double screened.

Noise output 600 kHz from the transmit frequency should be better than 80 dB down from the transmitter output (0.1 μ W). Valve transmitters can be 40 dB better.

The receiver should have a dynamic range of 80 dB or better, ie a signal 600 kHz away from its receive frequency and 80 dB stronger than the weakest signal you can receive (about 0.1 μ V) causes no de-sensing. A very good dynamic range of 115 dB is possible with solid state receivers. Front end tuned circuits have no effect on the dynamic range of a receiver with a signal only 600 kHz away. Even many tuned circuits in the average receiver all tuned to the same frequency are several MHz wide.

When the duplexer is first connected to the aerial, de-sensing may occur even though the receiver and transmitter are OK. It may be that the duplexer has drifted (this will be covered later), but if this is not so, it may be the aerial! This can be a very big problem, which is not evident on the split aerial system. Assuming the aerial has a good SWR (better than 1.5:1), the problem is poor and/or intermittent connections in the aerial structure. Aluminium, in particular, develops corrosion joints which act like a diode detector, producing wide-band white noise, which de-senses the receiver. Don't forget the aerial is both receiver and transmitter. It has about 20 volts of RF applied to it, and 0.4% away in frequency it is trying to receive a 1 μ V or less signal. Even poor joints on masts and other nearby metal objects will cause considerable de-sensing. Often this type of aerial or mast de-sensing is intermittent. To test for this type, replace the aerial with a good dummy load. If the problem goes, then your aerial or mast etc is causing the de-sensing. Solution is to solder or weld all joints, but if this is not possible, then clean thoroughly and apply

FLUKE 80 SERIES MULTIMETERS

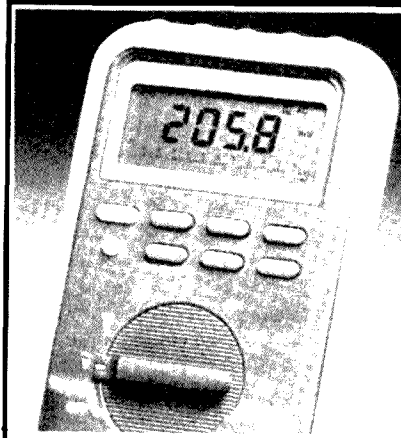

Count on them to measure up in more ways

Fluke multimeters are made in the USA, to the highest standards, offering accuracy you can depend on... and they are guaranteed for 3 years by Philips, the name you can trust.

Each measurement is clearly shown on the display, so you know exactly what you're measuring... without having to check connections or switch positions. Fluke Models 83 and 85 have bar graphs for analogue readings, while the Model 87 has a high resolution pointer.

The 10-times zoom facility lets you enhance resolution. And your Fluke Multimeter comes complete with protective holster, safety leads, 9V battery and operating instructions.

To find out why no other multimeter measures up to the Fluke 80 Series... call your local Fluke distributor today.

FLUKE AND PHILIPS - THE T & M ALLIANCE



PHILIPS

Alminox. The aerial mounting to the tower may be easier to insulate, rather than trying to achieve a good noise free connection. Please note this problem can be a big one, so the very best aerial system is needed.

Duplexer tuning is difficult, because there are three variables in each cavity filter. These are the amount of coupling ie the closeness of the coupling loops to the 1/4 wave resonator, the amount of L or C and the frequency to which the cavity is tuned. All of these three variables interact with one another. The easiest way to check the tuning of the duplexer is to take one of the receive filters out of circuit so some de-sensing is noticed, and adjust the other two for minimum de-sensing. Repeat with the filter that was taken out of circuit back in circuit, and one of the just-adjusted filters now out of circuit. Repeat with the Tx filters. An S meter on the repeater receiver can be most useful when making this adjustment, but a weak signal and the filters adjusted for minimum de-sensing (best quiet-

ing) are OK. Adjustment to the tuning should, if required only be a fraction of a turn, as half a turn shifts the notch several hundred kHz!

This brings us to another important point. The duplexer is a NOTCH FILTER, so it passes all frequencies except for a very narrow band. Any spurious output from the Tx will receive very little attenuation, at the best 10 dB.

Packet Radio

Amateurs seem to be in two camps when it comes to Packet Radio. If you use Packet Radio, you love it, and wonder what life could be without it. If you have never seen what Packet Radio is all about, the comment is often about that interfering noise on HF! Amateurs who have not seen what Packet Radio is doing in the way of information exchange, be it personal messages or general bulletins, are missing out on the greatest way of being in touch with what is happening in Amateur Radio. Packet Radio has done a poor

job of showing amateurs what Packet Radio is all about. Not all amateurs are computer orientated, and as soon as Packet Radio is mentioned thoughts of a language that many of us do not understand spring to mind. It may come as a surprise to Packeters, but not all amateurs know what a BBS is, or a Digipeater is, or what a vast world-wide network exists via Packet Radio. Many amateurs assume that, to be part of the Packet Radio scene, you must have a computer with all the add-ons. Well, it is true that a computer is the most versatile way to tap into Packet Radio, but a \$50 terminal and a \$200 TNC is all that is needed. When I first became interested in Packet Radio after seeing it at a fellow amateur's QTH, I talked to many who were into Packet Radio, and usually ended up with more questions than answers. But the leap into Packet Radio was made, and I cannot say enough about it. It is not a QSO medium, but as an information and keeping in touch medium, it is fantastic. ar

RANDOM RADIATORS

RON FISHER VK3OM
RON COOK VK3AFW

I hope by now that many of our readers are happy Z Match users and this month I want to look at some simple but effective antennas that can be used with the Z Match.

But first I would like to add a thought to the Z Match article and also add a few thoughts from some of our readers.

Firstly I had a query on how to use the Z Match with a random wire or single wire fed antenna. Simple. Just connect the antenna to one of the output terminals and a good earth connection to the other. I must admit that even a poor earth connection might work, but don't be surprised (you might be) if you feel a few RF tingles from the key or microphone. In an extreme situation you might even get RF feedback on your transmitted audio, so try it and see.

I have also been asked if the Z Match can be

used on 160 metres. The answer to this is yes, but a few modifications are required first. I am working on this one and will report back soon.

A letter from Maurie Phillips VK5ZU makes some interesting points. Maurie says, "I have built several along the lines you have described with one major difference. I used pre-formed coils supplied by William Willis & Co and found them ideal. Their No 4.08 is one inch in diameter with eight turns per inch and this fits snugly inside their No 5.08 which is 1 1/4 diameter with eight turns per inch. I used for L1, 10 turns and L2, 9 turns, L3, 12 turns and L4, 10 turns".

This sounds like a good idea Maurie, however I am not sure what the position is to obtain these coils as William Willis is now out of business. No doubt there are still plenty of

their coils around in junk boxes.

Maurie also supplies an idea on how to make your own open wire feeder. He uses 40/.0076 single core PVC insulated copper wire with sections of nylon tube as the spacer. Maurie enclosed a sample and it looked good. He says that the finished product hangs very neatly.

I've noted that a few people have had trouble with arcing in the capacitors when running 100 watts of power. Assuming that you are using the specified capacitors, then the trouble is almost certainly foreign matter in the capacitor plates. You need to remember that they are probably the best part of forty years old and after that period of time lying around in the junk box a certain amount of muck gets in. The answer, give them a good wash. I find that a couple of runs through the dishwasher works wonders.

Picking The Right Feeder Length

While the Z Match will tune up just about anything, there are limits. If you can choose a length of antenna and feeder that will produce a reasonable impedance, the ATU will tune up much easier. I came across an article in the July 1986 CQ magazine that gives all the required answers. While the article referred to the G5RV antenna, the principle applies to any balanced antenna fed with tuned feeders and a Z Match ATU, and by the way, a G5RV fed with open wire line and a Z Match makes an excellent all band antenna.

I have always found that the G5RV fed with the usual 300 Ohm feeder into a coax line to be a rather difficult antenna to get going. Of course you will always find someone who has got one going with a low SWR on all bands by shortening this or lengthening that, but it seems that no two are alike. Run your 300

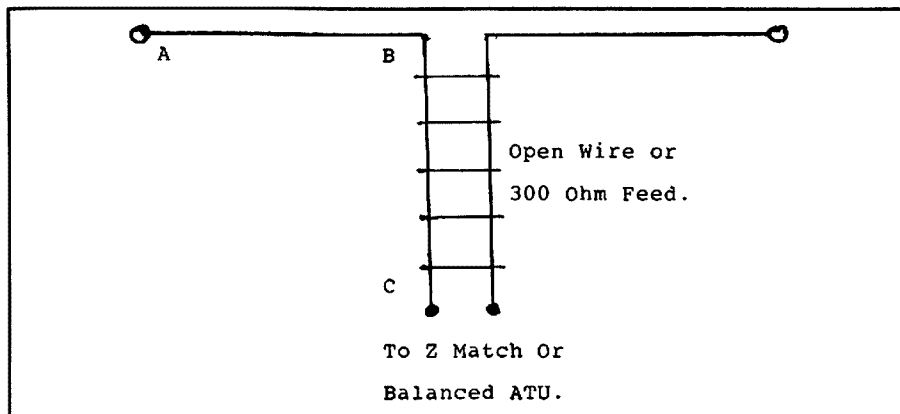

Figure 1. For Optimum Dimensions AB and BC see text.

Ohm feeder into the shack and then into the Z Match and you have an antenna that will work well on all frequencies. As we shall see later, the length of the actual antenna can be changed to suit different requirements.

The chart to calculate your feeder and flat top lengths is easy to follow, but I should emphasise that you should try a suitable length first and see if it will tune up. If not try the formula and modify your dimensions.

The Extended Double Zepp

This is a very technical sounding term for what is really a very simple antenna that has been around for the last sixty years or so. Of course the antenna can be designed for any frequency, but we will look at one for the twenty metre band.

Firstly, what is an extended double zepp? It's an antenna in which each half of the dipole is 0.64 wavelength long. This means that the overall length is in fact something over two half waves long. By effectively separating the two half waves by 0.28 wavelength, we can achieve an overall gain of 3dB in the broadside direction. In practice, this is not too far behind a three element triband beam. Of course, the double extended zepp is a bidirectional antenna. There is no front to back ratio. The additional lengths between the half wave ends and the feeder connection points carry RF currents which are opposite in phase to the main currents in the two half wave sections, and this gives four small lobes at about 35 degrees to the length of the antenna. The 3dB gain is however in the two major lobes at right angles to the wire.

This antenna must be fed with either open wire line or low loss 300 Ohm ribbon. However the story doesn't end there. The antenna will work very well on other bands. On 80 metres it will be a little down on a half wave dipole but will still perform very well. On 40, it will be a little better than a half wave dipole while on 30 metres it will have a useful gain as it is nearly two half waves in phase. On the higher bands the lobes will split into something like a figure eight pattern, but will still give useful radiation in a variety of directions.

If you have a space problem, this antenna might be just what you are looking for. Of course if you want to achieve the maximum gain, the antenna should be placed at a minimum height of about 10 metres. Anything lower and the radiation will be at high angles which are not conducive to good DX working.

I consider that the 3dB gain of the extended zepp is about as much as you can expect with a simple wire antenna. It is of course possible to achieve more, but the law of diminishing returns takes over and the antenna size increases out of proportion to the extra gain obtained.

The following lead-in lengths result in a resonant length that is within 0.05 of maximum off resonance

Feet	Inches	Feet	Inches	Feet	Inches
4	3	4	4	4	5
4	6	4	7	4	8
4	9	4	10	4	11
5	0	5	1	68	11
69	0	69	1	69	2
69	3	69	4	69	5
69	6	69	7	69	8
69	9	180	3	180	4
180	5	180	6	180	7
180	8	180	9	180	10
180	11	181	0	181	1

Fig 2 G5RV optimum dimensions. Surprisingly, the 33 foot feeder usually used with the G5RV does not appear in the table. Indeed lengths around 69 and 181 feet may be closer to the ideal.

In the case of the G5RV, it is best to cut the feeder so that its length plus the 51 feet of the flat top would not be an even multiple of 16 feet for 80, 40, 20 or 10 metres. The idea is to get a combination of lengths AB plus BC which when divided by 16 and 22 will produce an answer as close as possible to a "point-5" response (such as 5.5, 8.4, 3.6 etc) and as far as possible from "point-0" response (such as 7.0, 4.1, 6.9 etc).

While the figures apply to the classic G5RV with a 102 foot flat top you can of course apply the formula to any balanced antenna with a tuned feeder.

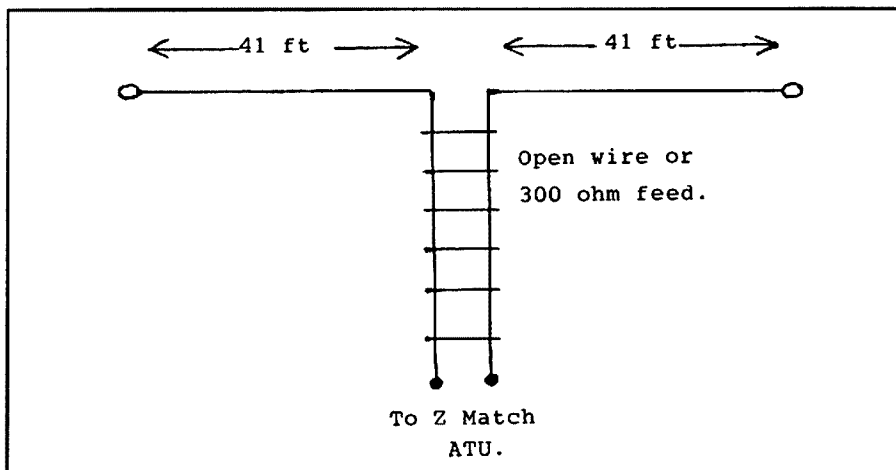

Fig 3. The dimensions for the twenty metre extended double zepp.

Balanced Feeders. Or Are They?

While on the subject of balanced feeders and balanced output ATUs, I noticed an article in the February issue of QST by Richard L Measures, AG6K. He says, "Now that we have nine amateur radio bands below 30 MHz (not all harmonically related) an open wire line, centre fed wire antenna looks even more attractive than it did when such antennas first came into popular use in the 1930s when we only had five bands below 30 MHz. Taking advantage of this versatile system requires a box that will interface the 50 Ohms unbalanced output of today's transceivers to the highly variable impedance (Z) of the balanced feed points of such multiband antennas".

However Richard considers that most of the current crop of "match anything" ATUs often produce only a semi-balanced output,

and the results are often less than perfect. As we pointed out in the last edition of this column, baluns and unmatched loads don't always go well together. The problem is that most commercial ATUs use a balun to provide a balanced output.

Richard continues, "Antenna tuners are like shovels. It takes more than one kind to perform a variety of jobs effectively. A balanced line tuner should be designed — from the ground up — for the job it is intended to do". The commercial "match everything" tuners produce unbalanced currents in the balanced feed system which can lead to problems like TVI and odd radiation patterns from the antenna. Richard then goes on to describe a balanced ATU capable of handling around 1.5 kW. I think I will stick to my Z Match.

That's all for this month, we will be back in two months with more antenna ideas for you to try.

ALARA

JOY COLLIS VK2EBX
PO Box 22 YEOVAL 2868

Annual General Meeting

It was gratifying to hear such a large group of members, and some non-members, on the Annual General Meeting Net on 28th May. To those recently licensed, we were very pleased to welcome you, and hope you will join us on Monday evenings for the normal ALARA Net, and a chat. If you are not hearing everybody, I'm sure someone will be happy to relay for you. It was also good to hear some of the members who do not manage to be with us very often.

A point raised by one of our new members was the matter of using phonetics when giving callsigns on an official net. As she said, it does make things easier for newcomers, particularly when conditions are poor, if callsigns are pronounced phonetically, at least during the first round or two.

Sometimes the "regulars" tend to forget how confusing the whole thing can be to newcomers, and how easily we can deter them from joining in if we fail to give sufficient thought to the way we operate.

Office Bearers 1990:

President Jenny Warrington VK5ANW
Immediate Past President
Historian
Contest Manager Marilyn Syme VK3DMS
Vice President Maria McLeod VK5BMT
Vice President
Minute Secretary Christine Taylor VK5CTY
Secretary Meg Box VK5AOV
Treasurer
Souvenir Custodian Val Rickaby VK4VR
Publicity Officer Joy Collis VK2EBX
Awards Custodian Mavis Stafford VK3KS
Librarian Kim Wilson VK3CYL
Sponsorship
Secretary Gwen Tilson VK3DYL
Newsletter Editor Bron Brown VK3DYF
State Representatives:

VK1/2 Joy Collis VK2EBX
VK3 Bron Brown VK3DYF
VK4 Margaret Schwerin VK4AOE
VK5/8 Maria McLeod VK5BMT
VK6 Poppy Bradshaw VK6YF
VK7 Helene Dowd VK7HD

Welcome back to Margaret VK4AOE and Poppy VK6YF, VK4 and VK6 State Representatives respectively. Our thanks to Josie VK4VG and Bev VK6DE, the previous holders of these positions.

A vote of thanks was given to Jenny VK5ANW for her efficient handling of first year as President.

BYLARA Contest

BYLARA is giving consideration to extending its contest to make it possible for overseas YLs to participate and would like some opinions, particularly from DX YLs who have not previously been able to join in. If you have any ideas about this please write to the BYLARA Secretary:

Sandie Franchi F1LXM
59 Hunters Place
Westlands, Droitwich, Worcestershire
UK WR9 9HD

YL Activity Day

Diana G4EZI says:

"YLs around the world are remembering to come on for YL Activity Day, so do let's try to be QRV on the sixth of the month! Talk to the OMs too, tell them about it, help them work for their YL awards, and maybe coax a shy XYL onto the band, which may bring a new enjoyment of radio to her. So keep it going girls!"

Joan VK3BJB

Joan VK3BJB is still very much involved with the Japanese and Japanese maritime mobile nets, and has come a long way since she first became interested, three or four years ago, in "learning a few basic conversational sentences in order to have "rubber stamp" QSOs with Japanese amateur radio operators".

The following quotes from local newspapers show that she is not only helping to keep amateur radio in the news, but rendering valuable assistance in emergencies:

"Mildura housewife, Mrs Joan Beevers, was last week involved in the search for a missing Japanese yacht off the coast of Chile.

Mrs Beevers is the controller, or key station, of a Japanese amateur maritime mobile network, and is often in contact with Japanese sailors throughout the world.

She was featured in a Sunraysia Daily article about a visiting lone Japanese sailor last week.

Mrs Beevers was listening in to the international yacht net two days ago when the Japanese yacht "Wahine" broadcast a may-day message.

The yacht was floundering in six-metre waves and the winds were helping hurricane force 12 (50-60 knots).

Mrs Beevers said the yacht was off the coast of Chile, heading south toward Cape Horn, when it issued the distress call.

All other operators were asked to clear the frequency and Mrs Beevers became the contact radio station between the yacht and the

northern Japanese base station.

The Chilean Navy had sent a ship out and a search aircraft had voice contact with the yacht.

The Chilean naval vessel located and rescued the yacht's skipper, a Japanese man, and his American wife, about 5.20am on Saturday.

The couple's yacht was abandoned as the wild seas made its recovery impossible.

Mrs Beevers said the navy ship took the pair into port at Punta Arenas.

"I was happy to play a part," she said."

"Antarctica to Australia . . . are you there Joan?" This was a frequent question on international air waves during a recent visit to the oceans of the icy continent by lone Japanese yachtsman Yoshiya Katoaka. He was speaking to Mildura housewife Joan Beevers, known in yachting and shipping circles throughout the world. The two had spoken frequently, but had never met until this week in Mildura, when Yoshiya came ashore to present Joan with one of his favourite landscapes which he set up on time exposure. He had spoken to Mrs Beevers only hours before sailing into the winter wonderland."

YL Awards

JLRS issues a number of attractive awards, ranging from fairly easy to obtain to considerably more difficult:

YL-10 Certificate

Ten confirmed contacts with licensed YL operators in the world, including at least one Japanese YL. All contacts must be dated after 1st January 1953. Apply in accordance with GCR to Yoshie Kamine JJ1QMD, 4-13-17 Nakahara, Mitaka, Tokyo 181, Japan. Cost plus surface mail postage outside Japan — 10 IRCs. Endorsements: Stickers for each group of 10 additional YLs confirmed. (Contact with a Japanese YL not required for endorsements). Cost — three IRCs for each group of 10 additional contacts.

YL-Alphabet Certificate:

Twenty-six confirmed contacts with licensed YL operators. The last letters of the callsigns of the contacts should contain all 26 letters of the alphabet. No time limitation.

Two classes:

Class A: contacts with JLRS members only

Class B: Contacts with YLs anywhere in the world including at least five Japanese YLs for operators outside Japan.

Apply in accordance with GCR to Tsuneko Watanabe JE1IWR, 5-15-2 Asahimachi, Alsung-shi, Kanagawa-ken 243, Japan. Cost — 10 IRCs.

CW Certificates:

(No time limitation)

YL-CW-AJD Certificate: Contact with a licensed YL in each of 10 districts in Japan

from 1 to 10.

YL-CW-WAJA Certificate: Contact with a licensed YL in each of 43 prefectures. Tokyo-to, Osaka-fu, Kyoto-fu and Hokkaido.

YL-CW-JCA Certificate: Contact with YLs in 10 different cities in Japan. Endorsements — each group of contacts with 10 additional different cities.

YL-CW-JDA Certificate: Contact with YLs in 10 different cities in Japan. Endorsements — each group of contacts with 10 additional different cities.

YL-CW-10 Certificate: Ten contacts with different licensed YLs anywhere in the world. Endorsements — each group of additional 10 contacts.

YL-CW-Alphabet Certificate: 26 contacts with licensed YL operators in the world. The last letters of the callsigns of the contacts should contain all 26 letters of the alphabet.

For all CW awards, apply in accordance with GCR to:

Nobuko Nishigori JA3UPR
2-6-11 Hirosedai, Kaai-machi,
Kitakatsuragi-gun, Nara-ken 636, Japan.

Cost — 10 IRCs. Certificates for multiband and each single band will be issued separately.

The Finnish Radio Amateur League offers one YL award: Finmaid Award:

Non-European stations need contacts with three OH-YL stations.

SWLs need 10 confirmations of their reports to OH-YLs.

Stations must be owned and operated by OH-YLs. QSOs after 18th July, 1947. Any band or mode, no endorsements. Contacts made with the same operator from different OH call areas count as separate stations.

Send list of contacts with usual log data and names of operators with statement that QSLs have been received. Fee — eight IRCs. Apply to:

SRAL, Award Manager,
Box 44, 004411
Helenski, Finland.

Bits and Pieces

For those lucky enough to work Kiyoko T3OKY on West Kiribati, the QSL information is: Kiyoko, Yamakami, PO Box 3, Tokaimura 31911, Japan.

QSL information for Maria CU2YA is: Maria Pinheiro, PO Box 211, Sao Miguel 9503, Ponta Delgada, The Azores.

Jeanette ex VK4BZL is now VK6AZL, and living at Tom Price.

Congratulations to Christine VK5CTY on being appointed an accredited examiner.

Marlene ex VK5QO is now VK3EQO.

Congratulations to Pearl ZL1WY, who has been awarded the Myrtle Earland Memorial

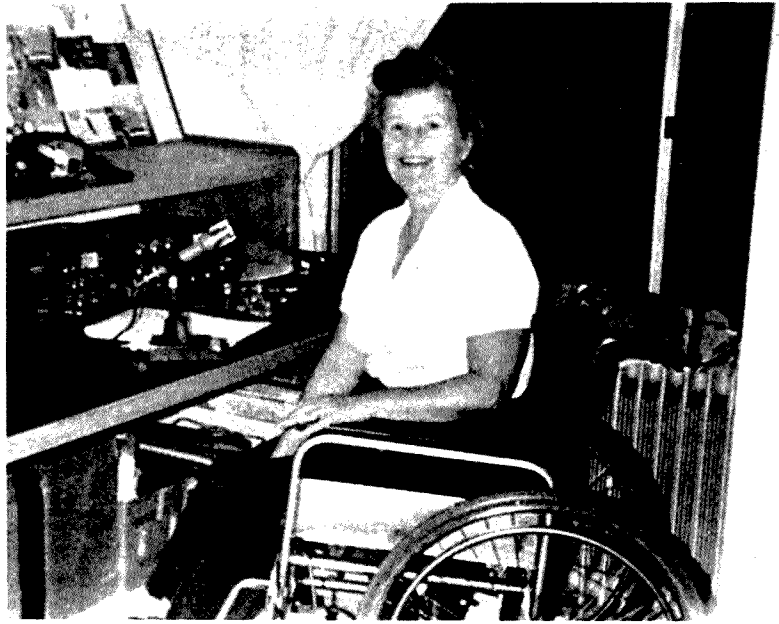

Peggy VK6NKU pictured at her rig

Rose Bowl as WARO Amateur of the Year.

New Members

A very warm welcome to: Sally VK4MDG, Paddy VK5ZBI, Susan XYL of VK5AIM, Margaret VK3END and DX member Sigrid DL3LG.

**Support the
advertisers who support
Amateur Radio Magazine.**

Wheelchair No Handicap

Peggy VK6NKU spent five years in a wheelchair after breaking her neck. This has not prevented her from actively participating in amateur radio activities, such as running the WA WICEN net, and more recently, since the WICEN boys erected a beam for her, working DX, and "having a ball".

She now only uses the wheelchair when she has to sit for any length of time, and as Peggy says "it reminds me that I am one of the lucky ones who make it out of the chair".

UNTIL NEXT MONTH, 73/33

Morseword No 40

Solution on page 56

Across

- 1 Dim
- 2 Lobe
- 3 Smooth fabric
- 4 French cheese
- 5 Secure
- 6 Not those
- 7 Therefore
- 8 Tailless cat
- 9 Willing
- 10 Mature

Down

- 1 Sell
- 2 Port side
- 3 Carry
- 4 Ankle
- 5 Egg on
- 6 Period of time
- 7 Donation
- 8 Junket ingredient
- 9 Spear
- 10 Boss

	1	2	3	4	5	6	7	8	9	10
1										
2										
3										
4										
5										
6										
7										
8										
9										
10										

Audrey Ryan © 1990

DIVISIONAL NOTES

VK2 NOTES

TIM MILLS VK2ZTM

The NSW Division conducted its first devolved exams during May with 18 candidates. Most took up grade subjects like morse or higher theory. The next exam to be conducted by the Division at Amateur Radio House, Parramatta, will be Sunday the 12th August. The closing date for this exam will be Friday the 20th July.

Many other groups also chose May to conduct their first exams. The Divisional office is starting to be able to put together details about the various exam centres available, and where some of the gaps are in the lack of local points. Would your club or group please keep this information flowing into the office?

Any exam information or inquiry should be posted to PO Box 1066 Parramatta, NSW 2124. Phone to (02) 689 2417, where there is an answering machine. (Phone answered 12 noon to 1pm Mon to Fri, and 7 to 9 pm Wed.) Fax, anytime, (02) 633 1525.

WICEN (NSW) Inc

The next Sydney based exercise is the "Sun Herald — City to Surf" fun run on Sunday morning the 12th August. Co-ordinator for this event is Brett VK2XMU. Leave inquiries via Parramatta office.

Divisional Voice Mailbox

An additional service has now been added to Divisional news by telephone. For some time there has been news headlines from an answering machine on (02) 651 1489. Now, thanks to AAP a test service has been set up with an interactive voice mailbox. Similar headlines to that on the older system can be obtained by dialing (02) 552 5188. If you have a push button phone you can control some of the functions, see details below. You may leave a message at the end of the text by following the instructions given by the mailbox. If you have a DTMF phone or one of the "tone senders" available from electronic stores or banking organisations you can obtain various functions by operating the buttons as follows:

1. Message rewind: This steps back 10 seconds, and is handy if you miss an important date or phone number. Pressing "1" "1" in quick succession causes the message to rewind to the start.
2. Pause message: As the name suggests this will pause the message review. Pressing "2" a second time will restart it.
3. Advance message: This will advance the message by 10 seconds. Pressing "3" "3" in

- quick succession causes the message to advance to the end. This will also happen if you press the "hash" key.
4. Slow down review: This will slow down the replaying of a message.
 5. Message information: This will tell you when the message was posted and by whom along with other information.
 6. Speed up review: This will speed up the replaying of a message.
 7. Not in use: Press this and nothings happens.
 8. Volume normal: This sets the volume to the normal level.
 9. Volume raise: This will increase the volume of a replayed message.

New Members

A warm welcome is extended to the following who were in the May/June intake.

A S Bryant	VK2YNI	Castle Hill
J R Cannon	VK2NJC	Kilabenn Bay
M S Carney	VK2XRU	Blackett
J Conde	Assoc	Rose Bay
M P Conradi	VK2ETM	Wahronga
E Fossey	VK2JFY	Penrith
G R Flood	Assoc	Minto
S A Guignon	VK2MIU	Tascott
C Hart-Smith	VK2CHS	Matcham
A P Hunter	Assoc	Glebe
P Johnston	Assoc	North Curl Curl
J H Lean	VK2YX	Chiswick
J B I Nydahl	Assoc	Roselands
C J M Pattison	VK2NIK	Hornsby
A P Shipp	Assoc	Mt Kuring-gai
R A Plater	Assoc	Asquith
P J Wright	VK2YPW	Hurstville ar

VK2 WICEN

This year's City to Surf is again closing upon us. As usual operators are required. The event is being held on Sunday 12th August. The commander for this years event is Brett Wilkinson VK2XMU. You can contact him on (02) 661 5457 or on the weekly WICEN Net which is held every Thursday evening at 9pm local time in the Sydney area on repeaters 7150 and 8275. Alternatively he may be contacted via the VK2 Divisional Packet BBS on 4850.

VK3 NOTES

JIM LINTON VK3PC

WIA Victorian Division Council

Most of the team which formed the Divisional Council in 1989-90 had nominated for the 1990-91 Council, and no other nominations were received. Due to there being less than the maximum number needed to fill the

council positions, they were elected ipso-facto. The new Council is Steve Harrington VK3BYI, Peter Mill VK3ZPP, Bill Trigg VK3JTW (Broadcast Officer), Barry Wilton VK3XV (Secretary), Jim Linton VK3PC (President), and Rob Hailey VK3XLZ (Treasurer). Steve and Peter continue in their role of providing technical expertise to Council, including maintenance of the WIA repeater network, and Bill, Barry and Jim also have other portfolio responsibilities.

Recruitment Campaigning Starts

Some members at the Division's Annual General Meeting voiced concern that they thought more could be done to increase the level of membership. Victoria had performed reasonably well with both its recruitment and retention of members, and some special initiatives are planned for the coming months..

Your Division is taking a leading role in a co-ordinated nationwide campaign to recruit both new members into the WIA, and encourage new people to take up the hobby of amateur radio. Each individual member of WIA Victoria will have a part to play in the campaign — please become active when the call is made for your help in recruitment activities. Recruitment activity costs the current members money, and the results of each activity will be closely monitored to see if they're financially viable and achieving worthwhile results.

Examinations Go Well

The conduct of the first statewide examinations at centres throughout Victoria and in Albury has been described by all involved as an outstanding success.

The 193 exam results were posted to the 120 candidates within two weeks of the examinations on May 15. The candidates' exam supervisors were provided by participating WIA member clubs and zones, and the Department of Transport and Communications were very complimentary about the conduct of the exams.

Drawing on the experience gained from the exercise, a review was conducted involving exam supervisors, and some refinements have been made to the examinations service.

WICEN Victoria Inc

The Divisional President Jim Linton VK3PC symbolically handed over the documentation for WICEN Victoria Incorporated at the Division's Annual General Meeting. The documents were received by WICEN State Co-ordinator, Mark Dods VK3ACX.

WICEN Victoria now has its own articles of incorporation. However it remains constitutionally linked to the WIA Victorian Division. The WICEN committee will consist of the State Co-ordinator (also known as the WICEN President under the constitution), four other

WICEN members, and five appointees nominated by the WIA Victorian Division Council.

The incorporation of WICEN was seen as necessary for it to continue the considerable progress made, since its resurgence resulting from the Ash Wednesday disaster. WIA Vic Div Secretary, Barry Wilton VK3XV, Mark, and his predecessor Leigh Baker VK3TP had worked steadily over the past year to draw up the constitution and see it through the long Corporate Affairs approval process.

The Council has unequivocal confidence in the management of WICEN into the foreseeable future. But, due to WICEN's importance to our hobby's rule in serving the community, it was jointly decided by WICEN and the WIA Vic Div to leave the way open for a future Council to step in, if a situation warranted. Barry Wilton explained at the AGM — it was not Council's intention to meddle in the affairs of WICEN. Mark Dods said WICEN wanted to remain part of the WIA Victorian Division. ar

VK4 NOTES

ROSS MUTZELBURG VK4IY

Upon my recent return from an overseas holiday that included a visit to the Dayton Hamvention, I was informed of WICEN involvement in the April Charleville floods. The following report was supplied by Neil VK4NF and appeared in the Ipswich and District Radio Club Newsletter. I wish to acknowledge Neil and the Ipswich Club for the information.

Charleville WICEN Activation

On Sunday 22 April 1990 a meeting was called between the Dalby Town and Wambo Shire Councils, the Dalby Wambo SES units and two representatives of WICEN (namely Reg Kerslake VK4AQU and Neil Holmes VK4NF) to formulate an assistance package which Dalby could offer to Charleville. This was faxed down to Brisbane SES and on Monday afternoon 23 April this offer was accepted.

The necessary organisation took place, and on Wednesday morning 25 April (Anzac Day) at 6am a convoy of equipment left Dalby for Charleville, with VK4NF on board with his equipment. We stopped at Miles and picked up Maurie King VK4JFF and his equipment, and we finally arrived at Charleville at about 4pm.

I, VK4NF, set up my 80m dipole and was operational on 3.605 MHz at about 5pm. The following morning, Maurie made up an 80-40m combination antenna, and we set this up on the same portable pole as my dipole, and found that this antenna of Maurie's worked the best on both 80 and 40 metres, mainly due to the direction it was set up at.

We had good communications at all times using 7.075 during the day and 3.605 at night and early morning. We had several monitoring stations including Reg 4AQU, Ian 4NVF, Margaret 4AOE in Dalby, Harry 4ASF and a few others in Brisbane and the Gold Coast as well as a few others from further afield.

Our biggest problem was that we were set up at the Charleville showgrounds, and the other services were set up at the airport, and we had no direct link with them for passing information, except for a link with the Royal Flying Doctor Service temporarily set up on 4.98 MHz, which was handy, but not the most beneficial.

On Sunday 29 April the Wambo Shire and Dalby SES units decided to pull out and come home, so I VK4NF, decided to also come home, and left Maurie to man the fort. Up until then, we had handled about 25 different messages. At this stage, a lot of the telephone services were being put back into service, so our need was not so great.

As I write this (2 May) Maurie is still operating, and he will be there until Friday 4 May, when the Dalby Council crew intend to wind down their operations.

On Tuesday 1 May I sent out to Maurie a UHF CB which he promptly set up, and he now has communications with the SES control centre. Had I taken this set with us when we went out first, we would have been much better off as far as liaising with the other services was concerned.

A few things we learnt:

1. Consider direction when placing antennas.
2. Have plenty of power available ie 100 watts.
3. Check on what equipment and frequencies are being used by other services and be prepared accordingly.

The WIAQ would also like to thank DOTC Brisbane for their support in quickly providing verbal permission for Maurie VK4JFF to operate on the 7.075 MHz WICEN flood net when it became necessary. DOTC followed up that permission with a letter that speaks for itself.

Letter from DOTC

Amateur Operations During The Charleville Flood

Further to your letter and our subsequent conversation on the above-mentioned subject, I am happy to confirm the department's agreement to Mr Maurice King operating outside Novice conditions, on occasions, while assisting with the provision of communications to Charleville, pending full restoration of normal services. Specifically, I understand that at times it is necessary for Mr King to use 7.075 MHz in addition to the frequencies authorised by his licence.

I congratulate the amateur movement on the valuable service it has provided during

this crisis and am pleased that the department has been able to assist in this small way.

Finally, thanks to those who have made donations to the WARC fund. Name withheld by request \$100; Name withheld by request \$100; Redcliff Radio Club \$10; Brisbane North Radio Club \$50.

Anyone wanting to match them will be very welcome! ar

5/8 WAVE

JENNIFER WARRINGTON VK5ANW

Historical Info Wanted

A few months ago, Lloyd Butler VK5BR volunteered to become the Historian of the Adelaide Hills Amateur Radio Society, with the idea of eventually publishing an article, like the one he did on Murray Bridge and the Lower Murray Club. Lloyd would be very pleased to hear from anyone who was a member of the "Blackwood ARC" (which was the forerunner of AHARS). Please contact him direct, he is QTHR in the callbook.

Jobs For The Boys!

Following the positions on Council which were published last month, here is the full list.

Rowland Bruce	VK5OU
President & QSL Buro Manager	
John McKellar	VK5BJM
Secretary, Membership Sec, & Education.	
Bill Wardrop	VK5AWM
Treasurer & Federal Councillor.	
Don McDonald	VK5ADD
Past President & Minutes Sec.	
Hans Van Der Zalm	VK5KHZ
DOTC Liaison & SATAC Assistant	
Bob Allan	VK5BJA
SATAC Co-Ord, Vice Pres, Alt Fed C & Assistant DOTC Liaison	
Ian Watson	VK5KIA
WICEN Director & Country Clubs' Rep*	

(*Country Clubs are also being encouraged to have a representative on Council, for example Darwin have nominated Harry VK5AHH to represent them at forthcoming Meetings.)

Peter Maddern	VK5PRM
Programme Co-ordinator (Peter had not re-nominated, but agreed to be co-opted back onto Council)	

In April, I mentioned that Nigel Hanwell VK5KAG had joined the Slow Morse Practice Panel. His new Callsign is one that will be very familiar to many, VK5VB. The former holder was the late Vern Blackmore known to one and all as "The Admiral".

Nigel would also like to see a "Buddy" system start in this State. In this way, new or "would-be" amateurs can be given the name of someone near them who would be willing to help them get on air and show them the ropes

etc. If you would like to be part of this, either as a newcomer or a buddy, you can contact Nigel at home on (08) 370 9727. We who have been in the hobby a long time tend to forget just what it is like to be a newcomer trying to find your way — so thanks Nigel for offering to get it going.

Diary Dates

Tues 24th July General Meeting — speaker, Mr Darrian Stringer, Communications Officer with SES (State Emergency Service) 7.45 pm.

Tues 31st July Buy and Sell night 7.30 pm.

Silent Keys

It was indeed a sad week back in May, when we mourned the passing of two comparatively young OMs, Russell Smith VK5KAK and Brian Warman VK5BI. Russell had been a regular attender of Clubs' Conventions, representing the South Coast ARC, having been a former President. A quiet, unassuming but always friendly man who will be sadly missed. Brian, on the other hand, (who, incidentally, was the son-in-law of Vern, the late VK5VB)

I had never met, but he had a special sentimental place in this household. He was the first holder of VK5ZBI, Mike (my OM, now VK5AMW) was the second and I was the third. I vividly remember the first time I worked Brian, shortly after I became VK5ZBI; I'm not sure who was the most pleased that I'd got it! Incidentally, the fourth and current holder, Ian Bedson, is also a family friend so the sentimental attachment continues. ar

QRM FROM VK7

JOHN ROGERS VK7JK

The 1990 World Rowing Championships at Lake Barrington in NW Tasmania, offer a great new opportunity for amateur radio to achieve international publicity. A successful exercise in providing communications for competitors and visitors at the World Rowing Championships would bring further recognition of the useful and effective role amateur radio can play in such special events and situations. With world conferences about to be held which will affect the future of amateur radio, the importance of such an opportunity

as this must be clear to all.

There will be more than a thousand top international sportsmen and women competing in the six days of championship events, between 28th October and 4th November 1990, and the proposal is to man a

SPECIAL EVENTS STATION

with a special call sign VK7WRC.

It is expected that the operation should take the form of a State WICEN exercise, and VK3 WICEN have been approached for support, perhaps resulting in an Australia-wide WICEN exercise. Other States are being notified.

DoTC approval has been sought and, from verbal contacts already made, it appears there should be very few, if any, problems.

VK7WRC should utilise VHF and UHF links from the rowing site to the main station, which, in turn, should be in a position to permit contact with interstate Australian and DX stations.

Repeater 6, Snow Hill, will be monitored at 09.30Z every Monday and Wednesday nights for reception of constructive ideas and suggestions, by Ted, VK7EB, the VK7 Divisional Secretary and WICEN co-ordinator. ar

CLUB CORNER

Radio Amateur Old Timers Club

Members are reminded that the Winter QSO Parties with the ZL OTC will be held next month as follows:-

1. Monday 6th August, 80 metres, 0800Z to 1100Z (the evening of the monthly broadcast).
2. Monday 13th August, 40 metres, 0800Z to 1100Z.

Frequencies, contest exchanges and log forwarding details are as shown in OTN Magazine 1990.

Numbers were down in the March Party, 18 VKs and 12 ZLs took part. Logs were received from:

	QSO	Area	Mode	Score
VK3JA	25	9	CW/SSB	1125
VK3KF	23	7	"	805
VK3AMD	18	7	"	630
VK3LC	18	7	"	630
VK3KS	20	6	"	600
VK3XB	20	6	"	600
VK3XF	15	6	"	450
VK2KA	14	6	SSB	420
VK3ZC	13	6	CW	390
VK7BJ	10	6	SSB	300
VK2AKE	10	5	CW	250
VK5RK	Check			

We are sad to report the death in early May of Dan Wilkinson ZL2AB at the age of 88. He was a "grand old man" of New Zealand amateur radio, first licensed in 1923, and one of the founders of these enjoyable QSO parties.

Riverland ARC

The Riverland Amateur Radio Club commenced testing its 2m repeater VK5RLD as from the 5/5/90 operating on 147.925 — 147.325 MHz.

Situated on the Sturt Highway at Berri in the Riverland, the repeater will complete the link for amateurs between Adelaide and the Eastern states via the Riverland.

The Riverland ARC has finally achieved its goal of establishing a repeater in the area, only 12 months after the club was formed.

We thank those who financially supported the project. Hopefully, this new benefit will help recruit others to the amateur ranks.

By the time the AR is posted to you VK5RLD should be fully operational.

On the 29th April, several members and their wives from the Riverland ARC enjoyed a social picnic hosted by the Barossa Amateur Radio Club, on the Mt Pleasant Oval. Those who travelled down for the day were Hugh Lloyd VK5BC and his wife Dawn, Mike MacIntosh and Wendy, Kingsley Brauer VK5NOU and Maureen, Doug Tamblin VK5PDT and Bev, John Ruston (President) VK5ARK and Ivan Smith VK5PAW.

Several events were held during the day. These included a transformer throwing competition, which was won by Ivan VK5PAW. In the tug of war, Riverland put up a good fight to win the heat. But age gave way to youth in the final and they were defeated!

Later in the afternoon, a fox hunt was organised. Ivan VK5PAW found his way into

a vehicle that was about to pursue the fox, and was rewarded, along with the rest of the crew, by returning home with the prize.

A good day was had by all.

Doug Tamblin VK5PDT
Secretary Riverland ARC

ar

AR 20 Year Index

IBM Format 5 1/4 inch floppy disk

dBase III Plus .DBF file	\$10.00
ASCII	\$10.00
Compiled .EXE file	\$10.00
36 page printout	\$5.00

Prices include disk (where applicable) and postage.

AR 20 Year Index

PO Box 300

Caulfield South VIC 3162

QSLs FROM THE WIA COLLECTION (23)

KEN MATCHETT VK3TL HON CURATOR WIA QSL COLLECTION
PO Box 1 SEVILLE VIC 3139

The Olympic Games and amateur radio (Part 1)

There would be few sporting events in the world to rival the position of the Olympic Games as the ultimate goal of those blessed with physical prowess. And yet, with such world-wide publicity (mainly through the advent of satellite TV communication), it is difficult for us to realise that at one stage in the history of the Games there was thought of abandoning the "Olympic Ideal" altogether. Readers will realise of course, that the modern Olympic Games are a revival of those contested in ancient Greece. This was a festival of sport, the first recorded Games being held in the year 776BC, nearly three thousand years ago. The site was Olympia, a plain lying about 200 or so kilometres west of Athens, on the Peloponnesos peninsula. The festival was held every four years and, although this tradition has been maintained, the Games themselves were very different from those of today. Foot racing seems to have been the number one sport in the Games, but this was later extended to include competition in wrestling, long-jumping, discus, javelin and even chariot racing. The Games came to a sudden end in the year 394AD after being banned by the Roman conquerors.

The modern Olympic (Summer) Games owe their existence to one man, Baron Pierre de Coubertin, a French aristocrat, scholar and educator. Much influenced by the character-building quality of English Public schools, de Coubertin felt that amateur participation in sport would be instrumental in building character in young men, in addition to engendering international understanding through friendly competition. Thus, in 1892 he proposed, in Paris, that the ancient Olympic Games be revived. An international conference was held two years later, at which 12 nations agreed that the first modern Olym-

pics should be held in 1896. It was appropriate that the host for these Games be Greece and that the Games be held in Athens. It is significant that today's governing body for the conduct of the Games, the International Olympic Committee (IOC) was established in those early days. Pierre de Coubertin became its first president in 1896, and remained so until 1925. (He stepped down from the position temporarily in 1914 to go off to war). The first Modern Olympic Games in Athens was a very small affair, judged by modern standards. Only 10 sports were contested (cycling, gymnastics, tennis, swimming, fencing, weightlifting, rowing, wrestling, shooting and, of course, athletics) and only 12 nations participated. The next two Modern Games (held in Paris and St Louis) proved a disaster, due mainly to particularly poor organisation and a certain amount of disinterest. The future of the Modern Games at that time lay in the balance.

From very simple beginnings, the Games have grown into an organisation of gargantuan proportions — literally millions of dollars being invested in every olympiad. Women now compete on an equal footing with men, but it will be remembered that it is only in comparatively recent years that the fair sex has been permitted to compete in long-distance events. There were no female competitors in the first Modern Olympics, it being against de Coubertin's principles to allow women to either compete or to become involved in the organisation of the Modern Games. He was principally concerned with the healthy upbringing of young men. His Olympic motto of "Citius, altius, fortius" (swifter, higher, stronger) suggests to us the attainment of physical excellence, a characteristic not to be associated in any way with the young ladies of his day!

Because of its ability to communicate throughout the world, it is not surprising that amateur radio has been given the task of bringing attention to a nation's good fortune in holding the Games, and to act as an important advertising medium. Even as far back as 1932, when Los Angeles hosted the Games, the especially allocated call sign W6USA was used for the Olympic Games station. These were the Games in which the great Eddie Tolan sprinted his way into the record book. It is interesting, too, that the Games were conducted during the Great Depression and in the middle of the Prohibition Era, which fact however, did not prevent the Italian contingent from being supplied with wine, which the team members had claimed was essential to their diet!!! It was the first time in which a photo-finish camera was used to assist the judges, and the first time, too, an Olympic Village was set up for participating athletes.

4A2IH

In 1968 Mexico hosted the Olympic Games in its capital, Mexico City. This was probably the first time that a commemorative prefix had been used to draw attention to the Games. Mexican amateurs were permitted to use the prefixes 4A1 (Central Mexico), 4A2 (Northern Mexico) and 4A3 (Yucatan) appropriate to their call area. This was in accordance with the ITU prefix block allocation 4AA-4CZ. On several QSL cards of that year we read "We offer and wish friendship from all the people in the world — Mexico 1968". The special calls commenced in March and continued until December of that year. These were the Games in which there was considerable controversy over the performance of athletes at high altitudes. Mexico City lies 2240 metres (approx 7000 ft) above sea level. Athletes such as the Kenyans who had trained at such altitude were naturally at an advantage and the results bore this out. Australia's Ron Clarke is said to have needed oxygen after having completed the 10,000 metres (in which he finished sixth). These Games saw evidence of the "Black Power" movement which led to the

4A2IH						MEXICO
						★ 1968 ★
RADIO	DATE	GMT	RS	MC	MODE	
VK3TL	31-III-68	1057	58	14	2X5813	
73		VALENTIN SANCHEZ Y S. APDO. POBAYAL 7M CULIACAN, SIN.				

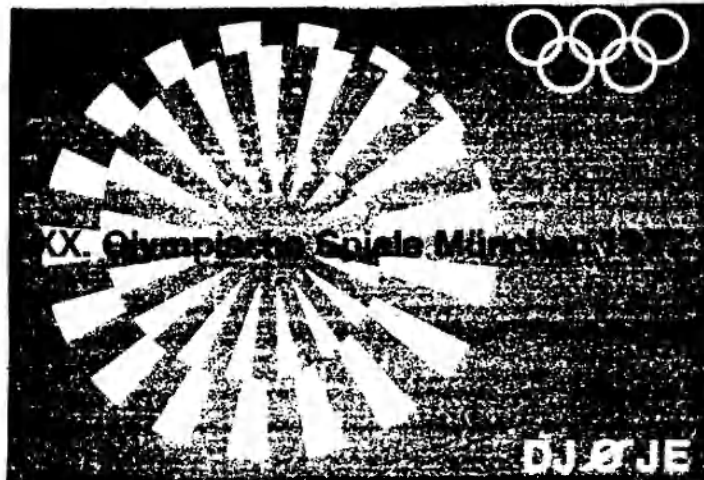

eventual suspension of two American Negro competitors who had given the clenched fist salute on the victory dais. It was at Mexico City too, that sex tests for women were first introduced in a Summer Olympics. The 4A21H QSL was sent to the writer and is dated March, 1968.

DJOJE

The 12th Summer Olympiad was held in West Germany in September 1972. On the front of the DJOJE QSL we read (from the German) "20th Olympic Games Munich, 1972". These Olympics will always be remembered for one of the most tragic events in the history of the Games. Eight Palestinians broke into the Olympic Village and killed two of the Israeli team in their dormitory. A further nine were killed when the terrorists tried to escape the country. The IOC declared a day of mourning but the Games went on. Possibly the best remembered performance at these Games was that of the American swimming champion, Mark Spitz, who won a record seven gold medals. The best Australian performance was that of the 15-year-old Shane Gould.

The DJ0JE QSL, dated October, 1972, was the result of a QSO with Gil Moody, one of our top DX men, who became a 'Silent Key' in March 1988. It was one of many QSLs kindly donated by his widow, Joan.

XJ3GCO

Mexico's 4A series of callsigns was the precursor of a veritable flood of especially allocated prefixes. Canada used the prefix XJ in commemoration of the XXI Olympic Games

held at Montreal in 1976. Prefixes XJ1 through to XJ8 were used by Canadian amateurs, depending upon the province in which they held their licence. These Olympic Games unfortunately suffered a boycott by African nations, caused by the refusal of New Zealand to interfere with plans for a rugby tour by a team from South Africa. There was also a most disappointing Games result from Australia, it being the first time in 40 years that Australia had failed to gain a single gold medal. (We did get a silver for the hockey). If nothing else, the Games drew the attention of Government to the need for future financial support in the field of sports training.

Next month: "The Olympic Games and Amateur Radio" Part 2.

If you would like to play a part in building up the WIA QSL collection and to save something for the future, would you please send a half-dozen (more if you can spare them) QSLs which you feel would really help the collection along.

All cards are appreciated but we especially need commemorative QSLs, special event station QSLs, especially assigned call QSLs (eg VK4RAN), pre-war QSLs, unusual prefixes, rare DX and pictorial QSLs of not-so-



common countries. Could you help? Send to PO Box 1, Seville, 3139 or phone (059) 64 3721 for card pick-up or consignment arrangements for larger quantities of cards.

Thanks

The WIA would like to thank the following for their contribution of QSL cards towards the WIA collection:

(Supplementary List)

Roley VK2GAL (G3VIR)
John VK6BA
Percy VK4CPA (ex VK3PA)
Peter VK3PJB

Also, thanks to the family and friends of the following "silent keys".

(Supplementary List)

Owen Rodgers G2HX
(courtesy of Tom G3XMM)
Bob Cunningham VK3ML
Gil Moody VK4AK (VK3ZR)

SILENT KEYS

DUE TO INCREASING DEMANDS ON SPACE WE REGRET THAT AS FROM JULY WE MUST IMPOSE A 200 WORD LIMIT ON OBITUARIES

We regret to announce the recent passing of:-

Mr Bill Pearce	VK2CW
Mr Fred Adams	VK2ALA
Mr Peter Vernon	VK2BZX
Mr Ken Robertson	VK4KT
Mr CL Lack	VK4ACL
Mr L D Walters	VK4AWL
Mr D W Reed	VK4CDR
Mr B J Warman	VK5BI
Mr Joe Brown	VK7BJ

Kenneth Thomas (Ken) Robertson — VK4KT

Townsville amateurs were shocked by the sudden passing of Ken Robertson VK4KT.

Ken was a member of the Townsville Amateur Radio Club for many years. He always provided a display of Icom equipment at the North Queensland Conventions held in Townsville.

Ken had been a pioneer of VHF in Townsville and during the 1950s and 60s was very active on 6 and 2 metres, using converted wartime equipment. This interest later extended to UHF, with a very well equipped shack. Ken had recently acquired a new computer and the associated packet radio equipment, but this had not been put on air at the time of his death.

He and his wife Judy were the founders of Robco Equipment, a firm specialising in tool supplies, originally in Townsville and later

with a branch in Cairns. He was also a dealer for Icom Amateur Radio Equipment.

Ken and Judy recently visited the USA, and intended to visit a major Amateur Radio Convention. Unfortunately, Ken fell while in a motel and broke his hip in three places. He was hospitalised for several weeks, and was only recently able to fly home to Townsville. It is understood that a blood clot formed as a result of the accident, and it was this which took his life.

To Judy and daughters Kerry and Jill, we extend our deepest sympathy.

PETER RENTON VK4PV

PUBLICITY OFFICER, TOWNSVILLE
AMATEUR RADIO CLUB

Bert Billings

We were saddened to learn of the death, in early June, of Bert Billings, the subject of Jim Linton's article "The Last Wireless Anzac" in the April issue.

Bert was reported as being in one of the leading vehicles in the Melbourne Anzac Day March, distributing photocopies of the article.

Bill Pearce VK2CW

It is with regret we advise the passing of Bill Pearce VK2CW of New Lambton Newcastle NSW. Bill passed away Saturday 28th April 1990. He was born on 8th August 1913. Recently he and his wife Jean, celebrated their 50th wedding anniversary.

Licensed as VK2CW on 18th May 1934, he was first Secretary of the Hunter branch of

NSW Division of Wireless Institute of Australia. He retired in 1978 from Telecom. The funeral was held on Wednesday 2nd May 1990 in the Northern Chapel of the Beresfield Crematorium.

Sincere sympathy to Jean and family.

RODNEY C PROUT VK2CN

SECRETARY HUNTER BRANCH RADIO GROUP, NEWCASTLE

Harrison Chapman VK3GU

On 6.2.1990 at the Bairnsdale Hospital, we lost one of our early pioneers of amateur radio. Harrison was first licensed in 1922 as 3JX and received a IARU WAC Certificate in 1931. He became a Member of the Institute of Radio Engineers in 1945 and had a 50 year badge on his Old Timer's Certificate.

Harrison was an Industrial Chemist employed by Dunlop, and then the Phosphate Co until World War II. He was a Radio Instructor in the RAAF at Ballarat during the War. Later, he lectured in Chemical Engineering at RMIT and instigated a Course in this subject at Melbourne University. He received

a Master's Degree in 1975.

Harrison was ordained as a Minister at St Paul's Cathedral in 1959, and was appointed to Melbourne Church of England Grammar School where he taught Physics and Chemistry and conducted an Amateur Radio Club for students.

Whilst in Melbourne, Harrison was active with the University of the Third Age and, on retiring to Bruthen in 1986, he established the Bairnsdale Campus. As an active lecturer, he also ran a course for prospective radio amateurs.

Harrison was a first class CW operator, which gained him many hundreds of cards from little-known countries. He particularly enjoyed operating from his daughter's property near Bruthen, away from man-made interference. He kept regular skeds with Joe W2TKG and visited him in 1948.

The Rev Chapman was a gentle, kindly man who freely shared his many talents with students and friends through his 80 years. To Harrison's daughter Gay and his many friends, we extend our sincere sympathy.

BOB NEAL VK3ZAN

COPIES OF ARTICLES

Photocopies of any article published in a back issue of AR available to members at \$2.50 each (plus \$2.00 for each additional issue in which the article appears)

**AR ARTICLES
PO Box 300
Caulfield South
Vic 3162**

OVER TO YOU

ALL LETTERS FROM MEMBERS WILL BE CONSIDERED FOR PUBLICATION AND MUST BE LESS THAN 200 WORDS.
THE WIA ACCEPTS NO RESPONSIBILITY FOR OPINIONS EXPRESSED BY CORRESPONDENTS.

Intruders And Tigers

Al Rechner says (AR, May 1990), that "...the overall activity on 10 metres is down". And, "...could part of the reason be all those Asian intruders have so effectively revealed our Intruder Watch for the paper tiger it is?"

The Intruder Watch (Monitoring System) is not a "Paper Tiger".

The job of the Intruder Watch is to Hear and Tell (The Administration). And it does. But the Administration has long been a Paper Tiger.

Over two years ago, I warned that the 10 metre band would be in a mess when the current cycle peaked, but the warning fell on (mostly) deaf ears. Now people are complaining.

Too late.

The sheer weight of numbers of unauthorised stations on 10 metres is proving too much for the authorities of all countries concerned. They are aware of the problem, and "Are trying to do something about it."

One solution, Al says, is to get on the band, and use it.

Fine. Do that, and complain to the Intruder Watch about unauthorised signals. But don't blame the Intruder Watch for the problem. It has been complaining on behalf of amateur operators, and will continue to do so.

Use the band, and good luck!

**BILL MARTIN VK2COP
IARU REGION 3 MONITORING
SYSTEM CO-ORDINATOR
33 SOMERVILLE RD,
HORNSBY HEIGHTS 2077**

Sensible And Correct Procedure

As a former professional radio operator and presently a communications instructor in emergency services I must comment on recent letters by Lindsay Lawless (AR April & June 1990).

These contain several statements in disagreement with Standard International Radio Telephone procedure.

1. "Roger" has NOT been replaced by "Romeo" in the majority of communication services.
"Roger" is a "Proword" and "Romeo" is the NATO phonetic for the letter R. The two are distinctly different.

The only services using "Romeo" for "Roger" are the Maritime, OTC and coastal radio stations. Lindsay's claim refers only to an obscure handbook used by these services.

I have never heard his suggested procedure used, particularly "Yes" and "No".

2. Yes is "affirmative" and No is "negative". This is for clarity under difficult conditions.
3. "Standby" is used to a station joining a busy net. Alternatively, "wait" means the operator is busy with traffic.
4. If something is not received clearly the procedure is:- "Say again all after (certain word) and before" (certain word) or:- "word before" (certain word).
An operator does NOT necessarily have to understand the meaning of a message but MUST copy it correctly and NOT ALTER IT.
5. "Repeat" is NOT used in general service communications because it means, (to artillery) "fire the same salvo again"! "Say again" is obviously preferable!
6. When transmitting "figures" (not called numbers!) the procedure is to say "figures, one, two" etc.
7. The "Q Code" is intended for CW, not phone.
WICEN uses Standard International R/T procedure since we MUST speak the same language as the other services we work with, so let's not confuse the issue.

**TED GABRIEL VK4YG
PO BOX 245 RAVENSHOE 4872**

CW — To Be Or Not To Be

Reference 3 recent items in AR — VK3ANJ, April & June OTY, and VK2EVB June p20 regarding "bar those who won't qualify in CW", "DOTC and the sale of 2HD gear", "censoring book sales" etc.

Nothing said addressed the real issue of declining activity on HF, and CW — it just made the authors feel better.

Lindsay, the Editor was right in his comment following your April letter, although he said it as gently as he could, "some who have Limited or Novice calls find that these permit as much activity as they have time to enjoy".

The activities now open to those who are CW illiterate are so interesting that many amateurs have concluded a "Full Call" is irrelevant.

To get more people onto HF, and CW, you must win their support — your comments in AR won't achieve that.

Let's open the whole matter to sensible, rational, debate — "Is compulsory CW for AOCF now in the best interests of amateur radio?"

Not everyone enjoys CW — many find it extremely difficult to master, due to a lack of aptitude, not a lack of intelligence, or diligence.

GRAHAM B JACKSON VK3TFN
SPLIT ROCK RD
UPPER BEACONSFIELD 3808

Federal Tapes

It was with a great deal of sadness that I read we will no longer hear the pleasant, clear tones of Ron Fisher VK3OM, and Bill Roper VK3ARZ, on the Sunday morning broadcasts giving us news of Federal activities. Their "Federal Tapes" were to me the highlight of these broadcasts.

After reading that, in lieu of the Federal Tapes, "Federal news segments in Divisional broadcasts will be provided to each Division from the Executive Office", I listened with interest on Sunday, 3rd June, to the VK3 broadcast to see how the new arrangement would work out. I was not altogether surprised to hear little if any of Federal matters. So at 11am, I listened to the VK2 broadcast and heard quite a good coverage of Federal matters. The criticism from at least one Division was clearly continuing.

So, from now on, my Sunday morning broadcast will commence at 11am, from VK2, on 7.146 MHz or 10.125 MHz. This way I hope I will be able to keep up with the important

matters which concern our hobby — even if those pleasant, clear voices will no longer be heard.

I'm sure I am not alone when I say "thanks" to Ron and Bill for a valuable job well done over so many years. It's a great pity that it had to end this way.

JACK O'SHANNASSY VK3SP
23 MCGOWANS RD DONVALE 3111

Two Letter Listing

In the letter from Dennis VK3DGB in May AR he raises the questions of elitism and discrimination in respect of two letter calls and asks what others think.

I find for everyday use that separation of the two and three letter calls makes use of the Call Book, especially in mid QSO, extremely simple.

Two letter calls are not exclusively the privilege of long term licence holders. I have been licensed for some 6 months having obtained my Novice call (VK3LDT) on 4.12.89 and my upgrade on 27.2.90. In applying for each licence I asked DOTC for a call which related to my name (last 2 letters of my Novice call). However, when upgrading the 2 letter call VK3DT was not available and, as I have had a nick-name of "D" or Big D for many years I enquired about the DD suffix. It was available, I handed over my licence fee and here I am!

I do not believe that separate listings are elitist or discriminatory.

Finally, as a "new" amateur and member of WIA I have had no reason to criticise the Institute and firmly believe it is essential for the continued good of amateur radio within Australia.

DEREK THURGOOD VK3DD
PO Box 234
YARRA GLEN 3775

EMC Advice

Two hints in the EMC Report (pp 33-34, May AR) offer dubious advice:

Hint a): The 470 pF capacitors between the antenna earth and the TV chassis are often put there to provide high voltage electrical isolation and are therefore a safety critical item. Refer to the manufacturer before remov-

ing these components. Many TV sets manufactured in the UK have their chassis at half-mains voltage and removal of these components represents a lethal hazard. I am not familiar with Australian practice in this matter but would advise caution.

Hint f): Positioning a high-pass filter between an unselective pre-amplifier and the TV tuner will not improve out-of-band immunity. The filter should go at the antenna side of any active device because intermodulation products caused by signals out of the TV bands can still fall in-band. The unselective preamplifier should be preceded by a band-defining preamplifier so that all such signals are partly rejected before the active device. This also applies to selective preamplifiers where the front-end filtering is not sufficient to prevent intermodulation. Additional filtering before the preamplifier will further reduce the unwanted signals. The additional noise-figure associated with the filter will usually be a small price to pay for improved dynamic range.

IAN BEEBY VK5ZEM, G80GJ
50 DORADUS AVE ST AGNES 5097

Field Day Rules

All members of the NCRG were relieved that this year's JMFD rules are becoming fairer for participants in WA.

At last — a chance to compete on a more equal footing with the "lucky" states.

As readers of my story "NCRG JMFD 1989" — May AR will realise WA is like another country when it comes to contest working on 80/40 metres, so removing the incredibly biased repeat contact rule was welcome in VK6.

Are VK3s CGH and VT ("Over To You — May AR) guarding their enviable position? — in their "under-populated" contest we made over 1000 contacts! Our operator skills were tried to the limits on all bands, phone and CW.

As for rule changes — it's just part of the challenge of contesting. The JMFD is meant to prepare us for emergency operating conditions — the rules are constantly changing during a disaster!

If the NERG really feels that a rule change which makes the contest fairer to other states is a reason to miss all the fun and fellowship,

ANTENNAS & ACCESSORIES

We manufacture a comprehensive range of HF, VHF and UHF antennas, baluns, power dividers etc to suit your application. Three of our log periodics provide continuous coverage from 13-30 MHz including WARC frequencies, and replace outdated tri-banders. Now in use in 24 overseas countries and 6 continents.

- CREATE ROTATORS, COAX CABLES & NON-CONDUCTING GUY HALYARD MATERIALS
- COMPLETE RANGE MIRAGE (USA) 5-YR WARRANTY 6M, 2M, 70CM AMPS & WATT SWR METERS
- HARD-DRAWN ANTENNA WIRE
- AUST/NZ DISTRIBUTOR FOR CREATE ANTENNAS/ROTATORS & PHYLSTRAN (KEVLAR) NON-CONDUCTING GUYING MATERIALS
- HIGH GAIN VHF & UHF AMATEUR, SCANNING & TV ANTENNAS
- BUTT SECTION TRIANGULAR ALUMIN IUM TOWERS FOR FIXED OR TILT-OVER APPLICATIONS (REFER MARCH/APRIL 1987 AR)
- SELECTION OF POWER CHIPS AT FRIENDLY PRICES
- VSWR/PWR METERS TO 1300MHZ

Write or phone for free catalogue

ATN ANTENNAS

56 Campbell Street
Birchip Vic 3483
Phone: (054) 92 2224
Fax: (054) 92 2666

then perhaps we are better off without them — but I'll miss reading their mail to check our relative scores!

It seems many amateurs are better "Over To You" letter writers than testers!

J E SPARKES VK6JX

RMB 737

DONNYBROOK 6239

Abbreviations

After reading letters from VK4YG and VK2AGL (Feb and May 1990) I thought this may be of interest to you:-

The international aspect of amateur radio having demonstrably become permanent, the ARRL in mid 1924 officially adopted ESPERANTO as its international auxiliary language. This official endorsement was about all the recognition Esperanto ever received. Amateur use of it was negligible. Instead, there sprang up an amateur-made international language understood by all amateurs world wide, commonly termed "QST ENGLISH".

This form of communication is based on the English language, together with a mixture of the international code or "Q" signals and a few relics from the old morse wire-line expressions.

The abbreviation of words to save transmission time and make transmissions understandable by all nations has, of course, long been a habit of all hams "oops" amateurs.

G TAYLOR VK4OH

Box 526

PIALBA 4655

VCR Problem

Many thanks for publishing my letter concerning VCR interference (Feb 90). I subsequently received letters from other Hams detailing their experiences with this same

problem. My thanks to Gavin of Tamworth, Laurie VK3DPD, Charlie VK5AOY, Rodney VK3UG and Hans VK2AOU (EMC reporter for AR magazine). Also to Sakari OH2AZG/VK3TJE (AR May p51). All help was very much appreciated.

In short, the results of my attempts to cure the problem were as follows;

1. VCR antenna removed and antenna input socket shorted. No reduction in interference during playback.

2. All forms of mains lead filters, as described by many of my correspondents, tried but to no avail.

3. Entire VCR wrapped in aluminium-foil. All interference disappeared. Wonderful! But hardly a practical solution. Still, it proved to my satisfaction that the interference was directly radiated into the playback head and not via VCR antenna or power leads, as suggested by some.

Anyway, it seems clear that there is no viable solution apart from improved VCR designs. I use a ground plane antenna, and cause no TVI whatsoever. So, rightly or wrongly, I now look upon the whole matter as a problem for VCR owners and not mine. While obviously one must try to live with one's neighbours, they understand that the problem is not of the amateur's making.

Some neighbours initially complained but after discussion and inviting them to contact the DOTC inspectorate, I have heard nothing more. However, I do not transmit on 80 or 40 on Tuesdays, Thursdays and Saturdays unless there is a contest. The result has been no complaints for the last two months. The neighbours are not aware of these "concessions" of mine, nor do I want them to be. They might assume this action is an admission of guilt, when in reality I am doing them a favour! So, at the moment all is quiet around the VK2COX

QTH. Thank you all.

RAY TURNER VK2COX

6/276 BUNNERONG ROAD

HILLSDALE 2036

Wartime Radar Equipment

I am involved with Bill Babb (VK3AQB) in helping in research for a series of books on RAAF World War II Ground Radar being prepared by Norm Smith and Ed Simmonds of NSW.

At present my main interest is in obtaining details of:-

1. Syllabuses and/or class or practical notes for RAAF Wireless Mechanics, Radar Mechanics and Radar Operators course, eg does anyone have the original instruction sheets for lining up the breadboarded 40 Watt transmitter which is now on display at the Point Cook Air Force Base? — or copies of the Massachusetts Institute of Technology Radiation Laboratories' "Radar Equipment Reference Books"?

2. The types of radar equipment used by the RAAF and manuals or circuit diagrams (or photos) of them.

3. The whereabouts of any actual equipment, eg can anyone locate part or all of an Australian LW/AW Radar Transmitter/Receiver?

This work is also partly tied in with a get-together and display at Bendigo in March 1992 for RAAF Radar Fiftieth Anniversary Celebrations. Bill Babb is restoring H2S and other radar and radio equipment for this function.

If anyone has anything they believe may be of help in these projects would they please get in touch with me?

NEIL TRAINOR VK3IJ

133 BLADIN ST LAVERTON 3028

(03) 369 1010

DUNKIRK AND BATTLE OF BRITAIN FIFTIETH ANNIVERSARY

A letter from Ron Churcher VK7RN refers to QSOs he had with special stations GB50DNK and GB50SUN on 10th and 29th May respectively. One commemorates the 50th anniversary of the Dunkirk evacuation (26 May to 4 June 1940) and the other a Thames tugboat (Sun XII) which figured largely in the rescue work.

Involving fleets of volunteers in small craft of all kinds, the Dunkirk evacuation lifted some 338,000 troops from the French coast before those remaining surrendered to the advancing

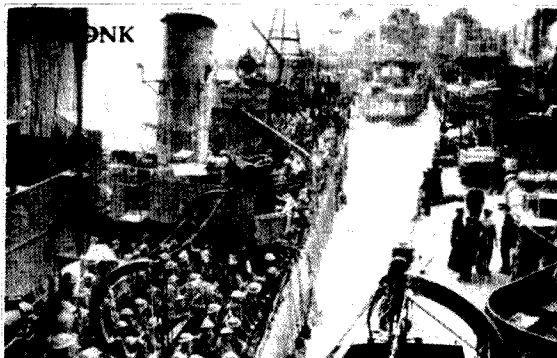

German forces.

Only weeks later the British defences were stretched to their limit in the Battle of Britain, involving the Luftwaffe and the RAF in a "do or die" struggle. This 50th anniversary from 7 to 15 July is being commemorated (among many other activities) by the operation of special station GB50MAN from RAF Manston. Presumably, like the other two stations, they will be active around 14150 kHz at 0745 Z approximately. ar

HF PREDICTIONS

ROGER HARRISON VK2ZTB

For ease of use and to accommodate space restrictions in the magazine, I have provided predictions applicable for three major regions of Australia:

VK EAST. Covers the major part of NSW and Queensland.

VK SOUTH. Covers southern-NSW, VK3, VK5 and VK7.

VK WEST. Covers the south-west of West Australia.

For each of these regions I have selected six "terminals" to major continental regions of the world, or regions of particular interest, such as Australian Antarctica (VK ANTARCTIC). Predictions for the long path to Europe are included again this month.

From time to time, I will include predictions to cover particular DXpeditions or other activities of special interest. There will be a DXpedition to Trindade during June and July for which I have run special predictions. Comments on bands, times and conditions are appended to the end of this column.

The predictions are calculated using a program known as "FTZ", for IBMs and compatibles, distributed by FT Promotions. If you want to know more about this program, call (02)818-4838.

The charts explained

These charts are different from those you see published elsewhere, and arguably more useful to the amateur fraternity as they give, effectively, the predicted signal/noise ratio for each hour and for selected bands.

The charts are organised in 24 rows, one for each hour UTC (first column on the left). Don't forget to add the appropriate number of hours for your time zone, including daylight saving where it applies. The next column give the MUF (maximum usable frequency) for each hour, followed by the field strength at the MUF, in decibels referred to 1 uV/metre (dBu). The column marked FOT gives the "optimum" frequency - the most reliable frequency for the path.

Then come five columns, one for each of five selected HF bands. The numbers in the column represent predicted field strength at each hour in decibels referred to 1 uV/metre. Here it represents "raw" signal to noise ratio as urban noise levels are typically 1-2 uV/metre, but does not take into account the advantage offered by particular transmission modes. The results are based on a transmitter power of 100 W output (except where noted later), the use of modest 3-element beams or similar, and for "median" conditions. Where

the results fall below -40 dB, no output is printed.

Enhanced conditions may improve S/N ratios by 9-15 dB. The use of CW or digital transmission modes show better results than SSB. If you've got 400 W output, you get a 6 dB improvements. Where conditions warrant it, I have include predictions for the bands below 14 MHz, deleting the upper bands.

Trindade DXpedition

As you would expect, 14 MHz via the short path will give you the best opportunity to work this region, except for VK WEST. However, while those running 100 W and a quad or small Yagi will be in there with a chance, signals won't be strong except during enhanced conditions.

For those in the VK EAST region, 20m will open abruptly around 2100 and fade out after 0100 UTC. For CW fans, you might get a chance between 0700 and 0800, too. 15m opens 2200-2400, while 10m opens weakly around 2300.

If you're in the VK SOUTH region, 20m opens abruptly at 2200 and closes an hour later. The higher bands are a washout.

For the VK WEST region, 20m provides three short time windows, but weak signals: 0600-0700, 1900 and 2300-0100 UTC. 15m is a better band with signals stronger than 20m between 0700 and 1000 UTC. On 10m, try between 0800 and 0900.

UTC	MUF	DBU	FOT	14.2	18.1	21.2	24.9	28.5
1	14.6	-24	10.5	-28	-15	-13	-17	-24
2	14.7	-29	10.4	-32	-17	-14	-16	-22
3	15.1	-30	11.0	-26	-19	-15	-16	-20
4	16.8	-28	11.8	...	-23	-16	-14	-17
5	18.8	-23	13.2	...	-25	-17	-13	-16
6	20.2	-19	14.8	...	-27	-17	-13	-13
7	21.1	-16	15.5	...	-25	-18	-12	-12
8	21.2	-14	15.7	...	-21	-14	-12	-14
9	19.4	-15	14.8	-34	-17	-13	-13	-16
10	17.6	-15	13.4	-26	-14	-12	-15	-21
11	15.8	-15	12.0	-19	-12	-11	-19	-28
12	14.3	-14	10.8	-14	-11	-15	-25	-37
13	13.2	-13	9.9	-11	-12	-19	-32	...
14	12.4	-9	9.5	...	-14	-23	-38	...
15	11.7	-5	8.8	...	-6	-16	-28	...
16	11.1	-2	8.4	...	-6	-20	-35	...
17	10.7	4	8.2	...	-5	-23
18	9.6	7	7.4	-10	-3
19	8.4	8	6.8	-20
20	8.4	10	6.5	-20
21	11.5	11	8.9	1	-39	-38
22	16.0	8	12.1	8	3	-5	-17	-32
23	16.0	-4	11.6	-3	-3	-6	-11	-23
24	15.4	-35	11.0	-18	-30	-11	-18	-24

VK EAST - EUROPE S.P.

VK STH - EUROPE S.P.

VK WEST - EUROPE S.P.

UTC	MUF	DBU	FOT	14.2	18.1	21.2	24.9	28.5
1	17.5	-1	11.9	-4	-1	-2	-8	-18
2	16.8	1	11.5	-1	1	-2	-9	-18
3	16.1	1	11.1	3	2	-3	-11	-22
4	15.3	8	10.8	7	3	-4	-14	-26
5	15.4	7	10.7	8	3	-3	-14	-26
6	15.8	8	11.1	9	5	-1	-12	-24
7	17.6	4	12.3	8	4	-3	-13	-24
8	15.0	-2	15.2	-2	-5	-12	-23	-37
9	12.6	-13	9.4	-11	-13	-19	-32	...
10	10.8	-27	8.0	-15	-17	-23	-38	...
11	9.4	...	6.5	-21	-21	-28
12	8.7	...	6.4	-40	-39
13	8.6	...	6.5
14	8.6	...	6.4
15	8.7	...	6.5
16	8.2	...	6.1
17	7.5	...	5.7
18	7.8	...	6.0
19	10.2	...	7.5
20	14.2	-29	10.9	-29	-17	-15	-19	-25
21	18.7	-15	14.1	-20	-16	-12	-13	-18
22	19.6	-8	13.5	-22	-10	-7	-7	-11
23	19.0	-4	13.0	-13	-4	-3	-6	-12
24	19.3	-2	12.5	-8	-2	-2	-7	-13

VK EAST - EUROPE L.P.

VK STH - EUROPE L.P.

VK WEST - EUROPE L.P.

UTC	MUF	DBU	FOT	14.2	18.1	21.2	14.9	28.5
1	20.0	7 15.2	7	9	5	8	-13	
2	19.7	7 14.8	7	9	5	8	-14	
3	19.4	8 14.7	9	9	5	9	-15	
4	18.9	9 14.3	11	10	5	12	-17	
5	18.0	11 13.6	15	11	4	15	-21	
6	16.6	16 12.6	21	12	2	20	-29	
7	14.9	18 11.3	20	7	-5	18	...	
8	13.1	19 9.9	16	-1	-16	13	...	
9	11.5	20 8.7	10	-10	-28	6	...	
10	10.2	21 7.7	3	-20	
11	9.2	22 6.9	-4	-30	
12	8.6	22 6.4	-9	-38	
13	8.2	22 6.3	-12	
14	8.0	22 6.0	-14	
15	7.8	22 6.0	-15	
16	7.0	23 5.5	-23	
17	6.4	22 4.9	-31	
18	6.5	22 5.1	-32	
19	8.7	19 6.5	-8	-35	
20	12.6	12 9.8	8	-6	-20	6	...	
21	16.3	9 12.6	11	6	-3	10	-30	
22	18.7	8 14.4	10	9	4	10	-18	
23	19.7	8 15.0	8	9	5	9	-14	
24	20.0	7 15.2	7	9	5	8	-12	

VK EAST - STH PACIFIC

UTC	MUF	DBU	FOT	14.2	18.1	21.2	14.9	28.5
1	22.0	0 16.6	2	4	1	3	-16	
2	22.2	0 16.6	2	5	2	3	-15	
3	22.0	1 16.5	4	5	2	5	-15	
4	21.5	2 16.2	7	7	3	8	-16	
5	20.2	4 15.3	12	8	2	11	-21	
6	18.4	8 13.9	18	9	-1	17	-31	
7	16.7	10 12.6	17	5	-7	15	...	
8	14.5	11 10.9	12	-4	-20	9	...	
9	12.5	12 9.4	5	-16	-36	1	...	
10	10.8	13 8.1	-4	-30	
11	9.5	14 7.1	-14	
12	8.4	14 6.2	-26	
13	7.8	14 5.8	-33	
14	7.7	14 5.7	-34	
15	7.7	14 5.7	-34	
16	7.6	15 5.8	-33	
17	7.1	15 5.5	
18	6.7	14 5.2	
19	7.0	9 5.4	
20	9.1	2 7.1	-19	-23	...	
21	12.6	-1 9.9	-4	-17	-33	-5	...	
22	16.6	-1 12.9	1	-4	-12	1	...	
23	19.6	0 14.9	2	1	2	-25	...	
24	21.2	0 16.1	1	3	0	2	-19	

VK STH - STH PACIFIC

UTC	MUF	DBU	FOT	14.2	18.1	21.2	14.9	28.5
1	21.5	-6 16.3	-12	-5	-5	-10	-18	
2	22.3	-5 16.8	-12	-4	-4	-10	-16	
3	22.5	-5 17.0	-11	-4	-4	-9	-15	
4	21.8	-4 16.5	-9	-2	-3	-7	-16	
5	20.5	-2 15.6	-4	-1	-3	-3	-20	
6	18.9	1 14.3	4	2	-4	4	-26	
7	17.2	4 13.0	9	2	-7	8	-36	
8	15.6	9 11.8	13	3	-12	11	...	
9	14.0	10 10.5	9	-6	-21	7	...	
10	11.9	12 9.0	3	-17	-36	0	...	
11	10.2	13 7.7	-5	-30	
12	9.0	14 6.7	-14	
13	8.4	14 6.2	-19	
14	7.9	14 5.9	-25	
15	7.8	14 5.9	-26	
16	7.8	14 5.9	-26	
17	7.7	14 5.9	-26	
18	7.1	14 5.4	-34	
19	6.9	9 5.3	-36	
20	7.2	-4 5.5	-31	
21	9.3	-9 6.9	-16	-35	
22	12.9	-8 10.0	-8	-15	-27	-8	...	
23	16.9	-6 13.0	-8	-7	-12	-7	-36	
24	19.9	-6 15.2	-10	-5	-7	-9	-23	

VK WEST - STH PACIFIC

UTC	MUF	DBU	FOT	14.2	18.1	21.2	14.9	28.5
1	23.2	-4 17.6	-18	-6	-4	-6	-11	
2	22.9	-5 17.8	-20	-7	-5	-7	-12	
3	22.6	-6 17.1	-20	-8	-6	-8	-13	
4	22.4	-6 17.0	-19	-7	-5	-8	-13	
5	22.1	-5 16.8	-17	-6	-5	-8	-14	
6	21.4	-5 16.3	-13	-5	-4	-9	-16	
7	20.1	-3 15.4	-7	-2	-4	-11	-20	
8	18.5	0 14.0	2	0	-6	-16	-29	
9	16.9	4 12.9	9	1	-9	-24	...	
10	15.3	6 11.7	9	-4	-17	-37	...	
11	14.0	7 10.6	6	-11	-27	
12	12.9	8 9.8	2	-18	-37	
13	12.2	8 9.2	-1	-24	
14	11.5	9 8.8	-5	-31	
15	10.8	9 8.2	-10	-39	
16	10.4	9 7.9	-14	
17	9.2	8 7.1	-25	
18	8.0	8 6.1	
19	7.9	8 6.2	
20	10.9	9 8.2	-10	-38	
21	15.9	3 12.4	7	-3	-14	-31	...	
22	20.4	-1 15.7	-2	1	-2	-10	-19	
23	22.7	-2 17.5	-9	-1	-1	-5	-11	
24	23.2	-3 17.7	-14	-4	-2	-5	-11	

VK EAST - ASIA

UTC	MUF	DBU	FOT	14.2	18.1	21.2	14.9	28.5
1	24.1	-4 18.3	-20	-7	-4	-5	-9	
2	24.6	-5 18.6	-23	-8	-4	-5	-8	
3	24.6	-5 18.5	-24	-9	-5	-5	-9	
4	24.3	-5 18.3	-23	-9	-5	-5	-9	
5	23.9	-5 18.0	-23	-9	-5	-5	-10	
6	23.1	-4 17.4	-16	-5	-4	-6	-11	
7	21.7	-4 16.4	-10	-3	-3	-8	-15	
8	19.9	-1 15.0	-1	1	-3	-11	-22	
9	17.5	3 13.2	8	1	-8	-21	-38	
10	15.0	4 11.3	7	-7	-21	
11	12.9	5 9.7	0	-20	-39	
12	11.1	5 8.4	-10	-36	
13	9.9	6 7.4	-21	
14	9.2	7 6.9	-29	
15	9.0	6 6.7	-31	
16	8.9	6 6.7	-32	
17	9.0	6 6.8	-31	
18	8.3	6 6.3	
19	7.6	6 5.8	
20	7.8	6 6.0	
21	10.5	7 8.2	-15	
22	15.0	-7 11.6	-7	-12	-21	-36	...	
23	19.6	-6 15.1	-10	-5	-7	-14	-23	
24	22.7	-4 17.4	-16	-5	-4	-6	-12	

VK STH - ASIA

UTC	MUF	DBU	FOT	14.2	18.1	21.2	14.9	28.5
1	21.4	-4 16.4	-13	-4	-4	-10	-15	
2	22.2	-5 16.9	-16	-6	-4	-13	-13	
3	22.4	-5 17.0	-19	-7	-5	-15	-13	
4	22.2	-6 17.3	-19	-7	-5	-16	-13	
5	21.9	-6 16.6	-19	-7	-6	-15	-14	
6	21.6	-5 16.4	-16	-6	-5	-14	-15	
7	21.2	-5 16.1	-13	-5	-5	-10	-16	
8	20.2	-4 15.4	-8	-3	-5	-9	-20	
9	18.8	-1 14.3	0	0	-5	-9	-27	
10	17.0	6 12.9	14	3	-8	12	...	
11	15.1	7 11.5	10	-5	-20	8	...	
12	13.4	7 10.2	4	-16	-35	0	...	
13	12.0	7 9.1	-4	-29	
14	10.9	7 8.2	-12	
15	10.2	7 7.7	-19	
16	9.9	6 7.5	-23	
17	9.5	6 7.2	-27	
18	9.3	6 7.1	-30	
19	8.4	6 6.4	
20	7.4	5 5.7	
21	7.5	5 5.8	
22	10.2	-4 7.6	-20	
23	14.7	-6 11.4	-6	-12	-23	-7	...	
24	18.9	-5 14.6	-9	-5	-8	-7	-26	

VK WEST - ASIA

UTC	MUF	DBU	FOT	1.8	3.6	7.2	10.1	14.2
1	9.2	-18 7.6	-28	-17	-18	
2	9.1	-19 7.5	-29	-18	-18	
3	8.9	-19 7.3	-28	-18	-19	
4	8.7	-18 7.0	-24	-17	-21	
5	8.1	-14 6.6	-16	-16	-28	
6	7.9	-7 6.3	-10	-6	-36	
7	8.1	-4 6.4	-16	-2	-35	
8	9.0	-1 7.4	-5	4	-24	
9	10.8	-9 8.5	-16	9	-10	
10	12.0	-15 9.3	-19	9	...	
11	10.3	-25 7.9	-26	-14	...	
12	9.1	-33 7.0	-27	-16	...	
13	8.6	...	6.5	-40	-28	
14	8.4	...	6.4	-33	
15	8.3	...	6.4	-32	
16	8.3	...	6.4	-36	
17	7.7	...	6.0	-29	
18	7.1	-29 5.7	-30	-21	-26	
19	7.5	-18 5.9	-19	-20	-34	
20	9.3	-11 7.4	-2	6	-23	
21	12.4	1 9.9	0	13	8	
22	11.5	-3 9.5	-40	1	0	-4
23	10.3	-9 8.5	-15	9	-12	
24	9.4	-16 7.8	-25	-16	-17	

VK EAST - TRINIDADE IS.

UTC	MUF	DBU	FOT	1.8	3.6	7.2	10.1	14.2
1	8.3	-13 6.7	-15	-15	-25	
2	8.1	-15 6.5	-18	-17	-27	
3	7.5	-20 6.0	...					

HAMADS

TRADE ADS

● **WEATHER FAX** programs for IBM XT/ATs *** "RAD-FAX2" is a high resolution, shortwave weather fax, morse & RTTY receiving program. Needs CGA, SSBhf radio & RADFAX decoder. Also "RF2HERC", "RF2EGA" & "RF2VGA", same as RADFAX2 but suitable for Hercules, EGA, & VGA cards respectively. \$35 *** "SATFAX" is a NOAA, Meteor & GMS weather satellite picture receiving program. Uses EGA or VGA modes. Needs EGA or VGA color monitor and card + "WEATHER FAX" PC card. \$45 *** All programs are on 5.25" or 3.5" disks (state which) & documentation, add \$3 postage. ONLY from M. Delahunty, 42 Villiers St, New Farm 4005 OLD. Ph (07) 358 2785.

● **AMIDON FERROMAGNETIC CORES:** For all transmitter and receiver applications. Send DL size SASE for data/price to RJ & US Imports, Box 157, Mortdale NSW 2223. (No enquiries at office please... 11 Macken St (Oatley). Agencies at: Geoff Wood Electronics, Sydney; Webb Electronics, Albury; Electronic Components, ACT; Truscott's Electronics, Melb; S Willis, Perth; Assoc TV Service, Hobart.

FOR SALE — ACT

● **ICOM IC260** 2m 10 watt multi-mode \$350. **YAESU FT720** 2m 25 watt FM \$300. **KENWOOD TR 8400** 70 cm 10 watt \$350. **TEN-TEC** ultramatic keyer \$120. All items good cond. with handbooks etc. John VK1CJ. (06) 25 4816.

FOR SALE — NSW

● **KENWOOD TS520** gc with handbook also DG5 dig. Readout with handbook also SP520 ext. speaker and lead \$400. No offers David Robertson (048) 85 1470.

● **NEW** and tested tubes all types ie: KT88 * 807 * 2C39 * 6550 * 6L6 * 211 * EC157 * DET16 * 2E26 * QQE06-40 * EC55 * 6CK6 * 4-400 * 4CX250B * E88CC * 3-500 and many, many more.

Send SAE for complete list to VK2WH E Reimann, QTHR.

● **TWO YAESU** transceivers all mint condition. No mods with exception 6KD6 finals complete set spares manuals included FDX401 \$425. FDX 560 \$450. Valves 100TH \$200, pair 4/808 \$125 4/807 \$25.00 3/ sets twenty new valves including 7360 no 6KD6 \$60. set \$150 lot. Communications receiver AR 88 D complete set valves \$25.00. Digital frequency readout YAESU suit FT 100/200 FT 400/560 \$310. Magazines AR, ARA 12 copies. \$14. JABEL variable voltage soldering iron tranny 240AC to 7-6-5-7 3A max \$35. SWR meters midland DSE * 181 \$25. HD Tranny Pri 240 A/c. 550-0-550 Sec. 1 Amp. \$50. 1kW HB linear. Tubes components not wired \$400. Laurie VK2IX (069) 488 321 no answer (069) 48 8320.

● **KENWOOD PS-30** power supply \$295. PS-50 \$450 new, Hidaka HF vertical \$195 HyGain TH5 yagi \$650 Wilson 3 element Triband yagi \$350, 3 Yaesu FNB4 batteries new \$95 each (02) 622 6268.

● **MINI QUAD HQ-1** antenna 2el. 6-10—15-20 metres 103 SAX rotator plus control and cable 10m coax, tech sheets 7 metres of 40mm steel tube. Heading list 300 cities \$220. Pick up QTHR Albury Reg VK2ELG (060) 43 1044.

● **YAESU FT209RA** MH12 speaker-mic PA3 car adapter charger all as new condition \$450. VK2DBI QTHR Ph (063) 67 5095.

● **BATTERY** model Iambic Keyer US design by A/A Engineering of Anaheim, Calif. Includes on/off sidetone switch and is very useful for Morse practice when transmitter is switched off. Price \$160 includes postage. Write or call (02) 477 6275. VK2AXR. Al Davis-Rice, 376 Pacific Hwy Hostel, Hornsby 2077.

● **OSKERBLOCK** SWR-200 dual meters 20/200 watt

75 and 50 Ohms \$25 Jack VK2AZP QTHR (02) 476 4013.

FOR SALE — VIC

● **VHF** receiver HALLICRAFTERS model no S95 \$50. Leo VK3YX QTHR ph (03) 232 9422.

● **TRANSCEIVER** ICOM IC-2A 2 meter plus IC-MLI linear plus battery pack power pack separate mic and antenna \$250 also YAESU cro YO-100 \$290 VK3TL (059) 64 3721.

● **KENWOOD TS820S** HF transceiver matching VFO 820, manuals, in excellent condition \$925 ono. Jim VK3DFL (052) 29 8339 ah QTHR.

● **DATONG D70** morse tutor ETM-5c morse keyer — both items original packaging keyer hardly used — reasonable offer VK3CUE QTHR ph (058) 21 3498.

● **TOWER** 13.7m extendable self supporting Nailo tower comps supplied. Will support 6EL YAGI/Quad purchaser to dismantle/remove from site \$800. VK3JY (03) 836 3841 QTHR.

● **ICOM IC202S** 2m transceiver. USB, LSB, CW. Covers 144.0 to 144.4 MHz plus oscar. Inc. mic and manual. Excellent condition. \$250 Roger VK3XRS (051) 56 8291.

● **ICOM IC 730** HF transceiver, all WARC bands, with remote control mic, CW filter, matching mains power supply PS 15, excellent condition, \$900. VK3BX, QTHR, (03) 830 4884.

● **DRAKE L4B** linear amplifier has pair 3500Z tubes, 2kw output, top USA amp good condition \$1950 ono Ray VK3CDR QTHR (03) 726 9222.

● **DECEASED ESTATE.** TS830S with manual and three 12BY7A valves and two S2001A (6146) valves. Kenwood digital remote VF0230 with manual, Kenwood MC50 microphone, speaker, \$800 the lot; Yaesu FL2100B linear with manual and two spare valves \$1,150; Heathkit SB200 linear with manual and one spare valve \$900; Heathkit wattmeter and manual \$75; Variac 9 amp 200 watts with meter and cabinet \$150; Ferris SWR meter \$30; audio phase shift network type 2Q4, two at \$20 each; 2N250A transistors and mounting micas, four at \$1 each; model making drill, sensitive, as a vertical drill press, capacity 5/16, \$100. VK3EQO (03) 592.6236.

● **DRAKE** final valves 6JB6 \$50 per pair, 813 valves (new) \$100 the pair. PL 177WA RF power beam pentode to 175MHz \$45 ea.

● **Telonic SM-2000** Sweep/Signal generator with plug-in LH-1 range 0-10 MHz and plug-in model SH-1 range 0-450 MHz. RF output up to 1 volt RMS 0-60 dB attenuator in 1 dB steps. Manual included. \$150 ono. Weight approx 25 kg. John VK3ZRV (03) 439 3389 QTHR.

● **PHILIPS 828/25A** VHF. Hi band FM TCVR. c/w: mic speaker. VGC commercial spec radio \$500. SONY



— VK2COP

AIR7 scanner 150-2194 kHz, 76-108 MHz, 108-136 MHz, 144-174 kHz. c/w: owners manual. 40 ch, priority, delay +- scan, manual auto squelch \$250. 150 mm B&W portable TV hi & lo VHF & all UHF channels, nicad bat pack available, good small light weight performer \$90. Bruce Kendall VK3WL (03) 741 7654 a/h.

FOR SALE — OLD.

- TH6 Emotorator rotator and Hills 16m telescopic tilt over tower \$1200 VK4CRO QTHR (07) 390 7762.
- RTTY FAX and CW demodulator (SEQTG) RTTY board in unit. Good working order. \$120 Bernie VK4OZ QTHR ph (075) 32 4078.
- TRIO SG402 sig gen 100 kHz — 30 MHz good condition. VK4DY QTHR ph (074) 96 1186.
- SELL valves 572B/T160L new unused \$375 the pair. Peter VK4APD QTHR ph (07) 397 3751.
- KENWOOD TS520S excel cond — checked over — \$450. VK4LN QTHR Barrie (074) 82 2675.
- HAND transceiver — KENWOOD TR2400. Digital readout, 10 programmable memories, many other features. Includes speaker/mike and base station charger w/mike. Good cond. Manuals. Original cartons. \$375 John VK4SZ (QTHR).
- 2M FM solid state transceiver, converted Pye Westminster, 12v 9w, 10 channels (fitted 8 repeater & 2 simplex) built in H/B scanner, ready to go, with manuals and crystals for 2 more channels, \$150 offers. 70 cm FM transceiver, DSE explorer, all official mods, plus improved TX audio, ready to go, with manuals \$180 offers. Dennis VK4ADY QTHR (075) 65 2226.
- YAESU FRG7700 h'book perf cond quick sale \$400 scanner SC7000 \$200 ONO QTHR (076) 27 3384 (ah) 27 3323 (bh) Ian VK4NIA.

FOR SALE — SA

- AUSTRALIAN (VOICE) REPEATER map and repeater LIST with place names arranged in state and alphabetical order for easy reference when mobile. Send

\$2 plus SSAE (9"x4") to Adelaide Hills AR Soc. VK5BAR Box 401 Blackwood SA 5051.

- ARMY tcvrs AN/PRC 10/10A \$50 ea. Transponder APX6 \$50. 4 ch Dick Smith radio control system, 29 MHz, complete, RX84 servos \$100. Belcom signal generator \$25. TH6DX Thunderbird ant \$300. FL2100 B linear \$950. Tubes 6146B, 6JS6C, 12BY7A all good cond. Bob VK5RI (088) 93 4001 QTHR.

FOR SALE — WA

- YAESU FL2100B linear amplifier very good condition — one owner since new \$600 ono. VK6PM QTHR ph (097) 33 1978.

FOR SALE — TAS

- TONO 9000E communication terminal. ASCII/BAUDOT morse. Set shifts and speeds. Keyboard. Also can be used as a word processor. \$450 ono
- TONO Theta 77 communications modem. ASCII/BAUDOT morse, ARQ/FEC, JIS and bit inversion. Adjustable shifts and speeds. Plugs into microprocessor but requires software. \$500 ono. 1 Dick Smith composite VDU with green phosphor \$50. The lot for \$900 ono. VK7RH (QTHR) ph (003) 31 9608.

WANTED — ACT

- FV102DM digital VFO, FC102 atu, contact Richard VK1UE QTHR.

WANTED — NSW

- Wanted IC1IC90 prescaler used EA frequency meter your spare or where I can obtain VK2IS (066) 52 3376.
- CAN anyone loan catalogue or photocopy details of TELECON coax connectors. Exp reimbursed. Art VK2AS QTHR (02) 416 7784.
- KDK VHF FM TXVR model FM2025. Maurie VK2SMH (02) 627 1434.
- ROLLER inductor preferably with dial/counter. 3 ceramic 1/4" couplers Jack VK2AZP QTHR (02) 476

4013.

- YAESU FT101E Peter VK2DBI QTHR ph (063) 67 5095.
- DC/DC converter DS-1A to suit Kenwood TS520S. VK2POA. QTHR ph (049) 48 9217.

WANTED — VIC

- GIANT five pin sockets to suit valve type 3/300, 4/125 etc. Also valves type 6DQ5. New if pos. Bob VK3ZL Merino ph (055) 79 1403.
- ANTENNA rotator controller for Daiwa DR-7500 or DR-7600 condition not important VK3BPN QTHR B/H (03) 580 9518 A/H (03) 551 7346

WANTED — OLD

- URGENTLY require Kenwood D65 in good condition for TS-520S Bernie VK4OZ QTHR ph (075) 32 4078.
- CIRCUIT or manual for IC255A, AVO 16 multimeter sinad meter. VK4DY QTHR ph (074) 96 1186.
- CIRCUIT for Traeger SSB-50 HF transceiver also any conversion details. Experience etc. Will pay copying postage costs. Dough VK4AZ QTHR (07) 391 5526.
- CIRCUIT and or manual to suit solid state oscilloscope type 400 manufactured by Microcell Electronics Surrey England ex-Telecom will meet all costs VK4APB QTHR.

WANTED — TAS

- CIRCUIT service info for SW receiver SONY ICF 6700L. Manuals or p/copy. Costs etc reimbursed. Tom VK7TL (002) 23 8755.
- HF solid state t'ceiver dead or alive 720A or similar pay to \$700 QTHR VK7JG ph (003) 27 2256.

WANTED — NT

- FM board and electronic keyer to fit Yaesu FT-ONE transceiver please phone (089) 85 1311 Geoff.



Please Note: If you are advertising items For Sale and Wanted please use a separate form for each. Include all details; eg Name, Address, Telephone Number (and STD code), on both forms. Please print copy for your Hamad as clearly as possible.

- *Eight lines free to all WIA members, ninth line for name and address Commercial rates apply for non-members. Please enclosed a mailing label from this magazine with your Hamad.
- *Deceased Estates: The full Hamad will appear in AR, even if the ad is not fully radio equipment.
- *Copy typed or in block letters to PO Box 300, Caulfield South, Vic 3162, by the deadline as indicated on page 1 of each issue.
- *QTHR means address is correct as set out in the WIA

current Call Book.

*WIA policy recommends that Hamads include the serial number of all equipment offered for sale.

*Please enclose a self addressed stamped envelope if an acknowledgement is required that the Hamad has been received.

Ordinary Hamads submitted from members who are deemed to be in general electronics retail and wholesale distributive trades should be certified as referring only to private articles not being re-sold for merchandising purposes.

Conditions for commercial advertising are as follows: \$22.50 for four lines, plus \$2.00 per line (or part thereof) Minimum charge — \$22.50 pre-payable.

State:

- Miscellaneous
- For Sale
- Wanted

Name:

Call Sign:

Address:

Solution to Morseword No 40

	1	2	3	4	5	6	7	8	9	10
1	.	.	-	.	.	-	-	.	.	.
2	.	-	-	-	-	.
3	-	-	.	.	-	.
4	-	-	-	.	.	.
5	-	.	.	-	.	.
6	-
7	.	.	-	.	-	-	.	-	-	-
8	-	-	.	-	-	.	-	.	.	-
9	.	.	-	.	.	-	.	.	-	.
10	.	-	-	-	.	.

Across: 1 fade 2 lug 3 satin 4 brie 5 safe
6 these 7 ergo 8 Manx 9 fain 10 ripe

Down: 1 vend 2 left 3 bear 4 heel 5 urge
6 year 7 gift 8 rennet 9 pike 10 head

TRADE PRACTICES ACT

It is impossible for us to ensure the advertisements submitted for publication comply with the Trade Practices Act 1974. Therefore advertisers and advertising agents will appreciate the absolute need for themselves to ensure that, the provisions of the Act are complied with strictly.

VICTORIAN CONSUMER AFFAIRS ACT

All advertisers are advised that advertisements containing only a PO Box number as the address cannot be accepted without the addition of the business address of the boxholder or seller of the goods.

TYPESETTING : Redfords Media
25 Glenferrie Rd
Malvern 3144
Tel: (03) 500 0377

PRINTING: Industrial Printing
Richmond

MAIL DISTRIBUTION: Polk Mailing Co.
PO Box 140,
Collingwood,
Vic. 3066
Tel:(03) 417 5161

The opinions expressed in this publication do not necessarily reflect the official view of the WIA, and the WIA cannot be held responsible for incorrect information published.

ADVERTISER'S INDEX

ATN Antennas	50
Dick Smith Electronics	28, 29
Electronics Australia	IBC
Icom Australia	OBC,
Kenwood Electronics Aust.	IFC
Magpubs	5
Moonraker Australia	18
Philips Australia	35, 37 & 39
WIA NSW Division	8

TRADE ADS

RJ & US Imports	54
M Delahunty	54

HOW TO JOIN THE WIA

Fill out the following form and send to:

The Membership Secretary
Wireless Institute of Australia
PO Box 300
Caulfield South, Vic 3162

I wish to obtain further information about the WIA.

Mr, Mrs, Miss, Ms:

Call Sign (if applicable):

Address:

.....

State and Postcode:

Radio Amateurs: Have you checked out EA lately?

No doubt most radio amateurs are aware that *Electronics Australia* is by far this country's largest-selling electronics magazine, as well as being its oldest (we began way back in 1922, as *Wireless Weekly*). But have you looked inside the magazine lately?

Now it's bigger and better than ever, because our leading competitor *ETI* has been merged with us, to form *Electronics Australia with ETI* – the biggest, brightest and most informative electronics magazine, bar none.

You'll now find lots of new 'departments' in the magazine, including Solid State Update (with news of new semiconductor devices), Silicon Valley Update (news from the USA) and What's New in Entertainment Electronics. Plus all of your old favourites like Forum, The Serviceman, Circuit and Design Ideas and so on. And of course plenty of 'meaty' technical articles and construction projects.

What about *amateur radio* projects? Well, as you can see there are more of these than before – but we're very interested in publishing more. So if YOU have developed an exciting amateur radio project, contact Jim Rowe by writing to him at EA, 180 Bourke Road, Alexandria 2015. Or phone him on (02) 693 6620, to discuss the possibility of publishing it as a contributed article. As well as earning a fee, you'll also be helping to boost interest in amateur radio!

Take a look at the new, bigger and brighter *Electronics Australia with ETI* – on sale at your newsagent at the beginning of each month. Or subscribe now, by phoning (02) 693 9517 or 693 9515.

INCLUDED IN OUR JULY ISSUE:

SSTV TRANSMIT SCANCONVERTER - 1

Tried looking in on SSTV skeds? Here's an easy to build transmit scanconverter that will let you join in, as well. Designed by Leon Williams VK2DOB, it plugs straight into your transceiver's mike input.

VHF POWERMATCH MK2

Remember the original design back in 1971? Jim Rowe has now revamped and updated his very popular multi-purpose VHF test instrument.

EDWIN ARMSTRONG

Radio amateur, engineer, US Army officer – Edwin Armstrong was the genius who invented the superhet and the superregen. He also pioneered the use of FM, as Neville Williams explains.

Electronics Australia WITH **eti**

Australia's Top Selling Electronics Magazine



Icom HF Transceivers meet the demands of Amateurs

As an Amateur operator, you know what you want in an HF rig. In fact, although Icom are THE professionals when it comes to communications, it is the Amateurs from whom we seek guidance when designing and developing superior equipment. That's why Icom leads the way in Amateur Communications. If space here permitted, we could go into lengthy discourse about Icom's outstanding features and options, but you're probably aware of most of them. Just to prompt your memory, here's a brief summary of our HF Range -



IC-726 Sophisticated, Compact, with built-in 6 metre band

All the features and reliability you've come to expect from Icom in an advanced, Multimode Transceiver - and still at a budget price! Designed with the beginner in mind, the IC-726 is easy to operate but has so many features it satisfies the needs of veterans too. This little beauty receives and transmits on LSB, USB, CW, AM and FM modes just as simply from home, as in a vehicle or the field. Enjoy great mobiling potential with our optional HF automatic antenna tuner.



IC-735 a highly advanced compact

An ultra-compact, 100W unit, the IC-735 is well suited for car, boat or aeroplane on 12V operation as well as a base station set-up. You'll cover all HF Amateur bands from 1.8 MHz to 28MHz including 10, 18 and 24 MHz with the IC-735 using features like Notch filter, Past band tuning, SWR bridge, and a Variable noise blanker. Ring Icom for a leaflet on this ham band, high performer which doubles as a superb general coverage receiver. Call us now for a colour brochure or the name of your nearest stockist.



IC-765 for the DX enthusiast talking to the world -

Icom have incorporated your most requested features to enable you to expand your HF world with the super-advanced IC-765. Equipped with our exclusive DDS (Direct Digital Synthesizer) System, it boasts a fully automatic, high-speed antenna tuner, built-in power supply and features appealing to CW enthusiasts - a built electronic keyer with iambic operation capability for example (paddle not included). If you'd like to read more about the IC-765's Band Stacking Registers, 99 Fully Tunable Memories and Full QSK Break-in.



IC-725 Compact - Fixed, mobile or portable

Easily operated, the IC-725 is a compact HF transceiver that really delivers extraordinary performance. This 12V powered, full-featured unit has a general coverage receiver as well that won't let you down when it comes to globe-listening operation. Enjoy great mobiling potential with our optional HF automatic antenna tuner - enquire when you call for a brochure or the name of your nearest stockist.

(amateurs are the professionals in the business of communications.)

For further information call Icom free on 008 338 915

Melbourne callers (03) 529 7582 Icom Australia Pty. Ltd., 7 Duke Street, Windsor 3181.

Icom Australia's warranty is only applicable to products purchased from their authorised Australian Dealers.

ICOM

■ AMATEUR ■ MARINE ■ LAND-MOBILE ■ AVIATION ■ CB ■ AMATEUR ■ MARINE ■ LAND-MOBILE ■ AVIATION ■ CB ■ AMATEUR ■ MARINE ■ LAND-MOBILE ■

Please rush to me your brochure on the IC-725 IC-726 IC-735 IC-765 and the name of my nearest Icom stockist.

SEND TO: Freepost 15, Icom Australia Pty Ltd, Windsor, 3181 (no stamp required).

Mr., Mrs., Ms. Company Title

Address Suburb

City Post Code Phone No.

NCAA 4642 AR

■ AMATEUR ■ MARINE ■ LAND-MOBILE ■ AVIATION ■ CB ■ AMATEUR ■ MARINE ■ LAND-MOBILE ■ AVIATION ■ CB ■ AMATEUR ■ MARINE ■ LAND-MOBILE ■

AMATEUR RADIO

AUGUST 1990

RRP \$3



THE WIA RADIO AMATEUR'S JOURNAL

KENWOOD

DUAL-BAND BANDIT

(a real steal!)

Buy either a **TM-701A** or a **TM-731A** and get a great **MA-700** Dual Band Mobile Antenna with duplexer **free!**

1



Kenwood's new TM-701A and TM-731A transceivers have all the best features for great mobile enjoyment — and when you have the best dual-band antenna in the business as well, you can't lose!

Buy a **TH-75A** Dual Band Handheld Transceiver and get a **BC-11** Rapid Charger **free!**

2

The TH-75A combines the 2m and 70cm bands together into one compact, feature-filled hand-held package. Large dual LCD displays, dual watch, selectable full duplex operation, tone alert, and many additional features make this dual-band HT different from the rest!



KENWOOD ELECTRONICS AUSTRALIA PTY. LTD.
(NC INCORPORATED IN N.S.W.)

8 Figtree Drive, Australia Centre, Homebush, N.S.W. 2140
Ph. (02) 746 1519, (02) 746 1888, Fax (02) 746 1509
Call now for further information and the name of your nearest authorised Kenwood dealer.

This offer starts 15th August, and is available only while stocks last.

Please phone, mail or fax for information

Name.....

Address.....

..... Postcode.....

Publication..... Issue.....

Model.....



Amateur Radio is published by the Wireless Institute of Australia, as its Official Journal, on the last Friday of the previous month.

EXECUTIVE EDITOR

Bill Rice VK3ABP

MANAGING EDITOR

Graham Thornton VK3IY

NEWS EDITOR

Jim Linton VK3PC

SENIOR TECHNICAL EDITOR

Peter Gibson VK3AZL

TECHNICAL EDITORS

David Brownsey VK4AFA
 Don Graham VK6HK
 Evan Jarman VK3ANI
 Peter O'Connor VK4KIP
 Gil Sones VK3AUI
 Phil Steen VK4APA
 Roy Watkins VK6XV

DRAFTING

Vicki Griffin VK3BNK

MARKETING

Bruce Kendall VK3WL
 Norm Eyres VK3ZEP

ADVERTISING

Ann McCurdy

All contributions and correspondence concerning the content of Amateur Radio should be forwarded to:

The Editor
 Amateur Radio
 PO Box 300
 Caulfield South
 VIC 3162

Registered Office

3/105 Hawthorn Road
 Caulfield North VIC 3161

Telephone: (03) 528 5962

(03) 523 8191

Fax: (03) 523 8191

(Non dedicated line)

Business hours: 9.30am to 3pm
 weekdays

Deadlines

Editorial Hamads

Sept 6/8/90 8/8/90

Oct 10/9/90 12/9/90

Nov 8/10/90 10/10/90

Delivery of AR: If this magazine is not received by the 15th of the month of issue, and you are a financial member of the WIA, please check with the Post Office before contacting the registered office of the WIA.
 © Wireless Institute of Australia 1990

CONTENTS

Technical

ATU in Cake Tin	7
<i>Peter Parker VK6BWI</i>	
Health Hazards of Soldering	9
<i>A M Brown VK2KJM & P J Hollis-Watts VK2YJW</i>	
Circuit for a Field Strength Indicator	10
<i>J A Heath VK2DVH</i>	
VLF-LF and the Loop Aerial	12
<i>Lloyd Butler VK5BR</i>	

General

Amateur Radio in the USSR	22
<i>Yuri Zolotov UA3HR</i>	
George Moss VK6GM Pioneer Radio Amateur	24
<i>Les Bradshaw VK6EB</i>	
DXpedition to St Peter and St Paul Rocks PY0S Brazil	27
<i>Natal DX Group</i>	
What is History	33
<i>J W Edmonds VK3AFU/ATG</i>	
The New Challenge	34
<i>J F Hanran VK4JH</i>	
24 MHz DX Over Seven Years 1982-1989	35
<i>Graham Rogers VK6RO</i>	

Equipment Review

The Yaesu FT-1000 HF All Mode Transceiver	17
<i>Ron Fisher VK3OM</i>	

Book Reviews

Morsum Magnificat	21
<i>Alan Shawsmith VK4SS</i>	
Amateur Band Plans Booklet	21
<i>Jim Linton VK3PC</i>	

Operating

Awards	37
Contests	
ALARA Rules	38
John Moyle Results	39

Columns

Advertisers' Index	56	Intruder Watch	46
ALARA	47	Morseword No 41	36
AMSAT	42	Over To You - Members' Opinions	53
Club Corner	52	Pounding Brass	42
Divisional Notes		QSLs from the WIA Collection	50
VK2, VK3 Notes	48	Silent Keys - Obituaries	52
VK4 Notes, 5/8 Wave	49	Spotlight on SWLing	46
Editor's Comment	2	Stolen Equipment	26
Education Notes	45	VHF/UHF and Expanding World	41
Hamads	54	WIA Directory	2
How's DX	39	WIA News	3

Cover

Yuri Zolotov — one of the more famous USSR amateurs, made contact with the trans-polar Soviet-Canadian expeditions in 1988. Photo shows Yuri Zolotov at home at his radio station. See his article on p22. Photo: B Prikhodho (Novosti 1988).

EDITOR'S COMMENT

BILL RICE VK3ABP EXECUTIVE EDITOR

Reading An Editorial

"Hey", you say, "What's this? You're the guy who's writing the stuff! We're reading it. What gives?"

The reason is that I have just been reading editorials; not just one, but many, from a whole range of overseas amateur radio magazines, so that I am now suffering from more than a little editorial indigestion! "Why this masochism?", you ask. You are allowed to insult all those hard-working editors. I mustn't, being one of them! So I can't call it masochism, even if it was, can I?

The first thing I noticed

about all those editorials was that they were too long. Mostly, they had lost me before the second column. That was a pity, because they were all on important themes, like the future of amateur radio, falling membership numbers, and the need for Morse Code. Don't let me get started on any of those; I might carry on for a page or two, too!

Why was I reading all these other editorials? Looking for inspiration, mainly. Having spent all of last weekend around the Executive Office table at the quarterly mini-Convention with all Federal Councillors present (unfortunately, one was missing, but that's irrelevant) I guess I,

like all the others, am still suffering from information overload. It was an excellent meeting, with over 30 agenda items, which occupied about 14 hours of formal discussion, plus much informal chatter during breaks. This relatively new way of running the WIA has certainly achieved its aim of bringing the Divisions closer together. All those big topics I don't want to get started on rated at least a mention in the discussions. Some were mentioned for hours.

Anyway, I don't know whether I was inspired or not by all those editorials. But I did see that we radio amateurs are not only a world-

wide fraternity, but we also have world-wide problems, some of which threaten our very existence. They can only be solved by united action. The IARU has as members virtually every national radio amateur society, and similarly each society should comprise most, if not all, of that country's amateurs.

I haven't lost you yet, have I? Surely I haven't gone on for too long already? Maybe you don't agree with all of the last paragraph. Do you want to be a Radio Amateur, much as now, beyond 2000? Or even beyond 1992? United we stand, divided we fall. And this editorial is now quite long enough!

Wireless Institute of Australia

The world's first and oldest National Radio Society - Founded 1910

Representing Australian Radio Amateurs - Member of the International Amateur Radio Union
Registered Executive Office of the WIA: 3/105 Hawthorn Road, Caulfield North, Vic, 3161
All mail to: **PO Box 300, Caulfield South, Vic, 3162** Telephone: (03) 528 5962 (03) 523 8191
Fax: (03) 523 8191 (Non-dedicated line)
Business Hours: 9.30 am to 3.00 pm on Weekdays

General Manager and Secretary: Bill Roper VK3ARZ

EXECUTIVE

President:	Peter Gamble	VK3YRP	VK1 Federal Councillor:	George Brzostowski	VK1GB
Vice Chairman:	Ron Henderson	VK1RH	VK2 Federal Councillor:	Terry Ryeland	VK2UX
	Kevin Olds	VK1OK	VK3 Federal Councillor:	Peter Maclellan	VK3BWD
	Brenda Edmonds	VK3KT	VK4 Federal Councillor:	David Jerome	VK4YAN
	Bill Rice	VK3ABP	VK5 Federal Councillor:	Bill Wardrop	VK5AWM
Immediate Past President:	David Wardlaw	VK3ADW	VK6 Federal Councillor:	Neil Penfold	VK6NE
			VK7 Federal Councillor:	Joe Gelston	VK7JG

FEDERAL CO-ORDINATORS

Amsat:	Graham Ratcliff	VK5AGR	Int'l Travel Host Exch:	Ash Nallawalla	VK3CIT
Awards:	Phil Hardstaff	VK3JFE	QSL Manager (VK9, VKØ):	Neil Penfold	VK6NE
Act Contest Manager:	Neil Penfold	VK6NE	FTAC:	John Martin	VK3ZJC
Education:	Brenda Edmonds	VK3KT	Federal Tapes:	Ron Fisher	VK3OM
EMC:	Hans Ruckert	VK2AOU	Videotape:	John Ingham	VK5KG
Historian:	John Edmonds	VK3AFU	WICEN:	Bill Wardrop	VK5AWM
Intruder Watch:	Gordon Loveday	VK4KAL			

WIA NEWS

BILL ROPER VK3ARZ GENERAL MANAGER & SECRETARY

Draft Spectrum Plan

DoTC recently forwarded a copy of a draft Australian Spectrum Plan to the WIA for comment. Here are some extracts from the WIA response to DoTC which clearly show the areas of our concern...

"The WIA notes with concern a major difference, as far as the Amateur and Amateur Satellite services are concerned, between this Draft Plan and the current Australian Table of Frequency Allocations. This difference con-

cerns the allocations on the band 420 to 450 MHz.

In the Australian Table of Frequency Allocations, 420 to 450 MHz is allocated to Radio Location on a primary basis, with Amateur on a secondary basis. This particular allocation arose out of footnotes 651 and 652 entered into the International Frequency Table at WARC 79 and carried over into the Australian Table of Frequency Allocations as a variation from the Frequency Table applying to Region 3.

The Draft Plan is different in that Fixed and Mobile have been inserted in the band 420 to 450 MHz as co-secondary

services alongside the Amateur Service.

The Amateur Service believes Australian Table of Frequency Allocations on the band 420 to 450 MHz should remain the same on any new Australian Spectrum Plan for the following reasons:

1. Since the withdrawal of the 576 MHz Amateur band it has been necessary to make arrangements for relocation of displaced amateur television repeaters. This will in many cases be achieved by the use of in-band repeaters on the 420 to 450 MHz band making use of both the TV channels in the Amateur Service band plan for this band. This will cause an extra load on the usage of this band by Amateur stations transmitting TV.

2. The band is extensively used by mobile stations in the Amateur Service with an Australia wide network of repeater stations.

3. The band is also used for propagation experiments using very weak signals, for example using the moon as a passive reflector.

Sharing with Radio Location has generally been satisfactory to date with some concern expressed due to the operation of SYLEDIS systems, which appear not to comply with Aus 11. However, the introduction of fixed and mobile services to the table in this band will cause unnecessary problems for the Amateur Service. It should be noted that this band is the lowest band on which amateur TV transmissions can be made.

WIA DIVISIONS

The WIA consists of seven autonomous State Divisions. Each member of the WIA is a member of a Division, usually their residential State or Territory, and each Division looks after amateur radio affairs within their State.

Division	Address	Officers	Weekly News Broadcasts	1990 Fees									
VK1	ACT Division GPO Box 600 Canberra ACT 2601	President Ted Pearce Secretary Jan Burrell Treasurer Ken Ray	VK1AOP 3.570 MHz VK1BR 2m ch 6950 VK1KEN 70cm ch 8525 2000 hrs Sun	(F) \$65.00 (G) (S) \$52.00 (X) \$39.00									
VK2	NSW Division 109 Wigram St Parramatta NSW (PO Box 1066 Parramatta) 2124 Phone (02) 689 2417 Fax (02) 633 1525	President Roger Henley Secretary Tim Mills Treasurer David Horsfall (Office hours Mon-Fri 1100 - 1400 Wed 1900 - 2100)	VK2ZIG 1.845 MHz AM, 3.595 AM(1045) SSB (1915 only), 7.146 AM (1045 only) 10.125 SSB (1045 only), 28.320 SSB, 52 120 SSB 52.525 FM 144.12 (SSB), 147.000 FM(R) 438.525 FM(R) 584.750 (ATV Sound) 1281.75FM (R) Relays also conducted via many repeaters throughout NSW.	(F) \$59.00 (G) (S) \$47.00 (X) \$33.00									
VK3	Victorian Division 38 Taylor St Ashburton Vic 3147 Phone (03) 885 9261	President Jim Linton Secretary Barry Wilton Treasurer Rob Hailey Office hours 0900-1600 Tue & Thur	VK3PC 1.840 MHz AM, 3.615 SSB, 7.085 SSB, 147.250 FM(R) Mt Macedon, VK3XV 147.225 FM(R) Mt Baw Baw VK3XLZ 146.800 FM(R) Mildura, 438.075 FM(R) Mt St Leonard 1030 hrs on Sunday	(F) \$65.00 (G) (S) \$52.00 (X) \$39.00									
VK4	Queensland Division GPO Box 638 Brisbane Old 4001 Phone (07) 284 9075	President Ross Mutzelburg Secretary Eddie Fisher Treasurer Eric Fittock	VK4IY 1.825, 3.605, 7.118, 10.135, 14.342, 18.132, 21.175, 24.950, 28.400, MHz VK4ABX VK4NEF 52.525 regional 2m repeaters and 1296.100 0900 hrs Sunday Repeated on 3.605 & 147.150 MHz, 1930 Monday	(F) \$65.00 (G) (S) \$52.00 (X) \$39.00									
VK5	South Australian Division 34 West Thebarton Rd Thebarton SA 5031 (GPO Box 1234 Adelaide SA 5001) Phone (08) 352 3428	President Rowland Bruce Secretary John McKellar Treasurer Bill Wardrop	VK5OU 1820 kHz 3.550 MHz, 7.095, 14.175, 28.470, 53.100, 145.000, (F) VK5BJM 147.000 FM(R) Adelaide, 146.700 FM(R) Mid North, 146.900 FM(R) (G) (S) \$52.00 VK5AWM South East, ATV Ch 34 579.00 Adelaide, ATV 444.250 Mid North (X) \$39.00 (NT) 3.555, 146.500, 0900 hrs Sunday										
VK6	West Australian Division PO Box 10 West Perth WA 6005 Phone (09) 388 3888	President Alyn Maschette Secretary John Farnan Treasurer Bruce Hedland Thomas	VK6KWN 146.700 FM(R) Perth, at 0930 hrs Sunday, relayed on 3.560, 7.075, (F) \$56.00 VK6AFA 14.115, 14.175, 21.185, 28.345, 50.150, 438.525 MHz Country re- (G) (S) \$45.00 lays 3582, 147.350(R) Busselton 146.900(R) Mt William (X) \$30.00 (Bunbury) 147.225(R) 147.250 (R) Mt Saddleback 146.725(R) Albany 146.825(R) Mt Barker Broadcast repeated on 3.560 at 1930 hrs.										
VK7	Tasmanian Division 148 Derwent Ave Lindisfarne TAS 7015	President Tom Allen Secretary Ted Beard Treasurer Peter King	VK7AL 146.700 MHz FM (VK7RHT) at 0930 hrs Sunday relayed on 147.000 (F) \$63.00 VK7EAB (VK7RAA), 146.750 (VK7RNW), 3.570, 7.090, 14.130, 52.100, (G) (S) \$50.00 VK7ZPK 144.100 (Hobart) Repeated Tues 3.590 at 1930 hrs (X) \$38.00										
VK8	(Northern Territory) is part of the VK5 Division and relays broadcasts from VK5 as shown (received on 14 or 28 MHz).		<table border="0"> <tr> <td>Membership Grades</td> <td>Three year membership available</td> </tr> <tr> <td>Full (F)</td> <td>to (F) (G) (X) grades at fee x 3</td> </tr> <tr> <td>Needy (G)</td> <td>times</td> </tr> <tr> <td>Student (S)</td> <td></td> </tr> <tr> <td>Non receipt of AR (X)</td> <td></td> </tr> </table>	Membership Grades	Three year membership available	Full (F)	to (F) (G) (X) grades at fee x 3	Needy (G)	times	Student (S)		Non receipt of AR (X)	
Membership Grades	Three year membership available												
Full (F)	to (F) (G) (X) grades at fee x 3												
Needy (G)	times												
Student (S)													
Non receipt of AR (X)													

Note: All times are local. All frequencies MHz.

We feel that the introduction of any fixed and mobile service stations would also be extremely detrimental to the limited facilities available to the Amateur Satellite Service and could lead to these services being unintentionally repeated on international amateur satellites.

The WIA feels rather disappointed that these changes have been proposed at a time when sharing issues are being studied by the CCIR as part of the preparation for WARC 92, thereby appearing to pre-empt CCIR considerations.

Other matters in the Draft Australian Spectrum Plan of concern to the WIA are:

1. BANDS AVAILABLE TO THE AMATEUR SATELLITE SERVICE.

Since 1979 there has been a great increase in the number and use of satellites in the Amateur Satellite Service - see CCIR report N8.

In the five amateur bands between 148 MHz and 10.45 GHz the Amateur Service has access to a sub-band as designated in footnotes 644 and 808 to the International Frequency table in the International Radio Regulations.

As the text of each footnote is only printed once, some confusion is caused to those who are not familiar with the Amateur Satellite Service. In fact this happened very recently during the preparation of the Spectrum Review for 930-3400 MHz.

We therefore suggest that for the sake of clarity the actual Amateur Satellite Sub-bands mentioned in the Footnotes should be included in the Frequency Table with the required direction indicators.

Due to the great importance of these Amateur Satellite Sub-bands to the Amateur Service as a whole, we feel that they should be mentioned in the Australian Table.

Further, we feel that in the Australian frequency Plan that within these Sub-bands, the Amateur and Amateur Satellite Service should be raised to the level of a primary service.

We also feel that the Amateur and the Amateur Satellite Service should be raised to primary status in the band 10.45 - 10.50 GHz.

In fact, we would prefer 10.45 - 10.50 GHz to be an exclusive Amateur and Amateur Satellite Service Band.

2. CONCERNING THE FREQUENCY BAND 10.100-10.200 MHz

At WARC-79 Australia proposed a new exclusive amateur band from 10.10 to 10.20 MHz. As you know, the Conference decided to allocate 10.10 to 10.15 MHz to the Amateur Service on a secondary basis. There was, however, significant support for a band 100 kHz wide and even support for an exclusive amateur band at these frequencies.

It is interesting to note that Footnote 510 to the International Frequency Table includes the 10.1 MHz band. This Footnote refers to the use of amateur bands in the event of natural disasters with reference to Resolution 640 contained in the ITU Radio Regulations. On this band the Amateur Service is very much aware of the importance of not causing interference to the primary service.

It has been demonstrated that this band has great potential for Australia-wide communications throughout the day, as well as for international communications during a period of each day. This communications potential is somewhat limited by the fact that the band is only 50 kHz wide and the Amateur Service is secondary which, at certain times, leaves only a few spots for the "frequency agile" Amateur Service to operate on.

The amateur Service takes considerable care not to cause harmful interference on its shared 10.1 MHz band. However, on many of the HF amateur bands where the Amateur Service has primary status, the stations of many administrations do not seem to care about the harmful interference that they cause to stations of the Amateur

Service.

It is therefore suggested that on the Australian Frequency Plan, the Amateur Service is also given access to 10.150 to 10.200 MHz on a non-interference basis.

3. THE BAND 3500-3800 kHz

One of the most used amateur bands in Australia is 3500 to 3700 kHz.

This is one of the three HF amateur bands which has a novice sub-band. This novice sub-band gives the novice amateur the ability to communicate over short to medium distances which is not often possible on the two other sub-bands that they are permitted to operate on, namely 21 and 28 MHz.

Due to the greater width of the 3500 kHz amateur band in most other countries, intercontinental communications by Australian amateurs are made more difficult due to overseas amateur band usage planning. This point has been appreciated by the Australian Administration and a small sub-band 3794 to 3800 kHz has been made available to the Amateur Service. It is interesting to note that the number of amateurs in Australia has grown from 12696 in 1979 to 18314 in 1989.

We consider that 3700 to 3800 kHz should be made available to the Amateur Service.

This is less than the Region 3 allocation, but is in line with the Region 1 allocation. An increase in the amateur allocation as a whole would make it possible to increase the very congested novice amateur sub-band.

We are aware of the perceived continued need for HF frequencies to be used by fixed and mobile stations. We are also aware of available satellite capacity and the development of future mobile satellite services which will be very reliable and will attract HF users. Given this situation, together with improving techniques on HF, we feel that any other services would not be disadvantaged in the long term by this proposed exten-

sion to the amateur band.

We are also aware that if there is an addition to the 3500 to 3700 kHz amateur band, transition procedures would have to be carried out over a period of time."

Current Issues

Two of the most controversial issues currently concerning radio amateurs in Australia are repeaters and repeater linking, and operation of packet radio. Many concerns, ideas and suggestions have been discussed over recent months.

The WIA recognises the need to identify current problems and to overcome any communication gaps between users, the WIA, and DoTC. The Chairman of FeTAC, John Martin VK3ZJC, prepared a six page report on repeater linking, with several recommendations for change. This report was discussed at length at the Executive meeting of the WIA held over the weekend of July 7th and 8th.

Amongst other things, it was resolved that:

1. The WIA would approach DoTC to seek the lifting of the ban on off-air linking of repeaters.
2. WIA Divisions negotiate immediately with repeater groups and licensees to adopt the existing 123 Hz CTCSS tone for intermodulation interference protection.
3. WIA Divisions negotiate immediately with repeater groups and licensees to adopt the 141.3 Hz CTCSS tone for access to repeaters that have the potential to retransmit a licensee out of his authorised band.
4. Standard DTMF tones be used for repeater system and control purposes.
5. The dual frequency link requirement and 5 watt power limit be removed from the bandplans.

It was also resolved that FeTAC prepare a detailed paper to support a request to DoTC to relax its stringent repeater identification re-

quirements.

After considerable discussion on packet radio, FeTAC was requested to prepare a detailed report on packet radio protocols and identification requirements. This report is to take into account the current requirements in Australia and overseas countries. It is also to emphasise the continuing need for freedom in packet networking experimentation

Executive Meeting

The first quarterly Executive meeting since the Convention in April was held over the weekend of 7th & 8th August 1990.

This meeting considered a wide range of issues. The agenda included over 30 items for discussion. A number of issues arose from or were postponed from the 1990 Convention. Some were fairly routine (eg. development of more uniform membership procedures; Executive office computer systems).

Many were of considerable importance to the future of the amateur service in Australia (eg. WARC 92 representation and IARU matters, in addition to the repeater and packet radio matters mentioned earlier).

The reviewing of some WIA policy, discussion of amateur examinations, the comprehensive report on the WIA QSL bureaux, planning of recruitment strategies for newcomers to our hobby and membership of the WIA took considerable time.

The 31 items placed on the agenda for the WIA/DoTC Joint Meeting to take place on 24th July 1990 were also discussed in detail.

Joint DoTC/WIA Meeting

The next joint meeting between representatives of the WIA and the DoTC Regulatory Section in Canberra, will take place on Tuesday July 24th in Melbourne.

These joint meetings are an established avenue of liaison between the two organisations. They contribute considerably to the good relationship the WIA has enjoyed with the Government body regulating the amateur service in Australia. The meetings are held every three to four months to allow discussion of matters which have arisen and to assess progress on continuing negotiations.

The 31 items on the agenda for this meeting include an update of reciprocal licensing with a number of countries, third party traffic agreements, on-air advertising, repeater linking, bandplans, and examination development.

Commercials on 80 Metres

A few weeks ago, Don Shand VK3DZM, a keen 80 metre DXer, contacted the WIA Executive Office. Several new commercial Fixed and Mobile Service stations had suddenly appeared in the middle of the 3.794 to 3.800 MHz "DX Window" segment of the amateur 80 metre band. These intruders were located in Western Australia, Victoria and Queensland.

The amateur service is the secondary service in this frequency segment. However, when the WIA won this "DX Window" for the Australian amateur service, DoTC promised not to allocate any new commercial licences in the segment.

After two weeks of approaches by the WIA, DoTC admitted an error had been made. The licences should have issued for the 3.9 MHz segment!

DoTC are now contacting these Fixed and Mobile Service stations and arranging for them to move to the correct frequencies. It may take a few weeks before they move.

Remembrance Day Contest

One of the most popular

events of the WIA calendar is the annual Remembrance Day Contest. This year it will take place on the 11th and 12th of August. The rules were published in the July 1990 issue of Amateur Radio magazine, commencing on page 22. Please check them, as there have been some minor alterations since last year.

Good luck to all participants. Remember that your score sheet has to be submitted for your Division to be credited with your score.

Recruiting WIA Members

The WIA is to conduct a national recruiting campaign during the second half of this year. WIA membership over the last few years has grown at a much slower rate than the total amateur population. This is a matter of concern, particularly when you consider the WIA represents the Australian amateur service nationally and internationally.

The cost of this representation is borne solely by WIA members. The WIA does not lobby for amateur service privileges or extensions to the bands for the exclusive use of WIA members only. WIA repeater policy has never limited access to members only.

Many of the costs of providing services to members are not in proportion to the numbers served. Office and telephone rental have a fixed component, and repeater licences and insurance do not depend on the amount of use they get. An increase in WIA membership would mean more services could be provided more cheaply.

Several possible ideas for recruiting have been submitted. Most of them eventually come down to the individual members making some effort to contact and persuade non-members of the WIA of the benefits of membership.

Have you forgotten some of the benefits of WIA membership? The Editorial in the

September 1987 issue of Amateur Radio magazine listed 35 services available to members overall.

Since then technical developments have added more services. WARC 92 has become of immediate interest.

Are YOU prepared to make an approach to non-members you know who are using WIA provided services such as repeaters? Are YOU prepared to persuade them to contribute their share towards the protection of the amateur radio service?

Callbook Entries

Please note that the closing date for changes to entries in the next Callbook has been set at July 31st. Information reaching the Executive office after that date will not be able to be included.

Please note that information or requests MUST be in writing.

Amateur Exam Confusion

Jim Linton, VK3PC, President of the VK3 Division of the WIA, has supplied the following news items relating to examinations:

Novice telegraphy test error

An error in the Department of Transport and Communications brochure DOC 70 has resulted in an alert being sent to all examiners.

The brochure sub-titled "Information for Prospective Amateur Operators" wrongly states that a candidate fails the Novice telegraphy receiving test if they have more than seven errors. Another document DOC 125B which contains the Novice syllabus correctly states "More than 10 errors will result in failure".

All examiners were instructed by DoTC to refer to DOC 70 when marking telegraphy tests.

The Department admits the error and has asked all examiners to supply it with the names and addresses of Novice telegraphy receiving test

MAGPUBS

A Special Service of the Wireless Institute of Australia

Morse Code:

The Essential Language L. Peter Carron, Jr., W3DKV
• Tells of the evolution from the straight key to computers • Gives practical advice on learning the code and its modern-day uses. There are 7 chapters • Why the code • A history of Telegraphy • The Code • Learning to receive and send • High speed operation • Distress calls • The Future.
Morse code is steeped in tradition, not only in Amateur Radio but in other services as well. Although some of the thoughts it conjures up are of times gone by, the code is as useful today as it was the day of its invention. This small book will help you find out much and help you to learn the code.

ARRL Stock Number BX223 \$10.00

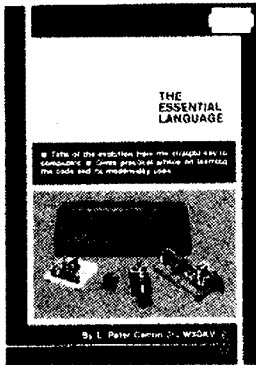

The ARRL World Grid Locator Atlas

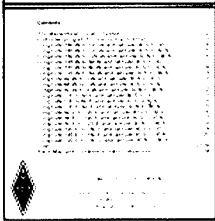

Maidenhead Locator

The ARRL World Grid Locator Atlas (Maidenhead Head Locator) contains 19 maps listing all 32,000 Maidenhead locator squares. Also there is a very complete Index of all world major cities to make it easy to find the correct page, a quick to look-up world map divided in the 324 Fields and a BASIC computer program listing for finding Direction and distance. In 1982 the Maidenhead locator system was adopted by IARU Region 3, in 1983 the Maidenhead locator system was adopted by IARU Region 2 and in April 1984 the Maidenhead locator system was adopted by IARU Region 1 as the new locator from 1985. Every DX'er and contest ham should have one in the shack.
8 1/2" x 11" Stock # BX197 \$8.00

THE RADIO AMATEURS WORLD ATLAS

All seven continents of the world including . . .

- North America
- South America
- Central America—West Indies
- Asia
- Indian Ocean
- Japan
- Australia & Pacific Ocean
- Europe
- Africa
- Antarctica
- North-Polar projection
- Country prefixes and zone boundaries on each map
- 20 pages in full color
- Size 8 1/2" X 10 1/8"



This WORLD ATLAS was compiled especially for radio amateurs. It is printed in four colours on durable coated stock, its compact size makes it ideal for use on Field Days or everyday use in the ham shack.

This fine atlas contains a North Polar projection of the world and maps of all seven continents, the West Indies-Caribbean area and the Pacific Ocean. All maps projections were carefully chosen for minimum distortion and maximum usefulness to amateurs. Continental and zone boundaries are shown and a table of international call sign allocations is included to help you locate those rare ones.

Stock Number BX246 \$6.00

The above books, plus many more, are available from your WIA Divisional Bookshop. All items are less 10% discount for WIA Members and are plus postage and handling where applicable.

If not in stock at your Divisional Bookshop, your order will be taken and filled promptly. Not all publications are available from all Divisions.

candidates wrongly failed.

It was expected only a few candidates would originally have failed due to them having eight, nine or ten errors in copying the test text. DoTC will write to the candidates involved pointing out the error, telling them they had now passed, and apologising for the inconvenience.

The error appears to be in the word-processing for DOC 70 involving a block transfer of text from the AOCF telegraphy receiving test which does have a fail point of more than seven errors.

Amateur theory exemptions

Some confusion exists on the amateur theory exemptions granted by DoTC to people holding certain technical qualifications.

The Department's brochure DOC 70 "Information for prospective Amateur Operators" Appendix A outlines the full and partial exemptions available.

An exemption from sitting an amateur theory examination can be obtained if an equivalent or higher qualification is held.

But the Department requires to individually assess the qualifications claimed and give an exemption in writing.

Several prospective radio amateurs have claimed they received a theory exemption "over the phone" from DoTC. The Department has recently confirmed that it does not give verbal exemptions on the basis of a telephone call. It requires to see a certified copy of the qualification and in some cases may need to make further inquiries before deciding to grant an exemption for either NAOCP or AOCF theory.

Novice Study Guide

In February 1988 the WIA published a Study Guide to assist students and instructors preparing for the Novice theory examination. This book expands the official DoTC syllabus to define the extent

of each topic, and indicates how deeply a candidate should study each section. It also includes a guide to the expected lecture time to be spent on each syllabus section.

DoTC officials took a close interest in the preparation of the Guide, and endorsed it by agreeing to the standard set. Copies of the Novice Study Guide are available from Divisional offices, or the Executive Office, at a cost of \$2.50 plus postage.

Egyptian Echoes

The Executive Office recently received a copy of the first edition of "Egyptian Echoes", the newsletter of the Egyptian Amateur Radio Society, (EARS).

It includes an introduction to the newsletter, a history of amateur radio in Egypt from the 1920s on, a list of the 20 or so licensed amateurs in the country, and a profile of SUIER, Ezzat Ramadan.

EARS is taking active steps to increase the amateur population, and suggests ways in which the average amateur can help.

Egyptian Echoes is available free of charge on receipt of a SASE. The Editor's address is available from the WIA Executive Office.

QST Canada

The Editorial of the July 1990 edition of QST Canada raises the familiar theme of the need for active recruitment to the amateur service, and suggests strategies and target groups.

As stated by many other groups, recruitment depends on the hobby presenting a higher profile to the public, and a wide spread of publicity, including displays, and approaches to schools. **ar**

*Have you advised
DoTC of your
new address?*

ATU IN A CAKETIN

PETER PARKER VK6BWI
C/O PO WITCHCLIFFE 6286

An aerial tuning unit transforms the impedance at the feedpoint of an antenna to the output impedance of the transmitter — usually 50 ohms. The ATU connects between the antenna feedline and the transmitter output and can allow a single antenna to operate on any band. For more information, I refer you to the excellent article by John Haerle WB1IR in the ARA Antenna Book 2, page 49. An ATU can also act as a harmonic suppressor.

An ATU is an excellent project for the beginner as it consists of only three or four principal components, but some of these can be difficult to obtain — notably the air spaced capacitor.

Plug in coils are employed to simplify the unit and to permit short leads (important for 10 metres). The socket for the coil is an 8 pin valve socket available from old valve radio and TV sets. The coil bases come from valve bases. If the constructor has a collection of inoperative tubes the bases are easily removed, but the glass is very sharp and the debasing should be wrapped in newspaper.

The chassis was a 20x20x7 cm cake tin obtained from the local general store for \$2.75. This is much cheaper than a commercially made aluminium box as well as being easily obtainable.

The variable capacitor can be any air spaced unit with a maximum capacitance greater than about 200 pF. Before mounting this onto the chassis check to see if any plates touch together when the spindle is turned. If they do, gently bend the plates to ensure that they do not touch. The capacitor must be mounted such that it is isolated from the earthed chassis. A way to do this is to glue a piece of wood or plastic to the bottom of the capacitor, which is in turn glued to the chassis (cake tin).

If the ATU is to be for high power operation, a special variable capacitor with wide plate spacing must be employed.

We next come to the coil. Figure 4 shows how it is constructed. The spigot must be removed by crushing it with pliers to make a hole for the coil mounting bolt. The absence of the spigot makes it important to mark the correct orientation of the coil in its socket. To solder the

wire to the pin of the plug (coil base), firstly heat the end of the appropriate pin and remove the wire which originally connected to the valve elements (ie grid, plate, cathode, etc). Strip and tin the last centimetre of the coil lead and push into the base pin. Apply the soldering iron and the connection should be complete.

Once all four wires have been soldered screw the assembly together. Ideally a coil should be made for each band. But it is possible to use a coil for several bands especially at the higher frequencies. By unplugging a coil and rotating by 180 degrees, the windings are transposed so a higher frequency band can be covered. With experimentation, it is possible to produce a 80/40m coil. If slightly more inductance is required, drop a piece of ferrite rod into the film container. By the application of these two techniques, only two or three coils may be needed to cover the HF bands.

The wire gauge used for the coils is not of great importance, but insulated wire must be used. Below is a table of coil turns.

Transmitter Coil	Tuning/Aerial Coil*
80m	5 turns
40m	5 turns
30m	4 turns
20m	3 turns
**15/10m	2 turns

*0.7mm, enamelled copper wire.
(From old transformers, etc)

**Note 1: The coil for 10/15m is wound on a 15mm tube, which can be fitted into a film container for protection.

Note 2: Coils for 12 and 17 metres are not shown. either the 10/15m coil or the 20m coil will operate on these WARC bands.

The light bulb used as the tuning indicator is a small torch globe. This is quite suitable for QRP (less or equal to 5 watts output) but a larger bulb should be substituted for higher power. Alternately, the wire across the bulb will conduct most of the current thus saving the indicator. The switch across the bulb is not essential but was included to save pre-

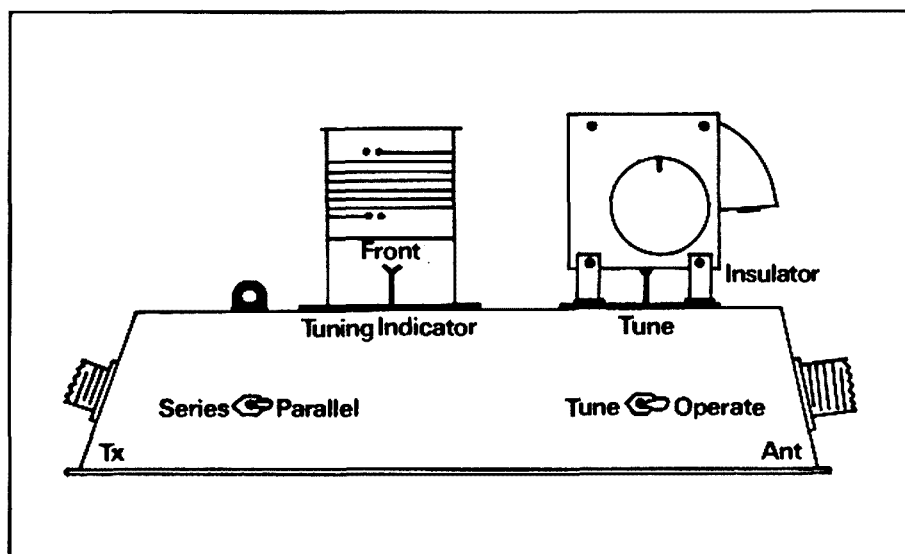

Parts List

- | | | | |
|---|------------------------|---|------------------------------|
| 2 | SO239 coax sockets | 1 | 10-415 pF variable capacitor |
| 1 | 20x20x7 cm chassis | 1 | 8 pin octal 8 pin socket |
| 2 | Binding post terminals | 1 | DPDT switch |
| 1 | 6.3v light bulb | 1 | SPST switch |
| | | | Knobs, wire, hardware |

cious output power when operating QRP.

The Series/Parallel switch allows the ATU to be used in two circuit configurations for both high and low impedance antennas: series for low impedances and parallel for high impedance aerial systems. The configuration chosen will vary from band to band; and sometimes both will operate satisfactorily on one band.

To test the ATU, short circuit the antenna connections and open the Tune/Operate switch. With the appropriate coil plugged in for the band in use, apply 5-10 watts of RF and vary the Tune capacitor for maximum bulb brightness. This position should not be at either end of the capacitor's range. If this is so, change the coil's inductance a little. Find a clear frequency, attach the antenna, and tune for maximum brightness. You are now tuned up on that frequency and operating can commence. For major shifts of frequency within a band, it is advisable to retune the ATU. If your transceiver has tune and load controls, there may be some interdependence with the ATU Tune control. Operators of solid state transmitters should note that the tuning of an ATU allows the impedance presented by the tuner to the RF output stage to depart significantly from 50 ohms and PA damage can result. To minimise this risk, low power should be used for the tuning process and a tuning indicator be fitted, such as the one in AR December 1985. This particular unit has been found to give good results and allows the antenna to be tuned with a constant 50 ohms on the PA output.

Note: It has been found necessary in some instances to include a coupling capacitor between the transmitter output and the RF input socket of the ATU. Its value should be around $0.005 \mu\text{F}$ with a voltage rating of 630 volts — more for

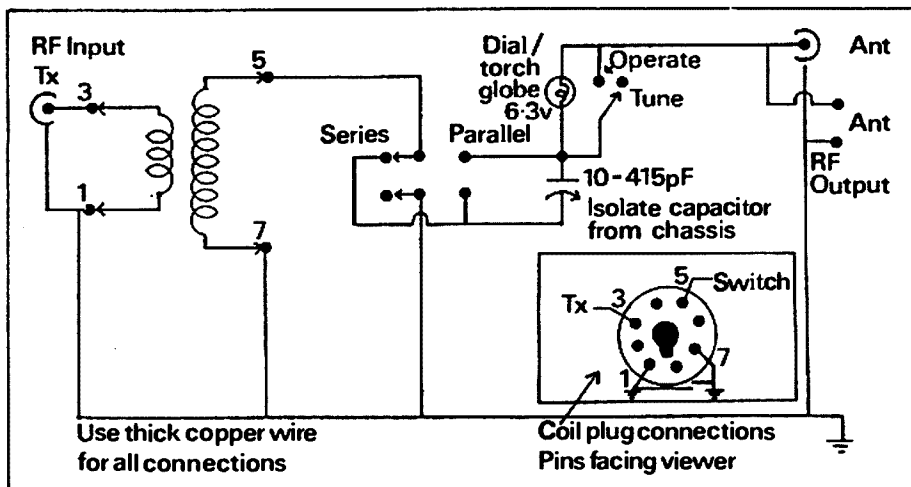

Fig2: Schematic Diagram of ATU

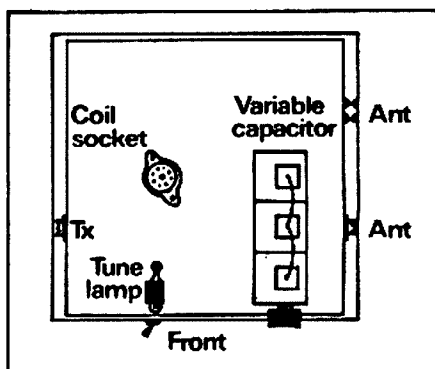

Fig 3: Top front view of ATU

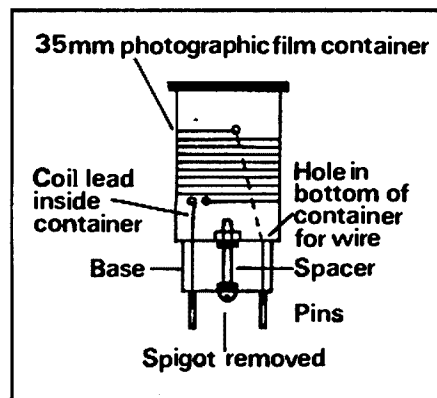

Fig4: Plug in Coil

high power. A styrofoam unit from old valve equipment works well.

References:

* John Haerle WB1IR, Understanding Antennas the Easy Way, ARA Antenna Book 2, p49-53.

* W9SCH, Rock on ator ATU, G-QRP Club Circuit Handbook, p64.

* Bruce Doyle, VK6ABD, Safe Tuning with the FT7, Amateur Radio, p9 December 1985.

ar



South Australian 10 GHz Record

Following their new national 5.7 GHz record last November, Nick Tebneff VK5NT, and Des Clift VK5ZO, turned their attention to the 10 GHz band. On May 7, Nick operated from Illawarra Hill, and Des took himself to the summit of Mt Lofty, to establish a new VK5 record of 147.1 km.

Both stations used Gunnplexer systems with a 30 MHz IF, operating on 10250 and 10280 MHz. One unit operated with AFC. The antennas were 40 cm fibreglass dishes with metallised paint surfaces, fed by tapered waveguide dipole-reflector feeds.

Signal reports were well over S9. As the test proceeded, they reduced system gain until at one stage Nick operated a 12 dB horn and could easily discern signals from the open waveguide of Des. Earlier tests had been made from Mt Barker and on a 68.5 km path from Mt Magnificent to Tailem Bend, also with 5x9 reports.

The photograph shows Des VK5ZO, smiling with glee on the summit of Mt Lofty.

INFORMATION SUPPLIED BY NICK TEBNEFF VK5NT

ar

HEALTH HAZARDS OF SOLDERING

A M BROWN VK2KJM

SENIOR LECTURER IN OCCUPATIONAL MEDICINE, UNIVERSITY OF NEWCASTLE.

P J HOLIS-WATTS VK2YJW ELECTRONICS TECHNICIAN, MEDICAL COMMUNICATIONS UNIT, ROYAL NEWCASTLE HOSPITAL

Over the last few years more attention has been given to occupational health and safety and there has been a corresponding recognition that hobby activities may also carry health and safety risks. Our hobby of amateur radio has hazards and articles have appeared in Amateur Radio magazines about electrical safety, general safety in the shack, and the hazards of radio-frequency radiation^{1,2,3}... Most amateurs do some soldering at sometime or other but may not recognise that this could be hazardous.

Recently an electronics engineer was referred to an occupational medicine unit because of symptoms of headache, hay fever, cough, wheeze and nose bleeds. Unusually for this condition, this person did not seem to get much better at the weekends. This person's symptoms were eventually related to soldering, and the reason he did not get better away from work was that as an amateur he did some soldering at home too. This amateur said that he had been in electronics for 25 years but had never heard that soldering could make one sick. This article is thus a response to inform other amateurs.

What Is Soldering?

Soldering is a technique for joining metals by wetting the parent metals with a filler metal and filling the joint gaps by capillary action. Brazing and "silver soldering" are similar processes that use different filler metals and require the parent metals to be at a much higher temperature while welding is a process whereby the parent metals are actually fused. This is not an article about technical aspects of soldering so only a brief outline is given here. A number of technical books have been written about soldering and readers should refer to these^{4,5}.

Soldering has been used in many applications in joining pipes or sheets as in plumbing or radiator manufacture, or making cans (a use that is being replaced by welding) and in electronics. The rest of this discussion will be restricted to the use of soldering in electronics.

Most of us think of soldering in terms of building or repairing a piece of equipment for ourselves. This is manual soldering — a soldering iron in one hand,

solder in the other and the equipment on the bench. Of course in the electronics industries there is much manual soldering, but there is also mass soldering of printed circuit boards in the commercial production of electronic equipment, where printed circuit boards with components attached are moved by a conveyor over a bath of molten solder and a wave brings the solder to the board. In other situations wires are "tinned" by dipping them in a pot of molten solder.

The soldering process requires four things:

- a) an appropriate filler metal (solder);
- b) appropriate parent metals;
- c) a source of heat; and
- d) a flux

Solder is a mixture of tin and lead often with very small amounts of other metals such as antimony, copper, silver or cadmium. Solder melts at a low temperature (dependent on its exact composition); thus the amount of heating needed is not very great and can be achieved with a soldering iron. The common combinations of tin and lead are 60/40, 50/50 and 40/60.

Not all parent metals can be soldered with tin/lead solder. The commonly used one is copper but silver, iron and steel, zinc, nickel, gold, platinum and palladium are also solderable. Chromium and cobalt are impossible to solder.

Heat is required to melt the solder, and for electronics work a soldering iron is used for manual soldering, while for mass soldering the solder is heated by an induction furnace.

To be soldered the parent metals need to be clean. This means not only free of dirt, oil or grease, but also free from metal oxides. This is the role of flux. A flux acts to dissolve metal oxide films and to evaporate them as the flux itself boils. This leaves the clean parent metal, and the solder can flow over the surface. Fluxes may be inorganic or organic. The inorganic fluxes are things such as zinc chloride. These tend to be acidic and to attack electronic components and so are primarily used in plumbing.

There are a few special organic fluxes, but the type used for electronic work are organic resins or rosins. The terms "rosin" and "resin" are used interchangeably by manufacturers. Usually resin refers to

an organic material that is insoluble in water, while rosin refers to the resin distilled from the turpentine of certain pine trees. The medical and occupational health literature usually refers to rosin as colophony. Rosin may be diluted with turpentine as a flux paste or with alcohol as a liquid flux. Because pure rosin is not a perfect flux other materials (such as organic amines, amides or hydro halides) may be added to it to 'activate' it. These are usually amine hydrochlorides, which increase the flux's reactivity with metal oxides and improve wetting. These activated rosins are used in rosin-cored solder.

When soldering is done, there is usually quite a lot of visible fume. This is almost entirely the flux and the metal oxides being evaporated from the work piece.

Hazards Of Soldering

The major hazards of soldering relate to the effects of lead, effects on the skin, effects on the respiratory tract.

a) A frequent concern about soldering is the possibility of lead poisoning, yet in fact this is most uncommon. The reason is that in normal use the lead in solder cannot enter the body easily. Inorganic lead (as in solder) penetrates the skin very poorly, and this is not a significant route. Solder melts and is used at a low temperature, about 180C, and there is very little lead fume given off until much higher temperatures, so breathing in lead is unlikely. (In some non electronic uses of soldering, joints are buffed and this can produce respirable dust and in some industrial applications very fine grade solder powder has been a source of lead poisoning.)

The other way solder could enter the body and cause lead poisoning is by eating it. Now few people would even deliberately eat solder but it is possible to have lead on one's hands and transfer it to the mouth when eating or smoking. This would only be small amounts but they can add up. The person most at risk from the lead in solder would not be you but your small children. Small blobs of solder on the bench or floor attract children's interest and they often put things into their mouth.

A survey of solderers in electronics fac-

tories in New Zealand found that generally solderers do not have higher blood lead levels than the general population⁶.

As far as lead is concerned, always wash hands after using solder, before eating or smoking, and clean up blobs of solder and keep small children from handling it.

b) Skin

(i) Heat

Whenever one uses a source of heat, there is the possibility of burns. Modern soldering irons tend to have stands that enclose the hot tip to reduce the possibility of burns. Care is always needed handling a soldering iron. Drops of molten solder usually only give small burns but even these can be quite painful.

(ii) Dermatitis

Skin can be affected by things other than heat. The inorganic fluxes are often acidic and cause irritation (or burns) to the skin.

Over the past few years, a number of cases of allergic contact dermatitis have been reported in people exposed to soldering fumes at work in electronics factories^{7,8,9}. Specific testing of these people showed that they had become allergic, either to colophony in the flux, or to aminoethylethanolamine used as a flux

activator. In the workplace, allergic contact dermatitis settles with removal from exposure and medication, but usually recurs with re-exposure, necessitating a change of job. This type of dermatitis from soldering is rare, but it is a possibility.

c) Respiratory Tract

Breathing in foreign material can cause various reactions. Commonly, materials cause irritation to the upper airways characterised by nose and throat irritation and cough. Some material can cause asthma, which is a narrowing of the small airways of the lung, usually in response to some external agent, either by direct inflammation or by an allergic mechanism. A number of studies have shown clearly that exposure to colophony in soldering fumes can cause asthma^{10,11,12}. In one electronics factory, 22% of solderers reported having work-related respiratory symptoms (mostly breathlessness and/or wheeze)¹³. In this factory, the solderers also had lower measures of lung function than workers in other jobs. Many of the solders also reported work-related rashes and nasal inflammation (rhinitis).

If people are being affected by their work, they tend to leave, so any survey of a workplace will see only "survivors", and

thus will tend to under-estimate the problem. A study of the people who had left this electronics factory found that there was a "survivor" situation, because a significantly greater proportion of people had left soldering jobs because of ill health than had left from non-soldering jobs.

The asthma that can be caused by work with colophony may occur after a variable period of time. It has been reported to occur after as short a time as two months and as long a time as 25 years¹⁴.

Colophony is not the only soldering relating cause of asthma. Other fluxes such as a polyether glycol mixture¹⁵ (used in electronics situations) and aminoethyl ethanolamine¹⁶ (in aluminium brazing) have been implicated. Other agents come not from fluxes but from wire coatings. The varnish on copper wire is often a polyurethane compound. Polyurethanes are made up of, and break down into, polyalcohols and isocyanates. The isocyanates, especially toluene di-isocyanate (TDI), are potent causes of asthma. When polyurethane is burnt off wires, TDI may be released, and this had lead to asthma in a person who tinned compound leads by dipping them in molten solder¹⁷.

Try This Field Strength Indicator

JA HEATH VK2DVH 161 CANBERRA ST ST MARYS 2670

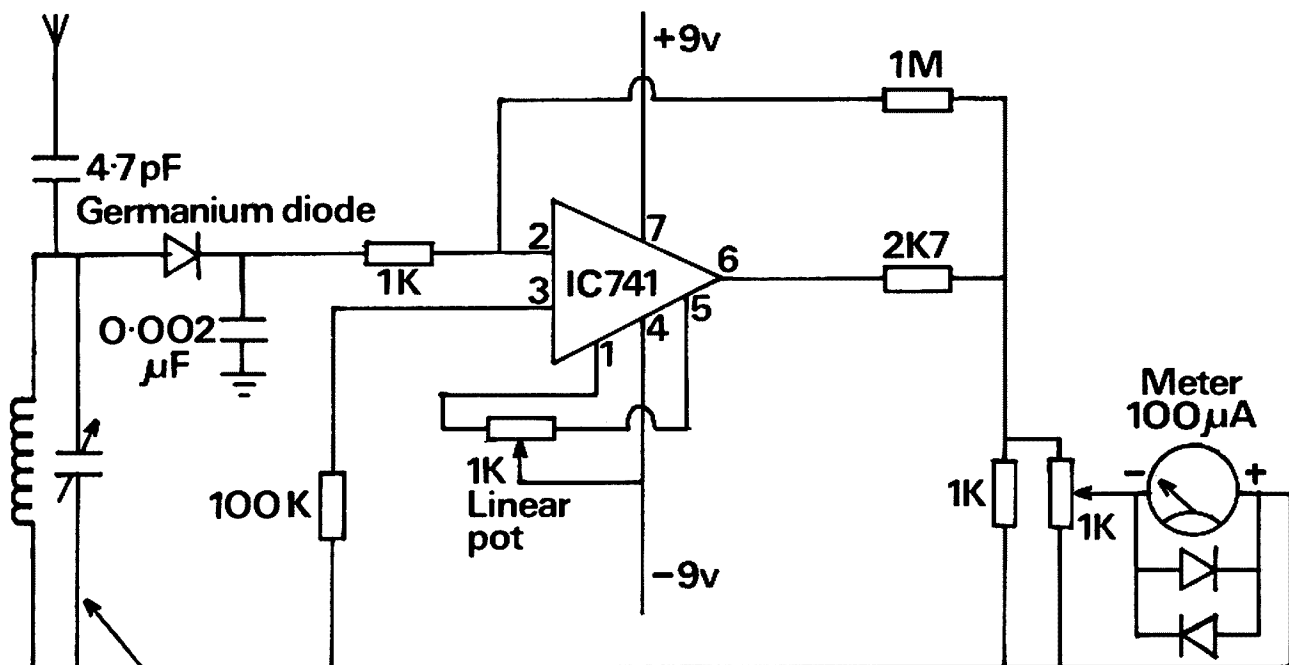

Note: Requires two 9V Batteries.
Use DPDT switch for power.

Similarly, the coloured plastic insulation on wires is often polyvinylchloride (PVC), and its thermal degradation products are known to trigger asthma¹⁸, though this has not been reported in electronics situations. The message here is always remove insulation from wires before soldering and do not try to burn it off with the iron (it makes a messy joint anyway).

What can be done about it?

Once a person has become sensitized to a chemical, he or she usually remains sensitive to it and will react to it again in the future. This means that, if you become sensitized to soldering, you will find it very difficult to ever do any soldering without symptoms. The only sure way to avoid further reactions is to avoid further exposure. It may be possible to change to another chemical, but often the alternatives are not very different — different brands may actually be identical in composition, or the body reacts to closely related compounds. Once sensitized, it can be very difficult to avoid exposure, even with good ventilation and respiratory protection. The best thing is to minimize exposure in the first place and so minimize the risk of sensitization. For the electronics industry, there are some guidelines, such as the ones produced by the New Zealand Department of Health detail good practice and regular assessments¹⁹.

In the shack, prevention is a matter of commonsense aimed at reducing the amount of fume breathed. Soldering iron bits should be kept clean and replaced when worn. Ensure ventilation in the area, preferably exhaust ventilation or at least moving away from you. If you are concerned about your health, consult your local doctor.

References:

1. Pilley DA
Safety around the shack
Amateur Radio 1987; 55(9):8-11
2. Farmer K
Safety in the shack
Amateur Radio Action 1987; 10(4):30-32
3. Odell M
Fatal Distraction
Amateur Radio 1989; 57(9):34-35
4. Thwaites C J
Capillary jointing — brazing and soft-soldering
Research Studies Press, Chichester. 1982
5. Eunson M
Solder — just what is it?
Amateur Radio Action 1988; 10(10):24
6. Hinton D, Cresswell BCL, Janus ED, Malpress WA
Industrial lead exposure: a review of blood lead levels in South Island industries, 1974-83
NZ Med J 1984; 97:769-73
7. Goh CL, Ng SK

Airborne contact dermatitis to colophony in soldering flux

Contact Dermatitis 1978; 17:889-91

8. Goh CL

Occupational dermatitis from soldering flux among workers in the electronics industry

Contact Dermatitis 1985; 13:85-90

9. Liden C

Patch testing with soldering fluxes

Contact Dermatitis 1984; 10:119-126

10. Burge PS, Harris MG, O'Brien IM, Pepys J

Respiratory disease in workers exposed to solder flux fumes containing colophony (pine resin)

Clin Allergy 1978; 8:1-14

11. Burge PS, O'Brien IM, Harris MG

Peak flow rate records in the diagnosis of occupational asthma due to colophony
Thorax 1979 34 308-316

12. Burge PS, Harris MG, O'Brien I, Pepys J.

Bronchial provocation studies in workers exposed to the fumes of electronic soldering fluxes

Clin Allergy 1980; 10:137-149

13. Burge PS, Perks W, O'Brien IM, Hawkins R, Green M

Occupational asthma in an electronics factory

Thorax 1979; 34:13-18

14. Perls WH, Burge PS, Rehahn M, Green M

Work-related respiratory disease in employees leaving an electronics factory

Thorax 1979; 34:19-22

15. Stevens JJ

Asthma due to soldering flux ; a poly-ether alcohol — polypropylene glycol mixture

Annals Allergy 1976; 36:419-422

16. Pepys J, Pickering CAC

Asthma due to inhaled chemical fumes — amino-ethyl ethanolamine in aluminium soldering flux

Clin Allergy 1972; 2:197

17. Liss GM, Halperin WE, Landrigan PJ

Occupational asthma in a home piece-worker

Arch Envir Health 1986; 41:359-362

18. Sokol WN, Aelong Y, Beall GN

Meat wrappers asthma

JAMA 1973; 226:639-641

19. Department of Health, NZ

Occupational Health Guide Series No.7
Soldering in the electronics industry October 1985.

ar

Technical Correspondence

My article "SWR: A can of worms" (June 1989 AR) was a concerted effort to simplify the subject of antenna matching and to try to remove such theoretical smoke-screens as reflected power and overheated finals.

One error made by me, as pointed out by a correspondent blessed with common-sense was to state blindly that the source impedance had to equal the transmission line impedance for maximum power transfer to occur. Of course, I forgot the same theory states that 1/2 the power generated will then be dissipated by the source (ie, your transmitter) — a fact which all amateurs know to be obviously false.

Thus Dr Lucas' glib paragraph on mismatched sources (p11, October '89 AR) must be incorrect, as I was in my article. Reflected power is a very confusing, theoretical interpretation of a simple physical process, which doesn't stand a hard looking into using practical experience.

As light displays a "dual" nature (particle or wave?), so energy flow in transmission lines will continue to confuse technical people at all levels.

I think I'll stick to my guns and consider only input impedance variations on my transmission lines — that way I can sleep nights!

Anybody else got some thoughts on this?

John Sparkes VK6JX
"Paradise Valley" RMB737
Donnybrook 6239

ar

NZART On 160

Propagation Experiment And Populate 160m Activity

Several New Zealand special event stations (with large aerials for the occasion) will be operating on 160m during Oct 1990. We look forward to many international contacts.

Oct 20-21 8pm-4am NZT

Oct 21-22 8pm-4am NZT

1840 kHz and/or 1940 kHz thank you.

David Walker (for Hastings-Havelock North NZART Branch, ZL2BEI).

ar

Have you advised the WIA Executive office of your new callsign?

VLF-LF AND THE LOOP AERIAL

LLOYD BUTLER VK5BR
18 OTTAWA AVE PANORAMA 5041

In the December 1989 issue of "Amateur Radio" we introduced a design for a receiver which tuned the VLF-LF bands, and followed up with further articles on bandwidth control and front end tuning. We now introduce loop aerials as another adjunct to the VLF-LF receiving equipment.

We begin with some theory on loop aerials and how they reduce the level of local noise. Some experiments, carried out by the writer, are described together with a circuit for a loop tuner and pre-amplifier. The discussion extends to the problems of amplifier noise and the advantages of tuning the loop.

Loop Aerial Theory

As discussed in our previous articles, a major problem in receiving VLF and LF signals is the high level of local noise generated from noisy power lines and consumer electrical equipment. In the presence of this type of noise, the received signal to noise ratio can be improved with the use of a loop aerial.

To explain this, we must briefly discuss the fields around a radiating element. At distances up to around half a wavelength, the induction or near field is prominent but it falls away at a greater rate with distance than the radiation field. At distances greater than one half wavelength, the radiation field is prominent. The relationship between field strength and distance is as follows:

1. The electric component of the induction field decreases with the cube of the distance and $\text{dB} = 60 \log(d_2/d_1)$ where d_2 and d_1 are the relative distances.

2. The magnetic component of the induction field decreases with the square of the distance and $\text{dB} = 40 \log(d_2/d_1)$.

3. Both the electric and magnetic components of the radiation field decrease directly with distance and $\text{dB} = 20 \log(d_2/d_1)$.

The effect of all this is that in the near field, the electric component is much stronger than the magnetic component. This is illustrated graphically in figure 1.

At VLF and LF (10 to 300 kHz), we are concerned with half wavelengths between 500 and 15,000 metres and reception of

localised noise is clearly in the induction or near field region. The shielded loop aerial is sensitive only to the magnetic component and since this is lower in level than the electric component in the near field, the level of noise interference is reduced. Furthermore, if the source of interference is from a different direction to that of the signal to be received, the noise is further reduced by the directional properties of the loop. The loop has a very sharp null at right angles to the plane of the loop and it can be rotated to position the noise source at the null.

The equivalent circuit of the loop aerial coupled to a load resistance R_1 is shown in figure 2. E_s is the voltage induced into the loop, R_t is the resistance of the circuit (the sum of radiation resistance and loss resistance), L is the inductance of the loop, C is the shunt capacitance of the loop with its cable coupled to the load and E_o is the output voltage across the load.

When the loop plane is in line with the

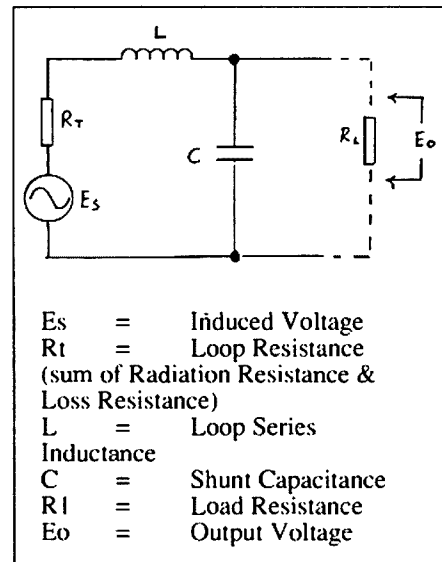

Figure 2. Equivalent circuit of the loop aerial.

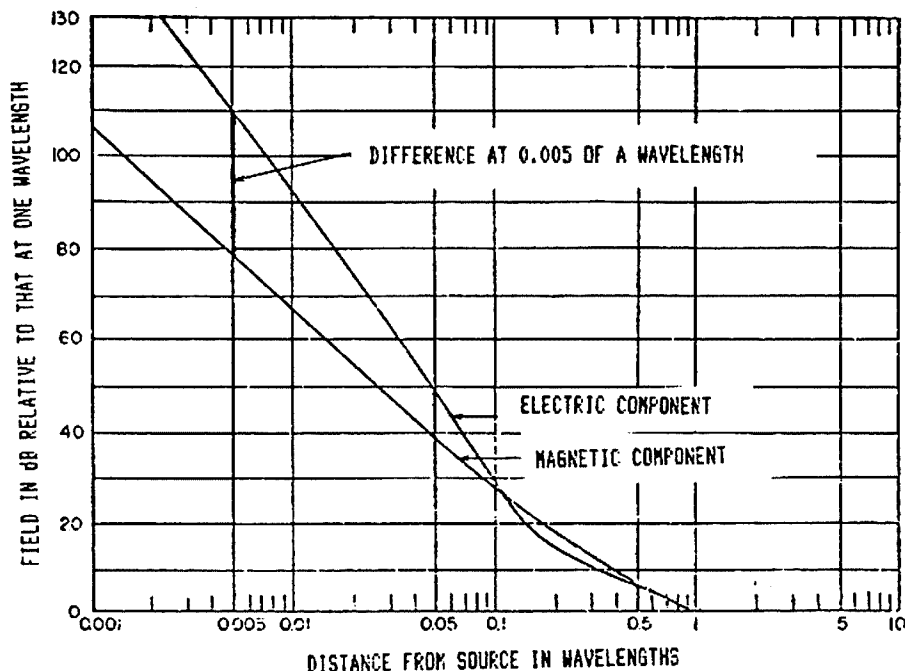

Figure 1. Comparison of electric and magnetic components of received field up to distances of one wavelength from the source.

direction of signal for maximum signal level, induced voltage E_s is given by the following formula (valid providing the loop dimensions are small compared to a wavelength):

$$E_s = (2\pi eNA)$$

where E_s is expressed in μV

e = Field strength in $\mu V/\text{metre}$

N = Number of turns

A = Area of loop in square metres

λ = Wavelength of the signal in metres

We can also express the formula in terms of frequency (f) as follows:

$$E_s = (2\pi eNAf)/V$$

where V = Wave velocity (3×10^8 metres/sec)

From the formula it is clear that the induced voltage is directly proportional to both the loop area and the number of turns and the larger we make either of these, the higher is the induced voltage. However, increasing these also increases the series inductance and shunt capacitance and depending on frequency, their reactances have a profound effect on the actual voltage E_o delivered to the load.

Resistance R_t is also in series with the load but its value is normally low enough to make little difference to the voltage delivered to the load.

Resonance

The loop aerial has a natural resonant frequency at which the reactance of L equals the reactance of C and at which the response peaks such that the output voltage E_o equals the induced voltage E_s multiplied by the Q factor of the circuit. Clearly there is much to gain by operat-

ing the loop in a parallel tuned mode and this can be achieved at any frequency lower than the natural resonant frequency by simply adding shunt capacity across C . At frequencies above the natural resonant frequency, resonance is not possible and good performance is better achieved by decreasing the number of turns on the loop to make natural resonance equal to or above that of the frequency used.

To achieve good performance in a resonance mode at a wide range of frequencies, a number of loop aerials with different numbers of turns, or one with a selectable number of turns, is needed. At low frequencies, a large number of turns is desirable to achieve good signal sensitivity but at higher frequencies a lesser number of turns might have to be used to raise the natural resonant frequency. Referring back to formula (2) we see that induced voltage E_s is proportional to both frequency and number of turns so that whilst we lose signal level with less turns, this tends to be compensated by the increase in frequency.

As the output voltage E_o is proportional to the Q factor at resonance, it is important to make the load resistance R_l a high value to prevent the lowering of Q . This calls for coupling directly into an amplifier with a high impedance input.

Shielded Loop

A multi-turn shielded loop can be constructed in many ways. The multi-turns can be spaced laterally, or in line, or bunched. They all seem to work but the essential requirement is that the shield, whilst fully enclosing the wires, must be discontinuous at one point (usually the loop apex) so that the shield does not form a shorted turn and upset the magnetic properties of the loop.

The writer found a simple way to make a shielded loop using 12 core computer bus cable. This is wrapped in conductive foil and has a heavy drain wire in contact with the foil. The loop of cable, 800mm square, is cleated to two crossed sections of light timber. The ends of the cable terminate at the base of the loop where individual wires are series joined and the drain wire and foil ends are paralleled to what becomes the cold end of the loop winding. At the apex of the cable loop, the drain wire and foil are cut so that the shield is discontinuous.

Measurements on the loop showed that 12 turns gave a natural resonant frequency of 210 kHz, 6 turns a frequency of 450 kHz and 3 turns a frequency of 730 kHz. Inductance measured around 500, 120 and 35 microhenries respectively for the different numbers of turns. As it was required to operate the loop aerial up to

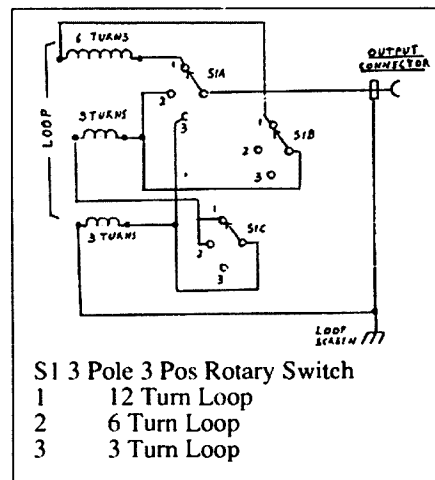

Figure 3. Loop switching circuit.

500 kHz, a switch was fitted at the base of the loop to select either 12, 6 or 3 turns. The circuit arrangement is shown in figure 3. It should be observed that both ends of the unused turns are disconnected when 6 or 3 turns are in use. This is very important because if one end of the unused turns is left connected, the unused turns add extra capacity and lower the resonant frequency.

The loop aerial using computer cable is shown in figure 4. It was assembled as an experimental unit and not intended, in its present form, to be weatherproof.

To resonate the loop, a 12 position switch connects a range of parallel capacitance values up to 0.47 microfarad which enables tuning down to 10 kHz with the 12 turn loop. The switched capacitor circuit is included in figure 5. With this arrangement, Q factors above 50 kHz were within the range of 13 to 20. At lower frequencies, the Q is lower and was measured as 6 at 18 kHz.

The dynamic impedance of the tuned circuit can be as high as 10,000 ohms at certain frequencies and hence the circuit is interfaced with the high impedance input of an operational amplifier. The amplifier is set for a maximum gain of 10 to increase further the signal level from the loop which, even with tuning, produces a much lower signal than that received from a random wire of reasonable length. The amplifier is provided with a switch to reduce its gain to unity in the event of very high signal levels causing cross modulation. This precaution has so far proved unnecessary.

The tuning capacitors and pre-amplifier have been fitted in a separate box so that it can be located at the receiver end of the coax cable which feeds the loop aerial. With this arrangement, the cable capacitance also forms part of the parallel tuning capacitance. At these low fre-

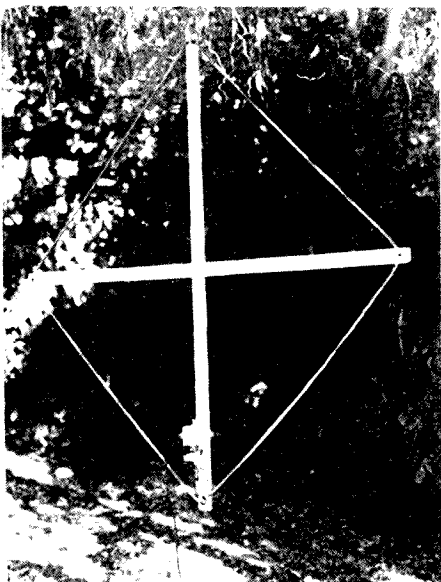

Figure 4: Loop Aerial assembly using 12 core computer cable

quencies, the only effect of this capacitance is to limit the maximum resonant frequency of the loop for a given number of loop turns. Coax cable (such as RG58) has a typical capacitance of around 100 pico-farad per metre. The loop capacitance is around one nano-farad so that a few metres of cable does not make a significant difference. The system can still be satisfactorily tuned with 6 metres of coax cable.

The loop tuning system was used in conjunction with the VLF-LF front-end tuning system and the VLF-LF receiver described in previous issues of "Amateur Radio". The complete equipment is shown in the photograph, figure 6. The loop tuner is on top of the front end unit at the left. The receiver is at the right.

In the loop aerial discussed, switching of the number of loop turns is provided by a 3x3 rotary switch. This must be fitted at the base of the loop and could be inconvenient if the loop aerial were located outside and inaccessible. A relay circuit could be devised which would replace the switch and be controlled remotely at the receiver.

Amplifier Noise

When operating VLF-LF using a wire aerial, the atmospheric noise level received is normally well above the noise floor of the first amplifier and amplifier noise is insignificant. With the loop aerial, the signal pick-up is much lower and when the atmospheric noise level is low, the minimum discernible signal level can be set by the amplifier noise floor rather than the atmospheric noise level. It is therefore important to select a pre-amplifier with a low inherent noise, much as one would do for a VHF or UHF front end.

For the amplifier used in the circuit of figure 5, a Burr-Brown low noise FET operational amplifier type OPA111AM was selected. This is specified as having the low voltage noise figure of 6 nano-volts per root hertz of bandwidth with the negligible current noise characteristic of the FET input circuit. It has a gain-bandwidth product of 2 MHz and hence it can maintain the gain of 10 up to a frequency of 200 kHz with a falling response at higher frequencies down to a gain of 4 at 500 kHz.

Another choice for a low noise amplifier could have been the bi-polar input Precision Monolithics type OP27 amplifier. This has a voltage noise of only 3 nano-volts per root hertz of bandwidth but, having a bi-polar input, there is a current noise component which would add noise when connected across the high impedance tuned loop circuit (reference 2). The amplifier has a gain-bandwidth

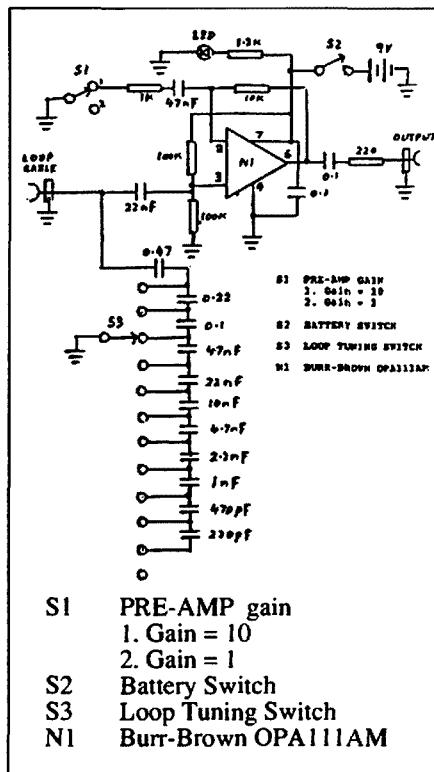

Figure 5: Loop aerial tuning & Pre-amp circuit

product of 8 MHz and hence could maintain the gain of 10 well up to 800 kHz.

A further approach might have been to use one of the low noise MOSFET VHF transistors such as the BF981.

Of course, good signal to noise ratio also gets back to the design of the loop for highest possible signal voltage. Recapitulating previous parts of our discussion, signal voltage is increased with more turns or larger area (consistent with natural resonance being not less than the operating frequency) or by designing the form of the loop for the highest possible Q factor.

Loop aerial circuits are frequently published with amplified signal fed back to the loop to form what they call a Q multiplier. This, of course, is a different name for what has been known as regeneration or reaction. Feedback in phase with the input signal raises the effective Q of the circuit to increase its gain and reduce its bandwidth. For the writer's receiving system, feedback in the loop system was not considered necessary as the loop amplifier was coupled into the VLF-LF front end, previously described in "Amateur Radio". This front end, with Q factors up to 200, has itself adequate gain and selectivity.

There is also a disadvantage with using regeneration in that the noise generated by the amplifier is also fed back to be re-amplified. Whilst the regeneration narrows the loop bandwidth and reduces the bandwidth of the incoming noise, it actually increases the level of the amplifier noise within the band.

Some Other Loop Forms

The natural resonant frequency of the loop and hence its upper frequency limit for a given number of turns, can be increased by spacing the wires and spacing the shield from the wires so that residual capacity is reduced. As it turns out, the loop aerial also gives quite good noise rejection without any shield at all. With this arrangement, the residual capacity can be reduced to provide a considerable increase in the upper frequency of the loop.

Another loop aerial assembled by the writer consisted of 20 turns of unshielded wire spaced in line with a separation of 10mm between turns and forming a 0.8 metre square. To achieve the spacing, the wire was wound around four pieces of dowelling fitted through two wood cross pieces. This aerial measured an inductance of about 500 microhenries and had

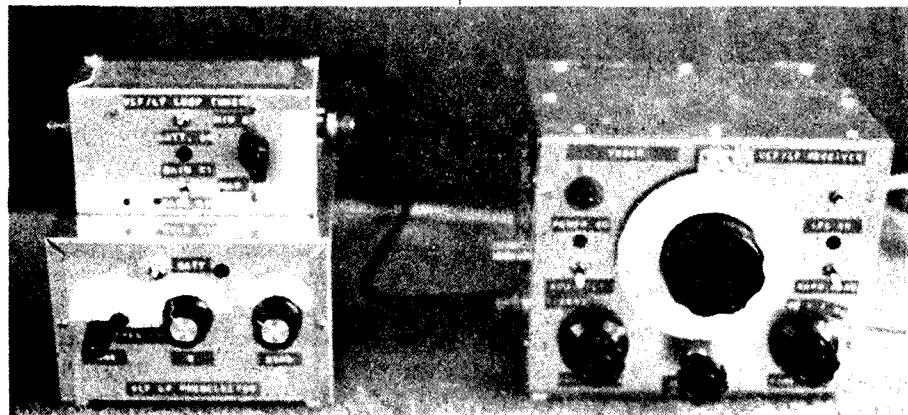

Figure 6: The receiving equipment. The loop tuner is upper left, the receiver front end is lower left and the receiver is on the right.

a natural frequency of several hundred kHz. (The actual frequency was unfortunately not recorded.)

The wire on the 20 turn loop was eventually replaced with shielded wire. Its second form is shown in figure 7. At the apex of the aerial, the shields on each of the 20 wires were cut and all joined together on either side of the cut. The shields were also joined at the base of the aerial and connected to the earth side of the feeder cable. The inductance of this aerial measured much the same as that of the previous aerial with unshielded wire but natural resonance was lowered to 100 kHz. All in all, the performance in receiving signals at VLF appeared much the same as for the unshielded loop. This raises a question whether the shield is much value at these low frequencies where the loop dimensions are very small compared to a wavelength. At these frequencies, there might be merit in using the unshielded loop to take advantage of the higher upper frequency limit achieved.

In a further form of loop aerial, a single turn of large area can be used. Clarrie Castle VK5KL described a single turn loop aerial for 1.8 MHz in March 1982 issue of "Amateur Radio". The aerial was formed by a single loop of around 9 metres of coaxial cable with its outer braid conductor cut at the loop apex. The outer braid thus formed the shield around the inner looped conductor. With lower frequencies in mind, the writer set up such a loop using 9 metres of RG58 and carried out some tests. The resonance measured 2.5 MHz. At 1.8 MHz, the loop resonated with around 500 pF of parallel capacitance and the circuit had a Q factor of 16.

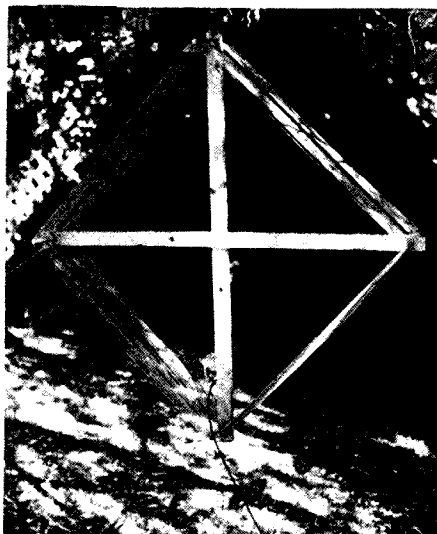

Figure 7: The 20 turn loop aerial wound with shielded wire

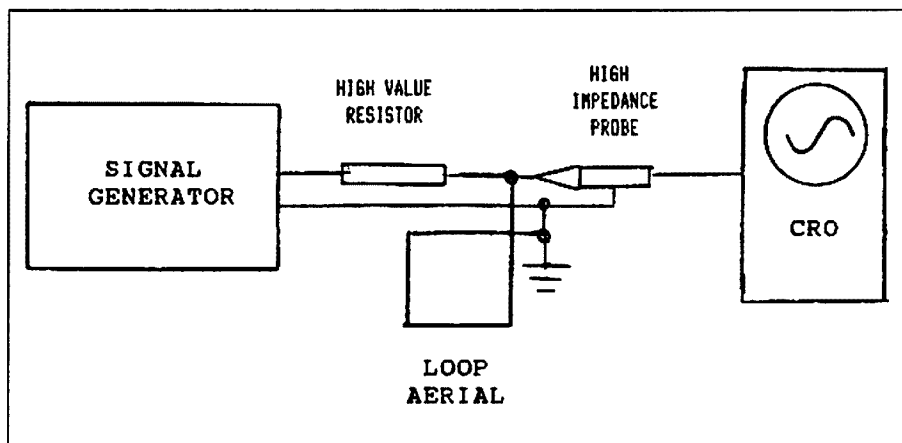

Figure 8: Measurement of loop aerial constants

Clearly, the loop was ideal for this frequency. Below 100 kHz, signal pick up was less than adequate and very large values of capacitance were needed to resonate the loop. This particular loop aerial is clearly a very good form for the MF band but not really suitable for VLF and lower LF. Nevertheless, it was another interesting experiment to find out what would work at the lower frequencies.

Measurement Of Loop Constants

At this point, it might be useful to explain how the loop constants were measured. Having constructed a loop aerial, we need to know its natural resonant frequency and its self inductance so that the maximum tunable frequency can be determined and the capacitance values worked out for the tuning range required. These factors can be measured using a signal generator fed via a fairly high resistance (say 10 k ohms) to the loop as shown in figure 8. More than one signal generator might be needed to tune from VLF to MF. The voltage across the loop is monitored on a CRO (or perhaps a VTVM) via high impedance probe. The signal generator frequency is adjusted for a peak in voltage at which the natural frequency is indicated. We now add a large capacitance (at least 20 nano-farad) sufficient to make the loop capacitance insignificant by comparison and retune for a peak at the new lower frequency. Inductance is then calculated from the normal resonance formula (or a resonance chart), using the parallel capacitance as the formula (or a resonance chart), using the parallel capacitance as the value of C and ignoring the self capacitance of the loop as this makes little difference to the accuracy of calculation.

Having measured the self resonant frequency and calculated the inductance,

the loop self capacitance can also then be derived from the resonance formula.

As a further operation, Q factor can be measured using the same equipment except that the resistance in series with the signal generator must be increased to around 100 kohms to prevent the Q being lowered by the signal source. With extra signal loss across the resistor, a high signal level and a sensitive CRO are needed. The procedure is simply to measure the frequencies, either side of resonance which give 0.707 of the voltage at resonance. Q factor is equal to the resonant frequency divided by the difference between the two frequencies recorded. Q factor at a range of frequencies can be carried out by varying the value of the shunt capacitor to obtain resonance at each of the frequencies.

To go one step further, we can now calculate the AC resistance of the loop (R_t) at any frequency for which we have derived Q. The inductive reactance at that frequency is calculated from $2\pi fL$ and the reactance is then divided by Q to obtain R_t . We now know all the constants R_t , L and C, as shown in figure 2.

Performance

Whilst the level of its signal pick up is low compared to the long wire aerial, it has been clearly demonstrated in the writer's experiments that the loop aerial can separate out signals in the presence of localised noise which overrides the signal on the long wire. As with any directional aerial, it also improves the signal to noise ratio for atmospheric noise by restricting noise received, in particular from a direction at right angles to its plane.

Surprisingly, this performance could be achieved with the loop aerial sitting on the cement floor of the writer's shack, which happens to be clad in sheet iron. With a suitably designed loop aerial and a highly selective front end tuning sys-

tem, good signals at VLF and LF can be received indoors, right down to 10 kHz. This is gratifying if one does not have room for an outdoor aerial. Of course there are the odd traps. It is very easy to miss a signal if it happens to arrive from a direction close to the null of the loop. It is also very easy to home in on some inside based signal source such as the writer's frequency counter.

Untuned Loop

Discussion has been centred around loop aerials, tuned to resonance and giving output voltage as in formula (1) or (2) multiplied by Q. However loop aerials can also be operated in a broadband mode and a design procedure for doing this over a range of frequencies is described in April 1989 issue of "Lowdown". The procedure is to load the loop aerial into a fairly low resistance, at the pre-amplifier input, equal in value to the loop inductive reactance at the lowest frequency of the frequency band required. Parallel resonance is set to a frequency calculated from the geometric mean of the lowest and highest frequency required. According to the article, the design produces a

loop response which is flat with frequency.

Whilst the broadband loop eliminates the complication of loop tuning when changing frequency, the loss of Q multiplication can drop atmospheric noise below the noise floor of the amplifier thus limiting the sensitivity to weak signals. As an example, if we apply formula (2) to the 12 turn 0.8 metre square loop described and use a typical atmospheric noise for 100 kHz, which can be around 0.2 micro-volts per metre per root hertz, we get a loop output voltage of 3.2 nano-volts per root hertz. This output level is barely comparable with equivalent input noise voltages at low impedance of the best of amplifiers.

Conclusions

A properly designed loop aerial system, with a low noise pre-amplifier, is a useful part of the VLF-LF receiving equipment and can enable signals to be picked out from noise which otherwise overrides the signal from the wire aerial. It also provides a means to obtain good signal reception at VLF-LF without the use of a large aerial installation usually considered necessary for low frequency

reception.

The signal level received from the loop aerial is low compared to the wire aerial and the signal to noise ratio can be limited by the noise generated in the first amplifier. To minimise this problem, a low noise pre-amplifier is used and the loop circuit is tuned so that the signal level into the amplifier is multiplied by the Q factor of the loop circuit.

Some experimental loop aerials and a loop tuning and interface circuit have been described. Operated in conjunction with the high Q front end tuner, previously described in "Amateur Radio", they have provided impressive performance when everything is carefully tuned up.

References

1. Direction Finding (Loop Aerials) — Admiralty Handbook of Wireless Telegraphy, Section T.
2. Lloyd Butler VK5BR — Amplifier Noise — Amateur Radio, November 1982.
3. Analysis & Design of Broadband Low Frequency Loops — Lowdown, April & May 1985.
4. Castle, C. H. VK5KL — A 10ft Diameter Receiving Loop on 1.8 MHz — Amateur Radio, March 1982.

ar

Technical Correspondence

Experimental Communications in the LF Band

Several of my recent articles have been concerned with receiving equipment for the VLF-LF bands and this has led to my taking quite an interest in what sort of activity occurs on these bands. There are certainly plenty of enthusiasts interested in listening on the low frequencies but there are also others who actually transmit signals and communicate with each other.

Low frequency experimentation does not seem to get much attention in the Amateur Radio magazines or in the Amateur Radio handbooks but there is an organisation called "the Longwave Club of America" which publishes a journal called "Lowdown". A number of copies of these have been kindly lent to me and they are certainly packed with plenty of low frequency information including transmitters, aerial systems and comprehensive lists of transmitted signals which can be heard on the bands.

The lack of information in amateur radio publications is probably due to

the fact that there is no official amateur radio band allocation at the lower frequencies. In the USA, transmission can apparently be carried out in a frequency band between 160 and 190 kHz by any citizen subject to certain FCC rules. These rules specify that the input power to the final transmitting radio frequency stage shall not exceed one watt and that the total length of the transmission line and antenna shall not exceed 15 metres. There does not appear to be any other restrictions, such as mode of transmission, or operating procedure except that emissions outside the band shall be suppressed by 20 dB below the modulated carrier level. One watt input represents a fraction of a watt radiated using the limited length of antenna one would have in the suburban house allotment and in any case, restricted by the rules to 15 metres. Notwithstanding this, experimenters have been able to communicate and have their beacons heard at quite some distance, using this low power.

There has also been low frequency activity on the Australian scene. In "Amateur Radio" July 1984, an article by John Adcock VK3ACA was published on LF experimentation. John describes how he and Peter Forbes VK3QI (and later Dennis Sillette VK3WV) applied for, and were granted, an "experimental Licence" to operate amateur radio type of equipment in the LF band. A frequency of 196 kHz was approved and the article deals

with the transmitting and aerial equipment John used on this frequency and some of the results obtained.

Clearly, the input power to the final amplifier was more than one watt (John used a pair of 6JS6S in the final) and signals from Melbourne were heard as far away as north of Newcastle and in the Flinders Ranges.

The question is whether there is any of this LF communications activity still going on in Australia today. Perhaps someone can provide some further information on this question.

Lloyd Butler VK5BR
18 Ottawa Ave
Panorama 5041

ar

**Support the
WIA in order
to protect
amateur
radio
frequencies
at WARC 92.**

THE YAESU-FT 1000 HF ALL MODE TRANSCEIVER

RON FISHER, VK3OM

Once upon a time (and this isn't the start of a fairy story) if you wanted an HF transceiver, you bought a Yaesu. Why? Because there wasn't much else about. These were the days before Icom and Kenwood had really appeared on the market, they were relatively expensive, and most of the operating aids were optional extras anyway. Along came Yaesu, and all the extras were built in. Cast your mind back. Transceivers like the FT-101 and the FT-200 were the ones that everyone had, and further more, they are mostly still going strong. These were followed up with famous models like the FT-101Z, the FT107 and, of course, the best known of them all the FT-7. Then to my way of thinking, things started to go slightly wrong. Over the last five or six years, Yaesu hasn't been a big name in HF transceivers. It seems that this is likely to change in the near future.

Enter The FT-1000

So just what is the FT-1000 and how will it change the Yaesu image? Read on...

The FT-1000 is Yaesu's flag ship. It's the front runner against such transceivers as the Kenwood TS-950S and the ICOM IC-765. The FT-1000 is a brand new transceiver, unlike the other two, which are continuations of popular and successful models. Let me say, that I was most impressed with the new model. Yaesu are off on the right track.

Features Of The FT-1000

Like the other transceivers in this class, the FT-1000 is big and heavy. It has all the features that are expected in a top line transceiver which has been designed to go into the 1990s, so let's go into detail. This rig is AC operated only. Even if you could run it from a battery (you can't), you would need a large bus to get it anywhere near the driver. The overall size is impressive. It measures 420 mm wide, 150 mm high and 375 mm deep. It weighs in at a massive 25.5 kg, which makes it the heaviest transceiver on the market. However, this extra weight is needed, because the FT-1000 also has the highest power output — just above 200 Watts. If you stick to the letter of the law, you won't need a linear. 400 Watts would



The Yaesu FT-1000 all mode HF transceiver

give you only about half an S point more signal at the other end. Of course, the FT-1000 has two receivers which can be used simultaneously over a wide frequency split, or over any split if the optional receiver front end filter (BPF-1) is installed.

Both VFOs have excellent tuning controls with fly-wheel weighted knobs. Naturally, the receivers have full general coverage range with 100 kHz to 30 MHz reception capability. The output from each receiver can be either split between each ear, or mixed to both ears with stereo headphones. However there is only one loudspeaker with a single audio channel feeding it. The digital readouts are exceptionally clear and easy to read. Frequency resolution is 10 Hz on the main VFO, the sub VFO and the receive and transmit clarifier. A read-out also indicates which of the 99 memory channels is selected. Metering of receive and transmit functions is via a large and clear analog meter. Metering functions include, S meter, ALC, compression, power output, SWR, final collector current, and final amplifier voltage.

The transmitter power output position gives a very accurate reading on steady RF power, but unfortunately is not designed to give proper reading of PEP output.

In addition to this, there are several status indicators for such things as mode selection, VFO selection, transmit, main

receiver busy and sub receiver busy. On the lower panel, status indicators show operation of the processor, noise blanker, notch filter and the audio peak filter used for CW reception. While on the subject of CW, the FT-1000 has a built-in electronic keyer, and is compatible with both packet and RTTY operation. As far as I can see, it lacks only one facility. There does not appear to be any provision for a voice frequency read-out. Our sight-impaired amateurs might have to wait for the FT-1001.

One of the outstanding features of the FT-1000 is the use of Direct Digital Synthesizers. While direct synthesis has been around for quite a few years, it is only just finding it way into the amateur field. If you are used to a normal synthesized transceiver or receiver, then you should try a direct synthesized rig and note the difference. I will cover this later in the "On Air section".

To explain direct digital synthesis a little better, I would like to quote from an article in Ham Radio for October 1988 by Robert Zarvel W7SX:-

"The direct digital synthesizer has arrived in amateur radio. In the past several months DDS state-of-the-art has progressed to the point where good radio performance is obtainable using DDS. The DDS offers some attractive features over the analogue or phase-locked loop (PLL) synthesizer. DDS is digitally con-

trolled. Tuning is regulated by either memories or counters which, in turn, are controlled by rotary optical couplers. Unlike the PLL, DDS doesn't use a vco, loop filter, phase detector, or digital divider and prescaler. Waveform information is generated using digital information only. The last step uses a digital-to-analogue converter (DAC) to generate the rf signal".

In the QRM reduction department, the FT-1000 is right up there with the best of them. Firstly, the Shift/Width controls allow the overall band-width while in all modes, except FM, to be adjusted to suit the prevailing conditions. A notch filter is there to take out those persistent tuner-uppers. IF filters are included for bandwidths of 250,500, 2K and 2.4 kHz, with a 6 kHz filter for normal AM reception. The FM mode is also provided with a suitable band-width filter.

On the transmit side of things, the quality of the output signal has had special care. The final output transistors are powered from a 30 volt rail for low inter-modulation distortion, and coupled with the Direct Synthesis, the transmitter has an exceptionally low noise output. An RF speech processor is available for SSB transmission.

The FT-1000 On The Air

The FT-1000 is very easy to get on the air. Most of the normal functions really don't even require reference to the instruction book. Each of the amateur bands can be selected via the dedicated "Band" button, or an exact frequency can be entered from the key pad. If you wish to enter a frequency into the sub receiver, this can be achieved by pressing the "Sub" button, then entering the required frequency. In its standard form, the sub receiver only operates in the same band as the main receiver. The actual offset depends on the width of the filter provided in the front end. Once beyond this, the sensitivity drops about 50 db. Unfortunately, the optional BPF-1 receiver bandpass filter module was not supplied. With this installed, a separate receive antenna can be connected to provide up to 29.5MHz frequency separation between the main and sub-receiver.

Being something of a short wave listener, I was keen to try out the receiver in the AM mode, and here was the first revelation. There are absolutely no clicks, plops and holes that you hear on the normal synthesized receiver. It tunes just like the old FRG-7, although it's there that the comparison ends. The selectivity on AM is very tight and thus audio quality a little lacking in high frequency response. However the audio appeared to be very clean. While normal synthesized



Right hand front: Note the large tuning control for the sub-receiver and the keyboard for frequency selection and direct amateur band selection

receivers don't show up with as many plops and clicks on SSB as they do on AM, the FT-1000 was notably clean in this mode too. Frequency read-out and stability were checked against the BBC and Radio Australia on the 21 MHz band, an found to be within 5 Hz. An excellent figure. The control system for the two receivers is very simple and user friendly. A single button places the sub-frequency into the main receiver and vice versa. Band change for the amateur bands as mentioned earlier, is easily accomplished via the individual "Band" buttons. When using this method, the actual frequency, previously used on each band will be brought up, and not the same decimal frequency, as most of the older generation of transceivers will do. The frequency "UP/DOWN" buttons move the tuning up or down in 500 kHz steps, with the "down" and "up" button producing this effect each time the button is pressed. Listening to two different signals at the same time must be an acquired taste, but plugging in a pair of stereo headphones produces some startling effects. I thought it rather a pity that Yaesu didn't provide two audio output channels for the receiver, so that two speakers could be used, say on either side of the transceiver, to give some separation between the two receivers. Sometimes, with the audio coming out of one speaker, it's rather hard to tell which signal is which.

Received quality on SSB was found to be very clean, with product detector distortion measured at only 1.1% distortion, but again just a little lacking in high frequency response for my test. A microphone was not supplied with our review



Close up of the Crystal Filter section

transceiver, but I did have a Yaesu MH1B8 on hand, which was used for all of my on-air tests. Reports were all very favourable, especially when using the speech processor. It seemed capable of taking a large amount of compression without producing any audible distortion. With over 200 Watts output available, you have the choice of two ways of running the transceiver. Firstly, run the

full power output without a linear and get a clear, clean and penetrating signal. Or secondly reduce the output to about 50 Watts and drive your linear to 400 Watts output, but with an exceptionally clean signal. I estimate that at 50 Watts output, the intermodulation distortion would be well in excess of -40 dB.

CW keying was a delight. You can connect either a straight key or a paddle, and full QSK operation is available. The keyer dot/dash weighting is fully adjustable via the DIP switches under the top panel hatch, as is the pitch of the received signal. A useful feature is the PLL spotting LED to let you know when you are on frequency.

With 99 memories to play with, I was anxious to load up a few of my favourite broadcast stations on both the standard and short wave broadcast bands. Getting them into the memory was easy. I even programmed a few on USB or LSB to eliminate an interfering signal. So far so good. With a couple of dozen in, I decided to scan around them to see what I had. The memories can be selected manually with the memory up/down selector knob.

The main tuning control is large and very smooth in operation. It reminded me of the tuning control on my old TS-930, but if anything, is a little better (that's saying something). The tuning rate is 10 kHz per knob revolution, and the tuning rate does not speed up if the knob is rotated quickly. Instead, there is a fast button just to the lower left of the main control. With this depressed, the tuning speeds up to about ten times the normal rate. However, it is necessary to keep this button depressed to produce the effect. By the way, with the AM mode selected, the tuning rate changes from 10 Hz steps to 100 Hz steps and gives 100 kHz per dial revolution. This rate is also automatically selected in the FM mode.

Ten metre FM operators are well catered for with a selectable repeater offset facility. During my test, the ten metre band was in rather poor shape and contacts on FM hard to get. However the transmitted and received quality were judged to be very good.

If you are one of the growing band of digital mode enthusiasts, then the FT-1000 is just the thing for you. Dedicated sockets are provided on the back panel for connection to a packet TNC or RTTY and AMTOR terminal unit. The FT-1000 has a built-in microprocessor to control the audio frequency shift keying tones for RTTY or AMTOR and a choice of shifts is available.

Of course, the entire rig can be controlled from your computer, and several pages of the manual are devoted to this. One page notes all of the CAT commands

available, giving their Opcodes and parameter Bytes. As with all upmarket transceivers, the FT-1000 has a built-in automatic antenna tuner. The specification states that this is able to match an impedance of 16.5 to 150 ohms; in other words about a three to one SWR on an unbalanced line. You should note that this ATU is not suitable to feed random length or unbalanced antenna systems. The ATU settings are stored in their own memory system for instant recall when your favourite frequency is selected. The auto ATU can also be controlled via the external computer input if required.

One of the interesting options offered

with the FT-1000 is the DVS-2 digital voice system. This allows recording and replay of either off-air or ex-microphone material. I know that Yaesu have offered this as an option on some of their VHF FM transceivers over the last year or so. As yet, I haven't had a chance to try one. I look forward to the opportunity to do so.

With 200 Watt output capability, the chances of things heating up somewhat are possible. A high volume fan is installed inside the finned heatsinking. I must say that I was somewhat taken aback when it first started up. For the first few seconds it sounds like a cow mooing. However when it settles down it's not too bad but nevertheless produces a little more noise than I consider acceptable.

The FT-1000 On Test

Firstly, the receiver was tested for audio output and distortion. The external speaker output socket was terminated with both a 4 and 8 ohm load.

8 Ohms 1.9 Watts maximum output

4 Ohms 2.4 Watts maximum output

With a 1 kHz beat note, SSB mode on 14.2 MHz the following distortion was noted:

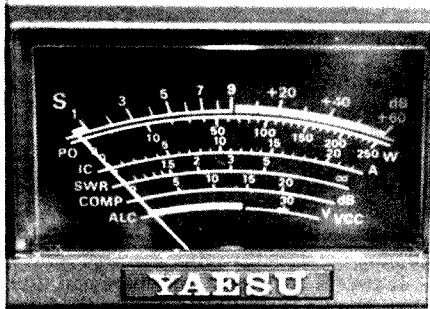

Close up of meter

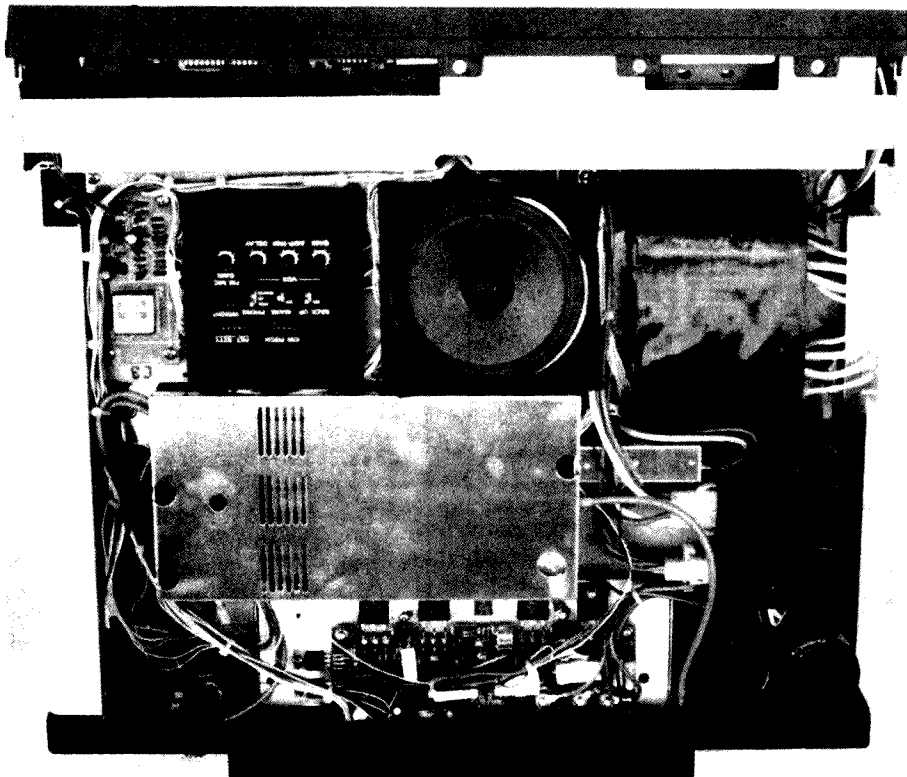

Top view of transceiver. Note size of power transceiver on right and top controls accessible through top hatch.

4 Ohms .5 Watts output. 1.1%

4 Ohms 1.5 Watts output. 10%

The notch filter was checked, and the maximum attenuation at both 1 kHz and 2 kHz was found to be 27 dB. The input signal was reading about S8 on 14.2 MHz.

The receiver response was measured with the 2.4 kHz filter in circuit.

190	300	500	1 kHz	1.5	2.0	2.4	2.7
-6	04	0	0	-.5	03	-6	-14dB

AGC was checked

Slow, 4 seconds decay time from S9

Medium, 3 seconds decay from S9

Fast, 1 second decay from S9

When the signal level was raised from 1 μ V, the audio output increased less than .5 dB.

The "S" meter calibration was checked:

S1	2	3	4	5	6
2 μ V	3 μ V	4 μ V	5 μ V	7 μ V	10 μ V
7	8	9	+20	+40	+60
25 μ V	40 μ V	100 μ V	1mV	10mV	60mV

This was measured at 14.2 MHz, but a quick check on other bands showed that the overall S meter sensitivity was within 2 dB. The above figures were taken with

the preamp switched in. I was unable to check the attenuator as the 6 and 18 dB positions were in-operative in our review transceiver.

The overall sensitivity was checked at 14.2 MHz in USB mode and with 2.4 kHz band-width to give a 10 dB S/N ratio. It measured .25 μ V (without preamp). Again the overall sensitivity remained very constant from band to band.

The transmitter power output was checked in the CW mode and found to be well in excess of 200 Watts on all bands, with the highest on 20 metres (215 Watts), and the lowest on 160 metres (204 Watts). The PEP output on SSB appeared to be a little higher than the above figures.

The FT-1000 Instruction Manual

The quality of printing and presentation of this book is the best that I have seen, and it was obviously written by an author well versed in the English language.

It covers all aspects of operation and also the installation of the options. However, there is almost no technical information provided, apart from the specification. As Yaesu are using many new techniques in this transceiver, a short description of their operation would have been welcome. No doubt a full workshop manual will be available in the near future, and I look forward to seeing this.

The FT-1000 Conclusions

In general, the technical operation of the FT-1000 is superb. The direct digital synthesizer works very well and produces receiver performance that sets new standards. The transmitter delivers more

power than almost any transceiver since the old days of the FTDX-400 series, but with an infinitely cleaner signal. Only one thing is needed when Yaesu brings out its improved FT-1000, a voice frequency readout is required for sight-impaired amateurs. With two frequencies to look at, this might be a complicated device. Dick Smith has discussed this with Yaesu which has advised that, due to complexity, such a speech device would entail so much additional circuitry that the cost of the transceiver would be substantially increased. However, the CAT (Computer Aided Transceiver) facility allows access to the main micro-processor data relating to almost all front panel control parameters. As most visually impaired operators would already have a computer available, it would not be a difficult task to investigate the possibility of connecting the computer to the transceiver.

The "in" thing these days is to quote the number of knobs and buttons on the front panel of a new transceiver. I haven't done that (there are plenty of them) because the layout and functions are very user friendly.

At a price of \$4995, with a Yaesu MD-1 desk microphone, and with the Dick Smith two-year warranty, the FT-1000 represents unbeatable value. I look forward in time to see what becomes available from Yaesu to replace the now ageing FT-757 transceiver. If the photos that I have seen in the latest Japanese magazines are an indication, we are in for a few surprises. It really seems that Yaesu are back in the HF transceiver market.

Our thanks to Dick Smith Electronics for the loan of our review transceiver. All enquiries should be directed to their nearest store. ar

New WIA logbooks available now

at your Divisional Bookshop

These quality logbooks are available in A4 format with plastic spiral binding so the book will open and lie flat on the bench.

VERTICAL OR HORIZONTAL column layout is optional, with the traditional column headings

Price is \$5.00 each plus post and packing where applicable

Regulations Governing Amateur Stations In Australia

Every radio amateur should by now have obtained a copy of two DOTC booklets to ensure they're aware of the latest regulations.

The free booklets are DOC71 "Licence Conditions and Regulations Applicable to the Amateur Service" and DOC72 "Amateur Service — Operating Procedures". A third booklet in the series DOC70 contains the information needed for prospective amateur operators. All amateur regulations examinations are now based on the contents of the three booklets.

Whether you're already licensed or intend to take out an amateur licence in the future, you should have copies of these booklets. They can be obtained free of charge by applying to the State Manager, Department of Transport and Communications, or to your local District Radio Inspector. Their addresses and phone numbers are in the telephone directory and the 1990 WIA Call Book.

ar

BOOK REVIEWS

AMATEUR BAND PLANS BOOKLET

REVIEWED BY JIM LINTON VK3PC

To accommodate both CW and telephony in amateur bands, gentlemen's agreements were drawn up many years ago as the hobby of amateur radio self-regulated use of its bands. In Australia, that was the method adopted in a commonsense approach to achieve harmony between the brass pounders and phone operators. The band plans have evolved over the years to accommodate new modes, specialist uses and repeaters.

While the radio amateur, through the Wireless Institute of Australia, gets a say on band planning, such is not the case in many other countries. In the USA, for example, they have chosen to regulate band

usage. No matter what method is used, the aim is promotion of orderly operation and accommodation of the various modes of transmission. However, band plans have to be readily available in a form easily understood, to ensure the average radio amateur can strive to abide by them.

The WIA has published a neat 38-page booklet explaining the philosophies behind band planning, and how to interpret published plans. Definitions are included to explain terms such as Primary Service, Secondary Service, Narrow and Wide Band modes. A brief explanation of all the radio service types like Fixed, Mobile and Radiolocation mentioned in the book-

let would also have been helpful to readers. A similar comment can be made about the lack of adequate definitions for terminology such as "DX Window" and "Weak Signal Working". The booklet contains, in graphical and tabular form with explanatory notes, the band plans from 1.8 MHz through to 241 GHz. These are clearly presented and easy to understand.

The WIA Federal Technical Advisory Committee deserves commendation for producing this booklet which is recommended for the in-shack library of every active radio amateur. Copies are available from the WIA Federal Office. Cost is \$2.80 posted. **ar**

MORSUM MAGNIFICAT

REVIEWED BY ALAN SHAWSMITH VK4SS

It is almost certain that most VK amateurs have not heard of the magazine "Morsum Magnificat".

"MM" as it has become affectionately known is produced quarterly by Tony Smith G4FAI and Geoff Arnold G3GSR and published in Britain. It aims to provide international coverage of all aspects of Morse, past, present and future.

Morsum Magnificat is for all enthusiasts, amateur or professional, active or retired. It brings together material which would otherwise be lost to posterity, providing invaluable source of interest, reference and record relating to the traditions and practice or Morse — Not forgetting many humorous interest stories.

As most readers know, many magazines have a life span of only a year or two. "MM" is still expanding after 8 years. Every "brasspounder" has at least one good story to tell. After reading "MM" you will want to share yours with "MM" readers. It's a hard magazine to put down.

Subscriptions: Issues Nos 17-20 (Autumn 1990-Summer 1991);

United Kingdom: £8.00 per annum, post paid.

Europe, including Eire: £8.50 sterling.

Other Countries: Surface Mail —

£8.50 Sterling (or US \$14.00 cash)

Air Mail — £10.50 Sterling (or US \$17.00 cash)

UK cheques payable to "G C Arnold Partners' Payment by Access, Eurocard, Mastercard or Visa also welcome; quote your card number and expiry date.

Owing to bank charges for currency exchange, overseas cheques, drafts, money orders, etc must be drawn on a

London clearing bank and payable in Sterling.

Editorial And Subscription Offices: Morsum Magnificat, 8A Corfe View Road, Corfe Mullen, Wimborne, Dorset BH21 3LZ, ENGLAND. Telephone: Broadstone (0202) 658474.

Editor: Geoff Arnold G3GSR

Consultant Editor: Tony Smith G4FAI, 1Tash place, LONDON N11 1PA, ENGLAND. Tel: 081-368 4588. **ar**

How To Run Your Own TV Station

(Or The Media Gets It Right)

That's how Channel Ten, Brisbane approached a brief program on Amateur Television. The segment was shown in prime time at 6.30 pm on the Anna McMahon Show on Friday April 13, and featured several members of the South East Queensland ATV Group. It was taped at the home of Richard VK4XRL and showed pictures transmitted from six other amateurs. Reporter, Mark Suleau compared the differences between commercial and amateur TV.

Viewers were told of the importance of the technical side of the hobby, and the need to be licensed. Richard pointed out how most equipment was home made.

ATVers consider the program a major coup for the hobby, and were impressed with their treatment, saying Channel Ten gave a fair and accurate report on the operation of Amateur TV in Brisbane.

Peter Jones VK4YAC President SEQATV Group

ar

AMATEUR RADIO IN THE USSR

THIS IS THE FIRST OF A TWO-PART ARTICLE WRITTEN FOR THE WIA JOURNAL, AMATEUR RADIO MAGAZINE, BY YURY ZOLOTOV UA3HR, A PROMINENT MEMBER OF THE USSR FEDERATION OF RADIO SPORT.

The amateur radio movement began in the early 1920s along with the commencement of radio broadcasting. The first broadcast station went on air in Moscow in 1922. Regular broadcasts then on the long and medium waves only began from October 12, 1924. At about the same time, a movement of radio amateur enthusiasts sprang up in the country. Many began to build radio sets themselves. In those years more than 80 per cent of sets operated by the population were home-made. On August 7, 1924, the Society of Radio Amateurs of the Russian Federation was set up, later renamed the Society of Radio Friends. In 1926, with the setting up of similar societies in other republics, the first nationwide congress of such societies met. At that time there were over 200,000 radio amateurs in the country. The congress decided to take action to spread the knowledge about radio among the population.

In 1922, radio amateurs in the US, France, Britain and Germany began using shortwaves, then considered useless for radio communication. An intercontinental link on shortwaves between US amateurs (1MO) and France (8AB) was a sensation. Soviet radio amateurs took up shortwave activity with great enthusiasm. The first to build a shortwave amateur radio station in the Soviet Union was Fedor Lbov, an accountant by profession. On January 15, 1925, he and his friend V Petrov went on air in the 96-metre band. For a while they sent Morse: CQ CQ CQ de R1FL pse kkk. The callsign had been invented by them. R1FL stood for Russia First Fedor Lbov. The transmitter had a capacity of 15 Watts and, because they had no receiver, the station's address was transmitted in the hope of reception reports. Two days later, Lbov received a telegram from Iraq where an English radio amateur (G5HS), at the time in Iraq, picked up the signals of the R1FL.

Government encourages shortwave experiments

Soon after this history-making event, the Soviet Government gave official permission for radio amateurs to build and operate their own shortwave stations. In 1927, the first nationwide competitions

in shortwave communications were held, mainly on the 20-metre band. Then, in the following year, the first international radio communication competitions were organised. Soviet and Spanish radio amateurs set up links on shortwaves. That was a time when Arctic exploration began on a wide scale. It was radio amateurs who introduced shortwave communication into that area of activity.

On May 25, 1928, the airship Italia crashed in the Arctic while carrying an expedition of Umberto Nobile to the North Pole. It was not until June 3, when an SOS was picked up by a Soviet radio amateur N Schmidt, that the location of the disaster was known. He immediately passed on to Moscow the co-ordinates of the survivors' camp. The Soviet ice-breaker Krasin went to the site and lifted seven to safety.

In 1937 the first Soviet scientific expedition led by Ivan Papanin was landed on the North Pole, consisting of four men including radio operator Ernst Krenkel. The callsign of the drifting station UPOL won unusual popularity around the world.

Later on, for his services in saving crew members from the ice-crushed steamer Chelyuskin, Krenkel was allowed to use for radio amateur activity the Chelyuskin call letters RAEM.

Hero Krenkel inspires Soviet youth

Krenkel had become a national hero. Many thousands of youths and girls followed his example, taking up radio and studying Morse code. The Krenkel Central Radio Club has a memorial work station of this legendary shortwave enthusiast, outstanding polar explorer and public figure.

In the early 1930s, Soviet radio amateurs began using the then so-called ultra high frequencies. Several dozen articles on equipment and specifics were published.

War stops amateur radio activity

In the autumn of 1939 amateur stations in Britain, France, Poland and Canada went off the air due to the outbreak of World War II. They were fol-

lowed by radio amateurs in Australia, New Zealand, India, Belgium, Norway, Sweden and many other countries.

Soviet amateurs remained active up to the summer of 1941. It was only the perfidious attack by Nazi Germany on the Soviet Union that put an end to amateur radio activity. The Soviet Union entered the war. In the first days thousands of radio amateurs joined the Red Army, becoming officers and soldiers of communications units.

After the war, as a tribute to war veteran radio amateurs, they were allowed callsigns that had only one letter in the prefix. Some 500 of these veterans survive today.

On May 2, 1945, on the eve of the Soviet Union victory over Hitler's Germany, the Soviet Government instituted Radio Day as an annual holiday. This was done as a recognition of radio amateur activities, and as a token of the need to develop radio-electronics as one of the significant and effective forms of public work.

Radio amateurs play role in post-war era

In March 1946, the Central Radio Club of the USSR was set up in Moscow — a centre for amateur radio sport and design. That marked the beginning of a new, post-war period in the amateur radio movement.

In the next decades, radio amateurs have joined in intensive scientific and technological programs in radio-electronics. New technologies and new components not only helped to upgrade amateur equipment, but also gave rise to entirely new activities.

The launching on October 4, 1957, of the first artificial Earth satellite, carried out in the Soviet Union, heralded the use of future satellites for amateur communications in the RS1-RS11 series.

Organisation and IARU involvement

On October 8, 1959, the USSR Federation of Radio Sport was set up. Its presidium has committees and commissions on various radio amateur and radio sport activities.



Alla and Yuri Zolotov – famous Moscow radio amateurs. Photo shows the Zolotov couple at home in their radio studio. They are holding their QSL cards.

In its work, the Federation draws extensively upon the Krenkel Central Radio Club of the USSR.

Local radio sport federations based on radio clubs are also set up in the various autonomous republics, territories and regions throughout the USSR. Since 1962, the USSR Federation of Radio Sport has been a member of the International Amateur Radio Union, and takes an active part in the work of the IARU Region 1.

The Federation, the USSR Central Radio Club and the magazine Radio hold annually several nationwide shortwave competitions, three USSR championships and the international CQ-M Contest, whose motto is "Peace to the World".

The CQ-M Contest began in 1957, and now traditionally takes place every year in the second week of May. All foreign participants get souvenir badges. Once in three years, the USSR Federation of Radio Sport, on behalf of the IARU Region 1, holds international competitions in shortwave telegraph communications, to contest the cup of the first cosmonaut Yuri Gagarin.

(To be continued in a later issue)

TRIAL EXAMINATIONS AVAILABLE

Candidates for amateur examinations can now be better prepared and confident by testing themselves with a trial examination. No matter where a candidate is in Australia, they can obtain a trial theory or regulations examination by mail order.

The questions used in the trial papers are typical of those in the "real" examinations. The candidate attempts the trial paper under examination conditions in their own home and then returns the answer sheet for marking. The marking is part of the service and readily helps the candidate identify those areas of weaknesses which need more study.

The cost of the theory trial examinations (specify whether you want the Novice or AOCV version) is \$12 while the regulations paper is \$8.

Applications should be sent to:
Trial Examinations
WIA Victorian Division
38 Taylor Street
Ashburton Vic 3147

ar

"AHH, YOSHI— WOULD YOU REPEAT ALL BEFORE,
 'WAKARIMASUKA, DOZO'?"



— VK2COP

GEORGE MOSS VK6GM — PIONEER RADIO AMATEUR

LES BRADSHAW VK6EB
203 THE STRAND, BEDFORD 6052

George Arthur Moss joined the Western Australian Division of the WIA in 1925, and is currently its longest standing member. Born 2 September 1903, George first became interested in communications at the end of WWI. He has pursued radio as a hobby and career since that time, and is still actively associated with the social, construction, and operating aspects of amateur radio.

Amongst the memorabilia in George's possession is an early textbook "Aerodionetics", published in 1908. Contained within the preface is the statement, "In the future it is unlikely that the flying-machine will be limited in performance to short flights over prepared ground at a few metres height, ready to come to earth at a moment's notice; it will rather seek safety in altitude, probably flying in the most part at a height of at least two or three thousand feet,..."

It was from a British periodical "Work" published in the same year as the aviation text, that George as a 16 year old school boy was to gain his introduction to wireless. While browsing through some back issues of the magazine, to which his

father subscribed, he came across an article describing the construction of a spark transmitter, and coherer detector — receiver. The innovative feature of the design was an electric bell type mechanism, which rapped the coherer in order to disorientate the iron filings in the column, to ensure continued operation.

Construction of the equipment was not attempted, since it was both illegal and beyond his means at the time. George's father however, sensing his son's newborn interest in electricity, brought home some discarded Helleston dry cells, which had been used to power the ignition system in a motor vehicle used by his employer. Experimentation followed, with the cells providing the supply for a variety of simple circuits. Having no electrically minded friends to consult, and with the scarcity of suitable literature at the time, the assimilation of a theoretical background in these early years was a slow and difficult process.

After obtaining his school Leaving Certificate and doing a further year of study in a commercial course, George obtained employment in 1921, with a firm specialising in piano maintenance

and tuning. His mastery of the art of tuning was materially assisted by his recently acquired knowledge of beating frequencies. Two years later he built his first wireless, a crystal set, in order to receive the 9PM time signal and weather report from the Perth coastal radio station VIP. The station operated a spark transmitter on 600m. An experimental licence costing 10 shillings had to be obtained from the PMG Department, Melbourne, in order to build the crystal set.

Following this first successful construction, numerous requests were received to build crystal and valve receivers, due to publicity given to the opening of 6WF the first public broadcast station in WA, on 4 June, 1924. At this time an experimental licence limited the building of equipment for personal use only, so that a dealers licence had to be obtained in order to build for a second party.

It was during this period that a decision was made to become a radio amateur. Two electrolytic interrupters were constructed in order to practice Morse code with a friend who lived several houses away. The signals were to be transmitted over the 250V power mains. According to George the device roared and thundered, and the house lights dimmed every time keying occurred, but at least the signal could be copied in headphones at the receiving end. He still gets a cold shiver down the spine when remembering that all that was between him and the next world was a homemade foil and paper capacitor. His friend also managed to survive, and later went on to a career with OTC.

George joined the WIA in 1925, and attended the dinner associated with the Institute's second annual conference, which was held in Perth during that year. Four eastern states delegates were in attendance.

The licensing examinations were passed the following year, and the call-sign A6GM issued, with operation permitted on the 30-35m band.

His first station transmitter consisted of a 210 triode operated base up, with the glass envelope immersed in a cup of oil for cooling. The antenna was a 70 foot long flat top, 35 ft high. Two bright emit-



Photo taken to commemorate first VK6 win of the RD Trophy. L to R: Eric Machin VK6VM, Wally Coxon VK6AG (SK), Jim Rumble VK6RW, George Moss VK6GM, Ron Hugo VK6KW (SK), Bert Sorley VK6RO (SK).

ter triodes were used in the receiver, one functioning as a Reinartz regenerative grid leak detector, and the other as an audio amplifier. The power supply for the filaments was a 6V lead-acid battery with vibrator rectifier charging. The 48V high tension supply was home made using 24 test tubes as enclosures for pasted plate lead-acid cells. The cell grids were fabricated from the "H" section used in the construction of lead-light windows. This battery was charged using an electrolytic rectifier.

According to George the term "hot lips" originated around this period as a result of attempts at voice communication using "absorption modulation". The procedure was to connect a carbon microphone directly into the feeder between transmitter and antenna. Absorption of RF by the operator's lips when speaking too close to the microphone, served as an incentive to develop improved techniques.

George's employment underwent a change in direction in the late '20s. His original employer was about to close his business, and recommended him to an associate at one of the city's largest musical establishments. An offer was made and accepted to take charge of their radio servicing division. This firm was to open a commercial radio station shortly afterwards, and George obtained a Broadcast Station Operator's licence, in order to participate in the operation of the station.

Rebuilding and improvements to his amateur equipment continued during these early years, and in the early '30s he commenced broadcasting music three nights a week. These broadcasts were extremely popular, since he had ready access to recent record releases through his employer. This activity continued until the broadcasting of music by amateur stations was prohibited.

George served as Secretary and President of the WA Division of the WIA during 1935-36, and in 1938 was named as the inaugural winner of the Carl Cohen trophy for amateur radio research in WA. During the same year he attended the World Radio Convention as WIA delegate, at the invitation of the Government of NSW. The convention was held at the University of Sydney as part of the State's 150th Anniversary celebrations. The WIA took advantage of the presence of the numerous state representatives to hold its 14th Annual Conference in conjunction with the World Radio Convention program.

Evening classes in radio theory commenced at Perth Technical College in the late '30s, and George was to commence his academic career by taking over the lecture program in 1938. The following year he was to inaugurate radio appren-



VK6GM shack in 1935. Note the turntable.

RADIO DINNER

23

To be held at

KEOUGH'S HALL, NEWCASTLE ST., PERTH,

at 8 p.m., on

MONDAY, 10th AUGUST, 1925,

In Honour of the Visiting Delegates to the Federal Convention
of the Wireless Institute of Australia

ADMIT ONE

J. C. PARK, Hon. Sec.

tice training in WA, and with the onset of WWII, was seconded half-time to teach Army radar trainees.

The onset of hostilities brought about a temporary halt to amateur radio activities. An official telegram dated 2 September, 1939 advised that all amateur radio transmissions had to cease immediately, and that stations had either to be dismantled or rendered inoperative. George obtained his First Class Commercial Operators Certificate in 1942 in case his

services should be required during the national emergency.

With the re-issue of licences following the end of the war, rebuilding a new station centred around this high quality war surplus equipment which became available. On the academic side of his career, he obtained a Diploma in Communications and became a full-time lecturer, an occupation he was to pursue until his retirement in 1969. His involvement with teaching however continued in a part-

time capacity for another 17 years.

George's contribution to amateur radio was formally recognised in 1965, when he was made a life member of the WIA. He still maintains a very active interest in the hobby by way of HF, VHF, and computer RTTY. He is also possibly the most regular attendee at the fortnightly get togethers of the Old Timers Club in the West.

There can be no doubt that the majority of benefits and privileges which the present day amateur takes for granted, is in no small way due to that small and enthusiastic group of pioneers, who paved the way for our existing technology. In these days of freely available technical education, and relatively cheap components, it is difficult to fully appreciate the innovative skills and dedication required to construct all but the most exacting items, with limited knowledge and facilities.

The present day amateur is however deprived of one great moment of life, that of hearing his first ever wireless signal after adjusting the cat's whisker on a home-made crystal set.

Well done George.

ar



A recent picture of George VK6GM at his rig.

Technical Correspondence

My article "SWR: A can of worms" (June 1989 AR) was a concerted effort to simplify the subject of antenna matching and to try to remove such theoretical smoke-screens as reflected power and overheated finals.

One error made by me, as pointed out by a correspondent blessed with common-sense was to state blindly that the source impedance had to equal the transmission line impedance for maximum power transfer to occur. Of course, I forgot the same theory states that 1/2 the power generated will then be dissipated by the source (ie, your transmitter) — a fact which all amateurs know to be obviously false.

Thus Dr Lucas' glib paragraph on mismatched sources (p11, October '89 AR) must be incorrect, as I was in my article. Reflected power is a very confusing, theoretical interpretation of a simple physical process, which doesn't stand a hard looking into using practical experience.

As light displays a "dual" nature (particle or wave?), so energy flow in transmission lines will continue to confuse technical people at all levels.

I think I'll stick to my guns and consider only input impedance variations on my transmission lines — that way I can sleep nights!

Anybody else got some thoughts on this?

JOHN SPARKES VK6JX

"PARADISE VALLEY" RMB737 DONNYBROOK 6239

Stolen Equipment

Stolen from R Ross-Wilson VK2FIT 11 James St Leichardt 2040 one TS440S transceiver Ser No 0060078.

Stolen from Laurie Freeman VK3KLF 18 Grant Grove East Keilor (03) 337 3249 on 14th June.

1 GME Electrophone 40 Channel UHF transceiver Model TX472S set 912 48058

1 Icom FM VHF transceiver model IC255A Ser 10308425

2 Antenna gutter mounts (electrophone and Hoxin).

Stolen from Albert Wojnar 9/203 Birrell St Waverley 2024 (02) 369 1803 one Icom IC 721 HF transceiver Ser 003663 equipped RFDS freqs.

Stolen from Norm Deitch VK2ZXC PO Box 192 Port Kembla 2505 (042) 74 1270 one Kenwood TS670 6m and HF transceiver.

ar

New Canadian Amateur Licences

The Canadian amateur licence system has been restructured into four levels of qualification.

It also breaks new ground by prohibiting all but the highest licence grade holder from building their own transmitting equipment.

Basic — all modes, 250 W all bands above 30 MHz, commercial gear only.

Add a 5 wpm Morse qualification to the above and additional privileges are granted on 1.8 MHz and 3.5 MHz.

Add 12 wpm Morse to the Basic licence and privileges are granted on all HF bands.

An Advanced licence will allow home-brew transmitting equipment and maximum legal power.

The new licence system starts from September 1, 1990.

ar

Prevent pirates — make sure you sell your transmitter to a licensed amateur.

DXPEDITION TO SAINT PETER & SAINT PAUL ROCKS — PY0S, BRAZIL

By NATAL DX GROUP

(THIS ACCOUNT WAS SENT TO US VIA AUSTIN CONDON VK5WO WHO WAS ONE OF THE EXPEDITION'S SUPPORTERS. ED)

This is the story of the radio amateur DXpedition accomplished by members of NATAL DX Group to Saint Peter & Saint Paul Rocks — PY0S, 14-20 May 1989. For those who know only of Natal in South Africa, the Brazilian city of Natal is on its north-east coast about 250 km north of Recife.

1. Location & Description

The early history of Saint Peter & Saint Paul Rocks is shrouded in mystery. They appear first in Mercator's Chart of 1538 and again in Ortelius' Chart of 1570. It is probable that they were discovered sometime between 1513 and 1538, since they are not shown on the Turkish World Chart of 1513. Schoot in 1942 on his chart showing dates of discovery of important spots on the Atlantic Ocean, places a question mark opposite Saint Peter & Saint Paul Rocks.

The Rochedos Sao Pedro & Sao Paulo, commonly known as "Saint Peter & Saint Paul Rocks", lie almost on the equator $0^{\circ} 56''$ N & $29^{\circ} 22''$ W. They belong to Brazil and are situated less than halfway between Cabo de Sao Roque, on the extreme eastern tip of the South American Continent and Dakar (Africa). More precisely, the Rocks lie 621 miles northeast of Cabo de Sao Roque, State of Rio Grande do Norte, PS7 land.

Saint Peter & Saint Paul Rocks are normally visible at a distance of from 10 to 15 miles at which range they appear as a small speck on the horizon. From 3 to 5 miles away, they look like one island about 40 metres long, low lying, and with a serrated crest which upon closer approach resolves itself into two or three distinct peaks. The appearance of the Rocks varies considerably with their bearing. In a bright sun, reflection from the guano-coated top and sides causes the peaks to glisten like sails. A heavy surf beats against the Rocks on all sides but is especially strong on the eastern side which faces the equatorial current. On further approach, a crying mass of birds becomes visible over the Rocks, and on them, while crabs scuttle across the

rock surface, which is very irregular and pinnacled.

At the present time, Saint Peter & Saint Paul Rocks are composed of five larger islets and four smaller rocks, plus four small pinnacles which extend above the sea surface near the larger islets. Their combined circumference is barely $1/2$ mile, and the extreme length (from N to S) is about $1/6$ mile. The four largest islands are, in order of size, the southwest, northwest and northeast islets. South islet is somewhat smaller. A large cove is formed by the four largest islands and opens to the northwest. It is approximately 40 m wide at the entrance and some 85 m long.

The cove also opens to the southwest through a narrow channel. The cove is between five and ten fathoms deep and landing has been most difficult for all expeditions visiting the Rocks. The bottom, at the entrance at least, is covered with coarse white sand. Swell and surf boil continuously through the cove except on the "very calmest days".

The highest point on the Rocks today is located on the northeast islet, where the remains of a lighthouse are located. Its top is approximately 34 m above sea level and makes an excellent observation point and DX operating site.

The temperature is very high during the day, reaching 40° to 45° C. At night, there is a breeze which drops the temperature to 20° to 25° C. Rainfall, at this time of year, occurs daily.

Usually, before the rain, there is a very strong wind, and on three occasions we had to change our operating site. On one of these, the wind was so strong it pulled the canvas off the tent, leaving everyone and everything exposed to the rain for over half an hour.

There is no vegetation or drinking water on these rocks; they are of volcanic origin, inhabited only by two types of sea birds and one solitary heron.

2. Preparations For The Voyage

For quite some time, the NATAL DX Group, and members Karl PS7KM, Leo

PS7JS and Tino PT7AA had been planning a DXpedition to the Rocks. In October 1988, we decided to go ahead. Help was requested from other PS7 amateurs. The response was good, and included rigs, tents, tarpaulins, antennas, cables, etc.

In January 1989 we made the first contacts at an international level, with DX foundations and clubs, in order to obtain, if possible, some financial assistance. Food, water, batteries, diesel fuel, rent of a boat, two generators, these were among the essentials.

The difficulties were great and the expenses were always greater than our resources, apart from an inflation of 30% a month. That was the real enemy.

We asked various amateurs to join the expedition, and some agreed, but in the hour of decision only the three mentioned above stood firm in the intention of putting PY0S on the air one more time. We asked the National Department of Telecommunications-DENTEL to give us prefixes to use on the DXpedition, ZY0SS for SSB, ZY0SW for CW, and ZY0SY for RTTY.

After intense publicity in DX bulletins worldwide, we started to receive the first donations. We wasted no time in renting the vessel "MOANAS". The countdown was started, heading, the Rocks.

Unhappily, a few days before planned departure, the owner of the boat told us that, because of sickness in his family, he couldn't take us to the Rocks. We immediately started looking for another vessel. We checked out several, but the cost was very high, far beyond our resources. Since we had already stated our budget, it would have been unfair to request more money from those who had already helped us.

After four days of searching, we met Peter Clemens Pereira, a German, resident of Natal, and owner of the sailing vessel "SHANTY". He agreed to rent us his vessel for US \$2000. We visited the vessel and verified that it was quite safe for such a trip. Of Dutch construction, it measured 15 metres. An experienced

FT-1000 HF ALL MODE TRANSCEIVER



THE BEST OF THE BEST

Attention all serious HF operators! To be a truly WORLD CLASS operator during these times of crowded band conditions, you've got to have a truly WORLD CLASS rig...and the rig you need is arriving in Australia very soon. Of course we're referring to the versatile new YAESU FT-1000.

The FT-1000 is the product of 3 years intensive research and development at YAESU, resulting in a highly reliable, fully featured, yet easy to use HF transceiver. It's bound to blow away the competition with its spectacular combination of power and operational flexibility. Compare!

Dual Channel Reception- Utilising independent VFOs and digital displays as standard, reception can be in different modes, on different frequencies, with different IF bandwidths. An optional Bandpass Filter Module (BPF-1), will allow cross-band dual-receive using two antennas.

Direct Digital Synthesis (DDS)- Two 10 bit DDS plus three 8 bit DDS provide fast lock-up times and lower synthesizer noise than traditional PLL systems. Using DDSs' results in a cleaner transmitted signal and much improved receiver performance.

High RF Output Power- Continuously adjustable output from 20 watts to a mighty 200 watts is under your control. A built-in blower sees that high duty cycle transmissions take place quietly and efficiently.

Ultra-High Performance Receiver- it provides all-mode coverage from 100kHz to 30MHz with a dynamic range of up to 108dB. Selectable filters for the following bandwidths are fitted as standard: 6kHz, 2.2kHz, 1.8kHz, 500Hz, 240Hz. The QRM rejection systems include cascaded IF filters, IF width and shift controls, IF notch filter, a variable noise blanker, and CW audio peaking filters.

2 Year Warranty - A world class transceiver should be covered by a world class warranty. That's why we provide a comprehensive parts and labour 2 year warranty on every Yaesu transceiver we sell, including the FT-1000! Don't settle for less.

Price - Compare with the opposition, and get a pleasant surprise. At \$5295, the FT-1000 offers by far the best value for money, as well as the best support. No wonder Yaesu call the FT-1000 'The Best of the Best'!

For the full story on the incomparable YAESU FT-1000, contact your local Dick Smith Electronics store for your copy of YAESU's 12 page full colour booklet.

Also, see A.R.A review in Vol 13 No. 2 issue, and A.R. review in July/August 1990 issues (copies of both reviews available upon request).

\$5295

Cat D-3200

DICK SMITH
ELECTRONICS

Yaesu FT-411 2m Hand-Held THE POWER OF A BASE STATION IN THE PALM OF YOUR HAND!



The FT-411 is a top-of-the-line ultra compact 2 metre handheld offering an incredible array of features without the size and weight of previous sets. Expanding on the microprocessor controlled features of previous models, the front panel multi-function back-lit keypad allows easy frequency entry, selection of the 49 tunable memories (which store repeater shifts, or separate Tx/Rx frequencies), setting of the programmable-interval 'power-saver' system, as well as a host of other convenience features. CPU control also offers 2 VFO's, rotary dial tuning with 5 selectable tuning steps, a multi-function back-lit 6 digit LCD screen with bargraph Signal/P.O. meter, and a range of scanning options. Even VOX (voice-activated transmit) circuitry is provided, allowing hands-free operation with the optional YH-2 headset.

Yaesu have also recognised that a hand-held radio must be ruggedly constructed, and yet be small enough and light enough to carry around all day. Through the extensive use of surface-mounted components, a heavy duty die-cast rear panel, rubber gasket seals around all external controls and connectors, and a carry case supplied as standard, the FT-411 will provide reliable operation even in dusty or humid environments while measuring only 55 (W) x 155 (H) x 32mm (D), and weighting less than 550 grams (including an ultra long-life 1000mAh NiCd battery giving 2.5W output). A range of inexpensive optional accessories are also available to provide flexibility for users differing requirements. See ARA review Vol 12 Issue 3, and AR review January 1990 issue.

Complete Package:

FT-411, 7.2V 1000mA/H NiCd (FNB-14), Carry Case, Antenna, Belt Clip, and Approved AC Charger.
D-3350

\$399

Optional Accessories

FNB-11	12V 600MAH NiCd Battery (for 5W RF out)	D-3496	\$99.00
MH-12A2B	Speaker/Microphone	D-2115	\$49.95
YH-2	Mic/Earphone Headset	D-2200	\$49.95
PA-6	12V DC Adaptor/Charger	D-3498	\$39.95

**EXCLUSIVE
2 YEAR WARRANTY**

YAESU STOCKS NOT HELD AT ALL STORES. PLEASE CONTACT YOUR LOCAL STORE FOR STOCK AVAILABILITY, OR ORDER BY PHONE...

DICK SMITH
ELECTRONICS

• **NSW** • Albury 21 8399 • Bankstown Square 707 4888 • Blacktown 671 7722 • Brookvale 905 0441 • Bondi 387 1444 • Campbelltown 27 2199 • Chatswood Chase 411 1955 • Chullora 642 8922 • Gore Hill 439 5311 • Gosford 25 0235 • Hornsby 477 6633 • Hurstville 580 8622 • Kotara 56 2092 • Liverpool 600 9888 • Maitland 33 7866 • Miranda 525 2722 • Newcastle 61 1896 • North Ryde 878 3855 • Parramatta 689 2188 • Penrith 32 3400 • Railway Square 211 3777 • Sydney City 267 9111 • Tarragong 66 1711 • Wollongong 28 3800 • **ACT** • Belconnen (06) 253 1785 • Fyshwick 80 4944 • **VIC** • Ballarat 31 5433 • Belmont 43 8522 • Bendigo 43 0388 • Box Hill 890 0699 • Coburg 383 4455 • Dandenong 794 9377 • East Brighton 592 2366 • Essendon 379 7444 • Footscray 689 2055 • Frankston 783 9144 • Geelong 232 7111 • Melbourne City 399 Elizabeth St 326 6088 and 246 Bourke St 639 0396 • Richmond 428 1614 • Ringwood 879 5338 • Springvale 547 0522 • **QLD** • Brisbane City 229 9377 • Buranda 391 6233 • Cairns 311 515 • Chermide 359 6255 • Redbank 288 5599 • Rockhampton 27 9644 • Southport 32 9033 • Toowoomba 38 4300 • Townsville 72 5722 • Underwood 341 0844 • **SA** • Adelaide City 223 4122 • Beverley 347 1900 • Elizabeth 255 6099 • Enfield 260 6088 • St. Marys 277 8977 • **WA** • Cannington 451 8666 • Fremantle 335 9733 • Perth City 481 3261 • Midland 250 1460 • Northbridge 328 6944 • **TAS** • Hobart 31 0800 • **NT** • Stuart Park 81 1977

ORDER BY PHONE OUTSIDE SYDNEY (008) 226610 Free Call Sydney Area 888 2105

navigator, Captain Peter had already gone to the Rocks several times. We contracted for his services, and set the departure date as May 6, 1989.

We had the great pleasure and satisfaction of including on our trip Sr Alexandre Filippini, oceanographer and diver, and chief of the Leatherback Turtle Project on the island of Fernando de Noronha. Thanks to his incredible willingness to help, he became an integral part of the expedition.

3. Departure

A full day of preparations included installing a radio and mounting an antenna on the stern of the vessel in order to operate maritime mobile, as well as carrying aboard all the needed materials. Finally, at 2108 UTC on May 6, 1989 we put out to sea from the Yacht Club at Natal. It was Saturday and we had a favourable wind. Our departure was recorded by TV Manchete, Channel 8, which broadcast the pictures at 2230 UTC on May 8.

We were quite tired and soon began to experience seasickness. We had a long trip ahead of us before arriving on the Rocks.

On the following day, Captain Peter advised that we were already 70 miles from Natal, taking advantage of a favourable wind. He showed us how to maintain the course, using the tiller and the compass. After that, we took turns in steering the vessel. While it was still morning, we turned on the old YAESU FT-707 and made the first contact, maritime mobile. It was with Felipe PS7FNG from Natal, at 1125 UTC. We were then contacted by Silveira PS7CW, who had contact with our families. Soon after Pepe PT7BR arrived on frequency from Fortaleza. These last two kept daily contact, passing news of the voyage to our families.

Early Monday morning, 8 May, we were visited by 12 dolphins which escorted the vessel for over an hour, making manoeuvres around the prow. We made contacts with Natal and Fortaleza, then Captain Peter started the motor, since there was a complete lack of wind. The ensuing calm lasted until our arrival at the Rocks.

On Tuesday the dolphins reappeared. We changed our heading towards the island of Fernando de Noronha, to refuel, since we were motoring more than had been anticipated. We arrived at PY0F at 1730 UTC. After a VHF contact with Andre PY0FF, we obtained fuel. A freshwater bath and an excellent meal in the hotel were next, and we left Fernando de Noronha at 2100 UTC headed for the

Rocks.

May 10, 1989, Wednesday. A normal day, we continued to motor. In the morning, we met a ship flying the British flag and verified that our heading was correct. It rained in the late afternoon, so we were able to take a bath on deck.

On the following day, a total calm, the ocean like a mirror, completely without wind, without waves. Sultry. We stopped the vessel and swam around it for a while.

On Friday, we continued without wind. We tested three generators and found that the 300 watt Honda was not working. We saw a distant ship which confirmed our position.

May 13, 1989, Saturday. An historical date, much celebrated in Brazil, Day of the Freeing of the Slaves. Still using the motor, we crossed the Equator at 1130 UTC and had a little joke with Leo PS7JS/ZY0SY. We told our radio contacts that he (Leo) had brought along a big knife in order to cut the Equator line!! In the afternoon, heavy rain all around us; we could once more wash off a little of the salt. Finally, at 1605 UTC, Karl PS7KM/ZY0SS spied the Rocks, still only a dot on the horizon. After confirming it with binoculars, we also noted a fishing boat next to the Rocks. At 1933 UTC, already quite close, we began circling the Rocks and identified the fishing boat as the Do Rio Negro, belonging to Sr Manoel Figueredo da Silva. We approached to speaking distance. Sr Manoel, a Portuguese resident of Recife, was jovial and outgoing, quite talkative and friendly, and had fished in the area for over eight

years. He immediately volunteered to help us in any way possible. We anchored for the night, about 200 metres off the Rocks.

4. Landing And Operations

Sunday, May 14 1989. The second Sunday in May, Mothers Day, an important day for all of us, we should love to be in our homes, near our families. To make up for our absence, we made contacts via radio from a distance of over 1000 km.

At about 1035 UTC, low tide, we began the landing, using the inflatable boat from the Shanty and a little aluminium boat from the Do Rio Negro. Karl PS7KM and Captain Peter stayed on our vessel, organizing and passing along the various items. Tino PT7AA and Alexandre in the inflatable, with Leo PS7JS and a seaman from the Do Rio Negro in the aluminium boat, made the first trip. The distance was only about 70 metres. They carried a large amount of material: canvas, wood, antennas, water, food, a radio and battery. The calm sea permitted an easy landing. Leo PS7JS was the first to set foot on the Rocks. We set the stores on top of the stones. A strong wave surprised us, soaking the Yamaha 1400-Watt generator, parts of the baggage, food, camera, flash, two two-metre rigs and the coaxial cables.

We carried the material up higher, near the remains of the old lighthouse, clear of the waves. Confronting hundreds of gulls, we set up the tent and two antennas: a vertical for 10/15/20/40 and a beam for 10/15/20. We installed radios



The pinnacle of success!



Place of operation

and generators, and began activities. High SWR on both antennas; after a change of coaxial cable, it appeared that the vertical would give better results. This proved to be the case.

At 1848 UTC, 28 MHz SSB, ZY0SS made the first contact of the expedition; it was with K2EWB, Leon. Soon after, we contacted the first Brazilian station, PT2BW. We continued although very tired. Propagation was excellent on all bands. At 2115 UTC, 28 MHz CW ZY0SW called CQ and made the first contact with PY2PA Jacintho, ex-PY0SJ. The next QSO was with WP4ACE. Unfortunately, ZY0SW had to use a hand-key, the electronic key was left on the boat, and we could not return in the dark.

Tuesday, May 15 1989. Quite early, still dark, we were awakened by strong gusts of wind and rain which hit with enormous force. We managed to keep the tent upright. At 1305 UTC the wind and rain returned and this time succeeded in knocking over the tent and antenna. After the storm had subsided, we moved the tent to a better protected location on an incline. The canvas was set low, giving us more safety. After a few hours, we returned to the radio on SSB, a great pile-up, and we used split up to 25 kHz. At noon the temperature reached 45° C. At 2109 UTC we began operating CW again.

May 16, 1989. A little accident, Karl ZY0SS fractured a toe. Captain Peter advised that, while running the motor during the storm, in order to avoid collision with the other vessel, he broke the gear box! Alexandre managed to catch about 10 lobsters for our lunch, at 1900 UTC. It was impossible to eat at the

usual time, due to the tremendous heat, our real enemy.

On the following day operations ran normally, and at night RTTY operations began. After connecting the equipment, Leo ZY0SY made the first contact on 14 MHz, with F2BS at 2225 UTC. This was followed by a QSO with PT2BW. The equipment began to misbehave. We made the last contact on May 18 at 0016 with JA1ACB, and soon afterwards the computer and interface stopped working. We worked 37 stations. The Commodore 64 computer and MID-1000 interface were damaged by over-voltage. This finished the RTTY operation, nevertheless, we were pioneers!

May 18. The operation continued normally, no problems, SSB and CW. Each operator worked three hours. Karl ZY0SS still suffered from his swollen foot, and could not stand up for long. Around 1400 UTC the Yaesu FT-707 stopped receiving, transmit still ok. We put the Kenwood TS-130 on the air.

Friday, May 19. We continued operating, more than 5000 contacts. Propagation very good for VK, ZL, JA and 3D2, from 10 to 40 metres. USA and Europe, no problems, but incredible pile-up. In the afternoon we were visited by Sr Manoel and some of his crew for lunch. They brought fish and some lobsters. We opened a bottle of champagne to celebrate the success of the operation. At night, after a CW contact with PY1BVY, the electronic key quit. Operation continued on SSB.

Last operating day, Saturday, May 20 1989. With some of the equipment already on the vessel, we started packing

the rest. Meanwhile, Karl ZY0SS continued operating and made the last contact at 0932 UTC on 40 metres. It was with JA2BAY, thus bringing to a successful conclusion the DXpedition to Saint Peter & Saint Paul Rocks by the Natal DX Group.

With a full moon and low tide, the sea quite choppy, we began to load the remainder of the equipment to the Shanty. It took several trips. Leo ZY0SY was the last to leave the Rocks. At 1315 UTC, we began the return trip, heading Fernando de Noronha, with a strong wind.

The wind stayed very good, but fatigue was general. We were, in fact, completely exhausted. We spotted the island at 1000 UTC on Wednesday, May 24. With a torn mainsail, we could not approach the island and wind and current were against us. We made radio contact once more with PY0FF Andre, who helped by sending two small fishing boats to tow us into port. At 1700 UTC we succeeded in landing. That evening, Andre presented us with a marvellous dinner at his house.

At 1800 UTC the following day, we continued the trip to Natal. On Friday it rained heavily. Unable to use the sextant, we made contact with some ships to learn our position. That night we glimpsed the beam from the lighthouse of the Atol das Rocas. In the early morning of May 27, Saturday, the current carried us dangerously close to the atoll. With difficulty Captain Peter avoided it, to our great relief, at 0412 UTC. The moon was very bright, we could see the birds and hear the noise of the waves beating on the rocks. A tense moment! Around 0700 UTC, a wind came up which carried us toward the continent and Natal. We sailed very well for the entire day.

Sunday, May 28, 22 days into the trip. A long way from home. At 2100 UTC, we saw the continent. In spite of Captain Peter's efforts, the current was carrying us toward the Ponta do Calcanhar, 65 km off, and to the north of Natal. We passed the day trying to overcome the current, the wind against us, and each hour farther away from the coastline.

At 1000 UTC on Monday, May 29, the wind improved and little by little the land came nearer. Still early in the morning, by radio, we were informed that PT7BR Pepe and PT7SY Nivardo were in Natal to welcome us. At 1800 UTC we sighted the highest buildings of Natal. At last, we entered the Rio Potengi and anchored at the Yacht Club of Natal at 2320 UTC. The DXpedition to Saint Peter & Saint Paul Rocks was successfully completed!

Various hams were awaiting us, PT7BR, PT7SY, PS7RN, PS7CW, PS7BY, PU7ILP, as well as our family members.



Landing

Tired but happy, we felt ourselves to be truly radio amateurs. It was a great adventure, an achievement of international renown, to put on the air one of the most difficult locations in the world — PYOS. And, after a magnificent dinner with friends and families, still tired, we slept soundly without the rolling of the sea.

5. Antennas And Equipment

We used the following rigs and antennas:

Radios:

- 2 - Yaesu FT101 & E, with VFO
- 1 - Yaesu FT707 with VFO
- 1 - Kenwood TS 130, with VFO
- 1 - Kenwood TS 820S, with VFO
- 1 - Yaesu FT 208R, HT 2 metres, damaged by the seawater, unrepaired.
- 1 - Icom IC2AT HT, 2 metres, damaged by the seawater, unrepaired.

Antennas:

- 1 - Tribander, 10/15/20 metres
- 2 - Ground plane, 10/15/20/40 metres
- 1 - Dipole w/traps for 80 and 160 metres
- 1 - Dipole for 10/15/20/40 metres

Miscellaneous:

- 1 - Computer, Commodore 64, unrepaired.

- 1 - TV B&W 5", Samsung.
- 1 - Interface, MID-1000, unrepaired.

6. Propagation

The propagation was excellent on any part of the bands from 10 to 40 metres. On 80 and 160 metres, strong QSB, QRN and QRM, few contacts made on these two bands. Stable propagation permitted hearing and working USA, Europe, Africa and Asia at any hour. We worked VK, ZL and JA at noon on 14 and 21 MHz.

7. Comments

We certainly had our shortcomings. The lack of a better knowledge of the location led us to make some mistakes. These will surely not be repeated, for we want to reactivate the Rocks in May of 1991. However, in spite of all the problems, we successfully accomplished our work with honesty and within the principles of the radio amateur. We made 6325 contacts overall, and worked 111 countries. On SSB there were 3502 contacts, on CW, 2786 and on RTTY, 37.

8. Losses & Damage

We suffered much equipment loss due to high seas and are forced to use all

donations to replace with new ones. The equipment belongs to PS7 ham friends.

Lost:

- 1 - Yaesu FT 208R, HT 2M
- 1 - Icom IC2AT, HT 2M
- 1 - Olympus 35mm camera
- 1 - Flash for Olympus
- 100m - Coaxial cable
- 1 - Tool box
- 1 - Computer, Commodore 64
- 1 - Interface for RTTY, MID-1000 & cartridge program

Damaged:

- 1 - Yaesu FT 707, reception unit

9. Acknowledgements

At this time we must express our most sincere thanks to all those who helped us, especially the following:

- Esquina Pneus, Natal, RN
- Helisom, Natal, RN
- CISAF, Natal, RN
- Poty Refrigerantes, Parnamirim, RN
- Dinel Baterias, Natal, RN
- Araucaria DX Group, Curitiba, PR
- Northern California DX Foundation, Inc., NCDXF, USA
- European DX Foundation E.V., EUDXF, West Germany
- International Amateur Radio Society, IARS, USA
- International DX Association, IN-DEXA, USA
- Down Town DX Association, DTDXA, Japan
- DXNS, TDXB, 59, QRX DX, QTC Bandeirantes, Worldradio, LIXB, DXPress, Les Nouvelles DX, RTTY Journal, Radio Sporting, Antena-Eletronica Popular, Radio Rivista, etc.
- Austin Condon, VK5WO, Australia
- Sr Manoel Figueredo da Silva, Recife, PE
- Alexandre Filippini, Fernando de Noronha, PE
- Andre Sampaio, PY0FF, Fernando de Noronha, PE
- Gin Naniwada, JA1ACB, Japan
- La Roy E Miller, KA7BSD, USA
- Harry Makler, KX6C, USA
- PY1AFL, BVY, PT2BW, PY2PA, PS7ACB, BB, BF, BW, BY, CW, ER, RF, RL, SO, WB, WP, PU7IBZ, PY7DY, PT7BR, BZ, CG, CQ, OQ, SD, SY, WA.
- JA2JW, EA7FWM, NI5D, IK5AAX, TG9VT, W8KV, NE8Q, W7AMM, JH1ROJ, JG1OUT, I5FLN.

Also, to all those who, directly or indirectly, contributed to the success of the expedition, our MUITO OBRIGADO! (grateful thanks).

Natal DX Group
Caixa Postal 597
59021 Natal RN
Brasil South America

Contacts By Band & Mode

Band/Mode	10	15	20	40	80	160	Tot Mode
SSB	820	955	1466	244	14	3	3502
CW	680	671	1053	370	10	2	2786
RTTY	-	-	37	-	-	-	37

Tot Band	1500	1626	2556	614	24	5	6325
-----------------	-------------	-------------	-------------	------------	-----------	----------	-------------

Countries worked - SSB, 104
 CW, 47
 RTTY, 11 — Total 111

Contacts By Band & Mode & Continent

Bd/Md/Cont	AF	OC	SA	EU	AS	NA	Tot Bd/Md
SSB	10	1	79	403	25	302	820

10							
CW	2	-	32	490	6	150	680

SSB	22	2	63	368	58	442	955
-----	----	---	----	-----	----	-----	-----

15							
CW	-	6	27	201	113	324	671

SSB	5	28	195	94	278	866	1466
-----	---	----	-----	----	-----	-----	------

20							
CW	2	5	61	236	366	383	1053

20							
RTTY	1	-	3	6	1	26	37

SSB	2	24	57	1	1	159	244
-----	---	----	----	---	---	-----	-----

40							
CW	1	-	18	104	-	247	370

SSB	-	-	14	-	-	-	14
-----	---	---	----	---	---	---	----

80							
CW	-	-	10	-	-	-	10

SSB	-	-	3	-	-	-	3
-----	---	---	---	---	---	---	---

160							
CW	-	-	2	-	-	-	2

Tot Cont	45	66	564	1903	848	2899	6325
-----------------	-----------	-----------	------------	-------------	------------	-------------	-------------

Average	0,72%	1,05%	8,92%	30,08%	13,41%	45,82%	100,0%
----------------	--------------	--------------	--------------	---------------	---------------	---------------	---------------

AF=Africa, OC=Oceania, SA=South America, EU=Europe, AS=Asia, NA=North America.

What Is History?

J W EDMONDS VK3AFU/ATG

FEDERAL HISTORIAN

PO Box 565 Mt WAVERLEY 3149

Henry Ford is alleged to have said that "history is bunk". The popular consensus is that history is a Good Thing provided we don't have to learn from it. The WIA has recognised for many years that it should have a consistent policy on the collection of historic material and information but by its very nature the Institute has not been able to catalogue its records on a consistent basis. We now have a large quantity of radio journals, ranging from seven copies of *Amateur Radio* for several months of 1973 to irreplaceable issues of journals from the 1910s and 1920s. This material is sorted but requires further cataloguing, the sort of work that is simple enough but tedious.

The sorting of other documentary material is far from tedious. Unfortunately it is only too easy to be distracted from the task of sorting by the fascination of the social history of amateur radio. The minutes of the Federal Convention of 1956 are interesting and perhaps useful to a historian but can they compare with the documentation of the foundation of the QRLT in 1927 because "the Wireless Institute is not all to the amateur that it should be"? At a time when the role and relevance of the WIA is being questioned and argued perhaps the several attempts to set up rival or complementary organisations have special interest.

Two characteristics define amateur radio, a lot of people with enthusiasm for their service and hobby, and frequently burning fervour for argument, division and discord. We seem to hold our opinions about our hobby with a simple passion which history sometimes shows to have been too simple. Attempts to set up rival organisations to the WIA have not been well documented. We don't have enough primary evidence. If any amateur has primary or secondary source material about the QRLT or our ARRL in particular, and other less successful groups, it could be consolidated into a less scrappy history than we now have. I would particularly appreciate copies of material collected by individual amateurs who have had a special interest in other organisations.

The social development of our hobby is perhaps as worthy of record as our technical achievements. After which cliché the amateur historian loses track of time in the records of 3HL's first two-way contact with England in 1926 with 5XY in Lancashire. "...at 6am Monday. The Morse signals came in most clearly and were interchanged for about half

ar

Use the form on the reverse of the Amateur Radio address flysheet.

an hour" reported the "Stawell Times". The "Kerang New Times" reported that "3HL has a very fine assistant operator in his mother who can handle the receiver and transmitter as effectively as her son." And that of course leads us into the need for well documented research into the historic role of the early women amateurs. Is anyone doing anything about it? If so please let me know. The WIA has a fair bit of anecdotal information but again we are lacking in primary source material so this is another request

ar

Novice Licences In Britain

Britain will have Novice licensing soon because the Government recognises amateur radio's role as a training ground for careers in electronics and radio engineering.

The Radiocommunications Agency has announced after more work is done on syllabus there will be Class A and Class B Novice licences available within 12 months.

Class B licence will permit operation on segments of 50 MHz and 430 MHz bands, plus 1.3 GHz and 10 GHz (the latter will be of particular use in classroom experiments).

On passing a 5 wpm Morse test Class B Novices will be permitted limited operation on 1.8 MHz, 3.5 MHz, 10 MHz, 21 MHz and 28 MHz.

Maximum power output will be 3 watts (or 5 W dc input).

The entry qualifications are attendance and completion of a training course which the RSGB intends to provide followed by a multi-choice examination.

ar

Berlin Wall Collapse Opens Up Amateur Radio

The pulling down of the Berlin Wall and moves towards reuniting East and West Germany have also seen radio amateurs in both countries coming together.

They can now operate in each other's countries using their own call sign without the need to obtain permission or a reciprocal licence.

It has been reported a very warm spirit of friendship now exists between the radio amateurs of the previously divided countries.

ar

THE NEW CHALLENGE

A FABLE BY "EYE SOP", OR A HIT IN THE EYE ON SIX METRES"
J F HANRAN VK4JH

The lush pastures of Magnetosphere had, over the past decade, been badly ravished by Greenhouse. It was however, the beginning of a new challenge for Ultraviolet, who looked longingly at Ionosphere, and dearly wished to caress her Oxygen and begin a new lineage of Electrons and Ions. Although Magnetosphere had been passive for quite some time, and had decided to help, its distant cousin, Rising Magnetic Loop, had suddenly become very disturbed and was moving at an alarming rate through Photospheric Granules Del Sol, hell bent on giving birth to its own prodigy at the beginning of this new era, Cycle 22.

The impulsiveness of Rising Magnetic Loop could not be subdued, and this created chaos. Havoc reigned supreme. Umbra and Penumbra joined forces with their brothers and sisters to restrain Rising Magnetic Loop, who for a while, seemed to be suspended in space by family ties. But with increasing contempt, and writhing in anguish with the restraint he rose majestically in an open arch, quivered and broke free. This was the exact moment Ultraviolet had been waiting for, and with the speed of light he seized Oxygen. The union gradually produced brother Electron and sister Ion. Dielectric Field watched them grow and Magnetosphere moulded their character.

However all was not well. The influence of Dielectric Field was catastrophic, but not to the offspring, who flourished! At the bottom of the Dielectric Gradient, low potential prevailed. Energy was all but exhausted. Hades had risen to the surface of the earth, and in many places, and a new phenomenon "50.110" had been unleashed. This was a contagious plague of major proportions, which threatened to engulf all.

The renowned scientist "COMMON-SENSE" at the bottom of the "Gradient", could find no answer to the plague that had covered the surface of the earth. There was no cure for the virus. Anyone approaching this domain, would surely be blighted, even when only approaching its vicinity, if they lingered too long, yet it was essential that this place be visited, if progress was to be made. All seemed lost! One glimmer of hope remained for those infected with "50.110".

Recent archaeological excavations had uncovered some rare clay tablets from the past, and upon translation of the archaic script, it was discovered that this was a cyclic virus. It had occurred only infrequently in the past, and had very quickly disappeared within two or three years of its appearance.

However, it had also been documented that occasional trips of short duration to its habitat, depending upon the nature of the visitor, could produce great rewards which appeared to be infinite. Conviviality, discovery, and rejuvenation of spirit, to name but some.

Having at long last found the formula for the lost vaccine to combat the virus, great quantities were manufactured. The inhabitants of the lower Gradient of the Dielectric Field then, having self-administered the vaccine, very quickly returned Hades to the Shades, so that these dejected souls would no longer feel lost.

The virus "50.110" remained, and eventually became neutralized. The pleasure of all who were later infected with the neutralized virus, was "EC-STATIC".

Finis

All characters and places mentioned herein are purely fictional, and bear no relationship whatsoever to anybody or anything — LIVING or DEAD.

ar

Support the advertisers who support Amateur Radio magazine.

24 MHZ DX OVER 7 YEARS 1982-1989

GRAHAM ROGERS VK6RO
22 GRACE ST FERNDAL 6155

Immediately after replacing the telephone hand piece after talking to Michael Owen VK3KI at approx 0810 GMT on 17 December 1982, I tuned up my 28 MHz quad on 24.940 MHz and called CQ. The actual time was 0829 GMT.

Of course I did not receive a reply but from that moment on I embarked on an exciting career in experimenting nearly every day on 24 MHz.

The 24 MHz band really is an exciting band, full of surprises.

Dozens of times I have called CQ DX on what seems to be a dead band and I have been happy to work a new station or country and have a long rag-chew with absolutely no other stations on the band at the time.

The lack of other VK stations was a surprise, but very, very few were heard until about 1988-1989 when more countries were able to use the band.

My very first contact with DL7UX at 1312 GMT on 17 Dec 1982 on CW was as exciting as my first ever contact on amateur radio and I was well and truly "hooked" on this brand new amateur band. How often do we get a new HF band to play with, the previous time was when 21 MHz was released many years before (apart from 10 MHz).

With the band only a day or so old, I spent a lot of time looking for contacts.

The next few countries were G3KMA, OZ2RH, F8FE, HB9FTR, 4F6CA, OE5HEW all in 1982 then came 1983 with PA0PN, GW3AHN, A4XYF, GI4GPC, VK9YC, ZS6JW, K1BJ/3B8, K1BJ/389, TR8DX, FB8ZQ, 5B4PW, LX1YZ. These were good contacts, something out of the blue with no warning that the band was open.

The bottom of the cycle from 1984 to 1987 saw T77C, VU2LO, I4ZFY, VK9XJ, KH6SB and then one day in 1987 I met Brian, K6STI, a real nice bloke, an electronics engineer in Vista California. Brian was to remain a good friend up to the present day. He has a very good signal using a 2 element yagi and about 600 watts output.

Some amateurs may recognise Brian as the inventor of the Y.O. Yagi optimizer computer program. He is an expert on

Yagi antennas!

It took about 2 years of experiments with Brian before I worked him long path.

Some European countries have been worked long path at any time from about 0800 to 1330 GMT, and I even worked Harold, N9DEO in Indiana at about 1320 GMT via short path which is very unusual.

The remainder of 1987 saw SM0NTE, KH2D, 9MZFS, G6ZY/EA6, ZY4CG, YU1UM, all new countries.

KH2D became a good friend. Jim used a triband Yagi with 24 MHz extensions hanging down from the elements at the correct positions to allow 24 MHz to be used with gain and directivity; it worked well. Jim certainly was a character and had some great stories to tell about life on Guam; he even offered to send me a Yaesu FL2100Z via B52 bomber aircraft to Darwin, and I would have it sent from Darwin. Alas, the amplifier ended up in Japan with major faults, it never did have a ride in a B52!

During 1988 the band really began to pick up with many new countries worked, starting with ZC4JV, EA5CHT, ON4AZR, OE8PRK/YK, OK1AGP, WY5I/KH3, SV0FG, KX6DC, TZ5TT, ZLIBEY, H44DL, EA5BS/EA8, TI2KO, then a young lady popped up in the guise of P29ZL, Jeanette. She became a good friend and we had round tables with K6STI, P29ZL, KH2D and myself, for hours at a time with no other stations on the band.

Also during 1988 9J2WS Bill, FO0BY, GM0HXV, TK5BF, FR5EL, CTIBCM, VE1YX, HZ1AB, ZS3OM, FK0BC, YC0ECF, ZK1DO (South Cook), YJ0AFU, GJ3EML, T30BC, K4EQY/KH0, 4S7NMR, 4X4FF/5N4, OD5RF, FM5WD, KV4AD, VK9NQ, AL7I, then T50DX (an Italian 24 MHz friend in disguise), BY1QH, 1A0KM, CE3ESS, LU5DJO, PY3NZ, OY5ML, 8Q7DL, IS0EP, EI4DQ, EA9TP, SP3AGE, 9K2DR, TU2QQ, VK9ZM (Mellish on 15/1/89). So that was the end of 1988 and a lot of fun was had working these new ones.

By 1989 the Sunspot cycle was really hopping with many new countries available, starting with VK9ZM, VP5/AA5AU,

HK0BKK, VQ9MQ, CA6XEA, 9N1MM, V85AA, (6ANX, TA1AW, KH6JEB/KH7, KC6MS (Micronesia), AP2MB, VK0JV, TL8WD, VS6UP, ZS8MI (a good one that!)) then on the 10 June 89 up popped my 100th country being XE2GFH, this was really my mate Brian K6STI who drove to Mexico without me knowing to give me the magic 100th! I thank you Brian, it was a very great pleasure and surprise.

After that came Z2ICS, VK0GC, GD4BEG, ZS4NS/3DA0, OH4RH, JH8RG0, HA3YC, CN8MC, T32IO, 5W1IK, KC6NX (Becau), OH3JF/OH0, 441ITU, 9H1IP C31LBB, UA3D0S (the first of many Russians), then a few other were JD1, XX9KPL, TF, S79, SV5QR so up to the 10 Dec 89 a total of 132 countries in just under seven years.

As you can see there have been many very rare countries on 24 MHz and a lot

A Call to all Holders of a Novice Licence

Now you have joined the ranks of amateur radio, why not extend your activities?

The Wireless Institute of Australia (N.S.W. Division) conducts a Bridging Correspondence Course for the AOC and LAOC Examinations.

Throughout the Course, your papers are checked and commented upon to lead you to a successful conclusion.

For further details write to:

The Course Supervisor

WIA

PO Box 1066

Parramatta NSW 2124

(109 Wigram Street, Parramatta)

Phone: (02) 689 2417

11am to 2pm Monday to Friday
7 to 9pm Wednesday

of exciting times were had. The last two countries in December 1989 were XV2AA and KE0SC/D43.

Some events which proved interesting included working SM and LA stations on CW with signals coming BOTH ways making CW very hard to decipher.

Many of the Caribbean countries were worked with the Beam across Europe between 1200 and 1500 GMT.

Longpath to the East Coast USA occurred at about 1200 GMT onwards.

K1ZFE, Bill was worked short path, long path and across both North and South Poles at different times. Very strong

signals from Bill and KA1PE occurred very often across the North Pole from 1100Z onwards.

Propagation on 24 MHz can be very different from other bands at times and experiments proved to be very interesting most of the time.

The Beacon IK6BAK is very often received as early as 0500 GMT until very late (1600 GMT).

The PY beacon on 24.900 shows up in Perth around 1030 GMT.

Once encountered a pirate — CBer on 24.950 talking on SSB to J28CB. This pirate was from West Germany and was

using CB talk! (SSB is illegal in DL on 24 MHz.)

Although the band is now amateur exclusive, in the old days many commercials would show up. Also some very salty language from Australian fishermen (pirates) using LSB off the East Coast was observed in 1988, 89.

I have also been active on 18 MHz and have worked around 100 countries, but it comes second to good old 12 metres. Perhaps you should try it. Good luck! Thanks to VK3KI for telling me we had the band during that phone call in December 1982.

ar

1 2 3 4 5 6 7 8 9 10

1										
2										
3										
4										
5										
6										
7										
8										
9										
10										

Morseword No.41

Clues To Morseword No.41

Across

- 1 Camera part
- 2 Hide
- 3 Band
- 4 Touch
- 5 Endure
- 6 Cook
- 7 Painful
- 8 Walk
- 9 Face with masonry
- 10 Slip

Down

- 1 Quick
- 2 Material
- 3 Part of the eye
- 4 Annoy
- 5 Slaps
- 6 Stare
- 7 Cost of journey
- 8 Severe
- 9 Skin
- 10 Within

Audrey Ryan © 1990

Solution Page 56



Storm watch co-ordinator Manfred Willinger VK4KHW of the Brisbane area WICEN group in his "bomb shelter" gathering damage reports. (Picture courtesy The Courier Mail Brisbane.)

The Storm Watch Net

In South-East Queensland, radio amateurs act as "storm spotters" and their observations help update the Weather Bureau and State Emergency Service on approaching severe weather. The group belongs to the Wireless Institute Civil Emergency Network, and has been involved in numerous storm situations for more than a decade.

WICEN State Director, Harry Stanfast VK4ACF said when there was the likelihood of a storm, reports were called for on the Brisbane two metre repeater VK4RBN. When damage reports start to be received an actual Storm Watch Net begins. The Net Co-ordinator Manfred Willinger VK4KHW of Moorooka operates from his radio shack in a European-style bomb shelter. Harry said the storms usually build up around 4-5pm and reports of power lines down, roofs damaged, tree debris, hail damage and flooded roads are gathered on the repeater. The reports provide advanced warning to the SES of where damage has occurred for activation for their volunteer crews, he said. The Weather Bureau monitors the net, which helps it plot the path of a storm cell, and has often expressed appreciation to those who provide timely weather and damage observations.

The Storm Watch Net was extremely busy when Cyclone Nancy unleashed her fury in February this year, causing widespread flooding and power blackouts.

ar

Don't buy stolen equipment — check the serial number against the WIA stolen equipment register first.

AWARDS

PHILL HARDSTAFF VK3JFE
FEDERAL AWARDS MANAGER

Recent Awards Issued

WAVKCA

No	Call	Name
1818	G4LVQ	Bob Williams
1819	N6PYN	Merle Elson
1820	DJ2PJ	H D Teichmann
1821	VK3BRZ	C Gnaccarni
1822	K5FNR	Terrence Morgan
1823	JF2WXS	Hiroshi Ban
1824	Y25TM	Dieter Phebe
1825	JE1DXC	Masayoshi Mihara
1826	JA6BZA	Isao Sakagami
1827	KE5PA	David Whittington
1828	JR1GJL	Kazuyoshi Amano
1829	ZL1BKY	A N Rankin
1830	LA4HW	Ole J Oddsen
1831	G4NXG	Alan J Birch

WIA80

42	W8AXI	Robert Weingartner First Michigan
43	KH6OE	Patricia Hibbs First Hawaii
44	DJ2MN	Manfred Vogt First Fed Republic of Germany
45	N4TKF	Philip Watkins
46	WA3MME	James Ferguson

WAS VHF

179 VK3BRZ (Six Metres) C Gnaccarini

Grid Square Award

Following my request in this column last month for some input about this award, I got a phone call from Charlie VK3BRZ, and we had a long discussion about this award. I would also like to point out that I have on file letters from John Martin VK3ZJC and Daniel Dobrosak VK3KKW, as well as numerous letters from Charlie VK3BRZ. Over the next month I will be putting together the draft rules mainly from the suggestions of the three people mentioned above, and my own ideas. These draft rules should be published next month. I won't really add any more at this stage but, suffice to say, if you want to have some input into this award — now is the time. I can be contacted weekdays after 7.30pm and at weekends on (03) 434 6424. I would like to have the draft rules in this column next month, and await some feedback. I will then try to have an amended set in the month after that, and, following from there, try to have the award available within three months.

DXCC

Until today (07-07-90) I have been unable to find enough time to get stuck into the DXCC records. My first goal is to issue awards for DXCC which are presently outstanding

(VK3EBP, VK3BRZ, VK4BJE) and then do some updated listings. I had a letter from Frank VK2QL who sent cards for 3COGD (Annobon) and ZS9/DK7PE to take his total up two. Frank kindly donated these cards to the QSL collection, and I will forward them to Ken Matchett and publish his updated figures very soon, I hope — thank you Frank!

I would like to hear from anyone else who has applied for DXCC, but as yet haven't heard anything in reply.

I would hope to be able to get stuck into all the DXCC within two months.

ARRL

I have written a letter to the ARRL to clarify my position re WAS. There should not be any problems with this, and I should be able to report back on this in the next column. I have only one outstanding request for them at the moment. (Andrew VK2GAH, so if you read this Andrew, I will be in touch soon).

Award fees

It would seem that one common way that overseas amateurs find out about our awards is by word-of-mouth from other amateurs. But please don't forget to tell them the correct costs, which are as follows:

WIA Members — free
VK Non-Members — \$5.00
Others — US\$5.00, or 8 IRCs.

The costs involved in getting awards printed, mailing tubes, stamps etc can really add up!

For an outline of the WIA Federal Awards, see AR February 1990 edition, pages 42 and 43. If you don't have this, I can send you a photocopy in exchange for an SSAE.

K1BV

I recently received a letter from Ted Melinosky 9K1BV) who publishes the "K1BV Directory of DX Awards".

I do not have current pricing, but will publish these prices when I receive them. This is most definitely the definitive awards directory and should be a 'must have' for all award hunters. The 1989 edition is 232 pages, and over 1005 awards are listed by country. Ted's address is:

Ted Melinosky
The K1BV DX Awards Directory
Suite 9
525 Fosters Street
South Windsor
Connecticut 06074-2936 USA

Ted sent me a list of awards that require contact during 1990. As the year is already halfway through, I am listing some of them

this month and some more next month, space permitting.

Germany — Bonn 2000 years award

Commemorating the foundation of the city of Bonn in the year 11BC! Contact stations in Bonn from 1 January 1988 to 31 December 1990. One contact per station per band. DLs need 100 points, Europeans need 60 points, all others need 40 points. Point values: Special stations DF0BNN and DK0BNN = 8 points, Club stations DK0AK, DK0HQ, DK0SG and DL0OV = 6 points; all other stations in DOK = 3 points each. CW contacts count double. SWL OK. GCR list and fee of DM7, 6 IRCs or \$US5 to: Harald Kuhnhardt DK1YU, Schulstrasse 10, D-5469 Windhagen, West Germany.

Germany — DARC jubilee award

This commemorates the 40th anniversary of DARC 1950-1990. Work club stations with prefixes DF0, DK0, DL0 during calendar year 1990. Earn 40 points with HF values as follows: SSB = 1 point, CW = 2 points, other modes = 3, DA0 = 5 points. Note, you may use only one DA0. These values may be doubled for DX stations. All modes and bands. GCR list and fee of DM15, \$US8 or 12 IRCs to: DARC — Jubilee Diploma, Postbox 1155, D-3507 Baunatal 1, West Germany.

Japan — WARC '79 award

This commemorates the occasion of official adoption of the WARC bands in Japan. Contact at least 79 stations (one station from each of the 10 areas in Japan must be included) using the 10, 18 and 24MHz bands and receive their cards. Contact must be made during the period 1 July 1989 to 31 December 1990, and the limit for applying is 31 December 1991. SWL OK. The actual cards or a CGR list is acceptable proof. Single-band endorsements are available. Use the JARL award application (see K1BV Radio League Award Desk, 1-14-2 Sugamo, Toshima, Tokyo 170, Japan).

San Marino award

Commemorating the 10th anniversary of San Marino RC. Contact 10 San Marino stations (you can work one station on more than one band to count towards total) between 15 April 1990 and 14 April 1991. GCR list and fee of \$US10 to ARSM, Box 77, San Marino 47031, Republic of San Marino. (TKSG1WMJ).

Sweden

Vasteras AROS Mellenial Celebration Award. Contact Vasteras during the 1000-year celebration period of calendar year 1990. One thousand points must be earned. Vasteras stations need 100 QSOs at 50 points each, all others are worth double the values. SWLs need to receive 10 different cards from amateurs in Vasteras. The same station may be contacted several times, but only one per

band and per day. No repeater QSOs. Special logging sheet available for SASE/IRC. Applications must be mailed by 31 January 1991; SWLs not later than 1 July 1991. GCR list and fee of four IRCs to: Vasteras Rodioklubb, Award Manager, Box 213, 5-721 06, Vasteras, Sweden.

USA — Wyoming Centennial Award

Work three Wyoming amateurs on any band or mode combination during the 1990 calendar year. Look for Wyoming stations to be especially active the week of 8-14 July 1990, Centennial Week. GCR list with \$US2 or three IRCs by 31 January 1991 to: Wyoming Centennial Award, University Amateur Radio

Club, PO Box 3625, Laramie WY 82071, USA.

GCR

General Certification Rule. Most awards allow GCR in lieu of actually wanting your cards. GCR usually means getting the signatures of two witnesses who certify that you possess the cards and that the information you state on the application is correct. If the award rules specify club officials, you should make sure their title follows their signature; include the name of the club just to make sure. (Acknowledgment to Ted Melinsky for the above awards and GCR information). That's all for this month. 73 Phill.

ar

**THIS SPACE
COULD BE
EARNING
YOU MONEY!**
ADVERTISING RATES
AVAILABLE FROM
PO BOX 300, CAULFIELD
SOUTH, 3162

CONTESTS

Contests — Publication of Rules and Results

With the increasing production costs for AR, coupled with the limited appeal of some overseas contests to Australian amateurs, some economies will be carried with overseas contest publicity in AR.

The contest calendar will continue to give the dates of contests, where these have been provided to the FCC. This will indicate that a copy of the rules may be obtained by sending a request with a SASE to the FCC. If overseas contest results are provided to the FCC, results of VK winners will be published.

Contest band segments

Many contests' rules are now giving specific segments to be used for that contest. Is this the way to go to ease some of the conflict that appears from time to time between contesters and other operators? This segmentation may be compared with the popular DXpedition's operating methods; it works well for them. A solid core of VK6 amateurs supports the idea. What is your opinion?

RD contest . . . rules

Please read carefully this year's rules. There have been changes made. Some contentious ones have been removed. Make an effort and participate this year.

Ross Hull Contest

After considering comments made on the Ross Hull Contest over the past few years, a number of major changes are suggested for the 1990-1991 contest.

These changes include allowing the use of all bands above 30MHz, and returning to a scoring system based on distance and frequency. This means dropping the maidenhead locator system and would require entrants to estimate distances to, say, the nearest 100km.

It is also suggested to lengthen the contest,

but to base scoring on the best seven days chosen by the entrant. This should make it easier for amateurs to participate, even if they are not free for the full contest period.

It has become clear that it is now impossible to win the contest without using satellites, so separate terrestrial and satellite divisions are proposed. A new single band section should also generate more activity.

It is hoped that these changes will make the contest more of a challenge while still providing more opportunities for all amateurs to participate.

Tentative dates for the contest are Saturday 22 December to Saturday 19 January, giving four full weeks, but with a week's break for anyone wishing to also enter the VHF/UHF contest. If you have any comments to make on the RX rules, now is the time to do so, because the rules are still being formulated.

ALARA Contest

Eligibility: All licensed operators throughout the world are invited to participate. Also open to SWLs.

Object: Participation: YL works everyone, OM works YLs only. One contest (combined phone and CW) run over 24 hours.

Starts: Saturday 10th November 1990 at 0001 hours UTC.

Ends: Saturday 10th November 1990 at 2359 hours UTC.

***Suggested frequencies:** Bands to be used are 3.5, 7, 14, 21 and 28 MHz only. The following are suggested frequencies for easier location of contacts:

28.380 to 28.410
21.190 to 21.200; 21.380 to 21.410
14.250 to 14.280

Sample Log

Date/Time UTC	Mode	Band	Call	Call	RS(T) & Serial No Sent	RS(T) & Serial No recd	Name	Points
10/11	0135	28	SSB	VK3EBX	59001	58028	Joy	5
	0141	21	CW	VK3KS	599002	599045	Mavis	10
	0600	14	SSB	FK8FA	59025	59011	Aimee	5

7.070 to 7.100
3.560 to 3.590

Operation: Phone and CW operation. Each station may be counted twice on each band for credit — once on phone and once on CW. All contacts must be made in accordance with operator and station licence regulations. No net or list operation, no crossmode.

Procedure: Phone: call "CQ ALARA Contest" CW: YLs call "CQ Test ALARA" OMs call "CQ YL"

Exchanges: ALARA member: RS or RST, serial no starting at 001, ALARA member, name. YL non-member: RS or RST, serial no starting at 001, or OM name.

Scoring: Phone: 5 points for ALARA member contacted 4 points for YL non-member contacted 3 points for OM contacted *CW: Contacts where at least 1 operator is Novice class count double points. SWL: 5 points for ALARA member logged 4 points for YL non-member logged.

*Changed from previous contests
Logs: Single log entry (but Australian YL novices entering for the Mrs Florence McKenzie CW trophy should indicate their CW score separately also). Logs must show date/time UTC, band, mode, callsign worked, report and serial number sent, report and serial number received, name of operator of station worked, and points claimed.

Logs Must Be Signed. Logs also to show full name, callsign and address of operator, and show final score (points claimed). Logs must be legible. No carbon copies. No logs will be returned. Decision of the Contest Manager will be final. Logs must be received by the Contest Manager by 31st December 1990.

Contest Manager: Mrs Marilyn Syme VK3DMS, PO Box 91, IRYMPLE Vic Australia 3498.

Mrs Florence McKenzie CW Trophy:

This will be awarded to the Australian YL novice operator with the highest CW score (not necessarily an ALARA member). Minimum score 50 points. The actual trophy, because of the size and weight, will not be forwarded to the winner, but a certificate bearing a photo depicting the trophy will be sent to the winner each year.

- Certificates will be awarded for the following:
- Top score overall
 - Top score phone only
 - Top score Australian YL novice CW (Mrs F McKenzie cert)
 - Top score ALARA member in each country and VK call area
 - Top score YL non-member in each continent
 - Top score OM in each continent
 - Top score SWL in each continent
 - Top score VK novice
 - Top score overseas YL novice CW
- Trophies will be awarded to the following:
- Top scoring Australian YL
 - Top scoring DX YL

(Mrs Florence Violet McKenzie, 1892-1982, was the first woman in Australia to take out a transmitting licence, in 1921. She passed the Amateur Operator's Certificate of Proficiency in 1925 and obtained the callsign 2GA (later VK2FV). Mrs Mac taught Morse code to thousands of people, particularly service personnel, during the 1939-45 war years. In 1984 the Townsville Amateur Radio Club kindly donated a trophy in her memory).

1990 John Moyie Memorial Field Day Contest Results

JOHN MOYLE FIELD DAY CONTEST
MANAGER
PHIL RAYNER VK1PJ

This is the first contest that I have checked and was surprised to find that some entries consisted of the actual field logs, including operator's scribbles, rubouts, corrections and, in some cases, illegible entries.

I do not expect every entry to be typed, printed by a computer or re-written, I just want to be able to read it.

From comments received with the entries and those heard during and after the contest, everyone enjoyed themselves. Yes, a few grumbles were heard, mainly about the rules. Even though they were in the minority, they did point to a few areas which need attention. Therefore, a thorough check was made of all logs leading to an adjustment of some scores and yes, unfortunately, another change to the rules. But, at least these changes will remain in force for the next three years.

The amended rules will be publicised once they are finalised. Congratulations to all who won their sections, and a special thanks to all who just dropped in to make a few contacts.

24-hour Results

A. VK5AW	2856
VK5GN	2497
VK4NEF	2036
VK5UE	235

6-hour Results

A. VK1PJ	2633
VK5QX	2139
VK4YB	2067
VK7KR	1262
VK3AFW	391
VK2EMU	261

			VK3MI	232
B.	VK2TR	618	B. VK3EFO	230
C.	VK5ABS	1988	C. No logs	
	VK4AIZ	1207		
	VK3CFI	645		
	VK4EV	317		
D.	VK4IZ	7219	D. VK4YX	2002
	VK1WI	5091	VK4WIM	961
	VK3ANR	3911	VK7CHT	546
	VK5SR	3666	VK2GHZ	161
	VK3ZI	3004		
	VK5AH	2928		
	VK2HZ	2658		
	VK3BCG	2538		
	VK3GH	1364		
E.	VK6ANZ	9492	E. VK4WIN	3149
	VK2JA	4925	VK4WIG	1211
	VK2CE	3422	VK6YG	887
	VK2FFG	2729	VK5BAR	826
	VK5ARC	2460	VK6AGN	630
			VK6AHR	506
G.	VK3XEX	346		
H.	No logs		H. VK5AGX	688
			VK4NFE	609
			VK2EL	262
			VK6BWI	36
			VK2JM	24
I.	VK4SEA	870	I. VK3CBT	660
	VK5ATU	799	VK2ENU	379
	VK7HX	626	VK6BEB	225
	VK3XB	117	VK2BDT	205
	VK4IY	85	VK4IS	130
	VK3KS	40	VK6WZ	69

HOW'S DX

STEPHEN PALL VK2PS
PO Box 93 DURAL NSW 2158

After the exciting month of May, which was packed with DX, June was a month of limited DX activity, and a month of "great expectations:...

Trindade Islands

This group of islands, off the Brazilian coast in the Atlantic Ocean, were expected to be on the air for two full months, June and July. (See AR June issue). Eventually ZY0TK and ZY0TW came on air with some delay, but the operation lasted only about 3 days, and it appears that the last day of operation was around the 12th of June. No one yet has explained why this expedition had to be abandoned so suddenly.

Yemen 70

It was reported that this DXpedition made over 20,000 QSOs. The correct address for QSLs is: Mohamed Al Sabah, PO Box 8944 —

22060 — Salmiyah, Kuwait, and not the one which was reported earlier.

Albania ZA

This proposed operation was "the great expectation" for the month of June. Rumours, announcements, news, net announcements, totally confused everybody. Early in June, a South American source said that the two well known Hungarian DXpeditioners are in Greece (Peter HA5WE and Zoli HA5PP) and will start operating from Albania on the 4th of June.

On the same night, listening to the 14165 DX net, I heard that, according to their QSL Manager (Jacques F2YS/W2), both Zoli and Peter are safe and well in Hungary, and not in Albania. Later somebody reported that Zoli is now in Tirana attending to securing licence. Warnings abounded about pirate operations with callsigns like: ZA5CW, ZA5DX, ZA5PL.

At one stage, even the name of Eva, PY2PE was mentioned as one who might be part of the expedition. This was later denied by Eva.

At the end of June, "well informed sources" already had the frequencies in their computers: 2855, 28535, 21335, 31235, 14235, 7003 and 3503. I am writing these notes in the first week of July.

The news service just announced that there were demonstrations in Tirana and shots were fired. No sign yet of the ZA operation. Oh well — it will be on the air — eventually.

However, taking into consideration the political turmoil which is now surfacing in that country, in my personal opinion, it will be in 1991 when we can work a genuine ZA station.

Tokelau Islands ZK3

Zbig, ex VK2EKY, arrived at these Islands on the 12th of June and became active as ZK3EKY.

He plans to stay for 2-3 weeks, and was heard almost every day on 14207 and on 14005. QSL to WA3HUP via the Bureau (VKs only).

World Soccer Cup — Italia 90

During June and July several Italian stations used the additional suffix/I90 at the end of the callsign, indicating that they are connected with the "Italia 90 Worked Soccer Countries" award. The activity was from the 1st of June to the 31st of July. The special event station used the call of I90A.

New DXCC Country?

Bill, KC1AG, Hans DK9KX, and Ian ZS9A have submitted an application to the DX Advisory Committee (DXAC), to recognise Penguin Islands as a separate DXCC country. These 13 tiny islands, covered with guano bird droppings, are situated in the Atlantic Ocean just off the Namibian coast and south of Walvis Bay. Access to these islands is strictly controlled. The application for a separate country status is based on the fact that these islands are more than 75 miles off the coast of Walvis Bay and South Africa. The decision of the DXAC is waited with great interest.

The World Radiosport Team Championship

This 10 hours event was held on the 20th July, in co-operation with the Goodwill Exchange Program of the 1990 Goodwill Games. The Goodwill Games itself, is an athletic event in Seattle USA held in July and August involving 2500 invited world class athletes. The World Radio Sport Team membership was endorsed by the Radio Sport Federation of the Soviet Union and the ARRL in the USA. There were 4 US and 4 USSR teams, and the following nations were invited to send competing teams: Canada, Japan, Spain, Hungary, Yugoslavia, Bulgaria, England, Sweden, France, Brazil, Finland, Italy, Argentina, Czechoslovakia and Germany. All standard contest bands were used from 10 metres to 80 metres, both CW and SSB. The official WRTC stations used the /WG supplementary suffix after their call.

Interesting QSOs And QSL Information

Note the following abbreviations: Callsign, name of operator, frequency, (kHz), mode, UTC time, ADAR means QSL info in previous AR issues.

LX2AP, Adam, 21240, SSB, 0700, QSL via the Bureau.

9H4L, Joe, 21190, SSB, 0640, QSL to: J Gauchi, 20 Parish Priest Hill St, Victoria, Gozo, Malta.

SV5TS, Vasilis, 21255, SSB, 0638, QSL to: PO Box 7, Paradissi, 85106, Rhodes Island, Greece.

HS1BV, Sombat, 21306, SSB, 0945, QSL to: S Tharincharoen, 1093-1 Pmaholythin Rd,

Bangkok 4, Thailand.

YS0AKY, Kiyoko, 14247, SSB, 0900, QSL to: PO Box 3 Tokaimura 31911, Japan.

V63AA, 21012, CW, 0700, QSL to: KB3R: Edward J Michal, 3670 Camden St, Washington DC 20020 USA.

FG5BP, 14025, CW, 1000, QSL via KA3DSW: Kent E Riegel, RFD 1 Box, 133-K, Mohrsville, PA, 19541, USA.

FR5DD, Jean, 14029, 1000, QSL to op: J Pierrat, 8 Ave de Badamiers, Les Filaos, F-97434, Saint Gilles, les Bains, Reunion Island.

3A/F6EGV, 14031, 0700, CW, QSL via op: Paul Maria, Ecole Adrien Camaret, Montee du Souvenir, F-06500, Mentone, France.

LX0SNJ, 14008, CW, 0600, QSL via Bureau.

6V1A, 14029, CW, 0600, QSL to: Box 971, Dakar, Senegal, Africa.

HS0AC, Terry, 14011, CW, 1040, QSL to: NY2E, R Riker, 819 Old Medford Ave, Medford, NY 11763.

TA5KA, John, 14030, CW, 0420. QSL to HA0NNN: Janos Bolyoczki, Arany J U 2, H-4622, Komoro, Hungary.

SV9/DL6RAI, Ben, 14032, 0500, CW, QSL to: DL6RAI, Bernhardt Buettner am Anger 4, D-8300, Ergolding, W Germany.

TZ0MAR, Tom, 14009, 0812, CW, QSL to: DJ5RT, W Ruppert Riesenkopfweg 7, D-8209, Stephanskirchen, W Germany.

YS1LS, 14013, CW, 0500. QSL to: REL Salcedo, 103 ave Norte y Pasaje 7 Escalon, San Salvador, El Salvador.

V63AY, George, 14250, SSB, 0905. QSL to: George, 4254A, Manohar Road, Wahiwa, Hawaii, 96786, USA.

RA8V/RB5YM, Ivan, 14053, CW, 1237, Oblast 175. QSL to: Box 261 Chernovtsy Zip. 274018, USSR.

UW8V/UA0UBG, Igor, 14030, CW, 1336, 0b1 175. QSL via UA9AB via Bureau.

4K4POL, Aleks, 14016, CW, 0837. QSL to: UA0KCL, via Bureau.

YJ8RN, Rod, 14226, SSB, 1149. QSL to: Rod Newell, Box 905, Port Vila, Vanuatu.

OM7LO, Tibor, 14211, SSB, 0436. QSL via OK3LO via Bureau.

J39BS, Derek, 14243, SSB, 0635. QSL to: WB2LCH, Gene W Ege Jr, PO Box 64, Gloucester NJ 08030-0064 USA.

VQ9RB, Dic, 21205, SSB, 0546. QSL to WA4DPU, Edwin E Black, 1110 Bagley Dr, Fayetteville, TN 37334, USA.

C6AFW, Farley, 14226, SSB, 1100. QSL to: Box N-1316, Nassau, Bahamas.

JY5DK, Mike, 14250, SSB, 0345. QSL to: ON6BY, Monique Van den dolder, Sartlaan 70, B-8400, Ostende, Belgium.

KP4AAQ, Will, 14165, SSB, 1155. QSL to: William Arce Crespo, A-C2 jardines De arecibo, Arecibo, PR 00612, Puerto Rico.

GJ3FKW, Ken, 14037, CW, 0706. QSL via the Bureau.

9H1GS, Sam, 21205, SSB, 0515. QSL via the Bureau to VK2AKP.

TA1AZ, Derya, 14222, 0635, SSB. QSL to: Derya Sevgen, Box 2011, Bakirkoy, TR-34710, Istanbul.

5H3TW, Tom, 21210, SSB, 0533. QSL to: K3ZO, Alfred A Laun III PO Box 31097, Temple Hills, MD 20748 USA.

RTTY News

And the news from Syd VK2SG.

EA9MY, 14087, 0026Z. QSL to: Box 368, Melilla, Spain.

5N8ALE, 21077, 1527Z. QSL to: DJ2VZ.

VR6WH, 14085, 0549Z. QSL to: Bill Haig, 12 Kauri Loop Road, Oratia, Auckland 1207 NZ.

RF6FC, 14090, 0449Z. QSL to: Box 21 Tblishi, Georgia, 38002 USSR.

FY4FS, 14083, 0304Z. QSL to: Box 168, F67600 Salestat, France.

8P9AT, 14088, 0505Z. QSL to: Wolf Wagner, 12230 St James Rd, Potomac MD 20854.

UG7GWY, 14082 0508Z. QSL to: Armenia Yerevan Indeks 5, Radio Club, 375007, Armenia, USSR.

ED9CI, 14083, 0001Z. QSL to: EA9KQ.

T5RM, 14074, 2114Z. QSL to: HB9RTR, 134 Saules, 1233 Berne Switzerland.

SU1HN, 14083, 0305Z. QSL to: Box 1578, Alf Maskan, Cairo, Egypt.

From Here And There And Everywhere

Bing, 3D2XV has left Rotuma and returned to Foster NSW. He said that he will go back to Rotuma and to A35 in October/November this year. — Czech radio amateurs are celebrating the 60th anniversary of the issue of the first amateur licence in their country. They are using the special prefix of OM instead of the well known OK. Ron ZLIAM0 was active on the Solomon Islands. He used the callsign H44RW. QSL direct only to his home call. — Dave, VK0DS is active from Mawson Station in the Australian Antarctic Territory. — CO3JA QSLs via I0WDX. — IK5DNE/IA5 IOTA Eu-28 — was on Capraia Island, situated between Corsica and Elba. — JA7FTJ/JD1 is on Iwo Jima, Ogasawara Islands QSL to: JA7BIJ. — ED9CI was active from the Chafarinas Islands, IOTA AF-36. The Chafarinas are located just off the coast of Morocco, 30 miles East South East from Melilla. The three small island group has belonged to Spain since 1848. QSL to: EA9KQ. — C53GB was John from The Gambia. QSL to: FD1MXH. — HR2FP was heard on 14226 at 1107. QSL direct to the callbook address. — IE0CM John, was a special event station celebrating the foundation of the University of Perugia. QSL to: IOGEJ. — IB1T was heard on 14179 at 0600 UTC. QSL to: I1RBJ. — 7Q7JM QSL direct to: Box 30135, Lilongwe, Malawi, Africa. HI8PGG was heard on 1422 at 0630. QSL to: Box 2310, Santo Domingo, Dominican Republic. KA2IJ was heard on 14165 at

1145 UTC. It is a US Coast Guard Loran Station on Iwo Jima. QSL to home call: WB3EXR after September. 1Z9B is Kenny. He was heard working from South East Burma. He gave his QSL manager as: KA6V. — Zedan was heard in June handling some emergency traffic with 4UN1UN in connection with the Iranian earthquake. — It is rumoured, that there will be some new activity later in the year from 70. VP2VM is "Mac" on Tortola Island British Virgin Islands. QSL via the Bureau. — Jack C2INI has made 1428 QSOs from Nauru and 1352 contacts from TUVALU T20. — QSLs for 9H1IV are to be sent to VK2FAG. — Worked 5T5FA Marco, Mauritania on 18125 kHz at 0650. He was located 80 kms south of Kifa and 20 kms from the Mali border. They are a group of Italians on work assignment. Marco often crosses the border, and then he uses the TZ callsign for which he has a licence. His vertical antenna for this band was a galvanized iron pipe. QSL to: IK3GES. — Since 1945 there were only three operations from Albania, all of them in the early 70s. Khalid 9K2KS has checked into the "222" net. QSL to: Box 3181 Safat, 13032, Kuwait. — The QSL address of TZ6PS is:

Peter Skalweit, BP 428, Bamako, Mali, West Africa. — Simon, S79SC leaves Seychelles in August. QSL to: Simon, Box 234, Seychelles, Indian Ocean. — The Spratly operation was approved by the DXCC. QSL direct only to: Box 308, Moscox 103009 USSR. (There is no stateside QSL Manager.) No callsign on envelopes. WZ6C/ST4 will return shortly to Sudan, this time on CW. — Crozet FT4WB is not often heard these days. QSL to F6ITD — 7K1AAA was the Japanese callsign issued in April. The No.1 call area in Japan has exhausted all the standard callsigns, and the callsign blocks of 7K1-7N1 were opened for amateurs. Ron, 7Q7RM is active from Malawi. QSL to: Ron MacFarlane, Box 472, Blantyre, Malawi. — Mike, 5B4TI has left Cyprus and returned to the USA. The 1S0XV cards are not yet printed. Jim, A51JS produced an excellent colour card and they were posted mid July to all parts of the globe.

MGR. JX1UG 6MO FM MGR, OY7ML 3W FM OP, C2INI 2W FM OP, — T30JH 2W FM OP, VR200PIJR 2W FM MGR, 7X2FK 6W FM OP, TZ6PS 6W FM OP, CN8GI 1MO FM OP, A51JS 2MO FM OP, 7Q7LA 3W FM MGR, KP2A 3W FM MGR, ZFIRC 6MO FM OP, V47KTG 4W FM MGR, C31UA 3W FM OP, JY5DK 2W FM MGR, 4Z4UR 3W, CT1CNT 7W, V31PC6W, SV2UA3W, 5W1KT 3W, YV5AAX 6W, A45ZP 4W, 4U1WB 2W, 9V1XB 2W.

Late News

Penguin Islands. News just to hand indicates that in the second part of July there will be a DX operation from these islands. (See notes above.) DL8CM/ZS1, DK9KX/ZS1, and ZS9A/1 operated both in CW and SSB on all DX bands. QSLs for ZS9A to home call direct, or via the Bureau, for DK9KX/ZS to be sent to DF0KD.

Thanks To You

Many thanks for the information received from: VK3DD, VK4DA, VK4OH, VK2SG, "QRZ DX" and the "The DX Bulletin." Your support is always appreciated.

Good DX and 73

ar

Interesting QSLs Received

Note: W=weeks, MO=months, FM=from, MGR=manager, OP=operator.

All cards received direct; TA1AL 3W FM

VHF/UHF AN EXPANDING WORLD

ERIC JAMIESON VK5LP
9 WEST TERRACE MENINGIE 5264

These few notes are written from the confines of a hospital bed once more. My progress seems to be very slow indeed.

I wish to thank all those people who responded to my request for latest information regarding the six metres standings box. Unfortunately, at this moment all information is locked in my computer and being in hospital has not permitted me to add the latest information, so reluctantly I cannot produce the list this month. I hope I can get home in time to produce the list for next month.

Six Metres

Ron VK4BRG reports an excellent opening to the USA on 29 May. Band opened at 0038 in Texas and closed at 0211 with New York state. Ron worked 39 stations in 11 states and covered such diverse areas as Oregon in the west,

New York in the East, 7 in Georgia, 2 in South Carolina, Kansas, Texas, Oklahoma, Colorado, New Mexico, Nebraska and Utah. What a thrill!

On the same day NI6E/KH6 had many hours of propagation to the US including the east coast. The US mainland was experiencing much Es with some extending to the Caribbean. Ron believes many of his contacts were assisted by Es at the US end, and possibly some at his end as he worked FK8EB via Es only an hour later.

Beacons

Peter VK3AWY reports that the Geelong 6 and 2 metre beacons are currently being relocated to Mt Anakie, QF22, the site of the Geelong 2 metre and 70 cm repeaters. When completed shortly, the beacon call signs will

be changed from VK3RGG to VK3RGL which means all amateur equipment on Mt Anakie will have a common callsign.

Closure

That's all I can manage this time, including one thought for the month: "Don't take if you are not willing to give!"

73 From the voice in the hospital!

ar

AMATEUR
RADIO
HELPING
OUR
COMMUNITY.

ANTENNAS & ACCESSORIES

We manufacture a comprehensive range of HF, VHF and UHF antennas, baluns, power dividers etc to suit your application. Three of our log periodics provide continuous coverage from 13-30 MHz including WARC frequencies, and replace outdated tri-banders. Now in use in 24 overseas countries and 6 continents.

- CREATE ROTATORS, COAX CABLES & NON-CONDUCTING GUY HALYARD MATERIALS
- COMPLETE RANGE MIRAGE (USA) 5-YR WARRANTY 6M, 2M, 70CM AMPS & WATT SWR METERS
- HARD-DRAWN ANTENNA WIRE
- AUST/NZ DISTRIBUTOR FOR CREATE ANTENNAS/ROTATORS & PHYLLSTRAN (KEVLAR) NON-CONDUCTING GUYING

- MATERIALS
- HIGH GAIN VHF & UHF AMATEUR, SCANNING & TV ANTENNAS
- BUTT SECTION TRIANGULAR ALUMIN IUM TOWERS FOR FIXED OR TILT-OVER APPLICATIONS (REFER MARCH/APRIL 1987 AR)
- SELECTION OF POWER CHIPS AT FRIENDLY PRICES
- VSWR/PWR METERS TO 1300MHZ

Write or phone for free catalogue

ATN ANTENNAS

56 Campbell Street
Birchip Vic 3483
Phone: (054) 92 2224
Fax: (054) 92 2666

POUNING BRASS

GILBERT GRIFFITH VK3CQ
7 CHURCH ST, BRIGHT 5264

As you are no doubt aware, I no longer spend as much time as I would like to on CW operating. Although I still consider myself a devout Morsiac, I like to be informed on other modes, as a good all-rounder should. To this end I have been devoting some time during the day to packet radio.

Packet Radio is an interesting mode, especially if you are toying with computers, and interested in communication (knowledge) for its own sake. Particularly if you can digest pages and pages of information of all kinds which are available on bulletin boards.

For instance, I first heard about the world record Morse code sending attempt by the Westlakes Amateur Radio Club to celebrate ITU Day on 17 May on packet BBS at VK3BSR. A team was to take part, in one-hour shifts, for continuous sending of the history of the ITU on 7050 KHz starting at 0000 UTC on 17 May and finishing 24 hours later. A representative from the Guinness Publishing Company in England was invited to attend the club's shack at Teralba. This information came from Greg VK2GJS@VK2CZZ (that's his packet address) and is an example of something I would normally have missed, never mind that you get the info three months later; that is my fault for writing this column three months ahead!

Another example, I downloaded four messages from ZL2UIV@ZL2WA which were addressed to CW@ASIA and entitled "Branch 74 Discussion Paper on Morse Code and Amateur Radio in the 1990s". The reason there were four messages under the one heading is that a bulletin can usually hold up to about 4K bytes and that is only about one page. This discussion paper is four pages long and, very briefly, it proposes the dropping of Morse Code testing for amateur candidates. It is not a proposed submission to WARC such

as the Israeli one featured last month, but an invitation to stimulate consideration and comment with constructive feedback to ZL2ARW@ZL2WA if you have packet, or The Secretary, Wellington VHF Group Inc, PO Box 12-259, Wellington North, New Zealand.

In this case I am sending the text of last month's column to them on packet, as they will probably not see it any other way. Isn't that handy!

You too can see the full text of the paper by looking for it on your local packet BBS or asking a friend to download and print it for you. You can send me a stamped addressed envelope and I will print it out for you.

Let us ask ourselves, "What is the motive for wanting to drop Morse Code?" In Australia we already have a no-code licence, which is very popular, and allows the use of bands over 30 MHz, which are where the new modes are being used anyway. Is it the Limited call holders who want a full call with no code? Or do the protagonists believe that a no-code licence will attract more people into the amateur ranks. I don't believe it will, because there is already a no-code licence available.

Do amateurs want to use the new modes on HF rather than VHF? I think it would be a mistake if they did. If you consider packet, it is not particularly reliable on HF, but there is room for experimentation, and bulletin board "getaway" stations are currently making good use of higher baud rates and satellite technology. I personally feel that there is not enough room in the HF bands to accommodate individual packet stations, or even many of the bulletin board gateways at their current rate of increase. You have probably seen some of the arguments already; you could even call them fights!

As far as I can see, the only motive for

wanting to drop Morse is that it is simply old fashioned. On the other hand, if countries do not have an equivalent to our Limited call they have a good case against the code.

I would much rather see a new licence which involved more emphasis on Morse Code. Perhaps a theory test with no SSB, VHF or other complications, together with 12wpm sending and receiving Morse, for a CW only. All HF bands only, maybe homebrew only, ticket. I think this would provide an opening separate and easier than a Limited call, and would attract new amateurs, especially those not so well off, and those not yet interested in computers.

Well, what do you think? We have only two years to talk about it, and if we want to further the use of Morse Code we are going to need good arguments and helpful advice to back us up.

You can contact me on packet at VK3EEE, which is my nearest BBS. I hope to hear from you.

A final note on the Westlakes ARC Marathon CW attempt. After sending a note of congratulations (on packet), I received a short note back from them saying that I would be sent a full report in due course. Perusing the BBS on the same day, I came across another report which said, "The plug was finally pulled at 0330 UTC on Sunday 20 May after 75-1/2 hours of Morse with no more than a five-second break (due to a loose lead on the key) ... Approximately 30 operators were involved in the attempt, and reports of signal strength — with messages of encouragement — were received from all over VK. It is understood that the previous record stood at less than 24 hours. The rig used during the whole of the marathon effort was the club's trusty Kenwood 520S, which performed flawlessly throughout. The club wishes to thank everyone who helped in the exercise ..."

from VK2JDH@VK2EHQ 21.5.90 ar

AMSAT AUSTRALIA

GRAHAM RATCLIFF VK5AGR
GPO BOX 2141 ADELAIDE 5001

Our usual AMSAT columnist, Maurie Hooper VK5EA, has unfortunately been struck by a sudden illness. Graham VK5AGR has kindly stepped in to fill the gap. We wish Maurie a speedy recovery.

National Co-ordinator
Graham Ratcliff VK5AGR

Information Nets

AMSAT Australia

Control :VK5AGR

Amateur check in :0945 UTC Sunday

Bulletins commence:1000 UTC

Primary frequency :3.685 MHz

Secondary frequency :7.064 MHz

AMSAT SW Pacific

Control :ZL1WN

Bulletins commence :2200 UTC Saturday

Primary frequency :14.282 Mhz

AMSAT-OSCAR-13 Orbit

Karl Meinzer DJ4ZC via Telemail 28 Jun 90

Recently some information has been circulated stipulating the decay of the AO-13 orbit

between 1992 and 1997.

Elliptic orbits with high inclination (like AO-13) are potentially unstable due to luni-solar perturbations. This has been known for a long time, and in fact some Molniya-satellites have prematurely decayed from this mechanism. AMSAT was aware of this problem, and had a study performed by a NASA expert in the late nineteen seventies for the Phase 3 programme. The conclusion of the study was, that the perigee height can oscillate with an amplitude of +-1000 km. As a consequence, the minimum perigee height for the Phase 3 satellites was chosen to be 1500 km. On AO-13, 2500 km was chosen for additional margin against decay.

Recently, the problem of orbit stability was revisited by Victor Kudielka, OE1VKW (AMSAT-DL Journal 2, 90, pp. 5-7) see in-

cluded graphical plots from this article for AO-10 and AO-13. OE1VKW discovered that the perturbations can have a longer "time-constant" and thus result in much larger effects than previously believed. In particular he predicted a possible decay of AO-13 for early 1997. At this time, we do not understand the discrepancy between the old study and OE1VKW's results. Since OE1VKW's results so far are in good agreement with the actual orbit of AO-13 (and AO-10), there is little doubt that his computations are basically correct. So the conclusion is inevitable that the old study was either too coarse, or that the change of the lunar orbit (18.6 years nutation period, 8.6 years period of perigee rotation) has invalidated the original study.

The publication of OE1VKW's work triggered a flurry of activity in the USA. In particular, Bob McGwier N4HY used a NORAD tracking program and found that a decay may happen as early as 1992. However, Bob states that he used the program as a "black box" without having user instructions (Sounds familiar!!! — Graham VK5AGR). Unfortunately, the orbit situation is such that some very slight parameter-changes have a dramatic influence on the lifetime. Also, numerical integration programmes have many potential pitfalls. So, at this time, we can only conclude that the perigee height of AO-13 is coming down and this could lead to the loss of AO-13 during the '90s.

Also, at this time it is unclear in what direction the orbit will be influenced by the onset of air drag (ie atmospheric drag). It could either make the orbit more stable or accelerate the decay. Also it will be worthwhile to investigate if we have any means to prolong the life of AO-13 by exploiting the on-board systems.

With the orbit of AO-13, we apparently were very lucky and very unlucky at the same time. We were lucky in that we used our propulsion excess to increase the perigee height over the original figure, just to "buy margin" without a strong reason. But we were also unlucky because the present studies were not available in 1988. It would have been easy to either wait after the first motor-burn for a sufficient change in RAAN before the final burn thus eliminating the problem, or to increase the perigee height even further. Certainly we will not be so blue-eyed with Phase 3D. Of course, AMSAT-DL will make every effort to keep AO-13 in operation as long as possible. We hope that we can keep AO-13 until Phase 3D is launched to give us continuity of operation.

Future Molniya Satellite Orbit Selection

Franklin Antonio N6NKF via Telemail 14Jun90

Lifetime for Molniya-type orbits is a very strong function of initial Right Ascension of

OSCAR-13 Schedule for 01Aug90 to 03Sep90

Station: Adelaide

	0	1	2	3	4	5	6	7	8	9	10	11	12	13	14	15	16	17	18	19	20	21	22	23	
01Aug90	-----	0	1	2	3	4	5	6	7	8	9	10	11	12	13	14	15	16	17	18	19	20	21	22	23
02Aug90	-----	0	1	2	3	4	5	6	7	8	9	10	11	12	13	14	15	16	17	18	19	20	21	22	23
03Aug90	-----	0	1	2	3	4	5	6	7	8	9	10	11	12	13	14	15	16	17	18	19	20	21	22	23
04Aug90	-----	0	1	2	3	4	5	6	7	8	9	10	11	12	13	14	15	16	17	18	19	20	21	22	23
05Aug90	-----	0	1	2	3	4	5	6	7	8	9	10	11	12	13	14	15	16	17	18	19	20	21	22	23
06Aug90	-----	0	1	2	3	4	5	6	7	8	9	10	11	12	13	14	15	16	17	18	19	20	21	22	23
07Aug90	-----	0	1	2	3	4	5	6	7	8	9	10	11	12	13	14	15	16	17	18	19	20	21	22	23
08Aug90	-----	0	1	2	3	4	5	6	7	8	9	10	11	12	13	14	15	16	17	18	19	20	21	22	23
09Aug90	-----	0	1	2	3	4	5	6	7	8	9	10	11	12	13	14	15	16	17	18	19	20	21	22	23
10Aug90	-----	0	1	2	3	4	5	6	7	8	9	10	11	12	13	14	15	16	17	18	19	20	21	22	23
11Aug90	-----	0	1	2	3	4	5	6	7	8	9	10	11	12	13	14	15	16	17	18	19	20	21	22	23
12Aug90	-----	0	1	2	3	4	5	6	7	8	9	10	11	12	13	14	15	16	17	18	19	20	21	22	23
13Aug90	-----	0	1	2	3	4	5	6	7	8	9	10	11	12	13	14	15	16	17	18	19	20	21	22	23
14Aug90	-----	0	1	2	3	4	5	6	7	8	9	10	11	12	13	14	15	16	17	18	19	20	21	22	23
15Aug90	-----	0	1	2	3	4	5	6	7	8	9	10	11	12	13	14	15	16	17	18	19	20	21	22	23
16Aug90	-----	0	1	2	3	4	5	6	7	8	9	10	11	12	13	14	15	16	17	18	19	20	21	22	23
17Aug90	-----	0	1	2	3	4	5	6	7	8	9	10	11	12	13	14	15	16	17	18	19	20	21	22	23
18Aug90	-----	0	1	2	3	4	5	6	7	8	9	10	11	12	13	14	15	16	17	18	19	20	21	22	23
19Aug90	-----	0	1	2	3	4	5	6	7	8	9	10	11	12	13	14	15	16	17	18	19	20	21	22	23
20Aug90	-----	0	1	2	3	4	5	6	7	8	9	10	11	12	13	14	15	16	17	18	19	20	21	22	23
21Aug90	-----	0	1	2	3	4	5	6	7	8	9	10	11	12	13	14	15	16	17	18	19	20	21	22	23
22Aug90	-----	0	1	2	3	4	5	6	7	8	9	10	11	12	13	14	15	16	17	18	19	20	21	22	23
23Aug90	-----	0	1	2	3	4	5	6	7	8	9	10	11	12	13	14	15	16	17	18	19	20	21	22	23
24Aug90	-----	0	1	2	3	4	5	6	7	8	9	10	11	12	13	14	15	16	17	18	19	20	21	22	23
25Aug90	-----	0	1	2	3	4	5	6	7	8	9	10	11	12	13	14	15	16	17	18	19	20	21	22	23
26Aug90	-----	0	1	2	3	4	5	6	7	8	9	10	11	12	13	14	15	16	17	18	19	20	21	22	23
27Aug90	-----	0	1	2	3	4	5	6	7	8	9	10	11	12	13	14	15	16	17	18	19	20	21	22	23
28Aug90	-----	0	1	2	3	4	5	6	7	8	9	10	11	12	13	14	15	16	17	18	19	20	21	22	23
29Aug90	-----	0	1	2	3	4	5	6	7	8	9	10	11	12	13	14	15	16	17	18	19	20	21	22	23
30Aug90	-----	0	1	2	3	4	5	6	7	8	9	10	11	12	13	14	15	16	17	18	19	20	21	22	23
31Aug90	-----	0	1	2	3	4	5	6	7	8	9	10	11	12	13	14	15	16	17	18	19	20	21	22	23
01Sep90	-----	0	1	2	3	4	5	6	7	8	9	10	11	12	13	14	15	16	17	18	19	20	21	22	23
02Sep90	-----	0	1	2	3	4	5	6	7	8	9	10	11	12	13	14	15	16	17	18	19	20	21	22	23
03Sep90	-----	0	1	2	3	4	5	6	7	8	9	10	11	12	13	14	15	16	17	18	19	20	21	22	23

- 'o' means OSCAR-13 is in view and ALL the transponders are OFF and the low gain omnidirectional antennas are in use i.e. Mode B beacon only.
- 'b' means OSCAR-13 is in view and the Mode B transponder is ON and is using the low gain omnidirectional antennas.
- 'B' means OSCAR-13 is in view and the Mode B transponder is ON and is using the high gain antennas.
- '-' means OSCAR-13 is NOT in view.

Ascending Node (RAAN). For every value of inclination and Argument of Perigee (ARGP), there are some values of RAAN which produce an orbit with a short life, and some that produce an orbit with a long life.

This happens because the solar and lunar gravity perturbations are a strong (and quite complex) function of how the satellite's orbit ellipse is oriented in space relative to the orbit plane of the Sun and Moon. This orientation is determined by the three orientation angles: inclination, ARGP, and RAAN.

In fact, it may be impossible to guarantee a reasonable lifetime without specifying RAAN. In the past, it appears that careful attention was paid to inclination and ARGP to provide the desired satellite utility, but not RAAN (not true see Karl DJ4ZC's article). After all, because the satellite is intentionally non-synchronous, RAAN doesn't affect its utility at all.

Now that we understand and appreciate the solar and lunar gravity perturbations, and are able to calculate their effect, we have the ability to select values of RAAN that will produce the desired life. Unfortunately, RAAN is determined mostly by the time of launch! If we were the primary payload, we could specify launch windows which would control RAAN to our specifications. Unfortunately, that is

probably out of the question.

References:

G E Cook, "Luni-Solar perturbations of the Orbit of an Earth Satellite" The Geophysical Journal of the Royal Astronomical Society, Vol 6, #3, April 1962, pp 271-291.

D G King-Hele, "The Orbital Lifetimes of Molniya Satellites", Journal of the British Interplanetary Society, Vol 28, pp 783-796, 1975.

AMSAT-OSCAR-13 Orbit Studies without a CRAY Computer!

James Miller G3RUH via Telemail 24 Jun 90

Just for the record, here is an outline of the work I have been doing on AO-13 orbit luni-solar perturbations over the last couple of months or so. This work has been discussed with Bob N4HY and others, but not in written form. Anyway, I started on this stuff in December 1987, for fun. Yep — I'm not easily amused.

Now I do not have the luxury of a Cray Vector-2 computer with 128 bit precision, still less the time to play with one. Fortunately, neither did the 19th century numerical astronomers, so they devised several methods of

perturbation analysis that were suited to "low" precision manipulation at a modest pace.

One of the principal difficulties with integrating the equation of motion of a satellite is that the central body force (the Earth's gravity, about 1 G) is many orders of magnitude larger than the other perturbing forces we are interested in namely:

Max Value (in units of 1G)

1. Non-spherical Earth, J2 term - 1E-3 G
2. Non-spherical Earth, J3-J - 1E-6 G
3. Moon's differential pull - 6E-7 G
at a range of S/C
4. Sun's differential pull - 3E-7 G
*(at a range of S/C of 40,000 km)

On the other hand, because of this large disparity, the mean satellite orbit is to a great extent predictable, viz it moves in an elliptic orbit as per Kepler's equations. Of course we all use this in our familiar satellite tracking packages.

(Then James discusses the mathematics he has used in his orbital studies — to obtain a copy of the full article send an SASE to AMSAT-Australia — Graham VK5AGR)

This technique of special perturbations was devised by Encke (c 1857) and is widely used in space mission analysis.

References:

Bate, Mueller and White, "Fundamentals of Astrodynamics", Dover 1971, ISBN 0-486-60061-0, Chapter 9.3

Roy A E, "Orbital Motion", Adam Hilger 1988, ISBN 0-85274-229-0, Chapter 7.4

The most arduous part of this work, whatever method you use, is choosing and driving the INTEGRATOR. It's hard enough to double integrate reliably over an hour, let alone a year or two! Just think about it. A miniscule force of say 1E-12 G acting for one year builds up a displacement of about 5 km. Yet we're dealing with forces 10000 times BIGGER than that, over several years.

Excellent Signals Heard On AMSAT-OSCAR-10-> Why Not Use It!!!

GRAHAM RATCLIFF VK5AGR

OSCAR-10 is currently receiving sufficient solar panel illumination to support Mode-B transponder operation. I am told that many stations are disappointed with the amount of activity on OSCAR-10 when the signals are so good — might I suggest that people put out the odd CQ call on 145.910 MHz and I think you will be pleasantly surprised to hear how many stations are actually listening and active on that frequency. The current estimate of OSCAR-10's attitude for 06 Aug 90 is Longitude 13 degrees Latitude — 3 degrees which equates to a solar illumination of 80%. Hopefully, OSCAR-10 will support Mode-B transponder operation through until the end of August, when the attitude estimate will be

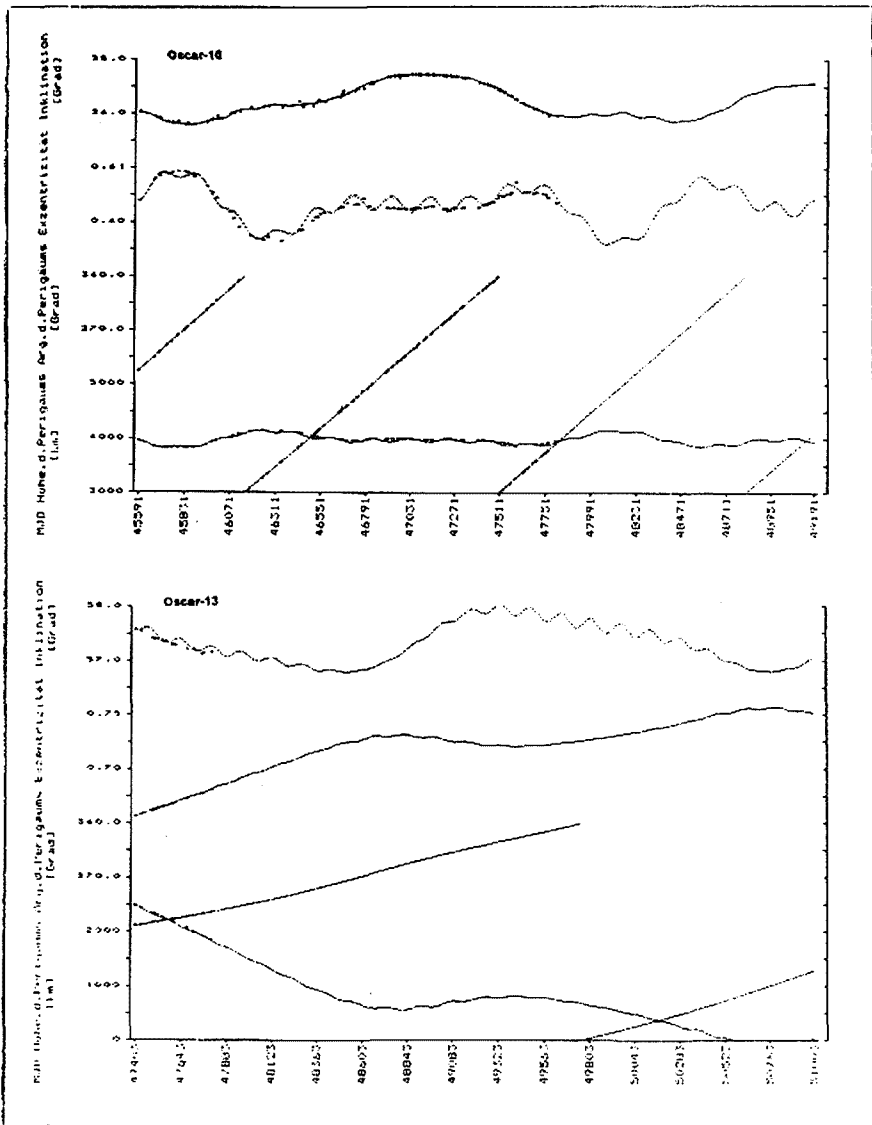

Longitude 10 degrees latitude-2 degrees, which equates to a solar illumination of approximately 50%. However, PLEASE DO NOT USE the TRANSPONDER if the beacon or transponder signals start FMing. This is likely to start at the end of August, and users will then be asked NOT TO USE the transponder until probably the beginning of November, when the attitude estimate on 05 Nov 90 Longitude 2 degrees and Latitude 3 degrees which equates to a solar illumination of 60%.

AMSAT-OSCAR-13 Transponder Schedules Until 17 Oct 90

Attitude approx 210/0

- Mode-B : MA 003 to MA 165
- Mode-JL : MA 165 to MA 190
- Mode-LS : MA 190 to MA 195
- Mode-S : MA 195 to MA 200
- Mode-BS : MA 200 to MA 205
- Mode-B : MA 205 to MA 240
- OFF : MA 240 to MA 003
- Omnis : MA 240 to MA 060

ar

COPIES OF ARTICLES

Photocopies of any article published in a back issue of AR available to members at \$2.50 each (plus \$2.00 for each additional issue in which the article appears)

**AR ARTICLES
PO Box 300
Caulfield South
Vic 3162**

EDUCATION NOTES

BRENDA EDMONDS VK3KT
FEDERAL EDUCATION CO-ORDINATOR
PO Box 565 MT WAVERLEY 3149

It has been suggested many times that we need to be recruiting more young people into our ranks. We are told "Get amateur radio into the schools". A few members have done this, either as teachers prepared to offer it on a regular or casual basis or as visitors into the school's setting up demonstration stations. But there is rarely any co-ordinated approach to either the schools or the students. There needs to be a continuing program, if students whose interests are aroused by a demonstration station, are to be nurtured along until licensed.

At the recent Federal Convention, I was given samples of work units produced in New Zealand and also America, which were designed as part of a classroom science program for primary students. The ZL ones comprise a set of booklets consisting mainly of simple electronic activities, with minimum theory. Completion of two projects earns an Attainment Certificate from the NZART.

As far as I know, nothing like this is occurring in any Australian primary schools. If it is, I would be most interested to hear from

those involved.

However the WIA has recently decided to investigate the possibility of producing a similar set of materials for use at either late primary or secondary level. We would need to provide projects that can be used by teachers who are not amateurs, and who may not even have much training in electronics.

It is envisaged that a package of materials could include worksheets for simple electronic experiments, more extended units of work requiring some understanding of theory, information on how to start becoming a SWL and on sources of components, some publicity about amateur radio and the WIA, and how to contact persons who can help. It should be available at minimum cost, and copyright free.

I am sure that a lot of this material is already in existence and is being used in some schools, or in Scout/Guide groups. Some of the old YRCS materials may still be in use. However, I have very little information, and no sample materials.

This seems to me to be a project that could well be carried out on a national basis, by an

approach to the Australian Science Teachers Association. So I would like to make a start by collecting samples of all materials that are presently available, whether being used or not, and any suggestions that members may care to offer. I would also appreciate offers of help to produce items which are not readily available. I am happy to co-ordinate, arrange production and approach the Teacher Associations, but I am sure there are many of you out there much more competent and experienced in many of the other aspects.

This is one instance where we must take a very long-term view. The children we approach next year may not join our ranks for several years, and even then we cannot expect to recruit more than a small percentage of them. But it is a section of the population that is at present receiving very little of our attention.

I am also interested in preparing a directory of schools with active amateur radio clubs or stations and their operating times/frequencies, so that schools can contact each other, or some of our more public spirited members can offer encouragement on air.

I look forward to receiving comments, ideas and information on all these matters.

ar

BOOK REVIEW

ROB CARMICHAEL VK3DTR

Title: The Official History of Australia in the War of 1914-1918. Vol IX. "The Royal Australian Navy".

Author: A W Jose

Publisher: University of Queensland Press in association with The Australian War Memorial

1990 is the 75th Anniversary of the landing by the Anzacs at Gallipoli in 1915. Reference to this battle was made by Bert Billings in the article "The Last Wireless Anzac" written by Jim Linton, VK3PC, and published in the April edition of AR Magazine.

I thought that many members of all ages who are interested in history, and particularly history in relation to the development of wireless as it was called in the early days, would like to read this enthralling book.

It is excellently detailed and contains a wealth of historical material regarding the roles played by the Australian and New Zealand Navies from the outbreak of the Great War in theatres spread throughout the globe.

Also included are very clearly reproduced photographs in support of several chapters describing many actions. The lenses of cameras used in those days were of wonderful

precision. There are sections dealing with official accounts from the German side of things including the Sydney/Emden fight.

Interesting too are the chapters dealing with the Australian troops take-over of the German Pacific Possession which covered parts of New Guinea, the Solomons and islands like Yap and Nauru where they had powerful radio stations.

Australia had no powerful radio installations in Melbourne, Sydney, Brisbane, Adelaide or Perth in the early days of the Great War. There is a chapter dealing with the development of high power spark transmitters. England was unable to despatch urgently required radio equipment to Australia at the time because of the demand of the Royal Navy and other British services.

The chapter on radio telegraphy is fascinating. It describes the then attitude of the Post Office which, in 1909, had been considering a proposal by the German Telefunken Company to erect stations in Sydney and Fremantle and had gone as far as to accept the Company's tender and to ask the Defence Department about sites. The report of the conference held in Melbourne in December 1909 therefore instead of hastening the intro-

duction of a wireless system delayed it by making the whole scheme Imperial, blocking the Telefunken proposals and necessitating negotiations with other Governments.

The Post Office maintained its right to sole control of the business and refused to do anything until the arrival of an expert whom it had engaged. He was John Graeme Balsillie who, when he reached Melbourne, caused work to be hurriedly begun on several stations without either the Naval or the Military authorities being consulted.

Because of the shortage of components, local factories came to the fore. No drawings were available in Australia at the time but twelve 5 kilowatt arc continuous wave transmitters were designed and manufactured. Amongst these new designs were a transmitting oscillator of the two-coil type permitting quick change in transmission of wavelengths from 300 up to 2500 metres for shore stations and a new type of aerial tuning coil. One wonders if there were any amateur radio experimenters who helped with those developments.

It's great reading. Try to borrow a copy from your Regional Library. You won't regret it.

ar

INTRUDER WATCH

GORDON LOVEDAY VK4KAL
FEDERAL INTRUDER WATCH CO-ORDINATOR
'AVIEMORE' RUBYVALE 4702

A request from the Philippines Association:

"Recently our National Telecommunications Commission (NTC) sub-allocated the 430-440 MHz band wherein we lost the Amateur Satellite Frequencies to commercial users. One of the strongest arguments we presented was the interference this may cause on the Amateur Satellites, especially with the launching of the Microsats.

Although we lost the fight, we have not given up the battle, and we intend to fight some more.

In this connection, could you please circularize this to all monitoring stations, so that if and when they hear a Philippine commercial intruder on the amateur satellites, to send us right away a signed official report of this interference. We intend to present this to our NTC for them to realize what they have done".

Any operators using the 430-440 MHz satellite, should lodge their observation with me for forwarding to the PARA. Is this a warning to us, use it or lose it?

A comment from the JARL News for May '90 caught my eye. Kokusai Denshin Denwa Co have recently developed equipment which almost completely eliminates the "wood-pecker"! For the moment it is being used on ship telephones, but utilization for amateur radio is also under consideration.

With a bit of luck, "AR" readers should see a return of the monthly summaries, in our magazine, these will be in an abbreviated form, owing to the restriction in size of the magazine to 56 odd pages, however, the full summary will be available to any person on receipt of a SAE.

I have received advise from DOTC, stating that we will be STILL sharing the 30 metre band with Landmobile Stations ie, 10100-

10150 kHz. I quote further, "The Australian Table of Frequency Allocations, as contained in the Radio Regulations published by the International Telecom Union (ITU), allocates primary use of the 10100 to 10150 kHz band to fixed services, and secondary use to amateur services. However, it also provides that use of this band by the fixed services will be limited.

The new draft Australian Spectrum Plan no longer references the limitations on the

use of the band by the fixed services. The plan also proposes that the band be allocated to the radio location service on the condition that harmful interference will not be caused to other services operating in accordance with the Australian Spectrum Plan or the ITU Radio Regulations.

While the Department has generally not allowed the expansion of fixed services in this band, there are no plans to have them vacate it. Amateur services will have to continue to share this band with the Fixed Services." So there you have it, no more queries about hearing voices, unless coming from Broadcasting Stations. They are intruders. These remarks also apply to 17 metres ... 18.068 — 18.168 MHz. Till next time, 73.

May 1990 Summary

Freq	UTC	Date	Logs	EMN	I D	Comments
			x			
144023.5	mni	mni	16	F1B	In	Cypher "Boris?" 250 Hz shift 3rd R
14046+/-	0900+	2004	34	A3E		U/LSB Rad Teleph 24 hr stn
14058+/-	0600+	"	44	A3C?		Suspect Ch Henschreiber update
14071/75.5	dly	dly	73	F1B	VRQ	Vietnam
14140	1040+	2004	10	A3E		2x B/C, USR + Radio Tirana??
14140.5	dly	dly	17	A1A	UMS	+F1B 250 Hz 3rd reg USR Naval
14211.5	0855+	mni	10	F1B		Txt in cypher 250 Hz shift
14217.5	1100+	"	17	"		same as above
18100.5	2057	1505	2	A3E		same freq 2x B/C speech & music
21032	dly	dly	54	A1A	UMS	24 hr op, USR Naval
21113	0600+	mni	6	A1A	CQ5	+F1B "Been on holiday"???
21115	0600+	1905	"	"	FH6	Uses same freq & text as CQ5
21284	dly	dly	30	"	UMS	+F1B very persistent intruder
21405 +21450	"	"	74	A3E		Rad Moscow, English, W/Wide service
24950	"	"	16	"		ID not U/stood/ B/C Chinese 18 hrs op
Above 5th harmonic of 4.990 MHz						
28095	2350+	2604+	7	A3E		R.Beijing/3rd Har of 9365 S 6 in Bris
28350	dly	dly	13	"		3rd H of 9505 MHz
28575	0812+	1405+	7	"		Music & talk in English B/C,

Many B/Cast stations in the 10mx band (28-29.7) causing unnecessary problems and disrupting legitimate use of amateur frequencies for very long periods of time. These are the most heard intruders in our bands for May 1990 and were compiled from reports of VKs 2COP, 2EYI, 3XB, 4BG, 4AKX, 4BHJ, 4BTW, 4BXC, 4KHQ, 5TL, 6RO, 6XW and 8HA.

A full copy of the May Summary will be supplied to anyone on receipt of SAE.

ar

SPOTLIGHT ON SWLING

ROBIN L HARWOOD VK7RH
52 CONNAUGHT CRES WEST LAUNCESTON 7250

As I'm writing this, we are in the grip of midwinter. It has been a very cold, damp late June-early July here in northern Tasmania. Only a few days ago, my old home town of Deloraine was snowed in, with the kids being sent home early from school.

For the past week, it has been raining continuously here, so this has provided me ample opportunities to spend some time monitoring the spectrum.

Naturally, the best period for doing just

that has been in the local daylight hours, with plenty of signals propagating in from Europe and the mid-east. Even the 49-metre band did provide some reasonable signals via the polar path around 0200 UTC, compared with last year.

Mainly it was Deutsche Welle or Radio Berlin International, Swiss Radio International or the BBC which were able to be identified.

And, while we are on Radio Berlin International and Deutsche Welle, I believe that it is

probably inevitable that these two international broadcasters will merge into a single organisation, ahead of German reunification, which could come as early as December this year. On 1 July, the two Germanys merged their economies, abolishing their domestic borders to allow the free flow of trade and commerce.

The name(s) of the new international arm of German international broadcasting have yet to be announced, although the superior technical facilities and studios are in Bonn; but if Berlin was to become re-established as the capital of a united German state the decision could be to centre the broadcasting activities there. Keep tuned to both RBI and Deutsche Welle for the latest developments.

The VOA recently had a budget overrun and consequently has had to cut back on its audience mail, according to "Media Network" on Radio Netherlands. I believe they will be back to normal by about October, when more funds become available. On the other hand, Radio Beijing is going out of its way to win back its listening audiences by sending listen-

ers a bulletin called "The Messenger" with advance program details and frequency lists. Incidentally, Radio Beijing has retimed its Australasian releases in English to 0900 to 1100 UTC, without any frequency alterations.

Recently, I came across a program specifically designed for amateur radio enthusiasts, from Radio HCJB in Quito, Ecuador. It is

aired on Wednesdays at approximately 0750 UTC on 9745 or 11925 KHz. Hosted by John Beck, who is himself an avid operator from Quito, the program is for amateurs by amateurs and runs for about 15 to 20 minutes.

Well, that is all for August. Until next time, the very best of listening and 73 DE VK7RH ar.

ALARA

JOY COLLIS VK2EBX
PO BOX 22 YEOVAL 2868

I was quite surprised to see the addition to the ALARA column in June AR, which, though a bit sneaky, was me. My thanks to the five contributors named, and also the Editor of AR for publishing the article. (I'm still trying to figure out where they got some of their information!)

Currently I am still getting used to retirement from school activities, and wondering how I ever found the time to go to work anyway. I must confess it is pleasant on these freezing winter mornings to linger by the heater sipping another leisurely cup of tea instead of having to get up early and rush out in the cold. Yes, I can definitely recommend it!

Schools And Amateur Radio

During Term One I was asked to talk to Year Seven at Yeoval Central School about amateur radio as part of a communications lesson. This was enthusiastically received, and as a follow-up the class came around to my home on 21st June to see how it all worked.

Squeezing twenty-two children and one teacher into my small radio shack required a little ingenuity, but somehow it was achieved.

We were very fortunate to have two school groups on air, and to be able to talk to children from other schools, and would very much like to thank the Blue Mountains Grammar School with John VK2BJA and Marryatville Primary School with Grahame VK5AQZ, also Camberwell Grammar School VK3BCG who came in just as we did not have much opportunity to let the children talk to the Blue Mountains Grammar School. Our sincere apologies to them.

The Yeoval children showed great interest, asked many questions, and hopefully gained some insight into what amateur radio is all about.

It has been suggested that, as many of our members are involved with schools, it might be a good idea to compile a list of those schools which do have amateur radio facilities to see if more get-togethers on air can be arranged between them. Some schools are quite active in the hobby of amateur radio, and would welcome such activities.

It is, after all, the younger generation who

will have to provide the radio amateurs of tomorrow, if our hobby, with all its facets, is to survive.

Dubbo ALARAMEET 29/30th September

The ALARAMEET is fast approaching, and by now all those attending should have booked their accommodation and made arrangements for someone to feed pets, water gardens etc. It is requested that everyone who has membership badges, (WARO, BYLARA etc) bring them along, and also give some thought to communications for local mobile contact (2 metre hand held etc). Another aid to recognising ALARAMEET vehicles is to look for those with yellow and black ribbons attached to the aerials. Rather an original idea for easy identification.

It should be a most enjoyable weekend.

Aerials Are For The Birds!

Any amateur radio operator is justly proud of a neat aerial array soaring magnificently skyward, resonant on the desired bands, and operating efficiently.

Unfortunately that mass of wires, piping and cable up there too often attracts avian acrobats in great numbers who enjoy nothing better than chewing our insulation, ripping cable to shreds and bending beams into useless "U" shapes!

Such a problem afflicts one of our VK2 members, who has had her activities severely curtailed by flocks of galahs prevalent in her area. Various solutions have been suggested, bearing in mind that the aim is only to deter the birds, not to destroy them.

A resident of Yeoval, endeavouring to keep galahs off his TV antenna regularly bangs on a piece of tin every night, just as the birds come to roost. Although the noise can be heard all over town, and the birds do fly away, they are back again the next night, so obviously this idea has limited value.

A certain OM came up with the idea of feeding the galahs wheat which had been dipped in whisky, so that they would be too drunk to fly! Apart from the obvious cost (even

cheap "plonk"?) and the rather doubtful eye of the RSPCA might cast on such proceedings, it is hard to imagine what this particular YL would do with all those inebriated birds staggering about the yard. There is also the danger they might become addicted to the stuff and keep coming back for more.

It is obvious some other solution will have to be found. Until then commiserations to everyone who has such problems. Suggestions welcome!

Bits And Pieces

Well known DX-er Clair, EI7CW was operative from EA6/maritime mobile off Majorca in June.

Denise VK5YL came on the 222 YL Net from KH6 during July, a new YL country for some.

Congratulations to Norma VK2DJO on the arrival of a baby daughter, Lorraine, and to Bobbie VK2PKS, the proud grandmother.

The VK5 ALARA Birthday luncheon was held on 29th July.

We were pleased to hear Beryl VK2BBM on the ALARA Net recently. Beryl is a long-standing member of ALARA, but does not get the opportunity to come on air very often.

I was very pleased to catch up with Austine VK3YL on the VE/VK/ZL net. Austine, in her 60th year of amateur radio activity (May "AR") still enjoys DX and a chat with her friends.

Regarding the photograph of Austine printed with the May article, we did omit to mention that it was taken by Ken McLachlan VK3AH. Our apologies to Ken for this oversight, and we do hope your health is improving, Ken.

Until next month,
73/33.

Two typesetting errors managed to creep into these notes in the July issue. The callsign of Sandie Franchi, BYLARA secretary should have read G1LXM. Pearl, WARO amateur of the year, was wrongly described as ZL1WY on the bottom of page 43. Her correct callsign is ZL2QY. ar

**Remember to leave a
three second break
between overs when
using a repeater**

DIVISIONAL NOTES

VK2 NOTES

TIM MILLS VK2ZTM

Division Introduces Classes

The VK2 Division moved from Atchison Street in July 1982. For twenty years prior to that, personal lecture classes had been conducted at Atchison Street, where a section of the building had been set aside as a class room. When the move was made to Parramatta, no provision was made to conduct any classes. With the recent exam transfer to the Amateur Radio Service, the Division has acquired suitable chairs and tables. The first class commenced on Monday the 23rd July. While this break in Divisional classes has been just under 10 years, a look back in the Division's history indicated that there was a break from 1929 to 1946 without a class. However, since the early 1960s the Division has conducted the Correspondence course and, judging by the number of books printed over the years, there must be a few thousand Amateurs both in Australia and overseas who have made use of the course.

Exams

The next exam to be conducted by the Division will be in conjunction with the Victorian Division. It will be held on Tuesday evening the 21st. August. Closing date for applicants is 31st July. This is a change from the dates shown in last month's notes. The Sydney end of the exams will be held at Amateur Radio House on this evening. Exams may also be held at other locations and these will have been advised over the VK2WI broadcasts.

During the past few weeks many clubs and groups have conducted their first exams in their local area. Don't forget to keep the Divisional office advised of future dates, so that we can let the many enquirers know what is available in their areas. It may be desirable to hold a get-together later this year with all those conducting exams, to discuss the various aspects and problems, if any, of the exams.

VK2WI

The recently introduced 30 metre morning SSB transmission on 10125 kHz has certainly improved the coverage. It nicely complements the 40 metre service. There have been times when one of the bands has gone out but the other remains up. The IPS predictions for this month indicates that to most parts of the State the optimum working frequency is centred on 10 MHz.

An ATV repeater is to be added to VK2RWI

soon. Input on 23 cm FM with an output on 70 cm Ch 2, A5. Tests have still to be conducted to see how it will live with the various bits of existing RF.

Now that the new voice Bulletin Board is available on (02) 552 5188 which is interactive, the old answering machine on 651 1489 will be taken out of service during this month.

The fireworks were not held this year. It seems hard to find a dry weekend for one thing, and the other was that the rain had made a real mess of the driveway at the gate.

Orange ARC Regional Meeting

The Orange ARC is to conduct a regional gathering at Orange in late September. Check the Club Corner column for details.

Repeater Linking

A meeting was held 30th June to discuss the possible development of a system to link together Capital Cities, like Sydney to Melbourne. It was noted at the meeting that similar interest was starting in other parts of Eastern Australia, and it would perhaps be desirable to proceed towards doing this on a nationally co-ordinated basis. The meeting had been requested by Bob VK2YRX and those attending the meeting appointed Bob to prepare the report for presentation to the Divisional Council.

Activity Registers

There is the need to establish registers of activity in the ATV and microwave regions. Would Clubs and Members please compile these and forward to the Divisional council ASAP. Details have been given on the broadcasts.

Sydney Field Day

The Sydney Radio Group will be conducting their annual event at the St Ives Showground on the 5th August. The Division and Gladesville ARC will share a display at the Field Day.

Repeaters

It is hoped that repeater groups will have checked the details of their systems for the next Australian CALLBOOK. Recent new systems and changes include: Chifley ARC commissioned their 7075 VK2RCZ in Western Sydney; Southern Highlands ARS channel changed VK2RHR from 7350 to 6825 to live with local pagers; Goulburn VK2RGN is back on air. Their system is reversed on 7925 also to avoid pagers. The Goulburn ARC will be adding a 70 cm repeater: Great Lakes at Forster is now operational on 7375; Hunter WICEN may establish a 2 metre repeater in

the Upper Hunter; An ATV repeater (23/70) is to be established at VK2RWI — Dural; An application for a 6 metre repeater for Jervis Bay on the South Coast has been received. With the changes to channel allocations on 6 metres, now is the time for any group to notify the State Repeater Co-ordinator, if they wish to be included in the allocations. Due to the nature of 6 metre propagation, the allocation of these channels will have to be co-ordinated through FTAC.

Wagga ARC have had to change their 70/50 repeater VK2RTW to an in-band 70 cm, as a channel 35 commercial service has been activated in their region.

WICEN (NSW) Inc

Major activities include City to Surf in Sydney 12th August. Brett VK2XMU is Co-ordinator; AGM at Amateur Radio House 18th August; Car Rally as a joint exercise with VK1 WICEN at Batemans Bay on the 1st September. Peter VK2EMU is Co-ordinator.

A posting of newsletters was made to members during July with the renewal notice for dues for the period 1/7/90 to 30/6/91. A separate posting for the AGM was also made. For details about WICEN write to PO Box 123 St Leonards NSW 2065, or leave a message with the Divisional office. By now most clubs should have received a posting with WICEN material for their information.

While WICEN has both National and State organisations, the operational side of WICEN is at the local level. It is here that those able to assist by being members of WICEN are trained and conduct the majority of exercises. A local group can be formed, often from members of one or more local clubs, and a local co-ordinator is co-opted (or arm twisted). In turn the local co-ordinator works under the Regional Co-ordinator. Your local club should have copies of the WICEN details and membership applications. If there is not a club local to you, then contact the State Committee at the address above for membership details.

Slow Morse Sessions

A reminder that VK2BWI is operational every night at 8pm (local) on 3550 kHz. It is conducted by a team of operators who spend considerable time in presenting the session. All amateurs are requested to leave the frequency clear so that future amateurs have every chance of learning the code. There have been problems at intervals where interstate amateurs decide that it is a "clean" channel for their nets. The morse session is intended for all of eastern Australia. The VK2BWI session is followed by VK5AWI with their session.

RD Contest

VK2 needs your participation and your log for the State score. The broadcast for the RD weekend is conducted at 5.15 pm on Saturday afternoon. There is no Sunday morning trans-

mission but the evening is at the usual time of 7.15pm.

New Members

Our usual warm welcome is extended to the following who joined the Division during July.

D J Barrett	VK2LDB	Edgeworth
P L Beecham	VK2XQV	Werrington
P H Clutter	Assoc	Bateau Bay
S Garozzo	Assoc	Revesby
F Horton	VK2MIL	Illawong
G R Jones	VK2CCK	Balmain
S Monzen	VK2FGP	Sydney
V Saunders	Assoc	Merrylands
B D Simpson	VK2BJ	Chatswood
E Turner	VK2NLU	Bradbury
J W Turner	VK2MIQ	Ryde
A E Zakaraudkas	VK2FJD	Maryland

ar

VK6 NOTES

JOHN HOWLETT VK6ATA

Council is not just relieved but in fact very pleased to welcome John Farnan VK6AFA as our new secretary. The position has been open for some 18 months, and secretarial duties being shared among the council members and co-ordinated by president Alyn VK6KWN. Ross VK6DA has done a splendid job as minute secretary and has decided to retire from the co-opted position. Thanks Ross, hope you will tackle another job soon.

Information

Christine VK6ZLZ has produced a new version of the information sheet giving details of services, clubs and affiliated groups, phone numbers etc. The information sheets will be given to new members when they join. No doubt copies will be available to existing members at WIA meetings or when renewing membership.

Bookshop

New titles are being introduced to the already substantial list of books held by booksales officer John VK6GU. Discuss your technical literature or QSL printing needs with John at the next WIA meeting or ring 497 1616 and do business by phone.

QSL Cards

Remember the station you worked a couple of months ago? Well, he has probably taken the trouble to send you a QSL card because you seemed a nice person. Don't let yourself down, collect the cards from the QSL Bureau on a regular basis and send one in return. Should you need help, or require QSL stamps, contact Jim VK6RU at WIA meetings or phone 385 9664. Country members can post cards to

PO Box F319 GPO Perth 6001. Remember to send Jim a quantity of SAE so incoming cards can be returned.

WA Division phone number is now (09) 388 3888.

73

ar

5/8 WAVE

JENNIFER WARRINGTON VK5ANW

Correction

It seems that even before this column gets into print it's out of date! It seems that Nigel VK5VB will not be around to get that "Buddy System" off the ground. Nigel will be moving to VK6 in the very near future and our loss will be their gain, but if anyone would like to take over that "Buddy System" Register, Council would be delighted to hear from you.

Resignation

Good volunteers are always hard to find and when it is one who has been around as long as John Gardiner VK5KJG then the

"void" is even harder to fill. According to my sources, John joined Council in April 1983 and held the position of Minute Secretary until April '84. In April '84 he took over the position of Publications Officer from John Mount VK5EV, and was also Building Supervisor at the BGB. In April '85 he swapped the Building Sup job for Education Officer but continued with Publications as well. He held the two portfolios until April '87 when he retired from council and since then he has continued to be Publications Officer. Unfortunately, John has now decided that enough is enough, and we are looking for someone or several people to run the Publications side of things. If you feel that you could help, please contact a member of Council. And to John, our grateful thanks for all you have done over the past six years. Listeners to the Sunday Morning Broadcast will also be aware that John has been one of the 2m relay team for the past couple of years, so we will be looking for another volunteer there.

Public Relations

Council is looking for a volunteer to fill this very important position also. don't be put off



The Retiring VK5 Council. Back row L to R. John McKellar VK5BJM, Ian Watson VK5KIA, Ben Broadbent VK5ABE, Bill Wardrop VK5AWM and Hans Van Der Zalm VK5KHZ.

Seated L to R

Alan Mallabone VK5NNM, Jenny Warrington VK5ANW, Don McDonald VK5ADD and Rowland Bruce VK5OU. Bob Allan VK5BJA and Peter Maddern VK5PRM were not present.

by the title. Perhaps "Recruiter of new members" would better describe what they have in mind. If you feel that you have some talents or ideas in this area, again, let Council know. Once again perhaps, a team could prove to work better than an individual. Don't keep those good ideas a secret!

What do I get for my membership? or what do "they" do with the money? are a couple of hackneyed phrases that get mumbled (of should that be "grumbled") around from time to time. Well, have you used a repeater or a Beacon lately?

The Insurance bill alone, for the Division this year is \$1788. That includes Insurance of all the Beacons and Repeaters, all the equipment at the BGB for fire and theft, public

liability at the building or anywhere we put on a Display and cover for people working on repeaters etc. Add to that, the cost of maintaining the Repeaters' Coax, site rents, licence fees, and you are JUST starting to see what they do with your money!

Incidentally, it is hoped that by the time you are reading this Ch 8 Repeater (7000) will again be in use after its untimely demise on July 2. It is hoped to have it in the air as quickly as possible, even if it has to be a temporary arrangement to start with.

Another Past President will be hung! (on the wall of the BGB, that is) My thanks to Ross Dow VK5KF, for providing me with the first colour photograph to add to our collection.

Diary Dates

Tues 28th Aug. A Deceased Estates Buy & Sell.

Tues 25 Sept. The Display of Members' Equipment Night. Bring along any piece of home brew gear that has not been entered before, tell us all about it, and be in the running for one of the prizes that are offered.

Congratulations

- to John VK5BJM who becomes the second Vice President.

- and to Don VK5ADD who becomes the new Examinations Officer.

Our thanks to John Andersen VK5ZFO who was the co-ordinator through the 'setting-up' stage.

ar

QSLs FROM THE WIA COLLECTION

KEN MATCHETT VK3TL HON CURATOR WIA QSL COLLECTION
PO Box 1 SEVILLE VIC 3139

The Olympic Games and Amateur Radio

(Part 2)

RM30

The 1980 Olympic Games held in the USSR was the first ever in a Communist country. Moscow was the principal centre, but some events were held in Minsk (White Russia), Kiev (in the Ukraine) and in Leningrad. Yachting was conducted in Tallinn (capital city of Estonia). The USSR was not backward in providing publicity for its Olympic Games through considerable numbers of QSL cards despatched from its central Bureau. The Radio Sports Federation of the USSR and the Krenkel Central Radio Club jointly sponsored the "Olympiada 80" award for radio contacts with certain stations using especially allocated prefixes for the Games during the period 1st Jan-3rd August 1980. These prefixes were: RK1, RW1, RX1, RZ1, RK2, RU2, RZ2, RK3, RV3, RW3, RX3, RZ3, RK5, RT5, RY5 and RZ5. In addition, there were five so-called "Olympic Club Stations" each carrying a special prefix. These were RM30 (Moscow), RL10 (Leningrad), RT20 (Tallinn, Estonia), RM20 (Minsk, White Russia) and RK50 (Kiev, in the Ukraine).

The RM30 QSL shown here was sent from the Olympic Station in Moscow to Ron VK3QP and is dated July, 1980. It was the Moscow Games that came under the boycott of the United States, a move led by the then President, Jimmy Carter, over the Soviet invasion of Afghanistan. A few other nations followed suit (including Australia), but athletes were allowed to decide for themselves (in the face of moral pressure) whether they wished to go. The US athletes had no such option, the President threatening to revoke the passport

of any participating athlete!! Despite the boycott, over 5000 athletes took part, and a large number of world records were set. Security was very tight, successful athletes not even being allowed to make a lap of honour after their success on the track.

NG840

This pictorial QSL shows the scene at the opening ceremony of the 1984 Olympic Games held in Los Angeles. The especially allotted callsign was a modification of the amateur call NG6O through the courtesy of that operator. The letter "O" in the call assumed a new significance with the Olympics. The QSL card was sent to Roy Jonassen VK4NE (now an "SK") from the official Olympic radio station at the Games. The reverse side of the QSL

tells the story "Located in a ticket booth at the rim of the Drake Stadium on the University of California at the Los Angeles (UCLA) campus, NG840 began operation as the first athletes were arriving at the Olympic Villages for the XXIII Summer Olympiad. The cramped quarters (6ft x 15ft) and modest antenna placement (15ft up amidst 40ft trees) were limitations we had to live with, in order to be located where the athletes could get to us . . . in the high security "main street" area."

The station successfully logged 8000 QSOs, despite the poor conditions prevailing, and was instrumental in originating hundreds of messages from athletes around the world. American amateurs were permitted to use the prefix W23 (standing for XXIII Olympiad) as well as W84. Depending upon the home call held, N, K, WD and other prefixes were also used. The WIA QSL collection also holds the special station QSLs K84OG, W84OG and W23OG (Olympic Games), all from Stanford University, site of the preliminary soccer matches. It will be noted that the NG840 QSL

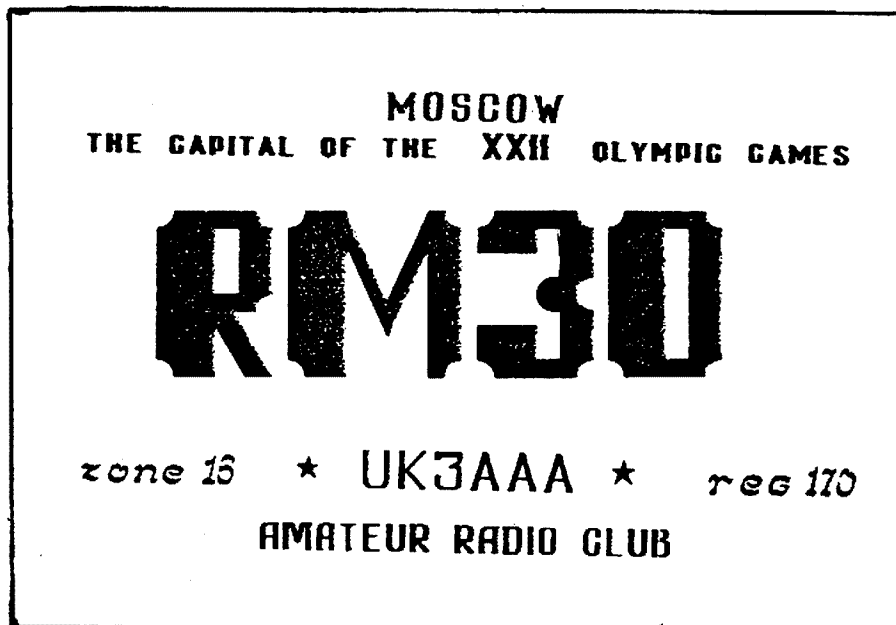



displays five interlaced rings — symbol of the Games. De Coubertin found the emblem at Delphi in 1913 and immediately saw its application to the Olympics. He wrote, "These five rings represent the five parts of the world, won over to Olympism and ready to accept its bountiful rivalries. The six colours combined in this way represent those of every nation without exception."

HL88AQB

The tradition of amateur radio participation in the Games was certainly maintained on the occasion of the XXIVth Olympiad at Seoul, Korea, in 1988. All HL stations were permitted to use the special prefix HL88, several producing particularly well-designed QSLs as the one shown here. As in recent Olympiads, Korea introduced special numerical prefixes. Those of 6K24 and 6K88 were used for its official radio stations at the Olympic Village, Olympic Park and the Pusan Yachting Centre.

Hopefully Australia may be granted the 1996 Olympiad, but this will not be decided until September, 1990. If successful, perhaps radio amateurs throughout Australia will be permitted to use a special prefix for the occasion. By that year we may be imaginative enough to suggest a special call allocation like VI3OG or maybe VM3OG. After all, there's always a first time for using our ITC-allocated prefix VM. In any case, let us all hope that should our bid be successful, the Games will be free from distasteful rivalry, and that they will enjoy a success no less than the "Friendly Games" of Melbourne 1956.

DX QSL contributors' award

As pointed out in an earlier edition of "Amateur Radio", last year's winner was Robin Lyon VK6LK of Margaret River, WA. Robin's success is gained on a Kenwood TS-830 S with an outboard VFO. The receiver is a very much modified Drake R4C. His antennas include a four-element yagi on 20m (at 80ft) and a five-element 10m yagi stacked above a five-

element 15m beam. For the lower frequencies there are three antennas for 80 metres and two V-beams on 40m — quite an antenna farm.

Robin joined the British Army at the age of 17 (although the authorities had to believe he was 18) and served in north-west Europe during the war, with the rank of lieutenant. After the war he joined the Regular Army and served in the Sudan and Aden. Of course he had to be active on the bands. His calls were ST2GL and VS9AH. Whilst stationed in Germany, he operated as DL2XR. Retiring from the British Army with the rank of Lt

Colonel (after 25 years service) he migrated to Western Australia and was issued with his present call, VK6LK.

His main interest is naturally amateur radio, with particular attention to 80-metre DX. His confirmed DXCC Honour Roll totals are 316/332, which is truly a splendid effort. Robin lives with his wife Bernadette and son Kevin (who, incidentally, holds the call VK6TM).

We wish him continued success on the bands and again thank him for contributing so generously towards the WIA's own QSL collection.



Robin at his rig. The Kenwood TS830 S is to the left, with a Ham M rotator on top. To the right are the Drake twins, the R-4C and a T-4XC.

AMATEUR RADIO
HELPING OUR COMMUNITY.

CLUB CORNER

The Orange & District Amateur Radio Club Inc will be hosting a Western Area Meeting of radio clubs, amateurs and other interested parties to discuss matters of mutual interest and concern on Saturday, September 22, 1990

All are welcome and encouraged to attend
Venue: Shortlist of three (Bloomfield, SES, Ex-Services Club)

Schedule: Four sessions in two time slots.

Preliminary agenda below:

	Session 1A	Session 1B
1pm	(Political) Federal Report VK2 Div Report	(Techno-Political) Packet Developments Present State & Future Directions
	Repeater Sites Repeater Linking	
5pm	Exam Devolution Feedback	
Dinner	Session 2A	Session 2B
7pm	(Operational) Band Planning — WARC 1992	(Technical) ATV Exotic Modes
9pm	WICEN recent reports Western area preparedness & exercises	CW

Logistics: Travel out on Friday or Saturday, travel back on Saturday or Sunday. Dinner on Saturday will be informal, either at participants' whim or at a restaurant chosen by the organisers. Excellent hotel accommodation, including a light breakfast, will be available.

A charge of \$5.00 per head will be made to cover refreshments and printed material. When accommodation arrangements are finalised, a deposit may be required from those wishing to take advantage of block booking rates. This will be advised in time for it to accompany the meeting fee.

More details to follow as the plot thickens

For information, contact the club at PO Box 1065, Orange 2800. Colin de Kantzow VK2JCD on (063) 62 6617 (BH) or (063) 65 3387 (AH) or Kim Stevens VK2ASY on (063) 62 3710 (AH).

This is a preliminary notice only, and more detailed information will follow soon. Suggestions for agenda items, topics and speakers are welcome, as are bookings for meals and accommodation.

SILENT KEYS

DUE TO INCREASING SPACE DEMANDS OBITUARIES MUST BE
NO LONGER THAN 200 WORDS

We regret to announce the recent passing of:

Mr Glen Russell-Smith	VK1ZGR
Mr R C (Ned) Paton	VK2BRP
Mr Roy Cornish	VK2KRW
Mr A Both	VK2PEB
Mr C J Reed	VK3IX
Mr G W Small	VK3DKJ
Mr Warren Edmanson	VK3NVM
Mr L E Catford	VK5LC
Mr L G Wilson	VK6LG
Mr V P A Magry	VK6VP
Mr H F Skipworth	VK6WS
Mr J C Milne	VK7AG
Mr Warren Gower	VK7JAD

Warren Edmanson VK3NVM

Warren died on 1/6/90 at Moe Hospital, following the onset of a stroke.

Warren was a prominent and popular member of the Southern Peninsula Amateur Radio Club. Over the past 10 years he served as Treasurer and President. Warren was in his mid 70s, and shifted residence from Blairgowrie to Trafalgar in 1988 to be near his family.

Warren always had a cheery disposition and a fund of humorous "sayings" — some, no doubt, gathered whilst serving with the RAF during WW2. He took pleasure in helping other members, especially in coming to grips with CW. He took part regularly in the SPARC net, and was also a well known participant in other nets. His presence and voice will be greatly missed by members and his other radio friends.

**SOUTHERN PENINSULA AMATEUR
RADIO CLUB**

Warren Edward Gower VK7JAD

The death of Warren was a loss, not only to his immediate family and friends, but also to amateur radio in general. Warren had been interested in radio for many years, coming up through the ranks of CB and obtaining a limited amateur call VK7ZWG in February 1987.

He passed the Novice licence 12 months later and obtained the callsign VK7JAD. He was a keen member of the WIA and enjoyed the regular Sunday morning broadcasts. Although not often in a position to call back after the sessions.

Warren's first love was for 2 metres, which he monitored virtually 24 hours a day. Warren was also keen on RTTY, and had several pieces of home made and modified commercial gear for this mode. He will be greatly missed by the other hams on King Island, for he was always ready and willing to assist with hoisting a mast, tuning an antenna, or helping to repair a piece of equipment.

Warren was only 31 years old at his death, and leaves a wife Tracey and four young children under 7 years of age.

MIKE WOOD VK7FE

Joe Brown VK7BJ

Joe was born in 1916 at a small town called Pyengana in the NE of Tasmania, where he began his education. Joe moved to Hobart in the early 1930s where he obtained employment with the National Broadcasting Service at 7ZL/7ZR Studios, which were then controlled by the PMG Department.

This was Joe's motivating interest, and eventually he became a Supervising Technician. Later he became Officer-in-Charge of the installation and operation of the TV transmitters on Mount Wellington.

Joe joined the Institute in 1933, and was State Secretary in 1945 through 1948; State President 1950 and Federal Councillor for a number of years in the 1950s. He was granted Life Membership in 1949. Joe was also involved in the RAOTC for many years, and was the local Co-ordinator.

Being a "professionally based" amateur, he was highly regarded by all who knew him, offering help to those with a problem, be it technical or personal. His knowledge and expertise seemed unlimited, as was his ability to pass on that knowledge. Joe maintained his deep interest in the WIA, State and Federal until his death. He will be keenly missed.

The Tasmanian Division extends its deepest sympathy to his wife Mary and family. Vale Joe SK.

(The sun are no longer shining in Thirza St — Ed)

T ALLEN VK7AL
ar

COPIES OF ARTICLES

Photocopies of any article published in a back issue of AR available to members at \$2.50 each (plus \$2.00 for each additional issue in which the article appears)

AR ARTICLES
PO Box 300, Caulfield South Vic 3162

OVER TO YOU

ALL LETTERS FROM MEMBERS WILL BE CONSIDERED FOR PUBLICATION AND MUST BE LESS THAN 200 WORDS. THE WIA ACCEPTS NO RESPONSIBILITY FOR OPINIONS EXPRESSED BY CORRESPONDENTS

Same Age

I must congratulate the Wireless Institute of Australia on its 80th anniversary.

My last letter, five years ago was on similar lines, when I said I was the same age as the Institute, but although we are still running neck and neck, we all know who will last the longer, hi!

I excitedly received my call in 1932, and joined the Institute the same year. We were given permission to broadcast on the higher end of the Broadcast Band and allotted certain frequencies and specific times on Saturdays and Sundays, but that ended suddenly at the outbreak of WW2. Besides the transmissions on the broadcast band we were allowed to use amateur bands at any hour. Mostly, amateurs constructed their own equipment and as there was not as much QRM nor high power stations around, the receivers did not have to be as selective as nowadays.

I must thank the Institute for their continuing battle in keeping our bands for our use, and especially the devoted people who spend so much time and thought in their preparations.

I would like to reiterate the important saying "USE THE BANDS OR LOSE THEM".

EDGAR NICHOLLS VK7RY

8 GARDEN LANE MIDWAY POINT 7171

Need For CW

In the June AR Lindsay Lawless in his "Dinkum Persuasion" letter, states that CW is a "pinnacle to be conquered". I agree, but must we use it to serve the international community that authorises our existence? I think not.

We become amateurs because of an interest in radio communications, which has many facets (not just CW).

Rag Chewing on 80 or the local repeater can breed parochialism, in some cases. Many amateurs use 80 or the local repeater for club nets or local contacts etc, and if operations are within the terms of the licence then we are, in fact, serving the "international community" referred to.

Yes — we are all persuaders and we should provide incentives and encourage upgrading but let's not coerce (and risk losing numbers). The decision as to licence level (and subsequent upgrading) is an individual choice based on what is desired from the hobby and what "affordable" radio communications means to that individual.

At this time, I do not use CW, spending most of my time on 10 or 15 DX (phone). However, I do not advocate the removal of CW

— nor do I consider the lack of its use necessarily relates to a lack of ability to master the code.

DEREK THURGOOD VK3DD
Box 234 YARRA GLEN 3775

Abuse Of Privilege

For some years now I have been aware of a continuing and escalating abuse of amateur radio transceivers and amateur radio frequencies as a cut-price alternative to the official Coastal Radio Service. For a number of obvious reasons I find this abhorrent and I have today requested that the WIA protest most strongly to DOTC about this situation.

It is my fear that if this is not done then commercial, industry, and industrial pressures will result in increased costs to Australian amateurs contemplating the purchase of new HF transceivers.

To ensure that this does not happen I urge thinking amateurs to add their voice to that of others protesting about the creeping commercialism and egotism pervading our bands. Failure to do so I fear will result in a loss of privileges for all Australian amateurs.

DEANE LAWS VK4ALN

27 AWOONGA AVE BURLEIGH HEADS
4220

Australian Pirates

Amateurs who value their hobby should be concerned at the level of pirate activity above 27.405 MHz. There are many hundreds of pirates operating from Australia, most using QRO amateur gear with little apparent interference from a short staffed DOTC.

Equipment is easily obtained by these types, ready modified, from unscrupulous dealers, who have little regard for the ethics of aiding and abetting defiance of the law.

What happens when the sunspot cycle declines and these people are left in limbo? Do they salt away expensive equipment for another five years or so? Not blooming likely! Today's pirates are tomorrow's intruders. At present there is little incentive for pirates to study for the AOCIP; why bother when you can do it all so easily, with little harassment from the authorities?

Every amateur who values his hobby should lobby the Government to have pirate activity stamped out, and should monitor the 27 MHz band reporting out-of-band activity. Remember 27 megs? It used to be yours; they got it but now they want more. It's your hobby that's up for grabs. Make a noise about it. It's up to you.

BOB ELMS VK6BE
72 DREW ST ALBANY 6330

Potato-Less Polarity

The June issue of Amateur Radio is great, particularly all the articles on test gear and basic principles which are explained clearly. Our licences imply we are technical people but still there is a need for more basic practical theory that one can learn from!

The bit I enjoyed was using the humble spud to determine the polarity of a battery. Very amusing indeed! If no potato is handy there is another simple method to do the same thing. Test gear needed, two bits of wire (perhaps scrounged from a fence?). Get a dollop of electrolyte from a cell, drop it on top of the battery case and with the two bits of wire connected to the battery terminals you dip the other ends into the dollop of acid without shorting them. Lots of little bubbles will appear around the Negative wire.

I thought it may interest someone out there. The technical explanation is that positive hydrogen ions are attracted to the negative (cathode) terminal from which hydrogen gas then bubbles up. I find it handy when working with strange and unmarked batteries one often finds around large machinery out bush. Usually start with a known battery so I don't get the polarity wrong and mostly a bit of fencing wire.

T BARKER VK4CBP

4 SEATON ST TOOWOOMBA 4350

All In For WARC

Congratulations to Henderson and Wardlaw for their excellent "WARC 92 Update" in April AR. I have made copies of the para headed "The Amateur and Amateur Satellite Service" to give to interested people and organisations in my district; to inform them of the real purpose of the ARS and the ARSS, and of some justification for their retention.

Our representatives will do their best to influence the administrations involved in WARC '92 (and '93) but it is unfair to expect them to succeed without the support and assistance of every radio amateur. Assistance and support which must be much more than membership of a "National Society". It is foolish to delegate that sort of responsibility in the belief that they alone have the answers — the truth is, they do not. Success at WARC '92 is a task for the collective responsibility and intelligence of all radio amateurs.

If membership of "National Societies" is essential for success at WARC, the first problem for our collective wisdom is to discover why those societies are poorly supported. Less than 50% of licencees, world wide, are members. Our intelligence will need to find effective inducement. Intimidation is not intelligent and doesn't work; our persuasion is also unsuccessful.

LINDSAY LAWLESS VK3ANJ
Box 112 LAKES ENTRANCE 3909

ar

HAM ADS

TRADE ADS

● **AMIDON FERROMAGNETIC CORES:** For all transmitter and receiver applications. Send DL size SASE for data/price to RJ & US Imports, Box 157, Mortdale NSW 2223. (No enquiries at office please ... 11 Macken St (Oatley). Agencies at: Geoff Wood Electronics, Sydney; Webb Electronics, Albany; Electronic Components, ACT; Truscott's Electronics, Melb; S Willis, Perth; Assoc TV Service, Hobart.

● **WEATHER FAX programs for IBM XT/AT's** *** "RADFAX2" is a high resolution, shortwave weather fax, morse & RTTY receiving program. Needs CGA, SSBHF radio & RADFAX decoder. Also "RF2HERC", "RF2EGA" & "RF2VGA", same as RADFAX2 but suitable for HERCULES, EGA, & VGA cards respectively. \$35 *** "SATFAX" is a NOAA, Meteor 7 GMS weather satellite picture receiving program. Uses EGA or VGA modes, needs EGA or VGA color monitor and card, + "WEATHER FAX" PC card. \$45 *** All programs are on 5.25" OR 3.5" disks (state which) + documentation, add \$3 postage. ONLY from M. Delahunty, 42 Villiers St New Farm 4005 QLD. Ph (07) 358 2785.

FOR SALE — NSW

● **KENWOOD 711 & 811.** As new \$1300 ea. Scope PHILIPS GM 5606 0-200 kHz \$150. Spectrum analyser "Singer" input attenu missing .1 MHz to 40 GHz. Sweep & monitor \$800. Tubes all types, 1935 to present. SAE for list. Eric VK2WH (02) 550 2288(w) (02) 958 1985 (H) (02) 517 1406 fax.

● **DRAKE TR7 transceiver** \$1250 1.30 MHz full coverage receive. Fully operational on WARC segments (02) 740 5924 Charles VK2ZR.

● **NEW 5 element channel - OTV antenna.** 12 foot boom. Ideal light weight 6 metre beam \$50. John VK2ATU (02) 772 3769.

● **PALOMAR ATU T network.** 3kW 1.8-30 MHz 1/4 inch copper tubing inductor for low losses tapped every turn built-in noise bridge for tune-up without transmitting \$400. WM NYE Viking MB II Matchbox ATU Pi network 3 kW 1.5-30 MHz 1/4 plated copper strip edge — wound rotary inductor for low losses. Built-in SWR meter \$400 tel (02) 787 2958.

● **FREE 39ft oregon 2 piece mast** guys halyard G5RV ant good condition VK2AVT. QTHR (02) 57 4325.

● **YAESU FT-209R VHF 2M FM transceiver** with 2 battery packs, charger and soft case. Jayson VK2JJR (02) 726 8278.

● **DICK SMITH VZ300 colour computer** in excellent condition with cassette player, orange screen monitor (also operates on colour TV), joysticks, parallel printer decoder and cable, Editor/Assembler tape, and DSE RTTY Modulator Demodulator Kit with Eprom and all instructions for kit, computer and add-ons. Price: \$180. Peter VK2BTI QTHR (02) 871 8394 (AH).

● **KENWOOD TS 700 SP all mode 2 M TXVR.** Digital readout, 12VDC or 240 VAC operation from inbuilt pwr supply. This TXVR is in brand new condition, very rarely used. Included are all original acc and packing, tone burst facilities. Also inc a 50 watt Kenwood dummy load RD-IS \$700 ono. Yaesu FT7 mobile bracket, no S meter \$270. Yaesu FT 200-FP200 \$350. Michael VK2VFT (066) 47 3271.

FOR SALE — VIC

● **YAESU FF-501 lowpass filter** \$50. Yaesu FL2100B excellent \$800. Realistic AX190 amateur band RX \$150. Kenwood AT200 \$200 Yaesu YH55 h'phones \$10. Ron VK3OM QTHR. Ph (059) 443 019

● **HEATHKIT code practice oscillator** batt powered model HD-16 in good working order only \$30 includes circuit VTVM Heathkit model TM-18 7AC & DC ranges

1.5, 5, 15, 150, 500 & 1500 volts. As new condition with tech manual & full cct diag \$210 ono. Phone AVH (03) 872 3503 VK3AJQ QTHR.

● **YAESU FT102 txvr am/fm** \$950. FT101E txvr \$400 FRG 8800 rcvr with vhf, preamps, \$650. Syd VK3DSP (059) 85 2170 tx rigs licensed amateurs only.

● **DECEASED estate VK3GU.** Offers are required for the following collector items. Radio Corp Receiver 150 kHz-15 MHz. 7 battery valves in steel case. Command tx 3 to 4 MHz. Central Electronics transceiver 1.8 to 29 MHz believed to be AM/CW. Auto Keyer — Buzza products USA. Very heavy base. Central Electronics Sideband Slicer — Receiver adaptor. RAAF A1047 radar display. AWA AT21 aircraft tx. RAAF APN4 ident unit — 5 inch cro. Army 108 set 2 to 3.5 MHz. Wavemeter. AWA class "C" 1.4 to 10 MHz. Contact John on (051) 56 6110 or Bob on (051) 56 7654 for more details.

● **NALLY** crank up tilt over tower with fibre glass quad and control box. Buyer to remove \$200. VK3VF QTHR (059) 75 1475.

● **YAESU FT107M 100W HF TRX 12/240V operation.** C/W 2 x 12V leads, MMB-1 Mobile Mount. YM38 Base Mic, MH-1 hand mic, FV107 ext VFO. All in good condition, in boxes with manuals etc. \$900. YAESU FT270ORH 2m/70cm dual band. 25w both bands, full duplex, C/W Voice Synth, spare power lead, spare mounting bracket, technical manual. As new in box \$780. Willing to drive to Albury for VK2s. Hi-Mound morse key, suit FT107 etc \$30. FT209 carry case brand new spare \$10 posted. Craig VK3KLI ph/fax (03) 527 6895.

● **RACAL Antenna Enhancer,** used between antenna and RA17 rx, 19 inch rack mount 3 stage tuneable unit, VGC circuit supplied \$150 ono Bill VK3AQB ph (03) 337 4902.

● **DRAKE final valves 6JB6** \$50 per pair, 813 valves (new) \$100 the pair. PL 177WA RF power beam pentode to 175 MHz \$45 ea. John VK3ZRV (03) 439 3389 QTHR.

● **APPLE 2+.** Twin floppies. 64k RAM with 80 column

& Z80 cards, Applesoft in rom, 12 inch green monitor, Stacks of free software, Perfect condition \$550. Ken VK3MW QTHR (03) 560 5278 (AH) (03) 522 1476 (BUS).

● **Valves new/GC.** 813, 5U4G, 807, 6J6, 6AN8, 6DC6, 6SL7GT, 6J5GT, 6V6GT, 6SK7GT, 6AQ5, 6BJ6, EL32, 6AK5, 1D8GT. GR Tube VCR 139A. \$1.50 ea exc 813. 600 V 150 mA power supply (866s). Fixed capacitors, modern disc cer polyst etc. Midget var. capacitors-Eddystone, Hammarlund. Resistors ww many values. Inductors, wide variety. Coil formers Eddystone Set AR mag 1987. 2M Yagi \$10. VK3XB QTHR (03) 808 4686.

● **YAESU CRO YO-100** with 2 tone generator for SSB monitoring with instr book \$290 phone Wandin (059) 64 3721.

● **ICOM UHF/VHF IC 32AT** handheld external power adapter AD-12 speaker microphone HM-46 \$735. Sr No 04823. VK3GWK (051) 74 3930.

● **KENWOOD TS440S HF txvr,** narrow SSB filter, built-in ATU, mic, manual, as new, \$1750. Yaesu FL110 HF linear, manual. Excellent condition. \$225. VK3ARZ QTHR (03) 584 0512 (AH) (03) 528 5962 (Bus).

● **HIGH voltage probe model HV20** for ferrocaart VTVM \$50. Leo VK3YZ QTHR (03) 232 9422.

● **OSCILLOSCOPE ARON 20 MHz** dual trace model BS-601, used twice, manual, extra lead for \$450 ono. Calculator HP 32E with reserve power pack for \$60 ono. Sam L30621 (03) 330 2557.

● **DECEASED estate (VK3ZHU)** VHF UHF gear 144 MHz to 2.3 GHz for list M. Moritz (053) 67 3595.

FOR SALE — OLD

● **RTTY terminal VZ300 computer RTTY** modem Apple 2C g/screen monitor all leads including printer interface pc. \$300. John VK4ET QTHR (07) 269 3942.

● **FT7 transceiver** handbook mic gc \$395. VK4ET QTHR (07) 269 3942.

● **HAND transceiver — Kenwood TR2400.** Digital readout, 10 programmable memories, many other

Over to You cont Packet Group Sales

There is an article in Amateur Radio dated April 1990 by John Day attacking non-profit organisations and naming MPRGI for involvement in TNC sales. It further accuses it of having an imperative to do so, which in dictionary terms means an extremely urgent need to make profit the main aim of the club.

In answer the MPRGI reaffirms the non-profit status of the organisation. All funds gained from TNC sales and membership dues are directed to maintenance and advancement of club activities. These include ownership of a network of repeaters covering Melbourne. The network outlay and ongoing maintenance costs are beyond the reach of the majority of amateurs or the pockets of our dedicated and highly skilled voluntary group. The Committee volunteers time and operates expensive equipment on a no-cost basis to provide four major 24 hour Bulletin Board services. Without a source of funds and voluntary dedication there would be no repeaters and certainly no statewide market for TNCs.

Perhaps Mr Day would care to attend a meeting of the Club and reconsider his method of slating everyone in range before learning whether his and our motives have a common denominator.

Peter Broughton VK3AZQ
Melbourne Packet Radio Group Incorporated

ar

features. Includes speaker/mike and base station charger w/mike. Good cond manuals, original cartons \$375. John VK4SZ (QTHR) (070) 61 3286.

● **ANTENNA** triband CE36 with BM86 balun \$300. Daiwa rotator model DR7500a control unit model DC7011 with 90 ft multicore cable \$300. VK4GB QTHR (07) 396 1836.

FOR SALE — SA

● **COLLINS CLASSICS** R390A/URR complete with manual \$400. S-Line (winged emblem) 75S3B (115V) receiver includes 250 and 500 hZ filters, 32S3 transmitter with 516F2 (115V) power supply, 312B4 console (provides swr, power meter and phone patch) very good condition \$850. S-Line (round emblem) 75S3C ((240V) receiver includes 500 hZ cw filter, am mechanical filter and noise blanker, 32S3 transmitter with 516FF2 (115V) power supply includes DX Engineering RF speech processor, 312B4 console excellent condition \$1000. Both the S-Lines include all manuals, circuits, cables and spare valves. 115V auto transformer for use with the above \$125. Martin VK5GN QTHR (08) 265 4188.

FOR SALE — WA

● **FINALS:** Emac 3CX1500A7 (8877) new in sealed box \$500 ea. Eimac 3-500Z as new \$250 pair New 809 \$15 each. VK6IK QTHR.

FOR SALE — NT

● **SHACK** clear out: Kenwood amplifier TL922 including 2 x 3-500Z Ampere tubes never used \$2800. Yaesu FT757AT little use \$600. Yaesu FT207R handheld with all accessories, including 2 new NICADs \$250. Yaesu FAS-4-R antenna selector, never used \$120. Yaesu FT726 with 6M and 2M modules \$2000. Icom AT-500 little used \$800. Icom IC-735 with keyer, little used \$1700. Palomar pwr/swr meter, M-827, never used \$200. Palomar noise bridge, never used \$90. All the above gear is in excellent condition. (089) 52 7560

after 12 noon everyday. P.O. Box 3718, Alice Springs NT 0871.

WANTED — NSW

● **CAN** anyone loan catalogue or photocopy details of TELCON (repeat TELCON (not TELECON or TELECOM coaxial connectors expenses reimbursed. Art VK2AS QTHR (02) 416 7784.

● **HOLE** cutter octal screw type Qmax or similar VK2KSD QTHR (066) 77 9292.

WANTED — VIC

● **STILL** looking for a TS130S & 930 or 940 speaker. Ron VK3OM QTHR ph (059) 44 3019.

WANTED — OLD

● **ANTENNA** or radio hand books by Bill Orr W6SAI. Jim VK4CBU QTHR (07) 203 4355 after 6pm please.
● **Manuals** for following AWA SS50 vinten 19A, 20, 20A, 29C. Pye test set N5A. Taeger 595A, 59 m 10

Weston LM18 VR60THM ferris marina 65TF Hammerlund RBG2. EMI scope WMS. Taylor Siggen 68A VK4DJS. QTHR (070) 91 2705.

● **HIGH** voltage capacitors for linear construction, also circuit diagram for **SIDEBAND** SE502 10 m converted CB rig, please. Advise John VK4SZ (QTHR) re costs (070) 61 32286.

WANTED — TAS

● **YAESU** FL2010 2m amp to suit FT290R. David VK7KDV QTHR (002) 47 9442.

● **ELECTRONICS** Australia TV field strength meter P Allford VK7AO Derby 7264 (003) 54 6138.

SWAP (MISC) — NT

● **SWAP** Telex 2000 for ham gear. HD — rotator wanted. Offers? Swap IC-751, PS-35, all options, swr bridge for computer. 80386-based system cash +/- Eddie VK8XX tel (089) 51 3138 (Bus) (089) 53 4056 (A/H).

Glad
Tha
subscription.
read ONE AR maga.
it's too late for me
amateur broadcaster?
Thanks again,

Clive Robertson

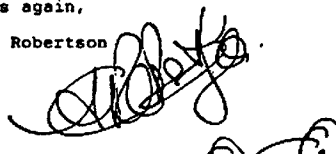

Clive Robertson, of TV fame, has written to the Executive Office, expressing interest in joining our ranks. We feel that, at least, the design of Robbo's QSL card is well under way!

73 (74, 75, 76, 77, 78, 79, 80, 81, 82, 83, 84, 85, 86, 87, 88, 89, 90, 91, 92, 93, 94, 95, 96, 97, 98, 99, 00), Channel Nine.

HAMADS

Please Note: If you are advertising items For Sale and Wanted please use a separate form for each. Include all details; eg Name, Address, Telephone Number (and STD code), on both forms. Please print copy for your Hamad as clearly as possible.

*Eight lines per issue free to all WIA members, ninth line for name and address Commercial rates apply for non-members. Please enclosed a mailing label from this magazine with your Hamad.

*Deceased Estates: The full Hamad will appear in AR, even if the ad is not fully radio equipment.

*Copy typed or in block letters to PO Box 300, Caulfield South, Vic 3162, by the deadline as indicated on page 1 of each issue.

*QTHR means address is correct as set out in the WIA

current Call Book.

*WIA policy recommends that Hamads include the serial number of all equipment offered for sale.

*Please enclose a self addressed stamped envelope if an acknowledgement is required that the Hamad has been received.

Ordinary Hamads submitted from members who are deemed to be in general electronics retail and wholesale distributive trades should be certified as referring only to private articles not being re-sold for merchandising purposes.

Conditions for commercial advertising are as follows: \$22.50 for four lines, plus \$2.00 per line (or part thereof) Minimum charge — \$22.50 pre-payable.

State:

- Miscellaneous
- For Sale
- Wanted

Name:

Call Sign:

Address:

Solution to Morseword No 41

	1	2	3	4	5	6	7	8	9	10
1	.	-
2	.	.	.	-	-	-
3	-	-	.	.	.	-
4	.	.	-	-	.	.
5	.	-	.	.	.	-	.	.	.	-
6	-	-	-	.	-	.
7	.	.	.	-	-	-	-	.	.	.
8	-	.	-	.	.
9	.	-	-	.	-
10	-	-

Across: 1 lens 2 skin 3 belt 4 feel
5 last 6 bake 7 sore 8 hike 9 revet
10 miss

Down: 1 fast 2 denim 3 iris 4 rife
5 hits 6 gaze 7 fare 8 stern 9 rind
10 inner

TRADE PRACTICES ACT

It is impossible for us to ensure the advertisements submitted for publication comply with the Trade Practices Act 1974. Therefore advertisers and advertising agents will appreciate the absolute need for themselves to ensure that, the provisions of the Act are complied with strictly.

VICTORIAN CONSUMER AFFAIRS ACT

All advertisers are advised that advertisements containing only a PO Box number as the address cannot be accepted without the addition of the business address of the boxholder or seller of the goods.

TYPESETTING : Redfords Media
25 Glenferrie Rd
Malvern 3144
Tel: (03) 500 0377

PRINTING: Industrial Printing
Richmond

MAIL DISTRIBUTION: Polk Mailing Co.
PO Box 140,
Collingwood,
Vic. 3066
Tel:(03) 417 5161

The opinions expressed in this publication do not necessarily reflect the official view of the WIA, and the WIA cannot be held responsible for incorrect information published.

ADVERTISER'S INDEX

ATN Antennas	41
Dick Smith Electronics	28, 29
Electronics Australia	IBC
Icom Australia	OBC,
Kenwood Electronics Aust.	IFC
Magpubs	6
WIA NSW Division	35

TRADE ADS

RJ & US Imports	54
M Delahunty	54

HOW TO JOIN THE WIA

Fill out the following form and send to:

The Membership Secretary
Wireless Institute of Australia
PO Box 300
Caulfield South, Vic 3162

I wish to obtain further information about the WIA.

Mr, Mrs, Miss, Ms:

Call Sign (if applicable):

Address:

State and Postcode:

Radio Amateurs: Have you checked out EA lately?

No doubt most radio amateurs are aware that *Electronics Australia* is by far this country's largest-selling electronics magazine, as well as being its oldest (we began way back in 1922, as *Wireless Weekly*). But have you looked inside the magazine lately?

Now it's bigger and better than ever, because our leading competitor *ETI* has been merged with us, to form *Electronics Australia with ETI* – the biggest, brightest and most informative electronics magazine, bar none.

You'll now find lots of new 'departments' in the magazine, including Solid State Update (with news of new semiconductor devices), Silicon Valley Update (news from the USA) and What's New in Entertainment Electronics. Plus all of your old favourites like Forum, The Serviceman, Circuit and Design Ideas and so on. And of course plenty of 'meaty' technical articles and construction projects.

What about *amateur radio* projects? Well, as you can see there are more of these than before – but we're very interested in publishing more. So if YOU have developed an exciting amateur radio project, contact Jim Rowe by writing to him at EA, 180 Bourke Road, Alexandria 2015. Or phone him on (02) 693 6620, to discuss the possibility of publishing it as a contributed article. As well as earning a fee, you'll also be helping to boost interest in amateur radio!

Take a look at the new, bigger and brighter *Electronics Australia with ETI* – on sale at your newsagent at the beginning of each month. Or subscribe now, by phoning (02) 693 9517 or 693 9515.

**Electronics
Australia** WITH **eti**

Australia's Top Selling Electronics Magazine

INCLUDED IN OUR AUGUST ISSUE:

SSTV TRANSMIT SCANCONVERTER – 2

The second article on this easy to build SSTV project by Leon Williams VK2DOB, describing the actual construction and testing.

EDWIN ARMSTRONG – 2

Neville Williams continues the story of this unhappy genius, radio amateur and engineer who was also inventor of the superhet and superregen and pioneer of FM.

LOOP AERIALS

Loop aerials have been an important part of radio ever since Hertz's experiments of 1887, and they still play a key role. Peter Lankshear looks at their development.

4 inches high, 1000 MHz wide puts the world in your pocket

The New IC-R1 handheld receiver

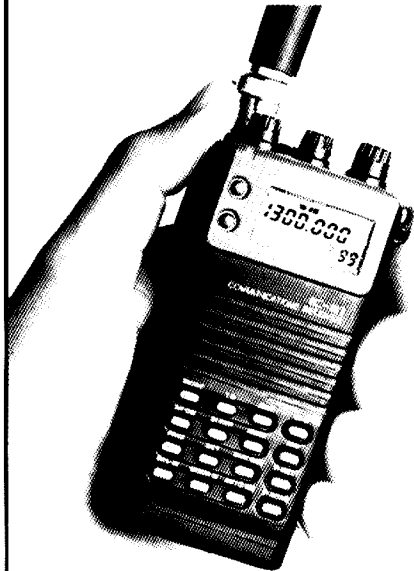

Icom, still leading the way again in communications technology and miniaturisation with the world's smallest wide band receiver.

It's so small you could carry it in the palm of your hand or the pocket of your shirt.

Yes, an AM/FM and FM/W wide-band receiver that continuously covers 2 MHz - 905 MHz (Guaranteed specifications) and yet is small enough to carry anywhere.

Weighing in at a mere 280g (9.9 oz) this tiny package features **MULTI - SCAN FUNCTIONS** including programmed, memory,

selected mode and auto memory write with a capacity for **100 MEMORY CHANNELS**. Electronic locking of tuning control and keyboard prevents accidental frequency change, dual frequency selection, a built-in clock and timer functions - all running off an internal Nicad battery. The IC-R1 is equipped for high performance and is a "must have" item for any one on the move who is keeping up with the world and technology.

Find out more about the IC-R1 and the optional extras available - send in or phone for a free brochure - **BUT HURRY** - the R1 is selling fast!

Versatile Mobile

The New IC-R100 wideband receiver brings the world to your car

The IC-R100, with an ultra-wide band width of 500 kHz to 1800 MHz, was born of the technologically marvellous IC-R9000 (Icom's and the world's most sophisticated receiver). Operating from 13.8V DC with a built-in 15dB pre-amp to enhance weak signals (50 to 905 MHz), the IC-R100 is invaluable as a mobile and for base station use. Other features, such as an enormous **121 channel memory, built-in**

clock/timer and, of course, **multi-mode scanning** functions for VHF/UHF /MW/HF make this a most desirable receiver.

Compact, economical and easy to operate as a scanning radio, it's no wonder the IC-R100 is stimulating great interest. By satisfying the demands of shortwave and broadcast listeners, scanner enthusiasts as well as business and professional users, Icom again leads the way. Contact us

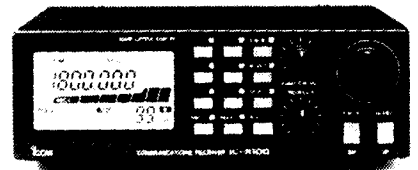

by Freepost or phone for the name of your stockist, colour brochures on the IC-R1, R100 and the complete range of Icom receivers - IC-R9000, IC-R7000, and IC-R71A.

For further information call Icom free on 008 338 915

Melbourne callers (03) 529 7582 Icom Australia Pty. Ltd., 7 Duke Street, Windsor 3181.

Icom Australia's warranty is only applicable to products purchased from their authorised Australian Dealers.

ICOM

■ AMATEUR ■ MARINE ■ LAND-MOBILE ■ AVIATION ■ CB ■ AMATEUR ■ MARINE ■ LAND-MOBILE ■ AVIATION ■ CB ■ AMATEUR ■ MARINE ■ LAND-MOBILE ■

Please rush to me your brochure on the IC-R1, IC-R100 and the name of my nearest Icom stockist.

SEND TO: Freepost 15, Icom Australia Pty Ltd, Windsor, 3181 (no stamp required).

Mr., Mrs., Ms. Company Title

Address Suburb

City Post Code Phone No.

NCAA 4672 HR AR

■ AMATEUR ■ MARINE ■ LAND-MOBILE ■ AVIATION ■ CB ■ AMATEUR ■ MARINE ■ LAND-MOBILE ■ AVIATION ■ CB ■ AMATEUR ■ MARINE ■ LAND-MOBILE ■

AMATEUR RADIO

SEPTEMBER 1990

RRP \$3

1990
Remembrance
Day



THE WIA RADIO AMATEUR'S JOURNAL

KENWOOD

Turn your rig into a radio station — with genuine Kenwood accessories!

It doesn't matter which transceiver you choose from the exciting Kenwood range — there's a complete range of genuine factory accessories to complement it.

Introduce your Kenwood VHF, UHF or dual-band mobile transceiver to a whole new world of versatility with the Kenwood **RC-10** or **RC-20** remote control units*. Mount your transceivers in the boot, away from prying eyes — and control them all with the space-age convenience of a slim-line remote head in the cabin!

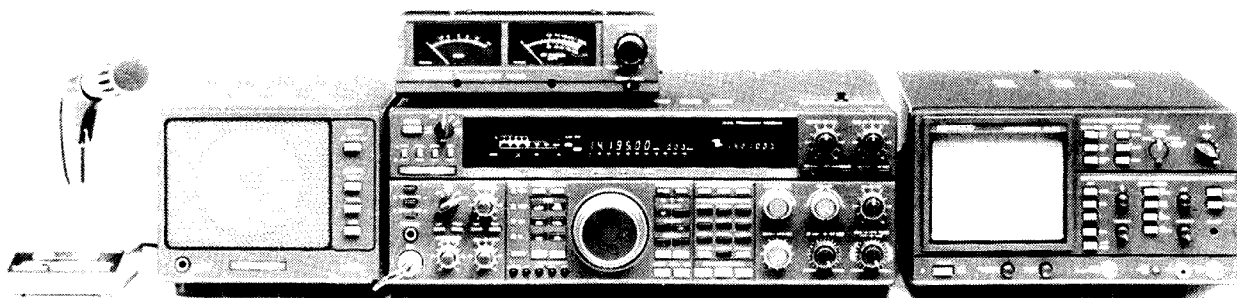

Your Kenwood transceiver works better with genuine Kenwood accessories!

There's a complete range of great new accessories to complement the new **TS-950S** and **TS-950SD** HF transceivers. Turn your HF rig into a complete radio station with the **MC-60A** deluxe desk-top base microphone with built-in pre-amplifier, the **SP-950** external speaker with a full range of built-in audio filters to enhance your listening pleasure, the **SW-2100** SWR/power meter to ensure you have the best match to your antenna at all times, and the superlative new **SM-230** station monitor. This exciting new model provides full monitoring facilities for all outgoing and incoming signals, as well as providing a full range of test and analysis modes.

* Selected models only.

KENWOOD ELECTRONICS AUSTRALIA PTY. LTD.
(INCORPORATED IN N.S.W.)

8 Figtree Drive, Australia Centre, Homebush, N.S.W. 2140
Ph. (02) 746 1519, (02) 746 1888, Fax (02) 746 1509
Call now for further information and the name of your nearest authorised Kenwood dealer.

Kenwood Electronics Australia Pty Ltd only warrants products purchased from their authorised Australian dealers.

Please phone, mail or fax for information

Name.....

Address.....

..... Postcode.....

Publication..... Issue

Model.....



Amateur Radio is published by the Wireless Institute of Australia, as its Official Journal, on the last Friday of the previous month.

EXECUTIVE EDITOR
Bill Rice VK3ABP

MANAGING EDITOR
Graham Thornton VK3IY

NEWS EDITOR
Jim Linton VK3PC

SENIOR TECHNICAL EDITOR
Peter Gibson VK3AZL

TECHNICAL EDITORS
David Brownsey VK4AFA
Don Graham VK6HK
Evan Jarman VK3ANI
Peter O'Connor VK4KIP
Gil Sones VK3AUI
Phil Steen VK4APA
Roy Watkins VK6XV

DRAFTING
Vicki Griffin VK3BNK

MARKETING
Bruce Kendall VK3WL
Norm Eyres VK3ZEP

ADVERTISING
Ann McCurdy
All contributions and correspondence concerning the content of Amateur Radio should be forwarded to: -
The Editor
Amateur Radio
PO Box 300
Caulfield South
VIC 3162

Registered Office
3/105 Hawthorn Road
Caulfield North VIC 3161

Telephone: (03) 528 5962
(03) 523 8191
Fax: (03) 523 8191
(Non dedicated line)

Business hours: 9.30am to 3pm
weekdays

Deadlines

	Editorial	Hamads
Oct	10/9/90	12/9/90
Nov	8/10/90	10/10/90
Dec	5/11/90	7/11/90

Delivery of AR: If this magazine is not received by the 15th of the month of issue, and you are a financial member of the WIA, please check with the Post Office before contacting the registered office of the WIA.
© Wireless Institute of Australia 1990

CONTENTS

Technical

Home Brew Double Paddle for Iambic Keyer 14	<i>Allen Crewther VK3SM</i>
Receiving Loop Aerials for 1.8 MHz 10	<i>Lloyd Butler VK5BR</i>
1GHz Frequency Counter Modifications for 1296 MHz and a 2.4 GHz Pre-scaler 16	<i>Chris Skeer VK5MC</i>

General

A Home Brew VNG Announcement 31	<i>Marion Leiba VK1BNG/VNG</i>
Anzac Day 1990 - The Vital ZL Link 24	<i>Ivor Stafford VK3XB</i>
Profile of a Net Controller 30	<i>Stephen Pall VK2PS</i>
The Singapore Seantet of 1989 26	<i>David Rankin 9V1RH/VK3QV and Ken Pincott VK3AFJ</i>
The 75th Anniversary Anzac Radio Link - 1990 18	<i>Phil Clark VK1PC</i>
Thirty Third JOTA 25	<i>Peter Hughes VK6HU</i>
1990 Remembrance Day Opening Address and Profile of Guest Speaker 9	Brigadier Keith R Colwill CBE

Operating

Awards 32
Contests
Calendar, Scandinavian Activity Contest 1990 Rules, 1990 VK ZL Oceania DX Contest Rules 34
1989 VK/ZL Oceania DX Results 35

Columns

Advertisers' Index 56	HF Predictions 52
ALARA 45	Hamads 54
AMSAT 39	How's DX 36
AR Showcase 51	Intruder Watch 44
Club Corner 43, 50	Morseword No 42 50
Divisional Notes	Over To You - Members' Opinions 51
Forward Bias 46	Pounding Brass 38
VK2, VK4 Notes 47	QSLs Bureaux Information 27
5/8 Wave 48	QSLs from the WIA Collection 48
Editor's Comment 2	Silent Keys - Obituary 51
Education Notes 43	Spotlight on SWLing 44
EMC Report 39	VHF/UHF and Expanding World 38
FTAC News 45	WIA Directory 2, 3
	WIA News 3

Cover

Brigadier Keith R Colwill CBE at the controls of an AWA 3BZ Telerado, typical of those used by Coastwatchers in WW2. We thank the Museum, School of Signals, Simpson Barracks, Watsonia for the loan of the equipment. See text of Remembrance Day broadcast and profile of Brigadier Colwill on p9. Photo: Ron Fisher VK3OM.

EDITOR'S COMMENT

BILL RICE VK3ABP EXECUTIVE EDITOR

Feast for the Media

This is being written late on 7 August. It won't be finished until 8 August, the last possible day on which it can go to the typesetters. As usual, it has been a little difficult to find a theme on which to write, but there has most certainly been no shortage of headline news in both the print and electronic media in the past few days. Yet, looking at the news from the amateur radio viewpoint, there are aspects of most items which have some significance to us.

Firstly, the big news, of course, was the invasion of Kuwait (9K) by Iraq (YI), both rather rare DX. Both, like most other countries in the area, are not only Moslem, but represent the same sect. This was not the case in the earlier eight-year war between Iraq and Iran (EP or EQ). It seemed

to me surprising that two such countries should come to blows. But only last night at the August meeting of the Publications Committee, we noted that our next meeting would be on 3 September, the 51st anniversary of war breaking out between Christian Britain and Christian Germany. We, the supposedly civilised inhabitants of this planet, often allow our differences to outweigh our similarities. Must it always be so?

Still in the Moslem world, the next major event was the coup which removed from office the Prime Minister of Pakistan (AP) Mrs Benazir Bhutto. Not only do we disagree between countries, but even within the same country disagreements can be violent. Politically, there are many dissimilarities between AP and VK3, but only one day

later, the Victorian Premier, John Cain, announced his resignation after eight years in office. At least, it was hardly a coup!

Back to the Middle East. One of the best-known radio amateurs in the world is JY1, King Hussein of Jordan. It is coincidental that the Iraqi President, Saddam Hussein, has the same name. It may well be that JY1 plays a large part in the current disturbance, not as a participant, but as a peacemaker. By the time you read this the whole affair may well be over. Most of the world would hope so. Most of the world has a very serious interest in a rapid return to peace, because otherwise the price of oil is likely to escalate out of sight, adding greatly to the cost of everything everywhere. Your magazine, 'Amateur Radio', is

already being squeezed between rising costs (notably postage) and falling membership. We need still more inflation like the proverbial 'hole in the head'!

To round off the story on a happier note, a few hours ago I watched the TV program 'Beyond 2000'. It included a story about the success of the University of Surrey in developing a whole range of small satellites for various purposes. The principal spokesman was Dr Martin Sweeting. We amateurs around the world know of the UoSats, and we know Martin as G3YJO. The whole series of projects has been a magnificent example of international co-operation. Let us radio amateurs try even more, internationally minded as we are, to add to all peoples' mutual understanding and help to create peace!

Wireless Institute of Australia

The world's first and oldest National Radio Society - Founded 1910

Representing Australian Radio Amateurs - Member of the International Amateur Radio Union
Registered Executive Office of the WIA: 3/105 Hawthorn Road, Caulfield North, Vic, 3161
All mail to: **PO Box 300, Caulfield South, Vic, 3162** Telephone: (03) 528 5962 (03) 523 8191
Fax: (03) 523 8191 (Non-dedicated line)

Business Hours: 9.30 am to 3.00 pm on Weekdays

General Manager and Secretary: Bill Roper VK3ARZ

EXECUTIVE

President:	Peter Gamble	VK3YRP	VK1 Federal Councillor:	George Brzostowski	VK1GB
Vice Chairman:	Ron Henderson	VK1RH	VK2 Federal Councillor:	Terry Ryeland	VK2UX
	Kevin Olds	VK1OK	VK3 Federal Councillor:	Peter Maclellan	VK3BWD
	Brenda Edmonds	VK3KT	VK4 Federal Councillor:	David Jerome	VK4YAN
	Bill Rice	VK3ABP	VK5 Federal Councillor:	Bill Wardrop	VK5AWM
Immediate Past President:	David Wardlaw	VK3ADW	VK6 Federal Councillor:	Neil Penfold	VK6NE
			VK7 Federal Councillor:	Joe Gelston	VK7JG

FEDERAL CO-ORDINATORS

Amsat:	Graham Ratcliff	VK5AGR	Int'l Travel Host Exch:	Ash Nallawalla	VK3CIT
Awards:	Phil Hardstaff	VK3JFE	QSL Manager (VK9, VK0):	Neil Penfold	VK6NE
Act Contest Manager:	Neil Penfold	VK6NE	FTAC:	John Martin	VK3ZJC
Education:	Brenda Edmonds	VK3KT	Federal Tapes:	Ron Fisher	VK3OM
EMC:	Hans Ruckert	VK2AOU	Videotape:	John Ingham	VK5KG
Historian:	John Edmonds	VK3AFU	WICEN:	Bill Wardrop	VK5AWM
Intruder Watch:	Gordon Loveday	VK4KAL			

WIA NEWS

COMPILED BY WIA NATIONAL OFFICE STAFF

Flying Visit from IARU Vice President

During August, while on a flying visit to Melbourne from London, where he is now living, Michael Owen VK3KI, Vice President of the IARU and the first member of the International Secretariat of the IARU to come from outside North America, visited the Executive Office of the WIA.

In a meeting with WIA Federal President, Peter Gamble VK3YRP, WIA WARC 92 team leader, David Wardlaw VK3ADW, and

General Manager, Bill Roper VK3ARZ, Michael, who is very much involved in the IARU preparation for WARC 92, was able to contribute to some very fruitful discussions on a range of subjects of importance to both the WIA and IARU.

QSL Bureaux

As a result of a comprehensive report on WIA QSL bureaux, prepared by Stephen Pall VK2PS, the WIA Federal Council agreed to a clear cut policy on QSL bureaux at their meeting on Sunday, 8th July 1990.

Noting the IARU Misc Rule 3(b) concerning member societies accepting inwards QSL cards for collection by non-members; and that there are no legal constraints on the disposal of QSL cards received; and that QSL cards have PR value, the Federal Council agreed that:-

1. there is no case at present for a single national QSL bureau for Australia, and that the existing arrangements of Divisional bureaux, with Executive providing for the VK0 & VK9 bureau, continue;
2. as a general principle QSL bureau services be available to all amateurs, with WIA members free of handling charges, and all non-members to pay charges without exception;
3. outwards cards for WIA

4. members should be sent free of handling charges;
5. outwards cards for non-members may be processed for a handling fee where cards are delivered free of charges to the bureau;
6. inwards cards be made available free of charge to members at a point of distribution at least monthly and Divisions may require members to pay postal charges if onwards posting is required;
7. inwards cards be made available free to non-members unsorted at the bureau distribution point, however transportation costs may be imposed;
8. incoming cards not collected after 12 months be disposed of by what ever means the Division decides

WIA DIVISIONS

The WIA consists of seven autonomous State Divisions. Each member of the WIA is a member of a Division, usually their residential State or Territory, and each Division looks after amateur radio affairs within their State.

Division	Address	Officers	Weekly News Broadcasts	1990 Fees
VK1	ACT Division GPO Box 600 Canberra ACT 2601 Phone (06) 247 7006	President Ted Pearce Secretary Jan Burrell Treasurer Ken Ray	VK1AOP 3.570 MHz VK1BR 2m ch 6950 VK1KEN 70cm ch 8525 2000 hrs Sun	(F) \$65.00 (G) (S) \$52.00 (X) \$39.00
VK2	NSW Division 109 Wigram St Parramatta NSW (PO Box 1066 Parramatta) 2124 Phone (02) 689 2417 Fax (02) 633 1525	President Roger Henley Secretary Tim Mills Treasurer David Horsfall (Office hours Mon-Fri 1100 - 1400 Wed 1900 - 2100)	VK2ZIG 1.845 MHz AM, 3.595 AM(1045) SSB (1915 only), 7.146 AM (1045 only) 10.125 SSB (1045 only), 28.320 SSB, 52.120 SSB 52.525 FM 144.12 (SSB), 147.000 FM(R) 438.525 FM(R) 584.750 (ATV Sound) 1281.75FM (R) Relays also conducted via many repeaters throughout NSW.	(F) \$59.00 (G) (S) \$47.00 (X) \$33.00
VK3	Victorian Division 38 Taylor St Ashburton Vic 3147 Phone (03) 885 9261	President Jim Linton Secretary Barry Wilton Treasurer Rob Hailey Office hours 0900-1600 Tue & Thur	VK3PC 1.840 MHz AM, 3.615 SSB, 7.085 SSB, 147.250 FM(R) Mt Macedon, VK3XV 147.225 FM(R) Mt Baw Baw VK3XLZ 146.800 FM(R) Mildura, 438.075 FM(R) Mt St Leonard 1030 hrs on Sunday	(F) \$65.00 (G) (S) \$52.00 (X) \$39.00
VK4	Queensland Division GPO Box 638 Brisbane Qld 4001 Phone (07) 284 9075	President Ross Mutzelburg Secretary Eddie Fisher Treasurer Eric Fittock	VK4IY 1.825, 3.605, 7.118, 10.135, 14.342, 18.132, 21.175, 24.950, 28.400, MHz VK4ABX 52.525 regional 2m repeaters and 1296.100 0900 hrs Sunday VK4NEF Repeated on 3.605 & 147.150 MHz, 1930 Monday	(F) \$65.00 (G) (S) \$52.00 (X) \$39.00
VK5	South Australian Division 34 West Thebarton Rd Thebarton SA 5031 (GPO Box 1234 Adelaide SA 5001) Phone (08) 352 3428	President Rowland Bruce Secretary John McKellar Treasurer Bill Wardrop	VK5OU 1820 kHz 3.550 MHz, 7.095, 14.175, 28.470, 53.100, 145.000, 147.000 FM(R) Adelaide, 146.700 FM(R) Mid North, 146.900 FM(R) South East, ATV Ch 34 579.00 Adelaide, ATV 444.250 Mid North (NT) 3.555, 146.500, 0900 hrs Sunday	(F) \$65.00 (G) (S) \$52.00 (X) \$39.00
VK6	West Australian Division PO Box 10 West Perth WA 6005 Phone (09) 388 3888	President Alyn Maschette Secretary John Farnan Treasurer Bruce Hedland - Thomas	VK6KWN 146.700 FM(R) Perth, at 0930 hrs Sunday, relayed on 3.560, 7.075, 14.115, 14.175, 21.185, 28.345, 50.150, 438.525 MHz Country relays 3582, 147.350(R) Busselton 146.900(R) Mt William (Bunbury) 147.225(R) 147.250 (R) Mt Saddleback 146.725(R) Albany 146.825(R) Mt Barker Broadcast repeated on 3.560 at 1930 hrs.	(F) \$56.00 (G) (S) \$45.00 (X) \$30.00
VK7	Tasmanian Division 148 Derwent Ave Lindisfarne TAS 7015	President Tom Allen Secretary Ted Beard Treasurer Peter King	VK7AL 146.700 MHz FM (VK7RHT) at 0930 hrs Sunday relayed on 147.000 (VK7RAA), 146.750 (VK7RNW), 3.570, 7.090, 14.130, 52.100, 144.100 (Hobart) Repeated Tues 3.590 at 1930 hrs	(F) \$63.00 (G) (S) \$50.00 (X) \$38.00
VK8	(Northern Territory) is part of the VK5 Division and relays broadcasts from VK5 as shown (received on 14 or 28 MHz).			

Note: All times are local. All frequencies MHz.

Membership Grades
Full (F) Pension (G)
Needy (G) Student (S)
Non receipt of AR (X)

Three year membership available to (F) (G) (X) grades at fee x 3 times

and this policy receive wide publicity; and

8. it is desirable to obtain written advice from WIA members who do not wish to receive QSL cards;

The Federal Council also decided to encourage:-

1. WIA Divisions to revise their QSL bureau administration systems to streamline operations and attract volunteer labour yet meet any local audit requirements; and
2. amateurs to use the interim standard IARU QSL card size of 140 mm by 80 mm, of a minimum paper weight of 100 gsm, laid out with all QSO information contained upon one side.

6 Metre Band Plan Changes

At the July 1990 meeting of the Federal Council of the WIA, it was agreed to amend the 6 metre Australian Amateur Band Plan as follows:

(a) add the following frequencies to the repeater segment on the 6 metre band:

52.550 MHz input, 53.550 MHz output

52.575 MHz input, 53.575 MHz output;

(b) drop the present 6 metre repeater allocation plan (two channels per call area) and adopt the following:

(i) seven channels to be reserved for exclusive use in VK1, VK2, VK3, VK4, VK5/8, VK6 and VK7;

(ii) the other 11 channels to be available for use in any call area;

(c) to allocate five channels for Data Transmission on the 6 metre band as follows:

(i) 53.000 MHz Packet radio BBS forwarding only

(ii) 53.025 - 53.100 General use.

Extra AR Flysheet

The WIA has been told that the machine which packages your copy of Amateur Radio magazine, together with the

address flysheet, in the plastic wrapper, very occasionally picks up more than one fly sheet at a time. This means that one magazine gets two fly sheets, and someone misses out.

If you receive some other member's fly sheet, as well as your own, with your copy of Amateur Radio magazine, please forward it immediately to PO Box 300, South Caulfield, 3162 so that a copy of Amateur Radio can be sent to the member who otherwise will miss out.

Service Awards

During the July 1990 weekend Executive meeting the VK4 Councillor, David Jerome VK4YAN, took the opportunity to present Distinguished Service Awards from the VK4 Division to Bill Roper VK3ARZ and Ron Fisher VK3OM for "outstanding, long term contribution to the Amateurs of Australia in the presentation of the WIA Federal news tapes".

These awards are not given lightly by the Queensland Division, and few have been presented. Bill and Ron received certificates numbers 8 and 9 respectively.

ZS Novice Licence

The ARRL Newsletter of June 29, 1990 announces that South Africa is about to institute a Novice licence. Applicants must be at least 12 years old, and are required to pass a 5 wpm Morse code exam before taking a written exam in operating procedure and "knowledge of the ITU phonetic alphabet".

The new Novices, who will receive ZU1 call signs, will be allowed 10 watts input (or 20 watts PEP output) and will be able to use phone, CW and data on 160 metres; CW and data on 80 and 15 metres; and CW, data, and phone on 10 metres and 70 cm.

The first technical examinations will be held in November.

Packet Mailbox Users

The following is the text of a letter to the Radio Society of Great Britain (RSGB) from the head of the British Radiocommunications Agency section dealing with amateur radio. It is very similar to communications the WIA has received from DoTC:-

"Over the last few months the Department has been made aware of a number of instances where the packet radio mode has been used for the transmission of messages which are far removed from the licence condition concerning self training and messages relating to technical investigations or remarks of a personal nature.

I am sure that you are equally aware as to the type of messages I mean. Included amongst them are messages inciting others to join in a particular dispute. The second type of message that I have in mind is where amateurs offer items for sale via packet radio.

I need not remind you that the terms and conditions of the Wireless Telegraphy Act licence are that amateurs must use the facility for self training and that where messages are addressed to other licensed amateurs they must relate solely to technical investigations or remarks of a personal character. The terms of this licence do, of course, reflect into the dispensation for amateur radio under the Telecommunications Act licence. The Department's Radio Investigation Service cannot give very much time to amateur radio because of its other priorities but it has followed up individual instances where messages do not conform to licence conditions. However I think it would be helpful if the RSGB would issue a general reminder to amateurs generally and mailbox operators in particular about the terms and conditions of the licence, and some guidance in good practice in mailbox operation. For example we would regard it as

reasonable for a mailbox operator to review the content of messages, and refuse to forward and delete those he considers unacceptable.

Frankly, if the sort of traffic described above continues or increases then the Department would have to give serious consideration to the continuation of the packet radio network in its present form. I hope, therefore, that we can look to the Society to give a positive lead in this area."

Soviet Amateur Aid

The same ARRL Newsletter gives a progress report on the condition of Oleg Porugov UA4FAY, who was critically injured in a car accident in May. Through Igor's club station, UZ4FWO, contact has been maintained with a network of American amateurs and medical practitioners who have provided shipments of medical supplies as well as advice and discussion with Igor's physician. Soviet club operators have stood by in Moscow to receive the shipments. West German amateurs have also sent medical supplies.

This is one more example of international co-operation and fellowship in amateur radio.

One Million Amateurs

JARL has recently announced that the total number of amateur radio stations in Japan now stands at 1,027,101. There are also 32,176 radio broadcasting stations, and 49 satellite stations. And we complain about lack of band space and QRM!

Historian Requests

A note from the Federal Historian, John VK3AFU, requests donation of any unwanted copies of early Amateur Radio magazines, Volumes 1 to 13, from 1933 on until the start of professional production after the war.

TEKTRONIX UPDATE . . .

Special Notes to Radio Amateurs

SEPTEMBER - 1990 PERSONAL TEST INSTRUMENTS DIVISION

WHAT'S THE BEST KEPT SECRET IN THE TEST & MEASUREMENT BUSINESS?

MODEL NUMBERS	LIST PRICE
2205 20 MHz Analog Oscilloscope	\$ 945.00
2201 20 MHz Digital Oscilloscope	\$2120.00
TM250 SERIES	
CFG250	\$ 568.00
CFC250	\$ 415.00
CPS250	\$ 578.00
CDM250	\$ 470.00
CMC250 NEW	\$ 538.00

**FOR MORE INFORMATION
CALL TOLL FREE
008-023342**

OR

**CALL YOUR NEAREST
TEKTRONIX OFFICE**

Sydney (02) 888-7066
Melbourne (03) 836-3355
Brisbane (07) 394-1155
Adelaide (08) 223-2811
Perth (09) 242-4688
Canberra (06) 251-6111

You probably know Tektronix equipment as being excellent, but sometimes too high priced for your budget. So you may be surprised to know that Tektronix provides instruments that have quality and performance but don't cost an arm and a leg!

Did you know that Tek offers a full featured **TRUE 20MHz Oscilloscope for \$945?**

Did you know that Tek offers a **basic set* of bench test equipment for \$1915*?**

***Includes:**

2 MHz Function Generator
100 MHz Frequency Counter
Triple Output Power Supply
3-1/2 Digit LED, DMM

Did you know that Tektronix introduced a **NEW 1.3-GHz Multifunction Counter for \$538** on March 5th? Up to now you've probably had to borrow more expensive test equipment whenever you needed to adjust or repair transmitters and receivers, and repeaters. Now you can afford to have a frequency counter on your own test bench to make those critical adjustments. And, it's portable too!

These instruments must pass the same exacting environmental testing that all of our top of the line products do. We haven't compromised, they're UL Listed. As a Radio Amateur, you know the value of this listing for product safety and reliability. Compare TEK to other low end equipment you've been purchasing.

The next time you're looking for affordable equipment **THINK TEK, BUY TEK!**

***Special Offer available until 30 November 1990 only.
Prices do not include Sales Tax.**

These early copies were produced by the Victorian Division.

During the war years they became even smaller. The June 1945 issue has 16 quarto size pages. It cost sixpence. John has several incomplete volumes, and also some duplicates. The duplicates may be made available to interested bodies or individuals when a little more sorting has been completed.

John is interested to collect any historical material relating to amateur radio which would otherwise be thrown out.

Hams in Space

Three more astronauts will soon have call signs, joining Ken Cameron KB5AWP, aboard STS-37(a SAREX mission) in November.

Space Shuttle STS-35, also a SAREX flight by astronaut Ron Parise WA4SIR, was postponed again on May 29 for repairs, and will not be launched until August 1990.

VK-ZL-O DX Contest

A special effort is being made this year by the NZART Contest Manager to encourage participation in this event as part of the celebrations commemorating New Zealand's 150 years as a nation. To this end, a station with the call ZL150A will be active in both sections of this contest.

VK and ZL stations who work ZL150A on 160 or 80 metres will, of course, be able to claim a bonus of an extra multiplier.

The full rules for this year's contest, to be held on 7/8th October and 13/14th October will be found in the Contests section of this magazine. It should be noted that, as a trial, Overseas and Oceania operators are not to be limited as to time and may operate for the full 24 hours if they desire.

More on Draft Spectrum Plan

A further letter has been sent to the Transmission Policy and Spectrum Planning Branch of DoTC by David Wardlaw VK3ADW, the WIA WARC 92 Co-ordinator. This letter contains WIA comments on the review of the 960-3400 MHz band.

Amongst other things, the WIA emphasised the increasing need of the amateur service for spectrum in the 1240 to 1300 MHz band. The WIA pointed out this band is the logical choice for ATV repeater outputs now that the 576 to 585 MHz band has been withdrawn.

The WIA also explained that it is trying to plan the 2300 to 2450 MHz Amateur Band around the MDS service. It pointed out that the amateur service internationally has a requirement for a narrow segment of frequencies free from interference where amateur stations can carry out weak signal experimentation, such as using the moon as a passive reflector.

Link Bearer Project

A proposal has been put to the VK2 Division of the WIA to investigate the feasibility of installing a microwave radio link between the capital cities of Australia. It is envisaged that local repeaters on VHF or UHF could be connected around Australia by this link. The proposal is modelled on the New Zealand scheme, which is based on a link on the 1296 MHz band throughout that country.

If you have any thoughts on such a proposal, please contact the Steering Committee Co-ordinator at 18 High Street, Mount Kuring-gai, N.S.W., 2080

Increasing Postal Charges

Headline news around Australia is that the inflation rate for the year ending 30th

June 1990 was 7.7%.

Why then has Australia Post increased the Category B postal rates for Amateur Radio magazine by a whopping 18.9% as from 3rd September 1990?

This means that the postage the WIA pays per magazine will increase by 7 cents per copy! While this may not seem very much, it will add nearly \$6000 to the annual postage bill for our magazine.

How can an organisation like the WIA accurately budget its finances when government monopolies do not play by the rules applied to others? Perhaps one could begin to accept such a steep increase in postal rates if the mail delivery service was improving, but a steadily increasing number of members know that this is not the case.

Backlog of AR Articles

The general policy of Amateur Radio magazine is that articles submitted by members should be published in order of receipt. However, at times this is over-ruled by the topicality of an item, or the lack of space because of a special issue, such as October's Antennas issue.

Articles which require drawings or circuits to be professionally drafted, or have to be returned with queries or for editing, will also take longer.

Please do not be discouraged if your article does not appear in Amateur Radio magazine for several issues. At present there is a backlog of over 40 articles awaiting publication.

All articles submitted for publication are acknowledged by the Executive Office as they are received, so you will know whether your contribution has been received or not and is in the queue.

Demise of VHF COMMS Magazine

The WIA, the sole Australia-

lian agents for the publication, have been advised by the German publishers of the popular VHF Communications magazine, that 1990 will be the last year of printing the magazine. After 22 years as the premier English language VHF magazine in the world, rising costs have become too much.

Subscribers who have paid in advance for the four 1990 issues will still receive these magazines.

The publication of the German language version of VHF Communications, UKW-Berichte, will continue together with the sale of kits and ancillary equipment.

A number of back issues of VHF Communications are available from the Executive Office of the WIA.

Remembrance Day Contest Confusion

The WIA regrets the confusion which seems to have developed in the minds of several people over the dates of the 1990 Remembrance Day Contest. The contest is traditionally held on the weekend nearest to the date of cessation of hostilities in the Pacific, that is August 15th.

In the past, when this date fell on a Wednesday, as it does this year, the Contest has been held on the preceding weekend in some years, and on the following weekend in other years. Of course it is possible to argue for either weekend. The end of the contest on the 12th would be 54 hours from the 15th - the start of the contest on 18th would be 66 hours from the 15th.

The weekend of 11/12th August 1990 was selected by the Contest Co-ordinators, and promulgated to all WIA Divisions during May 1990, without any awareness of that date contradicting any individual suggestion made by the previous Contest Co-ordinator.

It seems the confusion about the dates may have arisen during the change-over of

Contest Co-ordinators earlier this year. Who was it said that "as communicators, radio amateurs make good technicians"?

The WIA certainly hopes that confusion about the date of the "friendly contest" does not lead to any ill-feeling among the contestants.

QSL Bureaux & Slow Morse

As a service to members, listings of the WIA Inwards and Outward QSL Bureaux addresses will appear every second month in Amateur Radio magazine.

This information will alternate month and month about with a listing of the WIA Slow Morse transmissions available for those members learning, or up-grading, Morse reception skills.

Slow Morse in VK4

The VK4 Division has recently re-established Slow Morse transmissions, and is seeking more volunteers to assist in providing this important service.

There are no special requirements, apart from having a tape recorder. A Morse Interface Unit will be supplied.

If you can help, please contact Doug Inall VK4XX, Service Liaison, PO Box 57 Zillmere, Queensland, 4034.

Amateur Licences Increase

The quarterly licence statistics released recently by DoTC show an analysis of all licensed users of the Radio Spectrum in Australia.

Excluding beacons and repeater stations, the number of amateur station licences increased by 121 in the three months to 30th June 1990, a rise distributed fairly evenly throughout the Divisions.

Although the total amateur licences at the end of June stood at 18,929, the total of CBRS licensees was 380,037. Surely there must be more Cbers that we can encourage to join the ranks of radio

amateurs.

1991 Call Book

Work has begun in earnest on the new, 1991 edition of the Australian Radio Amateur Call Book, and it should be ready for distribution by the middle of September this year.

The 1991 Call Book will be a larger issue, including more reference material as well as increased station listings.

Unfortunately, although the price was held steady for the 1988 and 1990 Call Books, rising costs (we all know about those, don't we?) have forced a price rise to a recommended cover price of \$11.00, plus postage where applicable. However, as usual, there will be a substantial discount to WIA members, who will be able to buy their copy from their WIA Division at \$9.50, plus postage where applicable.

Your local WIA Division will let you know when they have the 1991 Call Books in stock.

Direct Subscribers to AR

Did you know that people living outside Australia do not have to be members of the WIA in order to receive Amateur Radio magazine by subscription? If you have a friend in another country who would like to receive our magazine each month, they can be signed up as a "Direct Subscriber" to Amateur Radio magazine at considerable savings over full membership of the WIA.

Postage, of course, becomes a major factor in overseas subscriptions. The 1990 "Direct Subscriber" rates are \$AUS36.00 for the magazine, plus postage. This postage can range from \$18.00 for surface mail delivery for Asia/Oceania, to \$54.00 for air mail delivery to countries in overseas Zone 5.

Members of NZART, the New Zealand equivalent of the WIA, can subscribe to Amateur Radio magazine at

MAGPUBS

HANDBOOKS

ARRL 1990 Handbook ARRL Hard Bound	#BX287	\$82.98
The Operating Manual ARRL	#BX192	\$30.00
The ARRL Electronics DATA BOOK ARRL	#BX201	\$24.00
Radio Data Reference Book O.R. Jansop RSGB	#BX189	\$38.00
Radio Communication Handbook Fifth Edition RSGB	#BX268	\$68.00
Radio Handbook 23rd Edition William I. Orr WBSAI	+ #BX22424	\$59.50
Motorola RF Device Data Motorola 5th Edition 2 Book Set	#BX8047	\$24.50

ANTENNA BOOKS

The ARRL Antenna Handbook 15th Edition	#BX161	\$38.00
Antenna Compendium Volume 1 ARRL	#BX163	\$22.00
Antenna Compendium Volume 2 ARRL	#BX292	\$24.00
Antenna Compendium Volume 2 & IBM PC Disk ARRL	+ #BX294	\$36.00
Antenna Impedance Matching ARRL	#BX257	\$30.00
Yagi Antenna Design ARRL	#BX164	\$30.00
W1FB's Antenna Notebook Doug DeMaw ARRL	#BX179	\$20.00*
Novice Antenna Notebook Doug DeMaw ARRL	#BX162	\$16.00
Practical Wire Antennas John D. Keys G3RQJ RSGB	#BX296	\$20.00
HF Antennas L.A. Mamon G6XN RSGB	#BX188	\$20.00
ANTENNAS 2nd Edition John D. Kraus WB6K	#BX259	\$104.00
Antenna Handbook William I. Orr WBSAI & Stuart D. Cowan W2LX	#BX217	\$17.30
Vertical Antenna William I. Orr WBSAI & Stuart D. Cowan W2LX	#BX220	\$15.85
Beam Antenna Handbook W I. Orr WBSAI & S D. Cowan W2LX	+ #BX225	\$19.30
Wire Antennas William I. Orr WBSAI & Stuart D. Cowan W2LX	#BX218	\$17.30
Cubical Quad Antennas W I. Orr WBSAI & S D. Cowan W2LX	#BX214	\$14.50
The truth about CB Antennas W. Orr WBSAI & S D. Cowan W2LX	#BX219	\$17.30
Transmission Line Transformers J. Sevick W2FMI Mrow 2nd Ed	BX329	\$40.00

PACKET RADIO BOOKS

Gateway To Packet Radio Stan Horzepa WA1LOU 2nd Edition	+ #BX160	\$24.00
The Packet Users Notebook Buck Rogers WA4BT CQ	#BX285	\$18.50
Packet Radio is Made Easy Buck Rogers WA4BT MFJ	#MFJ32	\$20.50
AX.25 Link Layer Protocol ARRL	#BX178	\$16.00
Computer Networking Conferences 1 - 4 1981 to 1986 ARRL	#BX188	\$38.00
Computer Networking Conferences 5th 1988 ARRL	#BX167	\$20.00
Computer Networking Conferences 6th 1987 ARRL	#BX168	\$20.00
Computer Networking Conferences 7th 1988 ARRL	#BX184	\$25.00
Computer Networking Conferences 8th 1989 ARRL	#BX295	\$24.00
SPECIAL — All 5 Books — Conferences 1 to 8	-#BX8008	\$80.00

VHF/UHF/MICROWAVE

RSGB Microwave Handbook Volume 1 M W Dixon G3PFR RSGB	#BX318	\$70.00
VHF-UHF Manual George Jansop G6JP RSGB	#BX287	\$48.00
all about VHF amateur Radio William Orr WBSAI	#BX210	\$17.30
21st Central States VHF Conference 1987 ARRL	-#BX172	\$17.50
Mid-Atlantic VHF Conference Oct 1987 ARRL	-#BX175	\$17.50
22nd Central States VHF Conference 1988 ARRL	-#X173	\$17.50
23rd Central States VHF Conference 1989 ARRL	-#BX296	\$17.50
Microwave Update 1987 Conference ARRL 1987	-#BX174	\$17.50
Microwave Update 1988 Conference ARRL 1988	-#BX183	\$17.50
Microwave Update 1989 Conference ARRL 1989	#SX321	\$24.00
UHF Compendium Part 1 & 2 Volume 1	#BX250	\$49.95
UHF Compendium Part 3 & 4 Volume 2	#BX251	\$49.95

General Interest

Hints & Kinks For The Radio Amateur ARRL	#BX330	\$18.00
The Short Wave Propagation Handbook G. J. Jacobs & T. J. Cohen	#BX288	\$18.50
Morse Tutor G6TE ARRL 5 1/4" IBM Disk	#BX197	\$20.00
Low Band DXing John Devoldere DM4UN	#BX195	\$20.00
Transmitter Hunting Joseph O. Maull TAB	#BX222	\$35.90
Radio Frequency Interference How to Identify & Cure It ARRL	#BX186	\$9.50
Interference Handbook William R. Nelson Radio Publications	#BX181	\$17.90
Golden Classics of Yesteryear Dave Ingram W4TWJ	#MFJ-30	\$20.50
The Complete OX'er 2nd Edition Gab Lacher W6KNI	#BX194	\$20.00
Solid State Design For The Radio Amateur DeMaw W1FB ARRL	#BX171	\$24.00
Amateur Radio Awards Book RSGB	#BX297	\$30.00

The above books, plus many more, are available from your WIA Divisional Bookshop. All items are less 10% discount for WIA Members and are plus postage and handling where applicable. All Prices are Subject To Change With-out NOTICE

If not in stock at your Divisional Bookshop, your order will be taken and filled promptly. Not all publications are available from all Divisions... * Price Changes... —# price Reduced... + Price Increase

a special rate of \$48.00 for surface mail delivery.

Within Australia, these "Direct Subscriber" facilities are only available to libraries and educational institutions, and not to individuals.

Draft Band Plan Changes

The Chairman of FTAC, John Martin VK3ZJC, submitted proposals for changes to the 1296 MHz band plan, and the 6 metre beacon segment above 50.200 MHz, to the Executive at the August weekend meeting.

After consideration, the Executive decided to ask John to publish these proposals in Amateur Radio magazine for members comments, with a view of adopting the changes at the October 1990 Executive meeting.

If you have an interest in these bands, make sure you read John Martin's FTAC column in this issue of Amateur Radio magazine.

Your Radio Club Need Funds?

Most of the several hundred amateur radio clubs in Australia are always looking for more funds. Next month the WIA will be releasing details of a scheme whereby radio club members will be able to boost their club's funds, and also assist the WIA. Look for details in October 1990 issue of Amateur Radio magazine.

Draft Rules for Fox Hunts

The National Fox-hunting Championship was first held in October 1985 as part of the 75th Anniversary Celebrations of the WIA. With the intention of establishing it as a regular event, a draft set of Fox Hunting rules has been prepared and circulated to all WIA Divisions for comment.

These draft rules are now printed for the information of members. Any comments received by the Executive Office will be considered when the rules are tabled for confirmation at the October 1990 weekend meeting of the Federal Council.

Overview

This paper describes some of the rules that may be applied in running the various forms of Radio Direction Finding competitions that are held. In all such events the purpose is to locate a hidden transmitter as quickly (or in as short a distance) as possible. Because the manner in which such events are run is limited only by the imagination of the organiser, one must allow for additional rules or local variations to those below.

Glossary

* Fox Hunt - Fox initially mobile. Hounds give chase. The fox may "go to ground" when appropriate. The transmitter may be hidden if desired.

* Hidden Transmitter Hunt - fox hunt. Transmitter always hidden. Sniffing gear required.

* Sniffer Hunt - Pedestrian fox hunt.

* Direction-finding event - an event to determine accuracy and skill in locating hidden transmitters with only a limited number of transmissions (usually two). Two brief transmissions, separated by 5-10 minutes, are made. Based upon this information hounds must place an X on a map showing where they believe the transmitter was located.

* Talk-In Hunt - a form of hunt in which hounds find their way to a predetermined location (not necessarily where the transmitter is) by asking questions. Primarily test the navigational skills and cunning of teams.

Rules and Regulations

1. General

a. All people taking part in Fox Hunts must obey traffic and local laws/regulations as appropriate. Police, traffic jams, etc. are considered normal obstacles.

b. The purpose, or goal, for a hunt must be defined before the hunt. All taking part must be aware of the criteria upon which success will be measured.

c. Penalty for breaking any rule, or acting against the spirit of the competition, is disqualification. Application of this penalty is at the discretion of the organisers and no discussion will be entered into.

2. Transmission Characteristics

a. Power output, modulation used and polarisation will be at the discretion of the organiser.

b. transmissions may be continuous or intermittent.

c. Where multiple transmissions are in use each must provide ID information.

3. Bands Available

a. Bands commonly in use include 80m, 10m, 6m, 2m, and 70cm.

b. Fox-Hunts may use any of these, or combinations of these, bands as required.

c. Other bands may be used... but only if adequate warning is given to all contestants. (At least three months recommended.)

4. The Fox

a. The fox must always be reachable legally and without risk.

* Public access must be available.

* It must not be necessary to risk injury, or damage to property, to reach the fox.

b. The fox must be able to be reached by all taking part in the event. (eg. A little old lady with a sniffer).

c. A 2m FM liaison frequency must be available to the hounds.

d. Unless specifically requested, the hounds will give the fox no more than 10

minutes head start.

e. The fox must not be hidden within the bounds of agreed "No-Go" areas, eg areas not available to Melbourne suburb hunts include "the Melbourne City Mile".

f. Remote Control of the transmitter is not encouraged (this has led, in the past, to accusations of favouritism). The transmitter will not be turned off as a hound approaches, unless it is part of a predetermined sequence.

5. The Hounds

a. All equipment for a fox-hunt must be contained within a single vehicle. All attachments to the vehicle must be safe and secure.

b. Communications with other vehicles during a fox-hunt is prohibited.

c. Direction finding equipment not related to the frequency currently in use must be removed or disabled.

d. No more than one sniffer is permitted to be used at a time. (Hand-Helds with non-directional antennas are permitted for communication between team members. Communication with any other team is illegal.)

e. Hounds must adhere to local traffic regulations. Penalty for breach of this regulation during a hunt is disqualification.

f. Hounds must not cross private property to reach the fox. Penalty for breach is disqualification from this hunt.

g. Hounds are not permitted to tamper with the transmitters in any way.

h. Hounds are not permitted to interfere with the transmitted signal.

i. Hounds are not permitted to interfere, in any way, with other teams' operation or equipment.

6. Scoring Two scoring techniques are commonly in use:

a. Time based:

* The first team to find the fox scores zero. Other teams score one point for each minute, or part thereof, that has elapsed since the first team found the transmitter, up to a maximum of 10 points.

* A team's overall score is the sum of all event scores. The team with the lowest total score takes first place.

* This technique requires every hound to either enter all events (or score 10 for non-entered events).

b. Point based:

* First in scores three points, second two points and third 1 point.

* Aggregate total determines the winner.

* To encourage participation, an additional point may be given for each event in which you are entered.

It is a fundamental requirement of all such competitions that the scoring or placing technique in use be published before the event.

ar

1990 REMEMBRANCE DAY OPENING ADDRESS

BRIGADIER K R COLWILL, CBE (RETD),
PRESIDENT, ROYAL AUSTRALIAN SIGNALS ASSOCIATION (VICTORIA)

I regard it as an honour indeed to be invited by the Wireless Institute of Australia to launch this year's Remembrance Day Contest.

This is the 42nd of your annual contests, proudly inaugurated in 1948 to commemorate those Australian amateur radio enthusiasts who lost their lives serving their country in 1939-45. Long may they be remembered, together with Institute veterans of that and other wars who have died since VJ Day, when World War II ended in the Pacific on 15 August 1945.

There are other historic events to be remembered especially this year. It is now 50 years since a number of Australia's famous units were raised by the Armed Forces for active service in the Second World War. It is also 50 years since the RAF's gallant 'few' triumphed so gloriously in the Battle of Britain. And, in years to come, no doubt 1990 will be noted for the ending of the Cold War between East and West in Europe.

The celebration three months ago of the 75th anniversary of ANZAC is another historic occasion to be remembered. A significant contribution to the success of that grand undertaking was the dedicated effort by VK1 members of your

Institute in establishing direct radio contact between Canberra and Turkey on Anzac Day. Although set up at relatively short notice, the communications got through, illustrating again the value of the amateur radio fraternity that exists around the world, regardless of international boundaries.

I must tell you that I was thrilled to learn later that a message I had telephoned to Canberra for despatch over that special link to Anzac Cove had been passed and acknowledged. In the message I referred to my dear old Signals friend and original Anzac, Bert Billings who, I am sad to report, passed away two months ago at the age of 95-1/2.

As many of you will know, he was a keen amateur wireless experimenter in 1912 (callsign XJP) and in 1913 became the soldier operator to send the first message ever transmitted in Victoria by means of an Army wireless set.

If we reflect for a moment on the fantastic advances in communications technology that have been made since those pioneer days, and even in the 42 years this contest has been in existence, people of my generation justifiably marvel at the magic of the progress we have had the good fortune to witness in our lifetime.

At the forefront throughout that period of dramatic development has been your amateur radio community. I recall clearly how, in World War II, we who served in the AIF Corps of Signals held in high esteem those members of our Corps who were licensed radio amateurs and also those who aspired to qualify for recognition by your Institute.

That admiration continues today, especially when we hear of the highly valued service which is rendered by members of the Wireless Institute Civil Emergency Network. I refer, of course, to the practical assistance provided in Darwin's Cyclone Tracy, Newcastle's earthquake, major floods and other natural disasters that have occurred on our vast continent. The outstanding deeds of WICEN volunteers who toil so selflessly to help the public in distress and, at other times, deserve the very highest praise.

To them, and to every member of the Institute, thank you for all you are doing for this great nation of ours.

Now, with the greatest pleasure, I declare the 1990 Remembrance Day Contest open.

Lest we forget.

• . . . •

BRIGADIER KEITH R COLWILL CBE — A BRIEF PROFILE

He enlisted as a Signaller in January 1940, and was commissioned as a Lieutenant in April 1941. His AIF service with the Australian Corps of Signals was in Torres Strait, Dutch New Guinea, Papua New Guinea, New Britain and the United Kingdom. When he was Officer Commanding Torres Strait Signals in 1942, his unit controlled an extensive coast-watching network. He held the rank of Major from 1944.

After graduating from the Australian Staff College at Queenscliff in 1953, he was appointed GOS1 Operations (Lieutenant-Colonel) Army Headquarters. Then followed nearly three years in the USA to attend the US Army Command and General Staff College, Fort Leaven-

worth, and serve with the Australian Military Mission in Washington DC. On return to Australia he joined the Directing Staff and later was Deputy Commandant of the Australian Staff College.

In the 1960s with the rank of Colonel, his command and postings included a term in Burma as Australian Services Attache, Commander 1st Aust Logistic Support Force and Honorary ADC to the Governor-General. As a Brigadier, from 1967 he was Chief of Staff and, for a period, Acting GOC, of Southern Command. Other senior staff appointments followed until his retirement in 1974.

After retiring from the Australian Regular Army, he successively became Colonel Commandant of the Corps, 3rd

Military District, then Representative Colonel Commandant of the RA Corps of Signals. Amongst other honorary appointments he was Chief Marshal, Anzac Day Ceremonies (RSL) in Melbourne, Vice-President of the United Service Institution of Victoria and President of the Victorian Association of the Most Excellent Order of the British Empire.

Recently, with a small group of Torres Strait Signals veterans, he revisited some of the islands in Torres Strait to present plaques to commemorate the wartime presence of the Signals Coastwatchers.

He has been President of the Royal Australian Signals Association (Victoria) since 1986.

ar
See also relevant articles pp 18, 24 - Ed.

RECEIVING LOOP AERIALS FOR 1.8 MHz

LLOYD BUTLER VK5BR
18 OTTAWA AVE PANORAMA 5041

In the March 1982 issue of 'AR', Clarrie Castle VK5KL described a receiving loop aerial for 1.8 MHz. The octagonal shaped loop, some three metres in length and breadth, was formed by a single turn of coaxial cable, the outer braid of which provided the electrostatic shield. From all accounts, the aerial was very successful in improving the received signal-to-noise ratio in the presence of localised noise interference.

It seemed to me that perhaps the same performance could be achieved with a loop of smaller dimensions but with more than one coaxial turn. This would allow operation in a more confined space and even inside the radio shack. With this in mind, the performance at 1.8 MHz of an 0.8m square multi-turn coax loop aerial has been investigated. Also examined is an unshielded version of the same sized loop aerial and a ferrite core loop aerial made for the 1.8MHz band. The performance of each is individually discussed and then compared.

Loop Sensitivity

For a tuned loop oriented to give maximum signal (that is, its plane in line with direction of signal source) the loop sensitivity (E_s/e) can be defined as follows:

$$E_s/e = (2\pi N A Q) / \lambda$$

where E_s = Output Voltage from loop
 e = Field strength in Volts per metre

N = Number of loop turns

A = Loop area in square metres

Q = Loop Q factor

λ = Wavelength in metres

Three-Turn Loop

Comparing the 0.8m square loop to the larger VK5KL loop, the area is only 0.64 square metre compared to 6.2 square metres for the latter. This reduction factor of around 1:10 means a loop sensitivity loss of around 1:10, but this can be partly compensated by increasing the number of turns. However, increasing the number of turns also increases the inductance of the loop and its inherent shunt capacitance and hence it reduces the loop natural resonant frequency. This frequency must be higher than the operating frequency (1.8 MHz) otherwise it cannot be tuned to the operating fre-

quency.

Three coax turns of 0.8 metre square appeared to approach this limit, and an experimental 0.8m square loop was assembled with three turns of the 75Ohm TV coax. There was no particular reason for selecting this type of coax except that I happened to have a piece just the right length! The construction of this aerial is illustrated in figures 1 and 2. Observe that the outer braids of each of the coax turns are broken at the apex of the loop, and all braids are joined at the base of the loop. The square loop is oriented with its diagonals vertical and horizontal. The reason for this is that it is convenient to mount the loop interface box, with its connection to the loop, on one of the crossed pieces of wood which support the loop. It also makes it convenient to hang the loop from a hook in the wood at the apex.

The increase in the number of turns of three to one does not fully compensate for the loss of 1:10 in area. However, the smaller three-turn loop measured a Q factor of 54 compared with 47 for a sample larger one-turn loop. The net result of all this is that loop sensitivity (E_s/e) for the smaller loop calculated to 3.9 compared with 3.7 for the larger loop and hence their performances could be expected to be much the same.

The natural resonant frequency of the three-turn loop was found to be around 3.5 MHz and well above the 1.8MHz operating frequency. It is possible that four turns could also have provided a

natural resonance above 1.8 MHz, with a possible further improvement in sensitivity. However, this was not checked out.

Unshielded Loop Aerial

Theory on how a shielded loop aerial reduces localised noise interference was given in my earlier article on loop aerials for VLF-LF (Reference 1). If localised noise is not a problem, loop sensitivity can be improved by not shielding the loop. This reduces the loop self capacitance and hence the number of turns for a given upper frequency limit can be increased. I found that seven turns of light-gauge hook-up wire, spaced 5mm apart on the 0.8m square frame, produced a natural resonance of 2 MHz, just conveniently above the 1.8 MHz required. The Q factor at 1.8 MHz measured 39 and loop sensitivity calculated to a value of 6.5, which is very close to a value calculated for a 10m high vertical aerial.

Conductor Size

As we have discussed earlier, the loop sensitivity at resonance is directly proportional to its Q factor which, in turn, is the ratio of its inductance to series resistance. The resistance is the sum of radiation resistance and the AC loss resistance in the loop, the latter being the prominent factor as the value of radiation resistance is very small. The AC loss resistance can be reduced by increasing the surface area of the loop conductor,

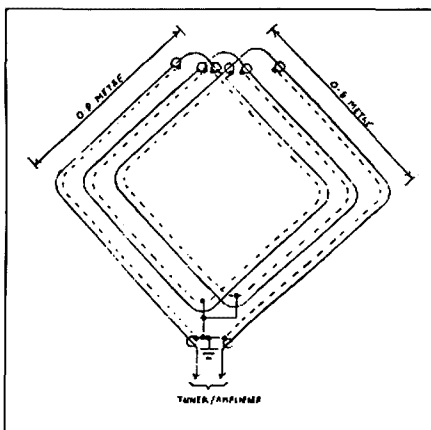

Figure 1: 3 turn coax loop aerial - circuit diagram

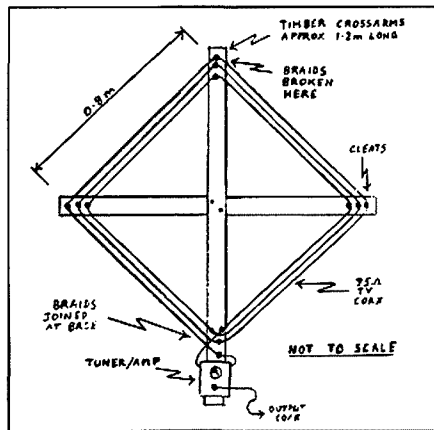

Figure 2: 3 turn coax loop aerial - assembly

and hence the Q can be increased by using a larger gauge of wire or litz wire.

The original seven-turn unshielded loop was wound with 0.4mm-diameter wire and produced a Q factor at 1.8 MHz of 39. The wire was ultimately replaced with a 1.7mm stranded conductor to improve the Q. A side effect in doing this was an increase in the self-capacitance of the loop, making it barely possible to peak the loop tuning at 1.8 MHz. To correct for this, the inductance was reduced by reducing the number of turns to 6.5 or, more correctly, one of the seven turns was returned from halfway around the loop across one of the crossarms so that the one turn had half the area of the others. The larger diameter conductor increased the Q factor to around 100. It would have been higher had it not been limited by the 200kOhm input resistance of the interface amplifier. Correcting for the reduced area of one turn and the increase in Q, the loop sensitivity (E_s/e) was derived as a value of 15.6, considerably higher than the 6.5 derived for the 0.4mm conductor.

In all fairness to the original VK5KL large single-turn loop, I must point out that this was made with RG8 coax, which has an inner conductor diameter around 2.2mm compared with the smaller diameter 0.8mm conductor in the coax used for my tests. The Q factor and, hence, the sensitivity of Clarrie's loop would, therefore, have been much higher than I have quoted. It also follows that I could have achieved higher sensitivity in my three-turn coax loop had RG8 been used. However, it is assumed that relativity between the signal sensitivities of the two loop forms would have been much the same with the smaller cable.

Loop interface

To obtain the best advantage of the high Q factor of the loop (and hence its highest sensitivity) the loop is tuned to resonance at the operating frequency and connected via a high impedance input interface circuit. For the experiments described, this was achieved with the circuit shown in figure 3.

The circuit makes use of twin JFET amplifier package type LF353 connected for balanced input. For the benefit of those who might not be quite familiar with operational amplifier theory, we will examine the stage gains. In the amplifier circuit around N1B, the gain via the inverting input is defined by the ratio $R6/R5$, and since $R5$ and $R6$ are equal, the inverting gain is equal to -1. However, the gain via the non-inverting input is defined by the ratio $R6/(R5+R6)$ and hence the non-inverting gain from the lower

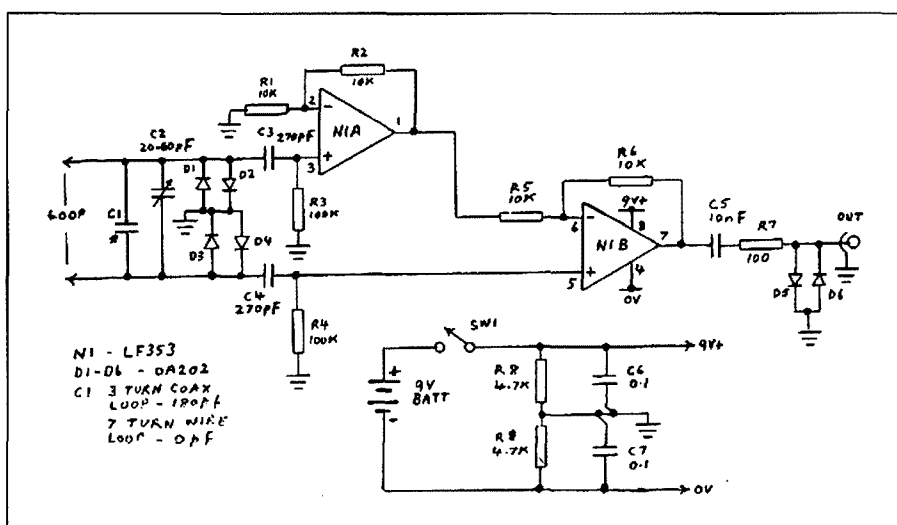

Figure 3 Loop tuner and interface amplifier

loop connection in the diagram is equal to two.

The other loop connection is fed via the non-inverting input of N1A. As the circuit around N1A is identical to that around N1B, it also has a gain from the non-inverting input of two. Since this connection of the loop is in anti-phase to the other connection, its signal via N1A must be inverted in mixing with the other signal in N1B. This is done via the inverting input of N1B without change of amplitude.

The loop aerial output is equally shared between the two amplifier inputs and hence the overall gain, balanced to unbalanced, is two or 6dB. This is about the limit one can get from the LF353 package at 1.8 MHz as its gain-bandwidth product is 4 MHz.

Tuning of the loop is set by variable capacitor C2 and, where necessary, parallel fixed capacitor C1. The input circuit resistance is 200 kOhms, set by R3 and R4 in series. This is sufficiently high to prevent the loop Q from being lowered excessively.

The output resistance is largely set by R7, included for stability. Operational amplifiers can be very temperamental if operated directly into a capacitive load (such as a coaxial cable) without some series resistance.

The multitude of diodes at input and output are protection against excessive RF signal which might happen to be fed in. At the home installation, the loop aerial amplifier was connected via a switch into the receive side of the transceiver transmit/receive relay. This provided an interlock to prevent feeding the transmitter directly into the loop circuits. However, there was still a concern about RF induced from the transmitting aerial back into the loop and hence the

diodes were included.

The amplifier circuit provides a very high impedance to low impedance conversion without loss of voltage developed by the loop or loss of loop Q.

Ferrite Core Loop Aerials

A further exercise was carried out to compare the performance of the loop aerial wound on a ferrite rod with that of the larger air-wound loops. Whilst this type of loop aerial has a very small loop area, the loss in area is compensated by the large number of turns which can be used and a high multiplying factor determined by the ferrite material permeability. For the aerial oriented to give maximum signal, the loop sensitivity formula is expanded to the following:

$$E_s/e = (2\pi N A Q \mu') / \lambda$$

Where μ' = The corrected permeability

Permeability requires some explanation. Permeability (μ) of the material is the multiplying factor which applies to the inductance of the winding compared to when it is air wound, assuming all lines of magnetic flux pass through the winding. In the ferrite rod, not all lines of flux pass through the winding, so there is leakage flux. The inductance is therefore less, and a multiplying factor called rod permeability (μ_{rod}) applies. Curves relating rod permeability to material permeability, for different rod length to diameter ratios, are published in the ARRL Antenna Handbook (reference 2) and in Amidon Associates brochures which have been widely distributed in Australia by Stewart Electronic Components Pty Ltd.

The corrected permeability (μ') is the multiplying factor applied to the loop formula. If the coil winding is the full length of the ferrite rod, then corrected permeability is equal to rod permeabil-

ity. If the rod is longer than the winding, the corrected permeability is increased as follows:

$$\mu' = \mu_{rod} \sqrt[3]{(a/b)}$$

where a = Length of the rod

b = Length of the winding

To carry out my tests, I purchased a ferrite rod (Cat L1401) from Dick Smith Electronics. The rod dimensions are 20cm long by 9.5mm diameter. No information seemed to be available on permeability, hence the rod permeability was derived by calculating the ratio of inductance, measured for a given number of turns on the rod, to that for the same sized winding in air. The inductance in air was determined by two different methods which gave much the same answer. The first method was to apply the well-known Wheeler's formula for air-wound coils which can be found in many handbooks. The second method was to wind the same number of turns on a length of bamboo which happened to have the same diameter as the rod, and the inductance of this coil was then measured.

The value of rod permeability was determined as 74, and from the curves previously mentioned, material permeability appeared to be around 120.

To operate at 1.8 MHz, 64 turns of 0.44mm single-core PVC-covered wire were wound around the ferrite rod. For this number of turns, the maximum which could be achieved, self-resonance was just above the 1.8MHz band at 2 MHz. The 64 turns occupied 7cm of the length of the rod and, from this measurement, a corrected permeability of 81 was derived.

The Q factor of the loop at 1.8 MHz was measured as 57, and loop sensitivity was calculated as 0.86, considerably less than all the air-wound loops discussed.

Comparison of Loop Sensitivities

The characteristics of the various loop aerials discussed are compared in Table 1. Despite its smaller area, the 0.8m square coax loop (B), with more turns and higher Q, has a signal sensitivity as good as the larger single-turn coax loop (A). With a self-resonance at 3.5 MHz, well above the required frequency of 1.8 MHz, it is probable that the sensitivity of (B) could have been improved further by adding another turn, still being tunable to 1.8 MHz.

The additional turns made possible by not shielding the seven-turn loop (C), enabled a higher signal sensitivity to be achieved comparable with that of a 10m vertical aerial (F). The importance of using a large sized conductor to reduce AC resistance is shown by comparing aerial (C) with aerial (D), which is simi-

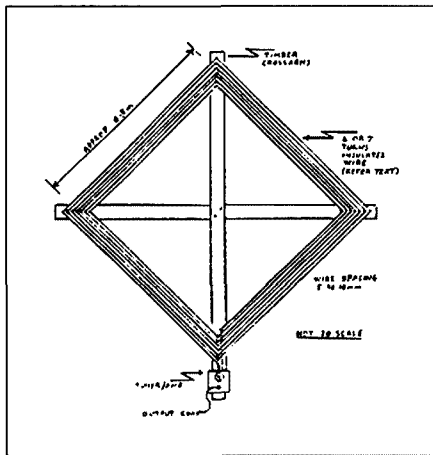

Figure 4 Unshielded loop aerial

lar to (C), but which has a large diameter conductor. The sensitivity of (D) is considerably higher than that of (C).

The ferrite rod loop aerial (E) works quite well because of the high permeability of its core, but it is no match in terms of signal sensitivity when compared with the larger air core loops.

Operational Performance

With the various loop aerials connected in turn to a receiver, the relative signal levels received followed much the same pattern as loop sensitivity shown in Table 1. Signal levels received on the three-turn coax loop were comparable with those received on a sloping wire Marconi aerial loaded for 1.8 MHz and normally used as the transmitting aerial. The unshielded loops, with more turns, delivered considerably higher signal levels than the sloping wire. Some of the extra level is due to the 6dB gain in the interface amplifier but, even taking this into account, there was still quite a level difference.

Quite apart from the ability of the loop aerial to reduce interference from a localised noise source, its directional properties can be used to improve the signal-to-noise ratio in the presence of atmospheric noise. This particularly applies if the noise has a directional property and the loop is oriented so that its null position faces the direction of maximum noise. Of course, the same technique can be applied to a source of QRM. For these applications, the unshielded loops, with their higher signal sensitivities, seemed to work best and they clearly improved the readability of signals otherwise difficult to copy on the sloping wire.

One would expect that the coax loop aerial would be more suitable than the unshielded loop in an environment of high local noise. Notwithstanding this, the seven-turn unshielded loop did not

appear to be any more sensitive to localised noise introduced from an electric drill and a signal generator operated in the radio shack. Unfortunately, up to the time of writing, the local power authorities had not obliged with some really good powerline noise to check out the loops in that particular environment.

(*Ssh, Lloyd, you might provoke cause for complaint! Ed*)

In actual fact, the unshielded loops could be expected to have quite reasonable rejection of the electric field component when operated into the type of interface amplifier circuit used. The electric field component of localised noise is the one which is the highest level and this is induced into the loop in a common mode with equal voltage at the loop output terminals referred to ground. The amplifier has a differential input circuit and hence the electric field component is essentially balanced out (see footnote). If the balance is good, there would appear to be a lesser need for electrostatic shielding to reduce localised noise. The additional shield might be needed more in using the loop for accurate direction finding (DF) work where a small amount of pick-up as a vertical aerial (called vertical or antenna effect) could make an error in the position of the signal null.

The ferrite rod loop aerial has an advantage in its small size and suitability for portable applications. However, its performance when connected to a receiver did not match that of the 0.8m square loops.

Conclusions

The performance of 0.8m square loop aerials for 1.8 MHz has been discussed. It is concluded that a three or four-turn coax loop aerial of this size would work as well as the larger single-turn coax loop aerial.

By using a loop of unshielded turns to reduce the capacitance, the number of turns and hence the loop sensitivity, can be increased. Provided that the unshielded loop aerial is operated in a balanced mode, rejection of localised noise is still quite good. Loop sensitivity is dependent on its Q factor, and to achieve a high Q, the conductor size, or at least its surface area, should be as large as practicable.

My recommendations for a good performance 1.8MHz loop aerial, small enough to operate both inside the radio shack or outside, is six or seven turns of a heavy-gauge copper wire spaced 5mm to 10mm on a 0.8m square frame. A simple assembly for this is shown in figure 4. As an alternative to ordinary wire, one might consider connecting up

the outer braid of the old style heavy shielded wire or some discarded coax cable.

Provided that the loop circuit is well balanced, I see little point in shielding the loop unless accurate DF work is envisaged. Some texts describe a step down coupling transformer to interface the loop to the receiver input. As a preference, I favour the use of the high impedance amplifier for the following reasons: Firstly, the transformer reflects a load from the receiver input and this must lower the loop Q. Secondly, the transformer provides a high-to-low-impedance transfer with step down of voltage. The amplifier does this as a voltage follower, or even with voltage gain. The only precaution is that the amplifier must be selected for a noise level below that coming in from the atmosphere. The higher the loop sensitivity, the less is the chance of this being a problem.

The discussion has also extended to experiments with the ferrite rod loop aerials. As stated earlier, the aerial has its limitations.

1. Lloyd Butler VK5BR — VLF-LF and the Loop Aerial. — Amateur Radio, August 1990.
2. C H Castle VK5KL — A 10ft Diameter Receiving Loop Aerial on 1.8 MHz — Amateur Radio, March 1982.
3. The ARRL Antenna Handbook 15th Edition 1988 — Chapter 5, Loop Antennas, and Chapter 14, Direction-Finding Antennas.

Footnote

I have pointed out in the text that when the loop is connected via the differential input circuit the electric field component is induced in a common mode against earth and is essentially balanced out by the circuit. This should be quali-

Table 1

Comparison of Loop Aerial Characteristics

Aerial

- A 2.8m cross-section single-turn RG58 coax loop — inner conductor diam = 0.8mm
- B 0.8m square three-turn TV cable coax loop — inner conductor diam = 0.8mm
- C 0.8m square seven-turn unshielded loop — conductor diam = 0.4mm
- D 0.8m square 6-1/2-turn unshielded loop — inner conductor diam = 1.7mm
- E Ferrite rod 20cm x 0.95mm diam overwound with 64 turns 0.4mm diam wire
- F 10m high vertical aerial

Aerial	Es/e	L	Q	Max F	Tuning C(1.8MHz)	Self C
A	3.73	12 μ H	16	2.5MHz	500pF	150pF
B	3.9	26 μ H	54	3.5MHz	220pF	80pF
C	6.5	130 μ H	39	1.98MHz	10pF	50pF
D	15.6	110 μ H	100	2.05MHz	10pF	60pF
E	0.86	223 μ H	57	2MHz	5pF	35pF
F	6.36					

Legend

- Es/e = Aerial sensitivity — ratio of output Volts to Volts/metre in space
- L = Loop inductance
- Q = Loop Q factor
- Max f = Resonant frequency with no capacitance added
- Tuning C = Capacitance added to resonate at 1.8 MHz
- Self C = Derived self-capacitance

fied as being conditional on the loop dimensions being small compared with a wavelength. If the plane of the loop is in line with the direction of signal, a phase difference must exist between the voltages induced into each side of the loop. This will develop a differential voltage between opposite sidewires of the loop. In the loop aerials discussed, the distance between the sides of the loop is 0.8m, small compared with a wavelength of 160m. Hence, the phase difference is small and the voltage generated is also assumed to be small. **ar**

Murphy's Corner

We managed to "desecrate" two expressions in Lloyd Butler's article "VLF-LF and the Loop Aerial" August 1990. P13 Column 1 first formula should read:

$$E_s = (2\pi eNA)/\lambda$$

and

$$V = \text{Wave velocity } (3 \times 10^8 \text{ metres/sec.})$$

(Why, Oh why do these errors always happen to Lloyd's work? — Ed)

AMATEUR TV BEATS 7, 9 & 10

Amateur Television was on in Brisbane in 1935, more than 20 years ahead of the commercial channels.

This was revealed to the general public in a full-page newspaper article in the Sunday Mail Colour Magazine.

The 3 June edition featured a large photo of Bob VK4BOB and a lengthy story about the South East Queens-

land Amateur TV Group.

The report explained how amateur TV was not public-access TV, but a station owned and operated by television buffs.

It said members were on air most nights from 7pm, and how everyone joins in the Tuesday night talkback session on the repeater, VK4RTV, UHF35.

The story also said miniaturisation had enabled the group to take telecasts outside its homes, and mount its own

outside broadcasts.

The article also acknowledged the important role amateur operators play during emergencies.

The group considers the article to be another source of good publicity for the hobby, and follows a successful program about amateur TV on Channel 10 earlier in the year.

PETER JONES VK4YAC
PRESIDENT SEQATV GROUP

HOME BREW DOUBLE PADDLE FOR IAMBIC KEYS

ALLEN CREWTHOR VK3SM
28 REYNOLDS PARADE
PASCOE VALE SOUTH 3044

Some years ago I made a double paddle for a new Iambic Keyer and have had a few people ask for details.

All the material is brass, except for the base and terminals. The arms and pillars are 3/16" (5mm). The saddle top and bottom 1/2" x 1/8" (12 x 3mm) and two 12 x 6mm spacers, held together and to the base by two 25 x 2.4mm RH screws.

Bearings for the pivots are the two 1.2mm holes in the bottom plate and two screws, and locknuts fitted to the same holes in the top plate. 1.2mm holes are drilled in the end of these screws to act as the upper bearings, which are adjustable.

The pivots are made from 12mm long

pieces of 3mm brass, or steel, rod held in the chuck of an electric drill and, by using a fine file, making a point on each end.

After making the two arms, the pivots are fitted through the 3mm hole 'c' and centred. A screw is installed in hole 'b' next to hole 'a' with 1mm extending through on the side where 'a' is drilled. The excess is cut off the screw, and both the screw and pivot are soldered into the arm.

Now a contact taken from a relay is soldered over hole 'a'.

Assemble the saddle on to the base and fit the two arms with the contacts pointing out. The backstop (15mm post with no hole) should also be installed. The hole is about in the middle of the base.

By measuring the height from the base to the centre of the contact, the distance on the other four pillars will be obtained. This will vary from one

key to another due to the position of the arm on the pivot and thickness of the bottom plate of the saddle.

After drilling and tapping these holes, assemble a screw with locknut into two pillars and carefully solder another contact on each. Fit the pillars to the base so that the contacts meet.

With the other two pillars, assemble a screw and locknut through the pillar and solder another nut on to the screw, leaving 1mm thread showing. Fit these pillars to the base and tension the arms to the backstop with a piece of spring as from a ballpoint pen.

The finger plates can now be fitted, as well as the three terminals and the three wires underneath. Make sure that the saddle screws are tight. Adjust the bearing screws and tighten the locknuts, set the contact gap (I like a double thickness of paper) and, lastly, the return spring tension.

Enjoy getting to know your paddle and take some pride when you say 'paddle here is home brew'.

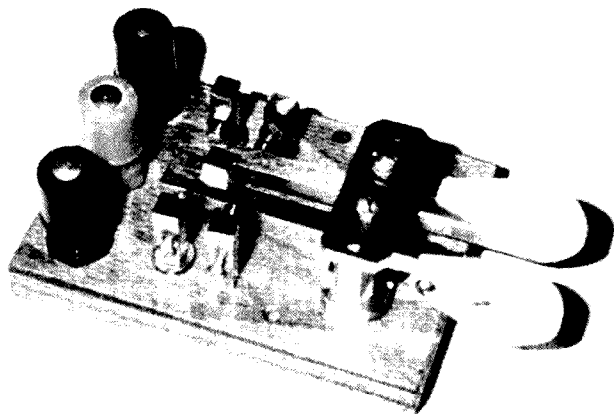
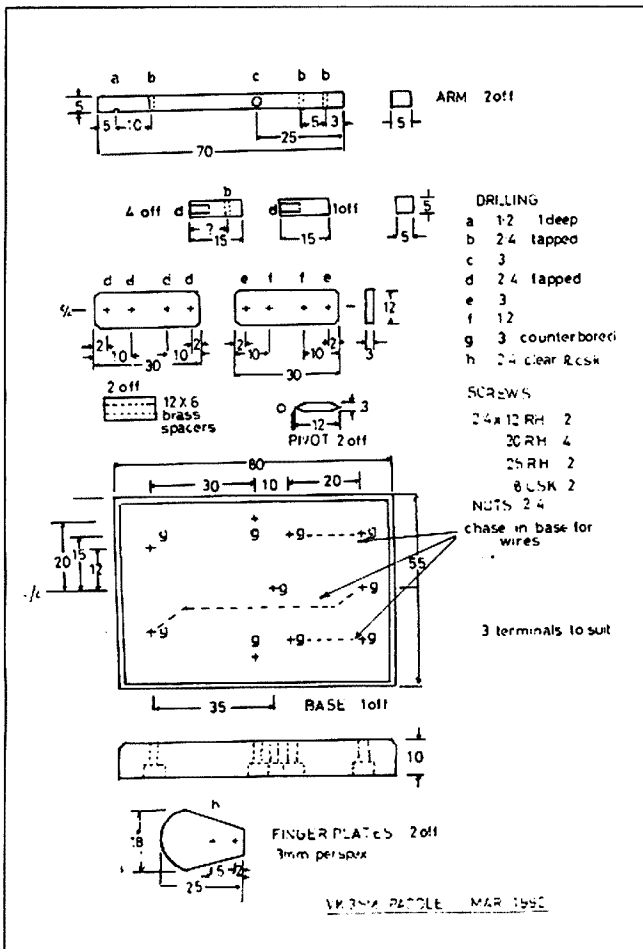

The completed Iambic Keyer

Don't buy stolen equipment
— check the serial number against the
WIA stolen equipment register first.

FT-1000 HF ALL MODE TRANSCEIVER

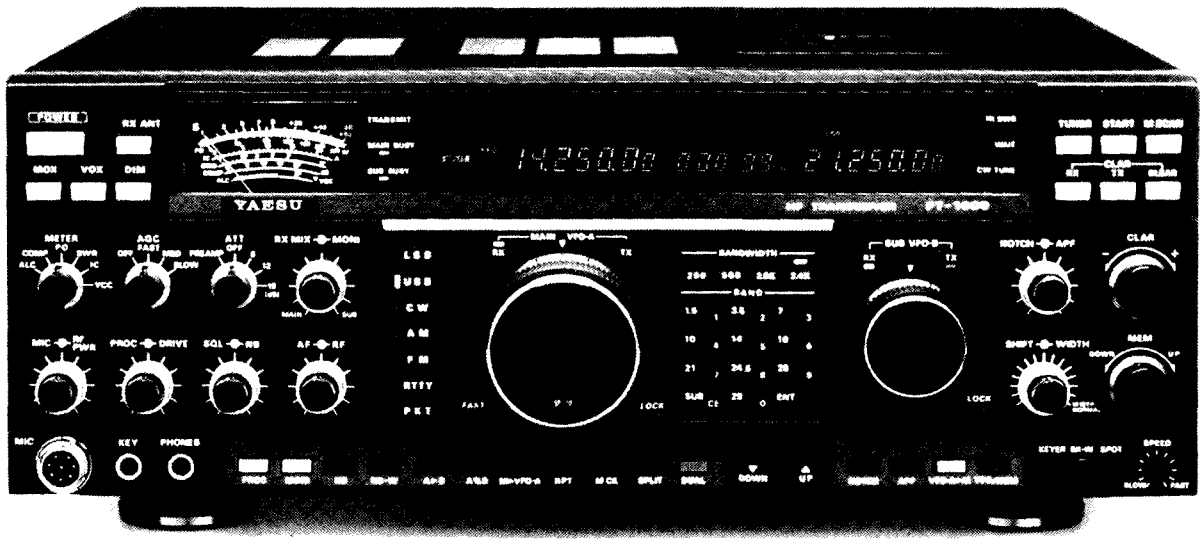

THE BEST OF THE BEST

Attention all serious HF operators! To be a truly WORLD CLASS operator during these times of crowded band conditions, you've got to have a truly WORLD CLASS rig...and the rig you need is arriving in Australia very soon. Of course we're referring to the versatile new YAESU FT-1000.

The FT-1000 is the product of 3 years intensive research and development at YAESU, resulting in a highly reliable, fully featured, yet easy to use HF transceiver. It's bound to blow away your competition with its spectacular combination of power and operational flexibility. Compare!

Direct Digital Synthesis (DDS)- Two 10 bit DDS plus three 8 bit DDS provide fast lock-up times and lower synthesizer noise than traditional PLL systems. Using DSS's results in a cleaner transmitted signal and much improved receiver performance.

High RF Output Power- Continuously adjustable output from 20 watts to a mighty 200 watts is under your control. A built-in blower sees that high duty cycle transmissions take place quietly and efficiently.

Dual Channel Reception- Utilising independent VFOs and digital displays as standard, reception can be in different modes, on different frequencies, with different IF bandwidths. An optional Bandpass Filter Module (BPF-1), will allow cross-band dual-receive using two antennas.

Ultra-High Performance Receiver- it provides all-mode coverage from 100kHz to 30MHz with a dynamic range of up to 108dB. Selectable filters for the following bandwidths are fitted as standard: 6kHz, 2.2kHz, 1.8kHz, 500Hz, 240Hz. The QRM rejection systems include cascaded IF filters, IF Width and Shift controls, IF notch filter, a variable noise blanker, and CW audio peaking filters.

2 Year Warranty — A world class transceiver should be covered by a world class warranty. That's why we provide a comprehensive parts and labour 2 year warranty on every Yaesu transceiver we sell, including the FT-1000! Don't settle for less.

Price - Compare with the opposition, and get a pleasant surprise. At \$4995, the FT-1000 offers by far the best value for money, as well as the best support. No wonder Yaesu call the FT-1000 'The Best of the Best'! Also, see A.R.A review in Vol 13 No. 2 issue, and A.R. review in the August 1990 issue (copies of both reviews available upon request).

Due to the huge worldwide demand, initial stocks of the FT-1000 will be limited. So place your order now!

D-3300

* Includes bonus MD-1 desk microphone

\$4995

DICK SMITH
ELECTRONICS

B1013/MS

1 GHz FREQUENCY COUNTER MODIFICATIONS FOR 1296MHz AND A 2.4GHz PRE-SCALER

BY CHRIS SKEER VK5MC
SUNNYBRAE HATHERLEIGH VIA MILLICENT 5044

This article deals with modifications to the 1GHz counter designed by Steve Payor in Silicon Chip magazine, November, December 1987 and January 1988, to make it more useful for those who need a 1296MHz or above counter. This unit is available as a kit for \$299 from various places.

Firstly, let me congratulate Steve Payor on his original design. He has really produced a nice counter which is not too difficult to put together.

I had the opportunity to debug a unit that was constructed by a local amateur who was convalescing after an illness early in 1988, and had never succeeded in getting it going. After a few solder bridges were removed and some dry joints corrected, the instrument started to work quite nicely.

The basic counter is an Intersil ICM7216A with a 10MHz specification, preceded by a divide by five and a divide by two to get it up to 100 MHz. For the 1GHz range it uses a Philips SAB6456 prescaler with a specification of 1.3 GHz, but a typical performance of 1.7GHz.

Initial checks indicated a frequency limit of 1290 MHz on the 1GHz range, and 10.03 MHz on 10MHz range.

This is fine as it meets the design specs of a 1GHz counter quite easily, but not so fine if your interest is in counting to 1296 MHz or higher.

It seemed a waste to have a 1.7GHz front end being limited by the performance of a later stage. Investigating with a CRO indicated that the prescaler was in fact working okay to the 1.6GHz area.

As the SAB6456 prescaler is a divide by 64 or 256 (working as a div by 64), I decided to make it divide by 256, simply by earthing pin five, this then gave a reading up to 1.6GHz, but it was divided by four, ie 1000 MHz read 250 MHz on the counter.

To make the counter read the correct numbers again, I needed to rearrange the circuitry slightly. The first thing I did was to bypass the divide-by-two stage which was used in the original divide by 128 (64 x 2). This was achieved by simply lifting a bridge wire to pin 11 to IC4 and connecting pins 14 and 15 of IC3 to-

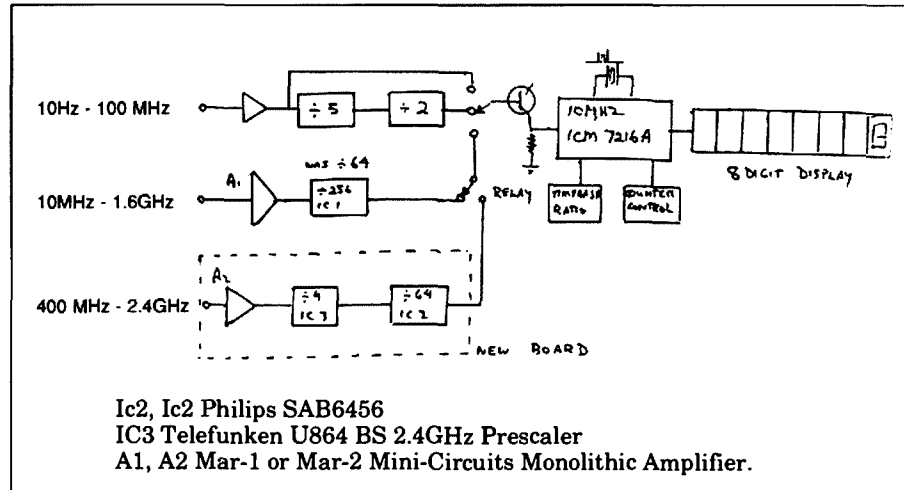

IC2, IC2 Philips SAB6456
IC3 Telefunken U864 BS 2.4GHz Prescaler
A1, A2 Mar-1 or Mar-2 Mini-Circuits Monolithic Amplifier.

Figure 1 Main counter circuit blocks showing new board.

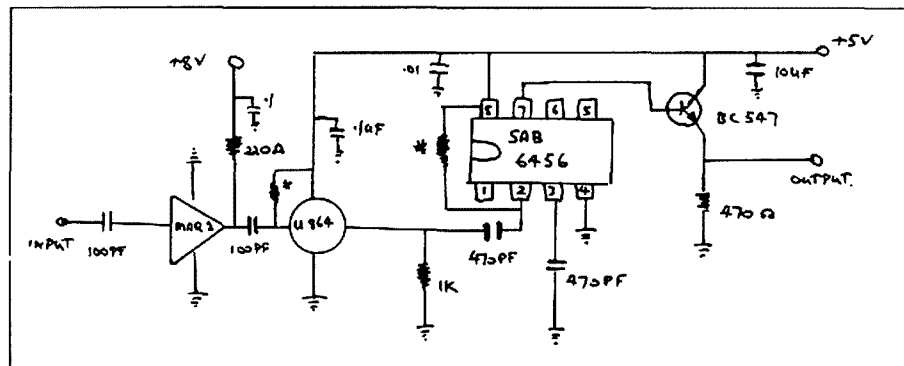

Figure 2 2.4GHz Prescaler circuit
*See text for bias resistor details

gether. The connection of two outputs together in normal TTL is not permitted, but in ECL with pull-down resistors, this is an approved method.

The second divide-by-two elimination was achieved in the Timebase Ratio section where the ICM7216A counter is used in its ratio mode. By changing the 4024 seven stage ripple counter output from its original divide by 64, to a divide by 128, this has the effect of leaving the counting gate open for twice the time. Hence, we now get a count twice the original. This modification is achieved by changing the reference output at IC7,

from pin four to pin three.

This has slowed the gating time to some extent, but it is still quite usable on the fastest gate time of 0.256 seconds. With this change we get a readout to the kiloHertz.

On the 1GHz range a frequency limit of 1.6 GHz at a signal level of 80 mVolts was obtained.

The SAB6456 prescaler apparently oscillates at its point of most sensitivity, giving a reading on the counter with no signal input, the unit I debugged oscillated at 1122 MHz.

Some other articles did mention neu-

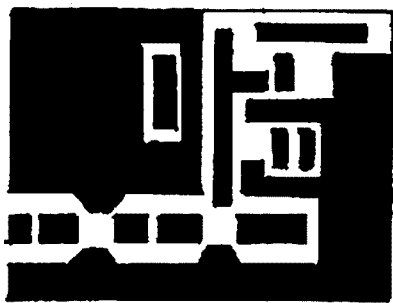

Figure 3 Prescaler board actual size 52 x 39 mm

trialisng this by some voltage bias at the input (ref 1). By putting a 33k from pin two to pin 8, this oscillation will stop, but it drops the sensitivity to 200 mV at 1.4GHz. However, installation of a MAR-1 or MAR-2 monolithic amplifier made by Mini-circuits (Ref 2 & 3) as a preamplifier will bring this back to near original sensitivity.

The second counter I had a chance to check did, in fact, go to 1.6 GHz in its original form because the basic counter was usable up to 13.5 MHz and could handle the lower division ratio.

2.4GHz prescaler

One reads overseas articles (Ref 1), sometimes with envy; on many occasions the devices used in them are not readily obtainable. However, a visit from a friend who had just purchased a 2.4GHz prescaler chip locally renewed my interest. The device, a Telefunken U864 BS, is used in 2.4GHz TV satellite-receiving systems, and is available from Stewart Electronics (Ref 3) and is moderately priced at \$14.40 plus tax. The U864 BS is a divide-by-four device which suits the counter available nicely.

The best way I could modify the original counter was to make the counter modifications already suggested, and to switch in a new prescaler with a divide by four and divide by 64, making an overall division 256. See Fig 1.

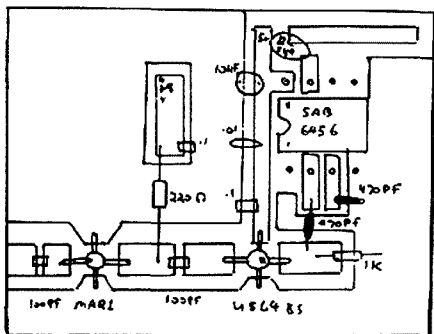

Figure 4 Prescaler board enlarged showing layout of components

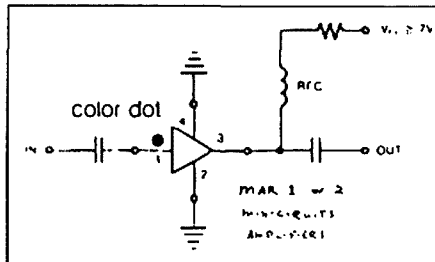

Figure 5 Typical Circuit Arrangement

A frequency of 2.4 GHz divided by 256 gives a 9.3MHz signal that can be handled by a simple miniature relay and Ten MHz counter.

Fig 2 gives the basic circuit of the prescaler. The very few components that are required are soldered on to a piece of the double sided fibreglass board. The components are mounted on the top or track side, with the earth plane on the bottom.

Top and bottom earth pads are connected together with wire stitching. The earth connections under the MAR-1 and U864 are connected to the ground plane with short straps.

My unit used a MAR-1, but a MAR-2 would probably have been a better choice as it has a 2GHz specification. If this is used it needs to be biased to 25 milliAmps by changing the 220Ohm resistor. If you use a different supply voltage this may also need changing. Although the MAR-1 and 2 are 5V devices they do need to have at least 2V drop across the bias resistor or they may go into thermal runaway and destroy themselves (Ref 4).

If a signal is not present, the prescaler will oscillate at its point of most sensitivity. This was a very annoying situation, as one was never sure if the count was signal or oscillation. This applies to the SAB 6456 prescaler as well.

To overcome this problem, start with the SAB6456. Lift the input capacitor and put a resistor from pin eight to pin two. I found a 33k would provide enough bias, but you may require a smaller value to neutralise it. Once you are happy with that stage, go on to the U864 BS and do the same thing from pin four to pin one remembering that the less resistance (ie highest value) you require, the more sensitivity you will have at the finish.

The monolithic amplifiers are a very stable device and will not cause any trouble.

The .1 µf bypass and 100 pF coupling condensers are chip capacitors.

Installation

I found room on the back of the case to put a BNC input connector and a push switch to control the miniature relay, which was mounted under the counter

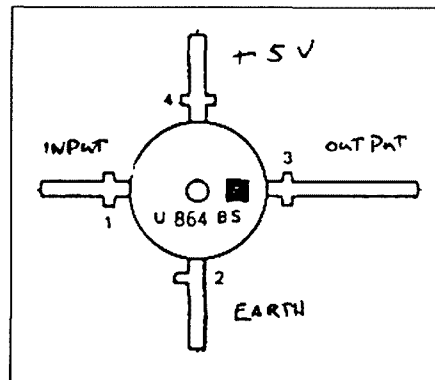

Figure 6 Telefunken Prescaler

board near IC3 (10100). The relay I had was a 6V unit and I ran it from the unregulated part of the supply with a suitable dropping resistor. Do not forget to put a diode across the coil to stop any spikes getting back to the supply. I also switched a second LED on the front panel to indicate the 2.4GHz prescaler was in use.

The output resistor of 470 Ohms shown on the circuit is actually on the main counter board at pin 10 of IC3. I switch the emitters of the BC549 using a short-shielded cable from the prescaler board.

Sensitivity of the prescaler was 50 mVolts at 2.3 GHz and 10 mV at 1296 MHz.

Frequency stability was one thing I thought may be a problem, but after putting one crystal in a small proportional oven and comparing it to the original, there appears to be enough heat generated by the transformer to lift the internal temperature above room temperature to give a reasonable result.

Ref 1.

A 2.3GHz prescaler VHF Communications 1/85 and 3/87

Ref 2.

MAR series wide-band amplifiers, made by Mini-Circuits, available from DC Electronics, 20 Nelson St, Adelaide. (08) 363 2312

Ref 3.

Stewart Electronic Comp, 44 Stafford St, Huntingdale, Vic. (03) 543 3733.

Ref 4.

Monolithic Microwave Integrated Circuits by Al Ward QST February 1987.

**CHRISTIAN
BLIND MISSION**

*Caring for
blind Children*



1245 Burke Rd.,
Kew 3101

THE 75TH ANNIVERSARY ANZAC RADIO LINK — 1990

BY PHIL CLARK VK1PC
57 PARTRIDGE ST
FADDEN 2904

It was just after 6.30pm on Wednesday, a typical cool autumn evening in Canberra, when Ted arrived home. He walked into the warm lounge and checked for telephone messages. There were two of them. He wondered about the second. Who was Bill Burch? Ted dialled the number. The distant telephone rang and a male voice answered.

"Hullo."

"Is this Bill Burch", said Ted.

"Yes," said Bill. "Who is this?"

"This is Ted Pearce, President of the ACT Division of the Wireless Institute of Australia, returning your call."

"Oh yes," said Bill, "I wonder if there is something that you and your boys could do for us on ANZAC Day. Perhaps it would help if I were to explain."

"Please do," said Ted.

Bill said, "I am the manager of Exhibit Design and Development at Questacon/ National Science and Technology Centre here in Canberra. I had this idea for something that we might be able to do for the 75th anniversary of the ANZAC Gallipoli landing."

"This sounds interesting," said Ted. "Please go on."

"In 1989, we returned the old telegraph station at Alice Springs to operation and now, as you may know," said Bill, "we have a telegraph line from the station at Alice Springs to Questacon here in Canberra. It occurred to me that we could re-enact the passing of messages between Australia and Europe during the First World War by linking the Alice Springs telegraph circuit to Gallipoli via a direct radio link. Could you do this for us?"

Ted thought for a moment about all the possible problems, including permission from another administration and, casting these aside, said, "Yes! We can do it for you."

At this point, Ted and Bill went on to discuss the setting up of the Gallipoli link. Bill said that he would contact the people in Turkey and get permission, if Ted could give him someone to speak with over there. Ted said he would be in touch with Bill again as soon as he had a name. On that note, they concluded their conversation. "Oh, strewth!" thought Ted, "What have I let us in for?"

Ted started to think out the steps necessary to get things moving. First, who to contact in Turkey? Early on the morning of Thursday, 19 April, Ted rang the WIA executive office and spoke to Bill Roper. Ted explained what he needed to Bill, and soon Bill was able to give Ted a contact. Ted should speak to Aziz Sasa TA1E, president of the Turkish Amateur Radio Society (TRAC). Ted then passed this information to Bill Burch at Questacon so he could begin the international arrangements.

Background

But what was the historical background to the Alice Springs telegraph station, radio and the Gallipoli landing?

Prior to November 1871, there was no direct contact between Australia and the outside world. Then, on 19 November 1871, the cable linking Java and the rest of the world to Australia was opened in Darwin. Only a few years previously, the very first telegraph line in Australia was opened on 3 March 1854 between Melbourne and Williamstown. In July, another line had been installed from Melbourne to Bendigo, and by December of that year, the Williamstown line had been extended to Geelong. In July 1858, a line had been completed between Adelaide and Melbourne, and by that October, the line between Sydney and Melbourne had opened. By 1859, almost all of eastern Australia was linked by telegraph!

It had been recognised some time earlier that for Australia to have direct contact with the rest of the world a link would have to be provided to connect to the south-eastern network. While the cable from Java was being laid, construction began on the Overland Telegraph from Adelaide to Darwin. However, the construction of this line was running behind time due to severe difficulties with unexplored country, aborigines, dust, disease and torrential rain of up to 10 inches per day. In spite of these tremendous difficulties, the line was opened on 22 August 1872, and the populous and administrative centres of Australia at last had a direct link to Britain and Europe. News and messages that had previously taken weeks or months to arrive were now being received in a few



Erecting the TH6 antenna on the roof of Questacon / National Science and Technology Centre. On the ladder, John VK1ZX, George Briskey NSTC. Lower left Michael Goiser NSTC, Ted VK1AOP.

days. This was a major advance in communications to Australia! The tenuous cable link between Australia and Britain went via Java and Ceylon, and still was an important communications link at the outbreak of World War I, although major advances had been made in radio telegraphy by then.

It was in 1888 that Hertz carried out his famous experiments demonstrating electromagnetic radiation. Nine years later, in 1897, Marconi gave the first demonstration of telegraphy without wires. A wireless demonstration using 'Marconi equipment' was conducted at Adelaide University, also in 1897. Even before Marconi had transmitted the letter 'S' across the Atlantic in 1901, experimental wireless stations were in operation in Australia. In 1906, the Marconi company had established two stations at Queenscliff in Victoria and Devonport in

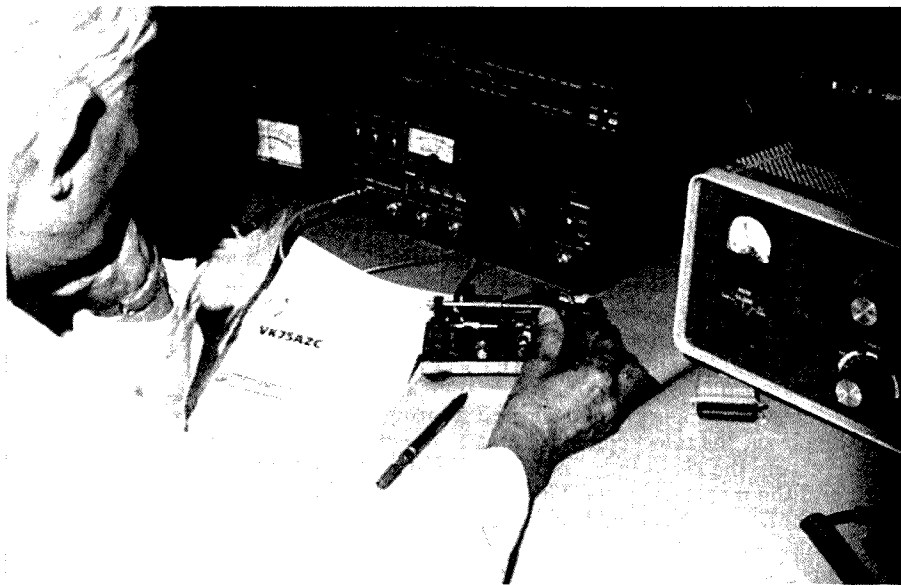

John Gore VK1PG at the key of VK7SAZC

Tasmania, the first professional wireless link between established land stations in Australia. W H Kelly moved in Federal parliament in 1909 for a chain of radio stations to be erected around the coast of Australia for the purposes of merchant shipping, intelligence gathering on the advent of 'hostile forces', and for safety at sea. Tenders were called for the construction of two high-powered stations, one at Perth and one at Sydney, in 1910.

Outbreak of War

In May of 1914, there were as many as 19 coast radio stations throughout Australia and New Guinea communicating with the off-shore islands and with ships, but the main communication with Britain and Europe was still by cable. These stations did, however, provide an important additional communications link to the European theatres of war through the chain of radio stations via Ceylon and South Africa.

At the outbreak of war, the British had cut the German trans-Atlantic cables in the English Channel and so the Germans went on to upgrade their radio transmitters near Berlin to the most powerful in the world at that time. In early 1915, the radio stations at Sydney, Perth and Townsville were equipped with the then new valve receivers and during testing they were able to receive readable signals from the German station. From that time, the German transmissions were regularly monitored by Australian stations. Some historians record that these were the first radio signals direct from Europe to be received in Australia.

In late 1914, the German raider 'Emden' attacked the communications centre on Cocos Island. An 'SOS' message

was sent by radio and cable to Australia. This message was also received by a convoy of ships carrying the first contingent of Australian and New Zealand troops, the ANZACS, only some 50 miles away. HMAS 'Sydney' was detached from the convoy and steamed towards Cocos where she engaged and sank the 'Emden'. Although the shore installations on Cocos had been severely damaged, they were repaired within a few weeks and, for the remainder of the war, Australia's cable links remained undamaged by enemy action.

On the battlefields of Europe and the Middle East, electronic communications were almost exclusively carried by wire augmented by a few short-range radio sets. In the early stages, telegraph was used and then, later, as technology advanced, telephony was introduced. At the time of the Gallipoli landing, telegraph by cable and radio was the only rapid communication link from Australia to the European theatres of war, and the station at Alice Springs was a vital part of these communications. It was also from the cable and wireless telegraph stations that the first naval wireless operators came. It was these people who later trained many of the operators for the services.

The Australian Army bought its first wireless sets, the 500-Watt Marconi "PACK" sets in 1913. Following the outbreak of war in 1914, a signal troop was formed to serve with the ANZAC forces at Gallipoli. One of the members of this troop was former amateur, Hubert (Bert) D Billings of Melbourne. The job of Bert and other members of this group was to set up a wireless station at Gallipoli for naval gunfire spotting. The first message

from Gallipoli to the warship HMS 'Euryalus' was sent by Bert Billings on 27 April 1915. At the time of the Gallipoli landing, the only mobile wireless stations in the Middle East were those of the Australian forces.

Negotiations

Armed with the information provided by Ted, Bill Burch rang Turkey and spoke to Aziz Sasa TA1E, president of the Turkish Amateur Radio Society (TRAC) about the proposed Gallipoli link. Aziz thought that this was a wonderful idea but had some doubts that he could obtain the necessary approvals from his administration. His doubts soon proved unfounded, as the Turkish Ministry agreed to the proposal and within 24 hours had issued a special callsign for the event, YM75GP. This was truly a feather in the cap for the Turkish Ministry and the TRAC!

In Canberra, Ted approached the local District Radio inspector for approval of the Australian end. He received a verbal OK subject to a formal application. Ted also contacted another local amateur, Rob VK1KRM, and asked him if he could design and manufacture a two-way interface between the current loop telegraph line and an amateur transceiver. Rob agreed to do this and met with Ted at Questacon on Friday at 1230 hours to sort out what was needed. Ted then rapidly called together a small group of available people to complete the installation of the equipment and carry out the operation on the day.

On Saturday, 21 April, in Canberra, planning continued apace with much thought being given to suitable equipment, frequency bands and antennas, and particularly as to where things could be mounted or placed. Back in Turkey, Aziz had made a five-hour drive to Gallipoli only to find that he was not allowed into the area for the ceremonies! Things had been approved so quickly by his Ministry that word had not yet been given to the Turkish garrison commander at Gallipoli. Aziz had a cellular telephone in his car (the wonders of modern communications technology!!) and called back to Australia to let Bill Burch know of the problem. Unfortunately, due to the seven-hour time difference between Canberra and Gallipoli, it was 11pm at night in Canberra. Bill rang the Duty Officer at the Department of Foreign Affairs and, within 45 minutes, the problem was solved! Here, thanks must go to the Department of Foreign Affairs and the Turkish authorities for such prompt response.

During Sunday, Ted and the antenna

team started getting the parts of the TH6DXX antenna that was to be mounted on the roof of the Questacon/National Science and Technology Centre. This involved quite a logistical problem transporting the tower and all of the antenna components to the site and lifting them up the outside of the building five storeys onto the roof. Meanwhile, back at the 'ranch', Rob VK1KRM and Alan VK1WX had designed and prototyped the interface unit for the telegraph circuit and were constructing the unit to be used.

Installation

First thing Monday morning, Ted lodged the official application for the special operation with the District Radio Inspector and, within two hours, approval had been granted and a special call sign, VK75AZC, issued. A study of predicted propagation showed that the long path was preferred. The optimum frequency would be around 18 MHz. This was a little unfortunate, as the only suitable antenna available at such short notice was the TH6, and the closest bands that it would tune were 20, 15 and 10 metres. However, the predictions for 10 and 15 metres did not look too bad so, after some discussion with the Turkish amateurs, frequencies at 14 MHz, 21 MHz and 28 MHz were agreed upon, with 21 MHz to be the prime frequency. It now looked like all of the arrangements were com-

plete and the station could be set up in the Questacon building. The team members of George VK1GB, Rob VK1KRM, Alan VK1WX, Ian VK1IC, Ted VK1TH and John VK1ZX gathered with Ted at the building on the morning of Tuesday, 24 April. While Alan, Rob, Ian and George started installing the equipment inside, the other members, together with Questacon staff, began the task of manually lifting the tower and antenna up the side of the building with ropes.

The operating plan was to have two sessions of contact. During these sessions, greeting messages would be exchanged between people in Australia and at Gallipoli via the telegraph station at Alice Springs, the radio link from Canberra and the members of the TRAC in Turkey. The first session would take place at the time of the dawn service at Gallipoli. This would be 12.30pm Canberra time. The second session would occur during the main service in the mid-morning at Gallipoli, and this would be at 4.30pm Canberra time. In between the two sessions, the stations would maintain a general dialogue and would work other stations of opportunity around the world.

By afternoon, the equipment was ready and the antenna was sitting on top of the tower, fixed at a heading of 110 degrees, the long path to Turkey. The individual pieces of the station had been tested but, by closing time of Questacon on Tuesday

evening, there had not been time to finish connecting all of the equipment and carry out a complete test of the station. That would have to wait until the morning of ANZAC Day.

The station was set up next to the Canberra end of the Alice Springs telegraph line and consisted of two complete transceivers and linear amplifiers, so that a backup was immediately available in case of failure. The main transmitter was an ICOM IC751 with a COLLINS 30L-1 linear amplifier. The backup system consisted of an ICOM IC720A and an ICOM IC2KL linear amplifier. The operating transceiver was connected to the telegraph line interface unit and also to a PK232 PAK-RATT. The PAK-RATT was to decode both the transmitted and received CW signals and transfer the decoded information to a Toshiba laptop computer. This, in turn, was driving a colour LCD display on an overhead projector so the public could see the decoded CW signals. At the Turkish end, the main station was to be established at the Canakkale Martyr's Memorial, the main ceremonial site, and would be linked to the site at ANZAC Cove on two-metre VHF. This was because the ceremonies were to be conducted at sites a considerable distance apart and so the HF station would not have to be moved. (ANZAC Cove is approximately 20 kilometres north from the Canakkale Memorial site).

Operators

The persons chosen to operate the station for the ANZAC link were John Gore VK1PG and Alan Moore VK1AL. John is an ex-naval communications operator and has also worked in Antarctica with ANARE. Before his retirement, he was for some time a respected Radio Inspector for the ACT region. John has extensive experience in radio telegraphy and the hobby of amateur radio, and it was because of this background, and his naval service, that he was requested to be the operator for this operation. John used his personal 'bug' for the contact. Alan Moore VK1AL has been a telegraphy communicator for a number of years and is one of the 'Old Morsecodeians' who were involved in the recommissioning of the Alice Springs telegraph station. On the telegraph circuit, the operators at Alice Springs were John Houlder, Reg (Curley) Moger, Fred Ryan, Gordon Hill, Jeff Butterworth, Keith Drury and Ian Jordan. The telegraph operators at the Canberra end were Harry Taswell, Kevin Curtis, Bill Irvine, Frank Mike, Alan Moore and Leo McGarrigle.

Early on the morning of 25 April, ANZAC Day, the members of the group



VK75AZC group. Rear from left Ian VK1IC, Ted VK1AOP, Phil VK1PC, George VK1GB, Alan VK1WX. Seated John Gore VK1PG. Front From Left Alan VK1AL, Rob VK1KRM, Harry Taswell of the "Old Morsecodeians".

gathered at Questacon to make the final tests and be ready for operation by the time the Centre opened to the public at 10.00am. The telegraph crews already had the circuit to the Alice chattering as the first visitors entered the centre. Everything seemed to be going smoothly; there were no real problems. Could everything be going too smoothly? Was there something waiting in the wings to bring disaster to the plan? You bet there was!! It was just that 'Murphy' had not arrived yet! For this operation, 'Murphy' was going to be subtle. He was not going to interfere with the equipment; that was to perform perfectly the whole time. He was going to introduce problems far more profoundly subtle, affecting people around the world.

Problems

First, it was clear that propagation was not going to be as predicted. Although VK75AZC was able to contact stations in countries all around, and even in Turkey, we were not able to get through to YM75GP at Gallipoli. What we did not know at this stage was that 'Murphy' had also landed at Gallipoli. Due to a mix-up, Australian forces handling security at the ceremonial sites at Gallipoli had refused entry to the Turkish amateurs. By this time, amateurs around the world had heard the Canberra station trying to contact YM75GP and were offering assistance as relays. The prime frequency at 21 MHz was poor, and 14 MHz was tried. This was no better. 21 MHz was attempted again, unsuccessfully. Back to 14 MHz and a few questions to operators in the area surrounding Turkey: what was propagation on 10 metres like? "Not much better" came the reply. Back to 20 metres. 'Murphy' had done his job well! With the assistance of amateurs in Turkey, Yugoslavia, Italy, New Zealand, Britain and Russia, contact was made between VK75AZC and YM75GP, but it was very poor. In fact it was so poor that neither the PK232 nor the telegraph interface was able to decode the signals, but luckily the experienced ears of VK1AL and VK1PG were able to read the weak CW. Time was marching on and the appointed hour for the first 'official' contact was approaching.

When he learned of the access problem in Turkey (again via cellular phone) Bill Burch contacted the appropriate Australian personnel in Melbourne who were co-ordinating the Australian security. Eventually, word was passed to Turkey and a somewhat harassed Aziz and his team were permitted to set up their equipment just as the dawn service was beginning. Even though Aziz and his

team gained access to the site for the dawn service, the combination of the delay and the poor propagation meant that the planned passing of messages at that ceremony was unable to take place. However, as contact had been established between the two stations, even if somewhat poor, arrangements were made to exchange the messages at the later service.

The time of the dawn service had passed and, as 'Murphy' took a break, propagation improved. Communication between Turkey and Australia was quite good on 21 MHz, even good enough for voice contact. As planned, both stations took the opportunity to keep the frequency 'alive' and worked one another and other stations around the world. VK75AZC in Canberra worked stations in Europe, Asia, North America and Australia. It was very pleasing to note the high level of interest in this operation from stations all over the world and to be able to explain the meaning of ANZAC to them.

While all this activity was taking place, the public in the Questacon had an excellent demonstration of amateur radio contacting the world. Many of the team present acted as guest operators during this period and had some memorable contacts as they explained the purpose of the station. As time for the next 'official' contact approached, it appeared that 'Murphy' had come back from his break, as the propagation conditions began to get worse.

Messages

As 21 MHz began to deteriorate, 14 MHz was tried, but was even worse, so it was decided to go with 21 MHz for the contact at the main ceremony. This time, conditions were a little better than those for the earlier ceremony and, although the signals were too poor to properly operate both the telegraph line interface and the PK232, messages were exchanged. Two messages were sent from Australia to Gallipoli and one message sent back. When the messages were received at Gallipoli, Aziz notified the authorities that he had messages from Australia. He was then asked if he would personally deliver them to the addresses, and he said he would be proud to do so.

Bert Billings, the first Gallipoli radio operator, was to take part in the 75th ANZAC ceremonies in Turkey, but was unfortunately unable to do so because of ill health. He did, however, send a message from Melbourne to be transmitted to the site at Gallipoli, and this was one

of those that Aziz was pleased to deliver at the ceremony. The message from Bert read: "From the President and members of the Signals Association of Victoria and other states, a special goodwill greeting to all signals veterans on Gallipoli. Mr Bert Billings, who came ashore with the British forces on 25 April 1915, sends his very best wishes and regrets that he was not well enough to be with you." The message was signed by Colwill. A message was then received from Turkey, sending greetings and regards to Bert from the amateurs at Gallipoli.

In spite of 'Murphy' and the very little time available to set up, the operation was considered a success. A great deal of interest and co-operation was expressed and received from amateurs in Australia and around the world, to whom the team on the day expresses many thanks. Without the great help and co-operation of the Turkish Amateur Radio Society and the Turkish authorities, this international operation would not have been possible. Thanks must also be extended to the Departments of Transport and Communications and Foreign Affairs in Australia. Special thanks to Bill Burch and all personnel at Questacon/National Science and Technology Centre in Canberra, the Old Morsecodians, all of the VK1 amateurs, both at Questacon and elsewhere, and to members of the Australian Defence Forces, who all contributed to this re-enactment. Thanks as well to MLA Communications and 3M Company of Canberra for the loan of equipment used for the electronic display.

References:

1. Moyal, Ann, Clear Across Australia, Thomas Nelson Australia 1984, ISBN 0 17 006266 X
2. Harcourt, Edgar, Taming the Tyrant, The first one hundred years of Australia's international communication services, Allen & Unwin Australia Pty Ltd 1987, ISBN 0 04 994011 2
3. Gallipoli Task Force, GALLIPOLI 1990, pamphlet
4. Linton, Jim, The Last Wireless Anzac, Amateur Radio, April 1990, pp32-33, The Wireless Institute of Australia, Melbourne
5. Holst, Arnold, Wireless in the 1914/18 war, Amateur Radio, April 1990, pp34-36, The Wireless Institute of Australia, Melbourne.

Copyright of this article is retained by the author and the ACT Division of the Wireless Institute of Australia. This article may be freely distributed, provided the source is acknowledged in full.

ar



EMTRONICS

THE AUSTRALIAN RADIO COMMUNICATION CENTRE!

NEW EDL - 1000 DC-600 MHz up to 1000 watts

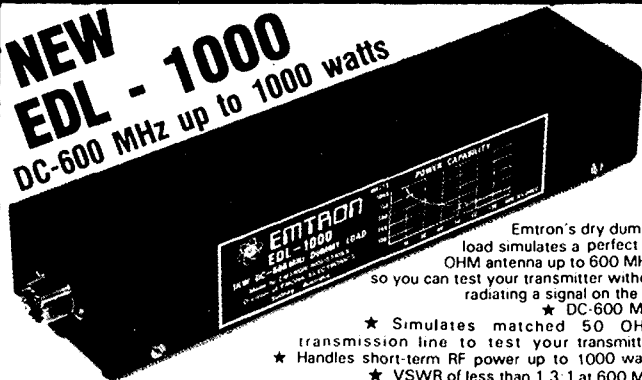

Emtron's dry dummy load simulates a perfect 50 OHM antenna up to 600 MHz, so you can test your transmitter without radiating a signal on the air.

- ★ DC-600 MHz
- ★ Simulates matched 50 OHM transmission line to test your transmitter.
- ★ Handles short-term RF power up to 1000 watts
- ★ VSWR of less than 1.3:1 at 600 MHz

NEW EMTRON EP-2000 Power Meter

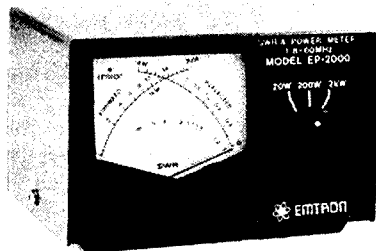

Yes, this new from EMTRON, highly-accurate CROSS-NEEDLE SWR and POWER meter, model EP-2000 with a frequency range from 1.8MHz to 60MHz and three power ranges 20, 200, 2000 watts gives instantaneous reading of forward/reverse power and SWR

ONLY \$110

1KW EMTRON TUNER EAT-1000A Only \$550



This new EAT-1000/A is EMTRON'S latest antenna tuner built on special request by many amateurs. Built with finest components available 5 position internal antenna switch, cross needle SWR/power meter, built in 3:1 balun for open feedline and antenna terminals for coax line, open feedline as well as longwire. EAT-1000/A will tune almost everything from 1.8 to 30 MHz. At lowest price professional design and quality that EMTRON provides. MADE IN AUST.

NEW 300W EMTRON TUNER EAT-300A Only \$369



The finest 300 watt antenna tuner on the market with quality that only EMTRON can provide! Unique features such as:

- Cross needle SW 12/forward & reverse power meter
- Built-in 100 watt dummy load
- Antenna switch including bypass
- Built-in 1:4 balun for open feedline
- Lowest price & professional design
- Matches everything from 1.8-30 MHz
- Made in Australia by Emtron

OVER 3000 FAMOUS EAT-300 SOLD

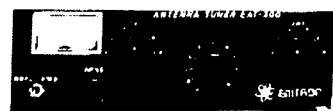

EMTRON'S fastest selling 300 watt antenna tuner with SWR meter, built-in 1:4 balun, heavy duty ceramic switch and top grade components. Works with all rigs and is found in Amateur, Commercial and Marine services.

Only \$259

EMTRON BALUNS WITH BUILT-IN LIGHTNING ARRESTOR

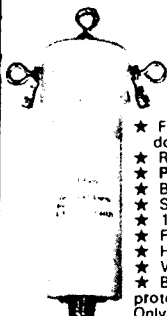

- ★ For dipoles, yagis, inverted vees and doublers
- ★ Replaces centre insulator
- ★ Puts power in antenna
- ★ Broadbanded 3-40 MHz.
- ★ Small, lightweight and weatherproof
- ★ 1:1 impedance ratio or 4:1
- ★ For full legal power and more
- ★ Helps eliminate TV
- ★ With SO 239 connector
- ★ Built-in DC ground helps protect against lightning

ANTENNA CENTRE INSULATOR

- ★ Small, rugged, lightweight, weatherproof
- ★ Replaces centre insulator
- ★ Handles full legal power and more
- ★ With SO 239 connector

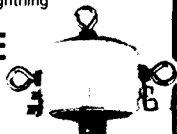

\$20

EMTRON'S HF SWR METER

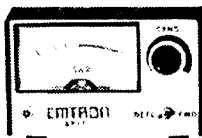

Specially designed with PRICE, QUALITY AND ECONOMY IN MIND. Freq range from 3.50 MHz. Reads forward and reflected relative power. Ideally suited for amateur and CB services.

\$59

EMTRON NOISE BRIDGE

ENB-2



Professionally made noise bridge for all kinds of RF measurements antenna adj, etc.

NOISE BRIDGE with EXPANDER EBN-2

\$129

NEW ED-52C ALL BAND WIRE TRAP ANTENNA

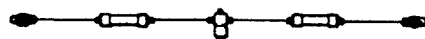

- Completely factory assembled ready to use
- Heavy 14 (7/22) gauge standard copper antenna wire to survive those severe storms.
- Centre fed tuned feedline supplied
- Only two traps
- Includes centre insulator with an eye hook for centre support.
- Includes custom insulators molded of top quality material with high dielectric qualities and excellent weatherability.
- Complete installation instructions included
- Overall length 33 mtrs less when erected as an inverted vee or sloper.
- Handles 2 kw PEP & covers 80 through 10 metres.

Only \$159

TELEREADER

Model CW-600 decoder
Model CWR-900 decoder

\$399 \$699

DIAMOND ANTENNA

DIAMOND ANTENNA:

- ★ D-130, 25 - 1300 MHz Discone.....\$139
- ★ D-707, 0.5 - 1500 MHz Active.....\$189
- ★ SG-2000 2m mobile 5.2 dB.....\$119
- ★ MA1500B 2m/70cm INCL G/GRIP.....\$139
- ★ X-500 2m/70cm, 8.3/11.7dB Base \$279
- ★ K-300 Gutter Mount.....\$49

SWR & POWER METERS:

- Revox W-560, 1.6-525MHz.....\$299
- Revox W-570, 1.6-1300MHz.....\$350
- Diamond SX-200 1.8-200MHz.....\$169

ANNOUNCING NEW EMTRON CROSS NEEDLE SWR/POWER METER MODEL EP270
140MHz to 500MHz in 2/20/200 WATT RANGE.

ICOM

Model	RRP	Sale Price
IC-751A	\$2439	\$2199
IC-735	\$1879	\$1779
IC-726	\$2013	\$1899
IC-471A	\$1800	\$1500
IC-2SAT	\$599	\$499
IC-4SAT	\$635	\$535
IC-4GAT	\$599	\$499
IC-u2AT	\$499	\$389
IC-u4AT	\$530	\$449
IC-32AT	\$873	\$773

KENWOOD

Model	RRP	Sale Price
TS-440S	\$2480	\$2399
TM-231A	\$598	\$545
TM-701	\$985	\$885
TM-45A	\$599	\$499
TH-25A	\$560	\$450
TL-922	\$3200	\$2999

VALVES

6146B	\$45	8950	\$39
6J56C	\$39	12BY7A	\$20
6KD6	\$39	6GK6	\$15
6LQ6	\$30	3-500Z	\$379
★ World Clocks	\$39		
★ Power Supplies			
7 amp	\$179		
11 amp	\$229		
★ Co-Ax Relays N Type Connectors	\$119		
★ BNC Connectors	\$99		
★ Electronic Morse Keyers			
KP 100	\$299		
KP 200 Memory	\$599		
★ Morse Tutors Datong	\$275		
★ Low Pass Filters 1.5kw	\$99		
★ Audio Filter from Datong	\$599		
★ Morse Keys	from \$55		
★ Co-axial switches Welx 2 pos'n	\$89		
★ Software for PK232 IBM incl Weather Fax	\$100		
Commodore 64 inc Weather Fax	\$150		
Macintosh	\$125		
★ Toroid Cores			
★ Co-Ax Cable			
★ Confidential Frequency Registers	\$20		
★ CB Radios	from \$39		
★ Lightning Surge Protectors	from \$2.50		
★ Insulators	from \$2.50		
★ Mobile Antennas	from \$20		

AEA

ISOPOLE — WORLD'S BEST VHF/UHF VERTICAL ANTENNA!

440
144
135-160
415-465
21 VSWR bandwidth
Power Rating
Gain
Repeating Element Length

> 12 MHz @ 146 MHz
1 kW
3 dBd
46 (1.2m)
125 S (3.2m)

IsoPole Specifications Model

PERTH-MELBOURNE-SYDNEY-BRISBANE

SR STANDARD

NEW TWIN BAND H/H TRANSCEIVER

(Not to be confused with other DUALBANDERS)

Standard have made it again! The C52B is the first H/H twin bander with completely independent functions. With incredible sensitivity of 0.16 UV for 12dB SINAD, it can also be used as a repeater on VHF/UHF band. Also covers cellular phone band 800-975 MHz for RX only.



FEATURES AT NO ADDITIONAL COST

- Simultaneous reception of two bands
- Simultaneous TX RX (FULL DUPLEX)
- Twin Frequency Display
- Twin 5 meter and other functions (squelch, busy scan etc)
- Band not being used may be switched off
- Independent controls (volume, squelch etc)
- Independent Audio output for VHF & UHF Band
- Dual monitoring of priority channels on UHF & VHF
- Built in DTMF for coded paging and squelch function
- Tone Squelch capability (optional)
- Handheld Repeater Operation
- 20 Channel Memory — Memory channels are included independently for VHF & UHF Band
- High RF Power output — SW on VHF & UHF with 13.8V DC
- Power Save Function
- Programmable offsets
- Various Scanning Modes
- High RX Sensitivity — 0.16 UV for 12 dB SINAD

Incl. Neck Pack Charger — **\$699**

NEW SR STANDARD

STANDARD INTRODUCE THE NEW C 150 ES

MINI, MINI 2 metre handheld with Maximum Performance. ONLY 55 mm wide & 31 mm deep. INCREDIBLE SENSITIVITY OF 0.16 UV for 12dB SINAD and 3 power ranges make it the most versatile compact 2 metre handheld on the market. Standard's super efficient design means much lower power consumption. Imagine less than 37 mA on Rx standby & less than 7mA with Power Save activated. That is design efficiency!

FEATURES AT NO ADDITIONAL COST

- Power 5 watts H.F. @ 13.8V
- Switchable power Ranges — low, medium, high
- High Sensitivity 0.16UV
- 20 memory channels
- Battery Saver
- Memory Scan
- Band Scan
- Splash proof
- Manual & direct channel selection
- Dual watch
- Multiple function keyboard
- Paging function
- S Meter

Write or call for a brochure or better still, call into one of our stores for a DEMO

SUPA VALUE PRICE \$399
incl. 700m Ah Nicad. Charger & DRY CELL BATTERY CASE

\$399

PLEASE COMPARE WITH ANY OTHER BRAND

SR STANDARD

NEW SPECTRUM SCANNER AX700E



The strange looking liquid crystal display not only shows the frequency, mode, channel and so on, it also displays the spectrum over a range of 150-250 or 1000 KHz. The vertical line on the left hand side of the display shows the signal strength and the horizontal line along the bottom is the frequency range. The freq. displayed at the top is the frequency at the centre of the line. Now comes the magic. Every time a signal comes up within the freq. range, it will show up as a spike on the display. The height will show the signal strength and the position will indicate the frequency. By moving the cursor to the desired spike or unknown signal, its exact frequency will be displayed. To receive the one signal, just press a button. It is possible to monitor visually more than 100 channels simultaneously.

FEATURES

- LARGE SIZE SPECTRUM DISPLAY
- FAST FREQUENCY SELECTION
- 100 CH MEMORY
- MULTIPLE SEARCH FUNCTIONS
- CONTINUOUS FREQ COVERAGE FROM 50-905 MHz
- MULTI MODE AM, FM, FM N
- MANY OTHER FEATURES

\$1050

\$899

HF TRANSCEIVER

JST-135 ONLY \$2376



The general coverage receiver front end offers variable tuning to enhance its dynamic range. Six interference rejection techniques including the newest notch follow filter, ensure high quality QSO's. The transmitter of heavy duty design uses a low distortion power amplifier to reduce the high order IMD and a specially constructed heat sink to enable continuous full power transmission.

The frequency synthesizer employs a one-chip direct synthesizer (DDS) ensuring high C/N and high speed response. The JST-135 is a sophisticated HF transceiver to meet your requirements for global DX communications.

FEATURES

- General Coverage Receiver
- All mode Operation
- Variable Tuning
- One-chip DDS IC
- Low Distortion Power Amplifier
- Complete Interference Rejection
- Fast Band Split (PDS)
- Noise Blanker (NB)
- Notch Filter (NOTCH)
- Bandwidth Control (BWC)
- Option
- Notch Follow Filter
- Option
- Exited Carrier Selectable Sideband (CSS)
- Option
- Full-Screen in CW Mode
- Easy to use Multi-function Display
- Complete Modular Design
- Transceiver Operation with the NRD-525
- Large Memory Capacity of 200 Channels
- Memory Scanning
- Digital Two W/D System with Equalization
- Highly stable Crystal Oscillator Rx — Option
- Remote Control from Personal Computer
- Option
- 10 150 W Continuously adjustable Output Power

JRC COMMUNICATIONS RECEIVER

NRD-525 ONLY \$1979



Following in the footsteps of the now famous '505' and '515', the NRD-525 offers a level of technology, performance and capability previously unavailable to listeners — at any price. If you could close your eyes and imagine the ultimate communications receiver, chances are it would come out looking much like the new JRC NRD-525! The high performance level for which JRC is famous is now coupled with the latest in advanced features.

FEATURES

- Wide frequency range
- Large Memory Capacity — 200 channels
- Scan Reception
- Sweep Reception
- Teletype Reception (optional)
- Electronic Tuning
- Direct Access Tuning
- Wide Dynamic Range
- Clock/timer
- Interface with P.C. (optional)
- Fully Solid State Modular Design

AOR AR3000 FROM LF TO MICROWAVE

100KHz 2036 MHz CONTINUOUS LF-MF-HF-VHF-UHF-SHF all mode AM—SSB-FM monitoring and surveillance

PROFESSIONAL RECEIVER



The AR3000 now extends your listening horizons further than anyone believed was possible. Covering the entire frequency spectrum from 1000KHz to 2036MHz without any gaps in the range. The AR3000 brings the general coverage receiver to a new level of performance and utility.

LIMITED STOCKS TO BE AVAILABLE

ONLY \$1650

Write for more info

NEW PK-232MBX With PakMail

A new software enhancement makes the AEA PK-232 the only amateur data controller to offer six transmit/receive modes in a single unit.

- Morse Code
- Baudot (RTTY)
- ASCII
- AMTOR
- Packet
- Weather FAX



WITH FAX Price \$640

PK-88 PACKET CONTROLLER

Your best choice for a packet only controller

Only \$299

ANTENNA ROTATORS

KEMPRO

KR-250	\$199
KR-400	\$379
KR-400RC	\$429
KR-500A	\$469
KR-5400B	\$799
KR-1000S	\$649
KR-2000	\$999

CREATE:

RC5-1	\$575
RC5A-3	\$1199
RC5B-3	\$1730

STAY BEARING:

KS-050	\$59
KS-065	\$79

Coax Cable RG-213 \$3.00/m
Coax Cable RG-58 \$1.00/m
Open feedline 450 OHM \$1.90/m

DON'T PAY \$599 YUPITERU MVT6000

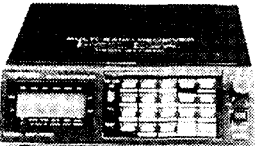

SCANNER FOR BASE/MOBILE 25-550/800-1300MHz

Only \$499

AR 1000 FROM HF TO MICROWAVE WITH 1000 MEMORY CHANNELS 8MHz-13GHz, AM-FM (M-FM) (W)

FEATURES:

- Ultra Wide Frequency Coverage
- Multiple programable search limits
- CPU controlled
- Multiple power sources AR 1000 can be operated from AA size x 4pcs Ni-Cad batteries (standard), optional AA size x 4pcs of dry cell batteries. Mable charger and AC DC charger are standard accessories
- Permanent memory back up

SPECIFICATION

Frequency Coverage: Sensitivity Scanning Speeds Audio output: Size: 70(W) x 170(H) x 39 (D) mm. Weight: 8600mhz/805 1300mhz NFM 0.5uV @ 12dB SINAD W FM 1.0uV @ 12dB SINAD AM 1.0uV @ 10dB S/N. Minimum 20 channels/second 130mhz into 8 others 10% THD 70(W) x 170(H) x 39 (D) mm. 370 grams without antenna.

Only \$549 \$499

WHY PAY MORE FOR LESS

BANKCARD MASTERCARD & VISA

NSW & HEAD OFFICE:

92-94 Wentworth Ave, Sydney NSW 2000. TLX: AA73900
P.O. Box K21 Haymarket, NSW 2000
Ph: (02) 211 0988
Fax: (02) 281 1508

VICTORIA

288-294 Queen St, Melbourne Vic. 3008
Entrance from Lt. Lonsdale St.
Ph: (03) 670 8551 or 670 0330
Fax: (03) 670 0671

QUEENSLAND

416 Logan Rd, Stones Corner Qld. 4210
Ph: (07) 394 2555
Fax: (07) 394 4316

WESTERN AUSTRALIA

336 Albany Highway Victoria Park, WA 6100
Ph: (09) 470 1118
Fax: (09) 472 3795

EMTRONICS

MAIL ORDERS WELCOME

ANZAC DAY 1990 — THE VITAL ZL LINK

IVOR STAFFORD VK3XB
16 BYRON ST
BOX HILL SOUTH 3128

The special Turkish amateur station, YM75GP, was on the air from the Gallipoli Peninsula, operating on CW on a frequency of 14040 kHz before 8am eastern Australian time on 25 April, calling "CQ VK/ZL", but the signal was not strong. ZL1AW made contact, but repeated replies from VK3XB were not answered. The Turkish station, after contacting many European and USA callers, faded out.

However, at 12.30pm EAST, the signal was again heard on CW, coming through weakly, but rising in strength. VK75AZC, operated by John Gore VK1PG, ex-RAN, was on frequency, as were also ZL1AW and VK3XB. But John had poor propagation. At 1.40pm, two official messages, one originated by the President of the Signals Association of Victoria, Brigadier Colwill, were passed to VK3XB and ZL1AW for possible relay to the Turkish station. ZL1AW had propagation to Gallipoli, and in a short time the messages were successfully passed by that operator. Texts of the messages were:

"Nr 1. From the President and members of the Signals Association of Victoria and other States, a special goodwill greeting to all signals veterans on Gallipoli. Bert Billings, who came ashore with the British Forces on 25 April 1915, sends his very best wishes and regrets he was not well enough to be with you. Colwill."

"Nr 2. Goodwill greetings to all signals veterans at Gallipoli from Col Bernie Odey, Director Army Signals, and all members of the Corps of Signals."

By 3pm EAST, propagation on 14 MHz was good to VK, and contacts on CW with the Gallipoli station were made by

VK75AZC, VK3KS, VK3XB, VK1AU and others. On CW, VK75AZC received two messages from Anzac Cove as follows:

"QTC No 1. From the President of TRAC in (sic) behalf of all Turkish amateurs, special greetings to all Australian and New Zealand amateurs from Gallipoli. Please greetings also to Bert Billings and all veterans from us. Unfortunately, conditions not favourable for VK1. We will be QRX for QAP and will QSP QTCs to Ceremony HQ 73."

"QTC No 2. From TRAC HQ your QTC No 1 delivered to press office on time 0427 GMT."

As 0427 GMT was 2.27pm EAST, it will be seen that the Turkish operators were very quick in forwarding the message to the news media.

Some efforts were made at contacts on 20 metres SSB but were spoilt by heavy interference. But, by 4pm EAST, conditions on 21 MHz were good and YM75GP appeared on 21160 kHz on SSB. Contacts were now quickly made with the VK1 Division office bearers, after which a pile-up developed and a number of Australian amateurs made contact.

All in all, the operation was a great success, particularly with regard to the message handled, once again demonstrating the superiority of CW over Phone in difficult conditions.

It is a pity that no New Zealand special station appeared, but ZL1AW should be thanked for his part in the operation.

Congratulations should be extended to the VK1 members who worked so hard to set up the equipment.

The Turkish operators were very good telegraphists, and John operated VK75AZC in the manner befitting an ex-RAN signaller. ar

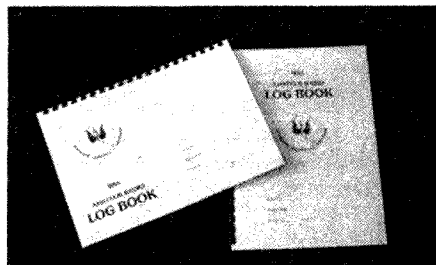

New WIA logbooks available now

at your Divisional Bookshop

These quality logbooks are available in A4 format with plastic spiral binding so the book will open and lie flat on the bench.

VERTICAL OR HORIZONTAL column layout is optional, with the traditional column headings

Price is \$5.00 each plus post and packing where applicable

A Call to all Holders of a Novice Licence

Now you have joined the ranks of amateur radio, why not extend your activities?

The Wireless Institute of Australia (N.S.W. Division) conducts a Bridging Correspondence Course for the AOCF and LAOCF Examinations.

Throughout the Course, your papers are checked and commented upon to lead you to a successful conclusion.

For further details write to:

The Course Supervisor
WIA
PO Box 1066
Parramatta NSW 2124
(109 Wigram Street, Parramatta)
Phone: (02) 689 2417

11am to 2pm Monday to Friday
7 to 9pm Wednesday

REPEATERS — ADDITIONS, DELETIONS, ALTERATIONS.

HAVE YOU ADVISED THE WIA OF CHANGES NEEDED
TO THE REPEATER LIST?

THIRTY THIRD JOTA

OCT 20/21 1990

PETER HUGHES VK6HU
NATIONAL CO-ORDINATOR FOR JOTA
58 PRESTON ST COMO 6152

Jamboree-on-the-Air has grown to the point of being quite inevitable, like death and taxes — although much more enjoyable.

Initial promotion for 1990 has gone out to Scouts and Guides, so operators might expect a call from a bright-eyed youngster (or just-as-keen leader) any time now with a request for assistance with operation for 'JOTA'. Last year, Australia reported 1416 callsigns involved at 683 stations over the weekend and, since most of these have participated before, many for many times, it must be a lot of fun for them.

Participation is entirely at the discretion of the amateur in the shack or elsewhere. While it is theoretically possible for one to operate the whole 48 hours, it is quite impracticable, so the field station is popular with a number of operators on roster — and many Scouts and/or Guides able to take part. Such portable stations may be in a hall or at camp (for the very keen). These stations are useful for first-time operators, those without their own equipment or who want to try HF operation. Their assistance is very welcome. Times of operation and numbers at the operating position at any time are the sole prerogative of the operator.

Any activity away from the 'shack' will be under the control of a Scout or Guide leader. The amateur operator has more than enough to do to optimise contacts, and has no responsibility for the young people. **IF NO LEADER IS PRESENT AND IN CONTROL, THE STATION SHOULD BE CLOSED DOWN — FOR THE AMATEUR'S PROTECTION.** In the shack with three to six visitors, one of those will be in charge as a Patrol Leader (or acting).

Participation is easy. The only 'rules' are the time, from 0001 hours on the Saturday, to 2400 hours on the Sunday LOCAL TIME, and that operation must be within the licence which the station is using. If operating a Scout or Guide callsign, remember to keep a log as these are 'club' calls. The movements must report their efforts on their own special log/report form within two weeks, and may need assistance in maintaining a running log during operation.

Much better results are achieved if your visitors are pre-trained in micro-

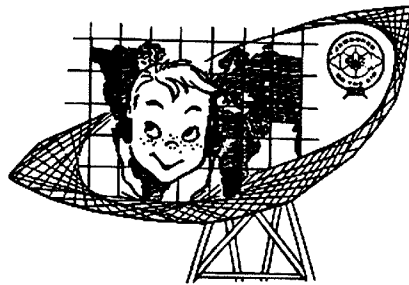

The 1990 JOTA Logo is based on a design from the Localidad Scout de Latacunga, Ecuador. It expresses very well the theme for the 33rd JOTA: "Listen to the World"

phone technique, operating procedure, the vagaries of propagation and the amateur service. They should have a copy of the phonetics and a translation of the Q code with them. A couple of nights talking to them with some practice on a tape recorder and perhaps use of a receiver to demonstrate the sounds of the signals would be very useful.

Those responsible for the running of JOTA in 1990 are:

Scout National JOTA Co-ordinator:

Peter Hughes VK6HU
58 Preston St
COMO WA 6152
(H) (09) 367 1740
(W) (09) 450 4722

National Guide Radio Activities Consultant (and Tasmania):

Miss Sue Wyatt VK7NRG
3/1 River Rd
BELLERIVE Tasmania 7015
(H) (002) 44 6604

Scout Branch Organisers:

Mr Chris Dennys
73 Hemmings St
RICHARDSON ACT 2905
(H) (06) 291 9029

Mr Bob Demkiw VK2ENU
18 Ettalong Pl
WOODBINE NSW 2560

Mr Arthur Gough

30 Stapley Cr
CHADSTONE VIC 3148
(H) (03) 569 8344

Mr Greg Eaves
PO Box 520
TOOWONG QLD 4066
(H) (07) 262 5829

Mr Peter Koen
27 Hoskin Ave
KIDMAN PARK South Aust 5025
(H) (08) 356 6990
(W) (08) 353 8398

Mr Les Ball VK6AN
20 High Rd
MARMION WA 6020
(W) (09) 382 9111

Mr Mike Wilson VK7ZWW
23 McCann Cr
LENAH VALLEY TAS 7008
(H) (002) 28 1942
(W) (002) 23 3499 (W) (002) 20 8096

Mr Frank Turnham VK8FT
PO Box 38266
WINNELLIE NT 0821
(H) (089) 27 6275
(W) (089) 89 1322

Guide Radio Activities Consultants:

Mrs Faye McBryde
23 Maralinga Ave
ELANORA HEIGHTS NSW 2101
(H) (02) 913 3273

Mrs Alma Brand
100 Marianne Way
MT WAVERLEY Victoria 3149

Mrs Christine Ashdown VK4KCA
37-37 Steven St
CAMIRA Queensland 4300
(H) (07) 288 3316

Mrs Viv Bing
229 Wright Rd
VALLEY VIEW South Aust 5093

Radio Activities Consultant

Girl Guide Assoc WA Inc
PO Box 6089
EAST PERTH WA 6004

Any queries will be welcomed and willingly answered on the Weekly National Scout Net from VK6SAN on Sundays.

ar

THE SINGAPORE SEANET OF 1989

DAVID RANKIN 9V1RH/VK3QV

Last year, 'Amateur Radio' carried some news of SEAnet and the SEAnet Convention from time to time.

Well, SEAnet '89 has now come and gone. It was the 17th meeting of interested amateurs and friends and was held in Singapore over the weekend of 17 to 19 November.

The host was the IARU member society — SARTS — Singapore Amateur Radio Transmitting society — and the organising committee chaired by Selva 9V1UV had planned events to keep all attendees busy for over two days.

Chief guest at the opening buffet dinner on Friday evening was the Minister of State for Education, Dr Tay Eng Soon. After his address, Dr Tay kindly started off the evening's SEAnet call-up via a special VHF link set up between the dining room and the HF transmitter room upstairs. 9V0SEA then proceeded to call SEAnet to order in the usual way.

By special permission of Singapore Telecoms, three stations were set up for the convention. 9V1ES operated on 50 MHz (from 12 to 19 November) whilst two other stations operated on the HF bands under the call 9V0SEA. Of especial interest to 9V1 amateurs was permission to use a modified TS950 — Kenwood's latest offering in the top-end market. Also, and again through the special permission of Telecoms, overseas amateurs who met the necessary criteria were permitted to operate using their own call signs — 9V0/JA0AD etc. This facility was particularly popular with a number of the Japanese delegates.

Bob Knowles ZL1BAD/ZL6IW, the international co-ordinator of IARU/MS, was present on holiday, both renewing old friendship and forging new ones, particularly where people showed interest in the work of the Monitoring Service, as did one or two members of SARTS. This interest may develop into participation.

The two full days, apart from the opening dinner, included a trip to the Singapore Telecoms to learn of the unique Singapore system of viewdata, called 'Televue', and then to the home of 9V1SC, the Singapore Science Centre, to see a rare exhibition of dinosaurs and an omnimax film. On Sunday morning, three invited technical papers were presented by such well-known and respected amateurs as Colin Richards 9M2CR, Peter Williams ZL2ARW and Dan Nelson 9V1SS/K6VKY.

Colin spoke on the history of amateur satellites, whilst Peter described the technical intricacies of the New Zealand National Link. It is an ambitious scheme involving repeaters up and down the length and breadth of New Zealand and involving frequencies in the 144, 432 and 1296MHz bands. The third presentation by Dan Nelson was on VHF propagation in the tropics and stirred up considerable interest amongst attendees.

Over 150 amateurs, wives and SWLs registered, with 15 different countries being represented. The biggest group from overseas was from Japan, with 26. There were 24 from Thailand, 13 from Malaysia, 11 from New Zealand and nine from Australia. There was even one from

Mexico and another from Germany. But, of course, the biggest contingent was from Singapore, with a total of 34 amateurs and friends enjoying the good company of overseas visitors.

The weather was kind to us for the weekend, but the propagation on six metres was a little disappointing. Many, many JA stations were worked but only a few VKs made the grade with 9V1ES. One W7 was heard, but no QSO made. Maybe the 10 Watts and fixed frequency limitations were too much. Hopefully, there will be another opportunity in the future.

The final item of formal work was consideration of the data and venue of the next, the 18th, SEAnet Convention. The IARU Society for Malaysia, MARTS, through its secretary, Sangat Singh 9M2SS, was the only society to bid for this honour, and the meeting accepted the offer with applause.

Tentative arrangements for SEAnet '90 are now firming up and MARTS has decided the venue will be in Kuching, Sarawak over the weekend of 9 to 11 November 1990. This information, when confirmed, will be circulated to all interested parties via the usual channels.

SEAnet continues to operate on 14320 kHz +/- QRM every evening at 1200 hrs Z with rostered net control stations — NCS — such as Paddy 4S7PB, Kevin 9M2ZZ, Hassan V85HG, Ben VK6XC and HS1BV on hand to keep matters running smoothly. Join us on the air sometime and then plan on being in Malaysia next November for an in-person meeting. After all, 1990 is 'Visit Malaysia Year'. **ar**

The Perceptions of a Couple of Visitors

BY KEN PINCOTT VK3AFJ & XYL

David 9V1RH/VK3QV has invited us to add our 'perceptions of our visit to Singapore and SEAnet '89' to his account.

To be fair, as our perceptions may seem biased, a little background history should be given.

We had been debating the pros and cons of visiting Singapore SEAnet '89 for several months, but kept delaying a decision as we were building a new house. Eventually, and almost at the last minute, we decided to go.

It was past the deadline for the Sin-

gapore people to arrange our accommodation, but we were lucky enough to make suitable arrangements in Melbourne.

Singapore is our favourite holiday resort. On previous visits we have seen most things on the list of tourist attractions and, thanks to some very good friends in the local community, many that are not. Consequently, we wanted more time than just the few days of the convention to enable us to visit these friends.

We were able to organise a full week in Singapore before the convention, and a

few extra days afterwards, so were able to spend time with our friends and (sadly for the bank balance) a couple of days' shopping!

Our perceptions of Singapore are, of course, now based on more than one visit, but to us several aspects always stand out. It is, without a doubt, the cleanest city we have visited. Public transport is fast and efficient and, above all, clean. It is a real pleasure to use a train that is spotlessly clean — no slashed seats and no graffiti. Bus and train fares are very reasonable. For those with any doubts

about using public transport, there are 10,000 taxis in Singapore, and the rates are quite low, but you may have to queue to get one.

Food is no problem. All tastes are catered for. Prices vary depending on where one eats, from very low to high, but you can eat very well without straining the budget.

The people are very friendly and helpful and nearly all are fluent in English. But this does not always apply to taxi drivers. It seems they can read it — they have to, as street signs are in English — but many of them have trouble understanding and speaking English.

Shop assistants, on the other hand, have no trouble with English. Shopping is almost a must in Singapore, although things are not as cheap now as a couple of years back.

Whilst on the topic of shops, I must refer to the letter from Barry McNeil VK2FP in February's Amateur Radio. We have been into virtually every shopping complex in Singapore and doubt if we have seen more than 50 hand-helds.

Hand-helds, even for licensed amateurs, are illegal. The 144-148MHz band is strictly monitored by the authorities. The shopkeepers are well aware of the situation, and most require a prospective purchaser to show a passport before they will sell to him. Law-breakers in Singapore are not treated lightly. In Indonesia, the situation may be different.

On the subject of law, very few police officers are seen. We have walked around Singapore at midnight without any problems, and not a single officer in sight. There is no way we would do that in any Australian town or city.

From the foregoing, our perceptions of Singapore should be quite clear. What about the SEAnet '89 Convention?

We have here a major convention organised by what is probably one of the smallest societies in the IARU, and all goes with barely a 'hiccough'. It was a really outstanding effort, and the members of SARTS can rightfully be proud of their efforts. Some of them worked unbelievably long hours on the project, and whoever organises the next convention

has a very difficult act to follow.

Right from the beginning, starting with registration on arrival, everything possible was done to ensure an enjoyable time. No mean achievement, considering the varying backgrounds and languages of those participating. How one Australian with no Japanese and two Japanese with no English managed by means of signs and laughter to convey their ideas to each other over two days will forever remain one of life's mysteries. Perhaps being females had something to do with it.

Of course, being in Singapore, eating, which appears to be a national pastime, took up a great deal of time. In a country where a snack resembles a meal, a buffet dinner one night followed by a banquet the next defies description.

Somehow, other activities as mentioned by David, were slotted in, giving us all a very exciting and full weekend; one we will always remember.

Hopefully the 'piggy-bank' will be replenished in time for SEAnet '90, where we hope to see you. **ar**

VK QSL BUREAUX

The official list of VK QSL Bureau. All are Inwards and Outwards unless otherwise stated.

- VK1 GPO Box 600 CANBERRA ACT 2601
- VK2 PO Box 73 TERALBA NSW 2284
- VK3 Inwards — GPO Box 757G MELBOURNE VIC 3001
Outwards — 38 Taylor St ASHBURTON VIC 3147
- VK4 GPO Box 638 BRISBANE OLD 4001
- VK5 PO Box 10092 Gouger St ADELAIDE SA 5000
- VK6 GPO Box F319 PERTH WA 6001
- VK7 GPO Box 371D HOBART TAS 7001
- VK8 C/o H G Andersson VK8HA Box 1418 DARWIN NT 0800
- VK9/VK0 C/o Neil Penfold VK6NE 2 Moss Court KINGSLEY WA 6026

Missing Wireless Set 109

The School of Signals Museum, Simpson Barracks, Watsonia, has an almost complete collection of WW2 wireless equipment. One notable absentee is the 109 set. Do you know where one may be located? Jim Payne VK3AZT QTHR is very keen to obtain one to complete the collection.

Vicki Griffin VK3LT, our draftsperson for AR, gave birth to a baby daughter Nicole Ellen on 27/7/90, weight 6lb 12 oz (3.07kg). Father is John VK3CU. Both are well. We trust Vicki will be back at the drawing board soon!

ANTENNAS & ACCESSORIES

We manufacture a comprehensive range of HF, VHF and UHF antennas, baluns, power dividers etc to suit your application. Three of our log periodics provide continuous coverage from 1.3-30 MHz including WARC frequencies, and replace outdated tri-banders. Now in use in 24 overseas countries and 6 continents.

- CREATE ROTATORS, COAX CABLES & NON-CONDUCTING GUY HALYARD MATERIALS
- COMPLETE RANGE MIRAGE (USA) 5-YR WARRANTY 6M, 2M, 70CM AMPS & WATT SWR METERS
- HARD-DRAWN ANTENNA WIRE
- AUST/NZ DISTRIBUTOR FOR CREATE ANTENNAS/ROTATORS & PHYLSTRAN (KEVLAR) NON-CONDUCTING GUYING
- MATERIALS
- HIGH GAIN VHF & UHF AMATEUR, SCANNING & TV ANTENNAS
- BUTT SECTION TRIANGULAR ALUMIN IUM TOWERS FOR FIXED OR TILT-OVER APPLICATIONS (REFER MARCH/APRIL 1987 AR)
- SELECTION OF POWER CHIPS AT FRIENDLY PRICES
- VSWR/PWR METERS TO 1300MHZ

Write or phone for free catalogue

ATN ANTENNAS

56 Campbell Street
Birchip Vic 3483
Phone: (054) 92 2224
Fax: (054) 92 2666

TRANSCEIVER SAVING!

BEST EVER DEALS!

2 year warranty

FT-212RH MOBILE TRANSCEIVER

Enjoy the performance that the latest refinements in microprocessor control have to offer with the FT-212RH 2 metre FM transceiver. With 45 watts output over the 144-148MHz range, a rugged diecast chassis for superb RF isolation, extensive use of surface mount components, and a large back-lit LCD with bargraph PO/S-meter, the FT-212RH is an ideal mobile transceiver that also doubles as an easy to use base station. Operating features include 5 selectable tuning steps, a total of 21 memories (18 general purpose, one CALL- channel, and 2 sub-band limit memories for band scanning), in-built C.T.C.S.S. encode, as well as a variety of scanning functions. The FT-212RH comes with a mobile mounting bracket, convenient MH-14A8 microphone, and DC power lead.



\$539
Cat D-3494

CLEARANCE PRICE!

Limited Stocks of the DVS-1 Digital Voice Recording module to suit the FT-212RH are still available!

Cat D-3497

Only **\$99**



2 year warranty

ALL MODE TRANSPORTABLE TRANSCEIVERS

The all-mode, transportable transceiver for serious field or mobile operations! The FT-290RII and FT-690RII feature FM, SSB (USB/LSB), and CW operation with 2.5W or 250mW switchable output power, twin VFOs, and 10 memories that store mode and simplex or repeater frequencies. Selectable tuning rates are provided for SSB/CW and FM (SSB- 25/100/2500Hz and 100kHz; FM- 5/10/20kHz and 1MHz), while mode specific features such as a noise blanker and clarifier control for SSB/CW, plus a full set of functions for FM repeater operation make these units very simple to operate. Each unit comes with an FBA-8 battery holder which takes nine C size standard or NiCad batteries (not supplied), antenna, and handheld microphone.

FT-290RII with flexible rubber antenna covers 144-148MHz.

Cat D-2875

Save \$50!

CLEARANCE PRICE! Save \$100!

FT-690RII with telescopic whip antenna covers 50-54MHz.

Cat D-2874

Only **\$699**

Now
\$749



Our Best Price Ever!

FT747GX HF TRANSCEIVER

Now is the time to enjoy the excellent HF band conditions with Australia's best value entry level HF transceiver! The FT-747GX is a compact SSB/CW/AM and (optional) FM transceiver that provides 100 watts P.E.P. output on the 1.8-30MHz Amateur bands, and general coverage reception from 100kHz to 30MHz. It features a front panel mounted speaker, a large backlit LCD display, dual selectable tuning steps for each mode, dual VFOs for split frequency operation, and 20 memory channels. A wideband 6kHz AM, and narrow 500Hz CW crystal filter are fitted as a standard feature, and an MH-1 hand mic is also supplied.

Cat D-2930



2 year warranty

\$1099

2 Year Warranty!

FT-767GX TRANSCEIVER

Our best deal ever! The FT767GX is the ONLY transceiver that offers such a high level of performance on all HF amateur bands, as well as on the 6m, 2m, and 70cm bands. Features include all amateur band coverage from 1.8 to 440MHz (100W max HF, 10W max VHF/UHF), all mode operation on all bands (SSB, CW, AM, FM, FSK), HF receiver covering 100kHz to 30MHz with up to 104dB dynamic range, inbuilt AC power supply, inbuilt automatic HF antenna tuner, digital wattmeter and auto-calculating SWR meter. Also includes bonus hand-held MH-1 microphone.

Cat D-2935

HF, 6M, 2M, 70CM



\$3295

Our Most Rugged HF Mobile Transceiver!

FT-757GX II ALL MODE COMPUTER AIDED TRANSCEIVER

Ready for action! Whether in a demanding H.F. mobile situation, or at home in the shack, the FT-757GX II won't let you down. Based on it's popular predecessor, the new MK2 features the heavy duty die-cast heatsink and rugged metal chassis of the earlier 757GX, but has been substantially upgraded to offer a number of new features. These include...

- All mode operation - SSB, CW, AM, FM, (160m - 10m)
- 100 watt output on SSB, CW, FM (25W AM) at 100% duty cycle
- High performance general coverage receiver - 150kHz to 30MHz
- Dual VFO's with single button VFO/memory swap functions
- Memories store freq and mode, plus allow band scanning between adjacent memories
- Inbuilt 600Hz CW filter, IF shift and IF notch filters, variable noise blanker, Speech Processor, iambic CW keyer, and SWR meter.

Cat D-3492

2 Year Warranty

* Yaesu stocks not held at all stores; please call your local store for details.

Only
\$1595
Limited Stocks!



DICK SMITH ELECTRONICS

NSW • Albany 21 8399 • Bankstown Square 707 4888 • Blacktown 671 7722 • Brookvale 905 0441 • Bundoora 387 1444 • Campbelltown 27 2199 • Chubbuck Chase 411 1955 • Chubbuck Chase 642 8922 • Coffs Harbour 439 5311 • Coffs Harbour 25 0235 • Coffs Harbour 477 6633 • Hurstville 580 8622 • Kotara 56 2092 • Liverpool 600 9888 • Maitland 33 7866 • Murrumbidgee 525 2722 • Newcastle 61 1896 • North Ryde 878 3855 • Parramatta 989 2188 • Penrith 32 3400 • Railway Square 211 3777 • Sydney City 267 9111 • Tamworth 66 1711 • Wollongong 28 3800 • ACT • Belconnen (06) 253 1785 • Fyshwick 80 4944 • VIC • Rialto 31 5433 • Werribee 43 8522 • Werribee 43 0388 • Box Hill 890 0699 • Coburg 383 4455 • Diamond Creek 794 9377 • Footscray 592 2366 • Essendon 379 7444 • Footscray 689 2055 • Frankston 783 9144 • Geelong 232 711 • Melbourne City 399 Elizabeth St 326 6088 and 746 Bourke St 639 0396 • Melbourne 428 1614 • Ringwood 879 5338 • Springvale 547 0522 • QLD • Brisbane City 229 9377 • Brisbane 391 6233 • Cairns 311 515 • Chermerside 359 6255 • Redbank 288 5599 • Rockhampton 27 9644 • St. Lawrence 32 9033 • Townsville 38 4300 • Townsville 72 5722 • Underwood 341 0844 • SA • Adelaide 223 4122 • Adelaide 347 1900 • Elizabeth 255 6099 • Enfield 260 6088 • St. Marys 277 8977 • WA • Perth 451 8666 • Perth 335 9733 • Perth City 481 3261 • Maitland 250 1460 • Northside 329 6044 • TAS • Hobart 31 0800 • NT • Stuart Park 81 1977

ORDER BY PHONE OUTSIDE SYDNEY (008) 226810 Free Call Sydney Area 888 2105

B1013/MS

PROFILE OF A NET CONTROLLER

THE ANZA NET IS 20 YEARS OLD

STEPHEN PALL
VK2PS
PO Box 93
DURAL NSW 2158

On every day of the week, at 0500 UTC time, an elderly gentleman, known among amateurs as 'Percy', sits at his transmitting station in Southern Queensland. His transmitter is tuned to the frequency of 21205 KHz, and he starts his regular afternoon session by announcing the following:

"This is VK4CPA, net controller for the ANZA net. My name is Percy. Any check-ins for the ANZA Net?" The reply is almost instantaneous. Amateurs in USA, Central and South America, the Pacific area, Indonesia, South East Asia, many African countries, often from Europe and, naturally, from Australia and New Zealand, respond. They all want to check in into the net, they all want to be part of a friendly get-together for a few hours. After about 10 minutes, a list of 50, 70, sometimes even more callsigns emerges, representing many nationalities with many accents, eager to talk to each other or to have a brief chat and to exchange signal reports, or talk about the weather, under the guidance of the net controller: Percy Anderson VK4CPA, who has been controlling the ANZA net for the past 20 years.

Let's have a brief look at this remarkable gentleman of the 'radio waves'. Who is he?

Percy is from Victoria and he lived the very great part of his life there. When he was attending West Melbourne Technical School in 1922, he became interested in what was then called 'wireless'. A group of wireless enthusiasts had the use of a room where they left some of their equipment, receivers of some crystal types and also some valve types. At lunchtime, young Percy would peer through the glass panels of the door leading to the room, whilst munching his sandwiches. The sight of those 'wireless things' had fascinated him, so he had to do something about it. A friend told him how to build a crystal set and he became an avid broadcast listener. This incident in 1922, when many of us who read this magazine were not yet born, started Percy on a career of electronics and the hobby of amateur radio. In 1926, Percy started to collect QSL cards from the broadcast stations

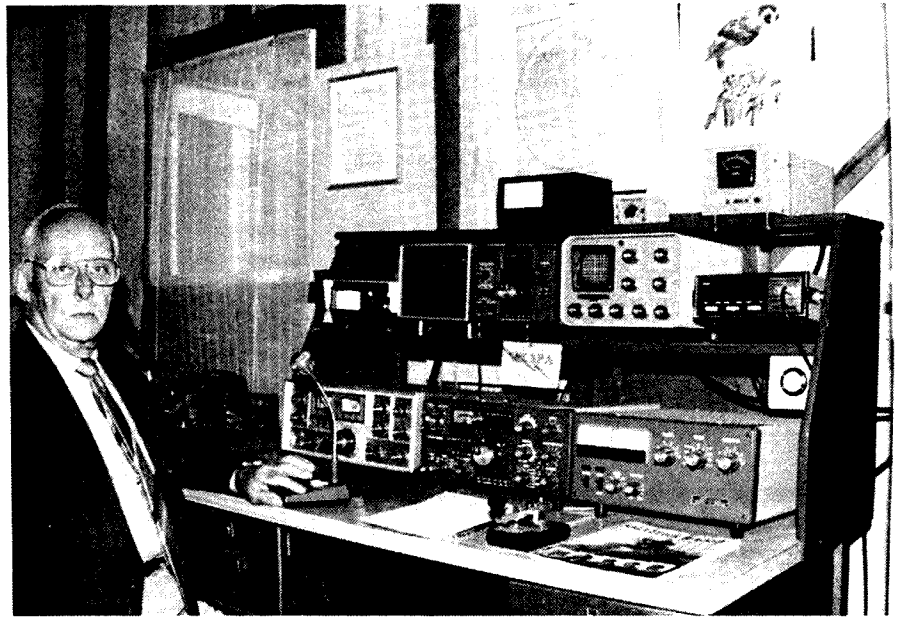

Percy and his station as VK3PA a few years ago in Wallington near Geelong, Victoria

and amateurs. In 1927, he had built his first shortwave receiver and listened to overseas shortwave broadcasts, including some of the first broadcasts from KDKA in the USA, somewhere around 80 metres.

The next year, 1928, saw Percy as a fully licensed amateur, using a simple CW transmitter and the callsign of OA3PA, later to be changed to VK3PA with the new prefix allocation for Australia. He worked a lot of crossband, as USA stations were on 7 MHz and we were on 10 MHz. Yes, we had the use of that band at that time, then we lost it for many years, until it was given back to amateurs in a modified version after the 1979 WARC session.

In 1931, Percy was active already on 'five metres' working local stations. He was also active in the broadcast band, playing music during the hours they were permitted to do so up to the outbreak of World War II.

War came. Percy was first on the RAAF reserve, then he was called up for active service in July 1940. He was posted to No 2 Squadron, then to the instructional

staff, and was also in charge of equipment maintenance. By this time he was a qualified radio operator on air and ground equipment, and a qualified aircraft electrician.

After the war, Percy joined the commercial world of radio. He was with the Australian Broadcasting Commission where he became a Senior Technical Officer and was located at a large country broadcast station where he remained until his retirement.

End of 1945 saw the recommencement of postwar amateur radio with crystal-controlled transmitters. All the equipment used by Percy was home-brew, including beam antennas. He purchased his first commercially built set in June 1968.

Percy joined the Pacific DX Net in 1970 and, in 1972, he became net controller, on 14265 kHz for 10 years, after which the net faded out due to lack of controllers. The ANZA Net was Percy's idea. (Meaning Australia, New Zealand and Africa Net). The net's first operational day was on 20 May 1970 on 21300 kHz. Later it

Continued on page 55

A HOME BREW VNG ANNOUNCEMENT

MARION LEIBA VK1VNG, VK1BNG
HONORARY SECRETARY, VNG USERS CONSORTIUM
26 FIMISTER CIRCUIT, KAMBAH, ACT 2902.

It's 7.30pm on 2 June at the VK1VNG/BNG QTH. The dishes have been cleared away and the washing up done. The family retreats to the rear of the house to watch TV and leave us to our misery.

Graham Conolly VK2BL disappears briefly into the Canberra winter night to raid the boot of his car, and comes back with chattering teeth, a cassette tape recorder, stereo microphones and a variety of leads. With some trepidation, I lift the cartridge recording machine from its box and place it on the end of the kitchen table. We'll have to learn to drive it later tonight (thank goodness, Graham is familiar with similar animals), but first we need a good take of our new VNG announcement.

Graham is searching for a suitable stand for his microphones — something non-resonant like a cardboard box. He comes back in triumph from the laundry, brandishing a tall yellow plastic lattice-work laundry basket. It joins the electronic gear on the kitchen table, and the microphones are clipped on, he scans the script, and we're ready to start recording the first-ever home-brew VNG announcement.

Suddenly, whirr! Graham starts. "What's that?"

"It's the heater. I'll turn it off."

Such dedication. This is winter in Canberra, remember!

Then, grrr! "What's that?"

"Oh dear, it's the fridge. I'll have to switch it off, but please remind me to turn it back on again."

Finally, Take 1.

"This is VNG, Llandilo, New South Wales, Australia on 5, 10 or 15 MHz. VNG is an Australian standard frequency and time-signal service. Your attention, please! VNG does not transmit time pips on 10 and 15 MHz between minute markers 8 and 11, and from minute marker 45 to minute marker 52. The carrier remains unaffected."

I check the stop-watch. The announcements must be 25-30 seconds long.

"Twenty-seven seconds. The timing is okay, but you sound kind of uptight."

"All right, I'll do another take."

Just as Graham prepares to roll the

tape, we hear a slurping sound from one of the chairs where our spoilt, elderly pug, Melly, is relaxing. Pugs have a flat face and a squashed-in breathing apparatus, and are renowned among lovers of the breed for being dogs which make what we kindly term 'comfortable noises'. Melly is doing just that, so she gets banished to the rear of the house with the rest of the family. Kenrick, my eight-year-old harmonic, takes her place and sits quietly after a severe look from me.

All is calm, and Take 2 is more relaxed. Too relaxed. It runs over time.

Bash, bash, bash on the door! Melly thinks she is missing something and wants to be where the action is. I groan, let her in, point to a more distant chair and tell her to go to sleep. She does what she is told and starts snoring. In desperation, I appeal to my retreated family, and they shut her in a bedroom with them and the TV. I put two doors between her and us and, nerves jangling, we are ready for Take 3.

"This is VNG, Llandilo, New South Wales, Australia . . ."

Crash! A pair of headphones bites the dust, and all, including our august announcer, dissolve into helpless laughter.

Take 4 is about to begin. The harmonic is still giggly. I look at him severely and he suppresses his laughter. Take 4 is a success!

Now we have to transfer it to cartridges to go in the two VNG announcing machines. This is going to be tricky. The cartridge has an endless tape with the same announcement on it several times, with a cue pulse at the start of each. There must be no more than 10 seconds between the end of one announcement and the start of the next on the cartridge or an alarm sounds in the VNG supervisory system. This means that the total playing length of the tape in the cartridge must be timed, and the number of announcements to be recorded on it must be calculated so that no gap exceeds 10 seconds. The cartridge recorder does not

have an eraser, we have only three blank cartridges, and we do not have a bulk eraser. It allows only a very narrow margin of error.

Graham is operating the tape recorder, which must be turned off immediately at the end of Take 4, and I have the stop-watch and am hopefully in control of the cartridge recorder. We have several practices before we dare insert a cartridge. We then transfer an announcement. So far, so good, but then the attempt to record the announcement a second time results in a dud. That is one cartridge temporarily written off, and only two more left. I feel tired and pessimistic.

"Let's try the shortest-running cartridge next," Graham suggests.

That is good thinking. Less opportunity to mess it up. It is a success! We now have one cartridge for the VNG announcing machines. It would be desirable to have a second one for the back-up machine. Emboldened, we tackle our last cartridge. It's 10.15pm. We are very weary, but the mission is completed.

The next day, Graham wends his way back to Sydney via Llandilo, and a puddle of water has appeared on the floor of my QTH. Yes, we forgot to turn the fridge back on! Neither of us wanted to wait for the cartridges to arrive by mail to find out whether they will work, hence Graham's decision to deliver them personally. That evening I turn on my radio, and there it is, broadcasting to the world. We have succeeded, and our announcement doesn't even sound home brew! ar



Marion Leiba VK1VNG, VK1BNG and Graham Conolly VK2BL transferring the announcement from cassette to cartridge. Note laundry basket microphone stand. Photo by Nadine Leiba.

AWARDS

PHILL HARDSTAFF VK3JFE
FEDERAL AWARDS MANAGER

Not too much to report this month as I took a couple of weeks holiday and have been pretty busy with work etc. As a consequence, not too much got done as far as awards are concerned, so I will be only presenting some details of awards this month and not much else.

I have had to put the grid square award on 'hold' for a month, and will be publishing draft rules next month for sure. I know there are quite a few people waiting for these to be published, so I will have to ask you to be patient and hold out for one more month.

This month I am presenting some awards from Sweden, these being the **Worked All Sweden** award, and the **Field award**. The **Worked All Sweden** award is also available to SWLs as the **Heard All Sweden** award. The certificates are very colourful and well designed, and would make a handsome addition to anyone's wall. I did not get a sample certificate of the **Field Award**, but imagine it would be the same. Bengt Hogkvist, who is the Swedish awards manager, also has sent me sample record books for the **Field Award** and **Worked All Sweden** award. These record books are five IRCs or \$US3.00 from SM6DEC (Bengt Hogkvist), and are recommended.

SSA Awards Manager
Bengt Hogkvist SM6DEC
Blabarstigen 11B
S-546 00 Karlsborg
Sweden.

Rules for Worked All Sweden Award — WASA

WASA will be issued to licensed radio amateurs for verified contacts with Swedish counties (län) and callsign districts, made after 1 January 1988.

Applicants shall be member of their own country's IARU-affiliated radio society.

All contacts shall have been made from the same QTH and/or within a radius of 150 km from that QTH.

Each individual contact shall be made with the same band and mode.

The same station may be contacted on several different bands.

All contacts shall be made with land-based stations.

Contacts with earth-based repeaters are not permitted.

Separate diplomas will be issued for **HF**, **144 MHz**, **432 MHz**, **1296 MHz** and **satellites**.

For **HF**, **1.8, 3.5, 7, 10, 14, 18, 21, 24** and **28 MHz** are counted as separate bands.

Within every group, separate diplomas can also be issued for the different classes.

Stickers can be gained for **2xCW**, **2xPhone**, **2xSSB** and **2xRTTY**.

All contacts shall be verified with QSL cards or equivalent, on which there is sufficient information to accurately determine the län/callsign district worked.

Applications shall consist of QSL cards and

a list of these with the län/districts in alphabetic/numerical order.

Instead of sending QSL cards, applicants may get their cards checked by the diploma managers in their own countries, if such a person exists.

The fee for each diploma is SEK 30 (US\$ 5 or 10 IRC).

Application address: WASA Diploma Manager, SSA, Östmarksgatan 43, S-123 42 Farsta, Sweden.

Requirements:

WASA-HF

HF	Applicants in Europe	Applicants outside Europe
Class 3	All läns on two different bands	All callsign districts (0-7)
Class 2	All läns on three different bands	All läns
Class 1	All läns on four different bands	All läns on two different bands
Shield	All läns on five different bands	

Swedish Locator Award

Issued for verified contacts with various locator squares in Sweden as defined by the Maidenhead system. SWL OK. Basic diploma for 25 squares endorsements at 35, 45, 55, 60 and all squares (I counted 65) fee for basic diploma is SEK 30, 10 IRCs or \$US5. Endorsement stickers are SEK 5, 2 IRCs or \$US1. Apply to SM6DEC (SSA awards manager) as listed above.

Field Award

The Swedish Amateur Radio Society will issue the **Field Award** diploma to licensed radio amateurs and short-wave listeners for verified contacts with **fields**, as defined by the locator system adopted as from 1 January 1985 (Maidenhead locator). Contacts on or later than this date are valid for the diploma.

The **FIELD** award is issued in four classes:
Bronze (basic diploma) 100 fields verified
Silver (sticker) 200 fields verified
Gold (sticker) 300 fields verified
Platinum (sticker) All 324 fields verified

All amateur radio bands and modes are permitted. Endorsements will not be issued.

All contacts shall be made with stations on the surface of the earth.

Contacts shall be verified by QSL cards or their equivalent, on which the field or position is clearly stated with such accuracy that the field can be determined. The term 'position' refers to latitude and longitude or to a place name.

WASA

Worked All Sweden Award

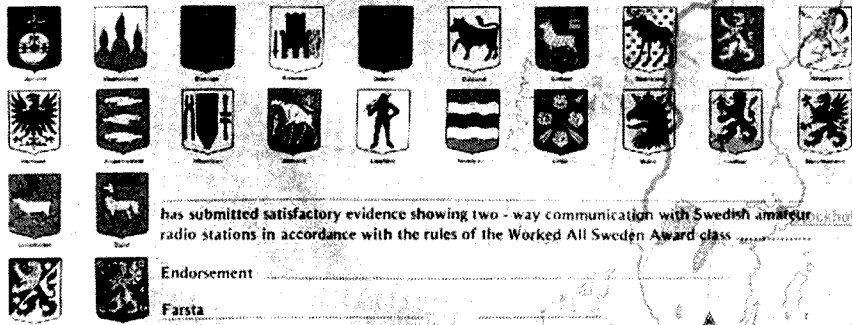

has submitted satisfactory evidence showing two-way communication with Swedish amateur radio stations in accordance with the rules of the Worked All Sweden Award class

Endorsement

Farsta
Date

Award No

President SSA

Award manager



SVERIGES
SÄNDARE AMATÖRER

Radio Amateurs: Have you checked out EA lately?

No doubt most radio amateurs are aware that *Electronics Australia* is by far this country's largest-selling electronics magazine, as well as being its oldest (we began way back in 1922, as *Wireless Weekly*). But have you looked inside the magazine lately?

Now it's bigger and better than ever, because our leading competitor *ETI* has been merged with us, to form *Electronics Australia with ETI* – the biggest, brightest and most informative electronics magazine, bar none.

You'll now find lots of new 'departments' in the magazine, including Solid State Update (with news of new semiconductor devices), Silicon Valley Update (news from the USA) and What's New in Entertainment Electronics. Plus all of your old favourites like Forum, The Serviceman, Circuit and Design Ideas and so on. And of course plenty of 'meaty' technical articles and construction projects.

What about *amateur radio* projects? Well, as you can see there are more of these than before – but we're very interested in publishing more. So if YOU have developed an exciting amateur radio project, contact Jim Rowe by writing to him at EA, 180 Bourke Road, Alexandria 2015. Or phone him on (02) 693 6620, to discuss the possibility of publishing it as a contributed article. As well as earning a fee, you'll also be helping to boost interest in amateur radio!

Take a look at the new, bigger and brighter *Electronics Australia with ETI* – on sale at your newsagent at the beginning of each month. Or subscribe now, by phoning (02) 693 9517 or 693 9515.

Electronics Australia WITH eti

Australia's Top Selling Electronics Magazine

INCLUDED IN OUR SEPTEMBER ISSUE:

ACCESSORIES FOR THE VHF POWERMATCH 2

Three handy 'attachments' for our updated VHF/UHF measuring system: an RF probe, a power measurement head and an SWR reflectometer which works well even at 1296MHz!

GEORGE COOKSON

A pioneering radio engineer at AWA, George Cookson designed and built many of the early broadcasting transmitters. Neville Williams explains his story.

SYNTONY & SPARK – 2

Peter Jensen, VK2AQJ explains how to make a replica of Marconi's famous Multiple Tuner.

If there is any uncertainty about a field, SAA may demand further information before approving the contact. If the uncertainty remains, then the contact will not be approved.

A random sample of individual QSL cards will be made, which must be sent in for checking.

The application shall be made on a GCR list, containing the information from each QSL card which is required for approval. The GCR list shall be verified by the applicant's national diploma manager or other official in the applicant's national amateur radio soci-

ety.

The fee is SEK 30, 10 IRCs or USD 4.

Application address is: Field Award Manager, SAA, Östmarksgatan 43, S-123 42 FARSTA, Sweden.

World Atlas

A world atlas, showing the new locator grid, has been produced by SM5AGM, which can normally be purchased from every national amateur radio society.*

The atlas can also be ordered from SAA by sending a SAE and 6 IRCs.

Record Books Again

Last, but not least, Bengt also has a record book for the Russian R-100-O award which lists award rules, all oblasts, with space to write in call signs, date, band, mode and RST, checklists, maps and even an application sheet. This record book is very detailed, and even if you have only a passing interest in the Russian oblast system, this is the book for you. Cost is \$U\$5 or seven IRCs from SM6DEC (address above).

* Not at present available from WIA

THAT'S ALL FOR THIS MONTH.

— 73 PHILL

CONTESTS

Reminder:

RD logs must be received by RDCC no later than 28 September 1990. Ten contacts constitute a valid log. Help your division by entering a log.

Calendar 1990

- 15-16 September
32nd Scandinavian Activity Contest, CW section.
- 22-23 September
Scandinavian Activity Contest, Phone section.
- 6-7 October
VK/ZL Oceania DX Contest, SSB section
- 13-14 October
VK/ZL Oceania DX Contest, CW section
- 27-28 October
November CQ WW DX SSB Contest
- 24-25 November
CQ WW DX CW Contest.

32nd Scandinavian Activity Contest 1990 Rules

Aim: To work Scandinavian stations, defined as follows; LA/LB/LG/LJ, JW, JX, OF/OG/OH/OI, OH0, OH0M, OX, OY, OZ. SJ/SK/SL/SM and TF.

Periods: 15 September to 16 September for CW . . . 22 September to 23 September, 1500 UTC first day to 1800 second day.

Sections: Single OP/single TX/all bands only; single OP/single TX/all bands QRP; multi OP/single TX/all bands.

Bands: 3.5-7-14-21-28

NB 3560-3600, 3650-3700, 14060=14125, 14300-14350 kHz to be kept free of contest traffic.

Exchanges: To consist of RS(T) and serial number starting from 001. Same station may be worked for each band.

Scoring: One point for contact with Scandinavian stations on 14, 21, 28 and three points on 3.5 and 7MHz.

Multipliers: Each call area in each Scandinavian country.

Final score: Multiply the sum of QSO points on all bands with sum of multipliers on

all bands.

Logs: To the Contest Manager OZ7HT

Adelvadvej2
Solsted, 6270 Tonder
Denmark

No later than 30 October 1990.

1990 VK-ZL-Oceania DX

Contest Rules

(by courtesy NZART)

SSB 6-7 October 1990

CW 13-14 October 1990

A special effort is being made this year by the NZART contest manager to encourage participation in this event, as part of the celebrations commemorating New Zealand's 150 years as a nation. To this end, a station with the call ZL150A will be active in both sections of this contest.

VK and ZL stations which work ZL150A on 160 or 80 metres will, of course, be able to claim a bonus of an extra multiplier (see rule No 2, below).

For VK and ZL Stations

1. SSB: Within a 24-hour period, from 1000 UTC Saturday, 6 October to 1000 UTC Sunday, 7 October, operate for a maximum of 12 hours.
2. CW: Within a 24-hour period, from 1000 UTC Saturday 13 October for 1000 UTC Sunday, 14 October, operate for a maximum of 12 hours.

Please indicate clearly hours of operation, and periods of rest, preferably in one-hour blocks (to make it easier for you and the Contest Manager).

3. VK and ZL stations are permitted to contact each other ONLY on 160 and 80 metres. VK to VK; ZL to ZL and ZL to VK contacts are permitted on these two bands.

4. SCORING: Different points for contacts on different bands are as follows:

160 metres	20 points
80 metres	10 points
40 metres	5 points
20 metres	1 point
15 metres	2 points
10 metres	2 points

FINAL SCORE will be the total QSO points multiplied by the total number of prefixes worked. The same prefix worked on a different band is counted. NOTE: K1, W1, AA1, N1 etc are all different prefixes. W1AAA/6 would count as W6, NOT W1.

5. CYPHERS: Exchange a five or six digit number composed of the RS (T) report, together with a three-digit number beginning at 001, and increasing by one for each QSO on that band.

6. LOGS:

- (a) Separate logs for each band please, and for SSB and CW.
- (b) Show date, time in UTC, call of station contacted, cyphers sent and received.
- (c) Indicate clearly each new prefix worked. (Underline, highlight or show in separate column, as in CQ WPX).
- (d) State QSO points claimed for each band.
- (e) State number of prefixes claimed for each band.

SUMMARY SHEET to show . . .

- ** Callsign, name and address
- ** Total points claimed on all bands
- ** Total prefixes claimed on all bands
- ** Total points claimed
- ** Declaration that the rules were observed.

SWL SECTION: As for transmitting section, BUT . . .

- ** VKs must hear and log ZL or other stations (NO VK stations)
- ** ZLs must hear and log VK or other stations (NO ZL stations)

POST LOGS TO — NZART VK/ZL/O Contest Manager ZL1AAS, 146 Sandspit Rd, Howick, New Zealand.

To arrive by 15 December 1990.

AWARDS: Separate awards for SSB and CW

- (a) Special certificates to top scorers in each prefix area
- (b) Special certificates to top scorers in each band
- (c) Participation certificates to all entrants on request (one IRC for postage, please).

Information for VK and ZL entrants

This year, as a trial and in response to many requests, Overseas and Oceania operators are not limited as to time, and may

operate for the whole 24 hours of each section if they so choose.

Overseas and Oceania operators score two points for each QSO with VK or ZL stations, and the same prefix multiplier system is used to calculate their score.

The special station, ZL150A, will NOT be competing for the VK and ZL awards as listed above.

1989 VK/ZL Oceania DX Contest Results

Frank Beech VK7BC VK/ZL/O Contest Manager

CW SECTION

TOP SCORER IN EACH CONTINENT

Oceania	KN0E/KH3
North America	K3ZO
South America	YV1OB
Africa	5H3TW
Europe	RB5IM
Asia	UA0SAU

TOP SCORER IN EACH COUNTRY

K3ZO, LA6FC, LZ2AP, SP5CJQ, OH2PM, YU7SF, G5MY, EA5CKP, Y44NO, OK1VD, UZ1AWT, RO4OA, UA0SAU, UQ2GLY, UD6DFF, RB5IM, UL8BWW, UM8MAA, UJ8JA, UP3BA, UC1OWA, UI8AWX, YB2FEA, 5H3TW, YV1OB, JP1DMX/HI8, VE3HX, HB9IK, OZ2E, HA5LZ, DL3RD, SM7ANB, ON4XG.

SWL CW RESULTS	HG0D	1577
LZ2K-308*	HA5FA	check log
LZ2K-434	HB9IK*	4160
UA9-090-601*	HB9DX	1716
OK2-9329*	LA6FC*	288
OK2-3947	LA9HFA	108
UA0-098-134	LA8CE	84
CW RESULTS	L Johansen,	check log
INDIVIDUAL SCORES	LZ2AP*	988
North America	LZ1KVZ	468
K3ZO	LZ1TA	140
WC0Y	OH2PM*	1968
K6NA	OH9RP	240
W5AT	OH8LC	40
W4XD	OH3GD	32
K4BAI	OH3NM	check log
K2PS	OH6NH	check log
K9VKY	OK1VD*	1440
VE3HX*	OK2BGR	1260
VE1ACK	OK2BD1	850
JP1DMX/HI8*	OK2PDT	480
South America	OK3TBB	156
YV1OB*	OK2ABU	108
Africa	OK3IR	50
5H3TW	OK2BCI	50
Europe	OK1FBH	48
DL3RD*	OK1KZ	40
DK3KD	OK1JDJ	20
EA5CKP*	OK3YCH	32
EA2CR	OK1US	check log
EA5CLO	OK2SG	check log
G5MY*	OZ2E*	1102
HA5LZ*	OZ7GRS	72
	OZ5PA	check log

OZ1JDX	check log
ON4XG*	510
SM7ANB*	1440
SM5BDY	check log
SP5CJQ*	390
SP3CDQ	308
UZ1AWT*	7290
UA1DZ	6720
UR1RXB	5168
UZ1OWZ	4224
UA1OT	1632
UA1NDR	408
UA1AUA	100
UA1OZ	check log
UA2EC*	40
RA3DX	2900
UA3TU	2337
UA3AAJ	40
UW3UO	396
UZ3DWX	check log
RO4TDS	check log
RO4OA*	4270
UT4UZ	4092
UB4EYN	768
UA4FDD	360
UZ4YWY	304
RA4PO	140
UA4YZ	check log
UZ6LWA	2728
UZ1ZZZ/A	756
Kildin Isd	DXpedition
UQ2GLY*	156
UD6DFF*	12
RB5IM	11712
UB5XBV	624
RB4JF	192
UP3BA*	5248
UP1BZO	2856
UC1OWA*	5256
UC2ADX	3400
UC2OL	570
UI9AWX*	690
YU7SF*	240
Y44NO*	1320
Y22UB	936
Y39ZC	320
Y32WF	160
Y23GB	108
Y25I/J/A	72
Y48UB	72
Y22PM	48
Y23TL	8
Y73RB	2
Y38ZB	2
Y25OF/A	check log
Y21UC	check log
Y22HF	check log
Y23CM	check log
Y23HJ	check log
Y24SL/A	check log
Y42WB	2
Oceania	
KN0E/KH3*	1,492,344
YB2FEA*	8130
YC7FH	2072

YC7CDQ	1380
Asia	
JA1YFG*	8550
JR3RWB/2	5016
JR7OMD/2	3300
JA6YJS	3234
JA6BWH	2430
JA1BNW	2132
JA7ASD	1800
JA1RK1	1540
JA2EJ1	1320
JA3UWB	736
JO1QZA	690
JA9CWJ	532
JA0BPY/6	416
JA5IP	384
JA1JGP	280
JA2FNY/1	260
JA1AA	208
JA4ETH	100
JQ1VNM	84
JR4ISK	84
JF8LPB/QRP	60
JA6QDU	40
JA3ARM	18
JA8RJ	8
UA0SAU*	9612
UA0QO	4218
RZ9UA	2050
UA9YNC	1488
UB7VA	1472
UA0IAP	1140
UZ0QWA	1080
UA9MX	84
RA0JD	748
UA0LCZ	736
UZ9XWV	50
UZ9XWA	24
UA9YNC	check log
UA0DM	check log
UA9XS	check log
UL8BWW*	1900
UM8MAA*	112
UJ8JA*	2236
UJ8AQ	816
UP3BA*	5248
TOP SCORERS	
IN EACH CONTINENT	
North America	
K3ZO	
South America	
No entry	
Europe	Y57WG
Asia	UW0LT
Africa	5H3TW
Oceania	YC2OK
TOP SCORER IN EACH COUNTRY	
K3ZO, DF8XCX, EA5CKP, G5MY, HB9IK, HG0D, I4FYF, LA1KQ, LZ1KHB, OK1KSO, OH2PM, OZ5XC, ON5FV, PA0ZH, SP8HPW, JA1YFG,	

UZ1OWZ, UW0LT, UB3IWA, UC1AWZ, UQ1GWW, UD6DFF, RL7PEO, LY2OU, UR1RWQ, UA2EC, RI8AB, RO4OA, YC2OK, Y57WG, JP1DMX/HI8, 5H3TW.	
SWL Phone section	
OK1-314-84	7056
JA8-3769	6272
JG7LBN	4960
LZ1C-187	4644
UA4-095-710	2150
LZ2-A-321	1787
UA9-090-601*	1496
JA1-7777	1320
UK3-142-364	728
UA0-098-143	922
OH3-694	420
UA9-090-1058	234
YO2-1572/HD	224
OE1-0140	196
Y38-01-B	140
SP-0189-GD	105
ONL-4003*	1702
PHONE RESULTS, INDIVIDUAL SCORES	
North America	
K3ZO*	19500
N2LT	8600
KB5GEO	3416
WF5E	2150
WC0Y	1360
K2PS	680
K3ND	286
K3ZPG	140
JP1DMX/HI8*	50
Africa	
5H3TW*	1794
Oceania	
YC2OK*	54404
YC9VGB	15360
YC8RFF	13514
YB3ASQ	2346
YC7DF	2184
YB7BC	408
YC7FH	784
YC7BMU	948
YC7BVY	864
PHONE RESULTS, INDIVIDUAL SCORES	
Europe	
DF8XCX*	1596
DK1I1	682
EA5CKP*	360
EA2CR	100
EA5EFV	check log
G5MY*	850
HG0D*	6293
HA5FA	check log
I4FYF*	6930
IK4GNH	2550
LA1KQ*	72

LA2AD	check log
LZ1KHB*	160
LZ1DM	check log
LZ2KRT	check log
OK1KSO*	14688
OK2KOD	646
OK2BHM	216
OK2PDT	198
OK2TH	170
OK1KZ	40
OK2KVI	32
OK1OFM	2
OH2PM*	3920
OH6SU	1178
OH6IU	880
OH3GD	24
ON5FV*	18
OZ5XC*	644
OZ7AX	check log
OZ7ENX	check log
PA0ZH*	1020
SM6KMD	check log
SP8HPW*	40
SP9EMQ	check log
Y57WG*	15400
Y22JJ	5332
Y54VA	2912
Y44NO	1800
Y23DD	744
Y32WF	448
Y24NG	360
Y45RJ	260
Y38ZB	72
Y72SL	50
Y21UC	24
Y24SG	check log
Y25OF/A	check log
Y55ZA/P	check log
UZ1OWZ*	4092
UB3IWA*	13230
UQ1GWW*	2880
UD6DFF*	60
LY2OU*	2326
UR1RWQ*	312
UA2EC*	180
RO4OA*	5084
UW3RR	check log
UA3EDH	check log
UA1OT	126
UA1OZ	check log
UA3TAM	check log
UA3DLB	check log
UA4RZ	1152
UA4NC	check log
UV6LAP	126
RV6LD	270
UA6XDL	check log
UA6LG	672
UB4MXR	1720
UB5XBV	1428
UB4QWW	884
UT4UZ	5940
RB5UQ	102
RB4JF	40
UC1AWZ*	3652
UC2OL	768
UC2AI	496

HB9IK*	2430	UA0SNT	1254	UZ9XWA	8	JA3LDH	5928	JA6YJS	700	JR2TRC	112
HB9DX	1632	UA0SU	280	UW9JC	16	JH1YDT	5056	JA1BNW	648	JA3RBC	98
HB9FR	1596	RZ9UA	7092	UZ9YXI	check log	JR3RWB	4104	JA5IP	504	JH9CAV	90
Asia		UA9CI	3848	RV9CFP	check log	J16BRB	3564	JR1MRG	480	JF1XOO	84
UW0LT*	30960	UA9QA	2150	UJ9KWC*	832	JQ1VNM	3410	JA8RJE	408	JA9RYL	48
OA0TO	21672	UA9TX	1950	RL7PEO*	1482	JA0BPY/6	1452	JA6QDU	408	JL1MWI	12
UZ0QWA	18912	UA9LFN	300	UL7RER	check log	JF1JLW	1280	JA6NQT	342	JF2LTH	8
UA0SAU	16830	RW9AB	2064	RI8AB*	690	JA6EFT	786	JA6BWH	198	JH2WHS	2
UA0QO	8280	UA9LFI	160	JA1YFG*	18020	JR7LVK	780	JA1RKI	112	*Denotes certificate winner	
								JA3UWB	112		

HOW'S DX

STEPHEN PALL VK2PS
PO Box 93 DURAL NSW 2158

The month of July just passed by. DX activity was limited, but rumours from 'reliable' sources were abundant.

Albania-ZA

The saga of a possible activity from this country continued. Early in July it was reported by a VK amateur that he heard on the Latin American Net that the activity will start on 20 July. If no activity will be forthcoming, donations which were made in advance will be refunded.

Around 22 July a new rumour surfaced. It was said that HA0DU reported that Zoli HA5PP and Peter HA5WE are in Tirana, they have no radio equipment with them, they have no permission yet to operate, but if they receive permission, the equipment can be airfreighted to them within 24 hours. The best rumour came from a W6 operator. He said, on 28 July, that Zoli is active in Albania with the callsign ZA1CZ. Several stations have reported to have worked them on 21250 kHz. Those who believed the story were 'looking' for him on all bands and in all modes. A few days later, the excitement died down and the 'lookers' realised that a pirate had had a big laugh at their expense. So it goes... These are the days of our lives... to be continued in the next issue.

South Sandwich and South Georgia Islands — VP8

Contrary to rumours, this expedition is definitely on at the end of the year. Tony WA4JQS, the leader of the expedition, announced on the Family Hour DX Net (14226.5 kHz at 1100 UTC) that passage on the ship was booked and confirmed. The expedition will leave the port of Punta Arenas on the ship "Indiana" on 13 November. They will arrive at South Georgia on 21 November and will start operating next day. Callsign will be VP8SGI until 5 December. The South Sandwich part of the expedition will take part from 25 November to 3 December, with the callsign VP8SSI. For most of the time, both stations will operate simultaneously. QSLs direct only,

with SAE and return postage to Jerry Branston AA6BB/7 for VP8SSI, and to Joanie Branston KA6V/7 for VP8SGI, both at the same address: 93787 Dorsey Lane, Junction City, OR 97448 USA.

Yemen — 7O, Market Reef — OJ0, and Others

If ever a 'traffic policeman' was needed on the bands, the day was 30 July, in the late afternoon, Sydney time.

Yemen 7O8AA started up on 14190 kHz, on a nearby frequency OJ0/KF7PO Market Reef was also active and, to top the lot, Gus 9Q5TE opened up with a booming signal on 14195 kHz. Three rare DX stations active at the same time — almost on the same frequency. What QRM. Finally, a well-known VK DXer separated the stations to their different frequencies and the bedlam died down. 7O8AA was operated by Paul F6EXC from 28 July to 12 August, and QSL will go to F2VX: Gerard Debelle, 4 Le Haut d'Yvrac, F-33370, Tresses C3, France.

The Market Reef operation was by OJ0/KF7PO (SSB) and OJ0/N7BG (CW). QSL to: KF7PO Frank Smith, 5933 West Grovers, Glendale, AZ 85308 USA or via the Bureau. Gus 7Q5TE in Zaire was exceptionally strong in Sydney at 0556. QSL to: SM0BFJ Leif Hammastrom, Birger Jarlsg 38, 4 Tr, S-11429, Stockholm, Sweden.

Vanuatu — YJ

The island nation of Vanuatu celebrated the 10th anniversary of its independence (see July AR) on Monday, 30 July. The politicians of all the 14 South Pacific Island nations (including VK and ZL) were there to celebrate by attending the South Pacific Forum. VARS — The Vanuatu Amateur Radio Society — celebrated the occasion by activating the special event station YJ10IND. QSL via the Bureau.

Grosse-Ile — CI0

This tiny island is located in the St Lawrence River, near Montmagny, 48 km down-

stream from Quebec. The Gross-Ile DX Groupe has submitted an application to the DXAC for a separate country status. Decision by the committee may be made during September 1990. In the meantime, special call CI0GI was activated at the tiny island from 26 July to 29 July 1990. QSL via the VE Bureau or direct to: The Gross-Ile Groupe, 88 Latouche, Beauport, PQ, Canada, G1E 6M8.

Cocos Island — TI9

This is not the Australia Cocos-Keeling Island group, but an island off the shores of Costa Rica in the Pacific Ocean. TI9US Jim (TI2US) and TI9CF Carlos were active from 19 July to 29 July. QSL for TI9CF goes to the home call: TI2CF: Carlos M Fonseca Q, Box 4300, San Jose 1000, Costa Rica, Central America.

Solomon Islands — H44

Al H44AP is quite active from the Solomon Islands. Al is a lay missionary teacher at St Joseph's School near Honiara. The school enrolled about 300 boys and girls, and is located in the bush on the site of a former World War II hospital, and is quite close to 'Bloody Ridge', the setting of a fierce World War II battle. Many Australians and Americans probably remember the site quite well.

Al operates an Icom 745, running approximately 60 Watts into a Butternut vertical antenna mounted on the metal roof of his house. QSL to Al direct only, with SAE and postage costs (note the new box no) to: Al Pearce, Box 11, Honiara, Solomon Islands, South Pacific.

Pitcairn Island Award — VR200PI

I received a long letter from Gary KB6ISL, the 'bicentennial manager' for the award. Whilst Gary is QSLing at the rate of 300 cards per day for a quick turnaround, those who have submitted their applications for the award certificate are allocated, for the time being in the computer, an awards number for record purposes. Gary had some delays with the printing. The picture to be used on the certificate is copyright, and he had also some transparency problems. These are now being solved, and he assures everybody that the quality of the award will outweigh the delays with the delivery. At this stage, however, he is

unable to give a specific date for the posting of the certificates.

Interesting QSOs and QSL Information

Note the following: Callsign — name of operator — frequency in kHz — mode — UTC — month of the QSO. ADAR = means QSL info in previous AR issues.

HK1KHK Gil — 14195 — SSB — 0930 — June. QSL to: Gilbert Jaime Daza Daza, PO Box 50151, Baranquilla, Colombia, South America.

T5RR Ruggero — Somali Republic 28475 — SSB — 0734 — June. QSL to: I2JSB: Giorgio Savini, Via Delle Primule 14. I-20089, Rozzano, Italia.

T2OAA — Ian — Tuvalu — 21275 — SSB — 0020 — June. QSL to: N4FJL: Thomas T Schreckengost, 8W Pine Tree Ave, Lake North, FL 33463, USA.

T77C — Tony — 21267 — SSB — 0208 — June. QSL to: Tony Ceccoli, via Delle, Carrare 67, RSM-47031, Republic of San Marino.

C56/ON7EH — 14195 — SSB — 0617 — July. QSL to: ON7EH: Michel Spelier, Blijde Inkomststraat 79, B-1830, Machelen BT, Belgium.

7X4BL — Boucif — 21205 — SSB — 0610 — July. QSL to: Boucif Labdelli, PO Box 929, Tlemcen City, Zip 13000, Algeria.

HK0BKX — 14018 — CW — 1208 — July. QSL to: WB9NUL: Joyce A Boothe, 705 May Ct, Channahom, Ill, 60410, USA.

KK5W/W90ES — Chuck — 14222 — SSB — 0620 — July. Special event station of the Economic Summit Conference of the World Trading Nations. Send three IRCs and an 9"x12" envelope for commemorative certificate to: 1515 Holcombe Blvd, Huston, Texas, 77030, USA.

OX3SG — Helge in Thule — 14144 — SSB-1016 — July. QSL to: LA5NM: Mathias Bjer-rang, Box 210, N9401, Harstad, Norway.

ZS8MI — Gerard — 21205 — SSB — 0518 — July. QSL to: PO Box 13077, Jacobs, Zip 4026, Natal, Republic of South Africa.

YS1EJ — Juan — 14222 — SSB — 0652 — July. QSL to: Juan Manuel Molina Zaldana, 3 Calle Poniente, 3685 Escalon, San Salvador, Central America.

7Q7JM — Billy — 21205 — SSB — 0525 — July. QSL to: NK2T: Hayden M Nadel, PO Box 22, Levitton, NY, 11756, USA.

XT2BX — Melitta (YL of XT2PS) — 14243 — SSB — 0626 — July. QSL to: PO Box 1716, Ougadougou, Burkina Faso, Africa.

HR1RMG — Rene — 7094 — SSB — 1117 — July. QSL to: Rene Mendoza Garay, Box 138C, Tegucigalpa, DC, Honduras, Central America.

3D2WM — Willy — 14222 — SSB — 0557 — July. Willy is ex-T3OAC, and is now a student. His address: Willy Maen, PO Box 1168, USP, Student Mail, University of Suva, Republic of Fiji.

708AA — Paul — 21295 — SSB — 0545 — July. QSL to F2VX (see address above).

YL75ID — Alex — 14222 — SSB — 0613 — July. Alex was on an island in a river, no IOTA number. QSL via: UQ1GWW via Bureau.

VP2EY — Fritz. Qsl via: HB9SL via Bureau.

KC6AZ — Annabelle — Western Caroline — Palau. QSL to: 523 Punaa St, Kailua, Hawaii, 96734, USA.

RTTY News

Selections from the vast list of Syd VK2SG J39BS — 14087 — 0125. QSL via: WB2CLH. 5NOETP — 21085 — 1448. Qsl to home call: N6QLQ. A41JW — 14086 — 0155. QSL via Callbook.

YL20LSF — 21090 — 1905. QSL via: YL1WW. VQ9RB — 28078 — 1700. QSL to: WA4DPU.

UZ3AXJ — 14091 — 0150. This is a Russian Bulletin Board station, which is new for the Russians. At the moment he is beaconing. PY0FF — 21094 — 1740. QSL to: W9VA. J73WA — 21092 — 2216. QSL to: Wayne, 40 Rodney St, Portsmouth, Commonwealth of Dominica, Caribbean. C6A/AB4ES — 14084 — 0141. QSL to: Home address. UH8AAB — 21091 — 1840. QSL to: Box 555, Ashkabad, 744020. Turkmenistan, USSR.

From Here and There and Everywhere

• Austin VK5WO reports that he received a letter from Romeo Stepanenko 3W3RR and 1S0XV. Romeo says that the QSL cards are being printed in Japan and USA for those stations. Donations and QSLs can be sent to: W4FRU John Parrott, PO Box 5127, Suffolk, VA 23435 USA. Other sources say that if you already QSLed to the Moscow PO Box, you should not re-QSL. Incidentally, Romeo has a new address: Romeo Stepanenko, PO Box 1, Simferopol, 36, 333036 USSR.

• ZS8MI Gerard reports that he will be on CW from Marion Island later on this year.

• The Abu Ail A15AW and the Djibuti J28SI cards started to arrive in Australia.

• Pete 5W1KT in his recent letter says: Samoa has still not recovered from the cyclone damage. The banana plants and paw-paws are still suffering. The ferry that goes from Apia to American Samoa was beached during the cyclone, and has not been salvaged yet. They have power cuts in town from 1200 most of the days. This situation is likely to continue for another 18 months.

* Frank VK2QL has written me a long letter reminiscing about his past amateur activities. Frank is 83 years old this year, and was licensed in 1935. He is not in the best of health, and spends most of his time in bed. Frank is strictly a CW man, and he tries to have a few contacts each day. It took him 55 years to work 3CO. Not so long ago he worked GB150PP, which was a special event station

commemorating the 150th anniversary of the penny postage in UK. I am sure Frank would welcome some get-well greeting cards, especially from old timers.

• Bill VK5NVW sent me a warning note. Some time ago he worked ET6AHG. After consulting with a local DXer he decided that it could be genuine because there was an 'alleged' Russian QSL mgr given in the QSO. He sent his card to: UA6HSN. The reply card came from EO6AHG. According to Bill, he now knows that he had been 'had' and that the ET6AHG was a fake.

• VP2EXX Paul said he intends to visit the USSR in August for three weeks and has applied for a licence. He will visit Leningrad, Moscow and Omsk.

• Jack T30JH (ex-VK2GHJ) and I had a few landline contacts when he was in Sydney recently. Jack is not over-enthusiastic about the QSLing practices and ethics of some amateurs, including VK novices. As you will remember, Jack had one month of intensive DXpedition style activity in Kiribati, Tuvalu and Nauru, and as a result received thousands of cards. He often finds that there are wrong dates on the cards, wrong times and even wrong bands. Some of the amateurs do not know what UTC, or Zulu, or GMT time means, so they put down local time. Some of them do not send a reply envelope, others do not include the cost of the return postage. He does not like 'fancy' phonetics during a QSO, like 'Big Brown Bear' for BBB. In future he will reply to a call only when the other station uses internationally accepted ITU phonetics. My comment: if you do not know how to QSL a DX station, please look up my column in the March and April issues 1990 of AR. And, please, if you are a DXer, you must keep a detailed proper log of your activities in proper UTC date and UTC time.

• Zbig ZK3EKY (ex-VK2EKY) has made about 15,000 QSOs from Tokelau, and he is now on a temporary visit to Sydney.

• Penguin Island (see Aug issue of AR) ZS9AAA/1 and DL8CM/ZS1 were quite active mid-July. A number of VKs worked them. QSL direct to homecalls or via the Bureau, but bureau cards for DK9KX/ZS1 should go to DF0KD.

• Palau-KC6. Three Japanese operators will be active from 12 to 16 September. KC6CW (JA2NQG), KC6DX (JH2BNL) and KC6MZ (JI2UAY). QSL to: home calls.

• QSL cards to OD5EH should be sent direct to UW6HS: Vasil M Kasyanenko, PO Box 20, Georgievs, 357800 USSR.

• It was reported that Palmyra Island was active in the last part of July as AA6LF/KH5. QSL to: home call.

• There is an alternative QSL address for 3W1RR: PO Box 43, Temirtau, 472310 USSR.

• Carl WA4BCQ has reported that all the three 7Q7 stations have now been accepted as good for DXCC (7Q7LA, 717JM and 7Q7RM).

• Patrick VK2RZ is now home from hospital.

He is using a walking brace, but it will be some time before he is able to come on air.

• The Bouvet and the Yemen QSL cards are out. Some have already arrived in VK.

• Pauline ZL2QW announced that she is not the QSL manager for Henry T30BC since April this year. Pauline is now unable to return the cards to the senders because of the heavy cost of local postage. The new QSL manager for T30BC is: K7EHI.

• QSL for 9H1EL goes to: LA2TO.

• UK radio clubs may use some special prefixes now. GX(G), GS(GM), GC(GW), GN(GI), GT(GD), GH(GJ) and GP(GU). QSL to the corresponding regular prefix.

• JARL reports that there are now more than 1,000,000 amateurs in Japan, an increase of 12 per cent over last year.

• The RSGB HF convention will be held from 29 to 30 September. Guest speakers will be: SM7PKK on Pacific Travels, LA1EE on the Bouvet 3Y5X activity, and Jim Smith VK9NS on his Bhutan A51JS activity. The JARL held a similar 'Ham Fair '90' at the new Tokyo International Trade Centre at Harumi in

Tokyo between 24 and 26 August. The DX speakers were JF1IST, LA1EE and VK9NS.

• Koji Tahara VK2FCA (ex JM1CAX) will operate on Norfolk Island as VK9NX between 22 and 28 August. QSL via the VK bureau.

• The complete house, station, computer and back-up tape, records of several 9Q5, TN4, TL8, TU73 DX operations were destroyed at KC4NC QTH, when lightning struck his antenna and house.

• ST4/WZ6C is back in Sudan. He was heard on 17m.

• Romanian amateurs (YO) are now operating on 30, 17 and 12 metres.

• V31BB passed away in front of his transmitter/amplifier, due to an accident. No one knows how the thousands of QSL cards waiting to be answered will be handled.

Interesting QSLs received

Note: W=weeks, MO=months, FM=from, MGR=manager, OP=operator.

T12QP 13W — FT5XA 12W FM MGR — A35WI and A35KA 11W FM MGR — T30NAD 8W FM MGR — YK1AO 8W — 7X4BL 9W — TL6WD 8W — VQ9HB 5W FM MGR —

WB9FR 8W — LX2AP 3W, 5H3TW 3W FM MGR — T20AA 3W FM MGR — HS1BV 2W — V85GA 3W FM OP — 8B7ITU 5W FM YB7BC — ZL0AIC 5W FM HB9AAA — ZD8HH 8W FM W4FRU — YJOR FM Bureau — J39BS 4W FM MGR — ZK1WL 9MO FM OP — CO3JA 1MO FM MGR — VQ9RB 1MO FM MGR — XF1C 7W FM MGR — ZL0AKH 5W FM MGR — FO0XXL 5W FM MGR — SC9AKI 4W FM MGR — KG4SG 7W FM OP — A15A 7W FM OP — XF4T 6MO FM MGR.

Thanks To You . . .

Last month the number of notes received from supporters were not as numerous as usual. This month the picture has changed.

Many thanks for the assistance received, to the following: VK2QL, VK2SG, VK3DD, VK4OH, VK5BAS, VK5WO, VK5NVW, H44AP, KB6ISL, DK2WV, 5W1KT, 'QRZ DX' and 'The DX Bulletin'. As always, your help is very much appreciated. Keep sending your reports about DX activities. We can never have enough.

GOOD DX AND 73.

POUNDING BRASS

GILBERT GRIFFITH VK3CQ
7 CHURCH ST, BRIGHT 3741

Westlakes ARC Markets CW Coherer Pills

It's the answer to novice and limited operators' prayers; a simple, safe, sure way to improve one's Morse Code speed by up to 100 per cent in 10 seconds.

After five years of secret trial and development, Westlakes has just released an aid to CW receiving that may well rewrite the way by which the subject is taught. Like most good ideas, it is so simple. A small tablet is taken just prior to the receiving task and that's it. The pills even taste nice. The user's comprehension of the received dots and dashes improves out of bounds through a complex chemical reaction within the brain.

Are they safe? Well, that was the first point to ensure, so the club engaged the services of a qualified chemist to perform tests on the CW Coherer Pills. He gave them the 'all clear' and his assurance in writing of the pill's complete safety if used as recommended.

The best news is the price. Boy, are they cheap! Twenty-five CW Coherer Pills posted anywhere for 50 cents. Yes, that includes the stamp.

Do they work? I found it hard to believe the claims put forward by Westlakes in its newsletter, but thanks to Greg VK2GJS who sent me a complimentary packet, I can say for sure that they work for me! Lately I have had 'lapses' of up to six months away from the shack and my receiving speed had fallen to

about 15wpm. Horrors! But after a couple of hours tuning around 80 metres, I found myself reading some of the old mates who were running around 30wpm. True.

For your CW Coherer Pills contact The Secretary, WARC, Box 1, Teralba, 2284.

They would make a great Christmas present!

Result of petition on Morse Code testing

"The result of the privately organised petition to the Ministry of Commerce in April regarding possible repeal of the international regulations on Morse Code testing was: 119 (75.3%) in favour of repeal; 39 (24.7%) in favour of no change.

I am satisfied that this was a fair sample of New Zealanders who have an interest in amateur radio. It was noted that there was

general apathy in responding. More are now aware of the main issues and, as time progresses, there appears to be increasing numbers of those who desire change to the current Morse Code requirements." — Bob Vernal ZL2CA, from 'Break-In' July 1990.

Pounding Brass readers please note " . . . general apathy . . . "

Thanks to Gary Bold ZL1AN, author of "The Morseman" column in Break-In, I have now a copy of his famous Morse Code Programs for IBM (MS-DOS) computers. The suite of programs feature an excellent teaching program, a reading program (to test your sending) plus a couple of other programs which I have not yet tried. All are written in Basic. You can get a copy by sending me your disk (3.5 or 5.25) together with the return postage and container, BUT I will not be bug-chaser for you. All enquiries about the programs should go to Gary (at his request) but you shouldn't have any problems as the 'read me' files explain all.

QLF Night

Put aside the evening of 18 September for limbering up the toes and putting foot to key.

VHF/UHF AN EXPANDING WORLD

ERIC JAMIESON VK5LP
9 WEST TERRACE MENINGIE 5264

As I am still confined to hospital, I am unable to provide a normal column. However, I hope to go back to Meningie on 3 August, and this should allow me to take up writing again.

Thank you to all those amateurs who

send cards and letters, and for the many telephone calls. A number of local amateurs made personal visits. The six-metre standings list should be in the October issue.

73 FROM THE VOICE IN THE HOSPITAL!

An excellent event for beginners, as nobody sends Morse very fast this way. Bill ZL1CQ is the organiser.

No further info was available, but I would guess at 80 metres and have a look if I were you. (from The Morseman, Break-In July 1990).

From Tony Smith G4FAI comes the news that Britain now has a new novice licence which was announced on 19 April, and will have a 5wpm Morse requirement for HF/VHF and a no-code version for VHF only. "The RSGB will be providing the training courses for the new licence. It would be useful if they could also arrange some follow-up by experienced operators to introduce the new novices to the reality of working on the bands."

"A helpful and sympathetic introduction to CW at this time could result in many novices continuing to use Morse Code throughout their amateur radio life." (from Morse Re-

port, Amateur Radio, July 1990.

I still have plenty of membership application forms for the CW Operators QRP Club, although I must ask you to send a prepaid self-addressed envelope for your reply. I have also had a couple of enquiries from people who have written or sent their membership subscriptions and not received a reply. Don't worry. Your membership card/number will arrive with the next printed issue of LO-Key. This is done to save postage; so, if you want a quick reply, send postage too.

I have been doing a bit of reading lately, thanks to a friend who recently gave me some copies of "Radio and Hobbies" from 1941 to 1960! (Now "Electronics Australia").

They are a mine of information, with editorials by John Moyle before he joined the Forces; many home-brew circuits which are all valve jobs, and much news on rockets, planes, bombs, radar, etc etc.

One article from R&H December 1942

describes a cure for badly sulphated batteries. Briefly, the cure is to empty the acid from the fully charged battery, rinse twice with distilled water, then fill with a 20 per cent solution of sodium sulphate (*This is correct as quoted from the original R&H issue. There is a suspicion that it should be 'sulphITE' rather than sulphATE. Can anyone help? - Ed.*) and re-charge. Empty and rinse twice more with distilled water and refill with sulphuric acid of specific gravity 1.25. I will be trying this out on my spare repeater batteries, but would like to suggest to anyone trying it themselves to do the following:

1. Use old clothes, as you will probably find holes in them after their next wash.
2. Wear goggles when handling acid, and have a supply of fresh water handy for washing.
3. Garages which sell batteries often have bulk acid of the right specific gravity. See you next month, Morsiacs . . . Gil ar

ELECTRO-MAGNETIC COMPATIBILITY REPORT

HANS RUCKERT VK2AOU EMC-REPORTER
25 BERRILLE RD BEVERLY HILLS 2209

1) A paper has been received on the 'International Wroclaw (formerly Breslau) Symposium on Electromagnetic Compatibility' via the Federal Office. I had sent a list of our EMC Reports as published in 'AR' to the session organizer on Amateur Radio and EMC Mr H Cichon. They kindly sent me an invitation to attend this symposium. Sorry that Wroclaw, Poland, is a bit far from Sydney, so it was not possible to attend the conference. They appreciated our EMC efforts. The next symposium will be held in 1991 in Zurich, Switzerland.

2) QST reports again and again that local authorities introduce local ordinances blaming amateurs for RFI, when it is clear that inadequate immunity of appliances is the cause of EMC problems, and that these cases must be dealt with by the FCC under

Federal law, which pre-empts local regulations.

3) CQ-DL 7/1990 describes the 'Searcher-Plus', which is a portable double conversion receiver/field strength indicator, made by the 'Texcan Co' in Hanau, Germany. This receiver, the size of a hand-held transceiver, covers the range of 108 to 157.2 MHz, using a range of crystals. It can be used either with a short 'rubber ducky' or a car radio antenna to find unwanted channel 6 cable TV radiation, causing RFI on the exclusive 144-148MHz radio amateur band. The received signal can be observed on the special S-meter or with headphones. This receiver is also intended for radiation tests carried out by PTT-EMC teams and cable TV installation personnel. A nine-volt battery powers the receiver, which uses 35mA. Mobile installation is available. A test

showed several RFI spots within one hour.

4) Information from various sources (via Norm Burton): RFI, affecting amateur band reception, can be caused in very different ways: a) harmonics from chroma crystals of colour TV sets on 3.579 545 MHz in the USA. b) burglar alarms causing 300kHz-wide hash around 50.11 MHz. c) Arcing mains switch of a burglar alarm. d) teleswitch of electricity meter receiver, working on 19.8 kHz, operated by pulses affecting 144.4MHz reception.

5) From "Buoyant Flight", Journal of the LTA Society of USA (LTA means 'lighter than air'). 15 April, Weeksville, NC — Airship Industries' Skyship N-602SK suffered failure of both engines on a flight from here. After free ballooning for about an hour, a successful landing was made and the envelope deflated. The engine failures occurred while the airship was near the powerful Voice of America radio transmitter, and are attributed to ignition failure due to electromagnetic emissions from the transmitter. Accidents are known to have occurred to HTA craft from this cause.

(HTA, Heavier than air) ar

AMSAT AUSTRALIA

GRAHAM RATCLIFF VK5AGR
GPO BOX 2141 ADELAIDE 5001

National Co-ordinator
Graham Ratcliff VK5AGR
Information Nets
AMSAT Australia

Control : VK5AGR
Amateur check in : 0945 UTC
Sunday
Bulletins commence : 1000 UTC
Primary frequency : 3.685 MHz
Secondary frequency : 7.064 MHz
AMSAT SW Pacific
Control : ZL1WN
Bulletins commence : 2200 UTC
Saturday

Primary frequency : 14.282 MHz

Understanding Keplerian Elements in the NASA Two-Line Format

A full description of the NASA Two-Line Format was published in May 1990 issue of 'Amateur Radio' and is also included in the documentation of Instant Track V1.0. However, I still get quite a few enquiries from people who have difficulty coming to grips with this format. Therefore, I will take the set of NASA Two-Line Keplerian Elements for

UO-11 (UoSAT-OSCAR-11) given below and explain how these relate to the more familiar (and verbose) AMSAT-style Keplerian Element.

At the top of each set appears the highlighted headings Epoch and Drag and at the bottom of each set the highlighted headings Inclination, RAAN, Eccentricity, Argument of Perigee, Mean Anomaly, Mean Motion and Orbit Number. Taking UO-11 as an example, Epoch is given as 90202.02148329 ie the Epoch Year is 1990 and the Epoch Day is 202.02148329, Drag is .00000839, Inclination is 97.9462, RAAN is 253.4681, Eccentricity is a little more tricky, in that the number has the decimal point left out, so 0013134 is the same as .0013134, Argument of Perigee is 136.1291, Mean Anomaly is 224.0953, Mean Motion is 14.65500823 and Orbit Number is

34092 as the last digit in each line is the modulo-10 checksum.

```
UO-11          Epoch drag
 1 14781U 84 21 B 90202.02148329
.00000839 00000-0 16327-3 0 7617
 2 14781 97.9462 253.4681 0013134
136.1291 224.0953 14.65500823340921
  Incln RAAN Eccen ArgPeri MeanAnom
  MeanMotion Orbit
```

DOVE-OSCAR-17 Returns to Two Metres

— Bob McGwier N4HY

(compiled from a number of Telemail bulletins)

22Jul90 0321UTC — I just turned DOVE on to two metres. All was fine as it went over the hill. I turned it on to two metres around 0241UTC. I heard it go through its cycle of 2.5 minutes on two metres and 0.5 minutes on S band twice. It accepted commands during the silence on two metres. I watched it wash the ENTIRETY of memory without changing the EDAC (Error Detection and Correction) counter once. The status line contains some new interesting bytes. If we start numbering the status bytes at 0 on the left to go to 19 on the right the following are new:

status[16]+256*status[17] = total no of AART (command system)

retries

status[18] = no of days without command before it resets to the ROM.

status[19] = module number causing the bad AART retries.

[AART an acronym for Addressable Asynchronous Receiver/Transmitter]

The batteries were at 10.6V and rising. The charging algorithm was functioning properly, and the solar arrays were generating power at a healthy level. I could not detect a single malfunction.

22Jul90 0447 UTC — The problem with DOVE is in the DOVE module itself. The AART talkback was missed many many tries on module 4 as reported by telemetry, yet when I send it a single command to the transmitter in that module it turns it on and off immediately. This will require some study. This is NOT a dangerous problem and that module IS accepting commands. I believe that for some reason, that module has lost its ability to talkback on the AART line. The batteries are being charged and all is okay at present. Harold's code performed its job perfectly before and when it didn't receive a talkback from the module 4 AART, it died. The retry problem will have to be factored into future use of that module, but is IS taking commands, so I have no complaints at present, since none of the spacecraft life critical functions is threatened by this minor malfunction.

22Jul90 1705UTC — We are retrying AART commands nine times before failing. On every module, but module 4, I let this kill

the code and go back to the ROM. This is an unauthorised modification of Harold's AART code. There are exactly two channels of telemetry in the DOVE S band module, the S band power sensor and the DOVE S band HPA temperature. The first says 1800C and the second says we are running .5 Watts out of the S band transmitter. By the way, this retrying, and delays between retries, accounts completely for the long time between the Uptime messages and the telemetry frames. You will notice the AART retries counter goes up exactly 18 times (two values in module 4 and nine retries allowed) every time one of these long delays is evident. The failure is DEFINITELY in the talkback from the module 4 AART. It still apparently takes commands all okay, as I am able to turn off the S band transmitter whenever I wish during the silent periods. This is my last status message on DOVE until I return from England at Surrey Satellite Conference. Whilst I am away, Jim de Arras WA4ONG is in charge of DOVE.

31Jul90 0115UTC — I am back from a nice conference in England — thanks to Ron G3AAJ as always. Anyway, as you may have been told by Harold, I forgot to tell Jim to change a single character in the command cryptovvariable, and his command was never accepted. If we could get command acks on DOVE as with the others, we would have seen this immediately. I guessed that this would happen when I saw a number in the status line I was looking to change didn't. It was all my fault. DOVE will be back on in a couple of days.

UoSAT/Microsat BBS Software Status Report

— Jeff Ward G0/K8KA (downloaded from Telemail 01Aug90)

During AMSAT-UK Colloquium Week (ie 24-30 Jul90) at UoS, Harold Price NK6K and I made significant progress in testing the store-and-forward communication software on UO-14. This software will also be run on AO-16 and LO-17, after it has been completely tested and debugged on UO-14.

Harold arrived on Tuesday, and we went directly to work, loading the 210 kbytes of code to UO-14 for testing. The tasks loaded are:

hit.exe,	the Housekeeping Integration task
cpe.exe,	the Cosmic Particle Experiment data collector,
mfile.exe,	the RAMDISK file system server,
t1m.exe,	the telemetry server,
qax25.exe,	the AX.25 'virtual TNC'
ft10.exe,	the BBS itself 'File Transfer Level 0'.

During the course of the week, we reloaded all of this code at least five times, to overcome operational glitches and install bug

fixes. When the satellite wasn't in range, we were examining memory dumps, compiling new versions and ground-testing. For ground tests we used two IBM Real-Time Interface Co-processor cards (in our respective PCs) and the UO-14 engineering model (at least the bits of it which would fit onto my desk).

By Saturday, we had ironed out several bugs in our code and circumvented some undesirable features we found in the TNC-2 full-duplex firmware. To stress the software and reveal bugs, we started a bulletin broadcast, which fills any free downlink time with UI frames. With this running, we connected to the BBS and downloaded a 30-kbyte file. Throughout the test, European stations continued digipeating. After downloading the file twice without incident, we declared the 'alpha tests' complete.

This week of activity clears the way for:

(1) Release of the UoSAT/Microsat PACSAT protocol specifications. Complete definitions of PACSAT File Headers, PACSAT Broadcast format, and the File Transfer protocol Level 0 will be freely available. All of these have been in draft form for some time, and Harold is getting final versions ready for publication in the ARRL Networking Conference proceedings. If all goes well, they should also be available in electronic format by mid-August.

(2) Development of user groundstation software for BBS access. The FTL0 protocol is designed for automated access — not hunt-and-peck keyboard control. The availability of groundstation programs, from AMSAT-UK, AMSAT-NA, and perhaps in a limited shareware version, will truly make UO-14 open for access.

(3) Porting of the file system and the FTL0 BBS to AO-16. Although most of the code will run without modification, there are some differences in satellite hardware and 'operating philosophy' which must be accounted for. This specifically involves drivers for the RAMDISKS, and support for ALOHA access on the AO-16. (UO-14 will use an experimental reservation multiple access scheme, with only limited ALOHA contention).

This is, of course, taking longer than a similar BBS-only effort on the ground. Reflect that UO-14 is simultaneously running six programs: sampling telemetry, collecting data from the Cosmic Particle Experiment, providing a multiple-connection virtual TNC, broadcasting using a new point-to-multipoint protocol, and waiting for full-duplex binary file transfers at 9600 bits/second. Including DOVE and WEBER, six programmers in two continents and four time zones have collaborated to bring this together.

Pakistani Amateur Satellite Launched 16Jul90

[downloaded from Telemail 31Jul90]

The following news release has been received at UoSAT from SUPARCO, Pakistan: Pakistan's first satellite, BADR-1, was

successfully injected into Earth's orbit at 5.50am Pakistan Standard Time on 16 July 1990 from Xichang Satellite Launch Centre of People's Republic of China. The launching of BADR-1 is a historic event, not only for Pakistan, but also for the entire Muslim Ummah. BADR-1 has been placed in the orbit by means of Chinese Long March 2E launch vehicle. Weighing 50 kg, it is orbiting round the Earth every 98 minutes with apogee (farthest distance) of 992 km and perigee (nearest distance) of 210 km, and orbital inclination of 28.5 from the equator. The satellite, which has been designed and fabricated by SUPARCO engineers, comprises several sub-systems such as power supply, tracking, telemetry, telecommand etc. The successful launch of BADR-1 has demonstrated the capability of Pakistani engineers in the field of space technology.

A high level delegation from Pakistan comprising (1) Mr Hasan Zaheer, Cabinet Secretary, (2) Dr M Shafi Ahmad, Chairman, SUPARCO and (3) Mr Sikandar Zaman, Deputy Chairman, SUPARCO, visited the preparation of BADR-1 launch. The delegation was joined in Beijing by Mr Akram Zaki, Pakistan Ambassador to the People's Republic of China.

The uplink of BADR-1 consists of two command receivers operating simultaneously in the UHF range, only one of which transmits at a given time. The downlink consists of two VHF transmitters, one on 145.825 MHz FM, and the other on 144.028MHz FM. The modulation on these two beacons is either single tone, AFSK 1200 baud telemetry (same format as UoSAT-OSCAR-11, ie 1200 baud seven bit even parity and one stop bit) or synthesised voice. Other on-board experiments are in-house monitoring of sub-systems through telemetry and the telecommand of satellite. Two primary ground stations with facilities for tracking, telemetry and telecommand of BADR-1 satellite are already in operation at Karachi and Lahore.

The objectives of BADR-1 project are (i) to test the performance of indigenously developed satellite sub-systems in space environment, (ii) to perform experiments in real-time voice data communications between two user groundstations, (ii) to demonstrate store-and-forward type message communication, and (iv) to educate the country's academic, scientific and amateur community in the tracking and use of low-Earth-orbiting satellites.

The successful culmination of BADR-1 project of SUPARCO is a testimony to the importance attached and the support given to the space program of Pakistan by the present democratic government, and personally by the Prime Minister, Mohtarma Benazir Bhutto, who is the President of Pakistan Space Research Council — the supreme body which directs and controls the space science and technology program of Pakistan.

BADR-1 was placed in orbit over the Pa-

OSCAR-13 Schedule Schedule 01Sept90 to 03Oct90																								
Station: Adelaide																								
Hour - UTC																								
	B	1	2	3	4	5	6	7	8	9	10	11	12	13	14	15	16	17	18	19	20	21	22	23
01Sep	-	b	b	b	b	b	b	b	b	b	b	b	b	b	b	b	b	b	b	b	b	b	b	b
02Sep	-	b	b	b	b	b	b	b	b	b	b	b	b	b	b	b	b	b	b	b	b	b	b	b
03Sep	-	b	b	b	b	b	b	b	b	b	b	b	b	b	b	b	b	b	b	b	b	b	b	b
04Sep	-	b	b	b	b	b	b	b	b	b	b	b	b	b	b	b	b	b	b	b	b	b	b	b
05Sep	-	b	b	b	b	b	b	b	b	b	b	b	b	b	b	b	b	b	b	b	b	b	b	b
06Sep	-	b	b	b	b	b	b	b	b	b	b	b	b	b	b	b	b	b	b	b	b	b	b	b
07Sep	-	b	b	b	b	b	b	b	b	b	b	b	b	b	b	b	b	b	b	b	b	b	b	b
08Sep	-	b	b	b	b	b	b	b	b	b	b	b	b	b	b	b	b	b	b	b	b	b	b	b
09Sep	-	b	b	b	b	b	b	b	b	b	b	b	b	b	b	b	b	b	b	b	b	b	b	b
10Sep	-	b	b	b	b	b	b	b	b	b	b	b	b	b	b	b	b	b	b	b	b	b	b	b
11Sep	-	b	b	b	b	b	b	b	b	b	b	b	b	b	b	b	b	b	b	b	b	b	b	b
12Sep	-	b	b	b	b	b	b	b	b	b	b	b	b	b	b	b	b	b	b	b	b	b	b	b
13Sep	-	b	b	b	b	b	b	b	b	b	b	b	b	b	b	b	b	b	b	b	b	b	b	b
14Sep	-	b	b	b	b	b	b	b	b	b	b	b	b	b	b	b	b	b	b	b	b	b	b	b
15Sep	-	b	b	b	b	b	b	b	b	b	b	b	b	b	b	b	b	b	b	b	b	b	b	b
16Sep	-	b	b	b	b	b	b	b	b	b	b	b	b	b	b	b	b	b	b	b	b	b	b	b
17Sep	-	b	b	b	b	b	b	b	b	b	b	b	b	b	b	b	b	b	b	b	b	b	b	b
18Sep	-	b	b	b	b	b	b	b	b	b	b	b	b	b	b	b	b	b	b	b	b	b	b	b
19Sep	-	b	b	b	b	b	b	b	b	b	b	b	b	b	b	b	b	b	b	b	b	b	b	b
20Sep	-	b	b	b	b	b	b	b	b	b	b	b	b	b	b	b	b	b	b	b	b	b	b	b
21Sep	-	b	b	b	b	b	b	b	b	b	b	b	b	b	b	b	b	b	b	b	b	b	b	b
22Sep	-	b	b	b	b	b	b	b	b	b	b	b	b	b	b	b	b	b	b	b	b	b	b	b
23Sep	-	b	b	b	b	b	b	b	b	b	b	b	b	b	b	b	b	b	b	b	b	b	b	b
24Sep	-	b	b	b	b	b	b	b	b	b	b	b	b	b	b	b	b	b	b	b	b	b	b	b
25Sep	-	b	b	b	b	b	b	b	b	b	b	b	b	b	b	b	b	b	b	b	b	b	b	b
26Sep	-	b	b	b	b	b	b	b	b	b	b	b	b	b	b	b	b	b	b	b	b	b	b	b
27Sep	-	b	b	b	b	b	b	b	b	b	b	b	b	b	b	b	b	b	b	b	b	b	b	b
28Sep	-	b	b	b	b	b	b	b	b	b	b	b	b	b	b	b	b	b	b	b	b	b	b	b
29Sep	-	b	b	b	b	b	b	b	b	b	b	b	b	b	b	b	b	b	b	b	b	b	b	b
30Sep	-	b	b	b	b	b	b	b	b	b	b	b	b	b	b	b	b	b	b	b	b	b	b	b
01Oct	-	b	b	b	b	b	b	b	b	b	b	b	b	b	b	b	b	b	b	b	b	b	b	b
02Oct	-	b	b	b	b	b	b	b	b	b	b	b	b	b	b	b	b	b	b	b	b	b	b	b
03Oct	-	b	b	b	b	b	b	b	b	b	b	b	b	b	b	b	b	b	b	b	b	b	b	b

o means OSCAR-13 is in view and Mode B is OFF using OMnidirectional antennas
 b means OSCAR-13 is in view and Mode B is ON using OMnidirectional antennas
 B means OSCAR-13 is in view and Mode B is ON using HIGH BAIN antennas
 - means OSCAR-13 is NOT in view

AMSAT_OSCAR-13 Transponder Schedules until 17 Oct 90

Mode-B	:	MA 003 to MA 165
Mode-JL	:	MA 165 to MA 190
Mode-LS	:	MA 190 to MA 195
Mode-S	:	MA 195 to MA 200
Mode-BS	:	MA 200 to MA 205
Mode-B	:	MA 205 to MA 240
OFF	:	MA 240 to MA 003
Omnis	:	MA 240 to MA 060

The current series of solar eclipses that affect AO-13 began on 9 July 1990 and extend through until 9 October 1990. The duration of these solar eclipses varies from as little as five minutes to as long as 27 minutes (around the middle of August) between MA 247 and MA 1, which will mean that ALL transponders will be OFF from MA 240 to MA 3 during this period. The next reorientation back to longitude 180 degrees latitude 0 degrees is planned to commence on 15 October 1990.

cific Ocean in an area between the Philippines and Taiwan. BADR-1 came in the field of view of SUPARCO's tracking stations at Lahore and Karachi for the first time around 0715 hours, when both the stations tracked the satellite successfully for a period of about eight minutes. It was again tracked in the next orbit at 0858 hours.

Having tracked BADR-1 successfully, and observed that the satellite performance is entirely satisfactory, the stage is set for SUPARCO's scientists to conduct the planned experiments which comprise the monitoring of the performance of satellite sub-systems, voice communication experiment between Karachi and Lahore via satellite and store-and-forward type of digital communication experiment.

We also have received the following orbital data:

BADR-1
 1 20685U 90 59 A 90208.31406776
 .00178759 -64716-5 42590-3 0 134
 2 20685 28.5006 231.4408 0546159
 245.9829 107.9802 14.94344519 1692

Fuji-OSCAR-20 BBS Status Report

After nearly two months of absence on FO-20 BBS (Mode-JD), I had a contact on AO-13 with Helmut DL1CX, who mentioned that FO-20's BBS had been quite busy of late, so I promised to send Helmut a message via FO-20's BBS during the next orbit.

The first thing I noticed, when FO-20 was

due over the horizon, was that there was no beacon on 435.910MHz +/- doppler shift. Then, to my surprise, there appeared a short burst from the beacon of five seconds, then 55 seconds of silence. However, immediately I sent a connect request to 8J1JBS, the beacon sprang into life and FO-20's BBS was on-line and appeared to be functioning extremely well. I suspect this mode of operation has been implemented to conserve the power budget, when stations are not accessing the spacecraft, and from the overall performance of the FO-20 BBS, it seems to be working extremely well.

The second thing I noticed was the incredible number of stations that were currently active, in particular some new VK callsigns, and that the message counter was going up almost 200 counts a day. Here is a list of callsigns seen on FO-20's BBS list in just three days: DL1CF, DL1CX, DG9MEA, DD4YR, DL6DBN, DL8NCI, DL1CR, DL1YDD, DU1POL, EA6IC, G3RUH, G2BFO, G3CDK, GB2SAT, G4AXC, G4WFG, HB9AQZ, IW1BMJ, JK3RLO, JR3FRF, JA1OGZ, JA6FTL, JA6AQV, JR1EDE, KJ1X, K8IRC, KB7HTA, LU1BEE, LU2EXS, LU2CGB, LU7XAC, LU8YDF, ON6UG, ON4KVI, PA3PVG, PY2BJO, RK3KP, SM5BVF, VK2XLG, VK2FKZ-2, VK3DTO, VK5ZTS, VK5ZTY, WD0E, W8LYD, WB5ERW, W9FMW, W9ODI, WB9ANQ, WB8QCN, WA4EJR, YB1BG, ZL1TDW, ZL1AOX, 9H1EY, 9M2BBS, 9M2DT — which, in my book, is not bad!!

WEBERSAT Picture Files Available from AMSAT-Australia

For those who have a copy of the IBM-PC Software WEBERWARE V1.0 (available from AMSAT-Australia for a donation of \$35 plus a blank formatted 360k disk and return postage) may be interested to know that I have received from WEBER STATE University a number of picture files taken by WEBERSAT. In fact, I have received a total of four pictures taken on the ground, and one picture taken after launch. The ground pictures are excellent. To obtain copies of the picture files, send three blank formatted 360k or two 720k or one 1.2Mb disk(s) plus return postage to AMSAT-Australia.

TELEPRO Version 2.7 for the IBM-PC — Now available from Calvin VK4ZCM

I have pleasure in announcing the release of an enhanced OSCAR-13 PSK telemetry display program, written by Calvin Melen VK4ZCM. The program is called Telepro V2.7, and is very similar to P3C.EXE V2.0, but has a number of extra features — the two most significant features are an extensive on-line help system, and a self-correcting mode for decoding the K, L, M and N message blocks

SATELLITE ACTIVITY FOR APRIL/MAY 1990

1. Launches

The following launching announcements have been received:

Int'l No	Satellite	Date	Nation	Period min	Apog km	Perig km	Inc deg
1990-037B	HST	Apr 25	USA	96.8	620	611	28.4
038A	COSMOS 2075	Apr 25	USSR	94.6	522	489	70.0
039A	MOLNIYA 1-77	Apr 26	USSR	12h16m	40747	654	62.8
040A	COSMOS 2076	Apr 28	USSR	11h49m	39342	613	62.8
041A	PROGRESS-42	May 05	USSR	88.7	261	194	51.6
042A	COSMOS 2077	May 07	USSR	89.6	346	195	62.9
043A	M-1	May 09	USA	98.6	783	641	89.8
043B	M-2	May 09	USA	98.6	782	640	89.8
044A	COSMOS 2078	May 15	USSR	89.3	307	206	70.0
045A	COSMOS 2079	May 19	USSR	11h15m	19130		64.9
045B	COSMOS 2080	May 19	USSR	11h15m	19130		64.9
045C	COSMOS 2081	May 19	USSR	11h15m	19130		64.9
046A	COSMOS 2082	May 22	USSR	102.0	880	852	71.0

2. Returns

During the period 46 objects decayed, including the following satellites:

1978-009A	MOLNIYA 3-9	Apr 24
1990-020A	PROGRESS M-3	Apr 28
1990-032A	FOTON 3	Apr 27
1990-035A	COSMOS 2073	Apr 28
1990-037A	STS-31 2062	Apr 29

3. Notes

HAGOROMO, a lunar orbiter, was released from MUSES-AV on 18 March 1990, when it made its first lunar swing-by. It is numbered 1990-007B.

1990-041A PROGRESS-42 docked with the MIR space station on 7 May 1990.

Bob Arnold VK3ZBB

under bad signal conditions.

Calvin has decided to distribute the program on a Shareware basis for a nominal licence fee of \$25, of which \$10 will be donated to AMSAT-Australia. Therefore, to obtain a copy, send \$25 to Calvin Melen, VK4ZCM, 94 Hawthorne Rd, Hawthorne, QLD 4171.

AO-10/13 Activity from Zimbabwe in Aug/Sep — Z21HJ/R via DL1CF

Nineteen-ninety is the 'Year of the Amateur Satellite' and we decided to undertake a special 'satellite activity' in Zimbabwe. We hope that with this activity we will not only provide regular satellite users with an operating challenge and enjoyment, but will also be able to raise funds for future satellite programs, such as a successor for AO-13. We are, therefore, asking for your support in our effort, and look forward to your participation in our Zimbabwean satellite activity. Our activity will consist of satellite operations from four different locations around Zimbabwe, for which our licensing authorities have issued the consecutive callsigns Z21SAT, Z22SAT, Z23SAT and Z24SAT. The stations will be activated over the weekends of 31 August until 30 September 1990.

This is a total of five weekends. One weekend is being left open so that our program can be flexible to take advantage of the best over-

all DX coverage on Oscar 10 and Oscar 13, as dictated by the predictions closer to the time. Special QSL cards will be available for each of the four stations/callsigns. If you require the speedy direct service for our special QSL cards, we request you to send Green Stamp and we shall QSL direct to you. Otherwise, we shall QSL via the Bureau.

We shall operate on Oscar 10 as well as on Oscar 13 on the downlink frequency 145.905 MHz. In addition to the special QSL cards, those stations which have worked at least two of the four callsigns will qualify for the 'Zimbabwe Satellite Achievement Award 1990'. The design of this award is based on African culture, and shows the famous mighty Victoria Falls in the background. The award will be available for a cover charge of \$US10 to be sent by registered letter, together with proof of the worked stations, to the above box number (*unfortunately not supplied — will follow — VK5AGR*). The QSL cards will be returned together with the award. All proceeds from this cover charge, as well as from the direct QSLing, will be donated equally to AMSAT-UK and AMSAT-DL.

Our activity has the patronage of the Honourable Minister for Transport and National Supplies of Zimbabwe, Mr Sen D Norman, and the active support of the Zimbabwe Amateur Radio Society, Des Z21GH and Guenter Z21HJ/R.

Using the G3RUH FO-20 Modem with the C64 and Digicom — Ed VK4KAA

The only real problem when using this board with the C64 and Digicom is the need to provide a 19.2kHz clock pulse in phase with the TXDATA.

If you are using a World Modem Chip (AMD7910) in your terrestrial packet modem, then everything is OK, as you can use the 2.4576MHz crystal oscillator output, and feed this to the PSK modem.

You must wire the 4040 divider U6 pin 15 to TP4 and omit LKC. If, however, you use the XR chips or something else, you can make a 19.2kHz oscillator (use something better than a 555 — try to get a mark/space ratio as close to 1:1 as you can), split the TXDATA two ways (in a buffer), feeding one to the TXD in and the other to the phase lock oscillator.

The output at 19.2 kHz is then fed into the TX clock input as a phase synchronised clock pulse, which is divided down and used in the Manchester encoding. If you make the board the same size as the space where the power transformer goes, it can be mounted there

with a piece of double-sided tape (many thanks to Alan VK4ABP for making the board for me). If you are feeding the decoder from a low but constant level output like the TS811A 13 pin DIN socket, you must add an extra stage of amplification, to bring the AF level up to a point where the decoder will lock reliably. I used a TL072 I had spare, but just about any low-noise OP AMP will do the job.

I hope this will encourage those Digicom users to give it a try. One final point, only Digicom V2, 2+ and 2.03 seem to have a full duplex available — later versions have deleted this facility — so how about someone familiar with machine code programming having a go at replacing this facility on V3.51 and V4.01.

By the way, if anyone wants to get a Commodore 1581 disc drive (3.5" 880k formatted) to run with a C64 or 128, they are available from HPD in Adelaide for \$389.

AMSAT Education News — A Worthwhile Publication

'AMSAT Educational News' is an excellent monthly publication edited by Richard En-

sign, AMSAT Science Education Adviser. Richard is a teacher and, over the past 28 years, has at some time or other taught physics, vocal music, electronics, earth science and radio/television production. His real joy has been the past 21 years he has spent as the Director of the Crestwood School District Planetarium, a 66-seat education-based facility in Dearborn Heights, Michigan.

As the name of the publication implies, it is primarily aimed at helping educators bring the Amateur Satellite Service to the classroom. I have been subscribing to this publication since January 1990, and in that time the following topics have been covered: 'Microsat Lifetime in Orbit', WEBERSAT Experiments, DOVE telemetry analysis, simple BASIC programs for IBM-PC and Apple for displaying DOVE telemetry, overview of Amateur Satellites for Educators, LUSAT CW telemetry decoding, Microsat Motion Studies, Shuttle Amateur Radio Experiment (SAREX), Sunrise and Microsat Telemetry and Using DOVE in the Classroom. To subscribe, send overseas bank draft for \$US20 to AMSAT Education News, 421 N Military, Dearborn, Michigan, 48124, USA. ar

EDUCATION NOTES

BRENDA EDMONDS VK3KT
FEDERAL EDUCATION CO-ORDINATOR
PO BOX 565 MT WAVERLEY 3149

Very many thanks to all those examiners who responded to my recent questionnaire. It has been very interesting to read the variety of approaches and the different views on problems. My aim in circulating the survey was to find if there were some matters seen as problems by a number of examiners, and to see what information is being recorded by the examiners.

At the recent Joint DoTC/WIA meeting we discussed the current progress and the future of devolvement. So far, from the DoTC standpoint, it has gone fairly smoothly, but it is acknowledged that the program to produce question papers has not come up to the expected standard. The present intention is that it will be further refined to prevent overlap, and also that the question order and answer orders are scrambled. It is also intended that the question banks will be re-

viewed and extended in the near future (no specific period was specified) and the whole system reviewed in a year or so.

A number of examiners have queried some of the answers, or are unhappy with some questions. I realise that some of these objections are due to personal preference or interpretation of the syllabus, but if a question is seen as invalid by a number of examiners, then it should be brought to the attention of the Department's Examination Officer and, if necessary, removed from the bank. I think most of the problems arise in the AOC bank, rather than the Novice one. If I receive complaints, I will pass them on to DoTC.

I would also be happy to collate and circulate for discussion any new questions that examiners may have that could be added to the bank. Most of those who responded to my survey agreed that the banks are too small

and unbalanced at present.

The departmental officers were insistent that control is being maintained over examinations. Results of some examinations have been queried, and visits have been made to examination centres. The reversion to the old system whereby a candidate has to receive the Certificate of Proficiency before applying for a licence is to allow for a check to be made with the examiners if it seems necessary. DoTC does not envisage devolvement of the issuing of certificates.

One thing that we seem to have lost with the devolvement is the ability to collect statistics on individual papers. The Department intends to publish the overall statistics annually, but I would urge all examiners to maintain as many records as they can of pass rates by paper and even by question, especially if a question is seen as dubious. I would also like to see records kept on all candidates, so that those who fail at the first attempt can be encouraged and helped to make another attempt. We lose too many potential recruits because they fail to qualify completely at the first attempt.

73 — BRENDA VK3KT

CLUB CORNER

Ballarat Amateur Radio Group

The Ballarat Amateur Radio Group's annual Hamvention will be held on Sunday, 28 October 1990.

The club has issued a challenge to all amateurs to build a Yagi antenna for the two-metre or 70cm bands. When completed, bring it to the Ballarat Hamvention and have its gain measured and see if it works. Any mate-

rial or design may be used, but the boom length on both bands must not exceed two metres in length. Measurements will be taken at the centre of the band for the antenna under test.

GO TO IT, CHAPS.
GOOD PRIZES TO THE WINNERS.

Ballarat Amateur Radio Group
PO Box 216E Ballarat East 3350
(Kevin Highes VK3WN (053) 35 5011)

Cronkite the Novice

The ranks of amateur radio have been joined recently by a celebrity, veteran US newsmen and author Walter Cronkite.

The 74-year-old is known mainly for his role as newsmen anchorman on CBS TV, but his long journalistic career also includes assignments as war and foreign correspondent.

Listen for Walter, now based in New York, under his newly obtained Novice callsign KB2GSD.

INTRUDER WATCH

GORDON LOVEDAY VK4KAL
FEDERAL INTRUDER WATCH CO-ORDINATOR
'AVIEMORE' RUBYVALE 4702

Abridged June Summary

Freq	UTC	Date	Logs X	EMN	ID	Comments
7002.5	1200+	dly	30	A1A	V	24-hr beacon
14023.5	dly	dly	35	F1B	-	24-hr mostly 250 Hz
14046.5	dly	dly	30	A3E +	U/LSB	24-hr on freq to S9
14058 +/-	0005+	dly	30	A1A	-	Ch 'Helsreiber'
This station location poss Shanghai. Op experiences QRM from US amateurs!						
14074.5	dly	dly	34	A1A	VRQ	VTN 5ltr code
This station appears to use Spark when challenged, with obvious results!!						
14140/1	dly	dly	45	A1A	UMS	+F1B 250 Hz USR
This freq also used by UPC8, ULY4, L1WO calls only no tfc						
14171	mni	mni	27	F1B	UMS	18 hrs on freq USR
14211.5	dly	dly	27	F1B	-	24-hr 70%tfc 250Hz
14215	1000+	1006	45	A1A	9TF or	UDE depends on Op
14217.5	0500+	dly	23	F1B	-	12 hrs 60% tfc time
14220.5	mni	mni	17	2xR7B	-	24 hrs 100% occupy
21032	0500+	2606	10	F1B	UMS	URS 250 Hz Sync
21115	0355+	mni	44	A1A	CQ5	This station Alias
F9T can be hrd on 13625 MHz from 1200z on . . . So, why must they use our frequencies?						
21283/4	0500+	mni	16	F1B	UMS	URS 250Hz Sync
28575	mni	mni	11	A3E	-	B/cast talks & prayers. Could be Yemen

It is pleasing to note the interest in obtaining the Modes tape, but I would like to see the same interest in the supply of observer log sheets, filled in with the intruders you have heard since receiving your tape. This is the reason for supplying those tapes. AR has, over a number of months, given hints for would-be observers. Go back and re-read your magazine. I am available to guide observers, by mail or over our IW net on Friday at 0700 UTC on 3593MHz +/- QRM. (I hear sufficient VK2 and VK3 stations to know the net is heard in the southern states). So, mark your calendars . . . it is about time we had some interstate input . . . if and when we go to 'Chinese Time' in VK4, the net will be held on 40m. Control station will be VK4BTW on 7075 at 0700Z.

My thanks to VKs 3XB, 4BG/4YD, 4AKX, 4BHJ, 4BXC, 6RO, 6XW, 7RH, 8HA. Hope I have not missed anyone.

If we could get rid of these universal intruders, just maybe the rest would go away!! Most of these are long-term offenders and will take all the expertise of DoTC to convince them of their misguided ways. Maybe a few toes will have to be trodden on, but we simply cannot allow any of these countries to dictate to us. ar

SPOTLIGHT ON SWLING

ROBIN L HARWOOD VK7RH
52 CONNAUGHT CRES WEST LAUNCESTON 7250

Just as I was compiling this month's column, the big news broke about the Iraqi invasion of the tiny Gulf state of Kuwait. As many experienced monitors are aware, Kuwait has an extensive HF service, which is easily audible in this region. It has put in consistently strong signals from 0200 hours UTC on 15495 and 15345 kHz with the 'Holy Quran' program and 17895 and 13610kHz transmission of the normal home service output. But, after the invasion, the programming has been combined. I'm at present unable to ascertain whether the audio that is being currently observed is under Iraqi control, or is it a clandestine operation in support of the Kuwaiti rulers, who reportedly fled to Saudi Arabia? I suspect the latter, because I keep hearing the Iraqi 'bubble' jammer on 15505 kHz. The station continually broadcasts music with occasional Arabic announcements.

I am not proficient in Arabic, along with the majority of western DXers. This highlights the severe handicap that we face in trying to unravel the fast-changing volatile situation that exists in the Mid-East. I personally find that tuning to English language broadcasts from regional stations keeps me in touch with fast-breaking developments. Stations such as R Kol Israel in Jerusalem at 0400 UTC on 15640 or 11655 kHz and UAE

Radio in Dubai at 0530 on 15435 kHz do have excellent English newscasts at that time. Kuwait itself did have an English news bulletin at 0530, but I suspect this has now been suspended. The BBC World Service still provides the most reliable overall view of what is happening there.

I would recommend that you keep monitoring the Kuwaiti channels, as Iraq does not have a very reliable HF signal. If they do go ahead and formally annexe Kuwait, I anticipate they will utilise the Kuwaiti site. At present, signals are holding up. 11990 has a bad ripple through its carrier, while the other channels seem all clear, the best one being 15495 or nearby 15505 kHz. Signal strength is sustained until 0900 UTC on 15 MHz.

I do note that UAE Radio in Dubai has not aired much on the crisis so far. It did report that its leaders went to Saudi Arabia, mainly concentrating on other international stories that had no relationship with the Kuwaiti situation. This is indicative of their sensitivity to Iraqi intentions. The Iraqis singled out the UAE at the same time as Kuwait, over the oil crisis.

Turning to Europe, the date for German reunification is now 2 December. There has been intense speculation over the future direction of international broadcasting from a

united Germany. Clearly the staff at Radio Berlin International have become worried over their future amalgamation with Deutsche Welle in Cologne, judging by their recent comments over their mailbag program. It will also see a deleted country reappear, for West and East Germany were separate DXCC countries. Also, my scribes tell me that we should expect to hear a legitimate ZA ham call on-air at any time, since Albania has emerged from its self-imposed isolation.

Incidentally, I'm back on packet, and will hopefully be contributing to an up-to-date SWL BBS. Don't forget there are important seasonal changes this month on Sunday 1 September and 30 September. The latter date is when the majority of northern hemisphere countries revert to standard time, so most broadcasts to European audiences will be one hour later. So, until October, the very best of DX and good listening! ar

AMATEUR
RADIO
HELPING
OUR
COMMUNITY.

FTAC NEWS

JOHN MARTIN VK3ZJC
FTAC CHAIRMAN

Band Plans

A report on Federal Council's resolutions has been given in WIANEWS elsewhere in this issue. Several matters (listed below) have been held over until October so, if you have any comments, please get them in soon!

50MHz Beacon Segment

The proposal is to establish a beacon segment for VK5/6/7/8/9 outside the DX Window at 50.250-50.300 MHz. This would allow continuous duty beacons to operate at 50 MHz without causing overcrowding or QRM in the 50.050-50.200MHz segment. Channels would be allotted on the same pattern as for the higher bands, ie 50.250-50.259 VK5, 50.260-50.269 VK6 etc. The 50.270-50.279 segment would not, of course, be available for VK7, so the space could be used by VK5 or VK6 if necessary in the future.

Rather than allot channels at 5kHz spacing, the suggestion is for a 2kHz channelling. This would provide space for new beacons in these call areas, and allow enough channels for existing 52MHz beacons to move down to 50 MHz.

23cm Band Plan

The band plan revision to restore an ATV channel at the top end of the band involves deleting the linear translator segments in the existing plan, and moving the voice and data simplex segments to 1283-1285 MHz. This would allow a VSB ATV channel at 1285-1292 MHz, which would make in-band ATV repeaters possible. This change will NOT affect the FM repeater channels.

The band plan for 1280-1295 MHz would therefore become (changes asterisked):

1280-1281 MHz Repeater Links
1281-1283 MHz Repeater Outputs
1283-1284 MHz FM simplex: Data*
1284-1285 MHz FM simplex: Voice*
1285-1292 MHz ATV: VSB AM*
1292-1293 MHz Repeater Links
1293-1295 MHz Repeater Inputs

Packet Radio Channels

The proposal to extend the two-metre packet radio segment to 144.700-144.925 MHz inclusive will double the number of available packet radio channels. This should be ample for future expansion, and may also provide more voice simplex space at 147 MHz, as packet systems move into the new segment. FTAC does not support any further extension of this segment below 144.700 MHz.

To ease pressure on the two-metre band, FTAC proposes finalising a packet channel allocation on the 70cm band. The suggestion is to allot five channels at 439 MHz, plus the five corresponding channels five MHz lower at 434 MHz. The suggested channels are:

439.050	439.075	439.200
439.225	439.250	434.050
434.075	434.200	434.225
434.250		

The first three 439MHz channels are already in use by packet radio systems. Adding the next two provides a block of three channels at the very 'top end' of the simplex segment. It is recommended that the 434MHz channels be preferred wherever possible for BBS forwarding and high-speed data transfer. Comments from packet radio groups would be appreciated.

Revision of EME/DX Segments

This proposal was published in July 'AR'

and is repeated here, with some clarification, for anyone who may still wish to comment. Feedback so far has been favourable.

(1) 2m, 70cm, 23cm and 13cm bands:

Extend the EME allocations as follows: 144.000-144.050; 431.950-432.050; 1295.900-1296.050; 2303.900-2304.050 MHz. Drop the .050 DX M/S calling frequency — it is only used on six metres. Move the CW calling frequency up to 144.05, 432.05, 1296.05 and 2304.05 MHz.

(2) Higher bands:

Extend the EME segments on these bands to 100 kHz either side of 3456, 5760 MHz etc, and retain only two all-mode calling frequencies (3456.1, 5760.1 etc (primary) and 3456.2, 5760.2 etc (secondary)).

Repeater Linking

Federal Executive is pursuing the issues of off-air linking, repeater identification and tone access. Through Federal Council, the Divisions have adopted the following standard CTCSS access tones:

123 Hz: for use if needed with repeaters suffering from cross-modulation or pager interference;

141.3 Hz: for access to linked repeaters with outputs on bands other than two metres.

Packet Radio Protocols

I would appreciate any comments on packet radio identification requirements, especially in relation to protocols such as Rose, Netrom etc.

New VHF Records

The Tasmanian six-metre record set by Joe VK7JG in 1982 has now fallen to Moss VK7IK, who worked Carey WR3QM on 27 April. The contact was CW, with Moss using only 15 Watts. Carey has apparently been active on six metres for over 40 years, and Moss was his first VK contact.

Nick Tebneff VK5NT and Des Cliff VK5ZO have extended their South Australian 10GHz record to 214.6 km. ar

ALARA

JOY COLLIS VK2EBX
PO Box 22 YEOVAL 2868

Dubbo ALARAMEET 29/30 September 1990

With only a few weeks to go to the Dubbo ALARAMEET final arrangements, programs etc have been organised efficiently by Maria VK5BMT, and all we need now is a fine weekend. Regardless of the weather, the weekend promises to be most enjoyable.

Tours have been arranged to the Western Plains Zoo, Jinchilla Gallery and Gardens and Old Dubbo Gaol. Our 'headquarters' for

the two days will be the Willoughby Room at the Orana Education Centre.

Time has been allowed for an open forum discussion, so if you have any ideas or comments you feel need 'airing' this will be your opportunity.

Those travelling to Dubbo who have mobile HF equipment are asked to check in with the Australian Travel Net at 0300 UTC on 14.116 MHz. The net control in VK6 is aware of the fact that ALARA members will be travelling to Dubbo in September, and will be pleased to

hear from you. There are relay stations standing by in other states, in case propagation is poor. In addition, if you are unable to call during the day, Maria VK5BMT and Keith VK5MT will monitor the normal ALARA 80m frequency (3.580 MHz) at 10.30 UTC. In Dubbo, they will be listening on 2m FM simplex, 146.550 MHz.

Maria would like to make up a group to dine out Friday night (28 September). Please let her know if you can be included.

It is not too late for anyone unable to make a firm decision to attend the ALARAMEET until the last week or two. Sometimes it is not possible to make definite arrangements in advance. Maria would be delighted to hear from you, and your name can still be included, together with those who will be accompany-

ing you.

Dubbo, here we come!

Amateur Radio Examinations

Christine Taylor VK5CTY, an accredited examiner, will be in Dubbo for the ALARA-MEET at the end of September from Thursday 27, and will be available to conduct examinations in the Dubbo area. Anyone wishing to take advantage of this facility please contact Christine so arrangements can be made.

YL Contests

JLRS 19th Party Contest:

Phone:

29 Sept 1990 at 0300 UTC to 30 Sept 1990 at 0300 UTC

CW:

6 Oct 1990 at 0300 UTC to 7 Oct 1990 at 0300 UTC

Exchange — OMs: RS or RST & QSO number starting at 001

YLs: RS or RST & QSO number starting at 2001

JLRS members: RS or RST & QSO number starting at 5001

Separate consecutive QSO numbers for CW and PHONE contests.

Entry limited to either:

Class A: more than 4 bands

or Class B: less than 3 bands.

Logs must be postmarked not later than 20 October 1990, and sent to: The Contest Custodian, Nobuko Wakabayashi JG1QQG, 5-21-7 Megurohoncho Meguro-ku, Tokyo 152, Japan.

YLRL Howdy Days:

5 and 6 September 1990

Logs to: Dana Tramba N0FYQ, 120 N Washington, Wellington KS. 67152, USA.

Here and There

The ALARA 15th Birthday Activity Day on

ALARA Award Update

No	Date	Recipient	Callsign	Stickers
158	12.4.90	Audrey Whiffin	G0CTQ	
136	23.5.90	Dawn Young	ZL2AGX	2
159	18.6.90	Val Rickaby	VK4VR/VK4KCJ	8
160	18.6.90	Trevor Boyd	VK4ARB	

Our Awards Custodian has requested that all applicants read the rules carefully to avoid disappointment.

28 July was disappointing. Very few YLs were heard on air that day, resulting in few contacts being made.

Birthday luncheons were held in VK5 and VK3 on 29 July. These were well attended.

Good to hear Elwyn VK2DLT on air once more after a long spell of 'silence'.

I enjoyed a visit from Doug VK5PDT and Bev in July. Bev, who is a member of ALARA, was able to participate in the ALARA Net on 23 July from this QTH. Unfortunately, conditions were very noisy on 80 metres, and we were unable to stay on air for long.

Weather played havoc with the 80-metre aerial of Marjorie VK2VME in July, when strong winds blew it into the swimming pool. Gwen VK3DYL also had antenna problems.

On the credit side, Meg VK5AOV now has a new 10-metre antenna, and Jenny VK5ANW has at long last got a 20-metre antenna operational, and hopes to be active on that band.

Aimee FK8FA, winner of the 1989 ALARA Contest, is, at the time of writing, very active from French Guiana, callsign FY4FC, and has worked some exotic DX from that QTH.

Diana G4EZI is looking for WARO members in a bid to achieve the WARO Century Award (not an easy award to gain). Any WARO members hearing Diana, please give her a call, as she is putting a great deal of effort into the attempt, despite poor health.

Membership

Callsign of new member Paddy VK5ZYB was erroneously given as VK5ZBI in July ALARA column.

Welcome to new member Robyn VK3ENZ.

Welcome back to former members who have rejoined: Elwyn VK3DLT and Zdena OK2BBI.

Congratulations to Jo-anne VK4CYL (formerly VK4JO) on upgrading.

Additions to membership list (June 'AR')

VK2DLT	Elwyn
VK2YQK	Wendy
VK3ENX	Robyn
VK4ASK	Jill
VK4BSQ	Wendy
VK4CEK	Cathy
VK4JOY	Joy
VK4MDG	Sally
VK5FK	Vicki
VK5LM	Lorraine
VK5YJ	Joy
VK5ZYB	Paddy

Susan Mahony	
VK6QL	Trish
G4OUZ	Joy
JA6KYP	Etsuko
KE5UO	Mary
K8ME	June
OK2BBI	Zdena
KA1OKF	Cathi

Corrections to membership list, June 'AR'.

Printed as:	Should be:
VK4ANZ Noela	VK4ANJ
J36JQC Mizuyo	JE6JQC
WB3CON Ruthanna	WB3CQN
WD5FOX Darleen	WD5FQX
KO7Q Shirley	KQ7Y
N0FYO Dana	N0FYQ
F0CCI Angelika	G0CCI
GM4LUX Shirley	GM4LUS
V37LOH Muriel	VE7LQH
ZL2BBOV Anne	ZL2BOV

Until next month, 73/33, Joy ar

DIVISIONAL NOTES

FORWARD BIAS

PHIL CLARK VK1PC

Three new members were accepted at the committee meeting held on 12 June. The ACT Division extends a welcome to David Ellis VK1LSD, Eric Erho VK1EE and Joseph Shavez VK1AJC.

Several very important items were discussed, including the possible impact of recent amendments to the Crimes Act on the hobby of amateur radio. Our Federal Councillor, George VK1GB, is in contact with the

appropriate department and is hopeful of a satisfactory resolution to this matter shortly.

Divisional Office

The new divisional office has been opened in the Griffin Centre. The telephone number is (06) 247 7006. You may leave a message on the answering machine about your enquiry, and it will be attended to as soon as possible. The office will be staffed by volunteers, so if you are able to put in one or two nights occasionally, let any member of the committee know. At the time of writing, the staffing hours have not been finalised. The plan is to

have the office open two or three nights a week between about 6pm and 8pm, but this might take a little while to finalise, so please be patient if the office is not yet open all the hours you would like. At least we have made a significant step forward! Some of the services available to members from the office are:

- Membership
- Book sales
- QSL Bureau
- QSL addresses
- Lodging of broadcast items
- Reference library
- Bulk buys/sales
- General enquiries

Members will be able to chat with the person on duty if the office is open by calling

on two metres via VK1RGI. The callsign of the office is VK1WI.

Technical Topics

At the time of writing, the 1990 technical symposium was due to be held on the weekend of 25/26 August. The planning and preparation for this have been very smooth and the indications are for a very successful weekend. Registrations have been received from the ACT and surrounding area, with some from as far away as Melbourne and Sydney. The symposium was organised by the VK1 packet group and co-ordinated by Gavan VK1EB, who is to be congratulated on his efforts. If you would like to know more about packet in the VK1 area, the packet group holds regular meetings about the middle of each month and anyone interested is welcome to attend. Meetings are usually held at the old South Curtin primary school. The dates are announced regularly on the VK1 divisional broadcast.

Demonstration Station

To promote the hobby of Amateur Radio, a demonstration station will be set up at the Hall markets on the first Sunday of each month. Volunteers are needed to man (person?) the station and to explain the equipment and hobby to anyone interested. If you can help out with this station, please contact George VK1GB QTHR or via two metres. You do not need to spend much time, and you don't have to come every month, but the more we have, the less each has to do. So, what about it? Will YOU come along and help promote amateur radio to the community? George would certainly be pleased to hear from all those who can help out, even if only once.

73 UNTIL NEXT TIME,

PHIL

VK2 NOTES

TIM MILLS VK2ZTM

Welcome to spring. The major activity for this month will be the WAM90 meeting being convened by the Orange Amateur Radio Club on Saturday, 22 September at Orange. Details have appeared in Club Corner notes, VK2WI broadcasts and personal mailouts.

A note to repeater groups. Recent changes to the six-metre band plan have made available a total of 18 channel pairs for repeaters on six metres. Eleven are available for sharing. Any group interested in registering for a channel should advise the State Repeater Co-ordinator by 14 September, c/- PO Box 1066, Parramatta, 2124. Channels on this band will have to be worked out on a national basis to try and site systems in the skip nulls from each other. To date, interest has been expressed by Tamworth, Nowra and Western

Sydney regions. All applications received by that date will be forwarded to FTAC to determine how many suitable channels are available.

On the two-metre side of things, I understand that it is now difficult to find a channel, even to be shared, which is not within range of another system. With this in mind, amateurs should keep their power level down, so as to work the intended system. There is little point in leaving the linear on, plus perhaps the beams, just to work the local repeater on the next hill. There is still plenty of room on 70cm for systems, a band which needs much more activity. Likewise 23cm: plenty of room for everything here.

Are there any clubs or groups interested in setting up automatic Morse training beacons on two metres? A low-powered transmitter, vertical antenna and an old computer can establish a service to future amateurs in your region. Sydney is well served by VK2RCW on 144.950 MHz, which also has its 80-metre transmission on 3699 kHz. It operates continuously. The nightly Slow Morse session 3550 kHz provides further sources for learning the code. There are still times when these services are not available in your area, and this is where a service in your region can be a benefit. The frequencies available are 144.950 and 144.975 MHz.

A reminder that the news headlines from the VK2 Division are now available on (02) 552 5188. You may leave your comments at the end of the text. The old service from Dural (651 1489) has been taken out of service after several years of operation. This number will remain on line for a while to communicate the new number, as well as providing general Divisional Information.

The next major Sydney region WICEN exercise will be the Hawkesbury Canoe Classic on the weekend of 3 and 4 November. In the Hunter Region there is the Lake Macquarie Chase. Contact Philip VK2IW for details. Hunter WICEN hold its weekly net on VK2RAN 6900 at 8pm Wednesday. From 20 to 29 September there is the Tour De Force, a 10-day cycle exercise from Sydney to the Gold Coast. This requires assistance from amateurs on the North Coast. Contact Morton VK2DEX for details. Phone (W) (02) 356 5419, (H) (02) 646 1187 or fax (02) 356 5443.

During August, the slightly delayed WICEN information package to clubs was sent out. Check with your local club if you would like details about WICEN (NSW) Inc. The WICEN membership register has now been put on computer, for better or worse. Part of the operation will be to get in touch with all past WICEN members.

The first of the personal classes conducted by the VK2 Division for some years started at Amateur Radio House, Parramatta in late July. If you have an interest in either the personal classes, correspondence course or examinations, contact the Divisional office by

mail to PO Box 1066, Parramatta 2124. Fax on (02) 633 1525 or phone on (02) 689 2417 (answering machine across the line or) answered live from 12 noon to 1pm weekdays or 7 to 9pm Wednesday.

Club notes to VK2WI can be sent by fax or mail to the office. Mail by Friday morning or faxes by 6pm Friday. When you submit notes, please write them in the third person. It is difficult for the announcers to read them about your club when they are in the first person. The roster for the final quarter of this year will be drawn up later this month. Contact Steve VK2KXX with your suitable or unsuitable dates.

It is now a suitable time for any club or group to advise the Division of the dates of its activities next year — if known — so that we may draw up a calendar of events for 1991. Also, have you had elections recently, or club details changed? Send updates to the office so the various inquiries received may be correctly directed.

New Members

Our usual warm welcome to the following who recently joined the NSW Division of the WIA.

R C Brown	VK2GFO	Broulee
A M Brooke	VK2VMB	Nambucca Heads
G M Campbell	Assoc	Orchard Hills
A Grados	Assoc	Penshurst
R J Hutchison	VK2MGZ	Fairfield West
C Hynds	VK2KLS	Georges Hall
M J Ickinger	VK2NNU	Guildford
D R Leys	Assoc	Blaxland
W J Mather	VK2KDP	Winston Hills
J W Nicol	VK2FAF	Warrawee
H Walters	Assoc	Cromer

VK4 NOTES

ROSS MUTZELBURG VK4IY

VK4 Bookshop

Anne VK4ANN and Guy VK4ZXZ have decided to retire at the end of 1990, and we are looking for prospective volunteers. I don't think many of you realise the amount of time and effort Anne and Guy have put into the bookshop for over 10 years, and they are looking to a well-deserved rest.

We'll miss their cheery smiles and friendly help at club meetings and hamfests in 1991, but look forward to hearing more of them on air in their newfound spare time.

On behalf of myself, and my predecessors over the past 10 years or so, thanks to 'the Minters' for a fantastic job.

Congratulations Ron and Bill!

At the July Federal Executive meeting, Federal Councillor David VK4YAN had the pleasure of making a presentation on behalf of the Queensland Division.

Ron Fisher VK3OM and Bill Roper VK3ARZ

were presented with the VK4 Distinguished Service Awards Nos 8 and 9 in recognition of their very valuable contribution through the Federal News Tapes.

The tapes were always a favourite in Queensland, nearly always being the first item in our broadcast. Although we still receive the scripts for local taping, we miss Ron and Bill's familiar voices.

Again, thanks for a great job, and VK4 would always welcome a return of your tapes.

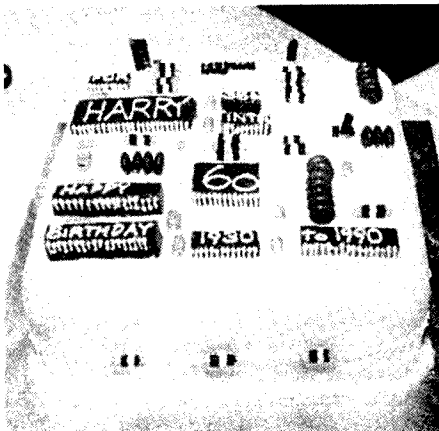

State WICEN co-ordinator Harry Standfast VK4ASF recently was the recipient of some very fast food. Reliably reported as 33 MHz birthday cake (see pictures). Harry thinks this is as close as he will get to his dream machine. Four generations of the family attended a Sunday surprise 'lunch and the future Ops all stood around while the Chief Op tried out his new laid-back operating chair.

The cake, made to order by his daughter, with colour-coded liquorice assortments of suitable speed to match the CPU, and 'Smartie' capacitors, was voted a huge success by the whole family, especially the littlies, who

demonstrated just how fast 'fast food' can go!

Your volunteer organisers are definitely a dedicated lot. Harry had arranged an Australia-wide WICEN State Co-ordinators net for that very same day, since it was all a surprise, and had to leave early to attend the phone conference — his family now knows where it comes in his list of priorities! We are lucky people.

5/8 WAVE

JENNIFER WARRINGTON VK5ANW

Buddy System — All Systems Go!

Well, perhaps I exaggerate a little, but I am pleased to be able to announce that we have a co-ordinator. Don Nairne VK5DON has volunteered to take on the job. However, I am sure that Don would be pleased to hear from anyone who is willing to be a 'buddy' or help in some other way. Ph: 271 3730 (AH), 43 5200 (BH).

On the publications front, John Butler VK5NX has offered to be part of a team to sell publications. Perhaps you would like to join him? Meanwhile, until you hear something different, please send your orders for publications to GPO Box 1234. That way they shouldn't get lost.

Christmas is coming

The Christmas social will be on either 4 or 11 December, and suggestions for a suitable speaker are requested, bearing in mind that we try to choose a non-technical subject, as we will be playing host to our 'partners'. Please pass on your suggestions to Peter Maddern VK5PRM.

Modem Mode

The WIA(SA) Modem is again up and running and members who are able are invited to log-on. However, Bill Wardrop VK5AWM advises that you won't be able to access much on your first log-on; the simple reason being that it is for WIA members only, and you will have to wait until Bill has checked your eligibility and then told the computer that it can talk to you. If you'd like to try it, ring 289 1359.

New ATV Group Committee

There has been a change of 'top management' at the SA ATV Group. Their new president is Greg VK5ZBD, secretary is Laurie VK5ZEX and treasurer is Bob VK5ZAX. Greg has also taken over the role of relay operator for the Sunday morning broadcast — a role which has been performed for many years by Bill Simister VK5KTV. I'm sure both the WIA and the ATV Group would want me to thank Bill for his many years of dedicated service.

I know that several other clubs have had a change of committee recently. Perhaps you would like to send them to me, along with meeting times and dates, net times and frequencies etc. I will be only too happy to publish them. Who knows, it might even gain you some new members? Don't forget also, that if you can sign up one of your club members as a WIA member it benefits your club financially.

Diary Dates

Tues, 25 September — Display of members' equipment night, 7.45pm. bring along a piece of 'homebrew' equipment, talk about it (how you made it, what it does, its shortcomings or triumphs!) and you could win some cash or a voucher to help you build the next one! ar

QSL's FROM THE WIA COLLECTION (28)

KEN MATCHETT VK3TL HON CURATOR WIA QSL COLLECTION
PO Box 1 SEVILLE VIC 3139

Cocos (Keeling) Islands (Part 1)

Despite the activity of some resident radio amateurs together with DXpeditions to Cocos Island, this DXCC country is still sought by many. The island group, 2750 km NW from Perth, is less than half this distance from the island of Java. It consists of two separate coral atolls, the Southern group and the Northern Cocos Island group, approximately 24 km distant. As on most of the Indian and Pacific islands, coconut palms abound, which accounts for the name Cocos, being the generic name for the coconut palm (*Cocos nucifera*). Not surprisingly, there are two other Cocos Islands, one (TI9) north-west of the Galapagos group, and the other part of the Guam group. For this reason, the island group

is usually written as Cocos followed by Keeling in parenthesis. The word 'Keeling' is neither an alternative name nor part of the name of the islands, but serves only to distinguish these Cocos Islands from their namesakes. The name 'Keeling' is derived from the name of the discoverer of the island group, Captain William Keeling. It was the Northern, still uninhabited, Cocos Island that he discovered in 1609. At the time he was commander of the East India Company's ship "Red Dragon". These islands lay on the trade route between the rich East Indies and the Cape of Good Hope, and so by the mid-17th century, all waters of the Cocos Islands had been chartered. Captain Keeling seems to have been forgotten, although there does exist a William

Keeling Crescent in one of the island's residential areas. The Northern Cocos Island is a single coral atoll, but the South Cocos group consists of no fewer than 26 separate coral islands, only two of which are inhabited. Great interest in these atolls was shown by the famous biologist, Charles Darwin, when he visited the islands 150 years ago.

The southern atoll is roughly in the shape of a horseshoe. To the west lies West Island, the largest island of the group, being approximately 10 km long and half a kilometre wide. This is the centre of the island administration. It also contains the quarantine station, school, golf course, hospital, radio station and the homes of most of the population not native to the island. To the east, separated by the entrance to a beautiful lagoon, is South Island, and north of this, Home Island, on which live the Cocos-Malays. Further to the north of Home Island are several other small islands, including Deception Island.

The first settlement of Cocos Islands took

place in 1826, established by an English merchant and adventurer, Alexander Hare. He brought with him approximately 100 native peoples, mostly of Malay origin, together with a few Chinese and Africans. It was from these that the present Cocos-Malays are descended. In the next year, a second settlement was made — this time by Captain John Clunies-Ross of Scottish descent, who once worked for Hare. He brought with him his family from England, together with a dozen or so colonists. Both men established coconut plantations.

However, it was not long before several of Hare's employees began deserting him for the better conditions offered by Clunies-Ross. Finally, in 1831, Hare left the island, leaving Clunies-Ross to develop the copra industry. In a climate of empire building, and fearful that some other power might take over the islands, Clunies-Ross appealed for the annexation of the Cocos Islands by Great Britain. It was not until 1857, however, that Captain Fremantle of the HMS "Juno" formally declared the island group part of the British Dominions. Later, it was merged with Ceylon (as it was known at the time) for purely administrative purposes. On 7 July 1886, recognising the pioneering work of the Clunies-Ross family, the British Crown, through a royal indenture, granted in perpetuity all land on the islands above the high-water mark to George, Clunies-Ross grandson, and all his heirs. George (half Scot, half Cocos-Malay) built up the establishment left by his father and grandfather, working to this end on the island 39 years (1871-1910).

It was on 23 November 1955 that sovereignty passed from the United Kingdom to Australia; the Cocos (Keeling) Islands joining the list of Australia's External Territories. Up to 1975, the island administration was in the charge of an Official Representative but, in that year, the position was upgraded to that of Administrator. The Australian Government purchased from the Clunies-Ross family all the land of the Cocos Islands, except for a small area of a few hectares containing the Clunies-Ross estate. The family continued to work the coconut plantations with Cocos-Malay workers. The fact that these were paid in plastic tokens (redeemable for commodities on the estate) caused some resentment. These gave place to Australian currency in 1978. On 6 April 1984, the islanders voted to integrate Cocos Islands with Australia. In 1986, the Commonwealth Grants Commission Inquiry was set up, which body addressed, inter-alia, the standard of living of the Cocos-Malays. The chairperson, Judge Else Mitchell, visited the islands. The result was that housing and training schemes were put into effect. Although literature on the Cocos Islands often mentions the copra industry as an important export earner, this is no longer the case. In fact, the Department of Territories' Annual Reports of the mid-1980s indicate

financial losses in the industry.

As is the case of so many island communities, a real problem exists with unemployment, many money-earning schemes being advanced especially in the field of agriculture. In the past, some pressure had been taken off the situation by the migration of Cocos-Malays to Australia, a sizable Muslim community having been established in Western Australia. The present population (late 1980s) stood at approximately 800, the majority being Cocos-Malays living on Home Island.

ZC2MAC

The ZC2 prefix was the first assigned to Cocos Island. As early as 1930 the ITU had allocated the prefix block ZBA-ZHZ to "British Colonies and Protectorates". The Radio Amateur's Handbook of 1933 sets down some of the government-assigned prefixes of that period: Transjordania ZC1, Palestine ZC6, Nigeria ZD and Southern Rhodesia ZE — all within the allocation, but no mention of Cocos (Keeling) Islands. In the "Wireless Weekly Call Sign Book and Technical Review" of 1937, an international prefix list does show ZC2 Cocos Islands. (Christmas Island ZC3 and Cyprus ZC4 were other ZC prefixes added to DXCC lists at the time).

The ZC2 prefix continued just after World War II, the WIA QSL collection containing the early QSLs G6CU/ZC2 (March 1946), ZC2CU (April 1946) and another QSL shown here, ZC2MAC, dated May 1952. It will be noted that the Cocos Island operator, Jim McConnachie, had his station on Direction Island. This island, north of Home Island, was the site of the relay station for the Trans-Indian Ocean Telegraph Cable and the original wireless station, Jim McConnachie being one of its employees. These were British nationals, the island being a British possession at the time. Direction Island also has an interesting history.

On 9 November 1914, shortly after the outbreak of World War I, the German raider, "Emden", arrived off the Cocos Island coast. The wireless station was located on Direction Island. The "Emden's" captain, Mueller (a nephew of the Kaiser), put ashore a party of a few dozen men, who promptly set about wrecking the station. Unfortunately for the "Emden" (whose guns earlier could have obliterated the whole station, along with its personnel), it had left its getaway too late. The Australian cruiser, HMAS "Sydney" engaged in a battle

DIRECTION ISLAND - COCOS KEELING ISLANDS

ZC2MAC

(ZC2AB)

.....VK3BZ M/CW QSO May 16 1952 1148 GMT 18 Mc/a. R57459.....

Transmitter: 75 watt "GSRV TVI Proof." Receiver: HRO Antenna: Dipole

QSL via BSGB or H.M. W.T Station, c/o Box 985, COLOMBO, CEYLON

73 JIM McCONNACHIE, Op.

that saw loss of life on both sides, and the eventual retreat of the "Emden". The German raider managed to reach the Northern Cocos Island, where it sank. It was the RAN's first action of the war.

The radio-telephone link mentioned in earlier articles on Cocos Island has been upgraded to satellite telegraphic and telephone services, employing the VISTA communication system, together with a back-up service. This service is located on West Island.

Cocos Island is also important as a centre for animal quarantine. The station (on West Island) was established in 1981. Horses and cattle undergo a period of quarantine on the island before entry into Australia. In March 1990, the islanders were amazed at the arrival at the island's airport of one of the world's largest aircraft. This was the Russian Antonov 124 (on charter by the CSIRO) that picked up 76 cattle — the result of breeding experiments at the island's quarantine stations.

The islands lie only 12° south of the equator, and so are subject to both the SE trade winds and the occasional cyclone. The Cocos Islands Meteorological Office carries out a full range of observations so useful for aviation briefing and cyclone warning. It is part of the international exchange network operated by the World Meteorology Centre located at Melbourne.

Next month:

Cocos (Keeling) Islands, part 2.

Thanks

The Wireless Institute of Australia would like to express its thanks to the following for their contribution of QSL cards towards the Collection:

(Supplementary List)

Ivor VK3XB, Mavis VK3KS, Percy VK4CPA, Chris VK3JR, John VK6BA (VK6NJV), Barry VK3XV, George VK5RX.

Also to the friends and families of the following "silent key" (Supplementary List) Cliff Pickering, VK3ATP.

The 1990 DX QSL Contributors' Ladder

Frank VK2QL	163 points
Jim VK9NS	158 points
Ivor VK3XB	47 points
Ray VK3RF	37 points
Austin VK5WO	30 points
Bruce VK3BM	13 points
Barry VK5BS	12 points

Some rare prefixes received:
3G1B (Chile), CL4RCB (Cuba), EE8WP

(Spain), YW6W (Venezuela) CN5SE (Morocco), DD7JO (West Germany UFH) LY7L, HG89HQ, UP4A, YU1FW/H25 (Cyprus), CI6MV (Canada) CU7AE (Azores) VA7BBL (Canada) CW4CR (Uruguay), AY1XQH (Argentina) V21AZL (Antigua), Z27JAM, WP2AAP (Virgin Is), ZV7BZ (Brazil), 7S6FRO (Sweden), YM1ZB (Turkey), VY0CA (St Paul Is), 3X3JA (Rep Guinea), 3Y1EE (Peter Is), XX7FR (Mozambique), OB8V (Peru).

If you would like to play a part in building up the WIA, QSL collection and to save something for the future, would you please send a

half-dozen (more if you can spare them) QSLs which you feel would really help the collection along.

All cards are appreciated, but we especially need commemorative QSLs, special-event stations QSL, especially assigned call QSLs (eg VK4RAN), pre-war QSLs, unusual prefixes, rare DX and pictorial QSLs of not-so-common countries. Could you help? Send to PO Box 1, Seville 3139, or phone (059) 64 3721 for card pick-up or consignment arrangements for larger quantities of cards.

ar

CLUB CORNER

Moorabbin & District Radio Club

The annual general meeting of the Moorabbin and District Radio Club was held on Friday 20 July.

Office bearers elected at the meeting are as under:

President	Steven Cima	VK3CIM
(03) 547 5894		
Vice President	Stewart Day	VK3ESD
Secretary	Doug Richards	VK3CCY
(03) 583 4462		
Treasurer	Morrie Lyons	VK3BCC
Committee	Hans Lindner	VK3DNS
	Denis Babore	VK3BGS
Station Officer	Keith Turner	VK3CWT
Components Officer	Ray Fowler	VK3BHL
Magazine Editor	Denis Babore	VK3BGS
QSL Officer	Fred Kolb	VK3CFK
Awards Officer	Ken Millis	VK3TKR
Librarian	Alistair Duff	VK3KAD
Publicity Officer	Allan Doble	VK3AMD
(03) 570 4610		

Morrie Lyons VK3BCC and Milton Crompton VK3MN were elected to life membership in recognition of outstanding service. The club conducts a net and award night each Monday evening on 3.567 MHz at 8pm.

General meetings are held on the third Friday of each month, and natter nights on the first Friday, both at 8pm.

The Tuesday morning coffee break increases in popularity and happens each Tuesday morning at 10am.

Clubrooms are in the Turner Rd Reserve, Melway map reference 77-G-9. Club callsign VK3APC. Club telephone (when attended) is (03) 553 1483.

Swan Hill District Radio Club

Power supply to the Swan Hill District Radio Club's two-metre repeater VK3RSH was augmented at 1600 on 22 July when a wind-powered generator was placed in service. This additional power source will supple-

ment the solar cells during winter months, keeping the batteries adequately charged. This is part of current upgrading works being carried out at the repeater site. The club is hopeful, when the work is completed, to be in a position to relay the Victorian Divisional weekly news broadcasts.

To provide amateurs in the mid-Murray area the opportunity to dispose of, or purchase, used equipment, the club will be conducting a disposals sale on Saturday, 29 September. The venue will be the SES Centre in Swan Hill. So that a catalogue can be made

available at least 10 days prior to the sale day, amateurs interested are invited to have any items they wish to dispose of listed, by advising the club by 14 September, either by mail to the SHDRC, PO Box 682, Swan Hill, Vic 3585, or by telephone call to (050) 34 5208. Transactions will be privately arranged between vendor and purchaser. Please remember that WIA policy recommends the serial number of equipment offered for sale be listed.

To cover costs, the club is asking for a donation of \$2.00 from all who attend on the afternoon. Afternoon tea will be available.

ALLEN FOUNTAIN VK2YAH
PUBLICITY OFFICER SHDRC
ar

Morseword No 42

	1	2	3	4	5	6	7	8	9	10	
1											Across
											1 Gaze
											2 Cosy
3											3 Sun-up
											4 Icy rain
3											5 Touched
											6 Top
4											7 Naked
											8 Pen
5											9 Cut through
											10 Fibs
6											Down
											1 Lose colour
7											2 Split
											3 Attack
8											4 Not that
											5 Car
9											6 Ordered
											7 More soaked
10											8 Dog
											9 Seed
											10 Flower

Audrey Ryan © 1990
Solution Page 56

SILENT KEYS

DUE TO INCREASING SPACE DEMANDS OBITUARIES MUST BE
NO LONGER THAN 200 WORDS

We regret to announce the recent passing of:

Mr Frank Bridgewater VK2ZI;
Mr Ted Corton VK2BEE;
Mr E V Cramp VK4ACR.

Francis Henry Bridgewater VK2ZI

It is with regret that I announce the

passing away of Mr Francis (Frank) Henry Bridgewater VK2ZI at the age of 83 years. Frank was trapped in his burning home on 17 July 1990.

Frank came to Australia at the age of 16 years and worked on farms in SA. After some years, he eventually settled in Sydney.

He obtained a ham licence in 1933, being the only blind citizen at the time to

be granted one. His callsign was VK2ZO. Apparently the licence lapsed, and it was not until about 1968 he renewed his licence under the callsign of VK2ZI. He was an avid 'satelliter', being interested in them from early days.

He had been in ill-health for some weeks prior to these tragic circumstances.

Frank was a widower and leaves no immediate family.

I might state he came to Broken Hill in 1948 and, with his wife Gladys, opened a school of dancing, which was well patronised over the years it was open.

EDGAR OLDS VK2BY
ar

AR SHOWCASE

The World's First Intelligent Disk Cleaner

Headmax is a totally new concept in floppy maintenance, head management and diagnostics. Using only one disk, you can rapidly service your own disk drive in a professional manner. Headmax is unique, intelligent and an invaluable service aid for all serious computer users. It will even stop cleaning the heads as soon as there is no improvement in performance! No need to reboot the system,

and the program uses all of the cleaning area!

Headmax can be an intelligent cleaning disk for the office, or a complete diagnostic tool for the repairman. When a cleaning cycle is initiated from the on-screen menu, the signal level is measured automatically from the calibration information on the disk. The heads are then placed over the cleaning material on the same disk and vibrated in a lateral manner. This we believe to be also unique in that Headmax interfaces directly with

the floppy controller chip to produce this extremely efficient cleaning movement. After this, the heads are then placed over the calibration area. If there has been an improvement in amplitude, then the cycle is repeated. If there is no significant improvement, then the cycle is stopped, and so it is impossible to damage the heads. Floppy drives are now always in peak condition to minimise data errors.

For further information please contact:

Westinghouse Systems
Industrial Products Department
PO Box 267
Williamstown 3016
ar

OVER TO YOU

ALL LETTERS FROM MEMBERS WILL BE CONSIDERED FOR PUBLICATION AND MUST BE
LESS THAN 200 WORDS. THE WIA ACCEPTS NO RESPONSIBILITY FOR OPINIONS
EXPRESSED BY CORRESPONDENTS

Special Floral Event

The following information is an update and supersedes any previous information regarding VI4COF Special Event station for the Carnival of Flowers on 22 to 29 September, run by the Darling Downs Radio Club in conjunction with HHELP (Help Handicapped Enter Life Project).

1. One contact and an extract of your log sent with \$5.00 to Theo Moller, Awards Manager, MS464, Helidon 4344, to gain the Special Event certificate.

2. SW listeners need only log one contact plus VI4COF and an extract of your log sent with \$5 to Theo Moller at the above address.

3. Our basic frequencies on each band are:

Band	Phone Freq	CW Freq
80 metres	3.587 MHz	3.535 MHz
40 metres	7.080	7.030
20 metres	14.295	14.060
15 metres	21.155	21.155
10 metres	28.495	28.495

Darling Downs Radio Club (David

Drew, Secretary) PO Box 3014, Town Hall,
Toowoomba 4350.

RAAF Museum

I have recently forwarded a number of WWII items, both personal and from a local estate, to the above museum.

There must be many members of the WIA who have ex-RAAF items of historic interest to this museum. Such items need not be of WWII origin, as this museum is trying to cover the complete history of the RAAF and its parent organisation, the Australian Flying Corps, from the inception of military aviation to the present time.

Should any reader have such items of interest and be willing to donate them to this museum, I am sure they would be welcomed. The address to obtain advice if items are of interest is: Commanding Officer, RAAF Museum, RAAF Williams, Point Cook, Vic 3029.

Maybe some of our ex-RAAF members may

volunteer for liaison between Federal Office and the museum? Remember, the mementos of our service life will possibly be dumped after we pass on. Instead, later generations may derive some benefits from these souvenirs. The same applies to donation of such material to the Australian War Memorial in Canberra. Such mementos need not involve only radio and communication. Old equipment manuals, orders, donations, items of uniform, badges etc, may well be of interest.

In conclusion, I strongly advise visitors to Melbourne to ring the RAAF Museum for details of open days each week and make the trip to Point Cook to see this display of the RAAF's history.

TED ROBERTS VK4QJ
38 BERNARD ST
ROCKHAMPTON 4701
ar

*Have you advised
DoTC of your
new address?*

HF PREDICTIONS

ROGER HARRISON VK2ZTB
THE APOGEE GROUP

September Charts

For ease of use and to accommodate space restrictions in the magazine, I have provided predictions applicable for three major regions of Australia:

VK EAST. Covers the major part of NSW and Queensland.

VK SOUTH. Covers southern-NSW, VK3, VK5 and VK7.

VK WEST. Covers the south-west of West Australia.

For each of these regions I have selected six "terminals" to major continental regions of the world, or regions of particular interest, such as the Mediterranean, which covers Italy, Greece, Egypt and the Middle East. Predictions for the long path to Europe are included again this month. As 28 MHz is poor, this has been dropped and the 10 MHz band has been included on all the predictions to Europe.

From time to time, I will include predictions to cover particular DXpeditions or other activities of special interest.

The charts explained

These charts are different to those you see published elsewhere, and arguably more useful to the amateur fraternity as they give, effectively, the predicted signal/noise ratio for

each hour and for selected bands.

The charts are organised in 24 rows, one for each hour UTC (first column on the left). Don't forget to add the appropriate number of hours for your time zone, including daylight saving where it applies. The next column gives the MUF (maximum usable frequency) for each hour, followed by the field strength at the MUF, in decibels referred to 1 µV/metre (dBU). The column marked FOT gives the "optimum" frequency - the most reliable frequency for the path.

Then come five columns, one for each of five selected HF bands.

The numbers in the column represent predicted field strength at each hour in decibels referred to 1 µV/metre. Here it represents "raw" signal to noise ratio as urban noise levels are typically 1-2 µV/metre, but does not take into account the advantage offered by particular transmission modes. The results are based on a transmitter power of 100 W output (except where noted later), the use of modest 3-element beams or similar, and for "median" conditions. Where the results fall below -40 dB, no output is printed.

Enhanced conditions may improve S/N ratios by 9-15 dB. The use of CW or digital transmission modes show better results than SSB. If you've got 400 W output, you get a 6 dB

improvement. Where conditions warrant it, I have included predictions for the bands below 14 MHz, deleting the upper bands.

The predictions are calculated using a program known as "FTZ", for IBMs and compatibles, distributed by FT Promotions. If you want to know more about this program, call (02)818-4838, or write to FT Promotions, PO Box 285, Balmain NSW 2041.

Cycle 22

Solar Cycle 22 is just beginning to decline, the average smoothed yearly sunspot number having peaked at 158.1 in July 1989. But don't despair! - it hasn't declined very far. Current predictions of the smoothed value for September show a value of 142.8, which will rise to 144 in December. This is still above the January 1988 value of 141.8, so the peak of Cycle 22 has been very broad and 'flat'.

Cycle 22 has been kinder to us than Cycle 21. Smoothed sunspot values will likely remain higher than we experienced in the last cycle for 12 months or more. Such a broad peak with comparatively high sunspot numbers has not been a feature of the past few cycles, and unusual solar activity has been a boon for ten and six metre operators, providing some spectacular DX opportunities which should continue over the next two years, albeit on fewer occasions.

As the spring equinox occurs this month, there is an upswing in DX conditions, particularly favouring transequatorial paths on ten and six metres for the next few months. Make the most of it.

UTC	MUF	DBU	FOT	10.1	14.2	18.1	21.2	24.9	UTC	MUF	DBU	FOT	10.1	14.2	18.1	21.2	24.9	UTC	MUF	DBU	FOT	10.1	14.2	18.1	21.2	24.9	
1	12.8	-26	9.3	...	-20	-14	-17	-24	1	13.8	-6	9.8	-16	-5	-9	-16	-29	1	13.8	-6	9.8	-16	-5	-9	-16	-29	
2	12.8	-24	9.4	...	-24	-15	-16	-22	2	13.8	-15	9.9	-35	-14	-12	-17	-26	2	13.8	-15	9.9	-35	-14	-12	-17	-26	
3	13.4	-32	10.0	...	-28	-17	-16	-20	3	14.5	-21	10.5	...	-16	-14	-16	-22	3	14.5	-21	10.5	...	-16	-14	-16	-22	
4	16.1	-26	11.3	...	-36	-19	-15	-16	4	17.1	-22	11.7	...	-37	-19	-14	-14	4	17.1	-22	11.7	...	-37	-19	-14	-14	
5	19.7	-18	14.8	...	-23	-15	-13	...	5	21.2	-15	15.7	...	-24	-15	-12	...	5	21.2	-15	15.7	...	-24	-15	-12	...	
6	22.8	-13	17.2	...	-26	-16	-11	...	6	24.6	-11	18.2	...	-28	-17	-11	...	6	24.6	-11	18.2	...	-28	-17	-11	...	
7	24.8	-10	18.7	...	-25	-15	-10	...	7	26.5	-9	19.7	...	-29	-17	-10	...	7	26.5	-9	19.7	...	-29	-17	-10	...	
8	25.6	-7	19.3	...	-22	-12	-9	...	8	26.1	-9	20.3	...	-27	-16	-9	...	8	26.1	-9	20.3	...	-27	-16	-9	...	
9	26.3	-3	19.8	...	-26	-15	-7	-4	9	24.4	-9	20.7	...	-21	-13	-8	...	9	24.4	-9	20.7	...	-21	-13	-8	...	
10	25.7	-1	19.8	...	-25	-8	-3	-1	10	21.9	-9	17.3	...	-34	-16	-10	-8	10	21.9	-9	17.3	...	-34	-16	-10	-8	
11	24.4	1	19.4	...	-14	-2	1	1	11	19.8	-8	15.7	...	-23	-10	-7	-9	11	19.8	-8	15.7	...	-23	-10	-7	-9	
12	23.0	3	18.2	-28	-3	4	4	1	12	17.8	-7	12.8	...	-6	-7	-12	...	12	17.8	-7	12.8	...	-6	-7	-12	...	
13	21.9	5	17.4	-13	4	7	6	1	13	16.2	-3	12.8	...	23	5	4	-8	16	13	16.2	-3	12.8	...	23	5	4	-8
14	20.8	7	16.4	0	10	10	7	0	14	15.1	-1	11.9	-7	1	-2	-10	-22	14	15.1	-1	11.9	-7	1	-2	-10	-22	
15	19.3	9	15.3	12	15	10	6	-3	15	14.4	6	11.4	5	6	-2	-12	-27	15	14.4	6	11.4	5	6	-2	-12	-27	
16	17.8	12	14.0	19	18	11	3	-8	16	13.6	10	10.6	14	8	-3	-16	-34	16	13.6	10	10.6	14	8	-3	-16	-34	
17	16.7	13	13.1	22	18	9	0	-13	17	13.2	11	10.5	17	7	5	-18	-38	17	13.2	11	10.5	17	7	5	-18	-38	
18	15.1	13	11.7	22	15	5	-4	-22	18	12.4	13	9.6	18	7	-8	-24	...	18	12.4	13	9.6	18	7	-8	-24	...	
19	13.4	14	10.3	21	12	-2	-15	-34	19	11.8	13	9.0	18	5	-12	-29	...	19	11.8	13	9.0	18	5	-12	-29	...	
20	14.1	14	10.8	22	13	1	-11	-29	20	13.0	13	9.9	20	10	-5	-20	-40	20	13.0	13	9.9	20	10	-5	-20	-40	
21	15.6	12	11.0	21	15	6	-4	-19	21	16.3	14	11.2	25	18	9	-1	-15	21	16.3	14	11.2	25	18	9	-1	-15	
22	16.6	8	10.4	0	4	-2	-11	-24	22	15.3	-34	10.7	15	12	4	-6	-20	22	15.3	-34	10.7	15	12	4	-6	-20	
23	14.2	-7	10.0	-22	7	-7	-13	-24	23	14.9	10.4	-1	4	-1	-9	-21	...	23	14.9	10.4	-1	4	-1	-9	-21	...	
24	13.6	-17	9.7	-40	-15	-12	-15	-24	24	14.3	-6	10.1	-22	-6	-7	-12	-23	24	14.3	-6	10.1	-22	-6	-7	-12	-23	

UTC	MUF	DBU	FOT	10.1	14.2	18.1	21.2	24.9	UTC	MUF	DBU	FOT	10.1	14.2	18.1	21.2	24.9	UTC	MUF	DBU	FOT	10.1	14.2	18.1	21.2	24.9
1	15.2	-13	10.2	...	-15	-10	-11	-17	1	14.5	-17	10.0	...	-18	-12	-13	-20	1	14.2	-27	9.9	...	-27	-18	-17	-21
2	14.8	-10	10.1	...	-11	-8	-10	-18	2	14.0	-12	9.8	-32	-12	-10	-14	-22	2	13.7	-25	9.6	...	-23	-16	-17	-23
3	14.4	-7	9.8	-23	-7	-7	-11	-20	3	13.1	-9	9.5	-12	-5	-10	-18	-26	3	13.1	-22	9.3	...	-19	-15	-18	-26
4	13.2	-4	9.4	-13	-3	-7	-13	-25	4	12.6	-5	9.0	-12	-5	-10	-18	-26	4	12.3	-20	8.9	...	-16	-14	-20	-31
5	13.4	0	9.5	-5	0	-5	-13	-23	5	12.7	-1	9.2	-5	-2	-9	-19	-34	5	12.3	-15	9.0	-25	-12	-14	-21	-32
6	14.0	5	10.1	3	5	-2	-10	-23	6	13.3	3	9.7	2	3	-6	-16	-31	6	13.0	-11	9.6	-21	-9	-12	-19	-30
7	16.9	8	12.2	9	11	6	0	-10	7	15.7	7	11.7	8	9	3	-5	-17	7	15.3	-4	11.4	-16	-5	-6	-11	-21
8	20.7	7	15.2	1	10	9	6	0	8	19.1	14.2	7	12	9	4	-5	...	8	18.4	0	13.7	-14	-1	0	-4	-10
9	17.7	2	13.6	-17	-1	2	0	-6	9	9.5	4	13.5	7	5	5	1	-5	9	9.1	2	15.9	-15	0	3	0	-4
10	16.9	-6	12.9	-37	-11	5	-5	-10	10	17.5	-2	12.1	-21	-4	-2	-5	-12	10	17.4	0	17.1	-21	-5	1	0	-4
11	16.7	-13	13.2	...	-21	-11	-10	-14	11	15.7	-10	10.8	-17	-13	-9	-11	-17	11	19.4	-5	15.3	-36	-12	-6	-4	-10
12	15.5	-22	12.2	...	-28	-16	-13	-16	12	14.6	-18	10.0	...	-20	-13	-14	-19	12	17.4	-13	13.6	...	-21	-12	-12	-15
13	14.7	-29	11.6	...	-32	-18	-15	-17	13	13.8	-27	9.6	...	-25	-15	-15	-20	13	15.6	-22	12.3	...	-27	-17	-15	-19
14	13.8	-36	10.8	...	-33	-19	-16	-17	14	12.9	-34	9.0	...	-27	-16	-16	-19	14	14.5	-30	11.5	...	-32	-19	-17	-20
15	13.3	-40	10.3	...	-37	-21	-18	-19	15	12.3	-40	8.6	...	-40	-27	-25	-29	15	13.7	-37	10.8	...	-34	-20	-18	-20
16	12.5	-45	9.6	...	-40	-26	-28	...	16	11.6	...	8.2	...	-39	-37	16	12.9	-40	10.1	...	-39	-26	-28	...
17	11.9	-49	9.0	...	-42	-26	-22	-23	17	11.3	...	8.1	...	-39	-37	17	12.3	-43	9.5	...	-39	-35	-37	...
18	11.1	-52	8.3	...	-43	-26	-22	-23	18	11.2	...	8.1	...	-39	-35	-37	...	18	11.6	...	8.9	...	-39	-35	-37	...
19	10.7	-54	7.6	...	-44	-26	-22	-23	19	10.8	...	7.9	...	-39	-35	-37	...	19	11.2	...	8.5	...	-39	-35	-37	...
20	10.3	-56	7.0	...	-45	-26	-22	-23	20	10.4	...	7.6	...	-40	-21	-16	-16	20	12.4	...	9.3	...	-38	-34	-36	...
21	10.0	-57	6.5	...	-45	-26	-22	-23	21	10.0	...	7.3	...	-40	-21	-16	-16	21	11.5	-35	12.0	...	-38	-34	-36	...
22	9.8	-57	6.1	...	-45	-26	-22	-23	22	9.8	...	7.0	...	-40	-21	-16	-16	22	17.5	-27	12.3	...	-38	-34	-36	...
23	9.7	-57	5.9	...	-45	-26	-22	-23	23	9.7	...	6.9	...	-40	-21	-16	-16	23	16.3	-29	11.4	...	-40	-23	-18	-17
24	9.6	-57	5.7	...	-45	-26	-22	-23	24	9.6	...	6.7	...	-40	-21	-16	-16	24	15.3	-28	10.7	...	-40	-23	-18	-19

UTC	MUF	DBU	FOT	14.2	18.1	21.2	24.9	28.5
1 24.6	11 18.7	8	14	14	11	5		
2 24.3	11 20.4	8	14	14	10	5		
3 24.1	12 20.0	10	15	14	11	5		
4 23.8	12 19.5	13	16	15	11	4		
5 23.2	14 18.8	17	18	16	11	4		
6 22.1	16 17.8	24	22	18	11	2		
7 21.0	20 17.4	31	25	19	10	0		
8 19.4	21 15.4	30	23	16	5	-7		
9 18.1	21 14.4	29	21	13	1	-12		
10 16.7	22 13.2	28	18	8	-5	-20		
11 15.6	22 12.4	26	15	8	-11	-26		
12 14.6	23 11.6	24	12	0	-16	-33		
13 13.7	23 10.9	22	8	-5	-22	...		
14 12.7	24 10.0	19	3	-11	-30	...		
15 12.1	24 9.5	17	0	-14	-35	...		
16 11.0	25 8.5	13	-5	-22		
17 10.2	24 7.8	8	-12	-31		
18 10.9	24 8.3	12	-7	-24		
19 14.1	18 10.9	18	7	-4	-20	-33		
20 18.7	14 14.4	17	15	9	0	-11		
21 22.4	13 17.6	16	14	9	1			
22 24.5	12 19.6	12	16	15	12	6		
23 25.0	12 20.4	10	15	15	12	6		
24 25.1	11 19.3	8	14	14	12	6		

VK EAST - STH PACIFIC

UTC	MUF	DBU	FOT	14.2	18.1	21.2	24.9	28.5
1 27.5	3 22.8	1	9	9	7	2		
2 26.9	3 22.8	2	9	9	6	1		
3 26.6	4 22.3	3	9	9	6	0		
4 26.4	4 21.9	6	11	10	7	1		
5 26.0	5 21.3	11	14	12	7	1		
6 25.2	8 20.2	19	18	15	8	0		
7 23.7	10 18.8	26	22	16	7	-3		
8 21.6	12 17.1	27	20	13	2	-10		
9 19.9	12 15.8	27	17	8	-4	-18		
10 18.1	13 14.3	23	13	3	-12	-28		
11 16.3	14 12.9	20	7	-5	-22	...		
12 14.8	14 11.7	16	2	-13	-33	...		
13 13.8	15 10.9	13	-3	-19		
14 13.1	15 10.3	11	-7	-24		
15 12.3	15 9.7	8	-12	-31		
16 11.9	16 9.3	6	-14	-34		
17 11.2	16 8.6	3	-20		
18 10.6	16 8.1	1	-25		
19 11.7	9 8.9	1	-17	-35		
20 14.9	4 11.2	5	-3	-14	-30	...		
21 19.4	3 14.8	6	5	0	-9	-21		
22 23.4	3 18.3	4	8	6	1	-7		
23 26.2	3 20.8	3	9	9	5	-1		
24 27.2	3 22.1	2	9	9	6	1		

VK STH - STH PACIFIC

UTC	MUF	DBU	FOT	14.2	18.1	21.2	24.9	28.5
1 27.6	-1 22.4	-16	-3	1	1	-2		
2 27.9	-1 23.2	-16	-3	1	1	-2		
3 27.4	-1 20.6	-15	-2	1	1	-3		
4 27.0	-1 22.7	-13	-1	2	1	-3		
5 26.8	0 21.9	-8	2	4	2	-2		
6 26.2	3 21.3	1	7	7	4	-1		
7 24.9	5 19.8	10	12	10	5	-2		
8 21.3	7 18.5	17	15	11	4	-5		
9 21.0	10 16.7	21	16	9	0	-11		
10 19.3	11 15.3	20	14	6	-5	-18		
11 17.4	12 13.8	20	10	1	-13	-28		
12 16.0	13 12.7	16	3	-9	-27	...		
13 14.9	14 11.8	16	3	-9	-27	...		
14 13.9	14 11.0	14	-1	-15	-34	...		
15 13.2	15 10.5	12	-4	-19	-40	...		
16 12.5	15 9.6	9	-7	-23	-47	...		
17 12.1	15 9.4	8	-9	-26		
18 11.3	16 8.7	5	-14	-32		
19 10.9	9 8.3	0	-18	-36		
20 12.0	1 9.1	-2	-13	-26		
21 15.2	-1 12.0	-1	-4	-12	-24	-39		
22 19.8	-1 15.2	-4	0	-2	-9	-18		
23 23.9	-1 18.7	-10	-1	0	-2	-8		
24 26.6	-1 21.2	-14	-2	1	0	-3		

VK WEST - STH PACIFIC

UTC	MUF	DBU	FOT	14.2	18.1	21.2	24.9	28.5
1 28.9	1 24.0	-18	-3	2	3	1		
2 28.6	0 21.9	-21	-4	1	2	1		
3 28.3	0 23.6	-21	-5	0	2	0		
4 28.3	0 23.4	-20	-4	1	2	0		
5 28.1	1 23.0	-17	-2	2	3	0		
6 27.6	2 22.5	-12	0	4	4	1		
7 26.7	3 21.5	-5	4	6	4	0		
8 25.7	5 21.6	7	11	10	6	0		
9 24.5	9 19.5	24	20	16	8	0		
10 23.3	10 18.6	25	20	15	6	-3		
11 22.4	10 17.6	25	19	12	3	-8		
12 21.1	11 16.8	22	18	10	0	-12		
13 20.0	11 15.9	24	16	7	-4	-18		
14 18.6	11 14.8	22	12	2	-11	-26		
15 17.0	11 13.4	19	7	-4	-20	-38		
16 15.9	11 12.5	16	3	-10	-28	...		
17 14.3	11 11.1	11	-5	-21		
18 12.6	11 9.8	4	-16	-36		
19 13.1	11 10.1	7	-12	-30		
20 15.2	12 11.7	15	1	-12	-31	...		
21 19.4	7 15.3	14	10	3	-7	-20		
22 26.3	5 20.4	2	8	9	6	1		
23 29.1	3 23.3	-7	4	7	4	0		
24 29.1	2 23.7	-14	0	4	5	3		

VK EAST - ASIA

UTC	MUF	DBU	FOT	14.2	18.1	21.2	24.9	28.5
1 30.6	1 24.9	-22	-5	1	3	3		
2 30.6	1 25.4	-25	-7	0	2	2		
3 29.9	0 23.9	-26	-8	-1	1	1		
4 29.4	0 24.6	-25	-7	-1	1	0		
5 29.1	0 24.1	-23	-6	0	2	0		
6 28.7	1 23.5	-18	-3	2	3	1		
7 27.9	1 22.6	-11	1	4	4	1		
8 26.8	3 21.2	0	7	7	5	0		
9 24.4	8 19.7	20	18	14	7	0		
10 22.5	8 17.8	22	17	11	2	-8		
11 20.7	9 16.6	22	15	7	-3	-16		
12 18.8	9 14.9	20	11	2	-12	-27		
13 17.4	9 13.8	18	7	-4	-20	-37		
14 16.3	9 12.9	16	3	-10	-27	...		
15 15.4	9 12.2	13	-1	-15	-34	...		
16 14.5	9 11.4	10	-6	-21		
17 14.0	9 10.9	8	-9	-25		
18 13.1	9 10.1	4	-15	-34		
19 12.1	9 9.3	0	-23		
20 13.2	9 10.1	5	-14	-32		
21 17.2	8 13.0	16	5	-6	-21	-38		
22 22.7	1 17.5	0	4	0	-2	-10		
23 27.3	2 21.1	-9	2	4	3	0		
24 30.0	2 23.9	-17	-2	3	4	3		

VK STH - ASIA

UTC	MUF	DBU	FOT	14.2	18.1	21.2	24.9	28.5
1 28.0	2 22.4	-13	0	4	4	1		
2 28.2	1 22.9	-17	-2	2	3	1		
3 28.0	1 23.2	-19	-4	1	2	0		
4 27.5	0 21.0	-20	-4	0	1	-1		
5 27.2	0 22.7	-19	-4	0	1	-1		
6 27.1	0 22.4	-17	-3	1	2	-1		
7 26.8	1 22.0	-12	0	3	3	-1		
8 26.2	2 21.3	-6	4	5	4	0		
9 25.1	4 20.2	4	9	8	4	-1		
10 23.9	7 20.2	17	16	12	5	-3		
11 22.8	10 17.8	20	16	10	2	-8		
12 21.0	9 16.7	21	15	8	-2	-14		
13 19.5	9 15.5	20	13	4	-8	-22		
14 18.5	10 14.7	21	11	1	-13	-29		
15 17.5	10 13.9	19	8	-4	-19	-37		
16 16.4	10 13.1	16	3	-9	-27	...		
17 15.2	9 12.0	13	-2	-17	-38	...		
18 14.4	9 11.3	10	-7	-23		
19 13.2	9 10.2	5	-15	-35		
20 11.9	9 9.2	-3	-27		
21 12.6	9 9.7	2	-20		
22 16.4	6 13.0	12	1	-10	-27	...		
23 21.7	1 16.8	1	4	2	-4	-12		
24 25.9	2 20.4	-7	3	5	3	-2		

VK WEST - ASIA

UTC	MUF	DBU	FOT	10.1	14.2	18.1	21.2	24.9
1 17.6	-9 13.6	...	-18	-8	-7	-11		
2 15.8	-20 12.1	...	-26	-14	-12	-15		
3 15.9	-24 12.1	...	-33	-17	-14	-15		
4 19.8	-17 14.8	...	-22	-14	-12			
5 25.4	-10 19.5	...	-8	-2	-10	-10		
6 29.8	-6 23.2	...	-3	-1	-9			
7 30.5	-5 24.7	...	-30	-17	-9			
8 29.2	-5 23.5	...	-27	-15	-8			
9 27.8	-5 22.1	...	-21	-11	-6			
10 25.9	-4 20.6	...	-14	-7	-4			
11 24.3	-2 19.3	...	-8	-3	-2			
12 22.6	0 17.9	...	-1	0	-1			
13 21.3	3 16.9	-2	4	3	-1			
14 20.1	7 15.9	-3	8	9	5	-2		
15 18.9	10 14.9	12	15	11	5	-4		
16 17.5	12 13.7	19	17	11	3	-8		
17 16.6	13 13.0	22	18	9	1	-12		
18 15.2	14 11.8	23	16	6	-5	-19		
19 13.7	15 10.6	22	13	1	-12	-29		
20 14.6	15 11.2	23	16	4	-7	-23		
21 19.0	13 14.4	24	21	15	8	-2		
22 20.8	11 16.1	9	15	14	11	4		
23 18.5	5 14.2	-13	4	5	2	-4		
24 19.6	0 15.2	-34	-8	-1	-1	-5		

VK EAST - MEDITERRANEAN

UTC	MUF	DBU	FOT	10.1	14.2	18.1	21.2	24.9</
-----	-----	-----	-----	------	------	------	------	--------

HAMADS

TRADE ADS

● **WEATHER FAX** programs for IBM XT/ATs. RAD-FAX2 is a high resolution shortwave weather fax, Morse & RTTY-receiving program. Needs CGA, SSBhf radio and RADFAX decoder. Also RF2HERC, RF2EGA & RF2VGA, same as RADFAX2 but suitable for Hercules, EGA & VGA cards respectively. \$35. SATFAX is a NOAA meteor & GMS weather satellite picture-receiving program. Uses EGA or VGA modes, needs EGA or VGA colour monitor and card, and WEATHER FAX PC card, \$45. All programs are on 5.25 or 3.5 discs (state which) and documentation, add \$3 postage. ONLY from M Delahunty, 42 Villiers St, New Farm, Old 4005. Ph (07) 358 2785.

● **AMIDON FERROMAGNETIC CORES:** for all transmitter and receiver applications. Send DL size SASE for data/price to RJ & US Imports, Box 157, Mortdale NSW 2223 (no enquiries at office please... 11 Macken St (Oatley). Agencies at: Geoff Wood Electronics, Sydney. Webb Electronics, Albury. Electronic Components, ACT. Truscott's Electronics, Melbourne. S Willis, Perth. Assoc TV Service, Hobart.

● **SPECIAL sale:** transmitting valves, QB 3-300 ea \$45; QB 08/200 ea \$45. All in original boxes, 5-pin giant sockets for 4-400, QB 3-300 ea \$22. We stock also electronic components and valves. D Dauner Electronics, 51 Georges Cres, Georges Hall, NSW 2198. Ph (02) 724 6982, fax (02) 725 7850.

FOR SALE — ACT

● **MICROBEE 64K** with two disk drives, monitor and modem. Ideal for running BEEPAC packet software (not supplied). Other software and manuals included. \$95 ono. VK1JL (06) 295 2352 (AH) or (06) 268 4049 (Bus).

● **YAESU FT707** (080958) all solid state transceiver (WARC freqs) with mike, manual & orig carton, plus matching Yaesu FP107E (070442) 240/13.4V power supply. \$600 the pair or offer. VK1WP (06) 254 9842.

FOR SALE NSW

● **TOWER 80ft** Southern Cross galvanised angle steel with mounting bases. EC. Supplied in kit form. Price \$1950. Laurie (02) 774 0234, (02) 587 9891.

● **TEN-TEC Paragon** all-mode transceiver. TURNER desk mike, \$2150. Power supply, 25Amp 100% duty cycle, \$520. Electronic morse keyer (c-mos) \$95. Iambic paddle chrome \$80. VK2DZD QTHR. Ph (047) 54 2299 after 6pm.

● **YAESU FT609R** 6-metre TXRXV all mode with FT6010 10W linear, \$650. DSE 6M 100W linear \$240. Martin VK2TMW. (H) (046) 27 2745, (W) (02) 680 2711.

● **ANTENNA ATN** centre 29 MHz 6 el 8.5m long 13.3dB gain, \$100 and remove from roof at Manly Vale. John VK8JW (W) (089) 81 2853, (H) (089) 81 3725.

● **PACKET HF & VHF** plus RTTY. AMTOR ASCII & CW for Commodore C64 with PK64 Pakrat by AEA. uses C64 expansion port. Complete with handbook. \$350 ono. (066) 52 7160.

● **YAESU FT200 TCVR** p/supply, manual, good app, goes well, all bands, \$275. Max VK2GE QTHR Ph: (065) 85 5732.

● **KENWOOD 120S VFO** \$150. 28MHz T/R AM-U/LSB Courier \$150. 3-inch CRO \$120. AM aircraft HF1 transmitter \$50. AM CBs \$35 & \$60 each. All offers considered. VK2AJY QTHR (043) 96 4553.

● **DECEASED** estate: valves, boxed, 150 types; Collins 51J4 EC, \$300. BC221T & AC PSU and satchel, \$120. TS175U +AC PSU \$110. ARC-55, \$70. Brian VK2KLH QTHR. (02) 545 2650.

● **KENWOOD TR8400** UHF transceiver, GC, \$350. Also TR7400 2m FM transceiver, \$250. QTHR (02) 971 9795. VK2HL

● **KENWOOD 930S** mint cond AT200 MC85 XT speaker h/phones, call Col (02) 427 4321 QTHR, also X YAGIS 2m 70cm. VK2JCO

FOR SALE — VIC

● **AZDEN PCS4000** 2m transceiver 5 or 25W 16 memories, reverse back-lit dial. No mods. New condition. Instruction book, carton, \$380. Alf VK3EJ. (AH) (03) 877 2983, (BH) (03) 873 3777.

● **OSCARBLOCK SWR/PWR** meter freq range 3.5 to 30MHz, 20 & 200W scales, VGC, \$60. Vincent VK3AJQ QTHR. (03) 872 3503 AH.

● **'AMATEUR RADIO'** 1981 to 1989, \$12 per year. Free to registered Amateur Radio clubs. VK3GI (054) 27 2576. Pick up at QTHR.

● **HAMPACK III.** Plug-in RTTY/CW/ASCII card for Apple II PC. Covers all amateur and commercial speeds and shifts. On-board modem. software & manual included. PC. \$200. Ken. VK3MW. QTHR. AH (03) 560 5278. BH (03) 522 1476.

● **KENWOOD TS830S** SN1042011 VF0230 SN1100234 MC50 deskmic. SN811+. All EC. \$900. VK3DPD QTHR (03) 818 6009.

● **YAESU** Musen FTDX 560 SSB transceiver. YAESU Musen FRG7 receiver. EMTRON EAT300 antenna tuner. Q-CRAFT SWR-2 bridge. FOSTER DF-438 50KOhm microphone. Tony Kruger (03) 337 3458 (AH).

● **KENWOOD TS520S** in EC, ideal first rig, \$450 ono. Bert VK3TU (052) 78 2374 QTHR. Can deliver in Melbourne.

● **LINEARS FL2100B** with manual S/No 280400, \$800. Heathkit SB200 with manual, \$725. Spare valves extra. GC. VK3EQO (03) 592 6236.

● **EIMAC SK800B** socket C/W SK806 chim suit 4CX1000A /1500B \$150. Brand new 4XC1500B in vac pack \$400. Stab 6V AC 28A fil supply \$45. Stab 325V DC 400mA supply \$60. Heatkit SBA-104-1 noise blander

\$40. 480pF/280pF 4mm spacing HP Johnson variables \$75. 100 & 100pF split stator Johnson \$80. Lots parts for amp builders, vernier dials, ceramic couplings etc. Gary VK3GY QTHR (03) 789 4363.

● **SHDRC** disposals sale Saturday 29 Sept 2pm at SES centre Swan Hill. Items for catalogue to be submitted by 14 Sept. Details Allen VK2YAH (050) 34 5208.

FOR SALE — OLD

● **VALVES 572B T160L** new, unused, \$375 the pair. Peter VK4APD QTHR (07) 397 3751.

● **YAESU FT200RH 25W2M** \$310. Kenwood TH21A H/H \$250 w/spkr mike. HF linear 4x4-125 1kW \$850. Mick (074) 98 2176.

FOR SALE — SA

● **YAESU FL2100Z** linear amplifier, has WARC bands and is in EC. \$990 ono. Please phone Gary VK5DX (08) 370 9196.

FOR SALE — WA

● **TMC VLF channel RX** model VLR A1 with 8 spare modules. TMC audio filter AX446. 2 Heathkit SSB (valve) transceivers HW18, not working. Power supply and manual included, swap for HF RX (solid state) or offers. Phil VK6RE QTHR (09) 341 7276.

● **YAESU FT101E** VGC \$400 ono. FTV650 VGC \$100. Sanyo b/w monitor \$50. Sanyo sync gen \$30 ASCII keyboard \$20 — 2m fm tx board (0.5W) \$20 — VK3 VHF group 2m conv \$10 — computer psu components \$20. Vidicon tube & yoke \$20. Leigh VK6WA (09) 401 5856.

WANTED — NSW

● **YC221** digital display 432 MHz, all mode T/R old model, may be able to do a swap if interested. VK2AJY QTHR (043) 96 4553.

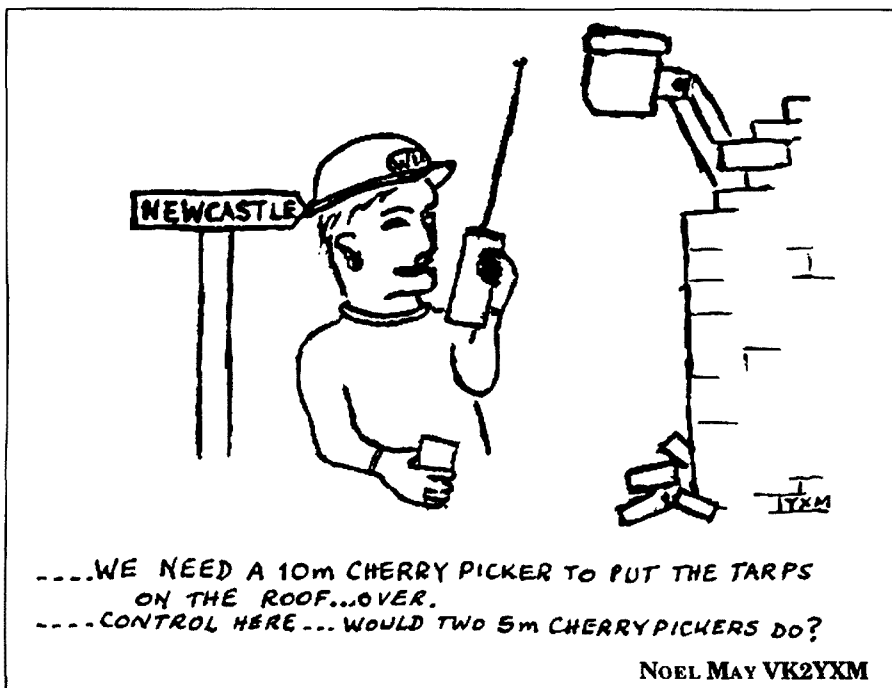

● REALISTIC patrolman 9 receiver, will pay top price for GC, but will consider other. Please phone (02) 489 5141 Bill Assoc Member.

WANTED — VIC

- CIRCUIT service info for SW receiver Sony ICF-2100D, manual or p/copy. Cost etc reimbursed. Franz VK3DVD 03 726 7137
- ANTENNA rotator with matching controller. Must be in good working condition. EG Daiwa DR7500, 7600 etc. heavy duty for HF beam. VK3AJO QTHR BH (03) 657 3385. AH (03) 872 3503.
- YAESU FC102 antenna tuner power (SWR) meter, any condition. Bob VK3BRF QTHR (03) 878 6613.
- VIBROPLEX bug, Clipsal hand key, early editions of ARRL, Radio Handbook any authentic parts to enable construction of 1920/30S (CW) station, esp 1-1/2" plug-in coil formers, dials, interstage audio transformers etc. Any vintage valves or parts of interest. Please send list and price to Garry VK3GY QTHR (03) 789 4363.
- BUYERS and sellers for Ballarat Hamvention Sun-

day 28 October 1990. Clean up the shack. Book your selling table now. Kevin Hughes VK3WN (053) 35 5011.

WANTED — WA

- ANTENNA rotator for lightweight single horizontal dipole type HB31. VK6CV PH (09) 332 8593.
- INTRUDER watch observers in VK6, free tapes, log sheets, info and advice. Please help. Thank you. Contact Graham VK6RO 451 3561 QTHR.

WANTED — TAS

- HF solid state receiver, dead or alive, 720A or similar. Pay to \$700. QTHR VK7JG PH: (003) 27 2356.

WANTED — NT

- KENWOOD TH205 or TH215 including charger, batteries etc. Details to VK8XX. Box 912 Alice Springs 0871. BH (089) 51 3138, AH (089) 53 4056. Fax 52 6893 any time.

*Profile of a Net Controller
The ANZA Net is 20 Years Old
Continued from page 30*

was moved to 21205 KHz, especially for Andrew ZS2OM a 'white cane' operator, who now has audible means of knowing his frequency.

"I know some amateurs object to nets, but one has to remember this: nets do serve a useful purpose. Many stations occupy only one frequency, and the nets allow those using simple or low-power equipment and homebrew antennas to work the DX station they might not be able to work otherwise. We welcome those who have some physical handicap and, over the years, I was happy to have them join the net," says Percy.

A few years ago Percy moved from Victoria to South Queensland near the Gold Coast, and he changed his callsign from VK3PA in May 1987 to VK4CPA.

The ANZA Net is alive and well, and is continuing to serve the DXing fraternity under the control of Percy, who sometimes gets occasional help from other net participants. We wish the Net and Percy many happy returns and continued good health for the future. ar

Kenwood Electronics Australia Pty Ltd moved on Monday 6 August to a brand new \$8 million building in the high technology Australia Centre at Homebush in Sydney's inner west.

Kenwood Electronics Australia Pty Ltd
PO Box 504
8 Figtree Drive
Australia Centre
Homebush NSW 2140

Tel: (02) 746-1888
Fax: (02) 746-1509

HAMADS

Please Note: If you are advertising items For Sale and Wanted please use a separate form for each. Include all details; eg Name, Address, Telephone Number (and STD code), on both forms. Please print copy for your Hamad as clearly as possible.

*Eight lines per issue free to all WIA members, ninth line for name and address Commercial rates apply for non-members. Please enclose a mailing label from this magazine with your Hamad.

*Deceased Estates: The full Hamad will appear in AR, even if the ad is not fully radio equipment.

*Copy typed or in block letters to PO Box 300, Caulfield South, Vic 3162, by the deadline as indicated on page 1 of each issue.

*QTHR means address is correct as set out in the WIA

current Call Book.

*WIA policy recommends that Hamads include the serial number of all equipment offered for sale.

*Please enclose a self addressed stamped envelope if an acknowledgement is required that the Hamad has been received.

Ordinary Hamads submitted from members who are deemed to be in general electronics retail and wholesale distributive trades should be certified as referring only to private articles not being re-sold for merchandising purposes.

Conditions for commercial advertising are as follows: \$22.50 for four lines, plus \$2.00 per line (or part thereof) Minimum charge — \$22.50 pre-payable.

State:

- Miscellaneous
- For Sale
- Wanted

Name:

Call Sign:

Address:

Solution to Morseword No 42

	1	2	3	4	5	6	7	8	9	10
1
2
3
4
5
6
7
8
9
10

Across: 1 stare; 2 warm; 3 dawn; 4 sleet; 5 felt; 6 dux; 7 bare; 8 write; 9 sawn; 10 lies.

Down: 1 fade; 2 rift; 3 raid; 4 this; 5 jeep; 6 bade; 7 wetter; 8 cur; 9 pip; 10 rose.

TRADE PRACTICES ACT

It is impossible for us to ensure the advertisements submitted for publication comply with the Trade Practices Act 1974. Therefore advertisers and advertising agents will appreciate the absolute need for themselves to ensure that, the provisions of the Act are complied with strictly.

VICTORIAN CONSUMER AFFAIRS ACT

All advertisers are advised that advertisements containing only a PO Box number as the address cannot be accepted without the addition of the business address of the boxholder or seller of the goods.

TYPESETTING : Redfords Media
25 Glenferrie Rd
Malvern 3144
Tel: (03) 500 0377

PRINTING: Industrial Printing
Richmond

MAIL DISTRIBUTION: Polk Mailing Co.
PO Box 140,
Collingwood,
Vic. 3066
Tel:(03) 417 5161

The opinions expressed in this publication do not necessarily reflect the official view of the WIA, and the WIA cannot be held responsible for incorrect information published.

ADVERTISERS INDEX

ATN Antennas	27
Dick Smith Electronics ..	15, 28, 29
Electronics Australia	33
Emtronics	22, 23
Icom Australia	OBC,
Kenwood Electronics Aust.	IFC
Magpubs	7
Tektronix Aust P/L	5, IBC
WIA Log Books	24
WIA NSW Division	34

TRADE ADS

RJ & US Imports	54
M Delahunty	54
D Dauner Electronics	54

HOW TO JOIN THE WIA

Fill out the following form and send to:

The Membership Secretary
Wireless Institute of Australia
PO Box 300
Caulfield South, Vic 3162

I wish to obtain further information about the WIA.

Mr, Mrs, Miss, Ms:

Call Sign (if applicable):

Address:

State and Postcode:

The World's Best-Selling Family of Affordable, Portable Scopes.

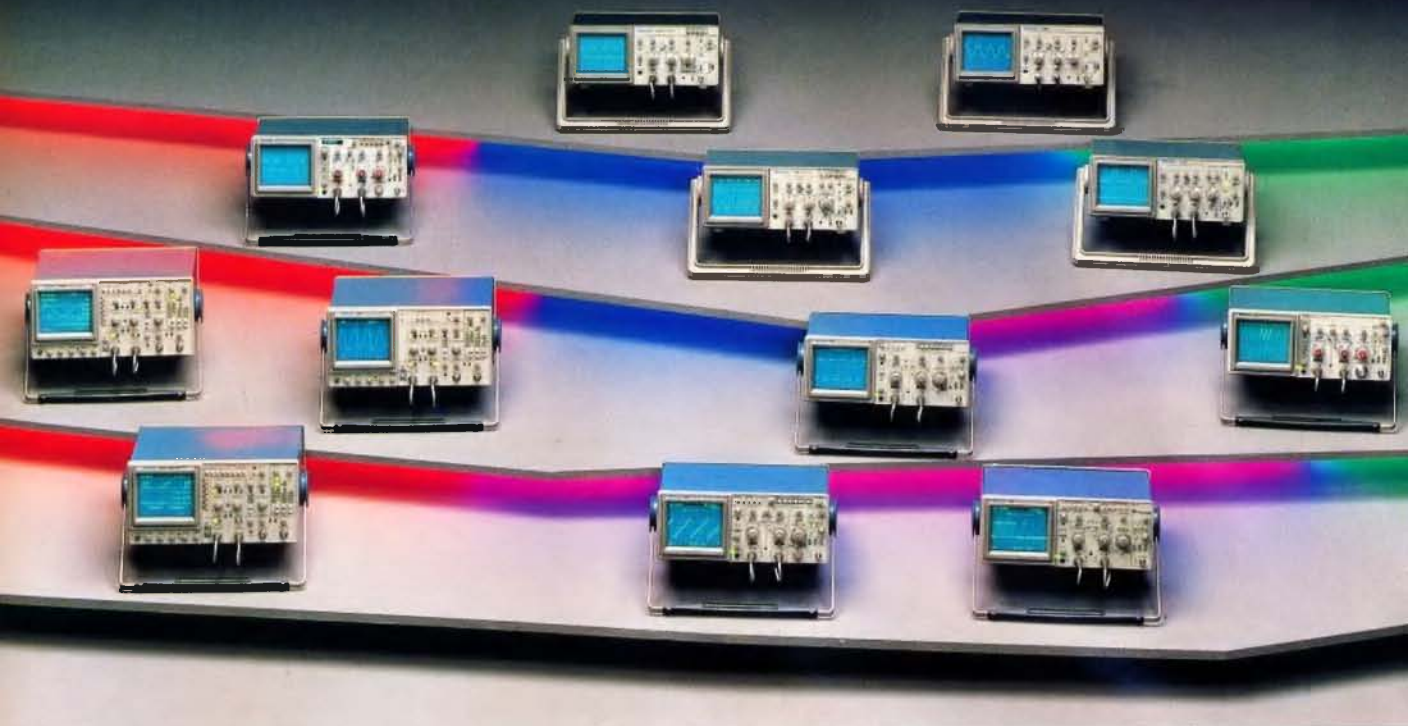

These are scopes you could buy for their price. But chances are you'll buy them for their performance, portability and support. There's no substitute for Tektronix quality, and when it's truly affordable, so much the better.

These are true "go anywhere" portables, built to meet Tektronix's exacting specifications for rugged treatment and tough environments, even rigorous military requirements. Simplified, practical internal design keeps costs low and confidence high. From the second you get your hands on one, you can tell these are tough scopes, built to last.

Scope for scope, feature for feature, no other portables make high performance as highly affordable.

Current 2200 Series users can easily make the move to newer analog or digital models. All feature Tektronix's familiar, sensible front-panel layout and easy to learn controls.

Whatever your application, you're sure to find the economy you're looking for and the performance you demand, in a Tektronix 2200 Series Oscilloscope. Analog or digital, stand alone or automated, whichever scope you choose, you can count on it to be one of the most versatile, affordable scopes you can buy.

2200 SERIES ANALOG OSCILLOSCOPES

Features	2247A	2246A	2245A	2235	2235	2225	2215
Bandwidth	100 MHz	100 MHz	100 MHz	100 MHz	100 MHz	50 MHz	20 MHz
Channels	4	4	4	2	2	2	2
Vertical Sensitivity	2 mV/5V	2 mV/5V	2 mV/5V	2 mV/5V	2 mV/5V	500 μ V/5V	5 mV/5V
Vertical Resolution	2%	2%	2%	2%	2%	3%	3%
Horizontal Resolution	2 ns/div	2 ns/div	2 ns/div	5 ns/div	5 ns/div	5 ns/div	10 ns/div
Triggering	Dual	Dual	Dual	Dual	Dual	Single	Single
Waveform Memory	Yes	No	No	Yes + DMM	No	No	No
Math Functions	Yes	Yes	Yes	No	No	No	No
External Sync	Yes	Yes	No	No	No	No	No
Power Supply	Yes	Yes	Yes	No	No	No	No
Warranty	3-year	3-year	3-year	3-year	3-year	3-year	1-year

2200 SERIES DIGITAL STORAGE OSCILLOSCOPES

Features	2247A	2246A	2245A	2235	2235	2225	2215
Bandwidth	100 MHz	100 MHz	100 MHz	100 MHz	100 MHz	50 MHz	20 MHz
Channels	4	4	4	2	2	2	2
Vertical Sensitivity	2 mV/5V	2 mV/5V	2 mV/5V	2 mV/5V	2 mV/5V	500 μ V/5V	5 mV/5V
Vertical Resolution	2%	2%	2%	2%	2%	3%	3%
Horizontal Resolution	2 ns/div	2 ns/div	2 ns/div	5 ns/div	5 ns/div	5 ns/div	10 ns/div
Triggering	Dual	Dual	Dual	Dual	Dual	Single	Single
Waveform Memory	Yes	No	No	Yes + DMM	No	No	No
Math Functions	Yes	Yes	Yes	No	No	No	No
External Sync	Yes	Yes	No	No	No	No	No
Power Supply	Yes	Yes	Yes	No	No	No	No
Warranty	3-year	3-year	3-year	3-year	3-year	3-year	1-year

Tektronix[®]
COMMITTED TO EXCELLENCE

For more information, contact Head Office: 80 Waterloo Rd, North Ryde, NSW. 2113
Sydney (02) 888 7066, Melbourne (03) 836 3355, Brisbane (07) 394 1155
Adelaide (08) 223 2811, Canberra (062) 51 6111, Perth (09) 325 8433, Toll free (008) 023342

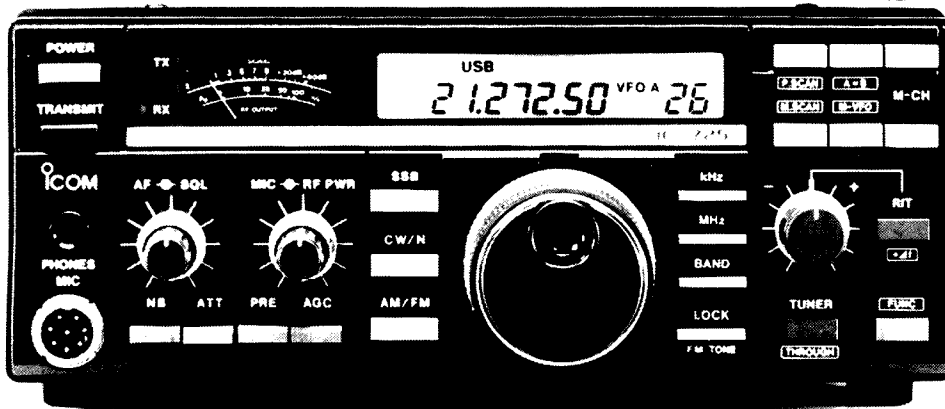

Icom HF Transceivers meet the demands of Amateurs

As an Amateur operator, you know what you want in an HF rig. In fact, although Icom are THE professionals when it comes to communications, it is the Amateurs from whom we seek guidance when designing and developing superior equipment. That's why Icom leads the way in Amateur Communications. If space here permitted, we could go into lengthy discourse about Icom's outstanding features and options, but you're probably aware of most of them. Just to prompt your memory, here's a brief summary of our HF Range -



IC-726 Sophisticated, Compact, with built-in 6 metre band

All the features and reliability you've come to expect from Icom in an advanced, Multimode Transceiver - and still at a budget price! Designed with the beginner in mind, the IC-726 is easy to operate but has so many features it satisfies the needs of veterans too. This little beauty receives and transmits on LSB, USB, CW, AM and FM modes just as simply from home, as in a vehicle or the field. Enjoy great mobiling potential with our optional HF automatic antenna tuner.



IC-735 a highly advanced compact

An ultra-compact, 100W unit, the IC-735 is well suited for car, boat or aeroplane on 12V operation as well as a base station set-up. You'll cover all HF Amateur bands from 1.8MHz to 28MHz including 10, 18 and 24 MHz with the IC-735 using features like Notch filter, Past band tuning, SWR bridge, and a Variable noise blanker. Ring Icom for a leaflet on this ham band, high performer which doubles as a superb general coverage receiver. Call us now for a colour brochure or the name of your nearest stockist.



IC-765 for the DX enthusiast talking to the world -

Icom have incorporated your most requested features to enable you to expand your HF world with the super-advanced IC-765. Equipped with our exclusive DDS (Direct Digital Synthesizer) System, it boasts a fully automatic, high-speed antenna tuner, built-in power supply and features appealing to CW enthusiasts - a built electronic keyer with iambic operation capability for example (paddle not included). If you'd like to read more about the IC-765's Band Stacking Registers, 99 Fully Tunable Memories and Full QSK Break-in.



IC-725 Compact - Fixed, mobile or portable

Easily operated, the IC-725 is a compact HF transceiver that really delivers extraordinary performance. This 12V powered, full-featured unit has a general coverage receiver as well that won't let you down when it comes to globe-listening operation. Enjoy great mobiling potential with our optional HF automatic antenna tuner - enquire when you call for a brochure or the name of your nearest stockist.

Icom are the professionals in the business of communications.

For further information call Icom free on 008 338 915

Melbourne callers (03) 529 7582 Icom Australia Pty. Ltd., 7 Duke Street, Windsor 3181.

Icom Australia's warranty is only applicable to products purchased from their authorised Australian Dealers.

■ AMATEUR ■ MARINE ■ LAND-MOBILE ■ AVIATION ■ CB ■ AMATEUR ■ MARINE ■ LAND-MOBILE ■ AVIATION ■ CB ■ AMATEUR ■ MARINE ■ LAND-MOBILE ■

Please rush to me your brochure on the IC-725 IC-726 IC-735 IC-765 and the name of my nearest Icom stockist.

SEND TO: Freepost 15, Icom Australia Pty Ltd, Windsor, 3181 (no stamp required).

Mr., Mrs., Ms. Company Title

Address Suburb

City Post Code Phone No.

NCAA 4642 AR

■ AMATEUR ■ MARINE ■ LAND-MOBILE ■ AVIATION ■ CB ■ AMATEUR ■ MARINE ■ LAND-MOBILE ■ AVIATION ■ CB ■ AMATEUR ■ MARINE ■ LAND-MOBILE ■

AMATEUR RADIO

OCTOBER 1990

RRP \$3

**Special
Antenna
Issue**



THE WIA RADIO AMATEUR'S JOURNAL

KENWOOD

Turn your rig into a radio station —
with genuine Kenwood accessories!

It doesn't matter which transceiver you choose from the exciting Kenwood range — there's a complete range of genuine factory accessories to complement it.

Introduce your Kenwood VHF, UHF or dual-band mobile transceiver to a whole new world of versatility with the Kenwood **RC-10** or **RC-20** remote control units*. Mount your transceivers in the boot, away from prying eyes — and control them all with the space-age convenience of a slim-line remote head in the cabin!

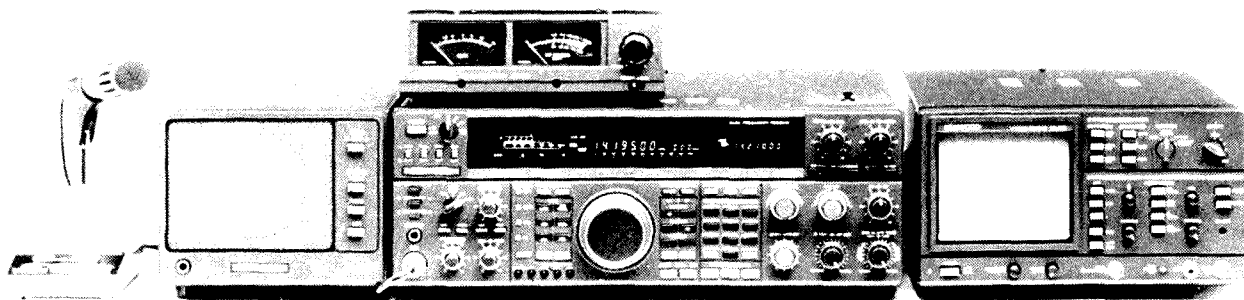

Your Kenwood transceiver works *better* with genuine Kenwood accessories!

There's a complete range of great new accessories to complement the new **TS-950S** and **TS-950SD** HF transceivers. Turn your HF rig into a complete radio station with the **MC-60A** deluxe desk-top base microphone with built-in pre-amplifier, the **SP-950** external speaker with a full range of built-in audio filters to enhance your listening pleasure, the **SW-2100** SWR/power meter to ensure you have the best match to your antenna at all times, and the superlative new **SM-230** station monitor. This exciting new model provides full monitoring facilities for all outgoing and incoming signals, as well as providing a full range of test and analysis modes.

* Selected models only.

KENWOOD ELECTRONICS AUSTRALIA PTY. LTD.
(INCORPORATED IN N.S.W.)

8 Figtree Drive, Australia Centre, Homebush, N.S.W. 2140

Ph. (02) 746 1519, (02) 746 1888, Fax (02) 746 1509

Call now for further information and the name of your nearest authorised Kenwood dealer.

Kenwood Electronics Australia Pty Ltd only warrants products purchased from their authorised Australian dealers.

Please phone, mail or fax for information

Name.....

Address.....

..... Postcode.....

Publication..... Issue.....

Model.....



Amateur Radio is published by the Wireless Institute of Australia, as its Official Journal, on the last Friday of the previous month.

EXECUTIVE EDITOR

Bill Rice VK3ABP

MANAGING EDITOR

Graham Thornton VK3IY

NEWS EDITOR

Jim Linton VK3PC

SENIOR TECHNICAL EDITOR

Peter Gibson VK3AZL

TECHNICAL EDITORS

David Brownsey VK4AFA
 Don Graham VK6HK
 Evan Jarman VK3ANI
 Peter O'Connor VK4KIP
 Gil Sones VK3AUI
 Phil Steen VK4APA
 Roy Watkins VK6XV

DRAFTING

Vicki Griffin VK3BNK

MARKETING

Bruce Kendall VK3WL
 Norm Eyres VK3ZEP

ADVERTISING

Ann McCurdy

All contributions and correspondence concerning the content of Amateur Radio should be forwarded to: -

The Editor
 Amateur Radio
 PO Box 300
 Caulfield South
 VIC 3162

Registered Office

3/105 Hawthorn Road
 Caulfield North VIC 3161

Telephone: (03) 528 5962

(03) 523 8191

Fax: (03) 523 8191

(Non dedicated line)

Business hours: 9.30am to 3pm
 weekdays

Deadlines

	Editorial	Hamads
Nov	8/10/90	10/10/90
Dec	5/11/90	7/11/90
Jan	3/12/90	5/12/90

Delivery of AR: If this magazine is not received by the 15th of the month of issue, and you are a financial member of the WIA, please check with the Post Office before contacting the registered office of the WIA.
 © Wireless Institute of Australia 1990

CONTENTS

Technical

Antenna Aimer	21
<i>Steve Mahony VK5AIM</i>	
Delta Loop for 80, 40,20 and 10	23
<i>Herb Unger VK2UJ</i>	
How to Wind That Non-Resonant Helical	15
<i>Richard Burdon VK6FKB</i>	
More Viewers for ATV	18
<i>Peter Jones</i>	
Phased Bobtail Curtains	16
<i>Odus W. Lovell W5VXG</i>	
You Too Can Have a 1 To 1 SWR	19
<i>Bill Roper VK3ARZ</i>	
2ABQ and 3ABP – Fun (?) with a Simple Beam	11
<i>Bill Rice VK3ABP</i>	
5/8 Wavelength Vertical for 435 MHz	20
<i>Norman E Griffiths VK4ZFQ</i>	
160m Helical Vertical	14
<i>N. Chivers VK2YO</i>	

General

Land of the Hornbill Welcomes SEAnet Amateurs	25
---	----

Operating

Awards	
Postcode, Grid Square Draft Rules	26
Radio Scouting	27
JOTA Award	30
Contests	
WIA 1990 Novice Results	30
Sunshine State Jack Files 1990 Results	31

Columns

Advertisers' Index	56	Morse Practice Schedules	34
ALARA	46	Morseword No 43	49
AMSAT	38	Pounding Brass	35
Club Corner	50	QSLs from the WIA Collection	48
Divisional Notes		Random Radiators	44
VK2, VK3 Notes		Silent Keys – Obituary	50
5/8 Wave, VK6 Notes		Spotlight on SWLing	41
Editor's Comment	2	Stolen Equipment	44
FTAC Notes	41	Technical Correspondence	25
HF Predictions	52	VHF/UHF and Expanding World	36
Hamads	54	WARC 92 Update	34
How's DX	32	WIA Directory	2,3
Intruder Watch	41	WIA News	3

Cover

One concept of a 'portable' antenna for the John Moyle Field Day! This approach solved a problem for the VK1WI team. (For the full story see 'Forward Bias' by Phil Clarke VK1PC AR June '90 p44.) The TH6 antenna belongs to VK1 President Ted Pearce VK1AOP, and is the same one featured atop the Questacon building in AR September 1990 p18. Photo Murray Duffus ex VK1ZMD now VK5HQ.

EDITOR'S COMMENT

BILL RICE VK3ABP EXECUTIVE EDITOR

Sundry Topics

JOTA. Undoubtedly combining, for many, their greatest two interests in one, amateur radio and Scouting, the Jamboree on the Air first took place in October 1958. There had been examples of co-operation between the two movements for a number of years prior to this. A Federal Executive station VK3WIA was operated at a Jamboree in Melbourne as early as 1955 but, by 1958, this ad hoc interest had evolved into an annual event.

Perhaps one might draw a parallel between JOTA and the utilisation of space! Just a year earlier, in October 1957, the Russian Sputnik had become the first man-made object to go into orbit. The development and exploitation of space technology since then has been nothing short of incredible. Perhaps JOTA has

not developed quite so impressively, but it is now a worldwide annual event involving hundreds of thousands of participants. And space technology has been part of this picture in Australia for some years now. Once again, by the co-operation and generosity of the operators of our domestic satellite AUSSAT, JOTA traffic is to be relayed across the continent free of charge, greatly enhancing the communication between States otherwise restricted almost wholly to the HF bands.

A further innovation this year is the introduction of two awards for amateurs and Scouting participants. These are the "Radio Scouting Award" and the "JOTA Award". Full details are given in this month's Awards column.

ACRONYMS. It was recently suggested to me that

one thing which may discourage newcomers to amateur radio from persevering with it in greater depth is the way in which we tend to talk and write in a seemingly incomprehensible "alphabet soup"! I was willing to agree that perhaps there might be 100 or so examples, like ALC, TVI or RAOTC, which needed occasional explanation, so I thought I would make a list of such abbreviations from the past two years' AR. After several days work my total was well on the way to 1000, and that was without well-known and listed collections like the Q code! Even after 45 years in amateur radio, and much of it also in professional engineering, I still found some letter groups at whose meaning I could only guess! When we have translated the list into plain English I hope we can find space for it in our annual data issue next February.

ELMER. Still on the theme of attracting (and keeping!) newcomers, we have all, early in our amateur careers, been influenced, advised and encouraged by an older, experienced amateur who could answer at least some of our multitudinous questions. In American tradition he was the "ham on the next block" and he may well have been named Elmer. But there must be thousands of potential amateurs who will never be licensed because there is no Elmer in their area. One of the functions of the WIA must be to fill this gap. Where there is a local radio club there may be no great problem, but in or near all areas there should be someone who can be nominated as the "official Elmer", technically competent and good at public relations.

Any volunteers? Any suggestions? Give it some thought. ar

Wireless Institute of Australia

The world's first and oldest National Radio Society - Founded 1910

Representing Australian Radio Amateurs - Member of the International Amateur Radio Union
Registered Executive Office of the WIA: 3/105 Hawthorn Road, Caulfield North, Vic, 3161
All mail to: **PO Box 300, Caulfield South, Vic, 3162** Telephone: (03) 528 5962 (03) 523 8191
Fax: (03) 523 8191 (Non-dedicated line)

Business Hours: 9.30 am to 3.00 pm on Weekdays

General Manager and Secretary: Bill Roper VK3ARZ

EXECUTIVE

President:	Peter Gamble	VK3YRP	VK1 Federal Councillor:	George Brzostowski	VK1GB
Vice Chairman:	Ron Henderson	VK1RH	VK2 Federal Councillor:	Terry Ryeland	VK2UX
Treasurer:	Arthur Evans	VK3VQ	VK3 Federal Councillor:	Peter Maclellan	VK3BWD
	Kevin Olds	VK1OK	VK4 Federal Councillor:	David Jerome	VK4YAN
	Brenda Edmonds	VK3KT	VK5 Federal Councillor:	Bill Wardrop	VK5AWM
	Bill Rice	VK3ABP	VK6 Federal Councillor:	Neil Penfold	VK6NE
Immediate Past President:	David Wardlaw	VK3ADW	VK7 Federal Councillor:	Joe Gelston	VK7JG

FEDERAL CO-ORDINATORS

Amsat:	Graham Ratcliff	VK5AGR	Int'l Travel Host Exch:	Ash Nallawalla	VK3CIT
Awards:	Phil Hardstaff	VK3JFE	QSL Manager (VK9, VK0):	Neil Penfold	VK6NE
Act Contest Manager:	Neil Penfold	VK6NE	FTAC:	John Martin	VK3ZJC
Education:	Brenda Edmonds	VK3KT	Federal Tapes:	Ron Fisher	VK3OM
EMC:	Hans Ruckert	VK2AOU	Videotape:	John Ingham	VK5KG
Historian:	John Edmonds	VK3AFU	WICEN:	Bill Wardrop	VK5AWM
Intruder Watch:	Gordon Loveday	VK4KAL			

WIA NEWS

COMPILED BY WIA NATIONAL OFFICE STAFF

DOC 71

The small pamphlet issued by DoTC as DOC 71, and which contains the "Licence Conditions and Regulations Applicable to the Amateur Service", was first published in March 1989. An updated version has just been published and, with the co-operation of the Department of Transport and Communications and the Australian Government Publishing Service, this latest copy of DOC 71 is included as an insert to this October 1990 issue of Amateur Radio magazine.

A letter from DoTC advises that there are only minor changes in the revised DOC

71 either reflecting changes which have been negotiated with the WIA or a rewording of existing provisions to clarify their intent.

However, a major improvement is the clarification of the use of repeater cross-linking. The totally inadequate paragraph 45 in the old DOC 71 has been replaced with paragraphs 48 and 49. The new paragraph 49 also shows that at long last DoTC have concluded their months of indecision on the subject and radio amateurs in Australia can now cross-link repeaters in the HF 28.0 to 29.7 MHz band to repeaters in the VHF and

UHF bands.

Other changes include the following. Paragraph 9(c), which was 6(c) in the previous edition, has been revised to state that an amateur station shall not be used "to transmit material relating to industrial, commercial, political, social or religious matters." DoTC apparently found this change necessary "to overcome a regulatory problem that has developed as a result of a deficiency with the existing wording" and this will allow the Department "to better control transmission of material believed to be inappropriate to the hobby of amateur radio".

The new paragraph 12 now specifies the countries which have negotiated Third Party Traffic agreements with Australia.

Paragraph 23 (previously

20) now reduces any possibility of misinterpretation if the paragraph is read in isolation.

The word "network" is now taboo in the reworded paragraph 30 which used to be 27.

The latest issue of DOC 72, "Operating Procedures and Practices Applicable to the Amateur Service" will be included with your copy of the November 1990 issue of Amateur Radio magazine.

Yet another WIA service to members.

1991 Call Book Now Available

After weeks of effort in the Executive Office the 1991 Australian Radio Amateur Call Book is now on sale, bigger, better and more accurate than ever, listing 18,707 Australian amateur stations, 600

WIA DIVISIONS

The WIA consists of seven autonomous State Divisions. Each member of the WIA is a member of a Division, usually their residential State or Territory, and each Division looks after amateur radio affairs within their State.

Division	Address	Officers	Weekly News Broadcasts	1990 Fees
VK1	ACT Division GPO Box 600 Canberra ACT 2601 Phone (06) 247 7006	President Ted Pearce Secretary Jan Burrell Treasurer Ken Ray	VK1AOP 3.570 MHz VK1BR 2m ch 6950 VK1KEN 70cm ch 8525 2000 hrs Sun	(F) \$65.00 (G) (S) \$52.00 (X) \$39.00
VK2	NSW Division 109 Wigram St Parramatta NSW (PO Box 1066 Parramatta) 2124 Phone (02) 689 2417 Fax (02) 633 1525	President Roger Henley Secretary Tim Mills Treasurer David Horstall (Office hours Mon-Fri 1100 - 1400 Wed 1900 - 2100)	VK2ZIG 1.845 MHz AM, 3.595 AM(1045) SSB (1915 only), 7.146 AM (1045 only) 10.125 SSB (1045 only), 28.320 SSB, 52 120 SSB 52.525 FM VK2ZTM 144.12 (SSB), 147.000 FM(R) 438.525 FM(R) VK2KFU 584.750 (ATV Sound) 1281.75FM (R) Relays also conducted via many repeaters throughout NSW.	(F) \$59.00 (G) (S) \$47.00 (X) \$33.00
VK3	Victorian Division 38 Taylor St Ashburton Vic 3147 Phone (03) 885 9261	President Jim Linton Secretary Barry Wilton Treasurer Rob Hailey Office hours 0900-1600 Tue & Thur	VK3PC 1.840 MHz AM, 3.615 SSB, 7.085 SSB, 147.250 FM(R) Mt Macedon, VK3XV 147.225 FM(R) Mt Baw Baw VK3XLZ 146.800 FM(R) Mildura, 438.075 FM(R) Mt St Leonard 1030 hrs on Sunday	(F) \$65.00 (G) (S) \$52.00 (X) \$39.00
VK4	Queensland Division GPO Box 638 Brisbane Old 4001 Phone (07) 284 9075	President Ross Mutzelburg Secretary Eddie Fisher Treasurer Eric Fittock	VK4IY 1.825, 3.605, 7.118, 10.135, 14.342, 18.132, 21.175, 24.910, 28.400, MHz VK4ABX 52.525 regional 2m repeaters and 1296.100 0900 hrs Sunday VK4NEF Repeated on 3.605 & 147.150 MHz, 1930 Monday	(F) \$65.00 (G) (S) \$52.00 (X) \$39.00
VK5	South Australian Division 34 West Thebarton Rd Thebarton SA 5031 (GPO Box 1234 Adelaide SA 5001) Phone (08) 352 3428	President Rowland Bruce Secretary John McKellar Treasurer Bill Wardrop	VK5OU 1820 kHz 3.550 MHz, 7.095, 14.175, 28.470, 53.100, 145.000, MHz VK5BJM 147.000 FM(R) Adelaide, 146.700 FM(R) Mid North, 146.900 FM(R) South East, ATV Ch 34 579.00 Adelaide, ATV 444.250 Mid North (NT) 3.555, 146.500, 0900 hrs Sunday	(F) \$65.00 (G) (S) \$52.00 (X) \$39.00
VK6	West Australian Division PO Box 10 West Perth WA 6005 Phone (09) 388 3888	President Alyn Maschette Secretary John Farnan Treasurer Bruce Hedland - Thomas	VK6KWN 146.700 FM(R) Perth, at 0930 hrs Sunday, relayed on 3.560, 7.075, 14.115, 14.175, 21.185, 28.345, 50.150, 438.525 MHz Country relays 3582, 147.350(R) Busselton 146.900(R) Mt William (Bunbury) 147.225(R) 147.250 (R) Mt Saddleback 146.725(R) Albany 146.825(R) Mt Barker Broadcast repeated on 3.560 at 1930 hrs.	(F) \$56.00 (G) (S) \$45.00 (X) \$30.00
VK7	Tasmanian Division 148 Derwent Ave Lindisfarne TAS 7015	President Tom Allen Secretary Ted Beard Treasurer Peter King	VK7AL 146.700 MHz FM (VK7RHT) at 0930 hrs Sunday relayed on 147.000 (VK7RAA), 146.750 (VK7RNW), 3.570, 7.090, 14.130, 52.100, 144.100 (Hobart) Repeated Tues 3.590 at 1930 hrs	(F) \$63.00 (G) (S) \$50.00 (X) \$38.00
VK8	(Northern Territory) is part of the VK5 Division and relays broadcasts from VK5 as shown (received on 14 or 28 MHz).			
Note: All times are local. All frequencies MHz.			Membership Grades Full (F) Pension (G) Needy (G) Student (S) Non receipt of AR (X)	Three year membership available to (F) (G) (X) grades at fee x 3 times

WIA registered SWLs, and pages of essential reference information.

Special thanks are due to John Martin VK3ZJC, who has ensured that the repeater and beacon lists, and the band plans, are the most complete and accurate ever published in a Call Book; to volunteers Jo Harris (the VK2 Division Historian), Brenda Edmonds VK3KT, Bill Rice VK3ABP, and Ron Fisher VK3OM for their sterling work in checking the lists of non-WIA members and correcting as many of the DoTC errors as possible; to Peter Hallgarten VK3AVE from DoTC in Melbourne whose liaison assistance was invaluable; and to Executive Office staff Ann McCurdy, Chris Russell, and Earl Russell (no relation) without whose extra effort and dedication the Call Book could not have been produced.

This new 1991 Call Book will be a big seller. Executive Office stocks of the last Call Book sold out in a matter of weeks, and this edition is expected to sell even more quickly. Don't miss out. Buy your copy of the 1991 Call Book now!

You can purchase the 1991 Call Book from your Divisional Bookshop, or from Dick Smith and other leading book sellers. Recommended retail price is \$11.00. However, if you are a WIA member, you can obtain your copy from your Division for the discount price of \$9.50, plus packing and postage if applicable.

Does Your Radio Club Need Money?

There are several hundred amateur radio clubs in Australia. Are you a member of one? Is your club looking for ways and means to raise money? Well, here is a way that your club can earn some income and help the WIA at the same time.

It's a fair bet that your radio club has a significant proportion of members who are not also members of the WIA. Sign

up these club members for membership of the WIA between 1st October and 31st December 1990 and **the WIA will pay your club a recruiting fee of \$5.00 for each new member!**

For the purpose of this offer, the definition of a radio club is any club which holds an amateur callsign, whether the club is affiliated with the WIA or not; and a new member is a person who has not been a financial member of the WIA in the 12 months prior to the date of the new application for membership.

If your club does not have a supply of WIA membership application forms, then use the form printed on the back of every Amateur Radio magazine flysheet - even photocopies of that form will suffice.

The application forms must be sent with the membership fees to the Division in which the applicant lives. In order for the club to receive the \$5.00 recruitment fee for each new member of the WIA they sign up, the club secretary should write, on club letterhead, to the Executive Office of the WIA (PO Box 300, Caulfield South, 3162) with details of the new member. At the end of each month of the offer, a cheque for the total amount of recruitment fees due to the radio club for the month will be forwarded to them.

Funding International Activities

In the past the WIA funded international activities on an ad-hoc basis, facing each new demand as it arose. However, this approach was changed at the 1989 Federal Convention of the WIA. Realising the need to plan better financially, the WIA Federal Council adopted a more formal approach to financing international commitments on behalf of Australian radio amateurs.

The WIA has long had a responsibility to pay dues annually to the International Amateur Radio Union (IARU) Region 3 Association. This

amount, set at 75 cents US per licensed member for the current triennium, is a component of WIA members' Federal membership subscription.

With the additional prospect of having to fund amateur representation on the Australian WARC 92 delegation, the WIA Federal Council decided to group all other international funding commitments into a new component of the Federal membership subscription. Thus was born the \$2 international levy which commenced as a component of the WIA membership fee as from 1st January 1990.

The WIA Federal Council also voted to provide an initial balance in the fund by introducing the levy effectively in 1989, with that "back payment" being paid by the Divisions in a lump sum due by the end of 1990. The Federal Councillors were aware some Divisions had been making financial provisions for WARC for some time and saw this as a means of dedicating those funds nationally.

The funds accumulated from this international levy will assist in paying for a WIA Australian delegation to attend a number of events in the future which will be of significant importance to the amateur radio service in Australia. Such events as the IARU Region 3 conferences, normally held somewhere in South East Asia every three years, and as part of the official Australian government delegation to the next WARC to be held in Spain during 1992.

In order to give some idea of the sums involved, the WIA estimates that there will be a minimum cost of \$11,000 to send each Australian amateur service representative to WARC 92 for thirty days, including accommodating and feeding him at the same hotel as the other members of the Australian government delegation, providing a modest sum for incidentals, and showing the Australian amateur radio flag. Incidentally, note

that there is no mention of recouping the lost earnings of the WIA representative. The duty is one of love for the amateur radio service, and one which may be able to be done during the long service leave of the representative!

The costs to send a delegation of four representatives to the Indonesian IARU Region 3 conference next year will be around \$9000. "Why four?" you might ask. This is very likely the last conference for the WIA international representation team leader, and the opportunity is right to expose three new delegates in the international sphere. This chance was missed in 1988 as the WIA did not have this financial planning system in place at that time.

"Is the WIA observing due economies with members' funds?"

The WIA Executive believes so. Early purchase economy air travel is used wherever possible, entertainment expenses are kept modest, and accommodation is usually arranged at group rates by the host society.

"Are the international representation provisions adequate?" Again, the WIA Executive believes so. The state of the funding provision is reviewed quarterly and Executive continues to manage international representation within current limits.

Bandplanning - The Big Picture

During the work up period for WARC 92 it is worth recalling how band planning is carried out in the "big picture".

International allocations for various users of the radio frequency spectrum are contained in the ITU Radio Regulations. These Radio Regulations are the product of international meetings of ITU members, often called World Administrative Radio Conferences (WARCs). Many Australian amateurs will be familiar with the last major WARC affecting amateur

radio - WARC 79 - although there have been many meetings of nations since then, usually devoted to a specific issue and not making elaborate changes to the Radio Regulations.

For the convenience of the nations spread around the world the surface of the globe is divided into three Regions. Region 1 covers Europe, Africa, the Middle East and Russia; Region 2 covers the Americas; and Region 3 covers the remainder, that is India through South East Asia and Australasia to the mid-Pacific.

A look at the Radio Regulations will find frequency allocations by Region. These are also shown in the Australian document, the Department of Transport and Communications' "Australian Table of Frequency Allocations - October 1982".

Because it is necessary to accommodate a wide range of potential users when drawing up frequency allocations, a system of priorities is used.

First, the "PRIMARY" users are designated (some times additional "Permitted" users are included), then the "Secondary" users are added. Also, as if that is not complicated enough, nations have the right to make local or national allocations provided they do not conflict with the ITU allocations. In fact, they can register these as national footnotes when agreeing with the ITU table before it is published in the Radio Regulations.

Please note that: "Secondary users shall not cause harmful interference to stations of 'PRIMARY' or 'Permitted' services and cannot claim protection from harmful interference from them."

What does all this mean to Australian radio amateurs?

Firstly, there are no such things as exclusive bands for any user! They are "PRIMARY" allocations and there may, or may not be, "Secondary" allocations overlaying them. For example, the 14.00 - 14.25 MHz band has only a "PRIMARY" allocation to the

amateur service and amateur satellite service.

"Secondary" allocations vary from Region to Region and nation to nation, so what applies in one part of the world may not apply elsewhere. Take the US 220 MHz band for instance. Australians cannot copy at this distance and it's in our VHF TV allocation anyway.

But what about 80 metres or 40 metres? Yes, the WIA Intruder Watch Co-ordinator correctly reports some fishing boats can use 80 metres provided they are operating in international waters and using assignments their home nation has authorised.

How do we as radio amateurs feel about sharing frequencies?

That is being the "PRIMARY" users with other services as "Secondary" users; or even being "Secondary" users with other services having "PRIMARY" user status of the allocation?

Its more common than the average Australian radio

amateur might think? Above 144 MHz Australian amateurs have very little "PRIMARY" allocation, yet we manage. Or do we? Is MDS going to be a problem? Is it a problem now?

Planning for the next WARC in 1992 is well on the way. The Australian Preparatory Group (APG) first met back in February this year and one side issue, being studied through its Technical Committee T, is "sharing".

The types of questions being resolved are "who can coexist with whom". The Australian amateur radio service is in the midst of these discussions through the WIA APG members.

Several years ago the WIA saw the sharing problem arising and adopted a policy of seeking small amateur "PRIMARY" allocations in shared bands. These bids applied across the UHF and microwave allocations and generally were designed to align with the international amateur satellite segments. These views have been relayed to

1991 WIA AUSTRALIAN RADIO Amateur Call Book Out Now

Over 18100 Current Callsign Listings

Plus Band Plans, Repeaters, Beacons, DXCC, etc.

**LIMITED STOCK!
SELLING FAST!**

Buy your copy NOW from your WIA Divisional Bookshop.

Cover Price \$11.00 Special Price to WIA Members of \$9.50

ALL PRICES are plus Postage and Handling

DO NOT MISS OUT!

DoTC on each occasion that national band planning issues for those bands have arisen. The most recent occasion was earlier this year when a new draft Australian Spectrum Plan was published for public comment. Remember, these allocations can be made on a national basis because of their short range nature.

Freeloaders

The WIA has frequently emphasised that the privileges and benefits of WIA membership should be available to members only. The WIA is not the only amateur radio organisation holding those views. In the latest issue to hand of "Break-In", the Journal of the New Zealand Association of Radio Transmitters (NZART), a sister society to the WIA, a Policy Statement from the Council expresses strong views on use of Association services by non-members.

To quote: "We cannot stop our non-member brethren enjoying some benefits such as the negotiations the NZART conducts with the licensing authorities, the use of repeaters, and the enjoyment of the benefits which band plans bring. Council is firmly of the view that it is unfair to those who do pay their subscriptions if the lot of the non-member is made easier by the ready availability of members' privileges which the Association is, in fact, able to withhold. Further, the NZART has to take into account the feelings of its many voluntary workers, who devote many hours to NZART matters and, in addition, pay their subscriptions as well. These persons have even greater cause to complain if the NZART makes benefits available to non-members who do not contribute to these benefits by at least joining the Association and paying a subscription."

That statement by the NZART applies equally well to the WIA and Australian radio amateurs. How many amateurs do you know who are "freeloading" on you? What are you doing about

them?

One way you can help is by signing up the non-member as a new member of the WIA. Use the application form on the reverse of your Amateur Radio magazine address flysheet.

Amateur Radio Magazine Content

An editorial comment in the latest issue of "Radio Communications", the Journal of the Radio Society of Great Britain (RSGB), emphasises the range of levels on which the magazine must function. Amateur Radio magazine is in a similar position.

Amateur Radio magazine must combine the functions of a scientific journal publishing new articles with that of a newsletter providing information on changes in licensing and operating conditions, while still educating new members on technical and traditional topics and WIA structure. It must also cover the extensive range of interests of a very diverse population.

While Amateur Radio magazine is restricted in space and content by costs and deadlines, the WIA strives to provide for all member interests. Because the content of the magazine is controlled by the range of articles submitted and every effort is made to print all articles received there will, at times, seem to be some imbalance between topics covered. If you, as a reader, feel that some topics or interests are being neglected, perhaps you can help to solve this problem by submitting articles to the editor.

CW as a Licence Requirement

One of the more controversial issues that can be raised among any group of amateurs is the need for CW as a radio amateur licence requirement. When the removal of a CW qualification was mooted a

couple of years ago, the WIA received some very strongly worded comments upholding both viewpoints.

This question is universal. A proposal to the recent IARU Region 1 Conference from the Israel Amateur Radio Club suggested "that IARU Region 1 agree in principle...the CW test for radio amateurs be replaced by some form of operating proficiency test more suitable to the present day data operating modes of amateur radio".

With the forthcoming WARC 92, amateurs may expect to see more proposals to reduce the CW qualifications, or to make other modifications to amateur licence requirements. However, present indications are that the lifting of the Morse Code requirement will not be considered until the next major WARC scheduled for 1998.

The WIA has been considering our current licensing regulations for some time, and is closely monitoring all WARC proposals. It is important to ensure that the uses and benefits of an existing mode are not lost to a communication form that has a much more restricted and/or temporary potential use.

Australian National Maritime Museum

"Signals", the Journal of the Australian National Maritime Museum, reports that "One of Australia's best known fighting vessels, 'Krait', has been entrusted to this museum by the Australian War Memorial in Canberra". The article summarises the history of the vessel and notes some of the items of equipment. Of particular interest is the recently acquired radio equipment, comprising an AT5 transmitter, AR8 receiver and antenna coupling unit, complete with handbooks and workshop manuals, all identical to the equipment carried during operation in 1943 and still in operating condition.

Historical Collections

From time to time the Executive Office receives enquiries as to what facilities exist for the custody of historical amateur radio material, both hardware and paper.

The WIA has a Federal Historian, who collects material relating to the history of amateur radio and the evolution of the WIA. The WIA also introduced a scheme to register historical material, but I fear it has not progressed very far.

Most Divisions of the WIA also have an historical officer who is concerned primarily with Divisional historical records.

Beyond these the WIA is aware of the following historical collections, both public and private, which may be worthy of contacting should you be involved in disposing of the estate of a Silent Key.

National amateur radio historical material - Federal Historian C/o Executive Office.

Divisional Historians - C/o Divisional postal addresses.

QSL cards - Ken Matchett VK3TL.

VK1 callsign holders, past and present - VK1PJ, C/o VK1 postal address.

VK2 callsign holders, past and present - C/o VK2 Divisional Historian.

Historical radio equipment - VK2 Division

Townsville ARC
Telecommunications Museum, Adelaide - contact VK5 Division

Wireless Hill Museum - contact VK6 division

VK7OW
Historical morse keys - VK4SS

Old military radios - Australian War Memorial, Canberra

VK2DYM (see Amateur Radio January 1988 issue)

Victoria Barracks Museum, Paddington, NSW

RA Sigs Museum, Simpson Barracks, Watsonia, VIC

RAAF Museum, RAAF Williams, VIC

RAAF Museum annex, RAAF Townsville, QLD

VK4EF

As you can see there are still gaps in this list. If you are

aware of a collector who has been missed please notify the Executive Office and the information will be added to the list. Remember, the aim of this activity is to compile a list of collections to assist in preserving some of the Australian amateur radio historical past for future generations.

Corporate Planning - An Update

In the April 1989 issue of Amateur Radio magazine the WIA provided an overview of its corporate planning endeavours. You will recall identification of the WIA "mission statement" which is:

"To promote and advance amateur radio locally, nationally and internationally in a way which:

** Meets member and community needs;*

** Encourages the maintenance of standards; and*

** Positions this organisation as the representative voice of amateur radio enthusiasts in Australia."*

Also listed, in some detail, were the five most important issues together with information on what the WIA was doing about them. Since that time not much has been publicised about corporate planning. Nevertheless the WIA has continued to make progress, even if it has appeared slow at times.

One of the inputs, which was connected with several important planning issues, was who provides what services for whom. This matter needed clarifying, firstly by defining what members services were provided, then by determining who provided them. All very simple you might think. However, the WIA historically created Divisional structure, based on the Australian system of Federation, has shown up seven sets of Divisional services in addition to those provided by the Federal Body through the Executive Office.

To further add difficulties to this task, not all Divisions were in agreement as to what services the Executive Office should provide on their behalf! It seems years ago that certain obvious functions were

formally tasked upon the Executive Office, such as the central membership system, the call book entries and Amateur Radio magazine; others were added informally as time went by, and still others were picked up by the Executive Office with its regular staffing, in an endeavour to improve the, at times, tarnished image of the WIA as a membership service organisation.

Quite naturally most Divisions, with predominantly volunteer workers, were happy to let this occur as it saved them effort. However, the crunch came when Executive Office savings had to be made to remain within budget and a fresh look was needed at who rendered which services. The base vehicle for this re-look was the 1988 members services survey, which gave a framework of services and members views on them.

Building on that survey, Divisions are now deciding which services they will DIRECT the Executive Office to provide (and fund them accordingly), and those services which they WILL provide themselves and which they MAY provide now or in the future. The outcome will be a resolution by Federal Council, which will provide a degree of planning stability for the next five years and be subject to review after that period.

Divisions, through their Federal Councillors, will accept responsibility to do certain agreed things, Executive Office will be directed to provide certain services and funded accordingly, and members will be made aware of "who does what for whom."

But, what if the Executive Office cannot afford to do all that it has been directed to do by the Council? Well, in the annual budget setting consultations, which will be a major topic of discussion at the meeting to be held on 13th and 14th October this year, where the Executive examines and refines initial proposals provided by the General Manager, these issues will be examined in detail and priorities set according to Divisional wishes. Some of these are fairly obvious, such as main-

MAGPUBS

ANTENNA BOOKS

The ARRL Antenna Handbook 15th Edition	#BX161	\$36.00
Antenna Compendium Volume 1 ARRL	#BX103	\$22.00
Antenna Compendium Volume 2 ARRL	#BX292	\$24.00
Antenna Compendium Volume 2 & IBM PC Disk ARRL	+#BX294	\$36.00
Antenna Impedance Matching ARRL	#BX257	\$30.00
Yagi Antenna Design ARRL	#BX164	\$30.00
WIFB's Antenna Notebook Doug DeMaw ARRL	#BX179	\$20.00*
Novice Antenna Notebook Doug DeMaw ARRL	#BX162	\$16.00
Practical Wire Antennas John O. Keys B390Q RSGB	#BX296	\$26.00
HF Antennas L.A. Maxon G8XM RSGB	#BX296	\$28.00
ANTENNAS 2nd Edition John O. Kraus WRJK	#BX259	\$104.00
Antenna Handbook Winlam I Orr W6SAI & Stuart O Cowan W2LX	#BX217	\$17.30
Vertical Antenna William I Orr W6SAI & Stuart O Cowan W2LX	#BX220	\$15.85
Beam Antenna Handbook W I Orr W6SAI & S O Cowan W2LX	+#BX215	\$19.30
Wire Antennas William I Orr W6SAI & Stuart O Cowan W2LX	#BX215	\$17.30
Cubical Quad Antennas W I Orr W6SAI & S O Cowan W2LX	#BX214	\$14.50
The truth about CB Antennas W Orr W6SAI & S O Cowan W2LX	#BX216	\$17.30
Transmission Line Transformers J Sevick W2FMI New 2nd Ed	+BX134	\$40.00

SATELLITE BOOKS

Oscar Satellite Review Dave Ingram K4TWWJ	#MFJ-31	\$17.00
Satellite Experimenters Handbook Martin R Davidoff ARRL	#BX177	\$25.00
Satellite Anthology The ARRL	-#BX180	\$16.00
AMSAT-NA 5th Space Symposium 1987 AMSAT-ARRL	-#BX192	\$17.50
AMSAT-NA 6th Space Symposium 1987 AMSAT-ARRL	-#BX108	\$17.50
SPECIAL the 2 books 5th & 6th Symposium	-#BX907	\$28.00
Space Almanac Anthony R Curtis ARRL	#BX299	\$40.00

PACKET RADIO BOOKS

Gateway To Packet Radio Stan Harzepa WAILDU 2nd Edition	+ #BX169	\$24.00
The Packet Users Notebook Buck Rogers WA4BT CQ	#BX265	\$18.50
Packet Radio is Made Easy Buck Rogers WA4BT MFJ	#MFJ32	\$20.50
AX.25 Link Layer Protocol ARRL	#BX178	\$18.00
Computer Networking Conferences 1 - 4 1981 to 1985 ARRL	#BX186	\$36.00
Computer Networking Conferences 5th 1986 ARRL	#BX187	\$20.00
Computer Networking Conferences 6th 1987 ARRL	#BX168	\$20.00
Computer Networking Conferences 7th 1988 ARRL	#BX184	\$25.00
Computer Networking Conferences 8th 1989 ARRL	#BX285	\$24.00
SPECIAL - All 5 Books - Conferences 1 to 8	-#BX906	\$80.00

VHF/UHF/MICROWAVE

RSGB Microwave Handbook Volume 1 M W Dixon G3PFR RSGB	#BX316	\$70.00
VHF-UHF Manual George Jessop G6JP RSGB	#BX267	\$48.00
all about VHF amateur Radio William Orr W6SAI	#BX216	\$17.30
21st Central States VHF Conference 1987 ARRL	-#BX172	\$17.50
Mid-Atlantic VHF Conference Oct 1987 ARRL	-#BX175	\$17.50
22nd Central States VHF Conference 1988 ARRL	-#X179	\$17.50
23rd Central States VHF Conference 1989 ARRL	-#BX286	\$17.50
Microwave Update 1987 Conference ARRL 1987	-#BX174	\$17.50
Microwave Update 1988 Conference ARRL 1988	-#BX174	\$17.50
Microwave Update 1989 Conference ARRL 1989	#BX213	\$24.00
UHF Compendium Part 1 & 2 Volume 1	#BX280	\$49.95
UHF Compendium Part 3 & 4 Volume 2	#BX261	\$49.95

HANDBOOKS

ARRL 1990 Handbook ARRL Hard Bound	#BX207	\$52.90
The Operating Manual ARRL	#BX162	\$30.00
The ARRL Electronics DATA BOOK ARRL	#BX201	\$24.00
Radio Data Reference Book G.R. Jessop RSGB	#BX189	\$36.00
Radio Communication Handbook Fifth Edition RSGB	#BX266	\$66.00
Radio Handbook 23rd Edition William I. Orr W6SAI	#BX22424	\$49.50
Motorola RF Device Data Motorola 5th Edition 2 Book Set	#BX8047	\$24.50

MAPS

Prefix Map of the World Radio Publications	#BX234	\$6.00
Prefix Map of North America Radio Publications	#BX235	\$9.00
Radio Amateurs World Atlas Radio Publications	#BX236	\$9.00
Madhead Locator - World Grid Atlas ARRL	+ #BX187	\$10.00

The above books, plus many more, are available from your WIA Divisional Bookshop. All items are less 10% discount for WIA Members and are plus postage and handling where applicable.

All Prices are Subject To Change With-out NOTICE
If not in stock at your Divisional Bookshop, your order will be taken and filled promptly. Not all publications are available from all Divisions. * Price Changes .. -# price Reduced .. + Price Increase

tenance of the membership database system. Company Act actions also rate quite high if the WIA is to avoid troubles with Corporate Affairs.

Some extensions of the membership database must be self funding, such as the Amateur Radio address aspects coming from the Amateur Radio component of subscriptions and the Call Book inputs from sales of that publication. Overseas liaison cannot fall below a certain level, but hopefully this can be sustained with essentially volunteer effort.

One of the more important actions, hinging on our corporate planning, is the review of the structure of the WIA. This was directed by Federal Council back in 1988, and reaffirmed and further detailed in 1989, but regrettably has proceeded only slowly since then. One of the aims of the structural review was to define members services and identify the providers. The WIA will shortly be in a position to complete much of that action.

From that basis the Federal Council wished to identify structures which would provide the desired services with no duplication, at minimum cost, and with minimum confusion to members as to where they should refer to for assistance.

The WIA has learned a lot from its sister societies around the world. Several office bearers have reported how other national associations have often envied our structure compared with theirs, so the WIA must have it correct in some respects!

But, in keeping with similar organisations in Australia, the biggest concern of the WIA is the declining volunteer effort available, despite the supposedly increasing leisure time. What volunteers the WIA does get must work on essential issues or activities, not duplicate what is being done elsewhere, and not be so bogged down with their duties of office as to be unable to "play amateur radio"!

In essence the WIA, your society, must do things well and do them more efficiently. The WIA must not "re-invent the wheel" in every Division but rather adapt what is being

done well elsewhere for the collective good of all.

Callsign Suffixes and De-regulation

During the last few weeks there has been a bit of a "kerfuffle" about the allocation of VK2GOD, VK3GOD and VK4GOD callsigns to radio amateurs by DoTC, and then their withdrawal.

After discussion with DoTC the following letter, dated 27th August 1990, and written by David Hunt, the Manager Licensing of DoTC in Canberra, was received by the WIA Executive Office. Although it is a lengthy letter, it is quoted in full. Quite apart from the question of possible censorship of amateur radio callsign suffixes, this letter is interesting because of the encouraging remarks about deregulation of the amateur service.

"I am writing in response to recent concerns from Amateur operators about a decision to withdraw the use of the Amateur callsign suffix 'GOD'. The decision to withdraw this suffix resulted from a complaint from an amateur operator who was offended by the use of the callsign. Because of the complaint an officer of the Department made a judgement to withdraw the use of the suffix.

Notwithstanding the correctness or otherwise of the decision, a much broader principle is involved. In a climate of government deregulation, regulatory authorities are mindful of the extent to which they become involved in the administration of services. There are a number of factors to be considered. When deciding when to be involved and when not to be involved, to a large degree depends on the nature of the service, the administration of the service and the behaviour of the participants within the service. In other words, we need to look at the extent of the rule making process and the capacity for the environment to sustain its own level of self regulation.

The amateur radio service in Australia is one example where there is always scope for review of the level of deregulation the service can sustain. Given the excellent administrative infrastructure that

exists in the amateur service through the State and Federal bodies of the Wireless Institute of Australia, I believe there is considerable scope for further review. We must not lose sight of the fact that many rules are still necessary. Concerning the allocation of suffixes to amateur callsigns, however, the need for the Department to engage in the appropriateness or otherwise of callsign suffixes, ie to apply censorship, is questionable. I have decided therefore, not to remove any of the AAA - ZZZ callsign suffixes from the international allocations for Australia.

The issuing of amateur callsigns happens automatically from the Department's Spectrum Management Information System (SMIS) database. There is also provision for amateurs to request a suffix of their choice. Amateur callsigns consist of both prefixes and suffixes, together. The suffix should not be separated from the callsign and used on its own.

If the Department were to place any restriction on one suffix, then there would be an expectation that other restrictions could be placed on any of the suffixes. It is far better for the Department not to be involved in judgements, in favour or otherwise, of suffixes associated with Amateur callsigns.

In cases where a suffix to a callsign could be interpreted as offensive, then I suggest that the full callsign be announced clearly and precisely, without any separation of the suffix from the prefix. In addition, the Department recommends the use of the phonetic alphabet for the announcement of callsigns to avoid any misinterpretation of callsign suffixes. When announcing callsigns, operators should use all of the allocated callsign, and not shorten the callsign for sake of convenience or to cause offence to others, particularly in circumstances where the suffix could be misinterpreted by others as being offensive.

The Department and the Executive of the Wireless Institute of Australia both recognise the concern expressed by some people about the content of transmissions by the hold-

ers of callsigns using the 'GOD' suffix. The content of transmissions is a separate matter from the allocation of the callsign. Where the content of amateur transmissions is of concern, the Department will consider any representations made from amateur operators.

I trust that this letter explains the Department's position on this matter. All holders of the callsigns in question will have their original allocation restored."

The original holder of the VK3GOD callsign, who is a minister of religion, informed the Executive Office the day after the above letter was received, that VK3GOD had been re-issued to him.

WARC 92

Much has already been publicised about WARC 92, and much more will appear in the run up to the event. Why, you might ask? What is so important about some event that will not take place until 1992 and will be held on the other side of the world?

The following extract from a speech delivered to the recent IARU Region 1 Conference in Europe by Dr Pekka Tarjanne, the Secretary General of the International Telecommunications Union (ITU) should provide an answer.

"These WARC's, especially WARC 92, once more challenge amateur radio on the international conference front. Although, by definition, radio amateurs do not have large financial or political resources at their disposal, the activity has survived - and even prospered thanks to the resources of its participants. And it has its 'guardian angels', as every participant in an ITU radio conference knows. Even in conferences where opposing participants are fighting fiercely for every kiloHertz for commercial or governmental services, the amateurs present - and there are often many of them among the 'combatants' - will join ranks to protect or improve the amateur services in the bands under consideration. The CCIR includes amateur radio in its studies, publishing updated reports on the technical developments, frequency utilisation of amateur

and amateur satellite service, frequency sharing and interference considerations.

Neither its recognition for public service, nor its guardian angels, add up to a 'carte blanche' for amateur radio in allocation battle. Far from it. During virtually every radio conference the amateur service is threatened, sometimes very seriously. It is the vigilance of radio amateurs everywhere, and national, regional and global leagues that serve as collective voices for the amateur services, that address the pressures on allocations. National amateur organisations have been effective in contributing to national positions for conferences."

Do you want to protect amateur service frequencies from commercial and governmental attack?

You can do so by supporting the WIA, the only body in Australia effectively fighting for the amateur service. Renew your membership promptly when it becomes due. Sign up non-member amateurs as new members at every opportunity.

VHF Comms Still Alive

Following the recent note about the cessation of publication of the quarterly publication "VHF Communications", the Executive Office has received word that the production will be taken over and continued by a newly formed company in England, "KM Publishing", as from the beginning of 1991. Subscribers will be notified as further information is received.

Spinoffs

The editorial of the August 1990 issue of the ARRL publication "QEX" refers to the technological developments from the Amateur Satellite Service, and their applications to engineering and commerce. It also notes a development that may not be wholly desirable.

"There's another (amateur to commercial) spinoff area of interest these days. Many are aware that packet radio technology developed by hams has been used by other radio serv-

ices, commercially and by governments. But there's one, in particular, that not only uses the amateur (AX.25) protocol but does so in the US 902-928 MHz amateur band. That system is known as LAWN, which is a radio local area network operating under the Part 15 provisions for 1 watt spread-spectrum. LAWN is not the only Part 15 spread-spectrum system operating in this band, but is the only one we know of using AX.25. As these spread-spectrum systems are relatively new, we have not received reports of interference from them to amateur operations in the 902-928 MHz band. If there are some, the ARRL Technical Department would appreciate the information.

Whatever emerges from the small satellite initiatives will change the way the world telecommunicates, particularly in less densely populated areas that are not economical for cellular radio. Amateur radio and satellite experimenters can take some pride in their contributions to this field. One has mixed feelings about commercial systems that benefit from Amateur Radio technology and want to operate in our spectrum, however."

Joint WIA/DoTC Meeting

At the Joint WIA/DoTC meeting held in Melbourne on 24th July 1990 the opportunity was taken to review the status of a number of outstanding items. It was agreed that the WIA will receive, in the near future, written confirmation of the status of Reciprocal Licence arrangements and Third Party Traffic bilateral agreements.

Once again, the definition of "Third Party" was discussed. DoTC is prepared to "seek a Third Party view on the matter" by discussing the differences in definitions with the Telecommunications Policy Group. It was agreed that the establishment of club stations in Antarctica would avoid the need for operators to be issued with special licences, and that DoTC will investigate the possibility of

the home addresses of Antarctica operators being made available to the VK0 QSL Manager.

The WIA submission on disposals items on WIA news broadcasts has been received by DoTC but is still under consideration. With regard to callsigns, arrangements have been made with DoTC offices for the issue of VK9 callsigns manually so as to ensure their appropriate sequence, but no change is envisaged in the system of issuing licences to visiting amateurs.

An application for a licence for a Digitised Voice Store Bulletin board has been approved. DoTC agreed to provide the WIA with information, for publication, of all actions taken on Intruders to any part of the spectrum, and assured the meeting that action is being taken on out-of-band transmissions.

There was extensive discussion on the subject of repeaters and repeater linking. The WIA is to prepare a submission on possible relaxation of identification requirements for linked repeaters, and also one on packet radio networking issues.

The progress of devolvement of amateur examinations and the monitoring of the new system were discussed in detail. DoTC indicated its intention to have the computer program for compilation of question papers refined, and then to review the question banks. There is no intention to devolve the issuing of Certificates of Proficiency, or the examination of Morse Code at a speed of more than 10 wpm.

The issue of RF tag identification of shipping containers was raised for future consideration. Although few new topics were added to the agenda, the meeting was very useful in clarifying issues that have been on the agenda for extended periods.

More RFI

A publicity leaflet from the State Electricity Commission

of Victoria extols the virtues of a new type of fluorescent lamp which plugs into a normal bayonet socket, consumes less power, and lasts considerably longer than a normal incandescent globe. However, note the last paragraph on the back page:

"Electronic compact fluorescent lamps currently on the market generate higher harmonic distortion and radio interference than do the ferromagnetic type. Therefore, some caution may be required if you operate sensitive electrical equipment (eg: computers, radio transmitters/receivers etc.) and you intend to install a large number of electronic lamps at the one site."

Hamads Misunderstanding

A WIA member recently publicly accused the people involved in the production of Amateur Radio magazine of taking advantage of their prior knowledge of items advertised in HAMADS.

HAMADS are not the only way many items are advertised - even a casual remark on air can be followed up by an interested listener. Investigation of the accusation proved that the item in question was sold before the HAMAD appeared to a member of the same radio club as the vendor where the item had been advertised some time earlier.

It has long been WIA policy that no person assisting with the production of Amateur Radio magazine takes any action about the possible purchase of any HAMAD item until his/her personal copy of the magazine arrives in the mail.

The WIA is concerned about the number of inaccurate, unfounded derogatory statements being made on air from time to time. If you feel you have a cause for complaint, please approach your Division or the Executive Office and get your facts right before you broadcast it and perhaps make a fool of yourself. The WIA has enough trouble keeping its small team of volunteers without ill-considered on-air criticism of their ethics. ar

FT-747GX

BUDGET H.F. TRANSCIEVER

The FT-747GX is a compact SSB/CW/AM and (optional) FM transceiver providing 100 watts of PEP output on all 1.8-30MHz amateur bands, and general coverage reception from 100kHz to 30MHz. Convenience features include a front panel mounted speaker and unobstructed digital display, dual operator selectable tuning steps for each mode, dual VFO's for split frequency operation, and 20 memory channels (eighteen of which can store split Tx/Rx frequencies). Wideband 6kHz AM and narrow 500Hz CW IF filters are also fitted as a standard feature. Includes bonus hand microphone. See ARA Review — Vol II, Issue II.

Cat D-2930

2 YEAR WARRANTY

\$1099



FT-4700RH DUALBAND MOBILE TRANSCIEVER

Continuing the tradition started by Yaesu with the FT-2700RH, the new FT-4700RH dualband 2M/70cm FM transceiver now provides higher levels of performance, while offering even better value for money!

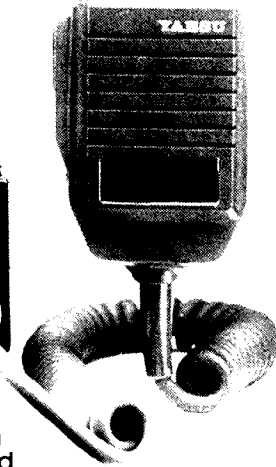
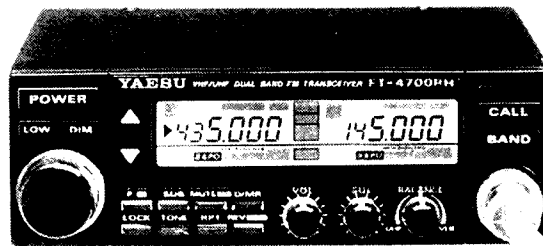

Features include 50 watts output on 2 metres (144-148MHz), and 40 watts output on 70cm (430-450MHz), with an inbuilt cooling fan for long term reliability. True full-duplex crossband operation is supplemented by dual band simultaneous reception or auto-muting reception (with independent squelch and mixing balance), so you can listen for calls on both bands simultaneously, or work someone on one band while also listening on the other band. The optional YSK-4700 controller cable allows the main body of the transceiver to be installed under a seat, while the front panel/controller mounts conveniently on the dashboard. On the control panel, the bright amber back-lit LCD shows both VHF and UHF frequencies and signal strengths, and all controls have back-lit labels for clear readability, with a dimmer switch for nighttime viewing. A total of 20 memories and 5 selectable tuning steps make frequency selection easy, while the advanced scanning features allow quick detection of signals on either, or both bands. And all this is backed up by our exclusive 2 year warranty, the longest in the industry. See ARA review Vol. 12 Issue 11 (Feb 1990), or A.R. review May '89.

\$999

D-3300

D-3301 YSK-4700 CABLE \$49.95



2ABQ AND 3ABP — FUN(?) WITH A SIMPLE BEAM

BILL RICE VK3ABP 54 MAIDSTONE ST ALTONA 3018
WITH ADDITIONAL DATA FROM
HARRY CAPSEY VK2OQ 58 ELLISTON ST CHESTER HILL 2162

Fred Caton VK2ABQ first published his design for a simple rotary wire-element triband beam in "Electronics Australia" of October 1973 (Ref 1). It consists of four horizontal radial spreaders arranged at 90° intervals around a rotatable mast. More than half of each spreader should be non-metallic, but the inner portion may be metal. Varnished wooden dowels inserted in electrical conduit or aluminium tubing were suggested. The length of each spreader (mast to tip) is to be 12 feet (3.66 m), but the metallic part should not exceed 5 feet (1.5 m).

Strung around these spreaders are three wire loops (Fig 1). The corners of the outermost loop (for the 20m band) are near the tips of the spreaders. The innermost (10m) loop is at half this radius (6 ft or 1.83 m), and the 15m element in between at a corner radius of 8 ft (2.4 m). If you calculate the circumference of each element, assuming it to be tightly stretched, you will find it is one wavelength at frequencies of 14.5, 21.7 and 29 MHz. In practice each wire should be longer, with considerable sag between radials, and then trimmed to resonance at the desired frequency in each band by use of a dip oscillator. Typical frequencies would be 14.2, 21.2 and 28.5 MHz. The resonant frequency of each loop, particularly the innermost, is influenced by the amount of metalwork in the spreaders. The height above ground at which it is checked will also have an effect on the resonant frequency. If they are set to the lower band edge at about chest height off the ground, the resonances will move up into each band when the antenna is raised to full operating height.

Coupling Insulators

So far described, the antenna is essentially three nested square loops, each of one wavelength circumference on its respective band, and all three fed more or less in parallel. Current at the feed point will have reversed its phase after travelling half a wavelength to the other side of the loop; but since it has travelled half-way round the circumference it is now going in the opposite direction, so is effectively in phase. Maximum radiation will therefore be broadside to the hori-

zontal element plane, ie vertical. An antenna which radiates straight upwards is not much use for HF DX. What is needed is horizontal radiation, which requires the feedpoint side and its opposite side (spaced by quarter wavelength) to have a 90° phase difference.

This is achieved by cutting each loop precisely into halves at points a quarter-wavelength each side of the feedpoint, and inserting small insulators, which double as coupling capacitors. In effect, the loop now becomes two half-wave dipoles, one centre fed, spaced a quarter wavelength and with the outer one-eighth wavelength extremities of each bent backwards on one and forwards on the other until the tips almost touch. Between the tips are inserted the coupling capacitors, which enable the driven element to energise the other more effectively than if they were simply lying parallel at quarter-wave spacing as in a parasitic array. This second element acts as a reflector.

The actual construction of the side insulators/coupling capacitors is not critical and is determined mostly by mechanical requirements. The original 2ABQ article suggested coat buttons, the wire ends threaded through opposite holes, then knotted to prevent them pulling out. Later information (Ref 2) and also from 20Q recommends small discs or squares of "Perspex" ("Lucite", methyl methacrylate) with the two holes not more than a quarter-inch (6 mm) apart. I would add to this that polystyrene should not be used (too sensitive to ultraviolet light) nor polythene (not strong enough). "Teflon" (PTFE) should be okay, but best is probably fibreglass, eg old printed circuit boards with the copper removed. Some PCBs may be phenolic; not so good, but it may do. Squares are as good as discs, and easier to cut out! The two wires should be threaded from opposite sides, and a single half-hitch knot in each is enough.

Why Not a Quad or a Yagi?

If you know anything about quads, you will realise that the 2ABQ antenna has the same dimensions as a single quad element. However, it lies in a horizontal rather than a vertical plane. But, whereas a single quad element is bi-directional, the 2ABQ has gain in the order of 4 dB

and a front-to-back ratio (f/b) of 12 to 18 dB (front is the feedpoint side of the square).

Admittedly, 4 dB is not a lot of gain, but for a quad to exhibit forward gain and good f/b, two elements are necessary, plus all the mounting hardware to attach them to the top of a mast midway between them. The array height (from top to bottom) is at least a quarter wavelength (17 ft or 5 m for 14 MHz). If diagonally mounted (sides at 45 degrees to the vertical) the height occupied by the array becomes 24 ft (7.3 m). The lowest point on the elements should be well clear of the ground. Even 20 ft (6 m) would be none too high, so the top of the array would be at least 37 ft (11 m) above ground. If other beam antennas (eg for VHF) are planned to go on the same mast they will need to be even higher.

Still on the theme of space requirements, the two-element quad will have a turning radius of about 11 ft (3.3 m) minimum, or 14 ft (4.4 m) for diagonal mounting. Altogether, the point of the argument is that the quad is not a good antenna for a small backyard, particularly if height is restricted by local regulations.

"Agreed," you say to this. "But what about a Yagi? One of the popular tribanders or, even better, a full-size 20m three or four-element monoband?"

True, such antennas need little space vertically. Essentially they are all in one plane. So is the 2ABQ. But even a small tribander has a turning radius like a quad, and a full-size 20m beam will need more like 20 ft (almost 6 m), whereas the 2ABQ needs only 12 ft (3.7 m). Agreed that the big beam will work much better; its gain may well be eight or 10 dB, but it's a major engineering structure and, together with an appropriate tower, it will cost you thousands of dollars. And it works on only one band!

You Get What You Pay For!

"Right," you now say, "I'm persuaded! My backyard is small; the Council won't agree to a big tower; I can't afford a small fortune anyway! The 2ABQ sounds like a cheap and easy homebrew answer. Where's the catch?"

Yes, there are catches! Mostly they involve finding the best technique for

getting all that wire into the air, and then keeping it there, year after year, in spite of wind, rain, rust and ultraviolet! In 1983 I built a 2ABQ and began to learn how!

I mentioned earlier the possibility of other antennas above the HF beam. This is the case in my installation where, attached to a rotating mast there is a 2m Yagi at 50 ft (15 m), 6m and 70cm Yagis at 40 ft (12 m), and the HF beam at about 26 ft (8 m). The original HF beam (back in 1965!) was a homebrew triband Yagi which eventually fell apart, partly because of the unbalanced loading of dozens of pigeons which just knew it was there for their use!

Herein lies a problem. All the material published on the 2ABQ, plus that from Harry, presumes that the antenna will be assembled on the ground, tuned-up on top of a step-ladder, then raised to its final height on top of a mast used solely to support it. In my case it had to be assembled some 25 ft up in the air, around the existing mast rather than on top of it, and with no access to tune the elements! It could not be lowered further, because the first 25 ft (8 m) of the supporting structure is a tapering triangular tower of welded water pipe, with its feet firmly planted in the ground!

Choice of Materials

What follows is a step-by-step chronicle of how the antenna was assembled, from what materials, and what problems were encountered. Firstly, radial arms were required. At that time we had a small clump of bamboo in the backyard. Home-grown is even better than home-brew, so four good canes were selected, tapering from about 25 mm to about 10 mm. Harry recommends giving canes like these three coats of good paint. In 1983 I hadn't been told this, so the canes went up unpainted. Even so, only one or two needed replacement over the next few years, but late in 1987 the whole antenna was demolished by our large, old (and rotten!) willow tree blowing down in a storm. It missed the VHF beams and didn't damage the tower, but it sure made a mess of the 2ABQ!

The new radials are all plastic. For three-quarters of the distance out from the mast, they use 1-1/2-inch (38mm) ID ABS pipe. ABS is acrylonitrile butadiene styrene, also called "Cyclac". The remainder of each radial is 3/4-inch (20mm) PVC electrical conduit. The small tube fits into the larger for about 20 cm, the gap between them being sleeved with split sections of scrap plastic tubing, and the whole held together with a 5mm aluminium wire pin right through the full diameter and its ends bent over.

Centre Bracket

As mentioned earlier, most variations on the 2ABQ theme are intended to be at the top of a mast, so the simple method of mounting the radials is to weld a flat horizontal plate to the top of a water-pipe mast, and either attach the radials directly to it, or perhaps via an intermediate wooden platform (suggest 1 ft square by an inch thick, ie 30 x 30 x 2.5 cm). The radials may be fastened with small U-bolts and should pass over the corners of the platform to gain maximum support from it. If metal tubing is used for the inner portion of the radials the individual tubes should not be connected together or to the mast, but left to "float" electrically.

Another alternative is to use four pieces of light steel angle (1-1/2 in, 40 mm or thereabouts) welded or bolted to the top plate. Each should be 12 in (30 cm) long; or, better still, one piece might be twice this length and continue unbroken across the top, with the other two butted up to its centre at right angles. The angles might even be arranged with their 90° trough facing downwards, so that each acts like a little roof over the inner end of the cane radial to protect it from the weather. In all cases the radials will be held into their angle troughs with hose clips or wire lashing.

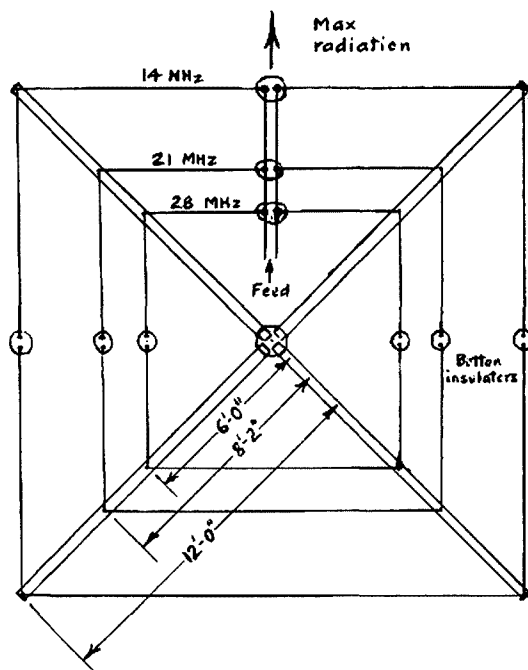

Fig 1 Original form of 2ABQ beam (as viewed from above)

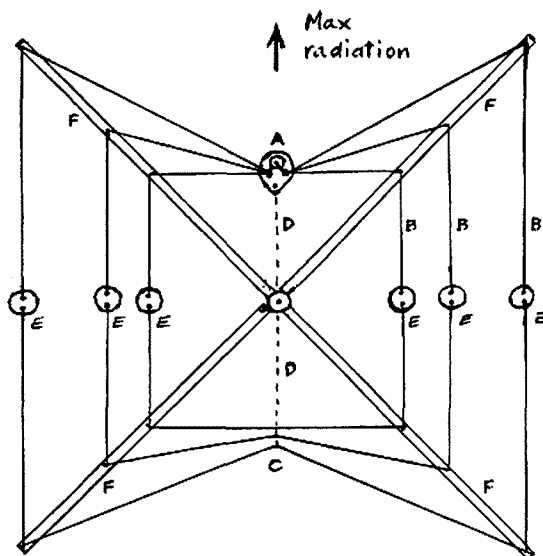

Fig 2 Improved version of 2ABQ beam

- Notes:
- A Feed point insulator and cable attachment point. Seal with silicone.
 - B Element lengths (complete loop)

14 MHz	69 ft 0 in	21.03 m
21 MHz	47 ft 0 in	14.33 m
28 MHz	35 ft 0 in	10.67 m
 - C No connection between elements at this point
 - D Nylon cord to pull in elements
 - E Button insulators — see text
 - F Insulating radials 12ft (3.66m) long

My first version used two steel angles one above the other at 90° to each other and the 2in water-pipe mast, and each clamped to the mast by a 2-1/2in U-bolt. The bamboo canes were lashed to the angles with twine. Obviously I didn't expect it to last, did I? Nevertheless, it was still usable until the willow fell all over it!

In the rebuild, I used a scrap piece of right-angle anodised aluminium building extrusion about 6 x 6 x 12 in (15 x 15 x 30 cm) bolted to the mast with two U-bolts. Two pieces of one-inch-square steel tube, each about a metre long, are clamped one to each face of the extrusion, and touching where their centres cross over. The tubes are each clamped with four bolts and two saddles, rather than weakening them by drilling bolt holes through them. The ABS plastic radials fit neatly over the square tubes, and are pushed on to them until they butt up against the centre bracket.

Element Wire and Clips

Once the radials are in place the element wires can be attached. This is obviously much easier near ground level than eight metres or more up in the air! The wire must be stranded for flexibility, as the durability of the whole antenna depends on it being able to "flap and flop around" in the wind. It is very important that the elements should not be tied down tightly to the radials where they pass over them, but should be free to slide sideways. In the original article (Ref 1) it was suggested that small cup-hooks should be screwed into the tops of the radials, at the correct radius for each element, to prevent the wire moving inwards while still permitting sideways motion.

Following this advice, I used cup-hooks on my first version, screwed into bamboo, but found quite soon that they either worked loose or rusted away much too quickly. Various schemes using aluminium wire were attempted, but the problem really had not been solved before "Willow Day" made it all past history. On the new plastic radials I have also used bent wire hooks, some wrapped around the tube, some through drilled holes, some restrained by cord out to the next one. Some are better than others, but as Browning said, "The best is yet to be!" Suspension by cord loops may be the answer.

A confession at this stage. I have yet to fit a 10-metre element! The 15 and 20-metre elements are working, but somehow I didn't finish one for 10 metres. When I do, I will take down the radials one by one and try to optimise the clips.

Availability of suitable stranded wire may be a problem. In the "good old days" seven-strand bare electrical earth wire was easily obtained. It is still much the

same size now (although metric) but is only available with yellow/green stripe PVC insulation, which reduces flexibility and increases weight and wind load. It is really too heavy, anyway, although some may have used it. Heavy grade plastic hookup wire is better. I really economised by stripping wire from burnt-out transformers or motors and twisting up seven strands to various lengths with a hand-drill, then spliced them together to make up the necessary length!

Putting the wire into place, way up in the air, is a problem which really taxes one's ingenuity. As mentioned earlier, it is virtually impossible to check *in situ* with a dip oscillator, so the elements must be pre-cut to the specified lengths and the insulators fitted before lifting them into position (see Fig 2 for preferred arrangement). First, one end is connected to the feed point. Working near the top of the tower, alongside the centre bracket, the free end is then pulled up over the radials and connected to the other feed point terminal. The wire is then pushed outwards with a length of bamboo (V-slotted at the outer end) until it can be hooked over its retaining clip on each radial in turn.

This is a frustrating procedure, particularly when the backyard near the tower is covered with fruit trees, garden beds, a wood-shed and the shack! The dangling wire inevitably catches on one or more of these obstacles and refuses to come unstuck! One gets one's exercise quota going up and down the tower like the proverbial "fiddler's elbow"! An assistant at ground level makes the job easier. While working at the job, a safety belt is essential, both to reduce the risk of falling and also to leave both hands free. Believe me, even two hands are insufficient for some of the snags one can encounter!

Feed Point and Feed Line

Fig 1 shows the antenna layout as originally published in Ref 1, with the feed point for each element being some distance from the other two, but all connected together by (as one possibility) 70 Ohm parallel wire feeder.

A later development (Ref 2) is to pull in the outer two elements to coincide with the inner at a common feed point for all three. The other side of these elements, diametrically opposite the feed point, is also pulled in (with nylon cord, for example) to form a near-symmetrical "bow-tie" shape. A warning here is that there should be NO CONNECTION between the elements at this point.

The feed point impedance is claimed to be around 60 Ohms on all three bands, so it is convenient to feed with either 50 or 70 Ohm coax cable, and is claimed not to require a balun. The impedance is proba-

bly a rather critical function of element length and the precision with which it is bisected by the insulators. I could not "dip" the elements and had to cut them in advance, while one or two subsequent breakages have caused them to become a little shorter and somewhat asymmetrical. The absence of the 10m element may also have some effect. Perhaps, therefore, it is not surprising that my SWR readings are not as good as Harry's! He claims 1.3 on 20 m, 1.2 on 15 m and 1.0 on 10 m. On my (home-brew and pre-Daiwa!) cross-pointer reflectometer I get more like three to one on both 20 and 15 m, and find it desirable to use a transmatch at the input to the 50 Ohm coax.

In Conclusion

This article came about for several reasons. Primarily, it goes back to the rebuilding of my 2ABQ after "Willow Day". I ran into all sorts of problems; many have been mentioned in this article. So, in my June 1988 editorial, I asked how many others had useful ideas about how to build a 2ABQ beam. I was surprised to get only one response, from Harry VK2OQ, but he provided much information, both direct from Fred VK2ABQ (himself a good friend of Harry) and from Harry's own experience. Ever since, it has been a problem to find time to "write it all up", but the decision to publish a special Antenna issue spurred me into action!

The second reason is that it is an antenna which I think needs to be better known. Largely because of G3VA and the RSGB, it is popular in the UK, especially for small backyards, but seems to be not as well known here (the prophet in his own country, perhaps?).

The third reason is that it is capable of performance not far inferior to many commercial beams, yet can be built cheaply by any average handyman (or even handylady?). With just 10 and 15m elements it could be a good Novice antenna. Since its original publication we now have the 18 and 24MHz bands. Could elements for these frequencies be inserted between the others? Sounds like a "five wire beam in space"! Would someone with more time than I have like to give it a go?

Incidentally, Harry says in his letter to me that he is aged 80 plus, while Fred is 70 plus. Since I am 60 plus, it seems time for someone younger to take on the development task. At least, you can't now claim that you don't know anything about it. Over!

References

1. Fred Caton VK2ABQ "Electronics Australia" October 1973 p69.
2. Pat Hawker G3VA "Amateur Radio Techniques" (7th ed 1980) p334. ar

160m HELICAL VERTICAL

N CHIVERS VK2YO
51 MEEKS CRES
FAULCONBRIDGE 2776

The VK2YO 160m helical vertical antenna system as illustrated should be capable of being duplicated by anyone with the will and patience to do so.

There are plenty of well proven antennas for 160 m in use, but they all have some disadvantage which precludes their use at my QTH.

1. I live in the Blue Mountains of NSW, on a quarter-acre block of land that is a rock shelf with a thin covering of poorly conducting soil.

2. I have been using an end-fed wire or a G5RV working against the ground whose resistance varies with the weather.

3. Other amateur operators have told me they would like to work 160 m but do not have enough room to put up a decent antenna and/or earth system.

The most popular 160m antennas seem to be some form of loaded vertical radiator worked against the ground, the ground being the missing half of the antenna. I have used helical whips on the higher HF bands for many years while mobile, and found them to be excellent short antennas, so helical short radiators would be the way to go, I thought. To try this out, I roughly coupled together two shortened surplus 11m whips.

The antenna is constructed on 2 x 2m fibreglass rods (wood curtain rod would do). Each rod has a PL259 coax plug at the end. These screw into a coax tee piece, (4) on the diagram, so that the bottom rod hangs vertically, and is mechanically rigid under the top rod. The top rod is fitted with a hook to hang it from a convenient support, or rope stretched between two points.

Wind enough wire onto one of the rods at the opposite end of the PL259 plug so that when coupled to a dip oscillator it will show self resonance at about 3.6 MHz. This took 132 m of 26 SWG enamelled wire scrounged from an old power transformer primary. The wire is close-wound over 1.2 m of the rod then the winding is tapered to connect with the PL259 plug coaxial connector at the other end.

Repeat this process for the other rod.

The upper rod's wire connects to the centre of the PL259 plug, while the lower rod's wire connects to the outer collar of its PL259 plug. When assembled as a dipole, the inner coax wire feeds the upper helix while the braid feeds the lower.

With the two rods assembled with the inter-connecting coax "tee", they were supported horizontally across the backs of three chairs. A socket with a one-turn loop was screwed onto the plug section of the tee coax connector (4). A GDO was coupled via this loop and dipped at 1.79 MHz, but when raised to its operating position vertically suspended from a crossarm half a metre out from the support pole and the bottom rod one metre above ground, the resonant frequency went up to 1.86 MHz. Squashing the turns up a bit produced self resonance at 1.83 MHz, which is near to the most used part of the 160m band. The turns were then fixed with a coating of araldite to keep the resonant frequency stable.

I coupled direct to the station transceiver, TS680S, with 50 Ohm coax. Receiving results were encouraging but on transmit they were poor due to a bad mismatch. With a tuner in line I could not get the VSWR down low enough for the transceiver protection circuits to allow full output. After constructing an impedance bridge I investigated the problem.

The bridge nulled broadly about 20 Ohms at 1.86 MHz. Obviously, impedance transformation needs to take place between the transceiver and its load. My available tuner would not do the job so I built one that would work. Remembering that receiver RF amplifiers using transistors are often tapped along the tuned circuit for best match and the aerial is

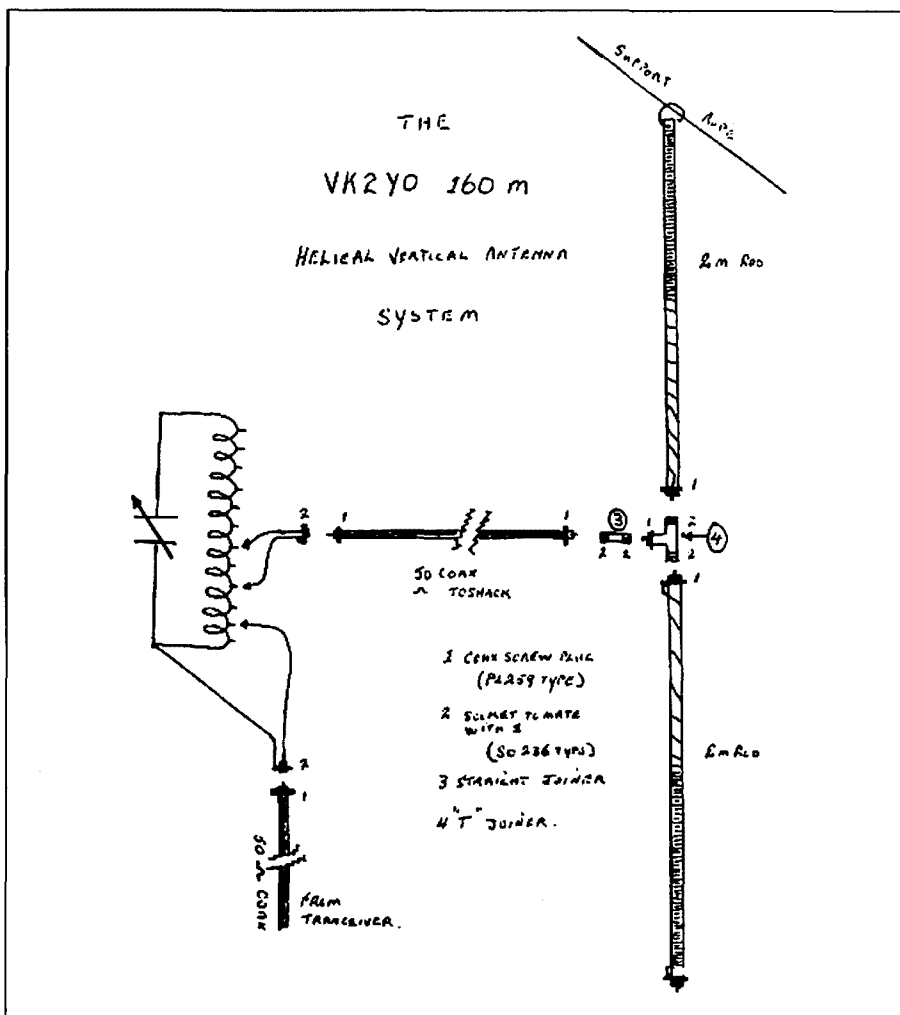

The VK2YO 160m Helical Vertical Antenna System.

HOW TO WIND THAT NON-RESONANT HELICAL

RICHARD BURDENVK6FKB PO Box 1164 BOORAGOON 6154

Recently I installed a modified CB into the car for operating 10m mobile. After several days of having to remove and replace a large whip every time I entered or left the carport I started to look for a better way. There were two options: mount the aerial somewhere else besides the centre of the roof or use a smaller whip.

A quick look at the price of buying the bits and pieces to mount the aerial elsewhere convinced me I should consider a shorter whip.

Whatever form of loading was used to resonate the whip it was unlikely to present a 50Ohm impedance to the feedline at resonance.

I didn't want to expose the reverse side of the aerial base to use a Dip Meter to check for resonance or to install a matching network at the base to match the feedline to the aerial. That was becoming altogether too hard. And a mechanism to adjust the length was ruled out because I wanted to use the biggest aerial possible.

But I did see a way out of the predicament. A length of coax between the aerial and the transceiver was going to transform whatever impedance the aerial had at the operating frequency to some different value of both resistance and reactance at the transceiver end of the feedline.

If the aerial presents the right value of reactance to the feedline, this would be transformed to a nil value at the other end. The resulting resistance could then

be matched to 50 Ohms with a simple L network. The aerial will still radiate, but the efficiency will be reduced.

This was a convenient approach because my homebrew noisebridge was calibrated on the resistive scale but not for the reactance scale. The approach I adopted was 'forget about resonance at the aerial and concentrate on getting a resistive impedance at the transceiver end of the feedline'.

The tape measure said I had only 85cm of clearance when the car was in the carport. The hacksaw quickly reduced an old whip to 80 cm. I stripped the outer covering and removed the remaining winding.

I was surprised at just how small a gauge of wire was used. The wire I used in the rewinding was approximately one millimetre in diameter, at least twice the diameter of the original wire. Initially I wound a half wavelength on the aerial, evenly spacing the turns. With a short whip this meant the turns were closely spaced.

Parking the car in an open space I set the radio to the centre of the frequencies it covered and attached the cables to the noisebridge. With the aerial in position I found a null on the noisebridge.

Removing a 20cm length and spreading the remaining turns evenly over the aerial's length I returned the aerial to its mount. The null had moved in the right direction! I repeated this process several times before the null indicated zero reactance was present at the transceiver end

of the feedline.

I slipped the heatshrink tubing over the aerial. At this stage I did not shrink the tubing. Checking the null I found I had to take more wire off. Two more wire removing exercises eventuated before I had returned to a null indicating a non-reactive termination of 15 Ohms.

Back in the garage I shrank the tubing. It was a straightforward exercise to calculate the required values for the L network and put it all together.

Back to the open space, and the SWR was measured as 1.5 to 1. How well did it work? A low-level signal was set up in the garage and the car placed at the far end of the driveway. The 80cm whip with matching network was measured as having a loss of just one decibel in comparison with a Yaesu 10m mobile aerial.

In mobile operation the results have been mixed. Local contacts have given signal reports which vary from good to very bad. Long distance contacts have usually been good. If you can hear a station over the electrical noise from a mobile environment, chances are it will hear you. Based on prior experience I would rate the overall results good for a mobile aerial.

I am not going to consider reverting to a larger whip mounted somewhere else. The ground loss increases if the aerial is mounted lower on the car, possibly negating any extra efficiency the larger aerial might produce. ar

Continued from page 14

sometimes also tapped to this coil in a different position for the same reason, if link coupling is not used, I reasoned that this system should work on transmit.

On a piece of orange 20mm diameter electrical conduit I wound 100 turns of 18 SWG, tapped every five turns. Across this coil is connected a wide-spaced 20pF to 150pF variable capacitor of World War Two vintage.

This combination tunes from about 1.75 MHz to 1.95 MHz, and, by trial and error moving the taps up and down the coil and adjusting the capacitor, a low VSWR is obtained.

Coax feed could be replaced with open wire if desired, if convenience of entry to the shack and insulation is not a consideration. I have not tried open wire feed as

it is not convenient. The interconnecting coax between the antenna and tuner should be kept as short as possible to minimise radiation from the braid of the coax as indicated on transmit by an absorption wave meter.

A word of warning at this point. Do not connect the transceiver to the tuner or the tuner to the load (antenna) via a coax switch, as the braid side is common to all connected antennas and is often connected to earth for lightning protection, and this helical vertical dipole floats above ground and is independent of it.

If the station transceiver is separately RF grounded, then the tuned circuit should be fed by a link coupling wound over the centre of the tapped coil with a series capacitor in one leg of the link. I have tried this, and it works equally as

well as direct coupling. I used a ceramic-based mica capacitor of 10pF to 100pF range in series with the link of about 20 turns 18SWG.

Compared to the end-fed wire about 80m long that I usually use at my QTH, it is in most respects equal or better, usually by one S point on transmit. I have worked stations such as VK2MQ in Tumut, VK2AMI in Glenbrook and VK4YB in Caboolture in a group with others on the same evening with reports better than the end-fed wire. On receive it seems to pick up more atmospheric noise than the horizontal end-fed wire.

If it means the difference between having a 160m QSO on net, then this antenna may be the answer for the cramped space amateur or the amateur with a poor earth. ar

PHASED BOBTAIL CURTAINS

ODUS W LOVELL W5VXG Rt 1 Box 398
 POLLOCK LA 71467 USA
 SUBMITTED BY J VOGEL VK6BA

The bobtail curtain has been around since the early 1930s. It is an oldtimer's antenna. Two of them can be phased for increased gain with little trouble. This article shows how to phase two bobtail curtains with a simple matching and phasing harness.

Phased bobtail curtains have a number of advantages. They have good bi-directional gain and no ground screen or radials are required.

Phasing two together is simple for a spacing between them of 0.2 wavelength. A closer spacing of one-eighth wavelength would yield more gain but the phasing harness and matching would be more complex. This would be due to the lowered feed impedance at a closer spacing.

A single bobtail curtain is shown in Fig 1 with dimensions for 15 and 20 metres given in Table 1. The bottom ends of the vertical have six-inch wire sprigs which are trimmed with sidecutters to tune for lowest VSWR.

A phased array of two bobtail curtains is shown in Fig 2. The phasing harness is shown in Fig 3.

The feed impedance of each bobtail curtain is approximately 25 Ohms. See Fig 3. This 25 Ohms is repeated a half-wave down the top line. It is then transformed to 100 Ohms by the next quarter-wave of line. The second bobtail curtain's feed of 25 Ohms is transformed to 100 Ohms by the bottom quarter-wave of line. The two 100 Ohm impedances in parallel at the "tee" give 50 Ohms. thence RG58 or RG8 of any length may be used to connect to the rig.

The top phasing line is physically longer than the bottom phasing line. Coil up the extra length in a six-inch-diameter coil near the tee connector. See Fig 2.

I believe it is good practice to keep the phasing lines and feed-line horizontal for at least a half-wave from the closest bobtail curtain. See Fig 2.

Height of the bobtail curtain flat-top portion ideally should be approximately 0.45 wavelengths. Thirty feet on 20 metres or 20 feet on 15 metres. This is to ensure good low-angle radiation.

My 20-metre version has two major lobes fore and aft, with minor lobes either side. See Fig 4.

Hope you try the phased bobtail curtain and that it works for you.

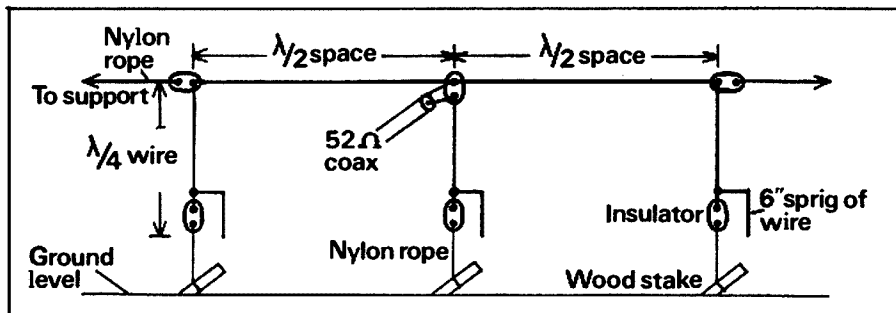

Figure 1 Single Bobtail Curtain

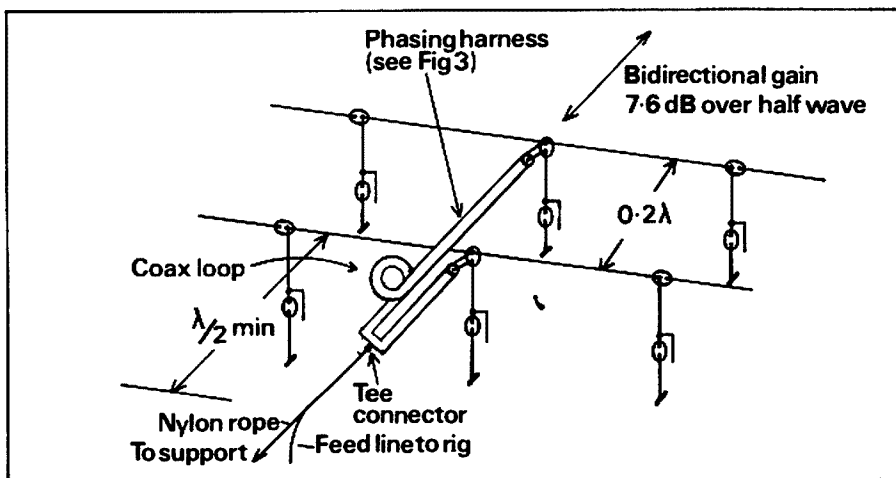

Figure 2 Phased Bobtail Curtain

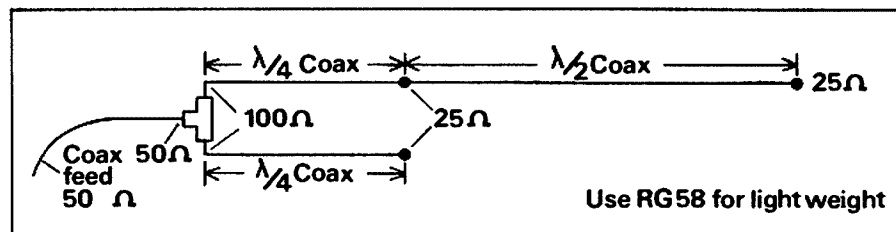

Figure 3 Phasing Harness

	20 metres f = 14.2 MHz	15 metres f = 21.25 MHz
$\lambda/2$ space = $492/f$	34 ft 7-3/4 in	23 ft 2 in
λ space =	69 ft 3-1/2 in	46 ft 4 in
$\lambda/4$ space	17 ft 3-15/16 in	11 ft 7 in
0.2 λ space	13 ft 10-5/16 in	9 ft 3 in
$\lambda/2$ wire = $468/f$	32 ft 11-1/2 in	22 ft 1/4 in
λ wire	65 ft 11 in	44 ft 1/2 in
$\lambda/4$ wire	16 ft 5-3/4 in	11 ft 1/8 in
$\lambda/4$ coax = $\lambda/4$ space x 0.66	11 ft 5-3/16 in	7 ft 7-5/8 in
$\lambda/2$ coax = $\lambda/2$ space x 0.66	22 ft 10-3/8 in	15 ft 3-3/8 in
3- $\lambda/4$ coax = 3- $\lambda/4$ space x 0.66	34 ft 3-9/16 in	22 ft 11 in

(Note: Dimensions given are feet and inches as the source country is not metric. Readers may convert if desired using 1ft = 0.3048m and 1in = 25.4mm. Tech Ed)

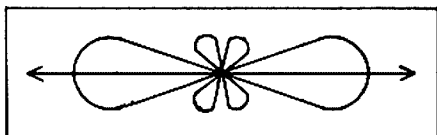

Figure 4

Radio Amateurs: Have you checked out EA lately?

No doubt most radio amateurs are aware that *Electronics Australia* is by far this country's largest-selling electronics magazine, as well as being its oldest (we began way back in 1922, as *Wireless Weekly*). But have you looked inside the magazine lately?

Now it's bigger and better than ever, because our leading competitor *ETI* has been merged with us, to form *Electronics Australia with ETI* – the biggest, brightest and most informative electronics magazine, bar none.

You'll now find lots of new 'departments' in the magazine, including Solid State Update (with news of new semiconductor devices), Silicon Valley Update (news from the USA) and What's New in Entertainment Electronics. Plus all of your old favourites like Forum, The Serviceman, Circuit and Design Ideas and so on. And of course plenty of 'meaty' technical articles and construction projects.

What about *amateur radio* projects? Well, as you can see there are more of these than before – but we're very interested in publishing more. So if YOU have developed an exciting amateur radio project, contact Jim Rowe by writing to him at EA, 180 Bourke Road, Alexandria 2015. Or phone him on (02) 693 6620, to discuss the possibility of publishing it as a contributed article. As well as earning a fee, you'll also be helping to boost interest in amateur radio!

Take a look at the new, bigger and brighter *Electronics Australia with ETI* – on sale at your newsagent at the beginning of each month. Or subscribe now, by phoning (02) 693 9517 or 693 9515.

**Electronics
Australia** WITH **eti**

Australia's Top Selling Electronics Magazine

INCLUDED IN OUR OCTOBER ISSUE:

FROM SPARKS & ARCS TO SOLID STATE – 1

Exactly how did those early spark and arc transmitters work – and why couldn't they be used for telephony? Former *EA* Editor in Chief and long-time amateur Neville Williams explains...

ICOM'S MIGHTY MIDGETS

The new Icom R1 and R100 wideband communications receivers are very tiny – but how do they perform? Jim Rowe has been trying them out.

TEN YEARS OF SBS

It's 10 years since Australia's unique low-budget multicultural TV broadcaster began operating. Here's a look behind the scenes, showing how it puts those programs to air.

MORE VIEWERS FOR ATV

PETER JONES
LIAISON OFFICER SEQ-ATV GROUP

The South-East Queensland ATV Group has increased the range of its television repeater with higher transmit power and a new antenna.

After months of planning and construction, a horizontally polarised double-stacked Alford Slot antenna was built and tested, before being put into position atop a 20m mast on an inner Brisbane building.

The Alford Slot was chosen to replace the vertically polarised collinear for several reasons:

1. It's more easily picked up by existing domestic TV antennae.
2. It's omni-directional.
3. It has a gain of approximately 9dB over a dipole.
4. Its solid construction stops it flexing in strong winds, which has been causing varying signal strengths in fringe areas.

The repeater has an input frequency of 444.25 MHz and an output of 579.25 MHz — approximately channel 35 in the UHF band.

ERP is now 200 Watts.

Signal strengths have increased in all suburbs, resulting in a number of new members joining the group.

The SEQUATV's address is PO Box 3, Chermside, 4032. ar

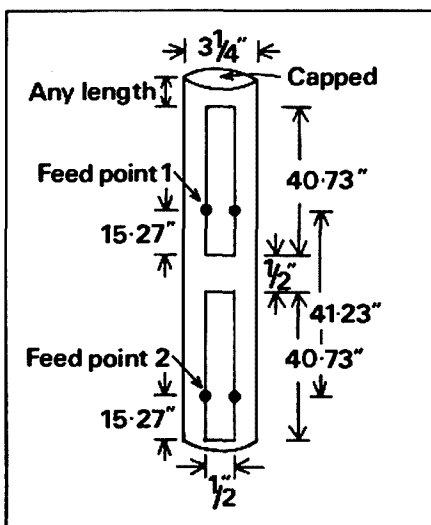

Dual Alford Slot for 580 MHz

$$\lambda = \frac{300}{580} = 517.24\text{mm (20.36")}$$

$$2\lambda = 1034.48\text{mm (40.73")}$$

$$\text{Feed Point} = 0.375 \times 1034.48$$

$$(50 \text{ Ohm})$$

$$= 387.95\text{mm (15.27")}$$

$$\text{Circumference} = \frac{\lambda}{2} = 258.62\text{mm (10.18")}$$

$$\text{Diam} = \frac{258.62}{\pi} = 82.32\text{mm (3.24")}$$

Phasing harness

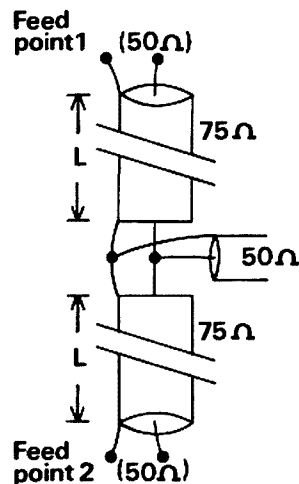

Matching Harness

$$\frac{\lambda}{4} = \frac{517.24}{4} = 129.31\text{mm (5.1")}$$

$$\text{Velocity Factor} = 0.79$$

$$\text{Corrected } \frac{\lambda}{4} = 102.15\text{mm (4.02")}$$

total length, for mechanical reasons, would be:-

$$L = \text{either 5 or 7 times } \frac{\lambda}{4}$$

(i.e. odd multiples of).

for 5 (multiples)

$$L = 510.8\text{mm (20.11")}$$

or for 7 (multiples)

$$L = 710.1\text{mm (28.15")}$$

CHINESE AMATEUR IN SYDNEY

Zhou Yu Hong, the Vice Secretary General, Shanghai Radio Sport Association, has arrived in Sydney for a six-month-long course of intensive English instruction. Greeting him at a welcome dinner in Sydney were, from left: Zhou; Thomas E King VK2ATJ; Sasha Baer, Publicity Officer, International Amateur Radio Network; and Sam Voron VK2BVS, IARN, Director for Overseas Development Projects and Disaster Assistance.



YOU TOO CAN HAVE A 1 TO 1 SWR

BILL ROPER VK3ARZ
3 TAMAR COURT
MENTONE 3194

One of the most talked about subjects on the lower amateur HF bands is SWR — standing wave ratio. Listening on the 80-metre band, it seems many amateurs spend a considerable amount of time trying to reduce the SWR at the transceiver end of their antenna feedline to a perfect one-to-one match.

Most modern transceivers require the antenna system load to be near to a perfect match, that is less than a two-to-one mismatch, although most generally work quite efficiently up to that level of SWR. That is a good reason to want to reduce the SWR.

One solution to the problem can be found with open wire feeders to the antenna, and an antenna tuning unit (ATU) at the transceiver.

However, as in my case, not everyone is prepared to accept the relative unsightliness of open wire feeders, particularly if the antenna feedpoint has to be over 100 feet from the shack. Also, having to retune an ATU every time you change bands or change frequency by a large amount is a nuisance.

Therefore, a common antenna in use, particularly in restricted real estate locations, is an inverted V dipole, hanging off the mast or tower supporting beams for the higher HF and/or VHF/UHF bands, fed with coaxial cable. It is relatively easy to adjust the SWR at resonance of such an antenna to below the two-to-one demanded by most modern transceivers. But difficulties then occur when you want to change frequency to either end of the band. The SWR soars up over two to one and the transceiver power output starts dropping off rapidly as the automatic SWR protection circuitry comes into operation.

Obviously the SWR of the antenna needs to be such, at the resonant frequency, that the SWR at either end of the band remains below two to one.

How to achieve that?

Like most amateurs you probably cut the 80-metre dipole to about 132 feet long, split it exactly in the middle for the feedpoint, and adjusted both ends by equal amounts until the lowest SWR measured at the transceiver was at your favourite

frequency, or at the middle of the band. Then, no matter what you did, the SWR refused to come down below two to one or, if you were lucky, below 1.7 to one.

Let us look at the perfect dipole for a moment. About 132 feet long for the Australian 80-metre band, it would have a centre impedance of 70 Ohms if it was the correct height above ground and was completely clear of all nearby objects such as trees, power and telephone lines, metal towers and gutting etc.

Is your antenna installed like that? If so, you are indeed lucky.

Most 80-metre antennas, especially if you live in the suburbs, are installed as an inverted V, with the dipole legs running close to all sorts of other objects, and are fed with 50 Ohms impedance coax.

In this type of installation it is most unlikely that you will achieve the desired SWR, because the antenna is both mismatched and unbalanced. The chances are that, with the presence of all the foreign objects, different ones to each leg of the dipole, one side of the antenna will have greater capacity to ground than the other.

The solution is easy. Assuming that each leg of the dipole was cut to the same length to start with, and both legs have been trimmed by an equal amount to adjust the resonance of the antenna to the desired frequency, lengthen one leg and shorten the other leg by the same amount. The resonant frequency of the antenna will be virtually unaffected, but the SWR will have changed. If the SWR went higher, then the alteration to the antenna was in the wrong direction. Reverse the alterations to leg length and try again. With a few adjustments you will soon achieve an SWR close to the idealistic one to one.

I have been using this method of adjustment of HF wire dipole antennas for many years, and am surprised how few amateurs seem to know about it. The 80, 40 and 30-metre inverted V dipoles at my location (a small suburban allotment) are all fed from the same feedpoint on the side of the tower supporting the HF and VHF beams via a balun and a common RG8 coaxial cable 120 feet long. These antennas were all tuned to show, at the

transceiver, an SWR of one to one at the relative band centre frequency, and facilitate rapid band and frequency changing without having to worry about adjusting an ATU or the SWR at the transceiver. ar

Prevent Pirates

Make sure you
sell your
transmitter to a
licensed amateur

A Call to all Holders of a Novice Licence

Now you have joined the ranks of amateur radio, why not extend your activities?

The Wireless Institute of Australia (N.S.W. Division) conducts a Bridging Correspondence Course for the AOCF and LAOCF Examinations.

Throughout the Course, your papers are checked and commented upon to lead you to a successful conclusion.

For further details write to:

The Course Supervisor
WIA
PO Box 1066
Parramatta NSW 2124
(109 Wigram Street, Parramatta)
Phone: (02) 689 2417

11am to 2pm Monday to Friday
7 to 9pm Wednesday

5/8 WAVELENGTH VERTICAL ANTENNA FOR 435 MHZ

NORMAN E GRIFFITHS VK4ZFQ
8 ALLAMANDA CRES TOWNSVILLE 4814

This antenna is based on a two-metre 5/8 wavelength mobile whip in use at this station. The dimensions have been scaled down to suit frequencies between 432-438 MHz, and an optional ground plane provided for fixed station use. It is simple to construct from readily available materials and easy to adjust for low SWR and has a gain of about 3 dBD. It comprises a 5/8 wavelength radiator fed by a length of coax which is also the matching section to 50 Ohm feedline.

Materials: 308mm length, 3mm diameter brass or brazing rod; 110mm length 6mm diameter brass or copper tube; 64mm length 16-19mm diameter nylon insulator (see text for alternative); 125mm length of RG-58/U with outer sheath removed; one PL-259 plug with points filed off.

Construction: Insert the 300mm length of brass rod into the 6mm diameter tube to a depth of 13 mm and solder. It may be necessary to use copper or brass shim packing to make a sound fit. The total length should be 405 mm after joining. Next take the nylon insulator and fill with epoxy or glass fibre resin. If

not obtainable, use a 24mm length of 16mm diameter glass fibre electrical conduit. This insulator should be drilled as shown in figure 1. Now slip the insulator into the modified PL-259 connector, bond the PL-259 sleeve centre portion and the insulator into a single unit with epoxy. This portion must be waterproof.

Take the prepared matching coaxial section. The soldering between inner and outer as shown in Fig 1 should be done carefully to ensure it slides easily into the radiator tube. Now tin the centre conductor and slide the coax into the tubing until the end of the braid is level with the tube end. The braid should be carefully soldered to the end of the tubing.

Measure the distance from the tip of the PL-259 to the tip of the insulator. Measure the same distance along the tubing from the tip of the coax centre conductor and mark the tubing. The radiator section should be inserted into the insulator to the mark and the coax conductor soldered temporarily in order to check VSWR before final assembly. A figure of 1.2:1 or less should be obtained.

When all is in order, the radiator and insulator should be fixed with epoxy.

If the VSWR is not very low, check at two frequencies about 6MHz apart and observe which VSWR is lower. For low VSWR with low frequency, shorten the coax or shorten the radiator. If the higher frequency shows the lower VSWR, the reverse applies.

For the best performance the antenna should be mounted on a good ground plane, either car boot or roof.

Optional Ground Plane: 4-2mm diameter, 200mm long brass rods or 16SWG copper wire; 1-50mm x 50mm piece of single-sided PCB. 1-SO-239 bulkhead socket. (See fig 2.)

Construction: Drill the PCB to take the SO-239 socket. Solder the four brass rods to the PCB at 90° to each other. Mount the socket and connect the coaxial conductor to centre pin and braid to a solder tag mounted under one of the socket mounting nuts. The cable and connections should be protected with a non-hardening silicone compound to prevent ingress of water. The radiator was silver plated as a final touch — but not strictly essential.

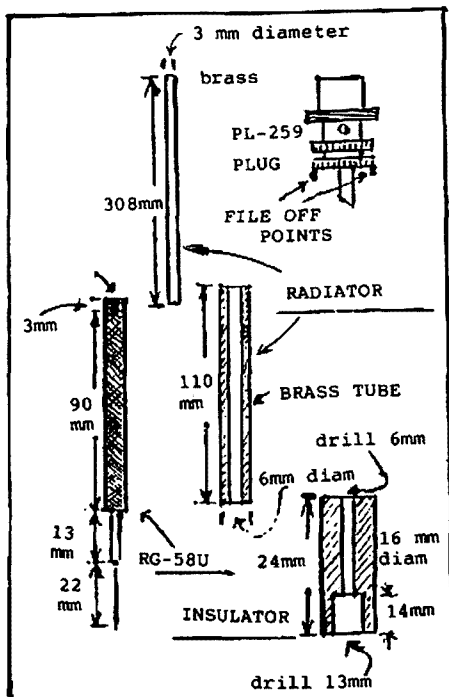
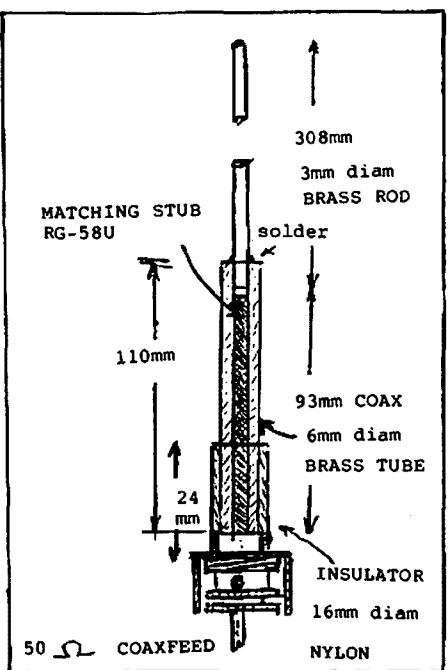

Fig 1 Details of parts for 5/8 Antenna



Section of Assembled 432 MHz Antenna

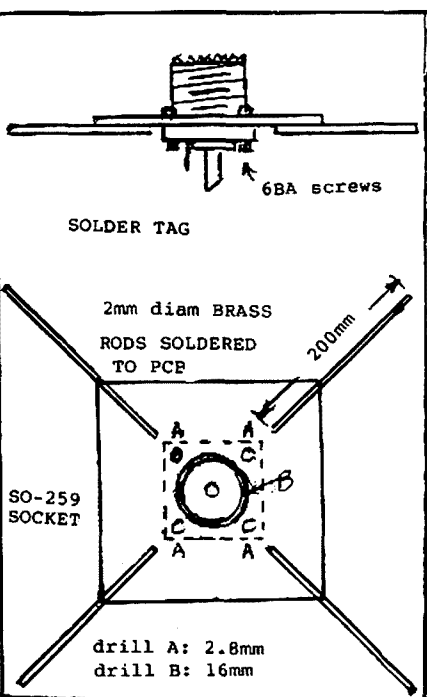

Fig 2 Details of Ground Plane

ANTENNA AIMER

HOW TO REBUILD AN ANTENNA ROTATOR CONTROLLER

STEVE MAHONY VK5AIM
19 KENTISH ROAD ELIZABETH DOWNS 5113

Some AR readers may have on hand or may in the future acquire an antenna rotator, the part that actually rotates the beam antenna, without the control box.

Typical may be a deceased estate, where the tower, rotator and beam antenna may be left still standing, as it is difficult for the relatives to dismantle and sell, while the gear in the shack, eg transceiver, power supply, antenna tuner, SWR bridge and rotator controller, is readily carted down to the local second-hand dealers and sold. After reading this article, you may decide to keep your ears and eyes open for just such an opportunity. It does happen.

Most rotators run at 30 Volts AC, for safety. The motor is usually about 1/10 Hp, 30 V AC, split windings, with a high value unpolarised capacitor, to enable its direction to be changed, ie CW and CCW. This is done by feeding either winding via the capacitor to make it rotate in the desired direction. (Fig 1)

Some form of remote indicator is required to indicate in which direction the antenna is pointing. This can be done

with a voltmeter rescaled in south, west, north, east, south, which is quite easy to duplicate. About 15 Volts AC is rectified, filtered and regulated down to 12 Volts DC. (fig 4). In the rotator, there is a potentiometer driven by the final drive system to travel through 360°, either directly or through a gearing system 36 to 27. The wiper of this pot, along with either end, is brought back to the controller. This pot is used to drive a voltage divider so that south it reads 0 Ohms, north 1/2 Ohms, and south again reads Max Ohms. If the 12V DC is connected across the ends of this potentiometer and the wiper connected to the voltmeter, then at the intermediate positions of the rotator, the voltmeter will read a proportional voltage, eg South = 0 V, north = 6 V and south again = 12 V. (Fig 2)

Before you decide to make your controller, you must check that the rotator is working so that you can identify the connections. If it is a well-known brand such as a DARWA 7500 series, you are halfway there. Beg or borrow a copy of the circuit. You will see a similarity between the maker's circuit and the circuits of this article.

If you cannot obtain a circuit, you will have to check out the terminals with an ohm-meter. The motor windings will be very low resistance, eight to about 18 Ohms each winding, eg a total of three terminals. Record this...

The position potentiometer will be from 500 Ohms to 1k Ohm total resistance, with an intermediate value for the wiper, eg 250 to 500 Ohms, depending from which end you measure. Again three Terminals. Note this for future reference...

It depends on the make of the rotator whether the phase shift capacitor is in the controller box or up in the rotator. If you are lucky enough to obtain a circuit, it will be shown on this. It is just a large value non-polarised capacitor, 90µF to 100µF at about 50 volts AC. If yours is in the rotator, it will be easy. If not, you will have to find out or guess its value. At this point it may be wise to seek assistance from someone who has some electrical knowledge, or give up and look for another rotator.

To check that the rotator is working, all that is necessary is to apply 15 to 30 Volts AC to the motor windings. It will run on as low as 15V AC. Three of 6.3V AC heater windings seriesed and phased will do the job. After identifying the motor common, connect one side of the AC to this terminal, and momentarily apply the 18 V to one of the motor terminals. You should have checked them for continuity and resistance to identify them. The motor should run, and the unit rotate in one direction. Transferring the AC to the other terminal should make it turn in the other direction. Some rotators (your circuit, if you have been able to obtain one, would show this) have two limit switches built-in. They are to prevent the unit from going more than 360°. After all, who wants to tie his coax cables in a knot? Simple, low power units only have a mechanical stop and stall the motor. Continued application of the AC will burn out the windings, so be careful. If your rotator won't go with the AC on one winding, try the other terminal. If it goes okay, return the AC to the previous terminal after the rotator has travelled

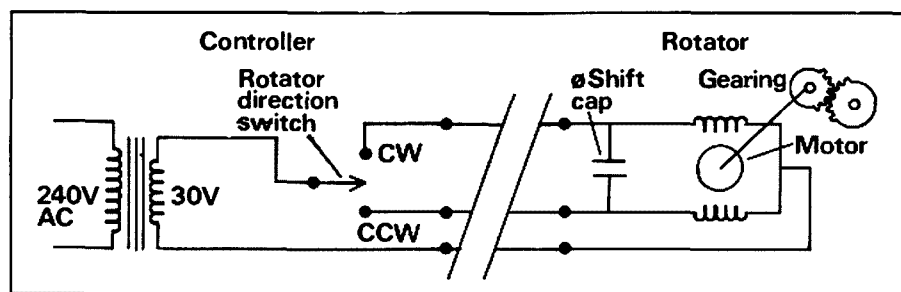

Figure 1

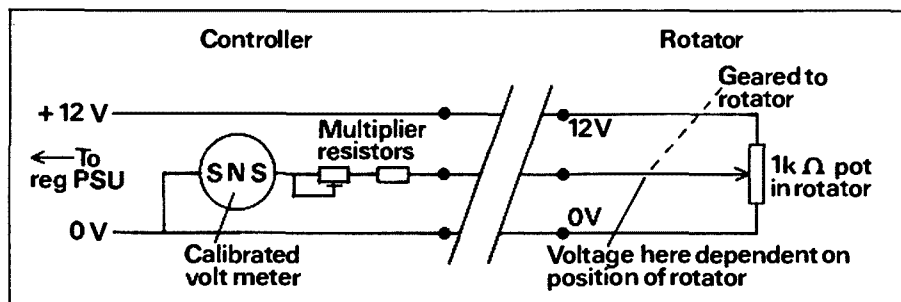

Figure 2

about 45°. If it goes the other way now, you probably had it at the stop, or had reached the limit and operated one of the limit switches. You should be able to trip these limit switches in both clockwise and counter-clockwise rotation. You should be able to run it the full 360° and back again.

While you have this set-up, it is a good time to check out the position potentiometer. If you have previously identified the pot terminals, you can connect your ohm-meter, multimeter on a suitable scale, across the end and wiper of this pot. You should have established its value on your previous checks. With the ohm-meter connected and it reading some value, lower than the total value, apply the 18 Volts AC briefly to the motor windings again. The resistance should either increase or decrease, depending on the direction of rotation, and the wiring of the pot. If you can get total resistance and minimum resistance as you go from clockwise to counter-clockwise, things are looking good. Change over the ohm-meter lead from one end of the pot to the other end and repeat the procedure. Minimum and maximum resistance should be obtained with no sudden jumps or open circuits. If all these tests work, then it is worth making up a control box for the rotator. Sometimes the motor common is internally connected to one end of the position potentiometer to save on conductors in the connecting cable.

Now, some ideas to assist you in making up a controller . . .

Most motors require only about one Amp only intermittently. After all, who runs a rotator for more than a minute, even if it is to get the antenna from south all the way around through north and nearly back to south again? One of the readily available A&R transformers has 30 Volts at one Amp, with taps down to 15 Volts, and is suitable. The 30V AC is used to run the motor via a three-position switch. A spring-loaded centre-off toggle switch is used for this. One with a larger

lever toggle is best. It is mounted so the toggle lever goes sideways. It must be spring-loaded with 'off' in the middle, otherwise you could run the motor continuously and possibly burn it out.

To run the position indicator, a single diode rectifies the 12 to 15 Volts from the transformer tap, and is filtered with a 1000 μF 25/30V electrolytic capacitor. This is further regulated with a three-terminal regulator IC, a UA7812 or LM317, or even a LM3805 5V regulator, jacked up to around 12 to 15 Volts. The voltage is not critical as long as it is regulated. Don't forget the 0.1 μF bypasses on the regulator IC. A heat sink is usually not necessary. A standard 12 to 15 Volts at 500 mA power supply would also be satisfactory. (Fig 4)

The indicating meter can be whatever you can obtain. 0-1mA is a good choice, 500 μA , or even 100 μA will do. It needs to be reasonably large to enable the position of the antenna to be read from a distance no smaller than 50 mm; larger is better. Choose a suitable series multiplier resistor and trim pot to make your meter read FSD for the supply voltage: eg 0-1mA = 1000 ohm/Volts, so a 10k Ohm resistor and a 5k Ohm trimpot would do. The power supply/regulator can be made up on some resistor strip or even a small PCB or Veroboard. The multipliers and trimpot can be mounted on the back of the meter on the terminals, along with a couple of back-to-back diodes to protect the meter movement. You may like to put a 1 μF low-voltage electrolytic cap across the meter to dampen it down a little. (Fig 4 lower)

Some form of indicator across the motor circuit is necessary to tell you the motor has voltage on it. A diode, a series resistor and a LED connected from the motor common to either side of the switched motor circuit will do this. A 1N4004, 1.5 kOhm resistor and a LED is suggested. It works in both directions, as the AC passes through the shift capacitor. (Fig 3)

An on/off toggle or rocker switch and a

neon indicator are used to control the 240V mains. Don't forget a fuse for the mains and an anchor for the mains cable. With all my rotator controllers, I have fitted a multi-pin socket on the control box and a corresponding plug to the end of the rotator cable. Something with respectable pins to avoid voltage drop. An eight-pin Octal valve base and plug is good. An eight-pin Jones plug/socket may be used, as long as the pins are sufficiently large.

Another help in identifying the controller to rotator wires, is to use the standard resistor colour code, eg 1 = brown, 2 = red, 3 = orange etc. The plug/socket along with the colour code makes it so easy to disconnect for checking, and minimises any error in connecting it up again. After all, you don't want to put 30V AC across the 500 Ohm pot up in the rotator and burn it out! The choice of box for the controller is left to you. Make it yourself or buy a nice commercial one, but make sure it is large enough to hold all of the components. Consider the depth the meter goes back into the box to make it easy to work in. (fig 5)

With the works wired up in the box, it's time to check it out. Before plugging in, the mains primary should be checked with an Ohm-meter for continuity via the on/off switch. You should see 20 to 30 Ohms across the active and neutral of the three-pin plug when you work the mains switch 'on', open circuit with it 'off'. Now, shift one of the leads of the Ohm-meter from the neutral pin to the earth pin and check for insulation to earth and active. Switch the Ohm-meter right up to the MOhm range. It should read 20 MOhm or more. The same with the neutral to earth. Repeat this with the power switch in the 'on' position. Anything below 10 MOhms indicates a dangerous fault in the mains wiring. Correct it immediately before going any further. If in doubt, get someone more competent to check it for you.

Some may comment on the use of the MOhm range of the multi-meter being used with only low voltage to check the 240V insulation! Most home-brewers do not have a 500V "megger", and this at least checks the insulation on the 240V wiring. If there is an error in the mains wiring, it will show up.

With the 240 mains okay, you can check the 30V AC at the motor switch. Set the multi-meter to 50V AC, connect one test lead to the common of the motor terminals, then check and see if the 30V AC appears at the terminals as the switch is moved each side for CW and CCW operation. The LED connected to the motor circuit should light, but only on one position, as you do not have the rotator and its capacitor connected. If this is okay, you can now check the 12V DC circuit.

With the multi-meter set up to the 30V DC range, check the voltage at the 1000

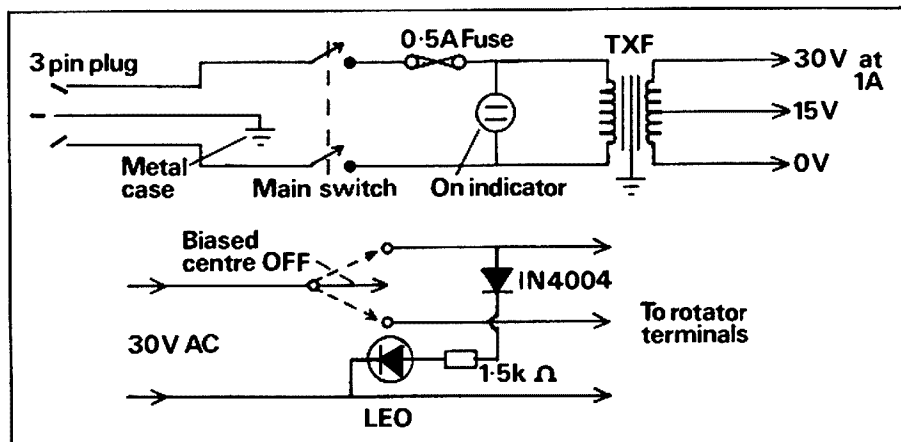

Fig 3

DELTA LOOP FOR 80, 40, 20 AND 10

HERB UNGER VK2UJ EL RANCHO ALECTOWN VIA PARKES 2870

After experimenting with most types of wire antennas for about half a century I found the Delta Loop a little ahead of all the others. How can I prove this?

I have a switching system in my shack consisting of three double-pole, double-throw knife switches to which can be connected six different antennas and by tuning in both DX and local stations it is easy to compare signal strengths and the Delta Loop finished easily the winner.

Using the formula for Delta Loops: Length (feet) = $1005/\text{Frequency (MHz)}$ the frequency of 3.55 MHz works out at 283 feet (86 metres) total length of a triangle of wire, making it possible to use 40, 20 and

10-metre bands as well as 80 in harmonic relationship.

This antenna is outstanding for DX as well as locals. It was originally an inverted V, and converting it to a Delta Loop gave improved performance. It is fed with open wire feeder to the top of the triangle 50 feet high so that radiation commences at the highest point.

This is a very simple and effective antenna for all bands requiring only one pole. The bottom only needs to be eight or 10 feet (three metres) above ground and the corners can be attached to a low tree or post.

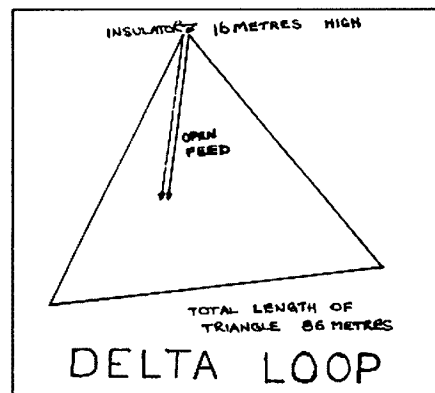

Continued from page 22

μF , capacitor. It should be 25 Volts or more. Check the voltage the other side of the regulator IC. Set it to 12 Volts if possible with your circuit. If it is fixed, it should be the set voltage. All being okay, obtain (from your junk box) a potentiometer of value approximately the same as in your rotator, eg 500 Ohm to 1k Ohm. Solder three off 300mm wires to the terminals and identify them in some way. The same colours as the rotator control cable will make it easy. Switch off the power and connect the three wires up to the correct terminals +12V, wiper to the meter +, 0V return. Switch on and observe the Voltmeter. It should read somewhere between 0V and full scale, provided you have selected the correct value of multiplier resistor and trimpot. If okay, rotate the temporary potentiometer. the meter should go from 0 to full scale. Should it go over scale at one extreme of the testpot, adjust the trimpot multiplier for FSD. Now, as you rotate the testpot, the meter should go from 0 to FSD, corresponding to south, west, north, east and south for your rotator and its motor drive pot.

Now comes the big test. Connect up the rotators, either with some temporary wires a couple of metres long, or the multi-core cable you will use for the job. You can use your plug and socket as suggested. Plug it in, switch it on and look for smoke!!! All being okay, try the rotator control switch. The indicator LED should light, the Voltmeter should read somewhere on the scale and move up and down. Check that the rotator goes clockwise for CW on the switch, and counter-clockwise for the CCW position of the switch. It should stop at each extreme, either with the limit switches or just stall.

You can now decide how to label your Voltmeter in SWNES according to the way the rotator goes. Caution! It's easy to get your W&E transposed, and your

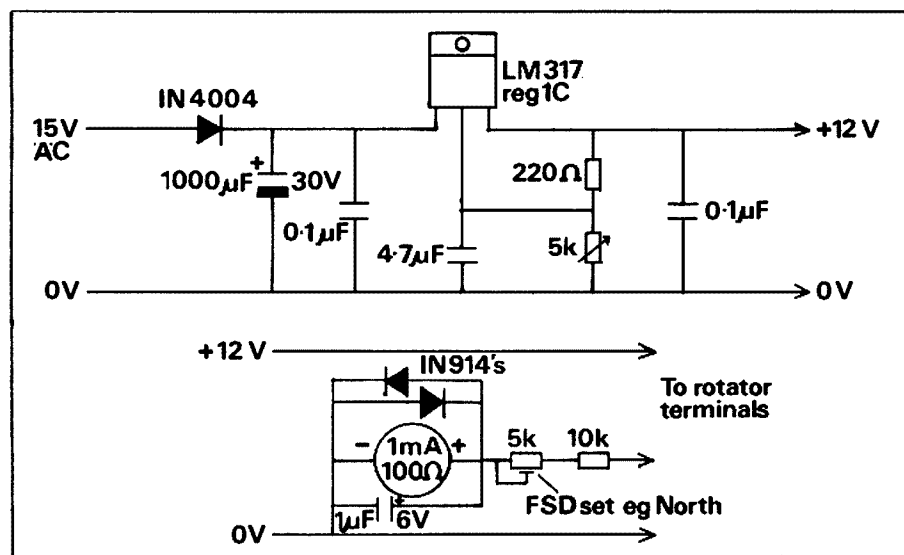

Fig 4

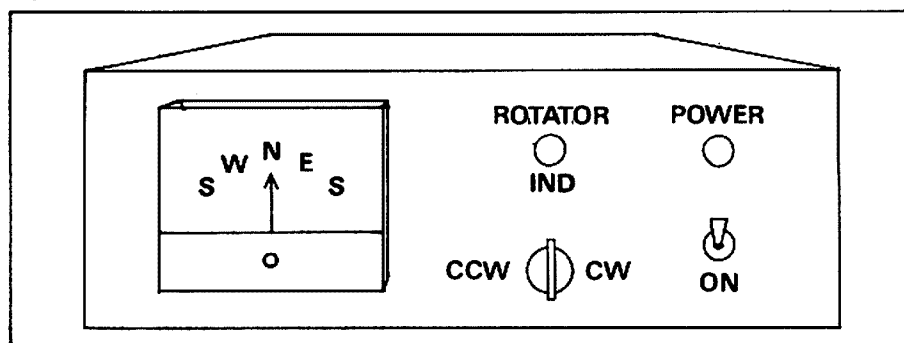

Fig 5

antenna 180° out. The rub-on dry transfer letters are ideal. They can be used for the power switch, CCW and CW switches, and the LED indicator. Depending on the design of the mA meter, you may be able to remove the front cover and then the scale to apply the SWNES letters. (Fig 5) You may have to remove it from the case to get to the scale. Watch the pointer

needle and the meter movement. Again, if you are not confident, get some help.

You can even give it a name; don't call it an "aimer", that's mine! Thanks to my good wife Sue for her suggestion.

You now have a usable rotator and a controller you can understand and even repair if necessary. Limited help will be given via a SASE. QTHR in the Callbook.

"The Outbacker"

- ALL BANDS IN ONE NEAT ANTENNA
- CONVENIENT MOBILING
- RUGGED CONSTRUCTION
- COMPLETELY WEATHERPROOF
- SAME COMMERCIAL DESIGN PROVEN IN THE OUTBACK FOR 15 YEARS.

The antenna is constructed of fibreglass with copper helical windings. The exterior is covered with a coating of epoxy and urethane for added strength, durability and protection. Tap points or frequencies are clearly engraved for each band. Sockets are made from brass, nickel-plated.

The wander lead is used for quick, easy, manual band changing – just plug one end into the lowest socket, wind the remainder clockwise around the antenna and plug the other end into the required frequency. Fine tuning for any resonant frequency within each band is made via the adjusting spike at the top of the antenna.

The optional mounting base and spring is made of solid brass, nickel-plating and the spring is zinc-plated spring steel.

An SO-239 is mounted on the side for feed termination. At the bottom of the base a threaded 1/2" hole is used for mounting to the vehicle, via a suitable adaptor (not supplied).

All Outbacker antennas are capable of handling 300 Watts PEP.

OUTBACKER CODE:

A 160-80-40-30-20-17-15-12-10 Metre ...	\$300.00
B 80L-80M-80U-40-20-15-10 Metre	\$266.40
C 80-40-20-15-11-10 Metre	\$255.00
D 80-40-20-15-10 Metre	\$247.00
E 160-80-40 Metre	\$214.00
F 80-40-20 Metre	\$193.00
G 20-15-10 Metre	\$175.00

Extra Frequencies Commercial –	
RFDS Etc	\$27.00
2-Piece Split Model Available with all codes except codes "A".....an extra	\$40.00
Mounting base and spring to suit all above antenna.....Complete	\$87.00
AIR deliver door to door anywhere in Australia	\$12.00

ANTENNA MANUFACTURE AND SALES

TERLIN AERIALS

15000 WALKER ROAD
WALLACEVILLE VIC 3248

(09) 457 6238

(09) 457 3807

FAX: (09) 457 7737

Club Contest

BOOST YOUR CLUB FUNDS

Help your club and give added strength to the WIA to protect Amateur Frequencies from Government and Commercial Attack

HOW?

Simple! Sign up a new member between 1st October and 31st December 1990 and the WIA will pay your radio club a recruitment fee of \$5.00.

In addition, the club which signs up the most new members win a free year membership of the WIA PLUS three great amateur radio books for the club library.

Every radio club is a winner in this competition! The WIA is a winner! The amateur radio service in Australia is a winner!

WHO CAN ENTER THIS CONTEST? Every radio club in Australia which holds an amateur callsign, whether the club is affiliated with the WIA or not.

WHO QUALIFIES TO BE A NEW WIA MEMBER? Any person in Australia who has not been a member during the immediately prior 12 months.

HOW DO YOU SIGN UP A NEW MEMBER? If your club does not have a supply of WIA membership application forms, then use the form printed on the back of every Amateur Radio magazine fly sheet - even photocopies of that form will suffice.

WHERE DO YOU SEND THE NEW WIA MEMBER APPLICATION? Send the application, together with the full membership fee as shown on page 3 of Amateur Radio magazine, to your local WIA Division.

HOW DOES YOUR CLUB CLAIM ITS FEE? The club secretary writes, on club letterhead, to "WIA Club Contest, PO box 300, Caulfield South, 3162" with details of the new WIA member. At the end of each month of the contest a cheque for the total amount of all \$5.00 recruitment fee due to the radio club will be forwarded.

The club which wins the grand prize of a free three year membership of the WIA, plus books for the club library, for signing up the most new WIA members, will be announced in February 1991.

Get to work now in this great fund raising contest where everybody is a winner!

LAND OF THE HORNBILL WELCOMES SEANET AMATEURS

INFORMATION RECEIVED VIA TOM KING VK2ATJ PO Box 140 KENSINGTON 2033

Amateur radio operators from around the world are making preparations to attend the 18th annual SeaNet Convention set for the weekend of 10, 11 and 12 November in Kuching, Sarawak, East Malaysia.

About 200 amateurs from a dozen countries are expected to attend the annual South East Asia Net Convention which is being organised by the newly established Sarawak Division of the Malaysian Amateur Radio Transmitting Society.

Venue for this year's SeaNet convention is the luxurious Sarawak River-sited Holiday Inn Kuching. The registration fee of \$M150, or about \$A70, includes a cocktail reception on the Friday evening, a hosted lunch on Saturday and a gala banquet on Saturday. Numerous door prizes will be presented at the fun-filled dinner.

The Chief Minister of Sarawak, Datuk Patinggi Tan Sri Haji Abdul Taib Mahum, will open the convention at 10am on Saturday, 10 November and then will host the lunch.

The highlight of the conference is expected to be the presentation of a pa-

per on the "Future of Amateur Radio in Relation to WARC 1992" by Richard Baldwin, W1RU, the President of the International Amateur Radio Union.

An invitation has also been made to the President of the Japan Amateur Radio Club. In addition, convention discussions will likely include a presentation on Malaysia's advanced telecommunications system.

A special event amateur station set up at the Holiday Inn Kuching is expected to use the callsign 9M8SEA. Special QSL cards will be sent to confirm contacts.

Sufficient time will also be provided for delegates to conduct their own eyeball QSOs. As recent SeaNet conventions have drawn amateurs from the six ASEAN nations: Singapore, Brunei, Malaysia, Thailand, the Philippines and Indonesia as well as enthusiasts from Japan, the USA, Australia, New Zealand, Canada, England, Germany, Sweden, Hong Kong, India and Sri Lanka there is ample opportunity for radio hobbyists to discuss problems and progress as well as techniques and technology.

Following the convention a three-day post conference tour and DXpedition is

scheduled to the world famous Mulu Caves in the heart of tropical northern Sarawak. The tour price of \$M720 or \$A340 includes return flights on Malaysia Airlines, boat trips, food and hotel.

Another special event station will be established for the first time ever at these remote caves which are located on the summit of a 1600m limestone hill. Wildlife to be seen during the exotic excursion may well include the elusive orangutan and the hornbill, the odd billed bird depicted on the state's crest.

Written information about SeaNet can be obtained from the MARTS-Sarawak Honorary Secretary, Mr Festus Havelock 9M8FH, 421 Cross Road, 93150 Kuching, Sarawak, East Malaysia.

Amateurs can obtain details from the daily SeaNet session on 14.320+/-QRM at 1200 GMT. All amateurs, regardless of their QTH, are invited to check into SeaNet and then match up faces behind the voices at this year's Kuching radioactive get-together. ar

TECHNICAL CORRESPONDENCE ABOUT RESISTORS

ROBERT R MCGREGOR VK3XZ
2 WILTSHIRE DRIVE SOMERVILLE 3912

They are our commonest circuit component, and our cheapest. They can suffer from overloading, loss of end-caps and open circuits. It is a wide band passive device covering from DC to 10s of MHz, its performance only limited by parasitic L&C. In spite of these we can, with appropriate loading, produce excellent dividing circuits that can handle 20MHz *square* waves without trouble. Unless attempting wide band design it is easier to work with lower values and accept the modified performance. A summation of phase shifts and change of feedback sign will send us back to basics!

Speaking of basics, do you still remember that formula you 'mugged up'

for the exam? It went $E^2 = RW$. Yes, it was included because it is useful. Consider a familiar 1k 1/3 W and analyse the potential. A few stabs at the calculator tells us full load is 17 Volts. The manufacturer, well sometimes, tells us the device should be run at 1/10 rating for good stability and reduced long-term drift, that's 5-1/2V. At higher values, 10k@18V, 100k@55V. It follows that in normal transistor circuits 3.3k and higher are loafing.

From 1k down, more calculations from your theory exam are the route to happy resistor life. A stable resistor network in any design is an excellent starting point for long life in the semi-conductors, and they cost more! Paralleling several resis-

tors on a circuit board will reduce the bulk of a higher wattage resistor and give a greater 'heatsink'. Series resistors can be used if you have low values handy. A simple move is to connect four in series/parallel, this gives the same value and four times the wattage. You can, of course, use four of these S&P networks to make another S&P — still the same value, 16 by 1/3 = 5-1/3 W and they said they were unobtainable! Three 3.3k in series for a 10k, 1W or in parallel for 1.1k @ 1W.

Ham radio is about finding solutions — I couldn't resist doing this note!

73 AR SK VK3XZ

AWARDS

PHILL HARDSTAFF VK3JFE
FEDERAL AWARDS MANAGER

Postcode Award

First up this month news of a new Australian award comes to me via Bill Horner VK4MWZ. This is the Australian Amateur Radio Postcode Club (Award). The following are the rules for this award:

Australian Amateur Radio Postcode Club (Award)

- This award is open to all amateurs and SWLs
- All contacts made after 31.06.90 will be eligible
- This award will have various levels (CLUBS), and each club will receive a certificate. The clubs are as follows: POST-CODES — 100, 250, 500, 750, 1000, 1500, 2000, 2500 (provision to extend).
- The 100 club shall consist of one postcode per alphabetical letter, plus 75 random postcodes (nil for X).
- Portable operation is encouraged with only five contacts required to claim each postcode. Australia Post prints a FREE postcode listing booklet which is available from post offices throughout Australia.
- All legitimate modes may be used — LF, HF, VHF, UHF, Oscar, EME etc.
- No crossband modes and nil via repeaters.
- All bands, including WARC, may be used.
- All certificates will be endorsed.
- Weekly nets will be held every Sunday at 09.00 UTC on 28.480 MHz, followed by 10.000 UTC on 3.595 MHz.
- The cost of these awards (each certificate) will be \$A2.00 for all VKs, \$US2.00 for all ZLP29 areas and \$US3.00 for all DX.
- A copy of your log is to be submitted upon application for awards and sent to:

AARPC Awards Manager
26 Iron Street

GYMPIE WA AUSTRALIA 4570

Unfortunately, no sample award made it to me, so if you would like to send one to me, Bill, I will try to fit it as soon as practicable. I like the concept of this award and encourage you to have a go.

Overdue Awards

The issuing of awards will be held over until next month as I spent quite a few nights this month putting together the draft rules for the Grid Square Award. So, if you are expecting an award, please be patient. I even envisage getting started on the DXCC updates etc next month.

Grid Square Award

Well, the time has come to finally get this

thing off the ground. I now know how a politician must feel when trying to put together a piece of legislation, trying to please everyone and upset no-one. Of course, this is not the reality, and I know it will not be possible to please everyone! I thank all those who contributed, either over the phone or by mail, in particular — VK3BRZ, VK3KKW and VK3ZJC.

After going through all of your letters, I have taken bits and pieces and tried to put them together into something that reflects what you are seeking to have introduced. I know what I present here will not make everyone happy, but at the same time I wish to make it clear that the rules as presented here are **draft** rules and are not final. I need input from you over the next month (up until 28 October; this gives me seven days before the November AR deadline to have something in the next column).

There were a couple of items that I feel will create a bit of controversy. These are to QSL or not to QSL, and the reciprocal rule. As it seems to be a majority view by those who did contribute that QSL cards should not be needed, that is how it is presented at the moment, and we will see what I get in the way of feedback. The reciprocal rule I think is a logical one and shouldn't meet with too much resistance. Put simply, it means that if you go portable to a rare grid square and manage to work someone in your own home grid square, you will receive credit for the rare grid square (these types of contacts are limited to 75 per cent of the contacts required).

It was also suggested that this be an Australian Grid Square only Award, ie contacts only with stations in grid squares in Australian territory. Well, that's how I am presenting it at the moment, because that's all anyone has suggested so far.

HF or VHF?

I also noted that when Ken originally suggested the idea in April 1989 (p 19) AR, he was talking only about HF. All the letters I received were from dedicated VHF operators, so there seems to be more interest from the VHF operators than the HF ones. However, I have never been in favour of separate HF and VHF awards. In my view, an award is an award, and no award should have band restrictions placed upon it and, as a consequence, neither will this one. The only difference is that it will be just a little easier to obtain on some of the higher bands.

Endorsements

Yes, there will be endorsements (eg CW only, 2XSSB, 50 MHz etc). There will be

stickers available for updates, but the multiple will be limited to keep down the costs for stickers. I haven't yet quite decided how this will operate — but, plenty of time for that.

Start Date

It was suggested by a couple of correspondents that the start date should be made retrospective, so as to give it a bit of a "kick start". I agree with this concept and propose 01.01.90 as the start date, as it was originally hoped to have the award going by then. I don't see any problems with this, but again would like to encourage your views on the subject.

Name ?

Always a hard one but, in this case, I think the default name "WIA GRID SQUARE AWARD" or "WIA GSA" as many people who have written to me have called it, is a suitable name and unless someone can come up with something better, this will be it.

I have steered clear of having either the words "Century" or "100" in the name as I believe these have already been 'thrashed to death' in other awards, and, as it will be available for a lesser amount in the higher bands, I see no reason to include them in the name — what do you think?

Design

Any person who would like to reveal his or her creative skills by having a go at designing a suitable award, then please put your pen to paper. I would stipulate only the following criteria:

- that it be based upon an Australian theme;
- the words 'WIA' be prominent;
- a clear indication to recipients that it is related to locators.

Even if you're not a graphic artist but have a good basic idea, then submit a rough example and I will attempt to make it clear and presentable.

I would also like to try to make it fairly colourful, but this of course depends on funding. If anyone knows of any commercial interest which may be willing to sponsor a certificate without wanting its name in 'highlights', then please let me know.

Standings

I also anticipate having updates every so often, of say, the top scorers, circa five on each band or similar, so people can see just what is possible and what is being achieved. This may encourage those who think they will never reach their target. It will also give those who like a bit of competition something to aim for.

So, here are the draft rules:

1. a) The Wireless Institute of Australia Grid Square Award (WIAGSA) is awarded for contact with a minimum number of "Maidenhead" 2 degree x 1 degree grid square locators per band as indicated in (b). Grid Squares are

designated by a combination of two letters and two numbers. (Refer to Awards column September 1990 for information on Locator Atlas).

b) The minimum number of squares needed to initially qualify for each individual band awards is as follows: all HF bands including WARC bands — 100, 50 MHz-75, 144 MHz-50, 432 MHz-25, 1296 MHz-10, 2420 MHz-5, all bands above -5.

2. Only contacts made on or after 1 January 1990 are creditable for this award.

3. a) Individual band awards are endor-
sable in the following increments:

- All HF bands — 25
- 50 MHz + 144 — 10
- 432 MHz + all bands above — 5.

b) Separate bands are considered as separate awards.

4. a) No crossband contacts permitted

b) No contacts through active repeater or satellite devices or any other relay method permitted

c) Contacts with aeronautical or maritime mobile stations *do not* count.

5. Stations which operate portable from a different locator to their "home" locator and work a station located in their "home" locator shall receive credit for the locator from which they are operating portable, limited to an amount equal to 75 per cent of total number of contacts required for a basic award.

6. a) All contacts for all of the individual band awards must be made from a location or locations, within the same grid square or locations in different grid squares no more than 25 miles apart. Excepting contacts made under the provisions of Rule 5. Note: (This provision is included because, say for example, you lived in the southern suburbs of Melbourne and then moved to the northern suburbs, chances are you moved from QF21 to QF22, but moved less than 25 miles, so you needn't start again).

b) If an award is claimed for contacts made from different grid squares as per 6(a) the grid square from which the majority of contacts are made shall be referred to as the "home" locator for Rule 5.

c) All contacts for this award must be made with stations located in Australia as defined by DXCC rules. (ie if a station is in Australia for DXCC purposes it is a valid contact for this award).

7. Only the following endorsements are available:

- "CW ONLY"
- "ALL TWO WAY SSB"
- "MIXED"
- BAND ENDORSEMENT.

8. a) QSL cards are not required. A certified log extract should be provided with the following information: date, time, callsign, mode, frequency, grid locator and signal report sent by the station concerned. This list should be certified by an official at a society affiliated with the WIA or by two licensed amateurs

reading as follows — "I/we certify that the enclosed list corresponds with the information contained in the said logbook".

b) For those who would have difficulty in getting a certified list, photocopies of your logbook signed by the applicant certifying all the information contained within to be true and accurate can be certified by the Awards Manager. NOTE: All entries must be legible.

9. The cost for each award is \$A5.00 or eight IRCS for amateurs in Australia, or \$US5.00 or eight IRCS for those outside Australia. Requests for endorsements should be accompanied by an SASE or one IRC and SAE.

10. This award is very much dependent upon the honesty of the operator. Any fraudulent applications will result in the disqualification of the applicant from all future WIA GSAs.

11. Any decisions regarding interpretation of the rules here printed made by the Federal Awards Manager are final and binding.

Well, there you have it! I hope not too complicated? If you can't get pen to paper but would like to have some input, you can phone me on (03) 434 8424 after 7.30pm on weekdays. Remember — these are draft rules only; if you don't like some aspect of them, then outline your objections and reasons and contact me.

Two other projects I will be attempting — an application information package for this award, consisting of a locator map of Australia and record book, plus an application form. This should make it easier to keep track of contacts.

ALL THE BEST UNTIL NEXT MONTH.

73 PHILL VK3JFE

Radio Scouting Awards

The New South Wales branch of the Scout Association makes two awards available to amateurs, Scouts and Guides in recognition of achieving communications with Amateur Scout and Amateur Guide stations. These are the "Radio Scouting Award" for making contact with Scout and Guide stations in all States of Australia, and the "JOTA Award" for making contact with amateur, Scout or Guide stations in the State of New South Wales during the Jamboree on the Air.

If you require further information, or would like to make application for these awards, then please write to:

Branch Activity Leader, JOTA,
The Scout Association of Australia,
NSW Branch,
PO Box 115, HABERFIELD 2045.

General Rules for all NSW Branch Radio Scouting Awards

1. Verifications

1.1 It will be necessary for the applicant to produce verifications in the form of QSL cards or other written evidence, from

the station contacted, showing that two-way communication has taken place.

1.2 Each verification submitted must be exactly as received from the station contacted, and altered or forged verifications will be grounds for disqualification of the applicant.

1.3 Each verification must show the date and time of contact, type of emission and frequency band used, the report and location or address of the station at the time of contact.

1.4 A checklist must accompany every application setting out the following details:

(a) Applicant's name, callsign and the name of the Scout/Guide group, if applicable.

(b) Where applicable, the date of change of callsign(s) and details of previous callsign(s).

(c) Details of each contact as required in Rule 1.3.

(d) The applicant's address/location at the time of each contact if land/portable/land mobile or marine mobile operation was involved.

(e) The callsign of the station worked.

(f) Any relevant details of any contact about which some doubt may exist.

1.5 In lieu of forwarding QSL cards or other written evidence as set out in Rules 1.1 to 1.4, a list giving details set out in Rule 1.3 (Log Extract), certified by the following will be acceptable.

The Awards Manager or a council member of the Wireless Institute of Australia (or affiliated society in the case of overseas amateur stations).

The Area Radio Activities Co-ordinator and the District Commissioner, or Two licensed amateurs known to the applicant.

Each person certifying an award application must sign the following declaration:

"I have checked the (insert number in words) QSLs submitted by (insert name and callsign of applicant) and certify that the details attached correspond with the verifications inspected by me.

Signed "

2. Applications

2.1 Applications for the awards should be addressed to the Branch Activity Leader, JOTA, accompanied by the verifications and checklist, with sufficient postage enclosed for their return to the applicant.

2.2 No charge will be made for the issue of certificates. However, an amount of \$3.00 or five IRCs per application will be charged to cover postage of certificates. Cheques should be made out in the name of "The Scout Association of New South Wales" and forwarded with the application.

2.3 Successful applicants will be listed periodically in "Australian Scout".

2.4 In all cases of dispute, the decision of

FT-1000 DELUXE HF ALL MODE TRANSCEIVER



Attention all serious HF operators! To be a truly WORLD CLASS operator during these times of crowded band conditions, you've got to have a truly WORLD CLASS rig...and the rig you need is arriving in Australia very soon. Of course we're referring to the versatile new YAESU FT-1000.

The FT-1000 is the product of 3 years intensive research and development at YAESU, resulting in a highly reliable, fully featured, yet easy to use HF transceiver. It's bound to blow away your competition with its spectacular combination of power and operational flexibility. Compare!

Direct Digital Synthesis (DDS) — Two 10 bit DDS plus three 8 bit DDS provide fast lock-up times and lower synthesizer noise than traditional PLL systems. Using DDS results in a cleaner transmitted signal and much improved receiver performance.

High RF Output Power — Continuously adjustable output from 20 watts to a mighty 200 watts is under your control. A built-in blower sees that high duty cycle transmissions take place quietly and efficiently.

Dual Channel Reception — Utilising independent VFOs and digital displays as standard, reception can be in different modes, on different frequencies, with different IF bandwidths. An optional Bandpass Filter Module (BPF-1), will allow cross-band dual-receive using two antennas.

Ultra-High Performance Receiver — it provides all-mode coverage from 100kHz to 30MHz with a dynamic range of up to 108dB. Selectable filters for the following bandwidths are fitted as standard: 6kHz, 2.2kHz, 1.8kHz, 500Hz, 240Hz. The QRM rejection systems include cascaded IF filters, IF Width and Shift controls, IF notch filter, a variable noise blanker, and CW audio peaking filters.

2 Year Warranty — A world class transceiver should be covered by a world class warranty. That's why we provide a comprehensive parts and labour 2 year warranty on every Yaesu transceiver we sell, including the FT-1000! Don't settle for less.

Price — Compare with the opposition, and get a pleasant surprise. At \$4995, the FT-1000 offers by far the best value for money, as well as the best support. No wonder Yaesu call the FT-1000 'The Best of the Best'! Also, see A.R.A review in Vol 13 No. 2 issue, and A.R. review in the August 1990 issue (copies of both reviews available upon request).

Due to the huge worldwide demand, initial stocks of the FT-1000 will be limited. So place your order now! *

Options -

D-3210 BPF-1 Band Pass Filter	\$169
D-3215 TCX0-1 +/-0.5ppm Oscillator	\$199
D-3220 DVS-2 Digital Voice System	\$299
D-3230 SP-5 External Spkr with filter	\$199

* Includes bonus MD-1 disk microphone

\$4995

D-3200



DICK SMITH
ELECTRONICS

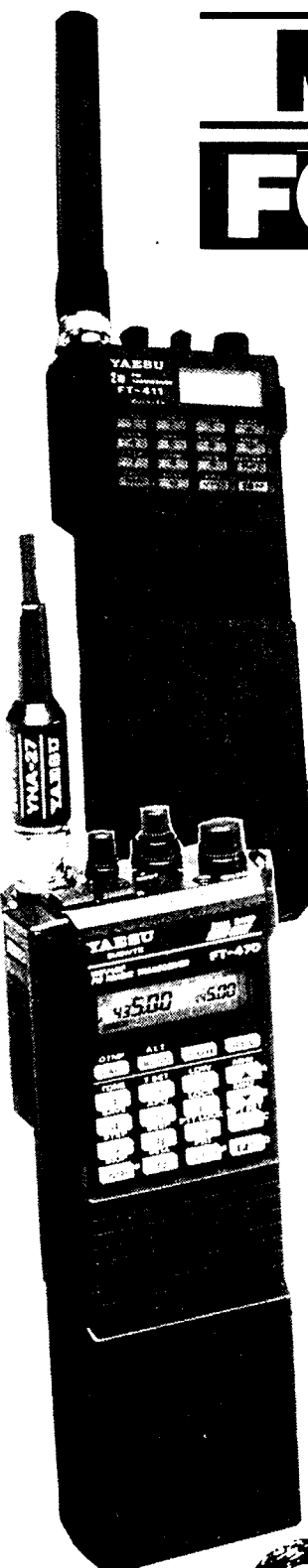

MORE FEATURES FOR YOUR MONEY!

FT-411 2M HAND-HELD

Superb performance on the 2M band with all of the 'top-of-the-line' features and reliability you know you can expect from Yaesu! Don't be fooled by unknown brands which can only offer some of these features...

- 144 to 148MHz transceive operation (optional 140-174MHz Rx)
- Ultra Long life 1000mAH NiCd battery pack
- 2.5 watts RF output as standard, up to 5 watts with 12V DC (or FNB-11)
- Better than 0.16uV (12dB SINAD) sensitivity
- Programmable power saver for extended operating periods
- Keypad or dial frequency entry, with 5 selectable tuning rates
- 49 tunable memories which store repeater offsets
- Band, memory, priority, or limited-band scanning
- Carry case, belt clip, approved AC charger.
- **2 Year Warranty!**

Cat D-3350

YAESU STOCKS NOT HELD AT ALL STORES. PLEASE CONTACT YOUR LOCAL STORE FOR STOCK AVAILABILITY. OR ORDER BY PHONE...

\$399



2m & 70cm In One!

THE AMAZING FT-470

Hand held performance at its best! Limited stocks of the sophisticated FT-470 transceiver at a very special price have just arrived. It represents the pinnacle of high-tech design in compact hand helds providing both 2m and 70cm coverage in one. 2.3 watts on the 2m and 70cm bands with the latest multi-tasking microprocessor control allows a high degree of flexibility. In fact, several functions can be performed simultaneously - including 'dual-band' reception, as well as 'full duplex' operation! That's right, you can be talking through your local 2m repeater and scanning channels for your next 70cm contact at the same time.

There are also 21 tuneable memories and 2 VFO's per band, plus inbuilt C.T.C.S.S. (Tone Squelch, encode/decode) with paging facility, a variety of scanning facilities, LCD display showing 5.5 frequency digits on both bands at the same time, and an LCD bargraph signal/P.O. meter. The programmable 'power saver' system helps maximize battery life, and frequency selection via tuning knob or direct keyboard entry is a standard feature. Comes complete with an ultra long-life 1000mAH NiCad battery pack, carry case, dual band antenna, and an approved AC charger. Why buy 2 hand-helds when you can have everything in one?

Cat D-3360

See A.R.A review Vol 12, Issue 5, or A.R. review Aug '89 issue.

**2 YEAR
WARRANTY**

Just \$699



- NSW** • Albury 21 8399 • Bankstown Square 707 4888 • Blacktown 671 7722 • Brookvale 905 0441 • Bondi 387 1444 • Carnubeltown 27 2199 • Chatswood Chase 411 1955 • Chullora 642 8922 • Gore Hill 439 5311 • Gosford 25 0235 • Hornsby 477 6633 • Hurstville 580 8622 • Kotara 56 2092 • Liverpool 600 9888 • Maitland 33 7866 • Miranda 525 2722 • Newcastle 61 1896 • North Ryde 878 3855 • Parramatta 689 2188 • Penrith 32 3400 • Railway Square 211 3777 • Sydney City 267 9111 • Tamworth 66 1711 • Wollongong 28 3800 • **ACT** • Belconnen (06) 253 1785 • Fyshwick 80 4944 • **VIC** • Ballarat 31 5433 • Bendigo 43 0388 • Box Hill 890 0699 • Coburg 383 4455 • Dandenong 794 9377 • East Brighton 592 2366 • Essendon 379 7444 • Footscray 689 2055 • Frankston 783 9144 • Geelong 232 7111 • Melbourne City 399 Elizabeth St 326 6088 and 246 Bourke St 639 0396 • Richmond 428 1614 • Ringwood 879 5338 • Springvale 547 0522 • **QLD** • Brisbane City 229 9377 • Buranda 391 6233 • Cairns 311 515 • Cherriside 3596255 • Redbank 288 5599 • Rockhampton 27 9644 • Southport 32 9033 • Toowoomba 38 4300 • Townsville 72 5722 • Underwood 341 0844 • **SA** • Adelaide City 223 4122 • Beverley 347 1900 • Elizabeth 255 6099 • Enfield 260 6088 • St. Marys 277 8977 • **WA** • Cannington 451 8666 • Fremantle 335 9733 • Perth City 481 3261 • Midland 250 1460 • Northbridge 328 6944 • **TAS** • Hobart 31 0800 • **NT** • Stuart Park 81 1977
- ORDER BY PHONE OUTSIDE SYDNEY (006) 226610 Free Call Sydney Area 888 2105**

the Radio Activities Branch Advisory Committee in the interpretation and application of these rules shall be final and binding.

2.5 Notwithstanding anything to the contrary in these rules, the Radio Activities Branch Advisory Committee of the Scout Association, NSW Branch, reserves the right to amend them when necessary.

Radio Scouting Award

1. Objectives

1.1 This award, to be known as the "Radio Scouting Award", is offered by the NSW branch as tangible evidence of the proficiency of Australian and overseas amateurs, including amateur Scouts and amateur Guides, in making contacts with Scouts and Guides in all States in the Commonwealth of Australia.

1.2 The award may be claimed by any amateur, amateur Scout or Amateur guide or Scout/Guide group in Australia or outside of Australia.

2. Requirements

2.1 A certificate will be awarded to any applicant who makes contact with Australian amateur Scout or Guide stations in the areas listed below.

2.2 All contacts can be made on a single band, ie six metres, 10 metres, 15 metres, 20 metres, 40 metres, 80 metres etc. Multi-band operations on the high frequency bands will be accepted, and certificates will be endorsed with the word "multi" to reflect this type of operation.

2.3 A separate application must be made for each band.

State	Call Area	QSOs	Required
		O'seas	Aust.
ACT	VK1	1	1
New South Wales	VK2	2	5
Victoria	VK3	2	5
Queensland	VK4	3	5
South Australia	VK5	2	5
Western Australia	VK6	2	3
Tasmania	VK7	1	2
Northern Territory	VK8	1	1
		14	27

3. Operation

3.1 All contacts for this award must have been made on or after 20 October 1990.

3.2 Contacts may be made using any authorised frequency band or type of emission permitted to Australian amateurs, but crossband contacts will not be permitted, except in the case of "Outback JOTA" stations operating on the Schools of the Air or Royal Flying Doctor Services, when authorised by the Department of Transport and Communications.

3.3 Repeat QSOs with the same station will count provided at least 24 hours has elapsed between each QSO.

3.4 Any authorised mode will qualify, however, there will not be separate awards for each mode.

JOTA Award

1. Objectives

1.1 This award, to be known as the "JOTA Award", is offered by the Scout Association of Australia, New South Wales Branch as tangible evidence of the proficiency of amateur, amateur Scout and amateur Guide stations in making contacts with New South Wales stations during the Jamboree on the Air.

1.2 The award may be claimed by any amateur, Scout, Guide, unit or group.

2. Requirements

2.1 A certificate will be awarded to any applicant who makes contact with any four amateur JOTA stations operating in the 12 Scout areas of Central Sydney, Cumberland, Hume, Manly-Warringah, Newcastle and Hunter, North West, Riverina, St George, South Coast and The Golden West.

2.2 Only one contact per area may be counted for this award.

2.3 Each contact must have a minimum duration of 15 minutes, and information must be exchanged with members of either the Scout Association or the Girl Guides Association.

2.4 In any four stations contacted, one station must be either a Girl Guide or Scout station.

For example: where three Scout stations have been contacted, one each in Hume, Hunter and Riverina, the fourth must be a Girl Guides station.

2.5 Stations operating under the callsign of an amateur assisting Scouts or Girl Guides during the Jamboree on the Air are eligible for this award.

3. Operation

3.1 Contacts for this award must have been made from 0001 UTC on the first day of the Jamboree, ie Saturday to 1000 UTC on the last day of the Jamboree, ie Sunday.

3.2 Contacts made on or after 20 October 1990 will be eligible for this award.

3.3 Contacts may be made using any authorised frequency band or emission permitted to Australian amateurs. Cross-band contacts will be allowed, including contacts made with "Outback JOTA" stations using Schools of the Air or Royal Flying Doctor Services authorised by the Department of Transport and Communications.

3.4 Contacts made through terrestrial repeaters or through satellite (AUSSAT) links will be permitted.

3.5 Where contacts are made using a mixture of HF, VHF and UHF bands, certificates will be endorsed with the word "multi" to reflect this type of operation.

3.6 No contact made with ship or aircraft stations in Australia will be eligible, UNLESS they are operated by either Sea Scouts or Air Scouts, but land-mobile and portable stations may be contacted provided the location at the time of contact is shown on the confirmation.

**ROBERT DEMKIW VK2ENU,
BRANCH ACTIVITY LEADER
JOTA
ar**

CONTESTS

**KEN MILLER VK2GKM
NOVICE CONTEST MANAGER**

Results of WIA 1990 Novice Contest

Entries in the phone section of this year's contest totalled 34, with 10 in the CW section and two SWL entries. Logs were generally of a high standard with few incorrect or duplicate contacts being recorded.

The Keith Howard VK2AKX Trophy will be awarded this year to VK4VAT for the

highest aggregate novice score.

The Clive Burns Memorial Trophy for the novice entrant with the highest CW score has been won by VK3PTB.

Both of these perpetual trophies are held on permanent display at the Executive Office. However, in each case the winner will receive a suitably inscribed wall plaque.

**Section A Novice Winner VK4VAT 1186
Section A AOCF Winner VK1PJ 1228
Section B Novice Winner VK3PTB 320
Section B AOCF Winner VK4OD 101
Section C SWL VK3 LL30037 1453**

Individual Scores — Section A

VK1PJ	1228	VK3MCN	852
VK4VAT	1171	VK5QX	750
VK6ANC	1038	VK4YB	626
VK6MMM	1006	VK3GH	597
VK5NOD	995	VK7NNN	585
VK2ZL	923	VK8AV	563
VK4VMP	895	VK5AFO	559
VK3APC	857	VK2LE	414

ZL2TJS	333	VK2SRM	181
VK6BB	290	VK2KTV	171
VK4AVR	275	VK1RH	158
VK1EV	268	VK5KNJ	157
VK2LEE	243	VK2PSW	156
VK4IS	221	VK2KJD	150
VK1BBA	205	VK7FD	126
VK1BR	187	VK3MDJ	82
VK4LAE	182		

Individual Scores Section B (CW)

VK3PTB	320	VK8AV	62
VK4VXX	203	VK6AF	55
VK4OD	101	VK4NEF	44
VK7FN	73	VK5NOD	41
VK4YB	71	VK4VAT	15

Individual Scores Section C (SWL)

VK3	L30037	1453
VK4	L40018	331

Additional Certificates Recommended

For the highest aggregate novice score for each State excluding national winners.

VK1 —	VK6MMM
VK2LEE	VK7NNN
VK3MCN	VK8 —
VK4VMP	ZL2TJS
VK5NOD	

Other special awards recommended:

Section A	Section B
VK6ANC	VK4VXX
VK2ZL	
VK3APC	

Comments Received with the Entries Were:

"Great contest — I will be in it next time with a new power supply (mine blew up half-way through)."

"I had an enjoyable time — best of luck to the winners."

"Club stations need to keep modulation down to 100 per cent; the available bandwidth on 80 metres is small enough at contest times."

"I always enjoy this contest — it is great to be able to give other operators the 10 points for a club contact. I recommend that the old method of identifying club stations be resurrected."

"A thoroughly enjoyable fun contest. ZL turnout was disappointing, but understandable, as the contest was not advertised in "Break-In"."

"I enjoyed the contest greatly and found all operators friendly and courteous."

"I enjoyed the contest and look forward to the next one."

"Conditions were good and the going was leisurely. Enjoyed it very much."

"Had a great weekend, but had one problem — the extremely uncomfortable "fobbing off" of non-VK, ZL and P2 stations."

Suggest either —

1. Allow overseas contacts (full call points).
2. Allow contacts by anyone but 0 points.

Sunshine State Jack Files Memorial Contest 1990

Results

Section 3, stations within VK4

a) TX All Band	
VK4ACC	1079
VK4CHS	262
b) TX HF Phone	
VK4MWZ/M	2133
VK4AVR	1016
VK4BB	956
VK4VMP	910
VK4NFE	862
VK4DRM	837
VK4EHW	647
VK4NSB/M	641
VK4KYV/M	624
VK4IS	287
VK4MCY/P	254
VK4PJ	155
VK4POM/M	147
d) TX VHF Only	
VK4NLV/M	25
e) Club Stations	
VK4WIE/M	2927
VK4WIR	910
VK4WIX	121

Section 4, Stations Outside VK4

a) TX All Bands Phone	
VK2MUZ	642
VK2CKW	606
ZM3KR	410
VK7SRS	132

Comments

As now appears the normal practice, there were more participants than logs received. It was particularly pleasing to have logs from "newer" amateurs, several stating that this their first contest — well done, and a good job they made of it too.

Thanks to the participants for their constructive comments; where possible they will be acted upon. For those who spoke of the time slot, be advised that this matter exercises me too. For interest, the participation by time this year was:

Hour	Percentage of participation, ie contacts
05-06	12%
06-07	17%
07-08	17%
08-09	15%
09-10	17%
10-11	20%

TED MULHOLLAND VK4AEM
VK4 DIVISION CONTEST MANAGER



MURRAY VALLEY LEAGUE

PO BOX 359, ALBURY 2640 TEL (060) 213 655 FAX (060) 412 770

ARE YOU A MURRAY RIVER LOVER?

Then you would no doubt like to become a member of the Murray Valley League. The League has been safeguarding the river for over 45 years and ensures no degradation occurs. Membership is just \$20.00 per year and we would welcome new members, especially from amongst the Amateur Radio Fraternity as Amateurs are often users of the wonderful Murray River and its beautiful valley.

Graeme Scott
EXECUTIVE MANAGER
VK2ZR

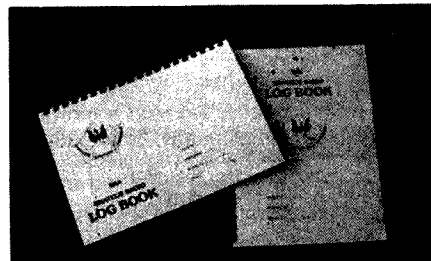

New WIA logbooks available now

at your Divisional Bookshop. These quality logbooks are available in A4 format with plastic spiral binding so the book will open and lie flat on the bench. VERTICAL OR HORIZONTAL column layout is optional, with the traditional column headings. Price is \$5.00 each plus post and packing where applicable.

HOW'S DX

STEPHEN PALL VK2PS
PO Box 93 DURAL NSW 2158

I am writing these notes on an early sunny September day. One hopes that the spring equinox will change band conditions for the better, as the sun moves southwards from the equator.

Albania ZA

The saga continues. Early August it was reported that Peter HA5WE returned from Albania, saying he was advised by a high government official (some even say it was the Albanian Prime Minister himself) to postpone the planned activity until September, when things will be "quieter". My direct source from Hungary advises that the President of Albania is expected on an official State visit to Hungary in September, and the amateur DXpedition will take place after that political event. Well, we will see . . .

Kuwait-9K — and the Middle East

If you are one of the many DXers who delayed sending the QSL cards to 9K2CS for the Yemeni 7O1AA operation, you are too late! Even those who sent their cards in the latter part of July will be disappointed. Mohamed 9K2CS, the leader of the Yemeni operation, was related to the Kuwait Royal Family. His whereabouts are known. Some sources say he was killed with several members of the Al-Sabah family. Other, allegedly

well-connected sources, say that he and his father 9K2KS are alive and well in Saudi Arabia . . . but the logbooks were left behind in Kuwait.

The ARRL DXCC still has to decide whether the 7O1AA activity refers to one of the two old Yemeni states, or to the new one after the merger? Please do not send your cards, if you are one of the lucky ones who has received a card, to the DXCC until further notice.

The French activity in Yemen 7O8AA finished its operation on 12 August. QSL to F6VX (See Sept AR).

Further on Yemen. According to some other reports, the callsign group from 7O1 to 7O5 will be allocated to Yemeni amateurs, the 7O7AA group will be allocated to club stations, and the 7O8AA group will be used by foreign visiting amateurs.

If you listened on the various DX nets during August, you would have heard that the club station YI1BGD was active on 11 and 18 August, on the latter occasion with a YL operator named Alar. There were very few takers for a QSO. Other DX stations active in the Middle East were YK1AA, A41KL and A41KJ.

Look out for a new Saudi Arab station 7Z1AB. This is the callsign assigned to the Amateur Radio Society at the US Embassy in the capital of Saudi Arabia, Riyadh.

Rwanda 9X

There are now five active resident amateurs in this country, most of them on work-contract basis. Wolf 9X5SW was heard on 21 MHz. QSL to DK5QB. The other active station is 9X5HG. The operator is Hartmut. His home call is DK2SC, and his QSL manager is DJ3FW W Wenske, Lindenkaamp 27, D-2060, Bad Oldeslohe, West Germany. Hartmut is a frequent visitor on the "ANZA" net (21205 kHz) with usually a strong signal on longpath to Sydney. He is a professional radio engineer and his wife is with him in Rwanda. He is one of the technicians who work on a shiftwork basis for a German relay broadcast station in Rwanda. He lives on a 1500m hill, only about 300m from the broadcast station and this sometimes creates local QRM problems for him. Hartmut said it took six months patient waiting to secure a licence, and he started operating at the beginning of August. He is using 400 Watts into a HB9CV two-element beam.

The Colvins

Iris W6QL and Lloyd W6KG are on the air again from Africa. This time from Tanzania

as 5HOQL. They plan to operate from other African countries which they have not visited before. They would like to go to Mozambique (C9) and to Madagascar (5R) but, as of now, they do not have permission to operate. Iris had a reasonable signal to VK2 on the "ANZA" net, and she sends greetings to her VK friends whom she met when they visited here in February. QSL to YASME Foundation, Box 2025, Castro Valley, CA 94546.

"Zbig" VK2EKY — and the Pacific

Received a long letter and several photos from Zbig, who was active in recent months as KH8/VK2EKY, 5W1KY, A35KY, ZK3EKY. I commented on Zbig's travels in previous issues of 'AR' and quoted him as an "ex-VK2EKY". Of course, this was one of those slips of the tongue or, rather, the pen. Zbig is very much a resident of VK2, and a local amateur, except that he has the good fortune to travel widely. He started his DX activity in 1971 as SP5EKY but went QRT with that callsign in December 1981. After travelling around the world he arrived in VK2 in June 1985, decided to stay and, soon after, obtained the call VK2EKY. His Pacific wanderings started in 1987 in ZK2, KH8, 5W1, A35 and 7J1. A year ago he met his wife, Kayoko from Japan, who was often mistaken on their recent Pacific tour, for Kiyoko, another Pacific DX operator from Japan.

Zbig returned to Sydney at the end of July, but 10 days later he was in Guam and I had a chat with him on 14 August, operating as KH2/VK2EKY. Zbig is going from there to Tokyo and Osaka where he hopes to operate from the 8J90EXPO club station.

Zbig plans to stay a while in Japan with his in-laws and will operate from there as 7J6AAK. He says he will build a "big" Yagi, three elements on 7 MHz. He sends greetings to all his friends who worked him on the various bands.



The well known Pacific traveller "Zbig" VK2EKY also known as KH8/VK2EKY, 5W1KY, A35KY, VK2EKY/KH2 and 7J6AAK seen here at Tokelau operating as ZK3EKY



Memories of the recent Bhutan DXpedition. Jim A51JS (VK9NS) and Prahan A51PN with the Butternut vertical in front of the hotel.

Christmas Island VK9X?

Harry VK2RQ (better known under his old callsign as VK2BJL) is planning a DXpedition to Christmas Island (Indian Ocean) mid-October. Other participants are Franz DJ9ZB and Bruce VK3DHT. However, the trip depends very much on the availability of accommodation on the island. If this cannot be solved, the October trip will be abandoned and rescheduled for March next year. Harry by the way, is a known DXer. He was on Spratly in 1979, on Mellish Reef in 1978 and 1982 and on Tokelau in 1981.

Bing, VK2BCH and the Pacific

Last year, Bing had to return home from his Rotuma DXpedition as a sick man. He recovered and decided to go back once more. He is leaving on 18 October for Fiji 3D2, then to Tonga A35 and, finally, to Rotuma as 3D2XV.

Malpelo Islands HK0

Fifteen Colombian operators belonging to the Colombian Radio Amateur League will operate from this tiny island in the Pacific Ocean about 350 km west of the city of Buenaventura. The expedition will take place between 3 and 7 November, but it depends very much on transportation facilities which the group hopes that the Colombian Navy will provide. The operation will be on all bands, CW, SSB, RTTY. The frequencies quoted are: 1825, 3505, 7005, 14025, 21025 and 28025 for CW. For SSB they are: 1835, 3795, 7085, 14145, 21195 and 28395. QSL via the Bureau or to HK3DDD: Edilberto Rojas M, PO Box 25827, Bogota 1, Colombia, with the usual SAE, IRCs or "green" stamp.

South Georgia and South Sandwich DXpedition VP8SGI and VP8SSI

The charter of the ship "Indiana" will cost \$US90,000 for 30 days, including fuel and meal for the 20 operators, which includes two team doctors who are also amateurs. The air transportation cost for a return trip from Miami to Punta Arenas is \$US1173 per member. A number of commercial radio firms have made equipment donations, but the expedition badly needs cash support. Please send your donation, no matter how small, to Jerry Branson, 93787 Dorsey Lane, Junction City OR 97448 USA.

Interesting QSOs and QSL Information

Note the following: callsign, name of operator; frequency in kHz; mode, UTC, month of operation. ADAR means QSL info in previous issue of 'AR'.

HC1XM Yeong — 7095 — SSB — 1020 — July. QSL to: Change P Yeong Seong, URB

Santa Rosa 87, Box 197, Santo Domingo de los Colorados, Ecuador.

VS6VO — Graham — 21225 — SSB — 0940 — July. QSL to: PO Box 12727 Hong Kong.

PJ2WG — Willy — 28485 — SSB — 0011 — August. QSL to: Box 3383 Curacao, Sth America.

HK0TCN — Vic — 14180 — SSB — 0928 — August. QSL to: Victor M Tesone, Box 464, San Andreas Island, Colombia.

9J2BO — Brian — 21132 — CW — 0847 — August. QSL via W6ORD: Box 19055, Encino CA 91416, 9055 USA.

3A2HB — Loi — 21253 — SSB — August. QSL via Bureau.

HI3PGJ — Jose — 14238 — SSB — August. QSL via Bureau or to: Jose I Dominguez Luis Bogaert 89, Santiago, Dominican Republic.

OY3QN — Ole — 21025 — CW — 0900 — QSL to: OZ1ACB, A L Andersen, Kagsaaevj 34, DK-2730 Herlev Denmark.

4S7CF — Cal — 14012 — CW — 1100. QSL to: 9V1JY N Vatheendran, Block 171, Bukit Ratok West, Av 8 23-349, Singapore 2365.

5N0ETP — 14222 — SSB — 0631 — QSL to: N6QLO Edward G Linskey Jr, PO Box 85, Burlingame CA 94010 USA.

YS0OR — 21295 — SSB — 0235 — July. QSL to: Box 976 San Salvador, El Salvador.

3DA0BK — 28485 — SSB — 0640 — July. QSL to: Box 122, Eveni Swaziland.

ZL3TY — 50120 — SSB — 0154 — August.

OX3ZM — Anny (YL) — 14226 — SSB — 1154 — August. QSL to: Ann Alice Rasmussen, Sanatorievej, Block 642, Box 360, DK-3920, Julianehaab, Greenland.

7X5AB — Ali — 21205 — SSB — 0510 — August. QSL to: PO Box 137, 07000 Biskra, Algeria.

J5CVF — 14222 — SSB — 0740 — August — QSL to: CT1DIZ Jose Alexandre C Barbosa, Baixo 66, Algueirao P-2725, Mem Martins, Portugal.

JU750BV — Naran — 14251 — SSB — 1412 — August. QSL to: JT1BV, PO Box 106, Ulan Bator (Zip 51) Mongolia.

5R8JD — Jean Paul — 21205 — SSB — 0502 — August. QSL to: F6FNU Antoine Baldeck, Box 14, F-91291 Arpajon Cedex, France.

EK0AC — Alex — 14001 — CW — 1152 — August. QTH: Iony Island, Sea of Okhotsk, 56°26'N and 143°25'E. QSL: via Bureau to UA00BA.

C56/DL7FT — Frank — 14195 — SSB — 0629 — August. QSL to home call via Bureau.

RTTY News

Thanks to Syd VK2SG for the following info:

HV3SJ — 14089 — 0557 — August. *****
FP5DX — 14089 — 0245 — August. QSL to: Box 4204 F-97500 St Pierre et Miquelon via France. *****
A41JW — 14088 — 0149 — August. QSL to: Aboulaziz Alla Baksh Al Balushi, Box 7421, Motrah, Oman. *****
ZD9BV — 21083 — 1700 — August — QSL to:

W4FRU. (Note: ZD9BV will have better signals after he finishes his house and his new beam) *****
J42DIO — 14089 — 2148 — August. QSL to: via SV2XYT, Box 10728 Tesaloniki, 54110 Greece. *****
TY1PS — 14093 — 0055 — August. QSL to: Peter Schulz, BP-06-2535, Cotonou, Benin, Africa. *****
VQ9RB — 21093 — 1757 — July. QSL to: Dick Barnes, Box 55, NSF, FPO, SF 96685 — 2000 USA. *****
JX9CAA — 14091 — 1130 — August. QSL: via LA5NM. *****
8P6MR — 14089 — 0208 — August. *****
It appears that whilst CW and SSB activity has stopped from Kuwait 9K2, RTTY activity was observed on 10, 17, 20 and 21 August on 21, 18 and 14 MHz.

From Here and There and Everywhere

Some time back in April I had a contact with an unusual call: VK6COM. The other day a nice colour certificate arrived from the City of Mandurah in Western Australia. Mandurah has been proclaimed a City and the station was a special event station.

The intended visit of Paul VP2EXX to the USSR has not taken place (See 'AR' Sept issue).

Al H44AP has now recovered from his malaria attack and from the infected foot which needed surgical intervention and evacuation by air to Hawaii. Al is back in Honiara and active as before.

The 3W3RR cards are arriving in VK from Romeo, direct from the USSR. Nice design, good quality paper, but nowhere on the card is stated that it confirms a QSO or that it was a two-way contact. A bit disappointing.

In contrast, the 1S0XV cards are very professional. Good design and lots of information. Thanks to W4FRU for a very quick turnaround. W4FRU is also QSL manager for XV0SU, XV100HCM and 3W100HCM.

Steve AA6LF/KH5 was worked on 3 August. He was operating from Home Island in the Palmyra Island Group. QSL to his home call, only in the 1990 callbook.

YB45RI was a special call celebrating Indonesian Independence Day.

The QSL cards for the 3D2AM Conway Reef Expedition are not out yet. YASME is waiting for the cards from the printer.

4K2PGO from Franz Joseph Land was active on the 14226.5 Family Hour Net. QSL to: RA9LA.

JA7BXS was busy as a net controller on 14182 at 1100 UTC for XU8DX which is a club station in Cambodia. For contacts made after 19 April. QSLs go to JA1NUT to his new correct address: 200-9, Naka, Mohka, Tochigi, Japan. SASE please. According to the ARRL DXCC this operation is not valid yet for the DXCC, due lack of documentation.

The Grosse — Ile expedition: CI0GI, in its 72 hours operation made 3650 contacts on SSB and 3800 contacts on CW. The DXAC will

vote in September for a recommendation whether it will recognise the operation as a separate DXCC country or not.

ZD8Z is active from Ascension Island for the next two months or so. QSL to W6CF.

Malawi is also active in the CW mode. The operator is Rudi DK7PE, and QSL to his home address.

It is rumoured that F2FYD will be active from Sudan as ST0YD and as ST2YD for the next nine months.

The Nicaraguan call areas have been changed, so do not be surprised if you hear "new" stations. YN1CC, Jose, had many contacts previously as YN3CC.

9H1XX will be the callsign used by DL2GBT for his 23 September to 21 October activity from Malta on 10 and 20 metres. QSL to home call via the Bureau.

John Rouse KA3DBN will operate as VP2EBN from Anguilla (NA-22) on CW, SSB and RTTY from 1 to 8 October. QSL direct to home call with SASE.

V31BB is a silent key due to an accident when he was operating. Logs are now with N3ADC.

Kioko Yamakami, Box 3, Toikamura, Zip

31911, Japan, was active as ZK1XY from Suwarow Atoll (OC-80) in the North Cook Islands.

If you worked S79NBD and S79DBI between 12 and 18 September, send your QSL cards to JG1NBD and JL1ARF, respectively.

The shortlived Trindade DXpedition ZY0TK and ZY0TW was on the island for only two days; a longer stay was refused by the naval authorities. They made only 2816 QSOs, mostly with North American and European stations due to poor propagation. They had only nine SSB QSOs on 14 MHz, two on 28 MHz, and one CW QSO; a total of 12 with Oceania. Any VK worked them?

Interesting QSLs Received

Note: W=weeks; MO=months; FM=from; MGR=manager; OP=operator.

Y93VL (7MO FM Bureau), ZM1WTD (6MO FM Bureau), SV5TS (5W FM OP), HK1KHK (4W FM OP), T5RR (72 FM OP), VK0JR (6W FM MGR), OA4ED (3W FM OP), 7Q7JM (3W FM MGR), VK9EW (2MO FM OP), S21U (3MO FM MGR), TZ6VV (6MO FM MGR), 5H3TW (2W FM MGR), KG4UN (2MO FM

OP), 3W3RR (4MO FM OP), PJ2HB (5W FM MGR), 5B4SA (8W FM OP), 7X2AK/3 (16 MO FM OP), HR1RMG (4W FM OP), 9L1US (10W FM MGR), FT4XG (3MO FM MGR), 9K2YA (12W FM MGR), ZS8MI (4W FM MGR), HR2FD (8W FM OP), FT5XA (12W FM MGR), 1S0XV (3W FM MGR), HJ1MPK and HJ6QKZ direct, unsolicited.

Thanks To You

To all the supporters of this column, many thanks. For the letters, reports, photographs special thanks to the following:

VK2SG, VK2RQ, VK2FNJ, VK2DID, VK2EKY, VK3DD, VK3TU, VK4OH, VK4MWZ, VK4DA, VK5WO, VK9NS, H44AP, WA4JQS, OE6EEG, HA5HR, "QRZ DX" and the "DX Bulletin".

And, if you want the DX to chase you, instead of the other way around, take part in the 1990 VK-ZL-Oceania Contest. SSB section on 6 and 7 October, and the CW section on 13 and 14 October. See September 'AR' for the slightly changed rules.

GOOD DX AND 73. ar

WARC-92 UPDATE

DAVID WARDLAW VK3ADW
WIA WARC-92 TEAM LEADER

While the agenda for the 1992 World Administrative Radio Conference (WARC-92) has been established, the full extent of possible threats to amateur allocations will not be known for some time.

Countries' proposals in response to the agenda are due eight months before the conference convenes on 3 February 1992. Over the weekend of 7 July, the Administrative Council of the International Amateur Radio Union met in Boston to review the WARC-92 agenda and to assess its possible impact on amateur radio.

The greatest threat is to the 7MHz band, from possible expansion of the exclusive allocations for HF broadcasting. Other bands facing significant potential threats include the 3.5, 10.1 and 14MHz bands, from the same source, and the 144 and 420MHz bands from low-orbit mobile service satellites, whose proponents are looking for spectrum to share with existing services. While no reallocation decision to accommodate wind profiler radars is to be made at WARC-92, discussions will take place that may eventually affect the 420MHz band and possibly others.

New space applications above 20 GHz may affect present allocations there. Pressure on the microwave bands below 3 GHz will be intense as a result of new and expanded services being considered in this range: satellite sound broadcasting (along with a complementary terrestrial broadcasting service),

future public land mobile telecommunications systems, an aeronautical public correspondence service and mobile satellite services.

And finally, high definition television broadcasting by satellite will create pressure on the microwave frequencies above 10 GHz.

The Australian preparation for WARC-92 continues to be twofold.

Firstly, through the Australian National Study Groups of the CCIR, which are concentrating on the various IWPs that are preparing input for JIWP WARC-92 which will prepare the CCIR report to WARC-92 which will be the technical basis of WARC-92.

Secondly, through the committees of the APG for WARC-92 which are now concentrating on the agenda for WARC-92.

The WIA is representing the amateur service at both of these levels.

The WIA has presented papers on the frequency requirements, operating and technical characteristics of the amateur service.

They describe the importance of the various bands to the amateur and amateur-satellite service and will assist in the discussion of the possible effect that any proposed changes to the existing frequency table will have on the amateur and amateur-satellite service. It is hoped this will help prevent a disadvantageous situation for the amateur amateur-satellite service arising.

IWP = Interim Working Party; JIWP = Joint Interim Working Party; APG = Australian Preparatory Group — Ed. ar

WIA SLOW MORSE TRANSMISSIONS

VK2BWI	Nightly at 0930 UTC on 3550 kHz
VK2RCW	Continuous on 144.950 MHz 5 wpm, 8 wpm, 12 wpm
VK3RCW	Continuous on 144.950 MHz 5 wpm, 10 wpm
VK4WII	Tuesday at 0930 UTC on 3535 kHz
VK4WIS	Nightly at 0900 UTC on 3542 kHz
VK4WIT	Monday at 0930 UTC on 3535 kHz
VK5AWI	Nightly at 1030 UTC on 3550 kHz
VK6RAP	Nightly at 2000 local on 146.700 MHz
VK6WIA	Nightly (except Saturday) at 1200 UTC on 3.555 MHz

POUNING BRASS

GILBERT GRIFFITH VK3CQ
7 CHURCH ST, BRIGHT 3741

By now, those Morsiacs who thought they could play with batteries without spilling acid everywhere should have some new holes in their trousers. I warned you . . . so, mums and XYLs, don't blame me! But a good battery is worth a pair of pants, in my book, anyway.

The fish are biting this month, because of my recent proposal for a new Morse-only licence, currently on packet radio bulletin boards and in many club newsletters, and the angry opponents are biting hardest. The simplest way for you to find out about the proposal is to contact your nearest packet expert and ask for a print-out. You can send me a SASE and I will run you off a copy, together with the quick answer form for your opinions. Believe me, there are many opponents who seem to hate CW and cloud the issue with their own ideas, which they are not really prepared to back up with the work involved in putting forward their own proposals. I guess this is to be expected on packet, and I would like to find out exactly how many amateurs use each mode. When and if I get enough support, I will submit details and statistics to the Institute for a serious application to DoTC.

Although a slanging match appears to have started on packet, I don't want to see the same thing in print; you know how it goes with "letters to the editor" etc.

We Morsiacs know about the operating skills and enthusiasm that use of CW engenders. We are the only members of the amateur fraternity who can be expected to communicate the advantages to prospective amateurs, and not, as many think, try to convert established amateurs who are not interested. Think about it. We are up against such things as the New Zealand Branch 74 Discussion Paper, so it won't be easy.

Peter Alexander VK2PA gives his answer to the discussion (below) BUT it is from a defensive position. An aggressive campaign to encourage CW and gain new amateurs is needed, and I'm just the sucker to provide it! But, enough from me, read Peter's case, he is a respected amateur, home-brewer etc, and was winning contests in 1946 or thereabouts. I've got the Radio & Hobbies magazine here to prove it! (Before I was born hi).

"The CW Saga: A Case for the Retention of Morse Code, by Peter Alexander VK2PA (Westlakes ARC Newsletter, June 1990).

This reply is to New Zealand Branch 74 Discussion Paper 7/2/90 which proposes to do away with Morse Code by the minority "CB mentality" group. Well, with WARC 1992

coming up, there is going to be a lobby to get rid of Morse code for sure. If they win this time, in a generation it will all be over. So here we go, point by point from the ZL discussion paper.

Morse code over the years has proved a very effective mode of communication and, in most cases, is far superior to any other mode given the same difficult conditions that more often than not exist. Reliability per Watt of power is more effective than any other mode.

Ongoing Decline of Morse Code?

Don't be mesmerised by this heading. I would like to know where are the facts for this statement. Observations made over the years, and in particular over the past 12 months, show an increase in the use of Morse code as a means of communication. During the present sunspot cycle, a count of the various modes on the HF bands shows that Morse code is the preferred mode (60 per cent) especially amongst DX stations. Westlakes Radio Club produced a CW kit for its members, selling for \$10, which became very popular. The polls taken in Australia favour the retention of Morse code and that it be an examination necessity.

No Objectivity in IR Regulations?

There is every assurance that demonstrating the ability to send and receive Morse code will make the candidate a better radio amateur. It demonstrates a skill and, with practice, becomes a second international language with no accent and allows one to communicate directly with any amateur in the world no matter what his/her native tongue. The dividing point should be 30 MHz as there will be a lot of Morse code below this frequency for years to come, and an amateur should have the ability to know "what is going on".

There is no skill required to be a communicator on SSB, or in the use of a black box, and certainly no skill is needed to operate packet radio; you don't even have to be able to type. One would suggest that it would be no harder to learn to type than to learn Morse code, so to provide effective communications on packet radio and RTTY the operator should have at least a 50wpm typing ability. Perhaps a typing test for digital operators should be included in any examination in future and made an international requirement. In this regard I would agree that the international regulations have been out of date for some years, but certainly not regarding Morse code requirements.

Survival on Merit for any Mode?

Perhaps this heading should read "Survival of Amateur Radio"? If anything is going to destroy amateur radio, it is going to be caused by lowering the standards that have been in place as basic requirements. Modes that require skill are necessary, as is the knowledge on the technical side. Morse code provides the training ground for good operating practices on HF bands that wash off on other modes of communication. Novices, once technically qualified, are either novice/limited licensees, or full call amateurs if they have qualified from 5 wpm to 10 wpm in Australia, so the extra privileges are automatic.

Impact of Commercial Equipment?

Yes, the black box syndrome, and isn't it a shame the number of so-called amateurs don't know what is going on behind the knobs, let alone adjust the transmitter correctly. And the splatter from the big linears! Agreed that commercial equipment has become the way out, but in spite of this, "do it yourself" kits are still available in many countries, and popular, so there is still a demand. The builders of home-brew gear are all the better for it.

The cost of commercial equipment is a far greater deterrent than passing a standard examination including Morse code. India, for instance, and many third-world countries, have this problem. The government of India has supported amateur radio with grants to construct home-made equipment from the ground up. The most used mode on HF is not SSB, but Morse code, certainly not packet or RTTY. The reason is obvious.

Vocational Aspects?

The basic knowledge gained from an amateur examination is hardly fitting for a position in the electronics industry. It has been made too easy with black boxes and the demise of the written technical examination, which was a step backwards. What is the basis that Morse code has little commercial significance? Hundreds of commercial stations can be heard on HF still using Morse code, and the fact that digital modes and FAX have been used in amateur and commercial for years is nothing new. SSB has been used since the radio-telephone circuit was introduced between London and New York in 1927. There was not much amateur SSB until the '60s, and there was even a New Zealand firm selling a phasing rig kit in the late '50s. How many of today's amateurs could build an SSB transmitter?

Need for Lobbying?

The push to have Morse code removed as an exam requirement comes from people who:

- want extra HF privileges but do not want to work for them;
- would like to become radio amateurs but

are not prepared to make the effort to learn code;

c) amateurs who lack the skill. The funny noises would no longer annoy them.

I have spoken with many amateurs, particularly novices, who have become or are becoming very skilled. They have made the effort. No way do they want Morse code removed from exams. The ease of learning the code is indicated by the area from Taree to Coffs Harbour, 150 miles of coastline. There are 238 amateurs and only eight are limited licensees. It is a known fact that Morse code is being phased out in the commercial world, although not entirely. It is for a basic economic reason, but we are amateurs; not in the business of trying to provide a commercial service. It should be that we carry on the basic traditions of amateur radio and maintain the capability of Morse code. Consider the advantages: it is the most reliable mode; it requires less power for the same distance covered; it has no language barrier; it takes less band space than any other mode; it can be used

with a transceiver costing \$75 or less.

It is significant to note that Morse code is still being taught in the armed services, and is also a requirement for commercial and private aviation.

The International Radio Regulations state: "Any person operating the apparatus of an amateur station shall have proved that he is capable to send by hand and receive correctly by ear texts in Morse code signals. Administrations may, however, waive this requirement in the case of stations above 144 MHz". (In Australia the Morse requirement is waived above 50 MHz).

Suggestions of a Morse code test with a 2wpm sending and receive capability and a 50 per cent error rate are ridiculous. This would not even be a pass in the Boy Scouts! The problem is not the international regulations. The people who want to be big boys are not prepared to do the work. They make the most noise and the least effort, or perhaps they are satisfied with the standard they have reached.

STAY ON COURSE, SAY YES MORSE!

73 PETER VK2PA

Peter makes plenty of valid comments, and I agree with some of them. But "letters" never seem to achieve anything concrete. The people who have made up their minds and started the discussion about dropping Morse code are not going to listen to arguments. They are simply going to lobby their cause as effectively as they can.

What I think we can do is provide, through our CW clubs etc, positive ideas to make radio attractive, ways that do not threaten any established spectrum users, so they are less inclined to oppose us. We can even turn their opposition around by showing them how they can use our methods to achieve their own aims, but we will all have to work at it in a positive manner. Let us agree with everything our opponents say, that Morse is obsolete, difficult, etc etc, and then ask them to help us make it easy to at least try it if somebody wants to.

73 FOR ANOTHER MONTH.

GIL AR

VHF/UHF AN EXPANDING WORLD

ERIC JAMIESON VK5LP
9 WEST TERRACE MENINGIE 5264

All times are UTC

Beacons on Six Metres

Freq	Call sign	Location	Grid square		
50.000	GB3BUX	England	IO73	50.080	KH6JJK Hawaii BL11
50.005	H44HIR	Honiara	Q100	50.080	HC8SIX Galapagos Is EI59
50.005	HL9TG	Korea		50.085	9H1SIX Malta JM75
50.005	ZS2SIX	South Africa	KF25	50.086	VP2MO Montserrat FK86
50.011	JA2IGY	Japan	PM84	50.088	VE1SIX Canada FN65
50.015	SZ2DH	Greece	KM18	50.090	KJ6BZ Johnston Is AK56
50.017	JA6YBR	Japan	PM51	50.092	W5GTP Louisiana USAEM40
50.020	GB3SIX	England	IO73	50.099	KP4EKG Puerto Rico FK68
50.020	CX1CCC	Uruguay		50.100	HC2FG Ecuador FI07
50.025	6Y5RC	Jamaica	FK17	50.100	5H1HK Tanzania
50.025	OH1VR	Finland	KP12	50.110	KG6DX Guam QK23
50.028	JA7ZMA	Japan	QM07	50.110	A61XL United Arab Emirates LL74
50.029	CT0WW	Portugal	IN61	50.120	5S7EA Sri Lanka MJ97
50.032	ZD8VHF	Ascension Is	II22	50.321	ZS5SIX South Africa KG50
50.032	ZS5SIX	South Africa	KG50	50.490	JG1ZGW Tokyo PM95
50.035	ZB2VHF	Gibraltar	IM76	50.499	5B4CY Cyprus KM54
50.035	ZS3VHF	South Africa	JG87	52.100	ZK2SIX Niue AH50
50.039	FY7THF	French Guyana	GJ35	52.200	VK8VF Darwin PH57
50.045	OX3VHF	Greenland	GP60	52.310	ZL3MHF Christchurch RE66
50.048	TG4BFB	Guatemala		52.320	VK6RTT Wickham OG89
50.050	GB3NHQ	England	IO91	52.325	VK2RHV Newcastle QF57
50.050	ZS6DN	South Africa	KG44	52.330	VK3RGG Geelong QF21
50.056	VK8VF	Darwin	PH57	52.345	VK4ABP Longreach QG26
50.057	TF3SIX	Iceland	HP94	52.370	VK7RST Hobart QE37
50.062	PY2AA	Brazil	GG66	52.420	VK2RSY Sydney QF56
50.064	WD7Z	Arizona	EL59	52.425	VK2RGB Gunnedah QF59
50.065	GJ4HXJ	England	IN89	52.435	VK3RMV Hamilton QF12
50.065	NB30/1	Rhode Island	FN41	52.440	VK4RTL Townsville QH30
50.066	VK6RPR	Perth	OF78	52.445	VK4RIK Cairns QH23
50.063	KH6HI	Hawaii	BL01	52.450	VK5VF Mount Lofty PF95
50.075	VS6SIX	Hong Kong	OL72	52.460	VK6RPH Perth OF78
50.078	TI2NA	Costa Rica	EK70	52.465	VK6RTW Albany OF84
				52.470	VK7RNT Launceston QE38
				52.485	VK8RAS Alice Springs PG66
				52.510	ZL2MHF Mount Climie RE78

Having recently returned from hospital to continue the recovery process, I found that my computer had decided to no longer work, so temporary measures have been undertaken to use another which, fortunately, is compatible (after adjustments) with my discs to allow the retrieval of already stored information.

A vast amount of new information has arrived regarding the Six Metre Standings, and this has to be added to the already stored computer information. If I am unable to finish this by my printing deadline, then it will be held over to the next issue.

Six Metres

From the few reports received during my absence, the six-metre band has been very quiet, even at the VK5BC establishment. John VK4ZJB reports from the Brisbane area that the only long distance signals appear to be a few openings to Japan. However, it seems that the solar count is rising (and falling) so, by the time you read this, some further good DX contacts may have ensued. I feel certain we have at least another two years during which we can expect to make some very rewarding contacts, especially during the equinoxial periods. It will be a case of being vigilant and prepared to get out of bed around 2120 for some of the best contacts, which often occur between then and 0000.

From the USA

Bill Tynan W3XO/5, in his QST column "The World Above 50 MHz", reports that despite often repeated comments that F2 conditions appear to be deteriorating, many were reporting good results. Bill said he had added eight new countries since early March.

LU3EX reported nine additions, bringing Alfredo's total to 105! Doug ZP6XDW in Paraguay, South America, made 283 contacts in 39 countries from February to April.

Some results of Joel's N6AMG Pacific DXpeditions were that as VK9LG at Lord Howe Island he had 820 contacts in 19 countries, including 97 VKs. From American Samoa as N6AMG/KH8, he made 450 contacts in 11 countries, including 106 VKs. His best contact from there was ZC4MK on long path over southern South America. From Western Samoa as 5W1JP, Joel made 550 contacts in 24 countries, including 63 VKs and notable contacts to 5H1, CEO, ZP, XX9 and HH, with the band open up to 20 hours a day! His station consisted of an IC-575H to a 1kW solid-state amplifier using MFR-154s and a two-wavelength Yagi modified so that it could go as carry-on baggage.

The W3XO/5 report in August QST covers the massive Es openings they enjoyed on six and two metres for about a week at the end of May. On 26/5 T12HL, CO2KK and CO2CB were available. On 27/5 W4s worked VK3OT and VK3AMZ and some ZLs. On 29/5 W1JA/4, using 10 Watts, worked VK4BRG. On two metres, WA3HMK worked CO2KK in Cuba, though they had been trying for some time to no avail to accomplish a contact via meteor scatter.

Via Japan

Courtesy Graham VK6RO, the Japanese "ham radio" magazine for July 1990 advises (from PA3EUI and PA3249) of six-metre operations now allowed from the following European countries: HB from 0400 to 0600 1/290 to 31/12/90 on 50.000 to 52.000 with an ERP of 100 Watts; LX 0000 to 2400 from 1/3/90 50.100 to 50.200 and 100 Watts; OE 0000 to 2400 1/2/90 to 31/1/91 50.000 to 52.000 and 25 Watts; ON 0000 to 2400 1/1/90 to 31/12/93 50.000 to 50.450 and 30 Watts; OY 0000 to 2400 from 1/1/90 50.000 to 51.000 and 500 Watts input; OZ 0000 to 2400 1/1/90 to 31/12/90 50.000 to 52.000 and 500 Watts inputs. Quite interesting!

The DX Window

From the SMIRK journal, the Six Shooter, comes the following: "SMIRK and other national organisations around the world have worked long and hard to develop the DX Window concept. It now has met with international approval. There is an agreement in effect that ALL NATIONAL QSOing will be kept out of 50.100 to 50.125. Only DX are to be worked there... if you make a non-DX contact in the window, move them out of it immediately. Ask those who are in the window in error to make out. Why risk screwing up someone's once-in-a-lifetime DX contact."

As always from SMIRK, the statement is very much to the point, but the text of the message has certainly been expressed on a

number of occasions here in Australia and through these columns. One can only hope general support will come from Australian amateurs for such sensible operating.

Other Items

10GHz Record

I hope you did not miss the item on page 8 of August 1990 AR of the new South Australian 10 GHz record created on 7/5/90 between Des VK5ZO and Nick VK5NT over a distance of 147.1 km. And this coming on top of their new national record on 5.7 GHz last November. Congratulations!

1296 MHz

Following the acceptance of the job of looking after the WIA VK5 Equipment Supplies material, David VK5KK and Mark VK5AVQ have done much to revitalise the section. David, in particular, has spent time and energy in the preparation of transverter kits for use on 1296 MHz. At last count, more than a dozen had been sold and it was difficult to keep up with demand. If all those who have made purchases now go ahead and bring the equipment to an operational stage, it seems 1296 MHz will be a busy band and perhaps rival that of the VK3 potential for activity.

Closure

As I am slowly beginning to take up the cudgels again, there has not been a lot to report this month. I hope that at least some of my fairly regular correspondents will now start writing again so we may learn of happenings in other places.

Two thoughts for the month: "Drowning problems in an ocean of information is not the same as solving them," and "Nobody is wholly tolerant. The more you believe in tolerance, the less you can tolerate the intolerant."

73 FROM THE VOICE BY THE LAKE

Late News

England

Ken Ellis G5KW advises that at the age of 82 he is still very active on amateur radio. He was recently appointed editor of the VHF/UHF column of Ham Radio Today. He has asked me to swap information with him, which I will do.

Ken advises that quite a number of stations in the British Isles have now worked around 90 countries on six metres, with Geoff Brown GJ4ICD heading the list with 96 worked and 88 confirmed. Ken has worked around 80 countries. This again confirms that there are decided advantages in living in the northern hemisphere where there are so many countries at distances which can be worked on six metres.

West German stations are now allowed 25 Watts ERP on CW and SSB, and about 300 stations have applied for the permits, which are being issued for 12 months operation.

Although of little value for operational purposes, the activation in recent times of the following areas on six metres is of value for record purposes. FE1JKK/FY French Guiana is on six metres, and his QSL manager is FD1JMH. On 2/5 CT1DQT worked RB5FLE(?) on CW. June through August DXpeditions were OH0BT from Aland Island; OH0M from Market Reef; JW5QFA, JW1MFA, JW9VDA and JW9ZV from Svalbard, activated by three PA stations. QSL via Box 3506, GL Utrecht, Netherlands; G3SDL activated the Geneva Club station 4U5ITU; from Leichtenstein HB0/HB9QQ. QSL via HB9QQ.

Brunei

Andrew Davis V85DA writes to say there has been limited six-metre activity since December 1989, when he heard JAs working W6, W7 and KL7. On 24/12 he worked KL7BB. Next contact was 20/1 to KJ6WO/DU3; 9/2 JAs on CW; 16/2 VK8s and VS6s; 21/2 JA and YB; 22/2 VQ9LW, who is one of several operators using one Swan 250 which has no RIT, no dual VFO, no split capability, so it becomes difficult to use during a JA pile-up! 28/2 JAs; 9/3 JAs; 10/3 KG6DX, a very difficult contact due to the placement of the equator; 11/3 VK8ZLX and VK8TM; 13/3 and 25/3 JAs; 31/3 JAs and 5H1HK and later VS6BI and P29PL. The above list shows not all places on this earth which may be loosely termed exotic are necessarily blessed with good six-metre signals with many countries from which to choose!

Andrew has now been joined by Brian V85EB, formerly VK2EEB, who has an FT690 and a power amplifier he is to build and will be active on six.

Andrew has worked all JA prefectures and almost 200 JA cities, to which he wants to add, as he is not sure how much longer he may be in Brunei.

Thanks for writing Andrew.

50-54MHz DX Standings

DXCC countries based on information received up to 15 August 1990. Crossband totals are those not duplicated by six-metre two-way contacts.

- Column 1: 50/52 MHz two-way confirmed contacts
- Column 2: 50/52 MHz two-way worked
- Column 3: Crossband 50/52 MHz to 28 MHz confirmed
- Column 4: Crossband 50/52 MHz to 28 MHz worked
- Column 5: Countries heard on 50/52 MHz

Call sign	1	2	3	4	5
VK3OT	63	69	2		6
VK4ZJB	63	68		4	
VK2QF	56	60			
VK2BA	55	58			
VK4ZSH	53	61			
VK8ZLX	44	52			
VK4ALM	42	48			
VK8GB	42	42			13

Call sign	1	2	3	4	5
VK4ZAL	37	49			
VK3AMK	34	42			
VK3AWY	34	36			
VK5RO	32	45			
VK3NM	31	34			
VK5LP	30	31		9	
VK3AUI	27	28			
VK2DDG	25	26	2	15	
VK4KHZ	23	34			
VK6HK	23	32	1	3	
VK3XQ	23	25		2	
VK4TL	22	23			
VK2KAY	21	23			
VK2BNN	20	21			
VK9LG	20	20			
VK4BJE	19	25			
VK6RO	19	23	3	13	
VK7JG	18	20		2	
VK3TU	17	19			
VK9XT	17	17		4	
VK2ZRU	16	19		4	
VK9LE	14	14			

Call sign	1	2	3	4	5
VK9YT	12	14			
VK6OX	10	10	1	1	
VK9ZLX	9	9			

Overseas

JA2TTO	48	48		6	
YJ8RG	25	25			

After many production problems, mainly due to absence from home, the August 1990 Six Metres Standings List has finally appeared. If there are any errors, please let me know.

Because there were too many hassles to safely designate who could work where and when, the present list contains all contacts made. I cannot safely state when Channel 0 was on, nor can I vet those contacts limited to 25 Watts; others were told to go on operating but not to cause interference.

In my present state of health recovery I

cannot find the energy to sit down and adequately fight what some might see as an issue. At this stage I believe it is very important to know the extent of the various worldwide contacts, and when I finally write the history of Cycle 22, then a large amount of information is readily available to me.

The next list should appear in February 1991, so information would be appreciated by 20 December 1990, please.

One would have to say "well done" to those who have turned in very high scores, most of whom live well up the country from Sydney, through to Brisbane and beyond. However, Steve VK3OT has worked hard for his top placing and has spent many hours calling on CW and listening for the occasional rewarding reply. I know he has been there because I can always hear him at Meningie, either on forward or back scatter or direct.

Finally, thank you to so many operators who have enquired after my health — your concern has meant a lot to me and will be remembered. ar

AMSAT AUSTRALIA

MAURIE HOOPER VK5EA
11 RICHLAND ROAD NEWTON SA 5074

Thanks to Graham VK5AGR for stepping in at a moment's notice and keeping this column going when I was unexpectedly put out of action for a while.

National Co-ordinator
Graham Ratcliff VK5AGR

Packet Address: VK5AGR@VK5WI

Information Nets AMSAT Australia

Control: VK5AGR

Amateur check in: 0945 UTC

Sunday bulletin commences: 1000 UTC

Primary frequency: 3.685 MHz

Secondary frequency: 7.064 MHz

(7.064 MHz is the frequency presently in use)

AMSAT SW Pacific 2200 UTC Saturday, 14.282 MHz

Participating stations and listeners are able to obtain basic orbital data including Keplerian elements from the AMSAT Australia net. This information is also included on some WIA divisional broadcasts.

AMSAT Australia Newsletter and Computer Software

The excellent AMSAT Australia newsletter is published monthly by Graham VK5AGR on behalf of AMSAT Australia and now has over 310 subscribers. Should you also wish to subscribe, send a cheque for \$20 payable to AMSAT Australia, addressed as follows: AMSAT Australia, GPO Box 2141, Adelaide 5001.

The newsletter provides the latest news items on all satellite activities and is a "must" for all those seriously interested in amateur satellites. Graham also provides a Software Service in respect to general satellite programs made available to him from various sources. To make use of this service, send Graham a blank formatted disk and a nominal donation of \$10 per item to AMSAT Australia, together with sufficient funds to cover return postage. To obtain details of the programs available and other AMSAT Australia services, send a SASE to Graham.

PACSAT Protocol Release Soon

(From AMSAT News Service Bulletin 230.01, 18 August 1990)

PACSAT Protocol Spec to be Released at ARRL Computer Networking Conference

Next month at the Ninth Annual ARRL Computer Networking Conference to be held in New London, Ontario, software developers will have an opportunity to examine the PACSAT File Transfer protocol specifications document. This document will have a profound effect on all PACSAT users because it will state in very precise language the rules that terminal communication programs will have to implement in order for hams to use the BBS capability of the PACSATs. This is in stark contrast to FO-20 which works with any of the popular communications programs. For example, using a regular computer terminal

program an FO-20 user can, using a station equipped with a PSK modem, TNC-2 and appropriate VHF/UHF antennas and transceivers, access the FO-20 BBS mailbox and download files or read mail etc. This can all be done without a special communications program. In other words, the same program that "talks" to a TNC-2 or telephone modem will do just fine for FO-20. For the PACSATs, it will be necessary for the user to have a specially written program for the specific computer which will be used in the PACSAT station. It must be a special program which follows all the rules specified in the PACSAT File Transfer Protocol document authored by NK6K, GO/K8KA and N4HY. The basic reason for using this new PACSAT File Transfer Protocol is to allow for more efficient file transfers, according to NK6K. He points out that using the UO-14 test bed, he was able to upload a 30kbyte file in less than a minute at 9600 baud. At 1200 baud, this will take about eight times longer. Without this more efficient file transfer protocol, it could take several passes to accomplish the same transfer. Hams familiar with the packet radio protocol AX.25 will immediately recognise that this PACSAT File Transfer Protocol is just another "layer" to AX.25. Although users may initially find this a burdensome requirement, it is AMSAT's intention to release this File Transfer Protocol far in advance of BBS operations on the PACSATs so that software developers can start to work immediately on terminal programs for the various computers found today in PACSAT stations. Also, there will be "shareware" programs which will provide examples for software developers. Stay tuned to AMSAT News Service (ANS) bulletins for further information about the availability of PACSAT terminal programs.

UoSAT-F News

(From Spacenews, 13 August 1990)

While efforts continue to get UoSAT-E (OSCAR-15) operational, the University of Surrey (England) is already designing a new spacecraft, UoSAT-F, which should be completed in time for a lift into orbit by an Ariane rocket on an ESA launch. UoSAT-F is expected to carry a Mode-A transponder (2m up, 10m down) along with other experiments.

Microsat Polarisation Studies

(From AMSAT News Service Bulletin 237.05, 25 August 1990)

AO-16 command station WD0E is studying the downlink polarisation sense, or 'handedness' of the signals from all the Microsats. In order to obtain as complete a picture as possible he is interested in receiving your observations. If you are receiving the Microsats with a circularly polarised antenna whose sense can be switched, Jim requests that you send him the following data: Microsat number, observed polarisation sense throughout, a high elevation pass over your station, and date and time of the observation. The sense of the downlink signal (left or right handed) can be found by switching your antenna between the two and noting which results in the stronger signal. Jim asks that you also include an observation of AO13 near apogee with the same antenna.

Results will be published in the AMSAT-NA Journal. Send your observations to Jim White, WD0E @ W0LJF, or via Compuserve 71477,546.

OSCAR-10 News

AMSAT-OSCAR-10 appears NOT TO have been receiving sufficient polar panel illumination to support Mode-B transponder operations. Both beacon and transponder signals started showing signs of FMing. Therefore, until further notice, please DO NOT use AO-10's transponder.

It is expected that AO-10 may once again receive sufficient solar illumination to support Mode-B transponder operation by November.

SAREX/Astro Mission News

(From SAREX Bulletin SAREX-238.04 from the SAREX team, 26 August)

The STS-35 Astro Mission (Note: This mission was rescheduled for a 1 September launch which, at the time of writing, had been set back to 5 September — Maurie VK5EA)

Although amateurs may view the Ron Parise (WA4SIR) on STS-35 in the Shuttle Columbia as the ultimate DXpedition, the real purpose of the mission is the flight of the Astro -1 astronomical research observatory.

The Astro -1 Observatory will function during the entire 9-10-day mission. Astro -1 is

NASA 2-line Keplerian Elements - 31 August 90

AO-10	Epoch	Drag				
1 14129U	83 58 B 90236.61336051	-0.00000014	00000-0	0000000 0	5461	
2 14129	26.0406 187.8160 5953791	170.7905	208.8811	2.05880617	54156	
UO-11						
1 14781U	84 21 B 90234.58891158	.00001231	00000-0	23517-3 0	7681	
2 14781	97.9463 284.9634 0013376	41.3870	318.8391	14.66571876345690		
MIR						
1 16609U	86 17 A 90242.25898469	.00009134	00000-0	10983-3 0	8981	
2 16609	51.6122 316.4065 0025994	309.3050	50.4888	15.61310960259680		
RS-10/11						
1 18129U	87 54 A 90238.82861413	.00000124	00000-0	12506-3 0	3011	
2 18129	82.9234 276.3374 0010324	285.3382	74.6628	13.72104781159130		
AO-13						
1 19216U	88 51 B 90233.10507939	.00000146	00000-0	99999-4 0	1444	
2 19216	56.9230 139.8507 7012370	234.0055	39.5251	2.09695679	16733	
UO-14						
1 20437U	90 5 B 90241.71324784	.00000735	00000-0	30786-3 0	2021	
2 20437	98.6918 317.5947 0010966	303.8477	56.1659	14.28695501	31365	
UO-15						
1 20438U	90 5 C 90239.08893472	.00000337	00000-0	15074-3 0	1158	
2 20438	98.6992 314.9507 0009756	311.1805	48.8550	14.28414913	30984	
AO-16						
1 20439U	90 5 O 90237.63603604	.00000506	00000-0	21667-3 0	1034	
2 20439	98.7008 313.6744 0011129	316.7523	43.2786	14.28790692	30787	
DO-17						
1 20440U	90 5 E 90234.47862021	.00000343	00000-0	15215-3 0	1104	
2 20440	98.7011 310.5391 0011466	326.8827	33.1640	14.28833851	30333	
WO-18						
1 20441U	90 5 F 90234.67340584	.00000335	00000-0	14868-3 0	1050	
2 20441	98.7007 310.7603 0012011	326.5190	33.5234	14.28927213	30366	
LO-19						
1 20442U	90 5 G 90240.47474793	.00000559	00000-0	23694-3 0	1095	
2 20442	98.7018 316.5720 0012051	308.5742	51.4364	14.29006741	31190	
FO-20						
1 20480U	90 13 B 90226.64199642	-0.00000003	00000-0	00000-0 0	1016	
2 20480	99.0365 262.1079 0540315	276.1807	77.8024	12.83158486	24240	
HUBBLE						
1 20580U	90 37 B 90235.99934326	.00006115	00000-0	00000-0 0	1870	
2 20580	28.4713 178.0831 0005875	117.1031	243.0465	14.84797747	18066	
BAOR-1						
1 20685U	90 59 A 90235.52089451	.00316680	00000-0	00000-0 0	497	
2 20685	28.4933 53.0515 0495022	176.2523	184.2844	15.07540744	5787	

NOTE: NASA has now correctly reverted to using Catalogue Number 20480 for Fuji-Oscar-20 in its 2-line format Keplerian Elements. (For the last 3 months the number 20479 has been used.)

OSCAR-13 Schedule for 1 Oct to 5 Nov 1990

Station: Adelaide

Mour - UTC

	0	1	2	3	4	5	6	7	8	9	10	11	12	13	14	15	16	17	18	19	20	21	22	23	
01oct	----	-----	-----	-----	-----	-----	-----	-----	-----	-----	-----	-----	-----	-----	-----	-----	-----	-----	-----	-----	-----	-----	-----	-----	-----
02oct	-----	-----	-----	-----	-----	-----	-----	-----	-----	-----	-----	-----	-----	-----	-----	-----	-----	-----	-----	-----	-----	-----	-----	-----	-----
03oct	-----	-----	-----	-----	-----	-----	-----	-----	-----	-----	-----	-----	-----	-----	-----	-----	-----	-----	-----	-----	-----	-----	-----	-----	-----
04oct	-----	-----	-----	-----	-----	-----	-----	-----	-----	-----	-----	-----	-----	-----	-----	-----	-----	-----	-----	-----	-----	-----	-----	-----	-----
05oct	-----	-----	-----	-----	-----	-----	-----	-----	-----	-----	-----	-----	-----	-----	-----	-----	-----	-----	-----	-----	-----	-----	-----	-----	-----
06oct	-----	-----	-----	-----	-----	-----	-----	-----	-----	-----	-----	-----	-----	-----	-----	-----	-----	-----	-----	-----	-----	-----	-----	-----	-----
07oct	-----	-----	-----	-----	-----	-----	-----	-----	-----	-----	-----	-----	-----	-----	-----	-----	-----	-----	-----	-----	-----	-----	-----	-----	-----
08oct	-----	-----	-----	-----	-----	-----	-----	-----	-----	-----	-----	-----	-----	-----	-----	-----	-----	-----	-----	-----	-----	-----	-----	-----	-----
09oct	-----	-----	-----	-----	-----	-----	-----	-----	-----	-----	-----	-----	-----	-----	-----	-----	-----	-----	-----	-----	-----	-----	-----	-----	-----
10oct	-----	-----	-----	-----	-----	-----	-----	-----	-----	-----	-----	-----	-----	-----	-----	-----	-----	-----	-----	-----	-----	-----	-----	-----	-----
11oct	-----	-----	-----	-----	-----	-----	-----	-----	-----	-----	-----	-----	-----	-----	-----	-----	-----	-----	-----	-----	-----	-----	-----	-----	-----
12oct	-----	-----	-----	-----	-----	-----	-----	-----	-----	-----	-----	-----	-----	-----	-----	-----	-----	-----	-----	-----	-----	-----	-----	-----	-----
13oct	-----	-----	-----	-----	-----	-----	-----	-----	-----	-----	-----	-----	-----	-----	-----	-----	-----	-----	-----	-----	-----	-----	-----	-----	-----
14oct	-----	-----	-----	-----	-----	-----	-----	-----	-----	-----	-----	-----	-----	-----	-----	-----	-----	-----	-----	-----	-----	-----	-----	-----	-----
15oct	-----	-----	-----	-----	-----	-----	-----	-----	-----	-----	-----	-----	-----	-----	-----	-----	-----	-----	-----	-----	-----	-----	-----	-----	-----
16oct	-----	-----	-----	-----	-----	-----	-----	-----	-----	-----	-----	-----	-----	-----	-----	-----	-----	-----	-----	-----	-----	-----	-----	-----	-----
17oct	-----	-----	-----	-----	-----	-----	-----	-----	-----	-----	-----	-----	-----	-----	-----	-----	-----	-----	-----	-----	-----	-----	-----	-----	-----
18oct	-----	-----	-----	-----	-----	-----	-----	-----	-----	-----	-----	-----	-----	-----	-----	-----	-----	-----	-----	-----	-----	-----	-----	-----	-----
19oct	-----	-----	-----	-----	-----	-----	-----	-----	-----	-----	-----	-----	-----	-----	-----	-----	-----	-----	-----	-----	-----	-----	-----	-----	-----
20oct	-----	-----	-----	-----	-----	-----	-----	-----	-----	-----	-----	-----	-----	-----	-----	-----	-----	-----	-----	-----	-----	-----	-----	-----	-----
21oct	-----	-----	-----	-----	-----	-----	-----	-----	-----	-----	-----	-----	-----	-----	-----	-----	-----	-----	-----	-----	-----	-----	-----	-----	-----
22oct	-----	-----	-----	-----	-----	-----	-----	-----	-----	-----	-----	-----	-----	-----	-----	-----	-----	-----	-----	-----	-----	-----	-----	-----	-----
23oct	-----	-----	-----	-----	-----	-----	-----	-----	-----	-----	-----	-----	-----	-----	-----	-----	-----	-----	-----	-----	-----	-----	-----	-----	-----
24oct	-----	-----	-----	-----	-----	-----	-----	-----	-----	-----	-----	-----	-----	-----	-----	-----	-----	-----	-----	-----	-----	-----	-----	-----	-----
25oct	-----	-----	-----	-----	-----	-----	-----	-----	-----	-----	-----	-----	-----	-----	-----	-----	-----	-----	-----	-----	-----	-----	-----	-----	-----
26oct	-----	-----	-----	-----	-----	-----	-----	-----	-----	-----	-----	-----	-----	-----	-----	-----	-----	-----	-----	-----	-----	-----	-----	-----	-----
27oct	-----	-----	-----	-----	-----	-----	-----	-----	-----	-----	-----	-----	-----	-----	-----	-----	-----	-----	-----	-----	-----	-----	-----	-----	-----
28oct	-----	-----	-----	-----	-----	-----	-----	-----	-----	-----	-----	-----	-----	-----	-----	-----	-----	-----	-----	-----	-----	-----	-----	-----	-----
29oct	-----	-----	-----	-----	-----	-----	-----	-----	-----	-----	-----	-----	-----	-----	-----	-----	-----	-----	-----	-----	-----	-----	-----	-----	-----
30oct	-----	-----	-----	-----	-----	-----	-----	-----	-----	-----	-----	-----	-----	-----	-----	-----	-----	-----	-----	-----	-----	-----	-----	-----	-----
31oct	-----	-----	-----	-----	-----	-----	-----	-----	-----	-----	-----	-----	-----	-----	-----	-----	-----	-----	-----	-----	-----	-----	-----	-----	-----
01Nov	-----	-----	-----	-----	-----	-----	-----	-----	-----	-----	-----	-----	-----	-----	-----	-----	-----	-----	-----	-----	-----	-----	-----	-----	-----
02Nov	-----	-----	-----	-----	-----	-----	-----	-----	-----	-----	-----	-----	-----	-----	-----	-----	-----	-----	-----	-----	-----	-----	-----	-----	-----
03Nov	-----	-----	-----	-----	-----	-----	-----	-----	-----	-----	-----	-----	-----	-----	-----	-----	-----	-----	-----	-----	-----	-----	-----	-----	-----
04Nov	-----	-----	-----	-----	-----	-----	-----	-----	-----	-----	-----	-----	-----	-----	-----	-----	-----	-----	-----	-----	-----	-----	-----	-----	-----
05Nov	-----	-----	-----	-----	-----	-----	-----	-----	-----	-----	-----	-----	-----	-----	-----	-----	-----	-----	-----	-----	-----	-----	-----	-----	-----

AO-13 Schedule 17Oct90 to 26Dec90

Mode-B	: MA 000 to MA 095
Mode-JL	: MA 095 to MA 125
Mode-LS	: MA 125 to MA 130
Mode-S	: MA 130 to MA 135
Mode-BS	: MA 135 to MA 140
Mode-B	: MA 140 to MA 256
Omnis	: MA 220 to MA 040

carrying four instruments:

- the Ultraviolet Imaging Telescope (UIT) from NASA Goddard which will take the best-ever ultraviolet photographs of faint stars and galaxies;
- the Hopkins Ultraviolet Telescope (HUT) from Johns Hopkins Uni, which can make spectral measurements in far ultraviolet;
- the Wisconsin Ultraviolet Photo-Polarimeter Experiment (WUPPE) developed at the Uni of Wisconsin which will study the polarisation and brightness properties of interstellar dust.
- the Broad-Band X-Ray Telescope (BBXRT) from NASA Goddard which will study the X-ray spectra of strange objects observed by earlier satellites.

The UIT, HUT and WUPPE instruments share a common telescope mount, so their observations will be collected in the same regions of the sky. BBXRT operates independently of the other three experiments.

The seven-man crew of STS-35 is:

Commander: Vance Brand

Pilot: Guy Gardner

Mission Specialists: Jeff Hoffman, Mike Lounge and Bob Parker

Payload Specialists: Ron Parise and Sam Durrance

WEBERWARE 1.0 Operating Hint

(From AMSAT News Service Bulletin 244.05, 1 September 1990)

WEBERWARE 1.0 Picture Processing S/W Operating Hint

Chris Williams WA3PSD of Weber State University (WSU) has provided the following operating hint to the AMSAT News Service (ANS) concerning the use of WEBERWARE-OSCAR-18 (WO-18) picture processing software, WEBERWARE 1.0.

WW1.0 expects captured data files to begin with complete packets, not in the middle of a packet. Specifically, the file must begin with the packet delimiter CO hex and appropriate packet header bytes. o ensure that this is the case, file capture (or "dump" in TLMDC) must be active before any packets are received from the TNC during a pass.

WA3PSD points out that it is standard

SATELLITE ACTIVITY FOR MAY/JUNE 1990

1. Launches

The following launching announcements have been received:

Int'l No	Satellite	Date	Nation	Period min	Apog km	Prg km	Inc deg
1990-							
047A	RESURS-F6	May 29	USSR	88.7	260	190	82.3
048A	KRISTALL	May 31	USSR	89.9	346	220	51.6
049A	ROSAT	Jun 01	USA	96.1	588	567	52.9
050A	USA 59A	Jun 08	USA				
051A	INSAT 1D	Jun 12	USA	1140.0	35974	35767	0.2
052A	MOLNIYA 3-38	Jun 13	USSR	738.0	40839	492	62.8
053A	COSMOS 2038	Jun 19	USSR	88.7	262	192	82.6
054B	GORIZONT 20	Jun 20	USSR	1436.0	35877		1.4
055A	COSMOS 2084	Jun 21	USSR	98.2	746	590	62.8
056A	INTELSAT	Jun 12	USA				

2. Returns

During the period 35 objects decayed including the following satellites:

1983-027A	COSMOS 1450	May 30
1989-088A	COSMOS 2049	Jun 19
1990-041A	PROGRESS 42	May 27
1990-047A	RESURS-F	Jun 14

3. Notes

1990-048A KRISTALL docked with the space station MIR on 10 June. On board were a number of instruments and materials for scientific research.

1990-049A ROSAT carried Roentgen, a West German/US X-ray satellite.

1990-051A INSAT 1D is an Indian communications satellite.

1990-054A GORIZONT 20, a communications satellite, carried a MAYAK transmitter developed jointly by Bulgaria, Hungary, the GDR, the Soviet Union and the CSFR.

BOB ARNOLD, VK3ZBB

procedure at Weber State to begin capture (or dump) mode before passes start so WW1.0 does not have a feature allowing the input file to start with a partial packet.

Of course, to successfully capture the binary WEBERSAT (or other binary Microsat data), your TNC must be in KISS mode and the PC program must handle binary data correctly. Since most commercial PC terminal programs do not handle binary data correctly, even in binary modes (ie characters such as OO hex, FF hex, etc are not passed correctly or at all), most data gatherers are using TLMDC, a program available from AMSAT, Compuserve and other AMSAT software sources.

To place a TNC-2 compatible TNC into KISS mode, it is necessary to issue the command: "KISS ON" and then to re-boot either with the "RESTART" command or by powering off and back on. This can be verified by the front panel lights. When KISS is started or when the TNC is powered up in KISS mode, the lights on the front flash three times. Otherwise, they flash once.

The recommended procedure is to:

- Verify that the TNC is in KISS mode.
- Run a program that will properly collect the binary data (such as TLMDC).
- Begin capture (or dump) before the pass starts so that only complete packets are recorded in the file.

73S FROM MAURIE VK5EA AR

ANTENNAS & ACCESSORIES

We manufacture a comprehensive range of HF, VHF and UHF antennas, baluns, power dividers etc to suit your application. Three of our log periodics provide continuous coverage from 1.3-30 MHz including WARC frequencies, and replace outdated tri-banders. Now in use in 24 overseas countries and 6 continents.

- CREATE ROTATORS, COAX CABLES & NON-CONDUCTING GUY HALYARD MATERIALS
- COMPLETE RANGE MIRAGE (USA) 5-YR WARRANTY 6M, 2M, 70CM AMPS & WATT SWR METERS
- HARD-DRAWN ANTENNA WIRE
- AUST/NZ DISTRIBUTOR FOR CREATE ANTENNAS/ROTATORS & PHYLSTRAN (KEVLAR) NON-CONDUCTING GUYING

- MATERIALS
- HIGH GAIN VHF & UHF AMATEUR, SCANNING & TV ANTENNAS
- BUTT SECTION TRIANGULAR ALUMIN IUM TOWERS FOR FIXED OR TILT-OVER APPLICATIONS (REFER MARCH/APRIL 1987 AR)
- SELECTION OF POWER CHIPS AT FRIENDLY PRICES
- VSWR/PWR METERS TO 1300MHz

Write or phone for free catalogue

ATN ANTENNAS

56 Campbell Street
Birchip Vic 3483
Phone: (054) 92 2224
Fax: (054) 92 2666

INTRUDER WATCH

GORDON LOVEDAY VK4KAL
FEDERAL INTRUDER WATCH CO-ORDINATOR
'AVIEMORE' RUBYVALE 4702

Some disturbing news from Britain appeared in the 'Times' newspaper recently. Plans for increasing by 40 per cent the number of in-flight telephones in the 1-8MHz frequency. Much lobbying is expected until 1992 WARC.

We should be aware of this in Australia also. European carriers are also planning an aero telephone service described as the last

"untapped market" for telecommunications. At the moment they are being denied freq spectrum (hooray). But, be warned — our carriers could have similar ideas, so get behind the WIA and our WARC reps with donations. This summer (UK) British Air will bring the trans-Atlantic in-flight telephone service — "Skyphone" — into commercial service. While this is satellite, a planned terres-

trial flight 'phone service based on CT2 technology is planned — each plane will be fitted with an aerial, PABX exchange, modem and transmitter/receiver to convey signals to the ground . . . no mention of frequency, but take heed, this warning **must not be ignored by all amateurs.**

Each month we see a new batch of coded messages. How do we deal with these fictitious(?) callsigns(?) Take heart, we still have a lot of intruders we can help remove, given the number of observers and the information input we require to pass on to DoTC to give it a fair chance of success. ar

SPOTLIGHT ON SWLING

ROBIN L HARWOOD VK7RH
52 CONNAUGHT CRES WEST LAUNCESTON 7250

I have been busily spending the past month monitoring on shortwave the current mid-eastern crisis over Kuwait. As I reported last month, Radio Kuwait continued to broadcast on HF after the Iraqis invaded that small Persian Gulf emirate. We now know there were several desert sites some distance from Kuwait City. Although the Iraqis had seized the studio complex, the Kuwaitis still had control of the HF transmitters for 28 hours after the invasion. They continued to broadcast defiantly with anti-Iraqi messages, calling on the population to resist the invaders, until it was silenced at 1112 UTC on Friday 2 August. It's not clear whether they destroyed it, or the invaders had captured the extensive facility. Indications so far are that the complex may have been destroyed, as the Iraqis have not utilised it for their propaganda output. They have continued to use Iraqi sites.

In the days following the invasion, the crisis deepened significantly. When the US, along with other nations, rapidly despatched troops to Saudi Arabia at the request of its monarch, the Iraqis retaliated swiftly by taking hostages from those countries which sent armed forces to the region.

The only way to broadcast messages to those trapped foreigners in the region was via

shortwave. The major international stations rapidly scheduled extra transmissions to the Gulf area to cater for the demand. Even our own Radio Australia started targeting the Middle East with a special two-hour daily transmission. It is currently on from 1300 till 1500 UTC on 17630 and 21775 kHz. This is likely to continue now we have a naval presence in the region.

As many HF monitors are aware, the Iraqis have been extensively jamming several international broadcasters over the past 10 years, particularly during the Iran-Iraq War. Since the current crisis erupted, the notorious 'bubble' jammer can be easily heard on top of or under many Arabic language broadcasts. Nearby channels have also been affected by it. Those who have been targeted, especially the BBC and VOA, have swiftly added extra channels and extended the duration of their programming. Radio Netherlands and Radio Japan have added Arabic to their schedules, whilst others increased their mid-east output.

At press time, Radio Baghdad is being heard in English from 2000 till 2155 UTC on the single channel of 13660 kHz. I have heard reports of a transmission in English from 0130 to 0330 on 11755 kHz, but I cannot

personally confirm this.

The British Forces Broadcasting Service has been given transmission time over BBC sends three times daily to broadcast cheerios to British forces and trapped expatriates in the Gulf. They are currently broadcasting from 0200 till 0230 on 13745 and from 0930 to 1000 on 15205, 17695 and 21735 KHz (The last channel is, unfortunately, also used by United Arab Emirates Radio in Dubai and negates the BFBS signals). They also are on from 1330 till 1400 on 15195, 17695 and 21505 kHz.

There has been increasing speculation whether we could see the reintroduction of the United States Armed Forces Radio Service on shortwave, specifically to cater for the huge American forces within the region. They do have a satellite feeder from LA, which is downlinked to the Gulf. However, I expect that the SW service could be reintroduced, in the short term, as there are no AFRTS stations yet on line within Saudi Arabia.

The other major development is that Germany will now become one nation on the third of this month at 2300 UTC. The economic collapse of the German Democratic Republic hastened the reunification process before the first all-German elections on 3 December. No word yet on the future alterations of international broadcasting from a united Germany. It will probably not emerge until after the elections.

Well, that is all for October. Until next time, the best of 73 and good listening. ar

FTAC NEWS

JOHN MARTIN VK3ZJC
FTAC CHAIRMAN

Murphy

In last month's issue, the callsign of the station worked by Moss VK7IK for a new VK7 six-metre record should have read W4EQM.

New Zealand News

New Zealand amateurs have lost the fight for 2300-2396 MHz, which has been divided

into twelve 8MHz wide TV channels for sale by tender. The move of ZL two-metre beacons to 144.250-144.300 MHz has not yet been implemented. On six metres, ZL amateurs may operate in the 50.0-51.3MHz range outside TV transmission hours, and may apply for certification to operate during TV hours. Repeater outputs and other transmitters will also be permitted on 53-54 MHz.

New Six-Metre Repeaters

The following channels have been reserved for proposed new six-metre repeaters: Sydney (Manly-Warringah) .550, Tamworth .575, Jervis Bay .575, Mackay .775.

Proposed Revised Band Plans for 2.3-10 GHz

The revised band plans are finally ready for comment and are included in this issue.

The present interim plans for these bands were derived from the Region 1 plans, and it is time to adopt new plans based directly on

actual operating practice in this country. The new plans also conform to international practice, with narrow band segments at multiples of 1152 MHz. However, IARU Regions I and II are proposing narrow band segments adjacent to the satellite bands, and these plans make provision to conform to those new sub-bands in the future.

The plans also include segments for narrow band simplex and duplex FM. FTAC does not recommend repeaters as such on these bands, however they are ideal for repeater links. Other modes are also catered for: there are segments for simplex and duplex data channels, which would also include high speed data forwarding links. A series of wideband "channels" is also provided, for modes such as FM ATV.

Planning for the 2.3GHz band is constrained by the need to avoid interference to MDS channels, which are located at 7MHz intervals from 2302 to 2400 MHz. The channels from 2344 MHz up are in current use and the plan allots only wideband modes above this frequency. The only exception to this rule is a "window" for the Region 1 EME band at 2390-2392 MHz, and provision for the possible new weak signal segment in the 2392-2400MHz region.

The 3.3GHz band is difficult to plan due to the possibility of interference to a number of other services, therefore the proposed plan contains a fair amount of open space.

On 5.7 and 10 GHz, there are few planning constraints and a wide variety of activities can be accommodated. The plans could take many forms, but the proposal presented here is very flexible. On both bands, narrow band segments are allotted on the current frequencies of 5760 and 10368 MHz. FM voice and data simplex segments are also provided, and there are also FM repeater link segments (separation is 80 MHz on 5.7 GHz and 150 MHz on 10 GHz).

Wideband operation is catered for on these bands with a series of 30MHz wide "channels". The four "channels" on 5.7 GHz are allotted two each to ATV and wideband data. On 10 GHz, there are eight "channels" for wideband FM, data or ATV. These "channels" can be paired up for duplex operation with 30, 60, 90, 120 or 150MHz separation, and even allow for four 60MHz wide channels at 10180, 10270, 10330 and 10420 MHz.

Some months of preparation has gone into these plans, and I would particularly like to thank Lyle Patison VK2ALU for making detailed comments and going to a great deal of trouble to collect information on overseas operating habits.

It is hoped to present these plans for adoption by Federal Council early next year, with any changes as a result of feedback from microwave operators. If you have any comments, please write.

Proposed Revised 13cm Band Plan

2300.000-2303.900	GENERAL USE, all modes
2303.900-2305.000	NARROW BAND MODES
2303.900-2304.050	DX only: EME
2304.050-2304.100	DX only: Terrestrial
2304.050	CW calling frequency
2304.075	RTTY (FSK) calling frequency
2304.100-1296.400	General Phone/CW
2304.100	Calling frequency (primary national)
2304.200	Calling frequency (secondary national)
2304.400-2304.500	Beacons: primary segment
2304.500-2304.600	Beacons: secondary segment
2304.600-2305.000	GENERAL USE, all modes
2305.000-2306.000	FM SIMPLEX — voice(25kHz channeling)
2306.000-2307.000	FM SIMPLEX — ditigal (25kHz channeling)
2307.000-2309.000	FM REPEATER LINK OUTPUTS (35MHz offset)
2309.000-2314.000	WIDEBAND MODES
2309.000-2314.000	Data: duplex (35MHz offset)
2314.000-2342.000	FM ATV Channel 1; 2328 +/- 14 MHz
2342.000-2344.000	FM REPEATER LINK INPUTS (35MHz offset)
2344.000-2386.000	WIDEBAND MODES
2344.000-2349.000	Data: duplex (35MHz offset)
2349.000-2358.000	Data: simplex
2358.000-2386.000	FM ATV Channel 2: 2372 +/- 14 MHz)
2386.000-2400.000	GENERAL USE, all modes
2390.000-2392.000	Region 1 EME window
2392.000-2400.000	Narrow band modes: segment to be adopted consistent with proposed Region 1/2 NB segment.
2400.000-2450.000	AMATEUR SATELLITES (downlinks)

Proposed Revised 13cm Band

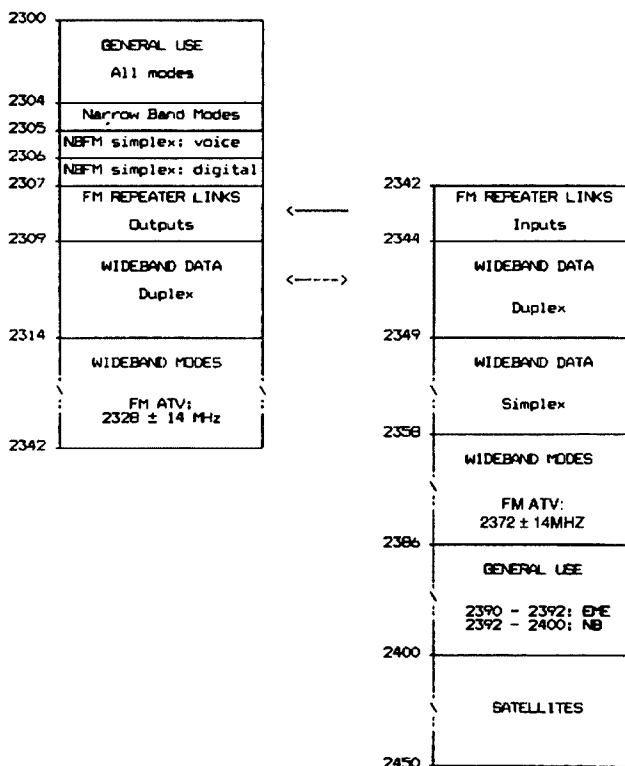

Proposed Revised 9cm Band Plan

3300.000-3446.000	GENERAL USE, all modes
3446.000-3455.900	FM LINKS — wideband voice and data
3455.900-3457.000	NARROW BAND MODES
3455.900-3456.100	EME
3456.100-3456.400	Terrestrial
3456.100	Calling frequency (all mode primary)
3456.200	Calling frequency (all mode secondary)
3456.400-3456.500	Beacons: primary segment
3456.500-3456.600	Beacons: secondary segment
3456.600-3457.000	GENERAL USE, all modes
3457.000-3458.000	FM SIMPLEX — voice (25kHz channeling)
3458.000-3459.000	FM SIMPLEX — digital (25kHz channeling)
3459.000-3462.000	FM LINKS — narrow band voice and data
3462.000-3600.000	GENERAL USE, all modes

Proposed Revised 6cm Band Plan

5650-5670	AMATEUR SATELLITES (uplinks)
5670-5760	WIDEBAND MODES
5670-5680	FM duplex (80MHz separation) (Possible future NB segment in the 5670MHz region to conform to Region 1 proposal)
5680-5685	FM simplex
5685-5690	FM REPEATER LINK INPUTS (80MHz separation)
5690-5760	WIDEBAND MODES
5690-5720	FM ATV Channel 1: 5705 +/- 15 MHz
5720-5750	Duplex data links (80MHz separation)
5750-5760	FM duplex (80MHz separation)
5759.900-5761.000	NARROW BAND MODES
5759.900-5760.100	EME
5760.100-5760.400	Terrestrial
5760.100	Calling frequency (all mode primary)
5760.200	Calling frequency (all mode secondary)
5760.400-5760.500	Beacons: primary segment
5760.500-5760.600	Beacons: secondary segment
5760.600-5761.000	GENERAL USE, all modes

5761-5763	FM SIMPLEX — narrow band voice
5763-5765	FM SIMPLEX — narrow band digital
5765-5770	FM REPEATER LINK OUTPUTS (80MHz separation)
5770-5830	WIDEBAND MODES
5770-5800	FM ATV Channel 2 5785±15MHz
5800-5830	Duplex data links (80MHz separation)
5830-5850	AMATEUR SATELLITES (downlinks)

Proposed Revised 3cm Band Plan

10000-10050	ALL MODES
10050-10150	WIDEBAND FM
10100	Centre frequency for wideband beacons
10150-10210	WIDEBAND MODES
10150-10180	Channel 1a (10165 +/- 15 MHz)
10180-10210	Channel 2a (10195 +/- 15 MHz)
10210-10225	ALL MODES
10225-10230	NBFM REPEATER LINK INPUTS (150MHz separation)
10230-10240	WIDEBAND DATA — duplex (150MHz separation)
10240-10360	WIDEBAND MODES
10240-10270	Channel 3a (10255 +/- 15 MHz)
10270-10300	Channel 4a (10285 +/- 15 MHz)
10300-10330	Channel 1b (10315 +/- 15 MHz)
10330-10360	Channel 2b (10345 +/- 15 MHz)
10360-10368	ALL MODES
10368-10370	NARROW BAND MODES
10368.0 +/- 100 kHz	EME
10368.1-10368.4	Terrestrial
10368.1	Calling frequency (all mode primary)
10368.2	Calling frequency (all mode secondary)
10368.5 +/- 100 kHz	Beacons
10368.6-10370	GENERAL USE, all modes
10370-10372	NBFM SIMPLEX — VOICE
10372-10375	NBFM SIMPLEX — DIGITAL
10375-10380	NBFM REPEATER LINK OUTPUTS (150MHz separation)
10380-10390	WIDEBAND DATA — duplex (150MHz separation)
10390-10450	WIDEBAND MODES
10390-10420	Channel 3b (10405 +/- 15 MHz)
10420-10450	Channel 4b (10435 +/- 15 MHz)
10450-10500	AMATEUR SATELLITES

Proposed Revised 6cm Band Plan

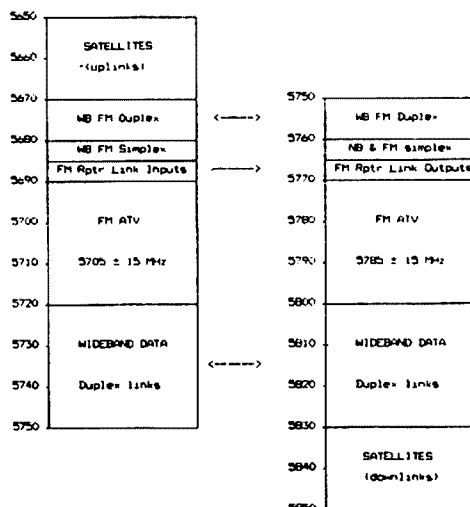

AMATEUR RADIO
HELPING OUR
COMMUNITY.

Proposed Revised 3cm Band Plan

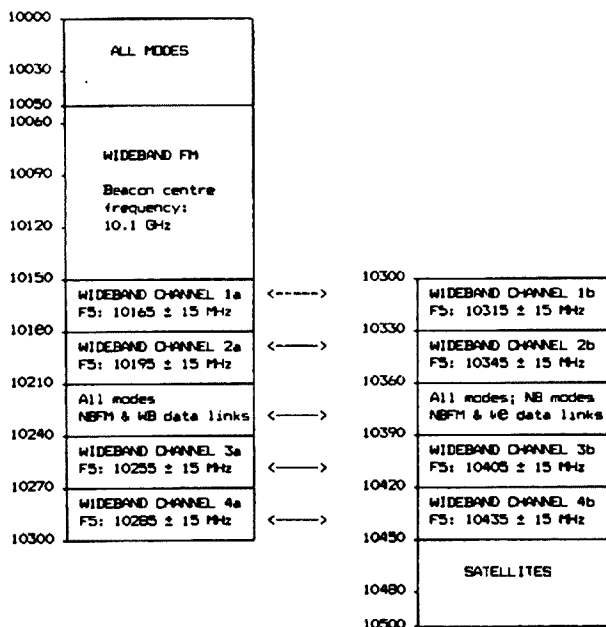

Stolen Equipment

Stolen from Ken Hanby VK4IS, 17 Kig Heights, 14 Queen St, Caloundra, on 27 July from Hooper Education Centre, Wavell Heights: **Kenwood TM231A, Ser 0051016 and TM441A, Ser 6010370**, and, on 15 August from same address: **Ex-CFA Philips 10-channel, Ser 44982, GME 40-channel AM TX830 Electrophone, Ser 8770556**. Contact owner or nearest police station.

Education Notes

To conserve space for this special antenna issue, Brenda Edmonds VK3KT has graciously consented to defer her regular column until November. Thanks Brenda.

RANDOM RADIATORS

RON FISHER VK3OM AND RON COOK VK3AFW

A Wire Signal Squirter for VHF

This is a contribution from Andrew Russell VK5ZUG, who writes as follows (some minor editing has been done).

"The use of long wire antennas at VHF and UHF seems obvious in retrospect as it is easy to make them many wavelengths long. Although not offering the steerability of a beam, a rolled-up loop of copper or aluminium wire takes up little space. It is possible then to get a reasonable antenna into a small Japanese car along with the XYL, rig, feedline, food, luggage, etc when setting off to the seaside for a holiday.

I used a length of wire cut to 10 half waves long on 2m (10m approx) fed via 1/4 wavelength stub (52cm approx) to match a 50Ohm line. (Ref Fig 1) The feed point XX was adjusted for the best VSWR, starting 1/3 of the way from the shorted end. The length of the

wire can be adjusted to give an improved match. An SWR of 1.2 to 1.5:1 should be easily obtained.

This antenna has gain along the axis of the wire in both directions, with the main lobes getting closer to the wire axis as the wire length is increased. Low-angle radiation can be obtained by sloping the antenna in the direction of interest. Terminating the antenna and using a balanced feed have not been tried, as the increase in performance did not seem worthwhile.

Over the path from Victor Harbour to Mt Gambier and SW Victoria it seemed to work as well as a five-element Yagi used on previous occasions. I hope to make some direct comparisons with a three-element quad in future.

This wire antenna can be readily assembled from available materials for use in field days or in emergency situations."

An interesting antenna, Andrew, which,

when installed horizontally 3m or more above the ground, should work very well indeed. Terminating it might be difficult in the absence of a good metallic ground plane. Thank you for the contribution; please let us know about your quad tests.

More Success with a Windom

Lee VK6HC has written to describe his success with a Windom using 136 feet overall and tapped at 44.4 feet or 32.6 per cent. Why is the Carolina Windom tapped at 38 per cent, he asks? There are several reasons. The best tapping point varies with height above ground and the ground conductivity. Both these variables change the impedance at a current maximum quite considerably so a five per cent variation in tapping point is not too surprising. Further, if the antenna is cut for resonance at a different frequency from that at which matching is done, there will be a variation in the position of the tap for lowest VSWR. Another area for the experimenter to invest some time!

A Failure with a Trapped Dipole

Another VK3 has written in saying that he tried the 18/24MHz trap antenna described in January AR, but the VSWR was about 5:1 in the amateur bands and reached a minimum value well outside the band limits. The antenna was only 3m above the ground and we think this was too low. Further, as indicated earlier, the impedance of an antenna depends on its height above ground, major variations taking place at heights of less than a wavelength. This design of antenna relies on a

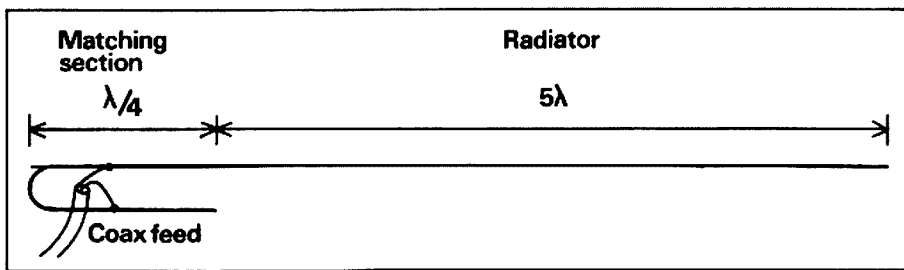

Figure 1 Sketch of a long wire for two metres. The length of the radiator should be a multiple of a half-wavelength

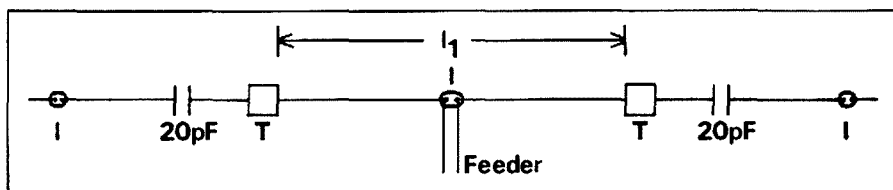

Figure 2 Trap dipole for 18/24 MHz, T= LC trap tuned for 24.9 MHz, 15.510m (18'-1") for 24.9 MHz. I = insulator

particular impedance being achieved and so some adjustment of both the inner dipole and the outer legs will be required in many cases before an acceptable VSWR is obtained. Even when the antenna is at a considerable height some adjustment might be required. Intending constructors should obtain a copy of the original article. The author used a height of nine metres in his design.

Some Success with a Trapped Dipole

The same writer built a trap dipole for 18/24 MHz along conventional lines some time back, but found that the tails for resonance at 18 MHz were very short so he inserted about 20 pF in series at four inches (10 cm) past the trap. The tails were then about four feet (1.2 m) long for resonance at 18 MHz. Note that these values are approximate, as the writer was relying on memory when describing the antenna. Ref Fig 2.

Fig 3 shows details of a trap dipole for 18/24 MHz which apparently doesn't require any such modification (W6SAI, Ham Radio Feb 1989).

More on Simple Multi-Band Wire Antennas

The last RR column dealt with the extended double zeppl and made reference to the famous G5RV. During the last NFD, one Ron used a 20m (66ft) dipole centre-fed with about 13.8 m (45 ft) of ladder line. In conjunction with a Z-match, this worked very well on all five pre-WARC bands. Whilst being shorter and thus easier to fit into a suburban backyard, its performance is comparable with the two-wire dipoles described last time.

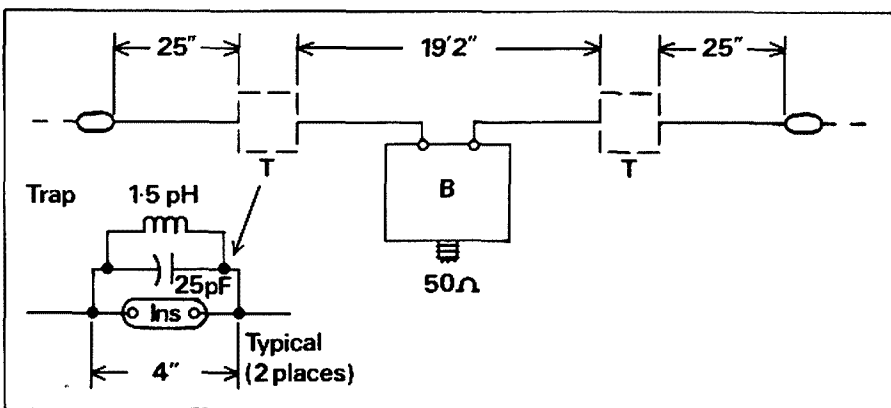

Figure 3 Trap antenna for 18/24 MHz. Trap is mounted across ceramic insulator. Coil consists of 12-3/4 turns, no 20, 5/8 inch diameter, 16 turns/inch. (Barker and Williamson 3007.)

It has frequently been stated that if the feeder and one half of the dipole has a total electrical length of 26 m (85 ft) then a relatively low VSWR occurs on these bands. (See RSGB Handbook and page 157 "HF Antennas For All Locations", L A Moxon). The length comes fairly close to an integer multiple of 22 feet which, as stated in the last instalment RR should be avoided; nevertheless, it is still a reasonable compromise. An ATU is still required for modern transceivers, and one of the popular commercial units with a balun may be used without much risk of the balun giving problems.

Of course, if a balanced tuner such as the Z-match is used, then all bands may be enjoyed and the combined length of the flat top and the feeder are less important. Several dB gain is obtained on frequencies of 14 MHz and above. It is a suitable antenna for city lots and works well in both inverted vee and horizontal configurations. (Note that the other Ron prefers to have the flat top twice as long, but then he has a bit more real estate for such things). The disadvantage of this antenna system compared to multiple dipoles in parallel or a trapped dipole is the appearance of notches in the radiation pattern at the higher frequencies. The advantages are its simplicity and useful gain in particular directions.

Low Cost Weatherproof Gamma Match Capacitor

John Gazard VK5JG writes on his experience with an inexpensive weatherproof capacitor for use in a gamma match.

"The "Gamma Match" is a very good device for matching a 50ohm cable into a Yagi or quad beam antenna. It, however, has one disadvantage in that it needs a variable ca-

pacitor which is adjusted during the initial tuning and then left exposed to the weather. The capacitor can be enclosed in a box, but this is not an easy operation and, in many cases, moisture eventually gets into the box.

This problem can be overcome if a weatherproof fixed capacitor of exactly the required value replaces the variable capacitor. This can be done as follows.

When the gamma match is first installed it is fitted with a variable capacitor that can be easily detached. The match is tuned up by adjusting the gamma bar length and tuning the capacitor until the minimum VSWR is achieved. The capacitor is then removed and measured on a bridge. The capacitance of a piece of double-sided printed circuit board of known area is measured and its capacitance per square centimetre calculated. The required area to obtain the same value as the variable capacitor is then calculated and a piece of board cut slightly oversize. It is then trimmed to the exact capacitance while measuring on the bridge.

Leads are then soldered to the new capacitor and the edges sealed with Araldite. The new capacitor is ready for installation on the match.

A capacitor, made as described, was fitted to a 28MHz quad. It had a capacitance of 31 pF and was 40 mm by 30 mm in size."

Thanks for writing in about this idea, John. The same approach has been used by other amateurs for constructing the capacitor in traps.

Optimum Yagi Design

The designs of DL6WU have been widely accepted as giving optimum or very close to optimum designs for Yagi antennas using seven or more elements. David VK3AUU has devised a formula for designing these Yagis, avoiding the tedious procedure of using the charts given in the original DL6WU articles. (See AR Feb 1988) The 6m band has produced some incredible DX, although much of the time it appears dead. Nothing improves a band like a good antenna, so we include details of several Yagi antennas with a design frequency of 50.1 MHz. (See Table 1) Because the element length depends on element diameter, we have given data for a range of diameters. For other diameters, the lengths

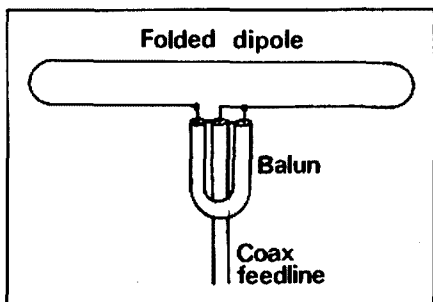

Figure 4 Matching system for DL6WU Yagi. The length of the dipole is given in table 1. It is suggested that the elements be spaced 75 mm apart. The Balun is made of an electrical half-wave, (about 1976 mm long typically at 50.1 MHz)

can be obtained by interpolation or by using David's formula.

Whilst other designs such as log periodics may sport as many elements and offer a wide bandwidth, many exhibit no more than 6dBd gain (6 dB over a dipole). The design here gives about 11 dBd with a useful bandwidth. If the elements pass through a metal boom then they should be lengthened by two-thirds of the boom diameter. Fig 4 shows details of a matching system. While it is possible to remove up to three directors and still get close to 9dBd gain, the matching may suffer and some adjustment in the spacing of the first director is likely to be required.

Well, that's it for this time. Let's hear about your ideas, successes, and even your failures and problems.

73 from me and 73 from him

The two Rons

ar

Table 1 50.1MHz Yagi Design

Both incremental and progressive spacing dimensions are given. The element lengths are for constant diameter tubing.

Element	Spacing		Length			
	inc	prog	6mm dia	9mm dia	12mm dia	16mm dia
Reflector	0	0	3002	2980	2964	2949
Radiator	1436	1436	2920	2880	2851	2823
Dir 1	449	1885	2774	2741	2716	2689
Dir 2	1077	2962	2753	2718	2692	2664
Dir 3	1287	4249	2733	2697	2669	2640
Dir 4	1496	5745	2715	2677	2649	2618
Dir 5	1675	7420	2698	2659	2630	2598
Dir 6	1795	9215	2682	2642	2612	2580
Dir 7	1884	11099	2667	2627	2596	2562

ALARA

JOY COLLIS VK2EBX
PO Box 22 YEOVAL 2868

ALARA Contest — Some Changes

Saturday, 10 November is the date of the 1990 ALARA Contest. (Rules August 'Amateur Radio').

Two important changes to previous contests should be noted:

Suggested frequencies for easier location of contacts have been changed to bring them more into line with international contest frequencies. These changes should make it easier for DX participants to locate us.

CW Scoring: To encourage novice operators, CW points are now doubled only if at least one operator is Novice class. Other CW contacts are counted at the normal points scoring rate. Two contacts with the same station on each frequency band will still count, being one contact phone and one CW. A maximum of 10 contacts with any one station.

This is not a "YLs only" contest, and we would like to stress that all licensed operators and SWLs are invited to participate. The more the merrier!

VK3 Birthday Luncheon

We had a lovely time at Raedie's, celebrating ALARA's 15th birthday — complete with cake provided by Jean Shaw. It was lovely to meet recently joined members Jenny VK3MDR, Erika VK3AEB and Robyn VK3ENX. Raedie's OM Ray was suffering from "dishwater" hands by the time we left, so I told him he could have the next day "off" to recuperate. Marlene VK3WQ (used to be VK3FML) sent a card of congratulations from Hervey Bay in VK4. We had 13 YLs and 4 OMs there; we swapped presents and thoroughly enjoyed ourselves, and yes, we did do a bit of conversing, hi!. (Bron VK3DYF).

Gaijahs Again!

Apparently the problem of galahs (the feathered variety) causing chaos in aerial systems is fairly widespread in country areas (August 'AR'). I suppose we should not entirely blame the galahs, as they are not the only birds that put us off the air by vandalising our aerials, but it would seem to me they are the commonest offenders.

One operator was kind enough to ring me and suggest fishing line around the edge of the aerial as a deterrent. The birds don't like getting their feet caught in it. (Who would?) This does seem an interesting solution if raising and lowering aerials is not too much of a

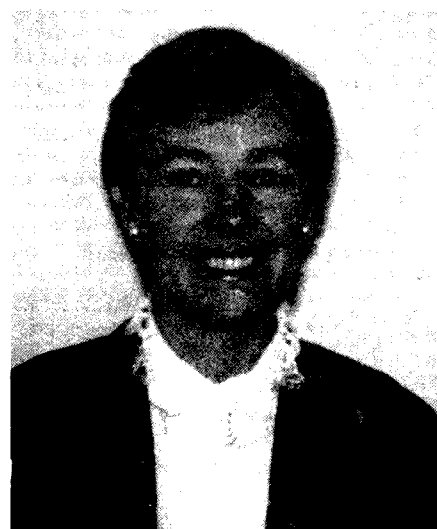

Robyn Gladwin VK3ENX



Elwyn Bell VK2DLT



Mary Dawkins VK5NMD

problem. City dwellers don't know what they miss!

The OM at this QTH rather unkindly suggested that, having thought the thing through, a speaker at the top of the aerial tower would solve the problem once and for all. When the birds heard the YLs talking, it would be enough to scare any self-respecting galah away for good (his words, definitely not mine) and would be so much less expensive than his previous idea.

Here and There

JOTA will once again be held on 20-21 October. Anyone who can assist with this project should contact their local scout or guide organisations, or state co-ordinator.

Joan VK3BJB is once more in the news, an article about her being printed in the 'Melbourne Herald' in July. She was subsequently interviewed on Peter Ackfield's afternoon radio

show (Melbourne ABC). Joan's knowledge of Japanese has proved invaluable on many occasions, and she continues to be very active on Japanese maritime mobile nets.

Mavis VK3KS and Ivor VK3XB must hold something of a record for participating in the RD Contest — they have missed only one year in the past 41.

VK5AIM Steve and XYL Sue (an ALARA member) are very proud of their new grandson.

Dan and I were also pleased to welcome number four granddaughter, Stephanie Anne, in mid-August.

Internationally known net-controller Mary KB6CLL has been on the sick list. Hopefully she will, by this time, be in better health.

Congratulations to Robyn VK3ENX on her accreditation as an examiner.

Silent Keys

We were shocked and saddened to hear

that Richard G4DZI (husband of Diana G4EZI) and Reg VE7BIY (husband of Elizabeth VE7YL) had become silent keys. We were also saddened by the death of Margaret VK6QM.

Margaret, Diana and Elizabeth have been ALARA members for many years.

Our sincere sympathy to Diana, Elizabeth and her family, and the family of Margaret VK6QM.

New Members

A warm welcome to the following members: Mary Dawkins VK5NMD, Marion Leiba VK1BNG, DX member Lynn Manalo DU1AUJ.

Congratulations to Marlene VK3WQ (ex-VK3FML) on the upgrade.

Correction to membership (Sept 'AR'). Elwyn is VK2DLT, not VK3DLT.

**73/33 UNTIL NEXT MONTH
JOY ar**

DIVISIONAL NOTES

VK2 NOTES

TIM MILLS VK2ZTM

VK2 QSL Bureau

All members should be aware that earlier this year the Bureau computer expired after lightning spikes were introduced into the local power mains with the most unhappy results. This threw the system, and they had to start from scratch in replacing the data into a new system. This has delayed the delivery of some cards where there was no written backup of instructions. It would be a good idea for all members, unless you did so recently, to advise again just how you would like to receive your incoming cards. Enclose a note with your next outward batch, write the Bureau at PO Box 73, Teralba NSW 2284, tell the Parramatta office or fill out one of the Bureau delivery sheets which can be obtained from either Parramatta or the Bureau.

Advise again your delivery method: Like Parramatta collect, club collect, posted at certain intervals or I do not collect cards. Further information will be given on the VK2WI broadcasts and there will be a further reminder in later notes. Besides, it is a good time to update your request with the Bureau.

Trash & Treasure

The October long weekend falls on the scheduled date so the next T & T will be on Sunday afternoon 7 October in the car park at Parramatta. The last for the year will be on 25 November.

Gosford Field Day

The Field Day Committee has advised that the 1991 event will be as usual at the Gosford

Showground on Sunday 17 February, so mark up the calendar now. It is understood that Wagga will not be holding an event this year. (It has been held in November in recent years).

Regional Meetings

Alterations to the Articles of Association were made at the last AGM to change the Conference of Clubs into regional groups. The weekend of 3/4 November has been set aside for the first of these gatherings. Details were posted to clubs early in September, so check out the new procedures at your next meeting.

New Members

During August, membership applications were received from the following, to whom we extend a warm welcome.

M G Bieniek	Assoc	Blastrand
R C Bowden	VK2AX	Spit Junction
J M Burkitt	Assoc	Glenhaven
W M Cowie	VK2XKG	Frenchs Forest
F J Davis	VK2KMS	Raymond Terrace
T M Fong	VK2WAA	Belmore
B S Griffin	Assoc	Lane Cove
I J C Kent	Assoc	Banora Point West
G K T Kwok	VK2GKT	Homebush West
M Lannoy	Assoc	Kenthurst
L F Miller	VK2XTA	Wamberal
D J Rosemergy	Assoc	Granville
T J Rumble	Assoc	Coogee
A D Sheedy	Assoc	Oakville
P Wilson	Assoc	Goulburn

**Help Protect Our
Frequencies —
Become an
Intruder Watcher Today!**

VK3 NOTES

JIM LINTON VK3PC

TVI Filter Kit

WIA Victoria has become aware that an ever increasing number of its members are experiencing TVI problems. A new membership service has been set up to try to help members in combating this problem. A number of specially made to order filters which can be fitted in the television or VCR antenna line have been obtained. These filters are made for WIA Victoria by Genlex Pty Ltd, and the range will include a high pass filter for 3, 7, 14 and 18 MHz with a notch of 50 dB on those frequencies. Special notch filters with 65dB notch are also available for 21, 28 and 144 MHz. The filter kit will include antenna line "braid breakers".

They will be available to members on a loan basis only. Members are required to pay a deposit when borrowing the filter kit, which will be fully refundable when the filters are returned in the specified loan period. The kit can be borrowed by making arrangement through the secretary/manager, Barry Wilton VK3XV. It must be collected personally from the Divisional Office and will not be available by mail order.

Examinations Service Grows

About 140 candidates sat more than 220 examinations in August throughout Victoria and at two New South Wales venues.

The Parramatta venue in western Sydney was supervised by the WIA NSW Division, with some 35 candidates sitting 56 exams. With the introduction of WIA Victoria examinations in Sydney, there has been considerable interest from clubs in country NSW. They are considering joining the WIA Victoria examinations system by making arrange-

ments through the WIA NSW Division. It was anticipated that half a dozen regional centres in NSW could join the system by early 1991. Our examinations are also supervised in Albury by the Twin Cities Club, which is a member of the WIA Victorian Division. WIA Victoria began conducting exams last February and instantly became the largest single examiner in Australia. It conducts examinations in theory, regulations and telegraphy receiving and sending each quarter in February, May, August and November. Applications to sit the November examinations close on 31 October.

5/8 WAVE

JENNIFER WARRINGTON VK5ANW

My thanks to Ray VK5AVR for the following information on the Naracoorte ARC. Ray is their secretary (ph: (087) 62 2034) and the president is Max VK5BMO (whom, I am told, "is the leading light on the technical side of the club activities and mainstay for any repeater problems"). VK5RNC has recently been quieted after a successful working bee 'killed' the very bad noise problem they had. Max and Paul VK5BVR have evolved some theory exam papers on their computers, which they hope to have accredited shortly; they will then be able to offer all types of exams for anyone in the SE or western Victoria. New members are always welcomed at the club (and the 'subs' are only \$10. You don't have to hold a licence — the club is always pleased to help and encourage would-be amateurs. The meetings are held every fourth Friday at 8pm at the Naracoorte Primary School. The president's work phone number is (087) 62 3744.

New Publications Officer

I am pleased to announce that we have a new publications officer. He is Arthur Tanner VK5AAR whom you may remember as a former broadcast officer. You can ring Arthur on

333 0627 or continue to send mail orders via Box 1234, GPO Adelaide, 5001.

Examinations

The WIA has now held its first exams. The fees are as follows: there is no charge to all WIA members, or those who have been doing the WIA course (exams are held at the conclusion of each course). Non-members will be charged \$10 per day.

JOTA — via Satellite

This year VK5 will be joining the other states which have previously been talking to each other via Aussat. I am sure this will make communication easier when HF propagation is bad, and for the 'young ears' who are not as used to listening to sidebands as we are. I believe the satellite hook-up will be via one of our repeaters and I hope the 'regulars' will give the 'would be' amateurs a 'fair go'. Let's face it, we need all the new blood we can get.

VK6 NOTES

JOHN HOWLETT VK6ATA

Intruder Watch at September's council meeting, a report from Bob VK6BE listing dozens of pirate intruders on our bands is enough to make you feel the takeover of amateur bands by unlicensed operators using their civil rights and ignoring the rights of other users is only a few years away. Don't pretend they are not there, we have all heard them, some people even comment what is the WIA going to do about it. They are right; what, for instance, is the VK6 council doing about it? As an operator, you know the date, time, frequency and mode of the intruders, so grab the phone and ring Graham VK6RO and ask him what are we going to do about it.

Get your friends to make notes about intruders and ring Graham on 451 3561 and

give him heaps!

Hamfest '90

Hamfest "90" is on again, but in no way is it a tired re-run of last year. New ideas will make it a great day out, so don't miss this annual get-together. Bring something you have made to put in the home-brew display, see the latest gear you can't afford but would like to know about. Bring the card or cheque book for the bargains the retailers save for this event and you could go home with a smile on your face. Load the car with the stuff you bought last year and recycle it. Either sell it yourself from a low-cost car bay or at the bring-and-buy stall and leave yourself free to enjoy the day out. Buy a raffle ticket, enter the quiz, look at the displays, catch up with people you haven't seen for years, enjoy a soft drink and a snack in the NCRG cafe; relax in the pleasant surroundings. Buy books from the WIA bookstall — it stocks \$5,000 worth! What's this packet racket all about? Order some new QSL cards — what a bargain! See how the news broadcast is put together; visit the 40m relay station.

VK6ANC, choose a cake from the cake stall. Look over the WICEN caravan; find out about repeaters, repeater linking and more.

Entrance and car parking are free. The venue is once again Carine College of TAFE, Silica Rd entrance, Carine. Direction signs will be in place; a HELP service will be on channel 4 repeater. Make a note now, Sunday, 28 October, after 10.30am.

Youth AR Group

Previously known as 21 group, the group welcomes any "youthful" person to join. Their aim is to promote AR to the younger generation, keep administration to a minimum and activity at a maximum. Meetings will be every two months at 1pm on the odd months. A net is also held first Sunday in the month at 1230 UTC on Perth channel 2 and 3.580 MHz.

73 JOHN VK6ATA

QSL's FROM THE WIA COLLECTION (28)

KEN MATCHETT VK3TL HON CURATOR WIA QSL COLLECTION
PO BOX 1 SEVILLE VIC 3139

Cocos (Keeling) Is — Part 2

VK1HM

During 1953 the ZC2 prefix was discontinued, changing to VK1, but it is interesting to note that it wasn't until 1955 that the island group became an external territory of the Commonwealth of Australia. At that time the VK1 prefix was shared with Heard Island and Macquarie Island. The January 1954 edition of QST included in its ARRL Countries List

the new prefix, but it appears together with the replaced ZC2 prefix.

The VK1HM QSL shown here was for a QSO dated 1954 with 'SK' Doug Paine VK3FH. Doug's QSL collection of several thousand cards was kindly donated to the WIA collection by his widow, Pat. The sender was Chas Holman, who was employed by DCA as a staff member at the island's airstrip. Cocos Island has always played an important role in aircraft movements. During World War 2, Qantas ran a Catalina service from Perth through

Cocos to what was then Ceylon. The airstrip is sited on West Island. It was constructed in 1945 and, in 1951, the Australian Government acquired and upgraded the strip for Qantas international flights through the island (as a refuelling spot). This service operated from 1952 to 1967. Nowadays the CAA (Civil Aviation Authority), the modern update of DCA, has a staff of flight service unit personnel and radio technicians on the island. A 24-hour flight information service is maintained, CAA officers being on a two-year term transfer. The island is also a refuelling base for RAAF and some USN and RAF aircraft.

The education system on Cocos is based on the Australian pattern, teachers from the West Australian Education Department providing the staff for the schools on the island.

COCOS ISLAND

To Radio VK3FN Confirming 5000/CW 16 MC. Contact
 Date 12-7-53 Time 0843 GMT. R. 5 S. 5 T. 9

V K I H M

Tnx PSE QSL to:

CHAS. HOLMAN c/o Department of Civil Aviation
 COCOS ISLAND

EAGLE PRESS 0000

ZONE 29

VK9YC



OCEANIA HOUSE
 HOME ISLAND
 COCOS (KEELING) ISLANDS
 INDIAN OCEAN

(There is both a primary and a secondary school on West Island, and a pre-school/primary school on Home Island for Cocos-Malays.)

Philatelists have always been attracted to the stamps of Cocos Island. The subject has been dealt with by Ken and Bett McLachlan in their article "Cocos Keeling — The Forgotten Atoll" which appeared in 'Amateur Radio' in February 1982. An account of some of the operators in the early 1980s is also given. A nice aerial photograph of the islands can be seen in Ken's notes on Cocos Island that appeared also in 'Amateur Radio' in October 1986. The Cocos (Keeling) Postal Service came into being in September 1979, replacing Australia Post. However, the island group does have an individual postcode (6799), it was at this time too, that the Philatelic Bureau was established. Both services are on West Island, as is the island's only broadcasting station, VKW. This is a non-commercial station which is limited to a power of 100 Watts.

VK9YC

This more modern QSL shows the geographical position of the island group. The relative positions of West Island, South Island and Home Island can be clearly seen. The VK9 prefix for Cocos Island came into use during 1956, joining Nauru, Norfolk Island, Papua and TNG, which countries shared that prefix at the time. (Macquarie Island and Heard Island, which had used the VK9 prefix, had already changed this to VK0). In the early 1960s, one of the most popular operators with the VK9 call was Lionel VK9LA, licensed in 1948 as VK6LA. He was a DCA employee and used a home-brew transmitter with that well known receiver, the Drake 2-A. He worked 20 metres with only 30 Watts but made many contacts. Lionel was an excellent QSLer who gave many VKs their first QSO with Cocos Island.

Some DX countries had for an appreciable period been using the first letter of the call-sign suffix as a country indicator (eg VP2D = Dominica, MP4B = Bahrein). This procedure was to be applied to the five VK9 prefix-bearing countries. Thus, from July 1969, the

Cocos Island prefix became specifically VK9Y. However, the older call signs of existing licensees could be retained. The VK9YC QSL shown is dated April 1982 and is from a resident operator, Cress (G4MBF). The WIA collection contains several QSLs from Australians and others who have operated from this rare spot. The Don Miller expedition (using the call sign of VK2ADY) operated portable on the island in 1967. Bill VK6SW used VK9YV in 1974. Alex VK5CCT was portable in 1976 and then later used the call VK9CCT. Paul VK5CGR

operated as VK9CGR in 1979, and as VK9YB in 1982. Neil VK6NE was active as VK9YE in 1982, as was Steve VK3OT (as VK9YT). Readers are referred to Steve's interesting account of his 1982 joint DXpedition with Bill K1MM, entitled "Indian Ocean Odyssey", which appeared in 'Amateur Radio Action' Vol 4, No 13 (April 1982). Steve gives an account of the sort of busy schedule kept and the problems facing the DXpeditionist to island locations such as Cocos and Christmas Islands.

Morseword No 43

	1	2	3	4	5	6	7	8	9	10	
1											Across
2											1 Dredge
3											2 Squander
4											3 Cut into cubes
5											4 Residue
6											5 Hand
7											6 Beginning
8											7 Dot
9											8 Seed case
10											9 Animal
											10 Ones here
											Down
											1 Fairy
											2 True
											3 Ranked
											4 Chooks
											5 Prevalent
											6 Secondhand
											7 Immerse
											8 Step
											9 Prefer
											10 Got up

Audrey Ryan © 1990

Solution Page 56

Ann F6CYL operated as VK9YL whilst on a DXpedition in 1978 with Jim Smith who used the call VK9YS. Jim (VK9NS on Norfolk Island) gives a full account of a later DXpedition to Cocos Is in an article entitled "DXing from Cocos Keeling" appearing in 'Amateur Radio Action' Vol 10 No 4 (August 1987). A very wide range of amateur bands and modes was used, including RTTY. If the reader ever has antenna problems, the reading of this article is sure to relieve any tension. Ken Young operated from the island with VK's special call AX9KY in 1970, as did AX9NXG (in 1989) and AX9YV. Frank VK9NYG was active on 10 metres in the early 1980s, as was Mike VK2YX. So VKs have done well to put Cocos Island on the map.

Although a long way from home, island employees have a range of interests (apart from ham radio) which includes fishing (mostly in the lagoon), snorkelling, shell collecting, surfing, golf (the fairways are on each side of

the airstrip), the 'Cocos Olympics' (competition between West Island and Home Island) and "exciting" hermit crab racing. Talking to some employees who have recently returned to Australia, one is left with the distinct impression that "Life really wasn't meant to be difficult". Due to the high cost of air freight, commodities tend to be more expensive than one might expect in the absence of high import duties. The fact that no income tax is payable is an attractive proposition, but even this is to be changed after July 1991.

No passport is necessary in order to visit the islands, nor is a departure tax payable. Tourism is being encouraged and full accommodation is now (Sept 1990) available on both West and Home Islands, the latter in the historic 100-year-old home of the Clunies-Ross family. Return air fares must be paid for in advance. Interested radio amateurs can seek more information from the Cocos Island

Travel Centre in Dalkeith, WA and from the island's Liaison Office (Dept of the Arts, Sport and Environment, Tourism and Territories) in Perth.

Will You Help?

If you would like to play a part in building up the WIA QSL collection and to save something for the future, would you please send a half-dozen (more if you can spare them) QSLs which you feel would really help the collection along.

All cards are appreciated but we especially need commemorative QSLs, special event station QSL, especially assigned call QSLs (eg VK4RAN), pre-war QSLs, unusual prefixes, rare DX and pictorial QSLs of not so common countries. Could you help? Send to PO Box 1, Seville 3139 or phone (059) 64 3721 for card pick-up or consignment arrangements for larger quantities of cards. **ar**

CLUB CORNER

Ballarat Hamvention

The Ballarat Amateur Radio Group will again hold its annual hamvention on Sunday, 28 October 1990. The venue will be the Sebastopol Football Club Rooms at the Marty Busch Recreation Reserve, seven kilometres south of Ballarat on the road to Colac.

This year's event will be similar to previous successful functions, with something for everyone. Also, a lucky registration prize of \$50.00. The usual trade display has again attracted many exhibitors.

A VHF competition will be run to find out who has the best performing home brew 2m or 70cm antenna. The only rules for the antenna gain measuring competition are that the antenna boom length on both bands must not exceed two metres in length. The antenna producing the highest gain will be the winner. Gain will be measured mid-band.

Mr John Day from Stewart Electronics will give a talk on new developments in the packet radio scene; also, a fully operational Yaesu ham station will be set up by Dick Smith Electronics.

Admission for the day is \$8.00 per person; children under 16 are free. The usual BBQ lunch will be provided, along with afternoon tea. Free tea and coffee will be on tap all day.

The club members will meet at the Red Lion Hotel in Main Road, Ballarat, on Saturday 27 October for a counter tea and chat. Those wishing to attend the counter tea must advise the convenor by 24 October of the number of bookings required, as space will be limited.

Amateurs and stall holders wishing to obtain more details may contact Kevin Hughes VK3WN on (053) 35 5011 (evenings).

VK5 Old Timers' Luncheon

Will be held again this year on Tuesday, 30 October 1990 at

Marion Hotel
Marion Road, MARION

Time: Assemble approximately 12 noon for luncheon at 1pm.

We would appreciate notification of your attendance by 10 October to facilitate catering arrangements.

As last year, it will be pay as you go, with Main Course \$10.00 with tea or coffee.

Please notify George Luxon (VK5RX). Phone: 272 4025 or Ray Deane (VK5RK). Phone: 271 5401 or John Allen (VK5UL). Phone: 344 7465

For those wishing to travel from the City by STA bus, catch bus number 243 from King William Street to Stop 24.

On the same day, the ladies are having a luncheon, and wives/daughters/friends wishing to attend, please contact George Luxon as above. **ar**

SILENT KEYS

DUE TO INCREASING SPACE DEMANDS OBITUARIES MUST BE
NO LONGER THAN 200 WORDS

We regret to announce the recent passing of:

Mr A E Sheppard VK2ED,
Mr A S G Fenton VK2VM,
Mr Sydney Sim VK2AVG,
Mr J W Ballinger VK3NK,
Mr John Weir VK3KMW,
Mr F J Christophr VK4NMX,
Mr A J H Wyle VK6BW.

Born 22 June 1916 at Sorell, Tasmania, Tiny matriculated from Hobart State High School and went into his own radio sales and repair business at Sorell. Radio was always Tiny's ambition and hobby.

During war years, Tiny served his country as a radio and electronics instructor based in Melbourne.

During the peace years, Tiny qualified in several spheres as shown below, in case of possible future hard times, an unnecessary labour as his great knowledge of radio took him into the (then) PMG Department as a technician. From there he rose through the ranks to the position of Senior Supervising

Technician in charge at the studios of 7ZL/7ZR in Hobart.

During Tiny's early years he built all his own gear, from VLF to VHF and, as a perfectionist, his equipment was A1 credit to him and admired by all who saw it and QSO'd him with it.

Some of Tiny's early documentation is as follows: ICS certificate in Radio Servicing, 13/9/39; Certificate of Proficiency in Refrigeration Servicing, 16/3/44; BSOCP (#667) 11/6/45; Member of IREE, 1/9/45; AOCF (#2982) 8/9/49 and Member WIA, 1/3/66.

All who came to Tiny for advice or counsel left with a greater knowledge and understanding previously not thought possible.

Tiny is survived by Norma and three family with four grandchildren. Sadly missed by Norma and all who knew him . . . Vale, Tiny . . . CUAGN SN!!

(TONY DORÉ — VK4KJD)

Verdun (Tiny) Doré VK4ZH (ex VK7JD)

. . . and, sadly, the first anniversary of this bereavement has passed by . . . lost to cancer on 6 September 1989.

Sydney Sim VK2AVG

It is with deep regret I announce the passing of Sydney Sim VK2AVG "the quiet man of radio", aged 70, on 17 August 1990. Syd served with the AIF Corps of Signals in WW2, surviving the Burma-Thailand railway, and received the British Empire Medal for clandestine radio construction at Changi Prisoner of War Camp. Post-WW2 Sydney, XYL Doris and family lived on the heights of Como West NSW and spent his working years at the Naval Dockyard Radio Centre Leichhardt, Cockatoo Island and Garden Island, as a communications technician. He retired in 1985 to follow his many interests, including amateur radio and computing. Shortly before his sudden death, he assisted his son construct a light aircraft. Syd is survived by his daughter Jenine, sons Geoffrey and Christopher and their families.

JOHN GRACE VK2ZCG

A S G Fenton VK2VM

I regret to advise you of the passing of Mr A S George Fenton VK2VM, who died in Royal North Shore Hospital on 19 May 1990. He was 74 years of age.

George's interest in radio extended over many years. He served with the RAAF during WW2 and was a proud member of No 3 Squadron RAAF when it departed for the Middle East on 15 July 1940.

After the war he joined the Department of Civil Aviation, and his career continued in the field of radio and aviation. His active interest in amateur radio continued until his death. George will be missed by his squadron and radio friends. Deepest sympathy is extended to his niece Helen and the family.

AL PEARSON VK2CU

John Weir VK3KMW

John died on 25 July 1990, after an illness lasting several months. He led a very active life, and had the philosophy that when you retired, you were retreated. He wondered how he ever had time to go to work.

His work was in communication engineering; he worked with the research laboratories of the PMG on specialised communications and prototype radar. He joined the RAAF in 1941 as a Radar Officer, and served as Flight Lieutenant until 1947.

Later, he was involved with the experimental laboratory of the Department of Civil Aviation, and flight testing of navigational equipment.

John derived great pleasure from his hobby of amateur radio, and developed great interest in the happenings of his fellow amateurs around the world.

John had his 80th birthday just before his death.

JOYCE WEIR, XYL OF JOHN ar

G-LAND TO BE M-LAND

The United Kingdom's time-honoured G prefix is nearly exhausted, and thoughts are turning to a new prefix system.

The Department of Trade & Industry's intention is to introduce prefixes in the series MA-MZ with the second letter indicating the class of licence.

This would be followed by a single number as a country indicator for England, Scotland, Wales, Northern Ireland, Isle of Man, Jersey, and Guernsey.

The RSGB has also asked that when two Novice licence grades are introduced soon they should have distinctive callsign prefixes and it favours using the series 2A-2Z.

ar

SOME THINGS HAVE NO COMPARISON

amateur
radio
action

The magazine for the serious radio operator

AT YOUR NEWSAGENT EVERY MONTH

HF PREDICTIONS

ROGER HARRISON VK2ZTB
THE APOGEE GROUP

October Charts

For ease of use and to accommodate space restrictions in the magazine, I have provided predictions applicable for three major regions of Australia:

VK EAST. Covers the major part of NSW and Queensland.

VKSOUTH. Covers southern-NSW, VK3, VK5 and VK7.

VK WEST. Covers the south-west of West Australia.

For each of these regions I have selected six "terminals" to major continental regions of the world. Note that, this month, I have included charts specifically for the Middle East, in lieu of the Mediterranean, because the region is so much in the news of late. The chart will cover the general region, including Greece, Turkey, Israel, Jordan, Saudi Arabia and Egypt.

Predictions for the long path to Europe are included again this month. As 28 MHz is poor, this has been dropped and the 10 MHz band has been included on all the predictions to Europe.

The charts explained

These charts are different to those you see published elsewhere and arguably more useful to the amateur fraternity as they give, effectively, the predicted signal/noise ratio for each hour and for selected bands.

The charts are organised in 24 rows, one for each hour UTC (first column on the left). Don't forget to add the appropriate number of hours for your time zone, including daylight saving where it applies. The next column gives the MUF (maximum usable frequency) for each hour, followed by the field strength at the MUF, in decibels referred to 1 uV/metre (dBU). The column marked FOT gives the "optimum" frequency - the most reliable frequency for the path.

Then come five columns, one for each of five selected HF bands. The numbers in the column represent predicted field strength at each hour in decibels referred to 1 uV/metre. Here it represents "raw" signal to noise ratio as urban noise levels are typically 1-2 uV/metre, but does not take into account the advantage offered by particular transmission

modes. The results are based on a transmitter power of 100 W output (except where noted later), the use of modest 3-element beams or similar, and for "median" conditions. Where the results fall below -40 dB, no output is printed.

Enhanced conditions may improve S/N ratios by 9-15 dB. The use of CW or digital transmission modes show better results than SSB. If you've got 400 W output, you get a 6 dB improvements. Where conditions warrant it, I have included predictions for the bands below 14 MHz, deleting the upper bands.

More Details About Cycle 22

According to the latest information from IPS Radio & Space Services, Cycle 22 may yet have a few surprises in store.

If the cycle reached its maximum in July last year, then the rise from the minimum in September 1986 looks to be the shortest on record at just 2.8 years.

Large solar cycle peaks, such as Cycle 19, which peaked in 1957, tend to rise to maximum more quickly than do the small cycles. If the current cycle is unusual or special because of its short rise time, then it has probably arrived early.

Alternatively, we may see a further rise in solar activity and the sunspot numbers which, according to IPS, will then bring Cycle 22 into better accord with previous cycles.

The best, as the say, may be yet to come!

VK EAST — AFRICA										VK STH — AFRICA										VK WEST — AFRICA									
UTC	MUF	DBU	FOT	10.1	14.2	18.1	21.2	24.9		UTC	MUF	DBU	FOT	10.1	14.2	18.1	21.2	24.9		UTC	MUF	DBU	FOT	10.1	14.2	18.1	21.2	24.9	
1	18.5	-4	13.6	-39	-11	-3	-5	-9		1	17.6	-1	12.0	-22	-4	-2	-5	-12		1	17.8	5	13.5	6	5	1	-7	-18	
2	19.0	-6	14.6	...	-18	-7	-5	-7		2	18.3	-3	14.1	-36	-10	-3	-4	-8		2	19.7	3	15.1	-1	4	2	-2	-9	
3	19.4	-9	14.8	...	-25	-11	-7	-8		3	18.7	-6	14.3	...	-17	-7	-6	-9		3	24.2	3	19.1	-8	2	4	1	-1	
4	23.8	-6	18.0	...	-35	-15	-8	-5		4	22.9	-4	17.4	...	-26	-10	-5	-5		4	10.6	1	21.7	-18	-7	6	4		
5	29.6	-4	21.7	-19	-9	-4		5	27.8	-3	20.2	...	-33	-13	-8	-3		5	31.9	1	23.9	-27	-8	-1	2	2	
6	30.3	-4	22.4	-20	-10	-5		6	27.7	-4	19.9	...	-37	-15	-8	-4		6	31.6	0	26.4	-31	-11	-3	1	1	
7	29.6	-4	22.1	-20	-10	-5		7	27.1	-5	19.3	...	-37	-16	-8	-5		7	31.1	-1	25.7	-33	-12	-4	0	0	
8	28.5	-4	21.8	-18	-9	-5		8	26.1	-5	18.4	...	-36	-15	-8	-5		8	30.7	-1	25.1	-33	-12	-4	0	0	
9	27.2	-3	21.3	...	-35	-14	-7	-3		9	25.0	-5	18.6	...	-31	-13	-7	-5		9	29.9	-1	24.1	-31	-11	-4	0	0	
10	25.0	-3	19.7	...	-27	-10	-4	-3		10	23.0	-5	16.0	...	-25	-10	-6	-6		10	28.7	-1	22.9	-27	-9	-2	0	-1	
11	23.2	-2	18.3	...	-19	-6	-3	-3		11	21.0	-5	14.5	...	-18	-7	-5	-7		11	27.3	0	23.2	-18	-4	1	2	-1	
12	23.4	-1	16.9	...	-11	-2	-1	-3		12	19.5	-4	13.4	-38	-11	-4	-4	-8		12	25.1	0	21.8	-9	1	3	2	-2	
13	20.0	1	15.8	-25	-7	2	1	-4		13	17.8	-2	12.3	-25	-5	-2	-5	-11		13	23.3	4	18.4	0	5	5	2	-4	
14	19.0	5	15.0	-7	5	6	2	-4		14	16.9	-2	11.6	-9	2	1	-4	-13		14	21.5	7	17.0	9	10	7	1	-7	
15	18.2	10	14.4	10	14	10	4	-5		15	16.1	8	11.2	9	10	4	-4	-16		15	20.1	10	15.9	17	13	8	0	-10	
16	17.3	12	13.5	18	17	11	4	-7		16	15.7	11	10.6	16	13	4	-5	-19		16	19.1	12	15.0	20	14	8	-2	-13	
17	16.6	13	12.9	21	18	10	2	-9		17	14.6	12	10.2	19	13	3	-8	-24		17	18.3	13	14.5	21	17	7	-4	-16	
18	15.8	15	12.1	23	18	9	0	-13		18	14.0	13	9.9	20	13	1	-11	-28		18	17.5	14	13.7	21	13	5	-7	-20	
19	15.5	15	11.6	24	18	9	-1	-14		19	14.0	14	10.1	22	13	1	-11	-28		19	16.8	15	13.1	21	12	3	-9	-24	
20	16.3	15	11.1	25	19	10	1	-11		20	15.1	14	10.8	23	16	5	-6	-21		20	16.0	15	12.3	19	10	0	-13	-28	
21	15.6	11	10.8	16	14	6	-2	-15		21	14.9	13	10.4	20	14	4	-7	-22		21	15.7	15	12.0	19	9	-1	-15	-30	
22	14.9	5	10.4	1	6	1	-7	-18		22	14.2	8	10.1	9	8	-1	-11	-25		22	16.9	15	12.8	21	12	3	-9	-23	
23	14.7	0	10.5	-11	-1	-3	-9	-19		23	14.1	2	10.2	-2	2	-1	-12	-25		23	17.1	14	13.1	19	12	4	-8	-21	
24	15.9	-4	11.4	-25	-6	-4	-7	-15		24	15.2	0	11.1	-10	0	-3	-9	-20		24	16.6	9	12.7	12	7	0	-11	-23	

VK EAST — EUROPE L.P.										VK STH — EUROPE L.P.										VK WEST — EUROPE L.P.									
UTC	MUF	DBU	FOT	10.1	14.2	18.1	21.2	24.9		UTC	MUF	DBU	FOT	10.1	14.2	18.1	21.2	24.9		UTC	MUF	DBU	FOT	10.1	14.2	18.1	21.2	24.9	
1	15.2	-17	10.2	...	-20	-12	-11	-16		1	14.8	-19	10.2	...	-21	-13	-13	-18		1	14.5	-30	10.1	...	-31	-19	-17	-20	
2	15.2	-13	10.3	...	-16	-9	-11	-16		2	14.7	-15	10.2	...	-16	-11	-12	-19		2	14.4	-26	10.1	...	-27	-17	-16	-20	
3	14.8	-10	10.2	-34	-12	-8	-10	-17		3	14.2	-12	10.0	-32	-12	-9	-13	-21		3	13.9	-24	9.9	...	-23	-16	-16	-22	
4	13.8	-8	9.7	-23	-7	-7	-12	-21		4	13.4	-9	9.6	-23	-8	-9	-15	-25		4	13.1	-22	9.5	...	-19	-15	-17	-25	
5	13.5	-3	9.6	-11	-2	-5	-12	-23		5	13.0	-4	9.4	-11	-4	-8	-16	-29		5	12.7	-19	9.3	-34	-15	-14	-18	-28	
6	13.8	3	9.9	-2	3	-3	-10	-23		6	13.3	1	9.7	-2	1	-6	-15	-29		6	13.0	-13	9.6	-25	-11	-12	-18	-28	
7	16.7	8	12.2	8	10	6	0	-10		7	15.8	6	11.7	5	8	2	-5	-16		7	15.3	-5	11.4	-19	-6	-6	-11	-20	
8	21.3	9	15.6	12	16	13	9	3		8	19.6	8	14.6	10	14	11	6	-2		8	18.8	0	14.1	-14	0	1	-2	-9	
9	21.0	7	16.1	-7	6	9	7	3		9	22.0	8	15.2	4	12	12	9	3		9	22.6	5	17.2	-10	3	6	4	0	
10	20.3	1	15.5	-33	-7	0	1	-1		10	20.3	4	14.0	-11	1	1	1	-7		10	21.3	3	18.8	-13	1	6	5	2	
11	20.2	-4	15.9	...	-21	-9	-6	-7		11	18.8	-2	12.9	-30	-7	-2	-3	-7		11	21.4	0	18.6	-27	-5	0	0	-3	
12	19.1	-13	15.0	...	-32	-15	-11	-10		12	17.7	-9	12.1	...	-18	-9	-8	-11		12	19.5	-6	15.1	...	-16	-7	-6	-9	
13	18.3	-19	14.4	...	-39	-20	-14	-12		13	16.9	-17	11.8	...	-28	-15	-12	-13		13	18.9	-13	14.8	...	-27	-14	-11	-12	
14	17.3	-25	13.6	...	-43	-23	-16	-14		14	16.1	-25	11.1	...	-34	-18	-14	-15		14	17.7	-20	14.0	...	-35	-20	-15	-15	
15	16.7	-30	12.9	...	-47	-24	-17	-15		15	15.3	-30	10.7	...	-37	-20	-16	-16		15	16.9	-27	13.3	...	-40	-23	-18	-17	
16	15.8	-34	12.1	...	-47	-24	-17	-15		16	14.6	-36	10.4	...	-39	-21	-16	-16		16	16.1	-33	12.5	...	-43	-25	-19	-18	
17	15.4	-36	11.7	...	-47	-24	-17	-15		17	14.5	-38	10.4	...	-40	-22	-17	-16		17	15.4	-37	11.9	...	-43	-25	-19	-18	
18	16.6	-31	12.5	...	-45	-21	-17	-15		18	15.6	-33	11.4	...	-37	-23	-17	-15		18	14.6	-40	11.2	...	-45	-25	-19	-18	
19	19.9	-21	15.5	...	-27	-18	-14		19	18.2	-26	12.4	...	-26	-19	-18	-15		19	14.5	-41	11.0	...	-45	-25	-19	-18		
20	23.9	-13	16.3	...	-20	-18	-12		20	22.0	-17	15.9	...	-22	-19	-19	-13		20	15.6	-36	11.7	...	-46	-26	-19	-18		
21	20.8	-16	14.2	...	-24	-15	-12		21	20.0	-20	13.9	...	-29	-21	-19	-14		21	18.3	-28	13.8	...	-46	-29	-21	-17		
22	18.5	-18	12.6	...	-27	-19	-13	-12		22	17.8	-22	12.4	...	-26	-21	-15	-14		22	17.4	-29	12.2	...	-47	-29	-20	-17	
23	17.0	-19	11.5	...	-31	-16	-12	-13		23	16.4	-23	11.4	...	-34	-18	-14	-15		23	16.1	-31	11.3	...	-47	-24	-18	-18	
24	16.0	-18	10.8	...	-25	-13	-12	-14		24	15.5	-22	10.7	...	-27	-15	-13	-16		24	15.2	-31	10.6	...	-47	-21	-18	-18	

UTC	MUF	DBU	FOT	14.2	18.1	21.2	24.9	28.5
1	26.3	13 19.9	8	15	16	14	10	
2	26.1	13 21.8	8	15	16	14	10	
3	25.7	14 21.3	10	16	17	14	10	
4	25.3	14 20.8	12	17	17	15	0	
5	24.7	15 20.1	16	20	19	15	9	
6	23.8	17 19.1	23	23	21	16	9	
7	22.8	20 19.0	30	27	23	16	8	
8	21.4	21 17.0	32	27	22	14	4	
9	20.4	22 16.2	32	26	20	11	1	
10	19.2	23 15.2	31	25	18	8	-3	
11	18.4	23 14.6	31	24	16	5	-7	
12	17.6	24 13.9	30	22	14	2	-10	
13	16.7	24 13.3	29	20	11	-1	-15	
14	15.7	24 12.3	27	18	8	-6	-20	
15	15.0	24 11.7	26	15	5	-10	-25	
16	13.9	25 10.8	24	12	0	-14	-30	
17	13.1	25 10.1	22	8	-4	-17	-34	
18	12.8	24 10.6	23	11	-1	-16	-33	
19	16.8	18 13.0	21	16	8	-3	-15	
20	20.8	15 16.1	17	18	15	8	0	
21	24.1	15 19.0	14	18	17	14	8	
22	25.9	14 20.7	11	17	17	15	10	
23	26.3	14 21.4	9	16	17	15	11	
24	26.5	13 21.0	8	15	16	15	11	

UTC	MUF	DBU	FOT	14.2	18.1	21.2	24.9	28.5
1	28.5	5 23.7	0	9	11	9	5	
2	28.0	5 23.8	1	9	10	9	4	
3	27.7	5 23.2	2	10	11	9	4	
4	27.3	5 22.6	5	11	12	9	4	
5	26.9	7 22.1	9	14	13	10	4	
6	26.2	9 21.2	16	18	16	11	4	
7	25.2	11 20.2	25	22	18	12	4	
8	23.9	13 19.0	29	24	18	10	1	
9	22.2	13 17.5	28	22	15	6	-5	
10	20.7	14 16.3	27	20	12	2	-10	
11	19.1	15 15.1	26	17	8	-4	-18	
12	17.9	15 14.2	25	15	5	-9	-24	
13	17.0	15 13.4	23	12	1	-14	-31	
14	16.3	16 12.9	22	10	-1	-17	-35	
15	15.5	16 12.1	20	7	-5	-23	...	
16	14.9	16 11.6	18	5	-8	-27	...	
17	14.1	17 10.9	16	2	-13	-33	...	
18	13.8	15 10.5	14	0	-15	-35	...	
19	14.8	9 11.2	10	1	-10	-27	...	
20	17.7	5 13.3	8	5	-1	-12	-25	
21	21.7	5 16.6	6	8	6	0	-9	
22	25.2	5 19.7	4	9	9	6	0	
23	27.4	5 21.8	2	9	10	8	4	
24	28.2	5 22.9	1	9	10	9	5	

UTC	MUF	DBU	FOT	14.2	18.1	21.2	24.9	28.5
1	28.6	0 23.3	-18	-3	2	3	1	
2	28.9	0 24.0	-19	-3	1	3	1	
3	28.4	0 21.4	-18	-3	2	3	0	
4	28.1	1 23.6	-15	-1	3	3	1	
5	27.7	2 22.9	-10	1	4	4	1	
6	27.3	3 22.3	-3	6	7	6	2	
7	26.5	6 21.2	7	11	11	8	2	
8	25.3	8 20.0	16	16	14	9	2	
9	23.4	11 18.5	22	19	15	8	-1	
10	22.0	12 17.4	25	20	14	5	-4	
11	20.4	13 16.1	25	18	11	2	-9	
12	19.2	14 15.2	24	16	9	-3	-15	
13	18.1	14 14.3	23	14	6	-7	-20	
14	17.1	15 13.6	22	12	3	-10	-25	
15	16.5	15 13.1	21	11	1	-12	-29	
16	15.7	15 12.3	19	9	-2	-17	-34	
17	15.2	16 11.8	18	7	-4	-20	-38	
18	14.4	15 11.1	16	4	-8	-25	...	
19	14.1	10 10.8	10	0	-11	-27	...	
20	15.2	4 11.5	4	0	-8	-21	-36	
21	18.2	1 14.4	-1	1	-3	-10	-20	
22	22.2	0 17.0	-7	1	1	-2	-8	
23	25.7	1 20.1	-12	-1	2	1	-3	
24	27.9	1 22.2	-16	-2	2	2	0	

VK EAST - STH PACIFIC

VK STH - STH PACIFIC

VK WEST - STH PACIFIC

UTC	MUF	DBU	FOT	14.2	18.1	21.2	24.9	28.5
1	30.9	3 25.6	-18	-2	4	6	5	
2	31.0	3 23.6	-20	-3	3	5	4	
3	30.9	3 25.8	-21	-4	3	5	4	
4	30.7	3 25.4	-20	-3	3	5	4	
5	30.4	3 24.9	-17	-1	4	6	5	
6	29.8	4 24.2	-12	2	6	7	5	
7	28.9	5 23.3	-5	6	9	8	5	
8	28.0	7 23.6	7	13	13	11	6	
9	26.9	10 21.4	21	21	18	13	7	
10	25.9	11 20.6	24	22	18	13	5	
11	24.9	11 19.8	26	22	18	11	3	
12	24.3	12 19.3	27	23	18	10	2	
13	23.5	12 18.6	28	23	17	9	0	
14	22.3	12 17.8	28	21	15	6	-5	
15	20.7	12 16.3	26	18	11	0	-11	
16	19.4	12 15.2	24	16	7	-5	-18	
17	17.7	12 13.8	21	11	1	-3	-29	
18	16.3	12 12.6	18	6	-5	-22	-40	
19	15.8	12 12.9	19	8	-3	-18	-36	
20	15.6	12 12.8	19	7	-4	-20	-38	
21	21.0	8 15.6	16	12	7	-1	-12	
22	28.5	6 22.1	3	10	11	10	6	
23	30.9	5 24.7	-7	5	9	9	8	
24	30.8	4 25.1	-13	1	6	7	6	

UTC	MUF	DBU	FOT	14.2	18.1	21.2	24.9	28.5
1	31.9	3 25.9	-22	-4	2	5	5	
2	32.0	2 26.5	-25	-6	1	4	4	
3	31.5	2 26.2	-27	-7	0	3	3	
4	31.1	2 26.0	-26	-7	0	3	3	
5	30.6	2 25.3	-23	-5	1	4	3	
6	30.1	2 24.7	-18	-3	3	5	4	
7	29.3	3 23.7	-11	2	5	6	4	
8	28.1	5 22.6	-1	7	9	8	4	
9	26.9	9 21.3	20	20	17	12	6	
10	25.9	10 19.8	24	21	17	10	2	
11	23.5	10 18.6	26	20	15	7	2	
12	21.9	11 17.4	25	19	12	3	-7	
13	20.9	11 16.5	24	17	10	0	-12	
14	19.9	11 15.7	24	16	8	-4	-17	
15	19.2	11 15.1	23	14	5	-7	-21	
16	18.2	11 14.2	21	11	1	-12	-28	
17	17.5	11 13.6	20	9	-1	-16	-33	
18	16.4	11 12.7	17	5	-7	-23	...	
19	15.8	11 12.1	16	3	-10	-28	...	
20	16.8	11 12.8	18	7	-4	-20	-38	
21	20.5	8 15.5	17	12	6	-3	-15	
22	25.3	4 19.5	2	8	8	5	-1	
23	29.3	4 22.9	-9	3	6	7	4	
24	31.4	3 25.1	-17	-1	4	6	6	

UTC	MUF	DBU	FOT	14.2	18.1	21.2	24.9	28.5
1	29.5	4 23.6	-12	1	6	7	5	
2	29.6	3 24.1	-17	-1	4	5	4	
3	29.7	3 24.6	-19	-3	3	5	4	
4	29.5	2 22.4	-20	-3	2	4	3	
5	29.3	2 24.5	-19	-3	2	4	3	
6	29.0	3 24.0	-16	-1	3	5	3	
7	28.6	3 23.5	-12	1	5	6	4	
8	28.0	4 22.7	-5	8	7	7	4	
9	27.0	6 21.7	5	11	11	9	4	
10	26.0	11 22.0	25	23	19	13	6	
11	24.7	11 19.6	27	23	18	11	3	
12	23.6	11 18.7	27	22	16	8	-1	
13	22.4	12 17.8	27	21	14	5	-5	
14	21.7	12 17.2	27	20	13	3	-8	
15	20.9	12 16.5	26	18	11	0	-12	
16	20.0	11 15.9	25	16	9	-4	-17	
17	18.7	11 14.7	22	13	4	-10	-25	
18	17.7	11 13.9	21	10	0	-15	-32	
19	16.4	11 12.8	18	5	-7	-24	...	
20	15.4	11 11.9	15	1	-23	-32	...	
21	16.1	11 12.4	17	4	-9	-26	...	
22	19.6	9 15.5	19	12	5	-6	-19	
23	24.3	4 18.8	2	8	7	3	-3	
24	27.9	4 22.0	-6	5	7	7	4	

VK EAST - ASIA

VK STH - ASIA

VK WEST - ASIA

UTC	MUF	DBU	FOT	14.2	18.1	21.2	24.9	28.5
1	15.4	-16 11.8	-17	-12	-12	-18	-26	
2	19.9	-11 15.7	-29	-11	-10	-10	-14	
3	27.3	-5 21.0	...	-10	-5	-5	-5	
4	32.0	-2 26.2	...	-24	-12	-5	-2	
5	31.6	-3 26.2	...	-27	-14	-7	-6	
6	31.3	-4 25.6	...	-27	-15	-7	-4	
7	30.6	-4 24.8	...	-25	-13	-6	-4	
8	29.5	-3 23.7	...	-21	-11	-5	-3	
9	28.4	-2 22.6	-36	-14	-6	-2	-2	
10	26.8	0 21.3	-22	-6	-1	1	-1	
11	25.6	3 20.2	-8	2	4	3	0	
12	24.2	6 19.2	5	9	9	5	0	
13	23.4	9 18.5	15	15	12	7	0	
14	22.4	11 17.7	21	18	14	7	-1	
15	21.5	12 17.0	23	18	13	5	-4	
16	20.1	13 15.8	23	17	11	2	-9	
17	19.1	14 14.9	23	16	9	-1	-13	
18	17.7	14 13.7	21	15	5	-6	-19	
19	16.7</							

HAMADS

TRADE

● **WEATHER FAX** programs for IBM XT/ATs * "RADFAX2" is a high resolution, shortwave weather fax, Morse & RTTY receiving program. Needs CGA, SSBhf radio & RADFAX decoder. Also RF2HERC, RF2EGA & RF2VGA, same as RADFAX2 but suitable for Hercules. EGA & VGA cards respectively, \$35. *SAT-FAX is a NOAA, Meteor & GMS weather satellite picture-receiving program. Uses EGA or VGA modes. Needs EGA or VGA colour monitor and card and WEATHERFAX PC card, \$45. *All programs are on 5.25" or 3.5" discs (state which) and documentation. Add \$3 postage. ONLY from M Delahunty, 42 Villiers St, New Farm Old 4005. Ph (07) 358 2785.

● **AMIDON FERROMAGNETIC CORES:** for all transmitter and receiver applications. Send DL size SASE for data/price to RJ & US Imports, Box 157, Mordale NSW 2223 (no enquiries at office please. . . 11 Macken St (Oatley). Agencies at: Geoff Wood Electronics, Sydney, Webb Electronics, Albury. Electronic Components, ACT. Truscott's Electronics, Melbourne. S Willis, Perth. Assoc TV Service, Hobart.

FOR SALE — ACT

● **KENWOOD TCVR TS530S** with hand-held mike and handbook, \$695. **KENWOOD MC50** desk mike, suitable for above unit, \$100. **TEN-TEC** antenna tuner, model 228, built in SWR meter handbook, \$100. **Power Transformer 240/110** Volts, extra heavy duty, 10 Amps at 110V. Suitable for workshop or 110V fridge or freezer, \$150. **COLLINS S-LINE** transmitter 32S3 and receiver 75-S-3. Power supply speaker 110/240 transformer, hand mike, handbook. Can be used as transceiver or separately. Leads supplied (does not cover 18MCS and 10MCS bands), \$750. Frank VK1XE QTHR (06) 295 0815 BH.

FOR SALE — NSW

● **HYGAIN TH5DXX** tri-band Yagi bencher 4kW balun s/steel hardware, \$650. **Kenwood PS-50**, \$550. **Hidaka HF** vertical trapped, \$225. **Kenwood 440S** with ATU, VS-1 voice, new in carton, \$1975. (02) 622 6268.

● **30-METRE** kit for Mosley TA-3 tri-bander, new, unused, complete, \$200. Identical to 40m kit except for end elements easily added. 2kW pep rating. Clem VK2AMA QTHR.

● **YAESU FT901DM** transceiver YO901 scope/spectrum analyser FL2100B amplifier FV107 (ext VFO mod for FT901), \$1750 the lot. Jim VK2AKJ Arthur (02) 427 1398.

● **YAESU FT101E** with FV101B mint, \$550. **Yaesu FT707** with Datong RF clipper, mint, \$650. **Oscilloscope BWD539 SS 5"** dual trace, \$400. Vince VK2VC (02) 713 6655. QTHR

● **YAESU FV101** external VFO for FT101, \$55. **CE1 2123** modem 300/300 1200/75, \$50. **Mark VK2BAK QTHR** (02) 487 1299. Fax (02) 489 7967.

● **YAESU FT707 100W HF** SSB tcvr (s/n IF70042), \$950. **Philips FM321** UHF tcvr (s/n 194), \$200. **Yaesu FT207R** VHF hand-held, \$175. **Midland 13-892 5W 10M** tcvr, \$175 (s/n

01200233). **power supply 12V 20W**, \$20. **H/duty mag base**, \$30. **VK2BSB** (02) 838 7937.

● **COMMODORE 128D** W German RFI shielded model, good for Amtr and Packet. As new, \$575. **Monitor 1901 RGB** for above, \$250. **IBM-compat monitor**, 14" paper, white with auto-switching dual graphics display and printer adaptor card, \$180. **Keyboard**, latest 101 model, \$75. **VK2WD QTHR** (02) 427 6080.

● **HOMEBREW RSGB** linear (2x813) 10-80M sorry, no PS plus 12 813 tubes (untested) plus one Eimac double socket with chimneys for 4CX250B, \$250 the lot. **Phone weekends** (02) 665 1082 QTHR Ted VK2AWR.

● **ICOM IC-25A 2m FM** transceiver with handbook. Serial No 27233, \$250. **VK2ZGM** (02) 99 3281.

● **DECEASED ESTATE SEC** millimeter, \$10. **Three 4" speakers**, \$5 ea. **Ken 2m handheld simplex 146.5 rpt 6700**, 6800, 6900, 7000, \$115. **DSE AM/FM stereo cassette car radio**, \$65. **Hills 40' crankup tower** with guys, \$500. **Midland 2m FM tcvr simplex 145.86**, 146.146.5 rpt 6700, 6850, 6950, 7000, \$185. **Microwave modules 144MHz converter**, \$150. **Morrabin RC 144MHz converter**, \$60. **KLM 2m 70W amp**, \$190. **Oscar block SWR meter**, \$50. **sonar battery charger**, \$12. **Two Qualitronics 2m 9e beams** with matching harness, \$80. **Lightbulb 2-speed drill**, \$30. **9m of beldin 9913** with N connector, \$18. **Talking alarm clock T-10**, \$25. **National cassette recorder**, \$10. **All prices ONO**. **Randall VK2EFA QTHR** (080) 5285.

FOR SALE — VIC

● **FL2100Z** linear, includes WARC bands, GC, \$1000 ono. **Buyer collects**. **Hepburn VK3AFO QTHR** (03) 596 2414.

● **KENWOOD TM2570A 2m FM** U/ceiver with DTMF 5 or 7W output, 23 mems. Suit base or mobile. EC in box, \$595. **Rob VK3JE** (060) 37 1262 or 584 5737.

● **OSCAR BLOCK SWR/PWR** meter, freq range 3.5 to 30 MHz, 50 or 75 Ohm switch, GC, \$50. **Vince VK3AJQ QTHR** (03) 657 3385 or (03) 872 3503 AH.

● **ICOM 765 HF** U/ceiver, as new, under warranty, current model, number leatures incl FM FSK plus SM6 desk mike. **Free delivery**, \$3400 ono. (060) 37 1262.

● **ICOM IC4-GAT** UHF tcvr 430-440 MHz FM, new in box. **BP70 battery pack**, 6W RF out leather case workshop manual, \$400. **Icom IC2-GAT VHF tcvr TX144-148 MHz RX 138-173 MHz**, BP8 battery pack, 7W RF out. **DC-DC converter**, DC cable **HM46L** speaker-mic, leather case, new in box, \$450. **Len VK3DLM** (056) 55 1859.

● **YAESU FT101E HF** transceiver in VGC. Includes CW filter, \$450. **Bert VK3TU** (052) 78 2374 AH.

● **FL2100Z** linear WARC bands. GC. **National video camera**, carry case, heaps of extras, EC. **VHF marine radio** with new fibreglass whip ant. GC. **VK3VRK**, 15 Wood St, Rosedale 3847.

● **YAESU FT625R 6m** all mode tcvr. Asking \$500. **OTHR**

VK5BRO (03) 885 2093.

● **ICOM IC32AT** handheld dual band 2m-70cm 5W charger. **Carton**, manual, near new cond. \$565 ono. **Andy VK3LJ QTHR** (03) 735 3335.

● **TANDY Realistic Pro 2022**, 200 ch scanner, as new, 3 mths old. **Original packing**. Very little use. **Sell \$300** ono. **David L30259 QTHR** (03) 370 3589.

● **IC202 2m SSB** tcvr. Not working. **IC502A 6m SSB** tcvr **VGO**. **VK3YNB QTHR**.

● **KENWOOD SM220** Mon Scope c/w all leads, manual, mint cond, \$350. **Kenwood AT250** auto ATU 9 mths, new c/w leads, manual, mint cond. **Ken VK3MW QTHR** (03) 560 5178 AH. (03) 522 1476 BH.

● **KENWOOD TR2400 2m FM** handheld tcvr with charger, \$250 ono. **Paul VK3YYF** (03) 758 4117. Serial No 0115107.

● **YAESU FT208 144-148MHz** handheld tcvr. Includes mic, battery and charger, \$249. **Realistic Pro30 scanner**, EC, includes Nicads, charger and case, \$249. **Norm VK3ZEP** (03) 782 1115 or (018) 35 7844.

● **DSE 9EL 2m YAGI K6297**, \$50. **DES rotator D5003** complete, \$50. **DSE folded J 2m ant** (Slim Jim) D4211, \$15. **Syd VK3DSP** (059) 85 2170. Rye.

● **HYGAIN TH6DX TRIBAND HF YAGI**, EC, \$350 ONO. **Alan VK3LW QTHR** (052) 822 2394.

● **YAESU FP107E** power supply, 20 Amps cont rating. As new condition C/W manual, etc, \$200. **Ken VK3MW, QTHR**. **AH** (03) 560 5278, **BH** (03) 522 1476.

FOR SALE — QUEENSLAND

● **ANTENNA CE38** with **BM36** balun 3-band 6-element, same as TH6, \$300. **Diawa rotator**, model DR7500a with control unit and 90' multi-core cable, \$300 ono. **VK4GB QTHR** (07) 396 1836.

● **FT-690R** Yaesu 6m all-mode tcvr, EC, \$495 ono. **Antenna tuner** Emtron EAT-300A 1.8-30MHz cross needle, dummy load, balun. **Matches anything**, \$289. **Geoff VK4CET** (077) 23 1453.

● **VALVES 572B/T160L**, new, unused, \$350 the pair. **Peter VK4APD QTHR** (07) 397 3751.

● **HAND** tcvr **Kenwood TR2400**. **Digital readout**, 10 programmable memories, many other features. Includes speaker/mike and base station charger w/mike. **GC. Manuals**. **Original cartons**, \$355. **John VK4SZ QTHR** (070) 61 3286.

● **ICOM IC2KL** linear amp, \$2100. **ICOM AT-500** auto tuner, \$900. **ICOM 720-A** transceiver, **PS-15** power supply and **SP-3** speaker, \$1300. **ICOM ML-1** VHF linear for handhelds one in 10 out, \$150. **The above units** have had little use and are in mint condition. **KENWOOD SM-220** station monitor, needs minor adjustment, \$290. **ICOM BC-30** fast charger, \$100. **ICOMIC-2A**

— ST. PIPS

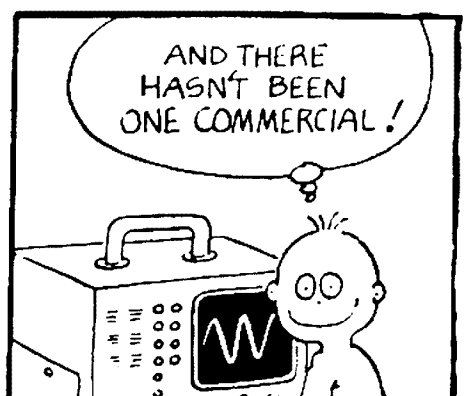
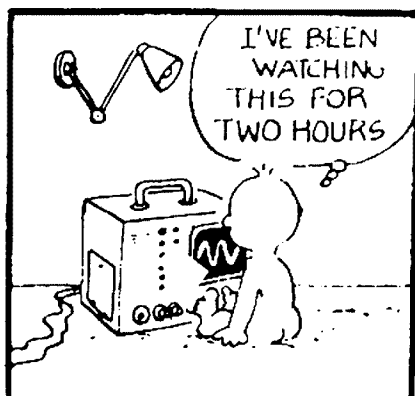
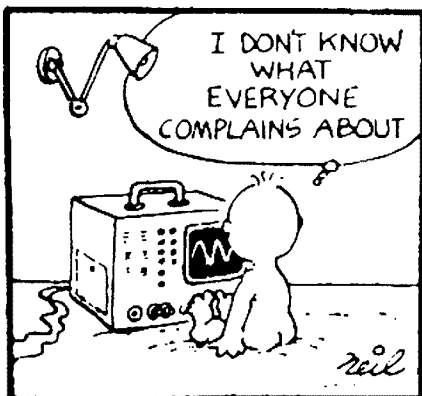

REPRINTED BY PERMISSION OF NEIL MATTERSON

handheld with 2 defunct fast charge packs, 12V regulator pack and HM-1 speaker microphone. \$150. Used 4CX-250-Bs. \$48, new QB3.5/750GA tubes, \$90. Black and white camera, no lens, suit ATV, \$60. Ceramic air chimneys for 4CX-250-Bs, \$20. Mail only please. VK4BGB. PO Box 275, Doovall Okd 4304.

FOR SALE — WA

● FT-726R 2m 70cm satellite units, \$1950. 16-element Tonna, 19-element Tonna, helical 20m mono beam. Offers. QTHR VK6TP (09) 299 6741.

● KENWOOD TS930S, \$2250. Kenwood TS430S ATU 130, \$1400. Both original owner, no mods, rarely used, in as-new condition. Manuals and original packing. Alastair QTHR (09) 527 7238. VK6AES.

● 1000W solid-state linear amplifier, 2-30MHz. Collins HF282 tsvr, synthesised 1.6-30MHz, 125W. Enquire on (09) 242 3559.

FOR SALE — TAS

KENWOOD TR-751A allmode 2m TXRX 5/25W, \$850. Kenwood AT250 auto tuner, \$450. Kenwood TS680S, HF & 6m, allmode, \$1400. Please phone Larry VK7JWL (003) 31 4562.

WANTED — NSW

● COLLINS KWM-2A General Radio 916A impedance bridge, Prop Pitch motor. Details to VK2OE, PO Box 1914, Wollongong, 2500.

● COMPLETE and original copy of ETI June 1988. Details of successfully using an FRA7700 with a DX302 as well as a source for pre-selector gears (plastic) for this receiver. (Tandy no longer has spares), contact with VKs using a BBC computer. VK2ATJ, Tom QTHR or (02) 349 6683.

● FT100, must be in good order. VK2DJM (066) 86 8742 QTHR.

WANTED — VIC

● CW filler for Kenwood TS520S tsvr. Kevin VK3ZI QTHR (03) 374 1389.

● PADDLE to suit an electronic keyer. Must be in working order. Contact Michael VK3EMJ QTHR AH (03) 531 9954.

● BRING your unwanted ham gear to the Ballarat Hamvention, 28 October. Plenty of buyers waiting to purchase. Book your spot. Details phone Kevin VK3WN (053) 35 5011.

WANTED — OLD

● FULL workshop manual for Kenwood TS-430S or copy of, costs refunded. Reg Male, 13 Henzell Street, Redcliffe Old 4020. (07) 284 6432.

● HIGH voltage capacitors for linear construction wanted, also circuit diagram for SIDEBAND SE502 10m converted CB rig, please. Will gratefully reimburse costs. John VK4SZ QTHR (070) 61 3296.

WANTED — SA

● THE Riverland Radio Club is looking for 2m cavity filters. Contact The Secretary, Box 646, Renmark SA 5341. Ph (085) 85 5320.

WANTED — WA

● INTRUDER Watch observers in VK6, free tapes, logs sheets, info and advice. Please help. Thank you. Contact Graham VK6RO 451 3561 QTHR.

● RELIABLE computer program for RD log keeping, preferably printing hard copy sequentially, plus disc save. IBM clone, 5" floppy, this year I lost 5 hrs of OSOs due to a program bug! Will pay good money for a good program. VK6ED QTHR (097) 52 1173.

COPIES OF ARTICLES

Photocopies of any article published in a back issue of AR available to members at \$2.50 each (plus \$2.00 for each additional issue in which the article appears)

**AR ARTICLES
PO Box 300
Caulfield South
Vic 3162**

HAMADS

Please Note: If you are advertising items For Sale and Wanted please use a separate form for each. Include all details; eg Name, Address, Telephone Number (and STD code), on both forms. Please print copy for your Hamad as clearly as possible.

*Eight lines per issue free to all WIA members, ninth line for name and address Commercial rates apply for non-members. Please enclose a mailing label from this magazine with your Hamad.

*Deceased Estates: The full Hamad will appear in AR, even if the ad is not fully radio equipment.

*Copy typed or in block letters to PO Box 300, Caulfield South, Vic 3162, by the deadline as indicated on page 1 of each issue.

*QTHR means address is correct as set out in the WIA

current Call Book.

*WIA policy recommends that Hamads include the serial number of all equipment offered for sale.

*Please enclose a self addressed stamped envelope if an acknowledgement is required that the Hamad has been received.

Ordinary Hamads submitted from members who are deemed to be in general electronics retail and wholesale distributive trades should be certified as referring only to private articles not being re-sold for merchandising purposes.

Conditions for commercial advertising are as follows: \$22.50 for four lines, plus \$2.00 per line (or part thereof) Minimum charge — \$22.50 pre-payable.

State:

- Miscellaneous
- For Sale
- Wanted

Name:

Call Sign:

Address:

Solution to Morseword No 43

	1	2	3	4	5	6	7	8	9	10
1
2	.	-	-	.	-	.	.	.	-	.
3	-	-	.	-	.	.
4	-	.	-
5	.	.	-	-
6	-	-	-	-	-
7	-	-	.	.
8	.	-	-	.	-	-	-	-	.	.
9	-	-	.	.
10	-

Across: 1 sift; 2 waste; 3 dice; 4 silt; 5 fist; 6 onset; 7 bip; 8 pod; 9 bear; 10 these.

Down: 1 fay; 2 real 3 rated; 4 hens; 5 rifle; 6 used; 7 steep; 8 tread; 9 like; 10 rose.

TRADE PRACTICES ACT

It is impossible for us to ensure the advertisements submitted for publication comply with the Trade Practices Act 1974. Therefore advertisers and advertising agents will appreciate the absolute need for themselves to ensure that, the provisions of the Act are complied with strictly.

VICTORIAN CONSUMER AFFAIRS ACT

All advertisers are advised that advertisements containing only a PO Box number as the address cannot be accepted without the addition of the business address of the boxholder or seller of the goods.

TYPESSETTING : Redfords Media
25 Glenferrie Rd
Malvern 3144
Tel: (03) 500 0377

PRINTING: Industrial Printing
Richmond

MAIL DISTRIBUTION: Polk Mailing Co.
PO Box 140,
Collingwood,
Vic. 3066
Tel:(03) 417 5161

The opinions expressed in this publication do not necessarily reflect the official view of the WIA, and the WIA cannot be held responsible for incorrect information published.

ADVERTISERS INDEX

Amateur Radio Action	51
ATN Antennas	40
Dick Smith Electronics ..28, 29, 10	
Electronics Australia	17
Icom Australia	OBC,
Kenwood Electronics Aust.	IFC
Magpubs	7
WIA Log Books	31
WIA NSW Division	19
WIA Callbook	5
Murray Valley League	31
Stewart Electronic	
Components	IBC
Terlin Aerials	24

TRADE ADS

RJ & US Imports	54
M Delahunty	54

HOW TO JOIN THE WIA

Fill out the following form and send to:

The Membership Secretary
Wireless Institute of Australia
PO Box 300
Caulfield South, Vic 3162

I wish to obtain further information about the WIA.

Mr, Mrs, Miss, Ms:

Call. Sign (if applicable):

Address:

State and Postcode:

MFJ's Deluxe 300 Watt Tuner

... gives you **full** 1.8-30 MHz coverage, a **peak reading** (and average) Cross-Needle meter, built-in **dummy load**, antenna switch and balun ... all covered by a **full one year unconditional guarantee** ... for only

MFJ-949D

\$324 00

PLT's Freight \$10 Within Australia
All Prices Include 20% Sales Tax

- **Peak reading meter**
- **Built-in dummy load**
- **Covers 1.8 to 30 MHz**
- **1 full year guarantee**



You won't find all these useful features in any other 300 watt tuner -- not even at twice the price.

New peak reading meter

The new **peak** and average reading Cross-Needle meter in the MFJ-949D shows you SWR, forward and reflected power -- all in a single glance.

Without a **peak reading** wattmeter you just won't be able to tell if your rig is putting out all the peak SSB power it's designed for. Don't be without one if you want top performance.

Built-in dummy load

A built-in 300 watt 50 ohm dummy load makes tuning up your rig sooooo easy. How do you tune up your rig without one?

An external dummy load will cost you about \$30 more -- plus it takes up valuable space at your operating position and requires another cable.

Full 1.8 to 30 MHz coverage

The MFJ-949D gives you **full** 1.8-30 MHz coverage.

Make sure the tuner you're considering covers all the HF bands.

Don't get a tuner that keeps you from operating all the frequencies you've worked for -- now or in the future.

Plus more ...

You get a versatile 6-position antenna switch and a 4:1 balun for balanced lines.

You can run up to 300 watts PEP and tune out SWR on coax, balanced lines or random wires.

Unconditional Guarantee

You get a **full one year unconditional guarantee**. That means we will repair or replace your MFJ tuner (at our option) **no matter what** for a full year.

Others give you a 90 day **limited** warranty. What do you do after 90 days? Or before 90 days when they say, "Sorry, it's your fault"?

What's really important? precise control for minimum SWR

What's really important is your tuner's ability to get your SWR down to a minimum -- and the MFJ-949D gives you more precise control over SWR than any tuner that uses two tapped inductors.

Why? Because the two **continuously** variable capacitors in the MFJ-949D give you **infinitely** more positions than the **limited** number on two switched coils.

This gives you the precise control you need to get minimum SWR and maximum power into your antenna.

After all, isn't that why you need a tuner?

High efficiency and a compact size: performance is most important

The MFJ-949D uses a **single** airwound coil. Using only one inductor takes up a minimum of space and there's no mutual coupling problems.

The excellent form factor of the short fat coil gives you highest Q. Plus you get plenty of inductance that gives you a much wider matching range than other designs.

This results in a highly efficient tuner that puts maximum power into your antenna and a compact 10 x 3 x 7 inch size that complements your rig and fits right into your station.

Competing tuners using **two** tapped coils require a large cabinet -- not just to house the coils but also to help reduce detrimental coupling between the inductors. The result? **A tuner that's bigger than your radio.**

Your very best value

The MFJ-949D gives you your very best value, first-rate performance, proven reliability and the best guarantee in ham radio ... all from the **most trusted** name in antenna tuners. Don't settle for less. Get yours today!

MFJ's 1500 Watt Tuner

MFJ-962C

\$499

Freight \$10
Within Australia



For a few extra dollars the MFJ-962C lets you use your barefoot rig now and have the capacity to add a 1.5 KW PEP linear amplifier later. It covers 1.8 to 30 MHz.

You get MFJ's **new peak** and average reading Cross-Needle SWR/Wattmeter.

You also get a 6-position antenna switch and a teflon wound balun with ceramic feed-thru insulators for balanced lines. Measures just 10 3/4 x 4 1/2 x 14 7/8 inches.

MFJ builds every tuner cabinet from scratch using the latest high-speed computer controlled punch presses.

MFJ manufactures, assembles and tests every PC board that goes into MFJ tuners.

Instruction manuals and other materials are printed in MFJ's print shop.

MFJ tuners go directly from our factory to your dealer. We're not just an importer adding profits, tariffs and import charges.

With MFJ's efficient in-house manufacturing and straight to your dealer distribution you get the most tuner for your money.

WHY CHOOSE AN MFJ TUNER?

Hard-earned Reputation: There's just no shortcut. *MFJ is a name you can trust* -- more hams trust MFJ tuners throughout the world than all other tuners combined.

Proven Reliability: *MFJ has made more tuners for more years than anyone else* -- with MFJ tuners you get a highly-developed product with proven reliability.

First-rate Performance: MFJ tuners have earned their reputation for being able to match just about anything -- anywhere.

One full year unconditional guarantee: That means we will repair or replace your tuner (at our option) **no matter what** for a full year.

Continuing Service: MFJ Customer Service Technicians are available to help you keep your MFJ tuner performing flawlessly -- no matter how long you have it --

Your very best value: MFJ tuners give you the most for your money. Not only do you get a **proven** tuner at the lowest cost -- you also get a one year **unconditional** guarantee and **continuing** service. That's how MFJ became the world's leading tuner manufacturer -- by giving you your very best value.

Choose your MFJ tuner with confidence! You're getting proven performance and reliability from the most trusted name in antenna tuners. Don't settle for less.

Call or write for a **free** full-line MFJ catalog with all 10 of our tuners and tons of ham radio accessories!

MrJ Enterprises, Inc

STEWART ELECTRONIC COMPONENTS Pty Ltd

44 Stafford St Huntingdale : P.O Box 281 Oakleigh 3166

Don't forget Stewart Elec tronics STOCKS the full range of AMIDON Ferrites (send now for your FREE catalogue)

BankCard, VISA, M/C, welcome

Phone (03) 543 3733

Fax (03) 543 7238

4 inches high, 1000 MHz wide puts the world in your pocket

The New IC-R1 handheld receiver



Icom, still leading the way again in communications technology and miniaturisation with the world's smallest wide band receiver.

It's so small you could carry it in the palm of your hand or the pocket of your shirt.

Yes, an AM/FM and FM/W wide-band receiver that continuously covers 2 MHz - 905 MHz (Guaranteed specifications) and yet is small enough to carry anywhere.

Weighing in at a mere 280g (9.9 oz) this tiny package features **MULTI - SCAN FUNCTIONS** including programmed, memory,

selected mode and auto memory write with a capacity for **100 MEMORY CHANNELS**. Electronic locking of tuning control and keyboard prevents accidental frequency change, dual frequency selection, a built-in clock and timer functions - all running off an internal Nicad battery. The IC-R1 is equipped for high performance and is a "must have" item for any one on the move who is keeping up with the world and technology.

Find out more about the IC-R1 and the optional extras available - send in or phone for a free brochure - **BUT HURRY** - the R1 is selling fast!

Versatile Mobile

The New IC-R100 wideband receiver brings the world to your car

The IC-R100, with an ultra-wide band width of 500 kHz to 1800 MHz, was born of the technologically marvellous IC-R9000 (Icom's and the world's most sophisticated receiver). Operating from 13.8V DC with a built-in 15dB pre-amp to enhance weak signals (50 to 905 MHz), the IC-R100 is invaluable as a mobile and for base station use. Other features, such as an enormous **121 channel memory, built-in**

clock/timer and, of course, **multi-mode scanning** functions for VHF/UHF /MW/HF make this a most desirable receiver.

Compact, economical and easy to operate as a scanning radio, it's no wonder the IC-R100 is stimulating great interest. By satisfying the demands of shortwave and broadcast listeners, scanner enthusiasts as well as business and professional users, Icom again leads the way. Contact us

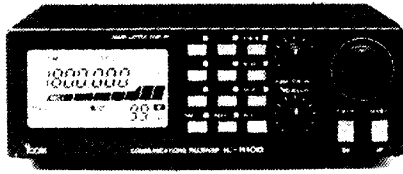

by Freepost or phone for the name of your stockist, colour brochures on the IC-R1, R100 and the complete range of Icom receivers - IC-R9000, IC-R7000, and IC-R71A.

For further information call Icom free on 008 338 915
Melbourne callers (03) 529 7582 Icom Australia Pty. Ltd., 7 Duke Street, Windsor 3181.
Icom Australia's warranty is only applicable to products purchased from their authorised Australian Dealers.



■ AMATEUR ■ MARINE ■ LAND-MOBILE ■ AVIATION ■ CB ■ AMATEUR ■ MARINE ■ LAND-MOBILE ■ AVIATION ■ CB ■ AMATEUR ■ MARINE ■ LAND-MOBILE ■

Please rush to me your brochure on the IC-R1, IC-R100 and the name of my nearest Icom stockist.

SEND TO: Freepost 15, Icom Australia Pty Ltd, Windsor, 3181 (no stamp required).

Mr., Mrs., Ms. Company Title

Address Suburb

City Post Code Phone No.

NCAA 4672 RR AR

■ AMATEUR ■ MARINE ■ LAND-MOBILE ■ AVIATION ■ CB ■ AMATEUR ■ MARINE ■ LAND-MOBILE ■ AVIATION ■ CB ■ AMATEUR ■ MARINE ■ LAND-MOBILE ■

AMATEUR RADIO

NOVEMBER 1990

RRP \$3



THE WIA RADIO AMATEUR'S JOURNAL

KENWOOD

TS-140S HF TRANSCEIVER

Why even look at a lesser rig when you can enjoy the famed *Kenwood competition edge* with the class-leading TS-140S HF transceiver?

- 160 to 10M operation — plus general coverage receive.
- All mode operation — great for modes like Packet too.
- 31 memory channels — store your frequency, mode and filter width.

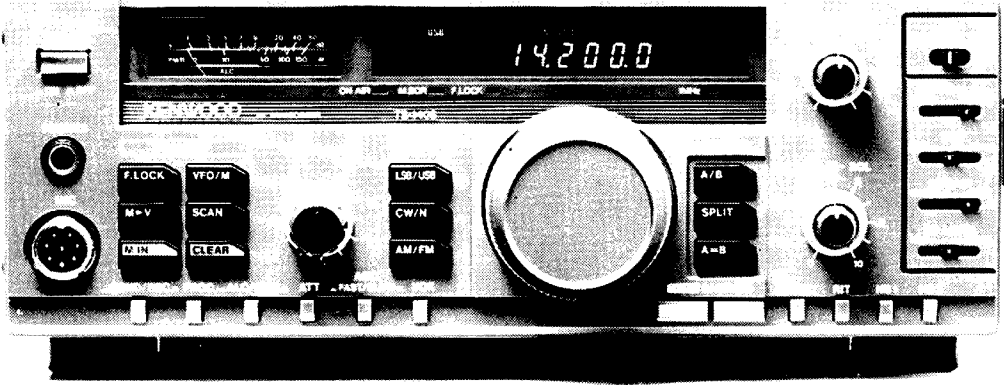

- CW full break-in, semi break-in and VOX
- 10Hz step dual digital VFOs — cross-mode split is a snap
- Full 102dB dynamic receive range
- Receiver noise floor -138dBm*

The only thing this attractive rig won't punch a hole in is your budget! It incorporates an outstanding 500 kHz to 30 MHz general coverage receiver with superior dynamic range, and combines the ultimate in compact size with advanced technology. You get a full 110 watts of SSB, 100 watts of CW, 50 watts of FM and 40 watts of AM on all HF amateur bands.

The TS-680S covers the exciting 6M amateur band as well as all the HF amateur bands. The TS-680S is similar to the TS-140S, but does not include vox, which is available as an option from your Kenwood dealer.

TS-680S HF + 6M TRANSCEIVER

Move up to either of these great Kenwood transceivers and you'll get great performance, both in the shack and out on the road.



* with optional 500Hz CW filter YK-455C-1.

KENWOOD ELECTRONICS AUSTRALIA PTY. LTD.
 (INCORPORATED IN N.S.W.)
 8 Figtree Drive, Australia Centre, Homebush, N.S.W. 2140
 Phone (02) 746 1519, (02) 746 1888, Fax (02) 746 1509
 Call now for further information and the name of your nearest authorised Kenwood dealer.

Please phone, mail or fax for information

Name.....

Address.....

..... Postcode.....

Publication..... Issue

Model.....



Amateur Radio is published by the Wireless Institute of Australia, as its Official Journal, on the last Friday of the previous month.

EXECUTIVE EDITOR	
Bill Rice	VK3ABP
MANAGING EDITOR	
Graham Thornton	VK3IY
NEWS EDITOR	
Jim Linton	VK3PC
SENIOR TECHNICAL EDITOR	
Peter Gibson	VK3AZL
TECHNICAL EDITORS	
David Brownsey	VK4AFA
Don Graham	VK6HK
Evan Jarman	VK3ANI
Peter O'Connor	VK4KIP
Gil Sones	VK3AUI
Phil Steen	VK4APA
Roy Watkins	VK6XV

DRAFTING	
Vicki Griffin	VK3BNK

MARKETING	
Bruce Kendall	VK3WL
Norm Eyres	VK3ZEP

ADVERTISING	
Ann McCurdy	

BUSINESS MANAGER	
Bill Roper	VK3ARZ

All contributions and correspondence concerning the content of Amateur Radio should be forwarded to: -

The Editor
Amateur Radio
PO Box 300
Caulfield South
VIC 3162

Registered Office
3/105 Hawthorn Road
Caulfield North VIC 3161

Telephone: (03) 528 5962
(03) 523 8191

Fax: (03) 523 8191
(Non dedicated line)

Business hours: 9.30am to 3pm
weekdays

Deadlines

	Editorial	Hamads
Dec	5/11/90	7/11/90
Jan	3/12/90	5/12/90
Feb	7/1/91	9/1/91

Delivery of AR: If this magazine is not received by the 15th of the month of issue, and you are a financial member of the WIA, please check with the Post Office before contacting the registered office of the WIA.

© Wireless Institute of Australia 1990

CONTENTS

Technical

A Ferrite Rod Loop for VLF	18
<i>Lloyd Butler VK5BR</i>	
'Fonest' SSB/CW Transmitter for 80m	10
<i>Drew Diamond VK3XU</i>	
The Commodore C64 Power Supply – Some problems and Symptoms	20
<i>Peter McAdam VK2EVB</i>	

General

Amateur Radio in Argentina	25
<i>Marcelo Franco VK4DWA/LU6DW and Joe Ellis VK4AGL</i>	
Amateur Radio in the USSR Part 2	27
<i>Yuri Zolotov UA3HR</i>	
Hungarian DXpedition	26
<i>Stephen Pall VK2PS</i>	
We're Off Air	23
<i>David G Barneveld VK4BGB</i>	

Operating

Awards	
British Post Code Award Rules	31
Contests	
Ross Hull Contest 1990-1991 Rules	32

Columns

Advertisers' Index	56	Morseword No 44	49
ALARA	41	Over to You - Members Opinions ...	51
AMSAT	42	Pounding Brass	35
Club Corner	49	QSLs from the WIA Collection	48
Divisional Notes		Random Radiators	37
VK2, VK3 Notes	46	Repeater Link	45
5/8 Wave	47	Silent Keys – Obituary	50
Editor's Comment	2	Spotlight on SWLing	40
Education Notes	39	Stolen Equipment	14
FTAC Notes	40	Technical Correspondence	22
HF Predictions	52	VHF/UHF and Expanding World	36
Hamads	54	WIA Directory	2,3
How's DX	33	WIA News	3
Intruder Watch	39	WICEN	47

Cover

Bonnie Lindsay VK3BBL pictured at her mobile rig. For full story see ALARA notes on p 41.

EDITOR'S COMMENT

BILL RICE VK3ABP EXECUTIVE EDITOR

Outback Odyssey

Back in July I really "stuck my neck out" when I said there was no doubt there would be sufficient depth for sailing on Lake Eyre by September, following the reports of the record floor in Cooper's Creek. In the middle of May the flow at Innamincka was 3500 cubic metres per second, and it didn't need much arithmetic to calculate that would fill the 27 cubic kilometres of Lake Eyre North in about three months, *if the flow stayed constant*. Of course, it did *not* stay constant. Instead of filling the lake by mid-August, the water had only reached the Cooper mouth on 17 August and, according to people who saw it, was not a flood but a trickle!

Nevertheless, a good Cooper flood is a rare sight, so (leaving the boat at home) your editor and his XYL set out for VK5 on 27 September, and

headed north from Adelaide on the 30th. In six days we covered almost 3000 kilometres, seeing such sights as the Strzelecki Track, with some water still in the Strzelecki Creek; the magnificent Cooper at Innamincka, a noble stream in the desert, but flowing at much less than one knot; and the road, barely even a track, from Innamincka north into Queensland. Four hundred kilometres of gibber plain! Sturt's Stony Desert all around. Still, we got through and made it to Birdsville, perhaps more than any other place the capital of the legendary Back of Beyond. Here is the other main river feeding Lake Eyre, the Diamantina. A big river too, with some water still, but no great flood. To fill the lake obviously needs record floods in both rivers at the same time.

South from Birdsville on the

famous Birdsville Track, 540 kilometres to Marree. Now a good enough road to cover its length in one day, even if it did write off one of our tyres in the process! By far the highlight of this leg (in fact, the main reason for the trip) was the ferry crossing of the Cooper, at least 100 metres wide at this point, and opening into a small lake with a big name, Killamperpunna, some two or three kilometres in diameter. From Marree back to Adelaide, with a night at Port Augusta, was back to sealed roads and civilisation!

I have held my amateur licence now for 43 years. For all that time my equipment has been "homebrew". But my trusty homebrew SSB rig is too big for the present car, so for this trip, and also to use in the boat, I "lashed out" and bought a new Japanese transceiver from one of our adver-

tisers. Editorial impartiality forbids me from naming the supplier or the model, but every day at 0300Z we checked into the Australian Travellers' Net, run so efficiently from Perth by Roy VK6BO and Peter VK6HH on 14.116 MHz. Helped by VK5RI, VK3BTS, VK3CAU, VK3CAY, VK2IV and VK4MX (forgive me if I err with these callsigns) they kept tabs on the daily whereabouts of 50 or 60 mobile tourist amateurs all over the continent. Not only that, but they have just begun an Indian Ocean maritime net at 1120Z daily, and have had up to 11 yachts participating there! A marvellous service, all callsigns computer listed. A fine example of philanthropy in the true amateur tradition. And, on that happy note, it's back into harness for the next issue.

73

Amateur Radio Service

A radiocommunication service for the purpose of self-training, intercommunication and technical investigations carried out by amateurs, that is, by duly authorised persons interested in radio technique solely with a personal aim and without pecuniary interest.

Wireless Institute of Australia

The world's first and oldest National Radio Society - Founded 1910

Representing Australian Radio Amateurs - Member of the International Amateur Radio Union
Registered Executive Office of the WIA: 3/105 Hawthorn Road, Caulfield North, Vic, 3161
All mail to: **PO Box 300, Caulfield South, Vic, 3162** Telephone: (03) 528 5962 (03) 523 8191
Fax: (03) 523 8191 (Non-dedicated line)

Business Hours: 9.30 am to 3.00 pm on Weekdays

General Manager and Secretary: Bill Roper VK3ARZ

EXECUTIVE

President:	Peter Gamble	VK3YRP	VK1 Federal Councillor:	George Brzostowski	VK1GB
Vice Chairman:	Ron Henderson	VK1RH	VK2 Federal Councillor:	Terry Ryeland	VK2UX
Treasurer:	Arthur Evans	VK3VQ	VK3 Federal Councillor:	Peter MacLellan	VK3BWD
	Kevin Olds	VK1OK	VK4 Federal Councillor:	David Jerome	VK4YAN
	Brenda Edmonds	VK3KT	VK5 Federal Councillor:	Bill Wardrop	VK5AWM
	Bill Rice	VK3ABP	VK6 Federal Councillor:	Neil Penfold	VK6NE
Immediate Past President:	David Wardlaw	VK3ADW	VK7 Federal Councillor:	Joe Gelston	VK7JG

FEDERAL CO-ORDINATORS

Amsat:	Graham Ratcliff	VK5AGR	Int'l Travel Host Exch:	Ash Nallawalla	VK3CIT
Awards:	Phil Hardstaff	VK3JFE	QSL Manager (VK9, VK0):	Neil Penfold	VK6NE
Act Contest Manager:	Neil Penfold	VK6NE	FTAC:	John Martin	VK3ZJC
Education:	Brenda Edmonds	VK3KT	Federal Tapes:	Ron Fisher	VK3OM
EMC:	Hans Ruckert	VK2AOU	Standards:	Roger Harrison	VK2ZTB
Historian:	John Edmonds	VK3AFU	Videotape:	John Ingham	VK5KG
Intruder Watch:	Gordon Loveday	VK4KAL	WICEN:	Leigh Baker	VK3TP

WIA NEWS

COMPILED BY WIA NATIONAL OFFICE STAFF

Band Planning Issues

In the October 1990 issue of Amateur Radio magazine, notes from Ron Henderson VK1RH provided some background information regarding international band planning. In particular you will recall the PRIMARY service has first choice of frequencies in the band segment under consideration, sometimes followed by a PERMITTED service, then by one or more SECONDARY services which may be allocated to the same band segment. You will also recall

that SECONDARY services shall not cause harmful interference to stations of the PRIMARY or PERMITTED services and cannot claim protection from harmful interference from such stations.

Having re-iterated those points, we now revisit the RF tag identification matter, a subject which has caused concern to some members. During 1989 WIANEWS advised of correspondence with DoTC on the subject. DoTC were seeking the WIA's views on the authorising of Radio Frequency tag identification devices of both passive and active nature in a number of

frequency bands. The proposal included the 9 - 14 kHz, 70 - 160 kHz, 3.025 - 3.4 MHz and 3.5 - 3.95 MHz segments and advised that "In the USA these devices may be operated without a licence as they have a very low probability of causing interference to other users of the bands."

Unfortunately, to the best of our knowledge, there is no international standard for RF tag devices. In the USA they operate under FCC Part 15, a USA regulation which has proven of concern to the ARRL. Naturally, the WIA can only comment upon the last frequency segment which extends across the Australian 80 metre amateur band.

The International (ITU) Radio Regulations allocate 3.5 - 3.90 MHz in Region 3 (the Region which includes Aus-

tralia) to AMATEUR, FIXED and MOBILE whilst 3.90 - 3.95 MHz is allocated to AERONAUTICAL MOBILE and BROADCASTING. From this you will see both band segments involved are allocated on a PRIMARY basis to several differing services with no delineating priorities. Moving nearer to home the 1982 Australian Table of Frequency Allocations makes an allocation of 3.5 - 3.7 MHz to AMATEUR, 3.7 - 3.9 MHz to FIXED and MOBILE and 3.9 - 3.95 MHz to AERONAUTICAL MOBILE (OFF ROUTE). These allocations are repeated in the new draft Australian Spectrum Plan 1990.

From these frequency allocation details you can see the DoTC proposal conforms with PRIMARY Regional allocations and PRIMARY Aus-

WIA DIVISIONS

The WIA consists of seven autonomous State Divisions. Each member of the WIA is a member of a Division, usually their residential State or Territory, and each Division looks after amateur radio affairs within their State.

Division	Address	Officers	Weekly News Broadcasts	1990 Fees
VK1	ACT Division GPO Box 600 Canberra ACT 2601 Phone (06) 247 7006	President Ted Pearce Secretary Jan Burrell Treasurer Ken Ray	VK1AOP 3.570 MHz VK1BR 2m ch 6950 VK1KEN 70cm ch 8525 2000 hrs Sun	(F) \$65.00 (G) (S) \$52.00 (X) \$39.00
VK2	NSW Division 109 Wigram St Parramatta NSW (PO Box 1066 Parramatta) 2124 Phone (02) 689 2417 Fax (02) 633 1525	President Roger Henley Secretary Tim Mills Treasurer David Horsfall (Office hours Mon-Fri 1100 - 1400 Wed 1900 - 2100)	VK2ZIG 1.845 MHz AM, 3.595 AM(1045) SSB (1915 only), 7.146 AM (1045 only) 10.125 SSB (1045 only), 28.320 SSB, 52 120 SSB 52.525 FM 144.12 (SSB), 147.000 FM(R) 438.525 FM(R) 584.750 (ATV Sound) 1281.75FM (R) Relays also conducted via many repeaters throughout NSW.	(F) \$59.00 (G) (S) \$47.00 (X) \$33.00
VK3	Victorian Division 38 Taylor St Ashburton Vic 3147 Phone (03) 885 9261	President Jim Linton Secretary Barry Wilton Treasurer Rob Hailey Office hours 0900-1600 Tue & Thur	VK3PC 1.840 MHz AM, 3.615 SSB, 7.085 SSB, 147.250 FM(R) Mt Macedon, VK3XV 147.225 FM(R) Mt Baw Baw VK3XLZ 146.800 FM(R) Mildura, 438.075 FM(R) Mt St Leonard 1030 hrs on Sunday	(F) \$65.00 (G) (S) \$52.00 (X) \$39.00
VK4	Queensland Division GPO Box 638 Brisbane Old 4001 Phone (07) 284 9075	President Murray Kelly Secretary Eddie Fisher Treasurer Eric Fittock	VK4AOK 1.825, 3.605, 7.118, 10.135, 14.342, 18.132, 21.175, 24.970, 28.400, MHz VK4ABX 52.525 regional 2m repeaters and 1296.100 0900 hrs Sunday VK4NEF Repeated on 3.605 & 147.150 MHz, 1930 Monday	(F) \$65.00 (G) (S) \$52.00 (X) \$39.00
VK5	South Australian Division 34 West Thebarton Rd Thebarton SA 5031 (GPO Box 1234 Adelaide SA 5001) Phone (08) 352 3428	President Rowland Bruce Secretary John McKellar Treasurer Bill Wardrop	VK5OU 1820 kHz 3.550 MHz, 7.095, 14.175, 28.470, 53.100, 145.000, 147.000 FM(R) Adelaide, 146.700 FM(R) Mid North, 146.900 FM(R) South East, ATV Ch 34 579.00 Adelaide, ATV 444.250 Mid North (NT) 3.555, 146.500, 0900 hrs Sunday	(F) \$65.00 (G) (S) \$52.00 (X) \$39.00
VK6	West Australian Division PO Box 10 West Perth WA 6005 Phone (09) 388 3888	President Alyn Maschette Secretary John Farnan Treasurer Bruce Hedland - Thomas	VK6KWN 146.700 FM(R) Perth, at 0930 hrs Sunday, relayed on 3.560, 7.075, 14.115, 14.175, 21.185, 28.345, 50.150, 438.525 MHz Country relays 3582, 147.350(R) Busselton 146.900(R) Mt William (Bunbury) 147.225(R) 147.250 (R) Mt Saddleback 146.725(R) Albany 146.825(R) Mt Barker Broadcast repeated on 3.560 at 1930 hrs.	(F) \$56.00 (G) (S) \$45.00 (X) \$30.00
VK7	Tasmanian Division 148 Derwent Ave Lindisfarne TAS 7015	President Tom Allen Secretary Ted Beard Treasurer Peter King	VK7AL 146.700 MHz FM (VK7RHT) at 0930 hrs Sunday relayed on 147.000 (VK7RAA), 146.750 (VK7RNW), 3.570, 7.090, 14.130, 52.100, 144.100 (Hobart) Repeated Tues 3.590 at 1930 hrs	(F) \$63.00 (G) (S) \$50.00 (X) \$38.00
VK8	(Northern Territory) is part of the VK5 Division and relays broadcasts from VK5 as shown (received on 14 or 28 MHz).			

Note: All times are local. All frequencies MHz.

Membership Grades Full (F) Pension (G) Needy (G) Student (S) Non receipt of AR (X)
Three year membership available to (F) (G) (X) grades at fee x 3 times

lian allocations in the segment 3.7 - 3.9 MHz. You can also see that below 3.7 MHz DoTC are free to make an Australian SECONDARY allocation should they so desire.

This means that, in the real world, the WIA cannot stop an allocation by DoTC provided it is within the ITU Radio Regulations. Therefore the tactics the WIA adopts must be chosen to have a chance of succeeding. The approach the WIA took in this instance was to examine the proposed power levels and consider the circumstances in which those powers might be radiated.

The WIA considered applications might include tagging shipping containers for air, sea and road services. As these generally are located in industrial areas when interrogation might occur, this gave the WIA a feel for the comparison of their radiated signals with the prevailing man made noise level powers. The WIA also considered that RF tag devices might be used for tagging high value articles in shops, for pets and for imprisonment in the home. This led the WIA to do the noise power comparison against "quiet rural" CCIR standards.

As the comparison was unfavourable, the WIA advised DoTC it could not accept the proposal, a fact which was reported in WIANEWS last year.

DoTC responded at a later date confirming some of the WIA's calculations and proposing a significantly lower power level for the 3.5 - 3.7 MHz amateur PRIMARY service segment. As that power level now equated to the CCIR "quiet rural" figures the WIA replied it believed the level was acceptable to the amateur community.

In practice, at a distance from the devices, their radiations would only be detected by long term monitoring of the noise floor level.

The WIA did not "give permission" for a SECONDARY service on 80 metres. It did ensure the possible SECONDARY service proposal by

DoTC was at an adequately low noise power level so as to be barely discernible.

This was also reported in a later edition of WIANEWS last year and the WIA's insistence on the issue by the Minister of an Australian standard for RF tag devices was also reported in some detail. The WIA has also advised the three IARU Regions, the ARRL and the RSGB about these RF tag device proposals.

In making its response the WIA considered the frequency of use and potential locations of RF tag devices and was of the opinion their nuisance was of a similar order to the routine ionosonde and allied scanning radiations that regularly sweep across the HF bands.

When arguing issues such as this the WIA must make a risk analysis, for we cannot "cry wolf" all the time and take every issue to the Minister. The WIA has, and will, continue to pursue with all vigour issues we believe we have a reasonable chance of winning (do you watch Rumpole?). In addition, we will always do damage control assessments and action on the other issues.

Summing up, DoTC and not the WIA make frequency allocations in Australia and, unlike some other nations, the WIA is not aware of any legal obligation upon DoTC to consult with other spectrum users. Fortunately, it is the current government's policy to seek public comment, so the WIA is able to influence those issues where the considerations support the radio amateurs' case.

Amateur Radio Magazine

Without question Amateur Radio magazine is the most tangible advantage offered to Australian radio amateurs as a benefit of membership of the WIA. It is the "flagship" of WIA efforts to gain new membership and retain existing members.

Amateur Radio magazine has a great, 58 year history of

production, mainly by volunteers. But, let us all face reality. The production of the present magazine is mostly the work of the paid Managing Editor, Graham Thornton, and the paid staff of the Executive Office. The volunteer effort has rapidly declined in recent times to just a handful of people.

Amateur Radio has been, and still is, an ad hoc publication. The editorial policy remains that everything submitted by members is published (unless totally and irresponsibly incorrect), more or less in the order received, and with a minimum of editing.

Since its inception Amateur Radio has been treated primarily as a membership technical journal, with technical articles being the first priority. But the winds of change are blowing relentlessly through amateur radio right around the world. The true amateur experimenter, who actually constructs and/or repairs his radio equipment, is rapidly becoming a smaller and smaller minority. The "technicians" amongst radio amateurs are no longer sufficient to justify a primarily technical journal.

The best technical amateur radio magazine in the world, "Ham Radio" has just folded; "QST" and "Radio Communications", the two leading amateur radio society journals in the world, have been relentlessly moving further away from their traditional roles as technical journals in response to the changing needs of their readers.

The WIA believes it is important to the future of the WIA that Amateur Radio magazine also consider change.

Should Amateur Radio magazine change from a primarily technical journal?

Should technical articles generally tend more towards add-ons (preamplifiers, antennas and ATUs, power supplies, etc, etc); modifications to existing equipment; weekend projects; and items of particular interest to the new or be-

ginning amateur, rather than complete transceivers?

Should technical reviews of radios and ancillary equipment take a much higher profile?

Should book reviews appear in each issue? Should a column for the new, non-technical amateur be introduced?

It is your magazine. What do you think?

Amateur Radio 20 Year Index

Since its introduction early last year, the Amateur Radio magazine 20 Year Index, available to WIA members on an IBM format 5 1/4 inch floppy disk in either ASCII or dBase .DBF file, or as hard copy, has proved to be very popular.

The index starts from the January 1968 issue of Amateur Radio, and is now almost a 22 year index. As a further service, the index has now also become available from the Executive Office of the WIA on an IBM format 3 1/2 inch floppy disk at the same low price of \$10.00, which includes the disk, packing and postage.

WIA and Jordan Activities

From the outset it must be stated the WIA neither sponsors, supports nor decries amateur activities concerned with refugee relief in Jordan. The WIA's policy on assistance to the civil community is contained in two policy statements adopted by Federal Council in 1983.

The first concerns WICEN, that arm of amateur radio devoted to providing communications, upon request, to disaster control agencies within Australia. Any national or international requests to WICEN would come through the Australian Government coordination agency, the Natural Disasters Organisation whose headquarters is in Canberra. Incidentally, no such requests have been received concerning Jordan.

The second policy statement is concerned with third party traffic nets. The WIA recognises these as but one of the many facets of amateur radio operating and as such supports third party traffic nets conducted within the DoTC regulations. Australian amateurs are free to take part in any international traffic nets provided they operate within the conditions of their licences. There are conditions, also, on soliciting for traffic.

The Australian amateurs seeking support to provide relief communications for refugees in Jordan are doing so as individuals. They have not sought WIA support or sponsorship and, to their credit, they have never implied any such support.

Regrettably some vocal and less informed amateurs have seen fit to denigrate those efforts, possibly in a libellous way and, by their actions, bring discredit upon the Australian amateur service. The WIA implores them to use the correct channels of debate through their WIA Divisions. The packet media is a powerful means of spreading information, therefore care must be taken to keep it as accurate as possible.

Incidentally, for those genuinely interested in disaster communications, the WIA recommends the report to the ARRL Council published in QST for March and April 1990. The real effectiveness of amateur communications is assessed in an analytical and impartial manner.

ARRL Emergency Communications

The American Radio Relay League (ARRL) set up a National Emergency Response Committee (ANERCOM) which recently made its final report to the ARRL's Board of Directors. The summarised report is contained in QST for March and April 1990. It includes a number of matters which will be of interest to Australian amateurs, particularly those involved in emer-

gency communications.

The report initially identifies the role of the IARU and the supported agencies in the USA; it then goes on to examine in some detail the several issues which are set out below.

Data Base

The need for a current data base, containing telephone numbers and addresses of amateurs active in emergency communications is seen as essential for the controlling agency.

News Media Interface

The ability to provide accurate information to news agencies is identified, observing that this activity must be handled well to obtain the maximum exposure for the amateur service.

Traffic Nets

Disaster nets are arenas of high tension and anxiety. People accustomed to day-to-day net controlling are sometimes completely out of their element during an actual emergency. ANERCOM observes a need for special training for net controllers.

To quote: "ANERCOM has wrestled with the question of health-and-welfare (H&W) traffic. H&W inquiries should flow out of the affected area to concerned relatives and friends. One such outgoing message can potentially head off half a dozen ingoing messages. Also, most H&W traffic sent from outside the affected area to the victims of the disaster remain undelivered. This is because the lack of telephone service, dislocation of the population and a general inability to deliver H&W traffic when more strategic needs of the population must be met with limited communications resources.

The Committee considered recommending a policy of non acceptance of "incoming" H&W traffic. It weighed the possible loss of credibility by not delivering much of the traffic against the eagerness of the Amateur Radio population at large to accept such traffic regardless of consequence. It decided that the following procedure was the

Club Contest

BOOST YOUR CLUB FUNDS

Help your club and give added strength to the WIA to protect Amateur Frequencies from Government and Commercial Attack

HOW?

Simple! Sign up a new member between 1st October and 31st December 1990 and the WIA will pay your radio club a recruitment fee of \$5.00.

In addition, the club which signs up the most new members wins a free three year membership of the WIA PLUS three great amateur radio books for the club library.

Every radio club is a winner in this competition! The WIA is a winner! The amateur radio service in Australia is a winner!

WHO CAN ENTER THIS CONTEST? Every radio club in Australia which holds an amateur call sign, whether the club is affiliated with the WIA or not.

WHO QUALIFIES TO BE A NEW WIA MEMBER? Any person in Australia who has not been a member during the immediately prior 12 months.

HOW DO YOU SIGN UP A NEW WIA MEMBER? If your club does not have a supply of WIA membership application forms, then use the form printed on the back of every Amateur Radio magazine fly sheet - even photocopies of that form will suffice.

WHERE DO YOU SEND THE NEW WIA MEMBER APPLICATION? Send the application, together with the full membership fee as shown on page 3 of Amateur Radio magazine, to your local WIA Division.

HOW DOES YOUR CLUB CLAIM ITS FEE? The club secretary writes, on club letterhead, to "WIA Club Contest, PO Box 300, Caulfield South, 3162" with details of the new WIA member. At the end of each month of the contest a cheque for the total amount of all \$5.00 recruitment fees due to the radio club will be forwarded.

The club which wins the grand prize of a free three year membership of the WIA, plus books for the club library, for signing up the most new WIA members, will be announced in February 1991.

Get to work now in this great fund raising contest where everybody is a winner!

best compromise:

1. Accept incoming health and welfare traffic, but advise the sender the chances of delivery are slim or at the best delayed.

2. Send the H&W traffic to the closest point of delivery until it can be taken into the affected area and processed.

3. Work towards better collection of outgoing H&W traffic from the affected area. [Work with supported agencies to prepare potential victims to carry names, addresses and phone numbers of friends and relatives they would want to notify. Their address books should be on the list of evacuation supplies taken with them to shelters.]

4. Work with IARU member organisations to establish better H&W traffic collection procedures in shelters and displaced-person camps."

Gateways

Gateways to interconnect multiple modes of transmission and multiple nodes are starting to appear. Their further development around the country is recommended by ANERCOM.

Software and Hardware

The automation of gateways relies heavily on the development of additional firmware which will automate many of the processes now requiring operator intervention. The next logical step is to be able to port messages between any digital modes through multiple ports of a single computer. This should include CW, RTTY, AMTOR, packet and land-line ASCII transfer.

Message Format

Message format remains perhaps the most controversial issue of H&W disaster communications. For example AMTOR does not support the full ASCII character set and there is perhaps a reluctance to adopt ARRL message numbers. ANERCOM feels that message simplification is important, as long as message numbers are translatable in the disaster area. They propose the ARRL message numbers be recommended to IARU for international use.

Standard Operating Procedure

The "watch officer" concept proposed by ANERCOM is the key to activating the Standard Operating Procedure (SOP). Its broad components include:

(A) Telephone call-up of supported agencies and amateur officials to establish continuous liaison for the duration of the emergency;

(B) W1AW activation by the Net Manager;

(C) W1AW activation as an emergency station with a presence on IATN;

(D) Activation of the W1AW emergency bulletin schedule;

(E) Offering of equipment or personnel assistance to the affected areas; and

(H) ARRL HQ's interface with news media.

Debrief

In the aftermath of a given disaster, ANERCOM proposes that the ARRL critique its response with the supported agencies.

How Does This Affect the WIA? Well, many of the points observed by the ANERCOM are applicable to amateur radio emergency communications in Australia. The matter of acceptance and delivery of H&W traffic into a disaster area is very pertinent, so much so that the WIA would strongly advise against soliciting for such inwards traffic, despite the natural inclination of amateurs to try to help in this manner.

The WIA, through its WICEN organisation, has observed in the past the role of the amateur operator in emergency situations is to provide the initial response, before the regular communications services can be re-established. This means the amateurs' involvement tapers off after a few hours or days and amateur communications can then be stood down. To that end it is generally the amateur operators on the spot who can provide that first response and it is they, or in reality every amateur, who must be prepared to operate in an emergency.

Frequency Management Submission

The House of Representatives Standing Committee on Transport, Communications and Infrastructure recently called for submissions from the public on management of the radio frequency spectrum. The WIA responded in writing and offered to give verbal evidence to the committee if required.

The WIA said that in circumstances where a single agency would manage the spectrum it would be difficult to go beyond the services already provided by DOTC. The one reservation the WIA had was the apparent inability of the Department to effectively control unauthorised use of the spectrum. One advantage of this arrangement is the proximate nature of the licensing and regulatory responsibilities.

An alternative management structure would be to appoint several agencies, with the division of responsibilities determined by customer requirements or application areas. Thus one could envisage separate agencies dealing with, for example, coastal and maritime, aeronautical, land mobile, broadcasting, amateurs and so on. In these circumstances the WIA would have to consider bidding for the agency responsibilities for amateur spectrum.

In respect of equitable access to spectrum, the WIA believes national adherence to the ITU Radio Regulations for amateur allocations within Region 3, suitably modified because of geographic and regional considerations associated with the size and remoteness of our continent, is the minimum acceptable situation.

The WIA responded to the recently issued draft Australian Spectrum Plan, drawing attention in particular to circumstances where proposed sharing could lead to interference problems with international amateur radio satellites. The WIA also proffered the view that issue of a new plan

only a year before WARC 92 could lead to difficulties, for the plan could have only a limited life for some frequency bands. A revised plan immediately after the WARC, incorporating its decisions, was preferred.

The WIA believes allocation of spectrum to users with highest value smacks of "selling off spectrum" to the highest bidders, without regard to its true worth to humanity on the broader scale. The intrinsic implication that financial overtures determine its real worth is emphatically denied.

A similar review was conducted several years ago in the United Kingdom and the analogy was made in the report (*"Deregulation of the Radio Spectrum in the UK"* by CSP International, HMSO.) to land and its use. Crown land was available for lease or sale but small pockets were designated parks for public recreational use by non-commercial interests. In the radio spectrum those parks equate to amateur allocations (and to a much lesser extent Citizens Band (CB) channels). The WIA would defend any attempts to "sell off" amateur spectrum to amateur or other users.

It is extremely difficult to devise an equitable valuation system for non-commercial spectrum. Some of that spectrum enhances a nation's research and development capability (industrial, scientific, and medical), some contributes to international space research. With regard to amateur spectrum, the secondary worth to Australia of self training, intercommunication and technical investigation is hard to cost. However, due acknowledgment must be made of its use by youth as well as by senior citizens in this age of "increasing leisure time".

The WIA holds the views that spectrum management must be responsive, but in a smooth and steady manner without major upheavals, except perhaps where external influences such as WARC's intrude. The system must also be matched to the life of the

equipment installed, for commercial owners must be able to amortise capital investments over a reasonable number of years without being forced to adopt the latest technology. Indeed, changes in technology should be the driving influences for changes to allocations, with obsolete and spectrum inefficient technology being permitted for an additional equipment generation if spectrum permits, but at a service use (licence) premium.

For the amateur, the nature of equipment sources suggests broad application standards can be applied through the setting of permitted modulation modes and bandwidths, not unlike the current licence conditions in DOC71.

The WIA cautioned against setting high profit demands, for the associated high use fees (licences) inevitably lead to unauthorised operation, a problem the present spectrum management agency (DoTC) is not coping with well. Indeed, the matter of regulatory constraints was not specifically addressed in the Terms of Reference and is a difficult consideration.

The WIA asked would these regulatory powers be also devolved to the spectrum management agencies and would the agencies be able to achieve a better track record of prosecutions than DoTC's dismal performance? The WIA has its serious reservations on this matter.

The WIA is also concerned that the need for profits would be greater with agencies, for not only do the agencies have to make a profit on their operations, but also portion of those profits must finance regulatory activities (for the fines will be inadequate), before a surplus can be provided to government revenue.

It is the present experience of the amateur service that little regulatory effort is expended upon its complaints and any devolution of spectrum management to agencies will only exacerbate the cost to service ratio. Conse-

quently, in examining any proposals to create spectrum management agencies, the WIA recommended it would wish to see each application specific agency working to its own specific government directed profit formula, which would closely relate costs to quality of services provided.

WIA Badges

Are you aware the WIA has two badges? Yes, in addition to our historical emblem, based on the Australian map, including Tasmania, a sore point from the early 40's, with superimposed "wings" and "lightning flash", we also have an alternative badge. It's fashioned around the international amateur radio diamond badge, used in various forms by most of our sister societies.

It was approved as an alternative WIA badge at the 1980 Federal Convention, the final design being derived from an idea put forward a year or two earlier by Bill Roper, VK3ARZ, now the WIA General Manager. This badge is diamond shaped, bears an antenna and an earth symbol, connecting to a capacitor in the centre. Between the plates of the capacitor appears our logo WIA.

For those interested in history, our winged emblem has a long and ancient background. It appears to have been designed a year or two before 1922. The "wings" and "lightning motif" are said to have derived from an Army Wireless Unit badge of World War 1. They also formed a large part of the RAAF Wireless Reserve emblem authorised in 1935.

If you are thinking of going overseas, and wish to be recognised internationally as a radio amateur, we suggest you procure one of these diamond badges. Divisional bookshops hold stocks or you can send \$4.00 to the Executive Office for one.

Contest Rules

Each year, at the Federal Convention, when the Federal Contest Coordinator reports

M A G P U B S

ANTENNA BOOKS

The ARRL Antenna Handbook 15th Edition	#BX101	\$36.00
Antenna Compendium Volume 1 ARRL	#BX103	\$22.00
Antenna Compendium Volume 2 ARRL	#BX202	\$24.00
Antenna Compendium Volume 2 & IBM PC Disk ARRL	+#BX204	\$36.00
Antenna Impedance Matching ARRL	#BX257	\$30.00
Yagi Antenna Design ARRL	#BX104	\$30.00
W1FB's Antenna Notebook Doug DeMaw ARRL	#BX179	\$20.00*
Novice Antenna Notebook Doug DeMaw ARRL	#BX102	\$18.00
Practical Wire Antennas John G. Heyo G3BQD RSGB	#BX206	\$28.00
HF Antennas L.A. Maxon G8XM RSGB	#BX206	\$28.00
ANTENNAS 2nd Edition John D. Kraus W5JK	#BX250	\$104.00
Antenna Handbook William I Orr W5SAI & Stuart D Cowan W2LX	#BX217	\$17.30
Vertical Antenna Handbook I Orr W5SAI & Stuart D Cowan W2LX	#BX220	\$15.55
Beam Antenna Handbook W I Orr W5SAI & S D Cowan W2LX	+#BX215	\$18.30
Wire Antennas William I Orr W5SAI & Stuart D Cowan W2LX	#BX215	\$17.30
Cubical Quad Antennas W I Orr W5SAI & S D Cowan W2LX	#BX214	\$14.50
The truth about CB Antennas W Orr W5SAI & S D Cowan W2LX	#BX219	\$17.30
Transmission Line Transformers J Sevcik W2FMI New 2nd Ed	+BX134	\$40.00

SATELLITE BOOKS

Oscar Satellite Review Dave Ingram K4TWJ	#MFJ-31	\$17.00
Satellite Experimenters Handbook Martin R Davidoff ARRL	#BX177	\$25.00
Satellite Anthology The ARRL	+#BX180	\$18.00
AMSAT-NA 5th Space Symposium 1987 AMSAT-ARRL	+#BX182	\$17.50
AMSAT-NA 8th Space Symposium 1987 AMSAT-ARRL	+#BX180	\$17.50
SPECIAL the 2 books 5th & 8th Symposium	+#BX6007	\$25.00
Space Almanac Anthony R Curtis ARRL	#BX290	\$40.00

PACKET RADIO BOOKS

Gateway To Packet Radio Stan Horzepa W4LLOU 2nd Edition	+ #BX100	\$24.00
The Packet Users Notebook Buck Rogers W4ABT G0	#BX205	\$18.50
Packet Radio is Made Easy Buck Rogers W4ABT MFJ	#MFJ32	\$20.50
AX.25 Link Layer Protocol ARRL	#BX178	\$18.00
Computer Networking Conferences 1 - 4 1981 to 1985 ARRL	#BX100	\$38.00
Computer Networking Conferences 5th 1986 ARRL	#BX107	\$20.00
Computer Networking Conferences 6th 1987 ARRL	#BX108	\$20.00
Computer Networking Conferences 7th 1988 ARRL	#BX109	\$25.00
Computer Networking Conferences 8th 1989 ARRL	#BX295	\$24.00
SPECIAL - All 5 Books - Conferences 1 to 8	+#BX5008	\$80.00

VHF/UHF/MICROWAVE

RSGB Microwave Handbook Volume 1 M W Dixon G8PFR RSGB	#BX310	\$70.00
VHF-UHF Manual George Jessop G8JF RSGB	#BX267	\$46.00
all about VHF amateur Radio William Orr W5SAI	#BX216	\$17.30
21st Central States VHF Conference 1987 ARRL	+#BX172	\$17.50
Mid-Atlantic VHF Conference Oct 1987 ARRL	+#BX175	\$17.50
22nd Central States VHF Conference 1988 ARRL	+#BX173	\$17.50
23rd Central States VHF Conference 1989 ARRL	+#BX286	\$17.50
Microwave Update 1987 Conference ARRL 1987	+#BX174	\$17.50
Microwave Update 1988 Conference ARRL 1988	+#BX174	\$17.50
Microwave Update 1989 Conference ARRL 1989	#BX213	\$24.00
UHF Compendium Part 1 & 2 Volume 1	#BX260	\$49.95
UHF Compendium Part 3 & 4 Volume 2	#BX261	\$49.95

HANDBOOKS

ARRL 1990 Handbook ARRL Herd Sound	#BX207	\$52.00
The Operating Manual ARRL	#BX102	\$30.00
The ARRL Electronics DATA BOOK ARRL	#BX201	\$24.00
Radio Data Reference Book G.R. Jessop RSGB	#BX109	\$38.00
Radio Communication Handbook Fifth Edition RSGB	#BX296	\$58.00
Radio Handbook 23rd Edition William I. Orr W5SAI	#BX22424	\$49.50
Motorola RF Device Data Motorola 6th Edition 2 Book Set	4BX8047	\$24.50

MAPS

Prefix Map of the World Radio Publications	#BX234	\$8.00
Prefix Map of North America Radio Publications	#BX235	\$8.00
Radio Amateurs World Atlas Radio Publications	#BX236	\$8.00
Madinhead Locator - World Grid Atlas ARRL	+ #BX197	\$10.00

The above books, plus many more, are available from your WIA Divisional Bookshop. All items are less 10% discount for WIA Members and are plus postage and handling where applicable. All Prices are Subject To Change With-out NOTICE if not in stock at your Divisional Bookshop, your order will be taken and filled promptly. Not all publications are available from all Divisions. * Price Change .. -# price Reduced .. + Price Increase

to Council, much discussion, some anguish, and considerable hot air is expended in considering the report. Motions are made to change contest guidelines and the annual cycle is repeated once more. Sadly, it appears as though we are not making a lot of constructive progress in refining our contests, that is if one is to believe the views expressed over the air and in print in the "Over to You" columns of Amateur Radio magazine.

At the 1990 Federal Convention the WIA, observing the heavy workload and constant abuse heaped upon the Federal Contest Manager, who incidentally is appointed for a three year term, divided up the duties. There is now one Federal Contest Coordinator, Neil Penfold, VK6NE, and a Contest Manager for each of the five WIA managed contests. The Contest Managers set the rules, working within Council guidelines, provide Amateur Radio magazine with contest notices, score the logs and provide the results for publication and issue of certificates and trophies by the Executive Office.

How does this affect you? Well, if you are unhappy with any contest rules put your thoughts down on paper, not forgetting to provide full reasoning, and send them off to Neil Penfold, or to the Executive Office, and they will be forwarded to the appropriate Contest Manager.

Incidentally, the WIA is looking to standardise on a log sheet format and a common front cover sheet layout for all our contests. In due course they should appear as sponsored inserts in Amateur Radio magazine for you to use as photocopy masters.

FTAC Communications

The Chairman of the Federal Technical Advisory Committee (FTAC), John Martin VK3ZJC recently reported to Executive that he had an effective network in place for technical communications with the Divisions.

John has a communicating member in each Division and, whilst the turnaround of mail is not that fast, he is generally getting answers. This has prompted John to ask, are those answers the consensus view of members? Do Divisions include FTAC news in their broadcasts and at meetings, or does the FTAC representative give the answer he or she believes applies with minimum consultation?

To provide an additional avenue for FTAC news John regularly provides notes for inclusion in Amateur Radio magazine. Do you read his column and do you pass your views to your local FTAC correspondent or Federal Councillor, or even write to John?

Remember, the quality of our technical decisions are only as good as the information John receives.

WARC 92 Donations

It was pleasing to see that the Amateur Radio News column in October's issue of Electronics Australia made mention of the WIA's role in commenting on proposed changes to the Australian Spectrum Plan.

The article quite forcefully made the point that "*the WIA is essentially acting in the interest of all Australian amateurs, not just those who are its members. Any privileges gained as a result of WIA representations are always available to non-members, as well as members. However, representing the interests of Australian amateurs in both national and international decision making arenas is costly, and funded directly by WIA members. Its therefore a good idea for as many hams as possible to lend both their moral and financial support to the WIA, by joining up.*"

It naturally follows that the WIA would be pleased to receive donations to the WARC 92 fund, and at this point acknowledgment must be made of the substantial donations received from a couple of radio clubs, and several individuals.

Has your club considered making a collection or running a raffle at a hamfest or on a meeting night and donating the proceeds to the WIA WARC 92 fighting fund?

Canadian Amateur Licence Restructure

News is to hand that the restructured Canadian Amateur Service commenced from 1st October. Interesting changes include the introduction of a new entry level licence.

This Basic Qualification examination consists of 100 multi-choice questions, 25 on regulations and the remainder on radio theory and operating procedures. The holder of this entry level licence may operate on all amateur frequencies above 30 MHz, using all classes of emission, but must not use "*home built transmitters*".

If the holder of the Basic Qualification licence also holds a 5 WPM Morse Qualification, they may additionally operate on all amateur frequencies below 4.00 MHz, but again must not use "*home built transmitters*".

WIA Membership

The Australian amateur service has WARC 92 looming on the horizon, and is subject to rapidly increasing commercial pressure on our frequencies. This is a time when a financially strong WIA is particularly needed, both in Australia and internationally.

What a pity that government fiscal policy is presently creating such economic difficulties.

In the past six months, although the number of new members joining the WIA has held steady, the number of existing members dropping out has increased.

The most common reason for non-renewal of membership is financial hardship. Many such people advise that they still support the WIA, but economic conditions have forced them to re-assess their financial priorities.

Of the 18,000 plus licensed radio amateurs in Australia only 7000 are presently members of the WIA. **This means that over 13,000 Australian amateurs are not supporting the fight, nationally or internationally, to protect our frequencies or privileges!**

Think about this for a moment. If WIA membership increased by a mere 3,000 to 10,000, membership fees could be reduced by up to \$20.00. Just imagine how low fees would be if all Australian amateurs were members of the WIA.

When was the last time you signed up a new WIA member?

Equipment Seized by DoTC

A press release from DoTC advises that regulatory officers from DoTC recently co-operated with South Australian police in a raid on "pirate" radiocommunications operators in the Adelaide area.

Scanning receivers, CB radios and modified commercial transceivers were seized in the raid.

DOC 72

The small pamphlet issued by DoTC as DOC 72, and which contains the "*Amateur Service - Operating Procedures*", was first published in March 1989. An updated version was published in July this year and, with the co-operation of the Department of Transport and Communications and the Australian Government Publishing Service, the latest copy of DOC 72 is included as an insert to this November 1990 issue of Amateur Radio magazine.

This pamphlet, together with DOC 71, which was included as an insert to the October 1990 issue of Amateur Radio magazine, means that all magazine receiving members of the WIA now have a copy of the latest Australian amateur service regulations.

Another service to members from the WIA.

Best Antenna Article

Feedback received from members indicates that they were impressed with the October 1990 "Special Antenna Issue" of Amateur Radio magazine.

The Publications Committee certainly found it interesting because there has been prolonged argument as to which author should receive the prize for the best article published. Part of this decision making difficulty arose when it was pointed out to the Committee that the articles by Bill Rice and Bill Roper

had to be classed as ineligible.

Finally, after much debate, the prize has been awarded to Mr. N. Chivers VK2YO, for his article "160m Helical Vertical". VK2YO receives a free one year membership of the WIA as his prize. Congratulations.

Intruder Watch Log Sheets

Are you an active member of the WIA Intruder Watch team?

The Intruder Watch service, or as it is more generally known overseas, the International Amateur Radio Union

Monitoring Service (IAR-UMS), is a very important function of organised amateur radio in the fight to protect amateur service frequencies.

Monitoring the amateur bands for unauthorised intruders (transmissions emanating from governmental, commercial or military sources), is a time consuming and precise task.

However, if the authorities are to be convinced that intruders are causing harmful interference to the amateur service, then they are not going to be convinced by the occasional report. The WIA Intruder Watch service needs a lot more reports if they are

going to have any success.

Through the co-operation and generosity of Dick Smith Electronics, there is an Intruder Watch log sheet fastened in the centre of this issue of Amateur Radio magazine. Use this form to get yourself started as an Intruder Watcher!

Your monthly reports should be sent to your Divisional Intruder Watch Co-ordinator. You don't know who he is? Contact your Division and find out (see page 3 of this magazine for your Division's telephone number and postal address).

Let us all participate in the ongoing fight to protect OUR frequencies! ar

USE IT OR LOSE IT BURGEONING PROBLEMS

MAX STARK VK2CMS BOX 89 KORALEIGH 2735

Pirates on 10m using AM CB equipment with 10kHz channel spacing have been with us for several summers now. Although a good indicator of propagation conditions, it disturbs most of us, particularly those who saw the takeover of 27 MHz and eventual loss of that band.

Peter VK2EVB and Gordon VK4KAL point out in 'AR' June 1990 that the Amateur Service is primary in the 28MHz band. All the more reason to worry about the current Asian invasion for, like a cancer, it will spread. So far, in 'AR' I have seen no authoritative statement on the the equipment or country the clutter emanates from (go on, shoot me down).

Regarding Indonesia, the economy makes unlikely that sort of equipment proliferation. Many people work for \$A10 to \$A15 per week and this can cover little but essentials. I am referring to Bali, but I expect it is the same in Java and Sumatra.

Indonesian licensing is tightly controlled, with no reciprocal rights for visitors. I found only one shop in Denpasar selling amateur radio equipment, and was

told an Indonesian amateur licence was essential to the purchase of transmitting equipment. In Australian dollars the equipment prices were little lower than ours, so there was no advantage in buying gear to take home. There are better things to spend the duty-free allowance on! There are several shops in Denpasar and Kuta selling consumer electronics: organs, stereos, TVs, VCRs, portable radios etc, but any enquiry for CB equipment was difficult to communicate, and finally dismissed with an apologetic shake of the head.

It seems the pirates are running 40Ch AM CB sets both hand-held/mobile and base-station. I believe hand-helds are in there because of poor frequency stability under modulation. This suggests battery operation and/or declining batteries. Some signals are better, with a steady heterodyne and recoverable audio. In none have I detected any Bahasa Indonesian language, which also cancels out Malaysia, as Bahasa Indonesian is derived from Malay. Somebody in a recent 'AR' said the signals emanated from Thailand. This I could believe, because I can't understand

Thai, and I can't understand the pirates. But then again, we know the Khmer Rouge has guns, but what does it do for communications?

Having modified a PLL JV352D from 27 MHz to 28 MHz, I envisage little problem in a manufacturer of CB sets reversing the frequency logic and kicking his production line from 11m to 10m. Someone would probably be able afford the things. Back to Indonesia. With a basic paycheck of, say RP15,000 per week (RP = Rupiah), and consumer electronics not much cheaper than VK-Land, do you see the population rushing forth to spend RP 130,000 on a chicken bander? (The equivalent of \$A100). A well-spoken waiter in Baris Restaurant in Sanur told me he had to save up RP 50,000 (\$A40) for his wedding ceremony, and he estimated it would take him a year or two to do it!

If you imagine many Indonesians who can afford to be communicators, legally, forget it! Listen on 10m when the Asian invasion is on and see if you can find a heap of YB/YC stations taking advantage of the cycle.

Unfortunately, if Austra-

lian importers do not locate the source of the equipment and get it into the amateur service, some dubious importer will bring it in and sell to the numerous illegal 27MHz operators. Like Peter says, "It's much more tempting for a pirate to use a quiet band than one full of licensed calls."

The offending sets are probably:

- (1) cheap
- (2) freely available
- (e) if obtainable in this country, would promote heaps of legal 10m activity if sold to licensed amateurs. One envisages mobiles and repeaters — the possibilities are there. What about it, Dick?

In conclusion, I ask — can anybody reliably state where the piracy stems from? I don't believe it's Bali!

Footnote: There was no 28MHz AM equipment available in Joko's ham shop in Denpasar, either. 70cm, 2m and HF rigs aplenty. I did find one 27MHz CB OP in Bali, QTH Kuta. A nice guy, proud of his 27MHz base station, proud of his government-issued call sign and proud of his QSL collection!

'FONEFIST' SSB/CW TRANSMITTER FOR 80 METRES

DREW DIAMOND VK3XU
'NAR MEIAN' GATTERS RD
WONGA PARK 3115

Would you like to have a go at building your own transmitter for 80m? For many of us, the main difficulty with such a project would probably be that of obtaining some of the necessary parts. Several overseas publications have recently published details of transmitters and receivers employing ICs which perform a multitude of functions, thereby greatly reducing complexity. Unfortunately for Australian experimenters, many of these devices are simply not economically available (you know the story — "yes, we can get those for you, four to six weeks delivery, \$50 minimum order"). So the scheme does not even get off the ground.

On the other hand, a project made largely from discrete components will be more fully understood, the parts more easily obtained, and any troubleshooting, either during construction or at some later date, will be greatly simplified.

This relatively simple SSB/CW transmitter was made with components purchased from local retail suppliers.

Performance

Modes:	SSB (LSB), CW
Frequency Range:	3.5 to 3.7 MHz
Output Power:	Nominally 2W PEP, 4W CW
Frequency Stability:	Typically less than 20Hz drift in any 10-minute sending period after 30-minute warm-up
Harmonically Related Products:	At least 50 dB down
Non-Harmonically Related Products:	At least 50 dB down
Unwanted Sideband Suppression:	In the order of 35 dB
Carrier Suppression:	At least 35 dB, typically 40 dB
CW Keying Ratio:	In the order of 60 dB (more available)
Supply Voltage:	Nominally 12 to 14 Volts at up to 1A

Output Protection: Will withstand any SWR, including short or open load without damage

Test Equipment Required

High impedance FET voltmeter or DMM, RF probe to suit, general coverage receiver, 50 ohm dummy load/power meter

Circuit Description

Crystal Y1, maintained in oscillation by Q1 supplies 'carrier' at about 4.433 MHz. This signal is applied to the parallel connected gates of balanced mixer Q2-Q3. Amplified audio signal from the microphone is applied to the push/pull connected gates, and the resulting double side-band (DSB) signal is extracted via the balanced tuned circuit connected between the FET drains.

For CW operation, switch S1a is opened, and trimmer capacitor C1 supplies the return path for Y1, which causes the crystal to oscillate at a higher frequency, and so places the 'carrier' inside the pass-band of the crystal filter.

To remove the unwanted lower side-band (the USB passed by the filter becomes inverted later by the frequency conversion); the DSB signal is passed through a crystal ladder filter whose pass-band in this application is about 3 kHz, and is determined mainly by the value of coupling capacitors; 27 pF each for the Philips crystals used here. These crystals must be of the same type and make. Other crystal makes will probably require a different value of coupling capacitor. Filter bandwidth is inversely proportional to C (see references 1-4).

The SSB or CW signal is applied to the parallel connected gates of a second balanced mixer, and VFO signal from the buffered Colpitts oscillator is applied to the push/pull connected gates. To convert the 4.433MHz signal to the 3.5 to 3.7MHz band we must apply VFO at 4.433 + 3.5 to 3.7 MHz, ie 7.933 to 8.133 MHz (in practice, about 7.930 to 8.140 MHz). A broadened balanced tuned circuit at mid-band (about 3.6 MHz) ex-

tracts the wanted signal appearing at the drains of Q4-Q5. The now-unwanted 4.433MHz signal is phased out. Selectivity is such that the unwanted signals (mainly 4.433, 2.567 MHz and VFO) are, at best, only about 40 dB below the wanted signal. This is not satisfactory, even for a low power transmitter, so the mixer is followed by a 3.5 to 3.7MHz band-pass filter which drops the unwanted signals by at least a further 10 dB, but offers little attenuation to the wanted signal.

Our carefully generated milliwatt SSB or CW signal is raised to about 100 mW by broadband amplifier Q6, and raised again by about 14 dB through power MOSFET Q7, a Motorola switcher FET type IRF510. These devices make a cheap, robust amplifier to about 10 MHz at the 5W power level. The drain output impedance is matched to 50 Ohms with 1:4 broadband transformer T2. As significant harmonic energy may exist at the output, this amplifier must be followed by a low-pass filter to reduce these to an acceptable level, in this case -50 dBc.

Problems have been encountered in the past with PA MOSFET heating due to excessive standing drain current, caused by use of an unstabilised gate bias supply. This problem has been solved by sourcing the gate bias from a 6.2V zener supply which renders the standing drain current substantially independent of supply voltage (within reasonable limits), so supply variations between 12 and 14 volts should cause no problem.

To generate a CW signal, the balanced modulator may be deliberately unbalanced, allowing carrier to 'sneak' through this stage. Transistor Q8 pulls one FET source closer to ground potential, upsetting the balance in proportion to 'carrier' pot rotation. The frequency of crystal Y1, as previously mentioned, must be placed nicely inside the SSB filter pass-band. Capacitor C1 is set so that Y1 oscillates at about 4.434 MHz. Voltage to the frequency conversion balanced mixer is ramped up and down by Q11 in response to the key. At key up, no frequency conversion can take place, which results in a respectable keying ratio, and no 'back-wave' will be detectable at the receiving station (if desired, the balanced

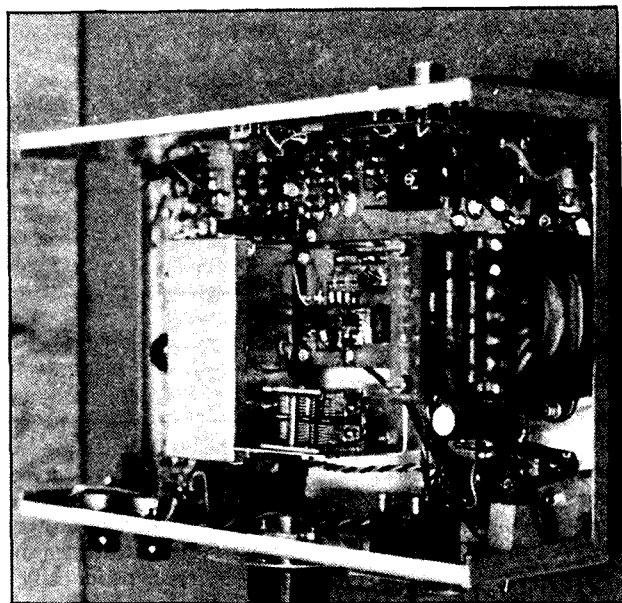
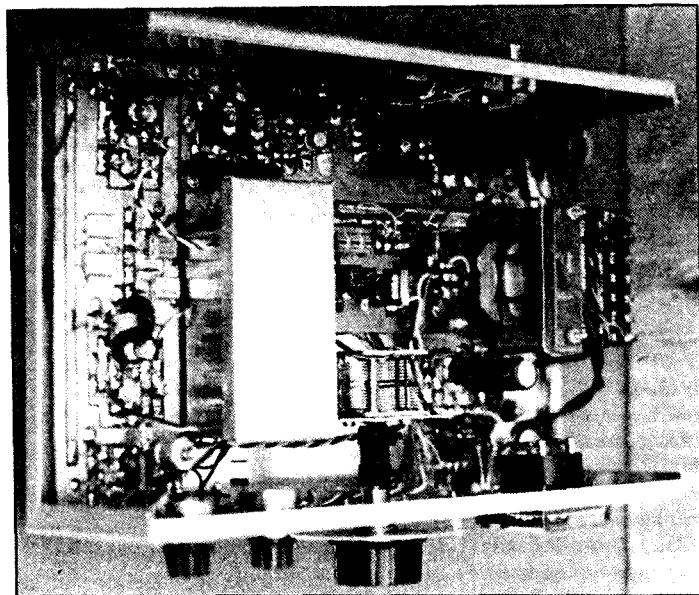

modulator may be keyed along with the mixer for a spectacular keying ratio, but with slightly degraded keying waveform characteristic).

Construction

This time I cheated, and bought a ready-made K&W number C1284 box measuring 305 mm W x 200 mm D x 90 mm H. All the boards, including power supply, will fit neatly in the space provided. The great majority of components are accommodated upon the etched side of five home-made double-sided printed wiring boards 'VHF fashion'. No holes are necessary for components (excepting one for the MOSFET heatsink). This project was first breadboarded up on scraps of circuit board, rat's nest fashion, and was debugged successfully in that state. We may assume then, that just about any construction method that you choose you will probably work, provided that signal carrying conductors and by-pass leads are kept as short as practicable.

The power supply (if you do not already have one) may be made first, followed by the VFO, SSB generator, amplifier and control board. The MOSFET drain is connected to the heatsink mounting tag, so don't forget to fit an insulating washer under this screw head.

If an internal mains supply is to be included, all mains wiring connections **MUST** be adequately covered to prevent accidental contact. Both line and neutral conductors must be switched, the mains earth connected to chassis ground, and a 500mA fuse fitted in the line side as shown.

Capacitors used in the VFO tank circuit must be NPO ceramic, styroseal (or silver mica) where specified. In order to exclude draughts and sudden temperature changes, the VFO should be enclosed in its own box. It may be constructed from double-sided printed board material with all conducting surfaces electrically connected. A small hole will be required each for the 13V supply line, the variable capacitor connection and

twisted pair VFO output. The tight fitting lid may be made of aluminium. To slow down frequency drift due to surrounding heat sources, consider mounting the VFO assembly upon insulated spacers. The ground path may be supplied via a braid to the variable capacitor stator (frame), and a second braid connection to the SSB board.

To minimise frequency wobbles, all VFO tank components must be firmly supported. Later, at the alignment stage when the VFO tuning range has been established — but before dial calibration, VFO tank coil L5 should be cemented with epoxy glue to a small perspex block placed between coil and the wall of the box (see photo).

The MFE131 FETS are rather prone to self-oscillation. To overcome this problem, a "Q-killer" ferrite bead should be fitted to the gate leads where shown. The beads may be held in place with a tiny length of insulation stripped from hook-up wire. Space the beads so that they do not touch.

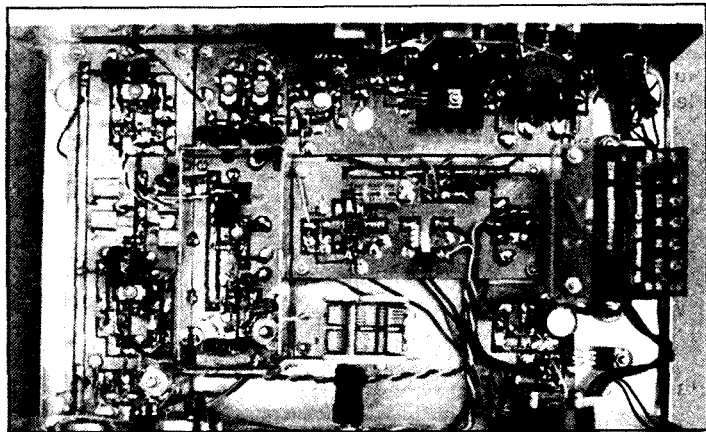

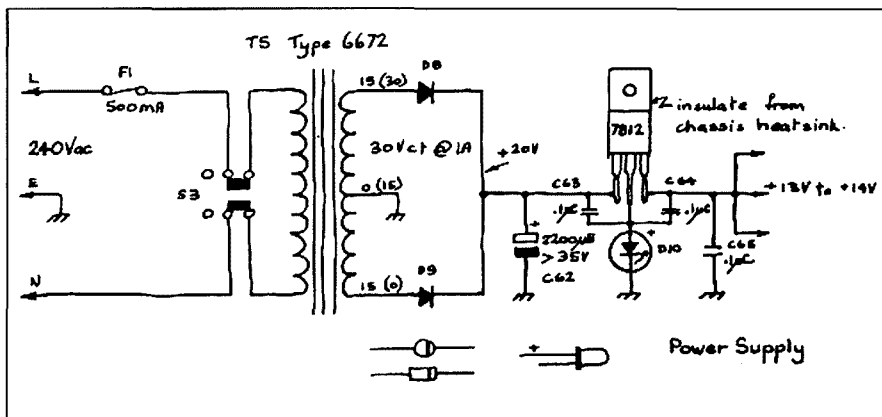

The mic amplifier chip U1 may be inserted into a wire wrap socket and the leads spread and cut to length to permit easy soldering of this device to the board. Note that one resistor, R36 is under the chip.

The power supply regulator IC U2 should be insulated from chassis ground with a mica washer. By inserting an LED in the common lead we can raise the voltage to the more usual 13 or 14V. Of course, the LED may be positioned into the front panel if desired.

Bifilar coils L1 and L3, and broadband transformers T1, T2 and T3 could be a bit tricky if you have not tackled these before: Take two (three for T3) 300mm lengths of #24 B&S enamelled wire. Place them parallel to each other, then twist them together at one end, and clamp that end in a vice. Twist the other ends together, then fix them in the chuck of an "egg-beater" type hand drill. Whilst maintaining tautness on the pair; turn the drill till you have about three twists per cm. Give the drill a tug to set the twist, then remove the pair. Carefully wind on the specified number of loops, leaving about 2cm free at each end. For L1 and L3, leave a small gap for the links L2 and L4 between start and finish of the winding. Use your multimeter on ohms to identify the starts and finishes. The start of one winding MUST be connected to the finish of the other to form the centre tap.

T3 is made in a similar manner, but now we have a trifilar winding. Three wires are twisted into a triplet. There must be no bumps or transpositions. After installing the specified number of loops, identify one winding — any one, and push this set to one side out of the way (this will be the "primary" of T3). Now deal with the remaining wires as for T1 and T2.

The 1A meter (or 1mA/180 ohm with a 0.2 ohm shunt) in the +13V supply line to the PA MOSFET is not an essential item, but it is useful to know the value of PA drain current during SSB and CW operation, and is a very handy antenna match indicator, as maximum drain current corresponds with best impedance match. So inclusion is up to the builder. If your power supply already has an ammeter, then none is required for the transmitter (the bulk of the current drawn is used by the PA). During SSB operation, the meter should flick up to about 300 or 400mA during voice peaks from the standing value of 200mA. Up to 1 amp may be drawn during key down for CW operation, depending on advancement of the carrier control.

The frequency indicating dial must be left to individual resources and preference. Shown in the photo is my own approach.

The variable capacitor is fitted to a home made right-angled aluminium bracket. A 6:1 planetary drive (from Dick

Smith) is mounted upon the front panel. The 0.25" shaft off-cut from one of the pots is fitted to the drive, and these are connected via a simple flexible coupler made from a length of 0.25" i.d. rubber fuel hose clamped with fuel filter clips. A coupler is necessary to avoid excessive wear of the drive due to mis-alignment, and VFO frequency variations due to the unreliable alternate ground path through the drive. It will be found that new rubber will soon vulcanize onto the shafts, but still provide some slip should the drive be forced too far past the capacitor stops.

The perspex disc, about 7cm dia. was made in a drill press using a fly cutter. A Stanley hole saw would also serve. The disc has a cursor line scribed across the diameter, and a corresponding cardboard dial scale of the same diameter is fixed to the panel with PVA glue. Press-on numbers may be applied at appropriate points later when the VFO tuning range has been established.

Alignment And Commissioning

The following assumes that the minimal previously mentioned test equipment is available. Those with access to a counter, spectrum analyser, oscilloscope etc will no doubt be able to make their own translation of the following.

Check out your wiring, and make sure that all polarised components are correctly oriented. Set the PA bias pot R31 to min (CCW), and balance pots R7 and R12 to mid range. Connect a 50 ohm dummy load/power meter to the output connector.

Apply power and check that you have 13 or 14V for the supply rail. Set S2 to "Net" and listen for the VFO signal on a general coverage receiver. With C24 at full mesh, set C26 so that 7.930 MHz is generated. If, for some reason the VFO frequency range is incorrect, C25 may be altered to a smaller or larger preferred value (10pF would increase the frequency,

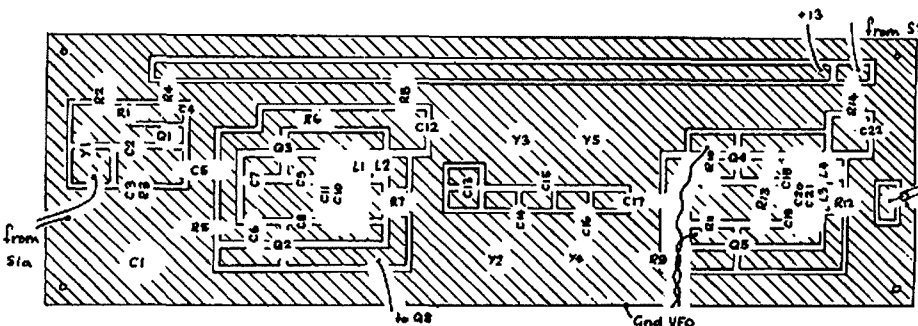

Component Locations - Carrier Osc, Bal Mod, SSB Filter and Bal Mixer

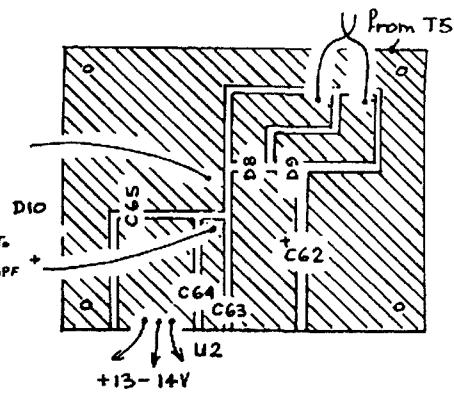

Component Locations - Power Supply

it, and I shall extend any reasonable amount of help necessary (SASE please).

Operation

During netting, you may have to advance the "carrier" control a little to produce an audible signal level. Don't forget to return the carrier pot to zero after netting on SSB mode. When sending, it will probably be necessary to turn the RF gain of the receiver down to minimum. Alternatively, if your receiver has a mute line, then it would be desirable to make use of this facility. Perhaps a spare contact set on the antenna relay could do the job.

Parts

All the parts for this project are available at present. Here in Victoria, there appears to be only two suppliers now handling radio type bits; Stewarts, and Truscotts Electronic World. The variable capacitor, trim capacitors and all the other components were obtained from Truscotts (will also answer mail orders). Stewarts can supply Amidon cores and most components. Other suppliers of Amidon cores also regularly advertise in this journal. Ordinary disc ceramics may be substituted for "monobloc" capacitors where space is not a problem.

Conclusion

A power of 2W SSB, or 4W CW may seem a very low level to use on 80m. Nevertheless, interstate contacts have been obtained with good readability reports. This transmitter may be regarded as an exciter of quite acceptable signal quality and spectral purity. Later, therefore, a linear amplifier may be added to raise the output power if desired. The development of a 20W MOSFET "afterburner" is already in hand, and it is hoped that details will be presented within the next few months.

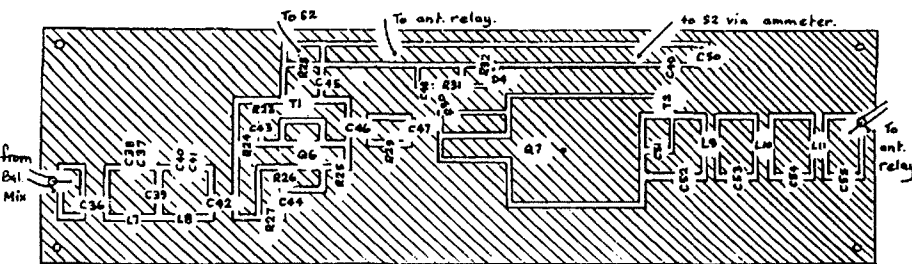

Component Locations - Driver and PA

39pF would lower it).

Set S2 to "Send". Adjust bias pot R31 so that about 200mA is drawn from the supply. Adjust C1 to mid range. Set S1 to "CW". Listen for the carrier crystal on about 4.433 MHz. If no signal — find out why.

The CW mode also provides the means of lining the thing up. Close the key and see if any output power is indicated as the carrier pot R40 is advanced. If nothing, check with an RF probe at the output of the balanced modulator (L2). Peak C10 for about 0.5V RF. Something should now be showing on the power meter. Peak C20 at about 3.6 MHz. If all is well, about 2 to 5W should be indicated. Also adjust C1 for a peak (i.e. place the carrier at some point of minimum attenuation in the SSB filter pass-band). Adjust C38 and C41 for maximum output consistent with best flatness between 3.5 and 3.7 MHz. These two interreact, and some compromise will be necessary.

Now set S1 to SSB and return the carrier pot to min CCW. Whilst listening to the signal on the receiver carefully adjust R7 for a deep null. The power meter should dip to zero. If a good null cannot be obtained reverse L1 coil connections at the drains of Q2-Q3 and try again. At least 35dB carrier suppression should be obtained.

Advance the mic gain pot R44 and

speak into the microphone. PA drain current should flick up to about 300 or 400mA, and about 1W will be indicated on the power meter (remember, the average power for speech is much lower than for CW). Listen to the SSB on your receiver to check that it sounds clean and natural. Also tune around the signal and check for any splatter (you may need to don headphones for this test).

Listen to the unwanted 4.433 MHz signal on CW mode, and adjust R12 for minimum level. It may appear that a deep null is not obtained, but in practice, the signal put to air will be at least 50dB below the wanted signal.

Troubleshooting

Some key DC and RF voltages are shown on the circuit as an aid to troubleshooting should this be necessary (the RF probe used here was the standard ARRL circuit from the "Handbook"), and a 10 megohm FET voltmeter or DMM. The values shown were obtained with the Tx delivering 2W CW output into 50 ohms, and those shown around U1 were obtained when "harlow" is spoken into the microphone in SSB mode. A voltage which departs significantly from that shown could indicate the faulty area. If, after unsuccessful attempts, you cannot locate a problem; please write to me about

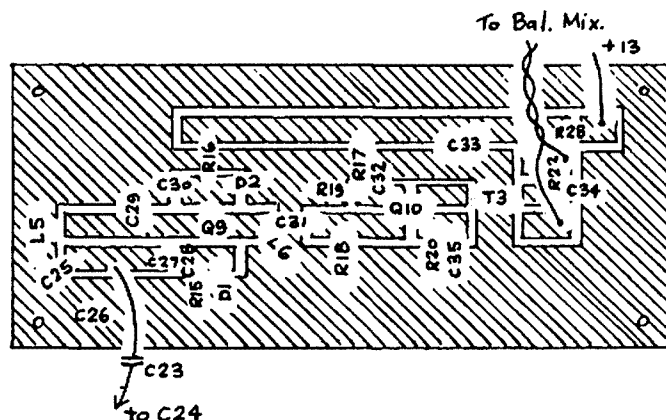

Component Locations - VFO

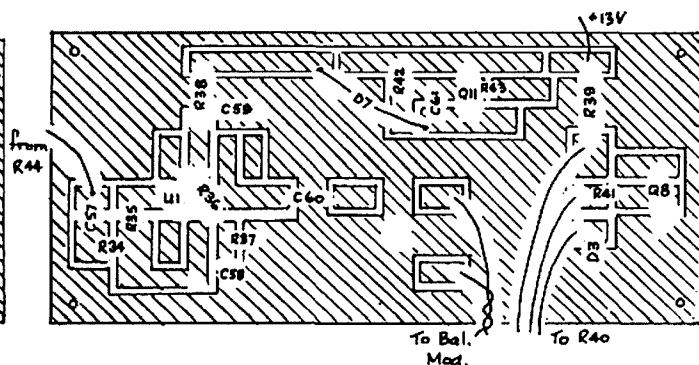

Component Locations - Mic Amp, Keyer, Unbalancer

Parts List For The "Fonefist" SSB/CW Transmitter

Capacitors

18pF NPO ceramic	C23, C31, C39.
22pF " "	C25.
25pF "beehive" air trimmer	C1, C26.
27pF NPO ceramic	C13, C14, C15, C16, C17.
5-55pF compression mica	C10, C20, C38, C40.
100pF air variable	C24.
120pF styroseal	C11, C21, C36, C42.
220pF " "	C2, C3, C27, C37, C41.
470pF " "	C28, C29.
820pF " "	C52, C55.
1000pF disc ceramic	C56.
1800pF mylar "Greencap"	C53, C54.
0.01µF ceramic or monobloc	C5, C6, C7, C43.
0.1µF monobloc	C4, C8, C9, C12, C18, C19, C22, C30, C32, C33, C34, C35, C44, C45, C46, C47, C48, C49, C51, C57, C60, C61, C63, C64, C65.
10µF tantalum >25V	C58.
100µF electrolytic >25V	C50, C59.
2200µF electrolytic >35V	C62.

Resistors

0.2 ohm 1/2W metal film	R33.
1 ohm 1/8W 5%	R26.
10 ohm 1/8W 5%	R4, R8, R14, R21, R28.
68 ohm " "	R27.
100 ohm " "	R20, R29, R38.
470 ohm " "	R3, R16, R24, R32.
500 ohm miniatur trimpot	R7, R12.
1 K ohm 1/8W 5%	R10, R11, R22, R25, R34.
1.5 kohm 1/8W 5%	R9, R30.
3.3 kohm " "	R23.
4.7 kohm " "	R41.
5 kohm miniature trimpot	R31.
10 kohm 1/8W 5%	R13, R43.
20 or 25 kohm lin pot	R40.
22 kohm 1/8W 5%	R2.
33 kohm 1/8W 5%	R36, R37, R42.
47 kohm " "	R1.
68 kohm " "	R5, R19.
100 kohm " "	R15, RR18, R39.
100 kohm log pot	R44.
220 kohm 1/8W 5%	R17, R35.
470 kohm " "	R6.

Semiconductors

MPF102, 2N5457 etc.	Q9.
MFE131, 40673	Q2, Q3, Q4, Q5, Q10.
2N2222, 2N3904 etc.	Q1, Q8.
2N3053, BFY50	Q6.
LF356 8-pin DIL I.C.	U1.
7812 +12V regulator I.C.	U2.
IRF510 MOSFET (motorola)	Q7.
6.2V/400mW zener	D2, D4.
200V/1A diode	D5, D6, D7, D8, D9.
1N914, 1N4148 diode	D1, D3.
LED	D10.

Inductive Components

Amidon T68-2 toroidal core	L1/2, L3/L4, L5, L7, L8, L9, L10, L11 (8).
Amidon FT50-43 toroidal core	T1, T2, T3.
Amidon FB43-101 ferrite bead	For Q2, Q3, Q4, Q5, Q10 (9).
2.2 or 2.5 mH RFC	L6 (DS P/N L1824).
3K to 3K ct transformer	T4 (DS P/N M-0222).
Type 6672 transformer, 30V/1A	T5.

References And Further Reading

1. Hayward, W7ZOI, Designing and Building Simple Crystal Filters, *QST*, July '87.
2. Butler VK5BR, The Ladder Filter Revisited, *AR* Mar, '90.
3. Gurr VK5RG, Ladder Crystal Filters, *AR* Jan. '84.
4. Pivichny N2DCH, Switchable Bandwidth Crystal Filter; *Ham Radio* February '90.
5. DeMaw & Collins, Modern Receiver Mixers for High Dynamic Range; *QST* Jan '81.
6. Hayward & DeMaw, *Solid State Design*, ARRL.
7. Method of Making Home Made Circuit Boards, *AR* Oct '88.
8. Some Practical Tips on VFO Construction, *AR* Jan '88.

Miscellaneous

4.4336 MHz crystals (e.g. Philips

04042.945) X5, vernier reduction drive, flexible coupler (see text), 1mA/180 ohm meter (most are 180 ohm) or 1A meter, printed circuit material, ANT connector, RX connector, fuse holder, 500mA fuse, power lead, DPDT switch (S1), DPDT centre off switch (S2), knobs, 12V ANT C/O relay, screws, nuts, spacers, #22 and #24 enam wire, hook-up wire, miniature coax, case to suit or material for same, perspex for dial and VFO coil, epoxy glue, 8-pin DIL wire wrap socket for U1, 6030 heatsink for Q7, mic. and key sockets.

ar

Stolen Equipment

Stolen from the home QTH of Bob Tait VK3BRG on 6/10/90: 1 Yaesu FT 227RA Ser 8L021912. Contact owner or nearest police station.

WIA 1990 Novice contest results published in *AR* October 90 did not mention Eric Fittock VK4NEF, who scored 680 points in section A.

COPIES OF ARTICLES

Photocopies of any article published in a back issue of *AR* available to members at \$2.50 each (plus \$2.00 for each additional issue in which the article appears)

AR ARTICLES
PO Box 300
Caulfield South
Vic 3162

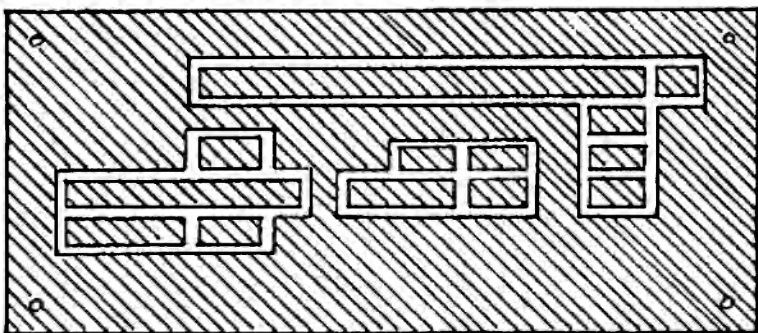
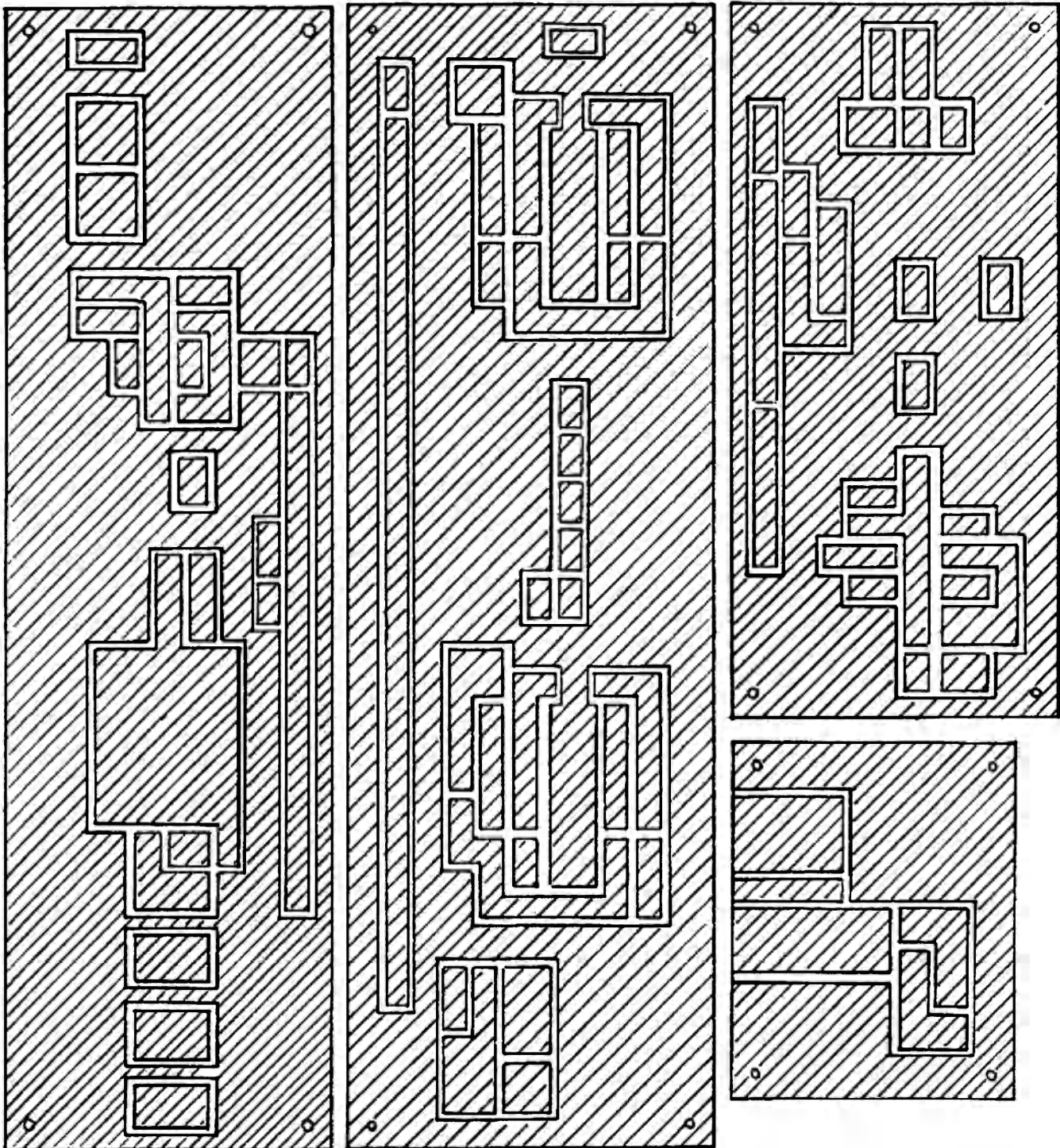

Printed Circuit Details

actual size

Upper Left: Driver and PA 192 x 55mm

Upper Centre: Carrier Osc, Bal Mod, SSB Filter and Bal Mixer 192 x 63mm

Upper Right: Mic Amp, Keyer, Unbalancer 120 x 55mm

Lower Left: VFO 100 x 45mm

Lower Right: Power Supply 60 x 48mm

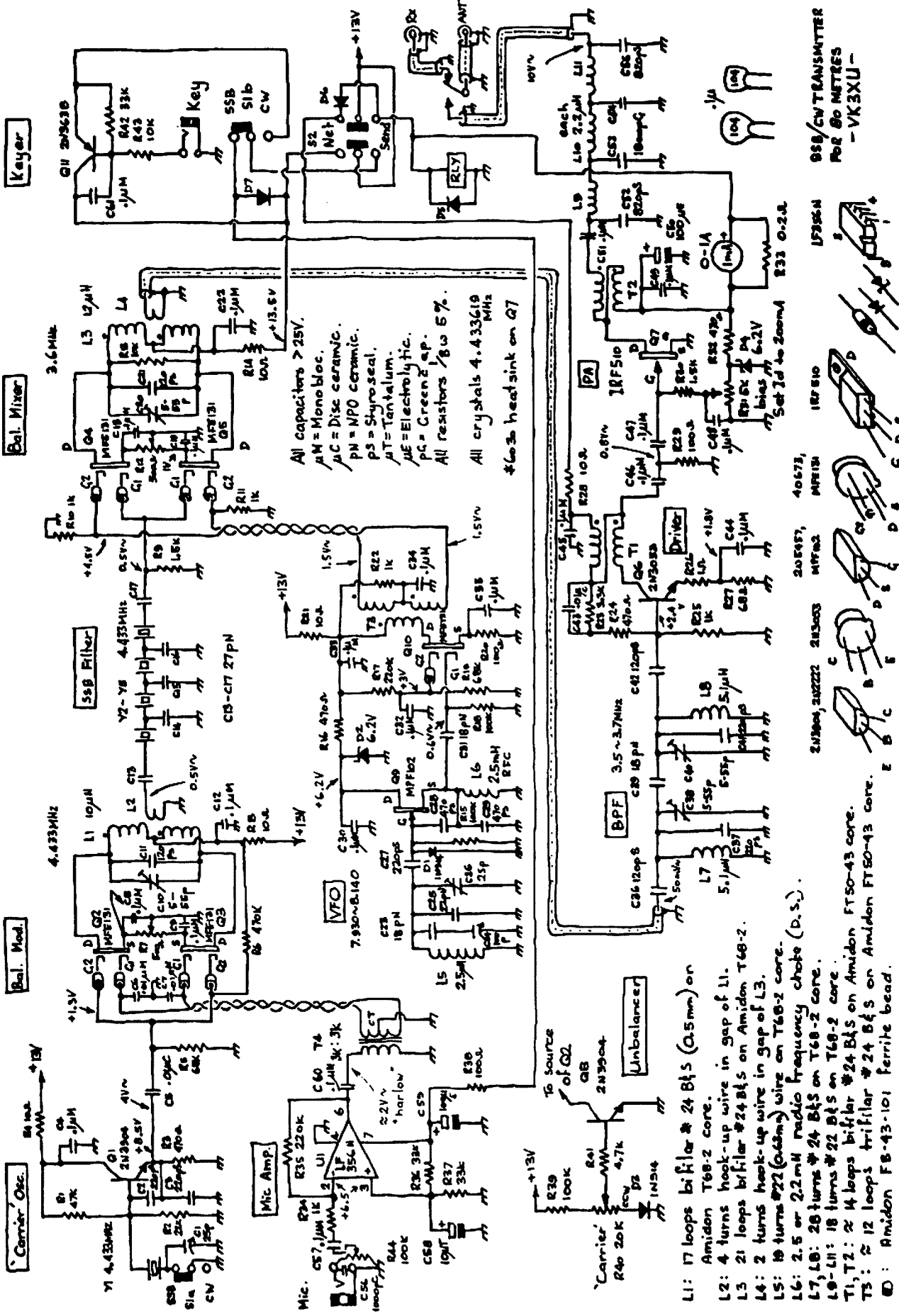

958/CW TRANSMITTER
FOR 80 METERS
-VK3XU-

- L1: 17 loops bifilar # 24 B&S (0.5mm) on Amidon T68-2 core.
- L2: 4 turns hook-up wire in gap of L1.
- L3: 21 loops bifilar # 24 B&S on Amidon T68-2.
- L4: 2 turns hook-up wire in gap of L3.
- L5: 19 turns #22 (0.45mm) wire on T68-2 core.
- L6: 2.5 or 2.2mH radio frequency choke (D.S.).
- L7, L8: 20 turns # 24 B&S on T68-2 core.
- L9-L11: 18 turns # 22 B&S on T68-2 core.
- T1, T2: 24 loops bifilar # 24 B&S on Amidon FT50-43 core.
- T3: 24 loops trifilar # 24 B&S on Amidon FT50-43 core.
- Q1: Amidon FB-43-101 ferrite bead.

All capacitors > 25V.
 μM = Monobloc.
 μC = Disc ceramic.
 PN = NPO ceramic.
 PS = Styroseal.
 AT = Tantalum.
 ME = Electrolytic.
 PC = Green 2 cap.
 All resistors 1/8w 5%.

All crystals 4.433619 MHz
 #603a heatsink on Q7

L1: 17 loops bifilar # 24 B&S (0.5mm) on Amidon T68-2 core.
 L2: 4 turns hook-up wire in gap of L1.
 L3: 21 loops bifilar # 24 B&S on Amidon T68-2.
 L4: 2 turns hook-up wire in gap of L3.
 L5: 19 turns #22 (0.45mm) wire on T68-2 core.
 L6: 2.5 or 2.2mH radio frequency choke (D.S.).
 L7, L8: 20 turns # 24 B&S on T68-2 core.
 L9-L11: 18 turns # 22 B&S on T68-2 core.
 T1, T2: 24 loops bifilar # 24 B&S on Amidon FT50-43 core.
 T3: 24 loops trifilar # 24 B&S on Amidon FT50-43 core.
 Q1: Amidon FB-43-101 ferrite bead.

Radio Amateurs: Have you checked out EA lately?

No doubt most radio amateurs are aware that *Electronics Australia* is by far this country's largest-selling electronics magazine, as well as being its oldest (we began way back in 1922, as *Wireless Weekly*). But have you looked inside the magazine lately?

Now it's bigger and better than ever, because our leading competitor *ETI* has been merged with us, to form *Electronics Australia with ETI* – the biggest, brightest and most informative electronics magazine, bar none.

You'll now find lots of new 'departments' in the magazine, including Solid State Update (with news of new semiconductor devices), Silicon Valley Update (news from the USA) and What's New in Entertainment Electronics. Plus all of your old favourites like Forum, The Serviceman, Circuit and Design Ideas and so on. And of course plenty of 'meaty' technical articles and construction projects.

What about *amateur radio* projects? Well, as you can see there are more of these than before – but we're very interested in publishing more. So if YOU have developed an exciting amateur radio project, contact Jim Rowe by writing to him at EA, 180 Bourke Road, Alexandria 2015. Or phone him on (02) 693 6620, to discuss the possibility of publishing it as a contributed article. As well as earning a fee, you'll also be helping to boost interest in amateur radio!

Take a look at the new, bigger and brighter *Electronics Australia with ETI* – on sale at your newsagent at the beginning of each month. Or subscribe now, by phoning (02) 693 9517 or 693 9515.

Electronics Australia WITH eti

Australia's Top Selling Electronics Magazine

INCLUDED IN OUR NOVEMBER ISSUE:

AMATEUR RADIO OUT OF A SUITCASE

How do you combine amateur radio with a job that involves almost constant travel? By assembling an HF rig that fits into an attache case – antenna, ATU and all, as Peter Jensen VK2AQJ explains.

FROM SPARKS & ARCS TO SOLID STATE - 2

The second part of Neville Williams' look at how radiotelephony developed. This month he looks at transmitters using either timed multiple sparks or true electric arcs.

NATIONAL'S 'HRO'

Back in 1934 was released in the US a true milestone in amateur radio receivers: National's legendary HRO. It set the pattern for many receivers to come, as Peter Lankshear explains.

A FERRITE ROD LOOP AERIAL FOR VLF

LLOYD BUTLER VK5BR
18 OTTAWA AVE
PANORAMA 5041

In a previous article (reference 1), I made comparisons between the performance at 1.8 MHz of the ferrite rod loop aerial and open frame loop aerials. Experiments were carried out using a ferrite rod 20cm long by 9.5mm diameter and open loops 0.8m square. Generally speaking, the open loop aerials performed with signal sensitivity considerably better than the ferrite loop aerial. However, at frequencies below 100 kHz, I was able to achieve results which were essentially the reverse.

By winding 1540 turns on the ferrite rod in several pies, an inductance of more than 100 millihenries was obtained with the low distributed capacitance of around 50 pF. Using a 15 to 450 pF x 2 gang variable capacitor and a switchable 100 pF fixed capacitor, a tuning range of 11 to 52 kHz was achieved. Higher frequency tuning was made possible by tapping down to junctions between the pies. The large number of turns used at the low frequencies provided a considerable advantage and, below 100 kHz, the signal sensitivity was found to be as much as 10 dB better than an open loop aerial with which it was compared.

More detail on the ferrite rod loop aerial and the comparison open loop is given in the paragraphs which follow.

Detail of the Loops

The ferrite rod was overwound with two pies of 600 turns and one each of 240 turns and 100 turns as shown in figure 1. The pies were wound in a criss-cross pattern to reduce capacitance between individual turns, and this formed a winding shape similar to that shown in the diagram. Machine-wound honeycomb-formed pies would have been better had one of these machines been available.

The diagram (figure 2) shows the loop

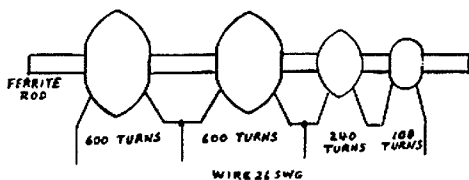

Figure 1 Layout of Ferrite Loop Aerial Windings

switching and tuning circuit and its connection via the interface amplifier. Combined with the two paralleled sections of the tuning gang capacitor, the series connection of all pie windings is tunable between 15.5 and 52 kHz. Tuning is extended down further to 11 kHz by switching in a 1000-pF capacitor across the circuit. Higher frequencies are tuned by switching out one or more of the pies. Q factor of the ferrite loop measured reasonably high at the lower frequencies. At 20 kHz it was 25.

The amplifier is the same as that previously described for VLF-LF loops (reference 2) except that the two resistors at the amplifier input have been increased in value to one megohm. This was necessary because of the higher value of inductance in the ferrite loop aerial, the consequent higher parallel impedance at resonance and the necessity to make the amplifier input resistance high by comparison so that it does not greatly lower the circuit Q.

The open loop aerial, used for comparison, was made up of 20 turns of wire spaced laterally apart by 1cm on a 0.8m square frame. A similar 20-turn loop aerial was described in reference 2, but the shielded wire in this was replaced by a heavier gauge of unshielded wire with 1.1mm diameter conductor. Without shielding, self resonance was increased to 750 kHz as compared to 100 kHz achieved with the shielded wire. This allowed tuning the full range of 10 to 500 kHz without tapping down loop turns. Of course, with only 500 microhenries of

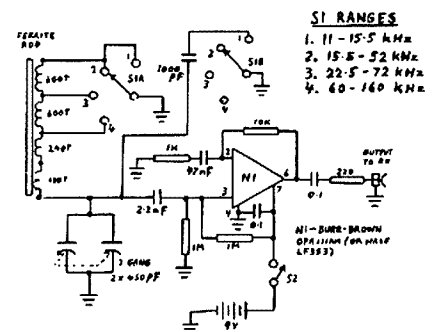

Figure 2 Ferrite Loop Switching, Tuning and Interface Amplifier

inductance, this loop had been tuned with large values of capacitance switched in as described in reference 2. The heavier gauge wire also increased the Q factor which measured 20 at 20 kHz.

Loop Shielding

One thing that is very noticeable about the ferrite loop aerial at these low frequencies is its high sensitivity to noise pickup from nearby mains cables. This is possibly aggravated by the higher impedance of the loop circuit which makes it more sensitive to electrostatic pickup. Those who have had audio frequency experience with high impedance valve grid circuits, working at low levels, will recognise the need for shielding from the mains leads and other stray noise. The lower VLF extends into the upper audio range and, similarly, electrostatic shielding of the high impedance ferrite loop circuit, including tuning components, is also essential. The loop aerial itself requires a special form of shield which does not act as a short circuit around the loop, restricting magnetic induction into its windings. Figure 3 is a sketch of an open-ended aluminium box which was built as a shield around the aerial under discussion. Observe that one edge of its lid is electrically isolated from the side of the box by insulating spacers.

Even with shielding, the ferrite loop still picks up some noise, and I found it necessary to operate the aerial at least one metre away from any power wiring.

Comparison of Performance

Signal sensitivity (or the ratio of output volts to field strength in volts per metre) for the 20-turn open loop was calculated from the loop formula to be a value of 0.1 at 20 kHz. Signal sensitivity for the ferrite loop was difficult to determine from calculation. Two of the variables in the formula are the corrected permeability and the area (and hence the diameter) of the turns. With the method of winding used, the value of corrected permeability was not clearly defined, and the diameter of turns varied from one centimetre at the centre of a pie to 3.5 cm at the outside. However, using some averaging and a little guesswork, it ap-

peared that, with all windings in circuit, the ferrite loop should be at least equal to, or more sensitive than, the 20-turn open loop. In practice, this proved to be correct, and, at VLF, the ferrite loop was found to have a sensitivity advantage. At 43 kHz, the two loops had much the same sensitivity. At Omega frequencies (around 12 kHz) the ferrite loop produced a signal level about 10 dB greater than the open loop.

Whilst the ferrite loop is quite sensitive at VLF and the lower part of the LF spectrum, its sensitivity falls off as turns are tapped down to enable tuning to higher frequencies. In fact, with only the 100 turn pie in circuit to tune up to 500 kHz, I had great difficulty in detecting the strongest of NDB stations. In consequence, the 100-turn junction was not connected into the loop switching circuit, which is shown in figure 2.

Apart from its higher sensitivity at VLF, the ferrite loop has an advantage over the open frame loop in size and portability. On the other hand, the open loop is less prone to pickup of localised

noise, and I have found that, even if less sensitive, it gives a better signal-to-noise ratio in the presence of such noise.

Conclusions

By using appropriate windings as discussed, the ferrite rod loop aerial can be made to operate with high signal sensitivity in the VLF spectrum. Furthermore, the values of self inductance and capacitance are such that the loop can be tuned over the VLF range of frequencies with an ordinary receiver variable tuning gang capacitor.

Whilst the sample ferrite loop aerial has been found to be more sensitive at VLF than a typical open frame loop aerial, it is inclined to pick up more noise, and its good performance is not maintained above 100 kHz.

In concluding this third article on receiving loop aerials, I must add that these aerials are an interesting field of experimentation which can be carried out with simple materials and minimal cost. Furthermore, they require only limited space and, in fact, operate quite well indoors.

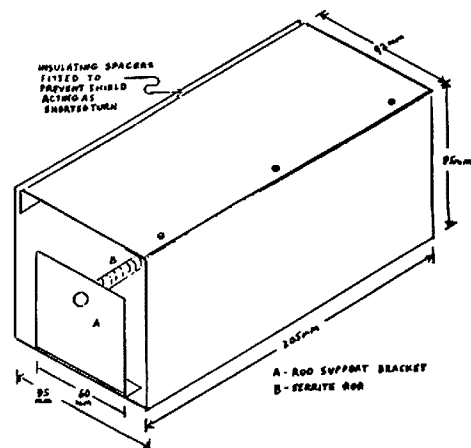

Figure 3 Ferrite Loop Aerial Shield

References

1. Lloyd Butler VK5BR, Receiving Loop Aerials for 1.8 MHz, *Amateur Radio*, September 1990 p10.
2. Lloyd Butler VK5BR, VLF/LF and the Loop Aerial, *Amateur Radio*, August 1990 p12.

You're obviously serious about amateur radio.

At Amateur Radio Action magazine we believe it is a way of life. For just \$3.00 we make sure you keep up with the latest information

in the industry, including complete reviews on the latest equipment.

Don't get left behind, make sure you read Amateur Radio Action.

amateur
radio
action

AT YOUR NEWSAGENT EVERY MONTH.

THE COMMODORE C-64 POWER SUPPLY — SOME PROBLEMS AND SYMPTOMS

PETER MCADAM VK2EVB
14 GRANT CLOSE COFFS HARBOUR 2450

The Commodore C-64 computer has been around for a long time and is still very popular amongst amateurs as a cheap way to get on packet as well as the other digital modes. Something that has become apparent since 24-hour packet operations began is that the C-64 power supplies were not designed for continuous or 100 per cent duty cycle operation. The symptoms arising from this sort of operation in some cases could easily be diagnosed as character ROM failure (U5-2332 or 901225) or VIC chip failure (U19-6567 or 6569) amongst others, even CPU problems (U7-6510 or 8500).

These symptoms are best described by the type of video on the monitor. A screen full of frozen alphanumeric and/or graphics characters, or a sudden complete loss of video and even just system lockup after running for an hour or more could be signs of a power supply fault developing. Usually, if this is the case, the period preceding the symptoms gradually shortens as the days go by until at switch-on the computer fails to perform even the normal systems check. Consequently no video is produced even though the red power on LED is alight.

The actions of the power supply in bringing forward these symptoms are easily explained, namely, expecting a 1-Amp, 5-Volt, 7805 regulator to supply an

average of 1.5 Amps which, over a long period, amounts to a very hot regulator. While the power supply may be very warm on the outside, the internal regulator is hotter than the tolerance range it was designed for and begins to close down. This drops the voltage below five volts and suddenly the symptoms begin. Once the regulator has been damaged in this way nothing seems to go right. Programs won't load and run properly or, if they do run, after a while they freeze up etc.

The cure seems to be to increase the ampere rating of the regulator and provide more effective cooling. Right about now you will be saying, "How does this bloke expect to do this when the power supply is filled with some sort of epoxy resin to prevent repair, or anything else, for that matter." Well, there are several different types of C-64 power supplies to start with, each with its own peculiarities, even if the circuits are basically the same. To identify the type is reasonably simple and is as follows: oldest type or No 1 = sloping front; No 2 = square with sloping sides and ends with ventilated top and bottom; No 3 = completely box shaped with no vents and ribbed all over; and the newest, No 4 = as number three but with external fuse access. There are varying degrees of difficulty associated with repair of these throw-away design power supplies. The oldest types may not

have resin poured over components, but the newer units are filled. With number three version the PCB is not immersed in resin, and by using a desoldering tool it may be completely removed, revealing a standard 3AG fuse on the component side of the PCB (designed for easy replacement by an office-bound expert). On number four, the complete case was filled with resin right to the brim, covering the PCB as well, which doesn't make for easy access. Obviously versions one and two are the easiest to repair, and versions three and four need a good deal of patience but, in the long run, a good heavy duty power supply will result at a much cheaper rate than the special HD supplies offered in the USA.

To begin the operation the bottom must be prised off the case. The case of the later supplies will snap six pillars of plastic to which the base has been glued. It will come off in one piece if you are careful, and will snap back into position when the job is finished. Now whatever you do, don't break the wires off the power transformer. Carefully chip the resin off the board if you have version four so you can desolder the PCB. Once this is achieved you will see that the components are secure in the resin. A mallet and chisel will be needed to make a cavity to fit a larger filter capacitor.

The new supply design calls for an

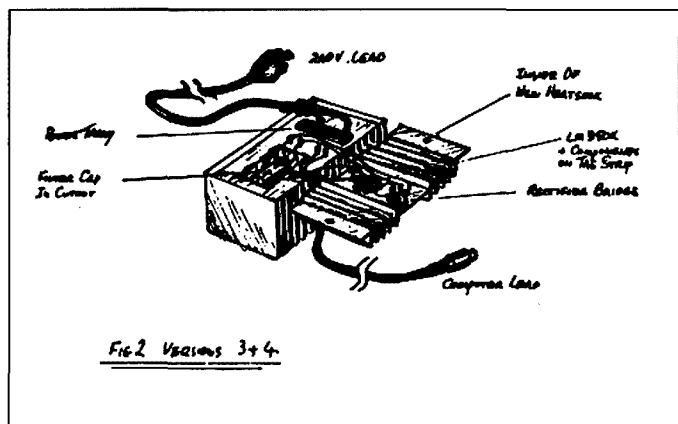
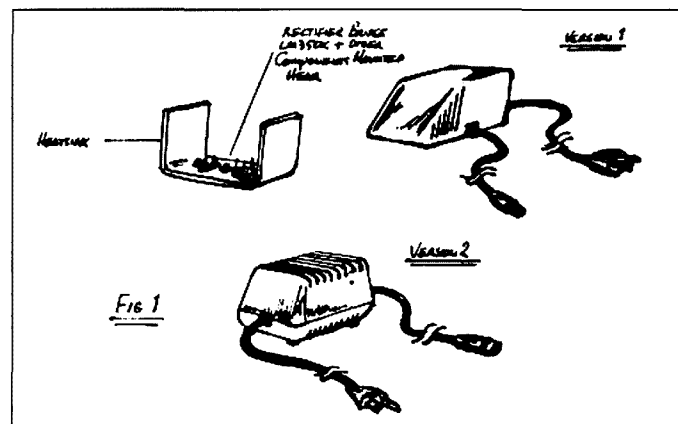

NEW SUPPLY CIRCUIT FIG. 3

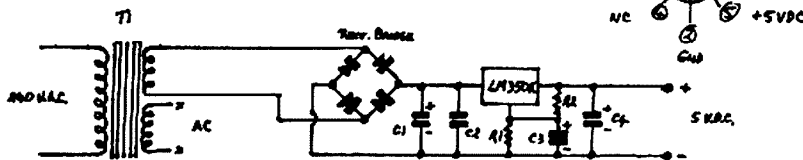

- C1 — 2500µF 25V ELECTROLYTIC
 C2 — 0.1µF
 C3 — 10µF 12V ELECTROLYTIC
 C4 — 1µF TANTALUM

- R1 — 2 x 680Ω ½ W 2% TOLERANCE
 R2 — 120Ω ½ W

FRONT OF POWER DIN PLUG

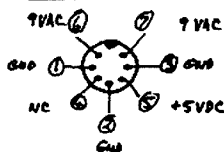

LM350K positive regulator capable of three amperes at between 1.2 and 33 volts which performs well in this circuit. At this point, modifications to versions one and two differ from versions three and four inasmuch as no special heatsink is required for the new regulator is mounted in the existing "U" shaped aluminium cooling fin (see fig 1).

Versions three and four have the regulator mounted on an external finned heatsink (similar to DSE cat:3471) which is screwed to what was the bottom of the old supply. When finished, versions three and four will stand upside down with the heatsink upwards to dissipate heat. On all supplies you will need to mount a full wave bridge rectifier on the heatsink (a 1.8-amp bridge will suffice) to assist it in dissipating heat. Don't forget heatsink compound or paste at this stage. Next the regulator and a five-lug tag strip are mounted on the heatsink, in versions one and two inside the "U" shape, and on versions three and four with the tag strip on the underside (see figs 1 and 2).

In versions three and four, a cavity is cut with mallet and chisel through the components and the resin next to the power transformer, being careful not to damage it in any way. This is needed to hold an electrolytic filter capacitor (25000µF 25V) and allows the heatsink to sit flat on power supply case. The rest of the components in the circuit (fig 3) are soldered in place and the transformer connected. Be careful to wire the 5 VDC and 9 VAC to the computer supply cable with the correct polarities etc (see fig 3). Connect the 240 VAC mains lead to the transformer and, before plugging it into the power point carefully check the circuit is right.

DO NOT CONNECT TO COMPUTER YET! Set up your multimeter to measure

the 5 VDC and switch power on. You should get a reading of about 4.89 to 5.00 Volts. Under NO CIRCUMSTANCES connect more than 5 VDC to the computer as SERIOUS DAMAGE WILL RESULT. If the DC is okay, then check that the AC output of the transformer is in the range 10.9 to 12 VAC. If all appears okay, a test run on your computer is in order BUT ONLY AFTER YOU MEASURE THE VOLTAGES and prove they are correct.

If the DC voltage is incorrect then resistor R1 fig 3 has to be changed. The formula $R1 = (96 \times 5 \text{ volts}) - 120$ is used to calculate the value and the required resistance is 360 ohms. The nearest value easily obtained is 340 ohms by placing two 680 ohm resistors in parallel, which yields 4.89 volts. Testing has shown that the computer happily runs all day on this voltage so the author could not see any further need for experimentation. Now that you are satisfied all is okay and voltages are stable, switch off and reassemble the unit, securing the heatsink to the case (versions three and four require two self-tapping screws to secure the heatsink to the resin). Once again measure voltages to make sure there are no shorts etc caused by reassembly and, if all okay, the new C-64 heavy duty power supply is ready for use.

During constant running the power supply heatsink will become rather warm but the combination of a higher rated regulator and better heatsink will handle the situation excellently. One further thought is to bear in mind that the Commodore C-64 has no protection whatsoever against power surges, transient voltages etc, so please use a surge protector and protect yourself and your computer from complete system failure.

ar

MATTEK H. F. SOLID STATE LINEAR AMPLIFIERS

Run 500 watts output from a 12v car battery with 30 watts of drive.

- No tuning
- 1.8-30 MHz coverage.
- 6 Selectable output filters.
- 3 position drive attenuator.
- SWR, overdrive, reverse battery, over-voltage protection.
- BAR-LED output and SWR indicator.
- Thermo-controlled fan. Overheat cutout.
- 100H-355W-180D 3.2 kg

\$995

Enquiries to —

Mattek Electronic Co
 144 Warrimoo Ave
 St Ives NSW 2075
 Phone (02) 449 9569

VHF Communications Magazine

1991 Issues Will Be Available After All!

The VHF Communications Magazine will now be translated and published in the UK, and will be available through subscription with the WIA, the Australian agents.

The 1991 prices are as follows:-
 Surface Mail \$35
 Airmail \$48

Please forward your cheque to
 WIA, PO Box 300,
 South Caulfield Vic 3162
 before 31st January, 1991 to ensure you receive your first issue for 1991. Separate cheques for WIA subscription and VHF Communications Magazine renewal please.

TECHNICAL CORRESPONDENCE — MATCHING AND LOADING

ROBERT R MCGREGOR VK3XZ
2 WILTSHIRE DRIVE
SOMERVILLE VIC 3912

I have followed with interest John Sparke's article, "A Can of Worms", June '89, Dr Lucas' comment, p11 October '89, and John Sparke's reflections, p11 August '90. It all confirms my suspicions that the use of that shiny expensive coaxial cable on a large scale by amateurs has clouded their perceptions of setting up a station.

There are three fundamental components. First, an antenna; it can be non-resonant and broad band, a terminated rhombic, resonant, that is an accurately trimmed half or quarter wave, or a random length conductor that must have external L or C added to resonate at the radiated frequency. Next, a connection between the antenna and the power source. This can be: (1) An open single wire, Zo around 500 ohms, depending on its diameter. (2) A coaxially shielded wire, air or solid dielectric, usually restricted to the range 35 to 100 ohms. (3) Two parallel wires, mainly air dielectric but, in the case of ribbon lines, the solid dielectric has considerable effect, range 200 to 800 ohms. (4) Four wire lines that can be either two parallel pairs forming a square or the wires can be diagonally connected, the preferred mode for minimum external coupling and radiation, also the lowest noise pick-up. Parallel pairs are easier when switching is required, range 400 to 600 ohms.

We have two options with our transmission line, tune it or terminate it in a non-reactive resistance that exactly equals its Zo. This will then appear at the sending end at exactly the same value, a matched line. Tuned lines are a separate subject, the discussion is on 'slightly imperfect' matched lines. The power source, your rig, has within it an active electronic device to convert DC power to RF power. It can be an electronic tube/valve, solid state, a transistor Vfet or next year's wonder from Silicon Valley. I am leaving out negative resistance diodes, Poulsen arcs, Alexanderson alternators and spark transmitters. These devices have one common requirement, for full power output and efficiency they require a value of load resistance within narrow limits, critical for the best linearity.

The figure at the sending end of the line has to be transformed to the load

requirements of the source. Failure to do so results in loss of conversion efficiency. You may achieve the same output power but the source will have higher losses — possibly fatal! The transformation of the antenna resistance to the load line of the RF source includes, in most cases, the addition of a reactive correction at the source. Tune the final! A basic approach with high impedance lines is to place a tuned circuit across the sending end, a second one in the output circuit of the transmitter and arrange mutual coupling of their coils. This allows a smooth adjustment of loading at the source. It works very well at Radio Australia, handling 400 kW PEP! Tuned circuits at 50 ohms require very difficult values so alternative circuitry is used. With untuned broadband amplifiers, suitable transformers are available. When we have a tuned PA this circuit can be utilised as a 'transformer' by 'link coupling'. Make a two or three-turn loop, connect its ends across the coaxial line and poke the loop into the inductance until you have loaded the output stage to the correct value. It is very good for experimenting in an open chassis before fixing it securely in the final position. Beware of volts! There have been many circuits devised to follow simultaneous load and tuning adjustments starting with the Pi Coupler. They will all cover a considerable range by using tapped or multiple coils and switched capacitors to extend the range of the variable C.

The prevalence of linear output stages has, however, forced designers to limit the adjustable range in the output stage to suit 50, maybe 70 ohms loads of negligible reactance. To achieve this load use an antenna peaked at the operating frequency and find a transmission line matching point in the antenna circuit to attach the line to. Failure to meet these requirements produces a 'mismatch'. The result is simple, our line is now a tuned feeder! We can cut the line length for a non-reactive point and hope the resulting R is within the scope of our transmitter output tuning/matching. The alternative is to read up on matching circuits. There is one, hopefully, to suit your case!

Where did I lose 'reflected power' and SWR? A mismatch between antenna and line produces a reflection that, combined

with the incident wave, your signal, produces an interference pattern in the feeder system. When the system is resonated, these signals synchronise and produce a stationary pattern. This can be demonstrated with a probe on a slotted coaxial line and a neon tube or a loop and torch globe on open lines. The SWR meter tells the observer there is an antenna transmission line mismatch.

Now for the difficult bit. What does that 50-ohm sign on the output socket tell the observer? It is simple; your transmitter requires a load of 50 ohms to perform properly! The designer has provided a limited panel control to correct and tune out minor errors so that the PA works into its correct load! Life wasn't meant to be easy, so what can be done to correct some of the 'bugs' that occur? Baluns are great for inter-connecting balanced to unbalanced systems and transforming antenna resistances, but they are usually in a few simple ratios. Take a common case; the folded dipole resonates and you have a 4:1 balun. The output stage will not adjust to the 75 ohms. What now? The rig will probably cope with a 60-ohm load, so use a few resistors and Ohm's Law to satisfy the requirements. Parallel the 300-ohm feeder at the balun terminals with 1200 ohms = 240 ohms which is transformed 4:1 to 60-ohms load for the PA. Dissipation? Well, 1200 will absorb a quarter as much as 300, so it will receive a quarter of one and a quarter = 5/16 or 31 per cent. The drop in signal will be negligible and your PA safer. Should the problem be too low a resistance, very serious for solid-state devices, add a series resistor between the rig and the balun primary or a pair of higher value in series with the feeder lines. Life can be made easier!

Dr Lucas' statement on the use of a matching source resistance is a technique used extensively in laboratory investigations where there is an unknown or variable load. It guarantees the value of the source signal level and resistance, no standing waves occur and your 'downstream' indicators give accurate read-outs. It is an excellent technique for this work but has a minimum loss of 3dB so is not usual in output circuits.

Final over, you match the antenna to the line and load the rig to get power into it.

ar

WE'RE OFF AIR!

DAVID G BARNEVELD VK4BGB
PO Box 275
BOOVAL 4304

For those of us who work in the broadcast industry, these are the magic words that send shock and tremor waves deep into our boots. This story is about a small community public access radio station with which I had the unfortunate task of being chief engineer. For obvious reasons, as you will see, the call sign of the station will remain anonymous.

The scene goes back some eight years ago.

As I recall, I had received a message on my pager to contact the station urgently. It seems the morning announcer had arrived at approximately 6am and proceeded to put his program to line without checking the status of the transmitters. This particular station had no remote control of its transmitters, so they were left running 24 hours a day, even though the station signed off the air at 2400 hours. The announcer had waded through roughly two and a half hours of program, talking into thin air. To paint the picture more clearly, it must be stated here that, being a public broadcast facility, the place was staffed by volunteer helpers who did not have any technical experience. The announcer was listening to the output of the console rather than to the off-air monitor. That's how he got caught.

Upon arrival at the studios, a quick check indicated the transmitter was off, as no carrier was present. Exit stage right. The transmitter hut at this particular station was also built by volunteer labour, and had built-in features such as natural air conditioning through the large gaps between the fibro-cement walls and the roof.

The whole installation was not exactly dust or vermin-proof.

Transmitters

The transmitting equipment involved, as main, a reasonably new 100W AM transmitter. The output device was an Eimac 8873 triode driven by two solid-state Sanken modulators. The standby transmitter was an old AWA 100W with valves bigger than footballs in it. To say the least, this transmitter was an antique. But it worked . . . somewhat! Upon arrival at the site it was found that the main transmitter had come to a dead stop. Unable to coax any life back into it, I fired up the standby. We were back on

air. Later observations discovered that the main had suffered severe arcing at the PA tube socket and in the vicinity of the output coupling coil. As there had been a storm the night before, it was highly likely that the mast had taken a blow, thereby knocking out the transmitters.

Having no spare parts available, I grabbed the handbook and proceeded to compile a list that would have to be phoned through to Sydney as soon as possible.

There was more to come.

Upon arriving back at the studios, I was met with those familiar words once again. "We're off the air." This is the point in time where one dives into his pocket and pulls out a Mintie. Back to the transmitter site once more. Fate had it that the old AWA transmitter was going to that big radio station in the sky this very day. The cause of the shutdown this time was a blown fuse in the PA HT supply. The fuses are located on a drawer at the base of the unit and back somewhat from the front panel. I replaced the fuse and, hey presto, we were back on air. Touch wood!

By now it was after lunch and I was sitting in the workshop organising the rapid delivery of those much needed spare parts for the main transmitter. I had also been joined by a good friend of mine, Mervyn VK4SO, who offered to lend a hand with the problems.

"We're off air" once again rang in my ears at about 5pm.

Both of us headed out to the transmitter site in the failing light, as this was the middle of winter. Same problem as before — blown PA power supply fuse. Looking around the unit, I could not decide what was causing this fuse to keep blowing. There had to be something amiss, but what on earth was it?

Arcing

Having replaced the fuse again, I re-energised the transmitter and we came up on air. Whilst I stood there talking to Mervyn, the tell-tale sound of something arcing was heard coming from the bottom of the power supply cubicle.

The transmitter was powered down again and the front cover on the power supply removed. Incidentally, this unit had no rear cover. Crouching down on my knees, I slowly gazed through the dust and rubbish that were in the bowels of

this old relic. Not seeing anything, I applied high tension once again. (Interlocks? . . . there was none!)

Ah-hah! There it was! A faint glow coming from approximately halfway back inside the cabinet. Grabbing the torch, I shone my way into the innards (after I turned off the power) but could not see the exact area I wanted due to heaps of cable looms and cobwebs which were in the way.

Readjusting my position on the floor, I pushed the wiring loom aside and discovered the arc was being formed across the insulators on the high tension filter choke by a form of conducting medium that was lying across them.

It so happened that the conducting medium was a six-foot carpet snake, still very much alive, and glaring at me in the light of the torch. Well, well, well! The human body is a marvellous thing. You have no idea of the time span between when I saw this snake to the point where my brain had issued orders to my feet to accelerate with full after-burners on.

It would have been measured in nanoseconds!

Somewhat later, having regained my confidence, the snake was removed from the transmitter with a piece of timber. Actually, it was the longest piece of wood I could get my hands on. Harry Butler I am not!

Once again the transmitter was returned to air. I should mention also that the station management was tearing its hair out by this time. They had been on air for less than an hour during the whole day, and were not impressed, to say the least. It was now about 7.30pm and, believe it or not, we were on air. But not for long! The fluorescent lights in the transmitter room, plus the open door, had attracted dozens of flying insects into the building and they were hovering in droves above the top of the transmitter, which had no metal cover plate. Please don't ask me where they dragged this unit in from. The previous owners must have been glad to see it go. Boat anchor material it certainly was! At approximately 8pm the curtain finally fell on the old AWA transmitter. An arc developed in the tank circuit caused by the build-up over the years of dirt and foreign material and this, combined with moths and bugs dropping down into it, turned out to

be the last straw for the poor old girl. The arc had set fire to one of the wiring harnesses, and the damage caused was quite immense.

Off air

Well, what a predicament! At this point I needed a truckload of Minties. Here we were with no transmitters at all. Completely off the air. This is how we stayed for the next two days until the spare parts for the main transmitter arrived from Sydney. I compiled a damage report over the next day or so, and pointed out that the damage to the AWA transmitter was beyond economic repair due to its age, and that a replacement unit should be obtained quickly.

After much duck-shoving and cries of financial doom and gloom, the management decided to give the second-hand market a miss, and accepted my recommendation to purchase a brand new transmitter. The new machine was a "Harris" MW-1A, fully solid state 1k beast. You little beauty! Preparations were then implemented to seal all the cracks and holes out at the transmitter site and make the building a little bit more respectable. Finally, all was complete, even down to industrial carpet tiles on the floor. Shangri-la!

More Minties please! Had I known what was about to happen, I would have ordered another truckload of them. The new transmitter duly arrived and was hoisted into the building with the aid of a forklift. Power, aerial and program lines were then connected to complete the in-

stallation. The machine worked first time around. After doing proof-of-performance checks, I adjusted the power output to 500W and went home happy.

A few days passed and it seemed as though Heaven had dropped in. No problems at all, just the announcer yelling that we were off-air. "Off-air?" Perhaps a power failure at the site? No! Worse to come. The transmitter was dropping in and out quite regularly. Exit stage right once again. The problem this time was not caused by snakes but rather a very high SWR on the antenna. Strange! This problem was not there the other day. Checks around the aerial and the tuning unit showed nothing amiss. To make matters more interesting, the value of reflected power was going up and down like Yogi Bear at random intervals. You could adjust the tuning only to readjust it an hour later. The thought of one of the decoupling capacitors in the tuning unit going faulty was beginning to cross my mind. But, as it turned out, there was nothing wrong with them at all.

The problem was eventually traced to a faulty aerial mast. Apparently, when the station was built, the owners had purloined this mast from an unknown source; just bolted it together and hoped for the best.

Bonding

For those of you not familiar with AM broadcast towers, the general rule is to bond a copper strap from the feed point at the base of the tower and extend it the full height of the mast. This ensures

continuity along the entire length. The copper strap is bonded to the framework at regular intervals along the tower run.

When the tower was erected, this procedure was not followed. What was happening now was that sections of the mast were decoupling themselves. The tower comprised a triangular framework like most AM radiators, which was made up of sections approximately 15ft long. These sections were painted the usual orange and white and bolted together to form the complete mast.

During the night, dew would collect on the tower and flow in between the bolted joints causing a good conductive path. When the sun shone on the tower, it heated up and drove the water out from between the joints. This, together with the sections being bolted together after painting, was causing sections of the mast to insulate themselves from one another, thus causing varying SWR readings.

The problem was overcome by bonding the tower with a two-inch copper strap from top to bottom. No more problems. It would appear that this condition had existed from day one. The other transmitters, having valve final stages, were more tolerant of this condition than was our new toy. Up until the time that I left the station there was no more trouble with the transmitter. That little incident just goes to prove that shortcuts can be your downfall at some later time.

Meanwhile, back at the shack . . . pass the Minties please. 73

ar

TRY THIS Morse Code Oscillator

J A HEATH VK2DVH
12A SOUTH DOWN ROAD
ELDERSLIE CAMBDEN 2570

It is claimed that this circuit produces a more pleasing tone than the usual 555 type oscillators.

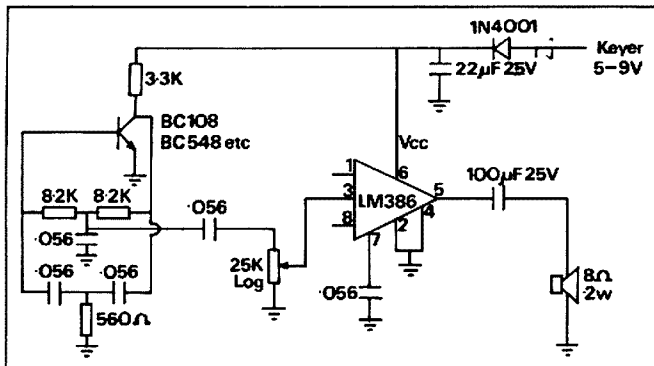

ar

QSP FROM TURKEY

We have received a letter from four notable Turkish DX operators who were active from Izmir between 1986 and 1989. They are Mustafa TA3B, Umit TA3C, Yasar TA3D and Levent TA3F. They wish to apologise to amateurs around the world who may have sent them QSL cards during these years, but have received no cards in reply.

Briefly, the problem appears to have been an inability by the Turkish Post Office to ensure that all such mail eventually reaches its addressees. The four amateurs suggest that cards should be sent to them by registered mail or, alternatively, via their QSL manager, Thomas Vortkamp DL5YQC, who is QTHR in the current International Callbook. ar

ar

AMATEUR RADIO IN ARGENTINA

MARCELO FRANCO VK4DWA/LU6DW,
WITH JOE ELLIS VK4AGL
BURNSIDE RD NAMBOUR 4560

There are 30,000 amateur radio operators and 90 radio clubs in Argentina. Almost all of them have their own club premises and radio equipment. There are very few clubs using public institutions for meetings. Those clubs that do not own their building borrow one. Meetings used to be 2 or 3 times a week, after hours during working days, and in the morning during holidays. Individual clubs may differ, but most of them have that scheme. Themes treated at each meeting are not very important, because not all of the members can attend the meetings. Each month there is a full meeting, and important matters about the club are discussed. Most of the clubs have acquired their own buildings by donations but that was some years ago when the Argentine economy was much better than now. Amateur radio in Argentina is considered of interest to the nation. There is not one national association, but two. Neither has the power of the WIA. Actually each club operates within its own region, and the two national associations only try to concentrate these efforts in a common direction. There is only one radio club member of the IARU (region 2). It is the Radio Club Argentina, founded in 1921. This club has the task of running the QSL bureau and amateurs being a member of the club can send and receive cards free of charge and non members have to pay a small charge per card. All the clubs provide courses for getting licences and information on technical matters. It is an obligation for clubs to help non-amateurs get their licences. CW operators are represented by the Argentine CW Group (GACW). It has more than 300 members.

Licences

There are four categories.

Novice

12 years old and above. Exam on morsecode, (written only) regulations and technical aspects. 100 W on 80M CW and fone, 40 M CW, 10 M fone, 2m all modes and 70 cm satellite only operation. They have access only to portions of the bands.

Intermediate

16 years old and above, exam on morsecode 5 wpm, regulations and tech-

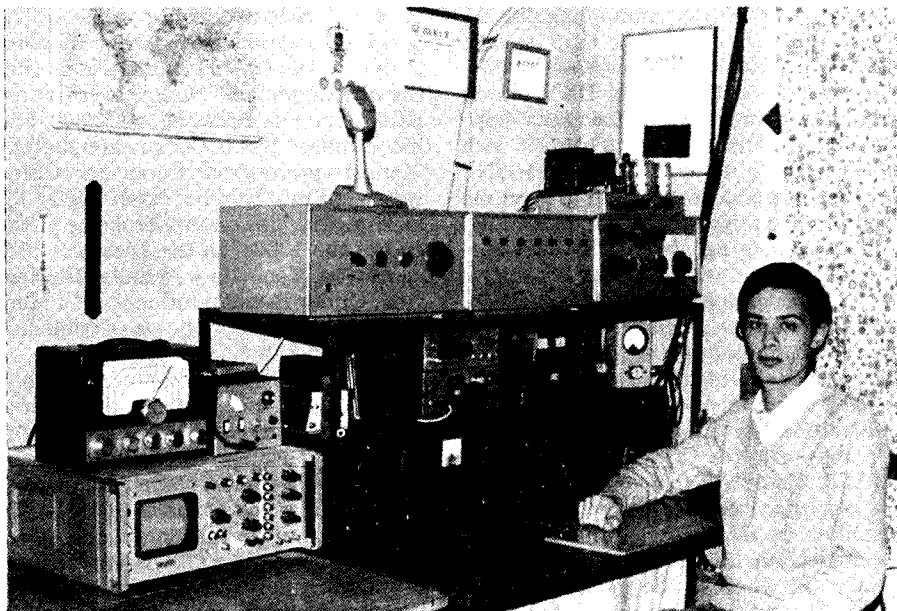

Marcelo's LU6DW Shack prior to departure for Australia; all home brew except for oscilloscope and Bird wattmeter.

nical aspects. 300 W on all bands on CW plus 80, 40 and 10 M on fone and the whole 50 MHz band.

General

18 years old and above. An amateur can only get this category by upgrading. That means he/she has to be active as novice or intermediate at least one year. Also required is an exam on morse code at 10 wpm, regulations and technical aspects. 1 kW on all bands and modes, except a portion of 15 M and the WARC bands.

Superior

Only after 3 years in general category. Morse code 15 wpm, regulations and technical aspects 1 kW all bands all modes.

The percentages of licences is as follows: novice 57.74%, Intermediate 11.64%, General 12% and Superior 18.62%. Fees to get a licence are moderate, and no fee is required for renewal, which is every five years.

Contests

There are 2 national championships every year, one on phone SSB, and one on

CW. They consist of several contests throughout the year. The WWSA (World Wide South America) CW contest is sponsored by the Argentine CW group every year, during the second weekend of July.

Prefixes

LU and LW are the most common ones. Special prefixes are issued for special events or contests. The callsigns do not change with the class of licence. The first letter of the suffix indicates the province.

Bands

All the bands are quite similar to the Australian bands except the 220 MHz band and the 70 cm (430-440 MHz). There is little activity on 160 or 6 metres. Eighty metres is very popular with the novices. 2 metres has a lot of traffic and there are repeaters throughout the country. Bands above 2 metres have little activity but some operators are on satellites and a few 70 cm repeaters. There are several digipeaters and BBS stations.

Equipment

You may find very simple homebrew stations or the most sophisticated equip-

Continued on page 30

HUNGARIAN DXPEDITION

STEPHEN PALL VK2PS
PO Box 93
DURAL NSW 2158

Here is JT0DX, from Mongolia . . . In the November 1989 issue of "Amateur Radio" there was a small paragraph in the "How's DX" column about the Hungarian DX activity from Mongolia. When I had the contact with JT0DX, the duty operator Dodi HA6NF at the controls, I asked him to send me some information about their expedition.

Not so long ago, a lengthy letter arrived from him which contained quite a lot of information about the expedition, the land and the people of Mongolia and the radio amateur activity in JT. Let me share the contents of the letter with you.

The planning and preparation for the expedition started in January 1989. The group — Andrea (YL) HG1DAI, Gyula HA1TJ, Dodi HA6NF and Gyozo HA0MM — was encouraged to undertake the expedition by HA1TJ who, in early 1988, visited Ulan Bator, the capital city of Mongolia, when, in the company of four other Hungarian amateurs they helped to establish and build a central amateur radio station for the Mongolian Radio Amateur Association.

After eight months of planning, letter writing, organising funds for the expedition (the expedition was privately funded by the members themselves) the day of departure arrived on 20 September '89. First stop in their long air journey was Moscow, for 24 hours of sightseeing, then onwards to the Far East. After an eight-hour flight they landed in Ulan Bator on 22 September. Here are a few vital statistics: Mongolia is situated on the continent of Asia, between China to the south and Soviet Siberia to the north. It has a land area of 1,565,000 square kilometres compared with Australia's 7,682,300. The population of Mongolia is 1,820,000. Mongolia is a rugged land. Plateaus and towering mountain ranges cover much of the country. The bleak Gobi Desert blankets much of southeastern Mongolia. Temperatures are usually very hot or very cold. Mongolia's little rainfall occurs in a few summer storms. The country's main economic activity is the raising of livestock. Mongolia is the original home of an Asian people, called Mongols, who built the largest land empire in history during the 1200s. They conquered an area from eastern Asia to eastern Europe. The capital city is Ulan Bator, other towns are Choybalsan, Tsetserleg, Moron, Altay. No part of Mongolia lies less

than 518 metres above sea level. The Altai Mountains in the west rise more than 4270 metres. History tells us that the various groups of Mongols were united under Genghis Khan in the 1200s, and his grandson Kublai Khan extended the Mongol empire from Korea and China westward into Europe, extending as far as Hungary. The empire broke up at the end of the 1300s. In the 18th and 19th centuries, Mongolia was under Chinese rule. Under Russian influence the Mongolian People's Republic was established in 1924.

After this brief geographical and historical detour, back again to the letter of HA6NF. On arrival at the airport, the small Hungarian group was welcomed by various radio amateur officials and, after a typical Mongolian lunch (a variety of dishes of mutton and lamb) they were shown the premises of the Central Amateur Radio Club in Ulan Bator (JT1KAA), which practically became their home during the stay, and they were given all the facilities of the club. Besides the club equipment, they used a Drake TR7 and a Commodore 64 computer with a contest log program developed by HA6NF. This program only needs the operator to log the callsign and the report — the rest of the functions are done automatically. The

antenna used, already in position on the top of the two-storey building, was a five-element tribander (FB53). Finally, the station was on the air, starting an intense 23 days of activity. It took some time before the operators adjusted themselves to the daily "dogpile". They soon changed their operating technique by calling by districts from 1 to 0. This reduced the confusion and enabled a more orderly method of contacts. The first three hours of operation produced 800 QSOs, and they went to bed after being constantly awake for 37 hours (the long journey and the first day's activity). Next day, the group concentrated mainly on the RTTY activity by taking part in the CQ-WW-RTTY Contest. This produced quite a number of contacts, despite a series of mishaps on that day (the balun of the antenna fused, the computer started to have hiccoughs, and a pipe break in the building produced a minor flood; they were up to their ankles in water). Worse was to come: the water got into their display unit, into the computer itself, and finally into their amplifier. It took three and a half hours and solid work by all concerned to get the station back into operation. As time went by, the group refined its operation by having two sta-

Continued on page 30



JT0DX Hungarian DXpedition team at work

AMATEUR RADIO IN THE USSR (PART 2)

This is second in a two part series written for the WIA journal, *Amateur Radio magazine*, by Yury Zolotov UA3HR, a prominent member of the USSR Federation of Radio Sport in Moscow. Yury is well-known for his work in 1988 when he kept contact with the Soviet-Canadian trans-polar expedition. Part 1 was in the August issue.

Licensing In The USSR

Licences are issued for amateur collective (club) stations and to individuals to operate their own amateur station.

Collective stations have three grades or categories of licence while individual stations have four categories. Three of the individual station categories are granted to radio amateurs who have reached 16 years of age, while the 4th category is available from the age of 14.

The right to operate a collective station can be granted even to 12 year olds who have observer call signs.

Licences to operate an amateur radio station in the USSR are issued in two steps. The first includes qualification examinations for electricity and radio engineering, safety, rules of amateur radio communications, and also sending the telegraph code and receiving it by ear. The 4th category needs only an interview without a test in Morse.

Examinations and interviews are arranged by qualification commissions of local radio sports federations of clubs or clubs of the Voluntary Society for Assisting the Armed Forces.

Each category has allocated bands, specific types of communications and maximum transmitter outpower power (see table).

Radio amateurs pay nothing for examinations, formalities and licences. Every shortwave radio amateur pays 3 roubles to his club annually — his membership dues. There are no taxes (licence fees) on radio activities.

Hobby Benefits From Glasnost

The development of glasnost (openness) and democratisation in the country in recent years has brought some changes to the rules of operating amateur stations.

You may have already noticed some Russian stations giving their own address during contacts. A previous ban on contacts with certain countries, such as

Israel, has now been lifted.

And all categories of licence are now allowed to work all DX countries, removing a previous restriction on DX working.

QSL cards can be received at one's home address, ending the long standing ruling that cards had to go only through

the QSL Bureau of the USSR Central Radio Club.

Gear Mostly Homebrew

Soviet radio amateurs are allowed to experiment with such forms of communi-

Continued on page 30

Table 1

Frequency bands, permissible outputs and types of communications allowed for Soviet radio stations

Station category	Output W	Band kHz	Type of Communication
4th category individual stations	5	1830-1930	CW
		1860-1930	SSB
		1900-1930	AM
3rd category individual and collective stations	5	1830-1930	CW
		1860-1930	SSB
		1900-1930	AM
		3500-3650	CW
		21000-21150	CW
2nd category individual and collective stations	10	28000-29700	CW
		28200-29700	SSB
	5	28800-29200	AM
		VHF bands	
		1830-1930	CW
		1860-1930	SSB
		1900-1930	AM
		3500-3650	CW
		3600-3650	SSB
		7000-7100	CW
7040-7100	SSB		
1st category individual and collective stations	50	14000-14350	CW
		21000-21450	CW
	5	21150-21450	SSB
		28000-29700	CW
		28200-29700	SSB
		28800-29200	AM
		VHF bands	
		1830-1930	CW
		1860-1930	SSB
		1900-1930	AM
3500-3650	CW		
200	10	3600-3650	SSB
		7000-7100	CW
	5	7040-7100	SSB
		10100-10150	CW
		14000-14350	CW
		14100-14350	SSB
		21000-21450	CW
		21150-21450	SSB
		28000-29700	CW
		28200-29700	SSB
28800-29200	AM		
5	VHF bands		

VHF bands

144-146 MHz, 430-440 MHz, 1260-1300 MHz, 5650-5670 MHz, 10-10.5 GHz, 47-47.2 GHz, 75.5-76 GHz, 119.98-120.02 GHz, 142-149 GHz and 241-250 GHz.

MOST AMATEURS DEAL WITH THE PROFESSIONALS — *THAT'S US!* AT DICK SMITH ELECTRONICS

2 year warranty FT-212RH MOBILE TRANSCEIVER

Enjoy the performance that the latest refinements in microprocessor control have to offer with the FT-212RH 2 metre FM transceiver. With 45 watts output over the 144-148MHz range, a rugged diecast chassis for superb RF isolation, extensive use of surface mount components, and a large back-lit LCD with bargraph PO/S-meter, the FT-212RH is an ideal mobile transceiver that also doubles as an easy to use base station. Operating features include 5 selectable tuning steps, a total of 21 memories (18 general purpose, one CALL-channel, and 2 sub-band limit memories for band scanning), in-built C.T.C.S.S. encode, as well as a variety of scanning functions. The FT-212RH comes with a mobile mounting bracket, convenient MH-14A8 microphone, and DC power lead. Cat D-3494



\$539



2 year warranty

ALL MODE TRANSPORTABLE TRANSCEIVERS

The all-mode, transportable transceiver for serious field or mobile operations! The FT-290RII and FT-690RII feature FM, SSB (USB/LSB), and CW operation with 2.5W or 250mW switchable output power, twin VFOs, and 10 memories that store mode and simplex or repeater frequencies. Selectable tuning rates are provided for SSB/CW and FM (SSB- 25/100/2500Hz and 100kHz; FM- 5/10/20kHz and 1MHz), while mode specific features such as a noise blanker and clarifier control for SSB/CW, plus a full set of functions for FM repeater operation make these units very simple to operate. Each unit comes with an FBA-8 battery holder which takes nine C size standard or NiCad batteries (not supplied), antenna, and handheld microphone.

FT-290RII with flexible rubber antenna covers 144-148MHz.

Cat D-2875

NOW \$749

CLEARANCE PRICE!

FT-690RII with telescopic whip antenna covers 50-54MHz.

Cat D-2874

\$699

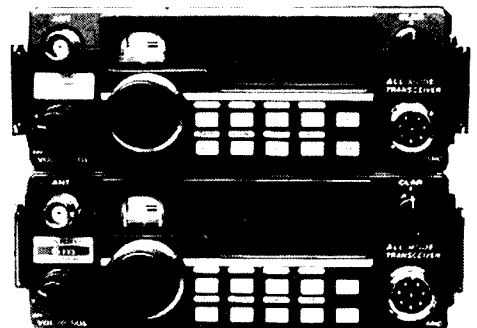

Yaesu stock not held at all stores. Please contact your local store for details.

NSW • Albury 21 8399 • Bankstown Square 707 4888 • Blacktown 671 7722 • Brookvale 905 0441 • Bondi 387 1444 • Campbelltown 27 2199 • Chatswood Chase 411 1955 • Chullora 642 8922 • Gore Hill 439 5311 • Gosford 25 0235 • Hornsby 477 6633 • Hurstville 580 8622 • Kotara 56 2092 • Liverpool 600 9888 • Maitland 33 7866 • Miranda 525 2722 • Newcastle 61 1896 • North Ryde 878 3855 • Parramatta 689 2188 • Penrith 32 3400 • Railway Square 211 3777 • Sydney City 267 9111 • Tamworth 66 1711 • Wollongong 28 3800 • **ACT** • Belconnen (06) 253 1785 • Fyshwick 80 4944 • **VIC** • Ballarat 31 5433 • Bendigo 43 0388 • Box Hill 890 0699 • Coburg 383 4455 • Dandenong 794 9377 • East Brighton 592 2366 • Essendon 379 7444 • Footscray 689 2055 • Frankston 783 9144 • Geelong 232 7111 • Melbourne City 399 Elizabeth St 326 6088 and 246 Bourke St 639 0396 • Richmond 428 1614 • Ringwood 879 5338 • Springvale 547 0522 • **QLD** • Brisbane City 229 9377 • Buranda 391 6233 • Cairns 311 515 • Chermside 359 6255 • Redbank 288 5599 • Rockhampton 27 9644 • Southport 32 9033 • Toowoomba 38 4300 • Townsville 72 5722 • Underwood 341 0844 • **SA** • Adelaide City 223 4122 • Beverley 347 1900 • Elizabeth 255 6099 • Enfield 260 6088 • St. Marys 277 8977 • **WA** • Cannington 451 8666 • Fremantle 335 9733 • Perth City 481 3261 • Midland 250 1460 • Northbridge 328 6944 • **TAS** • Hobart 31 0800 • **NT** • Stuart Park 81 1977 **ORDER BY PHONE OUTSIDE SYDNEY (008) 226610 Free Call Sydney Area 888 2105**

Most amateurs deal with the professionals...

That's us!

DICK SMITH
ELECTRONICS



When you've got a high powered hobby like Amateur Radio, you can't risk dealing with anyone but the professionals. With licensed amateurs in many of our stores and, of course, the best equipment in the country, we can take the hassle out of your next investment.

An increasing number of our stores now have a HAM SHACK! Ham Shacks have an Amateur on staff and can provide on-air demonstrations of most equipment plus they stock almost the entire Yaesu range.

Don't get caught by back-yard dealers! Their offers may seem tempting, but will they still be there when you need service? Will they give you the right advice? With over 22 years of experience behind us, Dick Smith Electronics will stand by you with service, spare parts, accessories, and professional advice — ALWAYS!

Who else has —

- 63 stores Australia wide
- A comprehensive range of spares in stock, at competitive prices
- A fast mail order department delivering anywhere in Australia
- The best advice from staff who are Amateurs themselves
- An exclusive 2 year warranty on all Yaesu transceivers, receivers, and linear amplifiers

There's a store near you!

NSW • Albury 21 8399 • Bankstown Square 707 4888 • Blacktown 671 7722 • Brookvale 905 0441 • Bondi 387 1444 • Campbelltown 27 2199 • Chatswood Chase 411 1955 • Chukora 642 8922 • Gore Hill 439 5311 • Gosford 25 0235 • Hornsby 477 6633 • Hurstville 580 8622 • Kolara 56 2092 • Liverpool 600 9888 • Maitland 33 7866 • Miranda 525 2722 • Newcastle 611 1896 • North Ryde 878 3855 • Parramatta 689 2188 • Penrith 32 3400 • Railway Square 211 3777 • Sydney City 267 9111 • Tamworth 66 1711 • Wollongong 28 3800 • **ACT** • Belconnen (06) 253 1785 • Fyshwick 80 4944 • **VIC** • Ballarat 31 5433 • Bendigo 43 0388 • Box Hill 890 0699 • Coburg 383 4455 • Dandenong 794 9377 • East Brighton 592 2366 • Essendon 379 7444 • Footscray 689 2055 • Frankston 783 9144 • Geelong 232 711 • Melbourne City 399 Elizabeth St 326 6088 and 246 Bourke St 639 0396 • Richmond 428 1614 • Ringwood 879 5338 • Springvale 547 0522 • **QLD** • Brisbane City 229 9377 • Buranda 391 6233 • Cairns 311 515 • Chermids 359 6255 • Redbank 288 5599 • Rockhampton 27 9644 • Southport 32 9033 • Toowoomba 38 4300 • Townsville 72 5722 • Underwood 341 0844 • **SA** • Adelaide City 223 4122 • Beverley 347 1900 • Elizabeth 255 6099 • Enfield 260 6088 • St. Marys 277 8977 • **WA** • Cannington 451 8666 • Fremantle 335 9733 • Perth City 481 3261 • Midland 250 1460 • Northbridge 328 6944 • **TAS** • Hobart 31 0800 • **NT** • Stuart Park 81 1977

ORDER BY PHONE OUTSIDE SYDNEY (086) 228610 Free Call Sydney Area 886 2106

B1034/BL

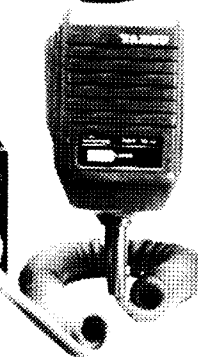
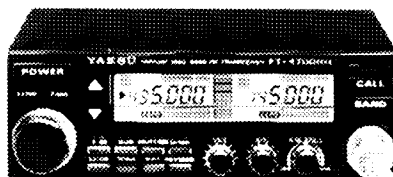
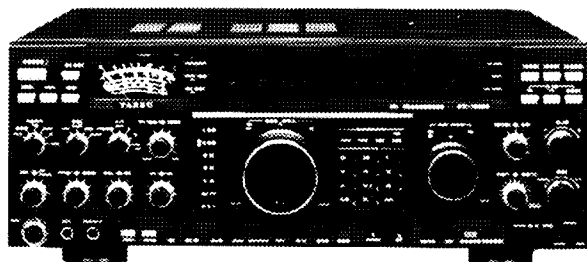

* Yaesu stock not available at all stores.
Please contact your local store for details.



**AUSTRALIA'S ONLY
FACTORY AUTHORISED
YAESU AGENT**

FT747GX HF TRANSCEIVER

Now is the time to enjoy the excellent HF band conditions with Australia's best value entry level HF transceiver! The FT-747GX is a compact SSB/CW/AM and (optional) FM transceiver that provides 100 watts P.E.P. output on the 1.8-30MHz Amateur bands, and general coverage reception from 100kHz to 30MHz. It features a front panel mounted speaker, a large backlit LCD display, dual selectable tuning steps for each mode, dual VFOs for split frequency operation, and 20 memory channels. A wideband 6kHz AM, and narrow 500Hz CW crystal filter are fitted as a standard feature, and an MH-1 hand mic is also supplied.

Cat D-2930

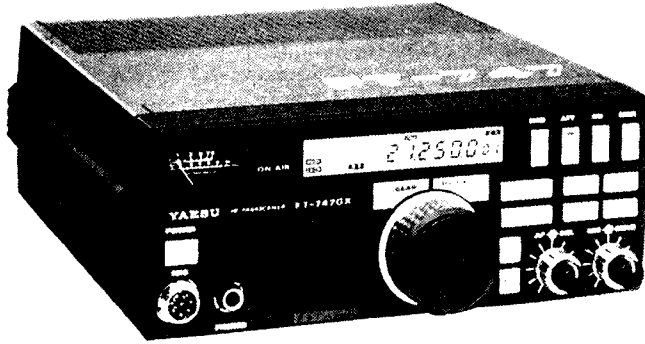

2 year warranty.

\$1099

2 Year Warranty!

FT-767GX TRANSCEIVER

Our best deal ever! The FT767GX is the ONLY transceiver that offers such a high level of performance on all HF amateur bands, as well as on the 6m, 2m, and 70cm bands. Features include all amateur band coverage from 1.8 to 440MHz (100W max HF, 10W max VHF/UHF), all mode operation on all bands (SSB, CW, AM, FM, FSK), HF receiver covering 100kHz to 30MHz with up to 104dB dynamic range, inbuilt AC power supply, inbuilt automatic HF antenna tuner, digital wattmeter and auto-calculating SWR meter. Also includes bonus hand-held MH-1 microphone.

Cat D-2935

HF, 6M, 2M, 70CM



\$3295

FT-4700RH DUALBAND MOBILE TRANSCEIVER

Continuing the tradition started by Yaesu with the FT-2700RH, the new FT-4700RH dualband 2M/70cm FM transceiver now provides higher levels of performance, while offering even better value for money!

Features include 50 watts output on 2 metres (144-148MHz), and 40 watts output on 70cm (430-450MHz), with an inbuilt cooling fan for long term reliability. True full-duplex crossband operation is supplemented by dual band simultaneous reception or auto-muting reception (with independent squelch and mixing balance), so you can listen for calls on both bands simultaneously, or work someone on one band while also listening on the other band. The optional YSK-4700 controller cable allows the main body of the transceiver to be installed under a seat, while the front panel/controller mounts conveniently on the dashboard. On the control panel, the bright amber backlit LCD shows both VHF and UHF frequencies and signal strengths, and all controls have backlit labels for clear readability, with a dimmer switch for nighttime viewing. A total of 20 memories and 5 selectable tuning steps make frequency selection easy, while the advanced scanning features allow quick detection of signals on either, or both bands. And all this is backed up by our exclusive 2 year warranty, the longest in the industry. See ARA review Vol. 12 Issue 11 (Feb 1990), or A.R. review May '89.

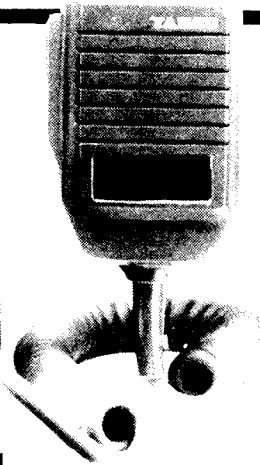
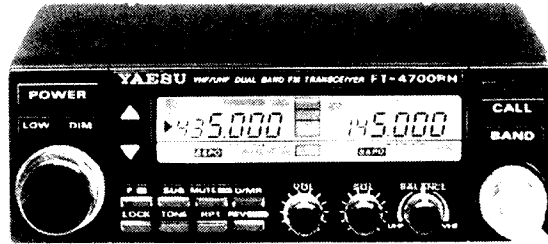

\$999

D-3300

D-3301 YSK-4700 CABLE \$49.95



DICK SMITH
ELECTRONICS

Amateur Radio in Argentina continued from page 25

ment. There are some stations having state of the art rigs, but that was more often some time ago. It's very common to find amateur newcomers building AM rigs using valves for 80 metres.

It may sound old fashioned but sometimes that's the only way to get on the air. There are some rigs manufactured in Argentina at low prices.

Amateur radio in Argentina is a very

popular hobby and it will continue as it has done for many years despite the transient economical situation. Packet radio will keep on growing and there may be an increase in activity within the UHF/SHF spectrum.

Footnote

Marcelo Franco migrated to Australia

in August 1989, at twenty three years of age. As there is no reciprocal licensing between Argentina and Australia, he sat for an AOC exam in November and was issued with callsign VK4DWA. He is employed as an electronic technician and is a member of the Sunshine Coast Amateur Radio Club.

ar

Hungarian DXpedition continued from page 26

tions operating independently, mainly on phone and CW. However, the RTTY mode was also used quite extensively.

Here are some operational statistics: 32,759 contacts were made. Operation was on 80, 40, 20 15 and 10-metre bands, 12240 CW, 19707 SSB and 812 RTTY contacts. Areas of contacts: Japan 8301, USA 7729, Europe 13,120, others 3609. There were 750 contacts on 80 metres, 2563 on 40 metres, 9921 on 20 metres, 10,964 on 15 metres and 8561 on 10 metres. QSLs direct to HA6KNB, to this address: Radio Club Salgotarjan, Box 115, H-3101, Salgotarjan, Hungary. Please include self-addressed reply airmail envelope and two IRCs. They have started QSLing. Each incoming card will be checked against the computer data and the computer printout will be attached to the cards.

Unfortunately, the Hungarian postal authorities decided to increase the postal rates by 40 per cent as from the

beginning of the year and this causes major problems for the group. If you can afford, send them more than two IRCs.

The Hungarian group, like probably most radio amateurs around the world, knew very little about radio amateur activity inside Mongolia. They were a little surprised to discover the following: the Mongol amateur radio activity is attached to the Mongolian National Defence Association (the same organisational structure applied, or applies still, to many East European amateurs. Every major settlement has an amateur radio club (the 1990 International callbook lists 13 such clubs). About 100 licensed operators are attached to these clubs. Twenty-six individual licences have been issued, the youngest operator being 17 years old (JT1BX) and the oldest 67 years old (JT2AB). Everyone who passes a technical, Morse and regulations test can get a licence. Since March 1989, the radio amateur tests are conducted by a four-member committee (amateurs them-

selves) of the Central Radio Amateur Club of Ulan Bator. The licences then are issued by the secretary of that club. The radio clubs have quite a number of non-licensed members totalling about 1000 — the main activities being orienteering, directional finding and fox-hunting: 600, radio sport: 150, and there are 200 advanced radio sport members (radio sport is a combination of fox-hunting, running, climbing, target-shooting). They have a good tradition of home-brewing. A home-brewing contest is held twice a year. The prominent employee members of the Central Club assist the other clubs by producing technical assistance, back-up and construction services.

After the many hundreds of hours spent at the radio sets, the day of departure arrived and, on 14 October 1989, the four Hungarian amateurs boarded their plane and flew home, still remembering the exciting days of this DXpedition.

ar

Amateur Radio in the USSR (Part 2) continued from page 27

ications as packet radio, and organise computer-based information networks.

It is a safe bet to say that 99 per cent of all radio amateurs use home-made transmitters or transceivers.

Only a few groups use professional industrial-type radio stations, a poor substitute for amateur sets. As for imported transceivers, there are only a few of them in the country.

It is extremely difficult to buy thin-walled tubes of light alloy metal for making aerials.

This explains the wide use of the double-square (cubical quad) aerials, using wooden poles and wire which are easily available.

Lack of amateur radio equipment hampers radio amateur activities in the schools. School stations are few and far between, although schoolboys of all grades are eager to take up radio as a hobby

Their progress, if any, is due to individual radio amateurs who mainly work in schools on a voluntary basis.

Even so the amateur radio movement is very popular and not confined to amateur communications.

Nationwide exhibitions of home-made radio devices are held regularly, once every two years.

Hundreds of exhibits show amateurs' ingenuity in various fields: radio communications, computer technology, instruments for industry, science, medicine, and agriculture.

A large number of exhibits are designed to help with studies at school, college or university.

Usually there are many domestic radio sets as well as control and measuring instruments. Special juries award the best exhibits diplomas and valuable prizes.

ar

CALLING VIETNAM VETERANS

A net for those associated with the Vietnam War is held on 14.330 +/- QRM at 0000 UTC each Sunday (Monday in VK).

Called the "Nam Net" it's attracting both former Military Affiliate Radio System (MARS) Vietnam Operators and war veterans who are radio amateurs.

MARS handled hundreds of thousands of third-party traffic messages via RTTY and phone-patch between Vietnam and the US. It still provides the link for US service personnel usually on authorised frequencies just outside the 10, 15 and 20-metre bands.

ar

AWARDS

PHILL HARDSTAFF VK3JFE
FEDERAL AWARDS MANAGER

DXCC — Current Status

First up this month a plea for help. When I first took on this job I thought I would be able to handle all the different aspects of this job without too much difficulty. Well I was wrong. The one part that I am finding it hard to keep up with, is the DXCC updates and issuing of certificates. What I need is someone to assist me with or take over the DXCC part of this job, which will enable me to give my full attention to the smooth running of the other awards. Also at the moment, I am trying to get a new award off the ground and this will require a bit more of my time than normal. I need someone who is most likely a keen DXer, and reasonably up with the status of DXCC affairs, who has some spare time he would be willing to contribute. I am still trying to get everything on to computer, but this could be done separately by myself. So don't be put off if you don't have a computer. You will also need a little room to house the current records (at present about 8-10 legal type binders). We can work out the details between us, so if you are interested, give me call on the phone (03) 434 6424 weeknights or weekends) or drop me a line. I will be shifting house some time during the next month but, should still have the same phone no.

DXCC Outstanding Updates

All those who have updates or applications for DXCC not yet dealt with, will be getting a short note very soon confirming the documentation. If you have asked for an update or DXCC itself, and have not got a letter from me by the end October, (ie by the time you read this) could you please let me know?

Grid Square Award

As I write this on Sunday 7/10/90, I am listening to the VK3 broadcast and have just heard about the delay in the printing of the October issue of AR. I had left the writing of this months notes to the last minute in the hope of getting some feedback from Oct AR regarding the GSA. But alas. This was not to be, so more about the GSA next month.

ZL National Parks Award

I received a small note which apparently came via VK2EHQ, with details of an expedition by a group of Gisborne Amateurs in ZL, who will be operating from a National Park on 9, 10 and 11 November. The actual award requires 2 contacts from stations operating from a National Park. Duplicate contacts are OK on different bands/days, but as there will be a group operating, it should be easy to get

the 2 contacts. No other info was supplied, but I have details from the 1988 Callbook, which says \$2.00 for the award + \$1.00 for airmail to: ZL2GX — Jock White. 152 Lytton Rd, Gisborne, New Zealand

British Post Codes Award

Well, it was our turn last month. This month, from the Civil Service Amateur Radio Society in Britain, comes details of a new award called the British Postcodes Award. This is timed to commemorate the 150th anniversary of the Penny Black, the world's first adhesive postage stamp.

Rules:

1. The award is for working the various UK Postcode areas on or after 6 May 1990, and is issued in three classes: Gold (all 120 Postcode areas); Silver (100 areas); Bronze (75 areas). A contact with a CSARS HQ callsign (G1CSR, G3CSR, GB0CSR, GX1CSR or GX3CSR) may be substituted for one unworked Postcode area.
2. General awards in any class can be claimed for any combination of licensed modes and bands (HF, VHF, WARC), but the award can be endorsed for single band, mode etc.
3. Contacts via repeaters or, with stations not operating from a postal address, do not count.
4. QSOs may be made from any one or more postal addresses from which the applicant is permitted to operate using the same callsign.
5. QSLs are not required, and should not be enclosed with applications.
6. Applications should show callsign, name, and full postal address of the applicant, and a list of claimed QSOs showing post-code areas, callsign, date, band, and mode, and certified by the applicant and countersigned by 2 other licensed amateurs, that the claimed QSOs conform with the relevant entries in the applicants log.
7. The award is also available to SWLs on a heard basis.
8. Application together with a fee of \$3.00 or US\$4.00 or 12 IRCs to be sent to the:-
CSARS
Civil Service Recreation Centre
Monek Street
London
SW1P 2BL
England

YL-DXCC Award:

From Gwen Tilson VK3DYL comes details of the YL DXCC Award. The details of which are listed below!

The rules are quite straight forward. As you will not be likely to qualify overnight, I will give a summary here for now. The basic award is for 100 contacts with YLs in 100 different DXCC countries. You must possess cards, but do not need to send them in. A certified list will do instead, signed by a club officer or 2 YL licensed amateurs (exactly why it can only be certified by YLs seems to be a bit unreasonable to me?).

Stations should be listed in the same order as the ARRL countries list. The log must show country worked, date, time, frequency, RS (T) reports and YL's name. There is no charge for the award, but you must include sufficient postage to cover mailing etc. (I would suggest US \$2.00 for air mail.) Upgraded stickers are available for each additional 25 contacts in different countries. Send applications to:

Martha (Marty) Silver, NY4H
New Custodian
3118 Eton Rd,
Raleigh, NC 27608
USA

Closing Thoughts

Well that's about it for this month. I am working my way through a pile of outstanding award applications at the moment, all of which will be mailed by 15/10/90. I will have to leave the details of these awards until next month, as I don't like to list them until they have been mailed. All the best till next time — Phill ar

A Call to all Holders of a Novice Licence

Now you have joined the ranks of amateur radio, why not extend your activities?

The Wireless Institute of Australia (N.S.W. Division) conducts a Bridging Correspondence Course for the AOCF and LAOCF Examinations.

Throughout the Course, your papers are checked and commented upon to lead you to a successful conclusion.

For further details write to:

The Course Supervisor
WIA
PO Box 1066
Parramatta NSW 2124
(109 Wigram Street, Parramatta)
Phone: (02) 689 2417

11am to 2pm Monday to Friday
7 to 9pm Wednesday

CONTESTS

JOHN MARTIN VK3ZJC
MANAGER, ROSS HULL CONTEST

Ross Hull Memorial VHF-UHF Contest 1990-1991

A number of rule changes have been made to the contest this year in an effort to increase its standing as a serious competition for VHF-UHF operators. The most important change has been to adopt scoring based on distance and frequency, rather than by totalling locator squares. The exchange of locators is still encouraged as an aid to distance calculation.

Another change this year is the introduction of separate sections for terrestrial and satellite contacts, allowing both groups to compete in their own areas without being disadvantaged. Anyone may enter for both the terrestrial and satellite sections if desired.

All bands above 50 MHz will be available, with band multipliers to reflect the greater difficulty of making contacts on higher bands. These multipliers are moderate and will guarantee that the contest cannot be won by a small number of contacts on the more "exotic" bands.

Most operators have a favourite band, and many may not have access to more than one or two bands. Awards will be made to the highest scorers on each band, as well as to the winners of the multiband and satellite sections.

The contest will again run during the summer "DX season", to stimulate activity at the time of year when DX contacts are most likely to be made — and when entrants are most likely to have free time.

Over most of its history, the contest has run for a month or more. In the last few years the time has been shorter, but there have still been complaints that even two weeks is too long to be locked away in the shack. On the other hand, a shorter contest would prevent a number of amateurs from participating due to the timing of their Christmas holiday breaks, or other commitments that might clash with the contest. There is also the point that the contest helps to stimulate activity, therefore the longer the better.

This year the contest will run for a longer period, but scores will be based on the entrant's best seven days (not necessarily consecutive). This will make it easier for everyone to join in when they can, even if they only have time at weekends. The contest will finish on the weekend before the VHF-UHF Field Day, to provide a break for anyone who wishes to enter both contests.

It is hoped that these new rules will help to increase participation and encourage more amateurs to send in a log. The success of a contest like this cannot of course just be

measured by the number of logs — it is the overall participation and the standard of achievement that count. But under these new rules there should be more incentive for participation, and more opportunity to win an award.

Ross Hull Contest 1990-1991: Rules

The WIA maintains a perpetual trophy in honour of the late Ross Hull and his pioneering achievements in the VHF-UHF field, especially the discovery and investigation of VHF tropospheric propagation.

The name of each year's contest winner is engraved on the trophy, and he/she will receive an attractive wall plaque and certificate. Any licensed amateur can enter this contest — it is **NOT confined to WIA members**.

1. Duration:

0000 UTC Saturday, December 22, 1990 to 2359 UTC Saturday, January 19, 1991. Scoring will be based on the total for the best seven UTC days (not necessarily consecutive) nominated by the entrant.

2. Sections:

- A. Multiband, terrestrial contacts only.
- B. Single band, terrestrial contacts only.
- C. Multiband, satellite contacts only.

Entrants for Section A will also be scored for Section B.

Section B entrants may submit logs for more than one band.

Entrants may submit logs for Section C as well as for Sections A/B. The seven UTC days nominated for Section C need not be the same days as those nominated for Sections A/B.

3. General Rules:

All bands above 30 MHz may be used. Single operator only. One contact per band per UTC day. Contacts through repeaters are not permitted. Crossband contacts and satellite contacts are permitted only in Section C. There is no restriction on portable or mobile operation.

4. Contest Exchange:

The exchange will be RS (or RST) numbers plus a two-digit serial number. Serial numbers should begin again at 01 at the start of each UTC day. The exchange of Maidenhead locator numbers is not essential but is encouraged as an aid to distance calculation.

5. Scoring — Sections A/B:

Contacts up to 2000 km: one point per 100 km or part thereof. (ie up to 99 km: 1 point, 100 — 199 km: 2 points, etc).

Contacts over 2000 km: five points per 500 km or part thereof.

Band multipliers:

6m	2m	70 cm	23 cm	13 cm	higher
x 1	x 3	x 5	x 7	x 10	x 15

Examples: 340 km on 2 metres: 12 points.
220 km on 23 cm: 21 points.

6. Scoring — Section C:

Stations may be worked once per mode (see below) per UTC day.

One point per contact. Band multipliers as follows:

- Mode A (145/29): x 3
- Mode B (435/145): x 5
- Mode J (145/435): x 5
- Mode L (1260/435): x 7
- Mode S (435/2401): x 10
- Mode T (21/145): x 3

7. Logs:

Logs should cover the full period of operation, but distance calculations need only be made for the seven chosen days. Separate logs for each band would be helpful, but are not essential. Section C logs must be separate from Section A/B logs.

Logs for Sections A/B must contain the following for each contact:

- UTC date and time.
- Station location.
- Callsign of station worked, band and mode.
- Location or Maidenhead locator of station worked.
- Reports and serial numbers sent and received.
- Estimated distance worked.
- Points claimed.

Logs for Section C should be as above, except that entries in the "band" column would be "Mode A", "Mode J" etc and there is no need to include the other station's location or the estimated distance.

8. Cover sheet:

Logs must be supplied with a cover sheet containing the following:

- Operator's callsign, name and address.
- The location of the station (if different from the postal address).
- Sections entered for: A/B and/or C.
- A scoring table set out as the example below (two tables if entering for both the terrestrial and satellite sections).
- A signed declaration that the station has been operated in accordance with the rules and spirit of the contest.

9. Deadline:

Post logs to WIA Ross Hull Contest Manager, PO Box 300, Caulfield South, Vic 3162. Logs must be received by Monday, February 18, 1991.

10. Disqualification:

The normal rules apply. Entrants may be disqualified if there is evidence that claimed contacts were not actually made, or if logs are incomplete or illegible.

11. Awards:

The overall winner of the contest will be the top scorer in Section A. Awards will also be made to the winner of Section C, and to the top scorer on each of the following bands; 6 metres; 2 metres; 70 cm; 23 cm; 13 cm; micro-waves (bands above 3 GHz).

Note On Calculating Distances

Absolute accuracy is not needed. It is only necessary to determine whether the distance is above or below the nearest multiple of 100 km. Entrants may estimate distances with a ruler and a map, or quote Maidenhead locator numbers. The contest manager will check claimed distances by computer and if locator numbers are given, the calculation will be made from the centre of the locator square. The contest manager reserves the right to increase or decrease claimed distances on the basis of computer calculation and his decision will be accepted as final.

Sample Scoring Table — Section A/B

Date	6 metres		2 metres		70 cm		23 cm		etc.
Day 1	xxx		xxx		xxx		xxx		
Day 2	xxx		xxx		xxx		xxx		
QSO Total	xxx		xxx		xxx		xxx		
Multiplier			x 1		x 3		x 5		x 7
Band Total	xxx	+	xxx	+	xxx	+	xxx	=	xxxxx (final score)

A scoring table for Section C would be similar, except that the band headings would be replaced by "Mode A", "Mode B" etc. ar

HOW'S DX

STEPHEN PALL VK2PS
PO BOX 93 DURAL NSW 2158

Sometimes I wonder, whether "all this" is really worthwhile and is appreciated by the readers and users of this column, and by the actors who create the news of this column: the DX stations themselves.

"All this" simply means the amount of work expended to prepare this monthly column. It makes a rigid daily routine. Each day hours are spent in the shack at various times, not so much to operate, but to listen to the activity on the various bands, as a news gathering exercise.

Hours are spent in reading, collecting and collating relevant and irrelevant information from a variety of sources. Beside the use of phone for local, interstate and sometimes overseas calls, there is the ever growing correspondence with all manner of people. With supporters of this column, and they are very much appreciated, with overseas publications, and with the DXers themselves. The DXers are an interesting lot. Most of them are very understanding and co-operative, but a very few of them have to be handled with silk gloves so as not to damage their egos. You also find from time to time interesting letters in the incoming overseas mail; like the two letters recently, both from amateurs from developing countries. One asked for direct assistance to facilitate his immigration to Australia, because he is sick and tired of his old country. The other hinted that we should place an ad in "AR" to assist him to find a local girl whom he can then marry, and thus assist him to migrate to this country!

And of course, there is the dreaded "deadline" towards the end of the month, when all the gathered information is put through a "mental mincer" and the end product is presented to you as the monthly column.

"So what", do I hear you say? "If he cannot stand the heat he should get out of the kitchen...". Yes, that could be the easy part. If I go out of this "hot kitchen", where are the volunteers, the enthusiastic DXers, who will

continue to write this column? Any takers? Do I hear voices or see raised hands?

But there are also a few rare compensating moments. Just as I was contemplating how to put this column together, a letter arrived from a VK amateur. I do not want to embarrass him by publishing his name or callsign, but he writes as follows:

"This is just a note of appreciation for the way in which you conduct the "How's DX?" column in "Amateur Radio". Although I do not work the HF bands, since I live in a flat and antennas are difficult to erect, nonetheless I appreciate hearing the news about various DXpeditions etc around the world. If I cannot work them myself, at least I can read about them. I sincerely hope your work will continue."

Thank you my friend. I will continue the struggle. So now to the news which really matters.

The Seanet Convention

The 18th South East Asia Amateur Radio Network (SEANET) convention will be hosted by the Sarawak Branch of the Malaysian Amateur Radio Transmitters Society (MARTS). The convention will be held at the Holiday Inn in Kuching, the capital city of Sarawak from the 10th to the 12th of November 1990. Prominent local and overseas speakers will address the convention which will be attended by the presidents of IARU, MARTS and JARL. Several local state officials as well as local DOC-Telecom and IPS Radio and Space Services Australia will be represented. During the convention the special event station 9M8SEA, Kuching will be active. Immediately at the end of the convention, the adventurous will proceed by air, coach, express boat and finally by long boat to Mt Mulu in a total travel time of ten hours. Here they will visit various famous caves and will operate a special DXpedition station: 9M8ULU. Try to work them both! Good luck and QSL via the

Bureau. Incidentally, SEANET continues to operate on 14320 kHz +/- QRM every evening at 1200 UTC with rostered net control stations (NCS) such as Paddy 4S7PB, Kevin 9M2ZZ, Hassan V85HG, Ben VK6XC and HS1BV on hand to keep matters running smoothly.

Wallis Islands — FWO

Two New Caledonian amateurs, Sam K8DD and Jean Michel FK8EL were very active in the second part of September as FWO0D and FWOET on several bands both in the SSB and CW mode. QSL with SAE and the usual IRCs to Sam Torone, PO Box 3040 Noumea, New Caledonia.

United Arab Emirates — A6I

Due to the Middle East situation, not many stations are on the band from that area. Saeed A61AD was worked early September at 1416 UTC on 14187 kHz with a good strong signal. His QSL goes to: WB2DND: Donald R Greenbaum, 250 Standish St, Duxbury, MA 02332, USA.

Curacao — PJ

According to various reports, Finland (OH) will send 55 operators and 40 support staff for a multi-multi contest operation for the CQ WW contest, in both SSB and CW modes. The calls will be PJ9W on SSB and PJ9A on CW.

Juan De Nova Island — FR/J

Jacques FR5ZU had various changes in his schedule. Originally he intended to work from Glorioso Island, but that part of the trip was cancelled. However he managed to work from Juan De Nova Island as FR5ZU/J. At the end of September he then proceeded to Europa Island. Whilst these islands, together with Glorioso, belong to the bigger island of Reunion, a French Territory in the Indian Ocean, their special location in the Mozambique Channel between Madagascar and the mainland of Africa, makes Juan de Nova and Glorioso a separate DXCC country. QSL to: J Quillet, 1 Cite de Meteorologique, F-97490 St Clotilde, Reunion Island, France, Indian Ocean.

The Colvins

Iris and Lloyd W6QL and W6KG were in Malawi at the end of September and the beginning of October, working as 7Q7KG. Their final aim is to work from Mozambique (C8-C9) and from Madagascar (5R). QSLs to YASME. (See Oct "AR" for address.)

Isle Of Man — GD

From time to time there is some activity from this UK island. Whilst the callbook lists over 300 callsigns, most of them are only VHF operators and only a very few are HF DXers, like GD4PTV Brian, GD4RAG John, and GD4WBY Mike. Stephen Munster G4UOL, Flat 4, 60 Genesta Road, Westcliff-on-Sea, Essex, UK, SSO 8DB, will be on the island between the 17th and 30th November and will operate as GD4UOL, mostly CW.

Tristan Da Cunha Islands — ZD9

Have you heard about these islands? As a DXer you should. What do you know of these islands? Not much? Here is a concentrated description. The islands of Tristan da Cunha, Gough, Inaccessible and Nightingale are a group of British islands in the South Atlantic between South America and southern Africa. The capital is Edinborough, and the group is a dependency of Saint Helena Island. The islands cover 79 sq miles (205 sq kms) and have a population of just under 300. In 1961 a volcano erupted on Tristan da Cunha and the entire population was evacuated to Great Britain. When the island was declared safe, they moved back in 1963.

In the past there were only sporadic operations audible from these remote islands in Australia. The latest was Carol (a YL) ZD9CS. Because of propagation and the fact that the local power supply does not start up before 7 o'clock in the morning local time, it is quite difficult to have a QSO with a ZD9 amateur. A number of net controllers during August and September tried several times to establish a workable QSO pattern without success. A few individuals managed a short contact with her. KB1BE Paul asked me to advise you, that the correct QSL manager for Carol is KA1DE and not Paul KB1BE as advised on the bands previously.

However, one has to be lucky sometimes. On the 28th of September ZD9BV appeared on 14166 at 0719. He came over the North Pole without any preliminary warning at an average signal strength of 5. An enterprising VK4 amateur, Bill VK4UA organised a small list (about 5) of takers. A number of VKs worked him. The operator is Andy, and his QSL manager is W4FRU, John Parroott, PO Box 5127, Suffolk, VA 23435 USA.

You should have heard two days later the long list of amateurs who all wanted to work the ZD9, to capture this rare DX country in their log!

The Woodpecker

For a very long time, this dreadful monster of the early 80s which made life difficult for all amateurs, especially on 20 metres, was silent. One would have thought that, due to the thaw between East and West, the irritating 9 plus broadband pulse signal really had been laid to rest. But what did I hear on the 19th of September at 0740 UTC on 14187 on the longpath towards Europe? Yes, your guess was right. The monster, or one of its relations, has reappeared. Maybe the Persian Gulf situation caused its rebirth. In any case, if you hear it, please report it immediately in writing to your Intruder Watch Coordinator.

Interesting QSOs And QSL Information

Note: Callsign-name-frequency in kHz-mode-UTC-month of the QSO. ADAR= QSL info in previous issues of AR.

*** KJ8M/C0H — Rodger — 14020 — CW — 0544 — IOTA NA 67 — QSL to: KJ8M.

Rodger C Phillips, 159E Temperance Road, Temperance, Michigan 48182 USA.

*** 7Q7CW — Rudi — 14022 — CW — 0500. QSL to: DK7PE Rudolf Klos Klein Unterg 25, D-6501, Nieder Ulm, Germany.

*** V73AZ — Dave — 21011 — CW — 2100 — QSL to: N4ASF David M Boulter PO Box 249, Wachapreague, Virginia 23480, USA.

***ZF2PM — 14025 — CW — 0530 — QSL to: NE4L Robin A Gist, RT5 — Box 471, Florence, AL 35630 USA.

*** OY7ML — Martin — 21034 — CW — 0830 — Sept — QSL to: Martin Haasen, PO Box 184, FR-110 Torshavn — Faroe Islands, North Atlantic.

*** ZC4BOB — David — 21205 — SSB — 0519 — Sept — Special event station to celebrate the 50th anniversary of the Battle of Britain. QSL to: Joint Signal Board HQ British Forces Cyprus, BF PO Box 53 London GPO UK.

*** PZ1EL — Ramon — 21205 — SSB — 0605 — Sept — QSL to: Box 9131 Paramaribo Surinam South America.

*** CX1TE — Rafael — 14189 — SSB — 0701 — Sept — QSL to: Rafael Guasp, Box 17, Montevideo, Uruguay, South America.

*** KC6GV — Kaare (one of the main organisers of the Bouvet DXpedition) 14175 — SSB — 1338 — Sept — QSL to: LA2GV: Kaare Pedersen Box 87 N-1580 Rygge, Norway.

*** 8P6OV — Fred — 14222 — SSB — 0643 — Sept — QSL to: Frederick Innis, 33 Harmony Hall, Saint Phillip, Barbados.

*** YJ0AMH — John — 14026 — CW — 0606 — Sept — QSL to: KF7PG: John M Hofstrand Jr 1849 Finn Hall Road Port Angeles, WA 98362.

*** XU8DX — Shokum (YL) 14226 — SSB — 1103 — Sept — QSL to: JA1NUT QSL info ADAR Oct 90.

*** 7J1ADJ/JD1 — Joe — Minami

Torishima — 14226 — SSB — Sept — QSL to: KB1BE Paul R Shafer, 7 Fern Dr Bloomfield CT-06002 USA.

*** XT2BW — Peter — 21205 — SSB — 0542 — Sept — QSL to: WB2YQH Robert E Nadolny, 135 Wetherstone Dr, West Seneca, NY 14224 USA.

*** 3X1SG — Edmond — 1422 — SSB — 0635 — Sept — QSL to: ON6BV, Victor Ravys, Free St 4, B-1590 — Bever — BT — Belgium.

RTTY News

Here is a selection of DX as supplied by Syd, VK2SG.

*** ZD9BV — 21083 at 1940 Z. *** J28TY — 21087 — at 1929Z QSL to Box 2417 Djibouti, Africa. *** YS1RJ — 21089 — at 2100Z. QSL to: Box 792 San Salvador El Salvador, Central America. *** HV3SJ — 14085 at 0156Z QSL to: IODUD. *** ZD8BOB — 21074 — at 2305Z *** A92ET — 21078 — at 1511Z *** 8P9HR — 14086 — at 0131. QSL to: K4BAI *** VQ9RB — 21088 at 1755Z, QSL to: WA4DFU*** 5Z4BI — 21097 — at 2033Z. QSL to: Bill Nesbitt, Box 147 Thika, Kenya, Africa. Incidentally, Syd VK2SG has now applied for the 250 sticker for the ARRL RTTY DXCC.

From Here And There And Everywhere

The ARRL DX Century Club (DXCC) has changed its operations to the "user pays" system. For new members there will be a registration fee of US\$10.00 and further additional charges for other submissions. The DXCC at present is at least 5 months behind with the processing of award applications and is now in the process of changing over to computerised data.

John W2GD will be operating from Aruba as P40GD between November 20th to 27th. He will be active also on the 12 and 17 metres WARC bands. QSL to: N2MM.

If you worked 4X90BS at the beginning of October, then you worked a special event station from the International Stamp Exhibition in Beersheba, Israel.

Ron, ZL1AMO was active from Chatham Island as ZM7AMO until 24th September. As usual, Ron was mostly on the CW section of the bands. QSL to his home address.

If you worked ZL150A in the VK-ZL-Oceania contest, it was a special event station, commemorating the 150th Anniversary of New Zealand. QSL for the SSB contact goes to ZL1AAS, and for the CW contact goes to ZL1AMO.

Many months ago I worked Martin OY7ML on the Faroe Islands. We exchanged the customary QSL cards and a few letters. Some time ago, a heavy packet arrived by seamount from him, with a number of booklets describing the natural beauties and the facilities on this 18 island group situated in the North Atlantic. The origins of the settlement of these

islands go back more than 1000 years to the Viking times. A return package is on its way back to the Faroes with booklets describing VK2 and the life in this country. Martin can be heard frequently when he works his CW friends, VK2QL, VK2DZD and VK6WT.

Steve, 5V7SA (Home call N8HKS) is active again from Togo. After a holiday in the USA, he returned with a complete RTTY station. He was worked at 0636 on 1422 with a good signal of 55. QSL for RTTY contact goes to KB8BS for other contacts to: WB4LFM.

IZ8SGV was a special event station for the celebration of San Gennarios Day. QSL to: IK8IPL.

Sokum (YL) XU8DX is quite active around 1110 to 1200 UTC on various nets. (See Oct 90 "AR".) This operation is now acceptable for the DXCC. If you worked C21JM, he is: Jim Motiti, PO Box 421 Republic of Nauru.

There is a new operator in Qatar. He is Ahmed A71CD.

By the time you read this, Bing, VK2BCH is already on his way to Tonga A35, and from there he will proceed to Rotuma.

Harry, VK2RQ (See Oct 90 "AR") was unable to secure accommodation on Christmas Island (VK9 Indian Ocean) therefore the planned DXpedition is now re-scheduled for around March 1991.

There is no further news from the planned Albanian operation. My confidential Hungarian source has not yielded further information. In Eastern Europe the people including amateurs are more interested in the day to day difficulties of living, and I think amateur radio is not the number one priority. An East German, when I asked him what will be his call sign after the 3rd of October (Unification day for the two Germans) said that the prefix

district numbers will change, otherwise the same call. We will see.

According to Thierry FD1MXH, QSL Mgr for John C53GB, John will be in Zambia next year with a special event station. FD1MXH advises that he is QSL Manager for the following calls: C53GB, TM5M, TM1K, F6BXC/LU, F3CJ/LU and for FF1MKK. By the way, if you worked C53GN, she is the XYL of John.

As many of you know, the Indian QSL Bureau has not been in operation for the past 3 years or more. Now, according to an official letter received by the WIA from the Amateur Radio Society of India (ARSI), there are new appointments to the Indian QSL bureau, and it is functioning again. The address is: ARSI — QSL Service — ARA PO Box 4015 — New Delhi — 11017 — India. Despite this, several Indian amateurs said that the Bureau is still not working, and they want QSLs direct.

The Ile-De-Grosse mini-expedition (see Sept 1990 "AR") had the following call signs active: CIOGI (op VE2EBK) VE2EDK/CIOGI and VE2DWU/CIOGI.

The Bouvet Island DXpeditions logs show an interesting picture. More than 47000 QSOs were made, about 30000 of which were on SSB, 16800 on CW, and only 291 on RTTY. Of the total, 0.8% were in Africa, 0.9% with Oceania, VK, ZL, 3.9% with Central and South America, 15.8% with Asia, 31.3% with Europe, and 47.3% with North America. Of the total, 11.8% were duplicate or "insurance QSOs". This is not a record of which the inconsiderate and selfish "bad boys" of the international amateur fraternity can be proud.

According to "Radio Communication" the official magazine of the RSGB (Aug 90 issue) the call signs SU1EE and SU1EX are "not registered in the licences issued by the Arab

Republic of Egypt".

Interesting QSLs Received

Note: W=weeks, MO=months, YRS=years, FM=from, MGR=manager, OP=operator.

Direct QSLs Received

***KC6AZ (5WFM OP) *** YO6BZL (4MO FM OP) *** CIOGI (3W FM OP) *** ZC4DG (3W FM OP), *** KH8/KK2EKY, 5W1KY, A35KY, ZK3EKY, KH2/VK2EKY all these 2W FM MGR), *** XU8DX (Hungarian operator) (4MO FM MGR), *** 7X4BL (2MO FM OP) *** OX3ZM (1 MO FM OP) *** C53GB (2W FM MGR) *** CN8GJ (3MO FM OP) *** 9X5HG (4W FM OP)

Bureau QSLs received:

UM8MDX (2 YRS), 5Z4BH (13MO), 8Q7KH (7 MO), 6Z2WK (13 MO), 6Z2DK (13 MO), JT2AB (20 MO), 4U1ITU (12 MO), FY5AN (12 MO), EL2E (18 MO), S79MX (12 MO), 5W1HC (16 MO), ZP5AA (16 MO), HG89HQ (14 MO), HL9TB (14 MO), ZS2RW (15 MO), 3D2AK (15 MO), ZS6P (14 MO), ZB2AZ (13 MO) ZS4AE (14 MO).

Thank You

Your help with information about interesting QSOs — as per format in these columns, or interesting QSL cards received, or any other DX information is always welcome. This month the number of contributors was not at its usual level.

Many thanks for the assistance received from the following: VK2SG, VK2KFU, VK not named contributor, VK4DA, VK4OH, VK5WO, VE2EBK, FD1MXH, Radio Communication, QRZ-DX, and The DX Bulletin.

GOOD DX AND 73.

ar

POUNDING BRASS

GILBERT GRIFFITH VK3CQ
7 CHURCH ST, BRIGHT 3741

Many thanks to Roger VK4YB, who sent me a book called "The Philosophy and Practice of Morse Telegraphy" by T Jarrard Smith and published by Manhattan Electrical Supply Co, Inc. If anyone knows the date that this book might have been printed I would be very interested to know. It features American Morse, sounders only and gravity batteries. As I seem to have been mentioning batteries lately I thought you may be interested in gravity batteries as described in the book.

The Battery.

"One complete set of the constituent parts of a galvanic battery is termed a "cell". All the various parts of a cell are denoted by special names, according to its make up. Although one of the two so-called "elements" entering into the composition of a cell of battery forms,

the Positive Element and the other the Negative Element of said cell, it does not follow that the material composing such element is invariably positive or negative, as the case may be, in any pattern of battery in which it may be found. An element consisting of either lead, iron or copper may be the negative element in a battery of a given construction, and in some other form of battery be the positive element. Its determination depends upon the character of the other element with which it is associated. If the other element consisted of zinc in the above reference, the former would be the case. If of platinum, the latter would be true. The comparative, negative and positive electric qualities of metals have been arranged in the following electromotive rotation:

All metals in this table being, in a single solution, positive towards those that follow,

and consequently negative to those that precede them in the order of mention.

Zinc, cadmium, tin, lead, iron, nickel, bismuth, antimony, copper, silver, gold, platinum, graphite.

It should be borne in mind also that the terms "element" and "pole" are not synonymous. On the contrary, the negative element is invariably the positive pole and Vice Versa. Therefore, to prevent being misunderstood, it is always safest in speaking of any battery element to mention the metal of which it is composed.

Although batteries most frequently contain not only two characters of metal but two mechanically separate solutions, those in general use today in the telegraph service have been reduced to a very simple form called the Gravity Battery.

The positive element of the gravity battery consists of a mass of zinc, variously shaped according to the whim of the manufacturer, with either thin strip copper or lead as the negative element. The solution in which they are commonly immersed, is water in which

both sulphate of copper and sulphate of zinc have been dissolved. Under the action of the current, these two solutions are separated and kept apart by the force of gravity. Hence the name of the battery. The copper solution being heavier falls to the bottom, its limit being defined by its blue colour, while the zinc solution is colourless and remains on top. The dividing line between the two is a jagged margin of weak blue. The dividing line should occur about half way between the two metals. The blue should never touch the zinc. When it does happen, it indicates that the battery is not doing enough work, which can be remedied by "short-circuiting" it for a few hours, or else that too much sulphate of copper is being put into the jar, the remedy for which is to refrain from putting any more in until the blue colour has subsided to the required point. Any excessive fall of the blue colour from the half way line indicates that there is not enough sulphate of copper in the cell, in which event add more, or else that the battery is doing too much work and generating an unwanted

surplus of zinc solution. Whether the latter is the case or not can best be ascertained by the use of a hydrometer.

No trouble will be experienced in managing the gravity battery, if the fact is kept in view that the natural tendency of the battery is to consume sulphate of copper, and create excessive quantities of sulphate of zinc. This explains why sulphate of copper is constantly added, and sulphate of zinc drawn off from time to time."

Back to the code, Morsiacs.

There is another part in this book which I would like to relate to you, and that pertains to the attitude of the student and reads as follows:

"Students should grow up in the art of preserving a tranquil and courteous demeanor in their work on the line. They must be careful to not burden their speeches with ceremony but treat their vis-a-vis with respect. There are circumstances in the peculiarity of telegraphers' work on a wire, dealing with men

they have never seen, that seems sometimes to breed irritation at every dot. The bickering of lawyers at the bar is not a parallel to it, and strange to say in an exceedingly large number of instances in which the operator on the line is pronounced "crank" or "mule", he in personal, individual intercourse is an affable, courteous gentleman, elevated above petty spite and unwilling to wound the sensibilities of even a tramp.

The only good rules to follow in working with nervous, ill-tempered or brutal morsemen, are, keep your temper, stick to the text, ignore innuendoes and try calmly to progress your business without attempting to either propitiate or further antagonize your partner on the line, and he will soon become ashamed of himself and special ill treatment on his part toward you at least will cease. These are rules more easily laid down than followed, but their practice yields a big return upon the investment."

73 GIL
ar

VHF/UHF AN EXPANDING WORLD

ERIC JAMIESON VK5LP
PO Box 169 MENINGIE 5264

All times are Universal Time Co-ordinated (UTC)

The Beacon List

As is usual for November, only alterations to the beacon list are published, so it seems FO5DR on 50.048 should be added to the list, as Bill Tynan from QST's "The World above 50 MHz" says Bob K6QXY and Joel N6AMG have supplied FO5DR with equipment to initiate a beacon.

Six Metres

From the absence of reports right around the country, it seems everyone is having a rather lean time on six metres. Speaking to Hugh VK5BC, I commented on the reduced frequency of CW calls he was making, and his reply was that as he never received any response, he had reduced the number of calls.

From my establishment at Meningie, the only signals heard have been some momentary backscatter signals, probably from NSW or QLD stations and from VK3OT.

John VK4ZJB reports that, apart from a few weak W and JA stations, the only event of any consequence was a good 5x9 opening to KH6 on 23/9 around 0900.

John also reports receiving his QSL from HH7PV in Haiti (I have a photocopy) for his contact on 3/4/90 at 2132. John said that, as the usual methods did not seem to promote a response, he finally sent a card by registered air mail at a cost of \$8.10 and finally got his confirmation. The address is Patrick de

Verteuil, Abriots, Jeremie, Haiti. This shows that perseverance does eventually bring its reward, and his countries confirmed list now stands at 64. Well done!

While on the subject of QSLs, it should be noted that JR6 Okinawa for DXCC purposes is part of Japan and not a separate country. JD1 Minami Torishima and JD1 Ogasawara are listed as separate countries.

From the Japanese CQ Ham Radio magazine for August 1990 (per Graham VK6RO) is a now a late item which may be of interest. From 22/4 to 29/4 JE3TXU operated from Jordan as JY5CI and worked IT9LCY, 9H5AB, 9H1CG, FR3EK, Z23JO, 5H1HK, ZS5AV, ZS6BMS, V51KC, plus several other calls in some of these areas. In addition beacons heard were V51E, ZS6PW, FR5SIX, ZD8VHF and PY2AMI.

From the same source is a QSL address for CX8BE as Jorge de Castro, PO Box 71, 11000 Montevideo, Uruguay.

Various Comments

During the course of receiving upgradings of the last Six Metres Standings from various amateurs, there were a number of comments appended which may be of general interest. As most would realise, I receive quite a lot of confidential information and comments not for publication or general discussion and this situation is always respected but, in addition, there is often general information which can be conveyed to readers for the benefit of all.

From time to time, I am asked if I have packet or fax to facilitate the exchange of

information. Unfortunately, at this stage I do not, and this is partly due to the severe physical limitations placed on me during the past five years (at the moment I move around using a wheelchair but hopefully this will change in due course). Were it not for the great amount of help given to me by David VK5KK, Keith VK5AKM and Mark VK5AVQ, I would not be on the air, so I need to limit what I ask them to do for me. Maybe later on I will be able to modify my shack to accept some more facilities.

Several people have queried the validity of a few claims of long path contacts and/or hearings of stations via such paths. The observations made include the view that such situations are unlikely to occur at any more than 15 degrees dip latitude of the geomagnetic equator. Does anyone want to start something?

Many readers have commented on the lack of South American and African stations which were worked in Australia. On similar east/west/east paths European stations have had hundreds of contacts into the USA and surrounding countries. Similarly, there have been many contacts between Europe and Africa and North America and South America each over the north/south path similar to our Australia/Japan path. Possibly because it is easier to work the latter type of path, operators in north/south directions tend to look that way more often. There has been no lack of vigilance on the part of Australian operators eager to work South America and Africa. I suppose it needs to be borne in mind that, generally speaking, the distances we need to cover are greater and this may be a contributing factor of more importance than we acknowledge. Whatever the reasons, there is no doubt that from Australia, it is easier to work the Caribbean area than South America.

GeoffVK3AMK included a note which originally came from JA1VOK regarding a modification to the IC-575 noise blanker. It involves the addition of an extra 2 to 3 pF across C1 the 1 pF capacitor in the gate of Q1 (2SK192A) in the main unit. Geoff has no other information, but it should not be too hard to make a temporary connection for trial purposes. It would be interesting to hear how the blanker performs under severe cross-modulation conditions!

John VK4TL advises that, since the implementation of the 60 km regulation from a Channel 0 translator, six metres is finished for those living in Cairns. John has dismantled his 9 element beam and 36 foot tower and is a very disappointed man, particularly as there is no evidence of any TVI due to 50 MHz operation.

Lyn VK4ALM at Rockhampton, said the vagaries of six metres were very evident this year, with southern stations working long-haul DX, but nothing heard in Rockhampton on many occasions. However, Lyn received much pleasure from working GJ4ICD at 5x9 each way on 12/10/89, then about a week later working a further 13 stations from G land, 5 from France and 2 from Holland all in the space of an hour. Good work but I hope VK5 can soon have a turn!

From The USA

Bill Tynan W3XO/5 from QST's "The World above 50 MHz" reports that JA1VOK, in his August column in "Five Nine" said that VU2AID is expected to be activated again from Madras, India.

Bill also writes that G4UPS advises that the UK 6-metre Groups coming contest will be held concurrently with the SMIRK contest on 17 and 18 November. Whether this will mean

the G stations will spend most of their time looking towards the USA is not known, but last year contacts between Europe and Australia were established around that time.

Some operators in the USA have classified their summer Es period as somewhat poor, but one reads the following from Bill Tynan's columns that on 3/6 Bob WA1OUB worked CT1DTQ and CT4KQ, the latter being worked again on 9/6. On 29/6 the same station worked CT1QP, ZB2EO and ZB2HN. Later the same day he worked EI, two in F, PA, GJ, four in G, two in ON and four Italians. On 30/6 Bob worked ZBOW and ZBOT and on 7/7 CU1EZ and again on 8/7, 11/7 and 22/7. On 18/7 a new country worked was LX1SI. Although the west coast stations mostly shared the contacts, on 11/7 N6CA and K6PVS were both fortunate to work CU2/G3RFS in the Azores Islands which would be a rather rare trans-continental contact from California. The whole affair doesn't appear too bad to me, as the Es distances would be around the 6000 km mark and more!

Steve W2CAP/1 had a memorable day on 26/6 when he worked eight 9H1s, nine in F, six in PA, one CT1, four Italians, five Germans, five Belgians plus OE5NEL and LX1JX thus giving him a score now of more than 100 countries worked. K1JRW also worked DK1PZ and SV1OE for new countries.

A contact of note occurred on 28/6 when G4UPS reported the first contact between San Marino and the USA when T77C worked K4CKS at 2016.

A major objective during the USA summer among N6CA and others is to span the Pacific on one or more microwave bands. N6CA has provided KH6HME with equipment for all bands through to 10 GHz. Despite this year's openings being below par so far, N6CA is hopeful of success. On one occasion, he was

able to hear signals from the 3456 MHz beacon on Mauna Loa from a portable location in the San Diego area. Perhaps these attempts will be of some concern to our present VK record holders.

Help Wanted

During the course of entering into the computer all entries for the Six Metres Standings, I came across a list of 17 stations confirmed which did not bear a callsign. After a lot of study, I thought the list was that of Alf VK4AYX, but he informs me that he has never worked six metres! The submission consisted of VK4ZJB worked on 9/11/80, VK9ZG 10/11/80, JA2HHO 17/11/80, KH6IAA 29/11/80, H44PT 30/11/80, ZL2BGJ 26/12/80, FK8CR 2/1/81, YJ8PD 4/1/81, P29ZFS 10/3/81, DL3ZM/YV5 18/3/81, KG6JDX 6/4/81, WA6BYA 15/4/81, AH8A 20/4/81, FO8DR 22/4/81, XE1GE 23/4/81, VS5LH 24/4/81 and KHOAB 25/4/81. Does anyone recognise these as his contacts? If so, I would be pleased to give them a name and add them to the next list.

Closure

By the time these notes are read, it is to be hoped the spring equinox has produced some exotic DX which has been shared around the country, instead of being so selective, as has often been the case in the past. I would appreciate being advised of your good contacts please.

Closing with two thoughts for the month; "Men may be convinced, but they cannot be pleased, against their will" and "He who believes that the past cannot be changed has not yet written his memoirs."

73 FROM THE VOICE BY THE LAKE.
ar

RANDOM RADIATORS

RON FISHER VK3OM AND
RON COOK VK3AFW

The Editor's comment in the July issue of AR got us thinking. Bill's dissertation on "Old Timers" and the problems they have in getting antennas up. Of course there are two distinct problems here. One is of course the problem of actually getting an antenna into the air due to physical incapacity, but perhaps the second problem of not being actually permitted to put up an antenna is the greatest one to overcome. It seems that many retirement villages for instance are not in favour of outdoor antennas, or for that matter amateur radio at all. Having just helped to move my elderly parents into a retirement village, I made a point of checking on the management's attitude to the inmates participating in hobby activities. Hobbies? Yes they are

definitely encouraged to participate in hobbies to keep active. Well that's great, so you won't mind a few outdoor antennas. Ah, well we might have to look into that one, there could be a few objections to that. I wonder just how many of our members are in a similar position. And I wonder how many might be in this situation in a few years time. What about a retirement village for radio amateurs? Anyhow we thought that a few ideas on hidden indoor antennas might be worth a look at. Don't imagine that indoor antennas are ineffective and worse than useless. For many years, I kept a regular sked with an English friend on 20 metres who used an indoor dipole with excellent results. In fact, over the last ten years, I have worked no less than twenty

"G" stations who were using indoor antennas of one sort or another. This month, we would like to present a few ideas on antennas that can be used either inside or outside where space is limited.

Some Thoughts On Indoor Antennas

Firstly it must be said that any given antenna will usually work better outdoors compared to its performance indoors. But, at the same time, any indoor antenna will work better than no antenna at all. It's better to be on the air than not to be on the air. Some years ago, we did some tests using two mobile whips set up end to end in dipole form. We used a one to one balun to feed the antennas as shown in the photo, and the antenna was then fed with 50 ohm coaxial cable. With this set up, the SWR was around 2:1 over a 25 kHz bandwidth on 40 metres. We pushed the antenna up to a height of about 6 metres on a length of pipe.

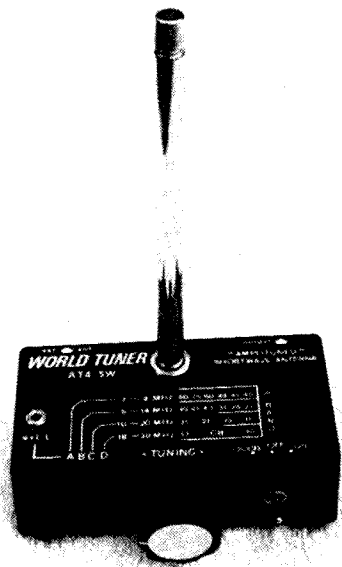

We found that it performed quite well. Compared with a full size dipole at something over twice the height, reports from interstate stations were down about 3 "S" points on average, but to counter this to some extent, the short dipole could be rotated to give a small amount of directivity. I am sure that if this antenna was raised to ten or fifteen metres it would have been a very good performer indeed.

Taking this example a stage further, I received an interesting letter from Ed Drying VK2ED, who told of his experiences with a "Shortened Forty Metre Dipole" that was described in the May 1977 issue of AR. This antenna was developed by Ramsay Travena VK3AZX. Over to Ed. "Having very little space, I constructed this antenna and have found it works very well. With the overall length of about 6 metres, it fits into almost any backyard. One advantage is that if a rotation system is available, the antenna can be rotated to take advantage of its lobes. I found it very sharp in tuning, so I made the outer tips a sliding fit with stainless steel clamps and moved the tips until it tuned to

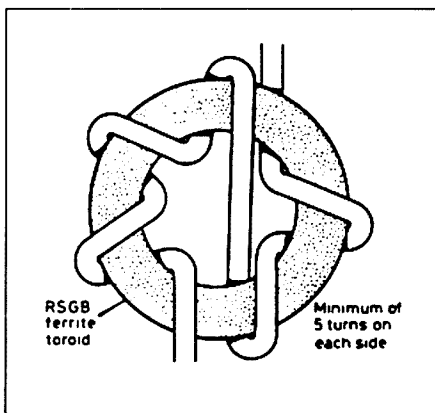

Fig. 1 Method of winding choke balun

7.0225 MHz (I work CW mostly.) At 7.1 MHz the SWR is about 2:1 but I have an ATU which helps." Thanks for that Ed, and I would think that with a change of coil size this antenna might be equally effective on any other amateur band.

Controlled Feeder Radiation

Radio Communication for May 1990 presented an interesting discussion on controlled feeder radiation by B Sykes G2HCG. We all know why baluns are used in antenna feed systems — or do we. Before getting down to the real purpose of the article, a few quotes from the introduction might be worthwhile. "The use of a balun to feed balanced antennas with coaxial feeder has always been a controversial point, the usual comment being — it works all right without one, so why should I bother. The two vital uses of a balun are to ensure that the polar diagram of the antenna is as planned, and to prevent interference pick-up on the feeder or radiation from it." The point is made that computer hash for instance can be greatly reduced when a coaxial antenna feeder is properly terminated with a balun.

However careful choice of the actual point in which the balun is inserted into the system, produces radiation which will actually improve the operation of the antenna. For instance, it may be that you want to have an omnidirectional radiation pattern or that physical limitations mean the antenna must be erected North-South although you want to work stations to the North and South. This can be achieved by simply moving the balun down the feeder from the antenna feed point by a quarter wave, allowing radiation from the top part of the feeder and using the balun to stop the radiation (and interference pick-up) from the lower part of the feeder.

G2HCG recommends a simple balun, made by passing the coax feeder through a ferrite toroid as shown in fig 1. Since high impedance with a minimum number of turns is required, the use of a high-permeability ferrite core is mandatory. Standard black ferrite cores as used for interference suppression are ideal,

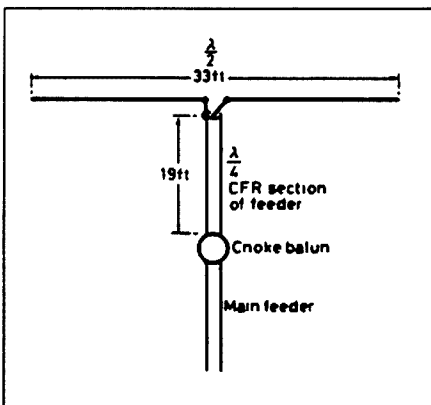
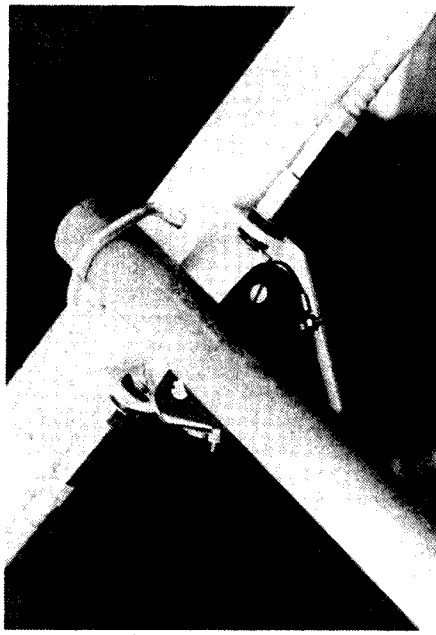

Fig 2. A 14.2MHz CFR half-wave dipole

and since the balun may need to be suspended from the antenna, the use of a small coaxial feeder is advantageous in the interests of weight reduction. A 4cm O/D core will take 11 turns of URM 76 cable. A single core is fine for 28 to 14 MHz and two cores taped together for 3.5 and 7 MHz radiation). One point to watch is of course the length of the CFR (Controlled Feeder) feeder section. The length will vary with the design of the choke balun and the example shown in fig 2 results in a CFR section length of 0.275 of a wavelength — 19 feet at 14.2 MHz and this, if added to an existing installation, will not alter the resonant frequency of the system. An idea certainly worth a try.

The World Tuner AT4-SW

We don't intend that reviews of commercial antennas will be a usual feature in this column. However I was so taken with this little device that I thought a mention was worthwhile. It has been around for a couple of years now and in fact I reviewed an early sample on the Radio Australia Communicator Program nearly eighteen months ago. I was so impressed that I bought one straight away and use it regularly. OK, so what is it. It's a receiver active antenna. In its normal state it covers a range from 3 to 30 MHz, but this can be extended down to cover the standard broadcast band if required. A one metre telescopic whip is amplified with a single FET and a BC548 is connected as an emitter follower to drive the receiver. I have used mine with a Sony ICF-7600D and the improvement in performance is nothing short of amazing. I have used this combination all over South East Asia to listen to Radio Australia and of course to also keep a check on the amateur bands. The front end is tuned with a four position band switch and a variable capacitor.



The two mobile whips shown mounted with balun

Many active antennas that I have checked over the past few years were very poor due to cross modulation produced by their wide band amplifiers. The World Tuner is sharply tuned

and no cross modulation results. it is even possible to connect a longer wire antenna to improve signal pick-up but in most situations this is not really necessary. The World Tuner

can be purchased either fully built or in kit form from JILOA Pty Ltd PO Box 73 Glenhuntingly 3163. For further details, you can phone them on (03) 571 6303. ar

INTRUDER WATCH

GORDON LOVEDAY VK4KAL
FEDERAL INTRUDER WATCH CO-ORDINATOR
AVIEMORE' RUBYVALE 4702

than promises! It is not much use their "bragging about" the number of Australian broadcasters they pull into line ... we want them to back our observations, not use their old "rubber stamp" replies to all questions asked of them. I can quote these from memory!!!

Since my last set of notes, I have received the July issue of "Region 3 News", the journal of the IARU — a very informative little booklet of 50 pages. A quote from Secretary General, Dr Pekka Tarjanne, from his address at the IARU Region 1 Conference, "The ITU has more than an official relationship with the IARU. Amateur radio and radio amateurs are important genes of telecommunications, shaping much of its development and character the world over. Perhaps, the attention of the world has been best captured by amateur radio emergency communications in times of natural disasters. The contribution of radio amateurs to emergency and relief operations is legendary, given sometimes at considerable personal cost and even risk of life. You know that things went fairly well at the last major ITU frequency allocation conference in 1979 for the amateur — the conference in 1992 will have the task of dealing with the 1 to 3 GHz band. A world conference in 1993 will deal again with HF broadcasting matters". I wish I had space to quote the full text, but it is vital to back our WARC rep to the hilt (have you made your donation yet?) It is also vital that all amateurs back the monitoring service to the full in their efforts to "clean out" these illegal intruders from our bands and "pour" so many worthwhile observations into the system, that DOTC will have to really do something more concrete about it — other

Summary For August 1990

Date	Time U/TC	Frequency		Callsign	Mode	Logs X	Details Of Traffic If Known And Any Other Information
		In MHz "M" or "E" If Heard					
220890	1239	3513			J3E		Asian B/caster USB
1208	0115	3526			A3E		Phone call — Australian
1608	1025	3608			"		B/caster music (hrd in WA)
260790	2200	14023.5			F1B	45	24hr/250Hz/3rd Register)
daily	24hrs	14045/6			mni	33	NON/F1B/R7B/SSB/B9W
"	"	14046			"	11	Asian Rad Telephone
"	"	14047.5			F1B	12	RTTY 250 Hz shift
daily	24hrs	14058			A3C	36	Helschreiber Fax Poss China
"	daily	14074.5VRQ			A1A	47	Often VBX on freq also
mni	mni	14119 QRJ??			F1B	6	RTTY 1000Hz shift
daily	daily	14141 UMS			mni	36	24hr/Naval Radio Moscow
"	"	14171 UMS			F1B	24	18hrs/RTTY 250Hz/75b
270790	0940+	14211.5			"	7	12hrs on air
1508	1000+	14215 RKR			A1A	5	Also RTTY/HO7 uses same freq
2507	0935	14217			F1B	8	12hrs/RTTY 250 Hz shift
2607	1206+	14222/5			2xR7B	12	24hrs/100% occupancy of freq
2408	0900+	21032/3 UMS			F1B	5	75bd/250Hz USSR Moscow Naval
daily	mni	21113/5 CQ5			A1A	25	Also FQ5traffic in/out
1308	0600+	21123 XW4			"	8	Mny calls Rec Tfc/a new one
290890	0242+	28094.8			A3E		B/cast Possibly Indian (WA)
1108	0906	28515			"	5	B/cast for,talks & music
mni	mni	28575			"	13	as above
2308	0900+	28980			A3E		USR B/cast talk in Russian

Logs by VKs 3XB, 4BG, 4AKX, 4BHJ, 4BTW, 4BXC, 4CAS, 4EKA, 4KHQ, 5GZ, 6AF, 6BEK, 6RO & 6XW, my thanks once again. This is an abridged summary 73 VK4KAL. Late report — Robin VK7RH. ar

EDUCATION NOTES

BRENDA EDMONDS VK3KT
FEDERAL EDUCATION CO-ORDINATOR
PO BOX 445 BLACKBURN 3130

Once again I have just been through the trauma of moving house, so have not been able to give a lot of attention to radio and education for a little while. However, I am hoping, and intending, that this move will be the last for a considerable period, so please insert the above address in your new callbook when you buy it.

I am also looking forward to finding and/or re-discovering a number of items which were not unpacked after the last move. I am now in a position where I should be able to get some decent antennas up, and use the gear for more than just keeping in touch with the family.

I do not recall ever having used this column

to publicise the benefits of multiple licensing within a family or group, but I have always advocated the encouragement of more YLs into the hobby. Recent Callbook listings show that there are now many multi-operator households, but the percentage of female licensees is still not high. Discrimination?! Equal Rights! Affirmative action!

It is still fairly universally accepted that amateurs are male, that if the amateur is married, the wife is "anti-radio", and that the "shack" is out of bounds and preferably out of the house. This attitude perpetuates a sad neglect of a significant potential source of recruits, and contributes to tension within

the household.

Some of the benefits of multiple licences will be apparent to all who have used CB to say they will be late home, or to call home to check for information, but I would particularly mention the value of having two members of a household attending classes together. The extra time that can be spent in discussion, the slightly differing information that each collects, and the experience of trying to explain a poorly grasped point to someone else are all valuable aids to the understanding needed for the final examination.

However, let us not neglect the ladies who wish or may need to tackle the exam on their own. Let me make it quite clear that there is no inherent reason why the exam should be more daunting for ladies than for gents. Most candidates will have to put in a significant effort — some more than others depending on educational and employment background.

Summary for August 1990 cont.

Date	Time U/TC	Frequency		Mode	Logs X	Details Of Traffic If Known And Any Other Information
		In MHz "M" or "E" If Heard	Callsign			
2408 daily	0900+ mni	21032/3	UMS	F1B	5	75bd/250Hz USSR Moscow Naval
1308	0600+	21113/5	CQ5	A1A	25	Also FQ5 traffic in/out
290890	0242+	21123	XW4	"	8	Mny calls Rec Tfc/a new one
1108	0906	28094.8			A3E	B/cast Possibly Indian (WA)
mni	0906	28515		"	5	B/cast for, talks & music
mni	0900+	28575		"	13	as above
2308	0900+	28980		A3E		USR B/cast talk in Russian

Logs by VKs 3XB, 4BG, 4AKX, 4BHJ, 4BTW, 4BXC, 4CAS, 4EKA, 4KHQ, 5GZ, 6AF, 6BEK, 6RO & 6XW, my thanks once again. This is an abridged summary 73 VK4KAL.
Late report — Robin VK7RH.

ar

Prevent Pirates

Make sure you sell your transmitter to a licensed amateur

SPOTLIGHT ON SWLING

ROBIN L HARWOOD VK7RH
52 CONNAUGHT CRES WEST LAUNCESTON 7250

As I am writing this, the tense situation in the Gulf Crisis has now shown signs of easing. The propaganda battle continues over the airwaves, and it is apparent that many people within the region are relying on shortwave radio to provide them with updated news on developments within the region and beyond. This has been a shot in the arm to many international broadcasters, who were facing a bleak budgetary future. The prominence of shortwave broadcasting has been now recognized by many administrations, who are believed to be re-assessing the financial and strategic needs of the stations.

Many of the hostages, who either escaped or were freed from their detention, have told that they relied totally on shortwave for news on what was going on and for news from home. Many stations broadcasting to the Middle East introduced segments where relatives could send messages and greeting to their loved ones either trapped in the Gulf, or serving with the multi-national forces in the region.

In last month's column, I mentioned the possibility that the Iraqis had destroyed the R Kuwait senders. Late in August, the transmitters sprang back into life, this time carry-

ing R Bagdad's output. They are utilising the R Kuwait frequencies, and I am hearing them on 15495 kHz from 0400 UTC. You can also hear Bagdad in Arabic at the very top of the 22 metre allocation on 13800 kHz in parallel at good levels. Incidentally, monitors have noted that the English output from Bagdad from 2000 to 2155 UTC has been changing between 13600 and 13660 kHz. It seems to be at the whim of the technicians or perhaps an engineering fault.

Reports in the DX press indicate that Radio Berlin International will cease broadcasting on the 3rd of October and Deutsche Welle will acquire the senders in East Germany. As previously mentioned in this column, the presenters at RBI made plain their displeasure at this development in their programming. So the German Democratic Republic is no more and is now therefore a deleted country. Berlin is going to be the Capital of a united Germany.

I came across Radio Tashkent the other day, after a long absence. When I commenced as a SWL in the late fifties and early sixties, I used to tune to this station regularly, as its programming was different from that of Radio Moscow. Yet now I find it sounds very similar

to the output Radio Moscow had pre-glasnost. I expect change moves slowly from Moscow. Judge for yourself on 17740 kHz at 1200 UTC in English, and it is on other channels as well at the same time.

Incidentally, as I am now operational on packet, you can now leave information there for me as follows: VK7RH@VK7BBS.

There is quite a deal of information on SWL loggings on your packet BBS now, and I am occasionally contributing updated information there as well as VK2XY and friends.

Belgium is a small nation in western Europe and has played a significant role in 20th Century history. Yet many outsiders are unaware that this country has been divided linguistically between Dutch and French. This has caused frictions which have spilled over into the political arena. The French speaking community known as the Walloons are in the south close to the French border and resent the more powerful Flemish community. Some Walloons would like to be part of a greater France. Belgium has two separate organizations for international broadcasting, one Flemish and the other French, although they utilize the same senders. You can hear the Flemish BRT in English at 1230 UTC on 21810 kHz and the French RTBF on 21.460 kHz at 0700 UTC. Incidentally, the future of RTBF is in doubt, as they are reportedly inhibited by budgetary cutbacks.

Well that is all for this month, until next time the very best of DX and 73 DE VK7RH.

ar

FTAC NEWS

JOHN MARTIN VK3ZJC
FTAC CHAIRMAN

Feedback

Comments would be appreciated on the proposed new plans published last month for the 2.3 GHz and higher bands.

New VHF Records

Steve Hutcheon VK4ZSH and Ed Penikis

VK1VP have set two new VK1 records — 104.7 km on 1296 MHz, and 6.8 km on 5.7 GHz. A report has just been received of a 6 metre contact between Rex VK8RH and an 8R1 station, which will almost certainly be a new national record.

ar

How's DX?

Unhappily, we report the sudden sickness and admission to hospital of Stephen Pall, VK2PS, our hard-working DX Editor. We hope he has a swift recovery, and a prompt return to writing his popular column.

ALARA

Joy Collis VK2EBX
PO Box 22 Yeoval 2868

ALARAMEET 1990

What a fabulous weekend! Even the weather was on its best behaviour for us to help make the Dubbo ALARAMEET, held on 29/30th September, an outstanding success.

It really started with an "icebreaker" dinner on Friday night, (not, of course, that there was very much ice to be broken). By 6.45 vehicles flying the black and gold ribbons were arriving at the Westside Hotel/Motel, and another group were walking from the nearby caravan park. (We will not talk about the YL who drove twice around the roundabout before she found the place, will we!) The meal was most enjoyable, and of course, there was as much talking as there was eating.

I have been informed by a "reliable source" that social visiting at the caravan park after everyone eventually got back there went on until a late hour, as it did for the whole weekend. It is unlikely that anyone managed to get to bed very early.

We arrived at our meeting venue, the Orana Education Centre, at 9.00 o'clock on Saturday morning to be greeted by Jenny VK5ANW (President) and Maria VK5BMT (ALARAMEET Co-ordinator), and collected our name tags before going in for tea/coffee and bikkies. The name tags were most impressive. Designed and made by Dale and Nancy VK2NPG they were small wooden maps of Australia featuring name and call sign, the words "ALARAMEET SEPT 1990", and the NSW border enclosing the word "DUBBO".

"Our" room was beautifully decorated with balloons and paper streamers in the ALARA colours of black and gold, and the ALARA banner was prominently displayed.

Proceedings began at 9.30 with the opening address from Jenny VK5ANW, followed by three presentations:

Marilyn VK3DMS was presented with a Meritorious Service Plaque in recognition of her many services to ALARA over the years; Maria VK5BMT received a bag of gold coins for her work in arranging and organising the ALARAMEET so efficiently; I was somewhat surprised to receive an ALARA sweater for assisting, (in a small way,) as "Jilly on the spot."

There was plenty of time to catch up with "old" friends, and put "new" faces to voices, ALL signals 5/9+. Lunch was served at 12 noon, after which we assembled to convoy out to the Western Plains Zoo, yours truly and OM being in the lead car because we were supposed to know our way around it. I think the worthy citizens of Dubbo were not quite sure what had invaded their fair town, as the cavalcade of cars sporting black and gold ribbons moved in slow and stately procession along the road leading to the zoo. We drove one circuit of the zoo, (well, there was only one road that went right around it, so even I couldn't get lost) then split up to go and make the acquaintance of whatever animals took our fancy, a very pleasant way to spend a warm, sunny afternoon. Not that any of us were anxious to get too acquainted with the Bengal tigers!

At 6.00 pm we reassembled for a delicious catered meal in "our" room, followed by a social evening, and no shortage of conversation, doubtless helped along by the pink champagne generously donated by Wolf Blass of South Australia.

During the evening Meg VK5AOV presented some rather special awards:

To Poppy VK6YF for suggesting the use of the black and gold ribbons, and for flying them in Dubbo three days early; to Anne VK4ANN for being so enthusiastic she arrived twelve hours ahead of her OM; Jenny VK5ANW for navigation — coming to Dubbo via Narrandera and Janet VK5NEI who was driving — for being so easily led astray; Maria VK5BMT for reminding us to make sure we had all our badges, and forgetting her own; Pat VK4PT and OM Ted — operating marine mobile on the road between Wyalong and Forbes; myself for arriving half-an-hour early for Friday night's meal (Dan claimed half of that one!) and Anne ZL2BOV who could not remember the name of her motel.

A tour of Old Dubbo Gaol had been arranged for Sunday morning, which proved interesting. Luckily nobody managed to lock themselves in a cell!

We assembled at our venue at 12 noon for chicken lunch and "closing ceremonies". Unfortunately Madam President was unable to officiate because she had lost her voice. (I



Barry VK7GE long-time controller of the 222 YL Net and DX visitor Zdena OK2BBI

wonder why?) Maria VK5BMT, who still had some voice left, took her place. Val VK4VR and Anne VK4ANN presented everyone present with a beautifully made coaster and bookmark as a souvenir. These were enthusiastically received.

The special effort was drawn, results being:
1st prize: Aimee FK8FA. ("Puss-in-Boots" donated by Marilyn VK3DMS.)

2nd prize: Aimee FK8FA. (Crocheted cushions donated by Maria VK5BMT.)

3rd prize: Christine VK5CTY. (Painting donated by Pat VK4PT.)

After lunch VK2EBX and VK4ANN were called upon to take down the ALARA banner, which was then handed to Margaret VK3DMS who will co-ordinate the next ALARAMEET in 1993 at Castlemaine, Victoria.

Our thanks to everyone involved in making ALARAMEET 1990 such an enjoyable and memorable occasion, and particularly to Maria VK5BMT, whose efficient and careful organisation ensured that everything went without a hitch.

ALARA Contest

We would like to remind you that the 24 hour ALARA Contest will be held on Saturday 10th November. (UTC). Please try and get on air, even if only for a short time. All licensed amateur radio operators and short-wave listeners are invited to participate, and this is also a good opportunity to pick up points for the attractive ALARA Award.

Bonnie VK3BBL

This month's front cover features Bonnie VK3BBL, a member of ALARA since 1983. Bonnie first became interested in amateur radio while travelling outback Australia with a group including Arthur VK3BII. Arthur



Sally VK4MDG

encouraged her to study, and she attained her novice licence in 1981 with the callsign VK3PBL, upgrading in 1989.

She has travelled around and across Australia over 17 years, crossing almost every desert. One of her most interesting trips was along the Canning Stock Route, approximately 2000 kilometres between Wiluna and Halls Creek, Western Australia. Bonnie has found the Travellers' Net invaluable while travelling through isolated places.

No one else in her family is interested in amateur radio, but she is hoping one day she may be able to recruit her grandchildren.

Another of Bonnie's interests is family tree research, and she has come across some very interesting ancestors while tracing her family history, including three convicts, a bushranger and the first settler in the Goulburn district.

Those Birds Again!

Regarding birds versus aeriels, I have received a very helpful letter from Al VK3PA

together with diagram, and further information on the idea of using fishing line in the aerial system. Al says: "Place fishing line 1-2" above the elements of the beam. Use TV cable feed insulators with wrap around element of stand-off for fishing line. Place two lines along boom in the same way, then look, no more birds!"

Al also suggests an idea for saving notepad paper — "Use the kids Magic Notepads, the ones with clear plastic page you write on, and just lift the page when full."

Thank you for these ideas Al, and thanks to all who have genuinely attempted to solve the rather vexing problem of birds and aeriels. (this excludes some of the rather facetious solutions we have been given!)

New Members, Changes Of Callsign Etc.

Welcome to ALARA to new members; Shelley VK6NSB, Esther N5NHY, Sharon KB6VCR and Pam VK3EYL.

Congratulations to Phyl VK3KYL (Ex:

VK3PYL.)

The "is my face red" department:

Jo-Anne is VK4JO (formerly VK4CYL). This is, of course, not an upgrade but a change of callsign. The same applies to Marlene VK3WQ (Ex: VK3FML).

Best wishes to Ivor, (husband of Mavis VK3KS,) who is recovering from illness.

This will probably be the last time I write the ALARA column, as health problems have necessitated my relinquishing the position of publicity officer.

I have thoroughly enjoyed this occupation during the last five years, and would like to thank the WIA and editorial staff of "Amateur Radio" for always making space for our column, and also everyone who has sent in articles, notes, comments and photographs without which it would have been very difficult at times.

I am sure you will all give my successor the same sort of support you have given me, and that she will have as much pleasure writing the column as I have had. **ar**

AMSAT AUSTRALIA

MAURIE HOOPER VK5EA
11 RICHLAND ROAD NEWTON SA 5074

National Coordinator

Graham Ratcliff VK5AGR

Packet Address:

VK5AGR @ VK5WI

Information Nets

AMSAT Australia

Control: VK5AGR

Amateur check in: 0945 UTC

Sunday Bulletin commences: 1000 UTC

Primary frequency: 3.685 MHz

Secondary frequency: 7.064 MHz

(7.064 MHz is the frequency presently in use)

AMSAT SW PACIFIC 2200 UTC Saturday, 14.282 MHz

Participating stations and listeners are able to obtain basic orbital data including Keplerian elements from the AMSAT Australia net. This information is also included on some WIA Divisional Broadcasts.

AMSAT Australia Newsletter And Computer Software

The excellent AMSAT Australia Newsletter is published monthly by Graham VK5AGR on behalf of AMSAT Australia and now has over 310 subscribers. Should you also wish to subscribe, send a cheque for \$20 payable to AMSAT Australia addressed as follows:

AMSAT Australia, GPO Box 2141, Adelaide 5001.

The newsletter provides the latest news items on all satellite activities and is a "must" for all those seriously interested in amateur

satellites. Graham also provides a Software Service in respect to general satellite programs made available to him from various sources. To make use of this service, send Graham a blank formatted disk and a nominal donation of \$10 per item to AMSAT Australia together with sufficient funds to cover return postage. To obtain details of the programs available and other AMSAT Australia services send a SASE to Graham.

FO-20 Update And Schedule

(From AMSAT News Service Bulletin 272.01, September 29, 1990)

Latest Japanese Bird Still Experiencing Temperature Problems

The FO-20 Command Team at JARL report that FO-20 is continuing to experience high temperature problems which is forcing a drastic reduction of operations on the bird. Unfortunately, because FO-20 is currently experiencing a period of eclipse-free orbits, the natural cooling off of the satellite during eclipse is not occurring. Therefore, the reduction of transponder operation availability is one way to reduce the internal temperature build up. As of the weekend of 29 Sept 90, the battery temperature had risen to near 45 degrees C. Extended exposure to high battery temperature will decrease the useful life of the battery.

Although subject to change at any moment, this list is the current schedule of operation for FO-20:

From	To	Mode
01 Oct 90 0900	02 Oct 90 0910	PSK Telemetry acquisition
04 Oct 90 0955	04 Oct 90 2330	JA
08 Oct 90 0920	08 Oct 90 1110	JA and JD
11 Oct 90 0825	12 Oct 90 0850	JD

The above dates and time are in UTC.

The FO-20 Command Team will be monitoring satellite performance and operations during these times and may turn off the transponder if they determine that the satellite is in danger.

Subject: Packet/Voice Experiment On MIR

(From AMSAT News Service Bulletin 272.02 September 29, 1990).

New 2m Packet/Voice Equipment to Fly on Mir Space Station In January '91

A new and exciting amateur radio project is being planned for the Mir space station known as the "Amateur Radio Experiment on Mir" or AREM. This project is the result of a collaboration between hams in the Soviet Union and the Austrian Amateur Radio Society (OEVSV). This project is designed to provide equipment for both 2m packet data and voice transmissions from Mir. The voice messages from Mir will provide timely information to radio amateurs while being another educational tool to help school teachers start students thinking about space science. The voice messages will be spoken in German, Russian, and English. The voice beacons will alternate with packet transmissions.

The basic AREM station will consist of a 2m transceiver, a lap-top computer, a TNC-2 running at 1200 baud and using AX.25 protocol, and a voice synthesizer. A special external

2m antenna will be attached to the outside of the Mir space station for this project. The first AREM operations are expected to begin around January 1991 when an Austrian cosmonaut will install the station after he joins the crew of the Mir. After the Austrian cosmonaut finishes his mission on Mir, the equipment will remain aboard the space station. It is envisaged that an upgrade to this station will be to incorporate Bulletin Board System (BBS) software on the lap-top computer. This upgrade is not expected to happen until November '91. Also, it must be emphasised that if the cosmonauts wish, at any time they can pick up the microphone and call CQ. To obtain further information about AREM, please write to:

Wolf Hoeller (OE7FTJ)
 Amraserstrasse 19
 A-6020 Innsbruck
 Austria

I hope to be able to serialize a set of articles covering the PACSAT protocols to be employed. Due to size of the articles they will have to be split between AR issues. The introductory article is an overview.

PACSAT Protocol Suite — An overview

Harold E Price, NK6K
 Jeff Ward, GO/K8KA

ABSTRACT

A low earth orbiting "Pacsat" has been described in the past as an orbiting bulletin board system. This is an over-simplification. A PACSAT is a multi-channel, full duplex device, with short, periodic access times dictated by orbital mechanics. These attributes mandate a different approach than the standard command-line interpreter style of BBS if the full potential of a PACSAT is to be realised.

The authors propose a new methodology for a PACSAT, and have developed several new protocols to implement more efficient access. These protocols all use AX.25, either in connected mode or with UI frames. This paper provides a description of the access model, and an overview of the new protocols.

Background

The authors have been struggling with the question "How can we make the best use of a bandwidth-limited low earth orbiting digital store-and-forward system with a worldwide, unstructured, heterogeneous user base" since an amateur Packet Radio satellite was first discussed in 1982. We began on air experimentation with the UoSAT-2 (UO-11) Digital Communications Experiment in December, 1984. In the following five and one half years, we've looked at where a resource like a PACSAT best fits in to the network as a whole. As a result of our study, we are proposing the use of a broadcast protocol as the basic downlink method, and a "file server" rather

OSCAR-13 Schedule																								
Station: Adelaide																								
Hour - UTC																								
	0	1	2	3	4	5	6	7	8	9	10	11	12	13	14	15	16	17	18	19	20	21	22	23
01Nov														bb										
02Nov														bb										
03Nov	bbbb										bb													b
04Nov	8BBB										bb													bbbb
05Nov	BBB							bbb																bbbb
06Nov	BLL							bb																bbbb
07Nov	L							bb																bbbb
08Nov																								bbbb
09Nov																								bbbb
10Nov																								bbbb
11Nov																								bbbb
12Nov																								bbbb
13Nov																								bbbb
14Nov	BB																							bbbb
15Nov	BB																							bbbb
16Nov	B																							bbbb
17Nov								bbb																bbbb
18Nov								bb																bbbb
19Nov																								bbbb
20Nov																								bbbb
21Nov																								bbbb
22Nov																								bbbb
23Nov																								bbbb
24Nov																								bbbb
25Nov																								bbbb
26Nov																								bbbb
27Nov																								bbbb
28Nov																								bbbb
29Nov																								bbbb
30Nov																								bbbb
01Dec																								bbbb
02Dec																								bbbb
03Dec																								bbb

than a BBS application as the basic service offered. This document provides a brief overview of these conclusions, the companion specification documents provide the implementation details.

This paper and the companion protocol specification papers assume that the reader has a basic understanding of the current packet radio satellites, for additional background, see references (1) through (6).

PACSAT

PACSAT is generic term in the amateur radio service for a low earth orbiting spacecraft which carries a large on-board memory for the purpose of data storage and retrieval by ground stations. A PACSAT can be the entire mission of a spacecraft, such as AMSAT-NA's AO-16, or a minor adjunct, such as the DCE on UO-11. The paper refers to the current "PACSAT" spacecraft — the University of Surrey's UoSAT-3 (UO-14) and the AMSAT Microsats AO-16 and LO-19. These spacecraft will be the hosts of software developed by the authors which implements the protocols described herein.

Each of these spacecraft is different. AO-16 and LO-19 are the most closely related, based on AMSAT's Microsat design. From the user's point of view, they have four 1200 bps uplinks and one 1200 bps downlink. These are switchable to 4800 bps, but no ground modems exist at this time. UO-14 has a single uplink and downlink, at 9600 bps. Although the on board computers are different, they are compatible at the application software level, permitting the same software to be used on all three.

In spite of these differences, all of these

spacecraft share the following attribute: each is a bandwidth limited device. The number of uplinks and downlinks is much less than the number of users, and the capacity of the link is much less than the offered load. Each is only visible to a particular user for about 14 minutes, four or five times a day at middle latitudes. We feel that this is the critical design driver, and the access methods must be optimized with this in view.

Keep in mind, however, that even while subject to access time limitations, the satellites can still move a prodigious amount of data, especially when compared to the current amateur radio long haul network standards. A typical gateway station, moving traffic from the US to the UK on 20 MHz at 300 baud, assuming the band is open for 16 hours, could move 1.7 million bytes of data per day, if the link was 100% efficient. The average HF link is not 100% efficient, at best it is perhaps 30% efficient. The link is only half duplex, so this data transfer is one way only.

UO-14, even with only 56 minutes of access time per day at 9600 baud, can move 3.2 million bytes of data in one direction. The excellent link quality of the current PACSATs, combined with their full duplex nature and the protocols we are proposing, can approach 90% efficiency. Full duplex means transfers can occur in both directions simultaneously, so that UO-14 could move nearly 5.7 million bytes of data between the US and the UK in a 24 hour period, vs 0.5 million bytes over an HF circuit.

The desire to realise this potential is the reason we choose some non-traditional (for the amateur radio service) access methods for

Proposed Revised 3cm Band Plan

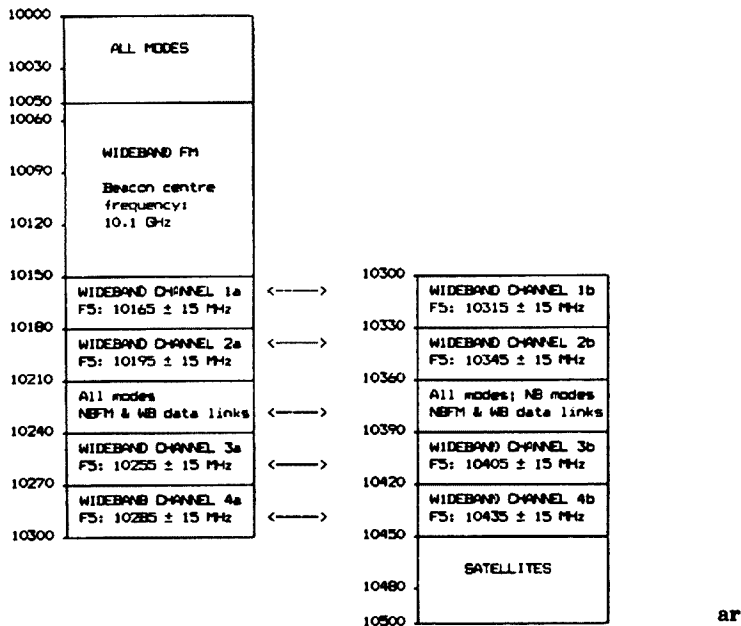

Stolen Equipment

Stolen from Ken Hanby VK4IS, 17 Kig Heights, 14 Queen St, Caloundra, on 27 July from Hooper Education Centre, Wavell Heights: **Kenwood TM231A, Ser 0051016 and TM441A, Ser 6010370**, and, on 15 August from same address: **Ex-CFA Philips 10-channel, Ser 44982, GME 40-channel AM TX830 Electrophone, Ser 8770556**. Contact owner or nearest police station.

Education Notes

To conserve space for this special antenna issue, Brenda Edmonds VK3KT has graciously consented to defer her regular column until November. Thanks Brenda.

RANDOM RADIATORS

RON FISHER VK3OM AND RON COOK VK3AFW

A Wire Signal Squirter for VHF

This is a contribution from Andrew Russell VK5ZUG, who writes as follows (some minor editing has been done).

"The use of long wire antennas at VHF and UHF seems obvious in retrospect as it is easy to make them many wavelengths long. Although not offering the steerability of a beam, a rolled-up loop of copper or aluminium wire takes up little space. It is possible then to get a reasonable antenna into a small Japanese car along with the XYL, rig, feedline, food, luggage, etc when setting off to the seaside for a holiday.

I used a length of wire cut to 10 half waves long on 2m (10m approx) fed via 1/4 wavelength stub (52cm approx) to match a 50Ohm line. (Ref Fig 1) The feed point XX was adjusted for the best VSWR, starting 1/3 of the way from the shorted end. The length of the

wire can be adjusted to give an improved match. An SWR of 1.2 to 1.5:1 should be easily obtained.

This antenna has gain along the axis of the wire in both directions, with the main lobes getting closer to the wire axis as the wire length is increased. Low-angle radiation can be obtained by sloping the antenna in the direction of interest. Terminating the antenna and using a balanced feed have not been tried, as the increase in performance did not seem worthwhile.

Over the path from Victor Harbour to Mt Gambier and SW Victoria it seemed to work as well as a five-element Yagi used on previous occasions. I hope to make some direct comparisons with a three-element quad in future.

This wire antenna can be readily assembled from available materials for use in field days or in emergency situations."

An interesting antenna, Andrew, which,

when installed horizontally 3m or more above the ground, should work very well indeed. Terminating it might be difficult in the absence of a good metallic ground plane. Thank you for the contribution; please let us know about your quad tests.

More Success with a Windom

Lee VK6HC has written to describe his success with a Windom using 136 feet overall and tapped at 44.4 feet or 32.6 per cent. Why is the Carolina Windom tapped at 38 per cent, he asks? There are several reasons. The best tapping point varies with height above ground and the ground conductivity. Both these variables change the impedance at a current maximum quite considerably so a five per cent variation in tapping point is not too surprising. Further, if the antenna is cut for resonance at a different frequency from that at which matching is done, there will be a variation in the position of the tap for lowest VSWR. Another area for the experimenter to invest some time!

A Failure with a Trapped Dipole

Another VK3 has written in saying that he tried the 18/24MHz trap antenna described in January AR, but the VSWR was about 5:1 in the amateur bands and reached a minimum value well outside the band limits. The antenna was only 3m above the ground and we think this was too low. Further, as indicated earlier, the impedance of an antenna depends on its height above ground, major variations taking place at heights of less than a wavelength. This design of antenna relies on a

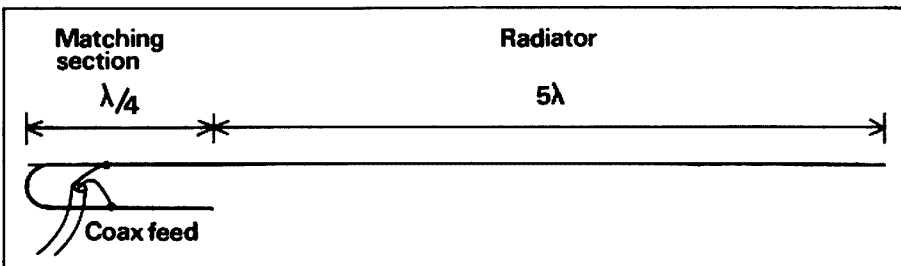

Figure 1 Sketch of a long wire for two metres. The length of the radiator should be a multiple of a half-wavelength

With a broadcast protocol, a ground station can simply monitor the downlink and accumulate files of data. Since files gathered in this way will have been unsolicited, the format of the contents may not be known to the user. For example, if one asked for a file of NASA format orbital elements, one can make a good guess that the resulting file contains NASA format orbital elements. However, if a "random" file is captured, its contents may not be understandable simply from inspection. Some additional information, such as a file name, data type, description, creation data, etc, may be required. Each broadcasted file, therefore, needs a header in a standard format with this information. The specification titled "PACSAT File Header Definition" describes a method of providing this information.

We hope that the broadcast protocol promote efficient use of the downlink. It should reduce the number of requests for files of general interest. It should also reduce the uplink loading, since a broadcasted file does not receive an ack for each frame or group of frames. In the best case, only on "ack" is sent for an entire file, and that would be the request to stop broadcasting it.

Even though the sky-to-ground link is broadcast in nature, the ground-to-sky link is not. PACSAT "sees" many ground stations at one time. For this reason, a connected-mode, non broadcast file transfer method is also defined, and is described in the paper on "PACSAT File Transfer Level O".

(Continued next issue.)

73s from Maurie VK5EA

ar

SATELLITE ACTIVITY FOR JUNE/JULY 1990

1. Launches

The following launching announcements have been received:

Int'l No	Satellite	Date	Nation	Period min	Apq km	Prg km	Inc deg
1990							
050B	USA 60	Jun 08	USA				
050C	USA 61	Jun 08	USA				
050D	USA 62	Jun 08	USA				
057A	METEOR 2-19	Jun 27	USSR	104.1	974	951	82.3
058A	GAMMA	Jul 11	USSR	88.5	233	190	51.6
059A	BADR-A	Jul 16	Pakistan	96.3	984	201	28.4
060A	RESURS-F7	Jul 17	USSR	88.9	278	194	82.3
061A	COSMOS 2085	Jul 18	USSR	24hr01m	35889		1.4
062A	COSMOS 2086	Jul 20	SSR	88.7	258	191	82.3

2. Returns

During the period thirty six objects decayed including the following satellites:-

1970-064A	COSMOS 358	Jun 26
1989-088A	COSMOS 2049	Jun 19
1990-027A	OFEQ-2	Jul 09
1990-042A	COSMOS 2077	Jul 04
1990-044A	COSMOS 2078	Jun 28
1990-053A	COSMOS 2083	Jul 03

3. Notes

1990-056A INTELSAT 6 F-4

Orbital parameters are period 958.8 min, apogee 38374 km, perigee 1328 km, inclination 1.4 deg.

1990-059A BADR-A

Was launched by the People's Republic of China using the Long March 2 cluster launch vehicle.

BOB ARNOLD, VK3ZBB

ar

REPEATER LINK

WILL MCGHIE VK6UU
WATERLOO CRESCENT LESMURDIE 6076

10 Metre FM

Several years of discussion and some construction has still not seen VK6RHF on air. A change in the final form of the repeater has taken place. Instead of a 10 m input and a 10 m output as is the case with the standard repeater, a cross band system is to be put into service. This will consist of a VHF input/output and a 10m input/output. It is important to note that a station on 10m can not talk through the repeater system to another station on 10m.

There are several reasons for the departure from the standard 10m arrangement. 10m repeaters are difficult to put on air; due to the narrow frequency difference between input and output they require a split site. The receiver is at one site and the transmitter, several kilometres away, at another. The two sites are linked together via UHF. In short — a lot of work.

The 10m system can be switched to trans-

ceive on a frequency split such as the 10m repeater VK3RHF in Melbourne. Mobile or home stations in Perth can then talk via the 10m system in Perth to the Melbourne repeater. The VHF input would be CTCSS encoded to gain access to the 10m system. If you have ever monitored 10m FM for any length of time, you would soon find it is a band full of signals and strange sounds. It may be required to fit CTCSS decoding on the 10m input.

10m FM is at times as good as 2m, with signals sounding like they are just down the road. Both the Melbourne and Wollongong repeaters are heard noise free in Perth every day for long periods of time. See you on 10 via 2 soon I hope.

Bit Scratchy

We have all heard signals on the local repeater that have next to no audio, and others that blow you out of the car. Why is it,

with all this modern technology, that the audio level varies so much from FM rig to FM rig? The answer is simple. Voice levels vary from amateur to amateur, and so does their operating environment. For the amateur operating from the shack, these different audio levels are not a big problem, but pity the poor mobile operator riding the volume control. Most transmitters do have a mic gain pot, but not everyone is prepared to lift the lid and adjust the audio level. Some rigs, even the very latest, do not have a mic gain pot. The solution is to fit all FM equipment with a front panel mic gain pot that can only be adjusted with a small screw-driver, through an access hole. Then you adjust the mic gain to suit your voice and operating situation. So please — makers of amateur FM mobile equipment, do this small thing, and let the long suffering mobile operator keep both hands on the wheel.

Duplex Linking

Correspondence received from Colin VK3BLE (in answer to my question — why the frequency pair for linking two repeaters?) makes interesting reading. From Colin's letter "the choice of full duplex was a deliberate one, to enable the remote repeaters to be

controlled via the links, even if they are locked on. Our repeater controllers have this ability built in. The other reason is to enable the audio of two repeaters to be mixed even if they are both keyed at the same time. This has proved itself beneficial in WICEN situations during bush fires on the portable WICEN system. This enables you to talk over incoming noise or traffic if necessary."

Control of the link system is a very important part of linking repeaters. If the link system locks up in the transmit mode from the distant end to the control end, then remote control of the overall system is lost. Duplex links solve this problem. Colin also mentioned that repeaters to be linked are VK3RLV to VK3RGS and VK3REB to VK3REG and VK3RGO. Thank you Colin for your reply.

Repeater Linking Standards

A proposal from Will Scott VK4XP on repeater linking standards makes for interesting reading. In short it proposes 4 points.

1. Assign a CTCSS tone to each grade of

- license.
2. Assign a unique 4 digit number to each repeater.
3. Use DTMF for user control of linking destination.
4. Audio feedback to identify status of linking.

If I understand Will's proposal, the 4 points are a very simplified outline of a very comprehensive document. As many of us have found, repeater linking is complex. It may look simple, and to the end user be simple to operate, but the engineering behind linking is complex. The West Australian Repeater Group put together a very similar document early in the year. The most fundamental conclusion was that each grade of licence had to be identified by the repeater to determine who is allowed to be linked to what. If you are involved in repeaters, it would be in your interest to obtain a copy of this document along with WARG's submission.

Wollongong 10m Repeater

I received some information from Rob VK2MT regarding the Wollongong 10m re-

peater. Most of this information is widely published and need not be repeated. An interesting and frustrating fault on the UHF link between the 10m receive and 10m transmit site took considerable time and effort to find. The fault manifested itself as a repeating pulse sound on the audio. I know the problem has been solved, but as yet do not know what was causing the problem. At the time it was thought to be external to the installation and in the UHF spectrum somewhere. When talking to Rob on the phone, he said the whole project was far more difficult than his wildest nightmare. I can only sympathise with Rob that an apparently simple project takes 10 times the effort originally thought. The 10 times rule is a good one to apply to all projects when estimating the time and effort required. If it can go wrong it will. If it can't go wrong it still will go wrong. All the best to VK2RAH, look for this repeater on 29.520 MHz input and 29.620 MHz output.

ar

DIVISIONAL NOTES

VK2 NOTES

TIM MILLS VK2ZTM

Gladesville ATV Test Transmission Via Aussat

Expanded coverage of the regular Wednesday evening test transmission from VK2TVG is scheduled to be relayed through AUSSAT 2, transponder 5, vertical polarization. This is a 12 watt south east beam which covers VK1, 2, 3 & 7 plus southern VK4 and eastern VK5. There may be a spot towards Perth. Time 7 to 10.30 pm Eastern Australia Summer Time, 14 November 1990. Thanks to AUSSAT for the facility they have extended to the Gladesville Amateur Radio Club. Listen to your WIA Sunday news broadcast on 4 and 11 Nov for last minute details. (See *Gladesville ARC item Club Corner — Ed.*)

QSL Bureau

A reminder to all members to advise what inward card handling arrangements you require, including the advice that you don't collect. With the volume of cards coming through the wishes of all must be known.

WICEN (NSW) Inc

The major exercise this month will be the Hawkesbury Canoe Classic on 3rd/4th Nov. The Hunter Region "Lake Macquarie Dash" scheduled for late in the month has been transferred to 1991 sometime.

Broadcasts

VK2WI transmits twice each Sunday, 1045 and 1915 hours local time. With the change into daylight saving the 30 metre 10125 kHz transmitter may be used in the evening for a trial period for the longer haul coverage. The Coffs Harbour and District ARC has recently joined with a relay of the morning broadcast through their local 2 metre repeater VK2RCH on 6650. A reminder that the deadline for broadcast material is 6pm Friday at the Parramatta office by mail, delivery, phone or fax. (Details on page 3.) Packet material to VK2WI @ VK2RWI. Voice mail headlines or news submission via (02) 552 5188.

Publications

A reminder that the latest Australian Callbook is available from the Divisional office. Cost details are given on the broadcast. A list of publications available from VK2 is included with the callbook; or collect one from the office. If you require a copy by mail send in a stamped, self addressed 9 x 4 envelope.

New Members

A reminder to members and clubs about the recruiting drive until the end of the year. Most clubs should have a stock of application forms so get one or more at your next club meeting and sign up your non-member friends. During September the following joined the NSW Division and a warm welcome is extended to them.

J Andrews	Assoc	Hornsby Heights
W W Aulsebrook	Assoc	Forster
P M Buckland	Assoc	Hornaby

P J Carter	VK2ETK	Orange
R Cason	Assoc	Stanmore
I W Dempsey	VK2TRX	Molong
D R Duke	VK2VLN	Penrith
D J Hardwicke	Assoc	Blacktown
P M Howchin	VK2TPH	Dapto
D J Joyce	VK2GG	Morisset
B J Kelly	VK2KBJ	Tamworth
R G Law	VK2MRL	Forbes
M Livens	VK2MEA	Mullumbimby
S G Marshall	VK2NSM	Murwillumbah
J J McFarlane	VK2NPX	Miranda
D H Moss	G6VNY	West Ryde (Surrey England)
D Nickolic	Assoc	Bossley Park
G W Price	VK2JGP	Argenton
A R Stuart	VK2ALX	Balgowlah Heights
G C Wakefield	Assoc	Dulwich Hill
M C York	VK2GFS	Blacktown

ar

VK3 NOTES

JIM LINTON VK3PC

Turbo Tutorial

As part of its education activities, WIA Victoria has arranged a special eight hour "Turbo Tutorial" day on Sunday November 18.

The course, being held at centrally located Canterbury, will concentrate specifically on the AOCPT theory syllabus and those attending should have at least Novice theory level knowledge. The instructor will be Fred Swainston VK3DAC, well known as the author of the Radio Theory Handbook for Amateur Operators.

TT Day is ideal for candidates sitting the AOCPT theory exam at this month's WIA Victoria examinations. Applications to join the course close on November 6. For further information, contact the WIA Victoria office without delay.

TVI Filter Kits Popular

Since their introduction in September, the kits of TVI and VCR interference filters on

loan to members have been consistently booked out. The kits can be borrowed by members having TVI or VCR interference problems — and reports we've received indicate this is an increasing problem for radio amateurs.

The scheme is that members pay a nominal security deposit and undertake to return the filters within a prescribed time. The kits can only be borrowed in person from the WIA Victoria Office — they're not available by mail order.

The idea is to borrow a complete set of filters and try them to find the one which cures the problem. Knowing the exact filter needed to overcome a particular situation means the interference can then be quickly fixed with the permanent installation of the right filter.

The TVI and VCR Interference Filter Kit — another membership service of WIA Victoria.

Trial Examinations

Requests for the trial Novice and AOCF theory examination papers, and the Regulations trial exam have been received from throughout Australia. These are proving very popular for candidates sitting the real examinations and wanting to brush up on their theory or regulatory knowledge.

The theory examination papers have just been updated with the addition of some new questions.

They are available on mail order only from WIA Victoria with a trial theory exam (specify AOCF or Novice). Price is \$12 for either Theory exam, \$8 for the Regulations. The cost includes a marking service to help candidates identify their study weakness areas.

ar

5/8 WAVE

JENNIFER WARRINGTON VK5ANW

Picnic

The Council, attempting to make the best use of its available person-power and resources, came up with what they thought was a great idea. They would make a donation to a club or pair of Clubs, North and South of the city, if the said groups agreed to organise the picnic. Adelaide Hills and South Coast clubs, were approached in the south, and Riverlands and Barossa were the northern clubs. As far as I know, Barossa has been the only one to accept, and theirs will be held in March 1991 at Mount Pleasant Oval.

Members Equipment Display Night

This year 10 exhibitors displayed 14 items between them. The ICS Award went to the group responsible for building the Elizabeth ARC 70cm repeater, namely, Bill VK5ZDV, Dallas VK5WA, and Trevor VK5ZTJ. Dave Minchin VK5KK won an ESC voucher for his test antenna (a double figure of 8) and a 23 element Yagi, also for his 1296 transverter. Martin Luther VK5GN also won an ESC voucher for a mic pre-amp, and a broad-band RF Amplifier. Clarry Castle VK5KL did a beautiful job on his 50 MHz linear amp and received an ESC voucher also.

The Merv Millar Encouragement Award was won by Colin Taylor VK5CE with his "novel" junk box Power Supply (the box and transformer began life as parts of a Pool Chlorinator!) Our thanks to Merv VK5MX, who continues to encourage "homebrewers" in this way. I believe John (harmonic of Steve VK5AIM) deserves a special mention. At 7years, John has to be our youngest ever participant. Keep up the good work John. At this rate, it won't be long before Steve is

sharing the shack with you and Mum!

ATV Merger

At a meeting on Sept 15th, it was resolved unanimously that the SA ATV Grp and the Southern ATV Grp should merge.

The name of the group will continue to be the SA ATV Grp Inc but at a subsequent meeting a new Committee will be formed, and can then sort out the 1296 licensing problems. They also intend extending invitations to past SA ATV Grp members, particularly in the Elizabeth and Northern areas, to join them once again.

Westfield Displays

We have been offered the opportunity to put Display Stations in the Arndale, Marion and Tea Tree Plaza shopping centres, possibly for a week at the end of the school holidays in Jan '91. Obviously we will need volunteers. If you would like to be part of this, please let Rowland VK5OU or John VK5BJM (or any member of Council) know. It really is a very rewarding experience.

By the time you are reading this, JOTA will just be a pleasant (we hope) memory. Our thanks to Peter Koen, Project Commissioner for Scout Radio Activities, for keeping Council and members informed and injecting his own "spark" of enthusiasm; also, for achieving the Aussat link and the V15 Prefix.

Diary Dates

Tues Nov 26

Computer Night

Bring along your computer, any "amateur" oriented programs (qntest logging, satellites, etc) (also extension cords etc).

Tues Dec 4th

Christmas Meeting

Come and hear Keith Rendell — a highly entertaining speaker — bring your spouse and a plate of supper, to Woodville Community Hall, 64C Woodville Rd, Woodville. ar

WICEN

IAN NANCE VK2BIN
PRESIDENT WICEN (NSW) INC

Funding!

It's good news time for the members of WICEN (NSW) Inc!

The NSW Volunteer Rescue Association, which is WICEN's parent organisation in this state, held its 22nd annual conference in Sydney on the 15/16 September.

The mood of the meeting rose considerably when the NSW Minister for Police & Emergency Services, Ted Pickering, handed VRA President Max Walters a cheque for \$375,000. This amount represented \$79,000 as an immediate allocation for VRA training, administration, and special assistance fund, with the balance going to the accredited VRA units

who were given an immediate grant of \$2000 each.

The Minister also announced an Incentive Grant of up to \$2000 per squad which the government will match on a dollar-for-dollar basis for donations raised in the financial year 90/91.

Recognising the difference between local rescue squads and groups such as WICEN who have state-wide responsibilities, the Minister doubled our Immediate Grant to \$4000, and raised the ceiling on the Incentive Grant to \$4000 also.

This funding of volunteer services is in line with the complete re-think of disaster planning policy for NSW, and follows the introduc-

tion of the State Emergency and Rescue Management Act 1989.

A condition attached to receipt of the Incentive Grant is that all units retain their accreditation, undertake training on a regular basis, possess equipment of acceptable standard, and report regularly on their operation and training.

That's exactly what WICEN is currently doing as part of its role as the state's emergency electronic communications resource, and now's a good time to suggest to amateurs who are not WICEN members that they are in a unique position to serve their community in times of emergency or disaster.

If you, as a concerned amateur, are prepared to support NSW rescue and emergency operations in a professional way and would like to join WICEN (NSW) Inc, call in on one of the various regional nets or write to us at PO Box 123 St Leonards NSW 2065.

ar

QSLs FROM THE WIA COLLECTION (28)

KEN MATCHETT VK3TL HON CURATOR WIA QSL COLLECTION
PO Box 1 SEVILLE VIC 3139

Bahrein — Middle East Emirate — Part 1

Bahrein is really an archipelago of some thirty small islands in the Persian Gulf lying about 24 kms off the coast of Saudi Arabia, not very far from troubled Kuwait, which lies to the north west at the top of the Gulf. The main island is called Bahrein Island, and is the only one of any importance. Its population is about half a million, approximately half of whom are Iranian descendents, the other half coming from Saudi Arabia. Almost all are Muslims. Early amateur activity was carried out by British nationals. In fact, Britain has exerted an appreciable influence in the area for many years. Several treaties of protection were negotiated as early as 1820, which were related to Britain's policy of keeping the Gulf free of any power that might threaten trade routes to India. In return for protection, rulers could not enter into relationships with other nations without British consent. Bahrein was never a Colony or a Dependency, the country being ruled by an Emir of the Khalifa family. This was the family who ousted the Persians in 1783, and which has been the power in the country ever since.

XYI6BZ

This QSL of the WIA collection would be one of the rarest in the world. It was sent to Val Petruchenia VK3DT (later VK2VS) for three QSOs in the 1930s, the earliest one being in December 1932. As pointed out in earlier articles, the letter X preceding the normal prefix of a callsign indicated a portable station. (See "QSLs of the WIA collection" in "Amateur Radio" August 1988.) This station belonged to an RAF squadron member based at Basrah, Iraq. It would be one of the very few stations operating out of that country at that time, when Bahrein was not generally recognised as a 'DX country'.

In 1934 the "Radio Amateurs' Handbook" listed the prefix allocation VPA-VSZ as British colonies and Protectorates, but there was no mention of Bahrein. Possibly the first listing of this country was in 1935, when the March issue of the radio magazine "R9" suggested the prefix VS8 for Bahrein, under the heading of an article entitled "British Empire Prefixes". (This prefix was also shared with the island of Kuria Muria.) During the 1930s there were several suggestions for callsigns which led to some confusion amongst radio amateurs. The "Radio Amateur Handbook" of 1936 suggested that the VS8 prefix be allotted to Straits Settlements. Callsigns

became more defined in the years just before the outbreak of war. The "Wireless Weekly Callsign Book and Technical Review" of 1937 lists Bahrein as VS8 (together with VS7 Ceylon, VS9 Maldives). One of the most active stations at that time was VS8AA (during 1938 and 1939.).

VU7JU

Both the VS8 and a new prefix, VU7 seem to have been used just before the war. (VU7BR was active both during 1938 and 1939.) The VU7JU QSL shown here is dated April 1947, and was for a QSO with SK Bob Grundy, VK5BG. The owner of the Bahrein station was also a member of the RAF. Although both the VS8 and VU7 prefixes were to be found in post-

war DXCC lists, the VU7 prefix would seem to be the only one used at that time. It is the only prefix listed in the QST issue of February 1947 which publication set out a "Post-War Countries List". This was the official list for ARRL DX Contest and Post-War DXCC.

Next Month: Bahrein — Middle East Emirate Part 2.

If you would like to play a part in building up the WIA QSL collection and to save something for the future, would you please send a half-dozen (more if you can spare them) QSLs which you feel would really help the collection along.

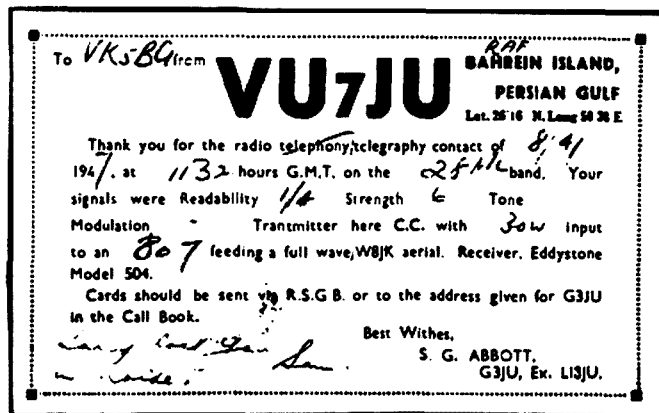

Morseword No 44

	1	2	3	4	5	6	7	8	9	10	
1											Across
2											1 Keen
3											2 Boyfriend
4											3 Ceremonies
5											4 Parts
6											5 Cabbage
7											6 Boss
8											7 Sheep
9											8 Ready
10											9 In what way?
											10 Wheeze
											Down
1											1 Monkeys
2											2 Awkward
3											3 Platform
4											4 Subs
5											5 Arid
6											6 Terror
7											7 Base
8											8 Leveret
9											9 Stand for coffin
10											10 Recliner

Audrey Ryan © 1990

Solution Page 56

All cards are appreciated but we especially need commemorative QSLs, special event station QSLs, especially assigned call QSLs (eg VK4RAN), pre-war QSLs, unusual prefixes, rare DX and pictorial QSLs of not so common countries. Could you help? Send to PO Box 1, Seville 3139 or phone (059) 64 3721 for card pick-up or consignment arrangements for larger quantities of cards.

Thanks

The Wireless Institute of Australia would like to express its thanks to the following for their contribution of QSL cards towards the collection:

(Supplementary List)
 Bob VK7KZ
 Jim VK9NS
 Frank VK2QL
 Bob W5GTY

Also the friends and families of the following "silent keys"

(Supplementary list).
 Brian Austin
 VK5CA
 Frank
 Bridgewater VK2ZI

ar

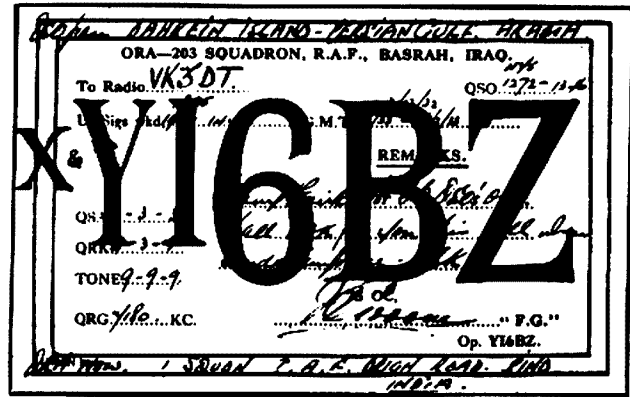

CLUB CORNER

Southern Peninsula Amateur Radio Club

The Annual General Meeting of the Southern Peninsula Amateur Radio Club was held at the club rooms in Rosebud, on Thursday, 4th October.

A vote of thanks was expressed to retiring President, Syd Keighley VK3DSP.

Elected office-bearers for the coming year are:-

President	Vic Vickery	VK3DEA (059) 861327
Vice President and Publicity	Tony Hamilton	VK3ENE (059) 864927
Secretary	Frank Feldman	VK3BC (059) 862031
Treasurer	Phil Carne	VK3AAM (059) 854784
Committee	Don Robertson	VK3CK
	Stewart Backhouse	VK3NV
	Alan Robinson	VK3SQ
Social Secretary and QSL Officer	Margaret Hamilton	VK3END (059) 864927

The SPARC club, which is comparatively small due to its location, has steadily progressed during recent years and looks forward to increasing membership in the future.

The club is a distribution point for QSL cards from the WIA Bureau. For further information phone Margaret (059) 864927.

The club conducts two nets a week on 3.620 MHz, Tuesday evenings at 7.30pm local time, and Sunday mornings at 9.30am local time. Any stations are welcome to join in. Enquiries and correspondence can be directed to the Secretary, PO Box 206, Rosebud, 3939, or phone (059) 862031..

TONY HAMILTON VK3ENE

AUSSAT Transponder For Gladesville ARC Television

Many amateurs may be aware that the Gladesville Amateur Radio Club — VK2TVG — in Sydney conducts a series of ATV test transmissions each week using a UHF ATV repeater on channel 35. (Vision 579.25; sound 584.75 MHz.)

Recently these tests came to the notice of

AUSSAT executives who approached Gladesville to find out more about the club and its function. AUSSAT then offered Gladesville the use of a transponder to conduct these tests over a wider coverage.

Further discussions took place and the test will be a joint operation between the Gladesville Amateur Radio Club and the VK2 Division of the WIA on the evening of Wednesday 14 November 1990, 7pm to 10.30pm Eastern Australian Summer Time.

The satellite to be used will be AUSSAT 2 — the most westerly of the three AUSSAT's (156 E) — on transponder 5 using an un-encoded PAL mode of transmission, 12 Watts, vertical polarized. The footprint will see at least south eastern Australia, which includes the State Capitals — Brisbane, Sydney, Melbourne, Hobart and Adelaide — not forgetting of course all the country regions in south east Australia. The 12 Watt transponder on this foot print is well received on a small dish. Outside the SE foot print the signal should be receivable on a larger dish over much of the rest of Australia. Some foot prints have a spot beam towards Perth.

For amateurs to benefit from this test transmission they will need to seek out AUSSAT

RF BYRNE

WITH ACKNOWLEDGEMENT TO RADIO COMMUNICATION JULY 1990



GEMEN

receiving facilities and perhaps where practical patch the signal into their local ATV repeater or simplex TV transmitter.

Alternatively seek out a satellite receiving facility at a local service club, TV production facility, education facility or a local equipment dealer and make it a radio club meeting night.

Perhaps you have your own AUSSAT system and are able to invite amateurs and interested parties to your facilities.

Gladesville ARC would like to hear from as many people as possible who will be able to receive this test transmission. See contact list below.

Gladesville ARC conducts this weekly test transmission live on Wednesday night using their ATV repeater VK2RTV on channel 35+, from West Lane Cove in Sydney. The format consists of a prerecorded lecture on NAACP or AACP theory followed by short technical or scientific items from sources like NASA, AUSSAT, Education colleges and material produced by Radio Amateurs, club lectures, projects etc. The presenter for the live transmission introduces each item and reads segments of news information from the

Gladesville Club, the WIA and ANARTS. The transmission is usually about 3 hours. Not everybody is able to see the transmission on Wednesday, so the log tape is replayed on Friday evening. Coverage from West Lane Cove is much of the North Shore of Sydney, the southern and south western suburbs and a few high spots like the eastern Blue Mountains. Much of western Sydney is in shadow from VK2RTV and a transmission is made on Thursday evening through VK2RTS which is in the eastern Blue Mountains. On Saturday evening Gladesville — VK2TVG — has a test transmission of computer and programming lectures. On Sunday evening the VK2WI broadcast is relayed, which is then followed by a selection of technical material. Gladesville records a range of lectures and classes for loan, the test transmissions and the Federal video tape library.

Gladesville is working towards extending the present coverage to other ATV repeaters and regions. In conjunction with the NSW Division, a repeater will be installed at VK2WI Dural and this site will be used to link to other locations.

The transponder booking has been made

by AUSSAT. It should be kept in mind that time changes may occur due to unforeseen satellite use. It is thought that this is the first time a national Satellite provider has carried an Amateur Radio test such as this one. The thanks of all to "AUSSAT" for the privilege.

For information about the AUSSAT test transmission on 14 Nov 1990 contact:-
Gladesville Amateur Radio Club
Keith Cuncliff VK2ZZO
PO Box 48 Gladesville NSW 2111
Phone 02 427 0530
NSW Division of the WIA
Tim Mills VK2ZTM
PO Box 1066 Parramatta NSW 2124
Phone 02 689 2417
Fax 02 633 1525
Media inquiries, Media East
Tom King VK2ATJ
PO Box 140 Kensington NSW 2033
Phone 02 349 6683
Satellite reception, Videosat
Wal Shand VK2AXW
PO Box 427 Wahroonga NSW 2076
Phone 02 489 5474
Fax 02 489 3557

ar

SILENT KEYS

DUE TO INCREASING SPACE DEMANDS OBITUARIES MUST BE
NO LONGER THAN 200 WORDS

We regret to announce the recent passing of:

Mr A E Sheppard VK2EDS*,
Mr Jock Simpson VK2DS
Mr Gordon Ewing VK2JS
Mr John Smith VK2NV
Mr John Traill VK2XQ
Mr T K Murphy VK2EBI
Mr Claude Singleton VK4UX
Mr M M Oosterbaan VK6QM

*Wrongly reported as VK2ED in
October issue.

Thomas Kevin Murphy VK2EBI

Kev passed away at his home in Balgownie on 25 August 1990. Kevin, aged 80 years, died from a heart attack.

Kevin was born in Nowra and first became interested in radio when he listened to the broadcast (on a crystal set) of the take off flight of Kingsford Smith on his solo flight to New Zealand in 1929/1930.

Kevin married Theresa and became a family man. In 1941 the family moved to Wollongong

and Kevin took a job at Lysaghts as an electrician. In 1943, he joined the Volunteer Coastal Patrol. In 1974, after his wife's death, Kevin resumed an interest in radio.

He joined the Illawarra Radio Club in 1976, sat for his exam in 1979, and passed the same year. A year later he sat and passed his full call exam. And so the well known call of VK2EBI was hitting the airwaves..

VK2EBI (Kev) will be missed but not forgotten, and there will always be a token reminder in the Illawarra Radio Club room as the Murphy family has kindly donated Kevin's Morse Key to the Club.

MORRY VK2EMV

John Traill VK2XQ

John was born in 1909, in the town of Pelaw Main, a coal mining town in the Hunter Valley of NSW.

He obtained his Operating Certificate in 1933 and operated as VK2XQ in the towns of Quirindi, Maitland, Mayfield and Hamilton South.

John was a great exponent of CW and on

numerous occasions when I visited him he would be talking to me and at the same time be laughing at the message coming over the air on CW. He really enjoyed his amateur radio and kept in regular contact with the many friends he had made over the years, and particularly his mates from the days in the RAAF. John had many contact with overseas amateurs particularly with the late Jim Kirk G6ZO (Stanmore-London).

In 1949, in the true amateur spirit, he gave valuable assistance to the Police on the occasion of disastrous floods in the Maitland District. He placed his station at the disposal of the Police and relayed messages, which otherwise could not have been passed between the police at Maitland, East Maitland and Waratah. For this service he was presented with a special certificate of recognition.

John served in the RAAF during WW2 including No 8 Squadron Signals Section, Sembawang 1940, concluding as Squadron Leader and Commanding Officer "Headquarters No 1 Detachment No 4 Wireless Unit 1945.

John was a member of the WIA since 1946, and was a member of the RAOTC since 1976.

Our sympathies are extended to John's wife, two sons and daughter.

PETER KING VK2QK

ar

**Support the advertisers who support
Amateur Radio Magazine**

OVER TO YOU

ALL LETTERS FROM MEMBERS WILL BE CONSIDERED FOR PUBLICATION BUT MUST BE LESS THAN 200 WORDS. THE WIA ACCEPTS NO RESPONSIBILITY FOR OPINIONS EXPRESSED BY CORRESPONDENTS

Packet Extravagance

I wish to add my support to the sentiments in Colin 9M2CR's article on HF Packet.

Much of the packet operation heard on HF consists of BBSs exchanging bulletins. I notice these BBSs need up to 10 retries before they can get even a small packet through successfully.

I recently saw a printed message received by Gerald V85GA from the DU1JMG BBS. The information part of the message is about 125 characters, but when the header and routing information is added it becomes about 2500 characters, or 20 times larger. The routing information indicates that it originated in ZL and passed through many BBSs; 3 ZLs, 5 VKs, 2 DUs, 28 JAs, and another 4 DUs.

Each time this message was passed on to another BBS, it grew by another 50 or 60 characters. Also, whenever this steadily growing message was transmitted on HF it was split into 20 or 30 character packets and each packet was transmitted 2, 3 or up to 10 times.

Obviously this is not the only message in the BBS networks.

Is the packet community working on a solution to this waste of spectrum time?

ANDREW DAVIS VK1DA/V85DA
PO Box 715 SERIA 7007
BRUNEI DARUSSALAM
BORNEO (VIA SINGAPORE)

Talking Newspaper

(The following information was passed on to us by Greg Baker PO Box 93, Braidwood NSW 2622.)

QTI is a tape magazine for radio amateurs and shortwave listeners who are blind or partially sighted. Each issue consists of two C90 cassettes which contain technical articles on amateur radio topics which have been recorded by a team of readers in UK. The articles are selected from UK radio and electronics magazines. (Articles from mags published in Australia could be included if we had the magazines and the publisher's waiver on copyright for this specific purpose.)

Until late last year, 1989, QTI was distributed on our behalf in Australia, but due to falling support, both in terms of manpower and donations this has now come to an end. There are at least 30 blind radio amateurs in Australia who no longer receive QTI.

Can you spread the word that QTI Talking Newspaper Association is standing by to distribute QTI to the amateur radio community in Australia? QTI can be sent every three weeks by airmail. Under the facilities for the blind the postage is 10p only from UK. I believe

that there is a concessionary rate for the return trip. After use, the QTI cassettes are returned to base for recirculation. The tapes are erased and the new issue copied on to the blank tapes. A direct service can be offered for \$A15 per year.

If you are unable to help directly, please pass on the word or better still, send me the names and addresses of persons who are in a better position to do this liaison.

Very many thanks and best wishes.

HARRY LONGLEY GOJKT
QTI TALKING NEWSPAPER ASSOCIATION
7 ANDERSON CLOSE, LANCASTER
LA1 3JE UK
(TEL 0524 33207)

Those GOD Suffixes

The recent upset over callsign suffixes GOD in NSW, Victoria and Queensland, and the VK4 Division's condemnation of activities of a station allegedly running a religious net must surely cause deep concern among all amateurs. Our hobby has always been non-political and non-religious. For DoTC to re-issue the contentious callsigns stating the suffixes are just groups of letters, not words, without securing an endorsement of this view from the applicants, is to condone a misuse of the system.

We would not expect DoTC to pass judgement on a long-standing tradition which in point of fact observes, supports and is based on one of the Department's own regulations.

I express utter contempt for those who, knowing little or nothing about our traditions, try to use the hobby for ends having nothing whatever to do with amateur radio. ("Render unto Caesar"...etc.)

The holding of an amateur radio licence and callsign do not bestow on one the status of a private broadcasting station. If these people want to go on the air on religious matters, the proper course is to apply for either a public access station licence or a commercial broadcasting licence and do what the laws of this land entitle them to do in the proper place and with the appropriate means.

Those of us who deplore this situation are neither agnostics nor atheists — we are radio amateurs. We are proud of our hobby's democratic, international, non-political and non-religious ideals.

HARRY ATKINSON VK6WZ
5/97 RAILWAY PARADE
MT LAWLEY 6050

Information Please

Can anyone help me? I'm trying to get more details about an old 5 valve radio that I am going to attempt to restore.

The valve line up is 2x UY-235 (TRF stages?) UY-224 (grid or plate pentode detector)?, 47 power pentode & an 80. The last two I remember from my earliest radio days. The cabinet and chassis are stamped 10-84C.

Tuning is via a 3-gang capacitor and trimmer front knob.

Internally, the transformers, etc are stamped Emmco, Aust. The bypass capacitors are 0, 5 F Hydra, made in Berlin, and possibly dated VII 31. Could the radio be this old? The cabinet was made by a J.Ratner, of Sydney.

In the region of the aerial connection there are 4 terminals marked S (?), M, B, Earth. Any clues on the first 3?

Because of a socket connection, the radio obviously once had an electro-magnetic loud-speaker, which has been replaced by an 8M Rola and speaker transformer. Some resoldering appears to have taken place.

Does anyone know the details of the speaker magnetising coil, eg winding wire, d.c. resistance, a.c. inductance, number of turns? (or typical values).

Finally, two wires go from the 8µF, 525V electrolytics back into the power transformer.

I can only speculate on this (apart from some sort of saturable reactor arrangement.)

Please note: Anyone who drops me a line, I will phone and then possibly use any HF band for discussion.

PETER WOOF VK1PW
PO Box 305
DICKSON ACT 2602
ar

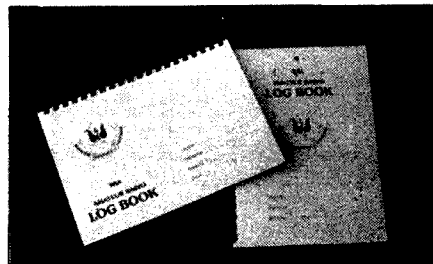

New WIA logbooks available now

at your Divisional Bookshop.

These quality logbooks are available in A4 format with plastic spiral binding so the book will open and lie flat on the bench. VERTICAL OR HORIZONTAL column layout is optional, with the traditional column headings.

Price is \$5.00 each plus post and packing where applicable.

HF PREDICTIONS

ROGER HARRISON VK2ZTB
THE APOGEE GROUP

November Charts

For ease of use and to accommodate space restrictions in the magazine, I have provided predictions applicable for three major regions of Australia:

VK East. Covers the major part of NSW and Queensland.

VK South. Covers southern-NSW, VK3, VK5 and VK7.

VK West. Covers the south-west of West Australia.

For each of these regions I have selected six "terminals" to major continental regions of the world. Note that, this month, I have included charts specifically for the Malpelo Island, in lieu of the Middle East charts which have featured over the past few months. This is to cover a DXpedition scheduled there for the first week of November.

Malpelo is an island located some 350 km west of Buenaventura in Colombia, on the north west corner of the south American continent. As this is well to the south west of the terminal I use for the North & Central America charts, you will notice significant differences between the predictions.

I understand there will be activity from the

South Sandwich Islands and South Georgia Island over the last few days of November through early December. I will include prediction charts in the December issue, but listen for advice on the VK2 and VK3 Divisional broadcasts on the last Sunday this month for updated information close to the event.

The Charts Explained

These charts are different to those you see published elsewhere, and arguably more useful to the amateur fraternity as they give, effectively, a value akin to the predicted signal/noise ratio for each hour and for selected bands.

The charts are organised in 24 rows, one for each hour UTC (first column on the left). Don't forget to add the appropriate number of hours for your time zone, including daylight saving where it applies. The next column gives the MUF (maximum usable frequency) for each hour, followed by the field strength at the MUF, in decibels referred to 1 µV/metre (dBU). The column marked FOT gives the "optimum frequency — the most reliable frequency for the path.

Then come five columns, one for each of five selected HF bands. The numbers in the column represent predicted field strength at each hour in decibels referred to 1 µV/metre. Here it represents "raw" signal to noise ratio as urban noise levels are typically 1-2 µV/metre, but does not take into account the advantage offered by particular transmission modes. The results are based on a transmitter power of 100 W output (except where noted later), the use of modest 3-element beams or similar, and for "median" conditions. Where the results fall below -40 dB, no output is printed.

Enhanced conditions may improve S/N ratios by 9-15 dB. The use of CW or digital transmission modes show better results than SSB. If you've got 400 W output, you get a 6 dB improvement. Where conditions warrant it, I have included predictions for the bands below 14 MHz, deleting the upper bands.

The Monthly Sunspot Numbers

The values of the predicted monthly smoothed sunspot numbers that I use to generate these charts, supplied by IPS Radio & Space Services, have begun to trend upwards in value. This is a good sign. At the time of writing, it has moved from 143 for October this year, rising to 150.8 in January next year. This puts the predicted values near those experienced through the first part of this year, or to those prevailing in late 1988-early 1989.

UTC	MUF	dBU	FOT	14.2	18.1	21.2	24.9	28.5
1	19.2	-5	13.5	-16	-6	-5	-8	-13
2	21.4	-5	15.4	-23	-9	-5	-5	-8
3	21.7	-7	16.5	-32	-14	-8	-6	-8
4	25.1	-6	18.1	...	-10	-10	-6	-6
5	26.6	-6	18.6	...	-21	-12	-7	-6
6	27.1	-6	19.0	...	-23	-13	-7	-6
7	26.6	-7	18.6	...	-23	-13	-6	-7
8	24.1	-4	18.5	...	-21	-12	-7	-6
9	25.5	-5	18.2	-40	-18	-10	-6	-6
10	24.2	-5	18.0	-31	-14	-7	-5	-6
11	23.1	-3	17.7	-24	-9	-4	-3	-6
12	22.0	-2	17.5	-16	-5	-2	-3	-7
13	21.1	1	16.4	-7	1	1	-2	-7
14	20.3	5	16.0	2	5	6	-1	-8
15	19.7	9	15.2	12	11	7	0	-8
16	18.8	12	14.4	18	14	8	-1	-11
17	18.0	14	13.6	19	16	7	-3	-14
18	17.2	15	13.0	20	13	6	-5	-17
19	17.3	15	12.5	21	14	6	-5	-17
20	17.5	14	12.0	20	13	6	-5	-17
21	16.8	10	11.5	12	8	1	-9	-21
22	16.2	4	11.2	5	3	-3	-12	-24
23	14.2	-1	11.3	-3	-2	-5	-13	-23
24	17.2	-4	12.0	-9	-4	-5	-11	-19

VK EAST — AFRICA

UTC	MUF	dBU	FOT	14.2	18.1	21.2	24.9	28.5
1	18.2	-4	12.5	-9	-4	-5	-10	-17
2	20.6	-3	14.8	-15	-5	-3	-6	-11
3	21.0	-5	15.9	-23	-9	-5	-5	-9
4	24.1	-5	17.2	-31	-13	-7	-5	-7
5	23.8	-7	16.9	-37	-16	-10	-7	-8
6	23.7	-8	16.8	-39	-18	-11	-8	-9
7	23.5	-9	16.4	-40	-19	-11	-8	-9
8	23.2	-9	16.4	-39	-18	-11	-8	-10
9	22.8	-9	16.2	-36	-16	-10	-8	-10
10	21.6	-8	15.2	-30	-12	-8	-8	-11
11	20.3	-8	14.2	-24	-10	-7	-8	-13
12	19.4	-6	13.5	-16	-7	-6	-8	-14
13	18.3	-3	12.7	-9	-3	-4	-9	-17
14	17.5	1	12.1	-1	1	-3	-10	-20
15	16.9	6	11.9	7	4	-2	-11	-23
16	16.2	10	11.2	13	6	-2	-13	-27
17	15.5	12	10.8	14	6	-3	-17	-32
18	15.1	13	10.6	15	5	-5	-19	-35
19	15.2	14	10.7	16	6	-4	-18	-35
20	16.1	14	11.4	18	9	0	-14	-29
21	15.9	11	11.1	13	6	-2	-15	-29
22	15.4	5	10.8	6	1	-6	-17	-31
23	15.4	2	10.9	1	-1	-7	-17	-30
24	16.3	-2	11.4	-4	-2	-6	-14	-25

VK STH — AFRICA

UTC	MUF	dBU	FOT	14.2	18.1	21.2	24.9	28.5
1	19.7	6	14.7	-4	6	4	-2	-10
2	22.1	4	16.8	-5	4	5	2	-3
3	25.4	3	19.9	-13	0	3	1	1
4	29.2	1	22.5	-23	-4	0	3	2
5	28.7	0	21.3	-30	-10	-3	0	0
6	28.5	-1	23.4	-34	-13	-5	-1	-1
7	27.8	-2	22.8	-36	-14	-6	-2	-2
8	27.5	-3	22.4	-36	-14	-7	-3	-3
9	26.9	-3	21.9	-34	-13	-6	-2	-3
10	26.4	-2	21.4	-30	-11	-5	-2	-3
11	25.7	-1	21.2	-24	-7	-2	-1	-3
12	24.3	1	19.6	-14	-2	1	0	-3
13	23.2	3	18.4	-4	4	2	2	-3
14	22.1	6	17.6	6	9	7	3	-4
15	21.2	10	16.9	15	14	10	4	-5
16	20.4	13	16.1	21	16	11	3	-6
17	19.8	14	16.0	22	17	11	2	-8
18	19.0	15	14.8	23	16	10	0	-11
19	18.3	15	14.1	23	16	8	-2	-14
20	17.5	16	13.3	23	14	6	-5	-18
21	17.5	16	13.2	22	14	4	-5	-18
22	18.5	15	13.9	22	16	9	-1	-13
23	18.7	13	14.3	19	14	8	-1	-11
24	18.6	9	14.1	11	10	5	-3	-12

VK WEST — AFRICA

UTC	MUF	dBU	FOT	14.2	18.1	21.2	24.9	28.5
1	11.1	-27	9.9	-22	-16	-15	-20	-29
2	13.4	-22	10.2	-19	-13	-16	-20	-30
3	13.3	-17	10.2	-15	-11	-16	-22	-32
4	12.5	-16	9.6	-12	-11	-16	-26	-38
5	11.7	-13	9.1	-9	-11	-19	-31	...
6	11.4	-4	9.1	-4	-11	-20	-35	...
7	14.2	6	11.3	6	0	-9	-21	-34
8	16.9	16	15.1	17	12	-6	-5	-14
9	22.3	10	17.0	13	14	11	7	1
10	21.8	4	16.5	-3	3	4	2	-3
11	21.4	-4	17.0	-20	-7	-4	-4	-7
12	20.5	-11	16.2	-34	-16	-10	-8	-10
13	19.9	-17	16.0	...	-22	-16	-11	-12
14	18.9	-22	14.7	...	-25	-17	-13	-14
15	18.1	-27	13.9	...	-27	-18	-14	-15
16	17.3	-30	13.1	...	-27	-18	-15	-14
17	17.2	-31	13.0	...	-27	-19	-15	-16
18	16.2	-28	13.6	...	-20	-19	-15	-15
19	20.0	-21	16.4	...	-30	-20	-14	-13
20	21.5	-18	16.7	...	-28	-19	-14	-13
21	18.3	-23	14.1	...	-23	-16	-14	-16
22	16.0	-27	12.3	-36	-20	-15	-15	-19
23	14.4	-29	11.0	-30	-17	-15	-17	-23
24	13.4	-30	12.0	-26	-15	-15	-19	-26

VK EAST — EUROPE L.P.

UTC	MUF	dBU	FOT	14.2	18.1	21.2	24.9	28.5
1	12.9	-28	9.8	-22	-15	-16	-22	-31
2	13.2	-22	10.1	-18	-13	-16	-23	-33
3	13.0	-18	10.1	-15	-12	-16	-25	-37
4	12.2	-16	9.5	-12	-12	-18	-30	...
5	11.4	-13	8.9	-9	-14	-22	-37	...
6	11.2	-8	8.8	-6	-14	-25
7	13.4	4	10.6	3	-5	-15	-29	-11
8	17.3	17	13.8	11	6	0	-11	-23
9	21.6	9	15.1	15	14	10	3	-4
10	20.6	8	14.3	10	10	7	1	-6
11	19.5	2	13.6	-2	2	1	-3	-10
12	18.7	-6	12.9	-15	-6	-5	-8	-13
13	18.0	-14	12.7	-28	-14	-10	-11	-15
14	17.2	-21	11.9	-36	-19	-14	-13	-16
15	16.5	-28	11.5	-45	-22	-16	-15	-17
16	15.9	-32	11.1	...	-23	-17	-15	-18
17	16.0	-33	11.2	...	-24	-17	-15	-17
18	16.9	-31	11.9	...	-26	-18	-15	-16
19	18.9	-25	13.0	...	-28	-19	-15	-15
20	20.3	-21	15.4	...	-28	-19	-14	-14
21	17.3	-26	13.5	...	-24	-17	-15	-17
22	15.2	-31	11.8	-36	-20	-16	-16	-20
23	13.9	-32	10.7	-30	-18	-15	-18	-24
24	13.1	-32	10.1	-26	-16	-15	-20	-28

VK STH — EUROPE L.P.

UTC	MUF	dBU	FOT	14.2	18.1	21.2	24.9	28.5	
1	12.7	-39	9.8	-30	-19	-18	-21	-28	
2	13.0	-34	10.0	-28	-18	-18	-22	-30	
3	12.8	-31	10.0	-24	-17	-18	-24	-33	
4	12.1	-30	9.4	-21	-17	-19	-27	-38	
5	11.2	-29	8.8	-18	-17	-22	-32	...	
6	11.0	-25	8.7	-16	-17	-24	-35	...	
7	13.0	-12	10.2	-11	-12	-18	-29	-11	
8	11.6	-3	13.2	-6	-4	-19	-36	-16	
9	21.3	1	17.0	2	4	2	-4	-11	
10	22.9	5	18.4	5	8	6	2	-3	
11	20.9	4	16.1	2	5	4	0	-6	
12	19.5	-2	15.0	-10	-3	-3	-6	-11	
13	19.6	-10	15.6	-24	-12	-9	-10	-14	
14	18.7	-18	14.8	-36	-19	-14	-13	-16	
15	18.1	-24	14.6	...	-24	-17	-15	-17	
16	17.3	-29	13.5	...	-26	-19	-17	-18	
17	16.6	-33	12.7	...	-27	-20	-17	-19	
18	15.9	-37	12.1	...	-27	-20	-18	-19	
19	16.0	-37	12.0	...	-28	-20	-18	-19	
20	15.9	-34	12.6	...	-29	-21	-18	-18	
21	16.8	-32	13.1	...	-27	-20	-18	-19	
22	14.7	-39	11.5	...	-24	-19	-18	-22	
23	13.6	...	10.6	...	-25	-21	-22	-27	
24	13.9	...	10.0	...	-26	-22	-20	-22	-28

UTC	MUF	DBU	FOT	14.2	18.1	21.2	24.9	28.5
1	24.8	13 18.6	6	14	15	13	9	
2	24.7	14 20.4	7	14	15	13	9	
3	24.2	14 19.9	8	15	16	13	8	
4	23.8	15 19.5	11	16	16	13	8	
5	23.2	16 19.0	14	18	17	13	8	
6	22.6	17 18.4	20	21	19	14	7	
7	22.0	20 18.2	27	25	21	15	7	
8	21.0	22 17.0	31	27	22	14	5	
9	20.4	23 16.4	32	27	21	13	3	
10	19.6	24 15.7	32	26	20	11	1	
11	19.3	24 15.3	32	26	20	10	-1	
12	18.7	24 14.8	32	26	18	8	-3	
13	18.1	25 14.7	32	25	17	6	-5	
14	17.1	25 13.4	30	22	14	3	-10	
15	16.3	25 12.6	29	20	11	-1	-14	
16	15.3	25 11.8	28	18	8	-6	-20	
17	14.9	25 11.4	27	16	6	-8	-22	
18	15.4	24 11.7	26	17	8	-5	-19	
19	17.7	18 13.7	21	18	12	2	-8	
20	20.7	16 15.8	16	17	15	9	1	
21	23.1	15 17.9	12	17	16	13	7	
22	24.2	14 19.0	10	16	16	14	9	
23	24.4	14 19.6	8	15	15	13	9	
24	24.8	14 20.1	7	14	15	13	9	

VK EAST — STH PACIFIC

UTC	MUF	DBU	FOT	14.2	18.1	21.2	24.9	28.5
1	25.9	5 21.0	-2	7	8	7	2	
2	25.5	5 21.0	-1	7	8	6	1	
3	25.3	6 20.7	0	8	9	6	1	
4	24.7	6 20.2	2	9	9	6	0	
5	24.4	7 19.9	6	11	10	6	0	
6	23.9	9 19.4	12	14	12	7	0	
7	23.4	11 19.0	20	18	15	8	0	
8	22.8	14 18.4	27	23	17	9	0	
9	21.6	15 17.4	28	22	16	7	-4	
10	20.7	15 16.6	28	21	14	4	-7	
11	19.7	16 15.7	28	20	12	1	-12	
12	19.0	16 15.1	27	19	10	-2	-15	
13	18.2	16 14.4	26	17	8	-5	-19	
14	17.7	17 14.0	25	16	6	-7	-22	
15	16.9	17 13.2	24	13	2	-11	-27	
16	16.2	17 12.5	22	13	0	-15	-32	
17	15.4	17 11.9	21	9	-3	-20	-38	
18	15.4	15 11.7	18	7	-4	-20	-38	
19	16.3	9 12.2	11	5	-3	-16	-31	
20	18.5	6 13.7	6	6	1	-7	-18	
21	21.4	5 16.1	4	7	6	0	-8	
22	23.8	6 18.2	2	8	8	4	-2	
23	25.2	6 19.7	0	8	8	6	1	
24	25.6	5 20.3	-2	7	8	6	2	

VK STH — STH PACIFIC

UTC	MUF	DBU	FOT	14.2	18.1	21.2	24.9	28.5
1	26.0	0 20.7	-20	-5	0	0	-2	
2	26.3	0 21.3	-21	-5	0	1	-2	
3	25.9	0 19.2	-20	-5	0	0	-2	
4	25.6	0 21.1	-17	-3	0	1	-2	
5	25.0	1 20.5	-13	-1	2	1	-2	
6	24.6	3 20.1	-7	2	8	4	2	
7	24.1	3 19.6	2	8	8	4	-1	
8	23.6	8 19.1	12	13	11	6	-1	
9	22.9	11 18.5	19	17	13	7	-1	
10	21.7	13 17.5	24	19	14	6	-3	
11	20.8	14 16.7	25	19	13	4	-6	
12	19.8	15 15.8	25	18	11	1	-10	
13	19.1	15 15.2	25	17	10	-1	-13	
14	18.4	16 14.6	24	16	8	-3	-16	
15	17.9	16 14.4	24	15	7	-5	-18	
16	17.2	16 13.4	23	14	5	-8	-22	
17	16.5	16 12.8	22	12	3	-11	-26	
18	15.8	15 12.0	18	7	-1	-15	-31	
19	15.8	9 12.0	10	5	-3	-15	-30	
20	16.7	4 12.5	4	2	-3	-12	-24	
21	19.0	1 15.0	-3	1	-1	-7	-15	
22	21.9	0 16.5	-10	-1	0	-2	-8	
23	24.3	0 18.7	-15	-3	0	0	-4	
24	25.7	0 20.1	-18	-4	0	1	-2	

VK WEST — STH PACIFIC

UTC	MUF	DBU	FOT	14.2	18.1	21.2	24.9	28.5
1	29.3	4 24.0	-18	-2	4	5	4	
2	29.7	4 22.5	-20	-3	3	5	4	
3	29.9	4 24.8	-21	-3	3	5	4	
4	29.6	4 24.4	-20	-3	3	5	4	
5	29.1	4 23.9	-17	-1	4	6	4	
6	28.5	5 23.3	-12	2	6	6	5	
7	27.7	6 22.6	-5	6	8	8	5	
8	27.1	8 22.5	6	12	13	10	6	
9	26.2	11 21.2	20	22	18	13	7	
10	25.6	12 20.5	23	22	19	13	7	
11	25.1	13 20.0	26	23	19	13	6	
12	24.9	13 19.8	28	24	20	13	6	
13	24.5	14 19.4	30	25	20	13	5	
14	23.8	14 19.3	30	24	19	12	3	
15	22.3	14 17.4	28	22	16	8	-2	
16	21.0	14 16.3	27	20	13	4	-7	
17	19.5	14 15.1	25	17	9	-2	-14	
18	18.5	14 14.2	24	15	6	-6	-20	
19	18.4	12 14.1	22	13	3	-10	-25	
20	17.2	13 13.4	18	8	-2	-10	-33	
21	16.6	16 13.3	15	13	8	0	-10	
22	28.3	8 22.1	5	12	13	11	7	
23	29.0	6 23.0	-6	5	8	9	7	
24	29.0	5 23.3	-13	1	5	6	5	

VK EAST — ASIA

UTC	MUF	DBU	FOT	14.2	18.1	21.2	24.9	28.5
1	29.2	2 23.4	-23	-5	1	4	3	
2	29.5	2 23.9	-26	-7	0	3	2	
3	29.1	2 24.1	-27	-8	-1	2	2	
4	28.9	1 23.8	-26	-7	-1	2	2	
5	28.2	1 23.2	-22	-6	0	2	1	
6	27.8	2 22.7	-19	-3	2	3	2	
7	27.1	3 22.1	-12	0	4	4	2	
8	26.4	5 21.5	-2	6	8	7	3	
9	25.7	10 20.8	17	18	16	11	5	
10	24.4	12 19.7	23	21	17	11	3	
11	23.6	12 18.9	25	21	17	9	1	
12	22.6	12 18.0	26	21	15	7	-2	
13	22.1	13 17.6	26	21	15	6	-4	
14	21.4	13 16.9	26	20	13	4	-6	
15	20.9	13 16.4	26	19	12	2	-9	
16	19.9	13 15.5	25	17	9	-1	-13	
17	19.0	13 14.7	23	15	7	-5	-18	
18	18.0	13 13.8	22	12	3	-10	-25	
19	17.8	13 13.6	21	12	2	-11	-26	
20	16.5	17 12.9	18	5	-3	-12	-32	
21	21.4	9 16.0	15	14	9	2	-7	
22	24.9	6 18.9	3	9	9	6	1	
23	27.7	4 21.4	-10	2	6	6	4	
24	29.1	3 22.8	-17	-2	3	5	4	

VK STH — ASIA

UTC	MUF	DBU	FOT	14.2	18.1	21.2	24.9	28.5
1	27.6	4 21.9	-12	1	5	6	3	
2	27.6	3 22.2	-17	-2	3	4	2	
3	27.8	3 22.8	-19	-3	2	4	2	
4	27.9	3 21.0	-20	-4	2	3	2	
5	27.9	3 23.1	-19	-3	2	4	2	
6	27.4	3 22.6	-16	-2	3	4	2	
7	27.0	4 22.2	-12	1	5	5	2	
8	26.4	5 21.6	-5	5	7	6	3	
9	25.7	7 20.9	6	11	11	8	3	
10	25.1	12 20.8	22	22	18	12	5	
11	24.1	13 19.6	26	22	18	11	3	
12	23.5	13 18.9	27	23	17	10	1	
13	22.8	13 18.2	28	22	17	8	-1	
14	22.5	14 17.9	28	22	16	8	-2	
15	22.1	14 17.5	28	22	16	7	-3	
16	21.5	14 17.5	27	21	14	5	-6	
17	20.3	13 15.9	26	19	11	1	-11	
18	19.3	13 15.0	24	16	8	-4	-17	
19	18.1	13 13.9	22	13	3	-10	-25	
20	17.5	13 13.4	21	11	1	-13	-29	
21	17.1	10 13.3	19	7	-4	-20	-38	
22	20.7	10 16.3	20	15	9	-1	-12	
23	24.1	6 18.5	3	8	8	5	-1	
24	26.7	5 20.8	-6	4	7	6	3	

VK WEST — ASIA

UTC	MUF	DBU	FOT	14.2	18.1	21.2	24.9	28.5
1	30.3	0 22.5	-36	-14	-5	0	1	
2	30.0	2 24.7	-26	-8	-1	3	3	
3	29.2	4 24.0	-16	-1	4	5	4	
4	28.8	6 23.5	-6	5	8	8	6	
5	28.1	8 22.9	4	11	12	11	7	
6	27.4	10 22.3	13	16	15	13	8	
7	26.7	12 22.0	21	21	19	14	9	
8	25.3	13 20.4	25	22	19	13	8	
9	24.4	14 19.3	26	23	19	13	8	
10	20.7	15 15.9	25	18	14	6	-3	
11	19.2	16 14.7	24	18	12	3	-7	
12	21.7	15 17.2	25	21	16	8	0	
13	20.9	11 15.9	15	14	11	4	-3	
14	20.1	5 15.7	3	6	4	-1	-8	
15	19.2	-1 14.9	-9	-2	-1	-5	-11	
16	18.2	-9 13.9	-20	-9	-7	-9	-15	
17	18.0	-14 13.7	-28	-13	-10	-11	-15	
18	19.0	-16 14.2	-36	-18	-12	-11	-14	
19	21.8	-13						

HAMADS

TRADE

● **WEATHER FAX** programs for IBM XT/AT's ***"RADFAX2" is a high resolution, shortwave weather fax, morse & RTTY receiving program. Needs CGA, SSBhf radio & RADFAX decoder. Also "RF2HERC", "RF2EGA" & "RF2VGA", same as RADFAX2 but suitable for Hercules, EGA, & VGA cards respectively. \$35 *** "SATFAX" is a NOAA, Meteor & GMS weather satellite picture receiving program. Uses EGA or VGA modes. Needs EGA or VGA color monitor and card. + "WEATHER FAX" PC card. \$45 *** All programs are on 5.25" OR 3.5" disks (state which) + documentation, add \$3 postage. ONLY from M. Delahunty, 42 Villiers St, New Farm 4005 OLD. Ph (07) 358 2785.

● **AMIDON FERROMAGNETIC CORES:** for all transmitter and receiver applications. Send DL size SASE for data/price to RJ & US Imports, Box 157, Mortdale NSW 2223 (no enquiries at office please ... 11 Macken St (Oatley). Agencies at: Geoff Wood Electronics, Sydney. Webb Electronics, Albury. Electronic Components, ACT. Truscott's Electronics, Melbourne. S. Willis, Perth. Assoc TV Service, Hobart.

FOR SALE — ACT

● **ICOM IC761** with all filters and speaker, hand and desk mic \$2,800. ALPHA 76A 3,000 Watt PEP linear WARC bands, as new. Replacement cost over \$8,000. \$3,650. Yaesu FT736 with 6m, 2m and 70 cm, narrow CW filter and desk mic, all still boxed, \$2,400. Solid state 6m linear 10 Watts in 100 Watts out \$200. Tokyo Hi Power 6m linear 1,000 Watts PEP. Unused in box with valves, \$1,350. Antenna tuner 3,000 Watts PEP MFJ989, still in box unused. Long wire, coax or balanced lines, \$750. 15m Swiss quad and crown rotator \$150. Hy Gain 10m 5el beam and Emolator rotator \$150. Mini loaded beam for 20, 15, 10 some work needed with as new KR400 rotator, \$375. Werner Wull 6el 6m beam, \$135. Hy Gain 14 AVO \$150. VK powermate 13.8 Volt 15 Amp supply \$150. Bencher paddle, black still in box \$100. 2 to 3 Volt laboratory supply with variable current limit, \$150. 2m rig \$50. Icom IC224 2m mobile \$550. Please note, transmitting equipment sold only to currently licensed amateurs. Phone Christopher VK1DO on (06) 285 1700 bus hours, (06) 286 3208 or (018) 62 5027.

FOR SALE — NSW

● **YAESU FT101Z** modified digital mic fan spare tubes service manual g condition \$600 ono emtron eat 300A atu \$200 VK2IS (066) 52 3376

● **YAESU FT736R** 50 MHz 430 MHz 144 MHz suitable satellite work Yaesu MD1 microphone still under warranty \$2,500 VK2IS (066) 52 3376.

● **YAESU FT 209R** 2 metre handie transceiver with 2 battery packs, charger and soft case \$385 Janson VK2JJR (046) 26 3904.

● **ENTIRE** contents of shack including FT 707 NEW FT100 components and fittings too numerous to list. Full price \$1,200.

For inspection please phone (049) 81 3413.

● **FT690** Yaesu serial 0309943 all mode 6m transceiver with FL6010 10dB amp mobile mount and mike as new in boxes \$625 phone (02) 488 7946.

● **FT290R** Yaesu all mode 2m transceiver with 10 dB amp and mike as new in boxes \$610 Ser 2M230208 phone (02) 488 7946.

● **DECEASED** estate — still a few valves and bits and pieces left — send SASE for list. Brian VK2KLH QTHR.

● **WORLD** Range Communication receiver Sangean ATS 803A. FM 87.5 108 megs AM 150 to 29,999 kHz. Has BFO and PLL synthesized. Branch new and with manuals. Kenwood TS 930S in top condition. Voted top Tcvr by many, only available to licensed persons. VK2AXR (02) 477 6275.

● **Electron** tubes, 6 Amperex 4B32 and 7 Eimac 304TH — most tubes unused. \$2300 or best offer for the lot. Contact Bradley Carter, School of Physics, University of NSW, (02) 697 4593.

FOR SALE — VIC

● **SW350** Tcvr PS/speaker \$150. HRO "M" rx. Speaker PS \$100. Both need TLC. Ken VK3ASN QTHR (03) 842 5905.

● **AMATEUR RADIO** — December 1963 to September 1990, except July '84 and May '86. Eighty "AR" magazines. Also couple Amateur Radio Action mags, \$100 ONO. David L30259. Buyer to pick up at QTHR (03) 370 3589.

● **ICOM AH2** mobile automatic antenna tuner \$700 ono Ted VK3TG (052) 59 3225.

● **EMOTATOR** 1200 FXX heavy duty beam rotator hardly used \$750 ono Ted VK3TG (052) 59 3225.

● **CROMEMCO** System One computer, 8 MHz bus, 750k RAM, 50 Mb voice coil hard disk, DSD5 1/4 inch floppy drive, Cromix Operating System, multi-user, multi-tasking, tape backup using DCR600, complete with two terminals ATL 004 and one spare. All in working condition. Ex WIA membership database computer. \$699 ono. Call the Executive Office on (03) 528 5962.

● **FL110** solid state linear amplifier, 100 Watt output, 160 to 10 metres. Companion to the Yaesu FT7 transceiver. Little used. In excellent condition in original canon. \$210. VK3ARZ QTHR (03) 584 9512.

● **UNIDEN** 2020 amateur 80m — 10m transceiver in good condition with h brew ext VFO. Has 240 vac and 12vdc inbuilt supply, manual, packing. \$500 (ah) (059) 96 2806.

● **National M3** VHS video camera C/W with extra battery pack, wide-angle lens, sky filter, lens hood, carry case, perfect mint condition, cost \$3,300 (1988), sell \$1,650. Floppy disks. 5 1/4 inch DSD5. Top brand, Xidex, etc still in sealed boxes of 10. \$10 per box. Ken VK3MW QTHR AH (03) 560 5278, BH (03) 522 1476.

● **ICOM IC202** s/n 0707 in g.c. covers 144 to 144.4 includes OSCAR xtal, manual with original packaging \$100. Ron VK3XOA QTHR (053) 35 6017.

● **FV102DM** serial 90045 external VFO for FT102 little used \$600 Kevin VK3CKL (03) 792 9503

FOR SALE — OLD

● **YAESU FL2100Z** linear \$900 and Yaesu FT726 2m 70 cm sat modules vgc \$1,750 Brian VK4EK via VK4AH Gary (07) 800 1003 QTHR.

● **8uF 6000V** paper capacitors \$50 buyer collect 4CX500A tube base excellent condition built in screen cap was used on 200 MHz enquire VK4TL (070) 54 3677.

● **FT901 HF**, transceiver with matching FV901 scanning VFO and FC901 antenna tuner PC \$1,160 Philips FM321 70 cm transceiver 10 W CTCSS fitted PC \$225 Emtron ENB-2 noise bridge as new \$100 AWA remote mounting 2m FM transceiver 25 W CTCSS fitted PC \$130. John VK4ET QTHR (07) 269 3942.

● **HAND** transceiver — Kenwood TR2400. Digital readout, 10 programmable memories, many other features. Includes speaker/mike and base station charger.. Good cond. Manuals. Original cartons. \$335 complete. John VK4SZ (QTHR) (070) 61 3286.

FOR SALE — SA

● **KENWOOD TR9130** all mode 2m transceiver six memories scan. Simplex repeater mobile 5/8 whip antenna coax fittings hardly used like new \$675 mobile clamp. VK5AUS QTHR.

FOR SALE — TAS

● **YAESU FL2100B** linear amp excellent condition \$700. Alinco DJ-500T dual band handheld only four months old. \$400. Ian VK7JY (003) 27 2011..

SWAP — SA

● **HUNDREDS** 78s and 16in transcriptions back to 1932 plus 16in turntable for amateur gear, rotator or what offers? VK5SJ QTHR (08) 295 6751.

WANTED — NSW

● **VZ300** mine won't load Ted Field PO Box 36 Huskisson NSW 2540 or (044) 43 0685.

● **KENWOOD R 1000** receiver. Maurea VK2SMH (02) 627 1434.

● **ANTENNA** tuning unit with SWR meter. George (02) 6252602 QTHR VK2YT.

● **ACITRON SSB 400** — ideally complete, but any non-working sets or PCBs welcome. Also ARC-5, PRC-10A, PRC-77, TRC-

— ST. PIPS



REPRINTED BY PERMISSION OF NEIL MATTERSON

WANTED — VIC

● MINI BCB & SW aerial coils, 455 kHz IFs for use in valve gear. Aegis, Q-Plus, Kingsley types or equiiv. Mini tuning capacitors 10-415 pF: 1, 2, 3, 4, gang types, Roblin, Eddystone, Plessey, Polar etc. Valves types: 1H5GT, 1Q5GT, 1P5GT, 3S4, 3V4, 1T4, 1R5, 1S5, 1U5, 12AD6, 12AE6, 12AL8, 12BL6, 12DL8, 12EM6, 12FK6, 12FM6, 12K5. Bruce VK3YBW (03) 527 2661 after 6pm QTHR.

● VARIAC or similar 150 Watts or any bench type unit. Ron VK3BRC QTHR (03) 819 3568.

WANTED — QLD

● CAPACITORS computer grade electrolytic, 2200 uF or bigger, 400 Volts minimum. Peter VK4APD phone (07) 397 3751.

● POWER supply PS30 or similar. Buy cash or exchange FRG7 in good condition will sell also \$200 Lan VK4BIH QTHR (07) 596 3650.

● VZ200-VZ300 serial interface complete or pcb only VK4KAL QTHR (079) 85 4168.

● HIGH voltage can or oil filled capacitors wanted for linear amp construction, details to John VK4SZ QTHR (070) 61 3286.

WANTED — WA

● KENWOOD transverter(s) 2 & 6m. TV-502 and/or TV-506 for TS-520S cond/price to Beau VK6COP (09) 457 8179 please. QTHR.

● CRYSTAL needed for overtone oscillator, freq 43.1 or 64.5 MHz. Phone Richard Burden (09) 417 3459 or PO Box 1164 Booragoon WA 6154 with details.

**DON C WALLACE,
W6AM**

This book describes the history of amateur radio, as experienced by Don Wallace.

He was on the air in 1911, before the first radio regulations. Don was the radio operator for President Wilson at the Versailles Peace Conference. He was the winner of the Hoover Cup for the Best Home-Built Amateur Radio Station, and was a charter member of WAC in 1926.

He went on to install 16 rhombic antennas on 120 acres in Rolling Hills, at that time the largest and most powerful amateur radio station in the world. By 1957, W6AM achieved the top of the ARRL DXCC Honour Roll, a spot he occupied most of the next 28 years.

By Jan D Perkins N6AW

Hardbound, 350 pages. Pre-publication price: US\$19.95. Available from Wallace & Wallace, 11823 E Slauson Avenue, Suite 38, Sante Fe Springs, CA 90670 USA.

**Back issues
of AR available
to WIA members**

Jan 1969 to Dec 1987
\$2.50 each

Jan 1988 to current issue
\$4.00 each

(Some issues out of stock)

Prices include postage

**AR BACK ISSUES
PO Box 300 Caulfield
South
Vic 3162**

**AMATEUR RADIO
HELPING OUR COMMUNITY.**

HAMADS

Please Note: If you are advertising items For Sale and Wanted please use a separate form for each. Include all details; eg Name, Address, Telephone Number (and STD code), on both forms. Please print copy for your Hamad as clearly as possible.

*Eight lines per issue free to all WIA members, ninth line for name and address Commercial rates apply for non-members. Please enclose a mailing label from this magazine with your Hamad.

*Deceased Estates: The full Hamad will appear in AR, even if the ad is not fully radio equipment.

*Copy typed or in block letters to PO Box 300, Caulfield South, Vic 3162, by the deadline as indicated on page 1 of each issue.

*QTHR means address is correct as set out in the WIA

current Call Book.

*WIA policy recommends that Hamads include the serial number of all equipment offered for sale.

*Please enclose a self addressed stamped envelope if an acknowledgement is required that the Hamad has been received.

Ordinary Hamads submitted from members who are deemed to be in general electronics retail and wholesale distributive trades should be certified as referring only to private articles not being re-sold for merchandising purposes.

Conditions for commercial advertising are as follows: \$22.50 for four lines, plus \$2.00 per line (or part thereof) Minimum charge — \$22.50 pre-payable.

State:

- Miscellaneous
- For Sale
- Wanted

Name:

Call Sign:

Address:

Solution to Morseword No 43

	1	2	3	4	5	6	7	8	9	10
1	.	.	-	-	-	.	.	.	-	.
2	-	-	.	.	-
3	.	-	.	.	.	-
4	-	-	.	.	.
5	-	.	-	.	-	.	-	.	.	.
6	-	.	.	-	.	.	-	-	.	.
7	.	-	.	.	-	-
8	.	-	-	-	.	.
9	-	-	.	-	-	-
10	-	-	.	.	-	.	-	.	.	.

Across: 1 sift; 2 waste; 3 dice; 4 silt; 5 fist; 6 onset; 7 bip; 8 pod; 9 bear; 10 these.

Down: 1 fay; 2 real 3 rated; 4 hens; 5 rife; 6 used; 7 steep; 8 tread; 9 like; 10 rose.

TRADE PRACTICES ACT

It is impossible for us to ensure the advertisements submitted for publication comply with the Trade Practices Act 1974. Therefore advertisers and advertising agents will appreciate the absolute need for themselves to ensure that, the provisions of the Act are complied with strictly.

VICTORIAN CONSUMER AFFAIRS ACT

All advertisers are advised that advertisements containing only a PO Box number as the address cannot be accepted without the addition of the business address of the boxholder or seller of the goods.

TYPESETTING : Redfords Media
25 Glenferrie Rd
Malvern 3144
Tel: (03) 500 0377

PRINTING: Industrial Printing
Richmond

MAIL DISTRIBUTION: Polk Mailing Co.
PO Box 140,
Collingwood,
Vic. 3066
Tel:(03) 417 5161

The opinions expressed in this publication do not necessarily reflect the official view of the WIA, and the WIA cannot be held responsible for incorrect information published.

ADVERTISERS INDEX

Amateur Radio Action	19
ATN Antennas	44
Dick Smith Electronics	28, 29
Electronics Australia	17
Icom Australia	OBC,
Kenwood Electronics Aust.	IFC
Magpups	7
Mattek Electronics Co.	21
VHF Communications	21
WIA Club Contest	5
WIA Log Books	51
WIA NSW Division	31

TRADE ADS

RJ & US Imports	54
M Delahunty	54

HOW TO JOIN THE WIA

Fill out the following form and send to:

The Membership Secretary
Wireless Institute of Australia
PO Box 300
Caulfield South, Vic 3162

I wish to obtain further information
about the WIA.

Mr, Mrs, Miss, Ms:

Call Sign (if applicable):

Address:

State and Postcode:

VK QSL BUREAUX

The official list of VK QSL Bureau. All are Inwards and Outwards unless otherwise stated.

VK1	GPO Box 600 CANBERRA ACT 2601
VK2	PO Box 73 TERALBA NSW 2284
VK3	Inwards — GPO Box 757G MELBOURNE VIC 3001
	Outwards — 38 Taylor St ASHBURTON VIC 3147
VK4	GPO Box 638 BRISBANE OLD 4001
VK5	PO Box 10092 Gouger St ADELAIDE SA 5001
VK6	GPO Box F319 PERTH WA 6001
VK7	GPO Box 371D HOBART TAS 7001
VK8	C/o H G Andersson VK8HA Box 619 HUMPTY DOO NT 0836
VK9/VK0	C/o Neil Penfold VK6NE 2 Moss Court KINGSLEY WA 6026

1991 WIA AUSTRALIAN RADIO Amateur Call Book Out Now

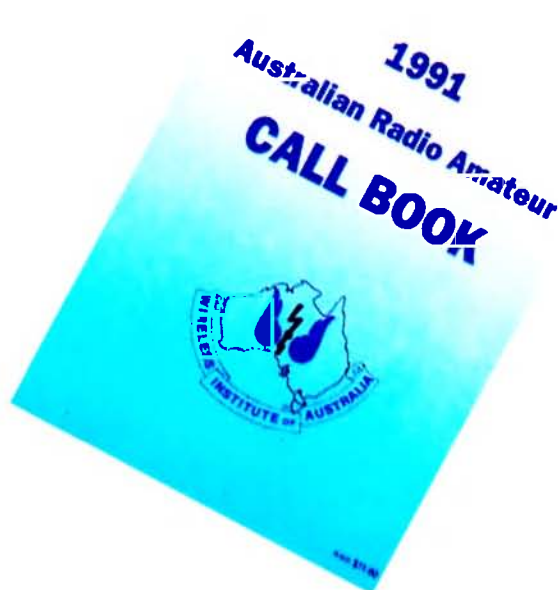
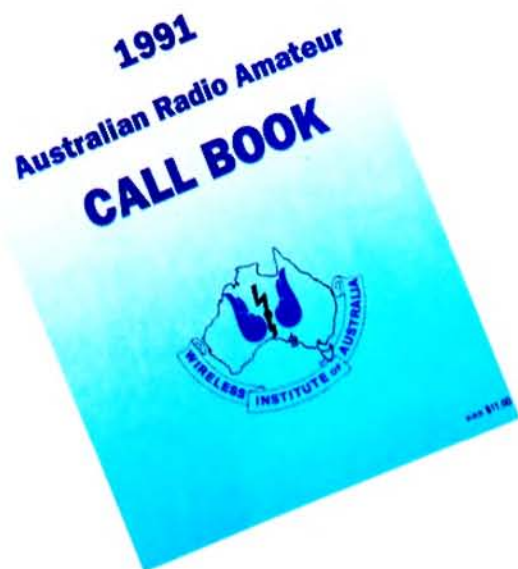

**Over 18100 Current Callsign Listings
Plus Band Plans, Repeaters, Beacons, DXCC, etc.**

**LIMITED STOCK!
SELLING FAST!**

**Buy your copy NOW from your WIA Divisional Bookshop.
Cover Price \$11.00 Special Price to WIA Members of \$9.50**

**ALL PRICES are plus Postage and Handling
DO NOT MISS OUT!**

Wide Band Receivers...



ICOM has broken the barriers with its new line of wideband receivers built to go the distance. Introducing the IC-R1 handheld receiver, the IC-R72 HF receiver and the IC-R100 multi-purpose receiver.

IC-R1. The smallest wideband handheld available today, the IC-R1 continuously covers 100kHz-1300MHz (Specifications Guaranteed 2-905MHz) with AM, FM and Wide-FM modes. This tiny receiver measures just 241mmW x 94mmH x 229mmD.

Easy operation is a snap with the IC-R1's Dual Frequency Selection (direct keyboard and rotary tuning), 100 memories and a 24-hour clock completes the world's smallest full-featured handheld receiver.

IC-R100. Install the IC-R100 at home or in your car. Listening pleasure is guaranteed

with continuous coverage from 100kHz-1856MHz (Specification Guaranteed 500kHz-1800MHz) in AM, FM and wide FM modes. Monitor VHF air and marine bands, emergency services, government as well as amateur stations. 121 fully programmable memory channels, multiple scanning system, an automatic noise limiter, built-in preamplifier and attenuator, clock with timer and built-in backup lithium battery make the IC-R100 the perfect package for mobile or base operation.

IC-R72. The IC-R72 continuously receives 100kHz-30MHz in SSB, AM and CW modes with very high sensitivity. An optional U-8 provides FM reception. Additional features include: Noise blanker, five scanning systems, AC/DC operation, internal backup battery, built-in clock and ICOM's DOS System. The IC-R72 boasts a 100dB wide dynamic range while

an easy-to-access keyboard provides convenient programming versatility. The easy to operate IC-R72 is superb for short wave listeners.

The IC-R1, IC-R72 and IC-R100 join ICOM's current line of professional quality receivers... the IC-R71A, IC-R7000 and IC-R9000. ICOM... expanding the horizons to bring you better technology, today. See the complete line of quality ICOM receivers at your local authorized ICOM dealer today.

For a brochure on this or any other ICOM product, call our Toll-Free Literature Request Hotline 008 338 915. Melb Callers- (03) 529 7582.

ICOM
First in Communications

...That Go The Distance.

ICOM Australia Pty. Ltd. 7 Duke Street, Windsor 3181

ICOM Australia's One Year Warranty is only applicable to products purchased from their authorised Australian Dealers. ICOM Australia's fully equipped service centre in Windsor, Victoria, is staffed by engineers from ICOM Japan and is available for after sales support.

AMATEUR RADIO

DECEMBER 1990

RRP \$3



THE WIA RADIO AMATEUR'S JOURNAL

KENWOOD

TS-140S HF TRANSCEIVER

Why even look at a lesser rig when you can enjoy the famed *Kenwood competition edge* with the class-leading TS-140S HF transceiver?

- 160 to 10M operation — plus general coverage receive.

- All mode operation — great for modes like Packet too.

- 31 memory channels — store your frequency, mode and filter width.

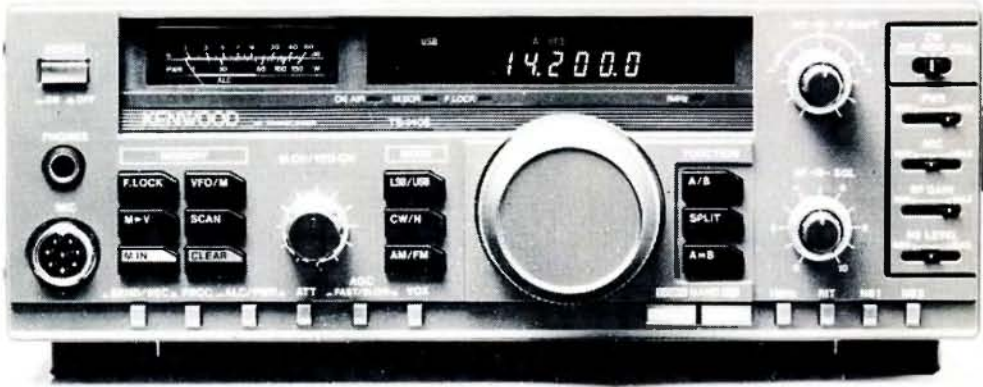

- CW full break-in, semi break-in and VOX

- 10Hz step dual digital VFOs — cross-mode split is a snap

- Full 102dB dynamic receive range

- Receiver noise floor -138dBm*

The only thing this attractive rig won't punch a hole in is your budget! It incorporates an outstanding 500 kHz to 30 MHz general coverage receiver with superior dynamic range, and combines the ultimate in compact size with advanced technology. You get a full 110 watts of SSB, 100 watts of CW, 50 watts of FM and 40 watts of AM on all HF amateur bands.

The TS-680S covers the exciting 6M amateur band as well as all the HF amateur bands. The TS-680S is similar to the TS-140S, but does not include vox, which is available as an option from your Kenwood dealer.

Move up to either of these great Kenwood transceivers and you'll get great performance, both in the shack and out on the road.

TS-680S HF + 6M TRANSCEIVER



* with optional 500Hz CW filter YK-455C-1.

KENWOOD ELECTRONICS AUSTRALIA PTY. LTD.
(INCORPORATED IN N.S.W.)

8 Figtree Drive, Australia Centre, Homebush, N.S.W. 2140
Phone (02) 746 1519, (02) 746 1888, Fax (02) 746 1509
Call now for further information and the name of your nearest authorised Kenwood dealer.

Please phone, mail or fax for information

Name.....

Address.....

..... Postcode.....

Publication..... Issue.....

Model.....



Amateur Radio is published by the Wireless Institute of Australia, as its Official Journal, on the last Friday of the previous month.

EXECUTIVE EDITOR	
Bill Rice	VK3ABP
MANAGING EDITOR	
Graham Thornton	VK3IY
NEWS EDITOR	
Jim Linton	VK3PC
SENIOR TECHNICAL EDITOR	
Peter Gibson	VK3AZL
TECHNICAL EDITORS	
David Brownsey	VK4AFA
Don Graham	VK6HK
Evan Jarman	VK3ANI
Peter O'Connor	VK4KIP
Gil Sones	VK3AUI
Phil Steen	VK4APA
Roy Watkins	VK6XV
DRAFTING	
Vicki Griffin	VK3BNK
MARKETING	
Bruce Kendall	VK3WL
Norm Eyles	VK3ZEP
ADVERTISING	
Brenda Edmonds	VK3KT
June Fox	
BUSINESS MANAGER	
Bill Roper	VK3ARZ

All contributions and correspondence concerning the content of Amateur Radio should be forwarded to: -

The Editor
Amateur Radio
PO Box 300
Caulfield South
VIC 3162

Registered Office
3/105 Hawthorn Road
Caulfield North VIC 3161

Telephone: (03) 528 5962
(03) 523 8191
Fax: (03) 523 8191
(Non dedicated line)

Business hours: 9.30am to 3pm
weekdays

Deadlines

	Editorial	Hamads
Jan	3/12/90	5/12/90
Feb	7/1/91	9/1/91
March	4/2/91	6/2/91

Delivery of AR: If this magazine is not received by the 15th of the month of issue, and you are a financial member of the WIA, please check with the Post Office before contacting the registered office of the WIA.

© Wireless Institute of Australia 1990

CONTENTS

Technical

A 28 Volt Power Supply for Use with an HF Linear Amplifier	15
<i>Brian Jones VK2BRD</i>	
Atlas 210/215 Keying Modifications	12
<i>Allen Crewther VK3SM</i>	
Six Metre Repeater VK3RMS	13
<i>Ian Woodman</i>	
Tests on the Compact Coil Z Match	20
<i>Lloyd Butler VK5BR</i>	
The Importance of Low Inductance Connections	14
<i>Felix Scerri VK4FUQ</i>	

General

A Japan Odyssey	32
<i>Terry Robinson VK3DWZ</i>	
Computers and Remembrance Day Contest 1990	18
<i>Arn Wierenga VK7KR</i>	
DXpedition - Conway Reef	27
<i>Stephen Pall VK2PS</i>	
Harry Atkinson VK6WZ - The Wizard of Words	24
<i>John Hawkins VK6HQ</i>	
Morse Recollections	16
<i>S Wright VK6YN</i>	
The Filter that was not	19
<i>David G Barneveld VK4BGB</i>	
VNG - How to Use It	26
<i>Quinton Foster</i>	
Wireless Museum Lindfield England	27
<i>Clive Wallis VK2DQE</i>	

Operating

Contests	
14th WA Annual 3.5 MHz Contest Results	34
1990 Australian Sprints Results	34
Six Digit Locator Finder Program	34

Columns

Advertisers' Index	56	How's DX?	35
ALARA	41	Intruder Watch	40
AMSAT	42	Morse Practice Schedules	56
Club Corner	48	Morseword No 45	45
Divisional Notes		Over to You - Members Opinions ..	49
VK2 Notes,	45	Pounding Brass	37
VK3 Notes, 5/8 Wave,		Presidents Seasonal Message	5
VK6 Notes	46	QSLs from the WIA Collection	47
Editor's Comment	2	Silent Keys - Obituaries	51
Education Notes	40	Spotlight on SWLing	41
EMC Report	40	Stolen Equipment	19
FTAC Notes	41	VHF/UHF and Expanding World	38
HF Predictions	52	WIA Directory	2,3
Hamads	54	WIA News	3
		WICEN Vic	47

Cover

In recognition of the assistance given by Aussat to JOTA, this month's cover has an Aussat theme. Derek Reuther VK5AGZ is pictured at Aussat's Regency Park earth station in Adelaide. Derek is holding an ICOM IC-2SA 2m hand held and a coaxial dipole in his right hand. His other hand displays the Amateur to Aussat interface and an ICOM IC-228A 2m rig. Both transceivers were supplied on loan by ICOM for the JOTA event. Photo by Peter Koen

(GUEST) EDITOR'S COMMENT

ALYN MASCHETTE VK6KWN PRESIDENT VK6 DIVISION

A Western Outlook

The New Year is imminent, so let's review our approach to amateur radio and what "we" can do for it.

Often on the air we hear the words "THEY should do something about it". We must realise that there is no "THEY", only "WE". We, the members, make up the Divisions. We, the Divisions, make up the Institute. It is only "WE" who can address and implement those items, actions or policies which others think "THEY" should do.

What have "THEY", the Federal body, achieved in the recent past? They have greatly updated the computing power of the Federal Office. The resulting improvement in managerial efficiency has permitted the 1991 Federal

fee component to be raised by only \$1 per member, much less than the increase in Consumer Price Index.

Some people think we should have uniform membership of a central Institute, and that in all States there should be uniform benefits and services. This would result in uniform fees for all, and thereby, say some, better Federal Office efficiency. With continually improving computer capability, is this still a problem?

Why do Divisional fees differ? Does VK3, with one of the highest subscriptions, provide more or better services than VK6, with the lowest? All Divisional Councils have to balance the books, and it is very true that "you get what you pay for". Let's look at two

services common to all States: Repeaters, and the QSL Bureau. VK3 supports a number of repeaters, paying licence fees and running costs. VK6 pays only for those repeaters directly coupled into the Divisional news broadcasts. VK6 repeaters generally are controlled and financed by a separate incorporated body (the WA Repeater Group) which repeater users are free to join, *for an additional subscription.*

Other separate and distinct bodies cater for Digital Operators (RTTY and RTTY Repeaters, Packet and Digi-peeters) and VHF/UHF operators. The WA VHF Group Inc runs its own business and controls the VHF and UHF beacons. Members of these bodies may or may not also be WIA members. About 60 per cent are.

Now, to compare QSL Bureau services. VK3 offers both inwards and outwards card movement free. VK6 has just revised its outwards charges to compensate for the 480 per cent rise in postage costs over the past five years so that the Bureau will again be user-sustained.

Who can say whether either Division has it right or wrong? One Division charges all members for services whether they use them or not. The other provides the required service, but on a "user pays" basis.

Let your Divisional Council know how "You", the "We" of the Institute want your Division run. By doing so you are also providing input to the Federal body which works for us all. A Merry Christmas to all of "You" from all of "Us". ar

Amateur Radio Service

A radiocommunication service for the purpose of self-training, intercommunication and technical investigations carried out by amateurs, that is, by duly authorised persons interested in radio technique solely with a personal aim and without pecuniary interest.

Wireless Institute of Australia

The world's first and oldest National Radio Society - Founded 1910

Representing Australian Radio Amateurs - Member of the International Amateur Radio Union

Registered Executive Office of the WIA: 3/105 Hawthorn Road, Caulfield North, Vic, 3161

All mail to: **PO Box 300, Caulfield South, Vic, 3162** Telephone: (03) 528 5962 (03) 523 8191

Fax: (03) 523 8191 (Non-dedicated line)

Business Hours: 9.30 am to 3.00 pm on Weekdays

General Manager and Secretary: Bill Roper VK3ARZ

EXECUTIVE

President:	Peter Gamble	VK3YRP	VK1 Federal Councillor:	George Brzostowski	VK1GB
Vice Chairman:	Ron Henderson	VK1RH	VK2 Federal Councillor:	Terry Ryeland	VK2UX
Treasurer:	Arthur Evans	VK3VQ	VK3 Federal Councillor:	Peter Maclellan	VK3BWD
	Kevin Olds	VK1OK	VK4 Federal Councillor:	David Jerome	VK4YAN
	Bill Rice	VK3ABP	VK5 Federal Councillor:	Bill Wardrop	VK5AWM
Immediate Past President:	David Wardlaw	VK3ADW	VK6 Federal Councillor:	Neil Penfold	VK6NE
			VK7 Federal Councillor:	Joe Gelston	VK7JG

FEDERAL CO-ORDINATORS

Amsat:	Graham Ratcliff	VK5AGR	Int'l Travel Host Exch:	Ash Nallawalla	VK3CIT
Awards:	Phil Hardstaff	VK3JFE	QSL Manager (VK9, VK0):	Neil Penfold	VK6NE
Act Contest Manager:	Neil Penfold	VK6NE	FTAC:	John Martin	VK3ZJC
Education:	Brenda Edmonds	VK3KT	Federal Tapes:	Ron Fisher	VK3OM
EMC:	Hans Ruckert	VK2AOU	Standards:	Roger Harrison	VK2ZTB
Historian:	John Edmonds	VK3AFU	Videotape:	John Ingham	VK5KG
Intruder Watch:	Gordon Loveday	VK4KAL	WICEN:	Leigh Baker	VK3TP

WIA NEWS

FROM THE WIA EXECUTIVE OFFICE

1991 Membership Fees

Although cyclic billing was introduced several years ago, the membership renewal date for the majority of WIA members is still the 1st January each year. During the first week of December 1990, 4650 WIA members will receive membership subscription renewal notices in the post.

Please renew your WIA membership promptly by cheque or credit card. If renewing by authorising the WIA to debit your plastic card, please carefully check your

credit card numbers on the renewal slip, and ensure that you sign the authority before returning it to the Executive office. At this stage, credit card renewal of membership by telephone or by fax is unacceptable.

Each year more and more WIA members are realising the advantages in taking out a three year membership renewal. Unless you are a student member, or are not resident in Australia, think about renewing for three years. All you have to do is to forward a remittance for an amount equal to three times the renewal amount shown

on the membership renewal notice. But please note, two year memberships are not available!

Also please note that receipts are not issued for membership renewals unless your remittance is accompanied by a request for a receipt and a self addressed stamped envelope.

WIA membership fees are reviewed once a year. As members will have heard on their Divisional broadcasts, the 1991 Divisional membership fees have increased by small and varying amounts over the 1990 fees. A list of the 1991 fees is shown in the WIA Divisional directory on this page (immediately below).

Because of the successful implementation of a number of cost cutting strategies, the Federal component of the 1991

WIA membership fee has only increased by \$1.00, well below the expected CPI increase.

As a matter of interest, the break up of the Federal component of the 1991 membership fee is as follows:

Full member

Amateur Radio magazine	\$31.00
Executive	\$16.25
IARU component	\$ 0.75
International levy	\$ 2.00
	<u>\$50.00</u>

Pensioner and Student member

Amateur Radio magazine	\$24.80
Executive	\$12.85
IARU component	\$ 0.75
International levy	\$ 1.60
	<u>\$40.00</u>

WIA DIVISIONS

The WIA consists of seven autonomous State Divisions. Each member of the WIA is a member of a Division, usually their residential State or Territory, and each Division looks after amateur radio affairs within their State.

Division	Address	Officers	Weekly News Broadcasts	1991 Fees
VK1	ACT Division GPO Box 600 Canberra ACT 2601 Phone (06) 247 7006	President Ted Pearce Secretary Jan Burreli Treasurer Ken Ray	VK1AOP 3.570 MHz VK1BR 2m ch 6950 VK1KEN 70cm ch 8525 2000 hrs Sun	(F) \$67.50 (G) (S) \$54.00 (X) \$40.50
VK2	NSW Division 109 Wigram St Parramatta NSW (PO Box 1066 Parramatta) 2124 Phone (02) 689 2417 Fax (02) 633 1525	President Roger Henley Secretary Tim Mills Treasurer David Horsfall (Office hours Mon-Fri 1100 - 1400 Wed 1900 - 2100)	VK2ZIG 1.845 MHz AM, 3.595 AM(1045) SSB (1915 only), 7.146 AM (1045 only) 10.125 SSB (1045 only), 28.320 SSB, 52.120 SSB 52.525 FM VK2ZTM 144.12 (SSB), 147.000 FM(R) 438.525 FM(R) VK2KFU 584.750 (ATV Sound) 1281.75FM (R) Relays also conducted via many repeaters throughout NSW.	(F) \$65.00 (G) (S) \$52.00 (X) \$38.00
VK3	Victorian Division 38 Taylor St Ashburton Vic 3147 Phone (03) 885 9261	President Jim Linton Secretary Barry Wilton Treasurer Rob Hailey Office hours 0900-1600 Tue & Thur	VK3PC 1.840 MHz AM, 3.615 SSB, 7.085 SSB, 147.250 FM(R) Mt Macedon. VK3XV 147.225 FM(R) Mt Baw Baw VK3XLZ 146.800 FM(R) Mildura, 438.075 FM(R) Mt St Leonard 1030 hrs on Sunday	(F) \$69.00 (G) (S) \$55.00 (X) \$42.00
VK4	Queensland Division GPO Box 638 Brisbane Qld 4001 Phone (07) 284 9075	President Murray Kelly Secretary Eddie Fisher Treasurer Eric Fittock	VK4AOK 1.825, 3.605, 7.118, 10.135, 14.342, 18.132, 21.175, 24.970, 28.400, 438.075 MHz VK4NEF 52.525 regional 2m repeaters and 1296.100 0900 hrs Sunday Repeated on 3.605 & 147.150 MHz, 1930 Monday	(F) \$67.50 (G) (S) \$54.00 (X) \$40.50
VK5	South Australian Division 34 West Thebarton Rd Thebarton SA 5031 (GPO Box 1234 Adelaide SA 5001) Phone (08) 352 3428	President Rowland Bruce Secretary John McKellar Treasurer Bill Wardrop	VK5OU 1820 kHz 3.550 MHz, 7.095, 14.175, 28.470, 53.100, 145.000, 147.000 FM(R) Adelaide, 146.700 FM(R) Mid North, 146.900 FM(R) (Bunbury) 147.225(R) 147.250 (R) Mt Saddleback 146.725(R) Albany 146.825(R) Mt Barker Broadcast repeated on 3.560 at 1930 hrs	(F) \$67.50 (G) (S) \$54.00 (X) \$40.50
VK6	West Australian Division PO Box 10 West Perth WA 6005 Phone (09) 388 3888	President Alyn Maschette Secretary John Faman Treasurer Bruce Hedland - Thomas	VK6KWN 146.700 FM(R) Perth, at 0930 hrs Sunday, relayed on 3.560, 7.075, 14.115, 14.175, 21.185, 28.345, 50.150, 438.525 MHz Country relays 3582, 147.350(R) Busselton 146.900(R) Mt William (Bunbury) 147.225(R) 147.250 (R) Mt Saddleback 146.725(R) Albany 146.825(R) Mt Barker Broadcast repeated on 3.560 at 1930 hrs.	(F) \$59.00 (G) (S) \$47.50 (X) \$32.00
VK7	Tasmanian Division 148 Derwent Ave Lindisfarne TAS 7015	President Tom Allen Secretary Ted Beard Treasurer Peter King	VK7AL 146.700 MHz FM (VK7RHT) at 0930 hrs Sunday relayed on 147.000 (VK7RAA), 146.750 (VK7RNW), 3.570, 7.090, 14.130, 52.100, 144.100 (Hobart) Repeated Tues 3.590 at 1930 hrs	(F) \$65.00 (G) (S) \$52.00 (X) \$38.00
VK8	(Northern Territory) is part of the VK5 Division and relays broadcasts from VK5 as shown (received on 14 or 28 MHz).		Membership Grades Full (F) Pensioner (G) Needy (G) Student (S) Non receipt of AR (X)	Three year membership available to (F) (G) (X) grades at fee x 3 times

Note: All times are local. All frequencies MHz.

Non-AR member

Amateur Radio magazine	\$ 0.00
Executive	\$20.25
IARU component	\$ 0.75
International levy	\$2.00
	<u>\$23.00</u>

The Executive component of the Non-AR member fee includes an additional \$4.00, which is the cost of maintenance of the member's records not recovered from the Amateur Radio component.

WIA QSL Card Collection

As most amateurs know by now the WIA, as part of its aim to record and preserve the history of amateur radio in Australia, is building up an extensive QSL card collection. These cards, while being historical material in their own right, also contain information on the history of amateur radio and are available for use by members for that purpose. It is important that QSL cards are saved for the future and not discarded.

The Honorary Curator of the WIA QSL Card Collection, Ken Matchett, VK3TL, is pleased to receive donations of small or large quantities of QSL cards. Of course rare DX, special prefixes, or pictorial cards are most in demand, but use can be made of VKs, USA, and even JA cards. Please remember this if you are helping the family of a Silent Key, and ensure that the WIA collection benefits.

All contributions are acknowledged both by letter and in Amateur Radio magazine. Contact Ken at PO Box 1, Seville, Victoria, 3139, or by telephone on (059) 64 3721. Arrangements can be made for consignment of large quantities of cards.

Band Plan Booklets

In the WIANEWS column in the July 1990 issue of Amateur Radio magazine, the WIA advised of the availability of

the newly published booklet "Band Plans for the Amateur Radio Service".

Those who have noted the five pages of Band Plans in the 1991 Australian Radio Amateur Call Book may wonder at the need for a separate booklet. However, a quick inspection shows that the booklet contains a lot more than just the bare band plans. It includes information on the history and philosophy of band planning agreements, definitions of terms and bandwidths, notes on DoTC or international specifications for particular bands and modes, and more detail on specific frequencies within the bands.

For those who have already purchased the booklet, an update sheet detailing the latest amendments is available on receipt of a request accompanied by a self addressed, stamped envelope.

This very informative booklet, the WIA "Band Plans for the Amateur Radio Service", is available from the Executive Office for a mere \$2.80 including handling and postage. But be quick. Supplies if this booklet are dwindling fast.

National Parks - An Allegory

In the course of recent conversation, Murray Kelly VK4AOK, the newly elected president of the Queensland Division of the WIA, queried what sort of response would come from pushing the WIA as the defender of the National Parks of the Radio Frequency Spectrum?

In response to the challenge to "put pen to paper", this is what Murray wrote:

"Once upon a time everyone believed that there was no more of the world left to discover. All the new Kingdoms were fixed and their people were happy. Except for a few, that is. These few, citizens of various kingdoms, were not content and wondered what was behind the mountains that all the lands of the world surrounded. A little group went

to explore, indifferent to the taunts that they were crazy. The explorers discovered, to everyone's surprise, that there was a large tract of land behind the mountains, and since it was in the middle of the kingdoms, belonged to all of them.

The Princes of the Kingdoms immediately claimed joint sovereignty over this new land so that it could only be used for "useful" things like industry, commerce and farming. The explorers were told they could only roam in the seemingly barren higher ground called "200 & DOWN". Nobody could see any use for it - let the explorers have it.

Soon the explorers reported that "200 & DOWN" was a place of great promise - indeed, better than anything found so far. The Princes moved quickly. The whole new land was claimed for industry, commerce and farming except for some small pieces called National Parks, where ordinary citizens could go - to picnic, exercise, explore some more, or whatever took their fancy - all for a small fee to cover upkeep.

Industry, Commerce and Farming were consumed with jealousy that these perfectly good places were wasted by excluding them. They wanted all the land for themselves. Only by organising their voices as one were the citizens able to protect these tiny tracts from those greedy eyes. So they set up and gave money to a Council whose task was to keep a watchful eye on the Parks. Thus their voice was heard and the parks were declared in perpetuity by the Princes.

The Amateur Bands are the National Parks of the Radio spectrum.. A good National Parks policy tries to set aside 10% of the land for the use of its citizens for recreation, exercise, exploration and conservation. A small fee is charged to enter. The Amateur Bands fit this picture. The entrance fee is the exam. We go to our favourite spot to ragchew, foxhunt, experiment or just

"sandbag on the side". Commercial interests look wistfully at the areas set aside for Amateurs. They think they are a waste of a resource that would make them a profit - that no constructive use is made of them.

Unlike National Parks our bands are not set aside in perpetuity by acts of law. At the stroke of a pen they can be, and often are, re-allocated.

Every country of the world has but one voice representing their interests at the great council controlling the Radio Spectrum. This council is the ITU, and amateurs have a say in its deliberations about RF National Parks through the IARU, the combined voices of amateurs throughout the world.

The exclusive Australian voice is the WIA. Do you support it? In 1992 the land will again be divided up and the Parks will possibly get even smaller unless all the citizens get together and cry out against such a happening.

If you do not belong to the WIA your monetary contribution will be sorely missed, as it will cost dearly to send our representatives to WARC 92. If you are one of those who used to use the Parks, keeping your ticket and planning to return soon when things get quiet at the office, just think what your reaction will be when you turn up at your favourite spot - and find there a supermarket or a factory! Your lovely Park will have been developed.

Radio Amateurs have lost spectrum in the last couple of years - who is game to say we won't lose more? Any contribution to the WIA WARC 92 fighting fund will help save the RF National Parks.

THINK ABOUT IT!"

Contest Rules

The WIA manages four major contests each year (Ross Hull Memorial, John Moyle Field Day, Remembrance Day and VK Novice), and the VK/ZL/Oceania contest every second year. The specific rules for each contest are published in

PRESIDENT'S SEASONAL MESSAGE

PETER GAMBLE, VK3YRP FEDERAL PRESIDENT

As we come to the end of another year, it is interesting to pause for a few moments and look at the achievements of the past year - and indeed the past few years. From where I view the WIA there have been many changes and I believe that they have generally improved the service to you, the member.

Firstly, the efficiency and responsiveness of the Executive Office have improved considerably, due to the hard work - both physical and mental - by Bill Roper and his office team. The changes that he has introduced have resulted in a more effective operation of the WIA at a Federal level.

Secondly, the changes in the organisation have developed a new sense of co-operation between the Divisions. Instead of meeting together just once a year for the Federal Convention, representatives from each Division now meet four times a year. The majority of the time at these weekend meetings is spent as the Federal Executive, with the remaining time being spent as the Federal Council meeting in convention. This has resulted in the speeding up of

much of the policy making process of the WIA.

However, I believe it has also had a much more beneficial effect on the WIA as a whole. As representatives from each of the seven Divisions sit around the table together, a team spirit develops. In the early days of these meetings (eighteen months ago!) it took a while for this to develop whereas now it happens quite quickly. The result is that there is more understanding of the unique situations that occur in particular areas and a greater willingness to see the other person's point of view. It also means that the decisions made reflect the inputs from a wider range of views. Occasionally things don't go quite the way they should. The new organisation enables these problems to be detected quickly and ensures that appropriate steps can be taken to rectify the situation.

Finally, there have been great changes in the regulatory environment. "Deregulation" is the word in many government circles these days, including amateur radio. The WIA believes that this is a positive step, after all our hobby is intended to be "self-regulating". However, this

process is not without its difficulties.

What does the New Year hold for amateur radio?

There are many positive things that we will continue to work for. These range from further deregulation of our hobby in various areas, such as packet radio, repeaters, third party traffic and reciprocal arrangements with other countries, to preparation for the coming WARC.

The requirements of the Amateur Service for spectrum space are simple and not excessive. It is only courteous that these be given full consideration when spectrum planning decisions are made. To ensure that our position is well known, the WIA is taking an active part alongside other spectrum users in the national process that will determine Australia's position at WARC 92.

Other activities of the Federal Council will include the ongoing review of the WIA to make sure that membership services continue to be provided in an effective and efficient manner. Existing policies will be reviewed to ensure that they are relevant and up-to-date.

It is also useful to reflect on the mission statement developed as part of the WIA's

corporate planning activities:

To promote and advance amateur radio locally, nationally and internationally in a way which:

- Meets member and community needs;
- Encourages the maintenance of standards; and
- Positions this organisation as the representative voice of amateur radio enthusiasts in Australia.

(AR, April 1989)

To achieve this goal, we need your help. Are we meeting your needs as a member? Are we providing the services that you need? If you have never talked or written to a member of your Divisional Council or your Federal Councillor to explain your point of view, why don't you try it! They are just other ordinary amateurs like you and I - anxious to do the best possible things for our hobby.

In conclusion, on behalf of the members of the Federal Executive and the staff of the Executive Office, I would like to extend Seasons Greetings to you and may 1991 be a challenging year that extends your amateur radio horizons.

Amateur Radio magazine prior to each contest, but there are also general rules applicable to all contests.

Neil Penfold VK6NE, the acting Federal Contest Co-ordinator, has recently reviewed these general rules in conjunction with several other parties. Here are the parts of main interest to contesters.

CONDITIONS OF CONTEST ENTRY

(i) Entrants must operate in accordance with the terms of their licence;

(ii) Each entrant agrees to be bound by the provisions, as well as the intent, of these

general rules and the specific rules published for each contest; and

(iii) All entries become the property of the WIA and, in the event of a dispute, the ruling of the Federal Contest Co-ordinator shall be final.

CLASSES OF CONTEST ENTRANT

(i) A single operator station is one manned by a single operator.

(ii) For certain contests multi-operator entries are permitted. These entries will be accepted subject to the contest declaration form being signed by one operator who

then becomes the entrant and is responsible for the entry. The entrant is required to ensure that the operator's call sign is shown in the log for the entry for each contact, or group of contacts, made by that operator and that the contest rules have been observed. Failure to observe these requirements will result in the entry being disallowed.

CONTEST ENTRY PROCEDURES

(i) Each entry will consist of a contest log, a cover sheet, and a summary sheet. The cover sheet, which may include the summary sheet,

must include a statement that the rules and spirit of the contest have been complied with;

(ii) Logs must be kept, and entries submitted, in UTC; and

(iii) Any log that is incomplete or illegible will not be accepted as an entry.

CONTEST DISQUALIFICATION CRITERIA

(i) An entry will be disqualified if, upon checking the logs, it is necessary that the overall score be reduced by more than two percent. Score reduction will not include

correction of arithmetic errors. However, reductions may be made for unconfirmed contacts or multipliers, duplicate contacts, or other scoring discrepancies.

(ii) For each duplicate or mis-copied callsign removed from the log by the Contest Manager, a penalty consisting of the deletion of three additional contacts, of equivalent value to the offending claim, may be applied. This penalty will not be considered as part of the two percent disqualification criterion.

(iii) Logs which are very untidy, or illegible to a major degree, may also be disqualified.

RF Tag Devices

The subject of RF tag devices has featured in the WIANEWS column several times in recent months. The WIA received several letters from members and non-members on the matter. News was published on how DoTC had approached the WIA to seek its views on using low power devices in the Australian 80 metre band, as well as several other bands ranging from VLF to microwave.

The most recent WIANEWS item described the successful negotiations which saw a decrease in 80 metre device emitted field strength by 24 dB to a level equal to the "quiet rural" man made noise level as given by CCIR Report 258-4. Mention was also made that the WIA was seeking an Australian DoTC ministerial standard for these devices.

A letter recently received from DoTC states that since RF tags are unprotected and unco-ordinated, DoTC intends to issue frequency and power limit specifications for each band, rather than a standard. The letter stated the revised field strength requirement for the 3.5 - 3.7 MHz band devices was accepted by one Australian company developing RF tags, but was too low for many proposals made to DoTC, hence they would not expect a proliferation of devices in that band.

The potential world market for international freight tag systems is very large and DoTC presume it will percolate into domestic use as well. They expect the international system to be in either the 400 MHz or 900 MHz bands. The WIA WARC 92 Australian Preparatory Group (APG) team have taken note of this point.

The WIA was also asked by some members what were the implications for devices imported as adjuncts to international cargo containers. DoTC have responded that an internationally agreed standard should eventuate, noting Standards Australia has formed a new committee TE/19 - Automatic Electronic identification (AEI) to continue the work previously done in TE/14/4.

From a Standards Australia letter of June this year it appears that group TE/14/4, working on behalf of the Telecommunications and Electronics Standard Board, TE/14, was responsible for drafting AS 2361, Freight containers - Automatic identification - Operating parameters (now published) and for liaison with the International Standards Organisation (ISO/TC 104/WG 3). The WIA will now obtain a copy of that Australian Standard and if necessary seek membership of the TE/19 committee.

One point this issue has made abundantly clear is the need for the WIA to have technically competent members who can monitor the activities of the Standards Association, amongst other agencies. This is a field of activity where the WIA is in need of further assistance. Can you help?

Quarterly Executive and Council Meeting

The latest quarterly meeting of the WIA Executive and Federal Council took place over the weekend of 13th and 14th October 1990. Delegates from the seven state Divisions which make up the WIA came to the Executive Office in

Melbourne for two full days of intensive discussion and decision making.

Literally dozens of matters were tabled, and the minutes, and attachments, of the Executive meeting alone totalled 29 pages.

Just some of the discussions over this busy weekend included the following:

Five pages of WIA membership statistical analysis were tabled and provoked considerable discussion on membership trends, and possible steps to be taken;

The resignation of Bill Wardrop VK5AWM was accepted from the position of Federal WICEN Co-ordinator. Leigh Baker VK3TP, a well known figure in WICEN, was appointed to replace Bill;

David Wardlaw VK3ADW, the WIA WARC 92 team leader, gave a comprehensive report on the current situation regarding the Australian WARC preparations and mentioned that, so far this year, he had attended over 20 official meetings regarding WARC 92, including both the Australian Preparatory Group and CCIR;

It was resolved that the WIA would send one member of the WARC 92 team to the Joint Interim Working Party (JIWP) in Geneva in March 1991, in addition to the WIA representation at WARC in 1992;

A paper seeking the relaxation of the identification requirements for packet networking protocols, submitted by John Martin VK3ZJC, the chairman of the Federal Technical Advisory Committee (FTAC), was approved and John was requested to prepare the WIA submission to DoTC on this important matter;

The recommendations by John Martin for changes to the Australian band plan, as detailed in recent issues of Amateur Radio magazine, were approved in full, and Executive recorded its appreciation to John for the procedures of consultation with WIA members which he used in preparing his recommendations;

A considerable number of proposed changes to the Articles of Association were approved for submission to the WIA's legal counsel for action;

Roger Harrison VK2ZTB was appointed to the position of Federal Standards Co-ordinator; and

Brenda Edmonds' VK3KT resignation from Executive was accepted prior to her taking up the position of assistant manager in the Executive office.

If you wish to know more about these Executive and Council meetings, contact your Divisional Federal Councillor.

You do not know who he is? Have a look on page two of Amateur Radio magazine.

Club Recruiting Campaign

The current three month WIA radio club member recruiting campaign is attracting a lot of interest, and a number of clubs have already begun signing up club members as members of the WIA so that their club can benefit from the WIA offer.

Full details of this offer were in the WIANEWS column in the October 1990 issue of Amateur Radio magazine, and also in advertisements in the last three issues of the magazine.

Do not let your radio club miss out on this offer. It closes on 31st December 1990.

WIA 80 Award

The WIA 80 Award was inaugurated to mark the 80th anniversary of the world's first and oldest national radio society, the WIA. This award is not an easy award to achieve. To date only 12 Australian amateurs have qualified for this award by working 80 members of the WIA.

The WIA 80 award finishes on 31st December 1990 so you only have a few weeks left in which to qualify. Full details were published in the WIANEWS column in Sep-

tember 1989 issue of Amateur Radio magazine.

Incidentally, overseas amateurs only had to work 8 members of the WIA. So far 51 overseas amateurs have qualified for the WIA 80 award.

Management of the WIA Budget

Each year at this time, when the annual fees for WIA membership are set, and seem to be inexorably increasing, the question is generally asked, "Does the WIA use modern management techniques for the derivation of its annual budget and to monitor progress against that budget throughout the year?"

Whilst there are several means of program control, one that readily springs to mind is Program Management and Budgeting or PMB, recently introduced in all Commonwealth Government departments. It is against PMB that this comparison of WIA financial management is made.

PMB is an iterative or cyclic process; it begins with establishing the several goals to be achieved during the year. The resource costs necessary to achieve these goals are estimated using normal, readily identified classifications and frequently the total costing for each goal or activity is determined. The summation of all activities constitutes the program which often, at this first round stage, exceeds the funds available. A process of review or cost cutting, and sometimes activity cutting, now takes place to establish the final budget or planning base.

How does this relate to the WIA? Well, each year the General Manager drafts a first budget, using best estimates from past achievements and incoming advice of new or changing activities. Executive meets to discuss each item, agree or adjust its size and go around the budgeting cycle to match the anticipated outgoings to expected income, whilst retaining a healthy surplus.

Much has been said about budget surpluses. However, it remains a fact that capital procurement in an organisation like the WIA must be funded from accumulated surpluses. Consequently Executive, on advice from the General Manager, now aims to create a budget surplus of around 5% of income each year. In the past a series of loss budgets and end of year financial loss circumstances has sadly depleted the WIA accumulated funds to only a very few dollars.

PMB aims to identify, within the total program, a series of sub-programs or discrete activities, and within sub-programs a series of components or lesser activities.

Obviously the three parts of the Federal subscription and the international representation levy define four sub-programs.

Desirably the financial health of all sub-programs should be readily available and managed in real time. For example, a reduction in Amateur Radio advertising leads to issues of the magazine with fewer pages. This is necessary for the pages are no longer required for advertisements and the advertising income is not available to support pages of editorial content. Hence the WIA balances the Amateur Radio progressive budget on an issue to issue or monthly basis but, due to lead times, it's usually a month in arrears!

The current financial reporting system employed in the Executive Office records by head of expenditure - postage, rent, salaries etc., rather than by sub-program, although the Amateur Radio magazine, and many other components, are set up and available from the system.

However, all these financial reporting systems are only part of the total WIA management information system. What has been considered only fleetingly above is the derivation and agreement of the activities which give rise to the program components discussed above. For example,

MAGPUBS

HANDBOOKS

ARRL 1990 Handbook ARRL Hard Bound	#BX267	\$52.90
The Operating Manual ARRL	#BX192	\$30.00
The ARRL Electronics DATA BOOK Ag8L	#BX201	\$24.00
Radio Data Reference Book S.R. Jessop RS68	#BX189	\$36.00
Radio Communication Handbook Fifth Edition RS88	#BX266	\$56.00
Radio Handbook 23rd Edition William I. Orr W6SAI	+ #BX22424	\$59.50
Motorola RF Device Data Motorola 5th Edition 2 Book Set	#BX5047	\$24.50

ANTENNA BOOKS

The ARRL Antenna Handbook 15th Edition	#BX161	\$38.00
Antenna Compendium Volume 1 ARRL	#BX163	\$22.00
Antenna Compendium Volume 2 ARRL	#BX292	\$24.00
Antenna Compendium Volume 2 & IBM PC Disk ARRL	+ #BX294	\$36.00
Antenna Impedance Matching ARRL	#BX257	\$30.00
Yagi Antenna Design ARRL	#BX184	\$30.00
W1FB's Antenna Notebook Doug DeMaw ARRL	#BX179	\$20.00*
Novice Antenna Notebook Doug DeMaw ARRL	#BX162	\$16.00
Practical Wire Antennas John O. Hays G3BDQ RS68	#BX296	\$28.00
HF Antennas L.A. Moxon G6XN RS68	#BX188	\$28.00
ANTENNAS 2nd Edition John D. Kraus WB3K	#BX259	\$104.00
Antenna Handbook William I. Orr W6SAI & Stuart O. Cowan W2LX	#BX217	\$17.30
Vertical Antenna Handbook William I. Orr W6SAI & Stuart O. Cowan W2LX	#BX220	\$15.85
Beam Antenna Handbook W. I. Orr W6SAI & S. O. Cowan W2LX	+ #BX215	\$19.30
Wire Antennas Handbook William I. Orr W6SAI & Stuart O. Cowan W2LX	#BX218	\$17.30
Cubical Quad Antennas W. I. Orr W6SAI & S. O. Cowan W2LX	#BX214	\$14.50
The Truth about CB Antennas W. I. Orr W6SAI & S. O. Cowan W2LX	#BX219	\$17.30
Transmission Line Transformers J. Sevick W2FMI Rev 2nd Ed	#BX329	\$40.00

PACKET RADIO BOOKS

Gateway To Packet Radio Stan Herzepa W1LOU 2nd Edition	+ #BX168	\$24.00
The Packet Users Notebook Buck Rogers W4ABT CQ	#BX285	\$18.50
Packet Radio is Made Easy Buck Rogers W4ABT MFJ	#MFJ32	\$20.50
AX.25 Link Layer Protocol ARRL	#BX178	\$16.00
Computer Networking Conferences 1 - 4 1981 to 1985 ARRL	#BX186	\$36.00
Computer Networking Conferences 5th 1988 ARRL	#BX167	\$20.00
Computer Networking Conferences 6th 1987 ARRL	#BX169	\$20.00
Computer Networking Conferences 7th 1988 ARRL	#BX184	\$25.00
Computer Networking Conferences 8th 1989 ARRL	#BX295	\$24.00
SPECIAL - All 5 Books - Conferences 1 to 8	- #BX5008	\$80.00

VHF/UHF/MICROWAVE

RSGB Microwave Handbook Volume 1 M W Dixon G3PFR RS68	#BX318	\$70.00
VHF-UHF Manual George Jessop G6JP RS68	#BX287	\$48.00
all about VHF amateur Radio William Orr W6SAI	#BX216	\$17.30
21st Central States VHF Conference 1987 ARRL	- #BX172	\$17.50
Mid-Atlantic VHF Conference Oct 1987 ARRL	- #BX175	\$17.50
22nd Central States VHF Conference 1988 ARRL	- #BX173	\$17.50
23rd Central States VHF Conference 1989 ARRL	- #BX286	\$17.50
Microwave Update 1987 Conference ARRL 1987	- #BX174	\$17.50
Microwave Update 1988 Conference ARRL 1988	- #BX183	\$17.50
Microwave Update 1989 Conference ARRL 1989	#BX321	\$24.00
UHF Compendium Part 1 & 2 Volume 1	#BX250	\$49.95
UHF Compendium Part 3 & 4 Volume 2	#BX251	\$49.95

General Interest

Hints & Kinks For The Radio Amateur ARRL	#BX330	\$16.00
The Short Wave Propagation Handbook G. J. Jacobs & T. J. Cohen	#BX268	\$18.50
Morse Tutor GGTE ARRL 5 1/4" IBM Disk	#BX187	\$20.00
Low Band DXing John Devaldere ON4UN	#BX195	\$20.00
Transmitter Hunting Joseph O. Moell TAB	#BX222	\$35.90
Radio Frequency Interference Now to Identify & Cure It ARRL	#BX185	\$9.50
Interference Handbook William R. Nelson Radio Publications	#BX181	\$17.80
Golden Classics of Yesteryear Dave Ingram W4TWJ	#MFJ-30	\$20.50
The Complete DX'er 2nd Edition Bob Lecher W9KNI	#BX194	\$20.00
Solid State Design For The Radio Amateur DeMaw W1FB ARRL	#BX171	\$24.00
Amateur Radio Awards Book RSGB	#BX297	\$30.00

The above books, plus many more, are available from your WIA Divisional Bookshop. All items are less 10% discount for WIA Members and are plus postage and handling where applicable. All Prices are Subject To Change With-out NOTICE

If not in stock at your Divisional Bookshop, your order will be taken and filled promptly. Not all publications are available from all Divisions. * Price Changes ... -# price Reduced ... + Price Increase

what are the WIA WARC 92 and Australian Preparatory Group (APG) proposed activities which are funded by the international representation levy? Fortunately, this example is one which has been defined in some detail, discussed by Council and Executive, and agreed.

Broadly speaking, the WIA aims to be represented at all relevant APG activities by at least one delegate and proposes to send one representative to the Joint International Working party in Geneva in March 1991 and at least one representative to Spain in 1992 as member of the national delegations. But can the WIA be as specific for the Publications sub-program? For the Call Book, yes. The WIA intends to publish, at a reasonable profit, an annual Call Book for as long as the WIA holds the contract to do so from the Australian Government Publishing Service (AGPS). However, the WIA is not so definite in its aims for Amateur Radio magazine, although you will have noticed from WIANEWS the Publications Committee is concentrating on this matter.

One could conclude that the financial management side of the WIA is well on the way to providing the information the Executive, as managers, require. However, the directions to Executive on what is required by and for the members is not yet set in concrete. Federal Council will be devoting some time in early 1991 to defining succinctly the activities the WIA should be carrying out, and arranging them in priority order. To do this, however, the Council needs to complete the agreement on what will be done centrally in the Executive Office, and what will be done in the Divisions. This part of the Corporate Plan is due for completion shortly and will make the management of the WIA much clearer and easier.

IARU Region 3 Conference Agenda

Ron Henderson VK1RH, the WIA IARU Region 3 Liaison

Officer, advises that it is fast approaching time to consider what matters the WIA wishes to see raised at the coming IARU Region 3 Conference to be held in Bandung, Indonesia during October 1991. The agenda used at the last Region 3 conference, excluding reports by member societies, management and procedural items, was as follows: (Ron believes that the items marked * could be potential inputs from the WIA.)

POLICY MATTERS

- *Bandplans
- *Use of bands in Region 3 ITU conferences and events
- Improvements in IARU Constitution and Bylaws
- IARU representation by a member society
- *Amateur radio licence
- *Electro-magnetic compatibility
- Amateur satellite
- Promotion of amateur radio in developing countries
- Region 3 News

OPERATING MATTERS

- *IARU monitoring service
- Intruders in amateur bands
- *International beacons
- Amateur Radio Direction Finding
- Contests
- *QSL cards and QSL services
- *Packet radio
- *Technical and operational standards of other modes
- Emergency communications
- *Station identification by alien amateur
- World amateur day

THE CONSTITUTION OF THE ASSOCIATION

- *Proposals for change
- Proxies

THE GENERAL REGULATIONS OF THE ASSOCIATION

THE FINANCES OF THE ASSOCIATION

At the October 1990 WIA Executive meeting a number of topics were flagged for inclusion in the 1991 IARU

Region 3 Conference. The WIA's IARU liaison officer would be grateful to receive further contributions which can be sent through your Divisional Federal Councillor or direct to the Executive Office.

*Intruder Watch - intruders from the north (raised by VK8 amateurs)

*Pacific Rim licence-maritime mobile implications (raised by VK4 and VK3)

*Regional Society structure - including treasurer (raised by WIA IARU liaison officer.)

*Funding system for Region 3 (raised by the Executive)

*RF tag devices (raised by WIA IARU liaison officer)

*Band plans - notify ours (raised by the Executive)

*Bands - usage nationally and internationally (also raised by Executive)

*Third Party Traffic status update (raised by the Executive.)

*Packet radio - national update (raised by FTAC)

*Packet radio - SYSOPS code of ethics (raised by the Executive)

*Packet radio - planning considerations (raised by FTAC & Executive.)

The usual procedure is for a well informed amateur to draft a short (1 or 2 page) paper on the topic, with conference recommendations if necessary. Executive then reviews and clears all papers for dispatch to Region 3 for reproduction and circulation well prior to the actual Conference. This suggests a June 1991 deadline if the WIA is to achieve maximum impact by having its views circulated and discussed by regional societies in advance of the meeting proper.

As noted above, if you have something to contribute to the next IARU Region 3 conference, please set down your ideas and get them in to the system as soon as practicable.

Australian Spectrum Plan

The WIANEWS columns in the August and September 1990 issues of Amateur Radio

magazine carried details of the WIA's submission to the Department of Transport and Communications (DoTC) in response to their call for comments on the draft Australian Spectrum Plan. The WIA, in its submission, made five major points concerned with:

- Designating more clearly the Amateur Satellite Service allocations;
- Elevating several segments in the amateur microwave bands to primary status in Australia;
- Extending the quite narrow 10 MHz band;
- Extending the 3.5 MHz band upwards to 3.9 MHz;
- Not placing fixed and mobile services in the 420 - 450 MHz band.

In its response DoTC did not accept the first four points but did revise the 420 MHz spectrum plan to ensure it continued to reflect the arrangements in the international table in this band. What this means is that amateurs will continue to be a secondary service in the full band 420 - 450 MHz, and be the only secondary service, with radiolocation as primary, in the segment 430 - 440 MHz which is designated amateur secondary in Regions 2 & 3.

Note that there are no international amateur allocations in the 420 - 430 and 440 - 450 MHz segments, but Australian amateurs have secondary allocations on these frequencies and continue to retain them as a result of the WIA submission.

On the Amateur Satellite Service, DoTC believed the inclusion of references to footnotes remained adequate to draw attention to these particular circumstances.

It is WIA policy to seek small amateur primary allocations within the larger secondary allocations in the microwave bands. These bids for primary segments generally align with the amateur satellite frequencies where orbiting space vehicles could interfere with other Australian allocations. This is a point the WIA has made strongly in the past. Indeed, quite recently,

attention was drawn to the potential problems should a SYLEDIS service be allocated in the 435 - 438 MHz satellite window. The WIA believes DoTC could have acknowledged these satellite windows, if not by making primary allocations to amateurs, then by ensuring no primary allocation was made in Australia so that the secondary amateur service remained in the clear. This point will not be allowed to rest.

The bid for increased allocation at 10 MHz, albeit a secondary band, follows from IARU stated policy developed over the last ten years since the amateur service gained this band at WARC 79. Again the WIA will continue to express this agreed viewpoint.

Unlike some of our neighbouring nations, who have a greater allocation ranging from 3.5 up to 3.9 MHz, we in Australia are confined to the segment 3.5 to 3.7 MHz with a narrow conditional DX window below 3.8 MHz. A number of amateurs, in monitoring the 3.7 to 3.9 MHz segment, have commented upon the appropriateness of the allocations made there.

DoTC stated in their reply that the segment is highly utilised providing fixed and mobile services in the Australian outback regions and to extend the band to amateurs would provide excessive congestion. The opinion has also been expressed by some amateurs that the segment is being used to relocate those services from elsewhere in the HF bands. The WIA's WARC 92 team are monitoring this issue for its HF broadcasting implications.

Executive seeks members' views on the appropriateness of the users of this segment and welcomes informed comments. A decision to pursue this matter further will depend upon the views expressed by members.

HF Beacons

On the HF beacon scene international beacons exist or are proposed for the 14, 21 and 28 MHz bands. There may be others on the WARC bands but these are not part of the IARU international beacon project (IBP).

On 14.100 MHz there exists a world-wide, time sharing, power stepping series of beacons which had their origin in the North California DX Association initiatives a number of years ago. These beacons are all on that same frequency, however they time share and in so doing radiate at several stepped power levels. Although there is no Australian beacon in the series you can still hear them if you listen on 14.100 MHz.

The IARU has also reserved the frequency 21.150 MHz for a similar time sharing, power stepping, beacon series.

The 28 MHz system is more extensive, for there exists a large number of 10 metre beacons, each on its exclusive frequency. The IARU proposal is to allocate a much narrower band of frequencies for a series of time sharing beacons. One frequency will be allocated for a world wide series, very like the twenty metre and fifteen metre schemes. Other adjacent frequencies will be allocated on a continental basis for beacon series within the region served.

Australasia will be one such continental allocation and in time all our existing beacons (except the one on the world wide frequency) will change to that new frequency and become time sharing, power stepping, beacons. These proposals are covered in IARU Administrative Council Resolution 86-1.

There is also provision for special purpose, continuously emitting, beacons to be set up in a separate beacon segment but these would be expected to be few and far between.

As the into-service date for the new ten metre scheme was 1st January 1990, but was recently extended to 1st January 1993, you might well ask what is happen-

VHF Communications Magazine

1991 Issues Will Be Available After All!

The VHF Communications Magazine will now be translated and published in the UK, and will be available through subscription with the WIA, the Australian agents.

The 1991 prices are as follows:-

Surface Mail	\$35
Airmail	\$48

Please forward your cheque to
WIA, PO Box 300,
South Caulfield Vic 3162
before 31st January, 1991 to ensure you receive your first issue for 1991. Separate cheques for WIA subscription and VHF Communications Magazine renewal please.

Hy-gain
WE SUPPORT OUR ANTENNAS!

**DX88 HF
VERTICAL
GROUND
TUNABLE
FOR 80
AND 40m**

The exceptional DX88 design uses the entire antenna on 80 or 40 metres for highly efficient radiation. Because you can easily tune 80 or 40 metres to any point on the band without lowering the antenna, you'll never again be limited to only one frequency. And, you can adjust the other six bands to any desired frequency without affecting the tuning of any other band. The DX88 handles maximum legal power, features unique traps for minimal loss and offers broadband VSWR of less than 2:1 on six of the eight bands. The self supporting DX88 comes with stainless steel hardware and enclosed coils of #12 gauge copper wire to reduce loading changes due to weather. With ground radials of 14' (4.27m) the DX88 requires only a small area for maximum operating efficiency. Optional kits for ground or roof radials, as well as for 160m operation are available. The DX88 can also be used as a dedicated SWL antenna and covers 12 bands from 11-90 metres. As with all Hy-Gain antennas, the DX88 comes with a two-year limited warranty.

FIREMOON PTY LTD
11 DUGNAN CLOSE EPPING
PO BOX 244 EPPING 2121
PHONE 018 64 1153
FAX (02) 876 6310

ing? FTAC took action about a year ago to register Australia's interest in a beacon on the world wide frequency and a series on beacons on an Australasian frequency, but to date the WIA has heard nothing in reply from the IBP coordinator. FTAC has also recommended the Sydney location for the Australian beacon on the worldwide frequency.

The WIA knows the IBP coordinator has been requested to provide technical data on the construction of a simple beacon controller which can adequately keep time for lengthy periods in a range of temperatures and conditions. Some time standards are available for reference purposes such as WWV, VNG, ELF signals and television line timebase frequencies. What is needed is a design with suitable inherent stability, easily re-synchronised and with suitable control signals to both switch the transmitter, step its radiated power and provide the identification.

The chairman of FTAC has recommended we hasten slowly with the ten metre change over, for there is an extensive system of beacons in place in Australia and they occupy a segment of that band, thus denying it to intruders from our north. The new beacon band plan will reduce that occupancy and may not be to our immediate advantage. On the

other hand the new band plan frees up some of the relatively narrow Australian novice segment for novice use. One of the driving factors for change in Australia could be a new demand for an exclusive beacon frequency.

DX Foundation HF Beacons

Whilst discussing HF beacons, the latest ARRL Newsletter contains the following note on additional HF beacons:

"There's a new look to the 14.1 MHz beacon system operated by the Northern California DX Foundation. In addition to the 14.1 signals transmitted by nine stations around the world, the Californian beacon, W6WX/B, has added signals at 21.150 and 28.2 MHz. These are activated after W6WX/B transmits on 14.1. This prototype 3-band beacon rig was designed and built by W6QHS and N6EK. The foundation hopes the other eight beacons can be upgraded to "tribanders" within a few years. Reports on the beacons are always welcome; send them to W6RQ."

VK/ZL Oceania DX Contest 1990

We reprint without comment a small item from the contest column of the

August 1990 issue of "Radio Rivista", the monthly magazine of the WIA sister society in Italy, as translated by George Cranby, VK3GI.

"The VK/ZL contest has never been seriously followed in Europe. In years of poor propagation the contest passes sometimes without realisation that it was "on". Only a few take note of the CW section.

New Zealanders and Australians, on their part, have never been serious contest followers. With the exception of a few stations which regularly take part in major contests there is not much doing.

I believe that the temperament of these people is not suited to the mental attitude of a contestant. They are perhaps more calm and relaxed, and more inclined to chit-chat than to a quick exchange of reports and the exchange of numbers. Might they be right."

Thanks are due to Brenda VK3KT, Ron VK1RH and George VK3GI for their assistance in compiling WIANEWS this month.

MERRY CHRISTMAS AND HAPPY NEW YEAR FROM BILL ROPER VK3ARZ.
ar

WIRELESS MUSEUM, LINDFIELD, ENGLAND

CLIVE WALLIS VK2DQE
3 DOUGLAS PLACE
MIRANDA 2228

DURING A BRIEF visit to England in July this year, quite by chance I came across the Wireless Museum at Lindfield, West Sussex. Though small, this museum contains an excellent collection of some 100 or more vintage wireless receivers dating from 1920 to 1960. Most are in working condition, and all are well restored. Some WW2 communications gear is on display, including an HRO, an 1155 and a CR100. Old amateur receivers are also on view and this section is presently being expanded. You can listen to a working crystal set and study an interesting display of old valves, amongst which is a Loewe 3NF built in Germany in 1926. This is actually three triodes, r-c coupled, and all mounted in one glass envelope with a special five-pin bayonet fitting base. Quite possibly it is the first commer-

cially produced integrated circuit, requiring only the addition of a tuning circuit, power supply and headphones to create a detector plus two LF stage receiver! HT voltage was 90-200, filaments needed four volts. The idea was very advanced for its day and must have been a marvel of German technology, but apparently the individual filaments were liable to failure, and loss of any one meant that the entire device was ruined. Replacement would have been an expensive proposition in 1926!

Ray Leworthy, owner and curator, was a wireless mechanic in the RAF during the war years and was in India at the cessation of hostilities. He held a VU call and homebrewed his rig from "borrowed" parts courtesy of the air force. Finals would have been VT60s (valves transmitting type 60), better known outside the RAF as 807s!

Ray no longer holds a licence but still maintains an interest in the hobby. He extends a warm welcome to any amateur who drops in. Entrance is free, but a small donation towards upkeep is appreciated.

Lindfield is a delightful old village which lies on the eastern border of West Sussex, just NE of Haywards Heath. An added bonus for the visitor is the famous steam-operated Bluebell Railway, virtually next-door. Anyone touring southern England would do well to include both the museum and the railway in their itinerary. The address of the museum is The Old Brewery, 53 High Street, Lindfield, West Sussex, RH16 2HN. Telephone (0444) 484 552.

Hope this is of some interest, and don't forget the camera!

ar

Club Contest

BOOST YOUR CLUB FUNDS

Help your club and give added strength to the WIA to protect Amateur Frequencies from Government and Commercial Attack

HOW?

Simple! Sign up a new member between 1st October and 31st December 1990 and the WIA will pay your radio club a recruitment fee of \$5.00.

In addition, the club which signs up the most new members wins a free three year membership of the WIA PLUS three great amateur radio books for the club library.

Every radio club is a winner in this competition! The WIA is a winner! The amateur radio service in Australia is a winner!

WHO CAN ENTER THIS CONTEST? Every radio club in Australia which holds an amateur call sign, whether the club is affiliated with the WIA or not.

WHO QUALIFIES TO BE A NEW WIA MEMBER? Any person in Australia who has not been a member during the immediately prior 12 months.

HOW DO YOU SIGN UP A NEW WIA MEMBER? If your club does not have a supply of WIA membership application forms, then use the form printed on the back of every Amateur Radio magazine fly sheet - even photocopies of that form will suffice.

WHERE DO YOU SEND THE NEW WIA MEMBER APPLICATION? Send the application, together with the full membership fee as shown on page 3 of Amateur Radio magazine, to your local WIA Division.

HOW DOES YOUR CLUB CLAIM ITS FEE? The club secretary writes, on club letterhead, to "WIA Club Contest, PO Box 300, Caulfield South, 3162" with details of the new WIA member. At the end of each month of the contest a cheque for the total amount of all \$5.00 recruitment fees due to the radio club will be forwarded.

The club which wins the grand prize of a free three year membership of the WIA, plus books for the club library, for signing up the most new WIA members, will be announced in February 1991.

Get to work now in this great fund raising contest where everybody is a winner!

"The Outbacker"

- ALL BANDS IN ONE NEAT ANTENNA
- CONVENIENT MOBILING
- RUGGED CONSTRUCTION
- COMPLETELY WEATHERPROOF
- SAME COMMERCIAL DESIGN PROVEN IN THE OUTBACK FOR 15 YEARS.

The antenna is constructed of fibreglass with copper helical windings. The exterior is covered with a coating of epoxy and urethane for added strength, durability and protection. Tap points or frequencies are clearly engraved for each band. Sockets are made from brass, nickel-plated.

The wander lead is used for quick, easy, manual band changing - just plug one end into the lowest socket, wind the remainder clockwise around the antenna and plug the other end into the required frequency. Fine tuning for any resonant frequency within each band is made via the adjusting spike at the top of the antenna.

The optional mounting base and spring is made of solid brass, nickel-plated and the spring is zinc-plated spring steel.

An SO-239 is mounted on the side for feed termination. At the bottom of the base a threaded 1/2" hole is used for mounting to the vehicle, via a suitable adaptor (not supplied).

All Outbacker antennas are capable of handling 300 Watts PEP.

OUTBACKER CODE:

A 160-80-40-30-20-17-15-12-10 Metre ...	\$300.00
B 80L-80M-80U-40-20-15-10 Metre	\$266.40
C 80-40-20-15-11-10 Metre	\$255.00
D 80-40-20-15-10 Metre	\$247.00
E 160-80-40 Metre	\$214.00
F 80-40-20 Metre	\$193.00
G 20-15-10 Metre	\$175.00

Extra Frequencies Commercial -	
RFDS Etc	\$27.00
2-Piece Split Model Available with all codes except codes "A".....an extra	\$40.00
Mounting base and spring to suit all above antenna.....Complete	\$87.00
AIR deliver door to door anywhere in Australia	\$12.00



ANTENNA MANUFACTURE AND SALES

TERLIN AERIALS

3 YAMPI WAY,
WILLETTON, W.A. 6155

(09) 457 6238

(09) 457 3807

FAX: (09) 457 7737

ATLAS 210/215 KEYING MODIFICATIONS

ALLEN CREWTHER VK3SM
28 REYNOLDS PARADE
PASCOE VALE SOUTH 3044

SOME TIME AGO I obtained an Atlas 210 transceiver and, a while later, decided to use it for CW. Having to operate the rotary switch every change-over got on my goat, so I installed the Atlas suggested modification using an external toggle switch.

The problem then was that there is no side-tone oscillator provided, and modification (fig 1) resulted.

All was well until I built a keyer, and of course it required a negative key line to operate, and the Atlas had a positive one. A polarity changer was tried and, at the same time, I looked at a means of going from CW to Phone without having to remove the key plug from the back of the set.

The resultant circuit is shown in fig 2, and also results in semi-break-in CW with instant change-over to Phone. The relay used was a Siemens cradle 12V coil 6000 Ohm, and a 200µF capacitor gave me a nice hang time even at 5wpm, although it may be a bit long at 20wpm, but it is easy to adjust — the larger the value the longer the time.

All the circuitry is built in the bottom of the AC console, and now the only connection at the back is the antenna.

If you cannot get a noval plug to fit the socket on the rear of the set, one can be made by cutting the base of a nine-pin valve. Wind one turn of 22G on the tube about 6mm up from the bottom and connect to a Scope iron transformer or 6V winding of an old TV transformer. Make sure the turn is not shorting, and turn on the power. The turn should get hot. Plunge the tube into cold water; the base should snap off, the works can be cut clear and, with some care, wires soldered on the pins. Care is needed as the glass edge may be quite sharp. The wires and base are filled with "Plastibond" or similar, and there is your noval plug.

ar

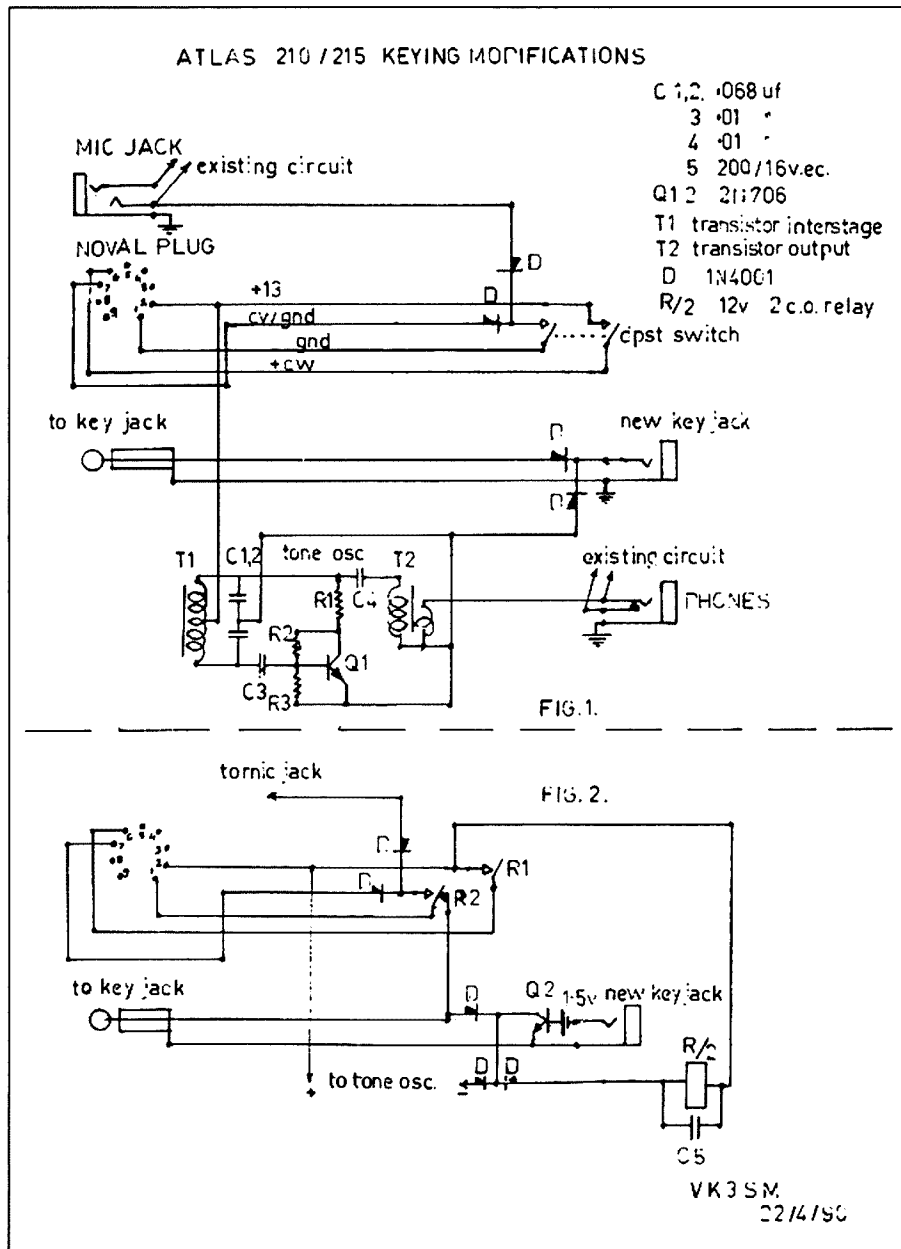

**Tell the advertiser you saw it in the
WIA Amateur Radio Magazine**

SIX-METRE REPEATER VK3RMS

IAN WOODMAN VK3ZBI
24 FEWSTER ROAD
HAMPTON 3188

THE MELBOURNE six-metre repeater VK3RMS, sponsored by the WIA Victorian Division, operates from the top of the Dandenong Ranges located approximately 35km east of the city of Melbourne. The repeater is being used to relay the Victorian Division broadcast held on Sunday mornings; it will also provide WICEN with additional facilities should they be required in an emergency. Interstate and overseas amateurs will find this new repeater useful in determining propagation conditions into the Melbourne area.

The motivation behind the erection of VK3RMS is to provide extended mobile to mobile communication and to increase the occupancy of the six-metre band and thereby relieve some of the pressure from the local two-metre repeaters in Melbourne.

The system was developed in three stages; experiments were carried out using low-power UHF signals into high-gain antenna systems to test the remote receiver to transmitter links to be used. These tests were conducted across the southern suburbs of Melbourne.

The transmitter was then installed on the Dandenongs with the receiver in the southern suburbs using a UHF link to relay the signal between the two pieces of six-metre equipment. After testing, the receiver was also installed on the mountains, but remote from the transmitter site.

The system operates in the following manner:

The input signal on 52.900MHz arrived at the receiving site 561m above sea level, and is fed to a Pye Overland FM receiver via low-loss coaxial cable from a half-wave vertical dipole mounted 24m up the mast. The audio from the six-metre received signal is used to modulate a Philips UHF transmitter operating on low-power FM. About a milliwatt is fed into a six-element Yagi, which fires the signal four kilometres to another six-element Yagi at the transmitter site 550m above sea level. The UHF link signal is demodulated, and the resultant audio modulates an STC transmitter to an output power of 50W on the output frequency of 53.900MHz.

The transmitter antenna is a half-wave vertical dipole mounted 24m up the mast; it is the same type of antenna as used at

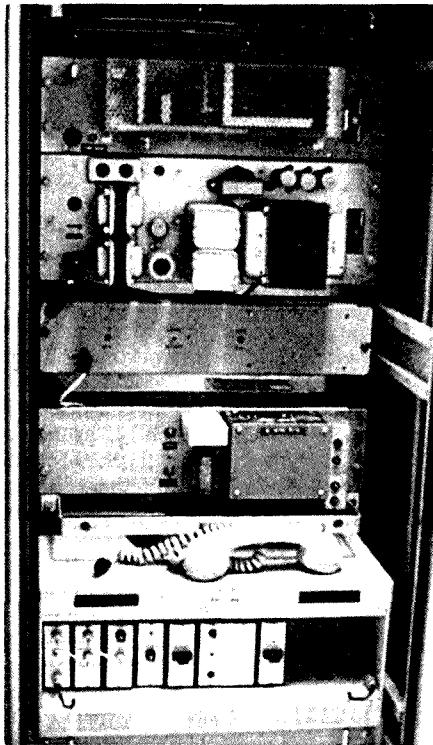

*Rack Mounted VK3RMS transmitter
UHF receiver*

the receiving site. This antenna was described in 'AR' May 1986. The reason for separating the receiver and transmitter was to reduce desensitisation of the receiver, without having to incur the high cost of the large cavities required for six metres and the tuning of stubs etc. The receiver site was chosen to keep the receiver on six metres as far as possible from the five commercial TV and FM transmitters located on the mountain. At this location there are about 30 two-way radio services within half a kilometre of the receiver antenna; as a result it has been necessary to add extensive selective filter networks to the receiver input.

The total system relies on 240V power without any back-up system; therefore, if the power fails, the whole system goes down until the power is restored. The system has the provision for remote shutdown if required, remote back-up reception, remote receiver sensitivity tests and output power measurement.

Field tests done so far indicate that

mobile stations using 25 watts can access the repeater 80km south of the receiver site. In the Melbourne suburbs, access has been gained using only half a watt and a roof-mounted antenna — two watts provides noise-free signals. A member of the installation group will be on hand to obtain signal reports after the WIA Sunday broadcasts. In the future, an RF pre-amp is to be added, along with a solid-state final to replace the valve final at the transmitter site.

All projects have their funny moments. Our installation crew arrived at the transmitter site and were admiring the white cockatoos sitting amongst the antennas. They were observed pecking away at something which turned out to be the plastic sheathing on the coaxial cables at the top of the mast! (Hope they weren't ours). It will be interesting to see how long it will be before the rainwater travels down the cable and into the shack. On the day the crew installed the transmitter antenna, a column of smoke was observed rising from the trees west of the nearby town of Olinda. The Olinda alarm sounded. The fire-truck siren could be heard wailing as it headed towards the smoke. The crew up the mast worked on the clamps faster as the smoke increased. The flashing lights of the fire truck could be seen through the trees below. The Mt Dandenong fire truck came wailing through the town headed for the fire. Meanwhile, the guys 25m up the mast were considering how quickly they could get out of the safety harness and climb down. We all remember Ash Wednesday in the Dandenong Ranges. More sirens and flashing lights; things were getting exciting. The Ferntree Gully fire unit arrived followed by more units, clamps tightened, coaxial cable connectors joined and sealed, smoke getting less now. By the time the tools were lowered to the ground the smoke appeared to have stopped and all the fire units returned to their respective bases — enough excitement for one day. Remember, the repeater's primary function is to provide communications for mobile stations. They often become occupied during the DX season, so why not try the international simplex frequency of 52.525MHz?

Continued on page 14

THE IMPORTANCE OF LOW-INDUCTANCE CONNECTIONS OR THE NATURE OF RF FLOW

FELIX SCERRI VK4FUQ
6 GARBUTT ST
INGHAM 4850

I HAVE BEEN PROMPTED to write relating my experiences of the strange things RF energy does when flowing on wires. This discussion will be entirely non-mathematical. In my opinion, the whole problem stems from a generally very poor understanding of the nature of RF energy. It seems to me that most amateurs I have spoken to tend to treat RF as if it was DC flow.

In DC circuits the only constants of importance are voltage, current and resistance (except during transient conditions). In the case of RF flow (being AC) other things become more important. These things are reactive components (capacitive or inductive). Stray reactive components can cause insidious effects, and a proper understanding of the effects may be helpful.

Recently, on air, a conversation between two amateurs was heard, discussion baluns, and one party remarked that he threw out his balun because it tested short circuit with an ohmmeter. Obviously in some need of enlightenment!

In an analysis of RF flow, one will come up with expressions such as "skin effect", which basically means RF tends to flow on the outside of the conductor, due to self-inductance. Even a straight piece of wire exhibits appreciable inductance. Remember, inductance gives rise to reactance, and that gives rise to phase shifts and other strange effects. What does all this mean?

Some time ago, I upgraded to an IC-735, and decided to add a high-quality microphone and pre-amp combination. This was done successfully. However, I began to receive reports of bad audio symptomatic of severe RF feedback. A mad search to find the cause ensued, and just about everything in sight was either bypassed or filtered, with no success. Eventually the cause was found to be one of those "insidious effects" I spoke of earlier. A word about my antenna system is now probably in order. I use open-wire

feeder to all antennas with 4:1 baluns at the station end feeding a home-made ATU to give 50 ohm unbalanced output.

The ATU was built in the good old-fashioned way, on a wooden baseboard, with all "earth" points on the ATU connected with heavy green "earth wire". Having once read of "stray" inductance in leads, I, by now clutching at straws, replaced the wire with lengths of RG213 braid (a known low-inductance conductor) and, in one fell swoop, all problems disappeared.

After some head-scratching it was finally realised what had happened. In any coaxial (ie unbalanced) type of circuits you have two conductors, one at a given RF potential and the other at a neutral or ground point, or so it should be. In any RF circuit, a stable ground-plane or RF earth is absolutely vital. A rough, but accurate analogy is, for example, building a structure on unstable ground (eg earthquake-prone). Nothing is going to be stable, is it?

In my own case, what was happening

was that the inductance present in the green earth wire provided "built-in reactance" into what should have been an ideally non-reactive reference. Initially I, for one, was quite sceptical, but tests conducted later proved this analysis. Since this incident I have seen these effects manifest in many other instances. I have seen it in two-metre yagis, mobile installations, and even commercially made gear. It isn't anything like DC is it?

In summary, the importance of low-reactance connections cannot be overstated and, especially critical for RF earths and groundplanes, ordinary wire is a definite no-no. Braid from RG-213 or similar coax or wide strips of flashing copper is ideal for low-inductance connections.

So, there you are. If you have — or suspect — a similar RF problem, examine your set-up for the possibility of reactive connections on earths; you might end up with a vastly improved amateur station. **ar**

Six Metre Repeater VK3RMS *Continued from page 13*

System Specifications:

Reception frequency	52.900 MHz
Receiver sensitivity	.20 mV for 20 dB signal to noise
UHF link deviation	± 5 kHz
Transmitter frequency	53.900 MHz
Transmitter RF power	50 watts
System time out	4 minutes
Repeater offset spacing	1 MHz
System polarisation	Vertical — six metres
Link polarisation	Horizontal — UHF
Identification VK3RMS	Tone/Morse Code
Transmitter tail	1.5 seconds

Victorian Six-Metre Repeaters

Callsign	Tx Frequency	Location	Distance from Melbourne
VK3RMH	53.550 MHz	Wattle Glen	35km north-east
VK3RDD	53.575 MHz	Dandenong	30km south-east
VK3RTN	53.675 MHz	Lake Mountain	100km north-east
VK3RMS	53.900 MHz	Mt Dandenong	35km east
VK3RGM	53.975 MHz	Mt Buller	155km north-east

The installation group Ian VK3AYK, Len VK3AQJ and Ian VK3ZBI wish to thank Peter VK3ZPP, Steve VK3BYI and Les VK3SL for their help with the repeater project. **ar**

A 28-VOLT POWER SUPPLY FOR USE WITH AN HF LINEAR AMPLIFIER

BRIAN JONES VK2BRD
15 JOHN T BELL DRIVE
WALLSEND 2287

THIS REGULATED POWER supply is designed to give good regulation over a wide range of load currents such as powering a 300W PEP output SSB linear amplifier and surviving accidental overloads. Good regulation is essential to prevent distortion in such an amplifier. Other factors taken into account in this design are controlled dissipation by all components to reduce the energy wasted at both low and high load currents. Component types used were chosen for their characteristics and reliability.

This power supply can be broken up into logical blocks: power transformer, rectifier and filter capacitors.

The power transformer should be rated

at about 1kW. The secondary voltage of the main winding should be $(42/1.414 + 2) = 32$ volts RMS. The auxiliary supply is derived from a 37V winding (this can be a separate transformer).

The main rectifier is a bridge configuration consisting of stud mount diodes (400V PIV 40 amp) mounted on two 76mm lengths of Philips 35D heatsink. The diodes should be complementary pairs mounting the normal pair on one heatsink and the reverse pair on the other. The heatsinks must be mounted vertically, insulated from one another and earth on, say, Dick Smith insulated spacers (H-1842) and mounted inside the power supply case. One heatsink is the positive rectifier output and the other is nega-

tive. You may think this is excessive heatsinking, but 20 watts is being dissipated on each heatsink at full load current. Bridge rectifier assemblies such as the four-terminal PB40 are unsuitable, as they can't dissipate the power efficiently and usually fail. Current flowing from the rectifier is I load + I filter capacitors.

The main filter capacitors used are low ESR types with high ripple current rating. By using capacitors with low equivalent series resistance, the voltage change across the capacitors is minimised between light load and full load. This reduces the power dissipated by the series pass devices. The type used was Philips 222 106 38153.

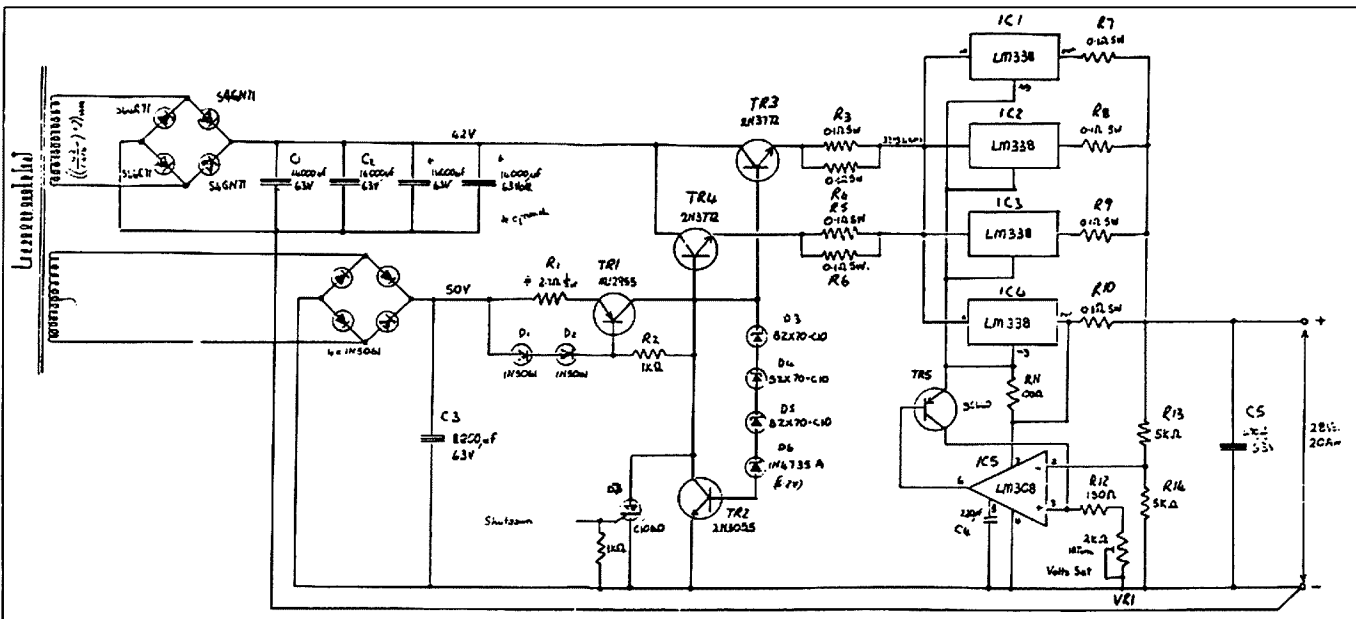

Power Supply Circuit

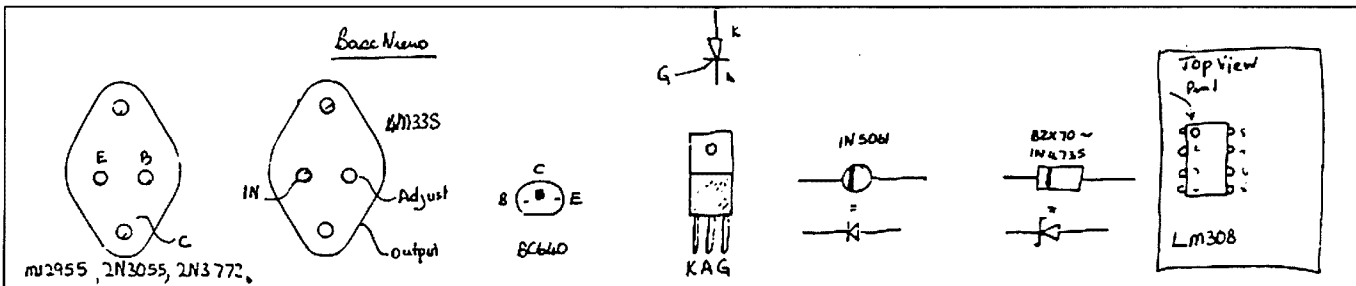

Semi-conductor connections

Wiring technique and component placement are important around this area. A minimum of 4sq mm hook-up wire should be used, and wire lengths should be kept as short as practicable. Capacitors should be mounted near the rectifier but not so close as to heat them from the power dissipated in the rectifier. Wiring should go from the transformer to the rectifier, from the rectifier to the filter capacitors and then from the filter capacitors to the regulator components.

Incorrect wiring technique will result in the equivalent of higher ESR which defeats our object.

The auxiliary winding voltage is rectified by a bridge rectifier and filtered by a capacitor. The drain on this auxiliary supply is approximately 100mA continuous.

Series Pass Pre-Regulator

This pre-regulator has its output voltage set by a zener diode network connected to the series pass transistors. This "zener diode" consists of D3, D4, D5, D6 and TR2 connected as a power zener. Power dissipated by this "zener" occurs when power output current is minimum. The current source consists of R1, R2, D1, D2 and TR1. The voltage drop across R1 is held constant by the voltage across D1

and D2 and the beta of TR1 thus forming a current source. TR1 and TR2 are mounted on a 76mm length of Philips 35D heatsink, but insulated from it. The series pass transistors TR3 and TR4 are high gain at high-current, high-voltage transistors. Using these transistors reduces the base current required to allow high collector currents to pass. Load current sharing between TR3 and TR4 is achieved by using R3, R4, R5 and R6. The output regulation of this pre-regulator is about two volts. Heatsinking of TR3 and TR4 is discussed later.

Series Pass Regulator

Final output voltage comes from four LM338 IC adjustable voltage regulators connected in parallel. The output of each regulator has a current sharing resistor which forces even sharing of the load current. The disadvantage of these resistors is that the voltage drop across them ruins output regulation. This is overcome by using an LM308 Op Amp (IC5) to monitor the output voltage and feed a modified control voltage to the adjustable voltage regulator's "adjust" pin via transistor TR5. Output current is limited by the input to output voltage differential across the regulators. Two 200mm lengths of Philips 55D heatsink are used

to mount all the series elements. TR3, IC1 and IC2 on one piece and TR4, IC3 and IC4 on the other. These heatsinks must be mounted vertically on the outside of the power supply case.

General Construction Requirements

All TO3 devices mounted on heatsinks need to be insulated from them using high-quality mica insulator washers with copious quantities of thermal paste applied.

Power diode mounting requires only thermal paste since these are mounted on insulated standoffs. All TO3 devices should have TO3 transistor insulator caps fitted to remove any voltage hazards. All components in the high current areas are mounted on the back of associated heatsink using tag-strip terminations. The negative output lead is connected to the negative output terminal directly from the filter capacitors. The positive lead is connected to the positive output terminal and R7, R8, R9 and R10 by short as possible lengths of 4sq mm wire. R13 is connected to the positive output terminal. C5 is connected across the output terminals. For all other wiring use 0.5sq mm insulated wire. **ar**

MORSE RECOLLECTIONS

S WRIGHT VK6YN (EX G3CYT, ZE1BY, ZE5JH, ZS5BG, VQ2SW)
19 JOHN ST GOOSEBERRY HILL 6076

I READ WITH MUCH interest the article by VK5BR on the early background of telegraph codes, published in the September 1989 issue.

It brought back many memories of life in Zimbabwe (then Rhodesia) in the immediate post-war years, when I was with the national railway as a station master at various remote bush stations.

The railway operated narrow-gauge line (3'6") single track, with manned stations every 50 miles or so, with several intermediate sidings between, where the train crews themselves effected what was called a 'crossing'. The method of control of the trains was the issue of our 'Authority to Proceed' by the station master, which instructed the crews to 'cross' various opposing trains at the intermediate sidings, and obviously the orders for all opposing trains had to 'match', otherwise it was possible for two opposing trains to meet each other at a point between any two intermediate sidings, with most unfortunate consequences.

The station master arranged the 'Authority to Proceed' by the use of the 'Morse Telegraph Instrument', and the whole of the 'authorities' were trans-

mitted along landlines between the stations using the standard Morse code.

A record of the exchange of the messages was achieved by the use of an INKING machine, which recorded the dots and dashes from the sending station on a narrow paper tape which was driven by a clockwork mechanism.

It was possible to read the incoming message (embodying the names of the intermediate sidings while the trains were instructed to 'cross') by the clicks of the telegraph relay, but this was strictly forbidden. The proper procedure was to examine the paper tape with its recorded dots and dashes, and if the crossing places for the opposing trains were the same, the 'authorities' could then be prepared and issued to the train crews.

The names of the 'intermediate' sidings were quite distinctive; many were derived from the traditional African name for that particular place, whereas others had names given by European settlers to perhaps remind them of their earlier days in other countries.

Some of the local names for the sidings were quite colourful and rhythmic, such as Chikonkomene, Muzungushi Sambawizi, but by some remarkable instance of juxtaposition — hardly anticipated by

Mr Morse — two adjacent sidings in one section between two manned stations were EAGLES NEST and UMFESERI. Completely different, you would say, with little or no possibility of mistaking one for the other with, perhaps, disastrous consequences in the preparation of the 'authorities to proceed' resulting in two opposing trains meeting head-on between the two sidings.

Well, having regard to the fact that the spacing of the dots and dashes on the paper tape was not always to the required standard, if you will write down the dots and dashes for the one siding and, immediately below, the dots and dashes for the other siding, you will see that the station masters in control of the section containing those two particular sidings were obliged to exercise more than usual vigilance in the preparation of 'authorities to proceed'.

Rapid development of signalling and train control soon overtook the basic "Telegraph Order System" and, with the implementation of "Centralised Train Control", the railways of Zambia and Zimbabwe were second to none in safety and efficiency. **ar**

Radio Amateurs: Have you checked out EA lately?

No doubt most radio amateurs are aware that *Electronics Australia* is by far this country's largest-selling electronics magazine, as well as being its oldest (we began way back in 1922, as *Wireless Weekly*). But have you looked inside the magazine lately?

Now it's bigger and better than ever, because our leading competitor *ETI* has been merged with us, to form *Electronics Australia with ETI* – the biggest, brightest and most informative electronics magazine, bar none.

You'll now find lots of new 'departments' in the magazine, including Solid State Update (with news of new semiconductor devices), Silicon Valley Update (news from the USA) and What's New in Entertainment Electronics. Plus all of your old favourites like Forum, The Serviceman, Circuit and Design Ideas and so on. And of course plenty of 'meaty' technical articles and construction projects.

What about *amateur radio* projects? Well, as you can see there are more of these than before – but we're very interested in publishing more. So if YOU have developed an exciting amateur radio project, contact Jim Rowe by writing to him at EA, 180 Bourke Road, Alexandria 2015. Or phone him on (02) 693 6620, to discuss the possibility of publishing it as a contributed article. As well as earning a fee, you'll also be helping to boost interest in amateur radio!

Take a look at the new, bigger and brighter *Electronics Australia with ETI* – on sale at your newsagent at the beginning of each month. Or subscribe now, by phoning (02) 693 9517 or 693 9515.

Electronics Australia WITH **eti**

Australia's Top Selling Electronics Magazine

INCLUDED IN OUR DECEMBER ISSUE:

IMPROVING ICOM'S BP-70 BATTERY PACK

Ever wished that you could transmit with your Icom hand-held, as the battery pack is being recharged? Lew Whitbourn, VK2ZIP shows you how it can be done, with a simple mod to the BP-70 battery pack (and others too).

RF Z-BRIDGE, DUMMY LOADS FOR UHF

In the final article describing his revamped VHF Powermatch, Jim Rowe VK2ZLO presents a new Impedance Bridge that operates right up to 1296MHz, plus a pair of low-power 50 ohm dummy loads.

REVIEW OF AT&M'S RADIO MODEM KIT

AT&M has a pair of kit modules that go together to make a V23 data modem for use with transceivers. Here's what we found when we built up a couple and tried them out.

COMPUTERS AND REMEMBRANCE DAY CONTEST 1990

ARN WIERENGA VK7KR
79 GRONINGEN RD
KINGSTON 7050

WITH TECHNOLOGY FORCING its way into the ham shack, computer-aided contesting appeared to be the order of the day.

Being a firm believer that the computer is the slave, the human is the master, I endeavoured to create a system to make the tasks of logging, duplicate checking, coffee brewing and CW sending a little easier than by using the traditional methods. After much trial and error I think I achieved some of these aims.

My last attempt in the contest some two years ago produced satisfying results aided by a personal contest logging program long since out of vogue. It was written over several contest weekends and developed into quite a program, but was severely limited due to being written in Basic and for a CPM machine with chronic memory problems. With my XT-compatible now proudly occupying the space of the old portable, I suffered a lack of enthusiasm at the idea of translating the old faithful logger into a form the PC would understand. Instead, a good database program, although not capable of doing some of the old fancy things, was able to supply the goods.

After some easy definitions and some more complex report formatting, the new contest logger was set to go. All I had to do for each contact was enter the callsign and number received, because the date, time, number sent, band and points were all generated by the machine automatically. The biggest limitation with the system was a lack of real time duplicate checking. Maybe that old Basic program is not yet redundant! To compensate for

this, the PC generated a neat little printed sheet for manual duplicate checking. Naturally the slave confirmed a lack of duplicates after the event.

As the contest was drawing near, I realised that the computer could also be used to automatically send my CW CQ calls. The junk box was raided and a makeshift interface was furiously constructed between the serial port and the Yaesu. The Morse program used to drive the radio ran like a dream and all was in readiness. T - 60 and disaster struck. A lack of multi-tasking meant that I had to make an unforeseen choice: a contest log or auto CQ calls. The dilemma was almost too great to resolve until I managed to procure a friend's portable machine 10 minutes before the contest. Having missed most of the broadcast by now, I brewed a coffee and set to the task of manipulating the appropriate files and connecting the hardware for my new CQ caller. At T+10, after much despair, the portable machine was stored away in a dark corner. The serial port connector was the opposite polarity of mine and I did not readily possess the resources to rectify the problem.

Manual CW keying is fine. I actually enjoy it. My wrist was in need of some good sending practice in any case. After some 12 months of stagnation on the key it took all of the evening to get some rhythm back into my sending. With RSI threatening, no new calls on the band and droopy eyelids, I called it a night not long after midnight.

Much too early for a Sunday, I arose with the birds, keen to score well this

year, my first all-CW RD contest. As luck would have it, the same calls I gave up on last night were still the only ones around. Amid expletives and exasperation I wondered what I could do in the meantime. Less than one hour later, stretching the resources, I was able to welcome the late risers with my auto CQ calls. Ahhh bliss! What a difference this made. The pace prior to this was frantic, but now I could remain calling while stretching, reading a magazine, talking to friends who visited, and even tidy up the log. With the addition of a small FM transmitter I could make breakfast and coffee, and complete the essentials all without breaking the calling process. I even had the ability to answer the moment a call was received.

The contest became so relaxing that, given sufficient space on the desk, I could have called on a third computer to begin the word-processing involved in this article. What a shame I have more multi-tasking ability than my humble PC, although with a 486 machine running at 25MHz, and 'windows' thrown in . . . Oh well, I can always dream on. It was fun to have computers do some of the repetitious tasks of amateur radio contesting. It was fun to answer stations with the hand key still rather than have the machine take over the station. It was fun to score well this year and enjoy being competitive.

See you on the CW end of the bands next year. If you hear VK7KR, imagine with a smile a wall of computers with the one-time master frantically trying to tame them. Please forgive him if he seems a little vague, as though his attention is elsewhere. ar

TALKING-BOOK REGULATIONS

The Department of Transport & Communications regulations brochures for the Amateur Service in Australia, DOC 70, 71 and 72, are now available on audio cassette for use by the visually impaired.

The Royal Blind Society of NSW has produced a talking-book version of these brochures which form the study syllabus for the Amateur Regulations Examination. Knowledge of the current regulations are also needed by radio amateurs

so they can comply with the conditions of their station licence. Enquiries should be directed to the Society at 4 Mitchell St, Enfield NSW 2136, or by telephone on (02) 747 6622.

ar

THE FILTER THAT WAS NOT

DAVID G BARNEVELD VK4BGB
PO Box 275 BOOVAL 4304

THIS ARTICLE HAS NOTHING to do with low pass filters nor, for that matter, high pass filters. To be truthful, it is about a water filter. Now, before anyone conjures up visions of yours truly in his shack with water-cooled anodes, multi-stage turbine water-circulating pumps and oodles of kilowatts emanating from a linear as big as a garden shed, let me explain this strangely titled story in more detail.

The incident that I am about to reflect upon concerns a commercial water-cooled RF dummy load. This load, rated at a continuous 25kW of thermal dissipation, is used to terminate the television transmitters at Channel 7 in Brisbane during periods of maintenance. The unit itself consists of a terminating resistor (50 ohms), a water pump and a forced air cooled heat exchanger (see diagram).

Under normal operation, the pump outlet discharge pressure into the load resistor housing runs at approximately

25psig. It had been noticed, however, that the pressure gauge had been registering a slow upward movement in pressure over a period of time. In fact, it had now risen to roughly 55psig. As the layout of this system is relatively simple, and being a closed coolant loop, it was hard to imagine a blockage forming anywhere due to contaminants entering the system.

A thorough investigation was called for, however, when maintenance records indicated a similar problem with an identical dummy load connected to the 20kW FM radio transmitters located in the same building.

Next day, armed with shifting spanners and an assortment of tools, work commenced on removing the faulty dummy load assembly from the three-inch rigid coaxial cable that fed the output of the transmitters into it, and then to dismantle it completely. As stated earlier, the entire unit is fully self-contained, therefore we were unsure as to what could be causing the unduly high pump-back pressure.

After the inspection covers were removed, the entire assembly was stripped down bit by bit and checked for blockages. However, none was found. At this point in time you will probably be suspecting that the pressure gauge itself is faulty, and this had occurred to us also; but why the same problem on two identical dummy load cells?

Further investigation was called for. This time the entire pump assembly was stripped down, but apart from minor pitting associated with the turbine blading on the impeller shaft,

nothing was found to be unduly amiss. A recheck of the operations manual assured us that no filters were in the lines, so what on earth could it be?

The only thing left that we had not attempted was the load cell housing which contained the main resistor. The associated cooling fins and pipework had been flushed, with not a trace of residue of any description whatsoever being found.

No, the load housing would not be at fault. After all, it contains only the resistor and nothing else. Even the handbook tells us that! Guess again, folks! After the 20th bolt was removed and the unit disassembled, it was found that the inside of the return water passage contained a small brass micromesh filter screen some 30mm in diameter. This screen was approximately 85 per cent blocked by a heavy, rock hard, calcium-like coating. Here was the answer to our high water pressure problem. This also explained why the increase in pressure was on a gradual incline. As the filter became progressively more clogged with this foreign material, the water pressure would start to increase downstream of the pump discharge port. This was as indicated by the pressure gauge. The cause of the blockage has as yet still to be determined; however, it appears from a closer study that the culprit may very well have been electrolysis between the copper and the brass in the system, accelerated by the RF electrical energy within the housing. This finding is not conclusive at the present time. The interesting point worth noting here, however, is that nowhere in the operations manual did it make mention of this filter. Had we been aware of its existence in the first place, this would have been our first port of call, and undoubtedly saved many hours of wasted trouble-shooting. It's easy to get caught, isn't it? 73 ar

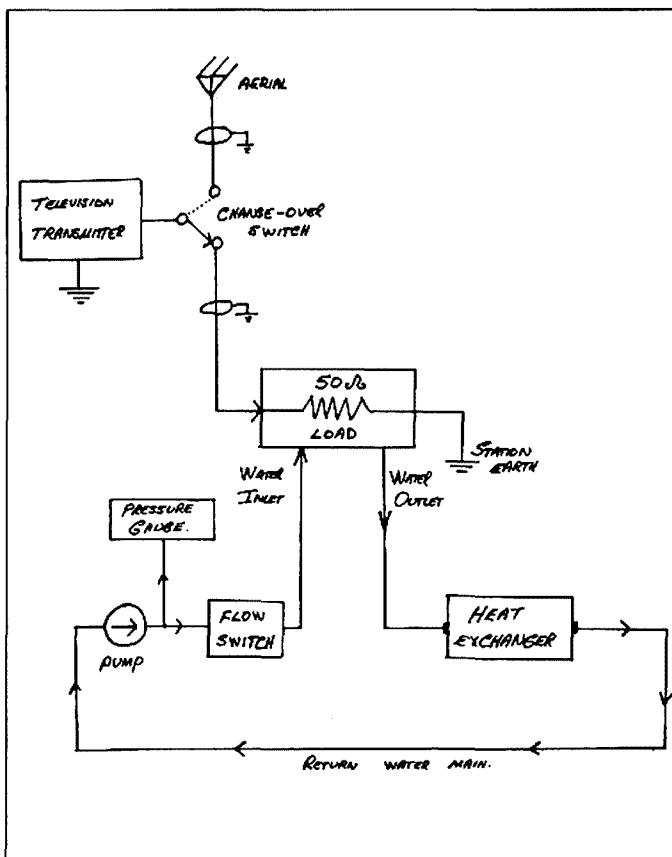

Basic Dummy Load Layout

Stolen Equipment

Stolen from Holden VN Commodore parked at Golden Sands Reception Blackburn Rd East Burwood November 1st 2 ICOM IC290A serial No 001532 All mode transceiver contact Geoff Atkinson VK3YFA or your local Police Station.

TESTS ON THE COMPACT COIL Z MATCH

LLOYD BUTLER VK5BR
18 OTTAWA AVE
PANORAMA 5041

Introduction

IN "RANDOM RADIATORS", a feature of 'AR' March 1990, Ron Cook VK3AFW and Ron Fisher VK3OM described a version of the Z match tuner which used smaller-dimension coils than others documented elsewhere for this type of tuner. The Z match tuner has had the reputation of being able to match a wide range of antenna circuit impedances and the question was raised whether, in using these smaller coils, this range has been restricted or otherwise affected. This question has been the subject of my many discussions with Ron Fisher on 80 metres of a Sunday night.

I recently found that I had a need for a small but versatile tuner for field use and decided it was the time to join the Z match user's club and build a Z match unit for myself. The unit was assembled with coils made to the precise specification given by the two Rons and hence I was in a position to test this unit and assess its performance. I had previously carried out tests on a Z match unit built by Dean Probert VK5LB to a specification published in the RSGB handbook. The objective of the previous examination was to find some explanation for how the "magic box" worked and to evaluate what range of antenna impedance it could match. Some theories on how it operated and a report on its performance were published in 'AR' May 1989. Tests have now been carried out on the compact coil version, and these tests are the subject of this new article. As a reference, detail of the coil forms and the circuit diagram, as published in "Random Radiators" is repeated in figure 1.

Comparison of Specifications

To provide some idea of the differences in specifications for different version of the Z match unit, table 1 has been prepared listing coil dimensions and inductances and tuning capacitor maximum capacitances. Quite apart from the compact coil version, it turns out that even

the RSGB version is a little different from the early Z match by A W King W1CJL, published in QST, May 1955. The "Random Radiators" coils, with smaller diameter windings, have lower inductances but not to a radical extent. The loss of inductance caused by the smaller diameter is partly compensated by increasing the number of turns.

In my May 1989 article, I drew attention to the importance of the coupling coefficient between the primary and secondary of the coils. A coupling coefficient of around 0.65 provided an effect which caused a low value of secondary load resistance to be reflected as a much higher impedance at the primary. This played a large part in extending the range of antenna load resistance which could be matched. A nice thing about coupled coils in air is that the degree of coupling and hence the reflected impedance can be adjusted with minimal loss of power. (This, of course, has always been a method of controlling output coupling in valve RF power amplifiers). Bearing this in mind, I measured the coefficient of coupling of the compact version coils to make further comparison with the RSGB coils. The results were very similar to the RSGB version with $L1-L2 = 0.61$ and $L3-L4 = 0.64$.

Another factor which should be recorded is the wire gauge I used on my models of the compact coils. I used enamel wire with a diameter of 1.8mm which is fairly close to 14-gauge B&S. "Random Radiators" specified 18 SWG but I think this must be a documentation error as the wire appeared to be a heavier gauge in the photographs included.

A further factor of comparison is the range of tuning capacitance used. The maximum value of C1 in the various Z match versions varies from 300pF to 500pF. From my own experience, the precise value is not critical. An important difference is the value of C2. The maximum value specified for the W1CJL and RSGB versions is $2 \times 250\text{pF}$, but this has been increased to $2 \times 400\text{pF}$ in the

"Random Radiators" version. As we will see further on, the extra capacitance is needed to tune 3.5MHz. In my own constructed unit, a pair of two-gang 200pF variable capacitors were selected. I chose these because they had plate spacing of 0.02 inch, double that of the usual receiver tuning gang. The two halves of one gang in parallel provided 400pF for C1. As it turned out, $2 \times 200\text{pF}$ for C2 proved to be inadequate and an extra switch had to be provided to switch in extra capacity and extend the range to above 360pF.

Matching Range

To check out the matching range, a test procedure was set up similar to that I had used in previous tests. Tests were carried out at 3.5, 7, 14, 21 and 28MHz for incremental load resistances within the range of 30 to 2000 ohms. A receiver, set to the required frequency, was coupled to the output of a noise bridge. The bridge input was first connected to a precision 50 ohm resistance and the bridge arms adjusted for a balance indicated by the noise null. Taking care not to upset the bridge adjustments, the bridge input was transferred to the TX/RX connection of the Z match. The Z match antenna terminals were then connected to a defined load resistance and balance attempted (indicated by the noise null), by adjusting the two Z matching tuning capacitor dials. Assuming balance was obtained, the settings of the dials were logged. This was repeated for all load resistance increments within the range specified and at all frequencies specified. Use was made of both L2 and L4 antenna feed points as discussed in the following paragraph.

General references to the Z match unit have specified that the larger coils be used for 3.5 and 7MHz and the smaller coils for 14 to 28MHz. My previous tests on the VK5LB unit were carried out on that basis and a number of gaps were found in the tunable load range. As pointed out in "Random Radiators", a number of Z match users have observed

that a match is often obtained by using the opposite antenna connection to that defined above. In fact, the procedure adopted by the users is to check both L2 and L4 connections. If one does not match, the other probably will. My tests have verified that by using this procedure, the compact coil Z match unit can match a 50 ohm transmitter output to the tested load range of 30 to 2000 ohms resistance, at all the frequencies selected.

Figures 2 to 6 plot the capacitance of C1 and C2 which were found to give a match over the tested load range. Dial settings have been converted to absolute capacitance by calibration using the tuning capacitor reconnected to a digital capacitance meter. Output A refers to the connection via the larger coils L3-L4 and Output B to the connection via the smaller coils L1-L2.

In figure 2, plotted for 3.5MHz, we see that matching above 100 ohms is achieved using output A. However, below 100 ohms, we run out of capacitance in C1 and output B must be used. If we extrapolate the curves of output B above 100 ohms, it can be seen that some resistance above 100 ohms could be matched using either output. Examining the maximum value of C2 on the curves, we see the reason why a 2x400pF capacitor must be used rather than 3x250pF as specified in the larger coil versions of the Z match.

Figure 3 shows that 7MHz can be matched for all resistances tested using only output A. This is a different result from that obtained from previous tests using the Z match unit with the RSGB specification coils. In that case, the output A circuit appeared to have too much inductance to match over the full resistance range.

Figure 4 shows that at 14MHz all resistances tested were matched using only output B. At around 200 ohms, the capacitance value of C1 rises to near 350pF,

more than the specification of 300pF for C1 given in "Random Radiators". If that is the limiting value, it is of no great concern because, in fact, the whole resistance range can also be covered using output A with no greater capacitance in C1 than 75pF.

In using output B for 21 and 28MHz (figures 5 and 6), it was found that output B could only be used for resistance values below 200 ohms and output A had to be selected for the higher resistance range. Extrapolating the output A curves indicates that this output could also be used for some values below 200 ohms.

It must be emphasised that the tests were carried out with only a resistive load. In practice, reactance in the antenna system must also be phased out by the tuning of the Z match unit. To assess the ability of unit to also correct for a range of reactance variations, a few additional tests were carried out with reactance in series with a 50 ohm resistive load. The procedure was to connect a reactance of 1000 ohms, as an extreme value, and attempt to match the resultant complex impedance load. If the match could not be achieved, the reactance was then progressively reduced in value until it was found that a match was possible. The tests were carried out for both capacitive and inductive reactance at all the frequencies previously tested with the resistive loads. The results of the tests provided an evaluation of the reactance correction range of the tuner for the condition set up. The evaluation is given in the following table:

3.5MHz — minus 1000 ohms to plus 1000 ohms
 7MHz — minus 800 ohms to plus 600 ohms
 14MHz — minus 1000 ohms to plus 800 ohms
 21MHz — minus 1000 ohms to plus 900 ohms

28MHz — minus 900 ohms to plus 700 ohms

To achieve the match at the extreme reactance values, output A was used at 7MHz, output B at 3.5, 14 and 21MHz and both outputs A & B at 28MHz. Whilst the reactances in series with a 50 ohms resistance represent only a segment of the possible range of complex antenna impedances, the results are sufficient to indicate that the Z match unit can handle quite a range of reactive loads.

Power Loss

Any coupling device must have some power loss and one might raise a question concerning power efficiency in the Z match tuner. To put the question, what proportion of power is fed to the antenna and what proportion is lost in the matching unit. This, of course, is where the choice of wire gauge used in the coils might have a profound affect. To make an efficiency assessment for a wide range of load conditions would be a difficult task but I did carry out some tests using a 50 ohm load.

The test procedure was as follows: The transmitter was first coupled via an SWR bridge directly into a 50 ohm dummy load and set for continuous carrier. The power into the load was derived by measuring the RF current into the load. The resonant plate current in the power amplifier was carefully noted to record the loaded condition of the transmitter. The transmitter with SWR meter was then reconnected to the load via the Z match unit which, with transmitter on, was adjusted for a null in reflected power as indicated on the SWR meter. The transmitter tuning and loading adjustment was checked to ensure that the loaded plate current was the same as before. The power was again recorded and the reading compared with the previous reading as a measure of power efficiency in the Z

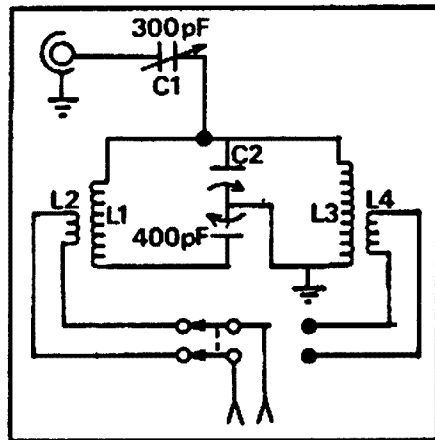
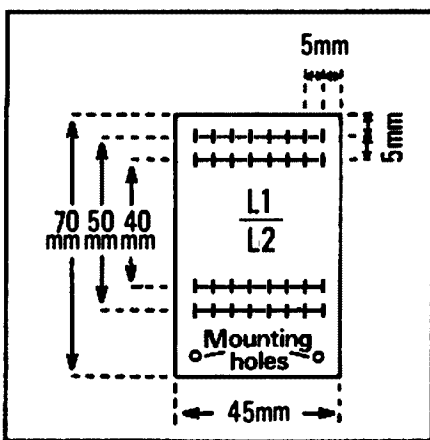
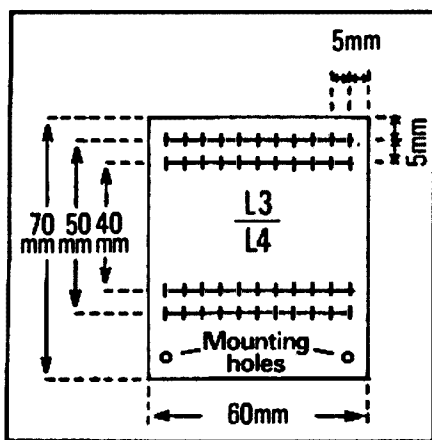

Figure 1 Compact coil version of the Z match - circuit diagram and coil forming details from "Random Radiators", Amateur Radio March 1990

match circuit. The tests, as described, were carried out at 3.5, 7, 14, 21 and 28MHz.

At 3.5 and 14MHz, there was little difference in the readings compared and loss of power was assumed to be negligible. At 7MHz the power measurement ratio was 85 per cent, and at 21 and 28MHz it was 80 per cent. The technique used can hardly be described as precision measurement but probably good enough to assess the Z match unit as having an acceptable loss factor, particularly at the lower frequencies. It would be interesting to know just how well other forms of antenna tuner would fare in being subjected to this type of test.

Features of the Z Match

I am not sure that all the features of the Z match tuner have been documented in 'AR' as completely as they might have been. I think that a summary of these features, at least as I see them, would be in order. Several writers have emphasised the ability of the tuner to match both balanced and unbalanced antenna loads. Other types of tuner are more often of an unbalanced form and to feed a balanced antenna circuit, a balun transformer is required at the tuner output. The usual type of toroidal balun unit is not suitable for high-impedance antenna loads and, for this type of load, the balun unit must be placed at the tuner low-impedance input. Following series reactive elements in the tuner must then be doubled up to retain a balanced circuit. The Z match tuner output coils provide the unbalanced to balanced conversion without these complications.

What seems to me to be another important feature of the Z match unit is that the two variable elements are capacitors which, being continuously variable, allow a precise match to be set. Other matching systems use variable inductors which have their own inherent limitations. Either the inductors must have multiple taps connected to multi-position switches or be of the roller inductor type. The switched taps inductor has the limitation that only incremental steps of inductance can be selected and a precise match is often difficult to achieve. Furthermore, from the construction point of view, quite a spider web of wiring is required between coils and switches. The roller inductor solves the problem of the incremental steps and eliminates the wiring complication but it is often difficult to obtain or expensive to purchase. Apart from that, changing bands can be a nuisance as the inductor often has to be wound many revolutions to achieve the inductance change needed.

The third feature, from the home constructor's point of view, is the simplicity of the Z match unit. Coils have to be assembled, but this is a straightforward task if constructed as recommended. I followed the instructions of first winding the wire on a smaller diameter former, as specified in "Random Radiators" and found that the resultant coil spiralled with ease into the holed formers prepared. The compact coil version of the Z match fitted easily into an aluminium box 180mm x 115mm x 158mm. This allowed considerable space between the coil assemblies and adjacent metal components such as the tuning capacitors and the sides of the box. This spacing is

necessary to minimise inductive coupling into the metal components and hence minimise absorption of RF power and loss of coil inductance. The unit, as constructed, did not include an SWR meter as shown in the photographs of the "Random Radiators" sample unit.

The last feature of the Z match unit is that, despite its simplicity, it seems to have the ability to match a wide range of antenna load impedances at frequencies covering most of the HF spectrum. Referring to our own test curves (figures 2 to 6), we have verified that the compact coil version can be matched for a load resistance range of 30 to 2000 ohms at amateur frequencies of 3.5 to 28MHz. This, of

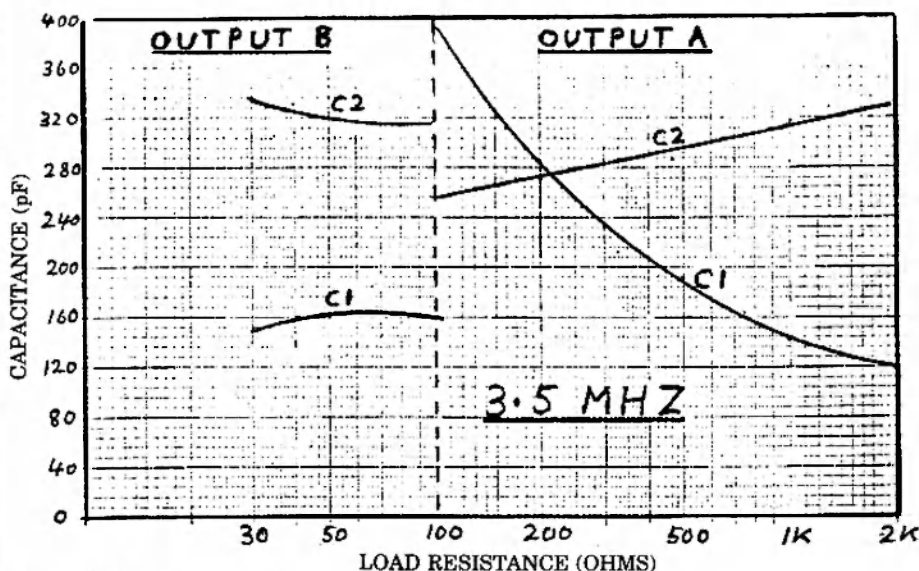

Figure 2 Matching capacitance vs load resistance 3.5 MHz

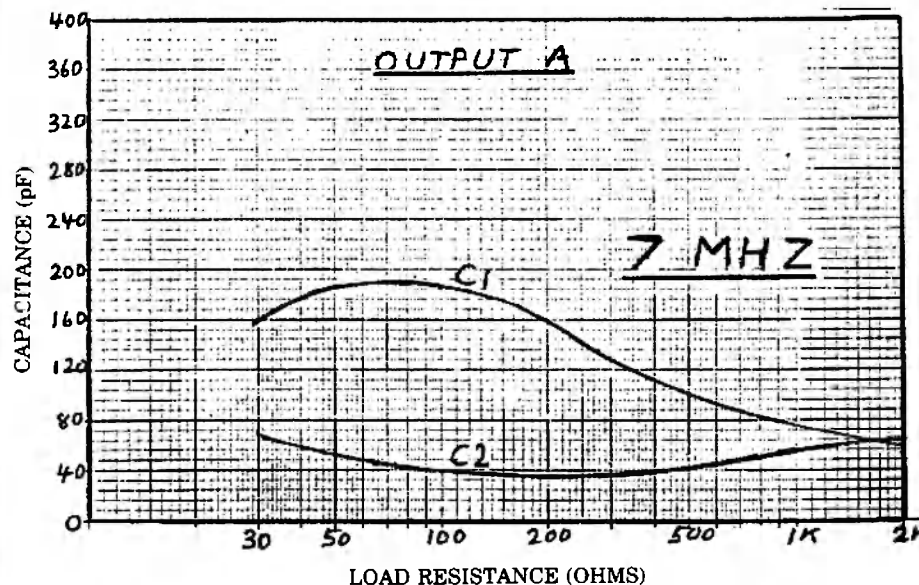

Figure 3 Matching capacitance vs load resistance 7 MHz

course, is provided the output circuits are switched as shown in the curves to suit the particular load resistance. Extrapolating the curves beyond 30 and 2000 ohms, a wider resistance range could be envisaged. Furthermore, additional tests have shown that the Z match unit can also cope with a wide range of reactive values in the antenna load.

Tuning

Generally speaking, a match is achieved by adjusting the two capacitors, one after the other a number of times, until either the best SWR is achieved with transmitter carrier on or, if using a noise bridge, a noise null is detected in the receiver. I have found that the result can be improved by then shifting C1 a little, one way or the other off what appears to be the best adjustment and then readjusting C2 for best SWR or noise null. A little experimentation with C1 moved one way or the other can produce a precise match.

The Z match tuning, for a good match, is fairly critical and a five-to-one vernier dial attached to each capacitor shaft makes tuning easier. The reduction drive also assists in locking the setting of the capacitor; a very useful function in mobile applications.

Conclusions

The tests confirm that, provided both output circuits are used at will over the whole frequency spectrum, the compact coil version of the Z match tuner (as described in "Random Radiators") can match a wide range of load impedances at frequencies inclusive of 3.5 to 28MHz. All of this has been well supported with practical results obtained by others in the field. However, it is nice to be able to specify the performance in more precise terms from measurements obtained at the test bench.

Further tests have indicated that there is no great problem of power loss in the tuner. Using the receiver type tuning capacitors (as specified), there might be a problem of arcing across the plates if high power were applied. If a high power linear amplifier were to be used, capacitors with greater plate spacing would be called for and, at 400pF maximum capacity, might be difficult to procure. As pointed out in "Random Radiators" there is no arcing problem with the receiver type tuning gangs if power is limited to 100 watts PEP.

The tuner can be made as quite a compact unit, suitable for use both at home and in the field. It is simple to assemble and as a construction project, well within capabilities of most radio amateurs. For more information on its construction, refer to the excellent de-

(Continued on page 25)

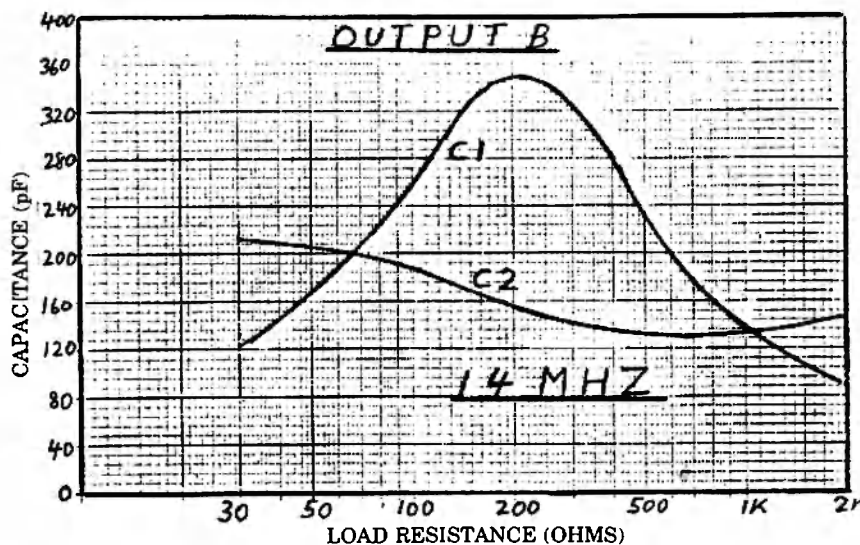

Figure 4 Matching capacitance vs load resistance 14 MHz

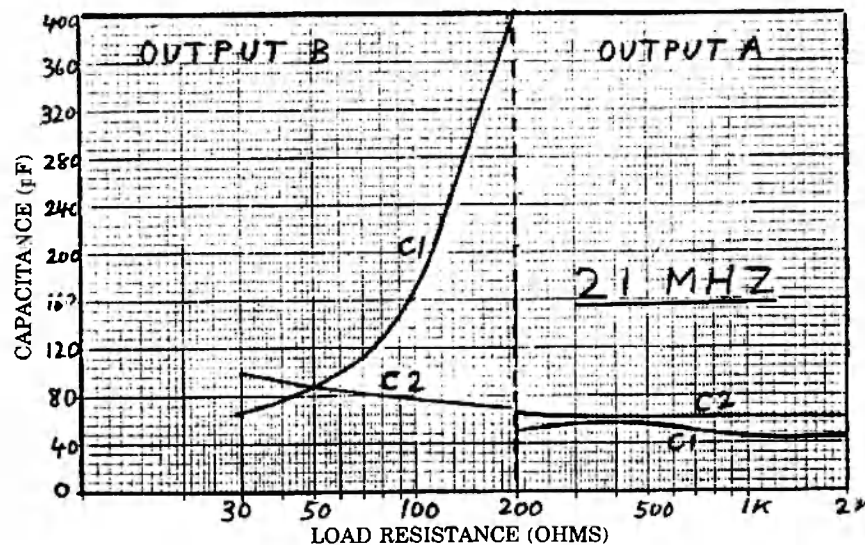

Figure 5 Matching capacitance vs load resistance 21 MHz

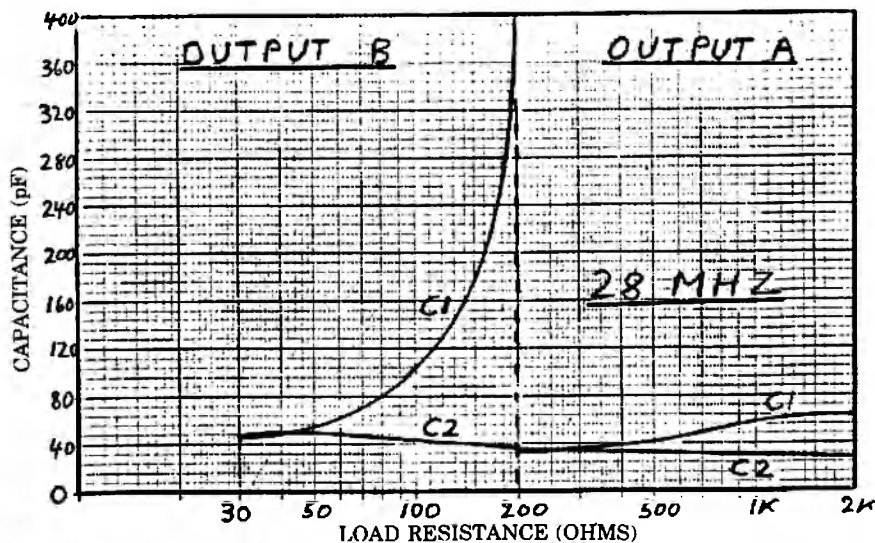

Figure 6 Matching capacitance vs load resistance 28 MHz

HARRY ATKINSON VK6WZ — THE WIZARD OF WORDS

JOHN HAWKINS VK6HQ
39 GLYDE RD
LESMURDIE 6076

IF YOU'VE TUNED to the West Australian WIA news broadcast at 0130Z on Sunday mornings you must have noticed a certain professionalism in its presentation. This is no happy accident. Harry Atkinson VK6WZ is a former commercial radio announcer.

Harry, nevertheless, is the first to acknowledge that his WIA predecessor, Douglas VK6ZMG, did more to change the shape, sound and format of the WA broadcast than anyone else in 'living memory'. 'Living memory' for Harry reaches back 50 years to when he and two other stalwarts in turn cycled their ways to broadcast combined Morse practice/news bulletins from a second-floor room, corner of Hay and Milligan Streets, Perth.

The brown envelope authorising Harry to use the call VK6WZ landed in his letterbox circa 1937. Reminiscing, Harry says that crystal control was preferred at that time. Most new VKs saved for at least one crystal on each of the 80 and 40m bands. There wasn't a lot left over for fancy components — his first super-regenerative receiver even sported a wooden baseboard and a sheet steel panel. That didn't stop it performing well and led to projects like a one-valve TX using a gold-painted E415 tube by Philips. The input on 7MHz was a "mitey" 1.5 watts which fed into an SWF (single wire fed) antenna, akin to the Windom. Harry says that on winter evenings many a solid AM fone contact from Victoria Park to the eastern States was enjoyed.

Going back a bit, Harry's first job was compiling a magazine called *Wireless News*, but the Depression set in, hard times bit and work dried up. Eventually, however, he moved into a long association with commercial radio, commencing in 1939 with 6GE Geraldton. It was with 6GE that a touch of VK6WZ innovation, coupled with assistance from the Australian Comforts Fund, enabled scores of tiptoeing, heavily booted soldiers to say a few words to mums and dads over the radio before embarking for service overseas. Messages were piped live by landline to Perth where they were cut directly on to 16" discs then despatched under plain white labels to eastern States broadcast stations for transmission. Due to censorship rules listeners were not

permitted to know where the participants were at the time of recording, or whence they were bound.

Another VK6WZ first came about through the importation of an up-to-the-minute 12V to 240-VAC 50Hz inverter from the USA. Harry seized the opportunity to exploit the new technology and record an interview while both he and the client were being driven in a car. The client was the wife of the local Ford franchise holder and the interview took place in the back seat of the latest from Henry T. "We were able to get a very good mark-up on that ad," quipped Harry, "as historically it had never happened before in WA."

Harry was at 6GE for 16 years, excluding a spell in 1941 with 6KG Kalgoorlie as senior announcer. Facilities at 6KG were somewhat primitive in those days. For a start, there was no separate area where the manager could interview clients. Worse of all, equipment had to be homebrewed to cope with 220VDC mains! Two inverters hummed constantly in the roof space so that at least some, AC only, equipment could be run, but the turntables, acquired from the film industry, were about as quiet as shearing ma-

chines, and the mike just had to be 'killed' before a record could be started up. Even the strobes wouldn't work with the DC lighting.

Nineteen-fifty-five was a very good year for Harry when he took over a brand new station, 6VA Albany, and managed it for two years, glad of the state-of-the-art equipment.

Between 1958 and 1978, VK6WZ went QRT so far as commercial and amateur radio were concerned, focusing his talents on his own business in Albany town. Ties with audio were not altogether severed, as the business sold records, hi-fi and a custom-disc-cutting service.

Between 1967 and 1970 Harry returned for a brief stint at 6WB Katanning, and once more to 6VA. But, apart from a spot of volunteer announcing work with 6NR's "University of the Third Age", Harry retired, once and for all(?), in January 1980.

Once his business operations had ended, the rig was dusted off and there was time again to play amateur radio. Harry discovered that while he had been gone the hobby had metamorphosed. AM was OUT; SSB was IN. Homebrewing was less in evidence; rigs were becoming

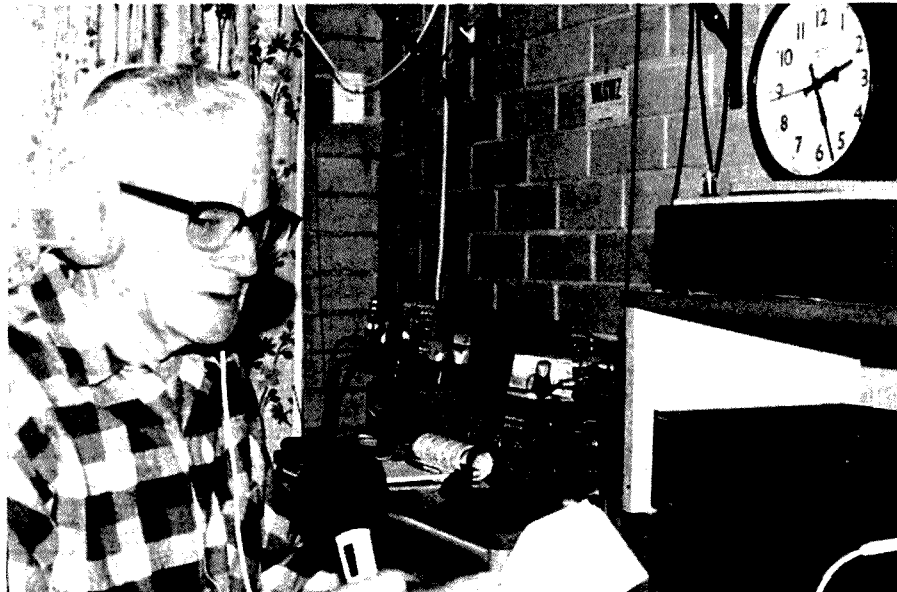

Harry Atkinson VK6WZ, pictured at his rig.

readily available 'off the shelf'. Two-metre FM was also very much IN, which led, in due course, to Harry's involvement with the news broadcast.

Starting as early as Thursday and with a view to putting the finished program 'to bed' by PM Saturday at the latest, Harry compiles a heady half-hour of news and views for radio amateurs and shortwave listeners. Included are edited WIA lectures (especially for those who can't get to meetings), contributions from the clubs, WIA Federal news, diary notes, ionospheric information (in season) from Miles VK6ZRY and the WA disposals service, courtesy Roy VK6XV.

Whilst he can sometimes be heard on fone or CW, and occasionally viewed in person contemplating a claret at old-timers' meetings, Harry donates a fair bit of his time to the broadcast. My visit to Harry's "Tadis" type studio at the small unit in Mount Lawley was an eye-opener, and I use the metaphor advisedly. Whilst the quality of the broadcast hints not at the effort required, Harry has a severe

vision handicap with which to cope, and is legally blind.

The broadcast is always scripted using a large-print typewriter, then transposed via an AKG mike to a Marantz cassette tape recorder. This is done away from the transmit area for two reasons. Firstly, the Ferrograph reel-to-reel tape deck used for break signs, test signals etc, together with the "Optolec" view, take up too much lounge room space and, secondly, acoustics in the bedroom are enhanced by absorption by pillows and blankets!

The "Optolec" viewer, incidentally, comprises a black and white shop surveillance TV camera fitted with a zoom lens looking down upon an adjustable roller-table. Print placed on the table is magnified something like 40 times and comes up on the screen of a 25" TV set alongside.

Future plans? Well, much depends on what the Institute decides, but Harry foresees some news input into digital modes. He has reservations about the televising of WIA broadcasts but it very

much in favour of the videotaping of WIA lectures and the airing of some of the audio component. Harry observes that repeater linking will eventually place good-quality transmittable 'copy' into remoter areas and extend the range of the broadcast.

I asked Harry if he had any idea of the number of broadcast listeners he has. He said he could only guess, but "in the trade", one letter received indicated about 100 listeners. As the call-backs on Perth Channel 2 repeater alone average 75 each week, and do not take into account relays as far-flung as Alice Springs, Harry's listening public must be quite substantial.

If you're reading this, the chances are there is at least one WA WIA broadcast source to which you could tune. A list of frequencies can always be found in 'AR'. Give Harry a call. Get a message back to the 'old pro', but don't tell him I put you up to it!

ar

Tests on the Compact Coil Version of the Z Match Antenna Tuner (Continued from page 23)

scription given in "Random Radiators", reference 1.

In this final paragraph I draw attention to the fact that there are commercially made versions of the Z match unit. It would be interesting to know how they compare in terms of the coil specifications and the size of tuning capacitors. If you have such information, it might be interesting to send it in to 'AR', perhaps to the two Rons for their popular column.

References

1. Random Radiators — Ron Cook VK3AFW & Ron Fisher VK3OM — *Amateur Radio*, March 1990
2. King A W W1CJL — The Z Match Antenna coupler *QST*, May 1955
3. *RSGB Handbook*
4. Lloyd Butler VK5BR — Analysis of the Z Match Antenna Tuner — *Amateur Radio*, May 1989
5. Dean Probert VK5LB — A Z Match Antenna Tuner — *Amateur Radio*, May 1989

Table 1

Comparison of Z Match Specifications

Allen W King W1CJL *QST*, May 1955

Winding	Diam	Turns	Length	Inductance*
L1	52.4mm	5.5	41.3mm	1.26µH
L2	66.7mm	4.75	12.7mm	2.31µH
L3	52.4mm	7.75	31.8mm	2.93µH
L4	66.7mm	6.5	15.9mm	4.03µH

Tuning Capacitors C1=340pF, C2=2x250pF

Winding	Diam	Turns	Length	Inductance*
L1	63.5mm	5	25.4mm	1.84µH
L2	76.2mm	5	25.4mm	2.4µH
L3	63.5mm	8	44.5mm	3.5µH
L4	76.2mm	6	31.8mm	3.1µH

Tuning Capacitors C1=500pF, C2=2x250pF

Random Radiators — *Amateur Radio* March 1990

Winding	Diam	Turns	Length	Inductance*
L1	40mm	7	30mm	1.57µH
L2	50mm	6	25mm	1.85µH
L3	40mm	10	45mm	2.52µH
L4	50mm	7	30mm	2.28µH

Tuning Capacitors C1=300pF, C2=2x400pF

*Inductance calculated from Wheeler's formula

ar

COPIES OF ARTICLES

Photocopies of any article published in a back issue of AR available to members at \$2.50 each (plus \$2.00 for each additional issue in which the article appears)

AR ARTICLES PO Box 300 Caulfield South Vic 3162

VNG — HOW TO USE IT

QUINTIN FOSTER
77 CHURCH ST
BEAUMARIS 3193

WE HAVE ALL HEARD VNG, a time signal and standard frequency station at Llandilo, New South Wales, beeping away on 5, 10 and 15MHz, but do we use it to the best advantage?

The purpose of this article is to explain how the time signals are arranged to show the day of the year, the hour (UTC) and the minutes of the hour.

Details of VNG transmissions and the time-code format are given below. VNG's emission is double-sideband full-carrier amplitude modulated telephony, so a simple short-wave receiver is all that is needed to receive the signals.

The time-signal information is transmitted using a basic 1000Hz tone of varying lengths. These tones as shown in the time-code format are:

- 500ms — Minute pulse
- 200ms — Second marker No 20 — designates the start of the time information. Also used for binary '1'.
- 100ms — Binary '0'
- 50ms — Seconds marker (not part of BCD time code)
- 5ms — Seconds marker 55-58, or seconds marker 50-58, during 5th, 10th, 15th etc minute.

For most practical purposes we listen to these time signals so, first of all, we should be able to identify the different signals in way as we do with the Morse code.

The first signal to identify is the long minute pulse of 500ms. Listen for this several times and then, using the time-code format, count down to No 20 to identify the seconds marker 20. Then count through the minute, hour and day of year signals until you come to four distinct "toc" sounding signals just before the minute pulse. If it is the 5th, 10th, 15th, 20th etc minute you will hear nine "tocs", not four, before the minute pulse.

Follow this routine, using the time-code format, for several minutes until you can positively identify the minute pulse, seconds marker, minute-hour-day-of-year section (more details later) and the toc signals.

The figure shows the time signals for day 156, hour 0600 UTC, next minute 15.

- In the minute section, the
- 21st second marker is a binary 1 = 1
 - 22nd second marker is a binary 0 = 0
 - 23rd second marker is a binary 1 = 4
 - 24th second marker is a binary 0 = 0
 - 25th second marker is a binary 1 = 10
 - 26th second marker is a binary 0 = 0
 - 27th second marker is a binary 0 = 0

The 28th second marker is a binary 1 and is a parity bit. Counting binary "ones" plus the corresponding parity bit gives an even number (in this case, 16).

A simple way of identifying the signals is to write a dash for a long signal (200ms, binary 1) and a dot for binary 0 (short signal, 100ms) under the appropriate second marker, then add up the values given to each binary 1 as shown above.

- Similarly, in the hour section the
- 29th second marker is a binary 0 = 0
 - 30th second marker is a binary 1 = 2
 - 31st second marker is a binary 1 = 4
 - 32nd second marker is a binary 0 = 0
 - 33rd second marker is a binary 0 = 0
 - 34th second marker is a binary 0 = 0
 - 35th second marker is a binary 0 (parity bit)

Likewise, the day-of-the-year section equates to the 156th day of the year — 5 June.

As the minute is the 15th past the hour you will hear nine "tocs" before the minute pulse and the time then will be 5 June 0600 UTC plus 15 minutes.

It is a good idea to have a timepiece which shows the correct time, more or less, so that you will have a fair idea of what the time should be when you are dividing the minute, day and hour sections until you feel confident that you can get it right. Of course you can check your time by waiting until you hear:

- a) the voice announcement just before the hour, and then every 15 minutes;
- b) the nine "tocs" which indicate the 5th, 10th, 15th etc minute. There are no time pips on 15 and 10 MHz during the 9th, 10th and 11th minutes, and also from the 46th to the 52nd minutes inclusive. Good use can always be made of the carrier-only period for alignment and frequency checking purposes.

Note: The continuation of Government funding for VNG is dependent on contributions from users. If you wish to help, write to: VNG Users Consortium, GPO Box 1090, Canberra, Act, 2601.

6

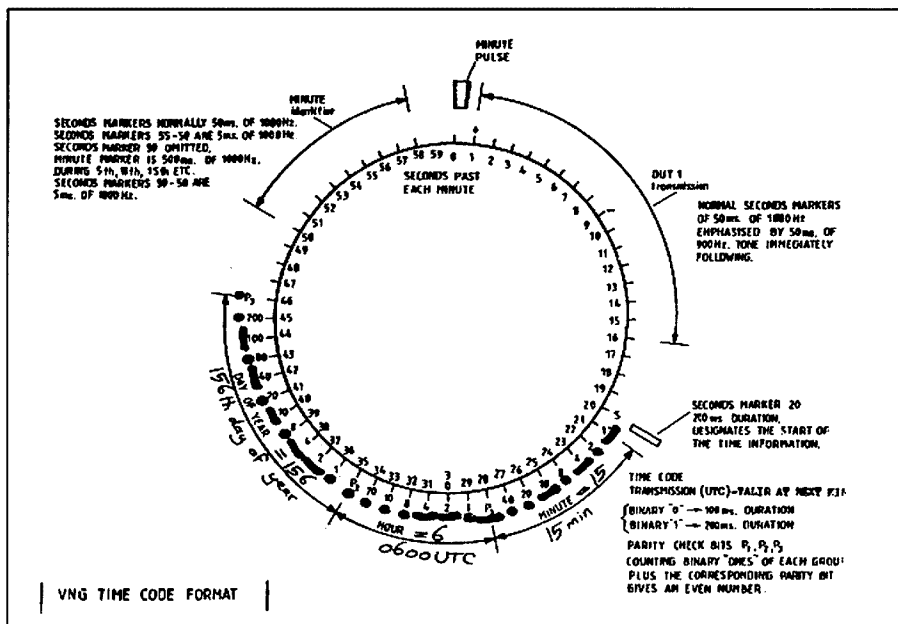

DXPEDITION — CONWAY REEF

STEPHEN PALL VK2PS
PO Box 93
DURAL NSW 2158

IT WAS IN LATE JULY, in the afternoon, in 1989. As usual, I was checking the band and propagation conditions, moving along with the dial on 21 MHz. Suddenly, on 21295, I heard a strong signal and an interesting QSO which was between a European station and a 'maritime mobile' in the South Pacific. DXers usually do not chase maritime mobile stations, as a QSO with such a station cannot be used for DXCC purposes, even if the callsign used by the marine operator is a very exotic one. This QSO was different. The discussion between the two stations indicated that a group of mostly German radio amateurs, DJ6SI Baldur, DJ6JC Henry, DK2WV Karl and Vince K5VT were on their way to Conway Reef for a short DXpedition.

Conway Reef—the Fijians call it Ceva-I-Ra, the 'island of the south and west'—belongs to Fiji, and lies about 300 miles in a south-westerly direction from Fiji's main island, Viti Levu. (21°44' south 174°38' east). It is a coral reef of about 2400 metres in length, and the highest point of the reef is about 1.5 metres (five feet), a 900m long sandbank with very sparse and weatherbeaten vegetation. The many shipwrecks around the reef are witness to the strong and treacherous conditions of the seas and to the ship navigators of the past who lost their way around this part of the South Pacific.

Conway Reef was discovered in 1838 by an Englishman named Drinkwater Bethune, who was the captain of the British ship "Conway". Henry Mangeles, who commanded the British surveyor ship "Herald", visited the reef in 1856. The reef is now part of Fiji and, after Fiji gained independence, it was renamed Ceva-I-Ra in 1976.

But, back to our maritime mobile radio amateurs, who were on their way to this tiny speck of sand on the sailing boat "Seax of Legra". The trip to the reef took three days from Suva. Landing on the reef was quite difficult due to the breakers. The landing took part in small rubber/plastic inflatable boats, but they made it in several trips without mishap. With the help of some driftwood found on the reef, and plastic sheeting, a real open-ended 'shack' was created which housed the radio equipment and gave limited protection against the frequent rain squalls which plagued the expedition during their 88 hours of stay on the reef.

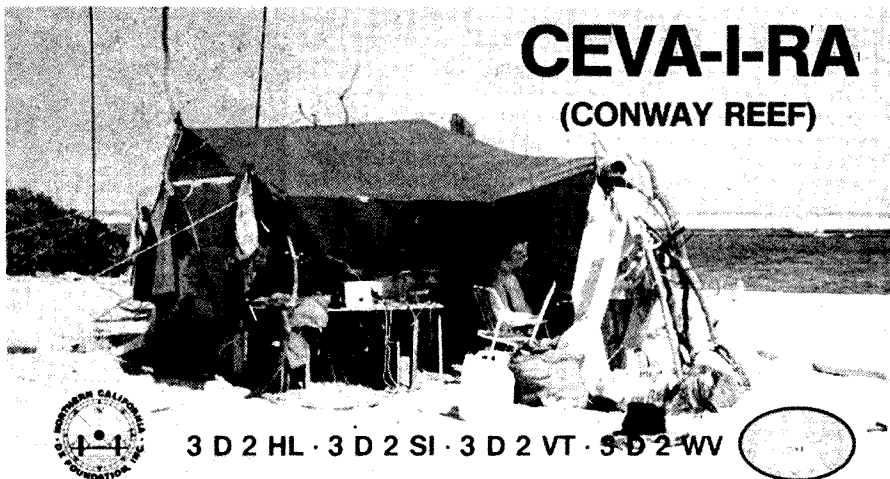

The DXpeditioners busy on the island

Soon after landing, there was a hive of activity to establish the three transmitting stations and get the generators going. The expeditioners used their individual callsigns, 3D2HL, 3D2SI, 3D2VT and 3D2WV, and they were operating on the usual DX bands in the SSB, CW and RTTY modes. The expedition was well equipped: three 900W generators for power, three IC-735s, automatic antenna tuners, Ten-Tec Corsair transmitter and FT757 as a reserve transceiver, amplifiers, and even a miniature distress rig for 15 metres. The main antennas were a two-element Fritzel-beam, a 10m high fibreglass quarter vertical for 7 MHz, and another 12m high fibreglass mast for a random antenna, a Butternut for 40, 80 and 160 metres and, of course, all other wires, cables and necessary odds and ends.

During the three and a half days, the expedition made 6000 SSB QSOs (DK2WV and K5VT as 3D2WV and 3D2VT), 7000 CW contacts (DJ6SI and K5VT as 3D2SI and 3D2VT) and 1000 RTTY contacts (DJ6JC as 3D2HL). The approximate regional distribution of QSOs was as follows: Japan 35 per cent; North America 40 per cent; Australia/New Zealand 15 per cent; Europe and others 10 per cent.

On the third day the sun finally came out from the rainclouds and shone on the weary, sleepless, wet group of amateurs. During the short stay the boat "Seax of Legra" lay at anchor at a safe distance from the reef and supplied the four operators and Frank, the generator mechanic (a non-amateur expedition member), with one hot meal per day, using the inflatable

boats for transport.

Every good thing, even a DXpedition, comes to an end. After 88 hours of operation, and satisfied with its success, the group headed back to Suva, which took four days. They travelled from Suva via the USA back to Germany, with a short break to attend a DX party in their honour in W6.

The sudden appearance of the July 1989 Conway DXpedition took the amateur world by surprise, as there was practically no advance publicity. The expedition had to be put together at very short notice, as the timing was dependent on Vince K5VT, who had some difficulty obtaining a short leave from his responsible position as a well-known Phoenix, Arizona, surgeon. For those who want to know even more personal details: the members of the expedition financed the trip themselves to the tune of DM6500 each, which equals roughly \$A5200 each.

The first DXpedition to Conway Reef took place a few months before, in April 1989. The German group DF3KX, DF9KH, DJ9ON, DK9KX and DL8CM operated from Conway under the callsign 2D2CR.

Conway Reef has now been accepted as a new DXCC country on the grounds of the distance from Fiji's main island, and QSL cards are now accepted by the ARRL for DXCC purposes as from 1 March 1990.

Finally, I would like to thank Karl DK2WV, who was kind enough to supply the information without which this report would not have been possible. ar

BIG SAVINGS... BIG BONUSES...



2 year warranty

FT-212RH 2M FM MOBILE TRANSCEIVER

With 45 watts output over the 144-148MHz range, a rugged diecast chassis for superb RF isolation, extensive use of surface mount components, and a large back-lit LCD with bargraph PO/S-meter, the FT-212RH is an ideal mobile FM transceiver that also doubles as an easy to use base station. Features include 5 selectable tuning steps, a total of 21 memories (18 general purpose, one CALL-channel, and 2 sub-band limit memories for band scanning), in-built C.T.C.S.S. encode, as well as a variety of scanning functions. The FT-212RH comes with a mobile mounting bracket, convenient MH-14A8 microphone, and DC power lead. Cat D-3494



BONUS D-4207 2M $\frac{5}{8}$ mobile antenna
D-4050 UHF base and lead set

SAVE \$33.90 **\$539**

2 year warranty

ALL MODE TRANSPORTABLE TRANSCEIVERS

The all-mode, transportable transceiver for serious field or mobile operations! The FT-290RII and FT-690RII feature FM, SSB (USB/LSB), and CW operation with 2.5W or 250mW switchable output power, twin VFOs, and 10 memories that store mode and simplex or repeater frequencies. Selectable tuning rates are provided for SSB/CW and FM, while mode specific features such as a noise blanker and clarifier control for SSB/CW, plus a full set of functions for FM repeater operation make these units very simple to operate. Each unit comes with an FBA-8 battery holder for nine C size standard or NiCad batteries (not supplied), antenna, and handheld microphone.

FT-290RII with flexible rubber antenna covers 144-148MHz.

Cat D-2875

BONUS D-4333 2M $\frac{5}{8}$ telescopic antenna worth \$39.95



\$749

CLEARANCE PRICE!

FT-690RII with telescopic whip antenna covers 50-54MHz.

Cat D-2874 LIMITED STOCK

\$699

2 year warranty

FT-4700RH DUALBAND MOBILE FM TRANSCEIVER

Features 50 watts output on 2 metres (144-148MHz), and 40 watts output on 70cm (430-450MHz), with an inbuilt cooling fan for long term reliability. Full-duplex crossband operation or dual-band reception modes are provided, so you can listen for calls on both bands simultaneously, or work someone on one band while also listening on the other band. The **bonus** YSK-4700 extension cable allows the main body of the transceiver to be installed remotely, while the front panel mounts conveniently on the dashboard.

On the front panel the amber back-lit LCD shows both VHF and UHF frequencies and signal strengths, and all controls are back-lit for clear readability, with a dimmer switch for nighttime viewing. A total of 20 memories and 5 selectable tuning steps make frequency selection easy, while the advanced scanning features allow quick detection of signals on either, or both bands. See ARA review Vol. 12 Issue 11 (Feb 1990), or A.R. review May '89.



\$999

D-3300

BONUS YSK-4700 extension cable worth \$49.95!



TRANSCEIVERS TO GO!

Ultra Compact - Rugged Construction - Superb Performance!

FT-23R 2M TRANSCEIVER

Superb performance on the 2m band with all the reliability you know you can expect from Yaesu. The FT-23R is tiny in size, only 55mm x 32mm x 139mm, yet this handheld packs more punch than you'd believe possible.

It's fully micro-processor controlled with 10 memories (7 memories store non-standard shifts), standard repeater splits (inc reverse function) pushbutton or manual scanning (busy/memory/priority), 1MHz up/down stepping, up to 5 watts output (with 12V DC) and more.

You get full 144 to 148MHz band coverage in the palm of your hand with rugged die-cast transceiver casing and rubber gaskets seals for reliable long-term operation. Supplied with high capacity 600mAh FNB-10 NiCad battery giving 2.5W output, AC charger, mini rubber-duckie antenna and carry case.

Cat D-3490

2 YEAR WARRANTY

Only **\$329**

2m & 70cm In One!

THE AMAZING FT-470

Hand held performance at its best! The FT-470 represents the pinnacle of high-tech design in compact hand helds providing both 2m and 70cm coverage in one transceiver. With 2.3 watts output on the 2m and 70cm bands, the latest multi-tasking microprocessor control allows a high degree of flexibility... in fact, several functions can be performed simultaneously - including 'dual-band' reception, as well as 'full duplex' operation! That's right, you can be talking through your local 2m repeater and scanning channels for your next 70cm contact at the same time.

There are also 21 tuneable memories and 2 VFO's per band, plus inbuilt C.T.C.S.S. (Tone Squelch, encode/decode) with a paging facility, a variety of scanning facilities, LCD display showing 5.5 frequency digits on both bands at the same time, and an LCD bargraph signal/P.O. meter. The programmable 'power saver' system helps maximize battery life, and frequency selection via tuning knob or direct keyboard entry is a standard feature. Comes complete with an ultra long-life 1000mAh NiCad battery pack, carry case, dual band antenna, and an approved AC charger.

Why buy 2 hand-helds when you can have everything in one?

Cat D-3360

See A.R.A review Vol 12, Issue 5, or A.R. review Aug '89 issue.

2 YEAR WARRANTY

Just **\$699**



MAJOR DICK SMITH ELECTRONICS AUTHORIZED STOCKISTS:

N.S.W.: ARMIDALE: New England Electronics 711655 BALLINA: Ballina Electronics 867022 BOWRAL: F.R.H. Electrical 611861 BROKEN HILL: Hobbies & Electronics 884098 COOTAMUNDRA: Cootamundra Music & Lite 422561 COFFS HARBOUR: Coffs Harbour Electronics 525684 DENILIQUIN: Deni Electronics 813672 DUBBO: Cnrs s Hi Fi 828711 FORSTER: Forster Village Electronics 545006 GLEN INNES: John Sommerlad Electronics 323661 GRAFTON: Repairs and Spares 421911 GRIFFITH: Micronics 624534 INVERELL: Inverell Electronics 221821 LEETON: Leeton Audioelectronics 532800 LIGHTNING RIDGE: Cycle & Sound 290579 LITHGOW: Doutry Photographics 513173 LISMORE: Uesco Electronic Services 214137 MUDGEE: Moore Electronics 522091 MUDGEE: Headware 723695 NARRABRI: Namco Computer Service 923274 NELSON BAY: Nelson Bay Elect & Hobbies 813685 NOWRA: Nowra Electronics 210722 ORANGE: Central West Electronics 626491 PARKES: Strad Music Centre 623366 PORT MACQUARIE: Hastings Computer Service 834574 YAREE: Brads Electronics 526603 WAGGA WAGGA: Philips Electronics 216558 YASS: Warrington Electrical 261116 YOUNG: Keith Dones Electronics 821279 VIC: BAIRNSDALE: LH & LM Crawford 525677 COLAC: Colac Electronics 312847 MILDURA: Pullinan Auto Pro 232882 MORWELL: Morwell Electronics 346133 SHEPPARTON: Andrew Guyatt Electronics 219497 SWAN HILL: Ivah District TV Service 329303 WARRAGUL: Roylane 234255 WARRNAMBOOL: Korot St Elec Services 627417 QLD: Ayr: Delta Electrix 831586 BUNDABERG: Bob Elkin Electronics 721785 CALOUNDRA: Electro-mart 918533 DYSART: Dysart Videotronics 582107 INGHAM: Masons Electronics 763188 MACOKAY: Stevens Electronics 511723 MARYBOROUGH: Keller Electronics 214559 MARRBORJ: Harbour Electronics Shop 411604 PIALBA: Keller Electronics 283749 TAS: BURNIE: Electronic City 314760 DEVONPORT: A.I. Electronics 248322 WA: MT GAMBIER: Hutchesson's Communication Centre 250400 PORT LINCOLN: Basshams TV & Comp World 822788 WHYALLA: Eyre Electronics 454764 WA: ALBANY: Micro Electronics 412077 BUNBURY: Micro Electronics 216222 GERALDTON: Batavia Lighting & Tometek 211966 KARRATHA: Oaves Oscimtron 854836 MANDRAH: Micro Electronics 5812206 PORT HEALAND: Ivan Tomek the Elect 732531

FT-1000 TRANSCEIVER



FT-1000 DELUXE HF ALL MODE TRANSCEIVER — *The Best Of The Best!*

Attention all serious HF operators! To be a truly WORLD CLASS operator during these times of crowded band conditions, you've got to have a truly WORLD CLASS RIG... And of course we're referring to the YAESU FT-1000.

The FT-1000 is the product of 3 years intensive research and development at YAESU. The result is a deluxe HF transceiver that is highly reliable, yet fully featured and easy to use. It's bound to blow away your competition with it's spectacular combination of power, performance, and operational flexibility!

COMPARE! Direct Digital Synthesis (DDS) —

Two 10 bit DDS plus three 8 bit DDS provide fast lock-up times. Using DDS results in a cleaner transmission and much improved receiver performance over systems using traditional PLL designs. For digital mode enthusiasts, the use of microprocessor controlled Digital Synthesized Keying (DSK) provides performance far ahead of traditional FSK or AFSK systems.

Higher RF Output Power — Continuously adjustable output from 20 watts to a mighty 200 watts is under your control. The built-in heavy duty AC power supply and blower allow high duty cycle transmissions to take place quietly and efficiently. An automatic antenna tuner with 39 memory settings is a standard feature on the FT-1000.

Dual Channel Reception — Utilising independent VFOs and digital displays, reception can be in different modes, on different frequencies, with different IF bandwidths. An optional Bandpass Filter Module (BPF-1), for the Sub-receiver will allow cross-band dual-recvie using two antennas.

Ultra-High Performance Receiver — High sensitivity all mode coverage from 100kHz to 30MHz with a dynamic range of up to 108dB. Selectable second IF crystal filters for the following bandwidths are fitted as standard: 6kHz, 2.2kHz, 1.8kHz, 500Hz, 240Hz. The QRM rejection systems include cascaded

sharp IF filters, IF Width and Shift controls, IF notch filter, a variable noise blanker, and CW audio peaking filters. A range of optional third IF (455kHz) crystal filters can also be installed for the ultimate in receiver skirt selectivity. (available Dec. 90)

2 Year Warranty — A world class transceiver should be covered by a world class warranty. That's why we provide a comprehensive 2 year parts and labour warranty on every Yaesu transceiver we sell. Don't YOU settle for less!

Price — Compare with the opposition and get a pleasant surprise. At \$4995, the FT-1000 offers the best value for money, as well as the best support. No wonder YAESU call the FT-1000 'The Best of the Best'!

See A.R.A. review in Vol.13 issue No.2 and A.R. review in August 1990 issue. Copies of these reviews plus the YAESU 12 page colour brochure are available on request by phoning: (008) 22 6610 or (02) 888 2105

Options.

D-3210	BPF-1 Band Pass Filter	\$169
D-3215	TCXO-1 +/- 0.5ppm Oscillator	\$199
D-3220	DVS-2 Digital Voice System	\$299
D-3230	SP-5 External Speaker with Filter	\$199

\$4995*

Cat D-3200

* Includes bonus MD-1 desk microphone

Limited Stocks due Dec — place your orders now and beat the price rise!



Beat the Price Rise!

FT747GX HF TRANSCEIVER

Now is the time to enjoy the excellent HF band conditions with Australia's best value entry level HF transceiver! The FT-747GX is a compact SSB/CW/AM and (optional) FM mobile transceiver that provides 100 watts P.E.P. output on the 1.8-30MHz Amateur bands, and general coverage reception from 100kHz to 30MHz. It features a front panel mounted speaker, a large back-lit LCD display, dual selectable tuning steps for each mode, dual VFOs for split frequency operation, and 20 memory channels. A wideband 6kHz AM, and narrow 500Hz CW crystal filter are fitted as a standard feature, and an MH-1 hand mic is also supplied.

Cat D-2930

2 YEAR WARRANTY

\$1099



FT-767GX BASE-STATION MULTIBAND TRANSCEIVER

The FT767GX is the ONLY transceiver that offers such a high level of performance on all HF amateur bands, as well as on the 6m, 2m, and 70cm bands. Features include all amateur band coverage from 1.8 to 440MHz (100W max HF, 10W max VHF/UHF), all mode operation on all bands (SSB, CW, AM, FM, FSK), HF receiver covering 100kHz to 30MHz with up to 104dB dynamic range, inbuilt AC power supply, inbuilt automatic HF antenna tuner, digital wattmeter and auto-calculating SWR meter. Also includes bonus hand-held MH-1 microphone.

Cat D-2935

2 YEAR WARRANTY



\$3295

HF, 6M, 2M, 70CM

YAESU ACCESSORY ITEMS

For current model hand-helds eg. FT-23R, FT-411, FT-470

Cat D-3498	PA-6 DC Adaptor/Charger suit FNB-9/10/14	\$39.95
Cat D-3496	FNB-11 12V 600mA/H NiCd — provides 5W output	\$99.00
Cat D-3351	FNB-14 7.2V 1000mA/H high capacity NiCd	\$99.00
Cat D-3355	CA-2 Desk Charging stand — use with plugpack charger	\$39.95
Cat D-2115	MH-12A2B Speaker/Microphone	\$49.95

Yaesu stock not held at all stores.
Please contact your local store for details.



NSW • Albury 21 8399 • Bankstown Square 707 4888 • Blacktown 671 7722 • Brookvale 905 0441 • Bondi 387 1444 • Campbelltown 27 2199 • Chatswood Chase 411 1955 • Chullora 642 8922 • Gore Hill 439 5311 • Gosford 25 0235 • Hornsby 477 6633 • Hurstville 580 8622 • Kotara 56 2092 • Liverpool 600 9888 • Maitland 33 7866 • Miranda 525 2722 • Newcastle 61 1896 • North Ryde 878 3855 • Parramatta 689 2188 • Penrith 32 3400 • Railway Square 211 3777 • Sydney City 267 9111 • Tainworth 66 1711 • Wollongong 28 3800 • **ACT** • Belconnen (06) 253 1785 • Fyshwick 80 4944 • **VIC** • Ballarat 31 5433 • Bendigo 43 0388 • Box Hill 890 0699 • Coburg 383 4455 • Dandenong 794 9377 • East Brighton 592 2366 • Essendon 379 7444 • Footscray 689 2055 • Frankston 7839 144 • Geelong 232 711 • Melbourne City 399 Elizabeth St 326 6088 and 246 Bourke St 639 0396 • Richmond 428 1614 • Ringwood 879 5338 • Springvale 547 0522 • **QLD** • Brisbane City 229 9377 • Buranda 391 6233 • Cairns 311 515 • Chermisde 359 6255 • Hedbank 288 5599 • Rockhampton 27 9644 • Southport 32 9033 • Toowoomba 38 4300 • Townsville 72 5722 • **Underwood** 341 0844 • **SA** • Adelaide City 223 4122 • Beverley 347 1900 • Elizabeth 255 6099 • Enfield 260 6088 • St. Marys 277 8977 • **WA** • Carrington 451 8666 • Fremantle 335 9733 • Perth City 481 3261 • Midland 250 1460 • Northbridge 328 6944 • **TAS** • Hobart 31 0800 • **NT** • Stuart Park 81 1977
ORDER BY PHONE OUTSIDE SYDNEY (008) 226610 Free Call Sydney Area 888 2105

A JAPAN ODYSSEY

TERRY ROBINSON VK3DWZ
21 RUSSELL AVE
WOODEND 3442

MACHINES THAT PLAY a melody as they dispense drinks; lifts that talk; incredible overcrowding; sumo wrestlers; incredible efficiency; trains that travel at 240kph. These are just some of the many things you'll experience if you visit Japan.

After many years as a monitor for Radio Japan, I finally decided to take the plunge and visit the country. I was not disappointed. It's the most exciting nation on earth!

Japan has the reputation for being outrageously expensive. ABSOLUTELY NOT! Sure, some accommodation, food and travel can be overpriced, but average prices are considerably below ours. Competition sees to that.

In my case I was able to get a super bargain in both accommodation and air travel, courtesy of Qantas.

Stepping off the plane at Narita, it seems like any airport in any country. It's not until you enter the immigration area that you finally realise here that Japanese and foreigners have to go through separate gates. As our flight contained hardly any non-Japanese, clearing immigration was relatively painless.

You collect your luggage; now the fun starts. *Lesson 1:* In Japan, everyone speaks Japanese — virtually no one speaks English! Luckily, in my case, transport to my hotel was pre-arranged. Finding the right queue was difficult, but not impossible.

Lesson 2: Learn to Love the Yamanote Line: So said one of my guidebooks. We took the book's advice and arranged hotel accommodation near one of this train-line's stations. In this case it was Ikebukuro, 150 metres from the hotel.

The Ikebukuro station is a huge underground station that services several JR (Japan Railways) and private train-lines.

The JR Yamanote Line, above-ground, encircles Tokyo. Some of its stops are Tokyo, Akihabara, Ueno (for the bullet train north), Harajuku (for Yoyogi Park and NHK/Radio Japan) and Shinjuku (for the nightlife).

Train travel on non-JR trains seems to be virtually impossible due to the scarcity of information in English. JR stations usually have just enough English-language signs to enable a non-Japanese person to travel around safely.

Lesson 3: As an independent traveller in Japan, don't expect to get very far if you pay for each ticket as you travel. Not only is travel expensive, but finding someone who understands English (and can tell you the correct fare) ranges somewhere between difficult and impossible.

A neat solution is to purchase a "JR Pass" before leaving Australia. Although initially expensive, the saving in both time and money is immense. And you can certainly get your money's worth. A trip from say, Tokyo to Kyoto on the shinkansen (bullet train) can cost almost as much as a seven-day pass. With the pass, all trips on JR trains, buses and ferries are free for the duration of the pass. You could spend all your time in Japan just riding the trains and spending virtually no money at all!

Not likely, though. Japan is a consumer's paradise. Shops are packed floor-to-ceiling with every item imaginable.

Akihabara has been described as the world's largest electronic bargain basement. Over 600 shops sell all manner of merchandise from capacitors to stereo systems. Some tiny little shops sell only one item! One shop may sell transformers, another resistors and yet another integrated circuits. One tiny shop I went to — several times — sold nothing but cartridges for playing long-playing gramophone records. I eventually purchased an Audio Technica AT-F5 at almost half the Australian price.

At Akihabara, as soon as you leave the station you see brightly coloured signs everywhere, and open-fronted shops selling things like Walkmans, tiny LCD colour TVs and portable radios, usually on the ground floor. On the first floor, the shop may sell large TV sets and video cameras. On the second floor, there could be hi-fi systems.

On the third floor, there are likely to be any number of computers and machines selling software (usually surrounded by young Japanese). On the fourth floor, home electrical appliances may be sold. Here, you will find kitchen appliances not seen in Australia.

The top floor may be allocated to amateur radio and shortwave. Receivers and transceivers are not only on display but they are actually connected up so it's possible to try them out before purchase.

Learning Morse code for your amateur

"ticket"? Not only were Morse keys on open display, but they were all connected to an oscillator so you could "try before you buy". Japanese amateurs must laugh at us and our archaic retail practices. I purchased in one of these shops the (then) latest issue of the Japanese amateur magazine 'CQ'. In its 540 pages (and two loose booklets) are contained all manner of news, construction articles and any number of colourful advertisements. Imported military receivers (like my R-390A) are listed in the back at amazingly high prices.

The range of Japanese-made radios is immense. Sony would have the largest range of any manufacturer in the world. Probably the most unique was one the size of a credit card. These are available for both AM and FM or AM only/FM only. Or they are available pre-tuned to just one station, such as FM Yokohama on 84.7MHz (the Japanese FM band runs from 76-90MHz).

It's difficult to quote prices here. "Official" prices (already up to 50 per cent below ours) can be subject to a "discount" of 10-20 per cent. In a Japanese catalogue I have in front of me, the Sony ICF-SW1S is listed at Y46,000 (\$396). The price you would eventually pay, however, could be as low as \$350.

The AC supply is a very strange 100V, 50/60Hz, so mains-powered equipment may not work here. Of course, suitable transformers can be purchased in Akihabara. I purchased a Sony Walkman of a type not yet available here. It's unique in that it incorporates a small FM transmitter in the main body and a completely separate FM radio to receive either "transmissions" from the Walkman, or normal off-air ones. The unit uses tiny re-chargeable 1.2V cells and a 100V charger is supplied. For about \$8.60 I was able to purchase a small 120V transformer (I have both 240 and 120V available) from a small shop in Akihabara.

Japan has many television channels available. NHK has four services (two on VHF and two on direct-broadcast satellite) — the rest are "commercial", with advertisements sensibly placed, between programs and only occasionally during them.

In my hotel, there seemed to be about 20 channels available. Some consisted of closed-circuit "information" programs that told about the hotel, how to travel

around Tokyo and so on. Four 'pay' channels offered 'adult' movies. Also available was a special "cable" channel that had programs exclusively in English. Most of the programming seemed to come directly from the US via satellite.

Of course, all the normal programming was in Japanese, but occasionally an "English" movie was shown. Using an ingenious button on the TV remote control, either the original sound-track or a "dubbed" one could be heard. It was fun to hear the US actor, Gene Hackman, speaking in Japanese!

Fast-food outlets and cafes are everywhere. I ate plenty of "real" Japanese food — some almost inedible, but most rather enjoyable. I can recommend tempura.

A trip on the shinkansen (bullet train to you) is an absolute must. The first one I took was, more or less, a "lucky dip". I just went to Tokyo station, found the booking office and went in. "Can I have a ride on the Shinkansen?" The man behind the desk spoke no English — he showed me a map entirely in Japanese. I pointed a finger somewhere south of Tokyo and, within a few moments, a ticket was printed. My heart sank — it was entirely in Japanese (what else!). Luckily there was just enough English (some figures) to allow me to find the right platform (just as the train was leaving) and the correct seat. Further examination (of the ticket) showed departure and arrival times. I still hadn't a clue where I was going!

At the exact arrival time printed on the ticket, the train pulled into Kyoto station. The journey had taken just under 2.5 hours; Kyoto is 530km south of Tokyo. Back in Australia some people don't believe I travelled all that distance in just five hours (remember, I had to return). Hah, I have a souvenir to prove it.

For some time now, I have been a technical monitor for Radio Japan. The former gentleman in charge was Mr Youjiro Kume. We have spoken (by telephone) several times. He and Radio Japan went out of their way to make my trip enjoyable.

I first spoke to Mr Kume at his home on my first afternoon in Tokyo. He speaks excellent English. We met at my hotel first, then he invited me to visit Radio Japan a few days later.

The NHK building houses all NHK facilities in Japan and, like many other things in Tokyo, is huge. Radio Japan occupies two (very cramped) floors. I met several of the English-language staff. Later I discovered that one, Mr Sakuri, did the Japanese speaking part on a Japanese-language course I have!

After looking at the NHK production

facilities, Mr Kume took me to his house. I saw that Japanese houses are not nearly as small as I'd thought. Blocks of land are small, but two-storey houses seem to be common so the living space is similar to ours.

I met Mr Kume's charming wife (who spoke no English) and we ate a meal of Japanese food that was most enjoyable. *Lesson 4:* the only place to find real Japanese food is in Japan (don't expect a knife and fork; it's always chopsticks!) I was then invited to take part in a Japanese tea ceremony conducted by Mr Kume and his wife, in a special room at his house.

The Japanese have a system that makes cars virtually worthless after a few years. This is good for their motor industry, but it must cause problems every few years when the average Japanese has to fork out for yet another new car. They certainly have their priorities right when it comes to good road maintenance, though.

Accommodation prices range from affordable to ridiculous. In my case, the hotel, although expensive by our standards, was all that I could have wished for. The room I had was on the 20th floor, with a magnificent view over Tokyo. Although small, every conceivable item a traveller could ever want was available, even a second telephone in the bathroom!

The "general store" in the hotel was like nothing I had ever seen before. Souvenirs, medicines, books and magazines — English and Japanese — and all manner of useful items. And another convenience store across the road!

One destination that is compulsory for any tourist is **Nikko**. There are two ways of getting there by train. A private-line train from Asakusa will take you directly there (but you have to find the station and pay), or JR offers a shinkansen train from Ueno to Utsunomiya, then a small, local train for the rest of the journey. This is the best way to go as the little train travels through the countryside, stopping at small railway stations and so you have a chance to experience the "real" Japan.

Nikko offers some spectacular temples, and you will be overcome by their beauty.

Two other places are The Ginza (a part of Tokyo) and Mt Fuji. I found the Ginza almost by accident when on a "private" train to somewhere (don't ask me where). The Ginza has the world's most expensive real estate and the swankiest shops this side of Fifth Avenue. If you haven't visited The Ginza, you haven't visited Japan.

If there's one highlight of the place, it must be the Sony building. It looks pretty ordinary from the outside, but inside it's

unique. You take the lift to the fifth floor then walk down to each showroom going clockwise. Sony products are on display and available for use. I "played" with portable compact disc player, short-wave radios, a portable DAT (digital audio tape) machine and, my favourite, the CRF-V21 receiver. Also on display was a very large TV set showing high-definition TV.

Mr Kume took me to the "lakes" area adjacent to Mt Fuji. We travelled around the largest lake in a boat shaped like a dolphin! I saw Mt Fuji many times that day and even have a photo (of me in front of Mt Fuji) to prove it.

Now, a little more about radio. I took along a little Sony ICF-7600D receiver and its companion power supply (set to 110V, it worked well on 100V). There were few medium wave frequencies clear of Japanese stations, although I heard some (unidentified) Soviet and Korean stations on the lower end of the band. On 810kHz the US Far East Network can be heard, usually with telephone grade audio. Programs seem to consist of little more than baseball!

On FM, a variety of programs was heard. NHK had a lot of serious music.

I returned to NHK on Saturday morning just before the taping of "Hello From Tokyo" and "DX Corner". Both programs were in the final stages of preparation when I arrived.

Once again, I met Kiyoko Tanaka who, with David Powers, is the presenter of "Hello". Then, we went down to the studio for the first taping. Most of the studio equipment seemed to be rather elderly, although two almost new compact disc players were used for the music segments. Then it happened . . .

The familiar theme music for "Hello" finished. The producer, Mr Takeshi, went into the studio and came out a moment later. "Would you like to come in and be interviewed for the program?" How could I refuse. So it was a very nervous yours truly who sat in the small studio being interviewed by the presenters of my favourite Radio Japan program.

After that it was back to the main office to prepare for "DX Corner" presented by a delightful lady, Rika Kobayashi. Then, sadly, it was farewell to NHK (and I was given a gift of a small world clock and a packet of coasters) and the final lunch, of tempura, that I mentioned earlier.

The trip back to Melbourne was fun. The plane was almost empty! After Japan, no wonder. Who wants to come to gloomy old Melbourne?

How to sum up Tokyo? Big, brash, Westernised but uniquely Japanese.

Everyone should experience Japan at least once in their lifetime — but then once is hardly likely to prove enough. ar

CONTESTS

JOHN MARTIN VK3ZJC
MANAGER, ROSS HULL CONTEST

Ross Hull Contest

A correction to last month's information: in the sample scoring table at the top of page 33, the multipliers were shifted one column to the right. They should have read: 6 metres x 1, 2 metres x 3 etc.

Using Locators

With scoring based on distance, it is necessary to know whether each contact is above or below the nearest multiple of 100 km. The simplest way to do this is with a ruler and a map, but it is also possible to get quite accurate measurements from Maidenhead locators.

Each locator square covers an area of two degrees of longitude and one degree of latitude. For example, the square PF94 covers the area 138-140 degrees east and 35-36 degrees south. The distance between adjacent squares in the north-south direction is 1/360th of the earth's circumference — about 111 km. The east-west "width" of the squares varies from about 222 km at the equator to zero at the poles.

The accuracy of four-digit locators is limited by the fact that a station may be located anywhere in its square. The possible north-south error is about ± 88 km. The same error may occur for both stations, so the worst case error for four-digit locators is equal to the size of one whole locator square.

Far better accuracy can be obtained with six-digit locators, eg PF94GH. The fifth and sixth digits divide each square into 24 x 24 "sub-squares", each five by two-and-a-half degrees. Again using Melbourne's latitude, the possible error is about ± 2.25 km north-south and ± 3.67 km east-west. This is far beyond the accuracy needed for the Ross Hull Contest.

If you know your latitude and longitude, the simple computer program below will find your six-digit locator, so you can quote it to

other stations during the contest.

The program inputs your co-ordinates in degrees, minutes and seconds, and converts these figures to a total number of minutes east of the International Date Line and north of the South Pole. These numbers are then converted into the corresponding locator number.

The program is simple and has no error trapping, so you can get ridiculous results if you deliberately enter impossible figures. It was written in GW Basic but is fairly universal. For use on an Apple, change the 'CLS' command to 'HOME', and replace lines 190 and 195 as follows:

```
190 GET K$: IF K$ = CHR$(13) THEN 110
195 END
```

If the program crashes, check what you typed in, especially the colons, semi-colons and mathematical signs. Note that there is no space between the quotation marks in lines 170 and 190.

Next month we will present a second short program which will accept two station locators and find the approximate distance between them — this will enable you to make the distance estimates for your Ross Hull log.

14th West Australian Annual 3.5 MHz Contest (from VK6NK)

	Call Sign	No. of Points
CW	VK6ELL	1940
	VK6BN	1582
	VK6AF	1400
	VK6RF	980
	VK6BEB	804
SSB	VK6ELL	5292
	VK6RG	5152
	VK6IU	3510
	VK6AMB	3146
	VK6DC	800
	VK6EJ	720
	VK6BBB	576

1990 Australasian Sprint Results

Entries for the fifth series of Australasian Sprints totalled 13 in the CW section (down one from last year) and 33 in the Phone section (up by 10) which was fairly pleasing. The CW scores were about average, but those in the Phone section were significantly higher than for 1989. Some operators experienced difficulties, but all those who added comments to their entries appear to have thoroughly enjoyed themselves.

The Adelaide Hills Amateur Radio Society and the South Australian divisions of the WIA congratulate the overall winner, and also the winners in the individual call areas. I say overall winner because, for the first time, one operator has recorded the highest score in both sections. A great effort by Roger Crofts VK4YB, who also finished high in the lists of both sections last year.

It was pleasing that the three novices who entered the Phone Sprint had very good scores, but disappointing that none entered a log in the CW section, even though a quick scan of other logs indicates that a few were operating. Speaking of logs, I continue to be mystified as to why only about half the operators taking part in the contests actually submit entries. Some holders of quite familiar call signs did not. Perhaps next year will be better.

This year was notable for (I think) the first entries from a P2 station and from an SWL.

Lists of the logs submitted, together with the points claimed (or in a few cases, points allowed), are shown below. Certificate winners are indicated by asterisks.

CW Sprint		VK4YB * 63	
ZL1GQ	* 19	VK4JO	57
ZM2IN	* 16	VK4OD	48
VK2AIC	* 17	VK4ACC	25
VK3JA	* 19	VK5AGX	* 21
VK4YB	* 23	VK5AFO	15
VK4SSB	14	VK5ADD	13
VK4SF	11	VK6AF	* 13
		VK7HX	* 9
		VK8AV	* 14
		VK5AFO	* 51
ZL1GQ	* 35	VK5NOD	48
ZL2AJB	* 9	VK5KGS	39
P29RB	* 3	VK5ZD	35
VK1EV	* 18	VK5RV	33
VK2RJ	* 46	VK5RG	27
VK2LEE	* 46	VK5TY	25
VK2AIC	22	VK5ZQ	23
VK2KTV/MM	22	VK5PEB	23
VK3YH	* 57	VK5ANW	21
VK3NKP	49	VK5AGI	19
VK3APC	48	VK6APK	* 23
VK3CTK	43	VK7HX	* 33
VK3JA	39	VK8AV	* 41
VK3DD	23	VK-L 40018	* 36

Some operator comments:

CW Sprint
ZL1GQ Contest fell within the NZART

Program: Six Digit Locator Finder

```

100 REM ----- Lat & Long to Locator Converter -----
105 DIM C(6)
110 CLS: PRINT "To find your locator square:": PRINT
115 PRINT "Enter your latitude and longitude in degrees, minutes, and seconds."
120 PRINT "Type the three figures separated by commas.": PRINT
125 INPUT "Latitude "; ND,NM,NS: NM = ND * 60 + NM + NS / 60
130 INPUT "North or South (N/S) "; NSS: IF NSS = "S" OR NSS = "s" THEN NM = -NM
135 INPUT "Longitude "; ED,EM,ES: EM = ED * 60 + EM + ES / 60
140 INPUT "East or West (E/W) "; EWS: IF EWS = "W" OR EWS = "w" THEN EM = -EM
145 EM = 10800 + EM: NM = 5400 + NM
150 C(1) = INT (EM / 1200): EM = EM - C(1) * 1200
155 C(3) = INT (EM / 120): EM = EM - C(3) * 120: C(5) = INT (EM / 5)
160 C(2) = INT (NM / 600): NM = NM - C(2) * 600
165 C(4) = INT (NM / 60): NM = NM - C(4) * 60: C(6) = INT (NM / 2.5)
170 L$ = "": RESTORE: DATA 65,65,48,48,65,65
175 FOR N = 1 TO 6: READ D(N): L$ = L$ + CHR$(D(N) + C(N)): NEXT
180 PRINT: PRINT "Six-digit locator is: "; L$: PRINT
185 PRINT "Options: <RETURN> to run again <ANY OTHER KEY> to quit"
190 K$ = INKEY$: IF K$ = "" THEN 190
195 IF K$ = CHR$(13) THEN 110 ELSE END

```

Memorial Contest but the two are compatible and could be mutually beneficial. Enjoyed the hour and wants to enter next year.

ZM2IN Interesting exercise but disappointed at the low numbers. Expected the hour to be hectic but turned out leisurely.

VK4SF Starting to believe CW is a dying art — the number of CW stations is getting less each year.

VK5AGX A pleasant hour well spent, but why so many absentees? Did not hear or work one novice — a great pity.

VK5ADD Thanks again for this hour of fun.

Phone Sprint

VK7HX My kind of contest — very enjoyable. Looking forward to next year.

VK2LEE Can't wait for the next sprint — see you all again next year.

VK2KTV MM Bass Strait. Enjoyed the

contest very much.

L40018 Enjoyed the contest very much, first for me and only for one hour.

VK40D Always a lot of fun. QRN early but did improve. Lots of stations seemed to appear near the end of the hour.

VK4JO The Sprint gets more enjoyable every year. This was my third and I hope to compete in many more.

P29RB The three contacts made were the only stations heard for the hour but QRN was very bad. Disappointed that more contacts not made, but enjoyed contest and looking forward to next year.

ZL2AJB Always enjoy trans-Tasman contests. If our Memorial Contest ended at 2400h as in the past, instead of 0200h, would avoid a clash with the CW Sprint. Hopefully there will be more ZL activity.

VK5RV Appeared a good time had by all — a very friendly contest.

VK5KGS Once again a most enjoyable contest. As usual contacts harder to obtain near the end of the hour. Look forward to next year.

VK3CTK After several misadventures resurrecting a defunct second-hand transceiver and three days' operating experience, had great fun, worked up a sweat and intends to continue contesting.

VK6APK A great little contest but conditions in the West were atrocious this year. See you next year, same time, same contest.

VK3YH Great contest this year. A bit noisy, but lots more activity. A quick contest is a good contest. The Sprint is my favourite.

ZL1GQ Likes this activity very much, particularly the ease of putting in the log. Hopes there will be more ZL entries as contest gets better known.

(Contributed by David Box VK5OV, Australasian Sprints Contest Manager) ar

HOW'S DX

STEPHEN PALL VK2PS
PO Box 93 DURAL NSW 2158

This month's column came into being by the grace of God.

Mid-October, early in the morning, a painful QRM took grip of my lungs, and I felt that this was it — I am on my way on a beautiful skywave to the eternal DX in the sky. However, medical QRN and some weeks QRT in a Sydney hospital resulted in my continued presence on this earth. I am now home, slowly recuperating, and desperately trying to put my monthly column together before the 5 November deadline arrives. So, if it is a bit rough around the edges, or you miss some information that is usually part of this column, I hope you will understand . . .

South Sandwich and South Georgia Islands DXpedition — VP8

The Middle East/Gulf situation is a problem; not only for the political powers but also for amateur DXpeditions. The eagerly awaited expedition to these islands has been postponed. Tony WA4JQS, the leader and organiser of the expedition, has stressed the word 'postponed'. It has not been cancelled. The Middle East situation has increased oil prices, which affected the charter fees of the ship, by pushing the cost of fuel up by an increase of \$US40,000. All the equipment and supplies will be stored until the event takes place. So far, all expenditure was paid by the members of the DX team, and the cash donations are safe in a bank account.

'CQ' Worldwide Contests

These events took place on 27/28 October for the phone section, and on 24/25 November for

the CW section. It is a very popular contest; one of "the" contests of the year in the amateur calendar. This is the time of the year when rare or exotic call signs or countries are activated. KH0AM was operated by a number of Japanese operators. QSL to JE1CKA, PO Box 22, Mitaka, Tokyo 181, Japan. YM5KA from Turkey was operated by a group of Hungarian operators during the phone contact. Outside the contest, they used the call sign TA5KA. QSL cards for both call signs go to HA0NNN, and not to the Turkish Bureau. ZD9Z was activated by N6TJ. QSL to W6CF. A number of OK amateurs were at the controls of 4U1ITU. QSL to OK3JW.

George W5YX activated V31YZ. QSL to home call. Martii OH2BH, the well known Finnish DXer, activated CT3BH. QSL to OH2BH. HC8A was also active. QSL to DX EX, PO Box DX, Cuenca, Ecuador, SA.

Futuna Island — FW

It has been reported that FE1GJO is active from this island as FW1FM. He will be at that location for the next three years. His address is: Michel Feillet, Box 20, Sigave, Ile Futuna, Wallis et Futuna, via France.

Mozambique — C9

The Colvins — Iris and Lloyd — left Malawi for Mozambique. In Malawi, in 16 days as 7P8KG, they made 7000 contacts with 155 countries. In Mozambique they are active as C9QL. QSL to YASME.

Banaba Islands — T33

After the pioneer operation in May 1989 of Jim VK9NS as T33JS, which resulted in the

acceptance of Banaba Island as a new DXCC country, some members of the 1990 Conway Reef DX team, such as Mats SM7PKK, Peter OH1RY, Sigi TF3CW and Kiyoko 5W1HM were active from this island between 6-20 November. The call signs used were T33R AND T33T. QSL to OH3GZ, Jukka Kovanen, Varuskunta Rak, 47 AS 11, SF-11310, Riihimak, Finland.

Malpelo Islands — HK0TU

Hopefully you have worked this rare DX country in the first week of November. It was a short five-days operation on CW, SSB, RTTY and satellite. Twenty Colombian amateurs comprised the DX team. QSL to Liga Colombiana De Radioaficionados, PO Box 584, Bogota, Colombia, or via HK3DDD.

Morocco — CN

In connection with the WW 'CQ' DX Contest, a number of French operators were very active from Morocco. CN2JO (F6ATQ), CN2LB (F1LBL), CN2MH (F6GKQ), CN2TT (F6IMS), CN2TU (F1NYQ) and CN2CW (F2CW). The contest station itself operated as CN0A and QSL for this particular call sign goes to the French DX Foundation, Box 88, F-35170, Bruz, France.

St Paul Island — CY9

A number of French operators were active from this island at the end of October. The call sign used was CY9CF and QSL goes to FP5DX.

Vanuatu — YJ8

Received from Rod YJ8RN the Vanuatu Independence Special Event Station YJ10IND QSL card. According to Rod, any valid VK call can get a visitor's call sign starting with the YJ0 prefix. Applications for a visitor's licence can be made by mail, prior to visit or on arrival, to:

Licensing Office, Radio Division, Telecom Vanitel, PO Box 146, Port Vila, Vanuatu, Attention Mr J Mael. Electricity supply in Vanuatu is 230V 50Hz. Standard three-pin plug outlet is used. Power limit is 100W CW and 200W PEP on SSB. Cost of licence is 500 VT or \$A5.00. Unfortunately the proposed reciprocal agreement is not yet in operation between VK and YJ.

Interesting QSOs and QSL Information

Note the following: callsign — name of operator — frequency in kHz — mode — UTC — month of operation. ADAR meas QSL info in previous issue of 'AR'.

*** 5U7NU — AI — 14028 — CW — 2100 — Sept. QSL to F6FNU: ADAR.

*** VP5P — 14015 — CW — 2200 — Sept. QSL to WN5A Mr Jack T VanDemark Jr, 7514 Wintergreen, Houston, TX, 77072 USA.

*** ZF2NE/ZF8 — 14018 — CW — 0430 — Qsl to W5ASP JA Staples, 10031 Meadowlake Ln, Houston, TX, 77042 USA.

*** ZP6XDW — 21026 — CW — 0430 — QSL via Bureau.

*** OX3EW — John — 14166 — SSB — 0750 — Sept. QSL to Box 1308, APO, New York, 09023, USA.

*** J6LMV — Tot — 28530 — SSB — 2206 — Oct. QSL direct only to Tot Henry, Box 1677, Castries, St Lucia, Windward Island, Caribbean.

*** V44KAY — Wayne — 21053 — CW — 1109 — Sept. QSL to Box 57, St Kitts, Caribbean.CP6AA — Gil — 21014 — CW — 1040 — Sept. QSL to Box 393, Santa Crus, Bolivia.4K4QQ — Nick — 21006 — CW — 0705 — Oct. QSL to home call RA1QQ. This station is on Bear Islands (Medvezhi Ostrova) 160°E-70°N.

*** 7P8EB — Rick — 21205 — SSB — 0508 — Oct. QSL to Box 1668, Maseru, Lesotho.

*** C21JM — Jim — 14226 — SSB — 1153 — Oct. QSL to Jim Motiti, Box 421, Republic of Nauru.

*** OM7EA — Harry — 14243 — SSB — 0623 — Oct. QSL via Bureau via OK3EA.

*** JT5AA — Eddy — 14226 — SSB — 1226 — Oct. QSL via Bureau.

*** VP8BXX — Paul — Sth Orkney — 14228 — SSB — 0710 — Oct. QSL to W9ARV Robett J Thibert, PO Box 730, Roscoe, Ill, 61073 USA.

*** A71AM Turos — 14243 — SSB — 0659 — Oct. QSL to DJ9ZB.

RTTY News

*** Syd VK2SG reports increased activity on bands, especially on 21 and 28 MHz.

*** FW1FM — 14086 — 0705Z. QSL to Box 20, Futuna Island.

*** UG7GW — 14070 — 0525Z. QSL to Box 1, Erevan, 375038, Armenia, USSR.

*** 4U1UN — 14089 — 2045. QSL to N2K. ZS9J — 21085 — 1710Z. QSL to Leo Heinonen, 80 Sixth St, Parrhorst, 2193 South Africa.

*** UI9ABC — 14084 — 1300 Z. QSL to

Box 40/1 Tashkent, 700040, Uzbek, USSR.

*** 3B9FR — 14082 — 1333 Z. QSL to Box 31, Rodrigues Island, Indian Ocean.

*** 8Q7DA — 14069 — 1600 Z. QSL to DL3RBE. PJ8JP — 14089 — 0036Z. QSL to AB1V.

*** ZLOAIC — 14090 — 0448 Z. QSL to HB9AAA.

*** 5Z4BI — 14082 — 1845Z. A41KB — 14074 — 0522Z. J39BS — 28091 — 1710 Z. QSL to WB2LCH. TF3KB — 28097 — 1816 Z. YI1BGD — 14070 — 0546 Z. V73AT — 14088 Z. QSL to K2CL.

From Here and There and Everywhere

Les VK4DA reports that he heard but not worked P7U, who gave his name as Kim, and his QTH as Pyongyang, North Korea. He was operating CW on 21011 at 2030.

Austin VK5WO reports good contacts on 80m around 1100UTC. 7J1ADJ/JD1 on Minami Torishima and H44AP was worked in the 'DX Window'.

Derek VK3DD is eager to reach the magical 100 confirmed countries. In 10 months since getting his licence he has worked 143 countries and has 75 confirmed.

Frank VK2QL, despite his variable health condition, still tries to work a few DX on CW. Lately he worked TI75S (75 years scouting in Costa Rica) —

*** ZX8CW. QSL via PT7AA. 6W1QB on 28 MHz. QSL via DK3NP.

*** V73BL. QSL via WB4CSK. SV0HS Rhodes. QSL via DJ8MT. C30EOA. QSL via FD1DGC.

I appreciated a 'get well' card from Mary KB6CLL from San Francisco. Mary is the net controller of the 'early' '222' net.

The May 1990 Conway Reef DXpedition QSL cards 3D2AM have arrived in VK. Beautifully presented, they also give some interesting insight into the tribulations of a DXpedition. Conway Reef is 300 miles SE from Fiji — a small sandbar less than 400 feet long. The expedition's 66ft schooner "Galatea" lost her engine power and they had to rely on sails only. Later, en-route, the generator and the toilet were lost in the seas.

Conway Reef is infested with tiny ticks, which decided to nest on the operators, causing considerable discomfort. Despite the fact that they lost their cooking utensils, and two major storms wrecked their tents, they managed 45,000 QSOs. The expedition members were: Masa JG2BRI, Wayne N7NG, Pekka OH1RY, Martii OH2BH, Mats SM7PKK, Steve VE7CT and Dave VE7SV.

*** Romeo 3W3RR of Spratly fame is planning a short return trip to these islands for one week in December. However, he needs funds for food, water, equipment, generators, fuel and antennas to be transported to the islands. A total of \$5000 is needed. Ed Kritsky NT2X is collecting the funds, which are refundable if the expedition cannot proceed. Send your contributions to: Box 300715, Brooklyn, NY, 11230, USA.

*** The Northern California DX Founda-

tion has added 21150 and 28200 kHz to its Beacon Network which is still operating on 14100 kHz. The callsign is W6WX/b, and the beacon is located in Stanford, California. Reception reports to be sent to W6RQ.

The ARRL DX Advisory Committee (DXAC) is currently discussing the DX status of Yemen, Penguin Island, Germany and Jarvis island.

*** DA0FRG was a special event station celebration the reunification of Germany. QSL to DF4VS.

*** SARRL (The South African Radio League) has announced the introduction of a novice licence, with ZU prefixes. The novices operate on 160, 80, 30, 15 and 10m bands. Maximum output is five watts CW and 20 watts PEP on SSB.

*** The DXAC has voted 16 to 0 not to recommend that Grosse-Ile (CIOGI) become a separate DXCC country.

*** Paul V47NXX and VP2EXX has a new QSL manager — KB2XR.

*** 9K2CS of Kuwait, operator of the first Yemeni DXpedition, is alive and well and living in Saudi Arabia. DL2BCH has spoken to him by telephone. The logs of the 70AA operation are also safe. 9K2DR and 9K2EC, the other operators, are also in safety. The status of Yemen, especially the status of that expedition, has not been resolved yet by the DXAC.

*** Lloyd and Iris Colvin made 7000 QSOs and worked 139 countries from Tanzania with the callsign 5H0QL.

*** If you worked an HF prefix (29 Sept to 7 Oct) then it was a blind operator from France with a special prefix.

*** VK7WRC was a special event station from the world rowing championships in Tasmania (27 Oct to 4 Nov).

*** The USA SSB sub-bands on 17 and 12m begin on 18110 kHz and 24930 kHz.

*** EL2CX has been evacuated from war-torn Liberia and is back in the USA as K3RV. EL2M lost his life in the fights.

Interesting QSLs Received

Note: W=weeks; MO=months; FM=from; MGR=manager; OP=operator.

Direct QSLs received: YJ0IND (9W FM OP), YJ8RN (9W FM OP), 9J2BO (TW FM MGR), V51GB (5MO FM OP), FW/YJ8M (4M FM OP), YJ8NMB (4M FM OP), YJ8DX (4M FM OP), 8P6OV (3W FM OP) 3C1EA (2W FM OP), YK1AO (4MO FM OP), 3D2AM (4MO FM MGR), T30NAD (8MO via MGR via Bureau).

Thanks to You . . .

As always, this column would not have been possible without the very much appreciated assistance of the following: VK2QL, VK2SG, VK2DID, VK3DD, VK4DA, VK4OH, VK4MWZ, VK5WO, VK6BA, KB6CLL, YJ8RN, "Break-In", "QRX DX", and "The DX Bulletin".

We also came to the end of our calendar year. The long, hot, windy bushfire danger days are ahead as we go into our normal Christmas break. I wish you safe motoring, plenty of DX, Merry Christmas and a happy and healthy New Year. ar

POUNDING BRASS

GILBERT GRIFFITH VK3CQ
7 CHURCH ST, BRIGHT 3741

Proposal for New Entry-Level Licence for Amateur Radio

As far as I can see, Australia leads the world in amateur radio licensing achievements with the current three grades giving different privileges at each level.

Rather than propose an easing of standards in an endeavour to increase numbers, I am proposing a new class of licence which is Morse only. In an effort to attract young, school-age people the corresponding requirements should require minimal theoretical knowledge but be tailored to encourage practical and theoretical learning as well as on-air operating expertise and incentives to upgrade, without compromising the present standards and yet establishing a base to upgrade them should the need arise.

In order to put forward a sound proposal to the WIA and DoTC I will need your help. But I hope to make your involvement as simple as a few minutes with a pen and a stamped envelope.

Name: CW/QRP Amateur Licence

Requirements:

- Morse Code 10 words per minute
 Regulations Current exam
 Theory Novice level CW only subjects
 or Examination equivalent to Year 10 maths and physics
 or Exemption for pass in maths and physics at Year 10 level

WIA membership Special rate

Privileges:

Access to all amateur HF bands on CW only.
 Five watts maximum power with homebrew transmitter only
 Callsign VK* ***M allocation
 Automatic upgrade to full Novice privileges (ie SSB) on logging 1000 contacts over 12 months or more.

1. The reason for suggesting a level of 10wpm for the Morse code is that 5wpm is too slow to be of much use on air. I would envisage that the Novice code requirement should be brought up to the 10wpm level as well, with a recommendation to drop the sending tests. This way the full HF band privileges could be extended to both categories in CW only.

2. A homebrew limitation on transmitters is to encourage learning and experimentation at low cost to the student. There is no reason why the student cannot have help in building the equipment, but the idea is to get away from the *black-box* methods, as well as the temptation of voice and data modes at this

level. Students can learn the benefits of low power, without the temptation of using the higher power of commercially built equipment.

3. The idea of an automatic upgrade to Novice SSB level is merely an encouragement. In this case, should a student build a transmitter (and perhaps receiver) and log 1000 contacts over a period of 12 months or more, they would have learned more than many a full-call operator. Logs could be submitted with references if necessary when applying for the upgrade.

4. Callsigns have been suggested with the inclusion of "M" after a normal three-letter call. We shall be seeing the need for four-letter callsigns in the future, so why not assign the M suffix now.

Before submitting this proposal to the Institute, I will need your comments and recommendations. A quick fill-in form is attached, but still write your comments if preferred. If you need the material on the other side perhaps you can photocopy the form. The proposals as they stand do not infringe on any present amateur rights, and even on 40 metres, five watts will not interfere with full-powered operations, but good operating practices will enable many more contacts to be made.

Results of the initial survey forms have been coming in, especially from the Westlakes ARC newsletter insert, and some preferences have been indicated already.

The name preferred is "CW/QRP Amateur Licence".

Ten wpm is the preferred speed.

Theory requirements were equal between Novice level (CW subjects only) and Year 10 maths and physics.

Regulations scored 10 to 1 for the current exam.

Votes were 8:3 for non-compulsory WIA membership.

Access to ALL HF amateur bands was preferred 4:1 over Novice segments.

There was a large majority which wants a maximum power of five watts.

Callsign suffix "M" was most popular.

Votes were 8:3 against the QRP club fees being paid by the WIA.

Auto upgrade to Novice was dead even.

For those of us who support this proposal, there is still a lot of work to do. WIA members have the advantage of the structure of the Institute to put the idea forward to other amateurs and to DoTC. However, this pro-

posal is not an official WIA project, yet. If the WIA Executive is impressed by the number of members backing my proposal, it can ask for a vote from all members.

I hope that this offering can be a Christmas present to all the young people of Australia, and it can be yours, too.

Merry Christmas Morsiacs.

Note: As Gil says, this is his own project and has not been considered by the WIA. Your responses MUST go to Gil, NOT to the WIA. Ed

Please circle your choice

Name:

CW/QRP Amateur Licence	yes	no
CW Novice Licence	yes	no

REQUIREMENTS:

Morse Code Receiving 10wpm	yes	no
Morse Code Sending 10wpm	yes	no
Another Speed Sending/Receiving	wpm

THEORY

Same as Novice with CW only	yes	no
Easier than Novice CW only	yes	no
Maths & Physics Year 10 level	yes	no

REGULATIONS

Current Exam	yes	no
Easier (subject to DOC)	yes	no

WIA MEMBERSHIP

Compulsory	yes	no
Reduced Fee	yes	no

PRIVILEGES:

Access to all HF Amateur bands on CW only	yes	no
Access to Novice segments only on CW only	yes	no
Power level maximum 5 watts	yes	no
Other power level	
Callsign proposal with suffix "M"	yes	no
Callsign proposal with suffix "N"	yes	no
Auto-upgrade to Novice	yes	no

YOUR CALLSIGN

NAME

COMMENTS:

.....

.....

.....

.....

.....

.....

.....

.....

.....

.....

.....

.....

.....

.....

PLEASE POST TO GIL GRIFFITH VK3CQ,
7 CHURCH ST, BRIGHT VIC 3741

Prevent Pirates

Make sure you sell your transmitter to a licensed amateur

VHF/UHF AN EXPANDING WORLD

ERIC JAMIESON VK5LP
PO Box 169 MENINGIE 5264

All times are UTC

Bacons on Six Metres

Freq	Callsign	Location	Grid square
50.000	GB3BUX	England	IO73
50.005	H44HIR	Honiara	QI00
50.005	HL9TG	Korea	
50.005	ZS2SIX	South Africa	KF25
50.011	JA2IGY	Japan	PM84
50.015	SZ2DH	Greece	KM18
50.017	JA6YBR	Japan	PM51
50.020	GB3SIX	England	IO73
50.020	CX1CCC	Uruguay	
50.025	6Y5RC	Jamaica	FK17
50.025	OH1VR	Finland	KP12
50.028	JA7ZMA	Japan	QM07
50.029	CT0WW	Portugal	IN61
50.032	ZD8VHF	Ascension Island	II22
50.032	ZS5SIX	South Africa	KG50
50.035	ZB2VHF	Gibraltar	IM76
50.035	ZS3VHF	South Africa	JG87
50.039	FY7THF	French Guyana	GJ35
50.041	FO5DR	Tahiti	
50.045	OX3VHF	Greenland	GP60
50.048	TG4BFB	Guatemala	
50.050	GB3NHQ	England	IO91
50.050	ZS6DN	South Africa	KG44
50.056	VK8VF	Darwin	PH57
50.057	TF3SIX	Iceland	HP94
50.062	PY2AA	Brazil	GG66
50.064	WD7Z	Arizona	EL59
50.065	GJ4HXJ	England	IN89
50.065	NB30/1	Rhode Island	FN41
50.066	VK6RPR	Perth	OF78
50.063	KH6HI	Hawaii	BL01
50.075	VS6SIX	Hong Kong	OL72
50.078	TI2NA	Costa Rica	EK70
50.080	KH6JJK	Hawaii	BL11
50.080	HC8SIX	Galapagos Is	EI59
50.085	9H1SIX	Malta	JM75
50.086	VP2MO	Montserrat	FK86
50.088	VE1SIX	Canada	FN65
50.090	KJ6BZ	Johnston Is	AK56
50.091	9L1US	Sierra Leone	
50.092	W5GTP	Louisiana USA	EM40
50.099	KP4EKG	Puerto Rico	FK68
50.100	HC2FG	Ecuador	FI07
50.100	5H1HK	Tanzania	
50.110	KG6DX	Guam	QK23
50.110	A61XL	United Arab Emir	LL74
50.120	4S7EA	Sri Lanka	MJ97
50.321	ZS5SIX	South Africa	KG50
50.490	JG1ZGW	Tokyo	PM95
50.499	5B4CY	Cyprus	KM54
52.100	ZK2SIX	Niue	AH50
52.200	VK8VF	Darwin	PH57
52.310	ZL3MHF	Christchurch	RE66
52.320	VK6RTT	Wickham	OG89
52.325	VK2RHV	Newcastle	QF57
52.330	VK3RGG	Geelong	QF21

52.345	VK4ABP	Longreach	QG26
52.370	VK7RST	Hobart	QE37
52.420	VK2RSY	Sydney	QF56
52.425	VK2RGB	Gunnedah	QF59
52.435	VK3RMV	Hamilton	QF12
52.440	VK4RTL	Townsville	QH30
52.445	VK4RIK	Cairns	QH23
52.450	VK5VF	Mount Lofty	PF95
52.460	VK6RPH	Perth	OF78
52.465	VK6RTW	Albany	OF84
52.470	VK7RNT	Launceston	QE38
52.485	VK8RAS	Alice Springs	PG66
52.510	ZL2MHF	Mount Climie	RE78

Six Metres

Ron VK4BRG from Sarina has written with some information regarding contacts in his area during September and part of October.

11/9: 0754 KH6IAA; 12/9: 0851 NI6E/KH6; 13/9: 0809 KH6JJK, 1007 H1MAO/JD1 Ogasawara; 14/9: 0256 KH6IAA, 0851 HL1JV; 17/9: 0824 KH6IAA; 23/9: 0621 KH6JEB, 0805 KH6IAA; 25/9: 0754 KH6IAA, 1152 BZ4SAA; 26/9: 0241 and 0526 NI6E/KH6, 0654 KH6IAA, 2320 ZD8VHF, 2355 9L1US, both beacons copied until 0015; 27/9: 0740 KH6IAA, 2142 ZD8VHF beacon until 2320; 28/9 0305 ten W6 stations in San Diego and Los Angeles area closing 0421, 0735 AH6Q/MM near Japan, 0741 KH6JJK, 0915 BZ4SAA (Kang in Suzhou running 10 watts to a two-element yagi two metres high!) From the VK5LP viewpoint I was interested to read how casually Ron referred to his contact with BZ4SAA!

2/10: 0621 NI6E/KH6, 0622 NH6LT (QRP one Watt), 2147 ZD8VHF beacon until 2200; 3/10: 0646 KH6IAA; 5/10: 0601 KH6HI and two others, 2235 KG6DX, 2341 N6XQ; 6/10: 0106 9L1US CW two-way, 0107 9L1US SSB two-way, 0150 9L1US reported CU1UZ (Azores) was hearing and calling VK4BRG, 2245 9L1US beacon for over three hours, 2330 ZD8VHF beacon until 0220; 9/10: 2220 ZD8VHF beacon until 2230; 10/10: 0024 NI6E/KH6 until 0200.

Ron's most significant observation was the number of hours the 9L1 and ZD8 beacons were heard. On 12/10 Ron was very happy to work OA8ABT in Peru using what appeared to be a scatter path with both stations working via the direction of Hawaii. Another good contact came at 0102 on 14/10 when Ron worked KB6SL/CE3 in Chile, also ZK3KY on Tokelau Island.

On 19/10 Ron worked GJ4ICD on Jersey Island for a repeat contact. A phone call from Jersey to the UK resulted in four Gs being worked. His final contact of importance was to ZK3F on 26/10 when he and VK4s ZAA, ZAL, ZJB, ZNC, DDG, KU, KJL, DDC and other VK4s grabbed him around 0127 — in

fact, John VK4ZJB relayed Kioka ZK3F on Tokelau Island back to me via the telephone! QSL is via JA1WHG. John said K6STI and K6GMY had been weak in Brisbane on 25 and 26/10.

Ron said 21/10 was a good day especially for the stations in the Townsville area with VK4FNQ and others working SM, DK, OZ, 9H and SV between 0800 and 0945. VK4VV also worked an IK6 in Italy. Stations there can work only between 50.150 and 50.162 and have a call frequency of 50.155. On the same day, Ron VK4BRG worked OZ7LO and Lyn VK4ALM worked SM7FJE. On 13/10 Lyn also worked ZK3KY.

Also on 8/10 there was an opening from JA8 to VK5 with JA8RC being worked here at 0355. The spread of the opening in Japan must have been very narrow as I noted only three JA stations operating, including a lone JA1. The same day at 0630 John VK4ZJB and Peter VK4APG worked AH3C from Johnson Island.

Dave 9L1US finally broke the barrier into Brisbane on 17/10 between 2330 and 2350, and was worked by VK4s ASV, ZJB, DDC, DDG, KJL, ZAA, ZAZ, ZNC and others to a total of about 15 stations. Lyn VK4ALM worked 9L1US at 0035. He sent 5x7 and received 5x5. During one QSO 9L1US discovered he had not switched on his linear, and was making the contacts using nine watts! (Thanks Geoff VK3AMK). It appeared the signal was coming in from across Canada. QSL is via WA8JOC.

On 19/10 there were some good signals into VK5 from VK4, at 0400 VK4FXZ was 5x9, 0437 VK4JS 579. At 0442 signals came in from JA0 and JA1 up to 5x9 and, at 0613, VK4ALM was heard working KH6KHP. At 0124 VK4ZJB worked KL7Y, then at 1112 HL1EIZ and at 1114 V73AT from Marshall Islands. K2CL is his QSL manager. The KH6HI beacon was heard in VK5 around 0600 as it was also the day before.

Hugh VK5BC said everything was relatively quiet at his QTH, with an occasional contact to JA, KH6 and VK4.

On 19/10 Peter VK8ZLX in Alice Springs caused a stir when his keyer was heard in several European countries. Between 0919 and 0926 he worked OH2TI, OH2HK and OH2BC, all in Finland. At 0952 he was also fortunate to score OZ8RW in Denmark for a new country. These contacts were almost 12 months to the day since the previous European contacts, but the hoped-for major opening into Europe for the next day did not eventuate. However, it was not unexpected that Peter, or someone placed on a similar latitude, should work Europe, as TV signals were evident from that direction during the afternoon. 21/10 produced a brief opening to KH6 from VK5, with KH6BC being worked by VK5RO. Geoff VK3AMK writes that JA1VOK recently reported the reception of European TV around 2230 via the long path, and also hearing the two-Watt Reunion Island beacon! Geoff confirmed that Chinese stations (BT,

BY, BZ etc) had been worked in Queensland and on 28/9, around 1340, VK1RX had worked VS6WV. On 29/9 Geoff had JAs from early afternoon until late at night with the new Japanese prefix being used by 7K1UBJ/3 and AH6Q/MM out from Yokohama causing some interest. Geoff was able to hear Steve VK3OT working BZ4SAA about 0830, and also a VS6 portable XX9 Macau, but these exotic signals not heard in Melbourne.

Apparently Peter VK1RX in Canberra often reports very strong TV in Canberra for long periods. When in Melbourne, it is either at very low level or inaudible. Peter has also been working into Melbourne on Sunday mornings using aircraft reflection. Signals usually peak very noticeably for several minutes at each QTH, but the path is critical and when he is in at one station he may not be audible at another. Peter is also able to copy the VK3AMK CW ident about 80 per cent of the time at varying strengths.

Lord Howe Island

On Saturday 27 October, Doug Speedy VK9YQS flew to Lord Howe Island and proposes to operate on six metres for a period of six weeks. Although you may not read this until towards the end of his operating period, I am certain someone will work him before then and spread the news. His QSL manager is Steve VK3OT.

Policy Announcement Six Metres Standings

Some years ago when I introduced the Six Metres Standings List in 'AR', it seemed like a good idea to know how well operators were going in assembling a list of countries worked and confirmed. Over the years, the list numbers have increased, especially with the excellent opportunities offered by Sunspot Cycle 22 in providing many worldwide contacts and to call areas probably never before believed possible. As a result, there have been some very high scores presented, and these scores are all the more remarkable because of the relative isolation of Australia in the southern hemisphere.

However, as the totals of worked countries continue to increase, the inevitable 'jockeying' for the top places will occur, as is already the case on the HF bands. In order to ensure all listings are accurate as possible, and in preparation for the day when it is inevitable the need will arise for me to relinquish the work for someone else to do, I propose that some new rules should be enacted following the publication of this notice.

(01/12/1990)

1. Amendments or additions to the published list in October 1990 'AR' will be accepted only upon receipt of a photocopy of the relevant QSL card.
2. Operators seeking to be listed for the first time to supply photocopies of all QSL

cards, accompanied by a list of the cards set out in date order, with the earliest date heading the list, by 1 May 1991.

3. Operators presently listed are requested to please:
 - (a) Supply me with a photocopy of all QSL cards relevant to their listing and showing details of the contact; or
 - (b) Provide me with a dated, written declaration that two licensed WIA member amateurs have examined and approved of the applicants' QSLs and entries as set out on a new list, the list to be signed by all three people;
 - (c) In parts (a) or (b) above the information to be supplied by 1 May 1991 to allow time for checking and preparation for publication in August 1991 'AR'. The February 1991 listing will be interim only, based on amendments to the October 1990 listing and received prior to 1 December 1990.

A number of amateurs have, in recent times, been sending me copies of their QSLs as they arrive. These need not be repeated when conforming to 3(a) above. Some years ago Graham VK8GB sent me, in book form, well-presented copies of all his QSL cards for his then 42 countries, so these need not be repeated. If you feel any explanation is required regarding a QSL card, then please send such notation.

If any amateur decides to opt out of the Listing due to the above provisions, I would accept his or her decision with regret. I know amateur radio is a hobby, a good hobby at that, and it will require some effort on the part of everyone involved but, hopefully, it will be seen in the light of tidying up our listings (if that is required) for viewing both here and overseas. I expect most of you keep your listed QSLs separate, anyway. Probably such measures should have been instituted right from the start, but, as they were not, let us start now without it being seen as a reflection on anyone. The final crunch will come when some fortunate amateurs reach 100 countries and apply for their ARRL DXCC Award, when the vetting of cards will be extremely strict, so we may as well get our house in order in readiness for that day! It may take until the next cycle, but that day will eventually come. Any costs in which you may be involved will still be small in comparison with the hundreds of dollars I spend annually on STD phone calls seeking information, and continuing postage costs, simply to keep the column going. I seek your co-operation and ongoing support.

IPS Predictions

A brief message from John VK4ZJB says that the Ionospheric Prediction Service has indicated that the peak of Cycle 22 occurred during June/July 1989 with a smoothed mean average sunspot level of 156.1. The figures for Cycle 21 were 186. Cycle 22 was the fourth

highest cycle. Based upon the above, we are certainly on the down-side of the cycle, but that does not mean we put away the six-metre gear. For the next two years at least, there should be bursts of exciting activity. It simply means that we will need to be more vigilant in being there when it happens, with the equinoctial periods probably still providing the best opportunities.

Other News

Unfortunately, nothing has been reported on bands higher than six metres, but anything of significance will eventually trickle through.

I was sorry to read in the Geelong Amateur Radio Club newsletter that Arie VK3AMZ, during high winds, had recently lost his six-metre antenna system, consisting of four by five element yagis on his 75ft tower. Last reports indicate Arie has temporarily installed an eight-element yagi, and is giving thought to reinstalling something with greater gain. Good luck.

Much of the September/October issue of the bulletin of the West Australian VHF Group is devoted to very interesting extracts from an article by W5UN in the "2 Meter EME Primer" and outlines the requirements to enable contacts via the moon with special emphasis on those with less than elaborate stations. If interested, you could write to the VHF Group at PO Box 189, Applecross, WA, 6153.

Closure

With this issue I commence the 22nd year of writing these notes. There have been a few difficulties during 1990 due to periods spent in hospital, but generally I have managed to keep in touch. Special thanks to the editor, his staff and all at 'AR'.

May I take this opportunity of wishing everyone the compliments of the season, and hope that it will be a happy time for all. As the Es season will soon be upon us, I hope all can share in the many contacts likely to be provided.

Closing with two thoughts for the month: "The trick is to hold opinions without letting opinions hold you" and "After the ship has sunk, everyone knows how it might have been saved".

73 FROM THE VOICE BY THE LAKE
ar

**Support the
advertisers who
support
Amateur Radio
Magazine**

INTRUDER WATCH

GORDON LOVEDAY VK4KAL
FEDERAL INTRUDER WATCH CO-ORDINATOR
FREEPOST NO 4 AG LOVEDAY RUBYVALE 4702

Please Report any Illegal Operators in VK to your State DoTC

As the hot WX comes to us, more activity will be experienced on all our bands — also we will be subject to intruders within our own shores, if the reports I've had over the past month are any indication. I stress . . . these reports should be directed to the State DoTC office, giving ALL relevant info — send a tape

as well if possible. The IARU Monitoring Service covers international intrusions to our legal bands, be they shared or not. In Region 3, 80m is not exclusive. RTTY and CW non-amateur signals CANNOT be considered intruders, BUT B/casters are. 40m: 7.1-7.3 is shared by international B/C stations only . . . non-amateur RTTY/CW are intruders. 30m: (10.1-10.15) is shared with fixed services.

20m: 14.00-14.25 is a primary allocation — 14.25-14.35 is shared. B/cast stations are intruders. 17m: 18.068-18.168 is shared. B/cast stations are intruders. 15m: 21.00-21.450 is a primary allocation. 12m: 24.89-24.99 is shared. B/cast stations are intruders. 10m: 28-29.7 is a primary allocation. ALL non-amateur signals are intruders. BUT don't waste time logging Asian CBers — we have no control over these intruders, nor has our DoTC which, like us, is aware of the problem. So, please don't waste our time with those loggings.

Have a happy and safe Christmas and New Year with good DX. 73, GORDON ar

EMC REPORT

HANS RUCKERT VK2AOU EMC REPORTER
25 BERRILLE RD
BEVERLY HILLS 2209

1) VCR and EMC: CQ-DL 6/1989 reported how an unshielded VCR was made immune to amateur radio radiation by placing the recorder in a metal case, when all other steps failed. Now CQ-DL 10/1990 reports that the Sanyo company submitted a VCR type VHR-5200G to the DL-EMC-reporter DJ1ZB, asking to check this model VCR for immunity. This model was a considerable improvement, and a ferrite choke at the inter-unit cable helped again at field strengths of 6V/m at 7MHz and at 15 V/m at 3.5MHz. The efforts and understanding of some manufacturers are greatly appreciated by all radio amateurs.

2) Channel S-6 Cable TV and EMC: CQ-DL 9/1990 reports the continuous argument between the German Post Office officials who granted the cable-TV companies the use of Channel S-6, which falls in the exclusive 144-148MHz radio amateur band. The responsible official claims that it is no serious problem, and where the cable signal interferes with amateur radio reception, or when 2m

transmissions disturb TV reception, installation improvements can overcome the EMC problem. The DARC claims that the opinion of the officials is wishful thinking, that the post office and cable-TV firms have been warned early enough, and that they now do not admit they were wrong. The signal strength of the unwanted cable-TV signal was severely underestimated (DK3VW, DK9MD). Should cable-TV ever come to VK-land, we can be sure the same problem would arise: "Australia is not a different country!"

3) The Motor Car and EMC:

a) QST reported some time ago that a proud owner of a new Asian-made car observed severe electric malfunctions of his car when he was operating his mobile amateur radio transmitter. His complaint was answered by the dealer, who recommended "that the transmitter antenna should be shielded." This would certainly have solved the car's problems.

b) QST reported some time ago that Gen-

eral-Motors would like to hear from radio amateurs who are truck owners who may have experienced EMC problems. A sign of welcome co-operation.

c) The 'AR' February 1989, page 61 EMC Report (by VK6WQ) listed the many problems we start to experience now, and more so in the near future, as more and more 'electronics' is used in modern cars. Walter VK6WQ has now submitted a press release by Mercedes-Benz on the 'torture test' it introduced in co-operation with Siemens company, to study and solve any EMC problems which do or may arise. (See page 55) Cars are tested in a similar way to electronic appliances in the Jacky test-cell. It is good to see that some car manufacturers know where shielding and filtering may have to be applied so that car phones can be used.

d) Car Alarm and Static Electricity: A friend of mine triggered the car alarm when he left his parked car (local manufacture, new car). The spark caused by the friction electricity, when the driver's pants slid along the seat cloth, was picked up by the alarm wiring and so operated the alarm electronics. The dealer may recommend that driver and passengers have to wear conductive clothes to avoid false alarms.

ar

EDUCATION NOTES

BRENDA EDMONDS VK3KT
FEDERAL EDUCATION CO-ORDINATOR
PO BOX 445 BLACKBURN 3130

I cannot decide whether I was serialised or censored last month. The editor assures me that it was entirely unintentional, and that it was all the fault of the printers, so I can only accept his apology, and I have to admit that the article was complete at the proofreading stage because I proofed it myself.

Whatever the cause, for those of you who felt that my November column had a somewhat unfinished feel to it, yes there were a couple of paragraphs missing, and so, in the best serial style, I say "Now read on".

The variations between candidate back-

grounds and levels of experience are equally wide for both sexes. But one of the big things about amateur radio is its tradition of the experienced helping the newcomer, and most established amateurs are happy to continue this tradition. So, please, all you male amateurs, give the girls a go and a bit of encouragement whenever possible.

And girls, do not feel this is not your 'territory'. Ask questions, listen in, take an interest, and have a go for your licences (or two or three goes if necessary — many of the men had to make more than one attempt). The one

time the two-metre box in the car saves you from a nasty experience on a trip or at night makes the whole effort worthwhile. Also, it is a hobby through which you can meet people whenever you feel like it, without having to get dressed up or even tidy the house.

Perhaps the current YLs and XYLs should present a slightly higher profile within both the hobby and the community. The ladies are poorly represented in Club or Divisional administrations, and rarely appear as contributors in this magazine. Whose fault, I wonder?

73

Brenda Edmonds VK3KT, Federal Education Co-ordinator, WIA. Licensed for 30 years, and mother of two licensed YLs. ar

FTAC NEWS

JOHN MARTIN VK3ZJC
FTAC CHAIRMAN

Data Base

Bah! I hate to confess that there are some Murphys in the listings published in the 1991 Call Book. Please note these corrections:

— The frequency of VK6RHF should read 29.680/29.580 MHz. This was a misprint on my part.

— The 146.975 repeater VK3RWQ should be VK3RSR, and its sponsor code should be VSA (Victorian Scout Association).

Band Plan Revision

At its October meeting, Federal Council

approved the band plan changes as last published in September 'AR'.

Records

Another microwave record has been verified this month, for a new Victorian 5650 MHz record: VK3ZBJ to VK4ZSH/3, a distance of 89.8 km.

In addition, the six-metre Digital modes record has reverted from VK3ZJC to its original holder, Steve Stephens VK4KHQ. The new record distance is 6392 km. ar

SPOTLIGHT ON SWLING

ROBIN L HARWOOD VK7RH
52 CONNAUGHT CRES WEST LAUNCESTON 7250

The end of the first year of the '90s has arrived and it has been an eventful one, as far as shortwave has been. The one dominating event has been the Iraqi invasion of Kuwait on 3 August. This clearly demonstrated the effectiveness of international radio. Thousands of foreigners were stranded in Kuwait, and shortwave became the only means of reaching them with up-to-date news of the fast-changing developments. Special programming was hastily arranged to cater for those who became unwilling guests of the Iraqi Government. At deadline time, this crisis has not been resolved, dragging on with no signs of any imminent changes, although it could still easily erupt, as witnessed by the violent events elsewhere, particularly in Jerusalem and the West Bank.

The dramatic alteration to the geographi-

cal and political map in Europe was reflected as well by international broadcasters. Towards the end of 1989, revolutionary political change had snowballed across eastern Europe, profoundly affecting events within the USSR itself.

Radio Prague in Czechoslovakia went off the air for three weeks in April and, when it returned, there were new personnel and a new emphasis. The signal from the Czech station has also dropped, indicating they are now concentrating on European and North American audiences.

The East Germans have had the most interesting and turbulent year. It was apparent that many of the Radio Berlin International personnel did not share in the euphoria within the GDR towards reunification, especially when the West Germans made it plain that

there were no jobs in the Deutsche Welle organisation for RBI staffers. The RBI publicly voiced its dissatisfaction at this arrangement, but to no avail. When reunification came, at precisely one second past midnight German time, the former RBI senders just switched their audio to DW in Cologne. RBI was no more.

As IARUMS co-ordinator for VK7, I have also noted that several intrusions in the WARC allocations, which were formerly located in the DDR, went QRT on or shortly after 3 October.

Another welcome trend has been the decision of many international broadcasting organisations to revert to two broadcasting periods, instead of four, as was the case. Many now make the change from summer to winter, at the end of March and September, which approximately coincide with the introduction of daylight saving in the northern and southern hemispheres.

Well, that is all for this month. Until next time, the very best of DX and 73. ar

ALARA

JENNY ADAMS VK3MDR
70 KANGAROO GROUND RD WATTLE GLEN 3096

Here it is at last. A little late perhaps, the official photograph of all who attended the ALARAMEET, held on the week end of 29/30 September.

The continuing saga of birds using antennas as perches, and another solution that comes from Ted VK3UI.

Subject: galahs, cockatoos and similar species that arrive in phased arrays and leave them in disarray!

Cure, which has been tested and proved successful, also with side benefits: washing stained with recycled mulberries, caravans and yard settings whitewashed by magpies etcetera no longer being experienced for over 12 months here, and longer down the south coast.

Secret solution: liberally smear all over the elements, radials, coax cable, strings, ropes or whatever you wish to save from being chewed, strained or broken when at least 44 galahs take to flight at the same time — Valvoline X-All Marine Grease or any other similar underwater lube used for outboard motors — any silicone grease should be okay. The one I used does NOT affect signals, nor does it deteriorate the coax. However, I don't know about the performance in dry duststorm areas if it rains AFTER an initial coating of dust — mine has some dust on it, but no problems have been experienced here to date — but I was suffering constant broken elements before, and no birds have landed on it since.

This particular antenna is a derivation of

the ABQ tri-bander, with 3/4 inch dowl radials, and elements of hard drawn copper, mounted on hubs originally cast for cubical quads. The radials are, consequently, inclined above horizontal by 22° or so.

This year for JOTA I found myself in a very high ridge operating with my husband VK3JNI for the local Scout group. We weathered several electrical storms and each time disconnected our antennas. The Scouts didn't fully understand why until a spark was seen at the end of our 80m antenna. A very practical lesson.

From Joy VK2EBX: I was asked to give a talk to the local church Ladies' Guild about amateur radio, as they knew very little about the subject. I was somewhat surprised at the enthusiastic response, and spent as long answering questions as giving the talk. Quite an interesting morning.

As usual, went to Wellington to run JOTA from the local Scout hall. Although stormy in the morning (we couldn't have a JOTA with-

out storms, could we?) it cleared by lunchtime, and some good solid contacts were made, with most of the Scouts, cub Scouts and Venturers present having at least one opportunity to talk to their counterparts elsewhere. Most were quite enthusiastic, and enjoyed the experience.

**SEASONS GREETINGS TO ALL
73/33
JENNY VK3MDR**



ALARAMEET 29/30 Sept 1990, Dubbo, NSW.
Back row: Erica VK3AEB, Anne ZL2BOV, Pam VK3EYL, Pat VK4PT, Margaret VK3DML, Bev VK6DE, Anne VK4ANN, Marlene VK3WQ, Janet VK5NEI, Val VK4VR, Bev Tambllyn.
2nd row: Marilyn VK3DMS, Joy VK2EBX, Lyndell VK5KLO, Maria VK5BMT, Norma VK2DJO, Jenny VK5ANW.
Front row: Dorothy VK2DDB, Christine VK5CTY, Jenny VK3MDR, Meg VK5AOV, Nancy VK2NPG, Poppy VK6YF.

Joy VK2EBX has been the hard-working columnist for ALARA for some years. All of us who are concerned with the production of AR would like to thank Joy for her literary efforts. We welcome Jenny VK3MDR, whose initial contribution appears in this issue

AMSAT AUSTRALIA

MAURIE HOOPER VK5EA
 11 RICHLAND ROAD NEWTON SA 5074
 PACKET: VK5EA@VK5WI

National Co-ordinator
 Graham Ratcliff VK5AGR
Packet Address: VK5AGR@VK5WI

Information Nets
AMSAT Australia
Control: VK5AGR

Amateur check in: 0945 UTC
Sunday Bulletin commences: 1000 UTC
Primary frequency: 3.685 MHz
Secondary frequency: 7.064 MHz
 (7.064 MHz is the frequency presently in use)
AMSAT SW Pacific 2200 UTC Saturday,
 14.282 MHz

Participating stations and listeners are able to obtain basic orbital data including Keplerian elements from the AMSAT Australia net. This information is also included on some WIA Divisional Broadcasts.

UoSAT-OSCAR-11 Bulletin 24 October 1990

UoSAT Mission Control Centre
 University of Surrey, Guildford, Surrey, GU2
 5XH, England

Command Stations performed magnetorquing procedures near perigee or orbits on 15-17 October. The new transponder schedule is as follows:

Mode-B: MA 000 to 095
 Mode-JL: MA 095 to 125
 Mode-LS: MA 125 to 130
 Mode-S: MA 130 to 135
 Mode-BS: MA 135 to 140
 Mode-B: MA 140 to 256
 Omnis: MA 220 to 040

This schedule is expected to continue to 261290. The spacecraft attitude is: BLON = 180 and BLAT = 0

AO-10

AMSAT-OSCAR-10 appears NOT TO have been receiving sufficient solar panel illumination to support Mode-B transponder operations. Both beacon and transponder signals show sign of FMing. Until further notice, please DO NOT use AO-10's transponder. AO-10 may be able to support Mode-B transponder operation in November.

AO-16 PACSAT

The microsat BBS has been tested on the ground engineering unit, and is now ready for uploading to AO-16. The satellite BBS software was written by Jeff Ward, GO/K8KA, at UoSAT and was ported to the microsats by NK6K. The porting was easily achieved, as there are only 10 lines of code that are different between the UoSAT version and the Microsat version. A lot of effort went into the design of the BBS, operating system and other support code to make that possible. Once complete, the following elements will be available:

256k File System:

This is just half of one of the four available banks of bank-switched memory. The more complete file system using all four banks and the 6MB mass memory will be uploaded after more testing.

This implements the protocol described in the FTLO document, available on CIS, the 9th ARRL Networking Conference proceedings, and elsewhere. It allows file uploading, downloading and a simple directory display. It requires the use of software at the ground station: a simple version, called 'PG' has been written by Jeff and will be on CIS soon.

Broadcast server:

This implements the broadcast protocol as described along with FTLO and has been running for several weeks on UO-14, and a few people have rolled their own receive program, at least one written in Basic. A simple version, called 'KISSUI', has been written by Jeff and will be on CIS soon.

After this is loaded, the following separate programs will be running on AO-16:

Kernel — Operating system — NK6K/Quadron
 AX25 — AX25 driver — NK6K/WB6YMH/Quadron, pd on a KA9Q AX25 implementation
 PHT — Spacecraft control, power management and program loader — N4HY/NK6K
 AARTDP — AART driver — NK6K/WB6YMH
 MFILE — File system — GO/K8KA/UoSAT
 FTLO — File upload/download — GO/K8KA/UoSAT
 PBP — File broadcaster — GO/K8KA/UoSAT

FO-20 Update

(from JARL FO-20 Control Team, 20 October 1990)

FO-20 has been in a period of no (solar) eclipse since the end of August. The temperature of its storage battery has continued to rise and has exceeded 35°C, the upper limit of safe operation.

We stopped routine operation and carried out tests on the operation of the transponder in each operating mode to check the different thermal equilibrium temperatures. The operation of the transmitter did not appear to have any effect on temperature. The battery temperature has a 'cycle time' of about 30 hours, probably due to the attitude variation of the satellite. The mean temperature is rising due to the changing distance between the earth and the sun.

The power generation of the solar cells is between 11 and 21 watts, or 17 watts average, which may allow parallel running of modes JA and JD. Consequently, both transponders were switched on late in October (20th). JD will be activated by a demand signal of uplink, as before.

In the event of power generation becoming less than 10 watts, mode JA will be turned off and, in any case, all transponder operation will be subject to switch off without notice in case of emergency.

PACSAT Protocol Suite — An Overview

Part 2 — continued from last issue

File Server

As a data transfer and storage device, a PACSAT can serve a multitude of purposes. It can store telemetry, digitised voice and video images, personal mail, forwarded mail, or anything else that can be stored in a computer file. Mail forwarding is a good example of an excellent use of a PACSAT. AO-16's 1200 baud link could easily be used to transfer 240k bytes of uncompressed forwarded mail in each direction between California and England in 24 hours, with just one morning and evening pass over each location. UO-14's 9600 baud link could move 1.6Mb of data in the same time. A PACSAT can store up to 8Mb of data. This would make a powerful addition to the current HF relay network.

The problem, however, is that the current amateur network is in a state of flux. New addressing schemes are proposed every few weeks, new routes and new ways of routing are proposed, tried, discarded or modified. This is good. Implementing the software on a spacecraft to follow these shifting designs is difficult, however. The testing required for the spacecraft is more rigorous, especially on the Microsats, where the same computer is used for the BBS and to keep the batteries charged. Faulty forwarding code could crash the computer, which could cause damage to the batteries or reduce their life expectancy.

The amount of program memory is limited on the spacecraft as well. To counter the effects of high-energy particles above the earth's atmosphere which cause memory bits to be changed, the PACSATs use 12 bits to store eight bits of program data. The extra

OSCAR-13 Schedule for 01Dec90 to 14Jan91

Station: Adelaide

	0	1	2	3	4	5	6	7	8	9	10	11	12	13	14	15	16	17	18	19	20	21	22	23	
01Dec																									
02Dec																									
03Dec																									
04Dec																									
05Dec																									
06Dec																									
07Dec																									
08Dec																									
09Dec																									
10Dec																									
11Dec																									
12Dec																									
13Dec																									
14Dec																									
15Dec																									
16Dec																									
17Dec																									
18Dec																									
19Dec																									
20Dec																									
21Dec																									
22Dec																									
23Dec																									
24Dec																									
25Dec																									
26Dec																									
27Dec																									
28Dec																									
29Dec																									
30Dec																									
31Dec																									
01Jan																									
02Jan																									
03Jan																									
04Jan																									
05Jan																									
06Jan																									
07Jan																									
08Jan																									
09Jan																									
10Jan																									
11Jan																									
12Jan																									
13Jan																									
14Jan																									

AO-13 Schedules

Mode	01Dec90 to 26Dec90	26Dec90 to 27Mar91
Mode-B	MA 000 to MA 095	MA 000 to MA 165
Mode-JL	MA 095 to MA 125	MA 165 to MA 190
Mode-S	MA 125 to MA 130	MA 190 to MA 195
Mode-S	MA 130 to MA 135	MA 195 to MA 200
Mode-BS	MA 135 to MA 140	MA 200 to MA 205
Mode-B	MA 140 to MA 256	MA 205 to MA 256
Omnis	MA 220 to MA 040	MA 240 to MA 030

NASA 2-Line Keplerian Elements — 26 Oct 90

AO-10	1	14129U	83 58	B	90291.49673605	.00000016	00000-0	0000000	0	5545
	2	14129	26.0935	179.3309	5954892	185.1631	164.1748	2.05879926	55248	
UO-11	1	14781U	84 21 <td>B <th>90297.12260385</th> <th>.00002090</th> <th>00000-0</th> <th>39125-3</th> <th>0</th> <th>8027</th> </td>	B <th>90297.12260385</th> <th>.00002090</th> <th>00000-0</th> <th>39125-3</th> <th>0</th> <th>8027</th>	90297.12260385	.00002090	00000-0	39125-3	0	8027
	2	14781	97.9370	345.3899	0011964	195.3256	164.7611	14.65804274	4354853	
MIR	1	16609U	86 17 <td>A <th>90296.69113258</th> <th>.00040228</th> <th>00000-0</th> <th>51186-3</th> <th>0</th> <th>97</th> </td>	A <th>90296.69113258</th> <th>.00040228</th> <th>00000-0</th> <th>51186-3</th> <th>0</th> <th>97</th>	90296.69113258	.00040228	00000-0	51186-3	0	97
	2	16609	51.6115	43.0151	0032664	172.2722	187.8428	15.58301653	268170	
RS-10/11	1	18129U	87 54 <td>A <th>90296.94697757</th> <th>.00000009</th> <th>00000-0</th> <th>35157-5</th> <th>0</th> <th>3613</th> </td>	A <th>90296.94697757</th> <th>.00000009</th> <th>00000-0</th> <th>35157-5</th> <th>0</th> <th>3613</th>	90296.94697757	.00000009	00000-0	35157-5	0	3613
	2	18129	82.9261	233.3816	0013152	119.0245	241.2209	13.72118295	167105	
AO-13	1	19216U	88 51 <td>B <th>90285.55558503</th> <th>-.00000132</th> <th>00000-0</th> <th>99999-4</th> <th>0</th> <th>1506</th> </td>	B <th>90285.55558503</th> <th>-.00000132</th> <th>00000-0</th> <th>99999-4</th> <th>0</th> <th>1506</th>	90285.55558503	-.00000132	00000-0	99999-4	0	1506
	2	19216	56.9677	131.3556	7041877	237.6838	35.4920	2.09702865	17837	
UO-14	1	20437U	90 5 <td>B <th>90297.24882574</th> <th>.00000676</th> <th>00000-0</th> <th>28451-3</th> <th>0</th> <th>2183</th> </td>	B <th>90297.24882574</th> <th>.00000676</th> <th>00000-0</th> <th>28451-3</th> <th>0</th> <th>2183</th>	90297.24882574	.00000676	00000-0	28451-3	0	2183
	2	20437	98.6913	12.9248	0010938	133.4532	226.7591	14.28762279	39295	
UO-15	1	20438U	90 5 <td>C <th>90293.23483277</th> <th>.00000504</th> <th>00000-0</th> <th>21707-3</th> <th>0</th> <th>1283</th> </td>	C <th>90293.23483277</th> <th>.00000504</th> <th>00000-0</th> <th>21707-3</th> <th>0</th> <th>1283</th>	90293.23483277	.00000504	00000-0	21707-3	0	1283
	2	20438	98.6928	8.8830	0010485	145.0366	215.1506	14.28459268	38719	
AO-16	1	20439U	90 5 <td>D <th>90295.40866860</th> <th>.00000686</th> <th>00000-0</th> <th>28772-3</th> <th>0</th> <th>1187</th> </td>	D <th>90295.40866860</th> <th>.00000686</th> <th>00000-0</th> <th>28772-3</th> <th>0</th> <th>1187</th>	90295.40866860	.00000686	00000-0	28772-3	0	1187
	2	20439	98.6962	11.2732	0012174	140.2587	219.9521	14.28860107	39039	
DO-17	1	20440U	90 5 <td>E <th>90295.96053991</th> <th>.00000770</th> <th>00000-0</th> <th>32049-3</th> <th>0</th> <th>1291</th> </td>	E <th>90295.96053991</th> <th>.00000770</th> <th>00000-0</th> <th>32049-3</th> <th>0</th> <th>1291</th>	90295.96053991	.00000770	00000-0	32049-3	0	1291
	2	20440	98.6959	11.8428	0012368	138.6657	221.5478	14.28915980	39118	
WO-18	1	20441U	90 5 <td>F <th>90296.64163114</th> <th>.00000673</th> <th>00000-0</th> <th>28191-3</th> <th>0</th> <th>1214</th> </td>	F <th>90296.64163114</th> <th>.00000673</th> <th>00000-0</th> <th>28191-3</th> <th>0</th> <th>1214</th>	90296.64163114	.00000673	00000-0	28191-3	0	1214
	2	20441	98.6960	12.5553	0012965	137.3260	222.8933	14.29001556	39214	
LO-19	1	20442U	90 5 <td>G <th>90297.11848910</th> <th>.00000788</th> <th>00000-0</th> <th>32645-3</th> <th>0</th> <th>1252</th> </td>	G <th>90297.11848910</th> <th>.00000788</th> <th>00000-0</th> <th>32645-3</th> <th>0</th> <th>1252</th>	90297.11848910	.00000788	00000-0	32645-3	0	1252
	2	20442	98.6941	13.0586	0013215	135.5831	224.6414	14.29074150	39280	
FO-20	1	20480U	90 13 <td>B <th>90296.97855528</th> <th>.00000077</th> <th>00000-0</th> <th>22052-3</th> <th>0</th> <th>1082</th> </td>	B <th>90296.97855528</th> <th>.00000077</th> <th>00000-0</th> <th>22052-3</th> <th>0</th> <th>1082</th>	90296.97855528	.00000077	00000-0	22052-3	0	1082
	2	20480	99.0259	319.1034	0541648	116.8206	248.9305	12.83151877	33261	

SATELLITE ACTIVITY FOR JULY/AUGUST 1990

1. Launches

The following launching announcements have been received:

Int'l No	Satellite	Date	Nation	Period min	Apgr km	Prg km	Inc deg
1990-063A	TDF-2	Jul 24	France	891.0	35837	12749	1.4
036B	DFS-2	Jul 24	Germany	1437.8	35853	35786	0.1
064A	COSMOS 2087	Jul 25	USSR	709.0	39342	613	62.8
065A	CRRES	Jul 25	USA	591.9	33612	335	18.2
066A	COSMOS 2088	Jul 30	USSR	116.0	1537	1502	73.6
067A	SOYUZ TM-10	Aug 01	USSR				
068A	USA-63	Aug 02	USA	722.7	20665	19931	54.7
069A	COSMOS 2089	Aug 03	USSR	89.9	357	186	62.8
070A	COSMOS 2090						
to							
070F	COSMOS 2095	Aug 08	USSR	113.8	1432	1390	82.6
071A	MOLNIYA 1-78	Aug 10	USSR	736.0	40634	646	62.7
072A	PROGRESS M-4	Aug 15	USSR	88.5	235	186	51.6
073A	RESURS-F 8	Aug 16	USSR	88.5	229	176	82.3
074A	BSB-R 2	Aug 18	UK	1432.2	35859	35565	0.3
075A	COSMOS 2096	Aug 23	USSR				

2. Returns

During the period 48 objects decayed, including the following satellites:

1963-022A	TRANSIT 5A3	Aug 03
1990014A	SOYUZ TM-9	Aug 09
1990-060A	RESURS-F 7	Aug 16
1990-062A	COSMOS 2086	Aug 03

3. Notes

- 1990-067A SOYUZ TM-10
With two astronauts aboard, docked with orbital station MIR on 3 August 1990
- 1990-072A PROGRESS M-4 Docked with space station MIR on August 17 1990.
- 1990-014A SOYUZ TM-9
The landing module, with two astronauts aboard, touched down at a pre-set area 72km north-east of the city of Arkalyk, USSR, on 9 August 1990.

BOB ARNOLD, VK3ZBB

ar

bits are used to correct for single bit errors. To keep the cost down, and to reduce the power used (AO-16's CPU uses about 500 milliwatts on average), only 256k bytes of program space is available. (This should not be confused with the message storage space, which is much larger than the program memory, and is protected with a software algorithm using three bytes to protect 253 bytes of data. Because this memory is protected with software, it is not suitable for storing a running program, since a program cannot protect its executing instruction).

We have a desire, then, to keep the spacecraft code simple and stable, while still allowing it to be a useful part of the changing amateur network.

We propose that the spacecraft be primarily used as a file server, moving data files from one point to another. The PACSAT would have no knowledge of the contents of the files, nor would it take an active role in the forwarding of mail messages. Groundbased software could, however, make the PACSAT system look like a familiar BBS to the user, and it could intelligently forward mail.

A PACSAT will know how to receive and transmit a standard file format. All files will

have a standard header, the same one that is used by the broadcast protocol. It will also know how to select files for transmission based on the contents of the header. This feature can then be used by groundstation software to emulate any desired user interface.

For example, assume that a user wanted to send a personal mail message to a friend. In the current terrestrial environment, he would connect to a BBS, which would lead him in a question and answer session something like this:

Remote Computer User

What do you want? Send message
To whom? Fred
Title? Club meeting
Message? Meeting at 8pm
What do you want? Read new mail
Message #200

....

Using the PACSAT system, exactly the same exchange would take place, except that the conversation is between the user and his local computer. The message is stored for later transmission to a PACSAT. The read new mail request is also stored. The next time the PACSAT comes overhead, the computer does the following:

1) builds a file with a standard PACSAT header. The header says that the file contains a mail message, from you, to Fred;

2) the file is compressed and sent to PACSAT;

3) the local computer then sends a message to PACSAT that says, "Send the next file whose header meets the following criteria: it's a mail message type, the destination is me, and the file number is bigger than "x"."

"x" is the number of the last file received on the ground, and is kept by the local computer. After the pass, the local computer can now print any new mail received. To the user, it looked pretty much the same.

What about file forwarding? A gateway would need to know what type of mail it could forward. Let's assume that the routing scheme of the week is based on a hierarchical string containing states, like nk6k.ca.usa, and this gateway handles mail to CA, NV and OR. The gateway would send a message to PACSAT containing the following request:

"Send the next file whose header meets the following criteria: it's a forwarded message, and the destination string contains "?ca.?" or "?nv.?" or "?or.?", and the download count is 0."

The file would be received, decompressed and imported into the standard BBS program after the pass.

In this way, the ground program can be as simple or as complex as required, the PACSAT only needs to know how to select a file for transmission based on the contents of fields in the standard file header.

Summary

These two ideas, broadcasting and file server, are certainly different than the current common usage of packet radio on the amateur bands. We feel that this is the best approach for the special case of a PACSAT, however, and that with suitable groundstation software, these concepts can be integrated into the mainstream.

Implementation Status

Prototype implementations of all of the protocols discussed in this group of papers are running on UO-14 as of late July, they should be running on the Microsats by the time of the ARRL conference. Prototype ground software is also running. We plan to make the source code for simple versions of the ground portion of the system available ASAP. Executable versions for the IBM PC will be made available as shareware, with the proceeds going to AMSAT-UK and AMSAT-NA to further development of future PACSATs. Fully integrated, automated, colour graphic, "all singing and dancing" software will be available for sale by AMSAT-UK and AMSAT-NA later in the year. Like QUICKTRAK and InstantTrak, the proceeds from this commercial quality software will go to finance future amateur satellite endeavours.

We hope that other software authors will use the documentation and source to develop support for non-IBM PC systems. The contents of these papers are sufficient to allow programmers to begin implementing their own software now.

References

[1] Loughmiller D and McGwier R, "Microsat: The Next Generation of OSCAR Satellites — Part 1", QST, May 1989, pp. 37-40.

[2] Loughmiller D and McGwier R, "Microsat: The Next Generation of OSCAR Satellites — Part 2", QST, June 1989, pp. 53-54, 70.

[3] Clark T, "Amsat's Microsat/Pacsat Program", ARRL 7th Computer Networking Conference, pp. 41-47, Columbia, Maryland, 1 October 1988.

[4] Ward J, "The UoSAT-D Packet Communications Experiment", ARRL 7th Computer

Networking Conference, pp. 186-193, Columbia, Maryland, 1 October 1988.

[5] Price H and McGwier R, "Pacsat Software", ARRL 7th Computer Networking Conference, pp. 145-149, Columbia, Maryland, 1 October 1988.

[6] Johnson L and Green C, "Microsat Project — Flight CPU Hardware", ARRL 7th Computer Networking Conference, pp. 186-193, Columbia, Maryland, 1 October.

73s from Maurie VK5EA ar

DIVISIONAL NOTES

VK2 NOTES

TIM MILLS VK2ZTM

1991 Fees

VK2 members are advised that the fee applying to new and renewing members from 1 January 1991 has been set at Full and Associate \$65; Student and Concession \$52; and Family and Non AR at \$38. Details about the fee make-up is covered in the WIANEWS columns at the front of this issue.

If you have a friend who is thinking about joining, have them contact the Divisional office early this month for an application, or make use of the reverse of your mailing label.

Divisional Office

A reminder that the office will be closed for a period during the Christmas break. The exact time will be conveyed on the VK2WI broadcasts. Contact with the Division may be made by mail to PO Box 1066, Parramatta NSW 2124, phone (02) 689 2417, with answering machine. Calls taken 12 noon to 1pm, Monday to Friday and 7-9pm Wednesday. Fax (02) 633 1525, 24-hour service. Personal visits to 109 Wigram Street, Parramatta, 11am-2pm Monday to Friday and Wednesday night.

Looking for a gift for Christmas or you need to leave a hint? Check out the Divisional Bookshop. Leave 'AR' open on your desk at this page.

QSL Bureau

For some reason the VK2 call region, while

having about one-third of the Australian call-sign population, handles something like two-thirds of Australian QSL cards. This is about 300,000 cards and is still increasing. This is a massive workload and the Division is at the moment planning a different style of Bureau — this will take time, and you are asked to keep in touch with Divisional broadcasts while this is developing.

Broadcasts

The last full broadcast for the year will be on Sunday 16 December. The first for next year is scheduled for 13 January. There will be a pre-recorded transmission of technical material on some of the Sundays between the above dates.

Call Book

Copies of the 1991 Call Book are still available from the office, \$9.50 to Members; \$11.00 for non-members. Add \$2.10 to cover postage. Several clubs obtained bulk stocks, so check with yours for a copy. Advise the Divisional office of any errors or changes. Would repeater groups advise of any changes needed to their listings in the data section, to update the data section in February 'AR'. Do this prior to Christmas. Remember the Divisional Bookshop has a wide selection.

WICEN (NSW) Inc

Now a fully accredited Statewide VRA Squad, it recently received a \$4000 grant from the State Government. Most other VRA squads

also received various amounts. During the past few months, most radio clubs in the State received a WICEN information package. Check with your club secretary if you would like a copy of the material. Postal address for WICEN (NSW) Inc is PO Box 123, St Leonards NSW 2065.

New Members

The following became Members of the NSW Division during October. A warm welcome is extended to them.

D J Ashley	VK2XQN	Wagga Wagga
C Bellenger	VK2MIB	Milperra
S J Bloxham	VK2NPC	Riverwood
AJ Bowman	VK2ASB	Wentworth Falls

G E Budden	VK2DJR	Lillian Rock
W K Chung	VK2WWW	Gilgandra
J Farkas	VK2BFA	Mudgee
G Foster	Assoc	Dudley
A R Gamble	Assoc	Gerrigong
R J Hardimon	VK2ZZK	Lethbridge Park

D J Kent	VK2BJI	Parkes
S A Kitchener	Assoc	Fairfield
C E Lambart	Assoc	Sans Souci
D K McEachern	VK2KOP	Rosemeadow
S J Mercer	Assoc	Castle Hill
J C Nicholas	G3HBH	Greenfield Park

P D Owen	Assoc	Woolloomooloo
S A Russ	VK2USR	Homebush
M Suzuki	VK2GHE	Davidson

On behalf of Divisional Council may I wish all Members and our various workers a Merry Christmas and a Happy New Year.

73 TIM VK2ZTM

ar

ANTENNAS & ACCESSORIES

We manufacture a comprehensive range of HF, VHF and UHF antennas, baluns, power dividers etc to suit your application. Three of our log periodics provide continuous coverage from 13-30 MHz including WARC frequencies, and replace outdated tri-banders. Now in use in 26 overseas countries and 6 continents.

- CREATE ROTATORS, COAX CABLES & NON-CONDUCTING GUY HALYARD MATERIALS.
- COMPLETE RANGE MIRAGE (USA) 5-YR WARRANTY 6M, 2M, 70CM AMPS & WATT SWR METERS.
- HARD-DRAWN COPPER ANTENNA WIRE
- AUST/NZ DISTRIBUTOR FOR CREATE ANTENNAS/ROTATORS & PHILLYSTRAN (KEVLAR) NON-CONDUCTING GUYING

- MATERIALS.
- HIGH GAIN VHF & UHF AMATEUR, SCANNING & TV ANTENNAS.
- BUTT SECTION TRIANGULAR ALUMINIUM TOWERS FOR FIXED OR TILT-OVER APPLICATIONS (REFER MARCH/APRIL 1987 AR)
- SELECTION OF POWER CHIPS AND TX TUBES AT FRIENDLY PRICES.
- VSWR/PWR METERS TO 1300 MHZ 5 MODELS.

Write or phone for free catalogue
ATN ANTENNAS

PO BOX 80
BIRCHIP VIC 3483
56 CAMPBELL STREET BIRCHIP VIC 3483
PHONE: (054) 92 2224
FAX: (054) 92 2666

VK3 NOTES

JIM LINTON VK3PC

Christmas-New Year Holiday Break

Firstly, may I, on behalf of the WIA Victorian Division Council, wish all members Seasons Greetings and hope 1991 is a good year for them and their families.

During the Christmas-New Year holiday period both the weekly VK3BWI broadcast and the office in Ashburton will take a break. The last broadcast for the year will be Sunday 16 December, and will resume on 3 February 1991. The Broadcast Officer, Bill Trigg VK3JTW, and his team, have consistently produced a good standard broadcast that has won praise from throughout Victoria and interstate. They have earned a rest.

The WIA Victoria office will cease trading at the close of business on Tuesday 18 December, and will reopen on Thursday 7 February 1991.

TVI Filter Kit

The kit of TVI filters available on personal loan as a membership service has helped borrowers quickly demonstrate to their neighbours how easily TVI problems can be cured.

Two sets of kits of various types of filters made by Jenlex Pty Ltd can be borrowed for 14 days by prior arrangement with the manager/secretary Barry Wilton VK3XV. A deposit is required, which will be fully refunded when a borrowed filter kit is returned. The kits can be borrowed in person only and are not available through mail order.

WIA Victoria and Jenlex Pty Ltd are working on a special cavity notch filter designed to counter interference experienced on the two-metre band from paging services. The closest paging frequency is 148.050MHz. A cavity notch filter under trial is designed to allow operation on the top end of our band without suffering from paging interference, particularly on the packet frequency of 147.600MHz.

Uncollected QSL Cards a Problem

The WIA Victoria Inwards QSL Bureau, at its last despatch to distribution points, sent some 20,000 cards but, unfortunately, some of them will never reach their intended recipient.

The reason? The holders of call signs who have nominated a distribution point are too lazy to make arrangements to collect their cards.

If registered with the Bureau, it would be wise to check with your nominated distribution point this month and collect your cards — if there are any.

The Bureau and distribution points can only be expected to hold unclaimed cards for a period of three months. After that they can be treated as dead cards and destroyed.

Examination Service Expands

WIA Victoria examinations continued to expand with the addition of two new centres in New South Wales at Gosford and Orange joining for the first time last month. The supervising clubs were the Central Coast Amateur Radio Club and the Orange Amateur Radio Club.

Those centres are in addition to Amateur Radio House, Parramatta, supervised by the WIA NSW Division, which joined Australia's largest examination service in August. The examinations were also held at a dozen other centres throughout Victoria and at Albury by the WIA Victoria affiliated Twin Cities Radio Club.

Call Book Available

Copies of the 1991 Australian Radio Amateur Call Book are in stock at the Divisional Bookshop and can be obtained in person during office hours, or via mail order. The over-the-counter price is \$9.50 a copy, or add \$1.50 for post and package, making the mail order price \$11 to members.

Several WIA Victoria member clubs have also placed bulk orders with the Division and will sell the Call Book at club meetings. **ar**

VK6 NOTES

JOHN HOWLETT VK6ATA

WAADCA

At their recent AGM, members of the Western Australian Amateur Digital Communication Association, Inc voted the following members to lead the group:

President	Cliff	VK6LZ
Vice President	John	VK6KRN
Treasurer	Bruce	VK6ABR
Secretary	Thrish	VK6QL
Broadcast	Christine	VK6ZLZ
Equipment	Chris	VK6KCH
Repeater Tech	Joe	VK6ZTN

Digital Communications is not a thing of the future, but is here today. It represents a different and interesting way to pass messages and collect information. Contact Cliff or one of the group for more information.

Equipment Bank

The bank has a selection of mainly test equipment and includes RF and AF generators, DIP meter, power meter and frequency counter. Some service manuals and reference books will be added in the future. Financial members of the WIA can borrow equipment by presenting the flier from the latest copy of 'AR' as proof of membership. The bank is located at the Northern Corridor Radio Group, at Carine College, Carine (where Hamfest is held). Call Sunday mornings between 0930 and 1030 or at club meetings, held on the second and fourth Tuesday evenings at 1900 on.

Lecture

The subject of October lecture was how to use packet radio. The display from a laptop computer was projected onto a large screen and gave everyone present an excellent demonstration of how to operate packet, which butted to push and what the screen should look like afterwards. This was one of the many well-presented lectures seen by members this year and has become a popular feature of meetings. Listen to Sunday Broadcast for details of future lectures and make full use of your membership.

Hamfest

This event seems to have established itself as an annual fixture with many businesses already asking for the same spot next year. A full story of the date is being prepared and will be presented to this magazine for consideration in the new year. If you attended and would like to offer some feedback, it will be appreciated. Jot down your likes and dislikes on paper and send to NCRG, PO Box 244, North Beach 6020.

HARG

Hills Group members once again attended the Kalamunda Festival and put on a display of radio activity. The group also has a permanent display in the local library promoting the hobby. With the festive season just a couple of weeks away, your president and council wish all readers a safe and merry Christmas. **ar**

5/8 WAVE

JENNIFER WARRINGTON VK5ANW

Westfield Displays

It has been suggested that perhaps this would be a great 'club' activity. In fact, Adelaide Hills ARS will probably take on the Marion display. If your club is interested, please tell John McKellar VK5BJM. If you don't belong to a club but would like to be involved, you will still be welcomed with open arms. (The venues are Arndale, Marion and TTP, in late January).

Old Timers' Lunch

Once again a most successful luncheon was held at the Marion Hotel on Tuesday 30 October. Despite various 'ills', the committee of George Luxon VK5RX, Ray Deane VK5RK, John Allan VK5UL and Max Farmer VK5GF did their usual fine job of organising the event. Bottles of wine were won by the following:

Margaret Butler XYL of Lloyd VK5BR
Eric Hauber VK5EZ
Nobby Prince VK5WK
Col Moore VK5RO.

If you would like to join us next year, do let a member of the committee know. It is not by 'invitation only' but if you aren't on their mailing list, the committee won't know you are interested.

Positions Vacant

Sometime between December '86 and April '87, Kevin May VK5IV volunteered to take over as broadcast producer and, having done an excellent job since that time, has decided that it is time to move on. So we are looking for a volunteer to produce the broadcast. I'm told it takes a couple of hours each week, but is a very rewarding experience. Kevin and others will be only too happy to help you initially and

act as back-up. If you'd like to give it a try, contact Kevin or a member of the council.

While we are talking of broadcasts, Chris Whitehorn VK5PN is still desperately in need of volunteers to relay the Sunday morning broadcasts. Please contact Chris if you can help.

Diary Dates

Tuesday 4 December Christmas Social, 8pm,

Woodville Community Hall, 64c Woodville Rd, Woodville (between Port Road and the town hall). Speaker — Keith Rendell (who, I'm told is a very entertaining after-dinner speaker). Bring your partner and a plate of supper.

As this is the last column before Christmas, I'd like to wish you all a very happy and safe holiday season.

ar

WICEN

IAN MARSH VK3PLL

Forthcoming Events

Communicating is one of WICEN's specialist tasks, and WICEN needs to keep its members, as well as members of the amateur fraternity at large, informed of its activities. December sees WICEN's biggest events, in terms of operators involved and the duration of the event. These are The Murray River Canoe Marathon, Great Victorian Bike Ride and the West Coast Bike Ride.

WICEN appreciates the problems of those amateurs not involved in the event having their usual call frequency or 'sked' interrupted by a stream of messages. To run an exercise,

we MUST notify DoTC of the time, date, place, duration and FREQUENCY of the operation at least three weeks in advance. If you need to use the frequency, just ask the controlling station (usually VK3AWI) if you can call a friend and then, if possible QSY, but if not, then exchange any appropriate information, leaving sufficient gaps to enable any emergency break-ins.

The Red Cross Murray River Ultra Marathon starts at Yarrowonga on 27 December and finishes at Swan Hill on 31 December. The hours of operation are generally between 6.30am and 7.30pm. The main frequencies to

be used are 3.600 MHz, 146.500 MHz, and some traffic on 147.300 MHz and 160 metres.

Operators for this event are needed for either one or more days, and it is open to operators from any State — we regularly have at least a couple of people from either NSW or SA. For further information, contact Ian Marsh VK3PLL on (03) 802 8593 or at 51 Doynton Pde, Mt Waverley, Victoria, 3149.

The Great Victorian Bike Ride commences in Bairnsdale on 1 December, and concludes in Melbourne on 9 December. The main frequencies will be 3.600 MHz and the two-metre repeaters VK3, REG, RLV, RSG, RWP (WICENportable) RMM, RML and UHF VK3RGW Mt Carrarung.

The West Coast Bike Ride runs between Portland on 1 December and Melbourne 9 December. The main frequencies being 3.600 MHz and the two-metre repeaters VK3 RWZ, 3RGL, 3RWL, 3ROW and 3RMM. ar

QSLs FROM THE WIA COLLECTION (28)

KEN MATCHETT VK3TL HON CURATOR WIA QSL COLLECTION
PO Box 1 SEVILLE VIC 3139

Bahrein — Middle East Emirate — Part 2

MP4BEE

The MP4 prefix came into use in 1949. As pointed out in some earlier articles on "QSLs of the WIA Collection", the allocation of the prefixes commencing with the letter M was not an official one by the ITU. These prefixes were used by military occupation forces in several Middle-East countries. (See 'AR' Dec 1989, Jan 1990, June 1990). The QSL shown here, MP4BBE, was for a QSO on 40m CW with well-known DXer, Ivor VK3XB. The Bahrein operator, John St Leger, was an employee of BAPCO (Bahrein Petroleum Co Ltd) at Awali, an inland town on Bahrein Island.

The attractive QSL in the desert colours of red and gold shows an oil well in addition to a tropical palm. In fact, before the discovery of petroleum in 1971 (which made Bahrein a country with one of the richest per capita incomes in the world), the country was suffering severely from a downturn in its pearling industry due to the Japanese development of the artificial pearl. Bahrein became the first Middle-East country to build an oil refinery. A

particularly active amateur in the early 1960s was Ian Cable MP4BBW (later A9XBW), Chairman of the Amateur Radio Association of Bahrein and QSL Manager. Like many other VKs of the late 1950s and early 1960s, the writer has to thank Ian for the initial QSO and confirmation with that country.

The discovery of petroleum changed the whole nature of the country. Desert areas gave way to six-lane highways — together with suburban sprawl. Bahrein has adopted many Western customs, but in some way manage to maintain an Eastern culture, due no doubt to their religious beliefs. Many of the inhabitants wear traditional white robes, and women the abbaya (black cloth covering the whole body), but some do wear Western dress. Tourist information advises foreigners not to wear scanty dress in public. The climate is oppressive and humid, and the fact that the country is so isolated

commands high salaries for expatriates. Side by side with Arab dhows, power boating can be seen. Camel and horse racing are other recreational activities.

During the 1960s, DXCC lists showed Bahrein's prefix as MP4B (cf MP4T = Trucial Oman, MP4Q = Qatar, MP4M = Muscat) and it was while this prefix was being used that the country became independent on 15 August 1971 as the State of Bahrein. (British forces had withdrawn during 1968).

A92EM and A9Z-BD

The military-style MP4B prefix gave way to the A9X prefix in the mid-1970s, not long after independence. This prefix in turn gave



STATE OF BAHRAIN

A92EM

P.O. BOX 5486, MANAMA, STATE OF BAHRAIN

RADIO	DATE	GMT	MHz	MODE	RPT
VK3MR	28.12.84	2015	7	aw	579

Rig IC701
Ant TET HB443

VIA BUREAU/DIRECT OR G3XHZ

73's
JOHN FARRER



A9Z-BD ZONE 21

BAHRAIN ISLANDS

SPECIAL PREFIX — BAHRAIN NATIONAL DAY

16TH DECEMBER 1978

9TH ANNIVERSARY OF INDEPENDANCE—200TH ANNIVERSARY AL-KHALIFA RULE

OPERATOR: G. B. SMITH, C AND W LTD P. O. BOX 14, BAHRAIN
TO RADIO VK3PR CONFIRMING QSO 23000 GMT 0710
UK SIGS WERE R S S C BAND 14 EQAMP. YAESU FT200/S8230
ANTENNA 0234 200 WATTS P.E.P. OUTPUT 73'S
PRE/TKS QML (MSOFF. ANLBD)

way to the A92 prefix. The QSL A92EM shown here was for a QSO with Old Timer and well-known DXer, 'Snow' VK3MR in December 1984. Little wonder he received an S9 report using his series of rhombic antennas. The QTH of the Bahrain station was Manama, the only major city of Bahrain and also its chief port. The WIA collection also contains the QSL A9ZBD (rather than A92BD). This card is dated 16 December 1978 and celebrated Bahrain's national day. It also served to celebrate the 200th anniversary of Al Khalifa's rule. Considering the fact that operation was confined to one day only, the special A9Z

prefix would indeed be a rare one. The Australian operator was SK Ron Jardine VK3PR of Leongatha, Victoria. His fine collection of QSL cards was kindly donated to the WIA by his widow, Vernie.

Bahrain has developed a tourist industry as well as having established itself as a banking centre for the area. It remains also as a rich source of the world's oil supply and therefore a very significant factor in the politics of the Middle-East.

Can You Help?

If you would like to play a part in building

up the WIA QSL collection and to save something for the future, would you please send a half-dozen (more if you can spare them) QSLs which you feel would really help the collection along.

All cards are appreciated but we especially need commemorative QSLs, special event station QSL, especially assigned call QSLs (eg VK4RAN), pre-war QSLs, unusual prefixes, rare DX and pictorial QSLs of not so common countries. Could you help? Send to PO Box 1, Seville 3139 or phone (059) 64 3721 for card pick-up or consignment arrangements for large quantities of cards. ar

CLUB CORNER

Cunningham Radio Club Formed

On Saturday 18 August eight people sat for the Regulations, Morse, NAACP and AOCB examinations at the Southern Downs Community College of TAFE in Warwick, Queensland. At 2pm of the same day a meeting was then held to discuss the potential for the formation of a local club. An attendance of 25, including representatives from the Wireless Institute of Australia, Queensland Division, resolved to form a radio club. The club's aims are to foster a community support for the hobby, encourage people to study toward their licence, and to be available in times of disaster for communications support.

The elected committee consists of the following: Chairman, Trevor Knight VK4NLX; Secretary, John Moulder VK4YX; Treasurer, Bill Washbourne VK4VJO; Publicity Officer, Bob Harper VK4KNH; Station Manager, Graham Muirhead VK4WEM; WICEN Officer, John Newley.

A second meeting was then held on 25 August, during which the name Cunningham Radio Club was chosen to represent an area centred on Warwick, Stanthorpe and regions. Trevor VK4NLX said that the club should accept membership from any area, but would endeavour to represent the region from the range to west of Goondiwindi, and from Toowoomba South to beyond the NSW border.

A modest membership fee of \$20 was chosen to encourage membership and assist the club to set up a local repeater.

An immediate project for the club, the 2m repeater is to service as much of the area as possible. Being situated on two of the major highways to Sydney, the repeater is seen to fill a gap between the northern NSW repeaters and the Brisbane, Ipswich and Gold Coast repeaters. A submission is already being prepared for the WIA and DoTC, but to date the frequencies and location have yet to be decided. Travellers will no doubt benefit from the added coverage and local support.

The club has already assembled a collection of components for the repeater, including a Philips FM828, a solar panel and battery, and a suitable antenna. As with all repeater projects, the cavity resonators remain the greatest problem, with manufacture seen as one possible alternative. Any donations of cavities would be greatly appreciated and would no doubt be seen in a similar light to winning the Lotto. Indeed, any donations towards the repeater would be greatly appreciated, and progress report will be sent to the magazine as completion draws near. Anybody interested in joining the club should contact Trevor or John at Audivision, Palmerin St, Warwick, phone (076) 61 3131 or on 146.500MHz.

If you are considering the NAACP/AOCP

examinations, you should contact Bob Harper, electrical teacher at the Southern Downs College of TAFE, (076) 61 6200, as classes may be run when student numbers are sufficient. The next class may run beginning February 1991.

BOB HARPER VK4KNH

Royal Naval Amateur Radio Society — NSW Chapter

The RNARS is looking for new members to join the NSW chapter. All seafarers — RAN, RN, Merchant Navy and past and serving members of ALL Navies and MNs of the world are invited to join our ranks.

We all share TWO things: our interest in amateur radio and the sea. All enquiries to the Secretary, C W Schreuder VK2CWS QTHR.

Ballarat Hamvention

On Sunday 28 October 1990, the Ballarat Amateur Radio Group held its annual Hamvention at the Marty Busch Recreation Reserve at Sebastopol.

This year's event attracted a record crowd of happy amateurs and friends from VK2, 3, 5, 7, who were eager to do business with the various traders.

The Ballarat Hamvention has become a very happy venue where amateurs and friends can meet and discuss their hobby, with many attending for the first time this year.

Much of the credit for the success of the

Hamvention must go to the many traders and stall-holders who brought the new and used gear to the Hamvention.

The BARG Ladies Group again supplied a great BBQ lunch; many more than expected were fed in a short time.

Fox hunts were held after lunch and the results were:

Sniffer Hunt: VK3DIP

2m Fox Hunts: 1st Heat: VK3XMD
Mark

2nd Heat: VK3DIP Paul

70cm Fox Hunt: VK3BQN

80m Fox Hunt: VK3DIP

Overall points winner: Paul VK3DIP

Winner of the CD player raffle was D Merret of Ballarat. Second raffle prize went to Bob

Wiley of Seddon. Door prize winner was Mike VK3JFC.

The BARG wishes to thank all who attended and made it another successful event on the amateur calendar.

Planning for 1991 is under-way to make it larger and even more interesting.

KEVIN HUGHES VK3WN ar

OVER TO YOU

ALL LETTERS FROM MEMBERS WILL BE CONSIDERED FOR PUBLICATION BUT MUST BE LESS THAN 200 WORDS. THE WIA ACCEPTS NO RESPONSIBILITY FOR OPINIONS EXPRESSED BY CORRESPONDENTS

SE-Asian Pirates

I was surprised to read (Seanet Convention Report, AR September '90) that Ken Pincott saw so few hand-held radios in Singapore.

I've been in Singapore about 15 times in the past three years and I reckon there are more than 50 hand-helds on display in the Orchard Road shops alone.

All of the large shopping plazas in Singapore have shops offering video and hi-fi gear, cameras and amateur band hand-held radios made by Icom, Yaesu and Kenwood.

Ken observed that the shops insist that buyers have licences. In my experience, some do, some don't. Buyers who are obviously foreigners can buy what they like as long as they take it out of Singapore.

It remains a fact that the regulation and control of radio equipment and spectrum usage in SE-Asia is generally slack. The use of amateur 2m gear in Indonesia for CB-style operation is just one symptom of the problem.

Another is the "hams" I hear on SSB on the CW end of the 40 and 80m bands, chatting in Bahasa Indonesia/Malaysia and ignoring bandplans and requests to QSY. They do not sound like licensed amateurs.

ANDREW DAVIS
VK1DA/V85DA
PO BOX 715,
SERIA 7007 BRUNEI
BORNEO, VIA SINGAPORE

What Price a Life?

A lot has been said about using Morse.

One aspect of major importance seems to have been overlooked during debate on this subject.

At the WARC's, deliberations of many people skilled in regulation of operations worldwide have resulted in the requirement for Morse code being established and retained.

We should come back to basics. There is a valid reason for the Morse requirement independent of other arguments.

Emergency situations occur and it is possible, and likely, that a radio call for help will be transmitted using Morse.

There are reasons why this can be the case.

It takes little understanding to conclude that Morse may be the only available means of transmission.

If a microphone is unserviceable, keyboard broken etc, an emergency message is still possible provided an oscillator functions. It can be sent by tapping two wires together.

If you are operating on HF, with a likelihood of intercepting an emergency message, it is incumbent upon you to be able to recognise an emergency message.

I disagree that the requirement for Morse will eventually be repealed.

My feelings are that, given the common sense of deliberations in the past, it may be that the requirement is never dropped.

I ask 'would you wish to be the one responsible for loss of someone's life because you were incapable of receiving a few Morse symbols??'

I understand that US astronauts are required to have Morse capability.

Perhaps these comments may throw a light on an area many have not considered.

IAN HUNT VK5QX
8 DEXTER DRIVE
SALISBURY EAST 5109

Morse Code for AOC

I have read members' comments proposing that Morse Code be discontinued as an AOC exam subject.

I strongly object to the remarks of Peter (VK2PA) in October AR, claiming that some people —

(a) want extra HF privileges, but do not want to work for them;

(b) would like to become radio amateurs, but

Morseword No 45

	1	2	3	4	5	6	7	8	9	10	
1											Across
2											1 Escape
3											2 Frosted
4											3 Wander
5											4 Vampires
6											5 Rub out
7											6 Bay
8											7 Informer
9											8 Listen
10											9 Smell is one
											10 In that place
											Down
											1 ___Lyn, singer
											2 Employs
											3 Openings
											4 Lie
											5 Wharf
											6 Ones and
											7 Metal
											8 Pictures
											9 Shoot
											10 Wonderful

Audrey Ryan © 1990

Solution Page 56

are not prepared to make the effort to learn the code etc.

May I remind Peter that there are many senior members of WIA who, suffering from blood pressure and/or stroke, are not able to take the pressure of 10wpm, although they passed 5wpm as novices. At present they have to be content with a "K" call.

In my case, I have passed 10wpm sending, continued with receiving practice, and sat for a number of exam tests. During the past two years, my brain (due to a stroke) will not function for five minutes at that speed without many errors due to fatigue.

The DoTC will not grant exemption even when claims are supported by medical certificates.

I would also suggest to Peter and others that there are many brilliant "K" call holders who would surpass some full call operators, in radio and electrical qualifications and ability (I exclude myself).

Perhaps Peter and others who make sweeping statements about lack of initiative and laziness will have another think!!

IAN RITSON VK5KIR
66 BARKER AVE
SOUTH PLYMPTOM 5038

Historical Collector

In your October issue an article headed "Historical Collections" requests the notification of additional collectors.

I wish to advise that I am always looking for military radio equipment to add to my collection.

I have been collecting for many years and am in a position to help others with information etc if required.

I am actively restoring the equipment in the collection and have many operational pieces of equipment.

The restored equipment has featured in many displays including JOTA, WIA displays, "Trash and Treasure" days, as well as being the subject of lectures at Hornsby and Westlakes Radio Clubs. A major display was mounted at this year's Gosford Field Day, where I found great interest was shown in the gear.

I have just finished restoring a 1936 US Navy TRF regenerative TBR1 receiver which brought many comments at the W.A on Sunday.

I would be very pleased to hear from anyone disposing of such equipment, and would certainly promise the gear a good home.

IAN O'TOOLE VK2ZIO
222 OLD NORTHERN RD
CASTLE HILL 2154
(02) 680 2112

RD Contest

Logs for this contest vary greatly, from a single page to monsters of 20 pages plus. The

work involves many hours of checking. In many hundreds of RD logs over the years, the honesty and error rate has been very commendable. Now, with many logs being generated by computer and the error rate of duplicates being almost nil, perhaps it's time to try something quite radical.

For next year's RD Contest would readers agree to the submission of a summary sheet ONLY.

From records kept for many years, it is known in advance how many logs will probably be received, and average scoring for each division.

I suggest a rule be added, stating that the contest co-ordinator may call up any log for checking, just to keep the possibility open of any log being required.

Postage is now expensive, so why line Australia Post's coffers? This could at present decide some operators when considering sending in their log.

NEIL PENFOLD VK6NE
ACTING FEDERAL CONTEST
CO-ORDINATOR
(FCM 1965-1981)
2 MOSS COURT
KINGSLEY 6026

Thanks for JOTA

I would like to thank John Jackson VK2FYD, John Watt VK2QN and Eric Fossey VK2JFY of Blue Mountains Amateur Radio Club for their wholehearted effort, support and time during the recent JOTA.

These operators spend weeks before organising gear and aerials to make the Emu Plains JOTA the best station and weekend I have ever been involved in. The boys went away from the base very happy and enthusiastic about coming to the next JOTA, some even enquiring about becoming licensed amateurs.

The Scouts enjoyed talking to stations in New Zealand, WA, SA, Vic, Qld, NSW, Tasmania, Oman, London, America and many more.

As most people would know, a Scout's favourite contact would be with Guides, and our Scouts got their fair share of QSL addresses from Guide stations.

The Blue Mountains Amateur Radio Club is no longer just a little radio club in the mountains. It is a driving force behind amateur radio operations in the Mountain Scouts districts and Penrith District. Once again, I would like to thank the operators, and hope to see you next year when our Scouts erect a tower for the aerials.

I myself hope to have my licence by next October '91 JOIA.

MARK GAPPS
1ST EMU PLAINS SCOUT GROUP

'AR' Technical Content

I read with dismay the item in November asking whether 'Amateur Radio' magazine

should follow the trend away from technical articles and concentrate more on simple projects, equipment reviews and so on.

My answer to this is a thousand times NO.

The technical content of 'AR' has decreased in recent years, and it is already difficult to get any useful information without subscribing to overseas magazines. Even the occasional overseas article not reprinted leaves many areas with no material available in this country. So we slide further into becoming a bunch of inward-looking appliance operators.

Technical competence is the basis of our hobby. Without it, we would resemble CBers, and certainly could not justify the spectrum space we use. We should be boosting our technical standards rather than letting them decline any further.

Many amateurs are WIA members solely because of the magazine. If the technical content is reduced any further these people would see less reason to remain members, and new amateurs would see less reason to join. Anyone who wants to read only equipment reviews and trivia can go to a newsagent and buy another magazine which covers these areas quite well.

The WIA exists to develop the hobby and to provide services to its members. The magazine is a crucial part of these responsibilities. To downgrade it any further would be a disservice and an insult to Australian amateurs.

JOHN MARTIN VK3ZJC
3 VERNAL AVE
MITCHAM 3132

A Call to all Holders of a Novice Licence

Now you have joined the ranks of amateur radio, why not extend your activities?

The Wireless Institute of Australia (N.S.W. Division) conducts a Bridging Correspondence Course for the AOCP and LAOCP Examinations.

Throughout the Course, your papers are checked and commented upon to lead you to a successful conclusion.

For further details write to:

The Course Supervisor
WIA
PO Box 1066
Parramatta NSW 2124
(109 Wigram Street, Parramatta)
Phone: (02) 689 2417

11am to 2pm Monday to Friday
7 to 9pm Wednesday

SILENT KEYS

DUE TO INCREASING SPACE DEMANDS OBITUARIES MUST BE
NO LONGER THAN 200 WORDS

We regret to announce the recent passing of:

Mr Neil Burne VK2GAT

Mr F A Maher VK3FZ

Mr D G Goode VK5BF

Mr R N Wreford VK5NW

Mr I A Broughton VK6AAK

Francis Anthony Maher VK3FZ

Frank Maher passed away on 24.10.90 at Royal Melbourne Hospital, aged 78.

First licensed in the late '20s, he used CW on his homebrew equipment until TV, then upgraded to a Galaxy V and Kenwood TS520.

In April 1929 he was apprenticed to the printing industry and spent his entire working life in the trade, ending up with his own business. He retired in 1982, after a stroke, but continued to enjoy an active amateur radio life.

He was a good father and husband to his family, a good friend to many, and will be sadly missed.

ALLEN CREWTER VK3SM

Neil Burne VK2GAT

Neil Burne passed away 4.3.90, aged 43 years.

He looked forward to your magazine and got a lot of knowledge and enjoyment out of it. He was confined to a wheelchair, and your magazine took away a lot of the boredom for him. He had purchased an Icom IC25A handheld after your write-up on them, for safety reasons in the car, and it worked well.

DONNA GRAY

Claude Singleton VK4UX

Jessie and family would like to thank amateurs Australia-wide for messages of condolence received at the loss of Claude VK4UX who passed away suddenly 14.9.90, aged 76 years.

Thank you most sincerely We were married for 49 years and I never bothered to get a callsign.

JESSIE SINGLETON

**THIS SPACE
COULD BE
EARNING YOU
MONEY!**

**ADVERTISING RATES
AVAILABLE FROM
PO BOX 300,
CAULFIELD SOUTH,
3162**

You're obviously serious about amateur radio.

At Amateur Radio Action magazine we believe it is a way of life. For just \$3.00 we make sure you keep up with the latest information

in the industry, including complete reviews on the latest equipment.

Don't get left behind, make sure you read Amateur Radio Action.

amateur
radio
action

AT YOUR NEWSAGENT EVERY MONTH.

HF PREDICTIONS

ROGER HARRISON VK2ZTB
THE APOGEE GROUP

December Charts

For ease of use and to accommodate space restrictions in the magazine, I have provided predictions applicable for three major regions of Australia:

VK EAST Covers the major part of NSW and Queensland.

VK SOUTH Covers southern-NSW, VK3, VK5 and VK7.

VK WEST Covers the south-west of West Australia.

For each of these regions I have selected six "terminals" to major continental regions of the world. Note that, this month, I have included charts for **South Georgia and the South Sandwich Islands** as there will be DXpeditions there early this month. Despite being geographically close, there are marked differences between the predictions, as you can see, which is the reason I did not do one set to cover the region.

Predictions for the long path to Europe are included again this month.

The charts explained

These charts are different to those you see published elsewhere, and arguably more useful to the amateur fraternity as they give,

effectively, the predicted signal/noise ratio for each hour and for selected bands.

The charts are organised in 24 rows, one for each hour UTC (first column on the left). Don't forget to add the appropriate number of hours for your time zone, including daylight saving where it applies. The next column gives the MUF (maximum usable frequency) for each hour, followed by the field strength at the MUF, in decibels referred to 1 uV/metre (dBu). The column marked FOT gives the "optimum" frequency - the most reliable frequency for the path.

Then come five columns, one for each of five selected HF bands. The numbers in the column represent predicted field strength at each hour in decibels referred to 1 uV/metre. Here it represents "raw" signal to noise ratio as urban noise levels are typically 1-2 uV/metre, but does not take into account the advantage offered by particular transmission modes. The results are based on a transmitter power of 100 W output (except where noted later), the use of modest 3-element beams or similar, and for "median" conditions. Where the results fall below -40 dB, no output is printed.

Enhanced conditions may improve S/N ratios by 9-15 dB. The use of CW or digital

transmission modes show better results than SSB. If you've got 400 W output, you get a 6 dB improvements. Where conditions warrant it, I have include predictions for the bands below 14 MHz, deleting the upper bands.

Ten Metres

The predictions look a little pessimistic for ten metres, but it only takes a slight "lift" in conditions to provide openings on this band. Keep a watch on the short-term geomagnetic and propagation forecasts.

South Georgia & South Sandwich Is.

These islands are in the southern Atlantic ocean, south east of the southern tip of South America, and not far from Antarctica. Propagation to this region from Australia is poor as the path is across the southern polar ionosphere, passing across the auroral zone. For these predictions I have assumed 400 watts of power - you'll need it, and/or better-than-average conditions.

I ran "trial" long path predictions, too. Curiously, it can provide marginally better signal strengths, on 14 and 18 MHz, but you get only two very narrow "windows", perhaps an hour each, centred on 0800 and again at 2000 hours UTC. For the long path to South Georgia and the South Sandwich Islands, point your beams pretty well due north.

UTC	MUF	DBU	FOT	10.1	14.2	18.1	21.2	24.9
1	14.2	-10	11.9	...	-10	-2	-2	-7
2	14.2	-9	12.2	...	-10	-1	-2	-7
3	14.3	-9	12.1	-40	-9	-1	-2	-7
4	14.4	-7	11.9	-39	-8	-1	-1	-6
5	14.6	-6	11.6	-36	-7	0	-2	-8
6	14.8	-5	11.5	-35	-7	1	-2	-9
7	15.0	-4	11.7	-34	-6	0	-2	-8
8	15.0	-2	12.2	-31	-4	2	0	-6
9	14.7	1	11.9	-24	-1	4	2	-5
10	14.6	4	11.7	-16	3	6	2	-5
11	14.3	4	11.4	-13	4	6	2	-7
12	14.1	3	11.2	-14	4	5	1	-8
13	13.9	2	11.4	-15	3	4	0	-9
14	13.6	1	10.9	-15	2	4	-1	-10
15	13.4	0	10.8	-16	2	3	-2	-12
16	13.3	-1	10.8	-17	1	2	-2	-12
17	13.4	-2	10.7	-19	0	2	-2	-11
18	13.6	-3	10.9	-23	-1	2	-2	-10
19	14.1	-5	11.1	-31	-5	1	-1	-8
20	14.6	-6	12.3	-38	-8	0	-1	-6
21	14.7	-7	12.5	...	-10	-1	-1	-5
22	14.6	-8	12.6	...	-10	-1	-1	-6
23	14.7	-9	12.6	...	-11	-1	-1	-6
24	14.6	-8	12.6	...	-10	-1	-1	-6

VK EAST - STH GEORGIA IS.

UTC	MUF	DBU	FOT	10.1	14.2	18.1	21.2	24.9
1	13.6	-7	11.7	-31	-5	0	-3	-10
2	13.3	-8	11.1	-30	-5	-1	-4	-11
3	13.3	-8	11.4	-30	-5	-1	-3	-11
4	13.4	-8	11.1	-30	-5	-1	-4	-11
5	13.6	-7	11.0	-29	-5	-1	-4	-13
6	13.7	-7	11.2	-30	-5	-1	-4	-12
7	14.0	-6	11.6	-31	-5	0	-2	-9
8	14.1	-5	12.1	-31	-4	1	-1	-8
9	14.1	-4	11.5	-28	-3	2	-1	-8
10	13.9	-2	11.3	-23	-1	3	-1	-9
11	13.8	0	11.1	-18	1	3	-1	-9
12	13.6	1	10.9	-16	2	3	-1	-10
13	13.4	1	10.7	-14	3	3	-2	-11
14	13.3	1	10.7	-14	3	3	-2	-12
15	13.3	0	10.2	-14	2	3	-2	-13
16	12.9	-1	10.0	-15	2	2	-4	-15
17	13.8	-2	10.0	-16	1	1	-4	-15
18	12.9	-3	10.2	-18	0	1	-4	-15
19	13.1	-5	10.7	-23	-2	0	-4	-13
20	13.4	-6	10.6	-28	-4	0	-3	-11
21	13.7	-6	11.5	-30	-5	0	-2	-10
22	13.8	-7	11.7	-32	-5	1	-2	-9
23	13.8	-6	11.8	-32	-5	0	-2	-9
24	13.7	-6	11.8	-30	-5	0	-2	-9

VK STH - STH GEORGIA IS.

UTC	MUF	DBU	FOT	10.1	14.2	18.1	21.2	24.9
1	13.6	-4	11.3	-26	-3	1	-1	-9
2	14.1	-5	11.7	-31	-5	1	-1	-7
3	14.2	-6	11.6	-35	-7	0	-1	-7
4	14.3	-8	11.3	-38	-8	-1	-2	-8
5	14.2	-9	11.1	-40	-9	-2	-3	-9
6	14.1	-11	11.4	...	-11	-3	-3	-8
7	13.7	-14	11.7	...	-12	-3	-3	-8
8	13.8	-14	11.6	...	-12	-3	-3	-8
9	13.8	-13	11.6	...	-12	-3	-3	-8
10	14.0	-11	11.6	...	-10	-2	-2	-8
11	14.1	-8	11.6	-39	-8	-1	-1	-7
12	14.4	-4	11.8	-31	-4	2	0	-6
13	14.6	0	11.8	-24	-1	4	2	-5
14	14.5	3	11.7	-19	2	5	2	-5
15	14.2	4	11.4	-16	3	6	2	-6
16	14.1	5	11.2	-12	5	6	2	-7
17	13.9	6	10.9	-9	6	6	1	-8
18	13.6	7	10.6	-6	8	7	1	-9
19	13.5	8	10.3	-3	9	7	1	-10
20	13.2	9	10.2	0	9	7	0	-12
21	13.0	6	10.3	-5	7	5	-2	-13
22	13.2	0	10.4	-1	3	3	-3	-13
23	13.0	-2	10.5	-17	1	2	-3	-12
24	13.2	-3	10.8	-21	-1	2	-2	-11

VK WEST - STH GEORGIA IS.

UTC	MUF	DBU	FOT	10.1	14.2	18.1	21.2	24.9
1	14.1	-9	12.2	-40	-9	-1	-2	-7
2	13.8	-11	11.5	-40	-9	-2	-3	-9
3	13.8	-11	11.5	-40	-9	-2	-3	-9
4	13.9	-10	11.2	-38	-9	-2	-4	-10
5	14.1	-10	11.2	-39	-9	-3	-4	-10
6	14.2	-9	11.4	-39	-9	-2	-4	-10
7	14.5	-7	12.0	-38	-8	-1	-2	-8
8	14.7	-5	12.7	-35	-6	0	0	-5
9	14.6	-1	11.9	-28	-3	1	1	-5
10	14.4	2	11.7	-19	2	5	2	-6
11	14.3	4	11.5	-16	4	2	2	-7
12	14.0	3	11.2	-14	4	5	1	-8
13	13.9	3	11.0	-13	4	5	0	-9
14	13.7	3	11.3	-13	4	4	0	-10
15	13.5	2	10.8	-12	4	4	-1	-11
16	13.3	2	10.7	-12	3	3	-2	-12
17	13.2	2	10.6	-12	3	3	-2	-13
18	13.2	0	10.8	-16	4	2	-2	-12
19	13.5	-4	11.2	-24	-2	1	-2	-11
20	13.8	-6	10.9	-31	-5	0	-2	-9
21	14.2	-7	11.9	-36	-7	0	-1	-7
22	14.3	-7	12.1	-38	-8	0	-1	-7
23	14.4	-8	12.2	-39	-8	-1	-1	-6
24	14.3	-8	12.2	-39	-9	-1	-2	-7

VK EAST - STH SANDWICH IS.

UTC	MUF	DBU	FOT	10.1	14.2	18.1	21.2	24.9
1	15.0	-11	12.8	-31	-4	3	2	-3
2	14.8	-12	12.1	-32	-4	2	1	-5
3	14.7	-13	11.9	-32	-5	1	0	-7
4	14.6	-14	11.7	-32	-5	1	0	-7
5	14.5	-15	12.2	-35	-6	1	-1	-6
6	14.6	-15	12.4	-36	-6	1	1	-5
7	14.9	-14	12.5	-36	-6	2	1	-4
8	15.0	-12	12.6	-34	-5	2	2	-3
9	15.3	0	12.7	-31	-3	4	3	-2
10	15.4	3	12.7	-25	0	6	5	-1
11	15.4	5	12.9	-20	3	7	5	-1
12	15.3	7	12.4	-16	5	8	6	-1
13	15.2	8	12.2	-12	6	9	6	-1
14	15.0	8	11.8	-12	7	9	6	-2
15	14.8	8	11.4	-11	7	9	5	-3
16	14.8	8	11.2	-10	7	8	4	-4
17	14.6	7	10.9	-10	6	7	3	-6
18	14.4	6	11.0	-11	6	7	2	-7
19	14.3	3	11.2	-17	3	5	2	-6
20	14.3	1	11.7	-22	0	4	2	-5
21	14.5	0	12.0	-26	-1	4	2	-5
22	14.7	-1	12.3	-28	-2	4	2	-4
23	14.9	0	12.6	-28	-2	4	3	-3
24	15.0	0	12.7	-29	-3	4	3	-3

VK STH - STH SANDWICH IS.

UTC	MUF	DBU	FOT	10.1	14.2	18.1	21.2	24.9
1	15.2	-2	12.1	-25	0	5	3	-3
2	15.2	-1	11.9	-20	-3	3	1	-5
3	15.2	-3	11.9	-25	-6	1	0	-5
4	15.3	-4	12.1	-38	-8	1	0	-5
5	15.0	-4	12.7	...	-10	0	1	-3
6	15.9	-5	12.9	...	-12	-1	1	-2
7	15.4	-7	12.8	...	-12	-1	0	-4
8	15.4	-7	12.7	...	-12	-1	0	-4
9	15.5	-6	12.7	...	-11	-1	0	-3
10	15.6	-4	12.7	...	-10	0	1	-3
11	15.2	-3	12.8	...	-9	1	2	-2
12	15.2	3	13.0	-30	-2	5	5	0
13	16.4	7	13.0	-22	6	8	7	1
14	16.3	9	12.9	-14	6	10	8	2
15	16.0	10	12.5	-11	8	10	8	1
16	15.8	12	12.1	-6	10	11	8	1
17	15.4	13	11.7	-1	12	12	8	-1
18	15.2	15	11.4	4	15	13	8	-1
19	14.9	16	11.1	8	16	13	8	-2
20	14.6	16	11.0	9	16	13	7	-4
21	14.3	14	11.2	5	14	11	5	-6
22	14.3	8	11.2	-6	8	8	3	-6
23	14.3	6	11.4	-11	6	7	3	-6
24	14.7	3	11.7	-18	3	6	3	-5

VK WEST - STH SANDWICH IS.

UTC	MUF	OBU	FOT	10.1	14.2	18.1	21.2	24.9						
1	18.3	-8	12.8	...	-19	-8	-6	-9						
2	20.0	-8	14.0	...	-26	-11	-7	-8						
3	21.1	-9	14.8	...	-34	-15	-9	-8						
4	21.7	-11	15.2	...	-39	-18	-12	-9						
5	21.8	-13	15.3	...	-41	-20	-14	-10						
6	22.0	-13	15.4	...	-41	-20	-14	-10						
7	21.4	-14	15.0	...	-43	-21	-15	-11						
8	21.3	-14	14.9	...	-43	-21	-15	-11						
9	20.8	-13	14.5	...	-40	-19	-12	-10						
10	20.6	-10	14.4	...	-34	-15	-10	-8						
11	20.5	-7	14.3	...	-26	-11	-7	-7						
12	20.5	-4	14.5	...	-18	-6	-3	-4						
13	20.3	0	14.5	-38	-9	-1	0	-3						
14	19.7	4	14.2	-20	0	4	3	-1						
15	19.4	9	13.8	1	10	10	7	0						
16	18.6	13	13.4	16	18	14	8	0						
17	17.8	14	13.0	21	19	14	8	-2						
18	17.1	15	12.6	23	20	13	6	-4						
19	17.4	16	12.2	25	22	15	7	-3						
20	17.2	15	11.8	22	19	13	6	-4						
21	16.5	9	11.3	5	10	7	1	-8						
22	16.1	3	11.1	-10	2	2	-3	-11						
23	16.3	-2	11.3	-25	-5	-2	-5	-11						
24	17.0	-6	11.8	-38	-11	-5	-6	-10						

UTC	MUF	OBU	FOT	14.2	18.1	21.2	24.9	28.5						
1	17.4	-5	12.0	-11	-5	-5	-10	-18						
2	19.0	-6	13.5	-18	-7	-5	-8	-13						
3	19.3	-9	13.8	-25	-11	-8	-9	-13						
4	19.2	-13	13.7	-32	-15	-11	-10	-14						
5	18.8	-16	13.4	-36	-18	-13	-12	-15						
6	18.0	-17	13.3	-38	-19	-13	-12	-15						
7	18.0	-18	13.3	-39	-20	-14	-12	-15						
8	19.2	-16	13.6	-38	-19	-13	-12	-14						
9	19.3	-15	13.8	-36	-18	-12	-11	-14						
10	19.0	-13	13.4	-32	-15	-11	-11	-14						
11	18.4	-12	12.9	-26	-12	-9	-10	-15						
12	18.1	-8	12.6	-18	-8	-7	-10	-16						
13	17.5	-5	12.2	-11	-5	-5	-10	-17						
14	17.0	-1	11.8	-4	-1	-3	-10	-19						
15	16.5	5	11.6	5	4	-1	-10	-21						
16	15.9	13	11.0	15	8	0	-11	-25						
17	15.4	14	10.7	16	8	-1	-14	-28						
18	15.1	15	10.6	17	8	-2	-15	-30						
19	15.3	16	10.8	18	9	-1	-14	-29						
20	16.0	15	11.3	18	10	1	-11	-25						
21	15.7	10	10.9	12	6	-2	-13	-26						
22	15.3	5	10.7	5	2	-5	-15	-28						
23	15.5	0	10.9	0	-1	-6	-15	-26						
24	16.2	-3	11.5	-5	-3	-6	-13	-23						

UTC	MUF	OBU	FOT	14.2	18.1	21.2	24.9	28.5						
1	19.6	5	14.7	2	5	4	-1	-9						
2	21.5	3	16.0	-5	2	3	0	-5						
3	23.6	1	17.8	-15	-3	1	0	-3						
4	24.0	-2	19.4	-24	-8	-3	-2	-4						
5	23.6	-4	17.5	-30	-12	-6	-4	-6						
6	23.4	-6	17.2	-34	-14	-8	-5	-7						
7	22.6	-7	16.5	-35	-15	-9	-7	-8						
8	22.4	-8	16.3	-35	-16	-9	-7	-8						
9	22.1	-8	17.9	-34	-15	-9	-7	-9						
10	22.1	-6	17.9	-30	-13	-7	-6	-8						
11	22.0	-4	18.2	-25	-9	-5	-4	-7						
12	21.6	-2	17.4	-16	-4	-2	-3	-7						
13	21.2	2	17.0	-7	1	2	-1	-6						
14	20.7	6	16.5	3	7	5	1	-6						
15	20.4	10	16.2	14	13	9	3	-5						
16	19.9	14	15.7	20	16	14	3	-6						
17	19.5	15	15.8	22	17	11	3	-7						
18	18.8	15	14.6	23	17	10	1	-10						
19	18.0	16	13.9	23	16	9	-1	-13						
20	17.3	17	13.2	23	15	7	-4	-16						
21	17.7	17	13.3	23	16	8	-3	-15						
22	18.4	16	13.7	23	16	9	0	-12						
23	18.6	13	14.2	18	14	8	0	-11						
24	18.9	9	14.3	10	10	6	-1	-10						

VK EAST - AFRICA

VK STH - AFRICA

VK WEST - AFRICA

UTC	MUF	OBU	FOT	14.2	18.1	21.2	24.9	28.5						
1	24.7	2	20.2	-18	-3	1	2	-1						
2	25.4	2	19.2	-20	-4	1	2	0						
3	25.8	2	21.4	-20	-4	1	2	0						
4	25.4	2	20.9	-19	-1	1	2	0						
5	24.9	2	20.4	-17	-2	2	2	-1						
6	24.2	3	19.8	-12	0	3	2	-1						
7	23.6	4	19.2	-5	4	5	3	-1						
8	23.3	8	19.4	5	10	9	6	0						
9	22.8	12	18.4	10	17	14	8	1						
10	22.5	13	18.1	22	20	15	9	1						
11	22.5	14	18.0	25	21	17	9	1						
12	22.8	15	18.2	27	23	18	11	3						
13	22.8	16	18.1	30	24	19	12	3						
14	22.6	16	18.4	29	24	19	11	2						
15	21.3	16	16.7	28	22	16	8	-2						
16	20.2	16	15.7	27	20	13	4	-7						
17	19.0	16	14.7	25	18	10	-1	-13						
18	18.5	16	14.2	25	17	9	-3	-16						
19	17.2	12	13.2	20	9	-2	-17	-34						
20	16.2	10	12.5	15	4	-7	-24	-51						
21	20.1	6	15.1	12	10	4	-5	-16						
22	24.2	8	18.9	5	16	10	7	2						
23	24.3	5	19.3	-7	19	5	4	0						
24	24.2	2	19.5	-13	-1	2	2	-1						

UTC	MUF	OBU	FOT	14.2	18.1	21.2	24.9	28.5						
1	24.3	-1	19.4	-22	-6	-2	-1	-3						
2	24.6	-1	20.0	-25	-8	-3	-1	-3						
3	24.5	-1	20.3	-25	-9	-3	-1	-3						
4	24.4	-1	20.1	-25	-8	-3	-1	-3						
5	23.6	-2	19.4	-23	-7	-3	-2	-5						
6	23.2	-2	19.0	-19	-5	-1	-1	-5						
7	22.7	1	18.5	-13	-2	1	-1	-5						
8	22.5	4	18.3	-3	4	4	2	-4						
9	22.2	11	18.0	15	15	12	6	-1						
10	21.7	13	17.5	22	19	14	7	-2						
11	21.5	14	17.3	24	20	14	7	-3						
12	21.1	16	16.7	25	14	6	4	-4						
13	21.1	15	16.8	26	21	15	6	-4						
14	20.8	15	16.4	27	21	14	5	-5						
15	20.5	15	16.2	27	20	14	4	-6						
16	19.7	15	15.4	26	18	11	1	-10						
17	18.8	15	14.5	24	16	9	-2	-15						
18	17.8	15	13.7	23	14	5	-7	-21						
19	18.0	12	13.7	22	12	3	-10	-25						
20	17.5	10	13.5	18	8	-2	-16	-33						
21	20.4	8	15.3	13	11	7	-1	-11						
22	22.4	8	17.0	2	7	3	3	2						
23	23.9	3	18.4	-10	1	3	2	-1						
24	24.3	1	19.1	-17	-3	1	1	-2						

UTC	MUF	OBU	FOT	14.2	18.1	21.2	24.9	28.5						
1	23.2	2	18.4	-13	-1	2	1	-3						
2	23.1	0	18.6	-17	-3	0	-1	-4						
3	23.4	0	19.2	-19	-5	-1	-1	-4						
4	23.7	0	17.9	-20	-5									

HAMADS

TRADE HAMADS

● WEATHER FAX programs for IBM XT/ATs *** RADFAX2 is a high-resolution shortwave weather fax, Morse & RTTY receiving program. Needs CGA, SSBht radio & RADFAX decoder. Also RF2HERC, RF2EGA and RG2VGA, same as RADFAX2 but suitable for Hercules, EGA and VGA cards respectively. \$35 *** SATFAX is a NOAA, Meteor and GMS weather satellite picture-receiving program. Uses EGA or VGA modes. Needs EGA or VGA colour monitor and card, + WEATHER FAX PC card, \$45 *** All programs are on 5.25" or 3.5" disks (state complete) + documentation, add \$3 postage. ONLY from M DeLahunty, 42 Villiers St, New Farm Qld 4005. Ph (07) 358 2785.

● AMIDON FERROMAGNETIC CORES: for all transmitter and receiver applications. Send DL size SASE for data/price to RJ & US Imports, Box 157, Moridale NSW 2223 (no enquiries at office please... 11 Macken St, Oatley). Agencies at: Geoff Wood Electronics, Sydney. Webb Electronics, Albury. Electronic Components, ACT. Truscott's Electronics, Melbourne. S Willis, Perth. Assoc TV Service, Hobart.

FOR SALE - NSW

● INFO TECH M300C keyboard transmitting and INFO TECH M200F code receiver converter. As brand new. Imported from USA, top level high-tech equipment. Cost \$1600. What offers? Also National Panasonic communications receiver DR48 double superhet. (02) 958 5412.

● YAESU FT101E, good cond, \$500. Hy-Gain 18V allband vert antenna \$85. Fuzz Buster radar detector \$85. Peter VK2DBI QTHR (063) 67 5095.

● TRANSFORMER 240V to 110V 2KVA \$150 ono. Jack VK2VO (02)982 4290.

● KENWOOD TM2570A 2M FM 5/70W keyboard entry \$550. ICOM IC701 HF Tcvr RM3 remote control digital TX audio laull service manual \$450. VK2RZ (043) 62 1235.

● 30-METRE kit of traps for Mosley TH33 complete new. Purchased in error. Identical to 40-metre kit 3KW pep C Maloot VK2AMA. (02) 599 1126. Otters.

● KENWOOD TL922 HF linear, as new in original box \$2100 ono. VK2DT QTHR (02) 868 1131.

● ICOM 28A/E 2M FM transceiver 25W, handbook, homebrew battery pack \$480. Bob VK2YEL QTHR (02) 639 0267.

● STC Lowband 100W base and 4MTR25 mobiles \$150 the lot. AR7 with all boxes \$50. BC640 VHF TX \$50. ASR33 Teletype \$75. AWA carphones \$10 each. SCR 522 \$15 each. Plus heaps of miscellaneous radio and computer chassis and parts. Everything must go — moving house. Dean VK2ZID (02) 487 3052.

● IBM-XT compatible computer, suit packet etc. Dual 360K drives. 512K RAM, CGA card, mono monitor, serial and parallel port, made in USA. \$395. VK2KGG QTHR (02) 958 8703.

FOR SALE - VIC

● YAESU FL2100Z linear amp WARC bands, good cond, best offer. Seiko SC700 scanner, good cond, best offer. (051) 99 2811 or (018) 51 3108.

● KENWOOD TS820 tcvr VF0820 XVFO \$700. VK3AMB Brian AH: (03) 467 5213.

● YAESU FT101E HF TRX FV101B ext VFO. Good cond. Complete with hand-mic and handbooks. New Q/P tubes (6JS6s). \$500 the lot. Dick VK3AEX (053) 32 1818 (BH) (053) 32 3273 (H).

● BRAND NEW boxed tubes, 4-400A \$125. 4 - 400C \$150. QB4-1100 \$125. QB3-300 \$30. 810 \$15. Used 4CX350A, GC, \$25. Quality Collins linear 30L-1exc unmarked cond. 4 new

811A fitted C/W manual \$1500. Kenwood TS430S, absolutely as new in box, 15 hrs shack use only. Purchased for mobile but never used. All options FM, AM, CW & 1.8 KHz SSB Filters. 2 DC leads, mobile bracket workshop manual \$1375. Kenwood MC60A desk mic, new in box \$110. SP930 as new in box \$125. VK3GY QTHR (03) 789 4363.

● YAESU FT101B just fully serviced, EC, h'book and full service manual \$400. FL2100B linear, EC, full output \$775. Ron VK30M QTHR (059) 44 3019.

● KENWOOD TS820S transceiver with VF0820 external VFO and MC50 desk mic \$800 ono. Yaesu mobile linear amplifier, model FL110, \$200. Mike Trickett VK3ASQ QTHR (052) 78 9766 (BH), (052) 78 1986 (AH).

● ICOM IC551D 6M all mode solid state 100W, good cond, handbook, desk mic, 4EL yagi. (053) 31 7425. Charlie VK3DCS QTHR.

● LINEAR amp tubes, Eimac 3-500Z, new in sealed cartons (two) \$200 ea. Bob VK3JE (060) 37 1262 or (03) 584 5737.

● TEN TEC Delta 580 HF transceiver 1.6-30MHz including the WARC bands, 100W mobile, digital readout, h'books, all solid state, \$825. Set of Yaesu mobile whips, including gutter mount and 2m stub \$150. Or both the above for \$850. Frequency meter, AN/URM-32 125KHz - 1.000 MHz with manuals, \$80. VK3UU Max (03) 798 2003 QTHR.

FOR SALE - OLD

● ICOM IC-02AT 2M FM handheld, GC, \$300. Icom IC-4E 70cm FM handheld, GC, \$200. AOR AR-2002 scanner 25-550 MHz and 800-1300 MHz. GC, \$750. Microwave Modules MML 432/50 50W 70cm amplifier, \$250. Ampere APB-82A 80W 2m amplifier, \$150. Offers considered. Ross VK4IY, QTHR (075) 65 1445.

● TS130S HF tcvr \$750. Mobile mount \$25. AT130 ATU \$70. AT230 ATU \$150. MC50 desk mike \$85. Barry VK4BIK (074) 91 7317 QTHR.

● HENRY radio linear, 3-500Z, silver plated inductor, \$850. Bruce VK4BV QTHR (076) 35 1457.

FOR SALE - SA

● 2X 15E1 470MHz yagis pwr divider and harness \$200 ono. Dale VK5AFO (08) 391 2300 QTHR.

FOR SALE - TAS

● YAESU FT707 80-10m t/cveier \$650. FV707DM ditigal extn VFO \$250. FC707 ATU \$250. FP707 20 Amp p/supply spkr. \$320. Above all mint, hardly used, boxes. VK7AN (003) 31 7914.

FOR SALE - WA

● KENWOOD TM221A 2m transceiver complete with books, hardly used, \$400. Andrew VK6WB (09) 447 1213 QTHR.

WANTED - NSW

● INFO on Yaesu FT480R loan or copy of handbook operation and maintenance. John VK2KXK (066) 21 2933.

● CIRCUIT for Breville console radio 1934 valve model 87 serial 206. Leo VK2QB OTHR.

● MYFT200 is OK on SSB, but IC reads full-scale on CW tuning, RF loading and drive has no effect. Any clues? George VK2YT (02) 625 2602.

● ANY info on Butternut vertical or purchase of same. VK2DJM OTHR (066) 86 8742.

● MILITARY radio equipment required by experienced collector for restoration and display. Give your old gear a good home. Manuals also. Ian VK2ZIO (02) 680 2112 QTHR.

● AN/PRC25 B47 C42 gear needed, headset and mic for C42 No 19 set and boxes. Call Scotty VK2KE (ex 3ZR). AH: (060) 21 8897 QTHR.

● COLLINS KWM2A prop pitch motor. Details to VK2OE, PO Box 1914, Wollongong, 2500.

● YAESU FV101 ext-VFO YO10 monitor scope YC601 digital display SP101 ext speaker FTV250 2m transverter FTV650 6m transverter. Peter VK2DBI QTHR (063) 67 5095.

WANTED - OLD

● COLLINS R390 receiver, service manual wanted. Lionel Sharp VK4NS QTHR.

● CIRCUIT diagram and control head for PYE UHF Vanguard. Also Bearcat 20/20 scanner for parts. VK4WHO Pat (074) 85 1240 after 6pm.

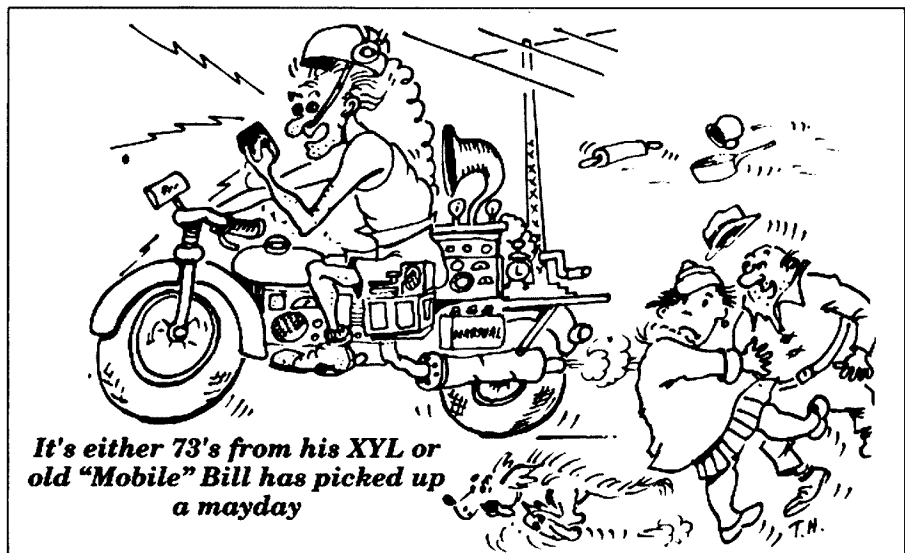

TONY HEATON VIA VK4ADS

MERCEDES CARS WITHSTAND 'TORTURE' TEST

A NEW 'torture' chamber where Mercedes-Benz cars and truck/trailers can be bombarded with powerful electronic and radio-wave forces is helping build in vital protection against potentially dangerous interference.

A high-powered radio transmitter and sophisticated monitors in the specially shielded chamber are used during a wide range of tests on a vehicle whilst it is running. The result is electronic units, computers and sensor systems in Mercedes vehicles which function undisturbed.

Features which undergo checks for electromagnetic compatibility (EMC) by Mercedes-Benz engineers in Germany (with the support of Siemens) include the air conditioning and sound systems. More critically, the advanced Mercedes ABS anti-locking braking and injection/ignition systems are tested for resistance to interference, from extremely high to minute levels.

Operators wear special space-like protective suits to protect them against the intense electromagnetic radiation forces in the chamber when the advanced automated measurement systems re-

quire human back-up.

To rule out disruptive interference of the electronic components on each other, ingenious shields and filters are developed through EMC research. Positive benefits include smarter engine management systems which lead to better control of exhaust emissions and more efficient fuel use.

Electronics is a rapidly growing feature of today's vehicles, with a nerve system of cables more than four kilometres long and dozens of micro-computers controlling almost everything which drives a Mercedes. ar

HAMADS

Please Note: If you are advertising items For Sale and Wanted please use a separate form for each. Include all details; eg Name, Address, Telephone Number (and STD code), on both forms. Please print copy for your Hamad as clearly as possible.

*Eight lines per issue free to all WIA members, ninth line for name and address Commercial rates apply for non-members. Please enclose a mailing label from this magazine with your Hamad.

*Deceased Estates: The full Hamad will appear in AR, even if the ad is not fully radio equipment.

*Copy typed or in block letters to PO Box 300, Caulfield South, Vic 3162, by the deadline as indicated on page 1 of each issue.

*QTHR means address is correct as set out in the WIA

current Call Book.

*WIA policy recommends that Hamads include the serial number of all equipment offered for sale.

*Please enclose a self addressed stamped envelope if an acknowledgement is required that the Hamad has been received.

Ordinary Hamads submitted from members who are deemed to be in general electronics retail and wholesale distributive trades should be certified as referring only to private articles not being re-sold for merchandising purposes.

Conditions for commercial advertising are as follows: \$22.50 for four lines, plus \$2.00 per line (or part thereof) Minimum charge — \$22.50 pre-payable.

State:

- Miscellaneous
- For Sale
- Wanted

Name:

Call Sign:

Address:

Solution to Morseword No 45

	1	2	3	4	5	6	7	8	9	10
1	.	.	-	.	.	-
2	.	.	-	.	-	.	.	-	.	.
3	.	-	.	-	-	.	-	-	-	-
4	-	-	-	.	.	.
5	.	.	-	.	.	-
6	.	.	-	.	.	-	.	.	-	-
7	-	.	.	-	.	-	-	-	-	-
8	-	.	-	.	.
9	.	.	.	-
10	-	-	.	.	.

Across: 1 flee; 2 iced; 3 roam; 4 bats;
5 erase; 6 inlet; 7 nark; 8 hear; 9
sense; 10 there

Down: 1 Vera; 2 uses; 3 gates; 4 fib; 5
pier; 6 twos; 7 steel; 8 pix; 9 fire; 10
fab

TRADE PRACTICES ACT

It is impossible for us to ensure the advertisements submitted for publication comply with the Trade Practices Act 1974. Therefore advertisers and advertising agents will appreciate the absolute need for themselves to ensure that, the provisions of the Act are complied with strictly.

VICTORIAN CONSUMER AFFAIRS ACT

All advertisers are advised that advertisements containing only a PO Box number as the address cannot be accepted without the addition of the business address of the boxholder or seller of the goods.

TYPESETTING : Redfords Media
25 Glenferrie Rd
Malvern 3144
Tel: (03) 500 9464

PRINTING: Industrial Printing
Richmond

MAIL DISTRIBUTION: Polk Mailing Co.
PO Box 140,
Collingwood,
Vic. 3066
Tel:(03) 417 5161

The opinions expressed in this publication do not necessarily reflect the official view of the WIA, and the WIA cannot be held responsible for incorrect information published.

ADVERTISERS INDEX

Amateur Radio Action	51
ATN Antennas	45
Dick Smith Electronics	28-31
Electronics Australia	17
Firemoon	9
Icom Australia	OBC,
Kenwood Electronics Aust.	IFC
Magpubs	7
Terlin Aerials	11
VHF Communications	9
WIA Call Books	IBC
WIA Club Contest	11
WIA NSW Division	50

TRADE ADS

RJ & US Imports	54
M Delahunty	54

HOW TO JOIN THE WIA

Fill out the following form and send to:

The Membership Secretary
Wireless Institute of Australia
PO Box 300
Caulfield South, Vic 3162

I wish to obtain further information
about the WIA.

Mr, Mrs, Miss, Ms:

Call Sign (if applicable):

Address:

State and Postcode:

WIA SLOW MORSE TRANSMISSIONS

VK2BWI	Nightly at 2000 local on 3550 kHz
VK2RCW	Continuous on 3699 kHz and 144.950 MHz 5 wpm, 8 wpm, 12 wpm
VK3RCW	Continuous on 144.950 MHz 5 wpm, 10 wpm
VK4WIT	Monday at 0930 UTC on 3535 kHz
VK4WII	Tuesday at 0930 UTC on 3535 kHz
VK4WCH	Wednesday at 0930 UTC on 3535 kHz
VK5WIS	Nightly at 0900 UTC on 3542 kHz
VK5AWI	Nightly at 1030 UTC on 3550 kHz
VK6RAP	Nightly at 2000 local on 146.700 MHz
VK6WIA	Nightly (except Saturday) at 1200 UTC on 3.555 MHz

1991 WIA AUSTRALIAN RADIO Amateur Call Book Out Now

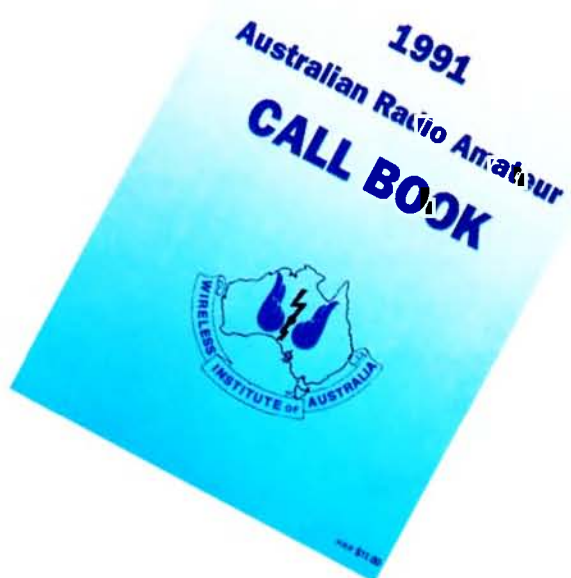
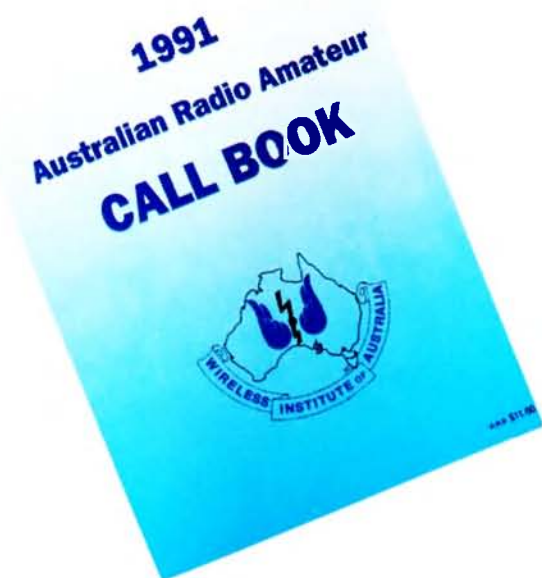

**Over 18100 Current Callsign Listings
Plus Band Plans, Repeaters, Beacons, DXCC, etc.**

**LIMITED STOCK!
SELLING FAST!**

Buy your copy NOW from your WIA Divisional Bookshop.
Cover Price **\$11.00** Special Price to WIA Members of **\$9.50**

ALL PRICES are plus Postage and Handling

DO NOT MISS OUT!



The smaller we get, the better we get!

ICOM's amazing new mini FM Handhelds

The minute you see and hold one of the Icom "S Series" mini handhelds you'll agree with our thought that "bigger is not always better and smaller is not always less".



By reducing the size of our product, maintaining high standards of quality and production and constantly improving our range, Icom's business continues to grow. So, the smaller we get, the better we get.

4 DTMF code memory channels for auto dialing.

24 hour clock with timer.

IC-2SAT, IC-4SAT, IC-24AT
Overall, Icom's family of tiny miracles, the 2SAT, 4SAT and 24AT give the Handheld enthusiast ease of operation through the convenient, multi-function keyboard. Delivering a full 5W output (at 12V) they feature clear, backlit function displays, splash resistant design and durable construction for outdoor use. One of these models is bound to suit your application, camping, skiing, in the field or vehicle. Use with built-in, rechargeable NiCd batteries (IC-2SAT, IC-4SAT only) or external power supply without having to use

DC socket for charging and external DC power entry.

40 memories

Dual band display.

Optional battery packs, various sizes, power output.

DC-DC converters, just the optional cigarette lighter cable or mini power cable.

IC-2SA

A super multi-function hand held with strong appeal for veterans, the 2SA is also the perfect way for newly licenced Amateurs to get started. This 144 MHz FM transceiver delivers 5W output (at 12V) with the optional BP-85 battery-pack, 40 memory channels, automatic power saver, LCD readout, operation from battery or external 12 volt DC supply. A PTT lockout switch is provided to prevent accidental transmissions. Amazingly its tremendous versatility and wide variety of functions are simply controlled by just six switches and three controls. An interesting and detailed colour brochure will be sent to you on request - call now for the name of your nearest stockist.

IC-24AT

Two Radios in one?

Would you believe a full dual-bander in the palm of your hand? Yes, full crossband duplex with 40 independent (simplex, 20 duplex) memory and 2 call channels, 5 watts out put from 12 volts direct power!

With all its features, you'd think the 24-AT would be quite a handful - and it is - almost. Even with its battery pack it only weighs 340gm but still gives you 6 scan functions, priority watch and built-in clock with a timer function.

We know you can't wait to find out more about our latest triumph in design and miniaturisation, so call us now for a free colour brochure giving full details on the 24AT and ask for the name of your nearest stockist.

For further information call Icom free on 008 338 915

Melbourne callers (03) 529 7582 Icom Australia Pty. Ltd., 7 Duke Street, Windsor 3181.
Icom Australia's warranty is only applicable to products purchased from their authorised Australian Dealers.



■ AMATEUR ■ MARINE ■ LAND-MOBILE ■ AVIATION ■ CB ■ AMATEUR ■ MARINE ■ LAND-MOBILE ■ AVIATION ■ CB ■ AMATEUR ■ MARINE ■ LAND-MOBILE ■

Please rush to me your brochure on the 2SA 2SAT 4SAT 24AT and the name of my nearest Icom stockist.

SEND TO: Freepost 15, Icom Australia Pty Ltd, Windsor, 3181 (no stamp required).

Mr., Mrs., Ms. Company Title

Address Suburb

City Post Code Phone No.

NCAA 4641 AF.

■ AMATEUR ■ MARINE ■ LAND-MOBILE ■ AVIATION ■ CB ■ AMATEUR ■ MARINE ■ LAND-MOBILE ■ AVIATION ■ CB ■ AMATEUR ■ MARINE ■ LAND-MOBILE ■