

# *Amateur Radio*

VOL. 51, No. 1 JANUARY 1983  
Registered by Australia Post — Publication No. VBH 0569



JOURNAL OF THE WIRELESS INSTITUTE OF AUSTRALIA

**1983 WORLD COMMUNICATIONS YEAR**



*Farewell Function  
Square-One Receiver*

*Nicad Charger  
Phased Verticals*

## HF-VHF-UHF ANTENNAS

The ATN range of HF, VHF and UHF Yagi, Log Periodic and dipole Antennas are ruggedly constructed for long life. High grade tapered, swaged and seamless aluminium is used throughout. The precision made injection moulded insulators use tough Lexan.

AH HF antennas include a 2 KW PEP balun, while the VHF and UHF range are supplied complete with a 200 W PEP balun. Also they may have up to 4 driven elements which provides both high gain and good broadband performance. The UHF range use "N" type connectors on their baluns.

MODEL	DESCRIPTION	GAIN (dBi)	BOOM (M)	PRICE \$
<b>(Showing bandwidth and number of elements)</b>				

### HF MONO BAND YAGI'S

27-28-3B	11 metre 3 element yagi	10.0	3.5	77.00
28-29-3B	10 metre 3 element yagi	10.0	3.5	77.00
27-30-3B	10/11 metre 3 element yagi	10.0	3.5	92.00
20-30-1	Rotary 15/11/10 dipole	2.2	-	-
20-30-111V	C.B. Base Dipole as above. Suit horiz. or vert. polarization.			

14-14-4-1  
20 metre heavy duty rotary dipole

14-14-4-3	20 metre 3 element yagi	9.2	6.0	183.00
14-14-4-4	20 metre 4 element yagi	10.0	7.0	276.00
21-21.5-3	15 metre 3 element yagi	9.2	4.5	122.00
21-21.5-4	15 metre 4 element yagi	9.9	6.0	204.00
21-21.5-5	15 metre 5 element yagi	11.2	8.0	296.00

### VHF MONO BAND YAGI'S

50-52.5-5	6 metre 5 element yagi	11.9	3.5	97.00
50-53-8	6 metre 8 element yagi	14.2	5.5	153.00
50-53-11	6 metre 11 element yagi	16.2	9.0	194.00
144-148-8	2 metre 8 element yagi	12.7	2.2	60.00
144-148-11	2 metre 11 element yagi	14.6	3.8	71.00
144-148-16	2 metre 16 element yagi	17.0	6.3	91.00
144-148-13	2 metre 13 element yagi	17.3	6.6	91.00

MODEL	DESCRIPTION	GAIN (dBi)	BOOM (M)	PRICE \$
-------	-------------	------------	----------	----------

### UHF MONO BAND YAGI'S

420-470-6	70 cm wideband 6 el.	10.2	0.6	46.00
420-470-14	70 cm wideband 14 el.	14.2	1.5	67.00
420-440-11	70 cm special 11 el.	15.7	1.85	71.00
420-440-15	70 cm special 15 el.	16.2	2.85	81.00
420-450-27	70 cm wideband 27 el.	16.7	3.05	101.00
432-16 LB	70 cm Narrow band 16 el.	17.2	3.7	87.00
47-5	UHFCB 5 element yagi	9.2	0.65	46.00
47-11	UHFCB 11 element yagi	17.2	1.7	67.00
47-15	UHFCB 15 element yagi	18.0	2.8	77.00
580-14	50 cm ATV repeater 14 el.	17.5	2.0	

10/30/9 (uses linearly loaded longest element for maximum efficiency O A 11.0 Mx) on 10m. boom available

### HF BROADBAND LOG PERIODICS

13-30-6	13-30 MHz 6 el. Log	7.5	6.0	327.00
13-30-8	13-30 MHz 8 el. Log	9.0	8.5	409.00
20-30-6S	20-30 MHz 6 el. Shortboom	7.5	4.0	204.00
20-30-6L	20-30 MHz 6 el. Longboom	8.5	6.0	235.00
20-30-8	20-30 MHz 8 el. Log	10.2	8.5	306.00

### RF POWER DIVIDERS

All power dividers are fitted with "N" connectors.

140-150-2	(Couples 2 x 50 OHm ants. to 50 OHm feeder at 140-150 MHz) \$49.00
400-470-2	450-500-2 and 470-520-2 UHF dividers, 2 port. \$46.00
140-150-4	(Couples 4 x 50 OHm ants to 50 OHm feeder at 140-150 MHz. \$62.00
400-470-4	450-500-4 and 470-520-4 UHF dividers, 4 port. \$57.00.

## FERRITE BALUNS

MODEL	RATIO	CONNECTOR	FREQUENCY	PRICE \$
3-150-1:1 200W	1:1	SO 239	3-150 MHz	14.00
100-600 1:1 200W	1:1	"N"	100-600 MHz	18.00
3-150-4:1 200W	4:1	SO 239	3-150 MHz	18.00
3-100-1:1 1KW	1:1	SO 239	3-100 MHz	26.00
3-100 4:1 1KW	4:1	SO 239	3-100 MHz	29.00

## QUARTER WAVE SLEEVE BALUNS

144-148-50U 2KW	1:1	SO 239	144-148 MHz	34.00
144-148-50N 2KW	1:1	"N"	144-148 MHz	37.00
420-470-50N 2KW	1:1	"N"	420-470 MHz	36.00

## INSULATORS

ATN Insulators are made available for those who wish to make their own antennas. They are manufactured from tough non-brittle ABS injection moulded plastic.

No. 1 for 1/2" or 3/8" elements on 2" boom. \$5.20.

No. 2 for 3/8" on a 1" boom (large size for VHF split dipole). \$1.65.

No. 3 for 3/8" on a 1" boom (small for VHF/UHF). \$1.35.

No. 4 for 3/8" elements on a 2" boom with 5" positive rake. \$5.20.

## TV ANTENNAS

Designed for extra high gain in poor signal situation on both VHF and UHF.

## COMMERCIAL ANTENNAS

A wide variety of commercial antennas can be supplied on request. For example the model 480-512-14 UHF commercial trigger link antenna.

## CUSTOM BUILT ANTENNAS

If you have an application but no antenna ATN antennas can probably help you. Contact us with your requirements.

## SHORTENED BOOM HF AMATEUR ANTENNAS

On special order ATN can supply a range of shortened boom HF yagi's for those with space problems.

## PHASE III SATELLITE PACKAGE

This new antenna system due to be available soon has both 144 and 430 MHz antennas mounted on the one sub-assembly to allow tracking of the new PHASE III Amateur satellite.

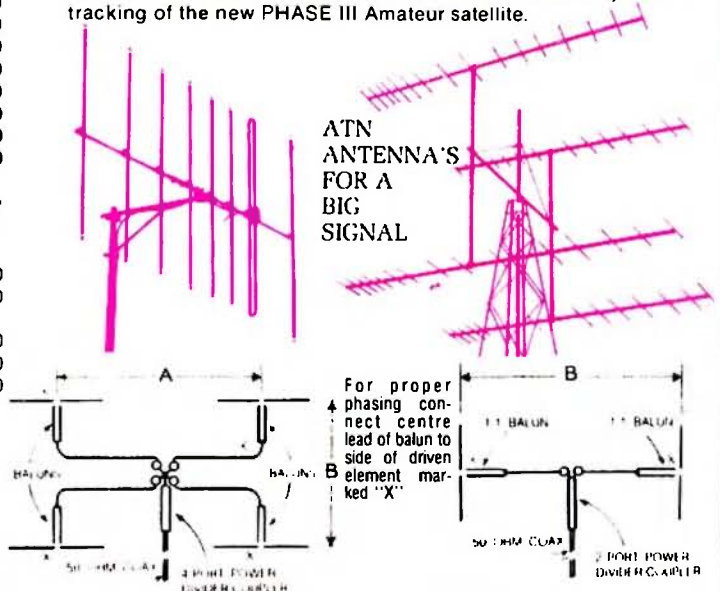

Also available power dividers/couplers, quarter wave sleeve baluns and matching harnesses for stacks of two or more arrays; also 1:1 and 4:1 baluns in 200W or 1 kW and Insulators for homebrew. Write for free catalogue.

# ATN ANTENNAS

56 CAMPBELL STREET, BIRCHIP, VIC. 3483  
PHONE (054) 92 2224, AH (054) 92 2264, 92 2319

ALSO AVAILABLE FROM: VIC. (03) 873 3939  
VIC. (059) 79 1975  
VIC. (051) 55 2777  
VIC. (03) 570 1698

TAS. (002) 47 6674  
TAS. (003) 31 7075  
N.T. (089) 52 2967

W.A. (09) 328 9229  
W.A. (09) 446 4448  
S.A. (08) 47 3688

QLD. (07) 397 0808  
QLD. (07) 52 8827  
N.S.W. (067) 65 4622 (069) 21 2125  
N.S.W. (067) 42 2838 (02) 407 1066

Dealer requests invited



**VOL. 51, No.1 JANUARY 1983**

Registered Office:  
3/105 Hawthorn Road,  
Caulfield North 3161.  
Tel. (03) 528 5962

# amateur radio

**... in this issue ...**

A NICAD CHARGER.....	16
A SQUARE-ONE RECEIVER.....	8
ALL MEN ARE EQUAL IN THE EYES OF RADIO ENTHUSIAST.....	40
ANOTHER ANTENNA STORY.....	18
BILL BLITHERINGTWIN IN TROUBLE AGAIN.....	17
CHUCKLE CORNER.....	26
COMPETITION WINNERS.....	29
DXPEDITIONS! ARE THEY WORTH THE TROUBLE?.....	27
DO YOU KNOW WHAT BONITO IS?.....	14
FAREWELL FUNCTION FOR PETER DODD.....	9
GETTING TO KNOW YOU.....	14
ISN'T IT STRANGE?.....	31
MY RULER.....	15
PHASED VERTICAL ANTENNA ARRAYS.....	10
THE RADIOCOMMUNICATIONS BILL.....	35
WCY — WORLD COMMUNICATIONS YEAR.....	6
WHAT THEY SAY IS WHAT THEY MEAN.....	31
WHO SAYS YOU DON'T HAVE ROOM TO PUT UP A LONG WIRE ANTENNA?.....	13

**... departments ...**

ALARA.....	35	Main QSP.....	5
AMSAT Australia.....	38	National EMC Advisory Service — Quietening Switching Power Supplies.....	32
AR Showcase.....	25	Obituaries.....	47
Advertising Index.....	48	Pounding Brass.....	30
Awards.....	34	QSP.....	39
Book Review — How to Buy and Convert Surplus Electronic Equipment.....	31	Service Bulletin — Yaesu FRG-7700SW Mod.....	12
Commercial Kinks — CW Switching with TS1520S ..	20	Spotlight on SWLing.....	39
Commercial Kinks — FT290R Battery Pack Blow-up Prevention.....	26	Thumbnail Sketches — Leighton Gibson, Norm Odgers, Bill Rohde.....	19
Contests.....	42	Try This — Folded Mobile Whip.....	21
Education Notes.....	37	Try This — Phase Shift Frequency Multiplier.....	15
Five-Eight Wave.....	45	VHF UHF — an expanding world.....	36
Forward Bias.....	45	VK2 Mini Bulletin.....	44
Hamads.....	48	VK4 WIA Notes.....	41
How's DX.....	22	WIA News.....	4
International News.....	4	WICEN News.....	25
Intruder Watch.....	31		
Ionospheric Predictions.....	46		
Letters to the Editor.....	47		
Listening Around.....	28		

**EDITOR:**  
BRUCE BATHOLS\* VK3UV

**TECHNICAL EDITORS:**  
BILL RICE\* VK3ABP  
EVAN JARMAN\* VK3ANI  
RON COOK\* VK3AFW  
GIL SONES\* VK3AUI

**CONTRIBUTING EDITORS:**  
BOB ARNOLD VK3ZBB  
ROY HARTKOPF\* VK3AOH  
RON FISHER\* VK3OM  
ERIC JAMIESON VK5LP  
LEN POYNTER\* VK3BYE  
MIKE BAZLEY VK6HD  
KEN McLACHLAN VK3AH  
REG DWYER VK1BR  
ROBIN HARWOOD VK7RH

**DRAFTING:**  
PETER KIMBER  
LIZZ KLINE  
DEREK FENN

**ADVERTISING MANAGER:**  
JOHN J A HILL VK3DKK

**BUSINESS MANAGER:**  
REG MACEY

\*Member of Publications Committee

Enquiries and material to:  
The Editor  
PO Box 150, Toorak, Vic. 3142

Copy is required the first of each month. Acknowledgement may not be made unless specially requested. All important items should be sent by certified mail. The editor reserves the right to edit all material, including Letters to the Editor and Hamads,

and reserves the right to refuse acceptance of any material, without specifying a reason.

Material should be sent direct to P.O. Box 150, Toorak, Vic., 3142, by the 25th of the second month preceding publication. Phone: (03) 528 5962. Hamads should be sent direct to the same address by the 1st of the month preceding publication.

**Trade Practices Act:** It is impossible for us to ensure that advertisements submitted for publication comply with the Trade Practices Act 1974. Therefore advertisers and advertising agents will appreciate the absolute need for themselves to ensure that the provisions of the Act are complied with strictly.

**Victorian Consumer Affairs Act:** All advertisers are advised that advertisements containing only a P.O. Box number as the address cannot be accepted without the addition of the business or residential address of the box-holder or seller of the goods.

**Production: BETKEN PRODUCTIONS**  
5 Masefield Avenue, Mooroolbark, 3138

Laser Scanned Colour Separations by:  
**QUADRICOLOUR INDUSTRIES PTY. LTD.,**  
Graphic Division,  
22-24 Glenvale Crescent, Mulgrave, 3170.  
Tel.: (03) 560 2222

Printers: **WAVERLEY OFFSET PUBLISHING GROUP**  
Geddes Street, Mulgrave, 3170  
Tel.: (03) 560 5111

Photographic film and processing material courtesy **AGFA-GEVAERT LTD. AUSTRALIA**

Typesetting by: **B.P. TYPESETTING PTY. LTD.,**  
7-17 Geddes Street, Mulgrave, 3170  
Tel.: (03) 561 2111.

**on the cover**

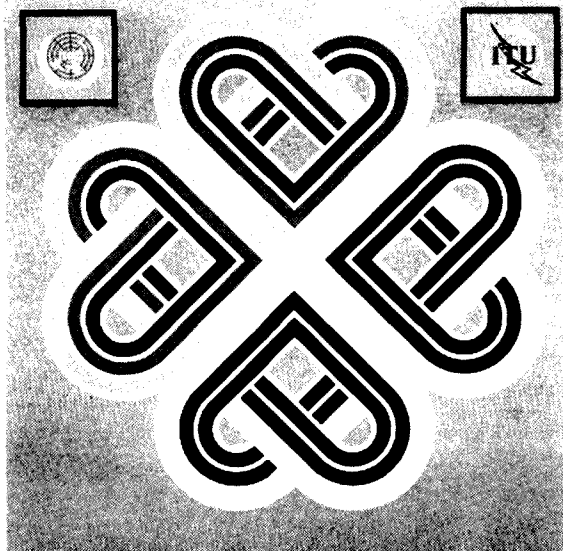

1983 has been proclaimed World Communications Year (WCY). Our cover features the official emblem and throughout 1983 we will have news and information from VK and throughout the world in reference to WCY. Turn to pages 5, 6 and 7 for our first features.

# Is the World of ELECTRONICS Your Scene?

- MICROPROCESSORS
- TRANSMITTERS

- RADAR
- RECEIVERS

Switch on to courses leading to challenging, well paid careers as a Radio Officer or Electronics Technical Officer at the



## Australian Maritime College

Two year, Associate Diploma courses, HSC or equivalent entry, available in Marine Radiocommunication and/or Maritime Electronics.

The Australian Maritime College is Australia's only national, tertiary educational institution providing multi-level, maritime courses exclusively for the fishing, shipping, port and off-shore industries. The AMC is the only place in Australia where training for Radio Officers is conducted.

Cut out and send to:

Admissions Office,  
Australian Maritime College,  
P.O. Box 986,  
Launceston, 7250,  
Tasmania.

Telephone: (003) 26 0731

AR

Please send me more information on  
Marine Radiocommunication and/or Maritime Electronics  
Courses.

Please print

Name: \_\_\_\_\_

Address: \_\_\_\_\_

Postcode \_\_\_\_\_

17084

## NOVICE OPERATOR TRAINING

Theory book and morse code tapes

**\*\*Novice Theory Handbook** — covers all the theory needed to get the licence. It follows closely the DOC syllabus. \*Simpler and cheaper than the foreign textbooks. \*Produced by a qualified teacher for professional-standard training. \*Multiple-choice questions at the end of each chapter so you can check your progress. \*Virtually a course in a self-contained package. \*Suitable for all age-groups. \*Used by many clubs and schools.

**\*\*MORSE CODE TAPES** \*Starts you off easily and gives all the letter and number sounds. \*Simple practice groups moving on to harder groups. \*Sample exam at the speed DOC uses. \*\*Other morse tape speeds on request.

- Enquire about the Novice training kits •

Available by mail order from:

VK1,2,4: Sandy Bruce-Smith VK2AD  
110 Rosemead Rd, Hornsby, NSW 2077  
VK3,5,6,7,8: Graeme Scott VK3ZR  
11 Balmoral Cres., Surrey Hills, Vic. 3127.

\*\*Dealer enquiries welcome \*\*Discounts to clubs and schools \*\*Stock-up for study and 1983 club and school courses.

COUPON

QTY.







\$ enclosed.

NAME \_\_\_\_\_

ADDRESS \_\_\_\_\_

POSTCODE \_\_\_\_\_

## KNOXTRONICS ELECTRONIC SERVICES

**SERVICE SPECIALISTS** for all types of RADIO EQUIPMENT — TELEVISION RECEIVERS — STEREO and HI-FI and VIDEO RECORDERS. Sales and Service of CB Radio and Accessories, 27 MHz and UHF.

## EASTERN VIDEO CENTRE

**VIDEO LIBRARY SPECIALISTS**, featuring latest releases from all major distributors. Video films to suit all tastes and requirements.

**LIBRARY MEMBERSHIP ONLY \$150 PER YEAR**, giving you unlimited exchange (one Video Cassette at a time). All titles in VHS and BETA formats.

Also Casual Video Film Rental Service. **BLANK VIDEO TAPES** at competitive prices **VIDEO RECORDER SALES** and **RENTAL** Special return mail service for country clients

8 DARRYL STREET, SCORESBY, 3179  
PHONE (03) 763 8425  
(SCORESBY SHOPPING VILLAGE)

W0806

# DICK SMITH HAS A GREAT DEAL ON YAESU!



look at these  
**DICK SMITH 'Invisible Extras'**

We honour Yaesu's 12 month guarantee; beware of others who may only offer you a 90 day or no warranty.



We have the largest service centre to back that guarantee; if anything does go wrong with your Yaesu, we can fix it fastest!



We have the largest range and consistently lowest prices.



Dick Smith Electronics: Australia's largest supplier and Yaesu factory approved distributor and service centre.



Dick Smith Electronics have over 33 stores throughout Australia (with more to come!) plus over 200 approved re-sellers. You're never far from friendly help and service!



Dick Smith Ham Shacks are located in the stores listed to the right. You'll find a licenced amateur at each shack - someone who can talk your language and give you any help you need. (Amateur items also available at other Dick Smith stores).

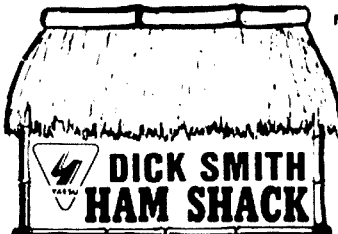

**SAVE \$96.00**

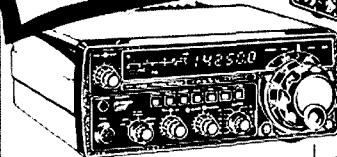

## FT707

The FT707 is a full power all HF band (including WARC) multi-mode transceiver not much bigger than an average 2 metre mobile! And you get digital display as well LED S/power meter, push button operation ... all the things the amateur needs for safe and yet reliable mobile operation. But it's more than that - team it up with a PP-707 supply and it's a superb base station, too! Cat D-2869

WAS \$795

**NOW ONLY \$699.00**

**BONUS MIC WORTH \$29.95**



## The brilliant FT ONE

LOOK AT THESE FEATURES  
All mode - even FM (optional extra) All band - it receives from 150kHz to 30MHz continuous, with resolution down to 10Hz and it includes all WARC bands. All micro-processor controlled. All area operation runs it from 100-120 or 200-240V AC in the shack, or 13.5V DC when mobile! All solid state (of course) and all performance - with better than 0.3uV sensitivity and more than 100W output (SSB)

Cat D-2852  
ONLY \$1995  
Includes free mic worth \$29.95

**LOW PRICES PLUS EXCLUSIVE DICK SMITH 'INVISIBLE EXTRAS'**



## NEW FT 102

New from Yaesu & Dick Smith - the fabulous FT102 240W all mode optional transceiver, push button controls, dual meters, digital display and much more. A superb base station transceiver with 3x6146B's in the final. Cat D-2880

**BONUS MIC WORTH \$29.95**

ONLY \$1225

## SUPER COMPACT! SUPER VALUE!

30W 2M Linear Amp



This is an all mode, high efficiency Linear amp for 2 meters. 30 watts output - 13.8V DC supply make it perfect for mobile use. Dual time constant for SSB or FM. Reverse polarity protection, works well with any 2M transceiver with up to 3 watts out. Cat D-2546

ONLY \$89.50

## The Go Anywhere FT290R



The brilliant Yaesu FT-290R is a portable or mobile set. Fully microprocessor controlled offering up to 10 channel memory, scanning, LCD display, high or low power operation, all modes (yes, CW SSB & FM) plus full 144-148 MHz band coverage. All this in a transceiver which can be operated both portable (from internal batteries & whip antenna) or mobile (ext antenna & power sockets fitted). Cat D-2885

### NEW ACCESSORIES

CASE Cat D-2910 \$7.50  
Foam A-1 Cat D-2912 \$9.50  
MMB11-290 (Mobile-Mixing Bracket) Cat D-2911 \$39.50

ONLY \$349

**NEW**

## NOVICE ALL MODE TRANSCEIVER



Fantastic for the Novice - 10W all band transceiver (100W with optional amp) operates from 12V DC so it's great mobile or base. Weighs only 5kg and is a tiny 124 x 178 x 272mm. Even goes FM with optional FM unit! And look at the low, low price. Cat D-2900

**GREAT VALUE \$549**

### NEW NEW NEW NOVICE AMATEUR RADIO COURSE

All you need to get a Novice license - covers theory, Morse (tape), exam forms etc. Cat D-7107 \$16.95

### NEW NEW NEW AMATEUR RADIO LOG PROGRAMME

All the information at your fingertips. Disk & manual, suits System 80: TRS80/II etc. Cat X-3774 \$39.50

- Sydney 125 York St 290 3377 • Sydney 6 Bridge St 27 5051
- Gore Hill 439 5311 • Melbourne 399 Lonsdale St 67 9834
- Springvale Dandenong Rd 547 0522 • Richmond 656 Bridge Rd 428 1614
- Brisbane: Buranda 166 Logan Rd 391 6233
- Chermside 842 Gympie Rd 596255 • Perth 414 William St 328 6944

bankcard welcome here  
Terms available to approved applicants through



A407CT

**\$50,000 IN PRIZES TO BE WON. SEE YOUR NEAREST DICK SMITH STORE.**



# WIA NEWS

## PUBLIC RELATIONS:

Mr John Hill (VK3DKK) currently the AR advertising manager has been appointed to the part time position of Public Relations co-ordinator. The appointment was made at the executive meeting held on 18th November, 1982. This follows the resolution made at the 1982 Federal Convention.

John's duties will include co-ordination of each division's current PR packages into a central point, and he will liaise directly with the divisions in the near future to establish a unified approach. A programme was drawn up by the convention, and gave suggestions as to where our efforts should be directed. A small budget was allocated and John will be working in close contact with the Executive at all times.

In due course it is hoped to establish a central 'bank' of media contracts for divisional use.

The success of this venture relies wholly on divisional input and support, and is an area which has been neglected for many years. It is hoped that the WIA involvement with a public relations arm will be an ongoing facility, however our continued efforts in this area will be subject to close review at the 1983 Federal convention.

## RETIREMENT

Mr J. D. Williamson VK3JD of the Department of Communications has recently retired.

During his service with DOC, he was deeply involved in the amateur service and congratulations and best wishes for a happy retirement go with him.

AR.



# INTERNATIONAL NEWS

## HOW TO APPLY FOR A GERMAN SHORT-TERM AMATEUR RADIO LICENCE

Licensed foreign radio amateurs staying temporarily in the Federal Republic of Germany (on visit or in transit) may obtain a short-term amateur radio licence from the Deutsche Bundespost, valid for a period of three months, by directing their application, at least 6 weeks in advance.

German short-term amateur radio licences are issued to foreign amateurs for periods of three months only, beginning on the first day of the month as requested by the applicant. The short-term licence will entitle the foreign amateur to operate a fixed, mobile or portable amateur station on the territory of the Federal Republic of Germany according to the class of licence.

The call sign to be used will consist of the prefix DL/... (for class B), DH/... (for class A) or DC/... (for class C) followed by the home calls sign of the foreign amateur. When operating mobile or portable on telegraphy, the indicators .../m or .../p should be added to the above mentioned call sign, or the words .../mobile or .../portable in the case of telephony operation. (Example: DL/VK3 ABC working from a fixed location, DL/VK3 ABC/mobile working mobile on telephony).

On issuance of the licence by the Deutsche Bundespost the holder undertakes to comply with all German amateur regulations.

Further information may be obtained from Federal Office of WIA.

## VS6 ACTIVITY DAY 1983

HARTS is pleased to announce that once again there will be a VS6 activity day between 0001 UTC Sat. 2nd April 1983 and 2359 UTC Sun 3rd April 1983.

As in previous years as many VS6 stations will be active on all band/modes. 1983 is World Communications Year (WCY) and during 1983 the special call-sign VS6WCY will be in use by the HARTS club station. Special QSL cards will be issued for QSOs with VS6WCY. QSLs for WCY station should be sent to the Hong Kong QSL bureau manager, PO. Box 541, Hong Kong.

## NEW CALL SIGN SERIES ALLOCATED TO AMATEUR STATIONS

According to the ITU Notifications, the following new call sign series have been allocated to amateur stations in the countries mentioned respectively since the beginning of 1982.

Bahrain	A92AA — A92ZZ
Cape Verde (Islands)	D44AA — D44ZZ
Comoros	D68AA — D68ZZ
Dominica	J73AA — J73ZZ
Gambia	C53AA — C53ZZ
German Democratic Republic	Y20AA — Y99ZZ
Zimbabwe	Z21AA — Z29ZZ

## FREQ. ALLOCATIONS FOR HONG KONG AMATEURS

10 MHz Band  
As you know HARTS had made formal application for use of this band by holders of class 'A' licence as far back as November 1979. At a meeting with the telecomms authorities in April this year all seemed to be fine and the authorities were prepared to allow us the use of the band after they had cleared this with the mainland China authorities. The latest position is no different due apparently to staff changes and summer holidays within the telecomms dept. Also they are shortly filling the vacant post of head of freq allocation.

In short we are sure to get this band but due to the above administrative problems within the govt. dept. concerned it now looks that this will not happen until about 1st Jan, 1983.

## 50 MHz Band

In Hong Kong this is a shared band and HARTS has for some time being pressing the telecomms dept. to allocate more of it to the amateur service. We have at their request made formal application for the following segments of the band and telecomms dept have agreed in principle subject to the existing users' agreement. This should be a formality and we are hopeful of getting this allocation on 1st Jan, 1983.

## UPCOMING REGION 2 CONFERENCE

IARU Region 2 Executive Committee in its meeting in Brasilia on June 19, 1982, among others approved that the next regional conference will be held in Cali, Colombia from June 6th to the 11th of 1983.

More detailed information will follow. However this secretariat wishes to inform this to our Headquarters as well as Regions 1 and 3 without further delay and thus extend the first formal invitations to our central and sister IARU organizations.

Specifically the minutes of our Brasilia meeting will also say: "... following an established tradition, the EC will also accept documents to be presented by IARU Hq, Region 1 EC and Region 3 Directors." So please consider sending your formal proposals as well as any information papers to this secretary if possible before March 6, 1983. Any documents originated by other IARU bodies, such as special committees, working groups or Region 1 and 3 societies, should be presented through Hq. or R/1 and 3 as may be the case.

From Pedro Seidemann, YV5BPG,  
IARU Region 2 Secretary  
AR

# QSP

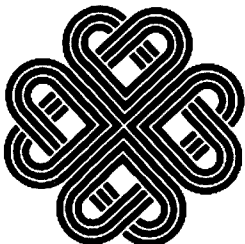

**1983**

**WORLD  
COMMUNICATIONS  
YEAR:**

“Everyone has the right . . . to seek, receive and impart information and ideas . . . through any media.”

*(Art. 19 of Universal Declaration of Human Rights adopted by the United Nations General Assembly on 10 December 1948)*

Next only to food, shelter and energy on the list of vital needs for human survival, communications constitute the life blood of today’s world and serve as a constant reminder of the oneness of human destiny.

The past half century or so has witnessed an exponential growth in the world’s communications capability; yet, with the introduction of every new service, man’s needs grow even faster and the spiralling demand for more and more communications facilities is a reflection of man’s endless search for a better life.

The development of communications infrastructures all over the world is the primary objective of the World Communications Year. The world of today is getting smaller and smaller, thanks to the constant growth of communications networks in many countries. However, there exists an imbalance in the development of communications infrastructures in various parts of the globe. Only through the redress of this imbalance by a more even development of communications infrastructures everywhere can the peoples of the world be brought together, thus creating more stable conditions for the maintenance of international peace and security.

Better communications mean . . .  
. . . better living conditions.

**WCY Secretariat  
International Telecommunications Union  
Geneva, Switzerland**

# WORLD COMMUNICATIONS YEAR: development of communications infrastructures

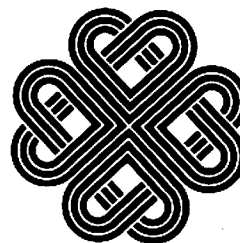

“The General Assembly,

...  
Recognizing the fundamental importance of communications infrastructures as an essential element in the economic and social development of all countries.

Convinced that a World Communications Year would provide the opportunity for all countries to undertake an in-depth review and analysis of their policies on communications development and stimulate the accelerated development of communications infrastructures.

1. Endorses the proposal made by the Economic and Social Council in paragraph 1 of its resolution 1981/60 and proclaims the year 1983 World Communications Year: Development of Communications Infrastructures, with the International Telecommunication Union serving as the lead agency for the Year and having responsibility for co-ordinating the inter-organizational aspects of the programmes and activities of other agencies;

2. Requests all States to participate actively in the attainment of the objectives of the World Communications Year;

...  
...

Extract from United Nations General Assembly resolution 36/40 adopted on 19 November 1981”

## A WORLD YEAR FOR WHAT PURPOSE?

Better communications . . .

. . . through improved infrastructures

The quality of a telephone conversation between two people depends on the quality of the circuits.

The quality of the postal service also depends on the quality of the available infrastructures.

The result of any move to improve communications infrastructures is an improvement of the communications which are essential to most human activities:

posts and telecommunications  
broadcasting, television, press, etc.  
transport (air, sea, river, rail, road)  
industry  
trade  
agriculture  
health  
education . . .

Better communications mean . . .

. . . better living conditions.

Communications infrastructures include:

All the fixed and mobile installations — building and equipment — needed to make communications work.

For example: telephone exchanges, radio stations on ships, aircraft, satellites and

manned space vessels, transmitters, antennae, cables, post offices, postal vehicles, etc.

World Communications Year 1983 emanates from the determination clearly expressed by all States to intensify the endeavours of the United Nations system to promote balanced social and economic development by speeding up the establishment of communications infrastructures.

It will be given practical expression in programmes of reflection and action at the world, regional and national levels.

### AT WORLD AND REGIONAL LEVELS

A specific programme of action has been drawn up under the authority of the International Telecommunication Union, which is responsible for co-ordinating the inter-agency aspects of the programme and the activities of the other organizations in the United Nations system.

The following are participating in the programme:

United Nations (UN); Economic Commission for Europe (ECE); Economic and Social Commission for Asia and the Pacific (ESCAP); Economic Commission for Latin America (ECLA); Economic Commission for Africa (ECA); Economic Commission for Western Asia

(ECWA); United Nations Industrial Development Organization (UNIDO); United Nations Development Programme (UNDP); Food and Agriculture Organization of the United Nations (FAO); United Nations Educational, Scientific and Cultural Organization (UNESCO); World Health Organization (WHO); International Bank Reconstruction and Development (IBRD); International Civil Aviation Organization (ICAO); Universal Postal Union (UPU); World Meteorological Organization (WMO); International Maritime Organization (IMO); International Telecommunication Union (ITU).

### AT NATIONAL LEVEL

The programme of action for the Year is prepared in each country by a National Committee composed of representatives of all governmental and non-governmental sectors responsible for the development of communications infrastructures or using such infrastructures.

Co-ordination of the Australian Committee and further information may be obtained from:—

Mr A. Guster  
First Assistant Secretary,  
Corporate Policy & Projects Division,  
Department of Communications,  
PO Box 34,  
Belconnen ACT 2616.



**ANNEE MONDIALE DES  
COMMUNICATIONS  
WORLD COMMUNICATIONS  
YEAR  
AÑO MUNDIAL DE LAS  
COMUNICACIONES**



Official symbol of  
World Communications Year 1983  
representing "infrastructures"

---

*During WCY '83 amateurs throughout the World will be participating in many different ways. Printed here are the ideas of some of our fellow amateur clubs and associations.*

---

**THE FEDERAL REPUBLIC OF GERMANY  
FIRST TO DONATE FOR PRIZE-WINNERS  
OF "YOUTH IN THE ELECTRONIC AGE"**

Following a campaign launched by the Year's secretariat inviting Member countries of the ITU to donate prizes for the winners of the "Youth in the Electronic Age 83", the world-wide photo and drawing competition organized in the framework of TELECOM 83 as one of the activities of WCY 83, the first donation, of an amount of DM 3000, was made by the PTT Ministry of the Federal Republic of Germany, (Bundesministerium für das Post-und Fernmeldewesen). All administrations, organizations, associations and individuals should consider the possibility of contributing donations, to stimulate young people around the world to participate in the contest, thus encouraging their interest in the field of telecommunication.

**SEVERAL RADIO AMATEURS ENDORSE  
WORLD COMMUNICATIONS YEAR 83**

Many radio amateur clubs have responded with enthusiasm to an appeal made by the Secretary-General of the ITU, Mr. Mili, to support the Year by publicizing it on the largest possible scale and by organizing, according to their possibilities, events relating to this major event.

Since the early days of radio, radio amateurs have contributed to the technological and scientific development of communications as an instrument of peace, friendship and technical education and have, on many occasions, proved to be of paramount importance in disaster relief operations. World Communications Year provides a unique opportunity for radio amateurs to help strengthening the ef-

forts ITU deploys in developing the world's communications infrastructure.

**ARGENTINA**

The Radio Club Argentino has accepted with enthusiasm the invitation of the Secretary-General to publicize widely the activities of the Year and informed him that contact with the authorities Under-Secretary's Office for Communications would be established to join their efforts to those of others in the country.

**CHILE**

The Radio Club of Chile has expressed a keen interest in WCY and plans to mobilize all radio amateurs members of the Club to ensure the widest publicity and stimulating the organization of special events in recognition of the Year. In addition, the Secretary-General has been informed of the Club's fullest support and close collaboration and of the widest dissemination possible of information on WCY through its magazine and bimonthly radio broadcasts.

**HONG KONG**

The Hong Kong Amateur Radio Transmitting Society is considering the possibility of focusing their annual "VS6 Activity Day" to be held in April 1983 in World Communications Year.

**ICELAND**

The proclamation of World Communications Year 1983 has been the subject of discussion at a recent meeting of the Board of the Icelandic Radio Amateur. (Islenskir radioamatörar). Members of the Board were very positive towards this major event and decided to unite with all other national societies of radio amateurs in the world to "make the Year a success long to be remembered".

**PORTUGAL**

The Portuguese Radio Amateur Association, (Associação de Radio amadores Portugueses), has offered to collaborate fully with the PTT administration in Portugal for the activities to be undertaken in the country in support of WCY 83.

**PHILIPPINES**

The Philippine Radio Amateur Association demonstrated its willingness to co-ordinate its activities with those of other communications users and regulators by becoming member of the WCY National Committee recently formed in the country. The Association will not only be in a privileged position to co-operate effectively in the Year's activities planned at the national level but their participation in the Committee's work will also enable them to ensure that the concerns of radio amateurs in the Philippines will be taken into consideration, should new communications policies be adopted as a result of the in-depth review and analysis that all countries have been requested to undertake during World Communications Year.

**USSR**

The Radio Sport Federation of the Union of Soviet Socialist Republics considers the possibility of organizing in 1983 a certain number of events in conjunction with World Communications Year. Further information will be transmitted through the Soviet Ministry of Communications when specific activities will have been identified.

**ECUADOR — EL SALVADOR —  
HONDURAS**

The Radio Amateur Clubs of these three countries communicated their intention to support fully national activities that would be carried out during World Communications Year and assured the Co-ordinator of the Year of their full collaboration.

# A Square-One Receiver

Drew Diamond, VK3XU,  
43 Boyana Cres., CROYDON, 3136.

The construction of a home-made HF receiver seems a daunting task if one examines some of the designs presented in traditional literature. One glance tells the intending builder that many of the components specified will be difficult to obtain, and that elaborate test equipment will be necessary to get the thing going properly. However, if the project is started with a relatively simple receiver, which tunes a low-frequency band, say 1.8 to 2.0 MHz, converters may be added later to cover other frequency bands of interest. References (1) and (2) at the end of this article have details of some suitable converters. It is also hoped that circuit details for converters may be published at a later date — depending upon response.

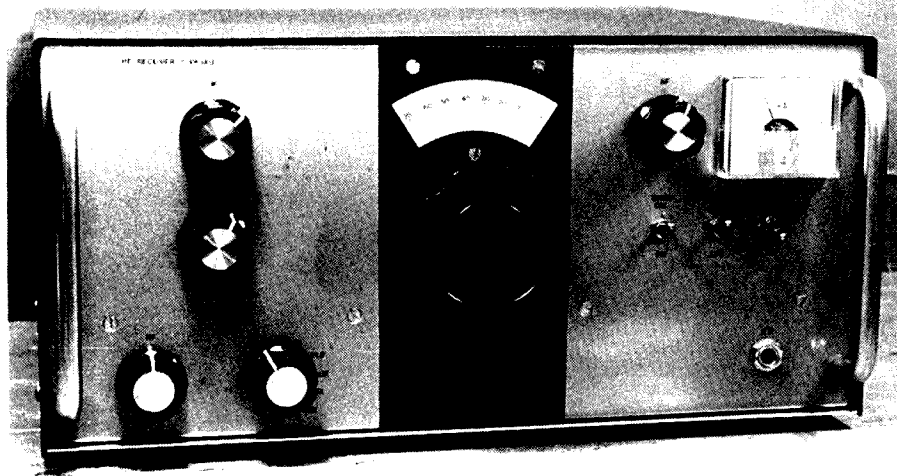

Those who expect cunning phase-locked loops and digital displays will be disappointed, as this receiver was empirically designed drawing on circuit ideas from many sources with cost, performance, reproducibility and parts availability in mind. All components are readily available in Melbourne at present. To keep costs down, and to minimise the production of spurious, an analogue dial is used. To preserve frequency resolution, a tuning range of 200 kHz is provided. Any greater coverage would cause a loss of resolution and necessitate the inclusion of a ganged capacitor or peaking control for the RF amplifier.

## PERFORMANCE SPECIFICATION

The prototype has the following characteristics:  
**BASIC FREQUENCY RANGE:** 1.8 to 2.0 MHz.  
**RECEPTION MODES:** CW, SSB USB/LSB and AM (as SSB).  
**SENSITIVITY:** 0.3 microvolts (-117dBm) for 10dB S + N : N.  
**MINIMUM DISCERNABLE SIGNAL:** 0.1 microvolts (-127dBm).  
**DYNAMIC RANGE:** 80dB for third-order intermod. products.

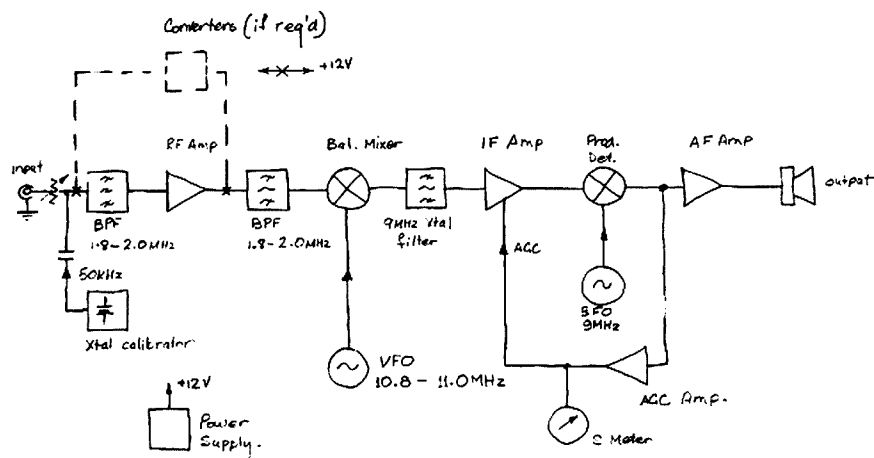

Block Diagram

**FREQUENCY STABILITY:** Less than 100Hz in any one hour period after warm-up.  
**IF BANDWIDTH:** 3kHz.  
**Image Rejection (2 x IF):** Greater than 100dB.  
**IF REJECTION:** 80dB.

**BLOCK DIAGRAM DESCRIPTION**

Input signals in the range of 1.8 to 2.0 MHz are routed to the RF amplifier via a gain control and an input band-pass filter (BPF). The filter is necessary to prevent overloading of the RF amplifier by strong out of band signals such as those from BC stations. After negotiating another BPF, the signal is applied to a balanced mixer where a local oscillator signal of 10.8 to 11.0 MHz is applied. For an input signal frequency of 1.8 MHz, the oscillator would have to supply 10.8 MHz to place the signal at the intended IF of 9 MHz, ie,  $10.8 - 1.8 = 9$ . A crystal filter (made from four 27 MHz, 3rd overtone CB crystals used on their 9 MHz fundamental series mode) yields a -6dB point selectivity of 3 kHz. A tuned IF amplifier increases the signal by about 50 dB. The product detector converts the 9MHz SSB or CW signal to audio by mixing it with about 9 MHz from the BFO (another 27 MHz crystal operated on its fundamental).

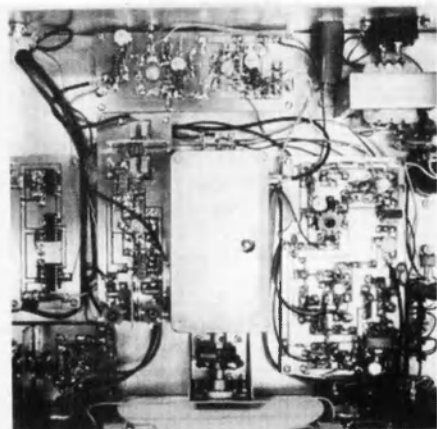

Underside view.

At this point, the detected audio signal is divided into two paths; one via an audio amplifier to drive speaker or headphones, the other via an AGC amplifier to derive an AGC voltage and drive the S-meter. As the IF amplifier comprises the greatest gain block, a voltage is applied to this stage to affect AGC action. This is necessary to protect the operators ears and to allow reception of signals which vary considerably in level without the need to continuously fiddle with gain controls.

When converters are added to allow reception of higher frequency bands, a wafer switch is employed to switch out the input BPF and RF amplifier as indicated in the block diagram. A 5 MHz crystal oscillator is divided by 100 to provide 50 kHz calibration markers. Part Two will have a full circuit description, and Part Three will have construction details and board layouts.

References: 1. Solid State Design — ARRL. 2. ARRL Handbook — 1980. 3. ARRL Handbook — 1982. 4. Radio Communication Handbook — RSGB. 5. "Modern Receiver Mixers for High Dynamic Range" — QST, Jan. '81.  
 Photos — Peter Dalliston.

AM

If you keep putting one word in front of the other you will become a rag chewer.

\* \* \*

While waiting for a DX station to come back to us in an instant is a breath-taking division of time.

ARNs Bulletin Sept. 1982

# FAREWELL DINNER FUNCTION PETER DODD VK3CIF

A farewell dinner was held at the Celebrant Restaurant on the 15th of November in honour of Peter Dodd, VK3CIF, retiring as Office Manager of the WIA.

It was good to see that fifty friends of Peter gathered and nostalgia was highlighted from pre-dinner beverages to late, late after dinner time speeches.

Presentations were made on behalf of the divisions and speeches were delivered by the Federal President Peter Wolfenden VK3KAU, the President of the VK3 Division Allan Noble,

VK3BBM, and Dave Williamson VK3JD of DOC on behalf of the VK6 Division.

Other speakers showing their appreciation for Peter's work were Michael Owen VK3KI and Dr David Wardlaw VK3ADW.

Peter, in his own inimitable way, went through the "History of Amateur Radio and the WIA".

It was an evening which will be remembered by all present, and in particular, by Peter Dodd VK3CIF.



L to R: Peter VK3KAU, Federal President, his XYL Cynthia, Peter VK3CIF and David VK3ADW.



Peter responds to a presentation by David VK3ADW.

John J. A. Hill VK3DKK.

AM



As the sunspot cycle declines activity will once again move to the lower bands. For DX operation a vertical antenna and in particular a directive vertical array would be a great advantage for operation on the lower HF bands. Hy Gain have produced a paper on phased vertical antenna arrays. This paper is entitled Amateur Phasing Engineering Report. Ref. 1. In the paper a number of vertical antenna configurations are shown. The vertical antennas used are their widely known trap verticals and their less widely known 18HT HY Tower.

# Phased Vertical Antenna Arrays

Gil Sones VK3AUI  
30 Moore Street, Box Hill South

## BROADSIDE ARRAY

When two vertical antennas are fed in phase with equal amplitudes of RF as shown in Fig. 1, the array will exhibit a broadside bi-directional pattern. The pattern is as shown in Fig. 2 for a spacing of half a wavelength. The pattern is held with some degradation of the null from a spacing of three-eighths of a wavelength to five-eighths of a wavelength. (See Ref. 2, page 294.) This sort of array exhibits a modest gain with excellent nulls at the sides of the bidirectional pattern.

## BROADSIDE ARRAY

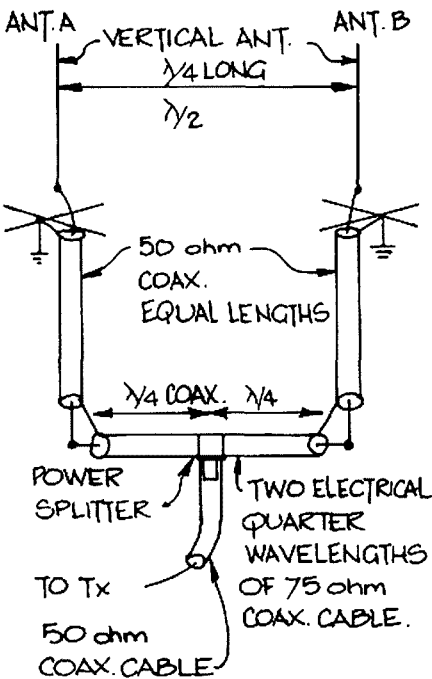

FIG. 1

## POWER SPLITTER

The power splitter shown in Fig. 1 is the one used by Hy-Gain and consist of two quarter wave transformers of 75 ohm coaxial cable. These are used to transform the 50 ohm coaxial cable impedance from each antenna to 100 ohms. The two 100

## BROADSIDE ARRAY PATTERN

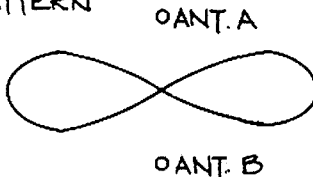

FIG. 2

ohm impedances in parallel to give 50 ohms to match the coaxial cable to the transmitter.

There are other ways of doing this and in the ARRL Antenna Anthology a somewhat more elegant system is described using Wilkinson Power Dividers. (Ref. 3, pp. 119-122.)

Another possibility for multi-band use would be one of the broadband power dividers using ferrite toroidal transformers. Indeed a system similar to the Hy-Gain system could be built using an RF matching transformer such as those manufactured by Palomar Engineers in California. Such a splitter would have the advantages of being frequency independent and of being much smaller than a roll of coaxial cable.

## ENDFIRE ARRAY PATTERN

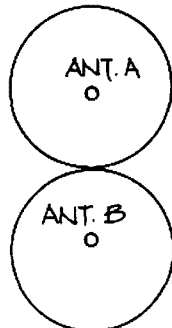

FIG. 3

## END FIRE ARRAY

When the two verticals are fed with equal amplitude RF but where the phase differ-

ence between the RF fed to each antenna is 180 degrees then an end fire bi-directional pattern will result. See Fig. 3. This may be achieved by feeding one antenna with a coaxial cable which is an electrical half wavelength longer than the coaxial cable to the other antenna. See Fig. 4. The extra half wavelength of coaxial cable provides the phase shift of 180 degrees.

The end fire bi-directional antenna pattern holds for antenna spacings from one-eighth wavelength to five-eighth wavelength.

The array yields a modest gain, together with excellent side nulls due to the bi-directional pattern.

## ENDFIRE ARRAY

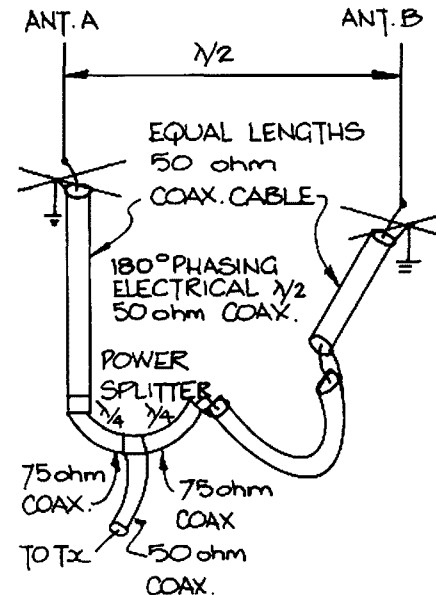

FIG. 4

## 180 DEGREE PHASING

The technique of using quarter wave transformers for power splitting has been used once again, together with a 180 degree phase shift obtained from a half wavelength of coaxial cable.

A broadband power splitter and the required 180 degrees phasing could be obtained using wideband toroidal transformers. Such power splitters and transformers are used in many transistor amplifiers and are also widely used for antenna matching. An antenna balun could provide both the power splitting and the required phase shift, since it provides two outputs which are balanced with respect to earth and have a phase difference of 180 degrees. A balun matching 50 ohms unbalanced to 100 ohms balanced would be quite suitable. Such baluns are manufactured by Palomar Engineers and others.

The advantage of broadband power splitters and 180 degrees phasing is that they are frequency independent and smaller than the rolls of coaxial cable which would otherwise be required.

Also, if a multiband antenna is used for each element in the array, band changing would not involve the selection of a whole new set of power dividers and phasing lines. This would greatly simplify the switching involved in implementing a multiband array.

### CARDIOID ARRAY

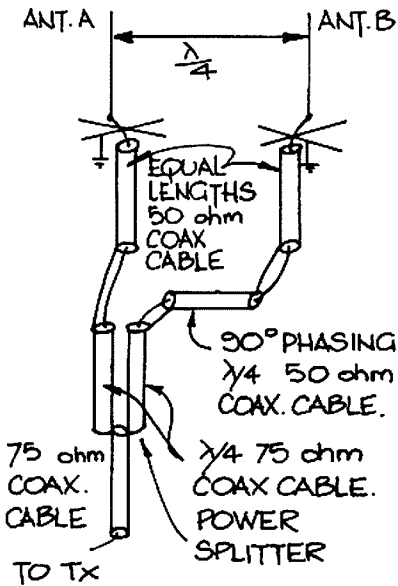

FIG. 5: Cardioid Array

### CARDIOID ARRAY

Two verticals which are fed with equal amplitudes of RF but with a phase difference of 90 degrees will produce a cardioid pattern. The minimum of the pattern will be in the direction of the vertical fed with a 90 degree lagging phase. The null is deep and modest forward gain may be obtained. The gain is greater than for the bi-directional cases. The array is shown in Fig. 5 and the directional pattern is shown in Fig. 6. The pattern starts to break up at three-eighths wave spacing and in the opposite direction it is only a flattened circle at one-eighth wave spacing. (Ref. 2, p. 294.)

### CARDIOID PATTERN

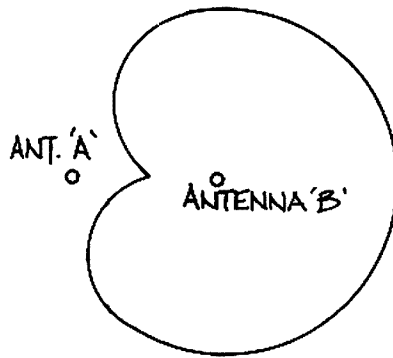

FIG. 6: Cardioid Pattern

The direction of the beam may be reversed by switching the elements so that the 90 degree delayed RF is fed to Antenna A and the zero degree RF is fed to Antenna B.

Also for antenna spacings less than a quarter wavelength the cardioid pattern may be obtained by using different phasing. For instance, for an antenna spacing of one-eighth wavelength the phase difference required is 135 degrees or three-eighths of a wavelength in coaxial cable. You must of course allow for the velocity factor of the coaxial cable.

### OPERATION ON SEVERAL BANDS

By suitable choice of the spacing between vertical antennas a useful range of antenna patterns may be obtained on several bands. This may be arranged using a range of coaxial cable power splitters and phasing lines. With some experimentation a broadband system is feasible. The use of multiband vertical antenna elements such as the trap verticals made by Hy-Gain and others, or a stub switched vertical such as the Hy-Gain 18HT will allow the same vertical elements to be used on all bands required without band switching the antenna elements. Other suitable verticals would be any of the wide band verticals such as the broadband bi-conical aerial. (Ref. 4, pp. 252, 253.)

### GROUND SYSTEM

All the vertical aerial systems described are critically dependent on the characteristics of the ground system used. With an elevated vertical the familiar four radials of the ground plane will suffice for an antenna well clear of the surroundings. However on the lower bands this condition is not met. The earth system must provide a low resistance in the vicinity of the antenna. To this end, radial systems of 120 radials are often employed. However, this may not be practical. Reduced numbers of radials may be employed but with corresponding reductions in efficiency. The reduction in efficiency will be noticed, both as reduced gain and an upward tilt of the pattern.

In general a large number of earth radials should be employed. Also it should be borne in mind that each vertical in a phased array will require its own system. The layout of a phased array earth system for a commercial application is shown in

Ref. 5, p. 20-17. Amateur systems may be seen in the ARRL Antenna Anthology, pages 22-31, where the ground systems used for single verticals are shown. The general effect of the number of radials on performance is shown in Fig. 7.

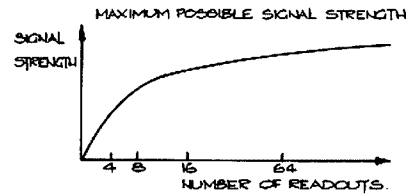

FIG. 7

Performance over a long distance path will be significantly improved by improving the earth radial system.

### INSTALLATION

Such an array and indeed even a single vertical should be mounted well clear of surrounding objects which will absorb or modify the RF radiation.

The RF switching should employ coaxial switches or relays and should be built with short leads and symmetry. This is necessary to minimise losses and stray couplings which could severely compromise performance.

### GAIN

Gain is a very touchy subject as it is so dependent on the actual installation. Suffice to say that with respect to a single vertical using the same ground system gains in the region of from 2 to 4 dB should be possible for verticals spaced one-half wavelength and around 4.5 dB for the cardioid using quarter wavelength spaced verticals.

These gain figures are a guide only:—

The side nulls, or the rear null for the cardioid, should be in the region of 20 to 30 dB when compared to the mean response.

When considering the gain figures it should be borne in mind that variations of several dB in the received signal over the same path with the same transmitter output power are possible by changing from a poor to a good earth system. As Bill Orr W6SAI said in the Antenna Handbook, "If you have the room to install a good radial system, a vertical phased array is a very effective antenna for the lower frequency bands". (Ref. 6, p. 112.)

### TYPICAL MULTIBAND SYSTEM

The multiband system shown in Fig. 8 is of an installation using two Hy-Gain 18HT verticals to provide Broadside and Endfire patterns on 80 metres and 40 metres and also two cardioid patterns on 80 metres.

### BROADSIDE AND ENDFIRE RADIATION PATTERNS

A series of radiation patterns for broadside and endfire arrays are shown in Fig. 9, which appears in the Hy-Gain publication.

### OTHER ARRAYS

A very interesting array is described in the ARRL Antenna Anthology, pages 119 to 122, for those who have the real estate.

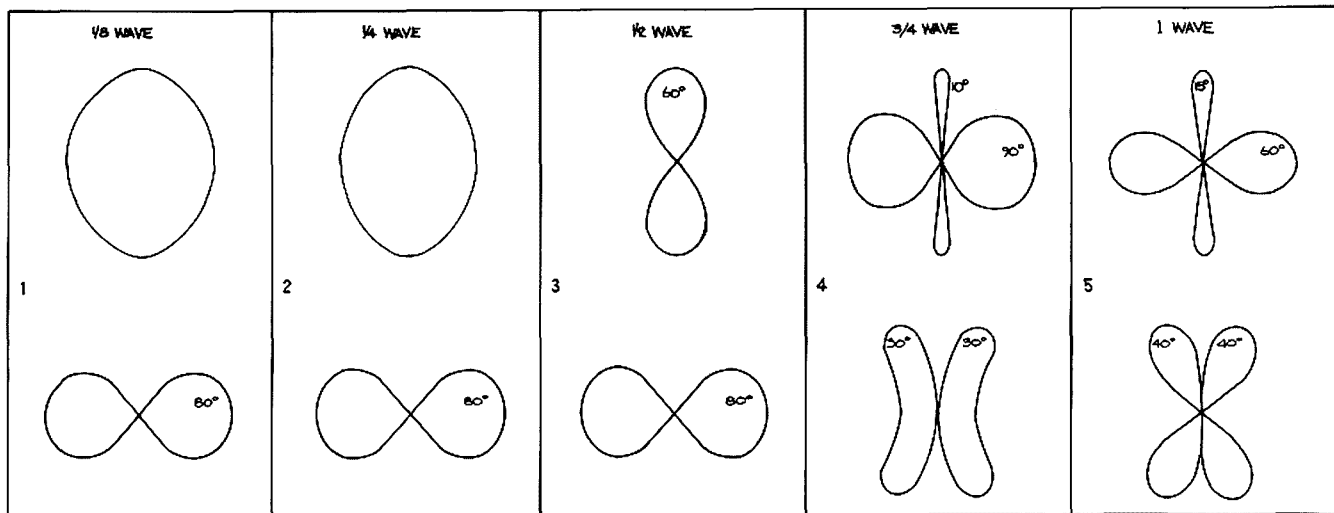

FIG. 9

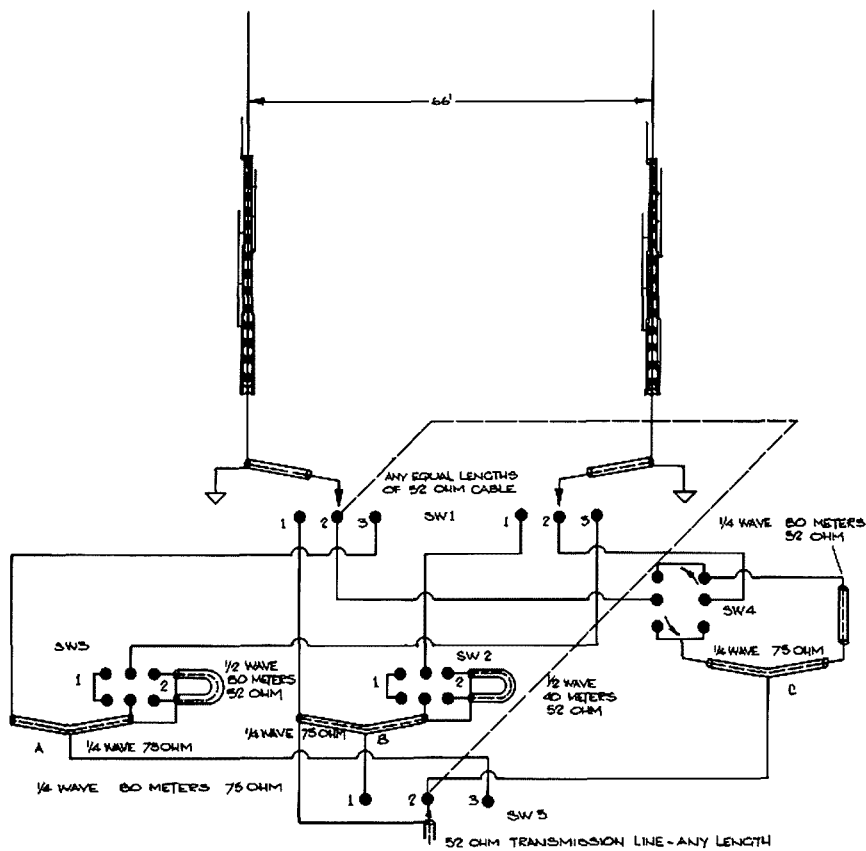

FIG. 8

**COSTS**

None of these antenna arrays is cheap. Multiband verticals are reasonably expensive. The quantities of coaxial cable and coaxial switches involved will set you back a tidy sum. So before embarking on such a project it would be wise to carefully consider the total cost.

**REFERENCES**

1. Hy Gain Engineering Report, Amateur Phasing, PN801774.
2. Antennas, by John D. Kraus, McGraw-Hill Book

Company, New York, 1950.

3. The ARRL Antenna Anthology, edited by Marion S. Anderson WB1FSB, The American Radio Relay League Inc., 1978.
4. Amateur Radio Techniques, Sixth Edition 1978, Pat Hawker G3VA, Radio Society of Great Britain.
5. Antenna Engineering Handbook, Henry Jasik, McGraw-Hill Book Company, New York, 1961.
6. The Radio Amateur Antenna Handbook, William Orr W6SA1 and Stuart Cowan W2LX, Radio Publications Inc., Wilton Ct., 1978.

# SERVICE BULLETIN

## YAESU FRG-7700SW MODIFICATION

The Yaesu FRG-7700SW is sold as a short-wave communication receiver — it does not have the 150 kHz to 2 MHz band available like the FRG-7700.

If you require the 150 kHz to 2 MHz band, this is easily fitted. The components required are already on the printed circuit board — it is just a matter of connecting them.

**STEP 1:** Remove the screws holding on the top cover (including the screws holding the handle on).

**STEP 2:** Remove the top cover.

**STEP 3:** With the receiver front panel towards you, locate the diodes D09, D10, D11 and D12, on the left side of the printed circuit board, slightly towards the top. These diodes are labelled on the board.

**STEP 4:** You will note each of these diodes is open. Solder the two ends of the diode leads together to re-connect them. (See illustration below.)

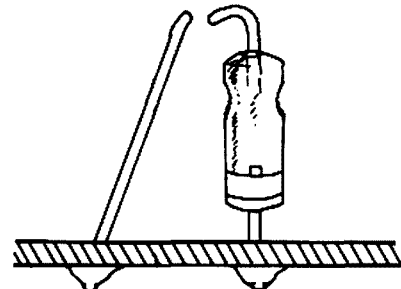

**STEP 5:** Test receiver: check that it now operates on all bands including the 150 kHz to 2 MHz band. If not, check your soldering.

**STEP 6:** Re-assemble receiver case.

This information is kindly supplied by Dick Smith Electronics, Technical Bulletin No. 75, and is available from all stores. ■

# Who Says You Don't Have The Room To Put Up a Long Antenna? Of Course You Do!

BY RICHARD E. JAMES, JR., W4DQU  
Reprinted from CQ Magazine Dec '81

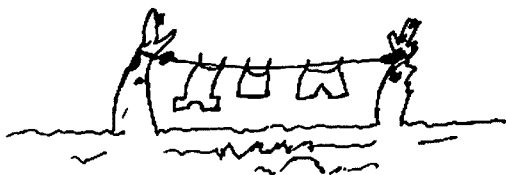

I seldom get on 80 or 40 metres without someone telling me he is using a dipole or inverted Vee antenna because he does not have room for a long-wire-type antenna. I believe part of the problem is in the terminology. Most amateurs think of a long-wire antenna as a single, end-fed, long wire. This is not one of the antennas I have in mind, because it has to be extremely long to achieve much gain, and it is unidirectional.

The antennas I have in mind are Vee-beams and rhombics. Both of these antennas are bidirectional as long as you do not use terminating resistors in them to make them unidirectional. Both of these antennas are also all-band antennas. The antennas in fig. 1 will work 160 metres and up and neither requires a lot longer than that required for an 80 metre dipole. A balanced antenna should be at least approximately one-half wavelength on the lowest frequency band for efficient operation on that band.

In these two antennas, for a given length in feet, the higher you go in frequency, the more gain you get. Of course, there is an optimum angle for each band for each length, but any given antenna will be usable on all bands and will give some gain on each band as long as the apex angle is between 32 degrees and 90 degrees. A short Vee-beam or rhombic will be closer to optimum on the higher bands if the angle is small and closer to optimum on the lower bands if the apex angle is large. A chart of gain and optimum apex angles is shown in Table I.

I have put up many of these antennas, using available trees in most cases. I do not worry too much about the apex angle. The antenna is still a usable antenna and a much better performer than a dipole or inverted Vee.

Yes, these antennas require the use of a tuner and open wire line, but you get some advantages:

1. All band operation.
2. Low feed line loss.
3. Due to higher impedance at the antenna feed point, on most bands, the RF voltage is higher and the amperage lower. This allows the use of light, inexpensive antenna wire

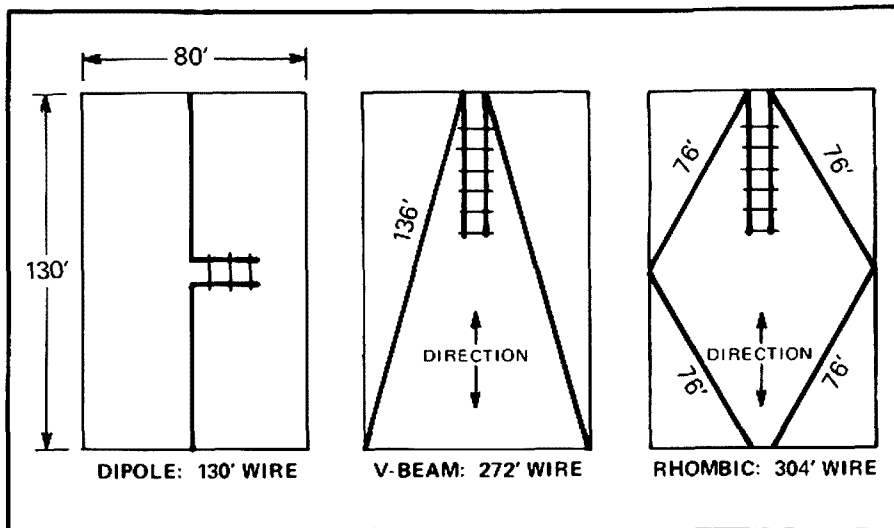

**Fig. 1 - Wire antennas placed on a typical small city lot. Of course, dimensions will vary.**

and feed lines. I use 18 gauge steel core antenna wire 18 gauge (spaced one inch) 450 ohms open wire feed line, and usually a short piece of insulated open wire line as lead-in between window and windowsill.

4. An extremely good ground system is not needed as in the case with a vertical antenna.

5. The antenna is cheap.

6. The antenna is so light that it can be pulled up to tree-top height with a nylon string thrown over a tree limb.

7. Two antennas can work the world, especially if one is oriented northeast and southwest and the other northwest and southeast.

8. Separate antennas for high and low bands are not needed.

In summing up, it is hard to understand why two such antennas have largely been overlooked.

The Vee-beam is almost as easy to put up as a dipole. The rhombic is a little more trouble because it requires four supports and all four in about the right places. However, the rhombic does have slightly more gain

for a given amount of wire and sometimes it is the more desirable on a narrow lot because the apex angle will be twice as large as on a Vee-beam erected on the same lot.

Try one of these antennas. You will like it. Remember, the longer it is, the more gain you get. But even if the antenna is short, it will do better than a dipole or an inverted Vee installed on the same length lot because it will have twice as much wire in it, more gain, and more space diversity.

Leg Length in Wavelengths	Gain	Optimum Apex Angle
1	3.0 dB	90°
2	4.5 dB	70°
3	5.5 dB	57°
4	6.5 dB	47°
5	7.5 dB	43°
6	8.5 dB	37°
7	9.3 dB	34°
8	10.0 dB	32°

**Table I - A chart of gain and optimum apex angles.**

# Getting to know you

Tom Delandre VK2PDT  
102 Buffalo Road, Ryde 2112, NSW

Well after almost two years in the amateur ranks and having retired August last, I feel it is time to put back into the fraternity some effort in appreciation of the many enjoyable hours both on and off the air.

First off I would like to express my appreciation for the efforts of Ron VK2DAE, Greg VK2DHI, Don VK2NUQ and Dick VK2DZX. It was due to the excellent lectures of Ron and the encouragement and assistance of these and many others that I managed to pass the novice exam. Hopefully I wish to update next February, rather slow progress compared to that to be expected if I had been able to continue with Ron's lectures.

Not long after I retired in July 1981, my XYL and I took a casual caravan tour of the Central West and the Riverina. The first night was spent at Lithgow, after a late start with last minute modifications needed to the wiring of the caravan and the little Mazda diesel utility. Next morning it was no trouble to get an early start as it was so cold. However, a little fan type radiator took care of that problem from then on.

While on route to Parkes we were able to do a favour for VK2EEE by picking up some electronic bits and pieces at Orange to be collected from VK2NNF at Parkes. On the way I was in touch with all the gang on the Koodkabarra net and given a precise talk in to Walter's QTH at Parkes, with the pot of tea ready just as we arrived.

After a most pleasant few days there, we

set off for Hillston to visit Wilf VK2BAW. As rain had set in we kept to the tar road and had no problem with navigation as Wilf and Col VK2EEE were in touch for the majority of the day.

At one stage, after lunch, Col assured me that if I cared to tarry at a little creek up ahead I would be able to get some good Yellow Belly (Gallop) as they came out on the bank to graze on the lush grass — he was so convincing the XYL was almost taken hook line and sinker.

What a welcome at Wilga Farm by Wilf and Elsie, who treated us like royalty. I could not do justice to Wilf's build-up on the fishing but at least we caught a small one for Margaret to try. After almost a week in Hillston we headed for Griffith, intending to stay only overnight, but we enjoyed it so much at the Tourist Caravan Park we spent four days there.

Bill VK2BBI heard me mobile in Griffith and popped in to see us and gave us a warm welcome to Griffith, as did Joyce VK2DIX. At this time of the year, August to September, Griffith proved an ideal spot to stop over for excursions to Kelly Country and many lovely spots on the Riverina.

On the way to Wagga we looked in at the Inland Fishery Research Station at Narrandera — don't miss this if you are in the area. At Wagga we had planned to look up Rex VK2YA but were informed by Bob VK2NOC that he was in hospital. So we visited Rex in hospital and he was, as

usual, busy, even in the hospital he was coaching a young chap for the novice exam. By the way, congratulations, Rex, on the new XYL, look forward to meeting you both on the next trip. Bob and Betty (also an amateur, VK2NSH) gave us a warm welcome, but we were sorry we didn't have a chance to call back (next time, Bob and Betty).

From Wagga the next stop was Burrenjack Dam, but my fishing efforts were in vain, once more. The XYL is sure I bought all fish from previous Bucks' party fishing trips. I had intended to pop into Tumut on the way back to visit Jack VK2DUL, Keith VK2DLZ and Bill VK2DPZ, who I had met on a previous trip to Tumut, but we were behind schedule and we had to be in Canberra to see our six-year-old grandson play football.

Thanks to all I have mentioned here and the many others in the amateur ranks for your company on the road and at home for the pleasure of your company.

Along the way I have seen many novel, interesting and effective ideas and in future articles in AR I will pass some on to you. There must be an enormous untapped wealth of ideas amongst you, how about passing them on and we will share them with the rest of the happy band. This is a big country and AR is an ideal medium to share your skills in so many spheres of radio.

73. VK2PDT. ■

## Do you know what "Bonito" is?

In amateur radio communication the computer has taken its place. BONITO is a new line for RTTY/ASCII/CW/FAX/SSTV and for amateur radio communication. For this the computer is the main element. For people out of this milieu a short introduction:—

The computer has received a new secondary machine, the transceiver. The normal BASIC has been modified. For RTTY the BONITO is already on the German market. A personal computer in a low price class can be used by a novice with little computer knowledge and can run a RTTY OSO. The better knowledge of basic comes automatically and you can use BONITO-BASIC without any trouble. You use 9 keys for different functions:—

1. Transmit/receive switch.
2. Split-screen for the control of rx/tx also during receive write text ready for transmission or to sink ships.
3. Baud 45-50-75-100.
4. Line length 40-60 - 75-80 characters.
5. Reverse or normal.
6. Bu switch.
7. Give out standard text — text is laid in DATA lines.
8. Shift 850-450-170 Hz.
9. Test picture for specialists.

Up to here everything is normal, the main thing is the BONITO-BASIC. The principle of this basic is that it can be used on all computer systems. The new amateur radio basic has the following orders:—

1. PRINT\* — transmission of all in this order of given variables.
2. DEF\* — then with DEF\* called up variables given a string of the last 11 received characters and in receive constantly changes its contents.
3. GET\* — get a RTTY character if none is received the variable = CHR\$(0).
4. WAIT\* — wait for RTTY character until it has been read.
5. WAIT\*ON — wait for an up to 11 character long RTTY string.
6. WAIT\*FRE — wait until system is ready for reception.
7. END\* — forces a switch over to receive by a mistake routine.
8. ON\* — switch to transmit with automatic switch over to receive with order 9.
9. INPUT\* — read in the RTTY characters into a variable up to carriage return or the 255 character.
10. CLR\* — clear RTTY buffer of old characters.
11. GO\* — help routine for jumps into system with hex.
12. INT\* — switch on interrupt so as when going out of the programme you can transmit or receive in direct mode.
13. CMD\* — split-screen on/off.
14. RESTORE\* — put DATA pointer behind the standard text.
15. RESTORE\*ON — with a compatible variable look for text block and put DATA pointer on to text block.

These orders make it possible for an OM to write a BASIC programme without having to worry about the RTTY technique. It is now possible to use new ideas by people with BASIC knowledge, i.e. automatic call acknowledgement, calling up club infos. Rotor control also for automatically following satellites, etc. These are all possibilities that can be solved in basic. You can build it up to a fully automatic club station. There is no end to the possibilities that are now open to the amateur radio operator.

The group BONITO is working on the next version of ASCII and CW and are keeping to the same standard as in RTTY. Note that the RTTY BONITO already has a CW transmission, part of which can be used. It is used in the RTTY chip as CW-ID or RTTY-ID. The ASCII version will receive 8 bits, which makes it possible to exchange programmes or transmit pictures. The SSTV version will be made up to work together with the 8 bit ASCII. SSTV will take a little longer than expected but will be kept as simple as possible. For those interested it will be a completely new concept; it will be a FAX graphic where only the picture points change; you can also get a print-out. For those interested, BONITO is not a club but a group of people looking for new ways in amateur radio communication, who use every new idea and try to make something out of it. BONITO is a loose group of people that help each other as best they can. Anybody can be a member of BONITO, he just has to join and you do not have to come from Germany. We accept help from any part of the world.

For information write to:—

Peter Walter, 3100 Celle an der Ziegelei 1, Germany.

The RTTY-BONITO can only be used on CBM systems for the moment. ■





# TRY THIS with the Technical Editors

## Phase Shift Frequency Multiplier

A form of frequency multiplier which uses phase shifted signals was described in *Designers Casebook in Electronics* for Jan. 13, 1982, by Fred Brown of Lake San Marcos, California.

The frequency multiplier operates by splitting the input signal into a number of equally spaced phases. The number of phases is equal to the desired multiplication factor. A doubler would use two phases 180 degrees apart and a tripler three phases spaced 120 degrees and a quadrupler would use four phases spaced 90 degrees, and so on.

The advantages claimed for this method are the high degree of suppression of harmonics other than the desired harmonic and the ability to build wideband multipliers by using wideband phase shift networks.

For amateur use an interesting approach would be to use coaxial cables as the phase shift network which would be fairly easy to set up.

A skeleton explanatory circuit of a quadrupler is shown in Fig. 1.

A more advanced quadrupler from 7.5 MHz to 30 MHz is shown in Fig. 2. This circuit is reported to have 50 dB suppression of the second and third harmonics below the desired fourth harmonic.

The 90 degree and 270 degree phases are obtained by using a simple LCR network (Fig. 3). The capacitive and inductive reactances are made equal and R is used to control the amplitude. The phase being controlled by trimming C and L. The inductance L is made up of the inductance of the primary of T1 in Fig. 2.

The 90 degree and 270 degree phases are obtained by using a simple LCR network (Fig. 3). The capacitive and inductive reactances are made equal and R is used to control the amplitude. The phase being controlled by trimming C and L. The inductance L is made up of the inductance of the primary of T1 in Fig. 2.

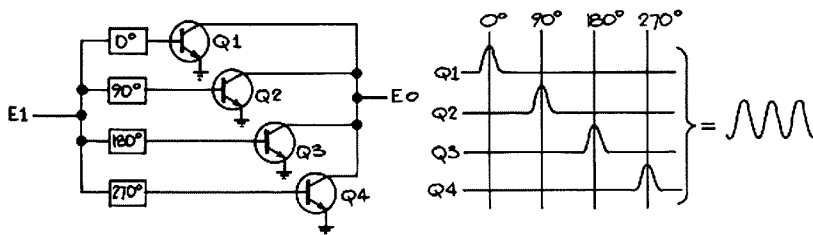

FIG. 1

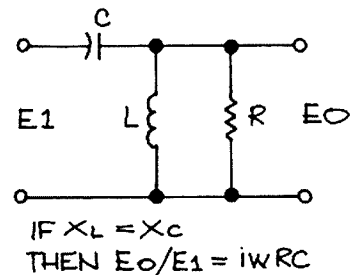
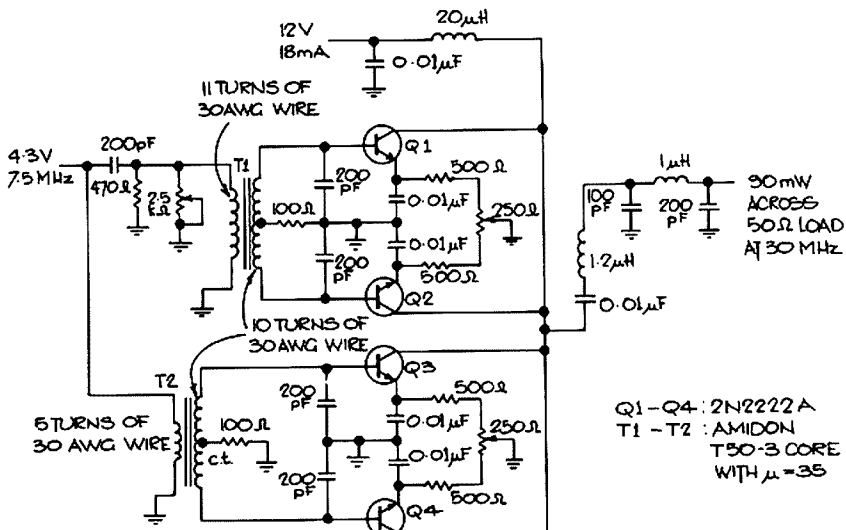

FIG. 3

The output network is used to match the output load to Q1, Q2, Q3, and Q4 and to provide some suppression of higher harmonics. The lower subharmonics being suppressed by the operation of the multipliers.



Q1-Q4: 2N2222A  
T1-T2: AMIDON  
T50-3 CORE  
WITH  $\mu = 35$

FIG. 2: Quadrupler. This high-frequency multiplier quadruples 7.5 megahertz to 30 MHz. The LCR network illustrated in Fig. 3 is used with T1 and T2 to provide a 0°, 90°, 180° and 270° phase shift for the four transistors. The second and third harmonics are suppressed more than 50 decibels below the desired 30 MHz level.

## My Ruler

I have a ruler, an ordinary 15 in. long ruler, which I guard jealously. I don't know where I got it from now, it's chipped, faded and a bit hard to read, but it's just about irreplaceable.

"Throw it away," you may say, "this is the metric age, you don't need inches any more!" And even if I do, I have other inch rulers, carefully hoarded or bought overseas, so what's so special about this one? Because it's a "decimal" inch rule, that is, the inches are divided into tenths, not quarters, eighths and sixteenths like the others. And that's important because IC pins are 0.1 inch spacing, and as long as the US retains the inch measurement (and they show no signs of going metric yet) we in electronics had better hang on to our inch rulers, and blow the Metric Conversion Board for not doing their homework properly. Just try to design a PC board layout with half a dozen ICs using a metric ruler and you'll see what I mean.

Ken VK2DOI in the Propagator June 1982.

# A Nicad Charger

By Terry Long VK3EC  
In The Radio Bulletin May 8 (EMDR)

Recent trends by manufacturers have produced a selection of hand-held transceivers which are becoming popular. These are mainly powered by nicad cells, and the charging of these have given many people grey hairs. The following article is my approach to this problem.

Nicads are, for the most part, expensive in outlay so the way to obtain value for one's money is to make sure they live as long and are recycled as many times as possible. In order to achieve this we have two "golden rules": (1) NEVER discharge them to the point where any cell goes reverse polarity, and (2) DO NOT overcharge them; despite what some say, they do "gas".

The following circuit will allow you to control the maximum voltage; other "refinements" are current and discharge controls. Firstly, the circuit in Fig. 1 consists of a clock (74C00/2), a voltage comparator (741), a timing switch (74C74/2), a gate and buffer (74C00/2) and switching transistors. Assuming the battery is low and start on a charge, when the clock goes low the charge is cut off, the 741 looks at the voltage applied to pin 2, compares it with voltage applied to pin 3 via the potentiometer and presents high/low to pin 12, 74C74, to decide if the next pulse will charge or miss. Beautiful in its simplicity!

Having decided to hit/miss, the next trick is, by how much? This can be controlled by using the 2N 3055 in a current limit, control provided by the 100 ohm W/W pot — take care when adjusting, it is possible to drive all the current through the 2N3638A and blow it! These transistors are not critical — the ones mentioned are

the ones I used but many others will do just as well. As you will see, the layout is designed to get the energy into the battery with as little as possible going to waste. By using a 22 K dropping resistor to the 5.6V Zener, consumption for the whole logic is less than 1 mA, not really required for your average battery charger!!

The next refinement is aimed at maintaining a high capacity in the battery. The feeling is that this is achieved by discharg-

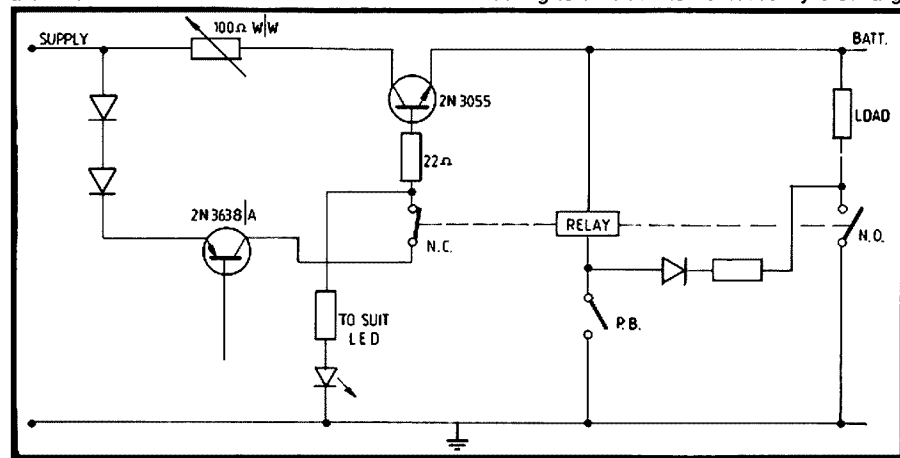

FIG. 2

ing the battery to a safe level and then recharging — nicads are considered discharged at 1.1V but if you're mean, then allow 1.0V/cell. The circuit in Fig. 2 allows me the option via the push button switch to discharge the battery down to 1V where the relay drops out and the contacts cut the load and re-establish the pulse charge. As you see, there is a red LED which lights to denote discharging, a green LED which lights to denote charging, and when they are both out the unit should be fully charged.

In the case of the 208R all this can be achieved without any alteration to the transceiver itself as the unit has 2.5 mm plug for charging, a separate plug for external power and contacts for direct battery access. If you wish to use the unit whilst it is charging, then use the external plug direct to the output of a LM317 voltage regulator.

By using a multi-position switch, e.g. 11-12 position single pole, the unit can charge any number of cells from 2-12 in, say, battery packs. The resistors can be a wide range of values but must be within, say, 100 ohm of one another. Even this is not critical, you just pick a handful of resistors and get the dozen or so which are the closest. Two of these must go in place of \*50 K, i.e. between earth and

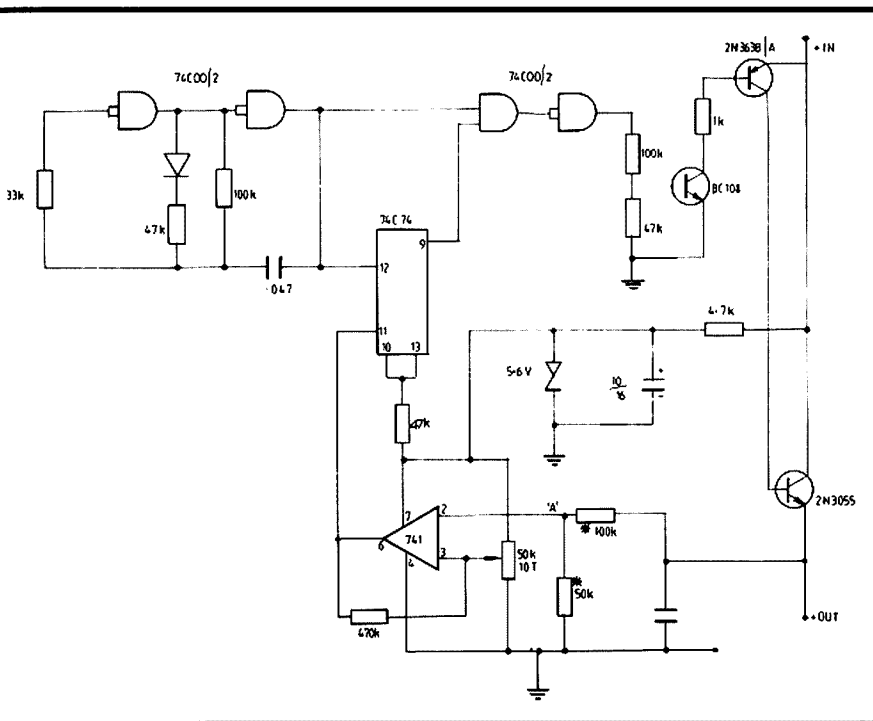
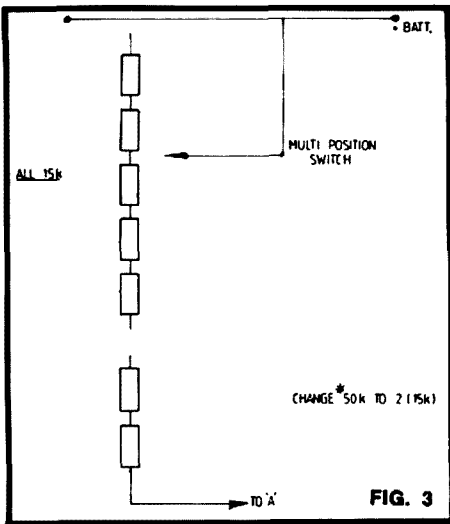
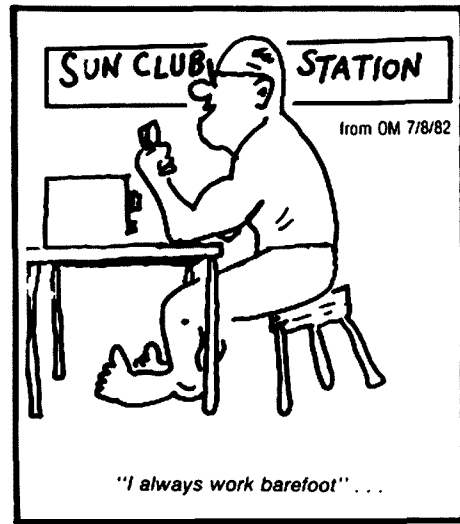

FIG. 1



"A", the rest of the string in place of 100 K but on the switch, the first resistor wired to "A"; the wiper to battery + and the other end of the string left open.

A word of caution — adjust the 100 ohm WW carefully; too high a value will send all the current through the 3638A and blow it. The 3055 is, of course, capable of passing many amps, so if you require only a couple of hundred milliamps, then just use the 3638A and make the base resistor 10 K ohm. I have used this type of circuit to charge much larger cells than nicads. It can be "tailored" to suit many applications and I'd be happy to discuss "reasonable" requirements! All care — no responsibility! Good luck! ■



# Bill Blitheringtwit in Trouble again

Ted Holmes VK3DEH  
20 Edmond Street, Parkdale 3195

## BILL HAS A GO AT A WHIP

After a crude sort of repair to his severed coax (necessary because he had slammed his car door on it) Bill Blitheringtwit was now setting up his mobile 2 metre rig in his car. He was in his back yard, complete with SWR meter and rather tatty looking patch cords. The two dents in his car's bonnet, caused by his size 9 boots, had been rapidly knocked out with a ball pane hammer. Unfortunately, the metal work showed the results of his pounding in the shape of some odd dome like protrusions, but Bill wasn't worried. After all, it was only a car, and a Holden at that!

For an antenna, Bill had decided upon a piece of straight coat hanger. This was good stuff. One end of it was jammed into the female half of a PL259 and several ounces of solder poured around it. The wire was about 2 ft. long or so — probably too long, but some could be chopped off to alter the SWR reading.

The SWR meter itself was ancient. Marconi would have recognised it, no doubt. The state of the device hadn't been at all improved by the fact that Bill had dropped it a couple of times and had also trodden on it. The fractured bakelite casing had been repaired here and there with masking tape.

He hooked everything up and dropped a carrier. The SWR needle shot straight across the dial and thumped against the stop. Obviously the antenna was too long. Out came the clippers and off came about two inches. He keyed again but the same thing happened. Still too long. Off came another couple of inches. This happened several times and he chopped away until the coathanger was only about 9 inches long. Lopped off fragments of coathanger lay scattered around everywhere.

Bill was mystified. It did not deter him at all that he had been dropping carriers all over the input of the local repeater and that the habitués thereof were at that moment expressing their displeasure. He decided to investigate and found that he had a dead short, in that the centre pin of his antenna was going to ground, due to excessive use of solder. Better get rid of some of it, but a heavy duty iron was needed.

He applied his massive plumber's iron (tried and trusted) to the pin area and within a very short space of time had totally melted all the solder, together with the plastic dielectric in the plug, which now looked decidedly droopy and unhappy.

Hot solder dripped to the ground and, rather painfully, Bill found out that it was not a good idea to wear thongs whilst using a soldering iron.

## BILL GOES MOBILE

Having safely installed his ancient mobile rig in his car, Bill Blitheringtwit was feeling mildly proud that, after several attempts, he had at last got an antenna to function. No real credit was due to him, however, as his own home-brew efforts had been nothing but consistent failures. He had been obliged to purchase a ready made steel quarter whip and this aspect went somewhat against his grain. After all, Amateur Radio was supposed to be about "do it yourself" and (in connection with the antenna) he hadn't done it himself. He had been driven to buying a factory made, workable antenna and this side of things wasn't really to his liking. Nevertheless, at least he had some sort of a system up and running. Now for the acid test: to see how the thing worked under driving conditions.

Unfortunately, the day he chose was rainy. Heavy showers swept across from the south-west, but Bill was not deterred.

After all, Amateur Radio was also about not being deterred. He climbed into the Holden, started up and moved safely out of his driveway. After a few miles along wet and miserable streets he was aware of something cold trickling down his neck. A quick glance told him that the hole he had made in the roof of the car for the coax should have been properly sealed. A steady stream of water was coming through and heading in the direction of his shirt collar.

He cursed and carried on driving. He switched on the rig. A steady whining noise came from the speaker, engendered by the windscreen wipers. It was a powerful sound, almost soporific, and below all this he could just hear the sound of somebody speaking. This must be the local repeater. He might as well have a go at it whilst he was about it.

Bill waited until the voice stopped and then grabbed for the microphone. It fell off its hook on to the floor and he found himself kicking it about so as to get at it and to lure it somewhere he could pick it up again. Eventually he managed to tread on it heavily with his size 9 boots. The sound of crunching plastic could be clearly heard. They didn't make things the way they used to: some of his old mikes could be trodden on by a regiment and survive — not this modern trash! Using the curly cord, he began to pull and, like someone bringing in a fish, hauled up the microphone's dangling viscera.

At this point he decided to pull over and stop in order to see what he could do to rectify matters. The rain hadn't stopped and Bill simply didn't see the overhanging tree branch, near where he had pulled over, which neatly and efficiently decapitated his brand new quarter wave whip, leaving only the base mount as a relic of the antenna's brief existence.

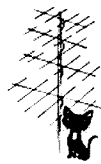

# Another Antenna Story

Rita G3NOB  
in "Jimmy", Jan. 1982

The antenna at this QTH is a trap dipole, and we had been keeping an eye on the tree in the next door garden which was being very loving and kept on growing towards one of the end masts. Whenever the wind was in the right direction, it would wrap itself round the mast and the end of the wire.

During the last gales, and, naturally around 2 o'clock in the morning, there was an almighty crack and bang went the poor old end mast, and one end of the trap dipole was laid on the ground. Being the middle of the night and pitch black and a howling gale, there was nothing to do but hope until daylight. Fortunately, the wind did lessen.

The next day we lowered the centre of the antenna having decided we might as well put in some new centre sections of wire, the existing ones being patched up with new bits twisted in and spliced into the stranded wire in use.

To lower the centre of the antenna we undid the halyard which has to be open ended in order to wrap it around the coax feeder and the mast to prevent the coax slapping about and making an awful racket in any wind.

We lowered the antenna very carefully so that it didn't get caught on the guttering of the house, and it was almost down to the ground when there was a flurry of wind and — yes, you've guessed — away went one end of the halyard.

A ghastly silence prevailed for a split second and then Tom, my OM G3HPJ, said, "Now look what you've made me do!" Then the awful realisation dawned that we would have to lower the central mast, all 35 feet of it. This entails undoing 'U' bolts which are threaded through two spaced angle iron supports bolted to the corner of the house. Then the old climbing rope is tied around the top part of the mast, and a turn taken round the upper angle iron, and then the mast is guided in towards the house so that it rests in a corner formed by the house and the angle irons. The free end of rope is then taken round an ancient apple tree half-way down the back garden.

This is where Shorty, that's me, has to stand at the foot of the mast, arms above my head as far as they will reach, and Tom takes the free end of rope to guide the mast down shouting to me to PUSH! PUSH! PUSH! I start PUSHING! All 5'3" and 8½ stones of me, and believe me, it's jolly hard to get 35 feet of metal masting over centre before you can guide it to ground.

We finally manage it and Tom lowers it safely within the confines of the garden without smashing up the neighbour's fencing.

Got to get a move on for the days are short. It is November, and the wind is rising again, and it's cold.

Measure out new centre sections using soft drawn copper wire this time so its not too bad to handle. Wish we had got the new traps we have talked about, but never mind these will have to do for we cannot be without an antenna.

We attach wire to traps and the balun and then check outer sections and see that one end of the stranded wire is holding by about three strands, but as the light is getting poor, our hands are cold and the wind is worse, we decide to chance it.

First thing is to re-erect the centre mast. This is done by Tom lifting the top of the mast and 'walking' it upright while I try to guide it with the rope, and correct the horrible sway that develops just before it becomes upright again.

All safely clamped to angle irons again and we haul up the centre section of the antenna. Then one end and last of all the weakened end which, of course, breaks!

Decide we can manage to replace end sections without lowering the centre again, so we lower both ends only and replace with nice new wire. Quite dark now and we are both perishing cold.

Have a quick cuppa and decide we'd better do some checks. The antenna is smashing on 80, 40, and 20 metres, but won't take more than 40 watts on 15 metres without the SWR going astronomical. So we decide the traps are US and the next morning telephone KW and order new traps, telling the man who answers the 'phone we think we have a dud one, and he asks how long have we had them in use? We say about 12 years, and he says, "Oh, well, they'll be out of guarantee!" They aren't KW anyway, they are IOW.

The new traps arrive in a few days time, but in the meantime I work 20 metres, and one morning as Tom had to be away earlier than usual, I saw him off the premises and thought I'd take a listen on 20, and there was ZL1AXM (whom we know as G2KK) just signing off at the end of a QSO. So I gave him a call with my 80 watts and there he was answering me! The band was changing, but we managed the bare bones of a QSO assuring each other that families were OK. There must be something in this business of "an ill wind"!

At the weekend we got to work to lower the antenna to put in the new traps. We lowered the centre of the antenna carefully, but the knot in the halyard slips — and — away she goes again to the top of the mast. So back to the mast lowering exercise — it's a shocking habit to get into you know.

Eventually we get the mast back up, the new traps fitted and the antenna raised. Now comes the big deal when we check the antenna from the rig again. We get exactly the same results. OK on 80, 40, and 20 but still only 40 watts on 15, without the very high SWR.

Ah ha, we say, it must be the balun. Oh well, we'll use the nice shiny Hygain that we are keeping for the beam whenever we can sneak one up without the neighbours noticing.

Lower the antenna once more — YES, YES, YES folks — away goes the halyard. Privately, I think that maybe one of those Snow Snakes that have invaded Long Clawson has strayed to Loughborough, eaten the halyard and taken its place.

Poor Tom cannot face managing with only me to push-pull twice in one day, so we have a brainwave and keeping our fingers crossed that he is at home, telephone a friend who lives a few yards down the road, Jack G3BKF, whom some of you may know for he is a cw only operator and works quite a number of VK/ZL stations.

Great! Jack is at home bottling wine, so he comes over and lends a hand. It makes everything so much easier, and the mast comes down and goes back up again like a dream.

Everything must be OK this time for even the coax feeder is new, having been replaced a few weeks earlier.

Inside to check that all is now well, and we just cannot believe it, for we get exactly the same results again!

So we go over everything we have done. New feeder, new wire, new traps, new balun, so what is it?

Suddenly, remember we have made up a shorter length of coax to connect the SWR Bridge to the ATU, so put back the old longer length and check again. EVERYTHING IS FINE ON ALL BANDS.

So we put the short length back and try again, and we are back to square one, fine on 80, 40 and 20 but not 15 metres.

So we are still with the longer length of connecting coax and are still in the dark as to why the short length is no good. It measures 77 cms and was checked so that there is no short and it works all right into a dummy load, but not into the antenna. The longer length is about 1½ metres. Any suggestions?

So, friends, remember, there is always an easy solution to every problem — neat, plausible and wrong. ■

---

**HELP** WITH INTRUDER  
WATCHING

---



# THUMBNAIL SKETCHES



Leighton Gibson, ex 4AN.

Leighton started building receivers in the 1920s with circuits from "Hertzian Waves" and his father brought a Marconi crystal set back from Canada, which would receive VIB and so to learning morse code, then in 1921 a "smuggled" "Anaka" valve six volt one amp. Next he used the inevitable spark coil to make a nuisance of himself and nearly lost his licence (it was untuned), but using a receiving valve got him out of trouble.

At that time, being a semi-invalid, enabled Leighton to spend much time experimenting and operating and he became very well known. For a time Leighton was Technical Editor of Queensland Radio News and also wrote under the pen name "Bananalander".

He joined Philips in 1928 and served with them in various parts of Australia and overseas until his retirement in 1967.

Leighton and Andy Couper 4BW were the sole means of communications between North Queensland and Brisbane after the 1927 cyclone which brought forward a letter of praise from the Deputy Director of Posts and Telegraphs, Mr. A J Christie. This event is well written up in "Radio" 30 March 1927.

sign initials and an assurance had to be given by Bob for issuance of a licence to Norm.

Included in Norm's equipment was an At-water Kent spark coil and a helix supported zinc plates condenser. Power was derived from a water driven car generator, permanent magnets and charging batteries.

Norm completed a Marconi course with AWA in 1925, Sydney, and went to sea in 1926, moving through many ships in his sea career.

He came ashore in 1936 to Coastal Radio, Port Moresby and remained in control there at times as Navy, through the war years until 1951.

Norm encompassed the Coast Watching System in his responsibilities. From 1951 to 1971 he was manager of International transmitter and receiver stations in WA, also having close association with NASA for whom he holds certificates of commendation.

Norm is quite active on the HF bands and would vie with Hal VK4DO as the longest licensed active amateur in VK.

"Bill" is very interested in historical matters, being closely associated with a Telecom display, and appreciates the vast changes that have taken place during his career to the extent that he recently gave his "Recollections of 50 years in Radio and Electronics" to a meeting of the Queensland Division, a talk which was very well received.



WC "BILL" ROHDE. 4RW. 1929.

"Bill", a Brisbaneite of 1906, was a schoolboy "wireless" addict. He joined the Woolloowin Radio Club in 1920 and the YMCA Radio Club in 1922. "Bill" was mostly a low power, 7 MHz, CW operator but occasionally played gramophone music over the air.

1924 saw him as a trainee mechanic with the PMG graduating to a telephone mechanic in 1928, to radio 4QG 1930, then to long line communications for some years to return to radio as Divisional Engineer for Queensland, Papua New Guinea, in 1953. In 1961 he was promoted to Supervising Engineer assuming departmental control of broadcasting, television and radio operations in Queensland. "Bill" retired in 1972.



NORMAN ODGERS. 4BO 1924, VK4NK/VK9NK 1937, VK6NF 1951, VK4CH.

Like so many of this period, Norm, of year 1906, started about 18 years of age and received a lot of assistance from his father in Charters Towers. Bob Odgers gave the call



# COMMERCIAL KINKS

## WIDE OR NARROW CW SWITCHING WITH THE TS-520S

It's always pleasing to get feedback on modifications published in Commercial Kinks. The wide / narrow CW switching for the TS-520 has proved useful to many amateurs but it seems that the modification is not directly transferable to the TS-520S. If you have tried without success here is the answer by Evan Jarman, VK3ANI . . .

I was interested in the TS-520 modification in the June 1979 issue of AR and attempted to change a TS-520S believing the circuitry to be identical.

The modified unit did not work as expected, casting suspicion on the procedure. However, a difference in circuitry came to light after talking with Andrew VK3BHC and some additional changes were found necessary.

The problem is in the carrier oscillator switching.

There are two frequencies used for CW operation: One on receive (CWR = 3.3943 MHz), the other on transmit (CWT = 3.3950 MHz). These frequencies are obtained by diode switching using the Rx/Tx relay. In the TS-520, the tune position retains this rationale, but the TS-520S does not; CWT is used on both Rx and Tx. This modification restores the function switch rationale to that of the TS-520 to enable use of VK5TT's alteration.

S-3 is the mode switch and section 1 activates the CWT frequency. There are two wires connected to the tune position; one

black, the other red. The black wire is removed. This wire removal requires some care as it bridges two fairly inaccessible switch lugs. The red wire is disconnected at the switch and reconnected to the 9 volt terminal (marked 9) on the RF generator board. The wire now connects the 9 volt terminals of the RF and AF boards together.

A bridge connection is now soldered between the CW and tune lugs of the switch section.

Section 2 of S-3 activates the CWR frequency. On this section a bridging connection is soldered between the tune and CW lugs.

Sections 1 and 2 are located on the wafer closest to the front panel with section 1 being concealed.

Section 8, which selects the filter, is in the same position as with the TS-520S as in the TS-520 and can now be modified as per VK5TT's instructions. There is one slight difference still to be mentioned: the JJJ/WVV has become the TS-520S's RF attenuator.

The modifications can be made "in situ" by removing the S meter but you have to be very careful.

The number of additional modifications required surprised me for what, I thought, were basically identical units. I am now quite wary of modifications for the TS-520 being used on the TS-520S, and vice versa.

Schematic diagram of modified switch S-3 on Kenwood TS-520S.

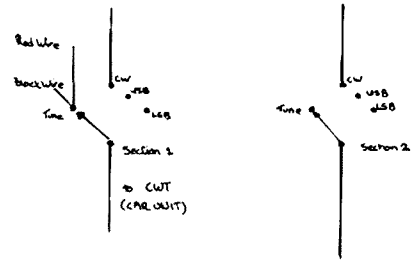

Switch S3 before Modification.

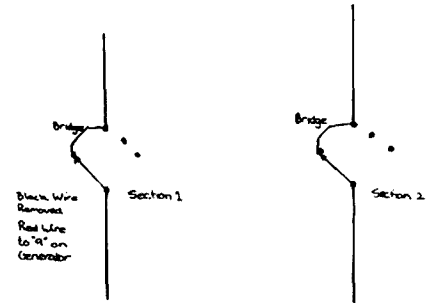

Switch S3 after Modification.

KENWOOD

TR-2500

See your dealer for more savings in our Super Summer Sizzler Sale

Dr. David Lewis leader of the 1982/83 Oceanic Research Antarctic Expedition has chosen Kenwood Communications Equipment on board the "Dick Smith Explorer". Where lives and safety are paramount and reliability is of prime importance - the professionals always choose KENWOOD

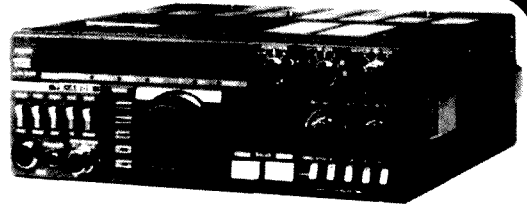

TS-430S NOW AVAILABLE EX STOCK!  
\$950 with Mobile Mount (FM additional \$49)



TR-7730



TS-130SE

TRIO-KENWOOD (AUSTRALIA) PTY. LTD.  
(INCORPORATED IN N.S.W.)  
4E WOODCOCK PLACE, LANE COVE, SYDNEY, N.S.W. 2065. Ph. (02) 428 1455.

**NEW SOUTH WALES**

- SPRINGWOOD CAR RADIO — SPRINGWOOD (047) 51 4930
- UNIQUE ELECTRONICS — 383 MERRYLANDS ROAD, MERRYLANDS (02) 682 3325
- WASSLEL ELECTRICAL — 10 McNAMARA STREET, ORANGE (063) 62 6249
- STOCKMAN & HIGGINS — BYRON STREET, INVERELL (067) 22 1300
- ELECTRON 2000 — 3 ELIZABETH STREET, TIGHS HILL, NEWCASTLE (049) 69 6399
- MACLEEC PTY. LTD. — 99 KENNY STREET, WOLLONGONG (042) 29 1455
- RADIO WORLD PTY. LTD. — 81 NEWCASTLE STREET, FYSWICK (062) 80 6550
- OX ENGINEERING — 5 JASMINE STREET, PORT MACQUARIE (065) 83 2127
- LAND LINK — MULLALEY ROAD, GUNNEDAH (067) 42 2839
- LAND LINK — 61 BARNES STREET, TAMWORTH (067) 65 4622

**INTER-STATE**

- MC: EASTERN COMMUNICATIONS — 168 ELGAR ROAD, BOX HILL (03) 288 3107
- BRIAN STARES — 11 MALMSBURY STREET, BALLARAT (053) 39 2808
- SUMNER ELECTRONICS — 78 KING STREET, BENDIGO (054) 43 1977
- CODLIN ELECTRONICS — MOE (051) 27 4516
- TAS: HOBBY ELECTRONICS — 83 CARELLA STREET, HOWRAH, HOBART (002) 47 6674
- GELSTON ELECTRONICS — 40 LAVENDER GROVE, SUMMER HILL (003) 44 3882
- ADVANCED ELECTRONICS — 5A THE QUADRANT, LAUNCESTON (003) 31 7075
- V.K. ELECTRONICS — 57 WEST PARK GROVE, BURNIE (004) 31 1708
- MLB: MITCHELL RADIO CO — 59 ALBION ROAD, ALBION (07) 57 6830
- S.A. & M.T.: INTERNATIONAL COMMUNICATIONS SYSTEMS PTY. LTD. — 8 MILE ST, PORT ADELAIDE (08) 47 3688
- W.A.: ARENA COMMUNICATIONS SERVICES — 642 ALBANY HWY, EAST VICTORIA PARK (09) 361 5422
- TRI-SALES — CNR NEWCASTLE & CHARLES STREETS, PERTH (09) 328 4160
- WILLIS ELECTRONICS — 73 STERLING STREET, PERTH (09) 328 9229
- GRAHAM ROGERS — 18 BANKSIA STREET, BUNBURY (097) 21 2236
- RON DENT — 115 PATON ROAD, SOUTH HEDLAND (091) 72 1112



TRY THIS

## ... The Folded Mobile Whip

John Teffer VK2BTQ

169 Mitchell Parade, Mollymook NSW 2539

If you have an interest in a different type of VHF whip antenna which has proved its worth to me ... what about trying this. I have been using, experimentally, for some 6 months or so, a mobile antenna made from fencing wire, which caused some stares but worked so well that I decided to set down the details for others to try out.

My old 50", 5/8th whip kept fouling the garage roof, but not so the folded whip, which is some 8" shorter. A good feature to start with! I find also, that the new whip has a performance edge over the 5/8th. Another bonus is its operation without the need of a ground plane some interesting possibilities. What about hanging it on the picture rail, or making one, using TV ribbon which could be suspended anywhere, or even rolled up and put in your pocket.

The sketches are self-explanatory. The two paralalled wires may be anything you think suitable ... stiff, or flexible. I finally used two thin stainless steel commercial whips which I bonded together at the top. For separators I used the black insulators from 'dog-bone' TV ribbon. An old 'Pental' pen served as a coil former.

Wind the coil as shown and shunt it with a small variable capacitor ... say, 0 to 5pF. Grid-dip the coil and capacitor circuit to the middle of the range you wish to operate, ... in my case 146.5MHz. Do the grid-dipping before connecting the antenna whip. The 50-ohm co-ax matching may be varied by adjusting the position of the tap ... about 3 turns.

Push the tuned circuit into the plastic conduit, and carefully drill a hole for final screwdriver adjustment of the capacitor. Afterwards I filled the hole with plasticine (easy to dig out again). The top end of the conduit sleeve where the antenna exists, was sealed with some hard-setting epoxy.

Have fun!

73 ... John VK2BTQ

AR

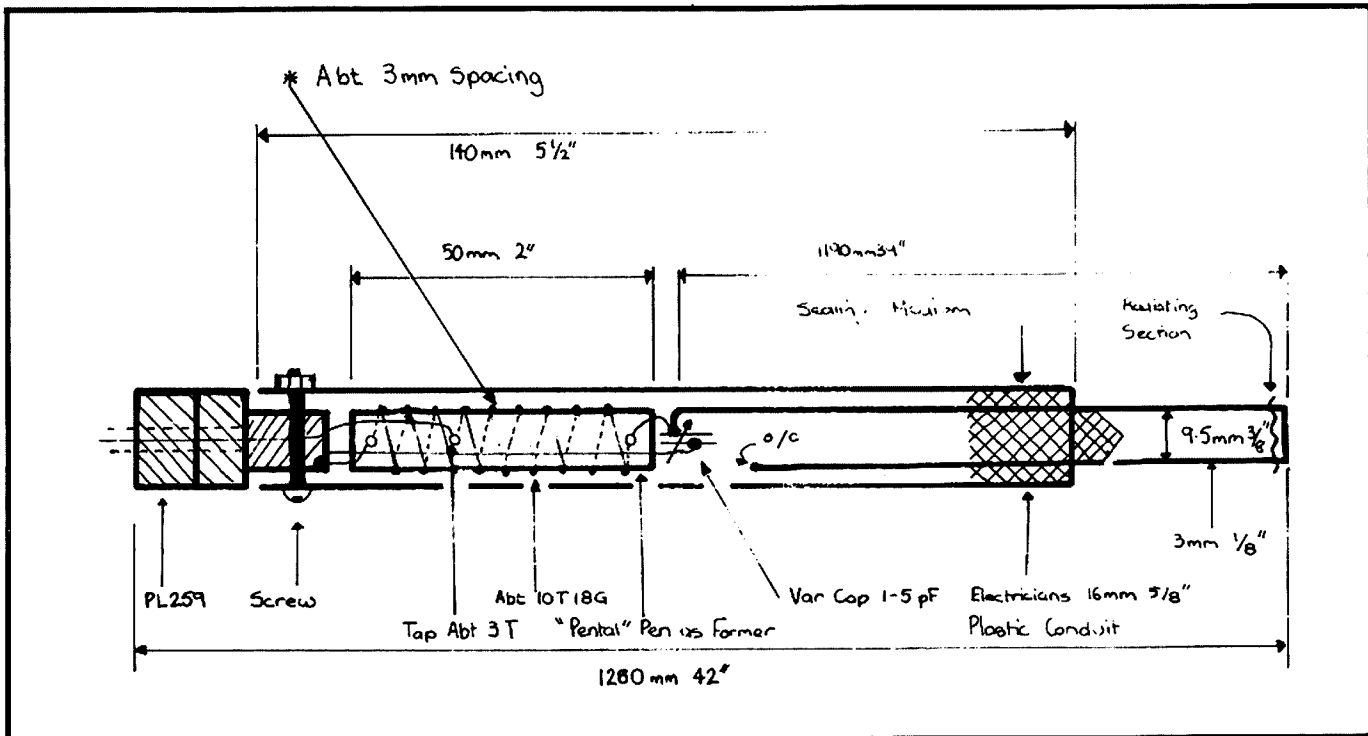
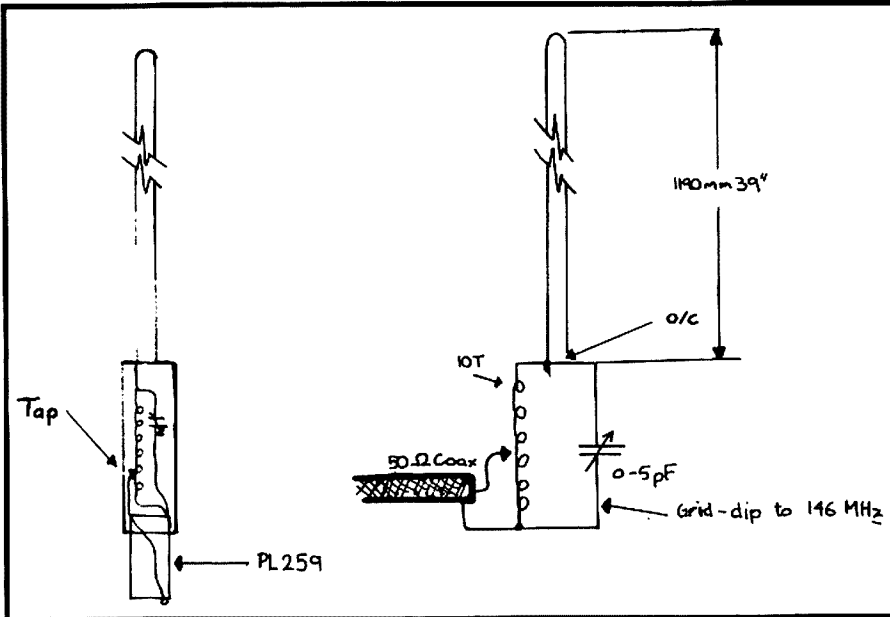



# HOW'S DX

Ken McLachlan VK3AH

Box 39 Mooroolbark Vic, 3138.

The start of the year 1983, World Communications Year, is now with us. One hasn't got to be prophetically inclined to be able to discuss with authority that ten metres will not be as good as it was last year, more licenses will be issued throughout the world and a number of DXpeditions will be undertaken.

One cannot say with certainty whether such occurrences as the appearance of BY stations on SSB, how many countries will be deleted from the DXCC list, will one or maybe two be added, and the activation of some of the rarer DX countries will cause a major shuffle in the DX achievement ladder.

We, as individual amateurs, can do little except enjoy the privileges, that have been granted to us over the years, by abiding with the regulations governing our hobby and remembering that you are an ambassador for the country that you prefix your call with.

Collectively, through being a member of your society, such as the Wireless Institute of Australia, you are part of the voice that negotiates on items that effect the future of your hobby on both a national and world basis.

This is only one of the numerous advantages that one receives with membership of ones society. Make one resolution for WCY 83 now, that being, that you will join a new member this year.

## POSTBOX BARE

The amateurs who incessantly make statements on air regarding spending all that money on stamps and IRC's in an effort to obtain cards that don't eventuate, either lethargically approach a problem when someone creates a positive approach to a solution or have not read of the offer as outlined in this column last November with reference to passing on any criticism of who were "good" or "bad" QSLers.

At the time of writing there were two letters of nominations to pass on to Jan and Jay, K6HHD and W6GO publishers of a QSL Manager and route directory. One letter was from Fred VK1MM, the other from myself. Not a very positive approach ladies and gentlemen seeing that the offer was discussed so much on at least two bands, namely fifteen and twenty metres.

Fred has given his permission for printing any or all of his submission and for the sake of brevity excerpts only have been selected.

*"The best QSL'er award would have to go to WA3HUP, Mary Ann. She is about the only manager in the game who consistently and promptly sends cards back. Moreover, the only delay she seems to encounter is getting the info from the station she manages, not due to 'missing mail bags' and the like. I think the longest time I have had to wait to get a card from her is about three weeks from the date I posted mine. I just wish all the managers were like her."*

Fred's nomination for the worst QSL'ers are copious but as Fred writes: *"The worst QSL'er would have to be Y11BGD. I've been trying to get a card direct for two years now. I've sent them to his PO Box, with mint stamps, with IRC's, and with green and brown stamps. I even went to the extent of finding out his home address to send cards there, but to no avail. I'd*

*say that the gentleman concerned is making a nice little business out of it for himself!"*

Personal comments endorse Fred's remarks regarding the best QSLer though I have to differ regarding Y11BGD, a card is in my possession, yet a lot of amateurs, particularly from North America are working the station again and asking how do they achieve the honour of a card.

Fred's summary of *"What it boils down to, is that too many of these people are in it to make a quid. Some of them reply to direct QSL cards by sending them back through the bureau. Some of them send the reply back via surface mail (when enough money has been sent for an air-mail reply — and to leave them some change). And the worst don't even bother to reply. Of course, there are the others that demand large sums and/or excessive amounts of IRC's before they will send you a card, but at least they are being blatantly honest in their business attitude."*

Thank you Fred, and your nominations will be passed on to Jan and Jay together with my own. Perhaps now that someone has broken the ice more VK's will be forthcoming with "nominations" or at least a resume of written experiences that may save some newcomers to our membership a lot of "hassles" in getting cards which according to media speculation will become more of a financial burden in 1983.

## COMMENT?

It would be appreciated if written comments regarding the value of the Heard and Worked segment of this column have enough following to justify their inclusion. If you have any doubt as to the value of their inclusion each month please ask yourself the question "Am I really interested in what DX is worked by someone else in my locale or across the other side of the continent?" Your comments will be appreciated.

## JY1 BIRTHDAY CELEBRATIONS

Mid November saw the proliferation of JY7 prefixes on the airwaves. This prefix was to celebrate the birthday of His Majesty King Hussein JY1. If you were fortunate enough to have seven different contacts (JY7ZH on 10, 15, 20, 40 and 80 metres would qualify as five contacts) you are eligible for an award which is presented by His Majesty. If the standard of previous awards that have come from the Royal Palace is anything to go by, this one should be a beauty.

Applications giving at least the listing of seven QSO's with JY7 prefixes noting date, time in UTC, call sign, frequency and reports exchanged together with 10 IRC's to assist in defraying postage expenses to "7 JY 7 DIPLOMA" PO Box 2353 Amman, Jordan. No QSL cards are required for this award.

## QSL MANAGER QTH's

A number of QSL Managers who look after the affairs of more than one station always seem to be in demand and this list has been prepared in the hope that it will provide a ready reference of the QTH's of some of the better known card handlers.

- WA3HUP (JY1, 8ZA, CE0AE, KP4KK/OU2, VQ9KK etc.)
- Mary Ann Crider, RD 2, PO Box 5A, Yorkhaven Pennsylvania 17370
- K3EST (HS1ABD etc.)
- Robert G. Cox, 6548 Spring Valley Drive, Alexandria VA 22312
- W4FRU (Z07HH, ZD9BV, ZD9YL, VK4NIC/3X, 3X1Z etc.)
- John H. Parrot Jr., 4640 Ocean View Ave., Va Beach VA 23455
- DJ9ZB (A71AA, JY3ZH etc.)
- Franz Langar, Carl-Kistnerstrasse 19, D 7800 Frieburg BRD
- N4NX (3C0AC, WN4FVU/5X etc.)
- William T. Barr, 305 Alpine Dr., Roswell GA30075
- N200 (VS500, 9M6MU etc.)
- Robert W. Schenck, PO Box 345, Tuckerton NJ 08087
- W3MNM (HC8GI, etc.)
- Joseph L. Acure Jr., PO Box 73, Edgemont PA19028
- SM3CXS (SM0AGD/-).
- Jorgen Svensson, Berghemsv. 11, 86021 SUNDSBRUK Sverige
- KSVT (9U5AV, S9VCT etc.)
- Dr Vince Thompson, PO Box 32487, Phoenix Arizona 85064
- Yasme Foundation, (The Globe Trotting Colvins etc.)
- PO Box 2025, Castro Valley CA 94546
- WA4VDE (W4MGN/Africa tours, 6W8HL etc.)
- William Dunbar, RFD 5 — Box 107, Canton Georgia 30114
- DJ6SI (. /5V. . /3X etc.)
- Baldur Dobrnica, Zedemweg 6, D 5010 Berghiem BRD



Luis EA1VG

## LUIS EA1VG

Luis EA1VG, a member of the LYNX DX Group and IDXF, classes himself as a newcomer to the bands having been licensed since late 1977. In this time he has achieved confirmations from 263 countries and certificates for WAS and WAZ.

The equipment used at the QTH consists of a Kenwood TS-830S driving a SB220 linear through a Drake MN2000 antenna tuner into a Swan three element Beam.



## SCIENTIFIC APPROACH

Have you ever been on the twenty metre band and wondered why one VK3 station always gives and gets signal reports from any continent that are beyond your wildest dreams. I have and one has had to listen over quite a period to gather what equipment this best VK report gatherer is using. The operator of this outstanding home-brew station is none other than Ian, VK3MO.



Ian VK3MO looking for elusive DX??

Ian, who is rather shy in discussing his accomplishments so far, has forwarded numerous photographs and a brief description of his equipment to me so that readers of this column may better understand the experiments he is undertaking.

The antenna system, in which lies the heart of Ian's success, consists of three by four element yagi's on forty foot booms that are mounted on the tower at 46, 94 and 142 foot above ground level. The tower is fully rotatable using a chain drive mounted at ground level and is held in the vertical plane by guys which consist of 1 1/2" circumference polyester rope attached to bearings at the three levels.

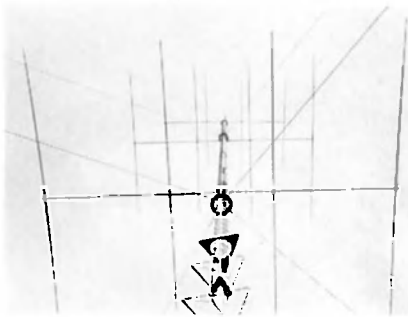

From inside the tower looking up to the yagis.

It is interesting to note that the yagi design was developed experimentally on 14 MHz by W0OKC and then scaled up to 440 MHz by Dr Jim Lindsay of the DENVER RESEARCH INSTITUTE, where the antenna was compared with other designs using an antenna range.

Ian's objective is to develop a computer based system which will automatically produce an optimum antenna radiation angle for transmissions to a specified target area. A "home brew" computer, specifically designed for this purpose, is on line and at his disposal.

Ian hopes to further develop the system along the following lines so that by sending out short pulses at various radiation angles and recording all the return signals (Back scatter etc.) he will be able to compare this data with signal strength reports and after correlation of the relationship of the two, be able to use the data programme produced to steer the antenna array automatically.

An example of how the system should operate in practice is given by quoting from Ian's notes to me. "A sched is arranged with the UK. G is keyed into the computer. The computer will take control.

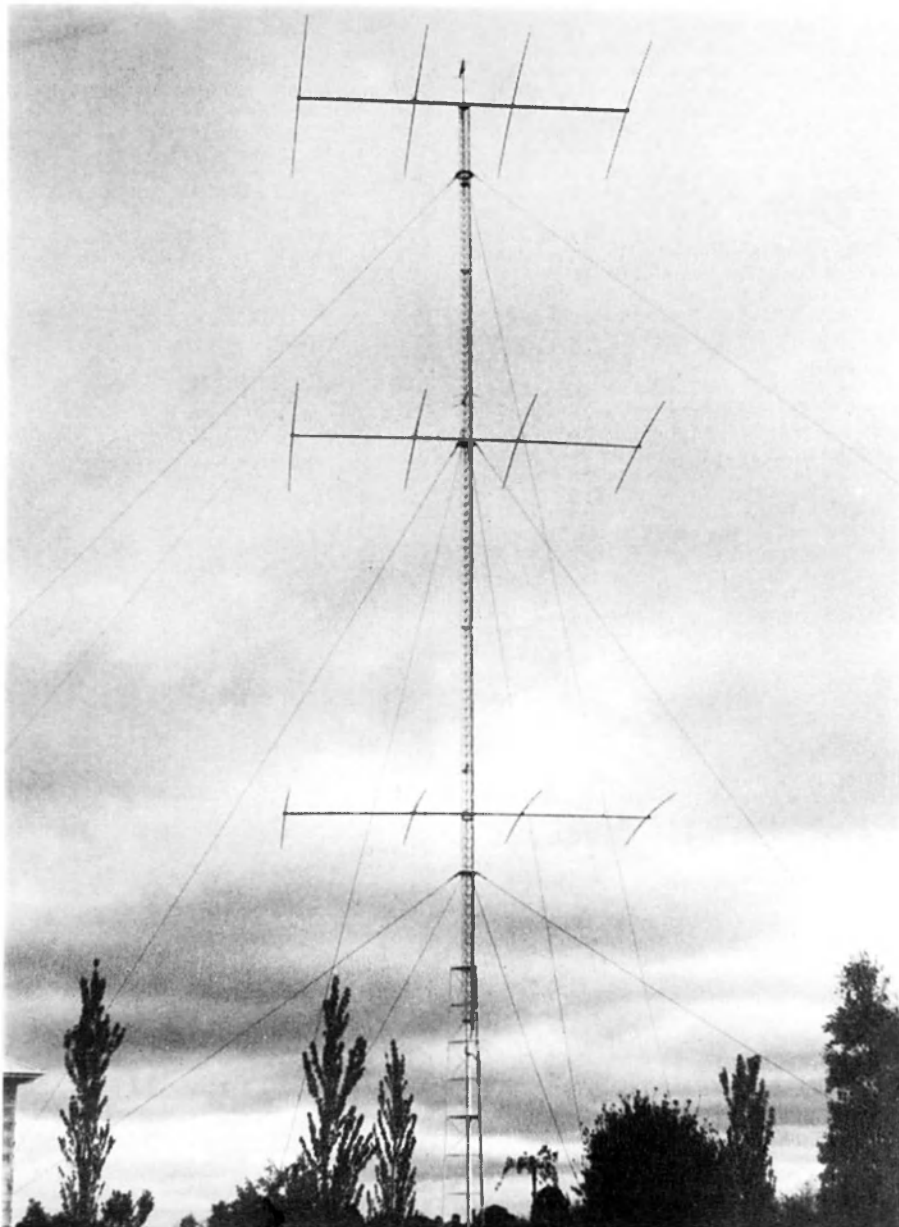

Ian's antenna system. The three, four element yagis are mounted 46, 94 and 142 feet above ground level.



The "home brew" computer used to produce optimum radiation angle.

Short pulses of RF will be sent out at various radiation angles. Using the data experimentally

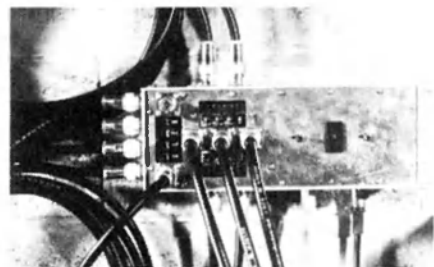

The switching setup for the antenna system.

determined the computer will adjust the phasing between the three antennas to produce the best radiation angle for G at that instant.

An update every minute will keep the array focused on the target area. The update will oc-

cur so rapidly both operators will barely perceive the brief interruption in speech etc." Ian states that the ultimate system would no doubt have computers at both ends of a circuit, communicating with each other, and making decisions about parameters necessary for most effective communications.

So when you hear that BIG signal, generally on the airways very late at night, and the operator is diplomatically trying to go ORT and get away from the ever growing pile up so he may go to bed it is usually Ian. Congratulations on your station and best of luck on your endeavours with the current project, Ian.

Perhaps, Ian, at a later date may be able to be persuaded to write a technical article on the aspects of the development and findings of his experimentation for Amateur Radio.

#### SV9 CRETE ACTIVITY

Cliff KA2PFV/SV9, was doing very good business running with the help of Franco I1KFB acting as MC. All QSL's via KA2PFV either direct or via the Bureau.

#### PLEASE QSY

DXers have a pretty rough time in chasing the elusive stations that appear from time to time let alone being QRMed by a station appearing out of the "night" and working split in a "Rag Chew".

Oceania stations have a great habit of "splitting" to 28.595, 21.295 and 14.195 MHz and obliterating any DX that may be in the vicinity. Generally one cannot alert them to the problems they are causing because of being unaware of their receive frequency.

With DXpeditions in the offing for this year, that are costing thousands of dollars to get underway, it would be appreciated by DXers worldwide, if the minority could give way to the majority by leaving the prime calling frequencies free.

#### HEARD ISLAND

Dave VK3DHF, the licensee of VK0HI has laid some ground rules for the proposed operation on the island and it would be appreciated if all callers could abide by them.

Initial appearances when propagation conditions permit will be made on the recognised SSB DX working frequencies of 3.690, 7.090, 14.195, 21.295 and 28.595 MHz using transceive operation working through the callers by using the last letter of the suffix as an identifier in alphabetic progression, then split frequency operation to upper and lower nominated listening segments.

Novice and other class licensees not having these frequencies at their disposal will be catered for on 3.620, 21.190 and 28.595 and 14.280MHz and other frequencies initially using the alphabetical progression method of the last letter of the suffix when optimum propagation conditions exist to give the maximum QSO's per hour. CW operation will commence 25kHz inside each band edge, shifting as QRM and operating techniques dictate. BINT SERVICES of Cheltenham Victoria have kindly donated three sets of computerised beam headings for the operators convenience which will further add to the efficiency of the operation.

Dave, as leader of the Radio Component of this DXpedition wishes to accommodate all callers and trusts that common sense and operating ethics are maintained.

Dave and his co-operators, Chuck and Fred's sanity is dependant on your operating technique, patience and station efficiency. Names, QTH and weather conditions are superfluous and may deprive a fellow amateur of that valued contact.

Dave also envisages working controlled Net operation, as time and propagation conditions

allow, which will be a deviation for a more relaxed operation.

All cards to be in correct date, UTC and RS(T) format which will expediate checking and prompt returns.

On behalf of all DXers, Dave, Chuck and Fred thank you for a positive approach and statement on your intentions. Best wishes to all that sail in ANACONDA II for a pleasant, safe and successful trip.

Good DXing ladies and gentlemen and please remember amateur radio is a hobby to be enjoyed by all.

### VK0HI DIRECT QSL INFORMATION

NORTH AMERICA via N2DT

REST OF THE WORLD EXCEPT  
JAPAN via VK6NE

QSL route for Japanese operators to be announced

#### ALEX VK5CCT

Alex, quite well known for his operation from Cocos (Keeling) Islands signing as VK9YA has now been stationed in West Malaysia and has made application for a local call.

Further information that has been passed on by Ian VK5QX is that the beam that Frank VK9NYG has been using will probably be returned to VK for use as a backup for VK0HI and on its return from down south it will be returned and stored for use on VK9 or any other location where it can be used to advantage.

#### PREFIX CHANGE?

Remember the XZ5 and XZ9 duo located in the Kaw Thoo Lei Province which isn't recognised by the Burmese Central Administration? They have now changed their prefix to 1Z0. One cannot help but wonder if this is an Oriental ploy to increase the chances of a reversal of the ARRL's decision on the acceptance of cards for DXCC credits or is it a method to increase the volume of the incoming managers already dwindling mailbag. Whatever is the eventual outcome of any decision on these stations validity one cannot speculate but it can be assured that someone, somewhere, with connections attributable to the new "PREFIX" will be counting the "green stamps" with glee.

#### THANKS

Due to the Holiday season and printing deadlines these notes were prepared in mid November from information received through the courtesy of VK's 1MM, 3PBA, MO, UX, DFD, 5QX, 6IH, HD and Eric L30042. Thanks to one and all.

#### QTH's YOU MAY NEED

4Z4BS PO Box 10191 Tel Aviv, Israel.  
5B4LY PO Box 375, Lamaca, Cyprus.  
OX1F PO Box 160, Quezon City.  
FM7WU PO Box 879, Forte de France, Martinique.  
F08FW PO Box 5006, Tahiti.  
H8APL PO Box 2318, Santo Domingo, Dominican Republic.  
KC4AAA PO Box 500, PPO San Francisco 95603 USA.  
T30BY PO Box 34, Tarawa Atoll, Kiribati.  
YJ8LT Laila Gaetan, PO Box 88, Port Vila, Vanuatu.

#### QSL ROUTES

302RW (ZL1AMO), 4D9RG (DU Bureau), 4N4BT (YU4ALM), 4N4TN (YU4HA), 4U1VIC (OE30LW), 5Y4CS (J11VLV), 5W5EJ (W0WP), 9Y4VU (W3EUV), FK8CE (K2ROR), FM7CF (WB3AKI), HB0AYX (HB9MM), IY4FGM (I4BFY), HZ1MZM (HR1RMG).  
( ) denotes manager.

## Faces Behind the Key and Microphone

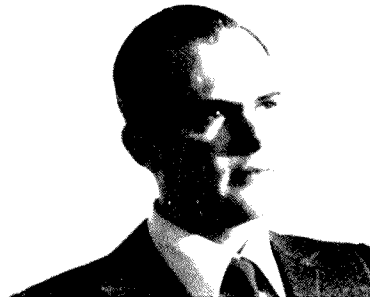

John 18SAT



Sig OE6KDG



Tricia VK6KI



Joe NSAMP and Judy WD5IPH

AR.

# AR SHOWCASE

# WICEN NEWS

Ron Henderson VK1RH  
Federal Wicen Co-ordinator

171 Kingsford Smith Dve, Melba ACT 2615.

## KENWOOD R-2000 COMMUNICATIONS RECEIVER

The R-2000 provides outstanding performance through the use of microprocessor controlled operating functions, allowing maximum flexibility and ease of operation throughout its operating range.

This all mode receiver covers 150 kHz to 30 MHz in thirty bands on SSB, CW, AM and FM.

Key features include stable digital VFO's, ten memories that store frequency, band and mode information, memory scan, programmable band scan, fluorescent tube 100

Hz resolution digital display with dual 24 hour dual clock with timer.

The high performance receiver circuits have three built-in IF filters with narrow-wide selection switch (CW filter optional), all mode built-in squelch circuit, noise blanker.

A large front mounted speaker, RF step attenuator, tone control, AGC switch, SINPO scale "S" meter, lithium battery memory back up and 100-240V AC operation round off this appealing receiver.

Further information may be obtained from Trio-Kenwood or any of their dealers.

## CHECKLISTS

Many issues ago I reprinted a VK1 equipment and kit check list for WICEN operators and suggested it might be an idea to pack it into a couple of cartons, boxes or old suit-cases held ready in the workshop or garage for a callout or exercise. Since that issue I chanced to see a similar list printed in a recent OST, however the US amateur emergency communications co-ordinator concerned had enough gear to fill a one tonne utility. Nevertheless this does serve to demonstrate that equipment checklists are a very personal thing, indeed some people can get by with a sweater, change of jeans, thongs and a plastic money card but any fool can be uncomfortable.

Also from a sister magazine, a recent RSGB Radio Communications RAYNET column discussed amateur communicators' dress. The writer's point was that for emergencies clothing was generally chosen to suit the need weatherwise; but for training exercises in civic aid situations many amateurs left much to be desired appearance wise. The columnist, an active RAYNET co-ordinator had an opportunity to view the voluntary communications for a recent major event from the public's side and concluded that amateurs should dress no worse than their companion emergency service and relief agency communicators for public events.

## ITEMS OF LEAST VALUE

Uncle Roger of Flight magazine recently ran an article calling for readers contributions on "items of least value". The aviators response was "runway behind the aircraft", should WICENs be flat NiCads in the handheld, or microphone home in the shack?

## THE FUTURE FOR WICEN

Next issue I will attempt a review of WICEN and what the future holds; do you have any thoughts on this matter? I would be glad to hear from them so drop me or the editor a line please.

73 Ron VK1RH

AR.



KENWOOD **R-2000**  
COMMUNICATIONS RECEIVER

## NEW EMI/RFI SHIELDING OF ELECTRONIC COMPONENTS

Scientific Electronics, Australian agents for the Sil-Pad range have released details of Sil-Pad Shield, a physically tough, greaseless product which provides excellent shielding characteristics coupled with low thermal resistance and high dielectric strength.

The shield consists of a 1 mil copper sandwich bonded between two layers of calendared 9 mil Sil-Pad. Part of the copper is exposed for the attachment of an earth lead to drain off the unwanted signal.

It can be used to shield any electronic component which could be emitting a frequency or a magnetic field. The copper absorbs radiated emissions that have a frequency of 10 kHz or more at a level of 60dB or higher, which is generally considered excellent. If a lower frequency is a problem thicker copper can be specified.

Components that can utilise the shield include high speed switching transistors, relays, oscillators, DIP packages, chips etc. In a lot of instances, attenuation at component level will

prevent the radiated signal from penetrating and interfering with other components and will also, in some cases, preclude total case shielding.

Shapes currently available are TO-3 and TO-220. Non standard shapes can be produced on request with a lead time of about eight weeks.

For further information contact: Mr Peter Lloyd, Scientific Electronics, 6 Holloway Drive, Bayswater, 3153. Telephone (03) 762 5777.



AR.

## WIA INSERTS INTO AR



### NOTICE TO WIA ZONES, CLUBS AND GROUPS

WIA Zone, Club and other Group Secretaries are hereby notified that inserts into AR henceforward will be accepted **ONLY** direct from a Division and then only by prior arrangement with the Secretary.

All inserts must comply with Postal Regulations and must be received not later than the 26th of the month preceding publication date.

# COMMERCIAL KINKS

Chuckle Corner



## FT290R BATTERY PACK BLOW-UP PREVENTION

by Theo Vidler VK1KV

Having heard of several cases of battery pack blow-ups in Yaesu FT290R two metre rigs I resolved that it would not happen to my FT290R.

The cause of the blow-up is the application of an excessive voltage to the battery pack. This may occur when the rig is operated from an external DC supply if the switch in the external power socket JO5 fails to operate. This may occur due to either improper switch action or improper insertion of the external power lead. The result of this is to supply 13.8 volts to the internal battery pack. With nickel cadmium cells this will cause an excessive charging current leading to rupture of the cells. Ordinary dry cells or alkaline cells will suffer also.

I have therefore fitted a 50 PIV 3 Amp diode between the internal battery pack and the switch contact of JO5 as shown in Figure 1. This arrangement prevents the 13.8 Volts from the external power supply being applied to the battery pack if the spring switch on the Ext DC jack JO5 fails to operate on insertion of the external power supply plug.

The additional diode does not prevent operation on the internal battery. The diode does cause a small voltage drop on the supply voltage from the battery. In my view the protection afforded to the NiCads or alkaline cells is worth more than the small voltage drop.

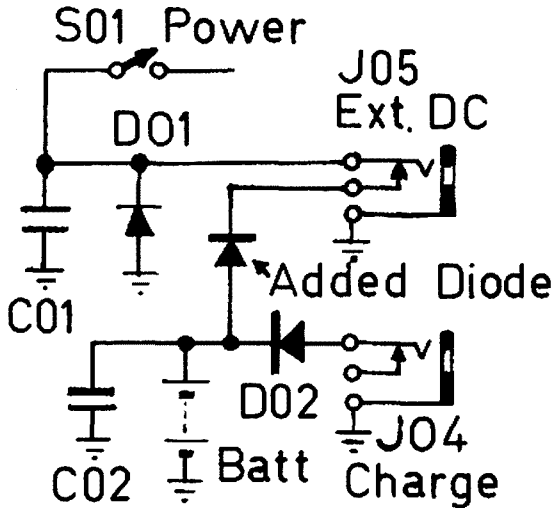

Fig 1: FT290 R External DC Modification.

Fitting of the diode is simple—

1. Remove Cells.
2. Undo 4 Phillips screws.
3. Remove battery carrier.
4. Cut red lead to battery carrier positive terminal.
5. Solder in Diode with cathode looking at P/S Socket.
6. Insulate soldered leads.
7. Replace battery carrier, screws and batteries.

I understand that a diode has been wired into the FT690 and the FT790 to perform this function.

On looking at a Yaesu FT208 hand held circuit it would appear that it might possibly suffer from the same problem and warrant the same protection.

Technical Editor's Note:- Examination of the circuit of an FT690 revealed a protection diode in the negative External DC connection. Whilst this would provide protection normally without the battery voltage drop of Theo's modification it may not work in all situations. Should an external antenna be connected which has the coaxial braid connected to the negative of the 13.8 V External DC source then the protection circuit will be inoperative. This may be reasonably expected to occur if mobile operation in a car, using an antenna fixed to the car, is intended. If such operation is intended then a modification such as that described by Theo VK1KV would be appropriate.

VK3AGI AM.

with Bill VK2EBM

"Speak up OM — you've gone right down"

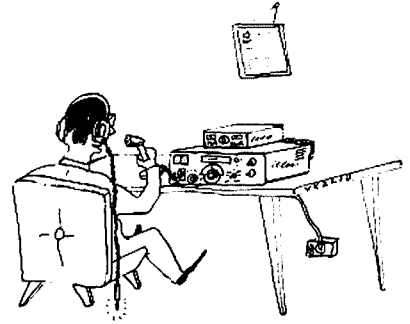

"Here is the IPS report — just handed to me"

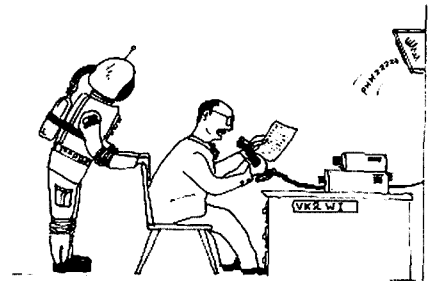

(... That's funny — I can hear the sea ...)



"Yes OM — all solid state ... except the final!"

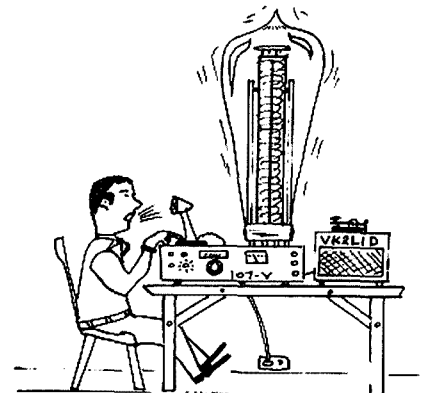

# DXpeditions! Are they worth the trouble?

Hugh Spence VK6FS  
VK6 DX Chasers Club

ANARE photo by G Budd

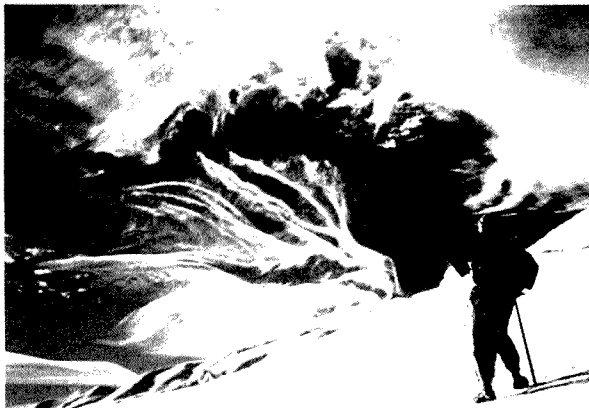

Mounting a DXpedition to one of Australia's Island Territories is not a case of just hopping on a plane or ship with rig under the arm, and upon landing, looking for a likely motel or some other place to set up shop.

For Cocos and Christmas Islands one must have accommodation guaranteed by a resident and a permit from the Administrator of the Island. Heard Island is slightly different in that there is no permanent population (human) so application for permission to land must be made to the Department of Science and Technology in Canberra. After many letters to and fro the application, if found in order, is then sent on to the Antarctic Division, who also consider it, and if found in order, then, and only then, a permit will be issued by the Department of Science and Technology.

This may have seemed straightforward so far, BUT, prior to submitting the application, the Department of Sc & T will have issued a set of guidelines to be observed by people wishing to go to Heard and McDonald Islands. Also a questionnaire to be answered.

Do not get me wrong, I am not knocking the Department. All this is vitally necessary to protect the extremely fragile ecology of the islands. This group of islands is extremely unique in this world in that no foreign animals or plants or diseases have been introduced by weekend trippers, such as has been the case with many of our off-shore holiday resorts.

Guidelines for a permit cover many things, the 12 most important being:

1. Application to be submitted four months prior to departure.
2. Tour is to be adequately equipped for the severe weather and ocean conditions.
3. Tour is to protect the environment.
4. Group must be competent in navigation, landing of personnel and equipment ship to shore, ability to live in antarctic conditions.
5. Tour must be equipped with all necessary safety aids both at sea and ashore, self contained in relation to precautions for emergencies, should not depend on government assistance if it gets into trouble.
6. Tour must provide own shelter.
7. Safety of the tour members is the responsibility of the organisers and the government may require a signed release of responsibility.
8. Organisers should arrange own insurance of personnel and equipment.
9. If Australian Government personnel are on site, there is to be no interference with

them, their work etc, and any buildings used must be left as found.

10. The number of visitors will be limited and tourists must not stay overnight.
11. Expeditions may apply for longer stay.
12. Bona fide scientists may apply to collect limited specimens.

#### INFORMATION REQUIRED INCLUDES:

1. Name of vessel.
  2. Size and description including capability under power.
  3. Number of persons going ashore.
  4. Nationality of visitors.
  5. Cold weather experience of organisers and members.
  6. Purpose of visit — include proposed activity and any temporary buildings that may be erected.
  7. Localities proposed to be visited.
  8. Dates, timetable and duration of visit.
  9. Means of transport ship to shore.
  10. Equipment to be taken ashore including camping, medical, food, clothing and communications.
  11. Ports of departure and return.
  12. Details of radio frequencies and skeds, both at sea and ashore.
  13. Any other questions thought necessary (this last one could develop into a lulu).
- NOTE: Expeditions are subject to the Environment Protection (Impact of Proposals) Act 1974.
14. A full report of activities must be sent to the Department of Sc & T within six months of return.

#### NO NO's:

Don't even think of killing, wounding, molesting, or even scaring penguins, seals, birds, etc, or disturb their living conditions, e.g. don't raid bird nests, don't walk on the grass or pick the daisies, and don't take the family cat, plants, ticks, fleas, diseases, or your own picnic ants, etc.

Don't try and sneak back with eggs, penguins, seals, etc, without permission. No cars, trucks or trail bikes allowed. Always move slowly when approaching bird colonies, but keep away from seals with pups (daddy seals won't like it). No guns or explosives, and no lighting of fires in the open or erection of

permanent holiday shacks. Choppers to keep clear of nesting birds as the rotors scare them. And keep out of restricted areas.

#### WASTE DISPOSAL:

1. Solids such as food scraps, tins, plastic, wire, batteries, etc, must be carted away for disposal at sea outside territorial waters.
2. Definitely no littering. (Didja drop somethin' sport?).
3. Liquids must be macerated and flushed out to sea (or) deposited in deep holes away from fresh water channels, swamps, etc.
4. Pits to be filled in prior to departing.
5. Oil must not be discharged at sea if liable to harm the territory, etc.
6. In the event of hasty departure a list of all alien material left on the island and its exact location must be notified to the Department within two months.
7. Bulk fuel can be carted in metal drums only; definitely no plastic containers or fuel bladders and all empty drums must be removed

In other words, no weekend revellers will be allowed to land. The government does not wish to spend taxpayers' money to pull anyone out of the place. They certainly do not want spray can graffiti painted all over the island.

It may be of interest to know that the submission from the VK0HI Heard Island Expedition 1983, filled 68 foolscap pages. Quite a book.

If anyone still has doubts as to the necessity for any of the above questions and rules I would suggest they read "Sea and Snow" by Philip Temple for a description of the Patanella Expedition and its trials and tribulations. Also "Ice Bird" by David Lewis gives a good description of ocean conditions around latitude 60° south. Also our own Jon Sanders will have a mighty tale to tell after sailing single-handed twice round the world.

Even though I may have seemed to introduce some levity with the rules, it was in no way intended to be derogatory of the department. They are to be commended in their stand to try and preserve this ecologically unsullied island, and its surrounding islands for posterity. Heard Island is unique in that it is one of the world's few remaining wilderness areas.

# LISTENING AROUND



Joe Baker VK2BJX  
Box 2121, Mildura Vic. 3500

## THE FULL STORY OF REG, W6ITH

Some of you may remember my reference some months ago to W6ITH then of Whittier, California, a station that I used often to listen to on 20 metres in pre-war days when I was an SWL in Sydney. Well, that story evoked an immediate response, first from my good friend Alf Ah Gee VK3DBV of Merbein, Victoria, who sent me the QSL card that Reg Tibbetts W6ITH, now of Morgana, California sent to him and which you saw published with my story, then came a letter from W6ITH himself.

This is what Reg wrote:

*"Several Australian amateurs I have talked with recently kindly sent me the page with your column 'Listening Around' from the March issue of Amateur Radio.*

*"Very interesting column and I enjoyed reading same.*

*"Since you mention if 'W6ITH is around today', I thought I would write to you and say hello and that I am still as active as ever and still around even though I was 71 this month (May).*

*"Have been on the air since 1927, first as 6PD (no prefix then) and have had W6ITH since the early 1930s. And to give you a better story I have enclosed a copy of my Professional Biography which will give you some details of my activities over the years. Have been very active on SSB, all bands 160 through 10 metres, and hope I will have the pleasure of talking with you before too long.*

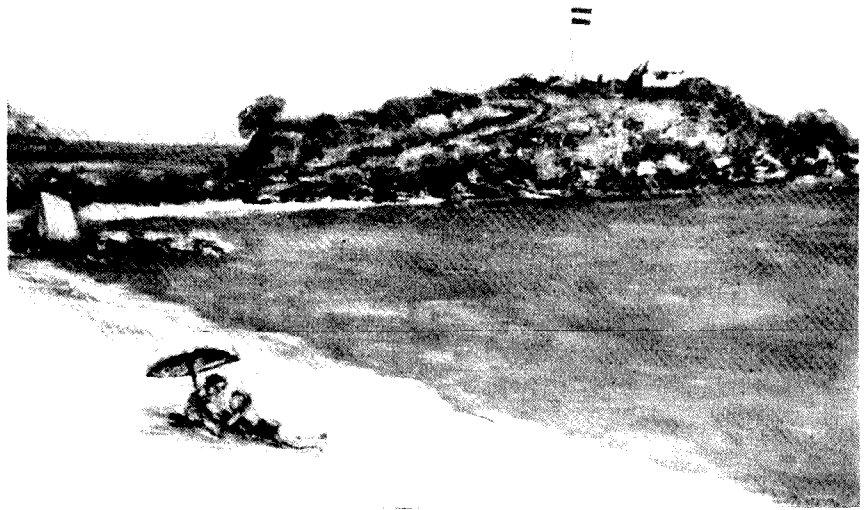

Reg Tibbetts PJ2MC card which features an oil painting by Mrs Louise Tibbetts at Sint-Maarten in 1956

*"Have enclosed my current QSL together with my 1936 QSL card and my card from PJ2MC which I operated 1956-1969 at intervals when I stayed at my home on Saint Martin*

*Island in the West Indies. Also operated FS7RT, VP2MR and VP0RT (Anguilla) when there during these years."*

So ends his letter and here are some of his achievements as mentioned in his Professional Biography.

Reg was born in Berkley California, where he attended various schools including Menlo College, Menlo Park California (and wasn't it Thomas Alva Edison who was called "The Wizard of Menlo Park" for his many inventions?)

Later he attended the University of California where he got his BS in electrical engineering and communications, later became a member of the California Engineering Council, the Circle C Society, the Lambda Chi Alpha Fraternity, and the Theta Kappa Nu Fraternity. (Unfortunately Reg did not explain to me what these societies are all about).

In 1926 he designed and installed the first Pacific Coast Police Radio System at Berkley, and in 1934 invented the portable shortwave radio telephones first used during construction of the San Francisco-Oakland Bay Bridge, a painting of which, painted by his wife, appears on his QSL cards. The use of these radios saved the State of California and bridge contractors over one million dollars in construction costs, and they also laid the foundation for two-way police and industrial radios which are now in widespread use.

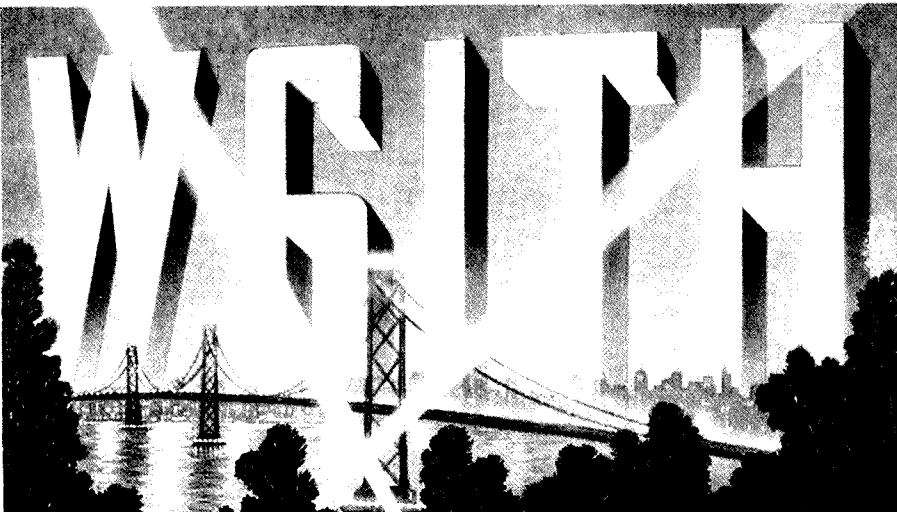

Reg's QSL card 1936 style



Current W6ITH card

Between 1930 and 1979 he was responsible for the design, installation, and operational maintenance of private telephone, signal, radioteletype, and data systems, and between 1966 and 1972 was directly responsible for the design, construction and implementation of multi-million dollar electric power generating facilities, communications, relay and receiving installations in the West Indies, Venezuela and Brazil.

And just to keep him busy in his spare moments when he's not been doing anything else, between 1950 and 1970, he developed—under contract to the Manhattan Project, US Army Corps of Engineers (later to be known as the Atomic Energy Commission) radiation detection instruments used nearly exclusively for the atomic bomb project and postwar atomic tests in the Pacific by the Atomic Energy Commission. Production of these instruments continued until 1966 for use in laboratories and industry for peaceful uses of atomic energy.

Between 1931 and 1966 Reg was chief engineer for United Press International where he was in charge of communication systems, and was responsible for the design, installation and operational maintenance of all worldwide radio communications systems for UPI, including RTTY, radio-photo and audio voice news event circuits. In 1963 he had additional duties as communications consultant to the Chairman of the Board of UPI.

And winding back the years a bit, between 1941 and 1945 he established jointly for UPI, US Dept of the Navy and the US Office of War Information, the intercept receiving station which copied numerous Japanese and Russian radio transmissions and was the prime source of news from enemy Asian territories.

Via the facilities of this intercept station, many news beats were received ahead of all other sources. Among these were the Doolittle bombing of Tokyo, the Japanese capture of Singapore and the East Indies, the shooting down of Admiral Yamamoto and the Japanese offer of surrender as well as the Japanese offer of surrender terms.

Reg Tibbetts, W6ITH was also engineer in charge of the office of War Information for secretly established communication circuits between the Republic of China and the US at San Francisco. From radio transmitters secreted in caves near Chungking, China, hundreds of radiophotos were successfully transmitted and received near San Francisco.

His honora and special achievements include being a registered professional electrical engineer in the State of California, a Life Member, Second Grade of the Institute of Electrical and Electronic Engineers, the author of many technical, and popular radio communications and electronics papers published in English and foreign languages. As a youth he was runner-up in the Thomas A Edison National Intelligence Contest for young men and was selected as being in the "higher than genius" group, for life study by the Stanford University and Dr Lewis I Truman. He was the recipient of the American Institute of Electrical

Engineers National Award for his paper on the San Francisco-Oakland Bay Bridge Construction radio telephone system.

As an amateur radio operator he is licensed with the FCC as Radiotelephone First Class and Amateur Advanced Class with his call W6ITH, and is a charter member of the North-Central Californian DX Club.

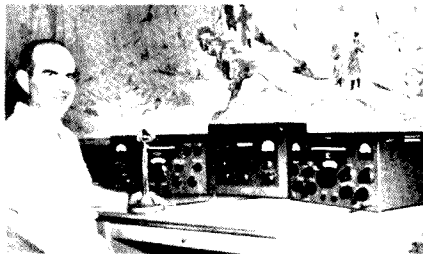

Reg Tibbetts — amateur extraordinaire

They say that Thomas A. Edison was called "The Wizard of Menlo Park." If Edison was the Wizard of Menlo Park in his day, surely, after all his achievements Reginald Tibbetts, aged 71, and amateur radio operator W6ITH, must claim a similar honour today. My thanks to Reg for supplying me with the data on which this article is based, and I do look forward to the day when I have better equipment and can speak with him directly.

I almost forgot to mention that Reg appears to be a keen stamp collector for the envelope which carried his letter to me was almost covered with a variety of United States stamps, many of them publicising the US space activities. So if you decide to write to Reg at 2151 Camino Pablo, Morgana, California 94556, stick as many varieties of Australian stamps as possible on your envelope. I know Reg will be pleased to have them.

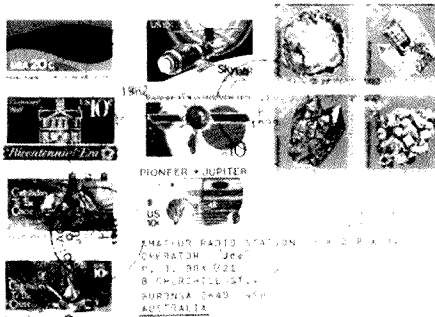

My thanks to those, who by letter or on air continue to say kindly things about this column which are most encouraging for the effort that I put into putting it together. Sometimes I find myself writing this under very difficult conditions, but it is all made worthwhile when I have such excellent feedback from what I write. I must apologise to those of you who will have searched the pre-Christmas issues and found "Listening Around" not there. This is because I missed the deadlines, but not to worry for there will be much more to come.

I'm writing this on the 4th of November so Christmas and New Year will have come and gone by the time you read this. Nevertheless I hope that you all will have a happy time, and that you will come up on "60" (approx. 3.590 MHz) almost any night around midnight so that I can speak to you personally.

73s, Joe VK2BJX  
AR

## COMPETITION WINNERS

The first correct answers drawn at random by Peter, VK3CIF from all entries submitted were winners of the handsome prizes donated by Bail Electronics for the Antenna Competition Quiz (Page 8 October AR).

The first prize a Yaesu RSL435 Collinear Array was won by:

J M Swan, VK2BQS  
PO Box 93,  
Toongabbie, NSW 2146

The second prize, a pair of Yaesu YH77 Headphones were won by:

F Robinson, VK3DDK  
PO Box 173,  
Pahran, Vic. 3181

If either winner does prefer some other article they are entitled to a voucher, redeemable on any purchase from Bail Electronics, which will be to the equal value of the prize.

The Publications Committee extends its sincere thanks to Bail Electronic Services for the donation of the prizes and to the many participants who made the competition possible.

Winners have been notified of their prizes by Mr Stan Roberts, Managing Director of Bail Electronic Services.

The correct answers to the quiz were 1 (d), 2 (c), 3 (a), 4 (b), 5 (b), 6 (b), 7 (c), 8 (a), 9 (d), 10 (b).

## SPECIAL EDUCATION QSP

Brenda VK3KT has available:  
Trial Exam Papers —  
Theory, Novice, AOC, Regulations.  
Past CW Exams from DOC.  
10 Exams at 5 w.p.m.  
10 Exams at 10 w.p.m.  
10 Exams fill a C60 tape. Send a tape and I will copy what you want onto it.  
Complaints — or other comments — about Exam papers?

Make them known to your Federal Education Officer, VK3KT, QTHR, or on the Education Net, Wednesday evenings 12.00 UTC. 3.685 MHz±

## WANTED

Any good technical articles for publication in AR

Please remember your STD code when you advertise in HAMADS.

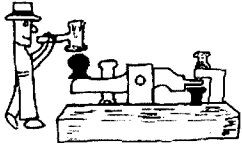

# POUNDING BRASS

Marshall Emm VK5FN  
PO Box 389, GPO Adelaide 5001

## KEYS AND KEYERS (Part I)

To the newcomer to CW operation the variety of available keys and keying equipment must be bewildering indeed. In order to try to make some sense of it all, we'll discuss the gear in three groups — manual, mechanical, and electronic.

Manual keys range from compact heavy-duty models designed for incorporation in military transmitters to flashy works of art on marble bases, costing many dB. A morse key is really nothing but a switch, and you could use any on-off switch as a key. You could make a quite functional key out of scrap timber and junk metal, but before you spend a lot of money on a "good" key it is important that you understand the parameters. The most important factors are ease of operation, and operator comfort.

There seem to be two basic designs in use among the amateur population. Most Australians would be familiar with the "high mound" round-knobbed key of the British pattern. Design follows function, and in this case the structure of the key is determined by the operating style, which has the forearm held above the table.

Americans, on the other hand, key with the forearm resting on the table, so a low-profile, flat-knob key is more appropriate. Why these two widely different styles have developed is beyond me, but it is safe to say that you should use the style which suits you best whether it is British, American, or African.

A problem with manual keys is that they get pounded, and therefore have a tendency to move around on the table. The solutions to this problem are legion. One of many found in "Hints And Kinks for the Radio Amateur" (published by the ARRL and available from the WIA) is to place the key on two pieces of fine-grade sandpaper glued back to back. Of course the only foolproof method is to bolt or screw the key firmly to the table, but for some reason this idea is unattractive to some (and understandably not the way to win the heart or co-operation of the XYL if you have to operate from the dining room table.)

Mechanically, most people seem to prefer a key with a great deal of inertia in the key lever, so a fairly massive bar is preferred. Additional mass is given to many keys by building them onto a heavy metal or even marble base, which helps to keep the thing in one spot as well as contribute to the price.

As far as the engineering of the key is concerned, there isn't a whole lot of variety. Adjustment to spring tension and contact spacing is usually, if not always, provided for, but you should ensure that once set, these adjustments won't move. Contacts should meet squarely or arcing will cause a build-up of dirt. Contacts should be cleaned by drawing a piece of paper between them; **THEY SHOULD NEVER BE FILED.** If there is an apparent need to file them, something else is grossly wrong.

Most of the keys readily available to the amateur are of good quality, and it is just a matter of finding the one that "feels right." The cheap and nasty keys that come with practice oscillators should be avoided like the plague, or you will develop bad keying habits in order to compensate for a bad key.

The best advice for the prospective purchaser of a key is to try several varieties so you can determine the type that suits you best — before spending a lot of money on the "lifetime" key with contacts of gold.

Next month we'll talk about mechanical keys and electronic keyers. Till then, 73 and keep pounding.

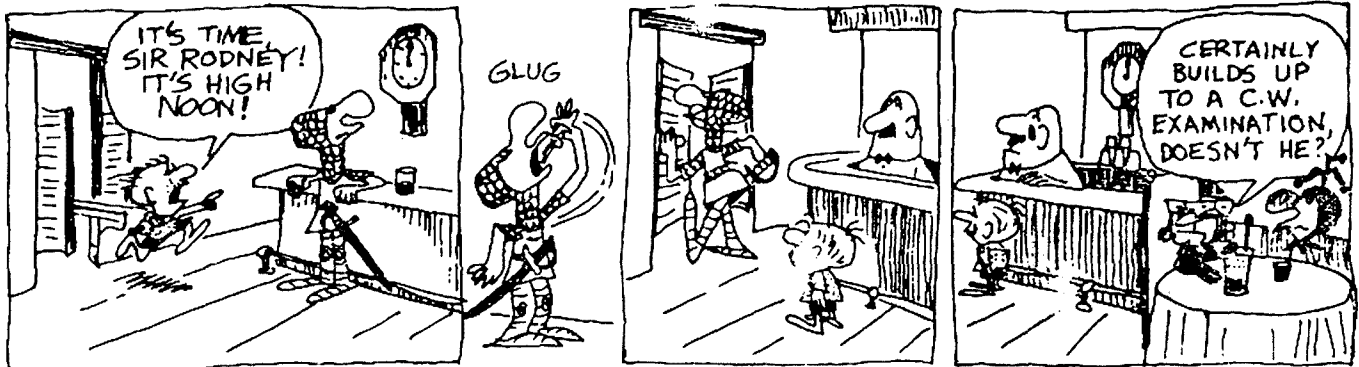

from "Propagator"



# INTRUDER WATCH



# BOOK REVIEW

Gil Sones VK3AU

Moore Street, Box Hill South, Vic. 3128.

## How to Buy and Convert Surplus Electronic Equipment

By Mark S. Starin.

A very comprehensive book with full circuits, alignment and conversion details for a number of USA surplus items. The equipment covered is from the Korean War up to the Vietnam War. Such equipment may well be found locally due to the Australian involvement in both wars.

The equipment covered includes two commercial items found in the USA.

Detailed information is presented for the following items:

RF Communications Co-Pilot Transceiver; AN/TRC-77, AN/PRC-6, RT70-GRC, RT-66, RT-67 and RT-68 Transceivers; AN/GRC-9 and AN/FRR-36 Receivers; and The Motorola Handie-Talkie.

If you have any of these items of surplus gear and are looking for information then this book will provide you with all the details you need.

Published by TAB Books Inc.

AR.

Bill Martin, VK2EBM,  
FEDERAL INTRUDER WATCH CO-ORDINATOR

33 Somerville Rd., Hornsby Heights,  
NSW, 2077.

Whilst preparing the Intruder Watch column this month, I was reminded of a few lines from Samuel Coleridge-Taylor's "Rhyme of the Ancient Mariner", which, slightly altered, becomes applicable to the intruder-plagued radio amateur.

"Intruders here, Intruders there,  
Intruders all around,

They pulse and growl and roar and howl,  
AND WE DON'T MAKE A SOUND".

"We", of course, being the long-suffering radio amateur, who SHOULD BE making sounds.

To keep on with the task of trying to rid the amateur bands of intruder stations, we must indeed make sounds; and we can do this via the convenience of the Intruder Watch, whose function is to make the sounds on your behalf. The Intruder Watch collates the sounds of fed-up amateurs whose QSOs are continually being interfered with by intruder stations.

Transfer the sounds of your indignation to paper. Put down the facts of the intruder's transgression, and send the details to your Divisional Intruder Watch Co-ordinator. Your objections to intruders are solicited, and you, AND ONLY YOU, can supply the Intruder Watch with the ammunition it needs to fire broadsides at the persons responsible for the intrusions. Reporting intruders is not an arduous task. Merely jot down the details of the offender's transmission, and send in the report. The more, the better.

As I've said so often before, intruders are not at all impressed by the odd complaint from some irate amateur. But great numbers of complaints are an entirely different thing. This is why we must have many people combining forces against a common enemy. Without the help of the listening amateur, the Intruder Watch would be, "As idle as a painted ship upon a painted Ocean" as the Ancient Mariner

tells us. If we have no reports, we have no effective Intruder Watch . . . if we have no effective Intruder Watch, we must then see an increase in the numbers of intruders on the amateur bands. WE DON'T NEED THIS.

Make the effort to send in reports of any intruders you hear on the bands. There are plenty from which to choose.

We're still looking for reports on the Russian Merchant Navy station, "UMS", which transmits daily on 21,032 MHz, using RTTY and CW. Come on you CW buffs, help us to get rid of him, and get more room for amateur operation. Let HIM find somewhere else to operate. It is, after all, OUR frequency.

Don't forget, if you send me a blank C60 cassette tape, I will return it to you with examples of all the modes of emission to be found on the amateur bands, some of them forbidden to amateur operators, and explanations of modes.

Send any reports to your Divisional Intruder Watch Co-ordinator. You can find his address in Amateur Radio, October, 1982. HELP TO KEEP THE AMATEUR BANDS FOR AMATEURS.

AR

## WHAT THEY SAY AND WHAT THEY MEAN

(Another one of those things)

YOU HAVE MY SUPPORT: "You do it, and I'll take credit."  
IT'S IN THE PROCESS: "We forgot about it until now."  
I HAVE A CONFLICT: "My wife won't let me go."  
IT FITS MY SCHEDULE: "She's visiting her sister."  
AN EDUCATIONAL INNOVATION: "Anything we didn't do last year."  
A PROJECT: "Any activity requiring more than ten minutes."  
A PROGRAM: "A project requiring more than one phone call."  
IT'S BEING CO-ORDINATED: "His secretary eats lunch with mine."  
A RELIABLE SOURCE: "I just met this man."  
AN INFORMED SOURCE: "The guy who told the man I just met."

AR

## ISN'T IT STRANGE?

(An Oldie)

When the English tongue we speak  
Why is break not rhymed with freak?  
Then tell me why it's true  
We say sew and likewise few.  
And the writer of poetic verse  
Cannot rhyme his horse with worse?  
Beard sounds not the same as heard,  
And cord is different than word.  
Cow is cow but low is low;  
Shoe never rhymes with foe  
Think of goose and then of choose;  
Also comb and tomb and bomb;  
Doll and roll and home and some.  
And since pay is rhymed with say,  
Why not paid with said, I pray?  
We have blood with food and good  
Mould is not pronounced like could.  
Is there any reason then, that we  
Have sounds and letters disagree?

AR

## ELECTRONIC HOBBYIST!

DO YOU LIVE IN . . .

Ringwood, Lilydale,  
Boronia, Wantirna,  
Bayswater,  
Mooroolbark etc? . . .

We carry a comprehensive range of electronic components at very keen prices.

Ian J. TRUSCOTT  
ELECTRONICS  
CNR EASTFIELD  
& BAYSWATER ROADS,  
SOUTH CROYDON,  
VIC.  
TELEPHONE  
(03) 723 3860

This month we have permission from Mr Dick Levine, Editor of Electronics News, to reprint an article written by Peter W. Grant, published in the May 1982 issue, pages 30 and 31.

The article titled "Quietening switching power supplies" should prove extremely interesting to all interested in EMC.

# NATIONAL EMC ADVISORY SERVICE

Tony Tregale VK3QQ  
Federal EMC Co-ordinator

38 Wattle Drive, Watsonia 3087

## Quietening switching power supplies

*By adjusting impedances of internal and external noise loops and using EMC approaches, noise reduction is possible.*

By Peter W. Grant, IBM Corp.

When designing power supplies requiring lightweight and small physical size, the transistor switching regulator (TSR) is an increasingly popular approach.

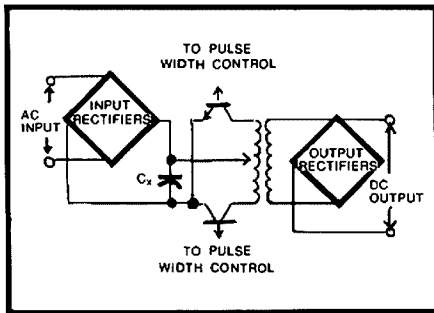

Figure 1. A fundamental transistor switching regulator circuit. AC power is rectified, stored in bulk. Capacitor  $C_x$  and then switched across the transformer primary winding by the transistors.

In such a design, prime power entering the TSR (Fig. 1) is rectified, stored in the bulk capacitor  $C$  and then switched by transistors across the transformer primary winding. Several hundred volts (at high currents) are switched at kilohertz rates, creating both audible and electronic noise. This unwanted electronic noise often spills into adjoining circuitry causing severe interference problems.

The reason why noise is generated in a TSR lies in the method of voltage regulation. The high degree of regulation obtained is achieved by adjusting the switched current's pulse width instead of the former method of quiet, dissipative series regulator circuits. But switching high voltages and currents creates electronic noise.

The usual "brute force" shielded-enclosure method of containing electrical noise consists

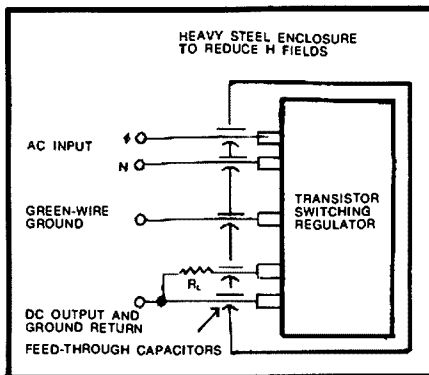

Figure 2. Brute force shielding of transistor switching regulator is a common method of containing the regulator's electrical noise. It consists of totally surrounding the noise source with a metal shield to reduce E and H fields, and requires the use of feed through capacitors on all wires entering or leaving the enclosure, thus adding greatly to the cost of the regulator's design.

of totally surrounding the noise source with a metal shield (Fig. 2). E (electrical) and H (magnetic) field radiation is reduced but feed-through capacitors must be used on all wires entering or leaving the enclosure, thus increasing the shield's cost. The capacitors can also put prime power voltages on the shield if it is not securely grounded.

There are other methods by which noise in a TSR can be controlled. These include lowering the impedance of internal circuit noise loops, increasing the impedance of external circuit noise loops and other electromagnetic-compatible (EMC) circuit approaches.

### NOISE SOURCE

The main source of noise in the TSR is the sudden charging and discharging of the parasitic capacitances of the transformer

winding, the transistor-to-heat-sink space, and the wiring by the basic TSR action of switching high currents and voltages.

The charging source is the bulk capacitor; so with the capacitor, transformer, transistors, and wiring making a complete circuit (small loop) there seems little reason for charging current to enter the outside world. However, the impedances of this small loop are irregular and some components have grounded heat sinks or cases through which current is dissipated to the entire TSR (larger loop) and thus to the outside world.

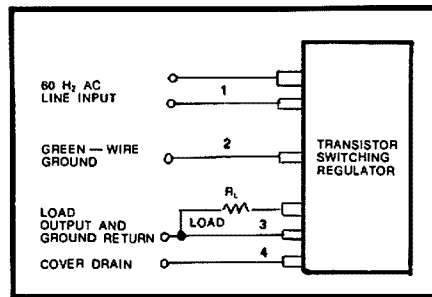

Figure 3. Noise from a transistor switching regulator leaves or re-enters the regulator's case by four ports; (1) prime power entry, (2) green-wire ground, (3) remote load grounding, and (4) the capacitive coupling drain-wire.

Noise from the TSR that could interfere with an associated system must leave and re-enter by four ports in the TSR's case. Referring to Fig. 3, they are (1) prime power entry, (2) green-wire ground, (3) remote load grounding, and (4) the capacitive coupled drain wire. This fourth and last port consists of the path of noise as it radiates to the case (spacecharge).

In reducing noise from the TSR, an understanding of the terms "differential mode" and "common mode" is required.

Differential mode (DM) refers to a system of conductors, usually a pair, having a signal contained in their voltage difference. In a simple single-ended DM system, the return line and the transmission line form a differential pair which contains the total signal. Also, the sum of conductors carrying current in one direction and the sum for the opposite direction could be called a DM pair.

In most cases, if the return current is divided among elements of a common return, the signal line and one element of the common return would not make a DM pair. The grounding or common return elements would constitute a common mode (CM) system, referred to as a system of conductors where a signal is common to two or more conductors.

If currents going past an observation point on the transmission line have their direction in common, they are common mode. If their directions are different, they are differential mode. That is, for differential mode the currents must be equal and exactly opposite in phase. For common mode the currents must be evenly divided among the impedances of the various conductors and exactly in phase.

The small charging circuit (small loop) in the TSR becomes part of a common-mode circuit when the current in the circuit finds a common-mode return. This return is found via the transformer secondary, out through the DC bus, through logic ground, to prime-power ground, and back through prime-power wires through the rectifiers to the bulk capacitor, and also via radiated paths. These paths can be traced with a current probe and scope; ie, a particular spike can be seen leaving by the power line and returning by the ground wire.

#### DESIGN CONSIDERATIONS

It would be ideal to design the small loop in the TSR so that the generated noise could be contained in the loop. However, since parasitic capacitance exists and energy escapes through transistor cases, heat sinks, etc., current is transmitted to the larger loop, which consists of the entire TSR. It would be difficult, if not impossible, to design the small loop in such a manner that no energy would be converted to a common mode and allowed to escape. But, the larger loop (entire TSR) can be "noise-shorted" so that the noise mainly circulates inside the TSR, without allowing ripple current and without seriously shunting any external series regulator.

If small spikes of ground current remain, they can be reduced in amplitude and frequency by winding the AC wires and green-wire ground around ferrite cores (common-mode impedances). Six turns of the twisted-pair AC wires around an X-30 ferrite core will reduce the spikes by a factor of 10.

The core has to be used with twisted-pair wires since each wire carries large amounts of prime current that would saturate the core, making it useless. Since the sum of AC currents in the twisted pair is zero, the core only sees common-mode noise.

Both wires of a pair (each of the AC wires or the positive and negative wires of a DC output) are sufficiently high-frequency coupled so only one wire of a pair is needed for noise shorting, as previously described. Since a large capacitor to AC neutral is used, another capacitor to the phase wire is, in effect, only parallel to the neutral one.

Noise energy that leaves the TSR by capacitive coupling must return by another port. A five sided metal box enclosing the TSR would simulate capacitive coupling. Such a box simulates a machine's frame and the fourth TSR port. Noise is capacitively coupled to this box and must be dealt with.

The ungrounded box supplies a nice gaussian shield, but safety requires grounding it. Grounding the box to the frame allows an increase in high-frequency energy to circulate

and the impedance of the loop outside the TSR can be increased to further reduce currents outside the TSR.

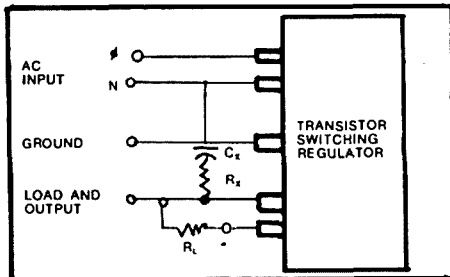

Figure 4. Noise can be "shorted" in a transistor switching regulator by placing a high-frequency capacitor  $C_x$  between the AC neutral and output. A series resistor  $R_x$  is added to dampen tank-circuit oscillations.

As a start, a high-frequency capacitor is placed across the bulk capacitor  $C$  as close to the transformer and transistor as possible. Adding a large high-frequency capacitor between the DC output and AC input (Fig. 4) reduces externally circulating ground currents significantly. A series resistor is added to dampen oscillation, since the capacitor is part of a large tank circuit whose inductances are created by wiring and magnetics.

For safety, capacitors should be run to green-wire ground from all of the input and output wires. Shorting one side of the DC output directly to the green-wire ground is an effective way of keeping the noise from the external world, except that return-leg series regulators should not be shorted with this wiring scheme.

The optimum noise correction system (Fig. 5) meets external circuit requirements and shunts a large amount of external noise current. A large, UL-approved, high-frequency capacitor and series resistor is placed between the AC neutral wire and green-wire ground.

Since a large capacitor from ground to AC neutral is used, another capacitor to the phase wire is, in effect, only paralleled to the neutral one. Also, since both wires of a pair are sufficiently high-frequency coupled, only one wire of a pair is needed for noise shorting.

The loop is closed to the DC output with a resistor that damps the oscillation through the

system ground back through the DC output. Grounding the box to TSR ground and system ground by-passes the high green-wire ground impedance and raises the noise level considerably.

#### DIODE NOISE

Another source of noise common to most power supplies is diode reverse-recovery noise. Because diode current does not shut off exactly as the diode voltage crosses zero, it takes a little reverse current to clear out the carriers. Depending on the types of diodes used, this reverse-recovery current comes in different amounts and different turn-off speeds result when the carriers are cleared.

Fast-recovery diodes do not allow the reverse current to reach very large levels and soft-recovery diodes shut off slowly at the end of recovery. Hard-recovery diodes shut off very rapidly, creating a current step function that causes adjacent circuitry to ring. So the choice is for both fast- and soft-recovery diodes.

Finally, circuit analysis of electric noise paths and currents can never be total or complete since the impedance of noise paths are extremely complex. The engineer must rely strongly on past experience, developing a "feel" for impedances of open wires and interframe capacitances.

AR

#### ELECTROMAGNETIC COMPATIBILITY

EMC is the present term covering a wide range of undesirable elements of electronics including interference to radio reception, computer errors caused by noise and some of the effects of lightning.

EMI, electro-magnetic interference, is part of EMC. This term covers radiated noise and is usually measured in terms of volts per metre of ampere-turns per metre. If the noise is broad-band, it is measured in complex terms such as  $\text{dB}/\mu\text{V}/\text{m}/\text{MHz}$  (decibels above one microvolt per metre per megahertz).

RFI, radio frequency interference, is the outdated term for EMI.

PLT, power line transients, is one kind of conducted noise generally caused by switching inductive loads and is measured on the power line.

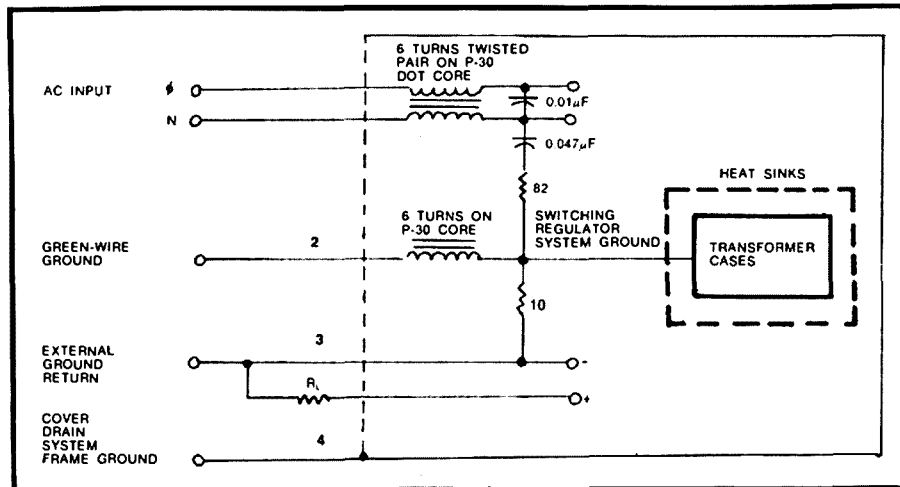

Figure 5. This optimum noise-correction system meets external circuit requirements and can shunt a large amount of noise current from external circuitry. The ferrite cores add even more protection by increasing noise path impedances.

# AWARDS

Mike Bazley VK6HD  
FEDERAL AWARDS MANAGER

8 James Road, Kalamunda, 6076

## DXCC News

HK0, Serrana Bank, HK0, Baja Neuvo and 8Z4, Neutral Zone have been deleted from the ARRL Countries List. The total number of current countries now stands at 315.

## DXCC LISTS AND NETS

In an earlier issue of this column, I reported on the proposal of WB4ZNH to have the ARRL DXCC Rules altered so as to make list operations unethical. The September issue of QST (pages 44 & 45) details the pros and cons of DX lists.

Whatever you may think of lists and nets you cannot get away from the fact that they exist and look as if they are here to stay. It seems to this writer that basically the controversy centres around one point and that is the definition of QSO. The supporter of lists believe the important part of a QSO is the report (usually his call sign has been passed to the DX station by the net control). The chaser of DX, through the "pile up", has to get his call copied by the DX station (he knows his report is going to be 5 & 9!!)

On marginal QSOs I would suggest it is harder for a call sign to be copied than a report. Further, as the report does not really matter for DXCC (any report is accepted, 1 & 1 or 5 & 0, as long as a two way exchange takes place), why is it considered so important?

The foregoing may suggest that I am against lists and nets. Nothing could be further from the truth. My concern is, that in a particular area of amateur achievement, DXCC awards, we have a division of opinion and unfortunately this division is getting wider.

A possible solution to the problem could be that "check ins" to nets are given a number by net control. When all "check ins" have been completed the net control announces the DX on frequency and then invites stations by number to make their call. This procedure means that a net station has to get his call and the report across plus receiving the DX station's report. This could result in a stronger QSO than that made via a DX "pile up". Further the advantages of DX net working are still retained: the low power or poor equipment station will still be able to compete with the big guns.

## DXCC AGAIN

It is interesting to note how emotive people are in any discussion of the DXCC Award programme. Since I last penned a few words on "why count rocks or buildings as countries", I have had quite a mail bag.

Opinions have ranged from, "Let's scrap DXCC altogether" to "we should tell the ARRL how to run a proper DXCC programme". Strong stuff this, but we should at least try to get some of these problems in their true perspective. The ARRL is perfectly entitled to lay down whatever conditions they wish for their DXCC, it is their award. The fact that they allow overseas stations to participate in their award programme is a plus for us.

At present our DXCC award policy is that we try to follow the ARRL DXCC guidelines as closely as possible. If we VKs do not like some of their country definitions and rules we have several solutions available to us. We can opt out altogether; accept their rules; start our own DXCC award with our rules or keep DXCC and have an alternative DX award.



## SARG AWARD

SOUTH AUSTRALIAN RADIO TELETYPE GROUP

*Sample*

Granted to ..... who has  
fulfilled the necessary conditions to earn this radioteletype award.

Award Classification .....

Certificate Number ..... Date .....

Signed .....

## SOUTH AUSTRALIAN RADIOTELETYPE GROUP (SARG) AWARD

### RULES:

- GENERAL AWARD** — Overseas and Interstate operators need to work ten different SARG members using 2 way RTTY. VK5 stations need to work fifteen instead of ten as mentioned above.
- CROSS MODE AWARD** — Available only to those whose licence does not permit RTTY transmissions. Such must copy in RTTY and transmit on SSB or CW. The number of stations required etc. is the same as for the General Award.
- VHF/UHF AWARD** — Operators must work ten different stations using 2 way VHF/UHF RTTY and not less than three of these must be SARG members and all qualifying contacts must be more than 50kms distant.

In addition to the above, from time to time, Special Awards will sometimes be issued for certain special occasions.

Applications for these awards are to be sent to the Group's official address enclosing a payment sufficient to cover printing and postage costs. Further details can be obtained from Bruce VK5XI QTHR.

## FIVE BAND WAP

As part of NZART activities for WCY 1983, a Five Band WAP will be made available.

REQUIRED: QSO 30 eligible Pacific Countries (as count for Oceania for WAC). each on five

different bands making a total of 150.

**ACTION:** Send list of log extracts (QSLs not required to be held) to NZART Awards Manager, 152 Lytton Road, Gisborne, New Zealand with \$6.

**REWARD:** Wooden Shield surmounted with NZART badge and appropriately inscribed.

\*\* Extra postage if airmail required overseas. \$3.

## AWARDS ISSUED

Awards issued and amendments received up to 6th November 1982 are listed below.

### WAVKCA AWARD

CALLSIGN	CERT. NO.	CALLSIGN	CERT. NO.
K1KTB	1054	JA1KAW	1074
I4BAC	1055	JH4OOF	1075
VK6DE	1056	UB5WBG	1076
JF1VST	1057	UA9CBO	1077
JH4UVU	1058	UAOCBW	1078
JA1PUK	1059	UQ2MU	1079
G3LDI	1060	UK90AW	1080
W18WS	1061	UK3SAB	1081
JA9NLS	1062	UW9V0	1082
N4AH	1063	UAOCDT	1083
JH1KRC	1064	UK3R	1084
JF3GKE	1065	UA0AG	1085
E11DH	1066	UW3U0	1086
JA6CM	1067	UI8ADQ	1087
JG1NNC	1068	UA0L FK	1088
P29NSF	1069	UK1NAO	1089
JF2PZH	1070	KA1JC	1090
JA2JRG	1071	VK2NHV	1091
JA1WPX	1072		
Y37XJ	1073		

### HAVKCA (SWL) AWARD

CERT. NO.	CALLSIGN
64	L50013 Richard Cybul
65	UA3-142-1256
66	UA3-168-74

### WAS (VHF) AWARD

CERT. NO.	CALLSIGN	CERT. NO.	CALLSIGN
147	VK4SH	150	JAGLLA
148	JF11RW	151	JH1VHS
149	JG3FEV		

### DXCC NEW MEMBERS

PHONE CALLSIGN	CERT. NO.	TALLY
VK6YF	296	121
VK7AN	297	122/121
VK3NAJ	298	101/100
VK3KHI	299	100
VK3PGT	300	100
VK5FF	301	110
VK2VBL	302	176
OPEN		
VK3NNH	210	106
VK3VGD	211	216/217

### DXCC AMENDMENTS

PHONE CALLSIGN	TALLY	CALLSIGN	TALLY
VK2AHH	278/301	VK4AK	301/310
VK2DPN	225	VK4BG	274/284
VK3BRM	269/270	VK6HO	305/314
VK3DU	282/284	VK6LK	310/324
VK3GB	229/247	VK9NYG	142
VK3VGD	216/217		

CW			
VK5ARA	126	VK6HD	268/279

OPEN			
VK2AHH	285/311	VK4BG	281/294
VK4AK	301/311	VK5ARA	217

AN



### AUSTRALIAN LADIES AMATEUR ASSOCIATION

# ALARA

Margaret Loft VK3DML

28 Lawrence Street, Castlemaine, Vic. 3450

A very happy New Year to you all, may all your hopes and dreams for the year ahead be realised.

Nice to meet so many YLs at the Ballarat Convention, Mavis VK3KS; Brenda VK3KT, Brenda VK3QT; Vicki VK3??, Dale VK3PEH, Maggie VK3NQQ, Joan VK3NLO. The weather was a bit miserable but the hospitality more than compensated. So thanks to all the organisers for a very enjoyable weekend. Dale, hope you enjoyed the contents of the competition.

Well our second contest is over and as you read this I hope to be "knee deep" in logs; thank you all for participating and hope you enjoyed it. Full details in March of contest results.

Remember the ALARA net is at 0930 UTC until 6 March, on 3.570 ± MHz.

As promised a list of ALARA members with their date of joining.

Until next month 7/3/88 to all.

Margaret VK3DML

### ALARA MEMBERS

VK1NEJ	21-2-82	WE	29-10-76	WP	31-1-79	P29NSF	2-10-80
VK2AHD	10-11-80	VAN	20-2-81	YF	3-7-78		
OIX	22-7-81	VBK	17-3-79	YL	15-9-76	NWN	23-3-81
DJO	20-8-75	VON	2-3-80	JW	21-12-78	NYL	26-4-79
DLT	22-7-80	YL	5-4-76			OK	23-9-78
DOG	20-3-82			VK7HD	29-12-77		
DVL	11-8-79	VK4ABM	14-7-79	JM	23-1-81	ZS5DC	1-6-80
HD	22-10-76	ACJ	22-7-80			6GH	1-6-78
KDX	14-7-79	AOE	10-10-80	VK9NL	1-6-80		
MI	5-11-76	AWE	17-9-79			K11JV	23-3-81
MR	4-11-76	BSQ	22-3-82	ZL1AJL	18-8-76	K6INK	9-6-79
NKN	6-8-81	NAM	21-5-76	ALE	12-12-79	K8BRT	2-10-80
NQI	14-7-79	NDG	12-1-81	ALK	1-11-81	KF7F	1-6-78
NYL	9-3-81	NNJ	21-8-79	BOZ	18-3-77	N5CFP	1-10-80
NZW	9-3-81	AWL	2-3-80	BOR	11-5-80	W2GLB/5	1-10-79
PAW	1-10-80			OC	1- -79	W3RXL	1-11-78
PLG	15-1-81	VK4NME	5-9-82			W3CQQ	1-11-78
SW	26-7-80	NXX	12-6-81	ZL2AZY	11-1-81	W4KJE	1-10-80
KJV	25-1-80	VAX	6-1-81	BAO	1-11-81	WA1WVJ	10-12-79
VLV	17-9-79	VDJ	1-10-80	OY	24-4-76	WA3HWP	6-10-81
YOK	20-3-82	VIT	28-2-82	THW	1976	WA4SRO	17-10-79
		VKT	7-10-81			WADWOF	24-4-81
		ZN		DF2SL	1-9-79	WB2YBA	1-6-78
VK3AGO	6-5-79	PZ	9-3-81	DT1TE	1-9-79	WB3CQN	20-3-78
AYL	1976	ATK	1-9-82	DJ9EK	1-11-81	WB7QQM/	
AZW	9-8-76			DK5TT	1-11-81	KQ7Y	1-10-80
BBJ	9-6-79	VK5ANW	21-4-76			KA7CRO	2-3-82
BIR	23-8-75	BJH	30-3-80	G3HCQ	20-5-81	WBOSXN	14-7-79
BJB	2-8-76	LM	4-4-76	G4EYL	28-3-81		
BRE	1-9-76	NKM	1-9-78	G4KVR	1-11-81		
BTU	1-9-77	NBV	5-6-79	G4EZI	29-9-78	VE6AUP	1-10-80
DML	8-6-77	ZN		G4KFP		7BIP	1-10-79
DMS	24-10-77	OO	12-2-81			CBK	28-10-78
DVT	24-10-81	YJ	14-7-79	GM4KMQ	12-8-81	CIX	28-5-78
DYL	20-4-81	YL	20-4-76	GM4LWS	20-12-80	DKC	6-78
HQ	3-10-76	YW	23-7-76			3HGA	27-8-78
KS	22-8-75	NNW	30-7-76				
NLO	19-10-81			JH1WWS/3	1-9-82	XY10V	30-1-82
NMM	11-11-76	VK6KYL	2-3-79	JH3XWY/2	9-3-81		
NDO	19-2-79	NYL	2-3-80			5Z4CM	20-2-82
PCI	2-3-82	QM	21-6-80	PA3ADR	12-6-81		
				PAOHIL	12-6-81		AR

## The Tenth Anniversary

## NORTH QUEENSLAND CONVENTION

will be hosted by the  
Townsville Amateur Radio Club  
at Townsville,  
24/25 September, 1983.

Come and join us in the  
birthday celebrations.

Further details from:  
TARC, P.O. Box 964,  
Townsville, Q. 4810.

### MENTION

*you saw it in AR*

### WHEN YOU BUY

*from*

### ADVERTISERS

## THE RADIOCOMMUNICATIONS BILL

Recent Government sources indicate that the BILL will not now be introduced into Parliament until the Davidson Report has been fully considered.

The Davidson Report, which is the comments and recommendations of the Davidson Committee who have been reviewing the operations of Telecom, is open for a three month comment period.

AR.



# VHF UHF - an expanding world

**Eric Jamieson VK5LP**

1 Quinns Rd, Forrester, SA  
5233.

## AMATEUR BAND BEACONS

Freq.	Call Sign	Location
50.005	H44HIR	Honiara
50.008	JA21GY	Mie
50.098	KH6EQJ	Pearl Harbour
51.022	ZL1UHF	Auckland
52.013	P29SIX	New Guinea
52.100	VK0AP	Macquarie Island*
52.150	VK5KK	Artherton
52.200	VK8VF	Darwin
52.250	ZL2VHP	Palmerston North
52.300	VK6RTV	Perth
52.320	VK6RTT	Carnarvon
52.330	VK3RGG	Geelong
52.350	VK6RTU	Kalgoorlie
52.370	VK7RST	Hobart
52.400	VK7RNT	Launceston
52.420	VK2W1	Sydney
52.425	VK2RGB	Gunnedah
52.435	VK3RMV	Hamilton
52.440	VK4RTL	Townsville
52.500	VK2BNT	Newcastle *
52.510	ZL2MHF	Mt. Climie
53.000	VK5VF	Mt. Lofty
144.400	VK4RTT	Mt. Mowbrallan
144.420	VK2W1	Sydney
144.430	VK3RTG	No advice of site
144.465	VK6RTW	Albany <sup>3</sup>
144.475	VK1RTA	Canberra
144.480	VK8VF	Darwin
144.550	VK5RSE	Mt. Gambier
144.600	VK6RTT	Carnarvon
144.800	VK5VF	Mt. Lofty
144.900	VK7RTX	Ulsterstone
145.000	VK6RTV	Perth
147.400	VK2RCW	Sydney
432.410	VK6RTT	Carnarvon
432.440	VK4RBB	Brisbane
432.450	VK3RMR	Mt. Buninyong

Regarding the Albany beacons, Karl VK6XW has written to say the 2 metre beacon has been somewhat spasmodic in operation recently, but is generally on and operating from his QTH in Albany with 10 watts to a 6 element yagi pointing east. The 432 MHz beacon is not yet running, but the one on 6 metres is going.

Karl and others in Albany confirm the VK5VF beacon on 144.800 MHz is actually 4 kHz high in frequency and outside the range of some monitor receivers. Checking this, I find 3.7 kHz high, so until we can get the frequency correct listeners should note this difference.

## WESTERN AUSTRALIA

Practically all the news this time comes from the West — is that where everything is happening? Graham VK6RO in Bunbury sends a copy of the Japan "CQ ham radio" containing a list of stations still working that country. All stations are either in the west or VK4, and include VK6OX, VK6ZDY, VK6ZLN, VK6KOJ, VK4RO, VK4AVV, VK4KDB, VK4ZYZ, VK4LE, VK8GB, plus the beacons VK4RTL, VK6RTT, VK8VF and P29SIX. Besides that, the JA's are still collecting a few exotic calls, like HL1QY, VS6EL, KG6JDX, KC6SZ, DU1MRC and YB1BZ!

Graham also enclosed a snippet from R A Ham in Sussex, England, who advised "the authorities have given the OK for UK amateurs to use 6 metres outside of TV hours; no good for DX, but a step in the right direction." It's certainly a start, but whilst it may be outside regular DX hours, 6 metres is so unpredictable it may still be that from time to time some useful contacts will result providing the operators are there!

Peter, VK6ZDY has also written from Gooseberry Hill (is that an elevated site?) to say most 6 metre openings are occurring north of Perth, with the MUF hovering just below 50 MHz much of the time, and allowing the JA stations to continue with their contacts to many other areas. Also, from his observations in the 49 to 50 MHz area, there are at least 3 UA TV transmitters, one from Vladivostok, one central UA, and one western UA on a bearing of 310°, which usually comes in late afternoon. The signals on 49.750 can reach tremendous strength for long periods of time, at others propagation is much like ionospheric scatter and meteor pings hovering on the noise level. Times are from 2330 UTC through to 1430 UTC at night.

The following has been heard or worked from Gooseberry Hill: 21/9: 0829 UTC weak JA on 50 MHz, 49.750 very strong 27/9: UA TV strong; 17/10: 0325 UTC JA on 50, JA to ZL. Then at 0333 UTC JG1, JR1, JE3, JR0, JR7 all on 50 MHz to 0611 UTC. JA's worked FY7, VS6, plus VK4, 5 and 6 on 52 MHz. Peter reported signals were weak at first then S9 + on 50 MHz, with a JA dogpile on 50.101 working VS6, 18/10: 0404 UTC JA on 50.0430 UTC JA to VK2 and 4 19/10: 0441 UTC JA on 50 again, JA9, JA1. Dogpile trying to work DU1WEN! JA on 50 right through to 0715 UTC. At 2230 - 2330 UTC JA working to Europe (ZB2) via long path, also open to South America same time to LU, T32AB etc.

20/10: 2400 UTC weak UA TV. 24/10: 0430 UTC weak JA's on 50 MHz; 29/10: 0900 UTC eastern UA TV S9. 30 and 31/10: weak UA TV 0125 UTC; at 0916 UTC western UA TV 5x7 bearing 310°. VK6WD and VK6HK heard TV carrier 5x3 on 48.250 (possibly Europe, BBC?); 1/11: 2338 UTC first CH0 from Wagga since last Christmas. 3/11: 1214 UTC UA TV strong, JA on 50. 1225 UTC JA1 and 2. 1256 UTC TV from Europe on 48.250, no modulation. JA's same morning working into South America, also KD6, KG6, ZL, and advised eastern Australia worked into USA (Strange we have to hear that news from the Japanese, never locally it seems . . . 5LP). Peter says nothing heard from Pacific area so far.

4/11: 2354 UTC JA1 and 2 on 50. 2400 UTC large JA dogpile working South America again. 0458 UTC JR3SQZ said CX and LU worked by them. Band open all day around 49 and 50 MHz with much strong UA TV, again on 5/11 and 6/11!

Peter is still looking for answers to his requests for skeds on meteor scatter and scatter on 6 metres, he's waiting to hear from the multitudes! Peter also says we have a bit of thinking to do should we get 50 to 50.150 (1) What should be the calling frequency, 50.050, 50.100, 50.110, 52.050 or what? In the US the

DX calling frequency is 50.110, with local and Es calling frequency 50.200. (2) During November, December Es period do we all crowd down to 50 MHz with resultant TVI in Channel 0 areas? Food for thought. Thanks for writing Peter.

On point 2 above, there seems little reason for a mad race by everyone to go down to 50 MHz for Es contacts. It would seem a pity to crowd out any possible 50 MHz contacts by everyone being there with S9+ signals, it is unlikely we would work Pacific and other areas DX with any certainty during Es periods, most of this has been done during the equinox periods, although there have been exceptions.

Not every 6 metre operator is set up to work long distance weak stations, one would generally hope that Es would continue on 52 MHz (or else we might lose this portion of the band anyway) and monitoring be done on 50 MHz so that should signals appear there they could be worked. Thus it seems sensible to consider 50.050 as a DX call frequency and 52.050 as at the moment for VK contacts, with the changing of the band switch to go from one band to the other without retuning. On the other hand, you might consider that W stations are not permitted phone below 50.100, that area being reserved for CW and other call areas. So there will need to be some thinking in regard to a band plan for any such changed circumstances. HOW ABOUT A BIT OF FEED-BACK ON YOUR IDEAS PLEASE?

## FROM CAIRNS

John VK4TL has written to say that JA paging beacons between 146.760 and 146.810 were heard on 27/9/82. They started coming in at 2051 at S1, with VK4KT in Townsville hearing them S4. They were also heard on 26/9 by VK4AFC and VK4AVV, and again on 28/9.

John also advises VK4AFC has had a two-way SSB contact on 1296.1 MHz with VK4KT, and on 31/10 VK4AFC, VK4TL and VK4RR had a QSO with Tom VK2DDG on 147 MHz SSB! That's a long haul from Cairns to Byron Bay. 144.1 was tried without success, this frequency being too low for propagation at the time. Good work chaps!

## FROM SOUTH AUSTRALIA

Not a lot to report other than the few usual JA openings, both on 50 and 52 MHz. However, a fairly stationary high in the Great Australian Bight did produce some interesting conditions on the late afternoon and night of 9/11, between Adelaide and Albany. Contacts resulted on 144 and 432 MHz with signals up to 5x9. Those involved included VK6KJ, VK6BE, VK6WG, VK6XY, from Albany, and VK6BQ from Denmark. At this end were VK5ZRO, VK5ZDR, VK5AIM, VK5RO, VK5LP, VK5ZTS, VK5ZUC — there were probably others but I cannot always hear them when they have their beams side on while pointing at VK6. We were also pleased to have a contact with Mal VK5KMW at Ceduna on 144.100 SSB. This is not an easy path, and I personally was most happy to have a contact from behind my big hill! Attempts were also made to contact Mai on 52.060 — some of us could hear him but he couldn't hear us, so it was pretty much a cross-



# RADIOCOMMUNICATION LICENSING CERTIFICATE

OP58  
Introduced  
Aug 1987

Name and Address of Licensee

Mr. J. J. Shaw,  
1 Milton Street,  
Mt. Pleasant, Vic 3135

In pursuance of section 5 of the Wireless Telegraphy Act 1905, the person or organization named herein as licensee is hereby licensed to establish and operate a radiocommunication station(s) or vessel(s) of the class or classes indicated in the Schedule below in accordance with the conditions specified therein and the provisions of the Wireless Telegraphy Regulations as are in force from time to time.

Renewal is not and cannot be automatic due to changing community demands on the radio frequency spectrum. Every effort will be made to give adequate notice of non-renewal or changes in licensing conditions. In any event, the Commonwealth accepts no liability for costs due to non-renewal or changes of licence conditions.

Issued by Authority of the Minister for Communications

Date of Issue

*H. Mellor*  
C. M. J.  
SCHEDULE

11-10-83

License Number	Date	Station Identification	Location or Area of Operation	Frequency(s)	Emission	Maximum Power (Watts) Transmitter EIRP	Stations with which communication is authorized
1,20468	6-10-83	VKDH1	Heard Island	As outlined for use by Amateur Operator's Certificate of Proficiency holders in the current Amateur Operator's Handbook			Amateur Stations

Special Conditions

**IMPORTANT** - The licensee must obtain prior approval for the transfer of any station to another person or location(s), change in operating frequency or other departure from the conditions of the licence.

An official receipt in respect of the payment made, in accordance with the Radiocommunication Licence Fees Act 1982, for the subsequent renewal of each licence must be held with this certificate.

band affair. Incidentally, in a recent listing of 432 operators I did omit Steve VK4AIM who is very keen.

### VK0HI ON SIX

Due to the forethought and dedication of a small group of VHF operators every endeavour has been made to allow VK0HI to be heard on six metres. This Australian territory, will if conditions favour the group, become a first for many operators.

Original planning and allocation of loaned equipment for VK0HI had to be rehashed due to the opportunity of putting Peter, VK0AP on Macquarie Island with adequate equipment for six metre transmissions.

Another keyer had to be manufactured, this was done by Gil VK3AUI and his merry band of helpers which included Kevin VK3AUI, Lionel

VK3NM and Ken VK3GJ.

Dave VK3DHF, the leader of the Radio Expedition and licensee of VK0HI volunteered to take his TS660 and the keyer was subsequently tailored to suit. A LUNAR amplifier has been kindly lent to assist the cause by Gil, VK3AUI, for the period of the expedition. The "listening and talking" part was taken care of, the next step an antenna. WERNER WULF VK3BWW, had no hesitation in agreeing to custom manufacture a five element yagi to loan the group when approached. Now all is needed is the luck and propagation to allow Dave to start filling the log with some VHF contacts.

Operating habits of the keyer are as follows: CQ call followed by Rx 6, followed by a listening period — the keyer then sends another CQ followed by Rx 10 and a listening break.

During the listening break, the keyer listens

on either the six metre or the ten metre liaison frequency.

**FREQUENCIES:**

*Six metres 52.008 MHz*

*Ten metres 28.885 MHz*

Good luck to all VHF operators in their quest for this new one.

As it is only two weeks since the last notes were sent in there isn't as much as usual to tell. However, I hope Christmas and New Year went off well for all of you, and those wanting new transceivers found them in their Christmas stockings. Closing with the thought for the month: "Time has no diversions to mark its passage; there is never a thunderstorm to announce the beginning of a new year. It is only we mortals who ring bells and fire off pistols." 73. The Voice in the Hills.

AM

## EDUCATION NOTES

**Brenda Edmonds VK3KT  
FEDERAL EDUCATION OFFICER**

56 Baden Powell Drive, Frankston Vic 3199



World Communication Year is being publicised elsewhere, but I would like to add a few comments for those who feel they are not likely to be affected or involved.

It has been said many times that for people whose hobby is communication, we are generally very bad communicators. We are very ready to criticise or complain among ourselves, but not so keen to make an effort to get a message across clearly in the right direction.

How many times have you tried to explain some technical point, and ended up floundering or leaving the listener more confused than ever?

Many of us are at times called on to try to explain amateur radio to a non-technical au-

dience. Here is a chance to do something for the hobby, for other amateurs, and incidentally for World Communication.

Although most people are generally less ignorant about radio than they were a few years ago, there are still many people to whom it is no more than a mysterious black box that makes noises.

Here are a few of the questions I have been asked by staff as well as students, during the time I have been running a school station.

*Why do you need an antenna?*

*Why can't you listen to the police on it?*

*Why is it so noisy (static)?*

*Why do you have to have a licence to use it?*

*How is it different from CB?*

*Can you call up my Auntie in Bendigo (London, Brussels)?*

*Why can't we understand what they're saying? (tuning off a sideband signal)*

*Will — (the one we talked to last time) be there again today?*

*How many channels has it got?*

Unless we meet these questions, occasionally, we tend to forget that many people do not know the answers. If you can produce spontaneous, clear, simple answers to questions such as these, you may be able to claim credit for introducing new enthusiasts to our ranks.

Talking of questions — I hope to have a new Trial AOCF Theory exam ready early in January for those planning to sit in February. Let me know if I can help you in any way.

73 Brenda VK3KT

AM

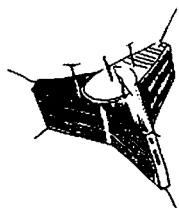

# AMSAT AUSTRALIA

Chas. Robinson VK3ACR

338 Dorset Road, Boronia 3155

## CO-ORDINATOR

Chas. Robinson VK3ACR

## CORRESPONDENCE

VK2RX, VK3YQX, VK5HI, VK5AGR, VK7PF

## INFORMATION NETS

AMSAT AUSTRALIA

Control: VK3ACR

1000UTC Sunday on 7.064 MHz

AMSAT PACIFIC

Control: JA1ANG

1100UTC Sunday, 14.305 MHz

AMSAT SW PACIFIC

Control: W6CG

2200UTC, Saturday 28.880 MHz

## ACKNOWLEDGEMENTS

ASR (AMSAT Report)

## STATUS OF SATELLITES

**OSCAR 7** — There have been reports that this satellite is still buoyant. From time to time AMSAT state that they have received quite a number of reports from amateurs that this satellite has been heard, but confirming these reports is difficult. However, while these reports continue to come in reference orbits will be given on the NETS.

**OSCAR 8** — Is performing normally, the battery count is stable and the base plate temperature is well in tolerance.

**UOSAT 9** — Is back to normal after the six months rest, and credit must be given to STANFORD RESEARCH INSTITUTE for their terrific effort in commanding on the on-board receivers.

**RS Series** — These satellites are very stable and this could be due to their high altitude, having less earth gravity pull than those orbiting at a much lower level.

The **KEPLERIAN ELEMENTS** for the above satellites are read each Sunday night on the **AMSAT AUSTRALIAN NET** for those amateurs who prefer to calculate their own reference orbits or are interested in the variations of parameters.

As this is the beginning of another year, I thought it an opportunity to summarize the happenings of 1982.

In this last year we have had the good news and the bad, but when looking back we see many interesting phenomena. In the beginning of the year we heard of the very successful multiple launch of the Soviet's six RS satellites, RS 3 & 4 which transmit telemetry only, RS 5 & 7 with their unique robot and codestore capabilities and RS 6 & 8 with transponders.

At this time we also had UOSAT 9, an English satellite made possible by the University of Surrey, and although not having communication facilities, proved to be a very highly scientific and experimental satellite that is capable of transmitting telemetry on ASCII at a

number of Baud rates, RTTY, CW, Synthesized voice, Data Beacon and Engineering Beacon as well as micro computers, Magnetometer and also including a CCD Camera.

On March 5th OSCAR 8 had its fourth birthday and the way that it is performing one would feel that this bird has quite a lot of life left. We hope so anyway, as Mode 'J' is still a challenge to the dedicated satellite operators.

In April 1982 it was a shock to find that UOSAT 9 was not performing as it should. Telemetry was missing and in place was a single tone. We later learned that both the 2m and 70cm beacons had accidentally been commanded on. This error de-sensed both command receivers so that they could not be ground controlled. On the 20th September 1982, the Stanford Research Institute (SRI) accomplished a dramatic success, and after six months restored UOSAT 9 back to normal by the use of their 150 ft dish, a lot of man hours and perseverance and 12 megawatts of ERP.

May 17th 1982, an amateur Soviet satellite ISKRA 2 was manually expelled from the airlock of the manned Russian space mission SALYUT 7. This satellite, although a short lived one, never fulfilled its primary objective of providing a 21 to 29 MHz linear transponder. However, the beacon of ISKRA 2 signing RKO 2 was prominent in the 10m band throughout its short life. It fell from orbit on the 9th July 1982 just north-west of the Canary Islands. The main feature of this satellite was the unique method of its launch.

One of the unfortunate happenings of the year was the failure of the L5 the fifth launch of the ARIANE Rocket which occurred on the 10th September 1982. You may remember LO3 was the fated rocket that plunged into the sea with Phase IIIA aboard. This means that out of the five ARIANE launches two have been unsuccessful. It has now been confirmed by the European Space Agency that Phase IIIB, our next satellite to be launched, has been re-scheduled from L7 to L6, which is expected to take place late April this year 1983.

Also at this stage it may be interesting to note that Phase IIIC is 80 per cent complete, and according to reports there is a possibility of a launch in approximately two years that AMSAT has been watching for some time.

AMSAT has submitted a proposal to the US Airforce for a high altitude launch for Phase IIIB. AMSAT are waiting a response.

## TELEMETRY REPORTS HEALTHY UOSAT

Stations around the world got back to the fun of watching UOSAT as the amateur scientific satellite renewed its promise of new vistas in amateur science and education. Sending its "medical chart" via its 2 metre telemetry beacon, UO-9 appeared in good health. Programme Manager at Surrey, Dr. Martin Sweeting, G3YJO, said last week that all of the parameters appeared favorable with the possible exception of the radiation experiment EHT

voltage (channel 13) which had been a bit lower than had been expected. The plan is to run the UO-9 for a few days with the CCD imaging memory on to detect any possible effects of radiation exposure as has been predicted for the long term. Damage from various radiation sources is a major source of concern in the design of satellites. Phase IIIB, for example, will be subject to doses of radiation in the van Allen belts which would be lethal to a human many times over. The UOSAT is expected to not be exposed to heavy radiation exposure except for an occasional solar outburst when particle influx over the poles increases dramatically. The memories aboard UOSAT are generally thought to be the most susceptible to radiation damage so they provide a relative index to the general health of the entire spacecraft.

Soon the stabilization regime will recommence from where it left off abruptly last April. Earlier it had been reported that the gravity gradient boom had been partially deployed last April but current telemetry indicates that the tip mass has not been uncaged (telemetry status point 29 = 0) yet. It is not clear if the 2.5 kg tip mass can be recaged or if earlier reports were in error. Nevertheless plans are proceeding on all fronts to make maximum use of the year to two years remaining in the useful life of UOSAT-OSCAR 9.

In related developments AMSAT UK Secretary Ron Broadbent, G3AAJ, appearing on the Radio Netherlands radio broadcast "Media Network", indicates that he expects UOSAT to exercise the balance of its on-board experiments soon. Although the CCD camera has been on briefly and has revealed a very rough image on its first shot, this experiment is the one which seems to have the widest general appeal despite its dubious scientific merit. On the other hand, the HF beacons (7.05, 14.002, 21.002 and 29.510 MHz) have notable amateur scientific appeal while failing to stir the imagination of most hard-boiled, show-me, amateurs. With UO-9 back on track and prospects brighter than ever for a meaningful regime of experiments, G3AAJ and crew are expected to once again trot out the CCD camera demodulator and display boards for use by amateurs. Placed between one's VHF or UHF receiver and one's commercial TV appliance, we are told these clever little devices will display the UO-9 CCD imagery when it is activated. The CCD camera can be activated after the stabilization is complete. Also, once the boom is fully deployed the HF beacons can be activated since they use the 50 foot (16 metre) structure as a linear antenna.

John Beanland, G3BVU/W3 and Ian Ashley, ZL1A0X both report that UOSAT forms the theme of the August/September issue of the British engineering "Journal of the Institute of Electrical and Radio Engineers (IERE)". Papers by the experimenters including G3YJO, LUHBG/W3 et al appear.



# SPOTLIGHT

## ON

## SWLING

Robin Harwood VK7RH

5 Helen St, Launceston, Tas. 7250

### WCY

This year of 1983 has been designated by the United Nations as the International Year of Communications, called World Communications Year (WCY). Previously, we have seen Years of the Tree, the Child, and the Disabled Person. There will be special events held to celebrate this, throughout the world during the twelve months. I am sure that further details will be included in "AR" over the next few months. I know that several international broadcasters are planning special competitions in conjunction with WCY '83.

Well, what will happen as far as listening goes in 1983? It is hard normally to predict what will happen, as far as propagation goes, from day to day. Yet various trends point to an increased usage of the HF spectrum, despite many services opting for satellite and tropospheric scatter techniques, yet other users quickly utilise any vacant channels on HF. Many also have SW frequencies as a back-up, for satellites have been known to fail. Many developing nations still prefer HF communications, as it is economically more feasible to their budgets.

### OTHR

We will continue to be plagued by interference from "Over The Horizon" Radar Systems on shortwave. As you are possibly aware, recently the United States commenced operating a 1,380 kW sender in Maine, to watch the North Atlantic. This FM/ICW sender is reportedly programmed to operate between 5 and 25 MHz, and on vacant frequencies (at least they are in America!). I believe that a second site on the American West Coast is contemplated for the Northern Pacific, as well as increasing the beam width on the existing site. With the USSR currently operating systems similar to this, from various sites within the Soviet Union, QRM from OTHR transmissions are bound to increase. Fortunately, they do have limitations as far as a radar system goes, but certainly have proved to be an effective disruption to telecommunications services.

### DIGITAL MODES

There will be a swing towards the employment of digital modes of transmissions, now the

technology and software are available. These enhance security and privacy factors, with times of occupancy per channel being measured in milliseconds, and will not be easily detectable on a normal receiver. Unfortunately, digital emissions are subject to dropouts, which can affect messages and their meanings, alleviated somewhat by repetition of the copy.

### SOCIETY TODAY

Amateur Radio seems to be fragmenting further into little groups, such as DXers, technicians, computers, RTTY, novices and Old Timers, each drifting apart to their interests. We have to realise that we have one thing in common, a hobby and a friendship, as well as an organisation that can adequately represent their needs and aspirations with the appropriate authorities. As Society becomes more technology-oriented, so the complexity of problems arise from the abuse and use of it, which can cause difficulties for the individual wishing to pursue his recreational pursuits.

Recently the Tasmanian Division of the WIA launched a voluntary levy from amongst its members, to cover any contingency that might conceivably arise from the problems to amateurs from today's complex living standards. A veritable increase in electronic wizardry and gadgetry in the home has meant a host of problems to the amateur who wishes to utilise his transmitter. In many cases, expensive legal litigation can accrue from consumers'/neighbours' use of mass produced equipment, which in many instances is of inferior standard to that of the amateur equipment. This has happened in America. As well, a plethora of local building codes make it difficult to erect towers and/or masts in urban areas. Hence, there is a need for such a contingency fund to cover these situations likely to be faced by amateurs TODAY. I do not know if other divisions are contemplating Contingency Funds, yet I would urge the members to support them, for it is probable that more of these problems will surface during 1983. Elsewhere in this journal, you will find details of the Federal EMC Coordinator — Tony Tregale, VK3QQ, who has compiled an extensive background of AFI/RFI from transmission sources.

### REJUVENATION

Recently, I resurrected an old Philips Model 2262 Receiver (circa 1939) from oblivion, hidden in the corner of my shack. With a friend's assistance, all old components were replaced, and dust removed. We were surprised by the performance of this forty year old receiver, especially its sensitivity and audio dynamic range, compared to today's sophisticated solid-state models. Its performance on MW was better than the Yaesu FRG-7 I mainly use. Of course the older receiver does have some drawbacks, primarily poor selectivity, but this is to be expected, as the spectrum is far more crowded than forty years ago. Neither does it have a Beat Frequency Oscillator (BFO). Yet, with the addition of a 'Q' Multiplier stage, it would become a very good receiver.

### RABBITS!!

On a recent "Waveguide" programme on the BBC World Service, the announcer referred to the problems of rabbits at the Daventry Site. It seems that Brer Rabbit has taken a fancy to gnawing at the plastic covering on the transmission cables! As the Daventry site covers quite an extensive area, just adjoining the M1 Motorway, the little bunnies have plenty of space to hop around and live. So be warned, keep your cables away from bunnies or any other creature, eager to gnaw away at the covering.

Incidentally if you are interested in listening to "Waveguide" from the BBC World Service, it can be heard at 0915 UTC Mondays on either 15.070, 21.550 or 25.650 MHz. Clayton Howard, the popular compere of HCJB's "DX Partyline" programme, has returned to Ecuador, after a twelve month sojourn in the States, and can be heard again with his session. It can be heard on Mondays and Saturdays at 0930 UTC on either 6.130, 9.745 or 11.925 MHz. As well, the European release at 2130 UTC can often be heard at 21.477.5 MHz.

Well, that is all for this month. I hope that I will be able to bring further developments from the World of Shortwave during the coming months. So until then, the best of 73's and good Dxing Robin.

AR.



# QSP

## STRIKE GOLD — BY CALLING ALL SCOTTISH DISTRICTS

The Scottish Tourist Board is to encourage radio amateurs throughout the world to make contact with Scotland in a new scheme which was launched in Edinburgh on 25 November, 1982.

Under the scheme, entitled "WORKED ALL SCOTTISH DISTRICTS", certificates will be awarded to overseas radio amateurs who confirm two-way communications with amateurs located in Scottish districts. In addition, a special plaque will be awarded to the first station in each country and in each USA and Canada call area to qualify for having worked all fifty six Scottish districts. The award is open to all licensed amateurs.

Alan Devereaux, GM8VJV, Chairman of the Scottish Tourist Board, which is sponsoring the scheme, said in

Edinburgh today, "We'd like to establish Scotland as a radio mecca for the half million radio amateurs throughout the world, and our new scheme will result in many thousands of contacts and enquiries from radio enthusiasts who want to visit Scotland."

Application forms and record books are obtainable from Mr A. G. Anderson, GM3BCL, West Balfour House, Durris, Banchory, Kincardineshire AB3 3BJ, Scotland, who will deal with all correspondence in connection with the scheme.

The award is in three classes:  
Gold for all districts; Silver for forty five districts; Bronze for thirty districts.

Endorsements are available for all bands, single band and all mobile.

OSL cards must be in possession of applicants and applications certified by two general class licensees.

AR.

## JAs ON 20

A group of approximately five hundred Japanese operators who work facsimile regularly on Saturdays and Sundays on 14.245 MHz at 0000 UTC are looking for VK stations who would like to work JA on facsimile.

All seeking information about facsimile and the JA group should contact JA2IGS.

# All men are equal in eyes of radio enthusiast

Christine Salins  
Townsville Daily Bulletin



Len VK4GD was recently awarded Life Membership of the Townsville Amateur Radio Club.

Phot by Townsville Daily Bulletin

It is almost 60 years since Len Dodds put his first radio together and he's been tinkering with amateur radio ever since.

Mr Dodds, 74, says he believes that one of the greatest attractions of amateur radio is the brotherhood it has created.

"You can talk to people all over the world, and it doesn't matter what sort of work you do, you've got something in common," he said.

"People using amateur radio in every country speak English—it's a universal language."

Mr Dodds recently spoke to a woman in Brussels. He has also made contact with people in Europe, Britain, America, South Africa and Japan.

"We talk about the equipment we're using, and about ourselves. After we've had a contact, we confirm it by sending what we call a QSL card."

Mr Dodds has a stack of cards from all over the world, confirming contacts and friendships struck up over the airwaves.

He was recently awarded a life membership of the Townsville Amateur Radio Club. He was delighted at the honour bestowed upon him.

"I'm very appreciative — they don't throw that around," he said.

Mr Dodds doesn't go to the club's meetings much any more, but he feels a close associa-

tion with it, having been involved with it since it was founded.

"In fact, I started the club with two other friends.

"It was about 12 months after World War II and we had a room in the Queensland Insurance Building just opposite the old Burns Philp building.

"We rented the room for 10 bob a week until no one would put their money in and we had to get out. After that, we just used to go wherever we could."

Mr Dodds made his first receiver in 1923 after reading about radios in a magazine.

"It was only a crystal set but I went on from there. There weren't many books about radio then, but I learnt a bit more when I joined the Navy and went through signal school to become an operator," he said.

"In 1927, I was on a destroyer in Sydney and I took out an amateur radio licence there. In those days it was called an experimental licence and it cost me one pound."

Mr Dodds stayed with the Navy until 1938, making himself a portable set to carry on the ship.

He and his wife, Elsie, moved to Townsville during the war, when Mr Dodds joined the RAAF as an operator mechanic.

He had to cease his amateur radio activities during the war years — the only time he has ever been off the air since he started.

"Amateur radio was closed down during the war years. The PMG had to check to see if people had dismantled their equipment.

"It was then taken into the PMG and locked away. We got our licences back after the war."

Mr Dodds was discharged from the RAAF in November 1945, and joined the PMG not long after. He retired in 1973 and has since had a heart attack and lost the lower part of his left leg.

But nothing will stop him from doing what he loves most.

"Today I've got three sets and a monitor scope to check the output of my transmitter. I still mess around with the equipment — I can still see well and my hands are pretty steady, but things are a lot smaller these days," Mr Dodds said.

"The trouble with building things now is finding things to build them with. The Japanese have got the market these days. You can just walk into a shop and buy what you want.

"I enjoyed making my equipment myself. It's a greater achievement to speak to someone in America or somewhere, when you've put it together yourself."

Apart from reading Mr Dodds spends the best part of his days making contact over the airwaves.

"It's a good hobby which you can be involved in regardless of the weather," he said.

"It can be expensive but, if you do the work yourself, it doesn't have to cost much.

"It's my being. It's what I live for really."

Reprinted from Townsville Daily Bulletin 23 August 1982

*In order to fill out the Amateur Radio details of Len's long and varied career, I should state that Len received his first "experimental" licence in 1927 as OA2LD in Sydney. This was changed to VK2LD when the new Australian "VK" prefix was introduced in 1929.*

*His first Tx was a tuned plate / tuned grid circuit utilising a UV202 valve.*

*Len had to stop all Amateur activities during his RAAF service during World War II. When the war ended, Len settled in Townsville, and requested a Queensland callsign. He was allotted VK4GD, the call which he has retained to this day.*

Peter VK4PV

ALL

The old fashioned man who had a good head for figures now has a grandson who has an eye for them.

★ ★ ★

In the good old days a boy would give his girl his class ring and they were going steady. Nowadays he lets her use his hair curlers.

ARNS Bulletin Sept 1982



# VK4 WIA NOTES

**Budd Pounsett**

33 Lasseter Street, Kedron 4031

*Scenes from the 1982 Gold Coast Hamfest and VK4 State Convention held at Broadbeach on 6th November 1982.*



Geoff Adcock, VK4AG, receives an ARRL Handbook from Ken Ayres, VK4KD, for winning the VHF Fox Hunt.

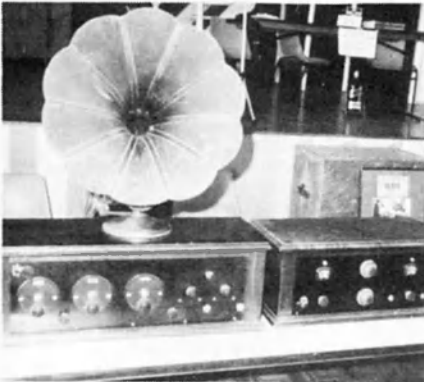

The Historical Display attracted a lot of interest.



One of the stalls that got well picked over was the Brisbane Amateur Radio Club's Disposals Stall.



Not everyone knew the way to the Convention Centre, so VK4WIG, the Gold Coast Amateur Radio Society Club Station was on hand for directions.

Photos courtesy Bud VK40Y



The Games Station Banner displayed behind the Kenwood Trade Display.

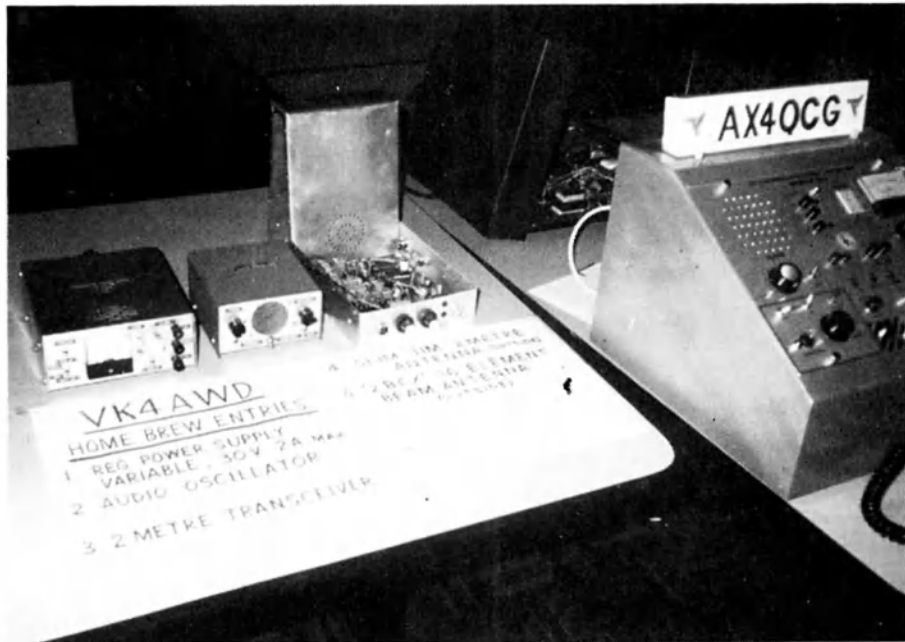

Entries in the Home Brew Competition. On the right is the interface unit designed and built by Geoff Adcock, VK4AG for use at the Commonwealth Games Station.



# CONTESTS



**Reg Dwyer VK1BR**  
**FEDERAL CONTEST MANAGER**

P.O. Box 236 Jamison ACT 2614

## CONTEST CALENDAR FOR JANUARY 1983

9 End of Ross Hull VHF  
8-9 73' 40 and 80 metre Test  
15 World Communication Year contest  
15-16 73' 160 metre Phone  
29-30 White Rose SWL Test  
29-30 French CW Test (not official)  
28-30 CO WW 160 metre CW

## FEBRUARY

5-6 French 40 metre Phone (not official)  
12-13 John Moyle National Field Day  
(Contest Champ)  
12-13 NZART National Field Day  
12-13 QCWA CW QSO Party  
12-13 Dutch PACC Test  
12-13 YL/OM Phone Test  
19-20 ARRL CW DX Test  
19-20 YL ISSB Phone Party  
26 73' RTTY Test  
25-27 CQ WW 160 metre Phone  
26-27 YL/OM CW Test  
26-27 RSGB 7 MHz Phone (not official)

## MARCH

5-6 ARRL DX Phone Test  
12-13 OCWA Phone QSO Party  
12-13 YL ISSB CW QSO Party  
26-27 CQ WW WPX SSB Test

## CONTEST RULES FOR JOHN MOYLE, WHITE ROSE SWL, NZART FIELD DAY

### JOHN MOYLE NATIONAL FIELD DAY CONTEST

CONTEST PERIOD From 0300 UTC 12 Feb 83 to 0500 UTC 13 Feb 83

OBJECT: To encourage portable operation on all bands by radio amateurs in VK and P2.

CALL AREAS Shall be defined as:-

(a) Within one's call area, VK2 to VK2, VK4 to VK4 etc.

(b) Outside one's call area, VK2 to VK4, VK6 to ZL etc.

### RULES

- In each division there are ten sections.
  - Portable field station, transmitting phone, solo operator.
  - Portable field station, transmitting CW, solo operator.
  - Portable field station, transmitting open, solo operator.
  - Portable field station, transmitting phone, multi operator.
  - Portable field station, transmitting open, multi operator.
  - Portable field station, transmitting HF open, solo operator.
  - Portable field station, transmitting HF open, multi operator.

(h) Portable field or mobile station, transmitting VHF.

(i) "Home" transmitting stations.

(j) Receiving portable and mobile stations.

- In each division, 6 or 24 hours, the operating period must be continuous.
- Contestants must operate within the terms of their licence.
- A portable field station is defined as one which operates from a power supply which is independent of any permanent installation. The power source must be fully portable, ie batteries, solar panels, motor generators / alternators etc.
- No radio apparatus, including masts, antennae, feeder cable etc., may be erected on the site more than twenty-four hours before the contestant begins operating.
- All amateur bands may be used, but cross band operation is not permitted.  
*Note: By gentlemen's agreement, we are refraining from using the 10 MHz band.*
- Cross mode contacts are permitted, and count single.
- The size of any portable field station shall be restricted to approximately that of an 800 metre diameter circle.
- Each multi-op transmitter should maintain a separate log for each band. An FM rig may be separate from an AM or SSB rig, but only one multi-op transmitter may operate on any one band at any one time.
- All multi-operator logs should be submitted under one call-sign.
- RS or RST reports should be followed by serial numbers beginning at 001 and increasing by one for each successive contact.
- SCORING FOR PORTABLE FIELD STATIONS AND MOBILES.

(a) Portable and mobile stations outside entrants call area — 15 points.

Portable field stations and mobiles within entrants call area — 10 points.

Home stations outside entrants call area — 5 points.

Home stations within entrants call area — 2 points.

(b) When a foreign portable station is worked, the contestants must determine whether or not the station worked is portable in the strict sense of the contest — see Rule 4.

- SCORING FOR HOME STATIONS.  
Portable field stations and mobiles outside entrants call area — 15 points.  
Portable field stations and mobiles within entrants call area — 10 points.  
No points are scored for home stations working other home stations, whether in entrants call area or foreign.
- Portable field stations may contact any other portable field station on ALL bands repeatedly, provided that at least four hours have elapsed since the previous contact with that station. Portable field stations may contact any home station only once on each band and mode. Note that AM, FM, SSB and any other voice

modes are grouped together as PHONE.

- Operation via active earth repeaters or translators is not acceptable for scoring. However, contacts via extra-terrestrial repeaters, eg satellites, EME is acceptable for scoring. Contestants should note Rule 6.
- All logs shall be set out under the following headings:  
Call sign, band, emission mode, RST/serial sent, RST/serial received, date-time in UTC, points claimed. Contacts must be listed in chronological order. There must be a front cover sheet showing the following:  
Name, address, division, section, call sign, call signs of operators (for multi-op. entrants), location of station, equipment used, power supply used. Contestants in all sections shall also include a "zero-value contacts list", showing all contacts made that were of zero-value, ie contravened the rules. This list shall be set out under the same headings as for the contestants logs. Contestants must also certify that they have operated in accordance with the rules and spirit of the contest. It should be noted that the practice of multi-op. station participants considering themselves to be portable stations and making regular contacts with the portable field contest station so as to bolster that station's score is deemed to be not in the spirit of the contest, and as such contravenes Rule 16.
- Certificates will be awarded to the winner of each section, in both the 6 and 24 hour divisions. The 6 hour certificates cannot be won by the 24 hour entrants.
- Entrants in sections (a) through (h) inclusive must show how their power was derived, in accordance with Rule 16.
- There is no bonus multiplier to be used in the case of CW-CW contacts. These count single.
- Logs must be received no later than 23 March 1983 and sent to PO Box 236, Jamison ACT 2614.

## RECEIVING SECTION

This section is open to all short wave listeners in VK and P2. Rules are the same as for transmitting stations, but do not have to show RST/serial of that station being worked by the portable or mobile field station. Logs must show the call sign of the portable or mobile station heard, the report and serial number sent by that station, and the call sign of the station called. Scoring is as shown in Rule 13. A station calling CQ does not count — only portable and mobile stations, which must be listed in the left-hand call sign column of your log, will count for scoring. Stations in the right-hand column (if available) may be any station contacted.

A certificate will be awarded to the highest scorer of each of the 6 hour and 24 hour divisions, individual or multi-operator entries.

The decisions of the FCM are final and no correspondence will be entered into.

**WHITE ROSE RADIO SOCIETY 3rd SWL LF BANDS CONTEST RULES**

- From 1200 UTC 29th January 1983 to 1200 UTC 30th January 1983 with contestants choosing their own period of eighteen consecutive hours.
- The contest is open to anyone in the world and there will be two sections — phone and CW. No mixed mode entries.
- The 1.8, 3.5 and 7 MHz bands are to be used.
- The practice of logging a series of contacts made by one station is deprecated. Log entries must not include the same call sign in the "Station Worked" column more than ten times on each band.
- The object of the contest is to log as many stations in as many countries as possible. Scores should be compiled as follows:- One point for each station heard on each band from one's own Continent and five points for each station heard on each band outside one's Continent. Total points to be multiplied by the number of different countries heard on each band added together. A list of countries heard must be furnished and a separate log must be submitted for each band.
- The call areas of the USA, Canada, Australia and New Zealand will count as a separate country. ie W1, W2, W3, W4, W5, W6, W7, W8, W9, W0, VO1, VO2, VE1, VE2, VE3, VE4, VE5, VE6, VE7, VE8, VY1, VK1, VK2, VK3, VK4, VK5, VK6, VK7, VK8 and ZL1, ZL2, ZL3, ZL4. All other countries will be determined by the ARRL Countries list.
- NO, CQ, QRZ or similar calls will be allowed to count for points. /AM or /MM stations are not to be included in the entries.
- Log Sheets to show the following information:- Date, Time UTC, Band, Station Heard, Station being Worked, Report at SWL QTH. Points may only be claimed for stations actually heard and the call sign must be shown in full. If points are claimed for both stations, the call sign must appear in the "Station Heard" column.
- Entries should be sent to the Contest Manager, Mr David McGregor G4 IDJ, c/o White Rose Radio Society, 8 Manor Court, Shadwell, Leeds LS17 8JE to arrive not later than 24th March 1983. Comments on the Contest will be appreciated and contestants are asked to give details of their receiving equipment and antennas.
- Certificates of Merit will be awarded at the discretion of the White Rose Radio Society, and its decision will be final.
- Contestants wishing to receive a copy of the results are asked to send a stamped self addressed envelope or two IRC's if outside the United Kingdom to the Contest Manager.

**NZART FIELD DAY RULES.**

DATE 1500 Sat Feb 12 to midnight the same day. 0600 Sun Feb 13 to 1500 the same day.

MODE Phone and CW, but no cross mode. CONTACTS Once per mode per band per hour FREQUENCIES 80 and 40 metres

MULTIPLIER A multiplier is earned when a Branch is worked on phone and another when the same Branch is worked on CW. This format is the same for each ZL Branch. SCORING. ZL stations score 10 points for each overseas station, (VK) (I can only assume that each VK would score 10 points for each ZL station.)

TOTAL. Total score points times multipliers. AWARDS: Apart from the impressive list of ZL

trophies, a certificate for the top scorer in each VK call area will be awarded. CYPHERS: Report and three figure number. LOGS: Sent in date, time, band, station worked, cypher sent, cypher received and points claimed. Use quarto sheets. Emphasise new multipliers.

DATE DUE: Send all logs to ZL2GX prior to 21 March 1983.

**SPECIAL NOTES FOR CONTESTANTS**

During all contests, the activity can become quite frantic. In some cases the effort being put into the contesting can cause the manners and responsible attitudes of some amateurs, to be relegated to a very poor second place.

These selfish attitudes manifest themselves in ignorance to his/her fellow amateur, deliberate interference of the others' signal and a form of jamming.

Other forms of 'tactics' are pre-arranged schedules extending in some cases to the pre-preparation of the logs for submission and the practice of the members of multi-operator stations, while 'on duty', regularly travelling a short distance from the station and making regular contacts with their own stations.

All these activities may boost the score and the morale of the individual stations. However, the damage caused by these tactics to the great majority of responsible amateurs and, in particular to the low powered novices, is tremendous and far outweighs any benefit that can be gained.

The Wireless Institute of Australia is trying to encourage amateur activity on all the bands and promotes contest activity in an attempt to maintain the span and sizes of the current spectrum.

When contesting, please assist in keeping the activity of the contest in accordance with the amateur's code and help promote a very exciting form of recreation.

Thankfully these comments are directed to only a few of the amateur fraternity and I feel sure that the majority of the interference is purely co-incidental with contest activity.



Nano VK6UN

**RESULTS OF THE 1981 RUSSIAN CQ M DX CONTEST "PEACE TO THE WORLD"**

Congratulations to N. Boegheim, VK6UN, who won overall fourth place from all foreign amateurs with a score of 20,160 points.

Australian amateurs that were medal winners in the Oceania section of the Contest are as follows:

"A" 14 Mhz	
C. Maughan VK5TI.....	Gold Medal
B. W. Thomas VK2FD.....	Bronze Medal
"A" 28 Mhz	
N. Boegheim VK6UN.....	Gold Medal
T. M. Darcy VK2D00.....	Silver Medal
"B" GR	
S. R. Coleston VK4XA.....	Gold Medal



"C" GR  
B. A. Pitman VK4AT0..... Gold Medal

Congratulations to all.

AR

**EMC (Electro Magnetic Compatibility)**

It radio frequency interference is causing you a problem you are reminded that — "Advice on all types and aspects of Interference (PLI, TVI, AFI, etc.) is available from the National EMC Advisory Service".

FORWARD DETAILS TO  
VK3QQ,  
Federal EMC Co-ordinator, QTHR.

**A Call to all holders of a NOVICE LICENCE**

Now you have joined the ranks of Amateur Radio, why not extend your activities?

**THE WIRELESS INSTITUTE OF AUSTRALIA (N.S.W. DIVISION)**

conducts a Bridging Correspondence Course for the AOCF and LAOCF Examinations.

Throughout the Course, your papers are checked and commented upon to lead you to a SUCCESSFUL CONCLUSION.

For further details write to:  
**THE COURSE SUPERVISOR, W.I.A.**

P.O. BOX 1066,  
PARRAMATTA, NSW 2150

W01106



# VK2 MINI BULLETIN

**Athol Tilley VK2BAD**

PO Box 1066 PARRAMATTA, NSW, 2150.

## DIVISIONAL OFFICE

The office of the WIA NSW Division is now located on the first floor, 109 Wigram Street, Parramatta. The office hours are between 11 am and 2 pm weekdays, and from 7 pm to 9 pm on Wednesday evenings. The phone number is 02-689 2417 and all correspondence should be sent to PO Box 1066, Parramatta, NSW, 2150.

Facilities include publication sales and information, QSL card drawers, and the members lounge/library area. Off-street parking is available for members visiting the new office.

## GOSFORD FIELD DAY

All amateur radio operators, their families, friends and all interested in amateur radio are invited to attend the 26th Annual Field Day of the Central Coast Amateur Radio Club on Sunday, the 20th of February, 1983, at the Gosford Showground in Showground Road, Gosford.

EVENTS include an open scramble, pedestrian DF foxhunts, with junior events on 144.4-144.7 MHz and open events on 146.7 MHz, ladies and gents quizzes, children's events, outing to the Reptile Park, an afternoon bus trip and a Ladies Stall.

CATERING is as for last year. You can bring your own picnic lunch or purchase at the take away food bar. Tea and coffee available separately at no charge.

ACCOMMODATION is usually scarce and early booking is advisable.

TRAINS from Newcastle at 8.10 am and Sydney at 7.20 and 8.50 am will be met at Gosford with free transport to the Showgrounds.

WET OR DRY, the Field Day will proceed as there is plenty of shelter.

DISPOSALS items must be booked in before 9.30 am on the day. Catalogue forms and lot numbers must be obtained in advance from Bill Smith VK2TS at RMB 4525, Gosford, NSW, 2250. You can phone 043-74 1207 after hours for forms and lot numbers. A commission is charged on all sales. Please note that late arrivals or improperly tagged or catalogued items may be refused. Lot numbers and forms will be available at the Showground on Saturday afternoon, 19.2.83.

DISPLAYS: Companies, persons, groups, clubs etc wishing to set up a table or display at the Field Day should contact the CCARC at PO Box 238, Gosford, 2250 before 7.1.83.

Phone enquiries can be made to Ray Wells VK2BVO on 043-25 8614 between 7.30 am and 3.30 pm weekdays only.

VK2 QSL BUREAU will be in attendance. Bring your QSL card for the "CALLS PRESENT" board.

PROGRAMME DETAILS can be obtained by sending an SASE to the CCARC, PO Box 238, Gosford, NSW, 2250.

## ANNUAL GENERAL MEETING

The Annual General Meeting of the WIA NSW Division will be held at 2 pm on Saturday, the 26th of March, 1983. Full notice and the agenda will be posted to all financial members in early March. Included will be the annual accounts, Auditor's report and annual reports of the division.

If you wish to nominate for election to Divisional Council, you may obtain a form from the

office. Please note that only Ordinary ie full Members can nominate.

Items for inclusion on the agenda of the AGM must reach the Divisional Office no later than Wednesday, the 23rd of February, 1983. Note that no business can be discussed or voted on at the AGM unless all members receive notice of such business (see Article 31).

(sgd) Athol Tilley, VK2BAD, Secretary, WIA NSW Division.

## 7TH CONFERENCE OF CLUBS

A full report of the 7th Conference will be included in the February 1983 VK2 MINI BULLETIN.

## COMPONENTS FOR SALE

The following components are for sale to members of the WIA NSW Division. Postage is given for small quantity individual item purchases. If you are making a multi item purchase, please include sufficient postage. We will return any excess as cash or components — please indicate preference. Send your order and payment to: WIA NSW DIVISION, Component offer, PO Box 1066, PARRAMATTA NSW, 2150.

Electrolytic capacitors, pigtail, mixed packs of values such as 22/250V, 1000/25, 1000/10, 100/63, 100/40, 220/10, 33/25. At least 15 items per pack. \$1 per pack. Post \$1.50 up to 5 packs.

Variable capacitors, 2 gang, broadcast band type. \$0.50 each. Post \$1.50 for 2, \$2.50 up to 6.

4.7 uF 250V non polarised capacitors. \$1 pack of 10. Post \$1.50 up to 3 packs.

24 pin Molex IC sockets. \$1 pack of 5. Post \$1 up to 5 packs.

Octal valve sockets, solid mica. \$1 pack of 10. Post \$1.50 up to 3 packs.

1 pF (pack a) and 4.7pF (pack b) ceramic disc capacitors. \$0.50 pack of 25. Post \$1 up to 10 packs.

2.5uH RF Chokes. \$1 pack of 25. Post \$1 up to 3 packs.

AS322 transistors (sim to BC107). \$1 pack of 20. Post \$1 up to 5 packs.

Computer PC Boards, containing transistors, card sockets etc. \$0.50 each. Post \$1.50 for 2, \$2.50 up to 8.

Relays all 5/10 amp contacts. Types include 3PDT-6V, DPDT-6V, DPDT-24V, 3PDT-24V, 3PDT-230V, DPDT-230V. They are open frame or sealed, some contact mount and others stud mount. Only \$1 each. Post \$1.50 up to 4, \$2.50 up to 7.

This relay offer was made possible by the generosity of PROMARK at 6 Clarke St, Crows Nest. Being distributors of Toshiba Semiconductors and other items they should be remembered for large purchases.

## DETAILS OF 4 CLUBS AFFILIATED WITH THE WIA NSW DIVISION

### HORNSBY ADARC

PO Box 362, Hornsby, NSW, 2077.  
Net: Mondays at 1930 EST on 28.370 MHz and repeater 7250 using VK2APF.

Meetings: 1st Wednesday of each month at the hall, cnr Sefton & Lockerie Sts, Normanhurst.

President: Barry VK2AAB, V-Pres: Geoff VK2BQ, Secretary: Bill VK2EBM, others: Colin VK2PLV, Gery VK2BMZ, Chris VK2YMW, Gareth VK2ANF.

Magazine: QUM, monthly. Editor: Gareth VK2ANF. Repeater: VK2RNS channel 7250.

### ILLAWARRA ARS

PO Box 1838, Wollongong, NSW, 2500.  
Meetings: Second Monday of each month, Congregational Hall, cnr Coombe and Market Streets, Wollongong at 7.30 pm.

President: K. Curie VK2OB, V-Pres: D. McKay VK2OMR, Secretary: D. Meyers VK2PBP, others: G. Cuthbert VK2ZHU, E. Fien VK2YVF, G. Dowse VK2CAG, M. Keech VK2YXS, I. Calcott VK2BXN, D. Henderson VK2VAV.

Classes: NAACP & AOCF Friday nights at 7.30 pm at the Wollongong Technical College.

Magazine: The Propagator, monthly. Editor: K. Frost VK2DOI and L. Kleeborn VK2YJK.

### WAGGA ARC

PO Box 294, WAGGA WAGGA, NSW 2650.  
Net: Saturday at 1200H EST on 28.490 MHz and repeater 6750 using VK2WG or VK2NWW.

Meetings: Last Friday of month at Wagga Rescue Club at 8 pm.

President: Peter VK2DOL, V-Pres: Graeme VK2OJD, Secretary: Neil VK2KNR, others: Simon VK2PMM, John VK2PMT, Peter VK2DUS, Barry VK2VDU.

Magazine: QRM, monthly. Editor: Peter VK2DOL. Repeater: VK2RWG channel 6750.

Field Day: Hosts SWARS Convention on alternate years.

### WESTLAKES ARC

PO Box 1 Teralba NSW 2284.  
Net: Tuesday at 2000H EST on 3.585 MHz and Sunday at 1130H EST on 3.585, 1.8125 and 147.1 MHz using VK2ATZ.

Meetings: Informal meetings at Westlakes ARC Clubrooms in York Street, Teralba on Saturdays.

President: K. Howard VK2AKX, Secretary: E. Brockbank VK2KEB, others: A. Efimov VK2DPY, M. Hall VK2DCW, G. Linthorne VK2GL, D. Pearson VK2AVO, P. Lorentzen VK2ATR, J. McLachlan, G. Taylor.

Classes: NAACP on Tuesdays at 6.30 pm and AOCF on Wednesdays at 6.45 pm — both at clubrooms.

Magazine: WARC Monthly Newsletter, monthly except January. Editor: E. Brockbank VK2KEB.

Repeater: VK2RTZ channel 7100.

## COMING EVENTS

John Moyle NFD contest: 12/13 February.  
Gosford Field Day: Sunday 20th February at Gosford Showground.

Nominations for election to Divisional Council and agenda items for AGM close: 23rd February.

Annual General Meeting, WIA NSW Division: 26th March at 2 pm.

NSW members and clubs are invited to submit news items for inclusion in these notes to: WIA NSW Division, PO Box 1066, Parramatta, NSW, 2150. Items for February AR must reach us by the 3rd of January and for March AR by the 22nd of January, 1983.

Athol VK2BAD.

AR.

**The WIA is in business for more members. Please help.**

# FORWARD BIAS

VK1 DIVISION



Fred Robertson — Mudie VK1MM

PO Box 46, Canberra, 2600

As advised last month, the Annual General Meeting of the VK1 Division will be held on 28 February 1982 in the Griffin Centre Studio at 8pm. Remember, it is in your interests to attend and participate.

The topic at the October meeting of the division was amateur television, and was most ably presented by Ron Harrison VK3AHJ and Ian Davis VK3ATY. The expert way they demonstrated and explained this mode made it look remarkably simple. The resultant interest generated surprised even a hardened cynic like myself.

As a result of this demonstration, an ATV group has been formed in VK1 and they hope to have about ten simplex ATV stations on air within a few months. They have also decided to construct an ATV repeater, with an input on 426.25MHz, to be located on Black Hill alongside the Channel 6, 2 metre repeater. The group will seek sub-committee status within the VK1 Division, and will approach the division for assistance in constructing the repeater.

Dennis VK1DG is the convener of the ATV group, and Reg VK1BR has been appointed Procurement Officer to handle bulk purchasing, enquiries about availability of parts and the like. The group will hold an ATV net on Channel 6, VK1RAC, every Sunday night after the VK1 broadcast. So if you are interested in ATV, contact Dennis, or check into the net on Sunday nights.

One of the increasing problems to amateurs in the Belconnen area of Canberra is our local

intruder. This is none other than the Naval Station. It was hoped that with the development of Canberra, the Naval Station would be relocated, if for no other reason than the fact that it occupies a choice piece of real estate which must be worth much more than the equipment in the station. Alas, this has not happened, and indications are that it will be with us for at least another ten years.

The problem with the Naval Station is not so much the amount of power they put out, but rather the fact that most of their equipment is getting on for thirty years old. This, combined with poor maintenance, results in the generation of unbelievable amounts of 'crud'. Their CW can be heard on 80, 40, 20 and 10 metres, their R7B buzz saw transmissions on 40, 20 and 10 metres, and their RTTY on 20 and 10 metres. The Melbourne meteorological broadcast is RST 579 on 14.119MHz, and they generate a strength 9 + 20dB carrier on 14.1995. Most of their transmissions generate spurs 200kHz either side of the fundamental.

If you are one of the unfortunates in the Belconnen area, make a note of every instance you hear the Naval Station in our bands and pass it to me. If our complaints to the local Radio Inspector don't do any good, we will bend the ears of a few politicians. For our soon to be \$18 per year, we deserve some protection from the Navy museum of broad-band junk.

73  
Fred VK1MM  
Editor pro tem

AR



## FIVE-EIGHTH WAVE

Jennifer Warrington VK5ANW

59 Albert Street, Clarence Gardens SA 5039

A very happy New Year to one and all. I hope that you all survived the Christmas Season, and are optimistically looking forward to the year ahead. As you will all be aware by now this is World Communications Year, or WCY-83, but not only will we, who have some connection with the field, be made aware of it, but the general public will also be aware. A coordinator has been appointed by the Government under the aegis of the Department of Communications, and with so much 'AWARENESS' going on, it would be foolish of us not to 'jump on the Band Wagon'. We can all do something towards public relations, but if you are in doubt as to whether you are on the right track, check with your PR person, or one of the Council. In VK5 our PR person is John Badcock VK5ZAP, and he would be pleased to hear of any ideas you may have.

One Saturday morning, back in October, we were in bed listening to the Broadcast bands, and my OM tuned in to 5CL to a programme called 'Practicalities'. It was an interview with Susan Brown VK2BSB, the President of the VK2 Division, and she did an excellent PR job for amateur radio, even to giving the WIA box

number for more information. It occurred to me to wonder just how many people would have heard that, at 8.45 am on the ABC's less popular channel, but as I believe it may have national coverage, I hope that there may have been a few 'handfuls'.

One thing we associate with the New Year is the making of New Year Resolutions. Well this year you won't have to rack your brains trying to think of one, I've taken the liberty of doing it for you! We are supposed to be in the business of communicating, and yet more problems and misunderstandings arise, because we fail to communicate through the right channels. Don't moan to your friends, or on the air; tell a Councillor or Divisional officer, or put it in writing to the council in general. After all, that's what you put us there for. So let's all make a new year resolution to be better communicators. And don't forget that it is time to get your suggestions for Federal Convention Items to your council, it may seem a long way ahead, but we need that much lead time to get things organised.

The first meeting for the year will be on Tuesday 25th Jan. at 8.00 pm.

# WANTED TO BUY

Ham gear, CB equipment, Hi Fi, video, car stereo, large or small quantities.

WE BUY AND SELL

ANYTHING ELECTRONIC

ANY QUANTITY

ANY CONDITION

# HAMRAD

104 Hightett Street,  
Richmond, Victoria.  
Phone: (03) 428 8136

## Sensitized P.C. Board Riston 3000 Coated

(Fibreglass Base)

	SINGLE	DOUBLE
36 x 24.....	\$46.00	\$67.00
24 x 18.....	\$22.00	\$30.00
18 x 12.....	\$12.50	\$18.00
12 x 12.....	\$ 7.90	\$10.75
12 x 6.....	\$ 4.50	\$ 3.85

### QUANTITY DISCOUNTS

\$100 + .....	10%
\$250 + .....	12½%
\$1000 + .....	15%

All plus sales tax if applicable

## RISTON DEVELOPER PROMOTION SPECIAL

Concentrate (1 = 4) \$4.25 litre

— 5 litre \$19.50 —

3M SCOTCHCAL  
Image 'N' Transfer  
MAJOR STOCKISTS  
Complete Catalogue  
Available on Request.

101 Burgundy St  
Heidelberg 3084  
(03) 468 2978  
Telex AA 37678  
MELTON  
(03) 743 1011

# KALEX

### COUPON

Special discount of 10% for WIA members.  
(Valid Nov., Dec., Jan.)

Enclose this coupon with your order.

CHEQUE OR BANKCARD

W01110

# IONOSPHERIC PREDICTIONS Len Poynter VK3BYE

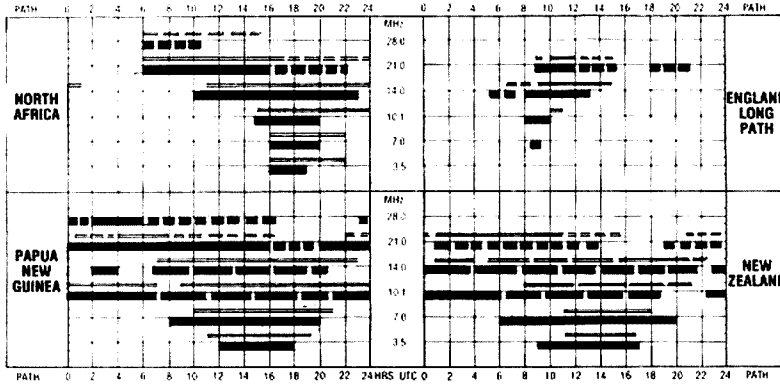
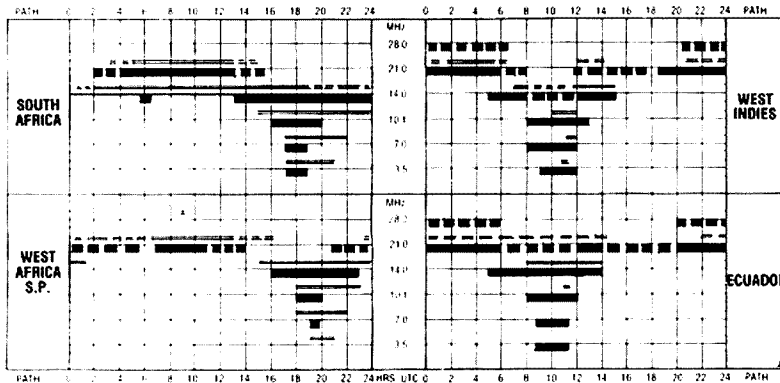
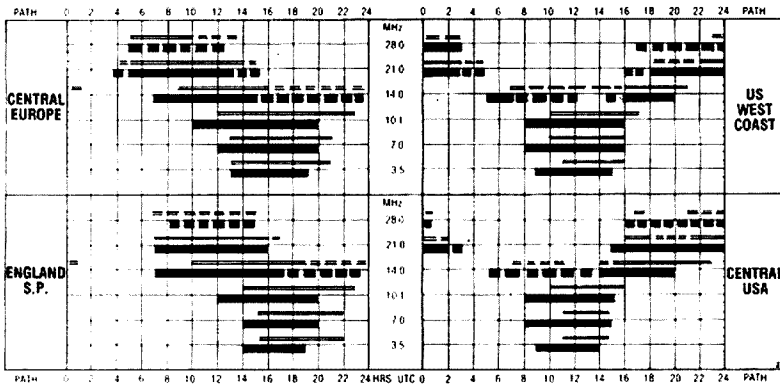
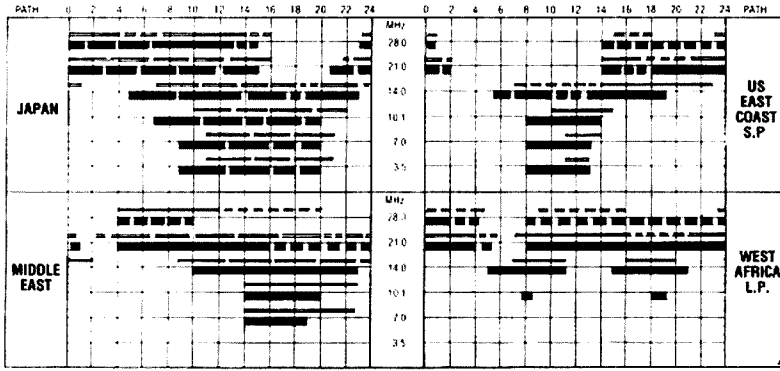

Due to early printing deadlines these predictions are reprinted from the Dec '82 issue.

## CUSTOM WOUND TRANSFORMERS

LOW COST  
HIGH QUALITY

Consult us about your special requirements in transformers, power chokes, r.f. chokes, etc.

Sample prices:

240V-24V @ 300VA ..... \$50.76  
Tax incl.

240V-8V @ 5A 2x15V @ 1A \$27.72  
Tax incl.

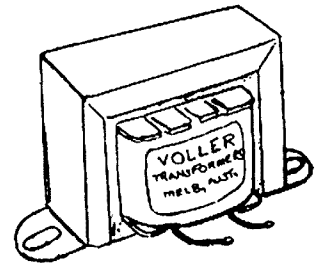

FREIGHT EXTRA

PLEASE RING (03) 551 1452  
VOLLER TRANSFORMERS  
PTY. LTD.

16 PIETRO RD.,  
HEATHERTON. 3202



# LETTERS TO THE EDITOR

Any opinion expressed under this heading is the individual opinion of the writer and does not necessarily coincide with that of the publisher.

P.O. Box 22,  
Yeoval, 2858  
7th November, 1982

Dear Sir,

It was with great interest that I read the article about Nara (9M2LN) in November AR. I became one of Nara's "pupils" in February 1980, when my CW was a very shaky five wpm. With his expert instruction, not only in receiving, but in sending CW, I was able to pass the 10 wpm CW in August of that year. He was always most kind, patient and encouraging, and unfailingly devoted hours of his time and effort to assisting myself and many others to pass their NAOCP and AOCW CW exams, although not always in good health himself.

He has always been most willing to assist with any theory question, aerial test, etc, and nothing has ever been too much trouble for him.

As I was only using a CB set converted to 10 metres it was impossible for me to listen to the WIA broadcasts on 80 metres, and my practices with Nara were therefore the only ones that I had.

I would just like to say a very big "Thank You" to Nara, and also more recently to Hock, without whose help I am sure I would never have obtained my "full call", and wish them both many more years of "Charley Willy" operation.

Yours faithfully,

JOY COLLIS VK2EBX

3/157 Brook Street, Coogee 2034

## "WORLD COMMUNICATIONS YEAR"

The Editor,

Dear Sir,

Here is a golden opportunity for all amateurs to become involved in activities and provide much needed publicity of our technical expertise, capabilities and remove the label of "a bunch of weirdos" that many members of the public feel when amateurs are mentioned.

We have such diverse activities that I'm sure would astound non amateurs such as DX'ing, computer logging, VHF repeaters, RTTY, satellite, moon-bounce, television, microwaves and many more. I expect the museum of Applied Arts and Sciences will be involved not forgetting due to a dedicated group of volunteers, they perform this much needed publicity all year round.

So why don't the clubs get in on the act and set up stations in shopping plazas, static displays in bank windows and release news value items such as distress and third party traffic to the news media.

Items such as the launching of our satellites (and failure during launch!) should be of interest, but at least we can try and let people know what we are doing. Perhaps the Melbourne ATV Group could set up a receive station in a public place so shoppers / passersby can see what's happening on the ATV repeater, they have a tremendous achievement to be proud of so why not tell everyone about it.

Personally, I will gladly volunteer for any activities and would hope many others would do the same, let's really make an effort for WCY.

R N SINCLAIR VK2DWF

## Obituaries

HARRY KINZBRUNNER

VK4HK

Harry passed away in hospital at Atherton, North Queensland on Sunday 24th October 1982, failing to survive the aftermath of an attack of flu received some months ago. We extend Condolences to his widow.

Refer Thumbnail Sketch in December issue

VK4PJ  
AR

IRVING (BILL) PERRY

It is with deep regret to advise the passing of a very good friend and workmate — Irving Perry (Bill) VK3BAV of Sandringham on the 6th November, 1982.

Bill served with the RAAF as a Flight Radio Instructor until 1945 when he joined the Department of Civil Aviation in ground/fair communications in Melbourne and subsequently in Mackay, Queensland (his home state).

In 1949, Bill and his family moved back to Melbourne where he took up a position with the State Electricity Commission in the Radio Laboratory in Richmond. He later transferred to the Educational and Training Branch of the SEC.

It was during this latter period that he established his amateur radio station with the desire to meet the amateur radio fraternity and to re-establish his practical interest in radio as a hobby, which he enthusiastically enjoyed after his early retirement in 1975 due to ill health.

Bill maintained his keen interest in radio until only recently when complications got the better of him. He made many new friends who will remember him for his cheery disposition and subtle remarks.

Our sincere sympathy goes to his wife Dorothy and his family. Bill will also be sadly missed by his close friends VK3s — NV, ARK, AZC, VQ, AMC and CF.

Harold VK4AKU

THE REV. ROBERT GUTHBERLET

Bob had a wide experience as a promoter of amateur radio and youth clubs dating back to his boyhood days in London as part of scouting and similar activities. He moved to Australia in the mid 20's.

In 1943 he was appointed to a church in South Broken Hill, where he inaugurated the Open Door Boys and Girls Club, bringing with it the activities of VK2AOD. Five years later he arrived in Port Pirie where he had charge of the Central Mission and continued his interest by establishing the first club in that city, transferring the club call sign to VK50D.

When the Youth Radio Club Scheme (YRCS) was adopted Federally by the WIA in 1962 there were a number of youth radio clubs existing in each state. In 1964 Bob had established the Open Door radio club at the Methodist Church at Mount Barker and later at Christies Beach.

That year (1964) he was appointed the WIA State Co-ordinator of youth radio clubs in South Australia and was instrumental in preparing a state constitution and publicity brochure.

Over the next decade, with Bob at the helm, there began an upsurge of youth radio club activity in which annual meetings of club leaders became a regular feature and did much to promote the scheme. Many club members were channelled into useful careers in electronics and allied fields. Many became radio amateurs. Inter-club visits and on air contacts were encouraged.

Bob was appointed Federal Co-ordinator of the scheme in 1972. During his term of office he showed unquestioned loyalty to the WIA and was actively involved in the three YRCS State Supervisors Conferences that brought club programmes and courses to a uniform standard throughout Australia.

Bob did not disclose the details of his radio background but one sensed that it was founded in the days of spark. He had been enthusiastically involved in promoting and administering the activities of the club station VK50D and as a result of visits overseas he was well informed with regard to developments of novice licensing in other countries prior to its introduction in Australia.

One thing stands out — he was well versed in the art of communication, particularly in encouraging others to communicate. He was also adept at getting things done. As a person he was down to earth, approachable, energetic and an enthusiastic supporter of youth. He did not think of himself as "a parson" in the popular usage of the word.

With the advent of novice licensing, the CB boom and his impending retirement, Bob withdrew from active participation in the radio scene by transferring the club call sign to his son John. Nevertheless, he retained an association with amateur radio and was occasionally seen at WIA functions.

There is no doubt that he displayed a remarkable sense of commitment.

Bob died in his sleep on 1st November, '82, aged 76.

To son John and other members of the family we extend our sincere sympathy.

Allen Dunn VK5FD  
John Allan VK5UL

## THE VK3BWW FORMULA FOR DX SUCCESS!! HIGH QUALITY AT LOW COST

### BEAMS

3 EL 10 & 11m .....	\$75.00
3 EL 15m .....	\$83.00
3 EL 20m .....	\$158.00
6 EL 6m .....	\$108.00
5 EL 2m .....	\$36.00
9 EL 2m .....	\$59.00

### DUOBANDER

3 EL 10m, 3 EL 15m \$148.00

Prices include Gamma match

Our beams are easy to assemble and adjust. Entirely NEW CONCEPT — NO NUTS OR BOLTS.

Spare parts, elements, booms and gamma matches available.  
Plus Freight

For further information  
PLEASE RING (03) 366 7042

VK3BWW  
WERNER & G. WULF  
92 LEONARD AVENUE  
ST. ALBANS, VICTORIA 3021

# NEW CHIRNSIDE VERTICAL ANTENNA

Model

## CE-5SS

5 band self supporting

Unlike our Model CE-5B, this vertical needs no guy ropes and stands only 5 metres high, is very easy to erect and can be disassembled again into four pieces in about 45 seconds.

Just the antenna to have in the boot of your car or caravan for quick portable operation and for JUST \$89 you can afford to have one for that occasion.

### Specifications

Frequencies ... 80M to 10M.  
Impedance ... 50 ohms at resonance.

Power handling ... up to 1 KW PEP on 20-15-10M, up to 400 watts PEP on 80M and 40M.

Wave length type operation.

Termination ... SO-239 socket.

Weight ... approx. 3 kg.

GET ONE DIRECT FROM OUR MAIL ORDER DEPT.

\$89 plus freight charges. Bankcard welcome.

### CHIRNSIDE ELECTRONICS PTY. LTD.

26 Edwards Rd.  
CHIRNSIDE PARK, LILYDALE.  
3116

Phone (03) 726 7353

W0818

# WARNING!!



Disposing of your old rig??

Please ensure it goes ONLY to someone licensed to use it on YOUR bands.

## HAMADS

\* Please insert STD code with phone numbers when you advertise.

**PLEASE NOTE:** If you are advertising items FOR SALE and WANTED, please write on separate sheets, including ALL details, e.g. Name, Address, on both. Please write copy for your Hamad as clearly as possible, preferably typed.

- Eight lines free to all WIA members.
- \$9 per 10 words minimum for non-members.
- Copy in typescript please or in block letters to P.O. Box 150, Toorak, Vic. 3142.
- Repeals may be charged at full rates.
- Closing date: 1st day of the month preceding publication. Cancellations received after about 12th of the month cannot be processed.
- QTHR means address is correct as set out in the WIA current Call Book.

### TRADE HAMADS

Conditions for commercial advertising are as follows: The rate is \$15 for 4 lines, plus \$2 per line (or part thereof) minimum charge \$15 pre-payable. Copy is required by the first day of the month preceding publication.

Ordinary Hamads submitted from members who are deemed to be in the general electronics retail and wholesale distributive trades should be certified as referring only to private articles not being resold for merchandising purposes.

**Amlidon Ferromagnetic Cores:** Large range for all receiver and transmitter applications. For data and price list send 105 x 220 SASE to: R. J. & U. S. Imports, Box 157, Mortdale, NSW 2223. (No enquiries at office: 11 Macken St. Oakley, 2223). BUSINESS CLOSED DURING FEBRUARY.

**CB Radios \$69:** walkie talkies, short wave radios, military, outback, business, amateur, marine, repairs, RTTY Siemens 100A printer \$120; base mic., \$45; ultrasonic alarm, \$35. all ham bands on a single 6 ft. whip, 1.8 to 30 MHz, for base or mobile, \$300; aeriels, installation, demonstrations, 40 ch. CB conversions, accessories, new rigs weekly. Bridge Disposals, 12 Old Town Plaza, opp. Bankstown Railway Station, NSW. Mail order service and all enquiries to 2 Griffith Avenue, Roseville 2069, or phone Sam VK2BVS, 7 p.m. to 9 p.m. only, on (02) 407 1066.

### WANTED — ACT

CRO, 1 or 2 inch CRO tube for an RTTY tuning indicator. VK1RH QTHR. Ph: (062) 58 7904.

### WANTED — NSW

DIGITAL DISPLAY, DG-5 to suit TS-520S. VK2DVJ. Ph: (044) 76 7650.

### WANTED — VIC

EIMAC 8877 (3CX1500-A7) wanted. Don VK3DBB QTHR. Ph: (059) 41 1351 AH.

### WANTED — WA

DG-5 DIGITAL DISPLAY for TS-520S. Ph (09) 446 1568 or write VK6LL, 139 Woodside St, Double View WA 6018.

### FOR SALE — ACT

KENWOOD TS530S, as new, 27MHz fitted, \$700 ONO. L10073 QTHR. Box 25 Cook 2614. Ph. (062) 51 2788.

### FOR SALE — NSW

FT101B with matching VFO and speaker, \$550; FT200 with FP200 power supply/speaker, \$300; FRG7 receiver \$200. All in excellent condition. VK2EE QTHR. Ph: (02) 587 2602.

KENWOOD TS820 with dig. display, DC converter, manuals and orig. carton. \$600 ONO. Kenwood TS120S with mobile bracket, manual and orig. carton. \$500 ONO. David VK2KLX QTHR. Ph: (02) 476 1048.

TOWER, 90ft. free standing, KVC Southern Cross Tower. Dismantled into 10ft sections for transportation. No rust. Hot dipped galvanised steel work. \$1000. Ian Buchanan VK2DVJ. 112 Ocean Pde, Dalmeny 2546 NSW. Ph: (044) 76 7650.

### FOR SALE — VIC

IC-22S, complete with mic, in original packing, little used, \$200. Trio TS-820S ex estate, complete with mic, small usage, \$580. VK3QZ. Ph: (051) 74 7707.

ICOM IC202E, 2M SSB, 144-144.4 MHz plus Oscar crystal, VGC, \$150. VK3ZMP. Ph: (03) 560 6995.

KENWOOD TR2400 2m, 800 channel, handheld tcvr. Complete with charger, manual and soft carry case. Perfect order and condition. \$240 ONO. Harry VK3ASI QTHR. Ph: (052) 43 1831.

KENWOOD TS120S, late model, as new in carton, with mic, \$465. Yaesu FT7, excellent order, extras, mic, \$360, 13.8V 5A regulated PSU, \$45. Fox Tango Club 9MHz, 2.1 kHz xtal filter for FT301, FT7, etc., new, \$60. Daiwa CL67A 500W ATU, 1.8 to 30 MHz, \$60. Kenwood R820 deluxe communications receiver, as new in carton, \$495. VK3ARZ QTHR. Ph: (03) 584 9512.

KENWOOD TS130V Tcvt, also remote VFO 120. Both units are in first class condition and come with all manuals and instructions, also original packing and 50K, N/C mike. Asking price \$650 the lot, will consider any reasonable offers. Exchange also considered for Yaesu mobile. VK3PBZ QTHR. Ph: (062) 21 6763.

### FOR SALE — QLD

KENWOOD TS520S HF Tcvt, EC, \$450. Ben 2m lin. amp, 70W, EC, \$100. Ben 6m lin. amp 80W, GC, \$100; Leader LDM-815 dip meter, as new, \$75; Katsumi mic compressor, A1, \$20; 6m 5 el home brew fold-up Yagi, \$30; 80m mobile ant with adj. tuning spike, \$20; 10 el of 2m beam. Only needs a boom, \$20. Most in org. cartons with manuals. Mike VK4KMD. Ph: (076) 35 6911.

## ADVERTISERS' INDEX

MAGRATH'S.....	18
AUSTRALIAN MARITIME COLLEGE.....	2
BAIL ELECTRONIC SERVICES.....	OB
CHIRNSIDE ELECTRONICS PTY LTD.....	48
DICK SMITH ELECTRONICS.....	3
HAMRAD.....	45
IAN J TRUSCOTT ELECTRONICS.....	31
KALEX.....	45
KNOXTRONICS ELECTRONIC SERVICES.....	2
ATN ANTENNAS.....	1F
NORTH QUEENSLAND CONVENTION.....	35
NOVICE OPERATOR TRAINING.....	2
TRIO-KENWOOD (AUSTRALIA) PTY LTD.....	20
VK2 WIA NOVICE LICENCE.....	43
VOLLER TRANSFORMERS PTY LTD.....	46
WERNER & G WULF.....	47

**SUPER LOW PRICES**

**AMPHENOL  
17 SERIES  
DB25 PLUGS  
& SOCKETS**

Plugs \$2.45 Sockets \$1.85



**SPEAK & SPELL  
IS HERE**

as featured in

**E.T.™**

**\$110.00**  
INCLUDES SALES TAX

**E.T. PACK INCLUDES**

- One Speak & Spell learning aid
- The new E.T. Fantasy Module
- New photo filled activity book
- Colorful movie poster
- T shirt decal with E.T. and Elliot

**MEMORY BARGAINS**

- HM6116P-3 (HITACHI) 2KX8 CMOSRAM \$7.50
- MB2716 (FUJITSU) 2KX8 EPROM \$3.00
- MB2764 (FUJITSU) 64K EPROM \$12.00
- MBB118 (FUJITSU) 16K DYNAMIC RAM (Intel 2118) 120ns \$4.00

**INDUSTRY STANDARD**

**BOURNS  
MODEL 3006P  
CERMET  
TRIMPOTS**

15 TURN 1.25 WATT  
ALL POPULAR VALUES

Standard Range  
100 OHM-1 MEG

Was \$1.60\*  
**\$1.10 ea.**

**MAGRATH'S —  
THE ONLY CITY SOURCE**  
Now you can make professional quality PC artwork and boards

**E-Z CIRCUIT™**  
BY DESIGN & FABRICATION

**PRESSURE SENSITIVE  
DRAFTING AIDS**

Ideal for small volume OEM users, Consultants, Breadboarders, Experimenters, Designers, Hobbyists Bishop quality in small, economical packages.

**CHRISTMAS SPECIAL**

**Professional  
Video  
Monitor**

Was \$227\*  
**\$199**

**18MHz Video Bandwidth  
BM-12E**

Input Signals: Composite  
Video Signal Negative  
SYNC 1.0 P-P 75 ohm  
CRT size: 31 cm diagonal  
Green Phosphor — P31  
non glare  
Power input 230V 50Hz  
Display format:  
1920 characters max.  
(80 characters X 24 lines)

**TI PERSONAL HOME  
COMPUTER**

TI-99/4A

**\$499.00** INCLUDES SALES TAX

You can buy just a video game — or you can get a full colour Home Computer

- Typewriter Keyboard
- 16K bytes RAM
- Expandable to 32K bytes RAM
- Easy to follow instructions
- Extensive range of programmes
- Educational
- Add on expandability

**HIGH QUALITY,  
LOW COST,  
DO-IT-YOURSELF  
BOOKSHELF  
SPEAKER SYSTEM**

**RUDAX**

The Compact 200 as featured in EA, Sept 82

Speakers, Electronics Kit **\$199**  
Cabinets (per pair) **\$99.50**

**TI CALCULATORS  
FROM MAGRATH'S**

- FINANCIAL
- SCIENTIFIC
- STUDENT

TI-35 Student math kit **\$27.00**  
TI-54 Engineers & Science **\$45.00**  
TI Business Analyst II **\$50.00**

PRICES INCLUDE SALES TAX

**MAGRATH'S DECEMBER MONEY SAVERS  
SEMICONDUCTORS**

See 6 pack Specials for super prices on asterisked products.

*4011B 19c	*741 S04 20c	*M3401 5 51c
*4016B 30c	*741 S14 40c	*M3401 15 60c
*4023B 19c	*741 S47 72c	*M3865 60c
*4028B 55c	*741 S90 42c	*M3955 25c
*4066B 44c	*741 S161 53c	*M341N DIP 23c
*4511B 69c	811 S95 87c	*M341 DIP 36c
*4520B 74c	811 S98 88c	*M3015 20c
*7406 20c	*M301A DIP 35c	*741 80 15.50
*7414 33c	*M308 DIP 49c	*741 107 30c
*74164 48c	*M324 42c	*M34100 REC 11.20
*74365 37c	*M339 DIP 42c	*KBPC602 GA, 100V BRK \$1.00
*741 S00 20c	*M3400C 15 \$1.20	*S80016 6A 60V BRK 80c

Add Sales Tax if applicable  
Prices valid until stock sold.  
Prices subject to alteration

**SUPER XMAS BARGAINS AT MAGRATH'S**

Visit us at our new address  
**55 A'BECKETT STREET  
MELBOURNE, 3000.**  
Tel (03) 347 1122





**Bail Electronics have the largest range of Yaesu Amateur Radio equipment in Australia.**

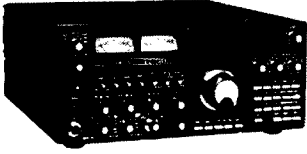

FT-ONE the ultimate HF rig for SSB, CW, FSK, AM, FM.

General coverage receiver 150 kHz to 30 MHz



FT-102 the DXer's dream. All mode with 100db Rx dynamic range. Accessories FC-102 antenna tuner 1.2Kw; FV-102DM Ext. VFO; SP-102 Ext. speaker with audio filter.

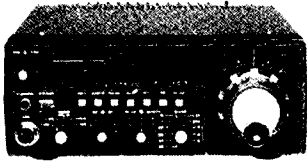

FT-707 the ideal mobile HF rig -can be used as base station transceiver with optional power supply, accessories - FC-707 Antenna Tuner, FV-707DM Ext. VFO.

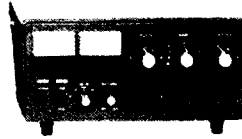

FL-2100Z Linear Amplifier 1.8 - 30mHz — coasts along at full legal power.



FT-208 — FT-708. Handhelds for 2m and 70cm.

- Fully synthesised
- 10 memories
- Keyboard entry

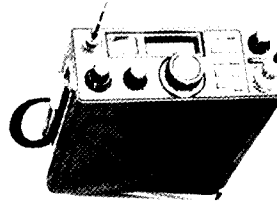

FT-290, FT-690, FT-790. All mode portable/mobile rigs for 2m, 6m, 70cm. The "go anywhere" rigs.

FL-2010 (2m), FL-6010 (6m), and FL-7010 (70cm) Linears for the FT-208, FT-290 series.

FT-480, FT-680, FT-780  
The popular all-mode Mobile or base Station transceivers for 2m, 6m, 70cm.

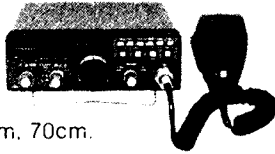

Boost your output to 70 W with the FL-2050 2m Linear Amplifier (12db Rx amp inbuilt.)

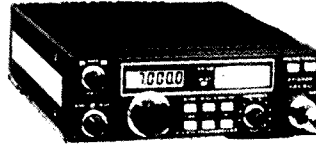

FT-230 the compact 2m mobile with 25 W output

- 10 memories
- Dual VFO

Stop Press — FT-230 70cm 10W due soon



FRG-7700

Listen to the world with the professional all mode Communications Receiver 150 kHz to 30 MHz. Accessories include FRA-7700 Active Antenna, FRT-7700 Antenna Tuner, FRV-7700 VHF Converters (for listening to hams, aircraft etc.)

Bail — gives full Yaesu 12 month guarantee.  
Bail — carries a range of Yaesu spares and Yaesu antennas  
Bail — provides expert repair service  
Bail — offers friendly advice to hams and hams-to-be.  
Bail — gives prompt attention to your mail orders.



**Bail Electronic Services**

38 Faithful Street,  
Wangaratta 3677  
Telephone: (057) 21 6260 — Telex: 56880



**Bankcard Welcome**

Stan Roberts  
VK3BSR

# HEARD ISLAND

# DX ASSOCIATION Inc.

The Heard Island DX Association was formed in PNG in mid 1980 with the then sole aim: amateur radio activation of Heard Island. The recent bad luck with VK0KM and the realisation that even if everything had gone exactly right, only about 1000 QSO's could have been made. This was a fraction of what seemed required. Nevertheless, it was a significant event since Heard Island had been activated once more.

The early ideas of HIDXA seem very naive these days - much of it based on international amateur radio and the idea of most wanted Heard Island as a DXCC country. After a while it became apparent that the cost of such an expedition would run into a 6-figure amount. It therefore seemed reasonable that amateur and other help would have to be requested. A letter of intent went to all amateur radio societies, with the request that the aims of HIDXA be made known. Since money was involved, it stated that all 'donations' would be acknowledged by numbered receipts, with a money-back guarantee if the expedition did not take place.

In the meantime, approaches were made to the authorities in Canberra to start paving the road to obtaining permission to visit Heard Island. At that stage it appeared that Canberra was not set up for such a request, involving an expedition for solely amateur radio purposes. Numerous letters, telephone calls and a visit to Canberra resulted in the "Guidelines for Private Visits to Heard Island and MacDonald Islands" becoming the ground rules for any private visit to Heard Island. The authorities put a great deal of thought and hard work into the generation of these guidelines.

Using these Guidelines, a proposal for the expedition covering all aspects of the document was presented and resulted in Permission In Principle being granted. As a generous gesture on behalf of the authorities, additionally, permission was given to use existing facilities on Heard. It is emphasised most strongly that the courtesy and genuine assistance given to HIDXA was absolutely tremendous.

On reflection, the initial attempt for the 1981 season was impossible.

An excellent vessel, excellent skipper, but a \$2,400 a day charter really set us back on our heels. However, the main stumbling block, never to be resolved, was that the owner wanted all the money on the line before actual departure. This sort of cost dictated a limited stay on HI and 10 days seemed the minimum to produce 40,000 QSO's with a good team and reasonable propagation. The 1982 season was a sad story of continual delaying tactics and non-committal responses from a fishing company based in W.A.. Our main interest in this company was a "magic" figure of \$20,000 being given as a starting point for a 6-7 man lift to HI. In addition, since the vessel would not be idle, no charge would be made whilst we were on the island. The vessel was apparently sound as it had been designated to carry out a fishing survey in the area off Heard Island. It, of course, seemed a dream chance, but that is what it exactly turned out to be. Even today we can still feel the frustration of the weekly "putting off session". The charge seemed reasonable, as it had always been, and still is, the intention of the expedition team to share the basic charter costs on an equal basis.

Negotiations were initiated for joining a possible expedition to HI with the "Dick Smith Explorer", and alternatively, a return to a charter of a fishing vessel for the usual X-thousand dollars a day.

At that stage there also was correspondence with the leader of the "Heard Island Expedition" (in those days "Heard Island Mountaineering and Photographic Expedition") in Sydney, about a possible joint-expedition.

However, time was running short, and none of the available alternatives turned out feasible. So ends season 1982.

For the current season, the Mountaineering group and HIDXA went separate ways. The reason for this is simply that the groups had different aims and objectives, and had differing ideas about how to achieve them.

After establishing contact with SoJo (VK0SJ), he expressed an interest in joining forces with HIDXA. A visit to Norfolk Island early in April '82 by SoJo resulted in discussions and exchange of ideas. New plans for 1983 were generated and organisation was continued with renewed energy.

The key to Heard Island has always been suitable transport, and several months of frantic international research, which resulted in a list of about 10-15 alternative fishing or sailing vessels, the Cheynes II became the most viable proposition.

The ex-whale chaser has proven her capability on 37 whaling expeditions to the Antarctic waters for the Norwegian company "Thordahl" from 1947 to 1962.

She later was operated from Albany, WA from 1962 until the Cheynes Beach Whaling Company was terminated in 1978. The Cheynes II was then released to the Maritime Museum of Tasmania, who didnot have sufficient resources to maintain the vessel. The present commercial owners since mid-1982 are refurbishing the Cheynes II to meet the survey requirements for a deepsea trawling and salvage vessel for international waters. However, the commercial fishing activity will only take off after the completion of the HIDXA charter. The master and licensed crew are very keen to undertake this expedition, and finally a favourable charter agreement could be negotiated.

An assessment of Cheynes II and the crew made by an independent master-mariner/surveyor cleared the way to sign the charter-contract on Sep. 4, 1982.

On further application, final Government approval was given to land on HI.

## HIDXA PO BOX 90 NORFOLK ISLAND SOUTH PACIFIC 2899

An assessment of the vessel and its crew made by an independent surveyor and master-mariner cleared the way for our chartercontract to be signed on the 4th of September 1982. Steps were taken to protect members of HIDXA by incorporating the association as a non-profit organisation in Tasmania. Final Government approval was then also given.

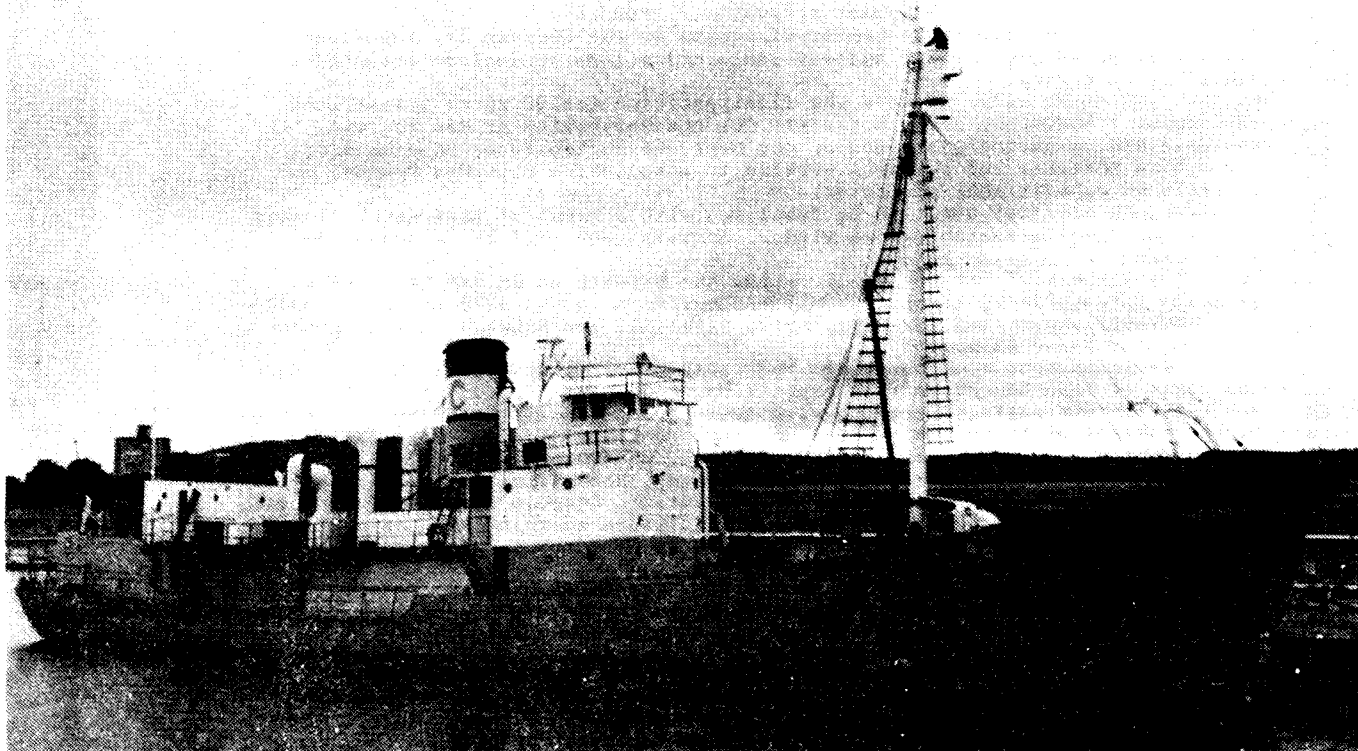

CHEYNES II in Hobart



TO: THE SECRETARY  
HEARD ISLAND DX ASSOCIATION  
P.O. BOX 90  
NORFOLK ISLAND  
AUSTRALIA 2899.

FROM: .....

- I would like to donate ..... to H.I.DX.A. to help to make the projected expedition a reality.
- I enclose an S.A.E. and IRC to cover return of my special receipt.
- I will be interested in the special Philatelic material which will be available soon after return from Heard Island.
- I request information on the 100 page definitive booklet on Heard and McDonald Islands available from H.I.DX.A.
- I request information on how I may become an Associated Member of H.I.DX.A.
- I feel I can help additionally .....

(Give details please.)

\*H.I.DX.A. use. Donation ..... Acknowledged Donation no. ....  
Further information sent as requested

STOP PRESS

HEARD ISLAND DX ASSOCIATION now INC.

Hobart Nov. 1982.

The British-built vessel is 156 ft long, of 440 gross tonnage, powered by a 1076 SHP triple expansion steam-engine with two independent boilers using furnace oil, good for 15 knots cruising or 19 knots top speed. For fuel-economy reasons to HIDXA, only one boiler will be used at the time, cruising at 10 knots. The 29 bunks will accommodate the 18 expeditioners/deckhands and 5 licensed crewmembers with room to spare. The bridge will be equipped with interacting satellite and Omega navigators with plotter/printer, a 100 NM radar, a 1000 m colour display depthsounder, a FAX weathermaps receiver, two HF and one VHF transceivers, gyro and magnetic compasses, autopilot, etc etc. In order to avoid a headwind battle from Hobart to Heard, a southernmost route near the Antarctic continent will be chosen. The stay on HI will be about two weeks, depending on weather and propagation, and the great-circle route will be used straight back to Hobart, with only about half of its bunkered fuel consumed. The itinerary is:

Hobart Departure	Jan 2, 1983
Heard Arrival	Jan 18
Heard Departure	Jan 31
Hobart Arrival	Feb 10

As a result of the available number of berths on the Cheynes II, the HIDXA has now expanded the initial amateur radio objectives to include scientific and other interests.

At the time of writing, we have the firm participation of three scientists (Zoologist + Assistant and a Botanist) for the University of New England, Armidale NSW, a veterinary surgeon of the Dept. of Agriculture, Bendigo VIC, and a bird observer (of the ANU) working in association with Max Downes, an early HI expeditioner/biologist.

Negotiations are just about to be finalised with a group of four expeditioners (including a radio-amateur) from Vienna, Austria, who will be joined by one Australian.

Callsigns to be used are: -- VK0JS -- for the DX-work on HF SSB/CW, --VK0NL-- as a new YL-country by Kirsti (VK9NL) and --VK0SJ-- to be used maritime mobile for progress reports and for RTTY, SSTV, satellite and 6-meter operation both maritime and fixed on HI.

Two American amateur operators from the H2LAB-club, Saudi-Arabia, have joined the ranks of keen DX-ers on this expedition.

Negotiations are still proceeding with newspaper journalists and/or a filmcrew. At the time of writing, the expedition group consists of: Jim Smith, Kirsti Jenkins-Smith, Sjoerd (SoJo) Jongens, Prof. H. Heatwole, Dr. Jeremy Smith, Dominique Ward, Dr. Robert Jones, Claire Speedy, Bob Walsh, Walter Marshall, Bruno Klausbruckner, Walter Floor, Werner Hoelzl, Leopold Krenn and P. Hardie.

HIDXA has left the announcement of the participants to this late, as a clause in the application procedure allowed members to withdraw or be declined before December 2nd, without great financial loss.

- Besides the scientific program of the actual expedition members, we will also
- replace the Automatic Weather Station for the Bureau of Meteorology,
  - make four-daily weather observations for the Metbureau enroute and on HI,
  - repair (by SoJo, ex-ANARE Electronics Engineer) or retrieve the automatic weather station for the Glaciology Section of the Antarctic Division,
  - perform exploratory trawls around HI, whereby the catch will be identified in a program in collaboration with marine-biologists of the Antarctic Divn,
  - take air samples for the CSIRO, Dept. of Atmospheric Physics,
  - keep an eye out for drift bottles onshore HI, released in a program for the Australian National University (ANU),
  - check tags on the flippers of the Southern Elephant Seals for the University of Pretoria, RSA,
  - etc, etc.

On Saturday, Nov 27, we had a gathering in Hobart, celebrating the first recorded sighting of Heard Island by the British master Peter Kemp on the same date in 1833. Note that next year will be the 150th anniversary.

We organised an introduction to HI for anyone interested, with the following speakers:

- Dr. Fred Jacka, physicist with the 1947-48 ANARE expedition, setting up the ANARE station, and later Assistant Director (Science) of the Antarctic Division. Since 1965 Dr. Jacka is Director of the Mawson Institute for Antarctic Research, Adelaide. He opened with an introduction to the early years of ANARE and the rough voyage to HI,
- Alan Campbell-Drury (VK3CD), with the same expedition in 1947-48. His humorous account of the those times really caught the audience. He was the first ham-radio operator on HI as VK3ACD, and showed the original transceiver used being in excellent operational condition,
- Dr. Gavin Johnstone, biologist with the Antarctic Division and member of the 1980 Natmap Heard Island expedition. His series of colourful and explicit slides was a great introduction to what we could expect to find on arrival at HI.

Chairman of this meeting was Jim Smith (VK9NS) who stays in Hobart until departure to HI, finalising the seemingly never-ending amount of preparation for this expedition.

We hereby would like to thank all individual amateurs, clubs, companies and other institutions who provided us with over 500 donations and other support like loan of equipment.

A complete list of names of companies who support us will be issued at a more appropriate place and time when all negotiations are finalised.

HIDXA-committee: Jim VK9NS, Kirsti VK9NL, SoJo VK0SJ, Ron VK7RM, Graham VK7GD.

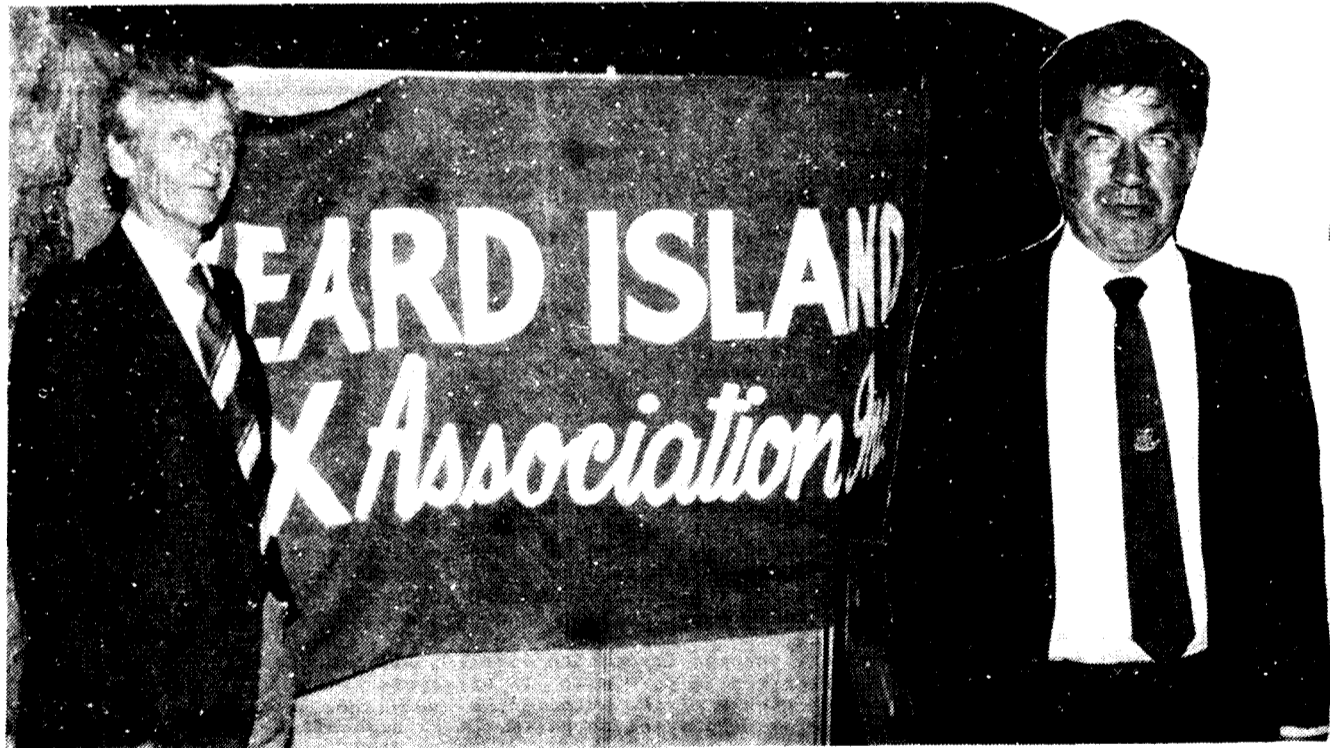

J.B. Smith (VK9NS)

R. Barnett (Master)



Dr. F. Jacka

Dr. G. Johnstone

A. Campbell-Drury

# *Amateur Radio*

VOL. 51, No. 2 FEBRUARY 1983

Registered by Australia Post — Publication No. VBH 0569



JOURNAL OF THE WIRELESS INSTITUTE OF AUSTRALIA

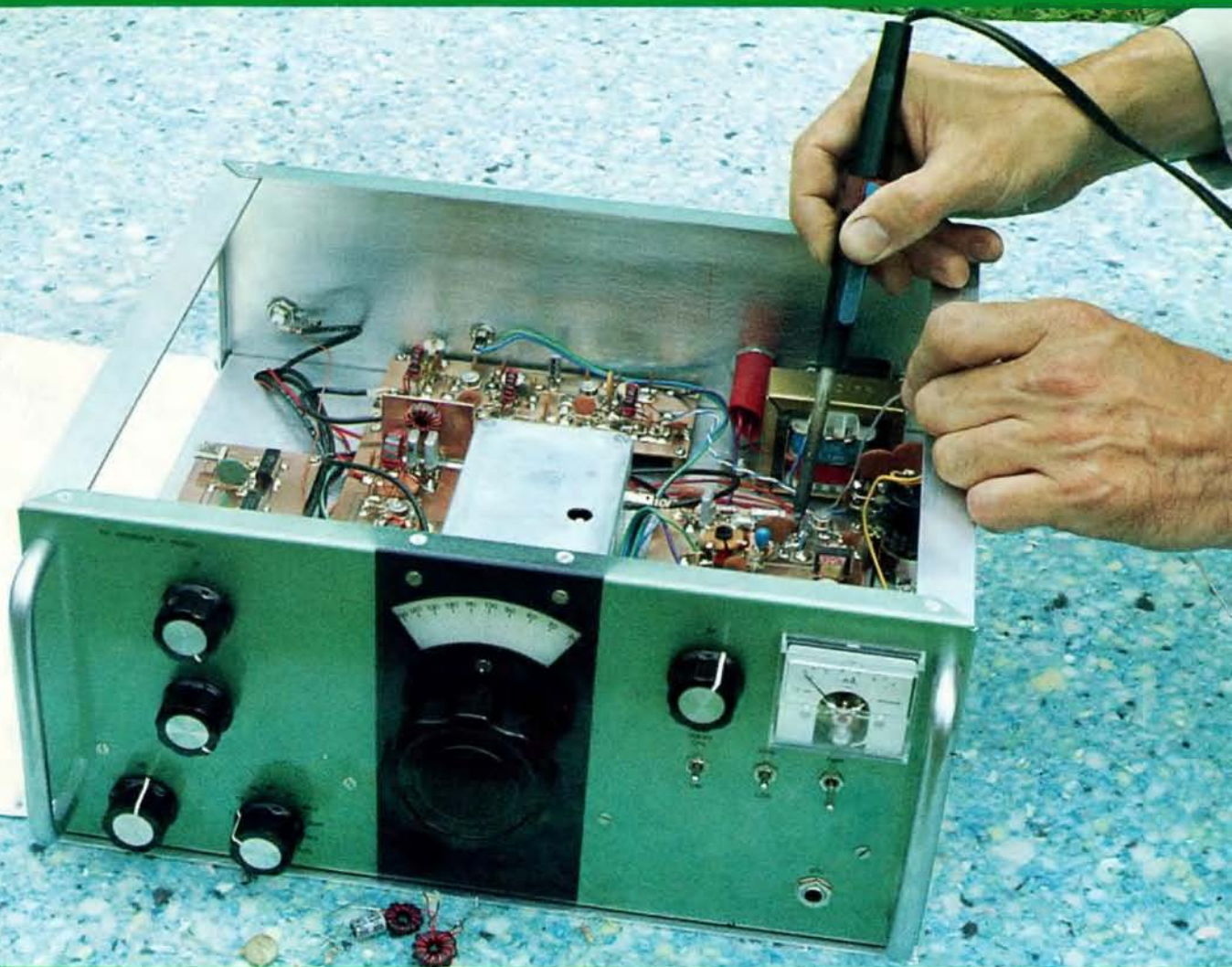

New RTTY column

Square One Receiver — Part 2

Canoe Marathon

Two Tone Oscillator

A Different Dipole

Review of TS430S Transceiver



# ANTENNAS AT USA PRICES

## A GENUINE OFFER FROM HYGAIN AND AUDIO TELEX COMMUNICATIONS

Most HAMS would prefer Hygain to any other brand antenna, until now price has placed them out of reach of most people. Now Audio Telex Communications are joining with Hygain in making this direct offer on the entire range of Hygain antennas.

*Here are some examples:*

<b>TH3JR Triband</b>	<b>\$267.00</b>
<b>TH3MK3 Thunderbird</b>	<b>\$364.00</b>
<b>18AVT Trap Vertical</b>	<b>\$149.00</b>
<b>204BA Long John 20 metre</b>	<b>\$382.00</b>
<b>V2 Colinear Gain Vertical</b>	<b>\$ 65.00</b>
<b>153BA 3 Element 15 metre</b>	<b>\$124.00</b>
<b>DB10-15A Duo Beam</b>	<b>\$230.00</b>
<b>Hyquad 3 Element Quad</b>	<b>\$447.00</b>
<b>TH5DXX Triband Supreme</b>	<b>\$528.00</b>
<b>TH7DXX Super Triband</b>	<b>\$643.00</b>

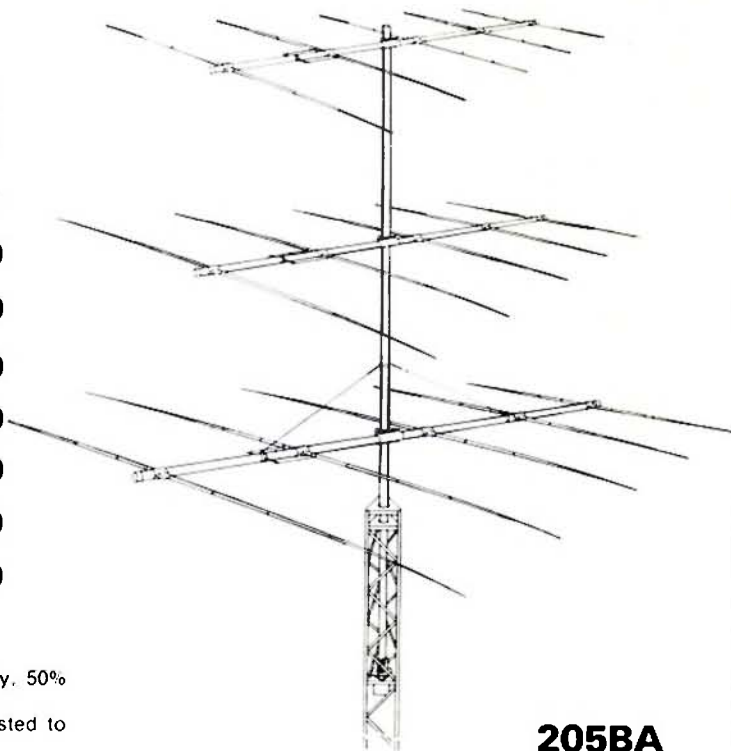

**205BA**

- Prices include Sales Tax.
- Delivery on some models 8-10 weeks approximately, 50% deposit required with order.
- Prices are equivalent to published USA prices, adjusted to Australian dollars, plus Australian Sales Tax.

## AUDIO TELEX COMMUNICATIONS PTY. LTD.

### **SYDNEY**

P.O. Box 421,  
1 Little Street,  
PARRAMATTA, 2150  
Phone: 633 4344

### **MELBOURNE**

P.O. Box 468,  
7 Essex Road,  
MT. WAVERLEY, 3149  
Phone: 277 5311

### **BRISBANE**

P.O. Box 871,  
42 Commercial Road,  
FORTITUDE VALLEY, 4006  
Phone: 52 1312

*Ring for prices or free catalogue.*





**VOL. 51, No. 2  
FEBRUARY 1983**

# amateur radio

Registered Office:  
3/105 Hawthorn Road,  
Caulfield North 3161.  
Tel. (03) 528 5962

**... in this issue ...**

A Call to all Amateurs .....	35
A Different Dipole .....	6
A Square One Receiver .....	14
Amateur Achievement .....	39
Emergency and Distress Calls .....	36
For You Antenna Buffs .....	23
HAAT is important .....	23
Heard Island Expedition .....	42
Improving the Duty Cycle of the FM 321 & 320 .....	25
Mayoral Letter .....	43
Radio Amateur Old Timers' Club QSO Parties .....	20
Red Cross Murray Canoe Marathon .....	17
Special Awards .....	43
The Raven .....	31
Two-Tone Oscillator .....	29
WCY '83 — Public Relations and Comments .....	37

**... departments ...**

A word from your Editor .....	11
ALARA .....	52
AMSAT Australia .....	48
AR Showcase — Radio Globe, Programmable Attenuator, HH Tcvt. TR7 PCB .....	34
Advertisers Index .....	64
Awards — VK Award changes, UK Prefixes, Blue Lake, Lighthouse & 2 African awards .....	40
Book Review — ARRL Antenna Handbook .....	52
Commercial Chatter — ICOM in Aust., free Fluke Literature, \$5 million contract .....	31
Contests — corrections RD, results 1982 Novice, rules Commonwealth (BERU) .....	30
Education Notes .....	35
Equipment Review — Kenwood TS-430S .....	22
Five-Eighth Wave .....	59
Hamads .....	63
Here's RTTY .....	38
How's DX .....	26
International News .....	28
Intruder Watch .....	47
Ionospheric Predictions .....	61
Letters to the Editor .....	60
Magazine Review .....	47
Main QSP .....	12
National EMC Advisory Service — comments on RSTV, CATV & DBS .....	50
Novice Notes — ATUs — Trick or Treat .....	18
Obituaries — VK2PX, VK3VZZ .....	62
Pounding Brass .....	39
QSP .....	25, 41, 46 & 56
Silent Keys — VK2PX, VK6VX, VK2YHD, VK7NR, VK5NSO, VK3VZZ, VK3IS .....	62
Spotlight on SWLing .....	53
Technical Correspondence — Update of G5RV .....	20
VHF UHF — an expanding world .....	44
VK2 Mini Bulletin .....	54
VK3 WIA News .....	58
VK4 WIA Notes .....	59
WIA News .....	8

**EDITOR:**  
BRUCE BATHOLS\* VK3UV

**TECHNICAL EDITORS:**  
BILL RICE\* VK3ABP  
EVAN JARMAN\* VK3ANI  
RON COOK\* VK3AFW  
GIL SONES\* VK3AUI

**CONTRIBUTING EDITORS:**  
BOB ARNOLD VK3ZBB  
ROY HARTKOPF\* VK3AOH  
RON FISHER\* VK3OM  
ERIC JAMIESON VK5LP  
LEN POYNTER\* VK3BYE  
MIKE BAZLEY VK6HD  
KEN McLACHLAN VK3AH  
REG DWYER VK1BR  
ROBIN HARWOOD VK7RH

**DRAFTING:**  
PETER KIMBER GEORGE BROOKS  
LIZZ KLINGE

**ADVERTISING MANAGER:**  
JOHN J A HILL VK3DKK

**BUSINESS MANAGER:**  
REG MACEY  
\*Member of Publications Committee

**Enquiries and material to:**  
The Editor  
PO Box 300, Caulfield South Vic. 3162

Copy is required the first of each month. Acknowledgement may not be made unless specially requested. All important items should be sent by certified mail. The editor reserves the right to edit all material, including Letters to the Editor and Hamads, and reserves the right to refuse acceptance of any material, without specifying a reason.

Material should be sent direct to **PO Box 300, Caulfield South Vic., 3162**, by the 25th of the second month preceding publication. Phone: (03) 528 5962. Hamads should be sent direct to the same address by the 1st of the month preceding publication.

**Trade Practices Act:** It is impossible for us to ensure that advertisements submitted for publication comply with the Trade Practices Act 1974. Therefore advertisers and advertising agents will appreciate the absolute need for themselves to ensure that the provisions of the Act are complied with strictly.

**Victorian Consumer Affairs Act:** All advertisers are advised that advertisements containing only a PO Box number as the address cannot be accepted without the addition of the business or residential address of the box-holder or seller of the goods.

**Production: BETKEN PRODUCTIONS**  
5 Masefield Avenue, Mooroolbark, 3138

**Laser Scanned Colour Separations by: QUADRICOLOR INDUSTRIES PTY LTD, Graphic Division**  
22-24 Glenvale Crescent, Mulgrave, 3170  
Tel.: (03) 560 2222

**Typesetting by: QUADRICOLOR INDUSTRIES PTY LTD,**  
22-24 Glenvale Crescent, Mulgrave, 3170  
Tel.: (03) 560 2222

**Printers: WAVERLEY OFFSET PUBLISHING GROUP**  
Geddes Street, Mulgrave, 3170  
Tel.: (03) 560 5111

**Photographic (film and processing material courtesy AGFA-GEVAERT LTD AUSTRALIA**

**on the cover**

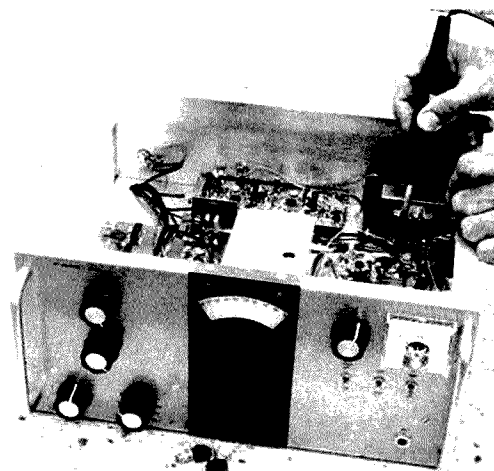

**The Square One Receiver designed and built by Drew Diamond VK3XU.**



# EMTRONICS

649 George St. Sydney, NSW. 2000 Phone: 211-0531.

**NEW**

## RTTY-CW-ASCII TERMINAL

### ONLY \$1090

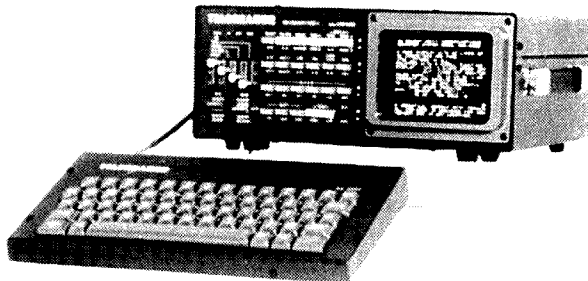

## "SWL-DREAM MACHINE" NEW CWR-670E TELEREADER

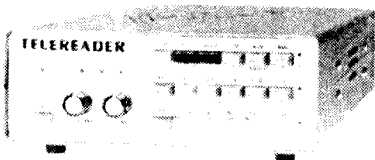

**ONLY \$447**

See What You've Been Missing!

Stay in touch with world events, monitor weather, press, ship traffic, and radio amateurs. Connect to your receiver and display shortwave radio teleprinter and Morse code transmissions with the new receive-only CWR-670E Telereader or CWR-610 Code Master

## NEW ECONOMY DECODER- CONVERTER

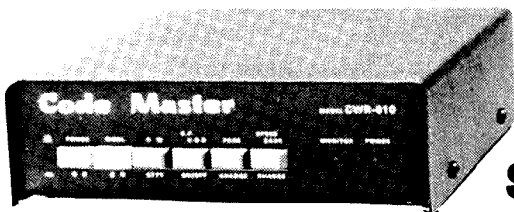

**Only \$247**

## CWR-685 TELEREADER

Yes, now you can take it with you! The new CWR-685E Telereader is the smallest RTTY and CW terminal available, complete with CRT display screen. Stay active with your RTTY and CW friends even while travelling. Some of the outstanding features of the CWR-685E are:

- Send and receive ASCII, Baudot, and Morse code
- RTTY and Morse demodulators are built-in
- RTTY speeds of 45, 80, 57, 74, 110, and 300 baud
- High or Low RTTY tones
- Send and receive CW at 3 to 40 wpm
- Built-in 5 inch green CRT display
- Four page video screen display
- Six programmable HERE IS messages
- Pretype up to 15 lines of text
- External keyboard included
- Runs on + 12 VDC at 1.7 Amperes.
- Small size (12.75 x 5" x 11.5")

## TELEREADER EXPORT VERSION

All above models are export versions and are available only from Emtronics. Japanese versions are useless in Australia or other countries.

As exclusive agents for all Telereader products we take no responsibility for service and/or spare parts for Japanese domestic models.

**NEW**  
the best  
from the  
USA

**ONLY \$1135**



## CT2100 COMMUNICATIONS TERMINAL

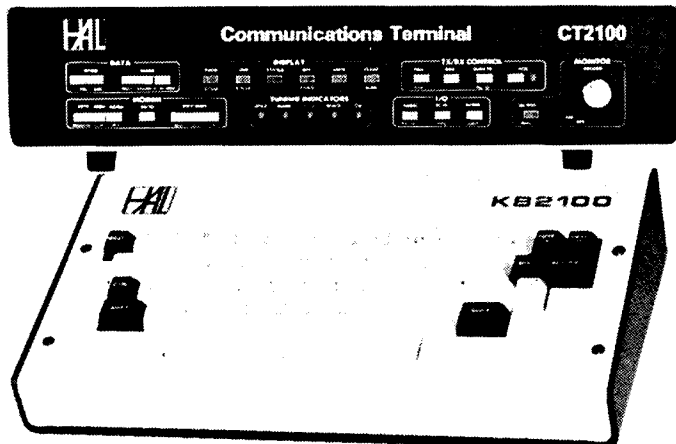

**KB2100 - \$255**

Compare feature for feature; you'll find that the CT2100 offers the most performance and flexibility for your dollar.

- Send or receive ASCII, Baudot, or Morse code
- RTTY and Morse demodulators are built-in
- RTTY speeds of 45, 50, 74, 100, 110, 300, 600, and 1200 baud — ASCII or Baudot
- FOUR RTTY Modems: "high tones", "low tones", "103 Modem tones", and "202 Modem tones"
- Three shifts for high and low tones (170, 425, and 850 Hz)
- Crystal-synthesized transmit tones
- Send and receive Morse code at 1 to 100 wpm
- Characters displayed on 24 line screen
- Choose either 30 or 72 characters per line
- 2 pages of 72 character lines or 4 pages of 38 character lines
- Split-screen for pre-typing transmit text.
- Audio, current loop, or RS232 data 1/0
- Printers available for hard-copy of all 3 codes
- On-screen RTTY tuning bar plus LED indicators
- ALL ASCII control characters; half or full duplex
- Brag-tape storage of 8-256 character messages in MSG2100 EPROM option
- Two programmable HERE IS messages

# NOVICE COURSE

## \* THEORY BOOK

- # covers entire theory for exams
  - # simple-to-follow text
  - # copious diagrams
  - # includes questions on each chapter
- \$7.50 incl. postage

## \* MORSE CODE TAPES

- # 5 word/min. Novice Tape
  - # 8/10/15 Word/min.
  - # 10 WPM exams
  - # 15 WPM practice
- all tapes \$5.00

Available from: G Scott, 11 Balmoral Cres.  
Surrey Hills 3127 Vic.  
Or: A. Bruce Smith, 110 Rosemead Rd.  
Hornsby, NSW 2077.



## NOTICE

All correspondence to Amateur Radio magazine and the Federal Office of the Wireless Institute of Australia should now be addressed to Post Office Box 300 Caulfield South, Victoria, 3162.



# BOOST YOUR SIGNALS WITH TONO!

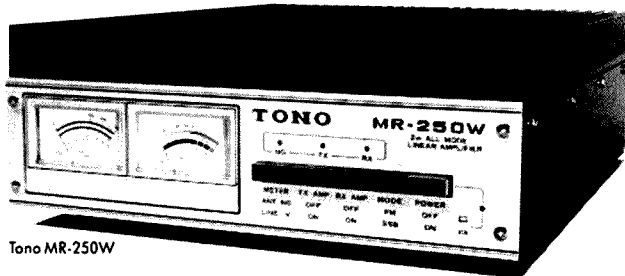

Tono MR-250W

With Tono linear amps you can boost those weak signals with this great range of tried and proven Tono Amps. With all-mode operation for versatility, they all share common supply voltage.

Models available are:

- 2M100W Tono 2M Linear Amp., 10-15W in 90W out.
- 2M50W Tono 2M Linear Amp., 3W in 30-45W out.
- 2M70W Tono 2M Linear Amp., 10W in 65W out.
- 4M50W Tono 70cm Linear Amp., 10W in 40W out.
- MR150W Tono 2M Linear Amp., 10W in 140W out.
- MR250W Tono 2M Linear Amp., 10W in 240W out.
- UC70 Tono 70cm Linear Amp., 10W in 60W out.

For the very best in communication and the latest in RTTY equipment, Tono is a brand that can't be beaten.

You can computerise your shack with the Tono Theta-9000E RTTY computer. It's ideal for the amateur or the professional, with an amazing array of features and capabilities.

Models available are:

- 9000E Tono RTTY Computer Incl. Word Processor
- CRT1200G Tono Video Monitor 12"

See the complete range of Tono equipment at Vicom's showroom in Melbourne. Alternatively, most reputable dealers stock Vicom products.

# VICOM

People to People.

MELBOURNE:

Vicom International Pty. Ltd.,  
57 City Road, South Melbourne, Victoria (03) 62 6931

SYDNEY:

Emtronics, 649 George St., Sydney (02) 211 0531

WELLINGTON, N.Z.:

Malvicom, 18 Raroa Road, Lower Hutt (4) 697 625

Dealer enquiries invited.

# INTRODUCING:

## THE COMMUNICATIONS ACCESSORY EVERY OPERATOR SHOULD HAVE

### Some of the features are:

- AMATEUR RADIO PREFIXES WITH STATE PREFIXES.
- GREAT CIRCLES.
- W.A.Z. ZONES.
- I.T.U. REGIONS.
- 10m BEACON LOCATIONS AND CALLSIGNS.
- THE MOST IMPORTANT STANDARD FREQUENCY AND TIME SIGNAL STATIONS.
- SHORTWAVE BROADCAST TRANSMITTERS.
- CONTINENTAL BORDERLINES.
- INTERNATIONAL DATELINE.
- DAYLIGHT/DARKNESS ZONES.
- TWILIGHT ZONES.
- SUNRISE/SUNSET TIMES.
- POSITION OF SUN DEPENDING ON DAY TIME AND SEASON.
- SUBSOLAR POINT PROJECTION.
- DISTANCE MARKINGS ON GREAT CIRCLES.

Price: \$169.00 ex warehouse Perth.

## "THE GRAY-LINE RADIO GLOBE" by Columbus



"THE GRAY-LINE RADIO GLOBE"  
(A WEST-GERMAN QUALITY PRODUCT)

For further information contact:

## RIALTO INTERNATIONAL

26 Karoonda Rd. Booragoo, W.A. 6154  
Tel. (09) 364 4768

Distributors for Columbus  
Terrestrial, Celestial  
and Lunar Globes



# ILP TOROIDALS — UNBEATABLE VALUE

ILP toroidal transformers meet modern day requirements for a smaller size, low magnetic interference field transformer. Featuring a nearly ideal physical construction, one can expect excellent performance. Small size and weight (approximately 50% of conventional transformers), extremely low noise and low magnetic interference field make the toroidal transformer ideal for compact power supplies.



TYPE	SERIES	SECONDARY RMS																		
	No.	Volts	Current																	
30 VA 70x30mm 0.45Kg	1X010	6+6	2.50	80 VA 90x30mm 1 kg	3X010	6+6	6.64	160 VA 110x40mm 1.8 Kg	5X011	9+9	8.89	300 VA 110x50mm 2.6 Kg	7X014	18+18	8.33	625 VA 140x75mm 5.0 Kg	9X017	30+30	10.41	
	1X011	9+9	1.66		3X011	9+9	4.44		5X012	12+12	6.66		7X015	22+22	6.82		9X018	35+35	8.92	
	1X012	12+12	1.25		3X012	12+12	3.33		5X013	15+15	5.33		7X016	25+25	6.00		9X026	40+40	7.81	
	1X013	15+15	1.00		3X013	15+15	2.66		5X014	18+18	4.44		7X017	30+30	5.00		9X025	45+45	6.94	
	1X014	18+18	0.83		3X014	18+18	2.22		5X015	22+22	3.63		7X018	35+35	4.28		9X033	50+50	6.25	
	1X015	22+22	0.68		3X015	22+22	1.81		5X016	25+25	3.20		7X026	40+40	3.75		9X042	55+55	5.68	
	1X016	25+25	0.60		3X016	25+25	1.60		5X017	30+30	2.66		7X025	45+45	3.33		9X028	110	5.68	
1X017	30+30	0.50	3X017	30+30	1.33	5X018	35+35	2.28	7X033	50+50	3.00	9X029	220	2.84						
Regulation				Regulation				Regulation				Regulation				9X028	110	5.68		
18%				12%	3X028	110	0.72	8%	5X028	110	1.45	6%	7X028	110	2.72	4%	9X029	220	2.84	
					3X029	220	0.36		5X029	220	0.72		7X029	220	1.36		9X030	240	2.60	
					3X030	240	0.33		5X030	240	0.66		7X030	240	1.25					
50VA 80x35mm 0.9 Kg	2X010	6+6	4.16	120 VA 90x40mm 1.2 Kg	4X010	6+6	10.00	225 VA 110x45mm 2.2 Kg	6X012	12+12	9.38	500 VA 140x60mm 4.0 Kg	8X017	30+30	8.33	Regulation				
	2X0011	9+9	2.77		4X011	9+9	6.66		6X013	15+15	7.50		8X018	35+35	7.14		30 VA	\$21.20	225 VA	\$48.20
	2X012	12+12	2.08		4X012	12+12	5.00		6X014	18+18	6.25		8X026	40+40	6.25		50 VA	26.60	300 VA	55.90
	2X013	15+15	1.66		4X013	15+15	4.00		6X015	22+22	5.11		8X025	45+45	5.55		80 VA	29.20	500 VA	77.30
	2X014	18+18	1.38		4X014	18+18	3.33		6X016	25+25	4.50		8X042	55+55	4.54		120 VA	33.00	625 VA	94.00
	2X015	22+22	1.13		4X015	22+22	2.72		6X017	30+30	3.75		8X028	110	4.54		160 VA	40.00	(+S.T. where app.)	
	2X016	25+25	1.00		4X016	25+25	2.40		6X018	35+35	3.21		8X029	220	2.27					
2X017	30+30	0.83	4X017	30+30	2.00	6X026	40+40	2.81	8X030	240	2.08									
Regulation				Regulation				Regulation				4%								
13%				11%	4X018	35+35	1.71	7%	6X025	45+45	2.50									
					4X028	110	1.09		6X028	110	2.04									
					4X029	220	0.54		6X029	220	1.02									
					4X030	240	0.50		6X030	240	0.93									

**IMPORTANT.** Regulator references - All voltages quoted are FULL LOAD. Please add regulation figure to secondary voltage to obtain off load voltage.

For 240 V primary substitute 2 in place of X in series numbering when ordering.

Rating	List	Rating	List
30 VA	\$21.20	225 VA	\$48.20
50 VA	26.60	300 VA	55.90
80 VA	29.20	500 VA	77.30
120 VA	33.00	625 VA	94.00
160 VA	40.00	(+S.T. where app.)	

To order or for further information please contact:

## ELECTROMARK Pty Ltd

40 Barry Avenue,  
Mortdale N.S.W. 2223  
Telephone (02) 533 4896

BANKCARD  
ACCEPTED

## **KNOXTRONICS ELECTRONIC SERVICES**

**SERVICE SPECIALISTS** for all types of **RADIO EQUIPMENT — TELEVISION RECEIVERS — STEREO and HI-FI and VIDEO RECORDERS.**  
Sales and Service of **CB Radio and Accessories, 27 MHz and UHF.**

## **EASTERN VIDEO CENTRE**

**VIDEO LIBRARY SPECIALISTS**, featuring latest releases from all major distributors. Video films to suit all tastes and requirements.

**LIBRARY MEMBERSHIP ONLY \$150 PER YEAR**, giving you unlimited exchange (one Video Cassette at a time). All titles in VHS and BETA formats.

Also Casual Video Film Rental Service.  
**BLANK VIDEO TAPES** at competitive prices  
**VIDEO RECORDER SALES and RENTAL**  
Special return mail service for country clients

**8 DARRYL STREET, SCORESBY, 3179**  
**PHONE (03) 763 8425**  
(SCORESBY SHOPPING VILLAGE)

W0806

## **WIDEST OPTIONS AVAILABLE**

Everything you ever wanted in  
Antennas and Antenna Accessories  
are Now Available including:

**“Antenna Specialists”  
and  
“Avanti”**

Our range optimises your range.  
Call us Now:

### **R. F. Industries**

**Melbourne (03) 570 1698**  
**Sydney (02) 519 5188**  
**Brisbane (07) 52 7600**

# **THE PROFESSIONALS**

## **THE TEST OF A PROFESSIONAL**

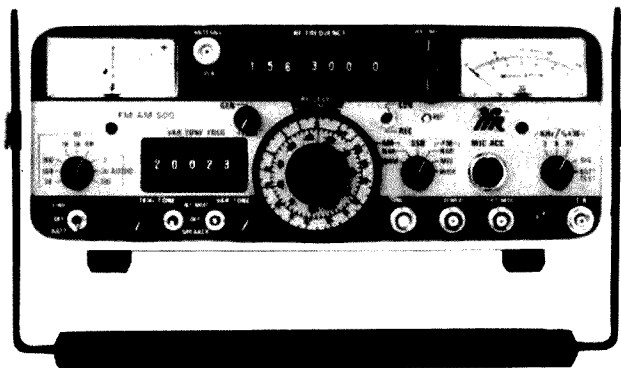

The IFR FM/AM-500 is a classic example of IFR design engineering. It incorporates the following features.

**STANDARD** • FM Signal Generator • AM Signal Generator  
• Sensitive 2uV receiver for AM, FM and SSB • 1kHz audio generator  
• Frequency error meter • Automatically protected generator output to 150 watts (no bothersome fuses to replace)  
• 0.5 PPM TCXO • Microphone/accessory input • Audio demodulator output • Low price

**OPTIONAL** • 0.2 PPM TCXO • 0.03 PPM oven oscillator plus high resolution frequency error meter (simulcast paging) • 10Hz to 9999.9Hz variable audio generator plus audio frequency error meter • Internal rechargeable battery (2 hour battery operation)  
• High output amplifier • Microphone • Telescoping Antenna

It weighs a remarkably low 7.2kg – 9.9kg with batteries and accessories, and is contained in a compact enclosure measuring only 29.2cm W x 12.5cm H x 36.2cm D. And it comes with Vicom's full two year warranty.

Inspect the IFR FM/AM-500 at your nearest Vicom office or agent (listed below).

Vicom. The Professionals. The official representatives of the most significant overseas companies in the Electronic Communication Industry. And backed up by Vicom's professional expertise and unbeatable after sales service.

**VICOM**  
People to People.

**VICOM INTERNATIONAL PTY. LTD.**  
57 City Road, South Melbourne, Victoria (03) 62 6931.  
Eagle House, 118 Alfred Street, Milsons Point, N.S.W. (02) 436 2766.  
Malvicom, 18 Rarua Road, Lower Hutt, Wellington, New Zealand (4) 697 625.  
Wormald Communications, 72-80 Rolgravia St., Belmont, W.A. (09) 277 8944.  
Elite Electronics, 8 Cox Road, Windsor, Q'ld. (07) 579 400.  
International Communications, 8 Nile Street, Port Adelaide, S.A. (08) 473 688.  
Navcom Electronics, 6 Manton St., Darwin, N.T. (089) 817 414.

# A DIFFERENT DIPOLE

Ray Wells VK2BVO

The coaxial dipole presented here is a variation of an HF design which has been described in a number of publications.

Claims for the antenna include improved bandwidth, Balun not required, less affected by proximity to trees etc, electrically quieter because the entire antenna is at ground potential and a direct match to 50 ohm coaxial feedline.

It is not the writer's intention to prove or disprove any of the above claims but merely to present his ideas on how to construct VHF/UHF versions. As can be seen, from the accompanying diagrams, two construction methods have been employed. One is a variation on the other. In method A, see fig 1, the entire antenna is made from a length of coaxial cable which, after construction, is suitably enclosed and weatherproofed. PVC conduit makes a very suitable enclosure.

Take note that the velocity factor of the coax used will affect the length of section "B". If there is any doubt as to the velocity factor of your piece of coax then DO NOT USE IT. Length "B" is an important dimension. For method B, see fig 2, the braid of the coaxial cable is removed and replaced with a suitably sized metal tube. 10mm OD

tube is a neat fit for RG8, UR67 style coax. The tube is cut for the total dipole length "A" with small brass plugs being used to provide the short between inner and outer conductors. The method used to achieve the short will depend on the material used but be guided by the following. Tin the brass slugs. If the tubing is copper or brass the plugs may be soldered in place through a small solder hole in the outer tube. If aluminium tube is used the plugs may be secured by some small screws into the brass slug. If the screws and tube are dissimilar metals then protection from the atmosphere will be necessary to avoid corrosion. In any case the brass plugs are first soldered to the inner conductor. Again dimension "B" is critical and remains dependant on the velocity factor of the cable used. With method B it is not necessary to enclose the entire antenna. Just seal up the ends of the tube and also the termination with the main feedline.

The author has constructed one of each type to date including 2m version using LDF4 hardline coax according to method A

and enclosed in PVC conduit for weather-proofing. This antenna was designed for 146.5 MHz and pruning of element lengths was not necessary to achieve the following VSWR characteristics; 144 MHz less than 1.2:1 146.5 less than 1.2:1 and 148 MHz 1.5:1.

A 70cm antenna was constructed in accordance with method B using 10mm aluminium tube and UR67 coax. It was designed for 435 MHz (Band Centre) and its VSWR was under 1.5:1 across the band (420-450 MHz). Again, these figures were obtained without the need to prune the element lengths.

These dipoles do work and offer a matching system and a construction method which is highly recommended to anyone looking for a simple yet rugged antenna. The elimination of external matching devices (gamma etc) make it an ideal portable antenna. Its on air performance is equal to any conventional unity gain antenna.

Reproduced by arrangement from 'Smoke signals' October '82 AR

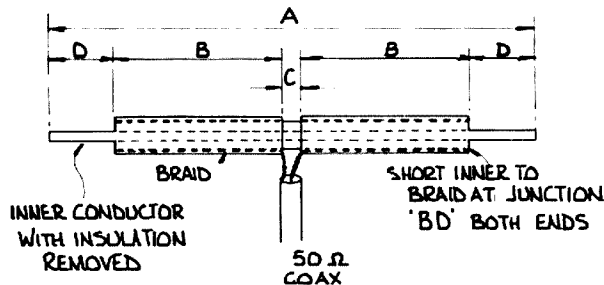

Fig 1: Method A. For construction — see table for dimensions

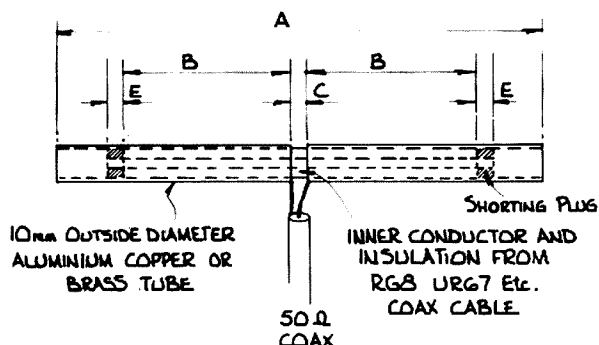
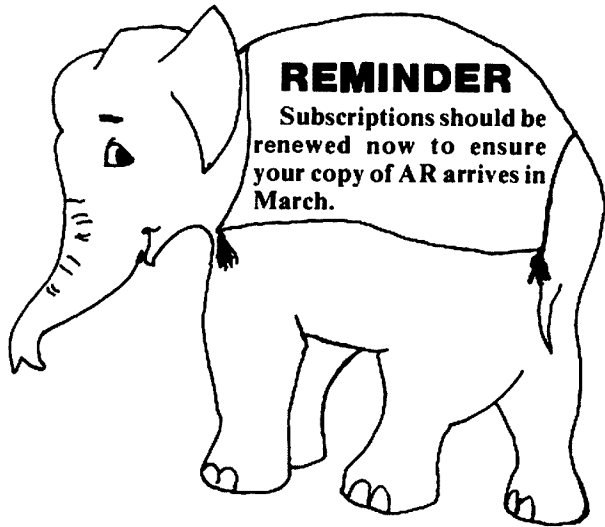

Fig 2: Method B. For construction — see table for dimensions

TABLE

Dimension	Remarks
A	Normal dipole length. $L(\text{mm}) = 299780 \times k$ $k = (\text{approx}) .9$ for 10mm tube @ 450 MHz $k = (\text{approx}) .93$ for 10mm tube @ 146 MHz
B (IMPORTANT DIMENSION)	Electrical $\frac{1}{4}$ wavelength. $L(\text{mm}) = 299780 \times v$ $v =$ velocity factor of coax used, allow .66 for RG8, UR67 etc. allow .88 for FHJ4, LDF4 etc.
C	The braid or outer jacket is removed for this dimension. Use 10mm for 2m band and 70cm band. A larger gap could be allowed for lower frequency bands.
D	Inner conductor without insulation. This length may be trimmed during final adjustment of antenna.
E	Shorting plug used to short inner conductor to outer tube. See comments in main text.



## REMINDER

Subscriptions should be renewed now to ensure your copy of AR arrives in March.

**MAGPUBS  
VHF  
COMMUNICATIONS**

Subscribers please note that annual subscription rates have been increased for 1983. The new rates are:

**By Airmail \$13.20**  
**By Surface \$ 9.00**

Subscriptions to : **MAGPUBS**  
— WIA PO Box 300 Sth  
Caulfield 3162.



# THE CONVENIENCE REVOLUTION



Daiwa CNA-1001

A brilliant line-up of high quality Amateur radio accessories from Daiwa.

Daiwa specialises in providing the very best in Amateur radio accessories.

You can set your antenna with a choice of Daiwa Heavy Duty and Medium Duty Rotators. They'll get you going in the right direction. Type X allows you to pre-set the call area you want and Type R comes with Paddle Switch control and world map display.

Daiwa Coaxial Switches give you low loss and good isolation. They all complement Vicom's own unbeatable relays and operate from HF to 70cm.

For hands off operation, the famous Daiwa cross-needle meters are ideal. They provide three measurements with the press of one PTT button. And their compact size means they'll fit into even the most crowded shack.

Daiwa make some of the most advanced Antenna Tuners on the market. both Automatic and Manual models are available. Their rugged design and ease of operation makes them a must for any Amateur station!

See the complete range of Daiwa accessories at Vicom's showroom in Melbourne. Alternatively, most reputable dealers stock Vicom products.



MELBOURNE:

Vicom International Pty. Ltd.,  
57 City Road, South Melbourne, Victoria (03) 62 6931

SYDNEY:

Emtronics, 649 George St., Sydney (02) 211 0531

WELLINGTON, N.Z.:

Malvicom, 18 Raroa Road, Lower Hutt (4) 697 625

Dealer enquiries invited.



# WIA NEWS

## AUSTRALIAN TABLE OF FREQUENCY ALLOCATIONS

As a result of lengthy negotiations by the WIA with the Department of Communications new frequencies have been allocated to amateurs. Still under discussion is the 50-50.15 MHz band which will hopefully be finalised this month.

Mr Ross Ramsey of the DOC wrote to the president on the publication of the tables thanking him for the part played by the WIA in the finalisation of the tables.

Further to the information given on the insert in the January issue of AR, a number of alterations have also been made to Australian VHF and higher amateur bands. Details of all changes are contained in the "Australian Table of Frequency Allocations October 1982" publication ISBN 0 644 01791 0 and now available from the Government Printing Service.

Briefly, changes to the VHF and higher frequencies are as follows:

52-54 MHz — No change

NOTE: A new allocation to amateur service (on a secondary basis) is included in the 50-52 MHz segment, however a frequency table footnote, AUS23 states —

"In the band 50-52 MHz, the amateur service shall not cause harmful interference to the broadcasting (television) service. Amateur operations in this band shall be subject to special conditions as determined by the Department of Communications from time to time."

At the time of printing (mid-Jan.) no part of the 50-52 MHz allocation is available to the amateur service as the special conditions referred to in footnote AUS23 are still under discussion between the Institute and the DOC.

144-148 MHz — No change, exclusive amateur allocation.

420-450 MHz — Remains a shared allocation, amateur secondary service.

576-585 MHz — No change, footnote AUS30 states:

"The band 576-585 MHz is also allocated to the amateur service until such time as the band is required for use by the broadcasting service."

1215-1240 MHz — Withdrawn, no longer available to amateur service world wide.

1240-1300 MHz — Remains a shared allocation, amateur secondary service.

2300-2450 MHz — Remains a shared allocation, amateur secondary service.

3300-3500 MHz — Remains a shared allocation, amateur secondary service.

3500-3600 MHz — New amateur allocation. Same status as for 3300-3500 MHz allocation.

5650-5850 MHz — Remains a shared allocation, amateur secondary service.

10.00-10.50 GHz — Remains a shared allocation, amateur secondary service.

24.00-24.05 GHz — Remains exclusive amateur allocation.

24.05-24.25 GHz — Remains a shared allocation, amateur secondary service.

47.00-47.20 GHz — New exclusive amateur allocation.

75.50-76.00 GHz — New exclusive amateur allocation.

76.00-81.00 GHz — New shared allocation, amateur secondary service.

119.98-120.02 GHz — New shared allocation, amateur secondary service.

142.00-144.00 GHz — New exclusive amateur allocation.

144.00-149.00 GHz — New shared allocation, amateur secondary service.

241.00-248.00 GHz — New shared allocation, amateur secondary service.

248.00-250.00 GHz — New exclusive amateur allocation.

Amateur satellite bands are as follows:

7000-7100 kHz

14000-14250 kHz

18068-18168 kHz — Available in future (ITU resolution 8)

21000-21450 kHz

24890-24990 kHz — Available in future (ITU resolution 8)

28000-297000 kHz

144-146 MHz

435-438 MHz

1260-1270 MHz

2400-2450 MHz

3400-3410 MHz

5650-5670 MHz

5830-5850 MHz

10.45-10.50 GHz

24.00-24.05 GHz

47.00-47.20 GHz

75.50-76.00 GHz

76.00-81.00 GHz

142.00-144.00 GHz

144.00-149.00 GHz

241.00-248.00 GHz

248.00-250.00 GHz

— Shared, refer to footnote 664.

— As above.

— As above.

— As above.

— As above.

— Shared, refer footnote 808.

— Shared, secondary allocations.

— Exclusive allocation.

— Exclusive allocation.

— Shared secondary allocation.

— Exclusive allocation.

— Shared secondary allocation.

— Shared secondary allocation.

— Exclusive allocation.

### NOTE:

1. Footnote 664 states:

"In the bands 435-438 MHz, 1260-1270 MHz, 2400-2450 MHz, 3400-3410 MHz (in Regions 2 and 3 only) and 5650-5670 MHz, the amateur-satellite service may operate subject to not causing harmful interference to other services operating in accordance with the Table (see No.



435). Administrations authorizing such use shall ensure that any harmful interference caused by emissions from a station in the amateur-satellite service is immediately eliminated in accordance with the provisions of No. 2741. The use of the bands 1260-1270 MHz and 5650-5670 MHz by the amateur-satellite service is limited to the Earth-to-space direction."

2. Footnote 808 states:

"The band 5830-5850 MHz is also allocated to the amateur-satellite service (space-to-Earth) on a secondary basis."

AR

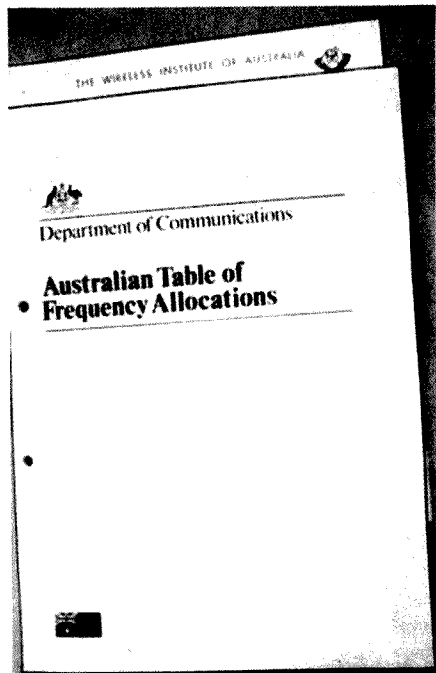

Information from DOC advises of revised arrangements concerning the issue of amateur radio station licences in respect to stations proposed to be operated in Australian External Territories. The listing hereunder details the State Offices and the Territories for which they are responsible.

STATE OFFICE	TERRITORY
New South Wales	Norfolk Island
Queensland	Coral Sea Island Group
	Willis Island
Western Australia	Christmas Island
	Cocos (Keeling) Islands
Tasmania	Heard Island
	Macquarie Island
	Australian Antarctic Mainland

Unnecessary delays will be avoided if in future all applications and enquiries are submitted to the Manager of the appropriate State, in accordance with normal procedure, as outlined in the Department's general licensing brochure RB68 and the information given above.

AR

\* Please remember your STD code when advertising in HAMADS.

THE PROFESSIONALS

# THE PROFESSIONAL SIGNAL

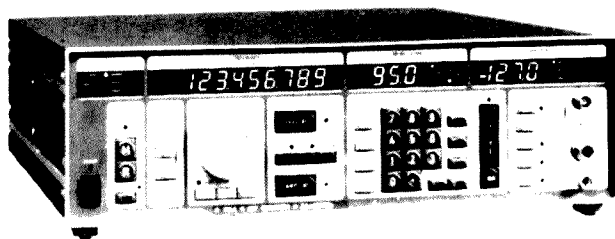

The Adret 740A Signal Generator is an advanced instrument incorporating the latest achievements of frequency synthesis and microprocessor management. It has exceptional ease of operation and incorporates the following features.

- 100kHz - 520 MHz
- 100kHz - 1120 MHz (with doubler option)
- AM-FM-PM-PULSE (option)
- Spin wheel or keyboard entry of all parameters
- Permanent storage of 40 complete configurations
  - 10Hz resolution
  - RF auxiliary output
  - IEEE488
- 20 ns switching time
- Clear and unambiguous controls
- Stability  $1 \times 10^{-7}$  per day

The Adret 740A Signal Generator is available from your nearest Vicom office or agent (listed below).

Vicom. The Professionals. The official representatives of the most significant overseas companies in the Electronic Communication Industry. And backed up by Vicom's professional expertise and unbeatable after sales service.



VICOM INTERNATIONAL PTY. LTD.,  
 57 City Road, South Melbourne, Victoria (03) 62 6931.  
 Eagle House, 118 Alfred Street, Milsons Point, N.S.W. (02) 436 2766.  
 Malvicom, 18 Raroo Road, Lower Hutt, Wellington, New Zealand (4) 697 623.  
 Wormald Communications, 72-80 Belgrovia St., Belmont, W.A. (09) 277 8944.  
 Elite Electronics, 8 Cox Road, Windsor, Q'ld. (07) 579 400.  
 International Communications, 8 Nile Street, Port Adelaide, S.A. (08) 473 658.  
 Navcom Electronics, 6 Mantou St., Darwin, N.T. (089) 817 414.

# KENWOOD



## TR-7950 2M FM TRANSCEIVER

**\$480** COMPLETE WITH MOBILE ANTENNA

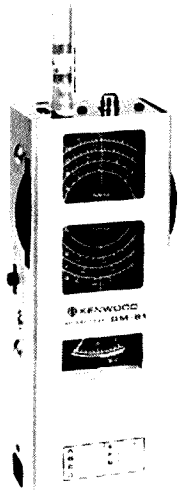

## DM-81 DIP METER

**\$95**  
WITH FREE BATTERIES



## NEW R-2000 RECEIVER WITH MEMORY SCAN, PROGRAMME SCAN & MEMORY MODE RETENTION

**\$599** OPTIONAL VHF CONVERTER  
AVAILABLE EASTER '83

**1983 is the year  
for Huge Savings  
on most of  
Kenwood's models!**

Dr. David Lewis leader of the 1982/83 Oceanic Research Antarctic Expedition has chosen Kenwood Communications Equipment on board the "Dick Smith Explorer". Where lives and safety are paramount and reliability is of prime importance - the professionals always choose **KENWOOD**

**PLUS  
FREE  
HAND  
MIKE**

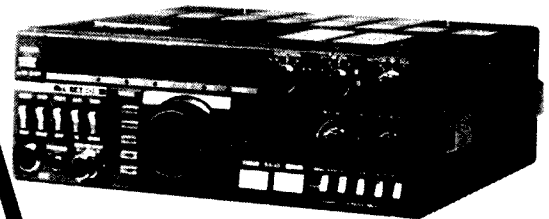

**TS-430S NOW AVAILABLE EX STOCK!**  
**\$950** with  
Mobile Mount (FM additional \$49)

**TRIO-KENWOOD (AUSTRALIA) PTY. LTD.**  
(INCORPORATED IN N.S.W.)  
4E WOODCOCK PLACE, LANE COVE, SYDNEY, N.S.W. 2065. Ph. (02) 428 1455.

### NEW SOUTH WALES

SPRINGWOOD CAR RADIO — SPRINGWOOD (047) 51 4930  
UNIQUE ELECTRONICS — 383 MERRYLANDS ROAD, MERRYLANDS (02) 682 3325  
WASSELL ELECTRICAL — 10 MCNAMARA STREET, ORANGE (063) 62 6249  
STOCKMAN & HIGGINS — BYRON STREET, INVERELL (067) 22 1300  
ELECTRON 2000 — 3 ELIZABETH STREET, TIGHS HILL, NEWCASTLE (049) 69 6399  
MACELEC PTY LTD — 99 KENNY STREET, WOLLONGONG (042) 29 1455  
RADIO WORLD PTY LTD — 81 NEWCASTLE STREET, Fyshwick (062) 80 6550  
OX ENGINEERING — 5 JASMINE STREET, PORT MACQUARIE (065) 83 2127  
LAND LINK — MULLALEY ROAD, GUNNEOAH (067) 42 2838  
LAND LINK — 61 BARNES STREET, TAMWORTH (067) 65 4622

### INTER-STATE

VIC: EASTERN COMMUNICATIONS — 168 ELGAR ROAD, BOX HILL (03) 288 3107  
BRIAN STARES — 11 MALMSBURY STREET, BALLARAT (053) 39 2808  
SUMMER ELECTRONICS — 78 KING STREET, BENDIGO (054) 43 1977  
CODLIN ELECTRONICS — MOE (051) 27 4516

TAS: HOBBY ELECTRONICS — 83 CARELLA STREET, HOWRAH, HOBART (002) 47 6674  
GELSTON ELECTRONICS — 40 LAVENDER GROVE, SUMMER HILL (003) 44 3882  
ADVANCED ELECTRONICS — 5A THE QUADRANT, LAUNCESTON (003) 31 7075  
V.K. ELECTRONICS — 57 WEST PARK GROVE, BURNIE (004) 31 1708

QLD: MITCHELL RADIO CO — 59 ALBION ROAD, ALBION (07) 57 6830  
S.A. & M.T.: INTERNATIONAL COMMUNICATIONS SYSTEMS PTY. LTD. — 8 NILE ST. PORT ADELAIDE (08) 47 3688  
W.A.: ARENA COMMUNICATIONS SERVICES — 642 ALBANY HWY, EAST VICTORIA PARK (09) 361 5422  
TRI-SALES — CNR NEWCASTLE & CHARLES STREETS, PERTH (09) 328 4160  
WILLIS ELECTRONICS — 73 STERLING STREET, PERTH (09) 328 9229  
GRAHAM ROGERS — 18 BANKSIA STREET, BUNBURY (097) 21 2236  
RON DENT — 115 PATON ROAD, SOUTH HEOLAND (091) 72 1112

# a word from your EDITOR



## 1983 AND ONWARDS

Now that the Christmas and New Year holidays are well behind us, it is time to face reality and start work again. This year we can foresee another busy year ahead for the Institute. Of prime importance at this time of the year is our forthcoming Federal Convention, to be held as usual at the Brighton Savoy motel, in Melbourne. The dates for the convention are April 23, 24 and 25, — that is only a little over **two months away**.

I can recall writing something similar this time last year, to remind readers of the need to forward your thoughts to your division early, so that your divisional representatives are adequately briefed in the presentation of your particular item.

Remember, under our constitution, all agenda items must be in the hands of the Federal Secretary 30 days prior to the convention. This is to enable agenda items to be forwarded to and discussed by the other divisions, so that a particular policy may be determined and voting cast accordingly. WIA policy is determined by the divisions, and **NOT** the Executive as some of our members have thought recently.

If you have a pet theory which you think is worthy of consideration, it **MUST** be submitted to your division for discussion first. Your division's representatives will decide whether or not your item is to become a convention agenda item at its next council meeting.

Too much convention time has been wasted in the past in dealing with agenda items which are of a local or parochial nature. The WIA policies as determined by the seven councillors at the convention reflect matters of **NATIONAL** importance, and embrace **all** amateurs throughout Australia.

The executive itself has the power to raise items to be placed on the agenda, but it is unable to vote on their acceptance or otherwise. The executive items are usually restricted to matters of administration, or Department of Communications liaison etc. The executive cannot accept agenda items direct from members.

Time is again closing in on us, and at the time of writing this editorial (1st January '83), only one agenda item has been raised so far. You should act immediately, and advise your division of your thoughts so that adequate investigation and preparation can be made on your behalf.

Visitors to the convention as usual will be made most welcome. To enable proceedings to continue without interruption, I would ask those members intending to 'look in' for a short while, could you let your councillor know in advance, and appropriate measures will be taken to ensure sufficient seating is available.

## RADIO MASTS INVESTIGATION

An item which will have gone unnoticed by many of you appeared in the Victorian Government Gazette during December 1982. It was only a small and insignificant announcement, but the ramifications contained therein could have far reaching effects on the entire amateur radio community. I refer to the proposed government investigation into the erection of radio masts and the environment. Full details of the announcement are published elsewhere in this issue, please read that item thoroughly.

## TWO HATS

Following the resignation of the Federal President, Mr Peter Wolfenden VK3KAU as announced on the federal tapes recently, the President's chair will be kept warm by yours truly in my capacity as Executive Vice Chairman. This appointment is for an interim period only up to the coming Federal Convention, when a new Federal President will be officially appointed.

## WCY

Most of you will have noticed our involvement with the World Communications Year (WCY '83) celebrations. This is an important step for the WIA and we trust all will be able to make some small personal contribution (not money!) to ensure its every success.

Publicity in the media for our hobby cannot be bought, it must be earned. The national dailies and commercial TV and radio stations are mainly interested in news of 'sensational' nature. Confusion by reporters and editors in comparing the amateur radio service and the citizens band radio (CB), more often than not tends to be detrimental to the amateur service. In their eyes, every person that operates a radio transmitter is a 'CBer', and 'CBers' and 'HAMS' are one and the same!

Naturally this type of publicity also confuses the general public, a point which we are all aware of, but have done little to rectify.

As part of the WCY preparations, the federal WIA is co-ordinating ideas from the divisions and is putting together various 'packages' which can be of use in the education of the general public.

One factor that is often overlooked is the local weekly newspaper. From past experiences, it has been shown that editors of local papers are more willing to accept news of a less sensational or insignificant nature. This is mainly because of the 'local' effect and its general interest impact on a smaller (by comparison) population and circulation.

News of clubs doings, WICEN, educational courses, community displays at the local level etc are able to be publicised quite effectively by this means. It is an area worth fostering further, but it does require an amateur in the local area to make the initial contact with those in control. I would ask that we all make a conscious effort to ensure suitable publicity is arranged for events which you consider are newsworthy, and which do not contravene the terms of the secrecy provisions associated with your licence.

## AR

This year also shows promise of a further successful year. Already plans are well advanced to bring you further 'bumper' issues, due mainly to our increased membership and support generated by our advertisers. There are some excellent technical articles in the preparation stages, and we intend to continue to improve the high quality publication you have come to expect from last year.

We would like to thank those members who have given us words of encouragement recently.

If you have not yet renewed your current subscription, then this will be your last issue of AR. Members who have not paid their 1983 subs by the 15th February will have their names deleted from our computer address labels. There is no guarantee that missed AR's will be replaced in the event of a subsequent renewal.

This seems a pity, but we must contain costs within our operating budget therefore only sufficient magazines will be printed to allow for distribution to the paid up members. Both of us are therefore the loser.

Your financial support through your membership subscription enables the WIA to continue its work to represent your interests. Without your individual membership support, we go backwards.

*Please give this serious thought.*

**Bruce R. Bathols, VK3UV,  
WIA Acting President and AR Editor.**

AR

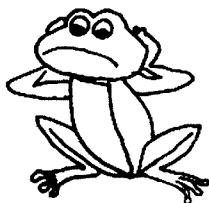

# QSP



## YOUR HOBBY IS UNDER THREAT

Intruders, pirates, interference, restrictions by Government decree on one hand and not enough on the other, these are the threats that face us. It is imperative that you are aware of these dangers and know how to combat them. It is essential that you keep yourself informed of all aspects of these threats.

There are intruders in our bands, broadcasters and commercial point to point services. There is a world wide intruder watch organization supported by most national societies, but it comes down to you, the individual amateur, to be the intruder watcher. The incidence of pirates appearing on our frequencies is increasing. How do you handle these situations?

Then there is EMC, electromagnetic compatibility. We all suffer from interference of one sort or another, often that which can be easily stopped at its source. In turn, we, ourselves, can cause interference to entertainment devices in our own and in our neighbours homes. How prepared are we to deal with these threats to our operating time?

Government regulation and the lack of it hangs over our heads, both local and federal. Already, in a number of states, court cases regarding aerial masts and towers have been fought. The lack of regulation allows all sorts of interference to continue unabated, and also allows transmitting equipment to be sold by anyone to anyone without question of licence.

These are the changes that amateur radio faces today but they pale into insignificance when we consider the greatest danger of all — APATHY.

**Bud Pounsett VK4QY**  
Editorial in QTC  
VK4 Division AR insert  
November '82

# MORE SCAN FOR YOUR DOLLAR

with the brilliant

## DICK SMITH PRO 40 SCANNER

Compare this superb Scanner with others of similar performance elsewhere, at nearly twice the price! The new PRO 40 Scanner from Dick Smith represents the state-of-the-art in computerised scanning receivers! Completely solid state computer-controlled circuitry - no expensive crystals to buy - complete with battery backup for stored frequencies.  
Cat D-2805

**\$399**



Also available from good bookshops and newsagents

## DICK SMITH'S AUSTRALIAN RADIO FREQUENCY HANDBOOK

Up-to-date and thorough listings of virtually all the VHF/UHF radio users we've been able to find. YES - find out who is where - and where to listen for all the excitement! PLUS: air band, marine band, and how to use a scanner, amateur radio and CB etc.  
Cat B-9600

**\$12<sup>95</sup>**

## SCAN X ANTENNA

Designed especially for scanners! Very easy to assemble, comes complete with 15m cable and plugs.

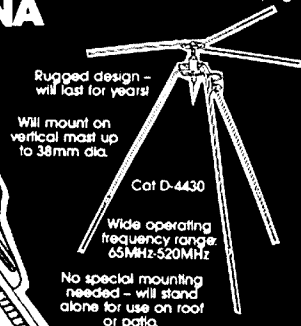

Rugged design - will last for years!

Will mount on vertical mast up to 38mm dia.

Cat D-4430

Wide operating frequency range: 65MHz-520MHz

No special mounting needed - will stand alone for use on roof or patio.

**\$49<sup>95</sup>**

## you can hear . . .

Just about everything from harbour control nudging a supertanker into its berth, to telephone conversations from cars speeding along city streets! All the emergency services, authorities and forces . . . And of course, there are thousands of business radio stations, amateur and CB radio operators. Plus the thousands of stations in the band that we don't know about yet (we're waiting for you to tell us about them!)

## look at these special features

Touch-type, splash proof keyboard for direct entry of all operational commands, frequencies, etc. Ideal as either a base or mobile scanner (operates on 12V - beware of others that don't operate from 12V!) with its own self-contained whip antenna or external plug-in antenna. Also included is a specially prepared Australian instruction manual written and produced by our own engineers.

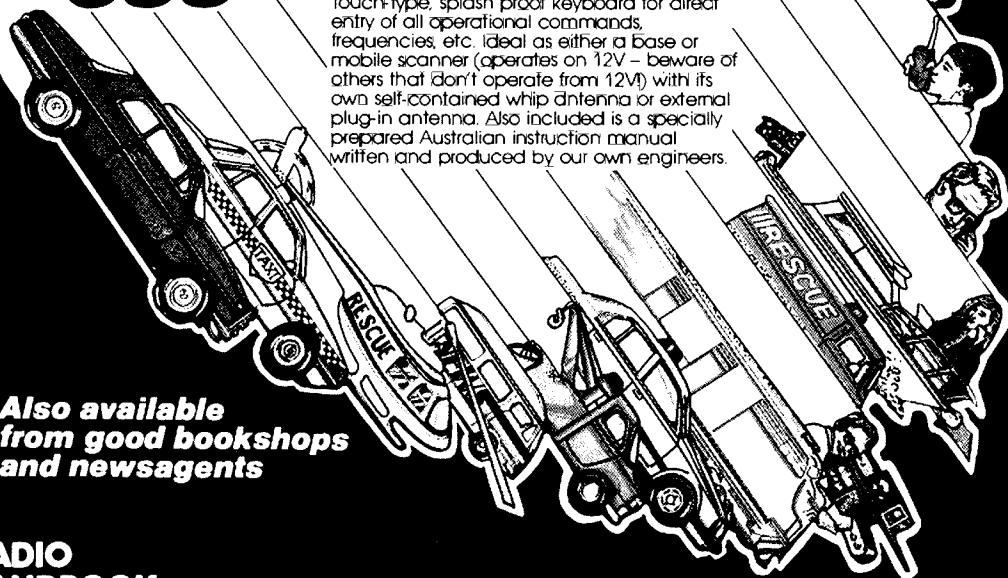

# DICK SMITH Electronics



DSE A413-LM

# A "SQUARE-ONE" RECEIVER

## Part 2

Drew Diamond, VK3XU,  
43 Boyana Cres., CROYDON, 3136

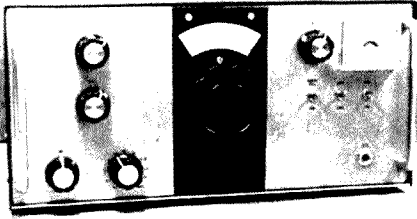

## CIRCUIT DESCRIPTION

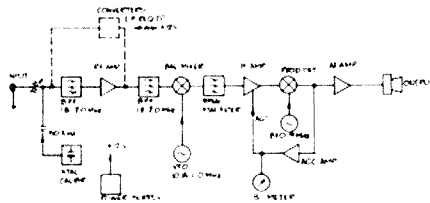

Block Diagram of Square One Transceiver.

on-air performance indicates that it is adequate for most listening conditions. Not a bad filter for under \$20.

The IF amplifier is tuned to 9MHz, and provides the greatest gain block in the receiver — about 50dB. CA3028s are used at U2 and U3 in the single-ended mode. A voltage is applied to pin 7 of U2 and U3 to effect AGC action. When a very strong signal is tuned in, the AGC line will drop to about +2V, and reduce the gain of the IF amplifier. When a weak, or no signal is applied, the AGC voltage will be about +8V, so allowing maximum IF gain.

The product detector performs similarly to the mixer already described, with the exception that IF plus or minus BFO equals audio. One

9MHz crystal filters have become hard to obtain, so 27MHz third overtone CB crystals were tried. By choosing crystals whose 9MHz fundamental frequencies are about 3kHz apart, a reasonable half-lattice filter can be made. The -6dB points were measured at 9005 and 9008kHz, passband ripple was less than 1dB, and insertion loss was about -6dB. Equipment was not available to measure shape factor, but

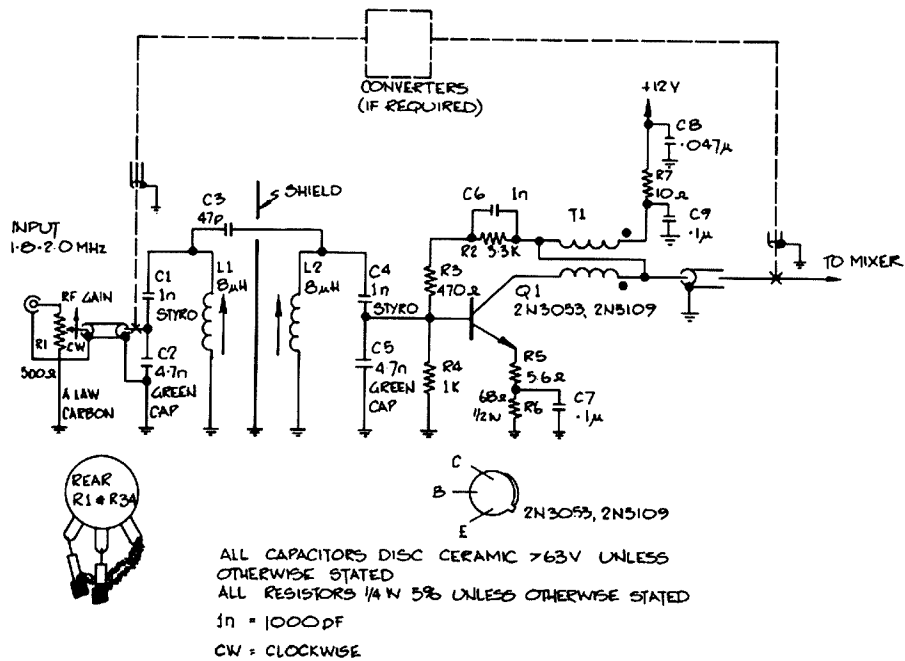

Figure 1 — RF Amplifier

The input RF amplifier is only used for reception of the 1.8 to 2.0MHz band. Ideally, a transistor specifically designed for this application, such as a 2N5109 or a 2N5179 should be used at Q1 to obtain low noise figure and high dynamic range. These devices are difficult to buy in small quantities however, so the easily obtainable 2N3053 was tried and found to perform satisfactorily. This stage has a gain of 10dB. It employs a bipolar transistor with feedback, and as a result is not easily overloaded or damaged by the application of excessively large signals. Rejection of out of band signals is obtained with a band-pass filter at the input and output of the RF amplifier. Input and output impedances are approximately 50 ohms.

Receivers with high dynamic range — greater than about 80dB, have become necessary due to the large number of strong signals which may be encountered on HF bands today. Much has been written lately about mixers and amplifiers with high dynamic range, and experimenters seem to favour the ring Schottky diode mixer. During the development of this receiver, IMD measurements were performed upon active mixers and a ring diode mixer. It was found that a dynamic range of 83dB could be obtained with the ring mixer, and 80dB using a CA3028 active mixer. However, the ring mixer required at least +10dB (10mW) of local oscillator signal to achieve this performance, had a -6dB insertion loss, the diodes were hard to obtain, and a weak spurious was noted at 1.812MHz. In view of these disadvantages, and the only marginally better performance, an active mixer was employed.

The mixer is singly balanced, and has 0dB gain. U1, a CA3028 differential pair is driven in push-pull via input transformer, T2. The 100 ohm resistors R10 and R11 terminate the balanced secondary of the mixer is close to 50 ohms. VFO at 10.8 to 11.0MHz is injected into the current source transistor of U1 in common mode, so little or no VFO signal appears at the output of the mixer. 9MHz IF energy is coupled via T3 to the crystal filter. Once again, 100 ohm resistors are used to obtain correct impedance values. R12 and R13 have the additional function of absorbing mixer products which are not at the IF, thus reducing their amplitude and the danger of reduced dynamic range. A diplexer is therefore not required.

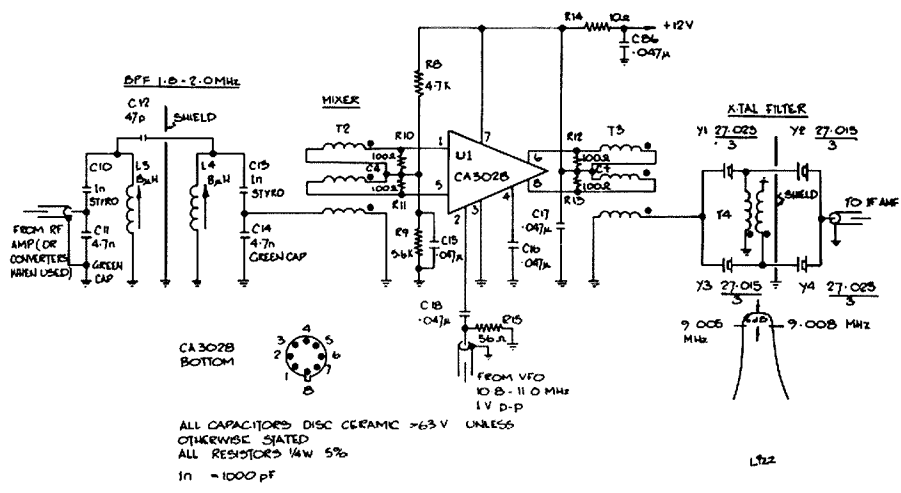

Figure 2 — Mixer and 9MHz Crystal Filter

Detected audio is divided into two paths at the secondary of T5. Audio gain is set by the front panel pot, R34. Some preamplification is provided by Q7 before the audio signal is applied to the ever-popular LM380 at U5, which supplies sufficient power to operate speaker or headphones.

crystal at about one third its marked frequency of 27.015 supplies BFO frequency. For USB reception, the BFO must be on the high side of the IF passband, eg, signal on 1.800, VFO on 9.008 + 1.800 = 10.808MHz. Now, if a modulating signal upon the incoming signal is 1kHz (1.801), 10.808 - 1.801 = 9.007MHz. 9.007 beats with 9.008 BFO and so produces 1kHz audio at the secondary of matching transformer T5. For LSB, the BFO must be on the low side of the IF passband. To supply 9.005MHz, the crystal Y5 is pulled low by the use of series inductor L10, switched in by removing the ground from the base of Q3. To produce 9.008MHz, the crystal is pulled high by switching in series capacitor C56 with the removal of the ground at the base of Q4.

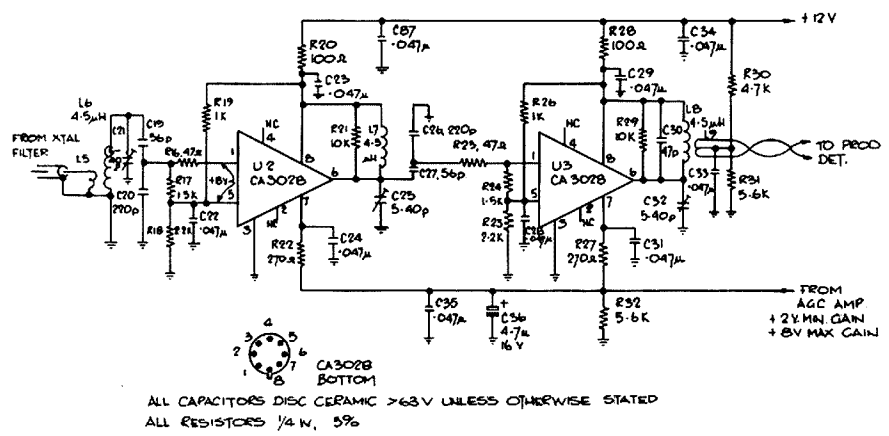

Figure 3 — 9MHz IF Amplifier

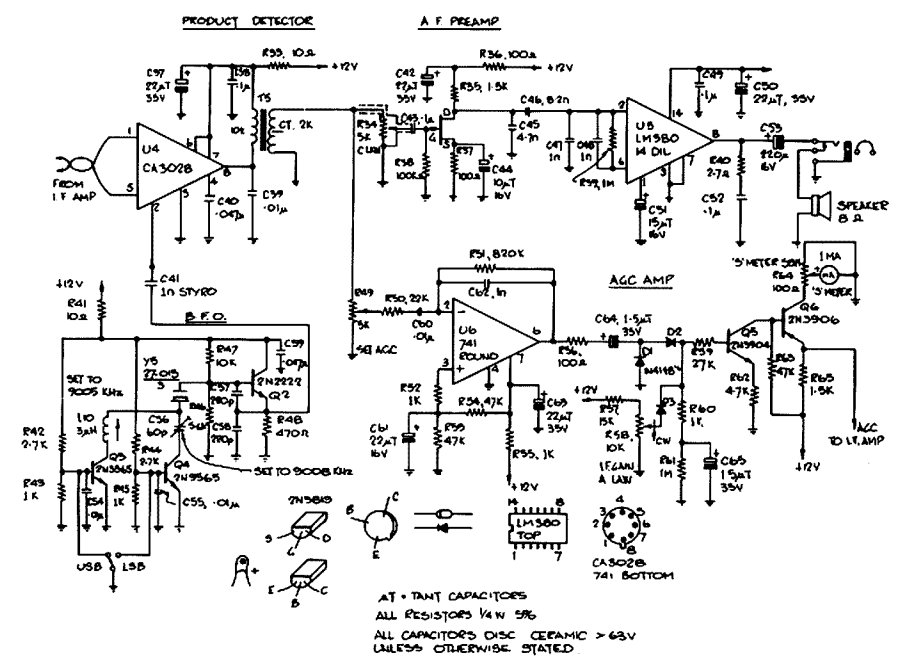
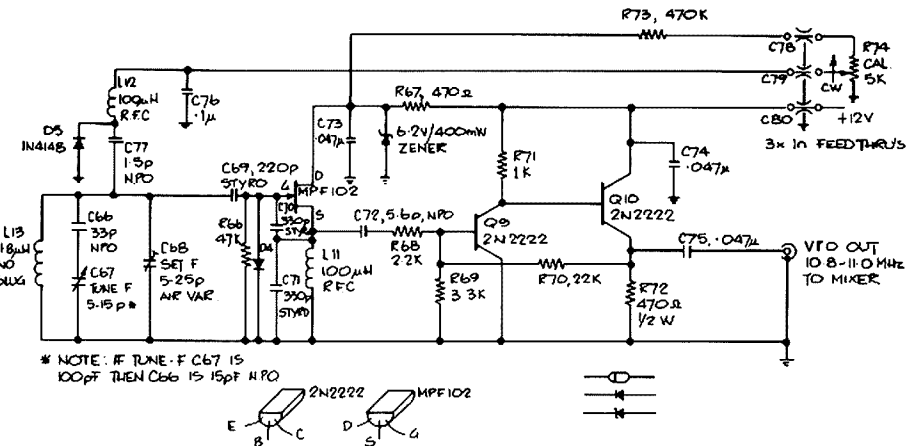
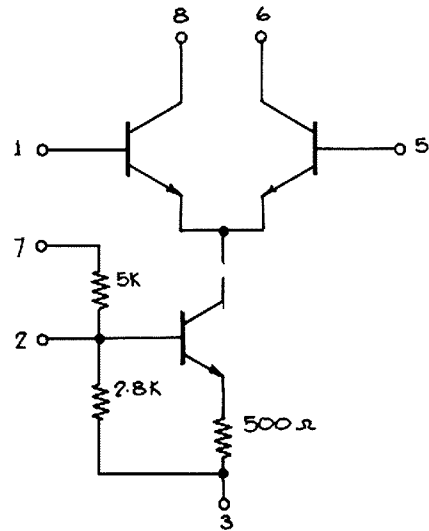

Figure 4 — Product Detector, AF Amplifier and AGC Amplifier

A small proportion of audio is picked off via R49 and applied to the AGC amplifier U6 — an ordinary LM741. Amplified audio is rectified by D1 and D2, and C65 is charged with a positive voltage which is proportional to the audio level of the received signal. AGC time constant is set by R61 and C65. The values indicated are a fair compromise for CW and SSB AGC characteristics. A DC amplifier, U5 and Q6, supplies the CA3028 compatible AGC voltage.



ALL CAPACITORS DISC CERAMIC >63V UNLESS OTHERWISE STATED  
 ALL RESISTORS 1/4 W 5% UNLESS OTHERWISE STATED  
**Figure 5 — VFO (Local Oscillator) 10.8-11 MHz**



**Figure 8 — Internal Circuit of the CA3028**

As collector current in Q6 is proportional to signal level, a millimeter is connected here to indicate signal strength. Manual IF gain control R58 injects a positive voltage into the base of Q5 to decrease the gain of the IF amplifier. Use of this gain control will only be necessary when extremely strong signals are being received.

Part Three will have construction details and board layouts.

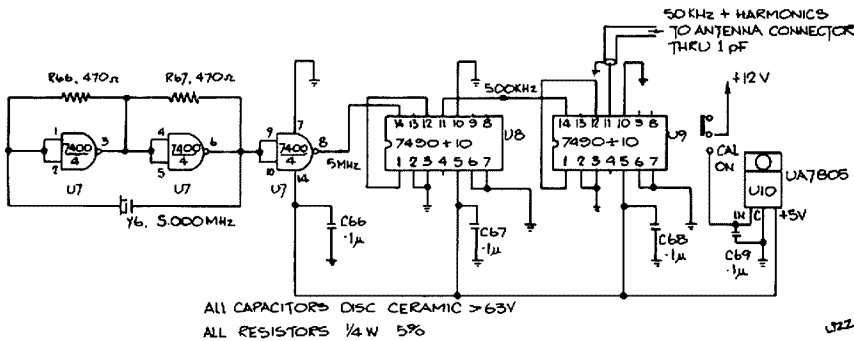

**Figure 6 — Crystal Calibrator**

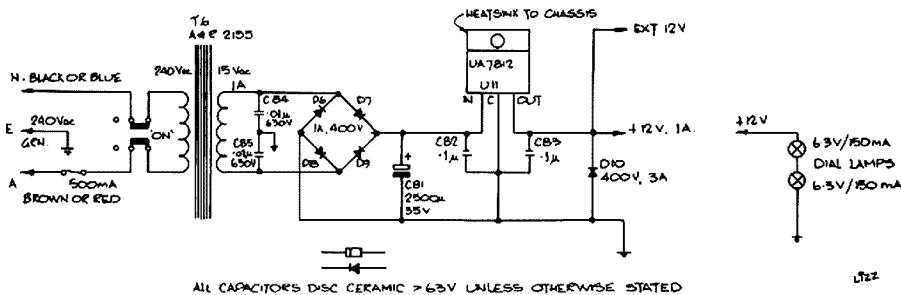

**Figure 7 — Power Supply**

References:

1. Solid State Design — ARRL.
2. ARRL Handbook — 1980.
3. ARRL Handbook — 1982.
4. Radio Communication Handbook — RSGB.
5. "Modern Receiver Mixers for High Dynamic Range" — QST Jan. '81.





# RED CROSS MURRAY CANOE MARATHON



Gil Sones VK3AUI  
30 Moore Street, Box Hill South.

**Between Christmas and New Year, a group of amateurs provided communications for the conduct and safety of the annual Red Cross Murray Canoe Marathon. This is the major WICEN practice exercise in Victoria. Operators taking part provide essential communications and safety links for the conduct of the marathon.**



**Checkpoint in Barmah Forest**



**Small Power Boat ferrying operator VK3XNW.**



**Nell VK3XNW operating on boat "Relax 78".**

The Red Cross Murray Canoe Marathon is a major canoeing event with a course of four hundred kilometres on the Murray River. The start is at Yarrawonga on Boxing Day, the 26th December and the finish is in Swan Hill on New Years Eve, 31st December.

WICEN operators set up stations at the start and finish of each days course and at intermediate checkpoints. Stations are also set up in power boats on the river and, this year, in an ambulance. Other stations are attached to mobile key officials and first aid teams.

As the marathon moves down the river, camps are established in a different town each night. Whilst facilities are steadily improving, the number of participants is also growing each year.

New ideas and techniques are tried to handle the volume of traffic. This year RTTY was tried with mixed results. The main lesson being that well established and field proven stations were required. Heat, dust and mobile power supplies can really play hell with sophisticated equipment.

Weather conditions are usually hot and it is usual for there to be one storm during the period. This year was no exception with a damp night in Echuca and a violent combination of dust and electrical storms at the finish in Swan Hill.

The drought meant that the river level was down on previous years, however the flow of water for irrigation was sufficient to

ensure the conduct of the event. Even the larger power boats were able to follow the canoes right through to Swan Hill.



**Ken VK3ALO operating RTTY at one of the checkpoints during the 1982 Murray Marathon. AN**

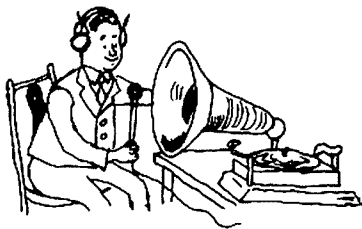

# NOVICE NOTES

Compiled by  
 Ron Cook, VK3AFW  
 7 Dallas Avenue, Oakleigh Vic 3166.

## Antenna Tuners — Trick or Treat?

This month we will discuss the general theory of antenna tuners in a descriptive manner followed by a practical design next month.

At some time in your amateur career you will be faced with the problem of using a single wire antenna or perhaps a dipole as a multi-band antenna. Assuming that you have a modern rig, connecting a feedline with a VSWR greater than 2:1 is undesirable and a VSWR greater than 3:1 unacceptable. So what can you do as the VSWR of an off-resonant antenna may be 10:1 and, if Murphy has his say, that's exactly the situation you will be facing. The answer is of course an Antenna Tuning Unit or an ATU for short.

Naturally your junk box has all the necessary bits but before you rush out and start drilling holes in Mother's aluminium baking dish or her best cake tin (what else would you use for a chassis?) lets consider the various circuit configurations. Indeed how does any ATU work?

### THE FUNCTION OF AN ATU

An ATU must perform two functions. Firstly it must resonate the antenna-feeder system. Secondly it must transform the resulting resistive load to the one required by the transceiver, which we will assume is 50 ohms.

series it will be resonant with the capacitor giving a zero series reactance so we are left with a 10 ohm load which is a VSWR of 5:1. A step-up transformer with a turns ratio of 2.24: 1:2.24 will give the perfect match we desire.

You will remember that the resonance of a circuit occurs when the reactive components cancel. Now it is not immediately obvious that 147 pF will resonate with 13.3  $\mu$ H at 3.6 MHz but if we use the standard formulae,  $X_c = 1/2 \pi fC$  and  $X_l = 2 \pi fL$ , we get 300 ohms for 147 pF and 13.3  $\mu$ H becomes 300 ohms and it is obvious that in series the sum is zero and hence we have resonance.

Back to the ATU. While performing the two functions the ATU should not be inefficient. That is, it should not be lossy or, if it is not connected to any external circuit, it should have a very high Q which amounts to the same thing. This condition is sometimes referred to as being a high unloaded Q.

When the transceiver is connected to the ATU which is in turn connected to the antenna system the Q should be low. This is referred to as a low loaded Q. A high loaded Q means that if the operating frequency is changed then the ATU must be readjusted even if the frequency change was relatively small. Most simple ATUs have a good matching range but also have a medium loaded Q requiring several

retunes of the ATU as the transceiver is moved across an amateur band. All practical ATU's must perform the functions of tuning and matching illustrated in Fig 1 a. Fig 1 b shows a possible circuit.

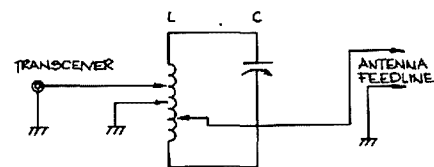

Fig 1(b) Simple ATU Circuit

L and C resonates the antenna system. Ratio adjustment is by variable tappings on L. This is a tuned transformer arrangement and is not broad-banded.

### ATU CIRCUITS

#### The L Network

Fig 2 shows a simple practical circuit. It is called an L network because of the circuit diagrams similarity to the letter L. L and C can be adjusted to have many combinations which resonate at the operating frequency but there is only one combination of settings that will give both resonance and a 50 ohm load for the transceiver. If the antenna system presents a reactance which

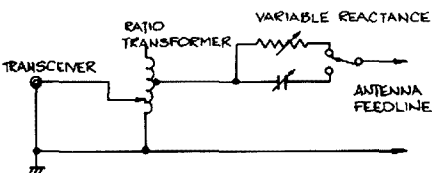

Fig 1(a) Elements of an ATU.

A variable reactance resonates antenna feedline system. Ratio transformer; transforms resistance of resonated system to 50 ohms.

Fig 1 (a) shows a stylised ATU. There is provision for connecting just the right amount of reactance in series with the line to cancel out the reactive component at the end of the line. If, for example, the antenna system presented a reactance that on 3.6 MHz looks like a 10 ohm resistance in series with a 147 pF capacitor, then the VSWR would be too high to measure on a VSWR meter. If we connect 13.3  $\mu$ H in

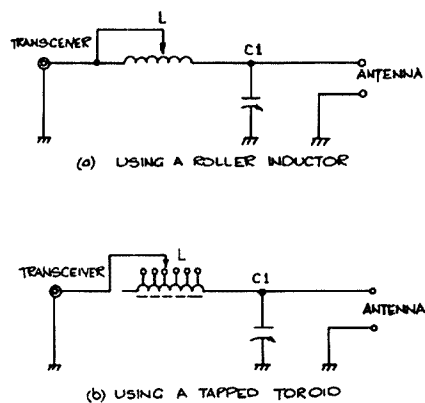

Fig 2 ATU using an L-Network circuit.

The circuit is slightly different if the coil L is wound on a toroid (see b) than when an air solenoid is used as in a. Inexpensive commercial ATU's use this circuit which works well with end fed wires.

is capacitive then the value of C1 for resonance is reduced by that amount. The antenna system is "tapped across" the tuned circuit formed by L and C1, while the transceiver load is in series.

This circuit is popular in inexpensive commercial ATU's. It is capable of matching most practical antennas. If you find that a particular ATU will not match an antenna add a length of wire or feeder about 1/4 of a wavelength long to the antenna system, in the shack at the ATU, and try again.

The L network provides additional harmonic suppression.

For low power or receiving applications a small toroidal coil with taps may be used for L and a receiving type variable capacitor used for C1.

On some occasions it may be advantageous to swap the antenna and transceiver connections.

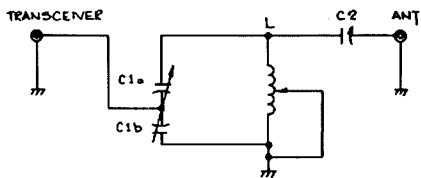

Fig 3 The Ultimate Transmatch

This ATU will match most random wires and other antennas used for HF operation. Note that C1 is a differential capacitor and not the usual two-gang capacitor.

### THE ULTIMATE TRANSMATCH

Another popular circuit is shown in Fig 3. This is the Ultimate Transmatch. As its name implies it can match most antennas to 50 ohms on all HF bands. It is also a circuit frequently misunderstood. The problem is C1. This must be a differential capacitor and not the ordinary "two gang". As C1a is increased in capacitance, by turning the shaft, C1b is reduced. Two

single capacitors can be connected in tandem, with one inverted, to produce a differential capacitor. L is an air-cored roller inductor and C2 is a variable capacitor typically of 270 pF maximum. For high power the spacing of the capacitor plates needs to be generous if arc-over is to be avoided. This is true of any ATU of course. A combination of C1 and C2 is used to resonate with L. Adjusting C1 varies the tapping point of the transceiver thus giving a correct match.

Adjustment can be a four-handed affair. One hand operates the rig, one tunes C1, one tunes C2 and the fourth adjusts L.

If you can locate a differential capacitor and a roller tuning inductor your antenna tuning problems are as good as solved.

Once the optimum settings for each band have been found record them on a card for future use.

The ultimate Transmatch does not always provide much harmonic rejection.

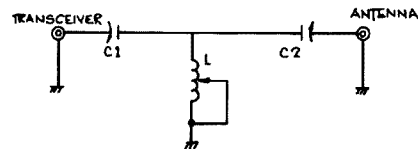

Fig 4 The T-Network ATU

This is a simplified version of the Ultimate Transmatch. It does not provide any harmonic suppression.

### THE T NETWORK

Fig 4 shows a T network, so called for the similarity to the circuit diagram and the letter T. It is similar to the previous circuit and is almost as versatile. C1b is omitted (otherwise it is the same circuit) so ordinary capacitors only are required. Note that the shafts of both capacitors are "hot" and both shafts should have insulating connections to the tuning knobs. A short length of knitting needle is useful here.

The T network does not have significant harmonic attenuation.

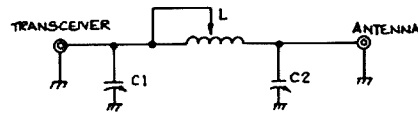

Fig 5 ATU using a Pi-Network

Many medium priced commercial ATU's use this circuit. C1 and C2 are often labelled "LOAD" and "TUNE" respectively. Harmonics are attenuated by this circuit.

### THE PI NETWORK

Fig 5 is our old friend the pi network. It looks like the Greek letter pi. Fig 6 shows the circuit redrawn to illustrate how the antenna system is tapped across C2 and the transceiver across C1. The circuit matches a wide range of reactances and is very popular with commercial ATU makers. The components used in the old AM transmitters are very suitable for a homebrew pi ATU. The inductor may be tapped if a roller inductor is not available.

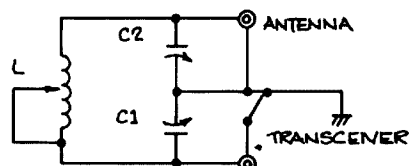

Fig 6 Alternative arrangement of Pi-Network Circuit which illustrates how antenna and transceiver taps are adjusted by C1, C2 which also provides tuning.

The adjustment of the relative settings of C1 and C2 vary the transformation ratio as well as the resonance which is of course achieved by adjustments of L as well.

The pi coupler has good harmonic suppression characteristics. C1 is sometimes called the LOAD control and C2 the TUNE control while L may be provided with one tap for each band. This tapping arrangement is a compromise between ease of operation and range of impedances that can be matched.

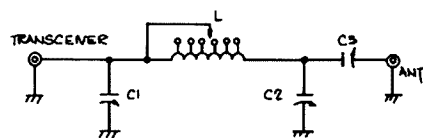

Fig 7 Wide Range ATU circuit

C3 transforms the antenna system impedance into a value suitable for connection across the tuning capacitor C2.

### WIDE RANGE TUNER

Fig 7 shows a wide range tuner based on the pi network. C3 has been added to allow tapping of L (no expensive roller inductor) yet retain the ability to match any useable antenna on any HF band (well as near as any other affordable system will). The details of its construction will appear next month.

It is in fact one of the old AM output circuits turned around. C2 is the old "tune" control and C1 is the "load" control. The switch which adjusts the tap on L is the old plate circuit band-change switch. In the AM transmitter the load was usually 50 ohms so with L switched to the appropriate band C1 is set in the same position for the ATU as it was in the AM rig, provided that the resistance across C2 is also the same as in the AM rig. A typical plate load was 2000 ohms so if C3 can be adjusted to give the antenna system the same equivalent resistance the rest of the network is as it was for the AM rig. The same components can of course be used. Unfortunately the operation of C3 is not always sufficient to provide this ideal situation. The result is an ATU that will match most practical HF antennas although sometimes the loaded Q is not as low as would occur in a perfect ATU.

Next month we will discuss the construction of this ATU which has an inbuilt twin VSWR meter.

73 de Ron VK3AFW



# TECHNICAL CORRESPONDENCE

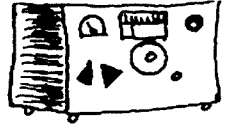

Following our reprint of articles on the G5RV antenna in our December issue (which by the way was done after many requests from newcomers), Jim Davis VK7OW has written to us and has outlined briefly an up-dated version of this popular antenna.

Here are relevant excerpts from Jim's letter:

"The popular G5RV antenna, which I understand, originally appeared in "AR" in 1973 is a most informative article, although now outdated. You will agree that a lot has happened in ten years.

In our little town, not only do we now have running water, but Bullock drays now no longer churn up our main street, instead, the occasional horseless carriage is noticed choofing up the street.

So also with the G5RV. There is a Mark II version now — since around 1979. About eighteen months ago, I had a long QSO with a "G" station who was a friend of Lou Varney — G5RV — and he gave the details of the improved Mark II G5RV.

I gave these details to a friend, David VK7MS, and he built the best G5RV I have seen. He has a row of pine trees — about seventy feet high either side of his property, and he slung the G5RV Mk2 between these.

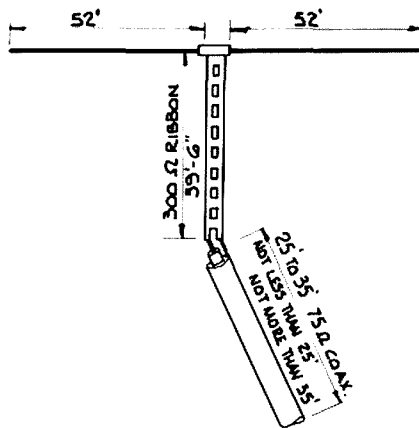

Revised details of the G5RV.

The down-lead drops straight all the way — into his shack. It performs superbly.

I also gave the information to a very good W7 friend, in Arizona. He built a Quarter sized version for portable work, and I have worked him on this antenna. Sure, he was 3-4 S points down on his beam, but he had a most readable signal.

The revised details are as follows."

#### Editors note:

Many thanks for your letter Jim, and we would be grateful if any reader has any further details of the G5RV Mk2 version, particularly the theory of operation, bands operative and critical lengths of the 300 ohm stub and 75 ohm coax. Please forward comments to me at PO Box 300, Caulfield South, Vic. 3162.

Bruce Bathols VK3UV Editor: **AR**

## RADIO AMATEUR OLD TIMERS' CLUB QSO PARTIES



Each year, two QSO parties will be held for members of RAOTC Australia, and Old Timers' Club New Zealand.

Members are requested to cut out this notification and keep it before them as the days, times, and bands will remain fixed.

#### RULES

**ELIGIBILITY** — The parties/contests are open to members of RAOTC (Australia) and OTC (New Zealand).

**Note** — There are members of the Australian Club in overseas countries who could possibly participate at the times laid down.

**CONTEST EXCHANGE** — Members will exchange:

1. Their Club membership number, VKs prefixed by "A", ZLs prefixed by "Z".
2. Year of first licence.
3. Name.

#### 4. Age.

E.g. Number A256 1951 Bill 49

Number Z128 1923 Harry 78

**SCORING** — One completed contact with a member on CW or SSB but not both, will score 5 points.

**MULTIPLIER** — the total of VK, ZL and Overseas call areas contacted.

**FINAL SCORE** — Contact points times multiplier.

#### DATES, TIMES, AND BANDS

No. 1 — Second Monday in March — 20 metres 0200 to 0500 UTC.

Please spread out around centre frequencies CW 14.050 and SSB 14.150 MHz.

No. 2 — Second Monday in August — 40 metres 0800 to 1100 UTC. Centre fre-

quencies CW 7.015, SSB 7.075 MHz.

**ENTRIES** — Claimed scores showing mode (CW, SSB or CW/SSB), number of QSOs and multiplier should be forwarded to John Tutton VK3ZC, 31 Denham Street, Hawthorn, Victoria 3122.

All amateurs who have been licensed for a period of 25 years or more are eligible to join the Radio Amateur Old Timers' Club. A self-addressed envelope (9 x 4) to the Secretary, Harry Cliff VK3HC, PO Box 50, Point Lonsdale, Vic. 3225 will bring you a membership application form.

**1983 Contests — 14th March and 8th August.**

**AR**

**C-5800E NEW FM, SSB, CW 25 WATT TRANSCEIVER**

So small it should be a portable. **\$532**

The Standard C-5800E includes many features not previously available on a 2 meter multi-mode transceiver. For example it weighs only 1.75 Kg with dimensions of 149 (w) x 54 (h) x 208 (d) mm. For complete details on this revolutionary transceiver write or call us for a brochure.

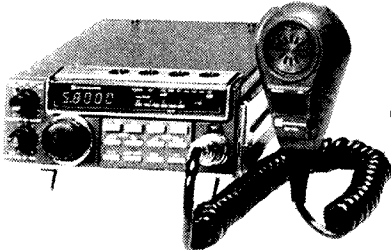

C-5800E

**C-7900E COMPACT 10 WATT UHF FM AMATEUR TRANSCEIVER** **\$409**

Small in size, 138 (w) x 31 (h) x 178 (d) mm., the 70 cm C-7900E uses unique circuitry and layout to achieve 10 watts power output and extremely high receiver sensitivity.

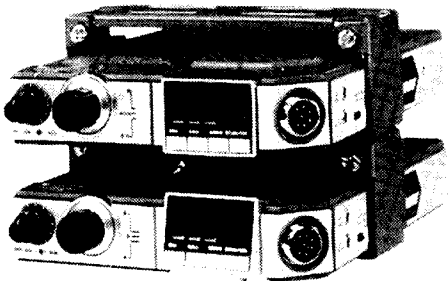

C-8900E

**\$358**

C-7900E

**C-8900E COMPACT 10 WATT 2 METER FM TRANSCEIVER**

Twin brother to the C-7900E, the C-8900E is equipped with all the same outstanding features except it is ready to operate on 144 to 148 MHz. For complete technical specifications on both these units write or call us for a brochure.

**NIRECOM VHF MONITOR RECEIVERS**

The FS-10 Series of VHF 10 channel pocket scanning monitor receivers are designed to give exceptionally high sensitivity. This is achieved by incorporating a cascade RF amplifier stage and a telescopic 1/4-wave antenna. No bigger than a cigarette packet and no heavier than a pocket notebook the Nirecom FS-10 uses a rugged double sided epoxy-glass printed circuit board and is housed in a high impact plastic case. With a capability of scanning up to 10 crystal controlled channels or being locked on just one, the FS-10 is ideally suited to a wide range of monitor applications. Both battery charger and rechargeable Ni-cad batteries are supplied with all versions.

- FS-10HF \$185** Victorian Country Fire Authority or South Australian GFS version. Fitted with 7 crystals for the VHF high band.
- FS-10H \$183** VHF high band, may be tuned to any 4 MHz segment from 150 to 170 MHz. No crystals supplied.
- FS-10L \$183** VHF low band may be tuned to any 2 MHz segment from 70 to 85 MHz. No crystals supplied.
- G-01H \$13** Short (10 cms) rubber duck antenna for FS-10H.
- G-01L \$13** Short (14 cms) rubber duck antenna for FS-10L.
- G-0C \$13** Bell mount carrying case for FS-10.
- PS-393 \$13** Car charger for FS-10 series.



**NR-6000 VHF MARINE TRANSCEIVER**

The NR-6000 6 channel marine transceiver is your passport to easy communication in the VHF sea-phone marine band. Operating on 6 crystal controlled channels within any 4 MHz segment of the marine band, the NR-6000 is the ideal way to keep in touch with other boats, shore stations, coastguards and emergency services. Approved to the Australian DOC specifications of RB275C, it is a self-contained communications system small enough to keep in your life jacket or on the bridge. The internal rechargeable battery pack gives complete freedom of use.

The NR-6000 is supplied complete with crystals fitted for Channel 16 (emergency channel), rechargeable batteries, AC/DC battery charger, rubber duck antenna, earphone, carrying case and handstrap.

**X-SA \$10**

**X-SO \$24**

Standard GFS stock crystals to suit Nirecom FS-10 series and NR-6000. (Enquire about frequencies.) Crystals to order for FS-10 and NR-6000 (2 weeks delivery).

**\$366**



**JIL MODEL SX-200 HF/VHF/UHF PROGRAMMABLE SCANNING RECEIVER**

THE SX-200 includes many unique features not provided on any other scanner. For example, its wide frequency coverage of 26 to 88, 108 to 180 and 380 to 514 MHz. Its capability of receiving over 33,000 channels, 3 mode squelch that can be set to only allow the SX-200 to stop on carrier with modulation signals, 16 Memory channels that can be expanded to 32 with the EXP-32 kit. AM and FM detection on all bands. For full details write or call us.

**\$525**

**SX-200 HF/VHF/UHF 33,000 CHANNELS**

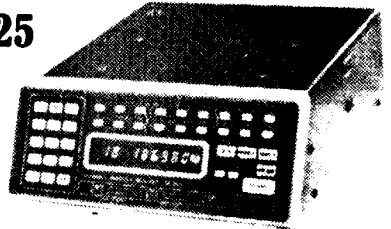

**SX-36 \$122**

**EXP-32 \$49**

**A-4AM \$30**

**SKY ACE**

**R-517 \$125**

**PS-30 \$12**

**X-SA \$10**

**X-SO \$24**

Converter for SX-200. Provides receiving capability of 280 to 320 MHz. Memory Expander kit increases memory channels in SX-200 from 16 to 32 channels. Air Band Auto AM Kit.

Palm-size airband receiver equipped with across the band tuning plus facilities for 3 crystal locked channels.

AC adaptor for R-517. Standard GFS stock crystals to suit R-517. (Enquire about frequencies.) Crystals to order for R-517 (2 weeks delivery).



NR-6000 MARINE RADIOTELEPHONE



NIRECOM FS-10



SKY ACE R-517

**AUSTRALIAN AGENT & DISTRIBUTOR**  
**GFS ELECTRONIC IMPORTS**

Division of GD & JA WHITER PTY. LTD

15 McKeon Road, Mitcham, Vic. 3132  
PO Box 97, Mitcham, Vic. 3132

Telex: AA 38053 GFS

Phone: (03) 873 3939, 873 2652



# EQUIPMENT REVIEW

Ron Fisher VK3OM

3 Fairview Avenue, Glen Waverley, Vic. 3150

## THE KENWOOD TS-430S HF TRANSCEIVER

The trend in amateur equipment design for HF operation seems to be towards the general coverage type transceiver. Up to the present time this has only been available in relatively expensive gear, but with the introduction of the new Kenwood TS-430S, we have the first popular priced transceiver with full general coverage capability. Maybe with the present state of the art in amateur design, it just might be as economically viable to build a full coverage design as it is to build a normal band switched transceiver.

TS-430S is to say that it is a compact version of the TS-930. It does not have a built-in A/C power supply, but is intended for operation from either a 13.8 volt power supply or a 12 volt battery for mobile operation.

A quick look at our photo will show that the 430 is just a little larger than the popular TS-130S transceiver. It is the same height, same depth but 29cm wider than the 130. Now pack into this package a 100 watt transceiver with operation on all amateur bands from 160 to 10 metres, a receiver with full coverage from 150kHz to 30 MHz and we start to see just the beginning of what this amazing transceiver has to offer. Unfortunately my time with the 430 was rather limited, so this review is perhaps more of a preview. However, I hope I can give you a good idea of what you might expect from this transceiver.

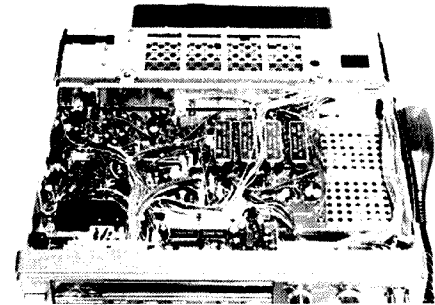
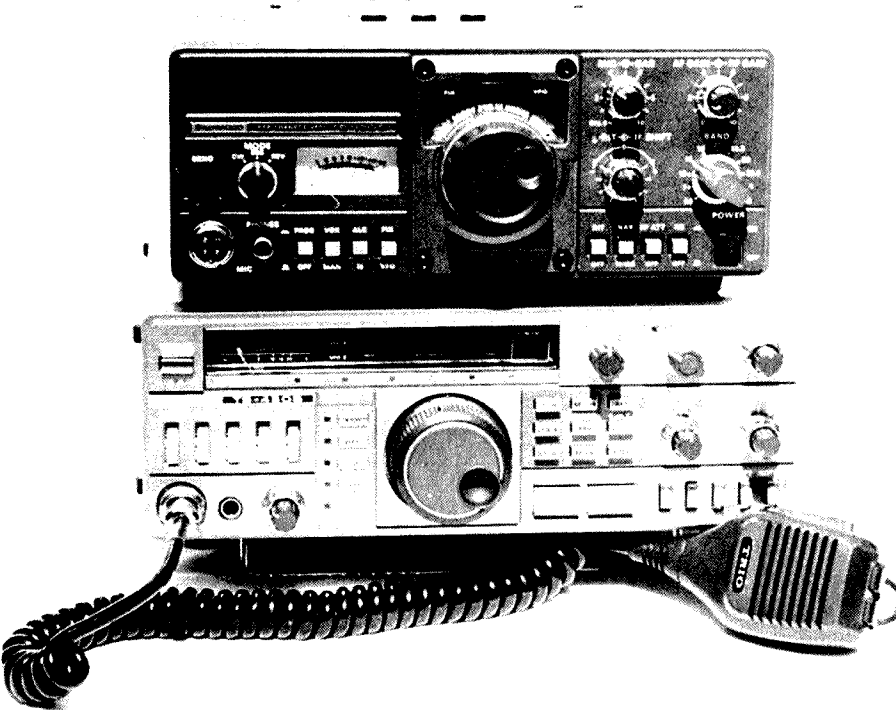

Top view with cover removed.

### THE TS-430S TECHNICAL FEATURES

The TS-430 is of course a fully solid state transceiver with a broad band final that does not require any tuning. The receiver has provision for reception on SSB, CW, AM and FM and has full general coverage from 150 kHz

keep its introduction rather subdued, as there will be no way they will be able to keep up the supply when the word gets around about their superb performance.

Perhaps the best way to describe the

Well you might ask, just what is the TS-430S. Many astute readers might have noticed the introduction of it in the Kenwood advertisement on page 50 of the December issue of Amateur Radio. I would guess that Kenwood decided to

to 30 MHz in one MHz steps. However the band switching up/down buttons can be programmed to select either the next higher or lower amateur band or one MHz up down steps. Split operation is available with two synthesized VFOs which have two tuning rates. Eight memories can be programmed and these are then available for recall at any time, even if the primary supply voltage is removed. An internal lithium battery is built in to store memories for up to five years. Not only do we have the eight memories but it is possible to set up each of them in any particular mode that the 430 is capable of operating in. Memory scanning is selectable from the front panel keyboard with five second monitoring on each in turn. Imagine being able to check a couple of local broadcast stations, your favourite amateur band channels on a mixture of USB, LSB, CW and FM. The FM feature is an optional extra, as are the CW, AM and narrow SSB filters. However with the very low basic price, I can see that many amateurs will put in all the options when they purchase the transceiver.

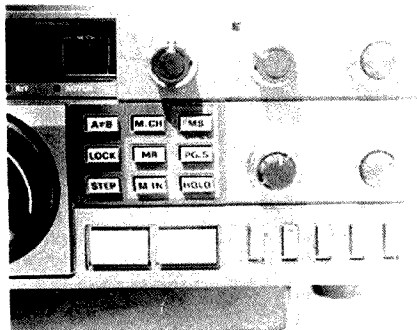

Front Panel Keyboard.

Other features include an IF shift, notch filter, RIT control for receive only, built-in speech processor, squelch control for use with the optional FM mode. In addition there is a noise blanker and a front end receiver attenuator. A wide/narrow switch selects either the normal or narrow (1.8kHz) SSB filter, or 2.4kHz or 500 Hz CW selectivity.

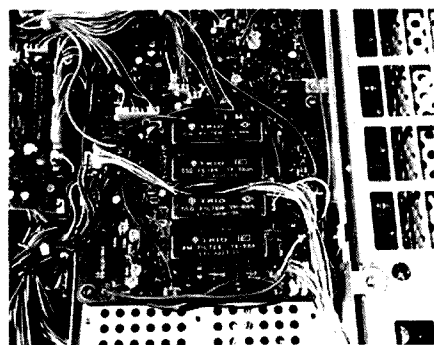

Filters.

The final transmitter output stage looks very much like the TS-130S PA unit and incorporates the same fan unit which is thermostatically controlled. A carry handle is fitted to one side of the cabinet, which is a great improvement over the TS-130, which did not provide one.

Unfortunately our review TS-430S did not come with a normal handbook, so it is rather hard to comment on the circuit. Apparently the transceiver was an early production model air mailed out for demonstration purposes. I look forward to seeing the handbook in the near future.

## THE TS-430S ON THE AIR

The first thing noted when I attempted to get the 430 set up was that there is no AC power switching with the power on/off switch. The power connector is compatible with the PS-30 but you will need to operate two switches instead of one as with the TS-130. Strange to say the least.

Once on and operating, the 430 is a joy to use. Although there are many controls on the front panel, it only takes a very short time to sort out the various functions. Band changing is by two large buttons. One produces an up frequency shift, the other a down shift. To the right of these is a smaller button labelled 1MHz step. Push this and the main band change button then gives the one MHz steps in place of the amateur bands. The tuning knob is a good size and has a very smooth action. The two tuning rates should please everyone. The slow rate is in 10Hz steps and this really spreads things out.

Operation mode is selected by five push buttons to the left of the tuning knob. As each is selected a status indicator comes up alongside the appropriate button. The mode selection is USB, LSB, CW, AM and FSK. By the way, if you are scanning the memories which includes different modes, the status indicators will follow the memory selected mode. The memory channel in use is shown by a special readout to the right of the frequency display.

For mobile operation a frequency lock button holds a given frequency regardless of any operation of tuning or scanning controls.

Due to the short time that I had the 430 I was unable to carry out our normal technical tests. Only power output was checked and the following results were obtained:

160	80 watts	20	70 watts
80	85 watts	17	65 watts
40	80 watts	15	60 watts
30	80 watts	13	60 watts
		10	70 watts

This is a little down on what we might consider a normal 100 watts output, but it is still a very satisfactory result and in fact quite comparable to the older TS-130S transceiver. PEP output on SSB was about the same as viewed on the scope with a clean pattern. On-air tests for intermodulation distortion showed that the 430 was not quite as good as some equipment tested, but quite satisfactory.

The speech processor used in the 430 is a simple audio type and not an RF clipper. It appears to be similar to the processor used in the TS-130 and the TS-530. Results obtained with it were certainly worthwhile but not up to the better RF clipper types. Audible distortion appeared to be quite low.

Receiver sensitivity was very good when compared to our normal station transceiver and strong signal handling excellent. Under normal use we found no front end overload at all.

The noise blanker worked well on ignition noise and fairly well on domestic electrical noise but produced no effect on the Wood Pecker at all. Pity, as in every other respect the 430 performed very well indeed.

## CONCLUSION

The TS-430S is certainly a new generation of HF transceiver. It would seem to be in a class of its own and will soon change amateurs' ideas of just what a transceiver should do. In one stroke, it has made most existing transceivers obsolete. The TS-430S is highly recommended. Our test transceiver from KENWOOD Australia via Eastern Communications of Box Hill South, Victoria.

## FOR YOU ANTENNA BUFFS:

Aside from physical damage, the most common fault in the antenna system is low resistance to ground. Moisture in the antenna system (ie impedance matching networks, coax cables, etc.) dirty insulators and coax dielectric breakdown all cause varying degrees of shunting resistance and must be guarded against if maximum efficiency is to be expected. Testing is accomplished by using a megger or if one is not handy, a simple ohm meter will suffice.

Theoretically, any transmission line system should read infinity on the megger, but this reading is not always possible to obtain. Abrupt changes in the weather, high humidity, or other natural causes often result in low resistance readings. Often resistances may be raised by cleaning the insulators. The coax cables and other cables and fittings used to connect the equipment should also be tested. A check of continuity of the antenna / transmission line system should be made periodically. The following values are suggested.

1. A resistance of 200 megohms or more to ground indicates that the antenna system is in good condition.
2. A resistance of 5 to 200 megohms to ground indicates the insulators need cleaning or the coax is contaminated with water.
3. A resistance of less than 5 megohms to ground indicates that the antenna system is in bad shape and an urgent need exists to locate the low resistance point and correct it.

from "ARNS Bulletin"  
Aug. '82  
AR

## HAAT IS IMPORTANT . . .

About twenty years ago I was employed by my fellow citizens to ride around in bombers, a mostly boring job, with occasional exciting moments. There is the excitement of physical danger (a different series of stories), and the excitement of snagging exotic DX.

On one of our training missions, due to a computer malfunction, we scrubbed, and hung around our home base to burn off fuel for a safe landing weight. The B-47 had no provisions for dumping. We flew big circles at 22,000 feet, just west of Abilene TX.

It was my custom to set in 14.340 in our ARC-65, for use when I wasn't busy. This mission was lost, so I played with the Collins, calling "CO, this is K5RPB mobile." I expected no reply, since it was 0300 local. Just maybe someone in Big D or Cowntown would be awake.

"K5RPB, this is VK3AHO."

I switched my Intercom from HF and asked the co-pilot where he learned the exotic call. He denied fooling me, saying he was half asleep. Back to HF. It really was VK3AHO! Excitement, excitement . . .

The three of us talked to Bram for 20 minutes or so, and to two other Aussies. For a little over an hour, K5RPB was the only signal heard from North America. That incident made a believer of me in LeMay's world-wide sideband nets, and highlighted the importance of Height of Antenna Above Terrain.

From Bud Martin, KV4FR  
ARNS Bulletin, Aug. '82  
AR

## EVALUATION AND ON-AIR TEST OF THE KENWOOD TS-430S

Category	Rating	Comments
<b>APPEARANCE</b>		
Packaging	***	Foam inserts, plastic wrapped, strong carton.
Size	****	For a full general coverage transceiver, amazing!
Weight	***	
External finish	***	Good, but not quite as good as other Kenwood gear.
Construction quality	***	Seems to be well constructed.
<b>FRONT PANEL</b>		
Location of controls	****	Very practicable layout.
Size of knobs	***	A bit small for big fingers, but for the number of functions, very good.
Labelling	****	Clearly labelled.
Meter	**	Rather tizzy appearance and hard to read.
VFO knob action	****	Very smooth. Finger hole right size and adjustable tension.
Digital readout	****	
Analogue	NA	No analogue dial.
Status indicators	***	
<b>REAR PANEL</b>		
<b>RECEIVER OPERATION</b>		
VFO stability	****	See test section.
Digital dial accuracy	****	Spot-on readout.
Analogue dial accuracy	NA	
Memories	****	Best yet seen in any transceiver.
Shift/width	**	Only IF shift provided.
Notch filter	***	Audio notch — not IF, but works well.
Peak filter	NA	
Optional filters	****	Four filters can be fitted.
Spurious responses	***	A few weak ones. Not audible with antenna connected.
'S' METER	**	Action good but hard to read under low external light conditions.
AGC PERFORMANCE	***	Not tested, but appeared very good.
SIGNAL HANDLING	****	No overload noted.
CLARIFIER (RIT)	**	Operates on receive only. No frequency indication of shift on digital dial.
<b>SENSITIVITY</b>		
RF ATTENUATOR	**	Normal attenuator — about 15dB.
RF GAIN	***	Smooth, progressive action. Threshold type.
<b>NOISE BLANKER</b>		
Line noise	**	Some reduction in certain types of line noise.
Auto ignition	***	Good effect, but effectiveness reduced on strong signals.
Woodpecker	*	No noticeable reduction.
Effect on signal handling	****	No apparent cross modulation.
<b>QUALITY OF RECEIVED AUDIO</b>		
Internal speaker	**	Reasonably well balanced.
External speaker	NA	No matching accessories have been released. Good quality with my own external speaker.
Headphone output	***	Stereo headphones match well.
Cooling fan noise	****	Fan only operates under extreme conditions and then very quiet
Relay noise	**	Quite noticeable with VOX operation.
<b>TRANSMIT OPERATION</b>		
CW power output	***	See test section of text.
PEP output	***	
Audio quality	***	Smooth transmit quality.
Audio sensitivity	***	Plenty of audio gain.
Speech processor	***	Audio compressor type.
ALC action	***	Easy to set mic level.
Metering	**	ALC, IC and 'S' meter only. Also see comments on meter above.
Cooling	****	Ran cool even on hot day.
VOX operation	***	Satisfactory apart from relay noise.
QSK operation	NA	
CW operation	***	VOX keying worked well.
Manual (owner's handbook)	NA	No manual available at time of test.
Further comments		A very compact, highly complex transceiver. Attractive to look at and easy to use after some practice. Band change method both for amateur bands only or for general coverage receive is superb. At the suggested retail price of \$999 with FM option is should sell like hot cakes.

Rating Code: Poor \* Satisfactory \*\* Very Good \*\*\* Excellent \*\*\*\*



# Improving the Duty Cycle of the FM 321 & 320



# QSP

Nev Fenton VK2BQ

10 22nd Avenue, West Hoxton, NSW 2171

## HUNTING PIRATES

Both these units can be modified very simply to improve their duty cycle. (Two minutes on transceive, two minutes on receive). The ventilation modification alone helps to keep the temperature down. The cooling fin/heat sink improved the duty cycle to four minutes transceive, two minutes receive or better on the writer's equipment.

An article by Mimmo Martinucci I5WWW in Radio Rivista of Oct. '82 lists the number of pirates by countries for the period Jan.-Dec. 1980 on *ten metres only*. The information came from the monitoring system of DARC in West Germany.

A total of 840 pirate stations were intercepted, 709 identified by country of origin, and 131 not identified.

The top five were Brazil with 264 (37.2% of 709), Italy 94, Spain 80, West Germany 36 and U.S.A. 30. Even the U.S.S.R. had 4, followed by U.K., Japan and five other countries 3 each, and Australia, together with 12 other countries, one each.

Translated by Jack VK3AXQ  
AR

Several variations on this modification exist. One operator fitted a heat sink, another an aluminium plate which extended some distance above and below the covers, while a third obtained a piece of aluminium tubing, 60mm x 50mm x 146mm and turned it into a double cooling fin.

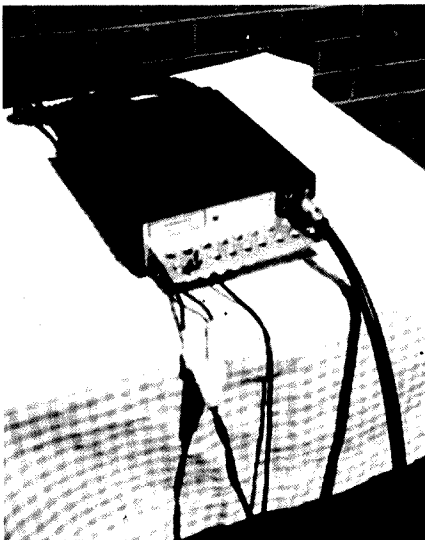
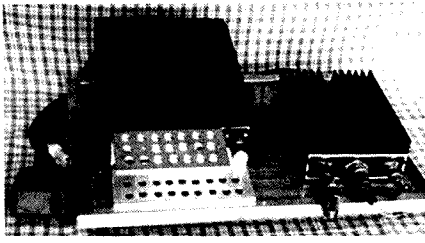
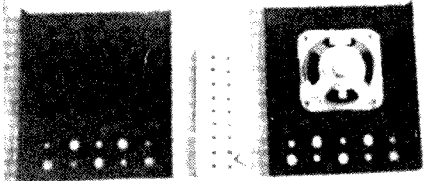

## VENTILATION

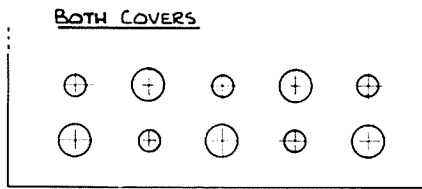

HOLE DIAMETERS 12.5mm AND 8mm

## THE COOLING FIN

SIZE, 136 x 50 x 3mm WITH 16mm FLANGE  
MATERIAL, ALUMINIUM

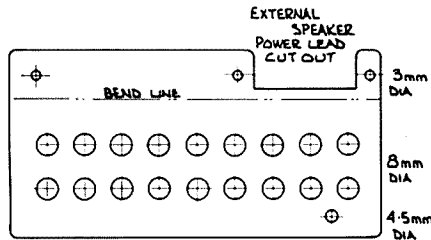

Do not forget to cement as well as bolt the fins or heat sinks into position.

The photographs give a reasonable indication of these modifications, and operators will no doubt use their ingenuity with material they may have on hand.

Before reassembly, it is beneficial to peak C141 on an offset frequency near the band centre, and also to solder XL801, on the FM321, into circuit, as this ensures less likelihood of the transceiver dropping out when in repeater mode.

For further information the writer may be contacted on the morning net via VK2RUS, the afternoon net via VK2RUG, or by letter.

## "THE COMPUTER CONTROLLED CAR"

Not only must we be very much aware of the possible interference problems caused by the inadequacies in home electronics and entertainment products — these present more of a frustration than a danger. We must be even more cautious in respect of the ever increasing use of 'computer style electronics' by vehicle manufacturers.

The erroneous operation of a low immunity factor fuel gauge caused by the presence of a correctly operating radio transmitter is little more than a nuisance.

Disturbance to an electronic braking system could be considered a more pressing problem!

It is interesting to see that even the automobile industry has been programmed to consider amateurs and amateur equipment to be inferior to commercial operators and equipment used by commercial stations, especially in respect to interference.

Subaru of America, Inc. recommends that, "Electrical transmission devices (CBs, HAMS, Garage door openers, etc.) not be installed on 1982 Subaru vehicles, since such installation may interfere with the ECC system and possibly result in erratic driveability."

If such a device is installed, care should be taken to route the antenna lead as far as possible from the ECM and ECM harness. Shielding the antenna may also help to cut down on interference. However, these procedures are not guaranteed to correct any interference problems.

The term ECC refers to the Electronically Controlled Carburettor, and the term ECM refers to the Electronic Control Module.

The interference, if any, is generated by the close proximity of the transmission device's cables to the cables of the ECC system and ECM. There would be no interference caused by large commercial transmitters (radio, TV, microwave transmitters, etc.)."

AR

**PLEASE HELP  
WITH INTRUDER  
WATCHING**

AR



# HOW'S DX

Ken McLachlan VK3AH  
Box 39 Mooroolbark Vic. 3138

The Christmas surprise package announced by the Minister for Communications as regards the release of the two WARC Bands, 18 and 24 MHz and the additional bandwidths to the 160, 80 and 40 metre bands will allow greater flexibility to the DXer and for the experimenter, new antennae to erect that may be "tweaked" to perfection.

DXer or not, one would have to be impressed with the extra amount of spectrum that has been made available for amateur use and it is hoped that these privileges are used and not abused. With sensible use the three WARC bands, though contacts made on them will NOT BE VALID for DXCC, should provide some interesting propagation through to the next sunspot maxima.

Unfortunately 10 MHz has not taken on, some excuses being that "I will not get interested in it until the other bands are allocated". That excuse no longer exists, nor does the argument of suitable antennas if you have equipment that will transmit on these frequencies. The dipole is effective, cheap and simple to erect.

Transverters, from junk box parts can be designed, built and coupled to the existing transmission equipment. Who is going to be the first experimenter to submit a suitable WARC band transverter for the perusal of the Technical Editors for printing in AR?

It is predicted that the economic climate of the "80s" will alter the trend of equipment for present and future amateurs. The "black box" will by no means disappear but more "homebrewing" will be anticipated. Also new and larger projects will be undertaken and there will be a major swing back to low power and CW operating habits.

The "budding" short wave listener or amateur should not be deterred from becoming active and getting on the air, as the designs of simple receivers and CW transmitters are available. One such receiver that will provide more than adequate coverage and service to the newcomers and old timers alike is the SQUARE ONE Receiver, the design of which commenced in AR last month. All parts are locally available and minimal test equipment is required to "tweak" it to optimum performance. This positive approach is a credit to the designer.

Dipoles are easily constructed and the ever popular and effective G5RV antenna, as described in detail in December 1982 "AR" will not break the family budget. Will you join the trend and boast "Using all home brew equipment at this QTH OM" in 1983?

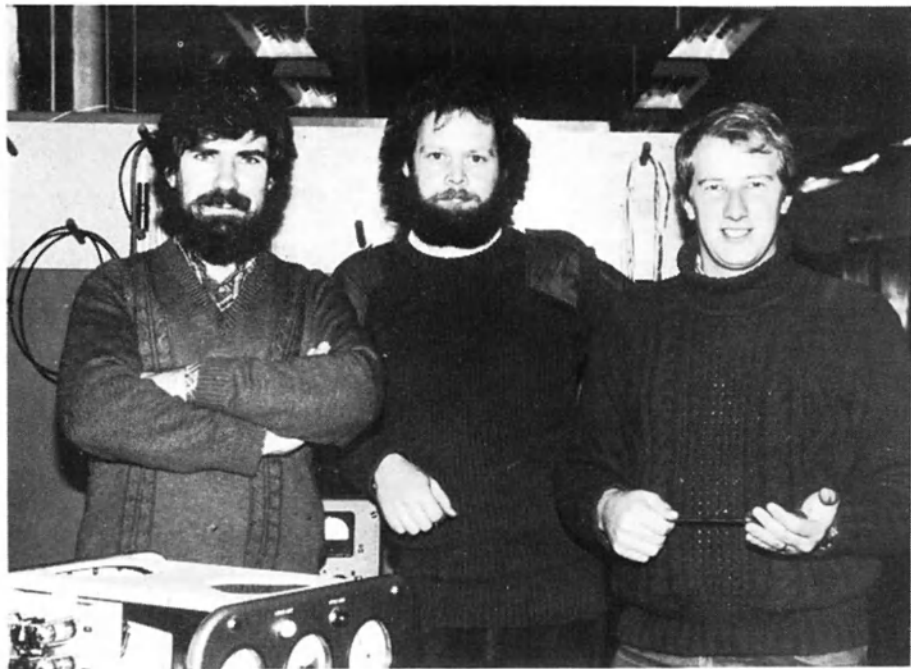

New operators are Ray Clarke VK0RC, Eric Endacott VK0RE and Adrian Smith VK0AS. QSLs to John VK3DJV QTHR.

## OTHER ANTARCTIC OPERATORS

Three other Antarctic signals should be heard this winter from the operators pictured. They will be at their respective sites until November this year.

## MACQUARIE ISLAND

Peter, VK0AP, seems to be settling in and has erected the VHF antenna on six metres. Many VK3 operators added a new country to their list when Peter's manned keyer was heard in mid December. As can be imagined, after no six metre activity from the island for nearly a decade, he was much in demand. One particular VK3 still couldn't believe it until he held the card in his hand. Peter hopes to be active on the HF frequencies as the winter months approach.

## WILLIS ISLAND

The new operator at Willis Island is John, VK9ZJ who is on the HF bands until June. The "permanent" Willis Island QSL Manager seems to be Gill, VK6YL, who has again taken on this chore for John's tour of duty.

## ANZA NET APPEAL

Can you help? This is the question asked by Percy, VK3PA. Percy, who has nurtured this net for in the vicinity of a decade, finds, due to the ill health of his XYL Linda, that he cannot devote as much time to act as controller as he has done in the past. The net presently meets on 21.204 MHz daily at 05.00 UTC and any assistance from someone with some spare time would be

appreciated. Further details from Percy, VK3PA when he is on the frequency or by writing to Percy at QTHR. To Linda, wishes for a speedy recovery are extended from DXers worldwide.

## SPOT NEWS ETHIOPIA

From reports received it appears that operations from this country have been suspended, including the Police Club Radio Station, by the National Security Agency. It is believed that a number of amateurs are working towards having this decision by the NSA reversed.

## CHINA

Overseas magazines and DX sheets are reporting CW activity from BY8AA on the low end of 21 MHz. No VK reports are to hand on an BY activity heard for the last couple of months.



## PREFIX CHANGES

It is on the cards that there will be further prefix changes with some of the island countries this year. These changes will bring all the newer prefixes into line with the ITU allocations.

## CHAFARINAS ISLAND

ED91CH was active and the QTH does exist. Chafarinas Island is one of a group of islands located about 30 miles ESE of Mellila. The island is under Spanish administration and a serviceable lighthouse is its main attribute. QSL's direct only to EA9JV. It is very unlikely that it will be of much interest to anyone except prefix hunters.

## TEN METRES AGAIN

The ten metre band behaved over the festive season and provided some excellent QSO's into all parts of Europe, Africa and the Middle East. Admittedly the signals were not as strong nor had the staying power of last season but they were there, generally appearing from seemingly "dead" band which wasn't even noisy.

One European told me that he had tried to break a number of VK novice operators speaking amongst themselves on numerous occasions but to no avail. Apparently many VK's have given ten away as on numerous occasions I was told that I was the only VK to be heard which is a pity and embarrassing to be in so much demand.

## IMPENDING DX

Unconfirmed reports indicate that PY1OR hopes to visit Trinidad in early February. If he is successful QSL's should be routed via PY1VOY.

Another unconfirmed report is that Aves Is will also be activated in the early part of this month. No further details are to hand.

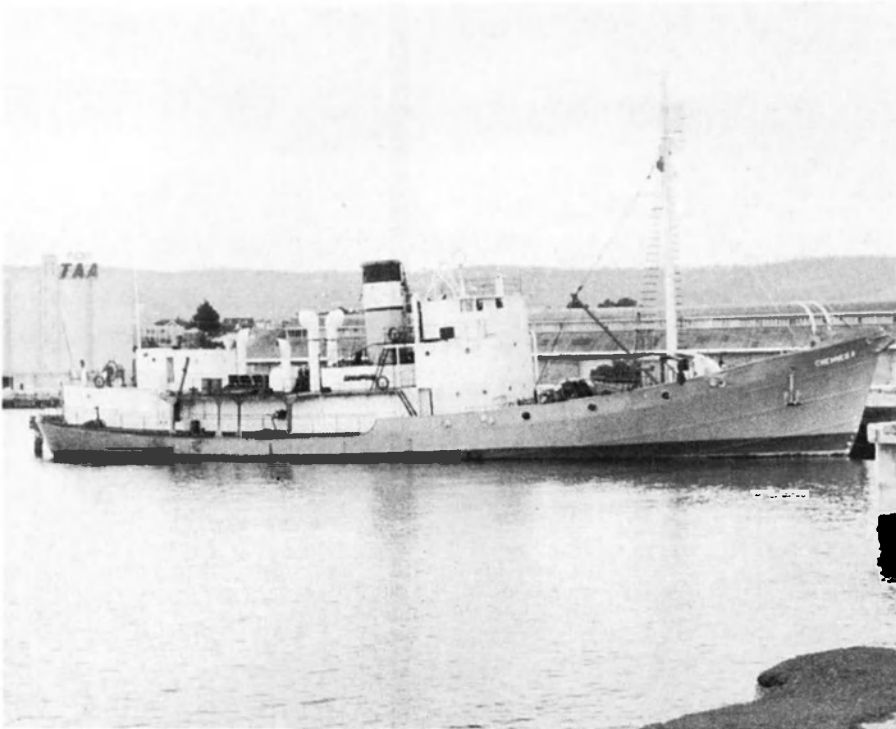

Heard Island bound -- VK0JS's Cheynes II.

## GLOBE TROTTING

Two US amateurs are visiting a number of countries (some much sought after) with their itineraries commencing late January 1983.

K4YT will be visiting AP, YI, VU, 4S7, HS, 9M2, XW, 9V, YB0, DU and BY.

K4DDA visits include areas such as JY, A4, A7, A6, A9, 9K, HZ, ST, 4W, SU, and YK.

Good tripping gentlemen and it is hoped that you are able to get on the air from some of these areas and that your call will appear in a few VK log books.

## 4U1VIC

Reports indicate that this station has now made in excess of 1000 QSO's and QSL's are 100% via the OE Bureau. The operators are using a 14AVQ which is mounted 125 metres above the ground on one of the towers at the Vienna International Centre. Many VK's are looking for this one in case it becomes a new one for DXCC.

## TRINIDADE IS

The operation from PY0TA on the 17/18th December was conducted by PY1RR and PY1VOY. Those that missed out, take heart, as these two have left the equipment in situ at the naval Base and will be making a return trip in the next couple of months with the supply boat. QSL's for the CW operation go to PY1BVY and SSB to PY1VOY.

## GUANTANAMO BAY

Dick KG4CD, has commenced a one year tour of duty at the base and promises lots of activity. QSL's to PO Box 585, FBPO, Norfolk VA 23593, USA.

## 3D2XN/XR

This station, that operated out of Rotuma, did not qualify for DXCC country status and will not be allowed as a new country by the ARRL.

## NEW BAND ACTIVITY

Derek 9K2BE, now has crystals in his possession which will allow him to operate on the 18 and 24 MHz bands. The antennae for these bands will be dipoles.



Ship Ahoy for Heard Island -- VK0HI's Anaconda II.

## ANOTHER DELETION?

A well known and respected VU DXer, in a recent QSO with a VK, was quite adamant that the Andaman and Nicobar Islands (VU7) would become a deleted country this year. If this does occur, he stated that the islands would revert back to the VU2 prefix. Many stations will remember how this country was so ably represented by Fred Burn, VU7ANI until his sudden and untimely death in 1977. Mary Ann WA3HUP still has logs for any one that still requires a card for Fred's operation.

Another country of much interest to the VK operator, is the Laccadives, the same informant believes that there will be NO LEGAL operation from this country in the impending future.

Ladies and gentlemen, not good tidings for those trying to reach or stay on the DX Honour Roll, which maintains its membership of those who have attained a standing of being within the top ten of the maximum current creditable countries.

## HEARD ISLAND

At the time of going to press both expeditions were underway and if "Murphy's Law" didn't intervene, should be emanating signals from this world sought after Australian Territory.

Some of the photographs of both the VK0JS and VK0HI vessels and loading preparations that have come to hand, have been suitably captioned and reproduced for the interest of readers.

## QSL STATISTICS

One more VK has come to light with some interesting facts correlated from factual observations of his attempt to attain DXCC on the CW mode. It is hoped to reproduce some of these thought provoking figures in this column in an ensuing issue. This amateur's accounting may provoke other amateurs into estimating how much that valued certificate has cost them.



## THANKS

Information for these notes has been derived from such magazines as cqDX, DX NEWS, RADCOM, W6G0/K6HHD QSL MANAGER LIST, QTC, QST, WORLD RADIO and amateurs including EA1VG, G3NBC, ON5NT, ZL1AAM and ZL1AMN. Also reports and information from VK2PS VK3's FR, PBA/XSD, YJ, YL, VK5AKH, VK6's HD, IH and NE and L30042. Thanks to one and all.

AR

## WORKED ON THE NOVICE BANDS

10 MX  
5W1DW (\*VK3VU). F08IW, SM5DYC, SM7LPJ, T32AJ (SM3CX5) and T32AL (\*WB7SIC).  
15 MX  
3D2WR, 5W1DW (\*VK3VU), 605XMT, F67XL, F08GF, HB08HA, HC2DG, HC5RZ, HC8RS, WH6AVA (CW), YV40DA.

## SSB WORKED ON THE EAST COAST

10 MX  
8P6JA (LP), DL's, E09ICH (EA9JV), FC9UC, G's, GJ's, GM's, I6.7 and 8, LA's, SM's, PA0, PA2 and PA3's, RA9AKM, UA's, UB's, UW's, Y22 and Y27's.  
15 MX  
3V8AA (\*ISOLYN), 6W8EX, F88WG, FWOXN, G5ACI/AA (\*YASME), JT1BG.  
20 MX  
3D2XR (\*0K6XR), 5H4KG, 5N3RTF, 5R8AL, 9N1WW, 9N1YOU, 9X5SL, 9Y4RD/SU, A71BJ, C21AF, CE0EVG, CN8AP, EP2TN, EI2AD, F88WG, FR7ZG, HC8GI, J28DM, JT1BG, VE3DF0/J73.

## SSB WORKED ON THE WEST COAST

10 MX  
5H3FH, 5N8AL, 5N8ARY, 9Y4RD/SU, A92F, HC2TM, PA0WAY/A6, UK8MAZ, UM8MDX, W4GSM/HC8.  
15 MX  
3V8AL, CN8CX, HH2CQ, J3AH, GJ3LJF, HZ1HZ, UF6CR, UJ8JCQ.  
20 MX  
5N8AJA, 9N38, FY7AN, J20DU, J88AM (YL), PY7AOL, T2GSH, T32AF, V3DX, W5NUT/PJ7.  
40MX  
9N1WW, J6LB, T32NX.  
80MX  
UJ8JCQ.

(\* Brackets indicate QSL Managers.)

## CW SWL-ing with Eric L30042 (Dec. 1982)

28 MHz  
DL2EAI, DF6VJ, OH2SN, OK1KPU, ON7LB, PA3CEF, SM3GV, UB5MBP, UO2GDW, KC7EY, WH6ACS.  
21 MHz  
BY8AA, DL6HAL, DU6HM, HA5KKK, HL2AAV, HL5GZ, KH6ANM, KL7AF, OH80D, ZS6BIM.  
14 MHz  
CN8AD, CT2ES, G5ACI/AA (Abu Ail), EA8BF, FM7CF, FR7CL, HZ1AB, HP1LO, HK0BKX, J20 BL, KP4V, TL8ER, V2AZL, VP2ME0, VP9DR, VU2KNS, YV5ANE, ZK1XX, 4Z4BS, 5B4LY, 5H3BH, 6D5XF.  
10 MHz  
DL6RAO, EA30G, EA8AK, EA9E0, F8RU, G6HL, GM3JDR, HB9AMO, J3AE, JA1XYB, JA4FM, K1JDC/KH6, OE6RH, PA05FW, VE3BDO, W (all call areas), 5Z4CS.  
7 MHz  
FK8CE, G4BKU, HA5KDO, HB9NL, IT9ZGY, LZ2KIM, OE6AM, VS6D0, VU2SUZ, YU2ACF, YU3DKR.  
3.5 MHz  
UL70F, VU2WTH.

## QSLs received (Dec.)

BV2A, CT2EV, CX1CZ, DH2FAI, F9HR, G2BY (10 MHz), GI3IVJ (3.5 MHz), W4GSM/HC8, J28BDP, KG6RT, OH0AL, K5YY/J6, K5YY/J8, UH8EAA, VE1ASJ/SPI, VE1SPI, VP5RFS, W6AM (10 MHz), YB5AES (10 MHz), YJ8IND (3.5 MHz), YJ8TT, YJ8VU (10 MHz), ZK2VU (10 MHz), ZC4YC, 3D2RW, 4S7AJG, 9Y4VU, T2ETA, T32AI.



## INTERNATIONAL NEWS

### NETHERLANDS — Expansion of teletext broadcasting.

With effect from February 1982, four lines in the field-blanking period of the television signal have been made available for teletext broadcasting in the Netherlands, instead of only two as was previously the case. The addition of lines 20 and 21 has enabled the average time required for access to any of the total of about 200 pages now broadcast cyclically to be halved in comparison with that required if only lines 15 and 16 are used, as was previously the case.

At the same time, several improvements have been made to the range of information broadcast by means of teletext. In particular, new pages of special interest to the hard-of-hearing, to users of inland waterways and to radio amateurs have been added. Research by the Nederlandse Omroep Stichting audience-research departments into the viewers' preferences is continuing, and it is expected that it will be decided, by 1st April 1983, to expand the use of teletext as a regular form of information broadcasting.

See European Broadcasting Union Review for February 1982.

### Cordless phones . . . more trouble???

A new interference menace has surfaced in the US according to the US amateur publication 'WESTLINK REPORT'. Two units of so-called "ultra-long-range cordless phones" are being made in the States "for export". One of these, the "Non-Cord

DX Model NC 20 M" boasts operation in the two-metre band, from 143 to 147 MHz, complete with a claimed 13 watts and a "twenty-mile range".

Accessories include "gain" antenna and a power amplifier of 25 watts. The second one, with similar "long-range" claims, is something called the Rova/Pro Cordless phone. Both of these units are illegal in Canada and the US.

Canadian regulations permit the operation of very low power devices without licensing if they operate above 510 kHz and if they do not interfere with regular radio services. Typical of these units is one sold by Radio Shack. The units which provide for full duplex working, use a number of channels between 1.6 and 1.8 MHz for the 'base' station and the remote sets transmit on various channels in the 49.8 to 49.9 MHz band. The outputs are so low that users are advised to operate them near the AC lines which can 'piggy-back' the very weak RF output. One obvious drawback is that this may introduce an AC hum. Another is that there is no privacy to phone conversations using these units. A third problem is that if your neighbour is using one and it happens to be on the same channel, one or the other of you will have to take the units back and exchange them for a different frequency pair.

These devices operate on a secondary use basis and licensed services, such as the Amateur Service, have priority in use and in any cases of interference.

(From: 'The Canadian Amateur' Oct. 82)

# TWO-TONE OSCILLATOR

Con Murphy VK6PM

RMB 237 Via Collic 6225

Many circuits for two-tone oscillators using ICs have appeared, so this is not anything new. However the use of transistors enables the home brewer to construct such small projects with less difficulty.

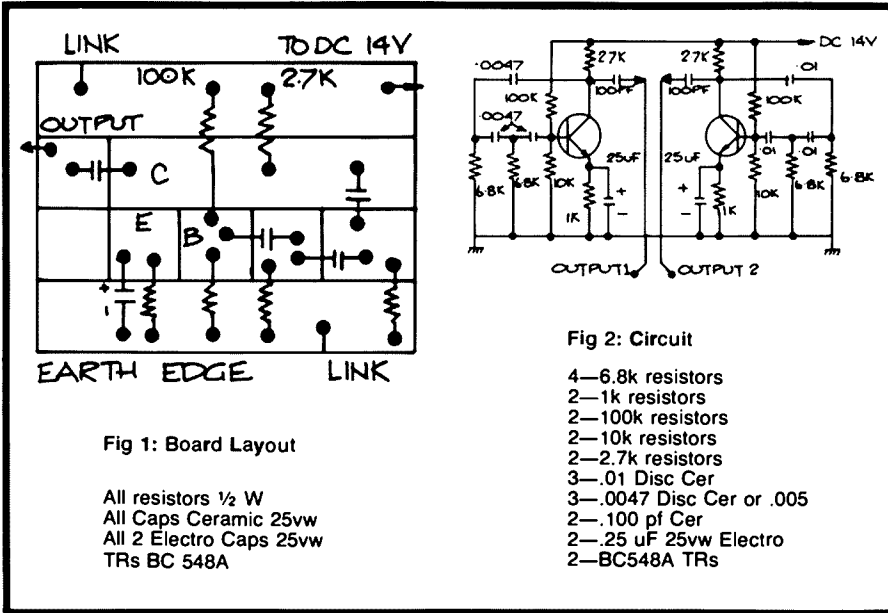

Fig 1: Board Layout

All resistors 1/2 W  
 All Caps Ceramic 25vw  
 All 2 Electro Caps 25vw  
 TRs BC 548A

Fig 2: Circuit

- 4—6.8k resistors
- 2—1k resistors
- 2—100k resistors
- 2—10k resistors
- 2—2.7k resistors
- 3—.01 Disc Cer
- 3—.0047 Disc Cer or .005
- 2—.100 pf Cer
- 2—.25 uF 25vw Electro
- 2—BC548A TRs

The two-tone oscillator, as shown, is constructed on a piece of double-sided board approx. 2 inches (50 mm) square. It may be placed inside an FRG7 receiver or other equipment. The output can be taken to the phone patch socket on any transceiver and as the coupling is light the connecting cord may be left permanently in place. To use it, switch on the power and press the PTT button. Adjust level with the transceiver microphone gain control.

The piece of double-sided board is marked off as shown. Each side is marked as a mirror of the other so that identical components are mounted back to back. Each side generates one tone, the two coming together at the output pads. However do not connect them together until tests show each to be operating.

All components are soldered direct on to the pads, and component leads are cut short so that resistors and capacitors stand about 1/4 inch above the board.

### TESTING

To test the unit, apply power and bring one output lead at a time to the top of the volume control pot in a receiver, when the tone should be heard from the speaker. The two outputs may then be joined together and checked in the same way.

To adjust for equal output the 100pF coupling capacitors may be altered, e.g. one may be 100pF and the other say 82pF if found necessary.

I have an FRG7 which has become the home of small units like this, as there is plenty of unused space available inside.

Power to operate the unit can be taken from the FRG7, controlled by a small switch mounted on the rear panel. Better still, if you have made the "Frog Remote", a 3 pole 3 way rotary switch can be fitted in lieu of the fine tune and the extra positions used thus:

- Position 1 Receiver only
- Position 2 Double unit for FROG REMOTE
- Position 3 Two-tone oscillator

The unit can be mounted inside the FRG7 or wherever space is available in other equipment.

\* See FROG REMOTE in December AR page 29.



These are just a few of the great books now available from MAGPUBS or your Division.



# CONTESTS



Reg Dwyer VK1BR  
Federal Contest Manager  
PO Box 236, Jamison, ACT 2614.

## FEBRUARY 1983 CONTEST CALENDAR

5-6	RSGB 7 MHz Phone Test
12-13	NZART National Field Day
12-13	John Moyle National Field Day
12-13	QCWA CW QSO Party
12-13	Dutch PACC Test
12-13	YL/OM Phone Test
19-20	ARRL CW DX Test
19-20	YL ISSB Phone Party
26	73 RTTY Test
25-27	CQ WW 160 Metre Phone
26-27	YL/OM CW Test
26-27	French Phone Test
26-27	RSGB 7 MHz CW Test

## MARCH

5-6	ARRL DX Phone Test
12-13	QCWA Phone QSO Party
12-13	YL/ISSB CW QSO Party
19-20	Bermuda Test
19-20	G QRP Day
26-27	CQ WW WPX SSB Test

## APRIL

9-10	CARF Commonwealth SSB Test
16-17	Polish Phone Test

## ADDENDUM AND CORRECTIONS TO 1982 REMEMBRANCE DAY CONTEST RESULTS

### SECTION B VK3

Full call winner VK3AEW with 149 points. Full call listed as VK6PC corrected to read VK6PF plus 19 points for CW entry.

## THE 1982 NOVICE CONTEST

Congratulations to the winners of the 1982 Novice Contest.

The trophy winner is VK4VIK, Mr R. Chalmers of Cairns. Very well done and congratulations.

The winners of section certificates are denoted by + and various 'excellent effort' certificates will be sent to other participants.

The contest was pretty poor this year, mainly due to the very poor propagation and to the almost total lack of interest by the amateurs.

This was the first year of the 10 WPM maximum speed to encourage the use of CW and as you can see from the result, the response was almost nil.

The deliberate restraint shown by Ivor VK3XB will allow the novice trophy to be re-allocated a new home for the next year, however there will be some fierce competition for its temporary ownership in 1983, so a big effort will be required by everyone in the next contest.

## NOVICE PHONE

CALL SIGN	POINTS
VK4VIK	1146+
VK3KHI	934
VK3NLO	864
VK3PBA	723
VK4NWH	696
VK5NOD	653
VK5NWS	594
VK7NAH	456
VK2VBY	357
VK5NSI	301
VK2VNV	277
VK4VWH	248
VK2NKN	220
VK2KEB	126
VK3PNS	112
VK3VYH	101
VK1NEJ	52
VK4NIJ	26

## FULL CALL PHONE

CALL SIGN	POINTS
VK3WP	649+
VK3DAK	581
VK5OX	457
VK2BOS	381
ZL1IM	336
VK5GZ	298
VK1LF	247
VK5D1	182
VK4AVR	98
VK3XB	87
VK7FD	86
VK3BKU	60
VK3KS	44

## CLUB PHONE

CALL SIGN	POINTS
VK3DOA	791+
VK8AR	264
VK4WIC	209
VK2AOA	197

## LISTENER PHONE

CALL SIGN	POINTS
L20475	694+

## COMMONWEALTH CONTEST 1983 (BERU)

From 1200 UTC Saturday 12th March to 1200 UTC Sunday 13th March 1983.

### MODE

CW (A1) only in the 3.5, 7, 14, 21 and 28 MHz bands. Call is CQ BERU. The Commonwealth contest is a single operator, single transmitter event.

Eligible entrants are radio amateurs licensed to operate in British Commonwealth call areas as listed below.

A contest exchange consists of RST plus a three figure serial number commencing with 001 and increasing by one for each successive contact throughout the contest, irrespective of band in use. Serial numbers sent from non-competing stations must be recorded.

## NOVICE CW

CALL SIGN	POINTS
VK4NRZ	99+
VK3NZO	98
VK3VYH	7
VK4VIK	6

## FULL CALL CW

CALL SIGN	POINTS
VK3AEW	131+
VK3BKU	100
VK3WP	68
VK3XB	49
VK5QX	40
VK5GZ	38

## CLUB CW

CALL SIGN	POINTS
VK2AOA	24+

## LISTENER CW

CALL SIGN	POINTS
L30042	120+

## SCORING

Five points for each contest exchange. Bonus of twenty points for each of the first, second, and third contact in each call area as listed, on each band. Contacts with one's own call area do not count at all. Note that G, GW, GD etc. are counted as one area.

## LOGS

Separate logs are required for each band showing columns:

1. Date and time UTC.
2. Station worked.
3. RST/Serial number sent.
4. RST/Serial number received.
5. Band.
6. Leave blank (for checking).
7. Contact points claimed.
8. Bonus points claimed.

Separate band totals should be added together and the total claimed score entered on a cover sheet giving particulars of station, QTH, equipment, power, antenna and a declaration that the rules and spirit of the contest have been observed.

It is important that logs are carefully checked for duplicate contacts. Unmarked duplicate contacts for which points have been claimed will be heavily penalised, and logs containing in excess of five will be disqualified.

Entries may be single or multiple band. Single band entries should claim contacts on one band only, but details of contacts on other bands should be submitted for checking purposes only.

Entries should be addressed by AIR MAIL to: D J Andrews G3MXJ, 18 Downsview Crescent, Uckfield, East Sussex TN221UB, England.

Closing date: 16th May 1983.

All entries become the property of the RSGB. In the event of any dispute the ruling of the Council of the RSGB shall be final.

## COMMONWEALTH CALL AREAS

The following call areas are recognised for the purposes of scoring in the 1983 Commonwealth Contest:

A2 Botswana. A3 Tonga Is.. A5 Bhutan. C2 Nauru. C5 Gambia. C6 Bahamas. G/GB/GD/GI/GJ/GM/GU/GW. H4 Solomon Is. J3 Grenada. J6 St Lucia. J7 Dominica. J8 St Vincent. P2 Papua New Guinea. S2 Bangladesh. S7 Seychelles. T2 Tuvalu. T3 Kiribati. V2 Antigua and Barbuda. V3 Belize. VE1. VE1 Sable Is.. VE1 St Paul Is.. VE2. VE3. VE4. VE5. VE6. VE7. VE8. VK1. VK2. VK2 Lord Howe Is.. VK3. VK4. VK5. VK6. VK7. VK8. VK9 Christmas Is.. VK9 Cocos (Keeling) Is.. VK9 Norfolk Is.. VK9 Willis Is.. VK0 Heard Is.. VK0 Macquarie Is  
VK0/VP8/ZL5 Antarctica\*. V0.

VP2E Anguilla. VP2K St Kitts Nevis. VP2M Montserrat. VP2V British Virgin Is.. VP5 Turks and Caicos. VP8 Falkland Is.. VP8 S. Georgia. VP8 S. Orkney Is.. VP8 S. Sandwich Is.. VP8 S. Shetland Is.. VP9. VQ9 Chagos. VR1 British Phoenix Is.. VR6. VS5. VS6. VU India. VU Laccadive Is.. VU Andaman & Nicobar Is. VY1 Yukon. YJ.

Z2. ZB2. ZC4/5B4. Z07. ZD8. ZD9. ZF. ZK1 Cook Is.. ZK1 Manihiki. ZK2 Niue. ZL1. ZL2. ZL3. ZL4. ZL Auckland and

Campbell Is., ZL Chatham Is., ZL Kermadec Is., ZM7.  
386/387 Agalega and St. Brandon, 388 Mauritius.  
389 Rodriguez Is., 3D2 Fiji, 3D6 Swaziland.  
4S7, 5H3, 5N, 5W Samoa, 5X5, 5Z4, 6Y5, 7P8, 7O7, 8P,  
8R.

9G1 9H, 9J2, 9L1, 9M2, W, Malaysia, 9M6/9M8 E.  
Malaysia, 9V1, 9Y4.

\*All calls operated from Commonwealth controlled  
areas of the Antarctic (VK0, VP8, ZL5, etc.) count as one  
call area.

### AUSTRALIAN AWARDS

1. An individual award to the highest VK scorer — a gold medallion.
2. A State Team award — four silver medallions to the state team of four which achieves the highest aggregate score. If the "individual" winner is a member of this team, he will receive the gold medallion instead of the silver one.
3. An award to the middle placing among VK entrants i.e. to, say the 22nd placing among 43 or 44 entrants — a bronze medallion.

## THE RAVIN

From QUA WJRA (West Jersey Radio Ass'n)  
*THE RTTYERS NIGHTMARE*

One upon a midnight dreary, as I labored,  
weak and weary  
O'er a battered Model 15 purchased at the  
surplus store —

While I nodded, nearly napping, suddenly  
there came a tapping  
Of the armature a-rapping, rapping at the  
magnet's core.

"This is receiver noise", I muttered. "Pulsing  
in my magnet's core —  
Only this and nothing more."

Ah, distinctly I remembered it was in the  
bleak December;  
And the main shaft's driven member lay in  
fragments on the floor.

RTTY contest was tomorrow; vainly had I  
sought to borrow

From this junk surcease of sorrow, sorrow for  
my Sweepstake score —  
Working rare and radiant stations to upgrade  
my Sweepstake score —  
Zeroed here for evermore.

Now unto my TU turning, all my soul within  
me burning,

Soon again I heard a tapping somewhat  
louder than before.

"Surely", said I, "Surely that is signal at my  
crystal lattice;

Let me see, then, what that is, and this  
mystery explore.

Plug the speaker in a moment and this  
mystery explore.

'Tis the RTTY I adore!"

I inserted one connector, pow'ring up the  
cross inspector.

There appeared a tape-sent signal which did  
make my heartbeat soar!

Not the least QRM frayed it, not one moment  
stopped or stayed it;

Pausing just for Car Ret/Line Feed, it ran  
RY's by the score —

Like a little kitten purring, running RY's by  
the score.

My trained ears these sounds adore.

Then the cross on scope face twitching set  
my fingertips to itching

To attempt to print the characters this  
warbling held in store.

Now thy works are oiled and greasy, to print  
this should be quite easy,

Now upon that paper sleazy print the RY's I  
adore.

On that yellow surplus paper type the RY's I  
adore!



## COMMERCIAL CHATTER

### ICOM OPENS AUSTRALIAN OFFICE

Icom Incorporated of Japan, announces the opening of its Australian office as part of its international expansion.

Icom Australia will not sell direct to amateurs, but rather, through a number of dealers in Australia. Vicom International, the company which has established the Icom name in Australia over a period of ten years will continue to be a dealer, selling from its premises at 57 City Road, South Melbourne.

Mr Kiyoshi Fukushima will manage the Australian operation. He is well placed to take this position, having worked for several years as the Service Manager at Vicom, where he helped set the existing high standards for Icom service in Australia.

Icom Australia will ensure that customers do not need to wait long periods for spare parts or new models of transceivers. As an Icom office, it will receive special priority in the receipt of equipment from its factory in Japan.

AR

### FREE LITERATURE

New Fluke 1982/1983 catalogue is available from Elmeasco Instruments.

This catalogue features all equipment manufactured by Fluke Manufacturing Inc. — a well-known instrument supplier.

All products are organised into groups by function and performance together with their relevant specifications.

Readers may receive their copy by contacting any of the Elmeasco offices, or for more information please contact Bert Kleverlaan on (02) 736 2888.

AR

Typed the printer, "464".

Much I marvelled this ungainly old machine to  
type so plainly,

Though the alternating figures quite hint of  
trouble bore.

For we cannot help agreeing that, the typebar  
carriage being

Shifted upwards, I was seeing in rotation 6  
and 4 —

The upper case of RY, alternating 6 and 4.  
Only this and nothing more.

But the carriage, sitting lonely on the greasy  
rails, typed only

These two numbers, which was all the flying  
typebars did outpour.

Nothing other than it uttered, as the printing  
bail it fluttered —

Till I scarcely more than muttered, "It needs  
run a little more".

Till the oil and grease have worked in, then  
assuredly no more

Shall it type that "464".

Then, methought, the air drew denser,  
perfumed by my oil can's censer,

Pumped until the vicious fluid trickled on the  
pock-marked floor.

"Oil", I cried, "A friend has sent me, this  
repairman he hath lent thee

### SIX MILLION DOLLAR CONTRACT AWARD FOR 1200-MR RECEIVERS AND 3200-PC COMBINERS.

Microdyne Corporation are pleased to announce their recent six million dollar plus contract award, to supply White Sands Missile Range with 152 1200-MR receivers and 157 3200-PC Diversity Combiners over the next five years. This is the second largest contract for this type of equipment awarded by a major US missile range since their initial contract with Vandenberg AFB.

Major features of the 1200-MR telemetry receiver include microprocessor controlled for local control or remote control using IEEE-488 or optional RS-232 interface, non-volatile memories used for last command and storage of addressable memory, keyboard entry for local control, synthesized control of local oscillators phase locked to a 5 MHz reference for stability without the use of crystals, voltage controlled stripline RF tuners, up to seven internal second IF filters to 10 MHz bandwidth with wider bandwidths available as options, 12 video filter positions standard (10 video filters plus by-pass and special bandwidth), low power liquid crystal digital readouts indicate RF frequency, IF bandwidth, video bandwidth, video level/gain, AGC time constant, deviation and relative second LO tuning. LED indicators are used for signal level, tuning and mode status, addressable memory (up to five complete receiver setups can be stored for instant recall), master / slave capability (two receivers can be slaved together to form the equivalent of a dual channel receiver. Local oscillators maintained in a coherent mode by phase locking to a 5 MHz standard supplied by the master receiver or common external source.)

For further information, please contact  
Scalar Distributors Pty Ltd, 20 Shelley Ave.,  
Kilsyth, Vic. 3137. Phone: (03) 725 9677.

Respite — respite and repent thee from this  
ill I so deplore.

Soak, O soak this magic liquid and type  
upper case no more!"

Typed the printer, "464".

"Rubbish!" said I, "Thing of evil! Rubbish  
still, designed by devil!

Whether Bell hath sent, or Western Union  
tossed thee here ashore,

By a legal waiver-granted, with the sixth vane  
firmly canted,

On this shack my horror haunted — Tell me  
truly, I implore —

Is there — is there sense in teletype — tell  
me — tell me, I implore!"

Typed the printer, "464".

But the carriage, never shifting, still is drifting  
O'er the fourteenth roll of paper it has  
gobbled to the core.

To attempt to break its fetters, I've worn out  
the key marked "LTRS".

And by now the Sweepstake-getters have run  
up an awesome score.

And my spirits from that pile of paper snaking  
on the floor

Shall be lifted nevermore!

Author unknown

From ARNS Bulletin, Aug., 82  
AR

# ICOM BRINGS THE WORLD

Now ICOM is directly represented in Australia with the establishment of its own company, ICOM AUSTRALIA Pty Ltd.

The Australian Amateur has known ICOM for many years as the leader in 2 metre and 6 metre transceivers, more recently for the State of The Art multi-band units such as the IC-740 with full WARC facilities.

You will soon know ICOM AUSTRALIA for the best in Australian service.



- ① MINICOM IC-25A A small 2 metres package with 25 watt punch. IC-25A is a full featured FM transceiver for the band transceiver with General Coverage Receiver. Multi mode operation includes CW/AM/SSB/RTTY. ② IC-740 2 metre and 70 cm multi mode transceivers providing many base station features in a mobile package. ③ IC-730 Go all band. ④ IC-R70 General coverage at its best. 100 kHz to 30 MHz commercial grade receiver. ⑤ IC-AT500 HF fully automatic. ⑥ IC-740 HF fully automatic. ⑦ IC-740 HF fully automatic. most successful hand-held on the market.

ICOM AUSTRALIA PTY. LTD.

7 DUKE ST



# TO AUSTRALIA



# ICOM

ICOM AUSTRALIA Pty Ltd and its authorised dealers can now offer you factory backed technical and service facilities here in Australia.

All dealers and prospective dealers, please feel free to call on us soon and talk with The Team that understands Amateur Radio.

## Discover a new deal with ICOM AUSTRALIA

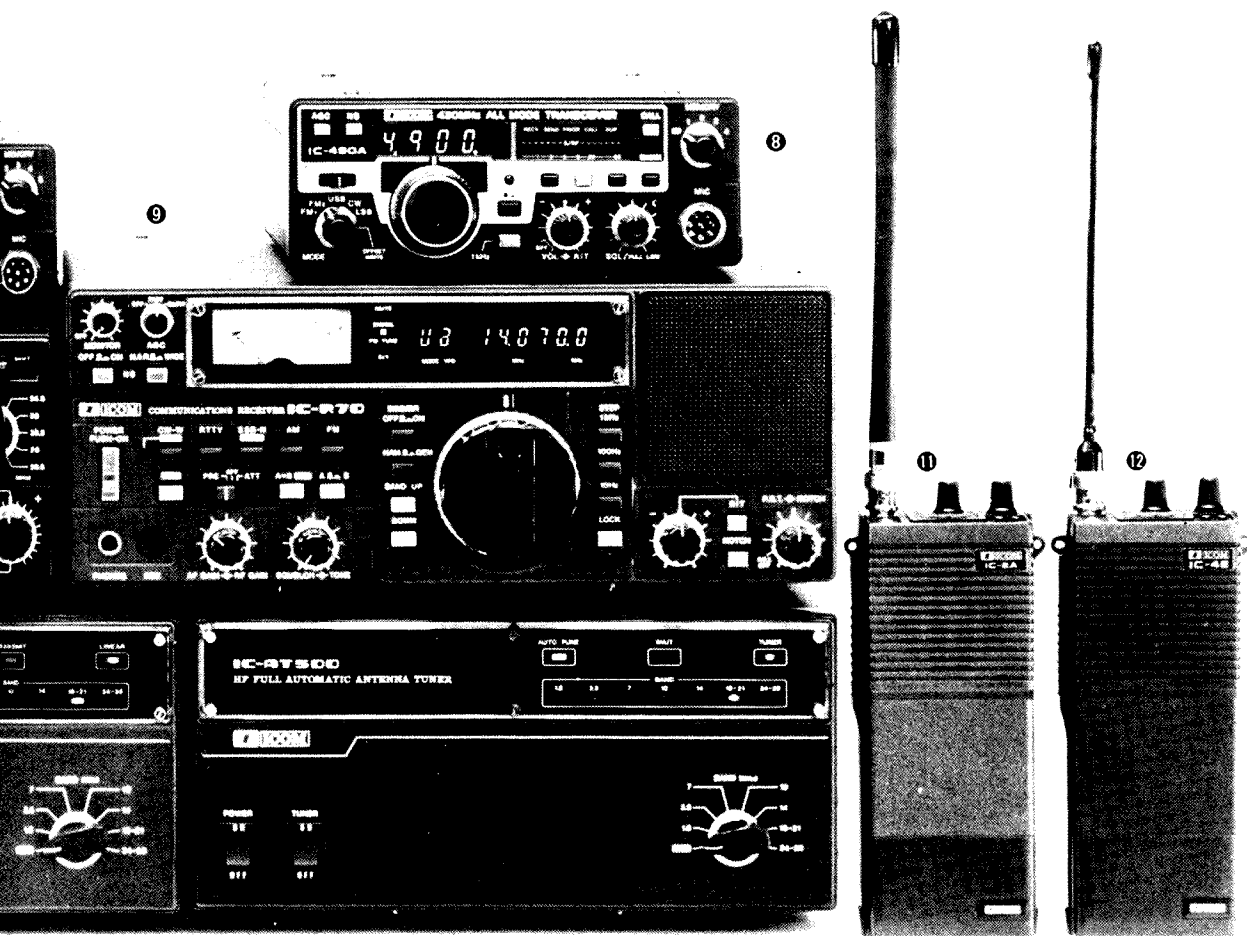

pace conscientious operator. ③ MINICOM IC-45A Full featured 70 cm 10 watt FM transceiver. ④ IC-720A HF all band SSB/ CW/ RTTY transceiver with extensive versatility for the serious operator. ⑤ IC-290H/IC490A 2 where HF rig for everyone's pocket. ⑥ IC-2KL Solid state Linear Amplifier 500 W output power SSB/ CW/ RTTY. atic antenna tuner 1 kW PEP. ① ② IC-2A IC-4E ICOM's reliable, field-proven IC-2A/ IC-4E series has become the

WINDSOR, VIC. TELEPHONE 529 7582 51 2284

# AR SHOWCASE

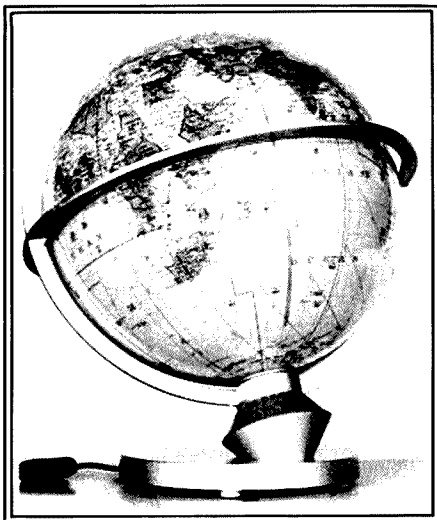

## GRAY LINE RADIO GLOBE

This globe of the world, which measures more than thirteen inches in diameter, is a useful tool for the amateur radio DXer, particularly for the lower frequencies.

The globe has very detailed printing which includes amateur radio prefixes, zones, great circle bearings with given distances, most standard frequency and time signal station call signs and locations, and 10 m beacon call signs and locations. In addition it is cleverly illuminated from within to accurately display the daylight and darkness zones.

The inclination of the earth's axis in relation to the sun can be set in increments of one day by the aid of a day to day calendar on the globe stand. Also, there is a time graduated ring along the equator to enable the setting of the position of the globe for any time of the day in increments which can easily be interpolated down to an accuracy of five minutes for any spot in the world.

Another feature is the ability to determine the sunrise and sunset times for any given location with an accuracy of  $\pm 3$  minutes, and to clearly see the sunrise/sunset path for the whole world.

The quality of construction appears to be sound and although, at the price, it may not be for everyone, it would make a useful tool and attractive addition to the shack of the DXer who "has everything".

The globe is available only from Realto International, 26 Karoonda Road, Booragoon 6154, Western Australia.

AR

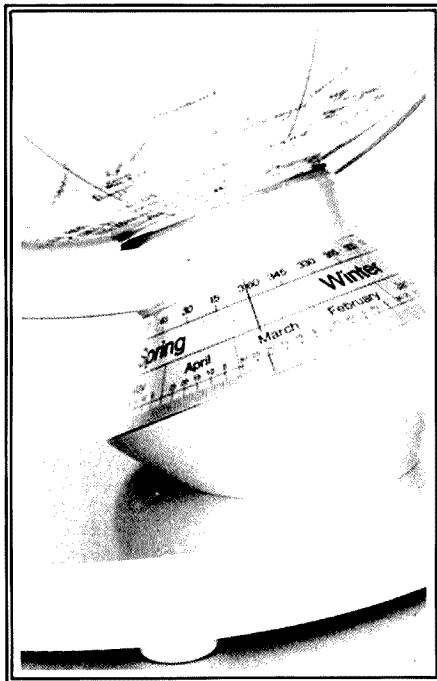

## WAVEGUIDE PROGRAMMABLE ROTARY-VANE ATTENUATORS

Programmable broadband rotary-vane attenuators and coaxial piston attenuators, complemented by micro-processor-based control devices, are offered for automatic test equipment and systems applications by a British firm, Flann Microwave.

The precision rotary-vane attenuators are available in all standard waveguide sizes from 3.94 GHz to 140 GHz and in 14 frequency bands. All versions have a voltage standby wave ratio better than 1.15 and an accuracy of 1 per cent or 0.1 dB, whichever is greater, from 0 to 60 dB. Resettability is stated to be better than 0.1 dB at 60 dB and to improve considerably over the lower attenuation ranges. The devices can be operated at ambients of 5-35°C.

There is a choice of four options for each of the 14 frequency bands. Devices bearing the suffix 01 reach their preset attenuation in the 0-60 dB range in 10 sec. The 02 types are similar in all respects but include a helical drum scale with manual control. Resembling the 01 devices in most respects, the 03 types differ in reading preset attenuation in only 3 sec. Finally, the 04 attenuators have a range up to 85 dB (their accuracy above 60 dB is 2 per cent) and reach preset values in 6 sec.

The coaxial piston attenuators are highly accurate instruments with a low insertion loss. They are fully screened to prevent leakage and provide good linearity to low attenuation levels.

The 17 types between them cover the 1-12 GHz band and have a relative attenuation range of 0-120 dB, traversing the full range in about 3½ sec. Both settability and resettability are in 0.1-dB increments, with an accuracy for most models of better than 2 per cent in the linear region (that is, 20-120 dB). Insertion loss is generally less than 5 dB at the 0-dB setting.

Micro-processor-based controllers suitable for both types of attenuator are equipped with an IEE-1975 interface for remote control using ASC11 code plus alphanumeric control setting. Pushbuttons are provided for manual control. The three models of operation comprise set attenuation to any dB value within the range; and either increase or decrease of the attenuation by any dB value in the range. Any operational mode is selected by pushbutton. Controllers are available for driving one or two microwave units, and are normally designed for operation from 110-V or 240-V AC supplies. For further information, please contact Scalar Distributors Pty Ltd, 20 Shelley Ave, Kilsyth, Vic 3137. Phone (03) 725 9677.

AR

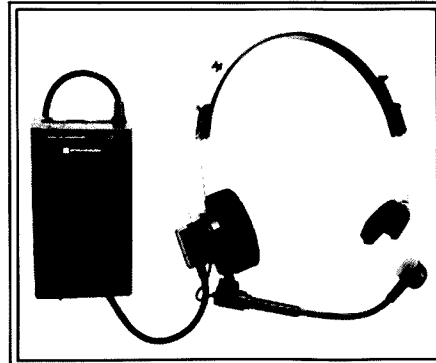

## TALKMAN HANDS-FREE TRANSCEIVER WITH NOISE CANCELLING MIC

Now even when operating in a situation where a high level of background noise is experienced, such as you would normally encounter in many industrial applications, the latest version of Standard's C-900 Talkman allows the operator's voice to come across clearly and concisely.

To achieve this, a unique built-in, noise cancelling microphone accepts only its operator's voice while rejecting any background noise. Beside allowing clear communication this system also prevents transmitter lock-up which would normally render a voice operated transceiver (VOX), unusable when background noise is present.

Unique in currently being the only unit of its type and price available in Australia with a noise cancelling microphone, this unit is ideally suited for many hundreds of communications

applications. They include any situation where a range of up to 1 km is required by operators who need their hands free to perform other tasks.

A range of options is also available, including rechargeable Ni-Cad batteries and battery charger.

For further information on the Talkman Headset communicator contact the Australian distributors: GFS Electronic Imports, 15 McKeon Road (PO Box 97) Mitcham, Victoria, 3132. Phone: (03) 873 3939; or one of their interstate outlets.



## EDUCATION NOTES

Brenda Edmonds VK3KT  
Federal Education Officer  
56 Baden Powell Drive, Frankston, Vic. 3199.

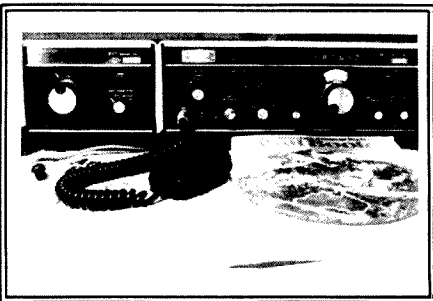

### ATTENTION DRAKE TR7 OWNERS

It is not often amateurs are offered something for cost price — Ian Hunt VK5QX, a well known amateur in WIA Federal and South Australian circles has produced a substitute PC board, fully wired and tested to allow the Drake TR7 to operate on the new WARC bands, together with receive operation from 1.5 MHz down through VLF.

The board is designed to simply plug in to the AUX 7 slot in the transceiver. No adjustments are necessary.

The PC board comes complete with instructions, and costs just \$25.00. Enquiries to Ian Hunt VK5QX, 8 Dexter Drive, Salisbury East 5109 or phone (08) 259 6418 (Bus. Hrs).

AR

## “A CALL TO ALL AMATEURS” and others

*Are you an active member, the kind that would be missed.*

*Or are you just contented that your name is on the list.*

*Do you attend the meetings and mingle with the flock.*

*Or stay at home in comfort to criticise and knock.*

*Do you take an active part to help the work along.*

*Or are you satisfied — just simply to belong.*

*Think it over members — you know right from wrong.*

*Are you an active member or do you just belong.*

Clem Brown

AR



I have just returned from a somewhat, exhausting few days with the WICEN team handling communications for the Murray River Marathon. Discussions there with other team members brought up several points relating to education of the newly licensed amateur with regard to operating techniques.

During the course of this exercise, operators may be required to:

- set up a portable station, HF, VHF or both, using emergency power source in a location which has not previously been investigated;
- establish and maintain communications under difficult propagation conditions;
- transmit and receive messages accurately and efficiently;
- operate or maintain a listening watch for long periods under unpleasant environmental conditions, high local noise or interference, heat, wind, rain, flies, or mosquitoes;
- make adjustments or temporary repairs to equipment under said unpleasant conditions;
- maintain radio silence except when handling traffic.

Practical operating skills such as these are not included in any exam syllabus or tested in any licence exam. So where does a newcomer go to learn them? Naturally, many licensees do not see any need to learn them. They have no desire to operate away from the comfort and convenience of their own shacks or cars, and accuracy of transmission or reception is not terribly important so long as call signs and QSL information are correct.

I wonder how many of us really listen to what the other operator is saying. Does it really matter if he has been operating for thirty-five or thirty-nine years, or lives seven or eleven miles from the nearest town? How many of us will attempt to establish or

maintain contact once conditions deteriorate? Do we speak clearly and set the mike gain to give the listener the best possible chance of copying?

These are all operating skills that can and should be practised. A new operator will learn them more rapidly if the established operators are prepared to give guidance and assistance when it is needed or requested.

Some of us will probably never be called on to operate in an emergency situation, but we are ranked as a 'SERVICE' and we do use our ability to provide communications in emergencies as a justification for many of our requests for privileges, so it is worth giving the occasional thought to how well you would cope if called on unexpectedly.

Now that we are into the new year I expect that various bodies will be starting to think about starting classes. I would very much appreciate being notified of classes that are arranged so that I can compile a current list. If you think I can help in any way, please say so.

Best of luck to those who are sitting for the February exam. Be prepared for some new questions, READ THE QUESTIONS, and answer the question that is asked.

73 Brenda VK3KT AR

### URGENT!

Please let us know of clubs and schools etc. starting theory classes.

Where, when, how much and whom to contact.

Contact Brenda QTHR

# EMERGENCY AND DISTRESS CALLS

It is of prime concern to the Wireless Institute of Australia, that there have been several instances lately where distress traffic has been improperly handled by radio amateurs. The reason for this is considered to be the lack of knowledge of the regulations covering distress calls by the amateurs concerned.

Every licensed amateur must be fully aware of the correct procedure in the event of hearing a distress call. The amateur service prides itself on being able to assist where necessary.

As a means of educating amateurs in the correct procedures of handling distress traffic, we have reproduced verbatim the requirements as printed in the Amateur Operators Handbook (revised edition Dec 1978). These requirements were made for a purpose, do not abuse them.

These regulations together with common sense will satisfy all of the requirements expected of us.

It is important that the following information be obtained from the person or vessel or vehicle in distress:

Name of person or vessel etc.

Location, Map reference or Latitude/Longitude or nearest township.

The nature of distress and the kind of assistance required.

Any other information that may be relevant, such as number of persons in distress.

If you do not have a copy of the regulations book, please send \$3.60 plus \$1.20 postage to the WIA, PO Box 300, Caulfield South Vic. 3162, or alternatively to your division. Every licensed amateur is expected to have a copy of the regulations in his/her radio shack.

VK3UV Editor

## DISTRESS PROCEDURE

### DISTRESS SIGNALS

7.17 The radiotelegraph distress signal consists of the group . . . - - - . symbolised herein by SOS, transmitted as a single signal in which the dashes are emphasised so as to be distinguished clearly from the dots.

7.18 The radiotelephone distress signal consists of the word MAYDAY pronounced as the French expression 'm'aider'.

7.19 These distress signals indicate that ship, aircraft or other vehicle is threatened by grave and imminent danger and requests immediate assistance.

7.20 The frequency 500 kHz is the international distress frequency for radiotelegraphy. The frequency 8364 kHz is additionally designated for use by survival craft for search and rescue communications.

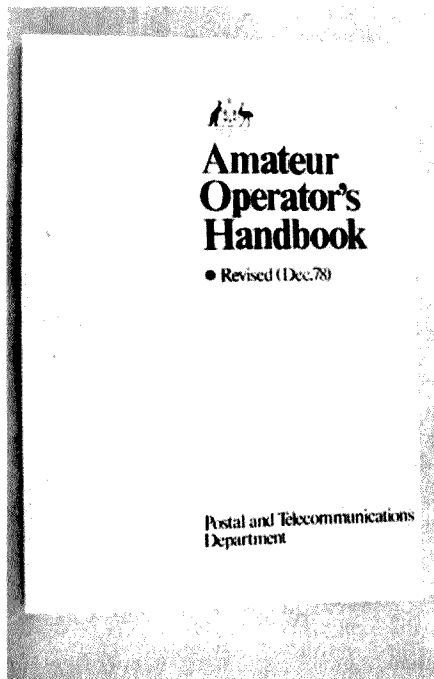

7.21 The frequency 2182 kHz is the international distress frequency for radiotelephony. The frequencies 4125 and 6215.5 kHz are designated to supplement the frequency 2182 kHz for distress and safety purposes.

7.22 The frequency 156.8 MHz is the international distress, safety and calling frequency for radiotelephony for stations of the maritime mobile service when using frequencies in the authorised bands between 156 MHz and 174 MHz.

### DISTRESS CALL AND MESSAGE

7.23 The distress call sent by radiotelegraphy consists of:

- the distress signal SOS sent three times;
- the word DE;
- the call sign of the mobile station in distress, sent three times.

7.24 The distress call sent by radiotelephony consists of:

- the distress signal MAYDAY, spoken three times;
- the words THIS IS (or DE spoken as DELTA ECHO in case of language difficulties);
- the call sign or other identification of the mobile station in distress, spoken three times.

7.25 The distress call shall have absolute priority over other transmissions. All stations which hear it shall immediately cease any transmission capable of interfering with the distress traffic and shall continue to listen on the frequency used for the emission of the distress call. Acknowledgement of receipt shall not be given before the distress message which follows a distress call is sent.

7.26 The distress message consists of:

- the distress signal SOS (for radiotelegraphy) or MAYDAY (for radio telephony);
- the name, or other identification of the mobile station in distress;
- particulars of its position;
- the nature of the distress and the kind of assistance desired;
- any other information which might facilitate the rescue.

### DISTRESS TRAFFIC, OBLIGATIONS

7.27 A licensee hearing a distress call must immediately cease all transmissions, continue to listen on the frequency and prepare to record full details of the distress message which follows. The information should be recorded in writing in the station log book and, if possible, by tape recorder.

7.28 A licensee who receives a distress message should defer acknowledgement for a short interval but should continue listening to ascertain whether the message has been received by a station in a better position to render assistance. If the distress message is not acknowledged within a reasonable time, the licensee is obliged to assist.

7.29 He should endeavour to acknowledge receipt of the distress message and then immediately alert and convey details of the distress situation to:

- (a) for land-based distress situations, the nearest police station;

- (b) for sea-based distress situations, the Australian Coastal Surveillance Centre, Canberra, ACT, telephone Canberra 47 5244 (reverse charges call) or STD (062) 47 5244;
- (c) any other appropriate authority; or
- (d) if the above proves difficult, an officer of the Regulatory Licensing Section, Postal and Telecommunications Department, in any of the areas listed in Appendix 1.

7.32 A licensee handling distress messages should in any case advise the Regulatory and Licensing Section of the Department within 24 hours of the conclusion of the distress working. If required, the station log book and copies of all messages handled must be made available to an officer of the Department.

### URGENCY SIGNAL

7.33 Where the transmission of the distress signal and call is not fully justified, the urgency signal may be used. The urgency signal, which comprises in radiotelegraphy the group XXX repeated three times and in radiotelephony the expression PAN PAN repeated three times, is to indicate that a ship has a very urgent message to transmit concerning the safety of the ship or aircraft or the safety of a person. The procedure for transmitting and replying to an urgency call and message shall follow the same lines as prescribed for the distress call and message.

7.34 The urgency signal has priority overall other communication except distress. All

stations which hear it shall take care not to interfere with the transmission of the message which follows it.

### EMERGENCY POSITION INDICATING RADIO BEACONS (EPIRBs)

7.35 These are small low-powered radio beacons which are usually released when a ship sinks or an aircraft crashes. The beacon transmits a repetitive emergency signal on 121.5 MHz and 243 MHz. These devices do not transmit an identification nor are they capable of speech modulation. Amateur operators should be aware that such a system is in world-wide use.

7.36 Further details are included in the Handbook for Radiotelephone Ship Station Operators, which may be obtained from any of the addresses shown in Appendix 1.

(The appendices as noted above have not been published here due to space requirements, we suggest you refer to your copy of the Amateur Operators Handbook)

— ED  
AR

7.30 The licensee should then resume listening and keep the respective Authority informed of any developments. He should continue to render any assistance practicable until cessation of distress traffic is announced (by means of the operating signals 'QUM' or 'SEELONCE FEENEE'), or he is advised that his assistance is no longer required.

7.31 A licensee hearing or becoming involved in a distress situation is not permitted to pass the text of any messages to anyone other than the above-mentioned authority (see Wireless Telegraphy Regulations 36 (3) in Appendix 2).



# WORLD COMMUNICATIONS YEAR: 1983

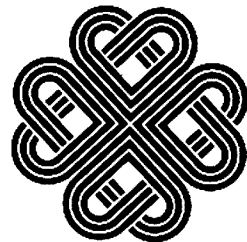

## PUBLIC RELATIONS

John Hill VK3DKK  
Public Relations Co-ordinator

I was really very surprised when I heard some amateurs actively engaged in voluntary work, for the WIA say that we do not need public relations. Well, these members may be very clever in their own field as far as electronics is concerned but, their knowledge of influence of good PR-work certainly leaves a lot to be desired.

In the first place, what is public relations? Well, to put it very simply: informing the public. In other words, creating an image. And... any person or organisation creates an image whether we like it or not. Even when breathing out, one can create an image particularly after eating garlic, an image which is not always appreciated by the recipient, and a "ring of confidence" approach would win and influence many more friends.

Now, let us be more positive and apply this to our own hobby. With "communications" being the name of our game and 1983 the World Communications Year, we have excellent reasons for improving our image to the public.

I say "we" because every member must be a PR Officer as from NOW. It is not a

matter of a handful of volunteers in divisional or federal circles to go all out. EVERY MEMBER should join in the activities during 1983.

How can you do that?

1. Contact your local division or club and offer your services.
2. Invite non-amateur friends into your shack and explain the many uses of amateur radio.
3. Introduce new members (always have a membership application form handy).
4. Let your friends (non-members) know what the WIA has to offer like: Amateur Radio monthly magazine, beacons, QSL-Bureaux, and don't forget the many successful negotiations with the authorities for extension of frequencies for amateur use. (See elsewhere in this issue for results.)

These are only a few pointers for this month, but I have one request to you all, please write to me and let me know what YOU are doing, and what YOUR CLUB is doing during 1983. Is it going to be "garlic" or "Ring of Confidence" Hi.

AR

## COMMENTS ABOUT WCY

"We should realize that inasmuch as we speak on the telephone, use a telex machine, listen to the radio, watch television, fly in an aircraft guided by radar, write a telegram or receive a press wire dispatch, we are immersed in the world of telecommunications."

El Jalisciense, Mexico

"I seriously believe that the overwhelming headlong development of modern technology is such that a person watching, say, a moonlanding on television sees no further than the actual landing itself and fails to realize that there is a whole infrastructure — a terribly sensitive and costly one — which is enabling him to see it."

General Caupolican Boisset  
Minister of Transport and  
Telecommunications in "La  
Tercera de la Hora", Santiago  
(Chile)

"Politicians and sociologists (have) realized that man is paying dearly for inadequate communication infrastructures and that this inadequacy is acting as a brake on progress in the economic and social sectors."

Electronique, Aarau (Switzerland)

Welcome Bruce, our new monthly RTTY columnist. Bruce is filling a much requested void in our magazine for RTTY enthusiasts and we hope it will also enlighten the many amateurs that have often wondered, but know very little of what RTTY is all about (Ed).

## HERE'S RTTY!

Bruce Hannaford VK5XI  
57 Haydown Road, Elizabeth Grove SA 5112

*Most people find RTTY fascinating as they watch the distant station's incoming message print out on their paper or screen. But quite apart from fascination the mode has many advantages that are well worth serious consideration.*

### RTTY ADVANTAGES

RTTY is superb for exact word messages, as for such, it is much faster and more accurate than phone and slightly better than a very good CW operator. Most RTTY stations either automatically print on paper in normal reception and transmission or if a visual display screen is used can additionally print on paper if required. This means an accurate, easily readable copy is always available with additional carbon copies if needed.

It is often said that RTTY is a form of instant letters as, with no delay at all, what the other chap is typing appears on your paper or screen and you can in like manner make an immediate reply.

Many people like to have pen friends in distant places but RTTY sure beats that idea and avoids high postage costs at the same time.

RTTY is a boon for certain disabled amateurs and, in some cases, it is the only mode suited to them. Deaf and near deaf amateurs can operate RTTY without difficulties as signals can be tuned in visually without any sound at all. This can also be handy for those with normal hearing such as when SSB operators come on your frequency to QRM you and start saying many rude things about RTTY.

Those with speech impediments and foreign language accents can communicate very well with RTTY. Some who have had strokes and find they can't use CW because of trembling hands find they can use a typewriter type keyboard quite well.

Using RTTY helps one to spell correctly as when you need to spell everything you say, you get to pondering how words should be spelt. However don't be guided by the other fellow's spelling as it might be worse than yours.

As RTTY can be combined with computer operation it can be a valuable teaching aid in the ever growing field of computer work. It also teaches one to type rapidly and this can be very useful to private people as well as office workers.

RTTY has a greater DX range than phone for similar power. I have at times got a perfect print from a signal that had faded so low I could no longer hear it. Although most RTTY is transmitted using normal SSB type transceivers by feeding audio tones into the microphone socket it does not have to be done that way and a very simple transmitter will suffice.

On the HF bands a single stage crystal oscillator transmitter could be used with the RTTY equipment switching a small capacitor on and off across the crystal to give frequency shift. Crystal control is not unreasonable for RTTY as most RTTY activity is centred around a few exact frequencies.

That old AM/CW transmitter gathering dust and spider webs in the corner of the shack could make a fine RTTY transmitter. Home brew RTTY transmitters are an easy project and even offer some advantages over SSB types that don't like continuous audio tones fed into them on transmit.

The 100% duty cycle of RTTY means SSB transceivers must be operated at very low power output but a home brew transmitter using class C stages give better efficiency and more power output for a given tube or transistor.

Concluding RTTY advantages, RTTY and similar data transmissions are of rapidly growing importance supplying the modern world's need for fast, accurate communications. Amateurs have previously often led the way in developing new communication techniques and it is in my opinion a great pity so few presently use their skills in improving RTTY and data transmission techniques.

### CW ONLY OR TELEGRAPHY ONLY?

The following motion was put to the SA Division of the WIA "That the South Australian Division of the WIA request the Federal WIA to change the words CW ONLY to TELEGRAPHY ONLY in all future Gentlemen's agreement band plans". This was carried and if the Federal body see fit to do this RTTY will benefit greatly from the change.

There are presently some CW operators that are saying RTTY is not CW so should stay out of the CW only portions of the bands. Such will need to revise their ideas if the wording becomes telegraphy only.

### THE GREATEST BENEFIT TO THE GREATEST NUMBER?

In order to underline the need to update existing Gentlemen's Agreement Band Plans I made the following statement in a SA Division broadcast 22/8/82. "If the WIA were to obtain statistics of CW as compared to Phone, say compare the number of CW contacts recorded as compared to the number of Phone contacts in the recent RD Contest I am sure CW would be less than 10% of the total. In other words 10% (or less) of amateur operators using a narrow band width mode have all the HF bands to use and 90% of operators using a medium band width mode are restricted to certain limited portions of these bands on a shared basis. Surely the rule should be the greatest benefit to the greatest number of people".

Well as the 1982 RD Contest results were published in the December issue of AR I have been doing some counting to check the ac-

curacy of my statement. I find CW/RTTY contact points compared to Phone contact points indicate twenty five to one in favour of Phone so my 10% for CW should have been say 4%. It certainly IS time that Gentlemen's Agreement Bands Plans were revised.

### USING STEREO EQUALIZERS

Stereo equalizers can be very useful at an RTTY station to tailor the frequency response between the receiver and the demodulator.

As each control gives 12dB gain or loss the response can be made to peak at or near the demodulation centre frequency. Twice as much equalizer range can be had by connecting the left and right channels in series (output of one to input of the other).

With this series connection you can get 24dB lift at the desired frequency and by setting all other controls at -12dB you get 24dB loss at all other frequencies. This means the desired frequency range is 48dB higher than all other frequencies outside this range.

Of course you really need an equalizer with a frequency band control at or near your demodulator centre frequency as if you need to raise two controls to include the desired frequency range the benefits may be somewhat reduced (especially if it is a five band equalizer).

This idea can be useful for CW and even for Phone as it will sometimes be found that hard to understand speech can be equalized and made more readable.

*In conclusion if you want advice or help concerning RTTY why not contact one of the following RTTY Clubs? Write to the Secretary of one of the following.*  
— ANARTS PO Box 860 Crows Nest NSW 2065 — Eastern and Mountain Districts Radio Club PO Box 87 Mitcham Vic. 3132 (note not an RTTY club but has many members involved in RTTY) — South East Qld. TT Group PO Box 184 Fortitude Valley Qld. 4006 — SARG 57 Haydown Road, Elizabeth Grove SA 5112 — AARTG 91 Arlunya Ave., Cloverdale WA 6105.

73 from Bruce VK5XI

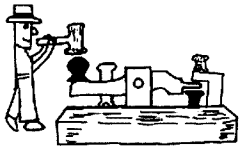

# POUNDDING BRASS

Marshall Emm VK5FN  
GPO Box 389, Adelaide, SA, 5001

This month's column was intended to be a continuation of the discussion of keying equipment, but it might be better to take this opportunity to answer some of the mail. As I intimated when the column began, I am not an expert CW operator, just an "enthusiast," and as such, feedback from the real experts is always valued. For example, Fred, VK4RF, has written advising me of some of his "pet hates," which are worth passing on because they should be everyone's pet hates!

- (a) Long CQ's without signing (as opposed to the standard 3 x 3 call.)
- (b) Ending a CQ call with KN (which means "called station only to respond" and is a contradiction of CQ). A CQ should end with AR or AR K.
- (c) The "bug" or mechanical key user who sends his dots at 35 WPM and the dashes at 20 WPM (more will be said about this later, in the context of mechanical keys.)

Fred also noted that a lot of operators seem to have trouble with spacing. You don't have to spend a lot of time listening to the "low end" of 80 metres to hear someone running words and letters together. CW sending is a fairly exact science, and any sending fault makes it less copyable at the other end.

My thanks to Fred to a new "abbreviation"—apparently a lot of ex-commercial ops use four dashes (—) to represent the letters CH in such words as such, much, touch, etc. This is a new one on me, but I can't recommend its adoption for everyday use.

At the other end of the scale of expertise, Ken, VK2BIW is approaching CW operation

from the angle of a complete newcomer, and his questions based on the first two columns have shown me how easy it is to overlook something.

First of all, my "golden rule" for sending speed is in need of revision. As printed, it read "Call at the speed you want to work; answer at the speed of the other station." There would be no point in answering a 20 WPM CQ at 20 WPM if you can only copy at 12 WPM! The revised standard version is "Call at the speed you want to work; answer at the speed of the other station if he is slower than you, or at your own speed if he is faster."

Ken also pointed out that I neglected to describe the use of "overlining" for procedural symbols. When two or more letters are written with a line over them (eg SK, SOS), they represent a special symbol which sounds like the written letters run together. For example, SK is sent as "-----", or S and K run together. In point of fact, SK is sometimes written VA, but SK is the more common usage. Theoretically, SK could be written all sorts of ways, including SNT, but it starts to look ridiculous.

Ken thought a full CQ call and response

sequence, with notes on the abbreviations (procedural signs or prosigns) would be of interest, so here goes . . .

CQ CQ CQ DE VK5FN VK5FN VK5FN AR  
VK5FN DE VK2BIW VK2BIW VK2BIW KN  
R VK2BIW DE VK5FN FB KEN HW U? K

The call is a "Three By Three" call because the CQ and the sending station's call sign are sent three times each. AR, as noted earlier, is the proper way to end a CQ because it is an invitation for any listening station to respond.

When VK2BIW responds to VK5FN, he uses a "One by Three" format because it is safe to assume that VK5FN will recognize his own call sign. The response ends in KN because VK2BIW only wants to hear VK5FN coming back.

I hope the above has cleared matters up for you, and I expect to hear a lot of unfamiliar calls sending CW CQ's on 80 in the next week or so. I'll answer any I hear, and I'm sure Fred will too if he isn't chasing DX.

It's been a pleasure to respond to both of these letters, and I hope I can do more of the same in the future — keep the mail coming! FER NW, 73 ES CU ON 80.

AR

## AMATEUR ACHIEVEMENT

Mike Provis VK3KKA

Two Victorians amateurs were involved in the production of a film which recently won a national award as the outstanding audio/visual production for 1982.

Dale VK3DXB, producer, and Chris VK3VYI, sound recordist, worked on "The Sounds of Silence" which was awarded a "Golden Target Award" by the Public Relations Institute of Australia. The award was presented by the Federal Treasurer, John Howard, at a special dinner in Sydney.

Dale said the film took a rather different look at the effects of noise deafness through the eyes of a man who lived with the disability. Produced for the Victorian

State Electricity Commission, the film also shows the workings of the SEC's hearing conservation programme. Dale and Chris work in the Public Relations Department of the SEC.

Dale said: "We set out to show how industrial deafness occurs and what the SEC is doing about the problem.

"We told the story through the eyes of one man and his family. We filmed them at home and work and our locations ranged from a power station, to home and to the 90 mile beach, on Victoria's east coast. Two out of the three members of our film crew are amateurs and we're both working on Barry, our cameraman to make it a full crew.



Dale VK3DXB, producer (left) and Barry Woodhouse, cameraman, receive the Golden Target award from Treasurer, John Howard.

AR

# AWARDS

Mike Bazley VK6HD  
Federal Awards Manager  
6 James Road, Kalamunda, WA 6076.

Easter is the time when the Federal Council usually gets together. One of the many items on the agenda is the Federal Award Manager's report. This year I am proposing some changes in our award rules. Could I suggest, if you are interested in the awards programme, that you read these proposed changes and make your point of view known to your federal councillor.

## Proposed Award Changes FOR ALL WIA AWARDS

1. *New rule. All applications for any WIA award must be accompanied by the applicant's address label taken from the latest edition of "Amateur Radio". Note WIA members will still have to enclose sufficient return postage for any QSLs submitted.*

Explanation of new rule. The Federal Awards Manager does not know whether applicants are WIA members or not. It seems unfair that members dues should be used to subsidise non-members. Most other bodies make a charge for any certificates issued.

2. **AMENDMENT, UNDER VERIFICATIONS, RULE 4.1**

Present rule reads: It will be necessary for the applicant to produce verifications in the form of QSL cards or other written evidence showing that two-way contacts have taken place.

*Proposed amendment: It will be necessary for the applicant to produce verifications in the form of QSL cards or other written evidence, from the station contacted, showing that two-way contacts have taken place.*

Explanation of amendment. This clears up the point raised by several members, that is, other written evidence could apply to the applicant's log.

3. **AMENDMENT UNDER VERIFICATIONS, RULE 4.5**

In addition to the present rule it is proposed that the following be added: *Every person certifying an award application must sign the following declaration: I have checked the (insert number in words) QSLs submitted by (insert call sign) and certify that the details attached correspond with the verifications inspected by me. Signed...* Explanation for amendment. Unfortunately there are some cases where the checking is not carried out properly. This year I have had certified applications which included QSLs from DX-peditions which were not active on the dates claimed. Also there have been claims for countries which do not correspond with the callsign used.

## PROPOSED OXCC AWARD CHANGE NEW RULE

1. *Delete rule 3.6 and insert the following: All stations must be contacted from the same DXCC "country".*

Explanation for the new rule. This would bring us in line with the ARRL award criteria. Further, it seems unfair that a station should be penalised because he is required to change locations, for example, to continue his experiment.

Well those are the proposed changes, which I believe should help to clarify a few points, at least I hope so. One further point, which does not involve a rule change, is that stickers should be available for additional countries past one hundred. These stickers could be issued for 150, 200, 225, 250, 275, 300 and then in intervals of 10 countries.

Also it is suggested that single band stickers should be available in the same increments. The different stickers could be distinguished by colour. For example, all band stickers could be red, 3.5 MHz blue, 7 MHz yellow, 14 MHz green, 21 MHz grey and 28 MHz purple. These stickers could apply equally to our Open, CW, and Phone DXCC awards. The cost of these stickers, I suggest, could be met by applicants. I do not know what the cost would be, though I am certain they should not be more than say, 20 cents each.

Further, the design could be the WIA crest with DXCC and the country total below. **WHAT DO YOU THINK?** Let your views be known.

## RUSSIAN PREFIXES

Several members seem to be confused with allocating the correct USSR country to a prefix. These can be easily found if you use the DXCC countries list in the current call book, page 53. The first letter U can be replaced by an R. For example, RJ8 or UJ8 is in Tadzhiik as is UK8J, RK8J, UK8R or RK8R. If you would like a copy of this DXCC list, an SASE to me will bring you one by return. Alternatively, you can send me a list of calls together with a SASE and I will sort them out for you.

## BLUE LAKE AWARD

The "BLUE LAKE AWARD" is offered by the South East Radio Group located in Mount Gambier, SA, to any amateur who establishes two-way contact with five SERG members. All bands and modes are permitted. Crossband operation is not permitted. No QSLs are required, only full log entry. The cost of the award is \$2 Aust. or 5 IRCs. Contacts made after 1st January 1980 will be eligible for the award.

Send applications to: The Awards Manager, SERG, PO Box 1103, Mount Gambier, SA 5290.

The following are member stations of the South East Radio Group Inc.

The following are member stations of the South East Radio Group Inc.:

VK5CC	VK5NC	VK5A00	VK5NEF	VK5Z0N
VK5CH	VK50A	VK5ATA	VK5NGH	VK5ZDX
VK5CJ	VK5QV	VK5ATD	VK5NHA	VK5Z0D
VK5DJ	VK5SI	VK5AVR	VK5NJV	VK5Z00
VK50K	VK5SR	VK5KBF	VK5N00	VK5ZWC
VK5FF	VK5TH	VK5KRR	VK5NRN	VK3MC
VK55J	VK5YM	VK5KTC	VK5NVC	VK3AGD
VK5JA	VK5AGO	VK5NBI	VK5NUE	VK3ALS
VK5LP	VK5AJR	VK5NBP	VK5NVF	VK3AXV
VK5MC	VK5AKJ	VK5NCZ	VK5ZBF	VK30GJ
VK5MS	VK5ALC	VK5NDP	VK5ZCH	VK3VEJ
VK5MV	VK5APD	VK5NDS	VK5ZCP	VK3YVV
			VK5ZGY	

SERG Net — 3.585 MHz — Mondays at 1030 UTC. Good hunting.

## THE CAPE NORTHUMBERLAND LIGHTHOUSE AWARD

Did you work VK5CNL on either 1st or 2nd May last year? If the answer is yes, then log details of your QSO and \$2.00 should be sent to the Awards Manager, SERG, PO Box 1103, Mt Gambier 5290 to claim this multi coloured award.

## PORT ELIZABETH BRANCH AWARD — SOUTH AFRICA

Confirmation of five QSOs with Port Elizabeth Branch stations. Certified logs or QSL cards plus 1 dollar or 5 IRCs to be sent to The Awards Manager, PO Box 462, Port Elizabeth 6000, Republic of South Africa. QSL cards will be returned.

Port Elizabeth Branch members are as follows: ZS1GV, 1WD; ZS2s — AB, AE, AI, AJ, AO, AW, BR, BX, CC, CM, CV, CZ, DD, DK, DR, EA, EE, EQ, FM, GH, GJ, GR, GU.



# CAPE NORTHUMBERLAND LIGHTHOUSE



Certificate No. \_\_\_\_\_ Awarded to \_\_\_\_\_ (In full name)  
 For contact with Special Station VK5CNL - 1st & 2nd May, 1982 SOUTH EAST RADIO GROUP, MOUNT GAMBIER, SOUTH AUSTRALIA

*John Somley*  
 President

HE, HR, HV, HW, HZ, ID, JJ, JR, K, KC, KD, KX, LL, LO, M, MC, MJ, NS, OB, PA, PD, PG, PP, PR, QF, RI, RM, RS, RT, SI, SW, TC, TJ, TW, TX, V, VM, WV: ZS4ME, ZS5DX, 3D6BP, ZS6 AEB, AXO, BTI, BZX, NX, UF.

## THE KENYAN AWARD

The Radio Society of Kenya will issue the above award to any licensed radio amateur located outside the Republic of Kenya who qualifies under the following conditions:

### TECHNICAL REQUIREMENTS:

Ten points are necessary, these are established as follows:

- a contact with each 5Z4 station who must be a member of the RSK = 1 point
- a contact with 5Z4RS, the club station = 5 points

MODES APPLICABLE: all modes

BANDS APPLICABLE: all bands

### ADMINISTRATIVE REQUIREMENTS:

- submission of log book photocopies witnessed and signed by a responsible official of the local radio society/club or the licensing authority
- only contacts made after 31 December 1977 are eligible
- for surface mail the charge is five US Dollars and for airmail ten US Dollars; Cheques and bankers' drafts must be crossed and made payable to the Radio Society of Kenya
- a self addressed adhesive label must be enclosed with the letter of application which should be addressed to the Society and marked "Kenyan Award" at top left hand corner of the envelope.
- all applications to The Radio Society of Kenya PO Box 45681, Nairobi KENYA

Until next month, Happy DXing, 73 de Mike, VK6HD.



# BLUE LAKE AWARD

SOUTH EAST RADIO GROUP



*The South East Radio Group has pleasure in granting this certificate*

to SAMPLE ONLY  
*who has complied with the conditions under which this award is granted by contacting the required number of members.*

Mode .....

Award No. .... Date .....

*John Somley*  
 Awards Manager

*John Somley*  
 President

**SERG: MOUNT GAMBIER, SOUTH AUSTRALIA**

P.O. Box 1103, Mount Gambier. 5290



# QSP

## SAN SP3RN

On 10 Oct., '82, a Polish Franciscan priest, Fr. Massimiliano Kolbe, SP3RN, was declared a saint by Pope John Paul II.

Fr. Kolbe was incarcerated in Auschwitz concentration camp during World War II. On the morning of 2 Aug., '41, a man escaped while being taken to work. The Nazis immediately instituted reprisals by killing 10 people from each block of the camp.

In Block 14, Fr. Kolbe asked that he be taken in place of one of the 10 who had a wife and children. This was agreed to by Lagerführer Fritsch, and Fr. Kolbe was killed by a lethal injection on Aug. 14. The man whose place he took is a Polish farmer, Francesco Gajowniczek, who is alive today.

Three weeks before his arrest, Fr. Kolbe was assigned the call-sign SP3RN. Is Fr. Kolbe our first radio amateur Saint?

Translated by Jack VK3AXO  
 AR

# HEARD ISLAND EXPEDITION '83

Neil Penfold VK6NE  
VK6 DX Chasers Club

**At 0237 UTC, on 30th December 1983, the maxi yacht Anaconda II slipped its moorings and put to sea. With it went our operators, mountaineers and photographers along with two tonnes of food, and one tonne of equipment. About one hundred people farewelled the vessel from the wharf in Success Harbour, Fremantle.**

Perth's three TV channels had camera crews there and commercial radio was also represented. The yacht was followed out to sea by TV helicopters and some small craft.

For the amateur component of this unique expedition, so many people and organisations have helped, that we became surprised, very pleasantly, and it showed that the spirit of adventure is still alive in people's hearts.

It was unfortunate that Chuck Brady VK0CW could not be with our other operators. Two days prior to sailing, he received phone calls from the USA. He then decided to return home, stressing that the reasons were connected with his personal life, and not the expedition. His decision threw a great burden onto our other two operators, so when you hear and try to work VK0HI, remember that only two men are working long hours in very cold weather to give you a contact.

Fortunately, there are other expeditioners around the main base camp at Atlas Cove, so loneliness is not a problem.

## RESUME OF THE COST OF THE EXPEDITION

\$30,000 was paid to the expedition company for transport, clothing, food, bedding and shelter. Equipment to the value of \$18,000 was obtained in various ways. By loan, donation and outright purchase, we managed to equip our DXpeditioners with brand new, but tried and proven gear, so that we have in effect two complete stations, plus 100% back up.

Briefly, VK6 division loaned an IC730 and power supply, three element HF beam rotator and controller plus sundry items; VK3 division, IC720A, two ICP515s; VK2 division, IC730 and power supply; VK6NE, two IC730s and power supply, two 2.5 Kw antenna tuners, SWR bridgers and special lighting units. Two new diesel-driven alternators were purchased in South Australia, which were run-in and tested by the company. One was purchased by a VK6 TV company and loaned to the expedition, and VK6FS also loaned one. The supply company kindly lowered their price, however VK6FS and the TV people still paid out over \$1000 each. Spares cost the expedition another \$330.

From JA arrived a new FT680 for use on six metres. Because of non-arrival from Cocos Island of the TET Beam, a new 6

element beam was hastily obtained from Victoria, again at reduced cost from the manufacturer. A host of other necessary articles were purchased, but one expense not required was that for forty "jerry cans" for cartage of fuel on the yacht. VK6 people have provided these, and it was greatly appreciated as their great gesture saved around \$800. The rest of the fuel which was provided free by a major oil company, was lashed on decks contained in 200 litre drums.

Other expenses over the past fourteen months, for publicity, postage, phone calls, came to about \$2000 each for VK6XI and VK6NE. We found that it was impossible to conduct expedition business via amateur radio, due to its content and also the deliberate QRM that we received.

The two American operators each spent \$3000 on fares to and from Perth in VK6. We know that Perth is a long way from anywhere, but Heard Island is further. And the intrepid operators have also taken three months leave of their employment for the chance to give you a VK0HI contact.

They brought with them two new LA 1000 Linear Amps; an IC740, Procom headsets, keyers and a two metre hand held unit. When they boarded the plane at Los Angeles for Perth the 2 metre unit was taken out of their hands as it was being carried in Al's hand then; we haven't seen the unit since. Other items included special baluns, lightning arrestors and 240 volt surge suppressors.

Of the \$30,000 paid, \$10,000 came from the Northern Californian DX Foundation INC, \$10,000 from the IDXF, \$2,000 from the DX Family Foundation of Japan, \$7,000 from KP2A, which possibly will be lowered to \$4,000 when the \$3,000 of the five thousand dollars promised from JA DX Family Foundation arrives.

The final cost of the expedition has worked out close to \$200,000. Whether the cost was justified, will only be judged when all return, and the projects evaluated, and the results obtained published. Perhaps in a future issue of AR, a list of equipment taken could be published, as a guide to forthcoming expeditions and perhaps a check list for operators making a "normal" trip to a good DX location. Purposely, names of companies and people who have helped are not given in this issue. We

intend to publish a full list in a later issue, as even this week, people have come forward with assistance.

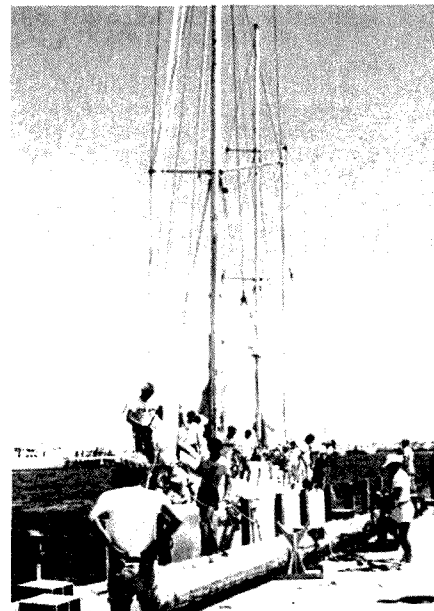
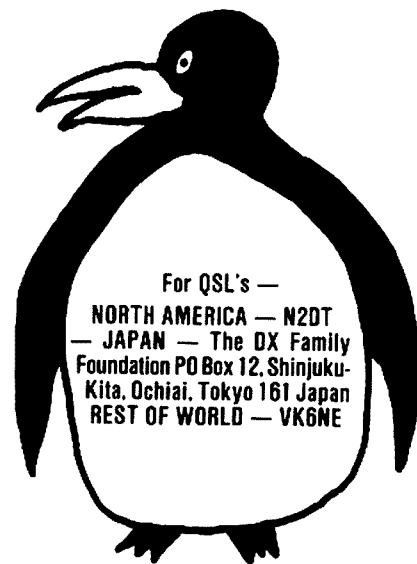

Anaconda II preparing to cast off from Fremantle.

HCRM:mm

December 15, 1982.

Members of the Heard Island Expedition 1982/83,  
On Board ANACONDA II,  
North Arm,  
OSBORNE. SA 5017.

Dear Members,

The Mayoress and myself, together with all citizens, not only in the Municipality of Port Adelaide, but throughout Australia would surely join in wishing each and every one of you a most successful and rewarding journey.

To all who have in any way supported this interesting venture, we pay a sincere tribute for such thoughtfulness, and take this opportunity to congratulate them, and particularly the selected personnel on board. Undoubtedly science will benefit considerably whilst the knowledge gained will also assist Australia's future.

Under the command of ANACONDA's Owner/Captain Mr Josko Grubic, who is well acquainted with all of Earth's oceans, the party will be in safe hands.

I wish to convey my personal appreciation to Mr Ian Hunt for his complete co-operation and assistance, and again extend our sincere gratitude to everyone taking part, and wish you all the best of luck on this wonderful voyage, and a safe return to port.

Yours truly,  
H. C. R. Marten, CBE, JP,  
Mayor.

## WIRELESS INSTITUTE OF AUSTRALIA



### 1982 SPECIAL AWARDS

At the December meeting of the Publications Committee the following Special Awards were made.

Alan Shawsmith Journalistic Award — **Mayday** by **Alan Campbell-Drury VK3CD** (May AR page 8).

Technical Award — **Single Frequency Crystal Ladder Filters** by **Rob Gurr VK5RG** (November AR page 14).

Higginbotham Award — **Peter Dodd VK3CIF**.



Alan Campbell-Drury.



Rob Gurr.



Peter Dodd.



# VHF UHF - an expanding world

All times are Universal Co-ordinated Time and indicated as UTC.

## AMATEUR BAND BEACONS

Freq.	Call sign	Location
50.005	H44HIR	Honiara
50.008	JA2IGY	Mie
50.060	KH6EQI	Pearl Harbour (1)
50.075	VS6SIX	Hong Kong (2)
51.022	ZL1UHF	Auckland
52.008	VK0HI	Heard Island
52.013	P29SIX	New Guinea
52.100	VK0AP	Macquarie Island
52.200	VK8VF	Darwin
52.250	ZL2VHP	Palmerston North
52.300	VK6RTV	Perth
52.320	VK6RTT	Carnarvon
52.330	VK3RGG	Geelong
52.350	VK6RTU	Kalgoorlie
52.370	VK7RST	Hobart
52.400	VK7RNT	Launceston
52.420	VK2WI	Sydney
52.425	VK2RGB	Gunnedah
52.435	VK3RMV	Hamilton
52.440	VK4RTL	Townsville
52.500	VK2BNT	Newcastle
52.510	ZL2MHF	Mt Climie
53.000	VK5VF	Mount Lofty
144.400	VK4RTT	Mt Mowbrall
144.420	VK2WI	Sydney
144.465	VK6RTW	Albany
144.475	VK1RTA	Canberra
144.480	VK8VF	Darwin
144.550	VK5RSE	Mount Gambier
144.600	VK6RTT	Carnarvon
144.800	VK5VF	Mount Lofty
144.900	VK7RTX	Ulverstone
145.000	VK6RTV	Perth
147.400	VK2RCW	Sydney
432.410	VK6RTT	Carnarvon
432.440	VK4RBB	Brisbane
432.450	VK3RMB	Mount Buninyong

There are quite a few changes to the beacons this month so they have been listed again. (1) and (2) are frequency changes for KH6EQI and VS6SIX. VK5KK (52.150) and VK3RTG (144.430) are not on the air.

## THE 1982 SPORADIC "E" SEASON

From reports filtering in to me it seems to have been a year of mixed successes, some have, some haven't! There is little doubt there has been a very wide area from which signals have been received, indicating operators are coming on the air in lots of places, but many familiar call signs and names have been missing from the scene particularly in VK2 and VK4. It is likely the VK2 boys are finding the full impact of a Channel 0 for the first time as their TV station goes on and on pouring out programmes and making 52 MHz contacts,

if not impossible, at least very difficult. The VK4 gang have had the problem for years along with VK3. There seems to have been an upsurge in activity in VK6 as noted in VK5 or else the band has been open to there longer!

Much of the following information comes from Bob VK5ZRO, who usefully fills in the gaps in my own log. Bob, incidentally, was awarded the Kenwood Trophy for the "Amateur of the Year in VK5" for his help and interest to those around him, and for showing the true amateur spirit of comradeship. We extend our congratulations Bob.

## AS IT WAS SEEN IN VK5

9/11/82: 0840 VK6WG and VK6KJ on 144 and 432. 1330: VK6XY, VK6BQ on 144. 12/11: From 2316 VK4ALM, VK4ZYA, VK4ZDK, VK4DO, VK4LE. 13/11 0001 VK2QF. 14/11: 0605 to 0830: VK6ZDR, VK6RO, VK6ZWH, VK4KRF, VK4ZSH, VK4PU, VK4DO, VK2BMX, VK4ALM, VK2ZZV, VK2ZMG. 19/11: 0740 VK6WG, VK6KJ on 144 & 432. 1000: VK6BE 144 & 432, plus VK6BQ, VK6NL, VK6AGW, and VK6BE on 144. 20/11: 0911 VK6WG 144 & 432. 25/11: 0942 VK6WG, VK6KJ, 144 & 432; 1026 VK5KMW (Ceduna) on 144; 1228 VK5ZEE (Woomera) 144 & 432, signals 5 x 5 on 144, 5 x 9 on 432, and weak on 6 metres! 26/11 0940 and 28/11 1135 VK5ZEE on 144 & 432. 29/11 0745 VK6ZFL/8 5 x 9; 0920 VK6KRY, VK6RO, VK6AKT, VK6WD, VK6XW, VK6BE.

1/12: 0710 VK2ZIR; 0733 ZL1BFQ, ZL1MQ, ZL2AAA. 3/12: 2325 VK4YJM. 4/12: 0205 VK4ABP, VK4RO, VK4ZYZ; 0430 to 0515 JA1, 2, 3, 7, 0, all 5 x 9. 5/12 and 7/12: VK5ZMJ (Port Pirie) 144 & 432. 8/12: 0840 VK6ZPG, VK6ZDY, VK6KRT. 9/12: 0725 ZL2TZP, ZL1AKW, ZL2TUV, ZL1MQ, ending 0805 most with 5 x 9 signals; 1100 VK6RO, VK6ZDR, VK6WD, VK6BV. 11/12: 0105 VK4ZWH, VK4DO, VK4ZTV; 1030 VK6SM; 2237 VK4DO, VK4LE and JA7NAM. 12/12: 0210 VK6BV, VK6RO, VK6ZPG, VK2ZZV, VK2AKK. 13/12: 1020 VK5ZEE 144 & 432; 1040 VK7ZOO, VK7ZIF, VK7ZUC. 14/12: 0610 VK6ZH, VK6ZWH, VK6SM, VK6AU, VK6ZPG, VK6UU, VK6RO, VK6ZDR, VK6VP, VK6KAT.

Just to prove he is rather versatile, Bob VK5ZRO wasn't content with all the above contacts so from his work car park at Hindmarsh (Adelaide suburb) on 15/12 at 2210 he had a two way contact on Ch. 50 FM with VK3ARR (mobile) who was in eastern Victoria. The mobile to mobile contact with whips was 5 x 3. (Not a bad effort Bob!) To prove it was no fluke the next day, 16/12 at 2155 he had a contact with VK3AKN and VK3ATN at 5 x 5 again

from the car park with his mobile equipment. However, he did use the Channel 7 repeater in Victoria this time!!

17/12: 0620 VK2BAE, VK2ZFS, VK2ZZV, VK2ZHE, VK2ZCV; 2106 VK5KMW 52 & 144; 2309 VK2BA, VK7ALM, VK7ZIF, VK2KFD, VK2XBW, VK2ZIR. 18/12: 0001 VK7AZ, VK7ZIF, VK7TC, VK7KWR; 0030 ZL3TIG, ZL2CD, ZL3ADT; 2222 VK5KMW 52 & 144; 2325 VK6ZFL/8; 2345 JA4MBM; 2348 VK4DO. 19/12: 0130 ZL2TLS, ZL2TZG, VK3CW, VK3CMD, VK3AZY, VK3CI; 0220 ZL1AKW, VK3AMQ, VK3EQ, VK3DQ, VK3YPY, VK3NM. 23/12: 1140 VK6WG 144 & 432; 24/12: VK5ZUC reported receiving the Albany 2 metre beacon from 2330 (23/12) to 1400, a period of fourteen and a half hours before he was able to raise anyone in Albany, finally working VK6KJ and VK6WG on 2 metres!

25/12: 2125 VK3NN on 144. Gary is the son of the late Herb VK3NN who lived in Western Victoria and who made many contacts into VK5 particularly with Mick VK5ZDR. Gary had his own call sign previously at the same time as his father, and it is good to see the original one being retained by a member of the family.

27/12: 0235 VK4AMH, VK4ZJB, VK4ZMD, VK4WQ, VK4XXM, VK4ABP, VK4LE. 28/12: 0630 to 1340 the band was open to VK6 rather exclusively except for VK8GB. Those worked were VK6RO, VK6BV, VK6ZDR, VK6ZZ, VK6SM, VK6ZH, VK6ZPG, VK6BE, VK6VP, VK6ZTT, VK6ZWH, VK6YH, VK6SQ, VK6AKT, VK6AB, VK6BA, VK6ZDY, VK6IQ, VK6MX, VK6PP, VK6XW with VK8GB at 1035! 29/12: 2245 VK5AYD (Peterborough) on 6 metres! 31/12: 1237 VK2ARA; 0940 VK5MC 144 & 432, and being copied as far as Cowell on Eyre Peninsula.

1/1/83: 2340 VK4ZWB. 2/1: 1010 ZL2KT, ZL2AQR; 1020 to 1320 VK2ASZ, VK1RK, VK2BA, VK2ZHT, VK1VP, VK1KAA, VK2YVG, VK3AZY, VK2ZNS, VK2ZRU, VK2BQN, VK2ZIR, VK2XAJ, VK4WS, VK4ZRL, VK2ZHE, VK3XQ/M (5 x 9), VK2BHO. 3/1: 0235 to 0545 VK6GU (Wyndham), VK3AZY, VK3BDL, VK2AWQ, VK6RO, VK6GU (again, still there 0417), VK6GL, VK6ZDR, VK6AKT, VK6ZPG, VK6KZ, VK6BV; 0648 JA7NAM, JA1VOK, JA1WHS.

Readers will be able to see from the above the high level of contacts made with the VK6 stations, spread right throughout the usual "season" and most of the contacts have been very strong. Particularly pleasing to have had words with John VK6GU whom I met while in Wyndham last July. John could be heard for at least three hours with signals from S3 to S9 and was able to make contact with stations over a very large area.

However, this was his first real DX day for the summer so he must spend a lot of time listening to a dead band except for JA's.

Bob VK5ZRO advises that for the past twelve months skeds have been kept with VK5ZRG in Cowell on 144 and 432 and it was only on rare occasions contacts could not be made over the 210 km path. Others to join in included Jim VK5ZMJ and Neil VK5ZEE at Woomera (500 km path).

## SIX METRES FROM MELBOURNE

Gil VK3AUI has written to say the work helping set up the VK0s has taken a toll of his operating time, but has been able to chalk up the following on 6 metres: 24/10: JA1, 2, 3, 4, 5, 6 from 0800 to 0930; 9/11 VK4; 11/11 VK4, ZL; 14/11 VK2, VK8GF, VK4, JA2; 15/11 VK4; 16/11 JA4, JA6; 26/11 VK5ZEE; 28/11 ZL; 29/11 VK8GB, VK8GF, VK4, VK5. 1/12: ZL1MQ; 3/12 ZL1AKW; 4/12 JA2, JA3, JAO, VK4; 9/12: VK2, VK4, VK6; 11/12: VK4; 12/12: VK6ZPG; 16/12 VK4DO; 17/12: JA1, JA2, JA7, heard P29SIX; 18/12 VKOAP, ZL3ADT; 24/12: ZL3TIB, ZL3HB.



# VK0AP

CONFIRMING QSO WITH  
AMATEUR RADIO STATION

CALLSIGN	DATE	UTC	MHZ	2-WAY	R	S	T
OP: PETER McLENNAN							
QTH: McQUARIE I							

LAT 56° S  
LONG 159° E  
CQ ZONE 30  
TXR FOR QSO

## MACQUARIE ISLAND

Gil VK3AUI has a few items of interest regarding the operations of VK0AP and says there were some problems not yet fully explained. One of the latest was a RIOMETER which is used to listen to solar/cosmic noise. Unfortunately it is basically a very sensitive receiver with very little filtering and almost any RF source interferes with it.

Gil, VK3AUI, at very short notice, manufactured two notch filters to alleviate the interference to the Riometer. These filters were believed to be of professional appearance and performance and were despatched to Peter VK0AP for express delivery to the supply vessel, by Australia Post, before the due sailing date of the last trip before next November.

There are many problems down there, not only RFI, with extreme conditions of wind, rain, snow, ice, salt spray, windblown sand etc. Outside work is difficult and survival of aerials is a real problem.

Signals were first heard in Melbourne by Geoff VK3AMK at 0030 on 18/12. Geoff also was the first to hear the VK0WW and VK0ZVS operations tan years ago! First station worked was Andrew VK3KAQ at 0051. The band opened again around 0730 and remained open until around 0730. Many Melbourne stations worked Peter, with him working twenty-six stations in VK2, VK3 and VK7 during the opening. The Keyer is temporarily off the air due to RFI but Peter will listen and call any station he hears. It is hoped the JA's will eventually reach that far.

## TWO METRES AND ABOVE TO ALBANY

Wally VK6WG has been kind enough to supply information of contacts between Reg VK5QR and himself on 19/11/82, and with others in VK5, with the following sequence of events.

2250 on 18/12 (UTC day) VK5VF on 144.800 first heard. 2322 gone. Beacon back again at 0120 but just audible. 0352 VK5VF fair strength, better at 0625. 0630 worked Andrew VK5ZUC. 0640 beacon steady. 0733 worked VK5ZUC, VK5ZDR and VK5ZK. All above on 144 MHz. Then worked VK5ZUC, VK5ZDR, and VK5ZRO 5 x 1 at start and going on to 5 x 7 on 432 MHz. This rise in signal seemed to indicate distinct possibilities for higher bands.

Reg VK5QR was contacted, and tests were made throughout the night on 1296 with good SSB quality and strength. Reg was also contacted on 2304 MHz for a period of over half an hour on one occasion. 3456 MHz was also tried but nothing heard. Went back to 2304 and 1296.

1296 MHz was being received by Reg on a 4 element beam one metre above his table. Then he tried a three inch length of wire in his converter and could read some of my SSB and the keyer, the time now being very late in the evening. Earlier in the night Bernie VK6KJ and I could read the one watt from Reg's 1296 at very good strength. We had many good contacts on 1296. I used about 50 watts into a six foot dish.

## AMATEUR TELEVISION ON 1290 MHZ

Wally VK6WG goes on to report that he received ATV signals from VK5QR on 1290 MHz that night of 19/11/82. Reg was using 100 watts, and Wally was using a Microwave Modules 1296 MHz transverter with an IF of 144 MHz into a Toshiba C531 monitor on Channel 5A. Wally reports as follows: "The pictures started off with fuzzy lines and plenty of snow, but good enough to recognise things. Bear in mind that the MM converter was not tuned to the 1290 MHz frequency, being 6 MHz away, and no pre-amp. I easily identified Reg when he televised himself, and on a meter he televised, I told him where the pointer was; he televised a man talking to a woman in a commercial, and used several odd movements of the camera in an effort to trick me but I was able to tell him each time where he was going. Next time I will try and get a photo of the screen."

I am sure the VHF fraternity offer their congratulations to you both on your achievements so far, and particularly in regard to spanning the 2000 km (approx.) distance between Albany and Adelaide with 1290 MHz television. Ultimately we hope this will become a 2-way achievement and we wish you well.

## MORE ON TWO METRES AND ABOVE

Andrew VK5ZUC has written to say how well the bands 144 and above were performing in November, several opportunities existed for good contacts to Albany, with the best being 19/11. It is interesting to note that the contacts Andrew made were as a result of hearing the VK6RTW beacon in Albany, and Wally VK6WG mentioned

above that his contacts resulted from hearing the Adelaide beacon VK5VF. So much more proof of the assistance given by beacons.

0625 worked VK6WG after hearing VK6RTW. Worked again at 0715 on 144.1 with VK5ZDR, VK5ZK and VK5ZRO joining in at 0730. VK6WG was also 5 x 1 at 0755 on 432.1 SSB. 1015 VK6BE 5 x 5 on 144.1. Next cycle VK6WG 5 x 9 at 1120 on 432. VK6BQ at Denmark (west of Albany) 5 x 4 at 1140 on 432. VK6KJ 5 x 9 at 1210 on 432. VK6NL 5 x 5 1240, VK6BE 5 x 9 1300, VK6NL 5 x 5 1320. VK6AGW 5 x 3 at 1350 with VK5ZDR and VK5ZRO.

VK6BE 5 x 7 1415 432.1; VK6SF 5 x 1 at 1420; VK6WG 2119 on 144, 2155 on 432 5 x 8; VK6KS 2135 on 144 5 x 9+, 2150 on 432 5 x 5, with VK5ZDR and VK5ZRO. VK6WG 2220 5 x 9 with VK5ZPE on 144, and 5 x 5 at 2225 on 432. On 20/11 VK6WG was 5 x 9+ on 432 with VK5ZRO, and VK5ZDR from 0909 to 0920. VK6KJ and VK6WG were 5 x 5 at 1010 on 432.

Thank you Andrew, shows what can be done when conditions are suitable and you move in the right places!

## TWO METRE ESCAPADES IN QUEENSLAND

Steven VK4ZSH has written with further exploits during his jaunts through the west of Queensland and into the Northern Territory. It's very interesting reading so I am sure you will want me to share it with you!

"QTH: 12 km west of Camooweal and in VK8 by 1 metre! Operating 2 metres. 22/10: 1132-1201 three JA1s with JA1VOK as first VK8 to JA1 QSO. Heavy doppler flutter on 6 metre signals at time, none on 2 metres with only slow tropo type QSB. Beacons in 1043 to 1230.

"23/10: 1138 to 1320 beacons only.  
"24/10: 1046 to 1139 seven JA1s, four JA7s and one JA9 (probably portable JA1), with JH7OGY first VK8/JA7 QSO, one of the JA7 QSOs will be a new VK8 two metre record. Beacons 1020 to 1230.

"25/10: 1138-1139 one JA7, one JA1. Beacons 1045-1230. Discussing the opening with Hidde JA2DDN we noted unlike April recent openings signals were all landing in Japan 2 to 4 degrees east of my longitude and concluded to work JA9 would have to shift west three degrees which I did the next day.

"28/10: QTH 60 km east of Tennant Creek in VK8. 1046-1146: two JA2, one JA3 and at least three JA9, with JA9WDE probably first VK to JA9 QSO on 2 metres. Beacons 1031-1227.

"29/10: Fired with enthusiasm I checked the map, chose the best area to try and work JA8 from and headed off via Mount Isa. By late dusk despite the mid 40 degree heat, a puncture in sight of Urandagi and having to change the points just over the border, I had selected the biggest and deepest bull-dust bog in the Simpson Desert!

"About 0930 TV signals on 50 MHz, 0945 JAs on 50 MHz, 1000 JAs on 52 MHz, 1042 paging transmitters on 146 MHz appeared. 1130-1140 JR7ICP Mutsa City (Northern JA7) JA8AKB Iwamizawa City about 40 km NE of Sappora both heard my signals but I

was only able to copy my call sign coming back. 1220 paging transmitters disappeared.

"Although no two-way QSOs resulted, it has proved the path possible. At approx. 138°E 22°S it's the farthest south signals have been heard so far and the farthest north in JA and about 800 km further than my longest two-way QSO. Also interesting that it was open to JA1, 7 and 8 at the same time, an 800 km spread N/S even though it was 3° longitude west of the N/S path. It is also the same geomagnetic latitude as Vladivostok (to Alice Springs area).

"1730: I was awakened by the roar of a 4WD and a 'You right mate' enquiry. The 'road' had been recently repaired and unfortunately the cattle agisting road trains heard about it and were using it as a short cut and had reduced it to a long series of bull dust bogs in just one week. In places it was so bad that the road had been buried 1½ metres below ground level. The sides were so steep and covered in bull dust that it took the 4WD five minutes to get up the bank so he could get around in front of my car to pull it out!

"2030: Started the 55 km back to Urangadi and despite cross country detours, the engine stopping three times due to burnt points, a part falling off the carby, and bull dust clogging the air filter and starter motor, by 0020 I was bogged again only 6 km from Urangadi. After half an hour of digging I arrived in town looking rather pale, covered from head to foot, inside and out in bull dust.

"The couple at the post office, which is also the telephone exchange, general store and one of the only three buildings in town, took pity on me and a much appreciated bath resulted. Apart from the 60 km around Urangadi and coming close to having my 2 metre yagi damaged by four Indian elephants, the 6700 km (short one this time) trip really was uneventful — honest (well, that is if you don't count the brakes failing coming down the Toowoomba Range!)

"I arrived back in Brisbane just in time to hear from locals 'you should have been here on the weekend, there was a great opening to ZL and P29 on 2 metres'. Conditions built up again and on 6/11 at 1000 worked ZL1UKE for country number four on 2 metres.

"The strongest paging signal copied this trip was S1½ compared with S7 in May. Also listened to paging transmitters on 142 MHz by tuning the IC251 out of band, signals were weak because of the front end selectivity but was able to tell that the 142 and 146 MHz beacons appeared within half a minute of each other at the start of openings.

"I would like to thank Hidde JA2DDN and Kazu JA1RJU for the considerable amount of telephoning they did to alert JA9s, northern JA7s and JA8s.

"Frank at Urangadi is offering one pound jars of genuine Simpson Desert bull dust for \$1. Enquiries and orders to the Postmaster, Urangadi, Queensland!"

Thank you for your letter Steven. I am sure you have many readers following your exploits in the back working 2 metres to

Japan. You are certainly following the true amateur spirit of adventure and experimentation and at the same time opening up new vistas and horizons of VHF interest, and giving food for thought to those able to have access to scientific think tanks. One wonders where it might all end. We wish you well for future trips. One of your rewards is working four countries on 2 metres. Has anyone else done that from Australia?

### HEARD ISLAND

The VK6 VHF Group News Bulletin mentions that the VK6 Heard Island expedition will be operating in the 52 MHz band for sixteen hours each day whilst on the island.

Two 6 metre rigs are part of the equipment list, as well as a 70 watt 6 metre linear amplifier and a 3 element beam. A beacon, beaming towards JA will be operating on 52.005 MHz . . . via VK6UN.

### LATE NEWS

A35GW in Tonga has been working into New Zealand, so far no reports to here of working to VK. Also noted that ZK2RS Niue has been worked by VK2BA, VK2ASZ, VK2ZYI, VK2BOD, VK2EDB, VK2EEC, VK2VC, VK2BNN and VK2YOE. This was on 29/12 on 6 metres around 0231 with signals to 5 x 9 for about an hour. Also, VK0AP was worked on 18/12 at 0537 for 10 minutes around 5 x 4 by VK2BA, VK2BHO, VK2VC, VK2YOE. (Thanks to VK2BA.) On 28/12 A35GW heard by VK2ASZ. On 29/12 VK2ASZ heard by A35GW! That's getting close!

2/1/83: Report of VK3KAZ hearing VK0 beacon on 52.100 at 1100. VK2 working right across continent to VK6 around 1215. VK4WS reported 6 metres open all day in Queensland to most states, plus P29, H44, ZL and JA.

ZL4OY/C will be operating 6 metres from Chatham Island south of New Zealand from early January 1983. Might still be on when you read this. Graham VK6RO sent word that Nori JR6IGG has worked his fifty eighth country on 6 metres by contacting the DX-pedition to St Peter & St Paul Island.

Incidentally, thank you to Nori JR6IGG who sends news of happenings in Japan regularly to Graham VK6RO who then passes on what's relevant to me. Thanks chaps.

Mark VK5AVQ advises of the installation of a new solid state 2 metre beacon, running at the moment with 10 watts output and reported as being stronger than the previous beacon which obviously was down in power! There are a few problems to be sorted out yet, but the unit looks good, and should be a useful asset to VK5 when operating as we would like it. It is planned to leave it on the present frequency for the moment, it's enough to sort out one lot of problems without compounding the matter with others which are more personal in nature! The VK5 VHF fraternity thanks Mark for his work and dedication.

Mark also advises the successful installation of the Adelaide UHF repeater near the site of the present Channel 8 repeater. It is running 12 watts output on a frequency of 438.525 MHz with the usual 5 MHz offset.

A masthead pre-amp has boosted the receiving range of the repeater. That this has been successful was demonstrated today (4/1/83) when VK3VL in central Victoria worked VK5KRA through it between 2100 and 2200. At this late hour details are scarce, but it's a pretty long haul for a UHF repeater!

I did hear during one of the last 6 metre openings before writing this that Des VK5ZO in Mount Barker had worked a station in Canberra on 2 metres. Unfortunately, in the short time available I have not been able to obtain any information, but will try to do so before next month's notes.

Readers please note that a letter symbol no longer follows any times given in the text. Since the demand to use UTC for any times based on what originally was known as GMT, and which could conveniently be shortened to Z, has now reached "AR", I feel to add UTC to the multiplicity of times used in my text is time wasting for me and the typesetter, so I believe the notation at the heading of the column that all times are UTC will help those involved. The times for our purposes are still GMT, Z or UTC whatever you like to call it.

I hope 1983 has started off well for you, and may continue so. Closing with the thought for the month: "The smallest good deed is better than the grandest intention". 73. The Voice in the Hills.

AR



### SAINT DAVID'S DAY SPECIAL EVENT STATION

In 1983 (The Year of The Castles) a Special Event Station will operate to commemorate the National Day of Wales and will run for the 24 hours of 1st March 1983. It is hoped to provide a focus for Welsh exiles, relations and friends throughout the world. All callers will be welcome and contacts will be mainly in English to serve this end.

The Special call sign will be GB2SDD (St David's Day) and all QSO's (contacts) will be acknowledged with the Special Event QSL card. In addition to this, an attractive HF award is available to radio amateurs who work the Special Event Station along with any other five GW stations during the month of March 1983.

It is intended to work on all HF bands (conditions permitting) which will include 10, 15, 20, 40 and 80 metres, contacts will also be welcome on 2 metres throughout the event period.

Further information can be obtained from the Event Co-ordinator GW4HOQ 13 Strawberry Place, Morriston, Swansea, Wales UK.

AR

### JOINS IN FEEDLINES

When making joins in feedlines etc, a neat way to make the join waterproof or just cover it, is to use the small plastic boxes 35mm films come in. Drill a hole in each end just enough for the respective cables to fit through. Pass the ends through the holes, join them and snap the lid shut. If necessary seal around the holes or maybe encapsulate in epoxy resin.

Jonathan Marshall SWL

AR

# INTRUDER WATCH

Bill Martin, VK2EBM,  
Federal Intruder Watch Co-ordinator,  
33 Somerville Rd.  
Hornsby Heights, NSW 2077.



## On the confounding aspects of radio signal propagation with respect to the signals of intruder stations.

I have long been puzzled by the inconsistencies of propagation. I have, for instance, been conducting a QSO with an amateur station in New Zealand, and have had the signals fade to zero before my very eyes/ears. Then, conversely, I have been in contact with a VK3 station, at about S2, and within minutes, his signal strength increases to an S9 plus. Mostly, I have observed, the fading of DX signals seems to coincide with my contact of a rare DX station, or a new country. How the "Ionosphere Manager" knows when I'm desperately trying for a new country, I'll never know — but he reacts always very quickly to shut me down!

All the foregoing leads me to question another amazing behavioural pattern of the ionosphere, and it's treatment of radio signals, with respect to the directivity of the signals of intruder stations.

Why, for example, are the signals of intruder stations only heard in certain states of Australia, and then why only in the same particular areas of those states?

To expound:

Intruders are NEVER heard in VK8;  
Intruders are RARELY heard in VK7;  
Seldom, if ever, are intruders heard in VK6 or VK5 . . . yet intruder signals are heard and logged in VK1, VK2, VK3 and VK4 almost daily. But, mind you, ONLY IN THE SAME AREAS OF THESE FOUR STATES! Why is this so? Is it because ionospheric propagation favours only the eastern states of Australia? Are the intruder stations working to a cunningly devised plan designed to thwart and abort the QSO's of radio amateurs ONLY in the eastern states? Is part 2 of their long-range, many-pointed plan designed to then create havoc on the amateur bands in the middle and western states — (after having first satisfied themselves that the amateurs on the eastern seaboard of Australia have been successfully silenced and have turned to some other leisure occupation)? I have noticed that, when a particular band is open, the intruders are invariably registering S9 or more on the meter. When the band is closed, so the intruder signal may fade to perhaps an S2 or S3. BUT THEY STILL GET THROUGH.

Which brings me to the point of the story:  
Why do some Australian amateurs always hear intruder stations, and MOST OTHERS



### INTRUDER PROPAGATION TO THESE AREAS

never hear them? I am, of course, basing my conclusions on the evidence of the quantity of intruder reports received by the Intruder Watch, and the geographical location of the reporting stations. And this evidence PROVES CONCLUSIVELY that the intruder stations are heard ONLY in some states of Australia, and then ONLY in some areas of these states.

It did occur to me that perhaps the intruders were in fact being heard in ALL the states, and in most parts of all the states, and that the amateurs who are hearing these intruders simply do not bother complaining, as they are happy to QSY to another spot on the band, and let the intruder(s) push them aside.

Of course, if this is so, then my whole theory of the idea of selective propagation favouring certain states and certain areas within those states, is completely erroneous. In other words, I'm wrong yet again!

I wonder which theory is true?

If your QTH is in one of the intruder-free areas (half your luck) but by chance you do happen to hear an intruder station, the Intruder Watch would be pleased to hear about it to at least confirm or abrogate the above theories.

Please send any intruder reports to your Divisional Intruder Watch Co-ordinator, whose particulars can be obtained from your Divisional Office, or in the 1982/3 Call-book.

**Please help the Intruder Watch.**

AR

# MAGAZINE REVIEW



Roy Hartkopf VK3AOH  
34 Toolangi Road, Alphington, Vic. 3078.

(G) General. (C) Constructional. (P) Practical without detailed constructional information. (T) Theoretical. (N) Of particular interest to the Novice.

### RADIO COMMUNICATION Nov. 1982

Directional active loop receiving antenna. (TC) Triambic keyer. (P) FT480R and IC290E compared. (G)

### CQ Nov. 1982

Special RTTY issue. (G)  
**ZERO BEAT Nov. 1982** (Youth Radio Clubs)  
VK CW QRP Club. (G) 5 Watt CW Transmitter. (P)

### HAM RADIO Sept. 1982

Phase lock principles. (G) Homebrew Microwave Antenna. (C)

### 73 MAGAZINE Dec. 1982

Taming two metre linears. (G) Co-axial feedlines. (N)

### QST Oct. 1982

Use of Solar Power. (G) Automatic antenna matching for mobiles. (C) 1982 International DX Contest. (G)

### ORBIT Aug. 1982

435 MHz Helix. (P) AMSAT Computer Project. (G) The NASA network. (G) AMSAT news. (G)

### MICROWAVES Sept. 1982

Among new developments is a 10 GHz video transmitter complete with 6 dB gain antenna all in a case 2" x 1" x 3/8". All it needs is a 1 Volt PP video signal and an 8-20 V DC supply . . . and 4,000 dollars!

AR

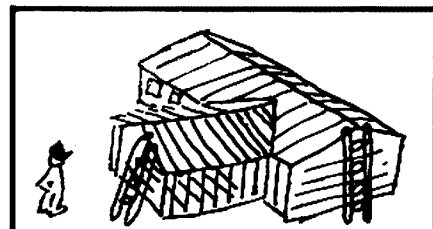

## WHAT ARE YOU BUILDING?

*Please tell AR about it so we can tell others.*

**Amateur Radio is an experimental hobby — if you share your experiments with us you are enriching our hobby!**

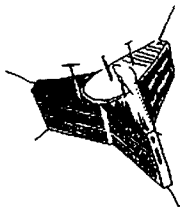

# AMSAT AUSTRALIA

Bob Arnold,  
41 Grammer St, Strathmore, 3041.

## NATIONAL CO-ORDINATOR

Chas Robinson VK3ACR.

## ACKNOWLEDGEMENTS

Amateur Satellite Report.

ARRL News Bulletins.

AMSAT-UK.

## INFORMATION NETS

AMSAT AUSTRALIA

Control VK3ACR.

1000 UTC Sunday.

7.064 MHz (Summer).

AMSAT PACIFIC

Control JA1ANG.

1100 UTC Sunday.

14.305 MHz.

AMSAT SW PACIFIC

Control W6CG.

2200 UTC Saturday.

28.880 MHz.

Updated information on Orbital Data may be heard on the above Nets, participation by all interested Amateurs is welcomed.

## SPACE SHUTTLE

There is a reasonable possibility that 'ASTROHAM' W5LFL, will carry on board Space Shuttle Mission No 9 a 2 metre handheld transceiver with ground plane antenna.

The equipment will be modified to NASA specifications and will give many amateurs around the world, an opportunity to work a Manned Orbital Spacecraft.

The majority of shuttle missions have an orbit inclination of 28.5 degrees which makes the spacecraft out of sight for most of the southern part of Australia; it is fortunate that Mission No 9, scheduled for launch early October 1983, will have an inclination of 57.0 degrees thus making it accessible to every part of the country.

We certainly hope this good news will be confirmed.

## AMSAT BOARD

Congratulations to Tom Clark W3IW, Pat Gowen G3IOR and Harry Yoneda JA1ANG on their re-election to the AMSAT Board of Directors.

## PHASE IIIB

The performance test results on the Phase IIIB equipment are summarised below:

### 1. MODE 'B' TRANSPONDER

Parameter	Performance @ 0°C	@35°C
Power Output	51W PEP	45W PEP

Av Power Out	14.3W	12.8W
Freq Out (435.100 In)	145.906	145.900
Eng Beacon	145.988	145.986
General Beacon	145.8105	145.8091
Receiver NF	3.0dB	
Gen Beacon Output 1.8W		
Eng Beacon Output 3.0W (25°C)	Transponder OFF	
Eng Beacon Output 1.5W (25°C)	Transponder ON	
Bandwidth	154 kHz @ 1dB point	
	152 kHz @ 3dB point	
	154 kHz @ 30dB point	

### Ground Station Requirements:

750/1000W EIRP, RHC Polarisation, Receiver NF 3dB or better.

## 2. L-BAND TRANSPONDER

Efficiency is less than designed. Power Output 35W. Interlock and 3rd order intercept products are now OK. The launch of Phase IIIB is still holding to the scheduled time slot around 20th April next.

## PHASE IIIC

Amateurs in this region of the globe will be pleased to hear that Phase IIIC is unlikely to be Geo-Sync (and at a location inaccessible to Australasia). More probably it will have parameters similar to Phase IIIB following a USAF launch.

## UOSAT 9

Little news is forthcoming on UO 9, the controllers at the University of Surrey are probably being exceedingly cautious in order to avoid the possibility of a further slip up. The spin down is virtually complete and is now one revolution per ten minutes, the Z-Axis has to be corrected before the Gravity Gradient Booms can be deployed.

Generally speaking all systems are good although there is some doubt about the efficiency of the CCD camera.

Status reports are given through the satellite's telemetry from time to time; whilst this information is readily determined it is not so easy to obtain the technical data via the high speed telemetry as this appears to be transmitted at weekends only and then during European daylight hours' ie at some unearthly hour in the middle of our night!

We certainly hope that the systems aboard UOSAT will be in an operating mode before many weeks of the new year have passed to give operators an opportunity to experiment before the delights of Phase III are with us.

## NEW RUSSIAN AMATEUR SATELLITE

At 0756 UTC on 18th November 1982 ISKRA 3 (RK03) was deployed from the Russian Salyut 7 spacecraft in a similar

manner to the launch of RK02.

Shortly after launch the satellite had an orbital period of 91.615461 minutes and a longitudinal increment of 23.275886 degrees west. The inclination was 51.6338 degrees.

The satellite has been transmitting complex telemetry data on 29.583 MHz and the transponder, with an uplink frequency of 21.230 to 21.580 MHz and a downlink frequency of 29.270 to 29.620 MHz, has carried a number of local and overseas QSO's. At the time of writing ISKRA 3 is losing height quite rapidly and will have re-entered the earth's atmosphere by the time these notes are published.

Congratulations to our Russian colleagues on a successful project.

## PUBLICATION REVIEW

AMSAT-UK continues its high standard of publications on satellite related subjects with a new book entitled "Satellite Tracking Software for the Radio Amateur" by John Branegan, CEng, MIRERE, GM4IHJ.

## INTRODUCTION

Every year an increasing variety of man made space craft and satellites take to the skies. These vehicles can provide a wealth of Scientific, Educational, Experimental and Entertainment information to individuals able to locate and track them. This tracking can involve some rather complex mathematics, however, the arrival of the micro computer has provided a cheap effective way to "hide the mathematics in the software of the computer". Thereby allowing anyone who has access to a micro, to locate and follow any satellite they wish.

This collection of satellite tracking software, ranges from the very simplest of programmes, through to very specialised programmes. The three major types of satellite orbit (Near earth circular, Elliptical and Geostationary), are all covered, and attention is given to the Weather satellites, Scientific Experiment satellites, Radio Amateur Communications satellites, professional Communications satellites and the Geostationary satellites providing Global Weather and Entertainment TV pictures. Additionally the programmes can be used to track near earth manned space vehicles such as Shuttle, Soyuz and Salyut.

The presentation of each programme is designed to allow someone with little or no knowledge of satellite mathematics, to input the programme listings into a micro computer and get useful



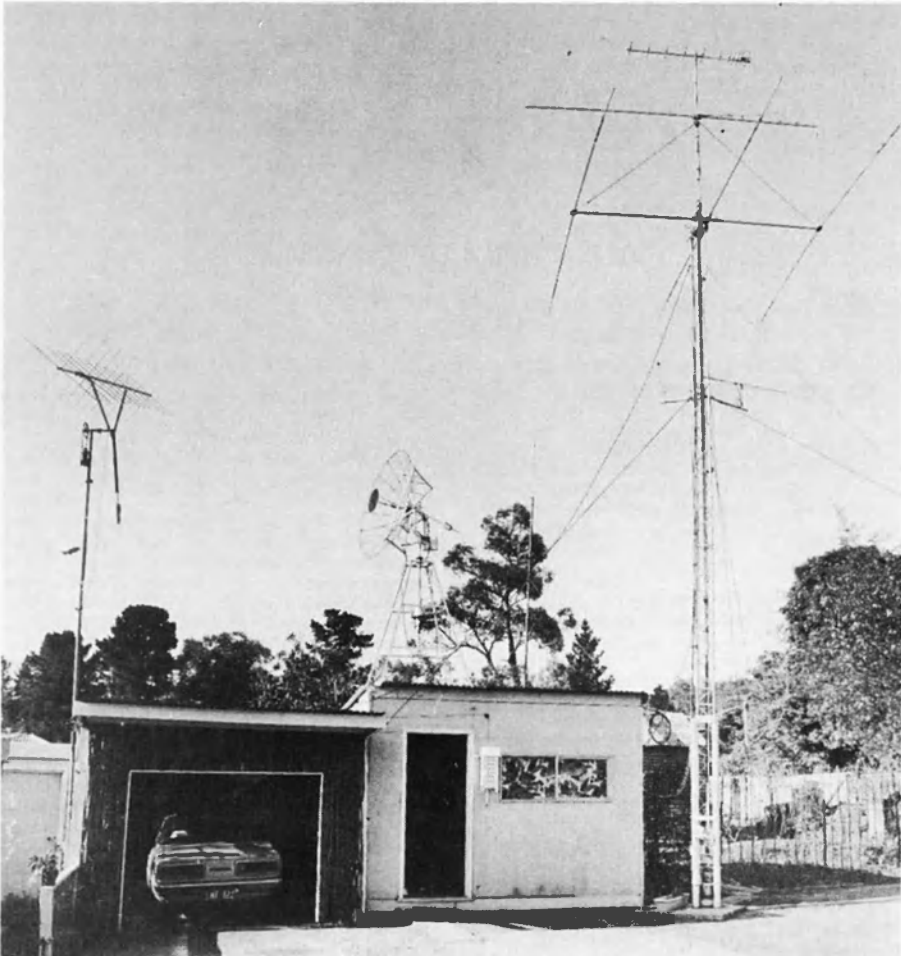

This photograph depicts the antenna farm at VK3ACR. Chas Robinson, the National Co-ordinator for AMSAT in Australia, uses most of these antennae in pursuit of his satellite interests whether they be communicating to and from satellites or maintaining links with AMSAT connections across the world.

Pictured are 144 MHz eleven element Cross Yagi, two metre Dish with Dual Feed for 70 and 23 cm, 146 MHz Ringo, 70 cm Ground Plane, 70 cm eleven element (ATN), 2 metre sixteen element ZL Special, TH3 junior, twelve element ATV Yagi, 3.5 and 7 MHz inverted 'V' Trapped Dipole, 1.8 MHz Marconi.

results at once. Appendices are provided giving detailed mathematical descriptions for those who want them and, the structure of the programmes is arranged, so that the user may progress from the simple programmes to the more involved ones simply by adding lines to the simple programme. In addition those who wish to construct their own programmes from pieces of individual programmes herein, will find that the programme structures do allow 'collections of parts' to be put together.

**BASIC LANGUAGE FEATURES**

The language used in these programmes attempts to keep near to Microsoft BASIC, whilst allowing the material to be directly input into ZX81 micros. Special features found in some Basic dialects have been excluded in an effort to keep the language as universal as possible. This has meant that several

programmes are longer than they need to be for some micros, but this has been accepted in the interests of universal applicability.

Despite the above, some micro owners will find a need to make changes to the listings, in order to accord with their personal dialect. Every effort has been made to make this as easy as possible even where this has meant the inclusion of WORDS and COMMANDS which are redundant in most modern BASIC dialects.

The following programmes are included:  
**PROGRAMMES FOR CIRCULAR ORBITS**

- Simple Nine — a UOSAT programme
- NOAA Weathersat
- RS8 Russian Amateur Satellite
- Russian Meteor Weathersat
- ASCOT — Any satellite circular orbit
- UOSAT all one days orbit
- OSCAR 8. Several weeks tracking
- RS 3 to RS 8 series — all six satellites time sequenced for several weeks orbit

**PROGRAMMES FOR ELLIPTICAL ORBITERS**

- A minimum elliptical programme SRET 2
- Phase 3B type tracking and communications programme

**PROGRAMME FOR A GEOSTATIONARY ORBITER**

- Locating a Geostationary Satellite

**APPENDICES**

- Glossary of Terms
- Sources of Orbital Data
- How to make up a BASIC satellite tracking programme — OSCAR 8.

This most useful book is printed in A4 format and may be purchased direct from AMSAT-UK, 94 Herongate Road, Wanstead Park, London, E12 5EQ, England.

The price for non-members of AMSAT-UK is £3.50 (members £3.00) plus £1.90 for packing and airmail. All remittances should be in English Currency.

AR

**ELECTRONIC HOBBYIST!**

DO YOU LIVE IN . . .

Ringwood, Lilydale,  
Boronia, Wantirna,  
Bayswater,  
Mooroolbark etc? . . .

We carry a comprehensive range of electronic components at very keen prices.

**Ian J. TRUSCOTT  
ELECTRONICS**

**CNR EASTFIELD  
& BAYSWATER ROADS,  
SOUTH CROYDON,  
VIC.**

**TELEPHONE  
(03) 723 3860**

*"Doris, you're my best friend. I feel it's my duty to tell you the truth about your husband."*  
*"What is it?"*  
*"I've seen your husband running around with other women."*  
*"Oh" yawned Doris, "is that all?"*  
*"Doesn't it bother you?"*  
*Doris simply shook her head.*  
*"Why not?"*  
*"Well, my husband is just like that old dog of yours that chases cars. Even if he caught one he wouldn't be able to drive it."*

AR

# NATIONAL EMC ADVISORY SERVICE

Tony Tregale VK3QQ  
FEDERAL EMC CO-ORDINATOR  
38 Wattle Drive, Watsonia Vic 3087

## RSTV ... CATV ... DBS ... AUSTRALIAN COMMENT

The Broadcasting Tribunal's recommendations are only the first step towards PAY-TV in Australia. How much will it affect you? How much will it cost? When will it start? The Government must first decide to introduce Radiated Subscription Television (RSTV).

The next step is creating a regulatory body which may or may not be part of the Australian Broadcasting Tribunal. Amendments to the present Broadcasting and Television Acts might have to be made and any new legislation could take some time if there is opposition in Parliament. Saving holdups, this new regulatory body could begin licence hearings early this year.

Successful applicants would need about one year to set up, so RSTV could be in operation by late 1984.

The introduction of Cable Television (CATV) is a little more complicated. The government probably won't announce its intentions until after the Davidson Report has been considered.

Nevertheless to be viable, Cable will probably need to use our domestic satellite (due to be in service in 1985) for the supply of programmes, so we are looking at Cable's introduction in about 1986 at the earliest and if at all.

The long-awaited Cable inquiry conducted by the Australian Broadcasting Tribunal was tabled in Federal Parliament on September 7, 1982, consisting of five volumes of recommendations covering the introduction of Cable Television (CATV), Radiated Subscription Television (RSTV) and Direct Broadcasting Satellite television (DBS) in Australia.

### TERMINOLOGY

"Subscription" or "Pay" television services are those services which, although offered to cable subscribers or to the general public within a certain area, may only be viewed by households who have paid an extra fee for the service and who are then eligible to use the special technical equipment necessary to convert the otherwise unuseable signals into standard television signals for viewing on conventional domestic television receivers.

The programmes distributed in the "scrambled" manner are usually high interest movies or sport but special programme material which may prove offensive to members of the public other than those to whom it is specially intended (medical lecture material and "adult" entertainment material) is also distributed in this mode in some countries.

When delivered over cable systems the services are designated "pay TV services". When delivered "over the air" by VHF, UHF, or SHF television transmission the services are designated "radiated subscription TV services (RSTV)".

In some countries alternative titles such as "conditional television transmissions", "exclusive television transmissions", and "restricted television transmissions" are in use

to distinguish the scrambled mode transmissions from normal "free to air" transmissions.

### RSTV TRANSMISSIONS

Depending upon the area to be served by the RSTV franchise holder, and also upon the radio frequency band made available for the RSTV transmissions, the radiated power of the transmitter may range from tens or hundreds of watts (low coverage station serving from 5 to 15 kilometres radially from the transmitter and operating on either VHF or UHF frequencies) to many hundreds of kilowatts (wide coverage station serving up to 100 kilometres radially from the transmitter). In the case of wide coverage RSTV transmissions, as is the case with conventional "free to air" transmissions, higher radiated powers are required when UHF channels are used. Depending upon the topography of the area being served, auxiliary transmissions from translator stations are required to "fill in" areas of poor reception of VHF, but especially of UHF, signals.

Although there are not, as yet, examples of the use of direct or community level broadcasting satellites to deliver RSTV transmissions to individual subscribers there are no technical reasons why this delivery method should not be used. There are many examples of the use of the transponders within fixed service satellites to distribute the programme material for RSTV services as well as for free to air and for CTV uses. This programme distribution began in North America with an unscrambled satellite transmission. The development of low cost "TV receive only" (TVRO) units for home use and the subsequent use of this equipment to "pirate" the RSTV and other TV programmes has led to announcements regarding the early introduction of scrambled transmissions from the programme distribution transponders of the North American domestic satellites.

The International Radio Regulations provide for the broadcasting of television signals in other bands than the well established VHF (47-230 MHz) and UHF (470-960 MHz) bands. There are examples of the use of SHF bands at 2.3 GHz and 12 GHz for the broadcasting of RSTV programmes where favourable terrain profiles and short transmitter to receiver paths exist.

On the other hand, the use of the 2.3 GHz band demands that there be clear line of sight from the transmitting aerial to all receiving dishes and that the radio lengths be relatively short. The 2.3 GHz band is a poor substitute for the VHF or UHF bands for use in broadcasting television signals and the particular frequencies used in the USA are already in use for other purposes in more heavily settled areas of Australia.

### CODING OF RSTV SIGNALS

The earliest regular pay TV services were those distributed by the cable TV system operators. The scrambling of the signal to prevent its use by cable subscribers other than those who were paying a premium subscription for the service was relatively simple (and still is in many cable systems in the USA). The security of the system against unauthorized use being, in the first case, assisted by the fact that only cabled homes could attempt unauthorized reception. Either negative security, which involves the use of a filter at the home of all subscribers who are not paying extra for the service, or positive security which involves the use of a decoder at the homes of all cable subscribers who are paying extra for the service, have been used successfully.

In the case of RSTV the scrambling methods used are more sophisticated to avoid piracy of the transmission by non-subscribers. A modern RSTV encoding system may incorporate the following features:

- both video and audio components of the picture signal are completely re-formed.
- the audio signal is digitized, encrypted and embedded within the composite video signal.
- digital addressing data is also inserted within the composite picture signal to enable each individual receiving decoder to be "addressed" from the programme source to authorize its use in receiving the scrambled picture signal.

The studio encoding facilities must include an appropriate computer to provide the "addressability" facility but this computer may then also be used for additional management functions. The address function, when provided, not only greatly enhances the security of the scrambling system but also permits subscriber disconnects to be effected without the need to visit individual premises.

### CONVENTIONAL COAXIAL CABLE NETWORK

Present day cable systems are based on coaxial cable technology and use a tree (as distinct from star) topology. Modern systems provide more than 40 channels and operate at frequencies up to 500 MHz. Two-way interactive capability is available and upstream video transmission is possible. Such cable television systems do not utilize subscriber-subscriber switching of either audio or video. Data, alarms, supervisory, polling capability are common features, however.

The cable is installed either aerially or underground depending on pole availability, local regulation and costs. Amplifiers are power fed along the cable and are installed either

aerially, in above-ground pedestals or underground.

## ALTERNATIVE TO COAXIAL CABLE NETWORK

Alternatives to the coaxial cable network are based on either balanced pair cable or optical fibre technology.

### BALANCED PAIR CABLE

Because of its practical bandwidth limitations due to a number of factors including crosstalk and induced noise, the pair cable is used necessarily in a different network configuration from conventional coaxial cable, viz multipair cable per subscriber or remote switched. In the first case (especially suited to low capacity systems, eg 6 channels) a multipair cable is provided to each subscriber and a simple rotary switch used by the subscriber to effect a choice of channel. With a larger channel offering, the switching takes place at a central location with the subscriber-actuated control signals being transmitted in the upstream direction, (possibly with the audio signals in the downstream direction) on one pair and the video signals being transmitted downstream over a separate pair.

Such pair cable systems have not proved favourable for high capacity systems and will not be considered further.

### DIRECT OPTICAL FIBRE EQUIVALENT TO COAXIAL CABLE TREE NETWORKS

At the present time the lack of suitable laser sources prevents application of the longer wavelength (1.3 micron) fibres to a single wideband fibre tree network topology. In the longer term (beyond 5 years), it may be possible to provide each subscriber with very wideband (eg 1 GHz) capability using a single fibre per household. Such a transmission medium would provide for video, telephony and other integrated services. Power feeding of subscriber equipment poses a serious problem, however, and suitable optical taps are presently unavailable.

### HYBRID COAXIAL/FIBRE NETWORKS

At the present time there are some commercial cable television systems which utilise a multi-fibre cable in the supertrunk/trunk portion of a cable network while distribution to households is performed using coaxial cable. The multi-mode fibre (850 mm wavelength) can provide up to four analogue video channels per fibre with channel capacity limited by source linearity and fibre mode dispersion.

The application of such fibre cables is based on costs and they can be cheaper than coaxial over relatively short distances (eg 5-10 km). Beyond this distance range the bandwidth-distance product of commercial fibres is inadequate to support systems of large capacity without repeating/regeneration which places the fibre option at a disadvantage.

With such systems, optical/electrical conversion and either time-division or frequency-division multiplex equipment must be provided at an intermediate position (between trunk and distribution plant).

Installations of the above type do not provide switched telephony facilities although such would be technically possible.

### CENTRAL OR REMOTE SWITCHED OPTICAL FIBRE NETWORKS

Two further alternatives utilising multi-mode (low bandwidth) fibres, eg 3-4 video channels, should be considered:

Firstly, a star connected network providing two multi-mode fibres per subscriber and centralised switching could

provide subscriber access to multi-channel cable television together with other services including telephony. Practical difficulties including the requirement for very large multi-fibre cables, eg up to 2700 fibres, and the realisation of a non-blocking, full availability video switch with a very large outlet capacity.

Alternatively, switching could be located at a remote position with a high capacity (eg 50 channels) fibre cable back to a central programme source (or exchange) and two narrowband fibres distributed to each subscriber. Again, the realisation of an appropriate switch would appear the major impediment to this approach.

## AUSTRALIAN NATIONAL SATELLITE SYSTEM

During the course of its Inquiry, the Tribunal, received submissions and heard evidence regarding the use of the planned Australian National Satellite System to provide programme relay facilities. These would be used for the distribution of television programmes from an originating centre (usually Sydney or Melbourne) to cable or RSTV head ends, located in many (and perhaps ultimately all) areas of Australia.

Attention was also drawn to the effect of the introduction of the homestead and community facility (HACBSS), provided on the satellite, for the distribution of the ABC television programme direct to viewers, mainly in the more outback areas of Australia. It would also be possible for other viewers currently experiencing poor reception, including those in metropolitan areas, to provide their own reception facilities to take advantage of the improved reception which will be possible from the HACBSS transmissions. Special attention was drawn to the effects upon the existing radiated free to air television services, as well as to any future cable and RSTV services, if a HACBSS type service is provided for the outback areas. This service would then become available as an additional programme in all or most areas of Australia.

The importance of the HACBSS transmissions is that they provide a higher field strength over the Australian continent than do the transmissions from the more plentiful fixed satellite service transponders, and so permit much simpler and cheaper receiving facilities to be used at outback homesteads, or at residences in the more settled areas.

## TECHNICAL FEATURES OF THE AUSTRALIAN SATELLITE SYSTEM FREQUENCY BANDS

- (i) for transmissions from the spacecraft (downlinks)  
Fixed satellite service (FSS): 12.25-12.75 GHz  
Community broadcasting satellite service (HACBSS): 12.5-12.75 HzG.
- (ii) for transmission to the spacecraft (uplinks): 14.0-14.5 GHz.

It is to be noted that the frequencies chosen, in the 12 GHz band, lead to increases in path loss and therefore lower field strengths under conditions of high rainfall, compared with the losses which would occur if operation in the 4 GHz or 6 GHz bands (as are used in the majority of the US national satellites) was to be undertaken. On the other hand there are many advantages which accrue from the use of the 12 GHz band, including:

- smaller aerial ("dish") diameters at earth terminals,
- higher aerial gains in the spacecraft,
- easier co-ordination with the operations of

satellite systems of other countries operating from nearby orbital positions,

- easier co-ordination of the satellite and terrestrial microwave system usage of the 12 GHz band than would be the case with the 4 GHz and 6 GHz bands, which are heavily used in Australia for main line trunk telephone circuits.

## SPACECRAFT RADIO DESIGN

The first generation system will comprise two spacecraft in orbit (located at 156 degrees and 164 degrees East longitude) with a third spacecraft available on the ground capable of operating at either of the first two orbital positions or at a third position midway between them at 160 degrees East.

Each spacecraft will be equipped with 15 transponders (11 of 10-15 watts transmitter power and 4 of nominal 30 watts transmitter power).

The receiving antenna beam will enable uplink signals to be received from any point in Australia, and a set of four spot beams will permit any four of the five beams to be used for each of the three spacecraft ie from out of the following five beams:

- Western Australian
- Central Australian (South Australia & NT)
- North Eastern (Queensland and Northern NSW)
- South Eastern (NSW, Victoria and Tasmania)
- Papua/New Guinea.

Various switching arrangements are possible in connecting the transponders to transmitting antennas in the spacecraft although full flexibility to connect any transponder to any aerial is not possible. With the aerial patterns as stated the ground field strengths for the various services are:

- HACBSS service (30 watt and spot beam) = 47 dBW minimum
- FSS service
- (i) 10-15W and spot beam approximately 42 dBW
- (ii) 10-15W and national beam approximately 36 dBW.

In choosing switching combinations within satellites and between the two satellites consideration must be given to the needs of the various proposed services. In particular to the need to maintain service on all of the HACBSS 1 beams by pre-empting other services in case of transponder failures.

It is to be noted that the 30W transponders may not be switched to the National beams and that the interconnectability of the low power transponders to spot beams is limited.

## BROADCASTING ISSUES

As indicated earlier, the Tribunal's attention was drawn to several issues involving the use of the National Satellite which have some relevance to the introduction of cable television or radiated subscription television:

- (a) most prospective CTV or RSTV licensees stressed their dependence upon the use of a satellite transponder(s) for the distribution of programme material. In general this would involve the use of a low power transponder into a National beam. There could be cases where the nature of the programme material (sport or news) may be limited in its appeal, so that a spot beam coverage would be acceptable. The resulting increased signal level from the spot beam would reduce the cost of the receive only earth terminal.
- (b) Evidence was also given of the intended use of satellite transponders, and associated privately owned receive only or two way TV terminals, for the relaying of television programmes by the existing terrestrial TV stations, as an alternative to the present uses of the Telecom terrestrial television relay system. The material

distributed would either be for instantaneous broadcast by the stations receiving the satellite signal, or for recording and later replay. In one case the material would be encoded after reception, to be re-broadcast as RSTV transmissions.

The Tribunal's attention was drawn to the likelihood that high interest programmes being distributed by the satellite may well be received by unauthorized users, including members of the public, as is now the case in North America and in Europe. Recent developments in the latter areas involve the encoding of the television programmes distributed by satellite, and such remedies for unauthorized reception may ultimately become necessary in Australia.

(c) FACTS drew to the Tribunal's attention a scheme whereby the low power transponders fed into spot beams could provide a "quasi BSS". The cost of receive facilities would be higher than would be the case for a "true BSS" using the power levels set down in the 1977 ITU Plan, and would also be about 5 dB lower than HACBSS-1. FACTS believed that members of the public, living in areas which are presently served by only one commercial programme and/or the ABC programme would readily accept the costs involved (about \$100 dearer than the HACBSS receive only terminal (\$1,000-\$1,500) to cover an increase in aerial diameter from 1.2m to 1.8m).

(d) Information was also provided regarding the methods which might be adopted to establish a second HACBSS service to provide a commercial programme to the outback and other areas not yet adequately provided with commercial TV programmes. In particular it was indicated that HACBSS-2 would be pre-emptible should any fault occur on the HACBSS-1 service and that because of the likely use of one of the 30W transponders for the PNG television transmissions, the coverage of HACBSS-2 may not be identical with that of HACBSS-1. As the HACBSS signals will be receivable in all areas of Australia any new commercial programme radiated from the satellite as an HACBSS-2 service could affect the viability of existing terrestrial licences, particularly the regional operators and particularly if TV receive only terminals become available at costs as low as \$700-\$800 as was predicted by some witnesses.

Australia is on the threshold of a new era in communications. The introduction as soon as practicable of CTV preceded by the introduction of RSTV, will enable the nation to further realise its potential for social development and economic growth. The entertainment applications of the new technologies provide the short run justification for the early development. These leisure and recreation orientated uses will be the catalysts for stimulating the construction of broad band local CTV systems in the immediate future . . . so saith the Australian Broadcasting Tribunal.



AUSTRALIAN LADIES AMATEUR  
ASSOCIATION

# ALARA

Margaret Loft VK3DML  
28 Lawrence St, Castlemaine 3450.

Weil our contest is all over and thank you to all who sent in logs, fifty-six this year. Slightly more than last year's result. Certificates have now been issued to the following ALARA members: VK2SU, VK3DYL, VK4ATK, VK5ANW, VK6KYL, VK7HD, P29NSF, G4EZI, DJ0EK, ZL1BIZ, 5Z4CM, KQ7Y, VK2PLG (top novice). Non Member YL's VK3KIM, G4GAJ, ZS2AA, I1MQ also received certificates as did OMs VK3XB (also top score in contest), G3VUH and SWLs VK4L40018 and ZL1-261.

A full list of the results will appear in the contest column shortly.

### NEW CALLS

Congratulations to Kim VK3CYL ex VK3KIM, Margaret VK3NZD, and Narelle VK1NG formerly VK3NMV/3DNG. Narelle was at Echuca and was one of the seven licensed YLs from the area.

### LIFE MEMBERSHIP

The first life membership in ALARA was very proudly awarded to Mavis VK3KS at our December meeting. Mavis has been a member of LARA, as it was then, since 1975. She has always been there on the nets ready to help in any way she can. First licensed in 1939, she was instructed by Ivor VK3XB a teacher in the country town where Mavis lived. After three months on air World War 2 intervened. Mavis and Ivor

were married in 1943, and after the war amateur operations were continued from East Gippsland using a 2½ watt input battery powered set. In 1951 they moved to their present QTH and over the years Mavis has been very active in contests, mainly on CW. She is a member of the First-Class Operators Club, having been nominated in November 1966. Mavis is a member of YLRL (1950) and joined the YLISSBers in 1963.

Mavis has won many cups and certificates over the years and is always on the lookout for new YLs to add to her lists, always being helpful to newcomers and has helped many of us to gain confidence and skill in the use of the key.

### SUBSCRIPTIONS

Subscriptions are now due. Valda VK3DVT, Box 4, PO Brighton 3186, our treasurer will be delighted to receive your subs — \$5.00 for Australian and Overseas Air-mail. \$3.00 for Overseas Sea-mail.

Valda also has teaspoons for \$2.80 ea., badges \$3.00 and charm for chain or key ring \$2.00 all with ALARA's logo on them.

I hope to meet some of you at the Midland Zone convention at Strathfieldsay on Sunday 20th February.

Until next month 73/33/88 to all.

AR

## BOOK REVIEW

### THE ARRL ANTENNA BOOK

Many amateurs deplore the passing of the "homebrew" era when, mainly because of necessity, amateurs built all their station equipment. In today's society, particularly with the advent of the ubiquitous "black" (or mainly grey, now) box, many interesting and welcome newcomers have entered the amateur ranks with little practical knowledge of electronics. Transceivers, like motor cars, now go "back to the dealer" for maintenance and repairs.

But there is one facet of our hobby in which all amateurs can (and most do) involve themselves, and that is antennas. (The purist will argue that I should use the word "antennae", but I disagree.

A number of books have been written about antennas for amateur use over the years, but only one has become, for many people, almost an antenna "bible" and that is THE ARRL ANTENNA BOOK.

This 14th Edition (over 600,000 previous editions have been sold) is a worthy successor.

Whether you are a newcomer interested in discovering how and why your commercial antenna works, or you are contemplating building an HF log periodic, or even a microwave dish, this book will be of value to you. I would even suggest it is a must for the library of any amateur. In fact I will be quickly obtaining a copy to replace my well worn 13th edition.

Chapters 1 to 7 cover the theory of antennas and transmission lines, wave propagation and its relationship to antenna design, and the performance characteristics of directive antenna systems. Chapters 8 to 14 give complete data on a variety of antenna designs from HF to UHF, base station to mobile / portable, space communications to direction finding, and antennas for restricted spaces.

Copies of this excellent publication are available from Magnums, and from leading booksellers in capital cities.

VK3ARZ

AR

## EMC

(Electro Magnetic Compatibility)

If radio frequency interference is causing you a problem you are reminded that — "Advice on all types and aspects of interference (PLI, TVI, AFI, etc.) is available from the National EMC Advisory Service".

FORWARD DETAILS TO

VK3QQ,

Federal EMC Co-ordinator, QTHR.

# SPOTLIGHT

## ON SWLING

Robin L. Harwood VK7RH

5 Helen Street, Launceston, Tas., 7250

One problem experienced by owners of the Sony ICF-2001 receiver is the heavy battery consumption, especially if one wants to use it as a portable. Using standard D cells, you hardly have more than two hours of operation, which destroys any portability it might have had. By using rechargeable batteries, a fairly satisfactory solution to listening is obtained, although it does depend on what cells are used. Nickel-cadmium batteries are satisfactory, but they have to be removed from the set, in order to be recharged. A way around this, is to have a spare set in the charger. But this can be expensive, and time consuming.

In the latest *Index* bulletin (1) put out by HCJB's popular "DX Partyline" programme, John Stanley suggests the use of Gates lead-acid cells. These cells are totally sealed, and will not leak and damage the innards of your set. He says that Gates cells are superior to Nicads in all respects bar one. If you happen to forget to turn your set off, the cells are fully discharged, taking weeks to recharge. However, by the use of the ICF-2001's sleep timer, you can rest easy, as the set will switch off, if you do forget to turn off the set.

These cells are nominally rated at two volts, but actually deliver 2.2 volts each at full charge. The ICF-2001 works satisfactorily down to 4.0 volts, which is the discharge value of a pair of the above cells. Also the AC power supply has enough reserve to charge the batteries whilst the receiver is operating. After ten hours of use, the Gates cells will be discharged, and are easily re-charged overnight.

These cells are installed as follows. Open your ICF-2001 and remove the six Phillips screws, (one under the type AA cells) and carefully separate the front and back of the plastic case. Then locate the 1000 microfarad, 6.3 V electrolytic capacitor located between the speaker and the power-earphone-tape output jack panel. Carefully manoeuvre a small wire from each side of the capacitor to the battery compartment. Importantly observe the polarity, connecting the lead from the positive side of the capacitor to the positive battery terminal, and the negative lead to the negative terminal of the other battery. Then join the two free battery terminals together by soldering or using push-on connectors. But be warned; Gates cells do have a high short-circuit current, so don't short the terminals, and use small hook-up wire, to act as a fuse, to prevent shorts. Or put a 1 amp fuse in the positive lead.

The quoted price for Gates cells in the *Index* bulletin, \$US5.00, is applicable in America, and I am unaware if these cells are readily available here in Australia, although in Europe they are known as Gates-Chloride.

While turning around on the 13 metre band, I came across the North American Service of Radio Moscow on 21.475 MHz.

It can be easily heard here in Australia at 0200 UTC, naturally in English. Presumably to

North America's West Coast, it is heard at the same time as the World Service on 21.530 MHz, and at the comparatively same strength, indicative that they are both located in the same area. Yet, I wonder if they are beaming their North American Service, to cover a wider area, for the presentation is more polished, and not so riddled with cliches as is the case with the World Service. And it is an up-beat tempo as well. In our winter months is the usual time when we can hear the North American Service, especially on the 25 and 31 metres allocations.

Another station, this time in Greece, is now easily heard in Australia on either 9.420 or 15.050 MHz. Programmes are for the most part in Greek, naturally, with plenty of Bazouki music, that I do confess I'm partial to. In some target areas, they do conclude with an English news bulletin. However, if you are trying to compile a reception report on it, many of the popular tunes do pop up on the Greek Variety Hour, a weekly television show, produced at WIN4, in Wollongong, and shown on some provincial channels, which could aid identification.

The use of these two frequencies, 9.420 and 15.050 MHz, must have been influenced by the success of the BBC World Service, who have utilized 9.410 and 15.070 for many years. Propagation on these channels is very good into Europe and America.

Which reminds me, recently the New Zealand Meteorological Office commenced transmitting facsimile signals on 9.410 MHz. This channel has been used by the BBC World Service for quite a number of years, especially beamed to the Pacific area. Quite naturally, longtime BBC listeners across the Tasman were up in arms. It even made the news headlines, current affairs programmes had interviews with Arthur Cushen, with excerpts of the QRM. All this had the result, that the Minister of Science directed the NZ Met to use another channel to transmit their facsimile. Would it not be wonderful if Australia's amateurs and shortwave listeners could rise up and complain about the broadcasters transmitting programmes in exclusive amateur allocations. For example, on 7.025 and 7.095 MHz in the evening hours, or 14.320 MHz, where an obscure European country (Albania) transmits Chinese programmes at 0500, 1100, and 1300 hours UTC daily. And the best way they can register their complaint is through their Intruder Watch Co-ordinator. There are plenty of other non-amateur signals within the exclusive allocations to report. If we don't support IW, we will never get these intruders off our bands.

Well, that is all for this month. In next month's issue, I will be reporting on my trip to Queensland and Victoria, among other things. Until then, the best of 73's and good dxing!

— Robin

# NEW CHIRNSIDE VERTICAL ANTENNA

Model

## CE-5SS

5 band self supporting

Unlike our Model CE-5B, this vertical needs no guy ropes and stands only 5 metres high, is very easy to erect and can be disassembled again into four pieces in about 45 seconds.

YES,  
ONLY  
\$89

Just the antenna to have in the boot of your car or caravan for quick portable operation and for JUST \$89 you can afford to have one for that occasion.

### Specifications

Frequencies ... 80M to 10M.  
Impedance ... 50 ohms at resonance.

Power handling ... up to 1 KW PEP on 20-15-10M, up to 400 watts PEP on 80M and 40M.

¼ wave length type operation.

Termination ... SO-239 socket.

Weight ... approx. 3 kg.

GET ONE DIRECT FROM  
OUR MAIL ORDER DEPT.

\$89 plus freight charges.  
Bankcard welcome.

CHIRNSIDE  
ELECTRONICS  
PTY. LTD.

26 Edwards Rd,  
CHIRNSIDE PARK, LILYDALE,  
3116

Phone (03) 726 7353

W0818



# VK2 MINI BULLETIN

Athol Tilley VK2BAD  
PO Box 1066, Parramatta, NSW, 2150.

## ANNUAL GENERAL MEETING

The Annual General Meeting of the WIA NSW Division will be held at 2 PM on Saturday, the 26th of March, 1983. The venue is the auditorium of the Granville RSL Club, located at the corner of William Street and Memorial Avenue, Granville. Full notice of the meeting will be posted in early March to all FINANCIAL NSW members.

Persons wishing to stand for election to Council may obtain a form from the office. Please note that only Ordinary i.e. Full Members are able to nominate and vote and that nominations must reach the office no later than the 23rd of February, 1983.

The duties of council involve the management of the division's affairs. These are covered by articles 45 to 77 inclusive. Perhaps this is the year that you wish to volunteer some of your time and energy to assist your division of the WIA and fellow members. The duties of a councillor are not particularly difficult nor time consuming, especially if all members of council are prepared to contribute their fair share of the workload.

## DIVISIONAL OFFICE

The office is open each weekday from 11 AM to 2 PM and additionally between 7 PM and 9 PM on Wednesdays. The phone number is 689-2417 and all correspondence should be sent to PO Box 1066, Parramatta, NSW, 2150.

The office is located on the first floor of 109 Wigram Street, Parramatta.

## COUNCIL REPORT

Divisional Council met on the 12th of November at the headquarters of the NSW Division at 109 Wigram Street, Parramatta.

After consideration of Federal WIA proposals to promote World Communications Year 1983, it was decided that the division would give \$2,000 to the Federal fund to promote WCY 83. Assistance is required at a state level for supporting PR work and we require volunteers who might be able to help in this campaign. Ideally there would be three volunteers, one in each of the major population centres. Their role would be to combine federally supplied material with locally produced material so as to produce items of interest for the local press and other media. If you wish to assist or have suggestions, please contact the division.

Jo Harris, VK2KAA, was appointed as the Divisional Historian. If you have any items such as photos, minutes or other records that tell the history of this division, Jo would appreciate you either donating them or loaning them so we can copy them.

Items discussed at the 7th Conference of Clubs were considered for action by council. These are listed in the report of the

conference with details of council's action to date.

Gordon McDonald VK2ZAB resigned from council.

Stephen Pall VK2PS presented a federal report and WCY 83 and the length of federal tapes were discussed.

Tim Mills VK2ZTM presented a repeater report and applications to establish repeaters from the North West ARG, Orana Region ARC and OTC (A) ARC were approved. A proposal to change the sponsorship of the Sydney Slow Scan repeater was also approved. These applications will now be forwarded to DOC for their approval and processing, following which licences will be issued.

The December council meeting was held at Parramatta on the 9th of December.

Council resolved that David Thompson, VK2BDT, be appointed as the Divisional Treasurer. David will prepare the annual accounts of the division.

Nineteen new applications for membership of the NSW Division were accepted.

Four entries were received for the division's Home Brew competition. One entry was of a particularly high standard and easily won the section for projects which were "Completely Home Designed and Built". Other entries displayed a high standard making a final choice difficult. After considerable discussion, placings were decided in the "Home Built from a Published Design" section. The applicants have been advised in writing as to the results and awards and presentations will be made at the Annual General Meeting of the division, to be held on the 26th of March, 1983.

Council was pleased to note that the VK2

Division had moved to second place in the Remembrance Day contest. Thanks to all those members who participated and returned a log entry. Merit Certificates have been sent to the top VK2 scorers in the various sections.

The division now has the VHS video tapes of titles from the WIA Video Tape library. These were dubbed by John Ingham, VK5KG, the Federal WIA Video Tape Co-ordinator.

Council decided that the loan conditions were: 1. Only available to Affiliated Clubs, 2. One month borrowing period, 3. Postal borrowings by written request only, 4. Tapes picked up personally must be signed for, 5. Only one tape at a time may be borrowed.

It was decided that \$5,000 be invested in AGC Debentures for a period of at least three years. The loan to the Westlakes ARC to purchase a computer for QSL Bureau use was reduced by \$300, in accord with a previous motion of council.

## REPORT — 7TH CONFERENCE OF CLUBS

Representatives of thirteen clubs and the NSW Divisional Council met at the clubrooms of the Westlakes Amateur Radio Club at Teralba to conduct the 7th Conference of Clubs.

These clubs were: *Avondale represented by R. Cottier, VK2ERC, with 1 vote; Bathurst by N. Wiide, VK2DR, with 1 vote; Castle Hill by C. MacKinnon, VK2DYM, with 2 votes; Central Coast by S. Dooger, VK2KSD, with 5 votes; Coffs Harbour by R. Fletcher, VK2BKV, with 2 votes; Hornsby by B. White, VK2AAB, with 2 votes; Liverpool by J. Ditfield, VK2KDJ, with 3 votes; Orange by*



Delegates in session at the 7th Conference of Clubs, Teralba.



Rick VK2BKV receiving the "Dick Smith Educator of the Year" award from Susan VK2BSB.

R. Wilson, VK2BRC; with 3 votes; Oxley Region by L. Smith, VK2LS, with 3 votes; St George by F. May, VK2PIO, with 8 votes; Taree by J. Farley, VK2ZMR, with 1 vote; Wagga by N. Russell, VK2KNR, with 3 votes; Westlakes by P. Lorentzen, VK2ATR, with 10 votes; Illawarra by D. McKay, VK2DMR, with 8 votes.

The NSW WIA Division was represented by councillors S. Brown VK2BSB, S. Pall VK2PS, J. Pages VK2BYY, A. Tilley VK2BAD and P. Jeremy VK2PJ.

Keith Howard VK2AKX was elected as the meetings Chairman and Milton Hall VK2DCU was elected as meeting Secretary.

As the minutes of the 6th Conference had been previously widely circulated to all Affiliated Clubs, the minutes were confirmed as printed. The meeting then considered business from the circulated agenda.

**ITEM A**, concerning duty free availability of amateur radio equipment was amended to read "That Australian amateurs be permitted to obtain free of sales tax, amateur radio equipment to an annual value of up to \$1,000". The motion was carried and this division will now put it as an agenda item to the next WIA Federal Convention.

**ITEM C** requested that the WIA purchase good quality WIA emblems for use on the inside of car windows. Council is presently investigating design and costing of these emblems.

**ITEM D**, suggesting that the twice yearly conferences be changed to an annual conference, along the lines of the Queensland "workshop" system, was carried. This will now be considered by council after investigation.

**ITEM F** recommended that even numbered Conferences of Clubs should discuss and vote on WIA Federal Convention items. These discussions would take place as

general business and would guide the VK2 Federal Councillor as to the views of members.

**ITEM G** recommended that the 8th Conference of Clubs be held at the WIA NSW Division building at Parramatta.

**ITEM H** recommended that QSL cards for rare locations be pooled with other VK QSL bureaux for economy. This means that instead of each bureau posting off small, uneconomic packages, all VK cards can be sent in one package to the rarer DX countries resulting in a speedier and cheaper service.

**ITEM J** requested that DOC advise examination candidates clearly of their results. Examples were produced where the official notification gave no indication at all as to how the candidate performed in some subjects. Council has referred this matter to WIA Federal so it can be discussed with DOC.

**ITEM K** recommended that QSL cards held for both members and non-members by the bureau and unclaimed be destroyed after two years after receipt at the bureau. Some amateurs have not collected their cards for many years, resulting in a storage problem of their unwanted cards. Council has adopted this recommendation and advised the VK2 QSL Bureau to implement this policy.

**ITEM L** recommended that the Australian Novice Contest be given improved publicity. Council notes this and is seeking a volunteer to act as the Contest Publicity Officer who will write short publicity items for broadcasts etc.

Under General Business, the Divisional President Susan Brown VK2BSB presented graphs comparing results by NSW examination candidates with those of other states. She reported on discussions with the Sydney branch of DOC on this matter. The conference moved that the WIA NSW Division continue its efforts on behalf of

candidates for NAOCP and AOCPE examinations in an attempt to remove the apparent bias in NSW results.

The conference expressed its appreciation to the Westlakes Amateur Radio Club for the conduct of the VK2 QSL Bureau.

Motions congratulating the current executive of the WIA NSW Division for the competent manner in which divisional business has been conducted and for the professional manner in which the transition of the divisional headquarters to Parramatta was effected were carried unanimously.

A proposal to allow special interest groups affiliated with the NSW Division use of the division's facilities for their meetings was lost.

The Westlakes Amateur Radio Club was thanked by the conference for its provision of meeting rooms and conduct of the 7th Conference of Clubs.

Divisional President Susan Brown VK2BSB then presented the "Dick Smith Educator of the Year" award to Rick Fletcher VK2BKV of the Coffs Harbour and District Amateur Radio Club. Sue commented that Rick had conducted eight consecutive classes for the novice licence in the Coffs Harbour area. The presentation of the award was greeted with acclamation.

Susan Brown then presented an award of a certificate and a 10 metre SSB Transceiver to the club which had achieved the highest percentage increase in WIA membership amongst club members since the last conference. The award was accepted on behalf of the Hornsby & District Amateur Radio Club by their President, Barry White VK2AAB.

The 8th Conference of Clubs will be held on Sunday, the 17th of April, 1983 at the WIA NSW Division building at 109 Wigram Street, Parramatta. The host club will be the St George Amateur Radio Society.

Conference Chairman Keith Howard, VK2AKX thanked all delegates for their attendance and declared the 7th Conference of Clubs closed.

As a finale, the QSL Bureau computer selected the winners of the "Westlakes Tryflecter", the results appearing in the December issue of AR. Proceeds from this contest were used to cover some of the cost of the computer purchased by the club for use by the VK2 QSL Bureau.

Divisional Council wishes to congratulate the Westlakes Amateur Radio Club for the preparation and conduct of the Conference of Clubs.

## ORANGE AMATEUR RADIO CLUB MEETING

The club Christmas party for 1982 was held on the 27th of November, at the QTH of Vicki VK2EVM, in Blayney.

Approximately twenty-five members, their wives and families attended from the Cowra, Forbes, Canowindra, Bathurst, Oberon and Orange areas. A thoroughly enjoyable, pleasant and informal gathering was held, at which Tony VK2KTO was wished bon voyage, as he is leaving the district and moving to the Tamworth area. A very big thank you is extended to the



Some of the happy throng enjoying the OARC party. Those pictured are, from left to right: John VK2AMV, Heather Drady, Wally VK2DEW, Neville VK2DR, Branda Wilde, Ian VK2KMA, Frank VK2ZFE, Bob VK2DSM, Diane VK2DZM, Tony VK2KTO, Vicki VK2EVM, Ross VK2BRC, Trevor VK2ZNU, Ruth Salmon, Marlyn VK2DLD. The front row is, left: Peter VK2DBI and right: Bill VK2BVW.

Marsden family of Blayney for providing a pleasant and hospitable venue and to those who attended, despite other commitments.  
From Ross VK2BRC, photo by courtesy of John, VK2AMV.

**COMING EVENTS**

John Moyle NFD Contest: 12/13 February.  
Gosford Field Day: Sunday 20th February at Gosford Show Ground.  
Nominations for election to Council and agenda items for AGM close: 23rd February.  
Annual General Meeting, WIA NSW Division: 26th March at 2 PM.  
Urunga Convention: Easter Weekend, 2/3 April.

NSW members and clubs are invited to submit news items for inclusion in these notes to: WIA NSW Division, PO Box 1066, NSW, 2150. Items for April AR must reach us by the 21st of February.

Athol VK2BAD  
AR



**TWO METRE REPEATER**

Keith Perry P290A of Kieta, Bougainville commissioned a two metre repeater recently which receives on 146.400 MHz and transmits on 147.000 MHz. The repeater is mounted on the Postal and Telecommunications tower at Arawa.

AR

★ **BRIGHT STAR CRYSTALS**

*Specifications, Dimensions and data sheets available on request*

**BULK ORDERS:** In addition to our normal range we can supply quantity orders (100 up) at very competitive prices. All we ask is 50% of cost with order balance 30 days.

**DELIVERY:** 5-6 weeks from receipt of Order. Ring for quote: (03) 546 5076. Telex: AA 36004.

**NEW NSW AGENT:**  
APP Master Communications,  
Sydney (02) 682 5044

**BRIGHT STAR CRYSTALS**  
35 EILEEN RD., CLAYTON, VIC.  
ALL MAIL TO: PO BOX 42, SPRINGVALE 3171

WATCH CRYSTALS  
OVERN OSCILLATOR UNITS  
CRYSTAL UNITS  
FOR QUARTZ  
CRYSTAL CLOCKS

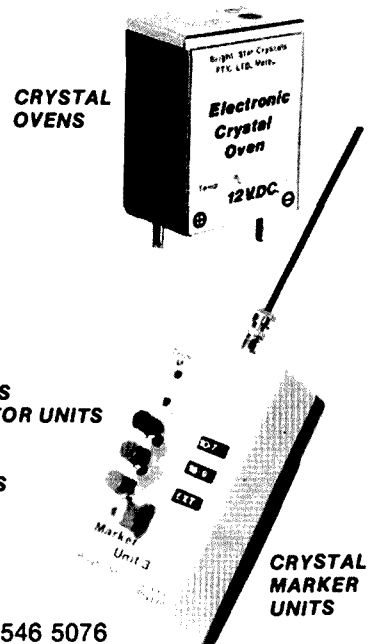

Phone MELBOURNE (03) 546 5076



# Andrews Communications Systems

KENWOOD FROM SOMEONE YOU CAN TRUST...

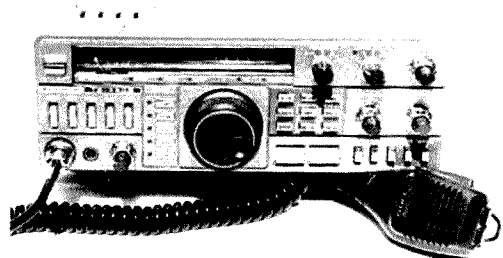

## TS-430S ... \$895

OPTIONAL PS-430 AND SP-430 DUE IN SOON

**WITH FULL 12 MONTHS WARRANTY. BUY DIRECT FROM IMPORTER. PLENTY IN STOCK!**

### NEW! YAESU FT-77 ..... \$660

100 W output mini HF SSB-CW — (opt. FM) transceiver.  
10 W output **YAESU FT-77S** ..... \$550

**FT-102** base station 160-10 m, WARC, VBC, notch, shift, 101 dB d.t., dual meters, 3 x 6146Bs ... \$1,050

SP-102 \$69, FC-102 \$289, FV-102DM \$369, YM-38 \$40

**FRG-7700SW** 2-29.99 MHz receiver ..... \$439

"FRA" \$55, "FRT" \$75, "FRV-B" \$119, Memory \$119  
**DISCONTINUED FT-707**, Only ..... \$665 Last few

FC-707 \$125, FV-707DM \$229, YM-37 \$15, YM35 \$28  
**FT-230R \$339, FT790R \$445, FT-708R \$329**

Full 12 months warranty on our imported YAESU, of course!

### TOP-LINE KENWOOD TS-930 SA MK II

WITH AUTO TUNER



## \$1,625

Why pay over \$1,800?

Full 12 months warranty.  
Buy direct from Importer and save ...

## only \$1675

HF SSB/CW/FSK/AM (NO FM) Transceiver with gen. cov. rec.  
Also in stock ... MC-6058 \$75, TR-3500 UHF h/h \$299  
Due in soon ... TS-430 V \$795, R-2000 \$595 ~~\$650~~

## ICOM

**WE WILL NOT BE UNDERSOLD ON ICOM!  
BEWARE OF ICOM WITHOUT 12 MONTHS WARRANTY!**

IC-720A \$1050 IC-740 ... \$865

IC-2KL .. \$1349 IC-R70SW \$695

IC-AT500 \$419 IC-505 ... \$419

Some ICOM items available on indent order only.

## SAIKO SC-7000

**INCREDIBLE  
70 CH.  
SCANNER**

Sole  
Australian  
Distributor

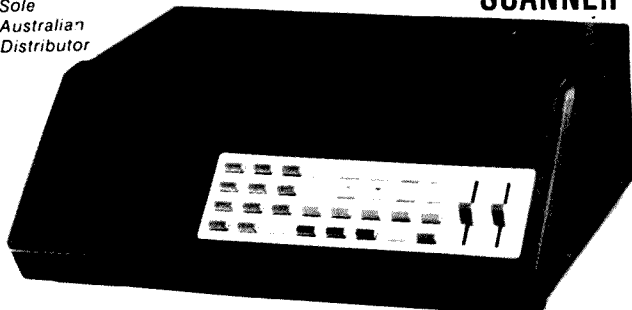

Scans & searches. Genuine lock out, AM/FM, etc, etc.  
Why pay more for a lesser scanner? Buy the Best!

**AMAZING 2.5 kHz STEPS ON AUSTRALIAN  
LOW BAND, HIGH BAND! HIGH SENSITIVITY!**  
60-90, 108-136, 140-180, 380-520 MHz.

## "STATE OF THE ART" ... \$449

### "KEN" ROTATORS

KR-400 medium duty, 28 V \$129

KR-400RC w/Round Controller \$149

KR-600RC heavy duty w/RC \$219

KR-2000RC super heavy duty \$429

Top & bottom mast clamps included

Direct  
Importer  
KR-400

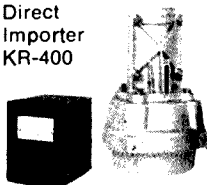

## CALL (02) 349 5792 or 344 7880 NOW!

**SHOP 7, GARDEN ST, MAROUBRA JUNCTION, SYDNEY N.S.W.**

Call For Closest Authorised Dealer To You!

**THE MAIL ORDER SPECIALISTS Write to: P.O. BOX 33, KENSINGTON N.S.W. 2033**



## VK3 WIA NOTES

### "INTRUDER WATCH"

Steve Phillips VK3JY is the new Intruder Watch Co-ordinator for VK3. Co-ordinator is the KEY word.

It is the duty of Amateur Radio operators to log and report all intruders on our bands. Unless this information is sent to Steve, he will have nothing to co-ordinate.

Report forms and identification tapes will be available from Steve or the VK3 office early in February '83.

### CONVENTION MARCH 18TH TO 20TH 1983.

The Victorian Division Convention 1983 will be held by the Eastern Zone at Moondarra Reservoir about twenty-five miles north of Moe in Gippsland. This is about an hour and a half's drive from Melbourne. It will be a family weekend at a reasonable price.

The programme includes: trade display, hidden transmitter hunt, home computers, technical tests, children's activities including treasure hunts and films, and the first round of the annual morse competition. *There will be no radio throwing contest!*

The convention will fully catered with lots of good food cooked by Eastern Zone amateurs with your assistance.

Bring your QSL card for the QSL tree.

The gathering starts after tea on Friday with supper for the travellers. Others will arrive on Saturday. Peter Wolfenden VK3KAU will speak on matters of interest after the Saturday night feast. The convention will wind up on Sunday afternoon after an auction and sale.

The camp, at the foot of the Baw Baw's, overlooks the Moondarra Reservoir and has a swimming pool. The accommodation is in two and three bedrooms.

Victorian amateurs received an insert in last month's AR. If there was no insert in your AR or if further forms or information is required, or if you have something to offer the convention, ring Stewart VK3BSM on (051) 27 4229, or write PO Box 339, Moe, Victoria 3825.

Accommodation will cost \$7.00 a night per adult and \$5.00 a night per child between 4 and 15 years inclusive. Registration for the weekend will be \$25.00 for adults, nothing for children, and \$15.00 for pen-

sioners and holders of health benefit cards. A heap of sleeping, eating, and activity at a very reasonable cost.

### MORSE COMPETITION

It is intended to commence a perpetual trophy for competence in Morse Code. It will be hoped to eventually extend this competition nationwide and in each year have a winner declared at each State Convention, the highest scorer being inscribed on a perpetual trophy.

Some general points on the competition are suggested:

1. The competition should be open to amateurs and non-amateurs.
2. The holder of a qualification in morse code such as an amateur or commercial licence could only enter the competition at a level above any licence held by that amateur.
3. Testing on transmission would only be undertaken at the highest level achieved by a competitor. The implication of this is that there would be no certificate given if a contestant could not reach competence in transmission at the speed he could reach in receive.
4. As competitors fall out in receive they will be tested to transmit at their highest receive speed achieved and certificates given.
5. It is intended that receive speed steps should be 5, 7.5, 10, 12, 14, 16, 18, 20, 22, 24 and above words per minute.
6. The examination should be set under the conditions of a DOC examination. This includes a small test transmission and no correction time allowed.
8. The Department of Communication will be asked to co-operate in assisting with this competition as it should be a stimulus to raising the level of competence in telegraphy.

AR



### 1982 2-METRE SCRAMBLE

Victorian President, Alan VK3BBM presenting the "Viccom" trophy to the winner, Robert VK3XQ at the December general meeting.

### MIDLAND ZONE CONVENTION

The Annual Midland Zone Convention will be held at the Strathfieldsaye Hall on Sunday 20th February 1983 from 10 AM. Lunch will be available and the usual trade displays, also a trading table section. So if you want to have a clean up of all your "junk" bring it along, it may be just what someone else is looking for. Everyone is most welcome and we look forward to meeting you. Enquiries to Margaret VK3DML, QTHR, talk in will be on VK3RCV ch. 11 147.750 input 147.150 out.

Meetings of the Zone are held on the 3rd Friday night monthly at 8 PM at the Eaglehawk and Long Gully Community Health Centre, Seymoure St, Eaglehawk. Office Bearers for 1983: President Don Hogg VK3XBL, V/Pres. George Loft VK3AGM, Secretary Margaret VK3DML, Treasurer VK3APB, Ass. Secretary Doug Fairbairn VK3KIT, Committee Ross Pittard VK3YXR (ATV) VK3BL (2 m rpt), Bill Kelly VK3XO, Max Williams VK3APB, Barry Lakey VK3BL.

AR

# CUSTOM WOUND TRANSFORMERS

LOW COST  
HIGH QUALITY

Consult us about  
your special requirements  
in transformers,  
power chokes, r.f. chokes, etc.

Sample prices:

240V — 1400V @ 0.4A .. \$82.56

Tax incl.

240V-8V @ 10A ..... \$28.32

2 x 15 @ 1.5A Tax incl.

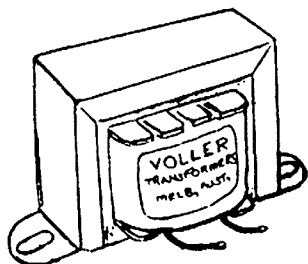

FREIGHT EXTRA

**PLEASE RING (03) 551 1452  
VOLLER TRANSFORMERS  
PTY. LTD.**

**16 PIETRO RD.,  
HEATHERTON. 3202**



## VK4 WIA NOTES

Bud Pounsett VK4QY

33 Lasseter Street, Kedron, Qld., 4031

There are some very important events coming in the first quarter of this year. First we have a new council to get working. There will be a mixture of old and new faces this year as there is most years. New councillors can be assured of a most rewarding year. The business side of the division ran very smoothly last year and should continue to do the same this year. This will allow councillors to spend more time debating important issues that will arise, and arriving at correct decisions.

Next we have our Radio Club Workshop, an event that grows in interest and importance year by year. This is the chance for club representatives from all over Queensland to get together formally and informally. This year, with few motions to occupy their time, delegates will be able to form into working groups and discuss items of importance to further amateur radio in Queensland and indeed, Australia. The workshop is an expensive weekend, but every cent spent is putting profit into our future.

After the workshop comes the Federal Convention. Our two federal councillors will go to Melbourne very well briefed by the Radio Club Workshop, this being one of the aims of the workshop.

### BRISBANE CONVENTION

The whispers are getting louder about a mid-year Convention / Hamfest / Amarama. The

venue will be Indooroopilly and a prominent Brisbane club will be the sponsor. Sometime in May?



The Media get together in Brisbane. The day after the Gold Coast Hamfest last November, Queensland Division members enjoyed a picnic at Mt Coot-tha. Bruce Bathols, VK3UV, AR Editor was there. Pictured are from left, Bruce, Jack Gayton, VK4AGY (VK4WIA Station Manager) Bonnie Pounsett, XYL of VK4QY (The Voice of VK4WIA) and Bud, VK4QY (VK4DIV News Editor).

Bud VK4QY

AR



## FIVE-EIGHTH WAVE

Jennifer Warrington VK5ANW

59 Albert Street,  
Clarence Gardens SA 5039

They say that old habits die hard, so I suppose that explains it. Explains what? Last week I had our former Intruder Watch Co-ordinator at my QTH, asking me to please publicise the fact that he is no longer our Divisional IWC AND HASN'T BEEN — FOR 12 MONTHS. Our new IWC is Colin Ralph VK5KCR who is QTHR in the latest call book listings, as well as appearing on page 62 under the IW heading. And for the cynics who are about to point out that the callbook has only been out a few months, I will add that Colin's name and phone number have been in the front of our local 'Journal' for at least eight months. We are constantly being told that very few people bother to report intruders and yet here were at least three people who did bother, and two of them had to make STD calls to do it. So please, in future give Colin a ring — he was only saying the other week that he doesn't get many!

Quite a few things have happened within the division over the past few months. We now have an editor for our local 'Journal' — Graham lies VK5KGI was the brave man who accepted the challenge. We thank you sincerely, Graham, and wish

you every success. I am sure that Graham would appreciate any articles and photographs (via PO Box 1234; GPO Adelaide, 5001) and technical articles would be very much appreciated by our Technical Editor, John VK5NX.

The alterations to the constitution as published in the October 'Journal' were all passed at the November meeting, though not without a great deal of discussion on some clauses. It is hoped that you will all receive a copy of the amended constitution, as part of your February 'Journal'.

We now have our first UHF (voice) repeater on air, and most of the credit must go to Mark VK5AVQ. The callsign is VK5RVP and it is situated on Mount Lofty, next to VK5RAD (Ch. 8). The I/P is 433.525 MHz, and the O/P is 438.525 MHz.

Finally, don't forget those Agenda Items for the Federal Convention as time is running out.

Forthcoming meetings will be held on the 22nd of February and 22nd of March, details of speakers not known at the time of going to press. March 29th will be a Buy and Sell Meeting — starting at 7.30 pm.

AR

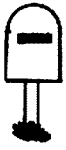

# LETTERS TO THE EDITOR

Any opinion expressed under this heading is the individual opinion of the writer and does not necessarily coincide with that of the publisher.



37 Landsborough Way,  
Padbury,  
WA 6025.

Dear Sir,

Now that the RD contest and the results published I feel that we should now evaluate the contest and rules as applying in 1982.

I know how much work was put into the formula and appreciate that the weight factor is there to encourage participation but I feel that the present scoring system will kill the contest because of the following:

1. SSB and CW/RTTY contacts counting 1 point each thus discouraging the longer CW/RTTY contacts — in fact the contest manager virtually states that because the CW/RTTY is a small contribution to the overall scores those contacts are insignificant.

2. No points increase for distance, therefore what is the point of say a VK4 or VK2 trying to work a scratchy signal from VK5 or VK6 when he can work Q5 signals from adjoining states on 80m.

3. Contacts on VHF being worth the same as HF contacts and those contacts being able to be repeated every hour so why work through QRM to score what used to be a reasonable amount by carefully identifying stations, checking for duplicates in case you may have worked that station some hours ago and then making the contact when all you need do is monitor a simplex VHF channel once every hour, work through the list and total up the score. This is very evident in the scores of the top stations.

My suggestion therefore is to retain a weighing factor to increase participation, give double points for all non SSB contacts TO ENCOURAGE THESE MODES, give extra points for distance (surely the idea of contests is to prove ones equipment) and, permit the working of stations on VHF on the same basis as HF that is once only — this should stop the RD contest — the friendly contest — developing into a frenzied numbers collecting game which is all too evident.

Finally, instead of vague inuendoes as to the reasons why logs haven't been included in the scores, surely common courtesy should dictate that amateurs who have participated in the contest and submitted a log should be informed either by letter or in print of the reasons their logs have not been included.

Yours faithfully,  
F A Parsonage VK6PF

25 Scrub Road,  
Coolool Beach, Qld., 4573  
15.11.82

The Editor,  
Dear OM,

## 'AR' COVER FORMAT

Probably I've left it a bit late, however I wish to raise the probably minor matter of the background colour of 'AR' covers.

Most years you have kept to one colour for the year, however once in a while the system goes crazy and covers come out 'hetero' as to colour.

I, for one, and I feel quite a few other members find it convenient for "filing and finding" to have all of one volume in one colour. It would probably be convenient for printer stocking also.

However, the only reason for divergence I can see is possibly 'change' on the public bookshelves to attract interest.

As I would guess that your largest volume of sales is to the VK-fraternity I would request that you give the above matter some consideration.

Yours — 73 etc.,  
John Stone, VK4NZ

## ARTICLE A 202

25 Beecroft Parade,  
Currarong, 2540  
15th. November, 1982

The Editor,  
Dear OM,

I have been a licensed amateur with the above call since 1936. I had a long lay off and re-activated last year.

However, I encountered an experience (which may be of interest to you) on 13th November which in retrospect made me wonder if amateurs really realise the immense responsibility which can be thrust upon them unexpectedly and do they know how to cope with it. Also, are they aware of the correct and most expedient procedures to adopt?

The following is a very contracted resume of my experience.

On 13th November I called CQ on 14.175 MHz at 0930 local time. A very weak signal Q4-5 S2-7 with lots of QSB and a voice with a strong accent replied giving the callsign HP2XBP/MM advising that they needed urgent medical help and advice — could I get a doctor to my transmitter.

They had a person on board unable to breathe and were applying mouth to mouth resuscitation.

My OTH is in a small country village on the coast with the nearest doctor 35 km distant. So it was impractical to do this.

Because I live the same distance from the naval station HMAS Albatross, I rang the Officer of the Day for help, who I understand, rang the Marine Surveillance Centre in Canberra. Canberra then rang me to check my bonafides and to find out the nature of the problem.

During all of this I am keeping up contact with HP2XBP who was stressing their crisis situation.

I advised Canberra the nature of the problem and that resuscitation had been in progress for quite some time and that the best fix I could obtain was that the people in trouble were in a small unidentified bay in Vanua Levin in the Fiji Islands.

Canberra advised Fiji, however, naturally, Fiji authorities said they need co-ordinates. I could not get these. Even though I gave them the frequency of transmissions, local skip would have prevented contact!

I am still, during this time, maintaining contact and also calling for additional aid from any amateur able to assist — negative.

I was eventually able to get a message from Canberra which I passed on to HP2XBP that Fiji was aware of the problem and were trying to help.

Time elapse is now 2½ hours and mouth to mouth is still being applied.

Around 1200 hours local I lost contact, but regained it a little later to hear HP2XBP talking to someone else.

The reception was poor but the gist of the conversation suggested that help was at hand.

Today — Monday 15th Canberra rang me to advise that the patient was a baby and that the Nadi authorities had taken control of the situation.

In retrospect, I asked myself these questions:

- (a) Could I have done more to help?
- (b) Did I handle the situation correctly?
- (c) Was there a more expedient procedure to follow?
- (d) Do other amateurs have knowledge of procedures in crisis situations?

(e) Was there a need for the WIA to maybe publish or update procedures for such situations? (maybe even a loose leaf insertion in AR).

Again, on reflection only this morning, I said to my XYL, I may never know if I did the right thing and that my actions were beneficial in an emergency situation.

In fact, the responsibility for the part I played was weighing fairly heavily, however, as intimated earlier in this letter, the authorities in Canberra, very thoughtfully and kindly rang me this morning, advised me of the outcome and put my mind to rest.

Dear Editor,

Is there a lesson in this for all of us related to our responsibilities as amateurs caught up in unexpected situations?

Is there a need for us to be alerted as to the correct and most expedient manner to handle like situations?

Finally the object of this letter is actual case information which may be of use in some future situation.

73  
Alex McMurray,  
VK2AEX

26 Karoonda Road,  
Booragoon 6154  
13-11-82

Dear Sir,

Referring to the item in the column "How's DX" (AR Nov 82) on the subject of using the AX prefix. I would like to add some comments to this topic.

There might be a perfectly natural explanation why so few Australian amateurs made use of the AX prefix during the Commonwealth Games — perhaps some feel like I do.

New or unknown prefixes will always attract attention and the use of unknown "pseudo-exotic" prefixes — like AX — by stations who are not on the most wanted list will also make other amateurs tune up their transmitters and follow with determination to work that "new" country. At least until they find out that it is no new country at all, but one that they have worked many times before. The nett result is disappointment. After all, changing two letters in a callsign does not make it more difficult to work a country.

Finally, the VK who did not know about AX may be excused. He might have been newly licensed and perhaps not a member of the WIA and therefore not in possession of AR or those other privileges which come with the membership.

Yours faithfully  
Walter Haenel

Dear Sirs,

I take the liberty of turning to you in a rather difficult matter and trust that you will see my point.

I am an East German radio amateur intending to emigrate with my family to

# IONOSPHERIC PREDICTIONS

Len Poynter  
VK3BYE

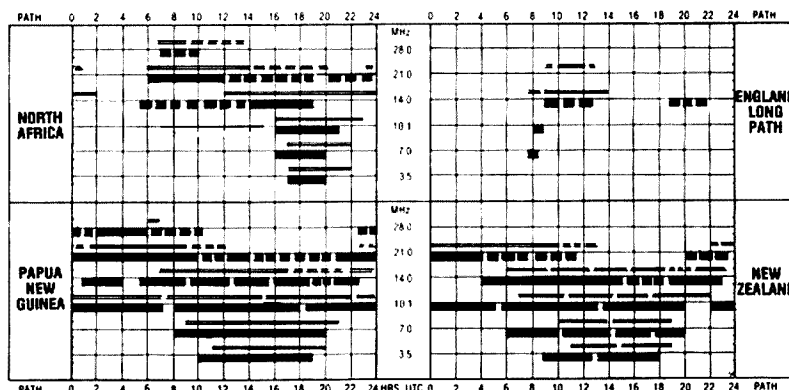
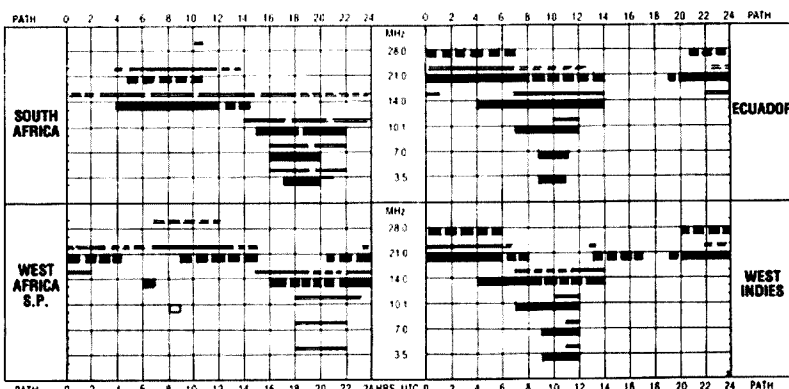
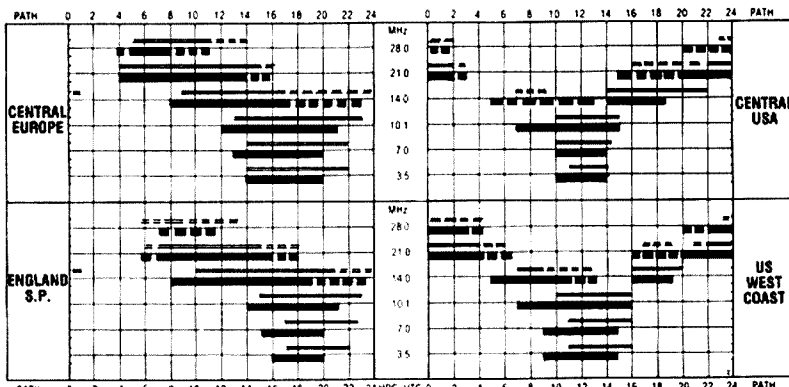
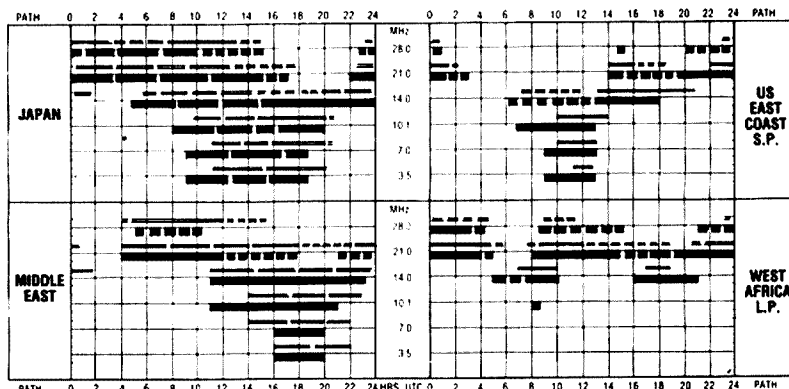

Australia because of political reasons. For this purpose I contacted the Australian embassy to the GDR in Berlin and Mr David Couch of Perth, WA, whom I know as a radio amateur under the call sign VK6WT, and asked him if he would nominate me for entry to Australia as this was suggested to be the best way to get to Australia. As my sponsor he would have been liable for our first accommodation and our first expenses until we would have got started. This is to ensure that we do not become a burden to the Australian society. On the other hand there is the restriction for us to convert our money into foreign currency when leaving which means that we can take with us only a few personal things, maybe some valuables too. So the difficulty for us is to find an individual or family who is able and willing to support us financially until we can manage things ourselves. After thorough consideration Mr Couch now told me that he would not be able to do this and therefore could not go on with my nomination. As a final possibility he suggested to turn to you requesting to circularize the divisions of the assistance I require so that my appeal would come to the notice of many Australian radio amateurs. I hesitated in following his advice but it occurs to me that this is my last and only chance left. So that is the reason why I ask you to help me solve my problem.

To introduce myself I must say that I was born in 1943, attended secondary school till 1962, worked as a grinder for a year, then did my army service and finally studied from 1965 to 68 at the Nautical College at Wustrow where I got the degree of a maritime radio engineer. Afterwards I worked as a ship's radio operator with the merchant fleet until 1971. At the end of that year the State security service refused to let me go to sea anymore out of political reasons. I was not allowed to work in my job and had to look for a new career as an engineer in the technical department of a furniture factory where I still work.

My family consists of my wife, born also in 1943, who learned the trade of hand-weaving. We have two children, both boys, aged 8 and 15. We are all in a very good state of health I have a good knowledge of English. My family speaks only little English yet. I am a radio amateur since 1960.

Further details about my qualification and my person may be obtained from Mr David Couch, 9 The Grove, Wembley 6014, Western Australia. He also possesses duplicates of my certificates.

Yours faithfully,  
H W Kohler

Editors Note:  
Any person interested in the above may write to VK6WT at the address mentioned above.

—VK3UV

## Note

John Moyle National Field Day Logs must be received by the Federal Contest Manager by the 23rd March, 1983, to qualify for any awards.

AR

## THE VK3BWW FORMULA FOR DX SUCCESS!!

**HIGH QUALITY  
AT LOW COST**

### BEAMS

3 EL 10 & 11m .....	\$75.00
3 EL 15m .....	\$83.00
3 EL 20m .....	\$158.00
6 EL 6m .....	\$108.00
5 EL 2m .....	\$36.00
9 EL 2m .....	\$59.00

### DUOBANDER

3 EL 10m, 3 EL 15m **\$148.00**  
Prices include Gamma match

Our beams are easy to assemble and adjust. Entirely **NEW CONCEPT** — **NO NUTS OR BOLTS.**

Spare parts, elements, booms and gamma matches available.  
**Plus Freight**

For further information  
**PLEASE RING (03) 366 7042**  
**VK3BWW**  
**WERNER & G. WULF**  
92 LEONARD AVENUE  
ST. ALBANS, VICTORIA 3021

## Silent Keys

*It is with deep regret we record the passing of—*

HAROLD ACKLING	VK2PX
RON HARVEY	VK6VX
T. G. PHILLIPS	VK2YHD
NORMAN RICHARDSON	VK7NR
J. SIMPSON	VK5NSO
P. T. SINCLAIR	VK3VZZ
KEITH WARDLEY	VK3IS

## THE KEY TO GOOD CW

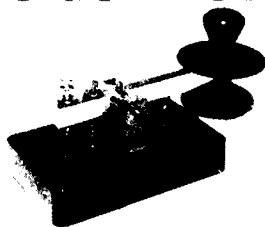

There has never been a better designed Morse Code Key — **SOLID, ROBUST and BEAUTIFULLY BALANCED.**

### MODEL 610 POST OFFICE PATTERN MORSE CODE KEY

Spring tension is adjustable to minimise wrist fatigue when transmitting for long periods and these quality Clipsal keys are beautifully balanced for fast, reliable operation.

**PRICE \$39** POST PAID AUSTRALIA  
**WILLIAM WILLIS & Co. Pty. Ltd.**

MANUFACTURERS AND IMPORTERS  
98 CANTERBURY ROAD, CANTERBURY, VIC., 3126  
PHONE: (03) 836 0707 W01107

## WARNING!!



Disposing of your old rig??

Please ensure it goes **ONLY** to someone licensed to use it on **YOUR** bands.

## Obituaries

**HAROLD D. ACKLING VK2PX**  
1892-1982

Many old timers will be saddened to learn of the passing of Harold, VK2PX at the grand old age of ninety years. He was born on Saint Patrick's Day 1892.

Harry, as he was known to his radio friends, was licensed in 1930, keeping his original call for fifty-two years. I well remember his original gear, all home-brew — a pair of UV202 bright emitters in a self-excited Hartley circuit, complete with slop jar HT supply. For reception an O-v-1 from wet batteries and 133 feet Zepp antenna. Harold worked an astonishing list of DX in his time including AC3YN in Tibet and he used to show me the treasured QSL for this contact.

At the outbreak of World War Two he volunteered for the army signals and left Australia in a large contingent on the Queen Mary. He saw service in Syria and was in Crete when the island was invaded by German paratroops. He escaped to Alexandria.

For many years prior to the war he was Treasurer of the original Lakemba Radio Club in the early thirties. There are unfortunately few of the old members left who will with some nostalgia remember Harry collecting the six-pences for the club funds. Harry has joined the long list of silent keys, 2JT, 2HW, 2CY, 2FY, 2EV and many others of the old club members. Right up to the time of his death in the Repatriation Hospital Concord on 22 November, 1982, Harold was active on our old timers 2 metre net. He is sadly missed.

He leaves behind a son and daughter and a host of friends.

Gilbert Pollock  
VK2FU  
AR

**PETER THOMAS SINCLAIR VK3VZZ**

Peter Sinclair VK3VZZ died suddenly at Lakes Entrance, Vic. on the 18th of December 1982, of a heart attack. He was 42 years of age. Apart from being my best friend, he was, I believe, what amateur radio is all about.

Although relatively new to the hobby, Peter was the first to offer assistance to others, and was always there when the antenna needed to come down, foundations needed digging, or simply for just a yarn.

In his job as a sales representative, he was held in high esteem by all who came in contact with him from Sale to the New South Wales border. Peter and I studied every Wednesday night for a pass at that elusive full call theory, and I'm sure that Peter would have made it this February.

He liked to "rag chew" and to renew friendships with DX stations whenever possible.

Peter was a gentleman and this was apparent in everything he did, especially his amateur operation. Amateur radio will suffer from the loss of Peter Sinclair, and his passing has left a large space in my life. To his wife Doris, and his children Shane and Joanne, I extend our deepest sympathy. I am proud and honoured to have known him. 73 mate.

Peter VK3VPC  
AR

## A Coll to all holders of a **NOVICE LICENCE**

Now you have joined the ranks of Amateur Radio, why not extend your activities?

### THE WIRELESS INSTITUTE OF AUSTRALIA (N.S.W. DIVISION)

conducts a Bridging Correspondence Course for the AACP and LAACP Examinations.

Throughout the Course, your papers are checked and commented upon to lead you to a **SUCCESSFUL CONCLUSION.**

For further details write to:  
**THE COURSE SUPERVISOR,**  
W.I.A.

P.O. BOX 1066,  
PARRAMATTA, NSW 2150

# HAMADS

**PLEASE NOTE:** If you are advertising items FOR SALE and WANTED please write on separate sheets, including ALL details, eg Name, Address, on both. Please write copy for your Hamad as clearly as possible, preferably typed.

\* Please insert STD code with phone numbers when you advertise.

- Eight lines free to all WIA members. \$9 per 10 words minimum for non-members.
- Copy in typescript please or in block letters double spaced to PO Box 300, Caulfield South 3162.
- Repeats may be charged at full rates.
- Closing date: 1st day of the month preceding publication. Cancellations received after about 12th of the month cannot be processed.
- QTHR means address is correct as set out in the WIA current Call Book.

Ordinary Hamads submitted from members who are deemed to be in the general electronics retail and wholesale distributive trades should be certified as referring only to private articles not being resold for merchandising purposes.

## TRADE HAMADS

Conditions for commercial advertising are as follows: The rate is \$15 for 4 lines, plus \$2 per line (or part thereof) minimum charge \$15 pre-payable. Copy is required by the first day of the month preceding publication.

**Amlidon Ferromagnetic Cores:** Large range for all receiver and transmitter applications. For data and price list send 105 x 220 SASE to: R. J. & U. S. Imports, Box 157, Mortdale, NSW 2223. (No enquiries at office: 11 Macken St, Oakley, 2223). BUSINESS CLOSED DURING FEBRUARY.

**CB Radios \$69;** walkie talkies, short wave radios, military, outback, business, amateur, marine, repairs, RTTY Siemens 100A printer \$120; base mic. \$45; ultrasonic alarm. \$35; all ham bands on a single 6 ft. whip, 1.8 to 30 MHz, for base or mobile. \$300; aerials, installation, demonstrations, 40 ch. CB conversions, accessories, new rigs weekly. Bridge Disposals, 12 Old Town Plaza, opp. Bankstown Railway Station, NSW. Mail order service and all enquiries to 2 Griffith Avenue, Roseville 2069, or phone Sam VK2BVS, 7 p.m. to 9 p.m. only, on (02) 407 1066.

## FOR SALE — ACT

**ICOM 551 Tcvt** 6 m, all mode 10W with FM board \$550. Icom 260A 2 m all mode 10W \$300. Glen VK1KAA QTHR. Ph: (062) 54 8002.

## FOR SALE — NSW

**AR MAGAZINES** — 45 Issues of AR between 1972 and 1979. \$20 plus postage. C MacKinnon, 16 Mills Rd, Glenhaven 2154.

**CALLBOOKS** 1981 USA \$8, 1982 foreign \$10, morse key HK708 \$10. Volumes 49 and 50 of AR, 24 mags in all \$10. VK2DET Blackheath NSW Ph: (047) 87 7003.

**COAXIAL RELAYS** 1.1 SWR at 450 MHz, 50 ohm, 50W, 12V DC coil, unused, sml Qty \$5 ea. Tektronix 564 storage CRO with 2B67 time base and 2A63 vertical plug-in, books and spare valves \$450 VK2ZIG QTHR PH: (02) 638 4864.

**COLLINS KWM2**, round emblem \$500. Collins S line 32S1 and 75 S3B immac \$850. Robot trimode keyboard and monitor \$850. Hygain 10/15 Duoband still in carton \$200. Drake TR4B Tcvt \$250. Drake TR4C both perfect. \$295. Cliff Coverdale VK2VK. Ph: (065) 52 4477 BH (065) 59 1508 (AH).

**DECEASED ESTATE:** Disposal of amateur equipment of the late VK2BB — Eddie Bailey of Murwillumbah. Offers are requested for the following equipment. The best offer will be accepted and the offerer will be notified. Offers to be in hand by the end of February 1983. FT 902D Tcvt new in orig case, Kenwood TS520S Tcvt new in orig case, FDK Multi 7 2 m FM Tcvt GC, Kenwood AT230 ant tuner new in orig case, FRG7 Rx GC, BC348 Rx, Osceblock SWR200 power Meter new in orig case, Kyoritsu K109 SWR Meter GC, Tandy 21522 SWR power meter new cond, Ringo Ranger 2 m ant new cond, 30 feet steel tower & 2 m beam GC, Dick Smith Freq meter GC, Webster Bandspringer Mobile Ant GC, 3 inch Oscilloscope T03, Bendix BC221 Freq Meter, Leader Sig Gen LSG10 in GC, Micronta Transistor Tester model 22024 GC, Leader Transistor Dip Meter LDM813 GC, Scope iron and transformer GC, large 250 Voltac Volt Meter GC offers to: Ian K. Dunlop VK2AVS 24 Countryside Drive, Murwillumbah, NSW 2484 Ph: (066) 72 2462.

**FT-227 D MEMORIZER** as new. Plus 13.5 VDC/5 amp. Regulated power supply. Offers? Nev VK2YMN QTHR Ph: (049) 61 1513.

**FT620 6 METRE SSB Tcvt**, with crystal on 52.1 MHz but no Mic. \$200. Also IC202 2 m SSB Tcvt less Mic and carry strap. \$190. Contact Jeff VK2BYU QTHR Ph: (02) 649 9829 AH.

**HY-GAIN TH5DXX 5 El** tri-band yagi with HY-gain BN-86 balun, 100 foot R88 cable, EC with instructions \$295 new Mics in box — Shure 404C \$40 Icom SM5 for IC 720, 730, 740, S35 new; Drake W4 wattmeter \$40 new B&W 5 position coax switch \$15 new Heath phone patch \$50 PO Box 505, Bondi Junction, 2022, NSW Ph: (02) 36 2981.

**IC202 2M SSB Tcvt** and IC20L linear amp and IC3PS power supply \$200 VK2YMW QTHR Ph: (02) 48 2818 AH.

**KENWOOD AT 200 GC S135**, Kenwood AT 230 as new \$180. Yaesu FT 207R, 2 spare Ni-Cd packs, case, YM47 Mic, 3 W-1 W S250, Kenwood TS 180S DFC ED \$950. AT 180 \$1500 VFO 180 \$150, SP 180 \$70, MC 50 \$40, PS 30 \$150 or \$1400 the lot Ph: (02) 588 4414.

**KENWOOD HF TS900 Tcvt** c/w PS and handbook A1 cond. Any trial \$430 ONO John VK2ANX QTHR Ph: (02) 638 4191.

**KENWOOD TR7400A 2 m Tcvt** 25 W 800 Ch perfect operating cond. Covers never been off, Mic Manual used only as base station \$295. Max VK2GE Ph: (043) 92 4900.

**KENWOOD TS130S** with 1.8 kHz SSB and 500Hz CW. Filters plus PS30 pwr Supply. VFO 120, MC50 Mic and AT130 tuner. Radio and VFO have had approx one months use other items new unmarked and in cartons \$950. 2 m Linear Jumbo HP-50V new \$100. Diawa CN-510 SWR and pwr meter 1.8-60 MHz 200 W new \$55 Alan VK2KPO Ph: (02) 524 2488.

**MC50 MICROPHONE S40**, YK88C 500Hz crystal filter \$35. W6TOG Rx upgrade kit \$40. Workshop manual \$8. All above suit TS 120/130. 455 kHz crystal filter, 5 kHz, suits FRG7 etc \$20. CPI linear 80 m-10 m, 20 W in-200 W out, with Rx preamp \$18. Daiwa CNW 217 tuner/SWR meter \$100. 10 m Rx preamp, RF switched \$25. Model 110 SWR/power meter \$18. Microwave precision test oscillator, G229/AP65371A covering 9.550 to 9.900 GHz, can be converted to 10 GHz \$60. Valve type, variable, regulated power supply, metered 0-600 VDC, 0-250 mA \$60. Electronics Australia 1958 to 1976 \$8 per year. CB Action No 1 to 50 \$25. Number of other magazines, send SAE for list. All above plus freight. C. MacKinnon 16 Mills Rd Glenhaven 2154. Ph: (02) 634 6259 AH.

**SHURE 444 Mic** \$50, Daiwa ant tuner \$60, KLM 2 m amp 50 W out, CW, FM and SSB \$60, Henry 2 m amp, 80 W out continuous duty, \$100, VK2BHF, QTHR. Ph: (02) 981 4762.

**YAESU FT75B HF Tcvt** full set xtals AC and DC PS \$300. Icom 202 2 m SSB Tcvt and Oscar Xtal \$160. Kenwood TR-2200G 2 m FM Tcvt, Simplex 40 and 50 Repeater 2

and 8 \$100. Hy-Gain TH6-DXX 10-15-20 m beam \$290. Dream 6800 computer and JR expansion board 5K of RAM, 12 mths news letters and construction articles, in working condition \$160. VK2KKL QTHR. Ph: (080) 5285.

**YAESU FC-107 ATU** — All band coverage (including WARC), separate meters SWR/Power Output to 250W RF, switchable 4 antennas (3 coax feed 1 random wire), EC, manual, original carton — \$120. VK2AFR Ph: (02) 635 7179.

## FOR SALE — VIC

**COMMUNICATIONS RECEIVER**, Kenwood R820, the best amateur receiver ever made by Kenwood. This unit has been advertised previously without one enquiry! Why? Doesn't anybody know that it is a receiver with superb features that out performs even the latest units? That it cost over \$1100, is as new in carton, and MUST be sold? What offers over \$400? VK3ARZ, QTHR. Ph: (03) 584 9512.

**COMPUTER PRINTER** Tono dot matrix bi-directional in as new condition \$650 ONO G. Scott Ph: (03) 890 4645.

**DECEASED ESTATE** — Kenwood TS520 C/W AC/DC cables and spares including 6146B's (has intermittent AGC fault) \$460. Oenon MT 2000A (ATU) \$200, Beam TH3-Mk2 (Thunderbird) C/W balun and 30ft tubular steel mast, \$150. University multimeter MVA-100-CN (as new) \$40. VK3NV QTHR. Ph: (03) 578 6866.

**DUO BAND BEAM** 15 m and 10 m 3 el on each, mono band with SEP gamma matches, W Wolf design EC \$90. VK3PEN. Ph: (03) 20 2501 BH (03) 596 5180 AH.

**FT7 HF 25W Tcvt**, excellent performer, extras incl RF attenuator, full 28-29 MHz coverage, Fox Tango 2.1 kHz filter, complete with mic, mobile mount, handbook, etc. \$355 ONO. FT7 very good condition, some extras, \$325 ONO. VK3ARZ QTHR. Ph: (03) 584 9512.

**IC 201 Tcvt** \$325, Robot 400 \$400, SSTV keyboard \$75, FSTV-SSTV unit \$100, SSTV Rx P29 screen \$50, Creed 75 \$85, Teletype tape distributor \$60, Teleprinter tester \$20. Prices ONO. VK3BOB, QTHR. Ph: 578 7441.

**IC22S** in mint cond - no mods. Comp with all cables, packing, book etc. Has standard Mic plus Vicom noise cancelling Mic and home brew vinyl carry bag. Sell lot \$200. Geoff — VK3DGV QTHR. Ph: (03) 560 3773.

**ICOM IC22S** brand new, the best 2 m rig ever made, mobile antenna to go with it. Ready to operate \$270, ring George VK3CGK ex 3XGK QTHR after 5 PM. Ph: (03) 687 6778.

**KENWOOD TS 8400 Tcvt** 430-440 MHz, FM 10 or 1 W output, 5 memories, 2 VFOs, up-down scan Mic. Near new in carton. \$325 ONO. VK3UU QTHR. Ph: (03) 874 5632.

**NALLY TOWER** — 50ft, \$450, TV502 transverter \$150, Ext VFO for TS520/\$120, SB610 monitorscope \$150, Creed 7B teleprinter \$45 ONO, ST5 modulator plus RY generator, plus ETI demodulator (not connected) in PSU \$75, Ham II rotator and cable \$75, CDE medium duty rotator \$50, AS33 triband beam antenna \$75, telegraph distortion set TDM55BV \$50 VK3AYP QTHR. Ph: (053) 97 5201.

**PHOTO MULTIPLIER TUBES:** 2 x Type TFS930S unused \$12.50 each ONO postage paid. VK3AH QTHR.

**RAAF TEST-SET** type TS16(Q)APN \$35 and AWA SSG Signal generator type 1A 95104 with built-in power supply \$40. Yaesu FT10E 240 V AC/12 V DC all cords, mic, manual, original packing and recently checked OK \$540 Ken VK3KGX. Ph: (03) 658 3869 or 528 4229 AH.

**RTTY EQUIPMENT:** ST6 (ANARTS) demodulator \$40; twin "T" generator (ANARTS) modulator \$8; Model 15 teletype printer with loop power supply \$45 including 240 V to 110 V transformer. 2 Friden Flexowriter Printers \$75. All above in good working condition. No further use. Max Wood VK3AFF QTHR. Ph: (060) 72 5217.

**FOR SALE — WA**

**HY-GAIN 2-EL QUAD TRIBAND.** Needs repair. Will consider any offer. Alan VK6MT QTHR. Ph: (09) 447 7941.

**YAESU 101 E** modified to suit novice license. GC one year's operation. Can be readily restored to full power. With manual and cartons \$525. Contact Ross VK6DA. Ph: (09) 444 2909.

**FOR SALE — TAS**

**DECEASED** from the estate of the late Norman Richardson VK7NR. Yaesu 101E comp with match speak and dynamic mic type YD-844 \$500. KW Electronics Ltd Supermatch KW107 \$100. Kenwood R1000 Rx as new \$400. Radiophone 2 m Tcwr C/W power supply type MTR25 \$100. Voltomys VTMV \$50. Ohmatsu Electric Ltd GDO 2-200 MHz model LDM-810 \$20. Oaiwa rotator DR-7500X comp with top stay bearing \$100, set of driver and PA boards STC 151 comp and ready to go. ¼ W in and 25 W out \$30. Nicad batt pack and charger 12 V \$20. 5 band trap dipole \$15, home brew impedance bridge \$5. PMG type morse key \$10. Kyokuto VHF FM Tcwr \$200. All enquiries to: Mr B Yeoman VK7ZBY 104 Hardwicke St Launceston 7250 Tas. Ph: 91 8288 ex 21 BH, 44 1466 AH.

**FOR SALE — NT**

**160 m-6 m TS520S/TV506.** New 6146-B's. DSE trap-vertical/coax \$695 or swap for mobile HF Tcwr. Ed DeYoung. VK8XX. Box 3367, Alice Springs, NT 5750. Ph: (089) 52 6536 AH.

**WANTED — NSW**

**CIRCUIT**, or copy required for model OM3 Heathkit 5" oscilloscope. Willing to pay costs for same. VK2DLM QTHR.

**HF SSB/CW Tcwr** by genuine cash buyer. fair price paid. OK mods: not necessarily working: all considered! PO Box 505, Bondi Junction, 2022 NSW or Ph: (02) 36 2981.

**INFORMATION PLEASE** — which radio magazine. CQ, QST, 73 etc published a ham conversion for National 8 Tran two band Rx model no T46 some years ago. VK2ABV Randwick 2031.

**TEN-TEC** type 247 ATU VK2KSD QTHR.

**VALVE MANUALS** — Bernards International Radio Tube Encyclopedia — RCA transmitting tubes, valves 811A's and ceramic sockets — counter dial for rotary inductor 50 turns or greater. VK2KEK. Box 131 Cooranbong 2265. Ph: (049) 77 2178.

**WANTED — VIC**

**A BUY OR SWAP** — short length Cathode Ray Tube (D67 type) 2 3/4" diam or similar VK30YZ 28 Foster Ave Glenhuntly.

**AIRCRAFT MORSE KEY** World War 2. RAAF pay cash or exchange good vintage Eddystone side swiper. VK3GG QTHR Ph: (03) 337 8094.

**PMG MORSE TELEGRAPH SOUNDER.** VK3DEK QTHR.

**SPEECH PROCESSOR:** RF type Toyomura Ken KP12A (IC and Xtal filter type) in GC. Details please to VK3AH QTHR.

**VALVES:** required to complete construction of Acitron 400 SSB rig. YL 1060. one or more. VK3KGR Ph: 429 2139 BH. 25 8255 AH.

**WANTED — OLD**

**COMMUNICATION RECEIVER.** MF-HF, 150 kHz to 30 MHz preferred. Old-timer would like to have an old friend. AR7, AR88, Super-pro, Eddystone, Marconi or similar, for general coverage. Age no barrier but should be complete even if not in working order. John VK4NRQ QTHR.

**DRAKE MS4 SPEAKER.** L4B linear. 500 Hz CW filter. Details to John VK4SZ. PO Box 26, Innisfail 4860. Ph: (070) 61 3286.

**IC551D 6 METRE Tcwr** GC. complete. please contact VK4GM QTHR. Ph: (079) 23815.

**RCA TRANSMITTING TUBE MANUAL** in good condition, also complete VHF 2 m amp using 4CX-250-B, 8877, or similar valves. Prefer commercial or well built home brew. VK4ZJL QTHR. Ph: (07) 44 1749.

**VALVES AND SOCKETS:** urgently require sockets for 6CW4 Nuvistor valves, 9 pin novar sockets for 6LQ6's also valves 6BA7, 6AK6, 6BE6, 6BJ6, 6BZ7, 6EW6, 6GH8, 6GK6, 6GX6, 12AU6, 12BZ6, 13DE7. VK4EF QTHR. Ph: (07) 38 1803.

**WANTED — WA**

**REMOTE VFO** to suit Kenwood TS520S VK6KG QTHR. Ph: (095) 31 8618 or (095) 31 1946 AH.

**WANTED — TAS**

**CAVITY FILTER** for VK7RNW (2 m), or info on obtaining or making. Contact VK7KTV, VK7ZAP QTHR or Phone VK7SE (004) 37 5240.

**ADVERTISERS' INDEX**

Andrews Communications Systems .....	57
Audio Telex Communications Pty Ltd .....	IFC
Bail Electronic Services .....	IBC
Bright Star Crystals .....	56
Chirnside Electronics Pty Ltd .....	53
Dick Smith .....	1
Electromark Pty Ltd .....	4
Emtronics .....	2
GFS Electronic Imports .....	21
Ian J. Truscott Electronics .....	49
ICOM Australia Pty Ltd .....	32, 33, IBC
Knoxtronics Electronic Services .....	5
Magpubs .....	7, 29
Novice Course .....	3
Rialto International .....	4
RF Industries .....	5
Trio Kenwood (Australia) Pty Ltd .....	10
Vicom .....	3, 5, 7, 9
VK2 WIA Novice Licence .....	62
Voller Transformers Pty Ltd .....	59
Werner & G. Wulf .....	62
William Willis & Co Pty Ltd .....	62

**SIDEBAND CB** converted to 10 m has a vernier fitted. Is a base station and only used a few times. \$150 ONO or will exchange for a 2 m hand held. DS Transverta 11 m to 80 m only used a few times \$110 ONO. VK3DIO Box 1528 Mildura.

**STEPPING MOTORS.** American slo-syn. M092-FC08, 1.8° step angle 3 V 4A (3) new in packs. \$100 each or near offer. Ph: (052) 61 3144.

**WIA CORRESPONDENCE COURSE** — Novice to AOCB bridging course. Change of student approved by Supervisor. Price \$30, cost \$70. Lesley VK3PZA Ph: (03) 509 0739 BH.

**YAESU FL2100Z** Linear amp. New still in box. 80 m to 10 m incl new bands \$540. Ph: (03) 850 2752.

**YAESU FT101.** Tcwr, FV101 ext VFO and SP101P land liner complete with inst manuals Ph: (03) 469 3272.

**YAESU FT107M/DMS TCVR.** reg AC supply. AM filter, scan Mic, maint manual as new, in orig carton, \$780 or reasonable offer considered. Ray VK3RF. Ph: (03) 878 5305.

**YAESU FT7.** excellent order. 80 thru 10 metres. xtals for 28, 100 to 28,600, 10B, 10C, manual, original carton. \$400. Home brew Linear to suit uses 3x6DQ5, 2 spare valves, 100w+. \$130. VK3PS Ph: (03) 879 2191 (AH).

**YAESU FT7** with power supply. Perfect order \$375 VK3AWB QTHR Ph: (03) 478 9265.

**FOB SALE — QLO**

**KENWOOD AT200** antenna tuner \$140 as new in orig carton. John VK4SZ QTHR. Ph: (070) 61 3286.

**PHILIPS FM770** High band link Tcwr (two avail). Ideal for 2 m repeaters Ex-Telecom single Ch radiotelephone links. Manual available. \$75 each plus postage. VK4ZDC QTHR. Ph: (07) 399 2114 after 5 PM.

**SWAN 350 CX** complete AC power supply and desk mic. Suit Novice or enthusiastic fiddler. \$125. Bill VK4W0 QTHR. Ph: (07) 59 8808.

**YAESU FT-107 DMS.** AC power supply. FC-107 antenna tuner. manuals, all in cartons. EC \$950. Noel Ph: (074) 22 2533 (work), (074) 22 1959 (home).

**FOR SALE — SA**

**VALVES:** Tx or linear 4-65A QE3-300: 2X807: 2X866A: 4CX250B new: 4X150A (7034): 4E27 (8001) 829B and socket: 815: 1 set valves for KW2000 new: 2 sets for KW2000 used but OK 150 valves octal and various AM Tx 160 in to6 829B in final: old Radios and mags VK5LC QTHR.

**VERTICAL ANTENNA** — D4305, five band (3.5, 7, 14, 21, 28 MHz) cost \$100 — will accept \$65 ONO. Bob VK5NWW QTHR. Ph: (08) 384 3471.

**YAESU FT-7 Tcwr.** Power supply. 5 EI 10/15 m duo band Yagi, 25 ft. Rotatable mast, 10/15 m mobile anl. C/W Yaesu gutter mount and 2 m stub, all in as new cond. \$650 ONO. Ph: (08) 270 3356.

**YAESU FT200.** EC. New tubes, recently realigned incl Power supply, desk mic, spare tubes \$300. Trio 3" CR0 \$70. Heathkit freq counter 30 MHz \$50. Trio power meter/SWR \$60. Arlec digi-multimeter \$30. Kyoritsu SWR meter \$20. Chirnside 33 triband and balun \$150. Daiwa rotator with control and cables \$180. Hills 33 ft. wind-up, guyed lattice tower \$200. All above equip in EC. VK5XQ QTHR or Ph: (08) 259 61418 BH.

'Old amateurs never die, they just drift off frequency.'

Jonathan Marshall SWL  
AR



# bail



# EMOTATOR ROTATORS FROM BAIL

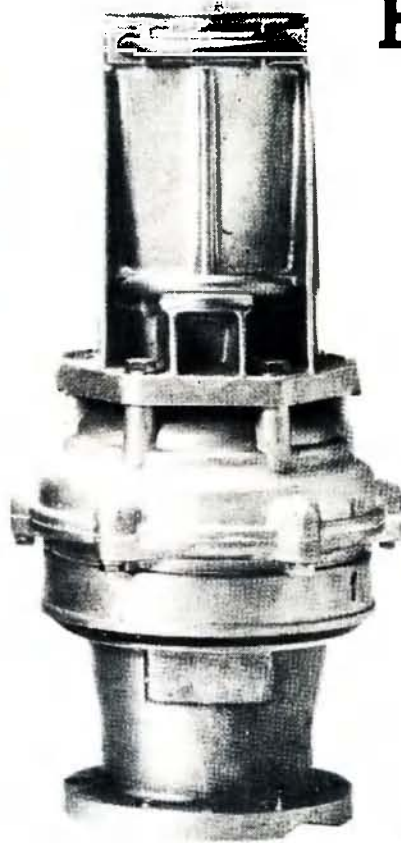

103SAX



502SAX



**SAX MODELS  
HAVE GREAT  
CIRCLE MAP  
CENTRED  
ON  
S.E. AUSTRALIA**

1102MXX  
1103MXX



Model	A M	GD KgM	Braking Torque Kg Cm	Rotation Torque Kg Cm	Vertical Load Kg
103SAX	0.7	75	1500	450	150
502SAX	1.5	130	4000	600	400
1102MXX MSAX	2.5	300	10 000	800	400
1103MXX MSAX	2.5	700	10 000	1000	400

A: Allowable Antenna wind area  
GD: Allowable Flywheel effect

Controller for  
1102MSAX, 1103MSAX

**CONTACT THE AUSTRALIAN  
AGENTS FOR EMOTATORS  
AND ALL ROTATOR  
ACCESSORIES . . .**

# bail

**BAIL ELECTRONIC SERVICES**  
38 FAITHFUL STREET, WANGARATTA 3677  
Telephone: (057) 21 6260 — Telex: 56880



Stan Roberts  
VK3BSR



# ICOM BRINGS THE WORLD TO AUSTRALIA

Now ICOM is directly represented in Australia with the establishment of its own company, ICOM AUSTRALIA Pty. Ltd.

The Australian Amateur has known ICOM for many years as the leader in 2 meter and 6 meter transceivers, more recently for the State of The Art multi-band units such as the IC-740 with full WARC facilities.

You will soon know ICOM AUSTRALIA for the best in Australian service.

ICOM AUSTRALIA Pty. Ltd. and its authorized dealers can now offer you factory backed technical and service facilities here in Australia.

All dealers and prospective dealers, please feel free to call on us soon and talk with The Team that understands Amateur Radio.



The IC-740 contains all the most asked for features, in the most advanced solidstate HF Base station and can be coupled with the now popular accessories. IC-2KL linear amplifier and IC-AT500 fully automated antenna coupler to complete the ICOM system.

## Discover a new deal with ICOM AUSTRALIA

**ICOM AUSTRALIA PTY. LTD.**

7 Duke Street, Windsor, Vic., 3181  
Telephone 529 7582, 51 2284

# *Amateur Radio*

VOL. 51, No. 3 MARCH 1983

Registered by Australia Post — Publication No. VBH 0569



JOURNAL OF THE WIRELESS INSTITUTE OF AUSTRALIA

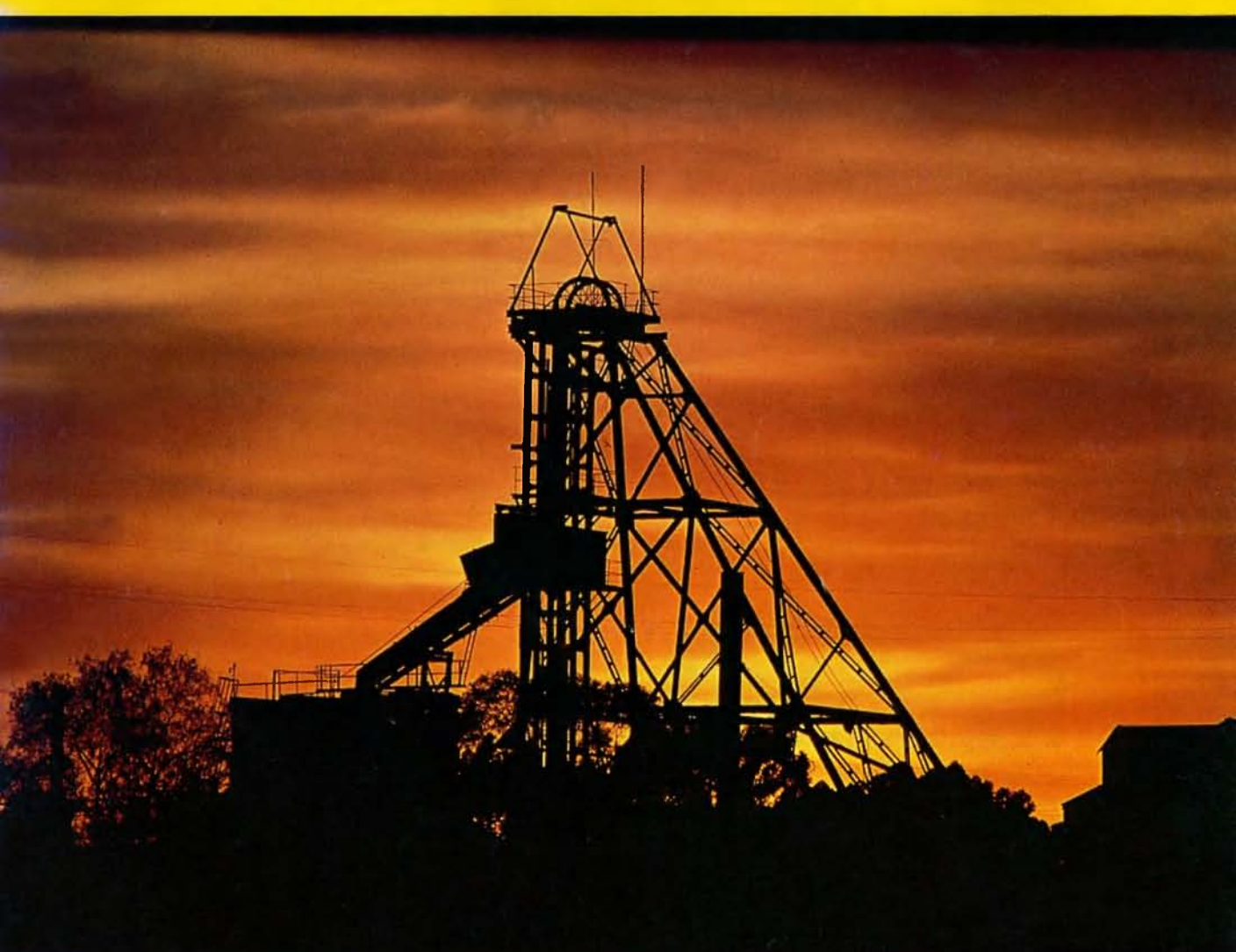

A "SQUARE ONE" RECEIVER — PART 3

NIGHT TIME VHF PROPAGATION

RON WILKINSON AWARD 1983

REVIEW — RTTY GEAR

JUNK BOX ATU

HIGH RESOLUTION MICROSCOPE



# YAESU'S NEW HF TRANSCEIVER



## FT-77

- ALL AMATEUR BANDS  
3.5 to 29.9 MHz (including WARC)
- CW, SSB MODES (FM optional)
- 100W OUTPUT
- WEIGHT: 6 kg
- SIZE: 240(W)x95(H)x300(D) mm,  
including heat sink

### FT-77 HF TRANSCEIVER

Featuring efficient, all solid state, no tune circuitry, the FT-77 offers a nominal 100 watts of RF output on all amateur bands between 3.5 and 29.9 MHz, including the three new WARC bands. The new CAD/CAM\* techniques plus the simple design of the FT-77 add up to one of the smallest, lightest HF transceivers ever, both in your hands, and on your wallet.

The front panel control layout and operation are actually simpler than some VHF FM transceivers, with only the essential operating controls. Nevertheless, all of the essential modern operating features for HF SSB and CW are included, along with extras such as dual selectable noise blanker

Computer-aided design of the circuit boards in the FT-77 ensures the most efficient component layout possible in the smallest space, while automatic parts insertion and soldering greatly diminish the chance of human error. Reliability and quality

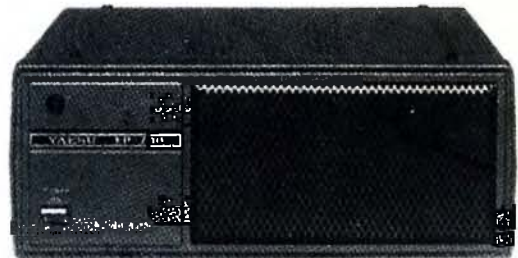

### FP-700 AC POWER SUPPLY

control are thus improved and simplified beyond the degree previously attainable in amateur equipment.

The extremely compact size and simple control layout make the FT-77 ideal for mobile operation, or as a complete base station with the optional FP-700 AC Power Supply, FV-700DM Digital Scanning VFO and Memory System, FTV-700 V/UHF Transverter and the FC-700 Antenna Tuner.

\* Computer-Aided Design/Computer-Aided Manufacture

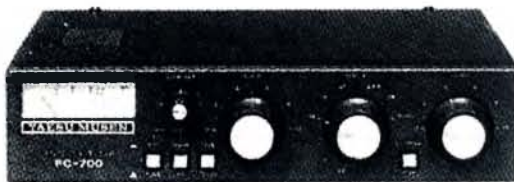

### FC-700 ANTENNA TUNER

pulse widths (designed to blank the woodpecker or common impulse noise), full SWR metering, and capabilities for an optional internal fixed-frequency channel crystal, narrow CW filter and FM Unit.



## Bail Electronic Services

38 Faithful Street,  
Wangaratta 3677  
Telephone: (057) 21 6260 — Telex: 56880



Bankcard Welcome

Stan Roberts  
VK3BSR



# amateur radio

## ... in this issue ...

A "SQUARE ONE" RECEIVER — PART 3 BY DREW VK3XU .....	11
A VERSE FOR THOSE OVER THIRTY BY VK5XI .....	35
ADELAIDE'S PARTICIPATION IN THE DEPARTURE OF ANACONDA II BY IAN VK5QX .....	22
NIGHT TIME VHF PROPAGATION BY GRAHAM VK8GB .....	16
THE 22S — A COMMON FAULT BY IAN VK3BUF .....	15
THE CAMBRIDGE UNIVERSITY 600 KV HIGH RESOLUTION MICROSCOPE COURTESY VK3UX & VK3ZSS .....	19
TWO TONE TEST OSCILLATOR FOR SSB BY VK5BR .....	18
WHERE DO IDEAS COME FROM? BY IAN VK3BUF .....	44
WHO IS THIS AMATEUR? BY PETER VK4PJ .....	13
WORLD COMMUNICATIONS YEAR .....	28
WILKINSON AWARD 1983 .....	45

## ... departments ...

A world from your Editor .....	8	Intruder Watch .....	31
AMSAT Australia .....	38	Ionospheric Predictions .....	51
AR Showcase — AMC Maritime Courses, Sea Survival, FT-77 FT-980, YH-1, FT-726R .....	34	Letters to the Editor .....	52
Advertising Index .....	56	Magazine Review .....	29
Awards — Award Amendments, Hainault's Reward, Helvetia Award .....	30	Main QSP .....	10
Book Review — Mini/Micro Soldering and Wire Wrapping .....	39	National EMC Advisory Service .....	42
Commercial Chatter .....	45	Novice Notes — Junk Box ATU .....	20
Contests — Champion Contest 1982/83, 27th CQ WW WPX rules, Helvetia Contest .....	32	Obituaries — VK3UH, VK4YB, VK3PR, VK5IQ .....	54
Education Notes .....	41	Pounding Brass .....	36
Equipment Review — Hal CT2100 & KB2100 RTTY Gear .....	14	QSP 36, 41, 45, 50 .....	—
Five-Eighth Wave .....	50	Silent Keys — VK3PR 7 & VK4VLM .....	54
Hamads .....	55	Spotlight on SWLing .....	37
Here's RTTY .....	40	Thumbnail Sketches — Maurie Batt VK3XEX & George Ham 4GW .....	27
How's DX .....	24	VHF UHF — an expanding world .....	33
International News .....	10	VK2 Mini Bulletin .....	49
		VK4 WIA Notes .....	47
		WA Bulletin .....	51
		WIA News .....	9

**EDITOR**  
GIL SONES\* VK3AUI

BRUCE BATHOLS\* VK3UV

**TECHNICAL EDITORS**  
RON COOK\* VK3AFW  
EVAN JARMAN\* VK3ANI  
BILL RICE\* VK3ABP  
GIL SONES\* VK3AUI

**CONTRIBUTING EDITORS**  
BOB ARNOLD VK3ZBB  
MIKE BAZELY VK6HD  
REG DWYER VK1BR  
MARSHALL EMMS VK5FN  
RON FISHER\* VK3OM  
BRUCE HANNAFORD VK5XI  
ROY HARTKOPF\* VK3AOH  
ROBIN HARWOOD VK7RH  
ERIC JAMIESON VK5LP  
KEN McLACHLAN VK3AH  
LEN POYNTER\* VK3BYE

**DRAFTING**  
GEORGE BROOKS  
LIZZ KLINE

**BUSINESS MANAGER**  
REG MACEY

**ADVERTISING MANAGER**  
JOHN J. A. HILL VK3DKK

\*Member of Publications Committee

Enquiries and material to:  
The Editor  
PO Box 300, Caulfield South Vic. 3162

Copy is required the first of each month. Acknowledgement may not be made unless specially requested. All important items should be sent by certified mail. The editor reserves the right to edit all material, including Letters to the Editor and Hamads, and reserves the right to refuse acceptance of any material, without specifying a reason.

Material should be sent direct to PO Box 300, Caulfield South Vic. 3162, by the 25th of the second month preceding publication. Phone: (03) 528 5962. Hamads should be sent direct to the same address by the 1st of the month preceding publication.

**Trade Practices Act:** It is impossible for us to ensure that advertisements submitted for publication comply with the Trade Practices Act 1974. Therefore advertisers and advertising agents will appreciate the absolute need for themselves to ensure that the provisions of the Act are complied with strictly.

**Victorian Consumer Affairs Act:** All advertisers are advised that advertisements containing only a PO Box number as the address cannot be accepted without the addition of the business or residential address of the box-holder or seller of the goods.

Production: BETKEN PRODUCTIONS  
5 Masefield Avenue, Mooroolbark, 3138

Printers: WAVERLEY OFFSET PUBLISHING GROUP  
Geddes Street, Mulgrave, 3170  
Tel.: (03) 560 5111

Laser Scanned Colour Separations by:  
QUADRICOLOR INDUSTRIES PTY LTD.  
Graphic Division  
22-24 Glenvale Crescent, Mulgrave, 3170.  
Tel.: (03) 560 2222

Typesetting by: QUADRICOLOR INDUSTRIES PTY LTD.  
22-24 Glenvale Crescent, Mulgrave, 3170  
Tel.: (03) 560 2222

Photographic film and processing material courtesy  
AGFA-GEVAERT LTD AUSTRALIA

## on the cover

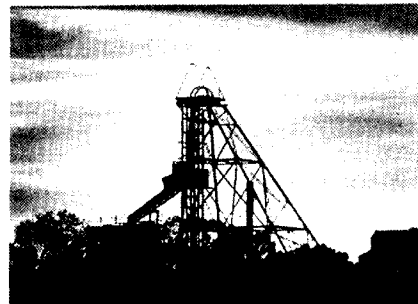

**The Poppet Head of the Hainault  
Tourist Mine, WA. See page 30 for  
Hainault's Reward.**



### HOXIN

- HF-5DX \$162** 3.5 to 30 MHz trapped vertical antenna which is completely self-supporting, no guys are necessary. Height 6.6 metres.
- G-SS** Heavy duty die-cast gutter mount.
- RINGO \$60** 2 metre high gain vertical 9 dB gain
- RK-1 \$18** Radial kit for Ringo.
- F-1E \$13** 2 metre Rubber Duck with PL-259 base.
- SCAN-X \$54** Broadband receiving discone antenna 65 to 520 MHz for use on Scanning Receivers.
- GDX-1 \$87** Transmitting discone antenna, 80-480 MHz.

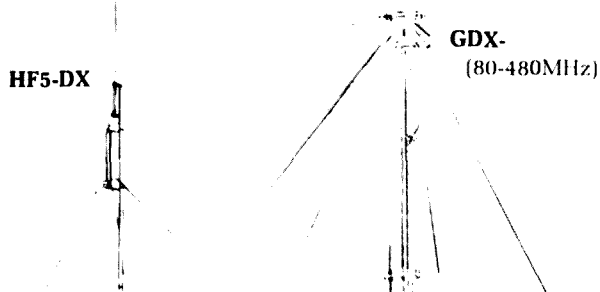

### VoCom

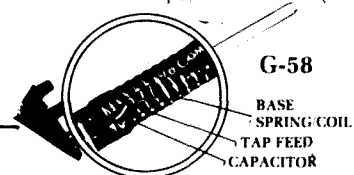

### VOCOM G-58

Telescopic 2m x 5/8 wave antenna to suit all hand holds. Up to 7 dB over a rubber ducky.



### UM PRODUCTS

- A-248D \$81** Triband trapped dipole for 80, 40 and 20 metres. Overall length is 60 feet. Maximum power 500 W. Ideal 80 Mx antenna for small backyards.



- \* 4 KHz BW at -6 dB on SSB.
- \* Size 325 W x 230 D x 140 Hmm.

**\$368**



### ANTENNA SCIENCE & ENGINEERING

### AMATEUR AND COMMERCIAL ANTENNAS, HELICAL MOBILE ANTENNAS

The ASE range of HF Helical Mobile antennas is designed to give you a signal to be proud of and get it further out because each antenna uses every known method to increase mobile efficiency.

- \* Thick wire (0.6 mm) to decrease resistive losses.
- \* Top winding—to increase current-length product.
- \* Top loading—large brass mass to act as capacity hat.
- \* Parallel former—allows top winding to be smaller in length producing a longer radiating part.

In addition you get top quality chrome plating, 3/16 stainless steel grub screw and adjustable sliding tuning tip and Allen key. Plus extra thick heat shrink to minimize impact trauma.

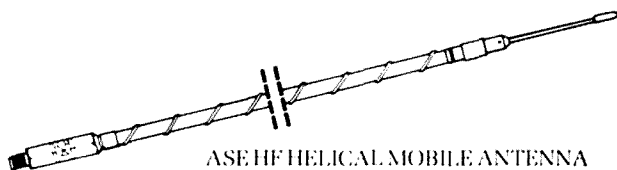

ASE HF HELICAL MOBILE ANTENNA

- Super G-80/15/10 Triband helical** covering 80, 15 and 10 meters, overall height on 80 meter is 7 feet.

- G-80 \$46** 80 meter heavy duty helical, 6 feet long.
- G40 to G-10 \$40** 40, 20, 15 and 10 meter helicals, 5 feet long.

- G-BM \$24** Stainless Steel bumper mount to suit the ASE Helicals, female, 3/8 x 24 thread.



### JIL MODEL SX-200 HF/VHF/UHF PROGRAMMABLE SCANNING RECEIVER

THE SX-200 includes many unique features not provided on any other scanner. For example, its wide frequency coverage of 26 to 88, 108 to 180 and 380 to 514 MHz. Its capability of receiving over 33,000 channels, 3 mode squelch that can be set to only allow the SX-200 to stop on carrier with modulation signals, 16 Memory channels that can be expanded to 32 with the EXP-32 kit. AM and FM detection on all bands. For full details write or call us.

**\$525**

- SX-200** HF/VHF/UHF 33,000 CHANNELS

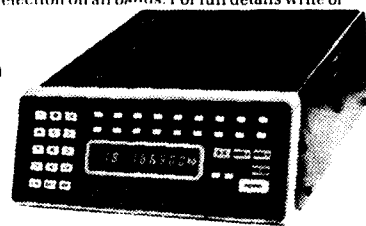

- EXP-32 \$40**

Memory Expander kit increases memory channels in SX-200 from 16 to 32 channels.

- A-4AM \$30**

Air Band Auto AM Kit.

### SEIKI ELECTRONICS

Century 21D Digital HF Communications receiver is designed for the keen SWL who desires a quality digital HF Receiver at a reasonable price. The Wadley loop combined with a 5 digit orange LED display makes operation of this new receiver a breeze. Some important features include:-

- \* 0.5 to 30 MHz
- \* 0.3 uV on SSB
- \* CW, USB, LSB, & AM.
- \* 1 uV on AM

AUSTRALIAN AGENT & DISTRIBUTOR

**GFS ELECTRONIC IMPORTS**

Division of G.D. & J.A. WHEELER PTY. LTD.

15 McKinnon Road, Mitcham, Vic. 3113  
PO Box 97, Mitcham, Vic. 3113  
Tel: 88 34 36051 GFS  
Phone: (03) 873 0900, 873 2932



# ILP TOROIDALS — UNBEATABLE VALUE

ILP toroidal transformers meet modern day requirements for a smaller size, low magnetic interference field transformer. Featuring a nearly ideal physical construction, one can expect excellent performance. Small size and weight (approximately 50% of conventional transformers), extremely low noise and low magnetic interference field make the toroidal transformer ideal for compact power supplies.



TYPE	SERIES	SECONDARY RMS																		
	No.	Volts	Current																	
30 VA	1X010	6+6	2.50		3X010	6+6	6.64		5X011	9+9	8.89		7X014	18+18	8.33		9X017	30+30	10.41	
70x30mm	1X011	9+9	1.66	80 VA	3X011	9+9	4.44		5X012	12+12	6.66		7X015	22+22	6.82		9X018	35+35	8.92	
0.45Kg	1X012	12+12	1.25	90x30mm	3X012	12+12	3.33	160 VA	5X013	15+15	5.33	300 VA	7X016	25+25	6.00		9X026	40+40	7.81	
Regulation	1X013	15+15	1.00	1 kg	3X013	15+15	2.66	110x40mm	5X014	18+18	4.44	110x50mm	7X017	30+30	5.00		9X025	45+45	6.94	
18%	1X014	18+18	0.83	Regulation	3X014	18+18	2.22	1.8 Kg	5X015	22+22	3.63	2.6 Kg	7X018	35+35	4.28		140x75mm	9X033	50+50	6.25
	1X015	22+22	0.68	12%	3X015	22+22	1.81	Regulation	5X016	25+25	3.20	Regulation	7X026	40+40	3.75		50 Kg	9X042	55+55	5.68
	1X016	25+25	0.60		3X016	25+25	1.60	8%	5X017	30+30	2.66	6%	7X025	45+45	3.33		Regulation	9X028	110	5.68
	1X017	30+30	0.50		3X017	30+30	1.33		5X018	35+35	2.28		7X033	50+50	3.00		4%	9X029	220	2.84
					3X028	110	0.72		5X026	40+40	2.00		7X028	110	2.72			9X030	240	2.60
					3X029	220	0.36		5X028	110	1.45		7X029	220	1.36					
					3X030	240	0.33		5X029	220	0.72		7X030	240	1.25					
									5X030	240	0.66									
50VA	2X010	6+6	4.16		4X010	6+6	10.00	225 VA	6X012	12+12	9.38		8X017	30+30	8.33					
80x35mm	2X011	9+9	2.77	120 VA	4X011	9+9	6.66	110x45mm	6X013	15+15	7.50	500 VA	8X018	35+35	7.14					
0.9 Kg	2X012	12+12	2.08	90x40mm	4X012	12+12	5.00	2.2 Kg	6X014	18+18	6.25	40 Kg	8X026	40+40	6.25					
Regulation	2X013	15+15	1.66	1.2 Kg	4X013	15+15	4.00		6X015	22+22	5.11	140x60mm	8X025	45+45	5.55					
13%	2X014	18+18	1.38		4X014	18+18	3.33		6X016	25+25	4.50	40 Kg	8X033	50+50	5.00					
	2X015	22+22	1.13		4X015	22+22	2.72		6X017	30+30	3.75	Regulation	8X042	55+55	4.54					
	2X016	25+25	1.00		4X016	25+25	2.40		6X018	35+35	3.21	4%	8X028	110	4.54					
	2X017	30+30	0.83		4X017	30+30	2.00		6X026	40+40	2.81		8X029	220	2.27					
	2X028	110	0.45		4X018	35+35	1.71		6X025	45+45	2.50		8X030	240	2.08					
	2X029	220	0.22		4X028	110	1.09		6X028	110	2.04									
	2X030	240	0.20		4X029	220	0.54		6X029	220	1.02									
					4X030	240	0.50		6X030	240	0.93									

**IMPORTANT.** Regulator references All voltages quoted are FULL LOAD Please add regulation figure to secondary voltage to obtain off load voltage

Rating	List	Rating	List
30 VA	\$24.38	225 VA	\$ 55.43
50 VA	30.59	300 VA	64.28
80 VA	33.58	500 VA	88.89
120 VA	37.96	625 VA	108.09
160 VA	45.99		

All prices. Sales Tax incl.

To order or for further information please contact:

**ELECTROMARK Pty Ltd**

40 Barry Avenue,  
Mortdale N.S.W. 2223  
Telephone (02) 533 4896

**BANKCARD  
ACCEPTED**



## NOVICE LICENCE

THE WHOLE FAMILY CAN GET ONE!

- \* THEORY BOOK \$7.50 incl. postage
- \* MORSE CODE TAPES \$5.00 incl. postage

Theory book: + covers whole syllabus  
+ simple text  
+ clear diagrams  
+ questions incl.

Morse tapes: + 5 WPM Novice  
+ 8/10/15 WPM  
+ 10 WPM exams  
+ 15 WPM

Available from: G.Scott 11 Balmoral Cres.  
Surrey Hills 3127 Vic.  
or : A.Brucsmith.110 Rosemead  
Rd. Hornsby 2077 NSW.

## CAMERAS & FILMS



TO COLOUR  
YOUR LIFE...  
BEAUTIFULLY

# INCREDIBLE PRICE BREAKTHROUGH!

## YOUR CHANCE TO GO SCANNING

The Exciting New Hobby Sweeping Australia

**FAMOUS BEARCAT**

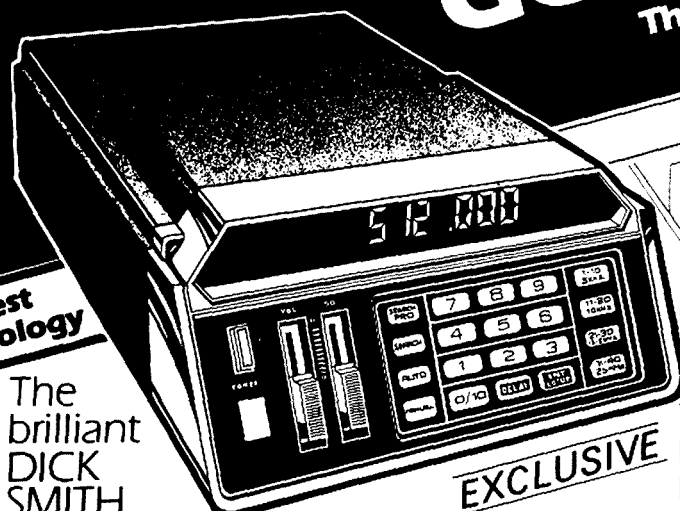

**Latest Technology**

The brilliant **DICK SMITH**

**EXCLUSIVE**

## PRO 40 SCANNER

Compare this superb Scanner with others of similar performance elsewhere at nearly twice the price! The new PRO 40 Scanner from Dick Smith represents the state-of-the-art in computerised scanning receivers! Completely solid state computer - controlled circuitry - no expensive crystals to buy - complete with backup battery for stored frequencies.

### LOOK AT THESE SPECIAL FEATURES

Touch-type splash proof keyboards for direct entry of all operational commands, frequencies etc. Ideal as either a base or mobile scanner (operates 12V - beware of others that don't operate from 12V!) with its own self-contained whip antenna or external plug-in antenna. Also included is a specially prepared Australian instruction manual written and produced by our own engineers.

### YOU CAN HEAR .....

Just about everything from harbour control nudging a supertanker into its berth, to telephone conversations from cars speeding along city streets! All the emergency services, authorities and forces ..... And of course there are thousands of business radio stations, amateur and CB radio operators. Plus the thousands of stations in the band that we don't know about yet (we're waiting for you to tell us about them!) Cat D-2805

### FREE THIS MONTH

This month 'Dick Smith's Australian Radio Frequency Handbook' (normally \$12.95) is yours free with every PRO 40 Scanner. (STOCKS LIMITED)

**ALL FOR ONLY**

**\$399**

65-520MHz Antenna specifically designed for scanners  
Cat D-4430 \$49.95

**BEARCAT QUALITY - ECONOMY PRICE!**

Amazing value - a quality micro-processor controlled scanner **UNDER \$300!** That's the superb Bearcat 150FB - the ideal monitor scanner for business, emergency services, news gathers, etc. With up to 15 channels programmable into its computer memory, with lockout and delay facilities available, you're ready to monitor a huge variety of special interest frequencies. At the touch of a button, you can lock any of them on so you won't miss any of the action. And changing the frequencies is as easy as punching in a few digits from the touch-sensitive keypad. If you're business depends on reliable monitoring, you need the Bearcat 150FB 12V operated, (240V with optional adaptor). Cat. D-2800

**That's the ONLY \$285 150FB**

**A BRAND NEW BEARCAT**

Introducing the all-new Bearcat 200 - a feature-packed scanner at a budget price. With extended frequency range (covers up to 512MHz to include mobile telephones, etc) and splash-proof keypad, you'll be amazed at the Bearcat 200's versatility - especially at the low, low price. Holds up to 16 channels in memory, with priority and lockout capabilities, delayed scanning, full band search facilities and direct channel access. Ideal as a mobile scanner, too - operates from 12V DC - or use at home with an optional 240V mains adaptor. And no crystals to buy: everything is controlled by the inbuilt microprocessor! Catch all the action with this superb new Bearcat 200. Cat D-2801

**That's the Bearcat 200 ONLY \$349**



### FIND OUT WHERE AND WHO! DICK SMITH'S AUSTRALIAN RADIO FREQUENCY HANDBOOK

Up-to date and thorough listings of virtually all the VHF/UHF radio users we've been able to find. YES - find out who is where - and where to listen for all the excitement! PLUS: air band, marine band, and how to use a scanner, amateur radio and CB etc. Cat B-9600

**VALUE AT \$12.95**

Or \$9.27 per week to approved customers.

## DICK SMITH ELECTRONICS

A405M/CT

NSW Auburn 648 0558 - Bankstown Sq. 707 4888 - Blakehurst 546 7744 - Bondi Jct. 387 1444 - Broadway 211 3777 - Brookvale 93 0441 - Chullora 642 8922 - Gore Hill 439 5311 - Liverpool 600 9888 - North Ryde 88 3855 - Panrematta 689 2188 - Sydney (Bridge St) 27 5051 - Sydney (York St) 290 3377 - Tamworth 66 1961 - Tighes Hill 61 1896 - Wollongong 28 3800 ACT Fyshwick 80 4944 VIC Coburg 383 4455 - Frankston 783 9144 - Geelong 78 6766 - Melbourne 67 9834 - Richmond 428 1614 QLD Brisbane 229 9377 - Buranda 391 6233 - Chermiside 59 6255 SA Adelaide 212 1962 - Darlington 298 8977 - Enfield 260 6088 WA Perth (William St) 328 6944 - Perth (Hay Street) 321 4357 Cannington 451 8666 TAS Hobart 31 0800



Prices correct and stock available at press time





PARLIAMENT OF VICTORIA  
NATURAL RESOURCES AND ENVIRONMENT  
COMMITTEE

## INQUIRY INTO RADIO MASTS

On 7 December 1982 the Governor in Council requested the Committee to inquire into, consider and report to Parliament by 30 June 1983, whether the environmental impact of larger radio masts throughout the metropolitan area is of a degree of significance sufficient to justify municipal control over the appearance of such masts in residential areas.

Persons or organizations wishing to assist the Committee in this inquiry are invited to forward submissions by 31 March 1983 to:

The Secretary,  
Natural Resources and Environment Committee,  
Parliament House,  
MELBOURNE, Vic. 3002.

For further information, telephone (03) 651 8911 Ext. 184.

## WIDEST OPTIONS AVAILABLE

Everything you ever wanted in  
Antennas and Antenna Accessories  
are Now Available including:

“Antenna Specialists”  
and  
“Avanti”

Our range optimises your range.

Call us Now:

219 Warrigal Road  
Oakleigh 3166

**R. F. Industries**

Melbourne (03) 570 1698  
Sydney (02) 519 5188  
Brisbane (07) 52 7600

## C. M. CRYSTALS PTY LTD



Manufacturers of high  
quality crystals for the  
Communications  
Industry.

Compare our prices  
and delivery with other  
Australian  
manufacturers.

27 HAWTHORY ROAD, KILSYTH  
VICTORIA 3137  
PHONE: (03) 725 5415

## RTTY THE EASY WAY

AFSK MOD-DEMODO FOR RTTY,  
ASCII, 45 to 1200 BAUD

### MODEL MDK-17 KIT

- \* Interfaces directly to baudot Type Machines.
- \* Provides for all Combinations of TTL or high voltage send-receive systems. \* Only single +12V Supply required. A high Gain Amp/Limiter and active band pass filter precede an XR2211 Demod I.C. \* Good Data recovery is assured, even under difficult conditions \* Excellent temperature stability is provided by an XR2206 I.C. in the tone generator. \* Sense invert capability \* LED indication of transmit tones, receiver tuning and valid signal. \* Auto start output available (TTL). \* Supplied with comprehensive documentation.

MDK-17 Kit \$98 Plus \$10 Airmail,  
Assembled and Tested \$148

GFS Electronic Imports,  
15 McKeon Road, Mitcham, 3132, Victoria,  
Australia. Ph. 61 3 873 3939. Telex 38053 GFS

FAMOUS AMATEUR MICROPHONE  
DUAL IMPEDANCE SUITS ANY “RIG”

## SHURE MODEL 444-D

SHURE

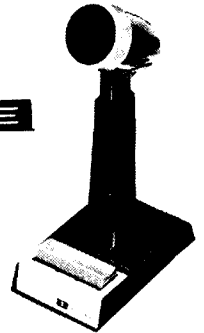

- Microphone Features:
- High-output, durable, totally reliable CONTROLLED MAGNETIC cartridge.
  - Response tailored for speech intelligibility.
  - Switch selectable high or low impedance.
  - Normal/VOX switch on microphone.
  - Double-pole, double-throw, Million-Cycle leaf-type push-to-talk switch with momentary or locking switch bar.
  - Three-conductor, one-conductor shielded coiled cable.
  - Cable and switch arranged for instant connection to grounded or isolated transmitter keying.
  - Rubber feet keep microphone from slipping.
  - Height adjustment for operator comfort.
  - Strong ARMO-DUR case impervious to rust and corrosion.

PRICE \$136.00  
(\$4.00 Post & Packing)

WILLIAM WILLIS & Co. Pty. Ltd.

PHONE: (03) 836 0707 w0809  
98 CANTERBURY ROAD, CANTERBURY, VIC., 3216

**A Call to all  
holders of a  
*NOVICE  
LICENCE***

Now you have joined the ranks of Amateur Radio, why not extend your activities?

**THE WIRELESS INSTITUTE  
OF AUSTRALIA  
(N.S.W. DIVISION)**

conducts a Bridging Correspondence Course for the AOCF and LAOCF Examinations.

Throughout the Course, your papers are checked and commented upon to lead you to a **SUCCESSFUL CONCLUSION.**

For further details write to:  
**THE COURSE SUPERVISOR,  
W.I.A.**

P.O. BOX 1066,  
PARRAMATTA, NSW 2150

W01108

**ELECTRONIC  
HOBBYIST!**

DO YOU LIVE IN . . .  
Ringwood, Lilydale,  
Boronia, Wantirna,  
Bayswater,  
Mooroolbark etc? . . .

We carry a comprehensive range of electronic components at very keen prices.

**Ian J. TRUSCOTT  
ELECTRONICS**

**CNR EASTFIELD  
& BAYSWATER ROADS,  
SOUTH CROYDON,  
VIC.  
TELEPHONE  
(03) 723 3860**

**WANTED  
TO BUY**

*Ham gear, CB equipment, Hi Fi,  
video, car stereo, large or small  
quantities.*

**WE BUY AND SELL  
ANYTHING ELECTRONIC  
ANY QUANTITY  
ANY CONDITION**

**HAMRAD**

104 Hightt Street,  
Richmond, Victoria.  
Phone: (03) 428 8136

**★ BRIGHT STAR CRYSTALS**

*Specifications, Dimensions and data sheets available on request*

**BULK ORDERS:** In addition to our normal range we can supply quantity orders (100 up) at very competitive prices. All we ask is 50% of cost with order balance 30 days.

**DELIVERY:** 5-6 weeks from receipt of Order. Ring for quote: (03) 546 5076. Telex: AA 36004.

**NEW NSW AGENT:**  
**APP Master Communications,**  
Sydney (02) 682 5044

**BRIGHT STAR CRYSTALS**  
35 EILEEN RD., CLAYTON, VIC.  
ALL MAIL TO: PO BOX 42, SPRINGVALE 3171

Phone MELBOURNE (03) 546 5076

**CRYSTAL  
OVENS**

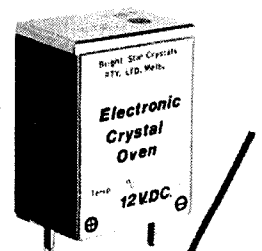

**WATCH CRYSTALS  
OVERN OSCILLATOR UNITS  
CRYSTAL UNITS  
FOR QUARTZ  
CRYSTAL CLOCKS**

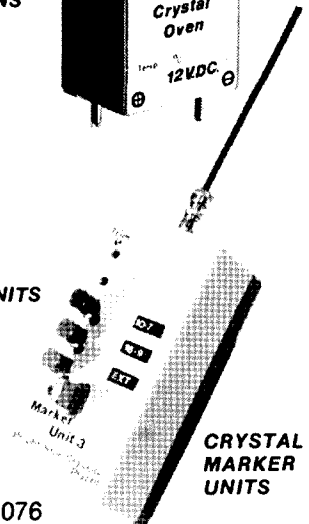

**CRYSTAL  
MARKER  
UNITS**

# VICOM SPECIALS!

Vicom is still bringing you regular monthly specials! For our specials, see us at Vicom, or visit one of our many dealers throughout Australia.

Our popular Tono and Daiwa products provide you with the best in accessories too. We can't special these, but we can assure you of great value.

Specials! Icom Transceivers		Normally	Now
IC251A	Icom 2M all-Mode Transceiver	\$881	<b>\$699</b>
IC25A	Icom 2M FM Mobile Transceiver, 25 watts	\$456	<b>\$343</b>
IC290	Icom 2M Transceiver FM/SSB/CW Mobile	\$674	<b>\$537</b>
IC2A	Icom 2M FM Handheld Transceiver	\$326	<b>\$229</b>
IC451	Icom 70CM Transceiver AC/DC	\$1113	<b>\$750</b>
IC490A	Icom UHF SSB/FM Mobile Transceiver	\$726	<b>\$579</b>
IC551D	Icom 6M Transceiver with PBT/VOX (No. FM)	\$919	<b>\$555</b>
IC560	Icom Mobile Transceiver, 6M, SSB/FM, 10W	\$643	<b>\$493</b>
IC730	Icom HF Transceiver	\$1021	<b>\$846</b>

Specials! Antenna Products		Normally	Now
I55	Katsumi 1 kw 32 MHz Fc Low Pass Filter	\$47.50	<b>\$34</b>
AS-NK	Asahi Bumper Mount Kit	\$33.00	<b>\$27</b>
BM-1	Hustler Universal Bumper Mount	\$31.00	<b>\$22</b>
FD30LS	Daiwa Low Pass Filter 32 MHz Fc, 200w	\$12.00	<b>\$2</b>
IDS-1	Mark Light Duty Antenna Spring	\$5.00	<b>\$3</b>
AS203W	Asahi Full Size 20m Beam, 3 el.	\$299	<b>\$252</b>

Specials! Leader		Normally	Now
C895	Leader Antenna Coupler 3.5 to 28MHz	\$202	<b>\$125</b>
LAG26	Leader Audio Generator 20Hz-200KHz	\$202	<b>\$99</b>
I80310A	Leader 3" 20mV/4MHz C.R.O.	\$305	<b>\$170</b>
I80310HAM	Leader 3" Oscilloscope 20mV-4MHz	\$356	<b>\$200</b>
I80510A	Leader 5" 20mV/4MHz C.R.O.	\$379	<b>\$204</b>
I80515B	Leader 5" CRO Delayed Sweep 5mV/30MHz	\$2589	<b>\$1494</b>
LCR740	Leader LCR Bridge	\$375	<b>\$180</b>
IDC822A	Leader 7 Dig Freq Counter 10Hz/80MHz	\$549	<b>\$304</b>
IDM815	Leader Dip Meter	\$115	<b>\$65</b>
IDPO76	Leader Logic Probe (Digital) to 60MHz	\$142	<b>\$82</b>
IFC944C	Leader TV Field Level Checker Aust. Chs	\$542	<b>\$295</b>
IIM870A	Leader Antenna Impedance Meter	\$116	<b>\$67</b>
IMV181A	Leader AC Millivoltmeter 100u/300v	\$314	<b>\$144</b>
IPO3	Leader RF Probe for IEM75A	\$27	<b>\$15</b>
IPIIY	Leader Probe	\$27	<b>\$15</b>
IPI7AX	Leader Probe	\$65	<b>\$29</b>
IPG	Leader High Voltage Probe 30KV	\$48	<b>\$20</b>
ISG16	Leader Signal Generator, 100KHz-100MHz	\$169	<b>\$60</b>
ISG231	Leader FM Stereo Signal	\$569	<b>\$346</b>
ITC905	Leader Curve Tracer	\$289	<b>\$153</b>
ITC907	Leader TR Checker/Signal Injector/Tracer	\$465	<b>\$284</b>

Specials! Jostykit		Normally	Now
<small>(All Jostykit products accepted! Please send \$2 for postage and packing!)</small>			
AT320	Jostykit AC/DC Relay Amplifier	\$47	<b>\$10</b>
AT347	Jostykit Electronic Roulette Kit	\$62	<b>\$13</b>
AT357	Touch Dimmer	\$35	<b>\$9</b>
JK08	Jostykit Light Relay for 240V AC	\$24	<b>\$8</b>
HF385	Jostykit VHF/UHF Preamp	\$34	<b>\$15</b>
JK01	Jostykit General Purpose Amp. 0.5w	\$22	<b>\$6</b>
AT468	Jostykit 4-Channel Light Show	\$85	<b>\$30</b>
AT465	Jostykit 3-Channel Light Show 02	\$76	<b>\$25</b>
JK02	Jostykit Microphone Amplifier	\$20	<b>\$5</b>
AT356	Jostykit 6 Amp. AC Regulator	\$31	<b>\$10</b>
AF340	Jostykit 40W Audio Amplifier	\$39	<b>\$15</b>
AF380	Jostykit 2W General Purpose Amplifier	\$15	<b>\$5</b>
AT350	Jostykit 2 amp. Trial Light Controller	\$15	<b>\$5</b>
AT365	Jostykit 3 Channel Light show kit	\$74	<b>\$39</b>
B606P	Jostykit Box for AT468 light show	\$31	<b>\$14</b>
HF305	Jostykit Converter 175-105MHz to 105MHz	\$31	<b>\$14</b>
HF310	Jostykit FM Tuner	\$55	<b>\$14</b>
HF330	Jostykit Stereo Decoder	\$27	<b>\$10</b>
HF61	Jostykit Medium Wave Receiver	\$22	<b>\$6</b>
JK09	Jostykit Siren incl. loudspeaker	\$20	<b>\$4</b>
NT300	Jostykit Lab. Power Supply, 2-30V	\$126	<b>\$49</b>
NT415	Jostykit Lab. Power Supply kit	\$149	<b>\$69</b>

Specials! Miscellaneous		Normally	Now
HK708	Morse Key, Economy	\$24	<b>\$16</b>
MR940	Daiwa Infrared Mobile Mic.	\$152	<b>\$119</b>

Daiwa — SWR/PWR Meters:		Normally	Now
CN510	Daiwa SWR/PWR Met. 1.8-60MHz 20/200W		<b>\$79</b>
CN520	Daiwa X-needle SWR/PWR Met. 1.9-60MHz		<b>\$81</b>
CN540	Daiwa X-needle SWR/PWR Met. 50-150MHz		<b>\$89</b>
CN550	Daiwa X-needle SWR/PWR Met. 144-250MHz		<b>\$99</b>
CN620A	Daiwa X-needle SWR/PWR Met. 1.8-150MHz		<b>\$119</b>
CN630	Daiwa X-needle SWR/PWR Met. 140-450MHz		<b>\$169</b>
CN630N	Daiwa X-needle SWR/PWR Meter 140-450MHz "N" Conn.		<b>\$199</b>
CN650	Daiwa X-needle SWR/PWR Met. 1.2-2.5MHz		<b>\$206</b>
CN720	Daiwa X-needle SWR/PWR Met. 1.8-150MHz		<b>\$199</b>
CNA1001	Daiwa Automatic Antenna Tuner 200W		<b>\$307</b>
CNA2002	Daiwa Auto Antenna Tuner 2.5Kw		<b>\$437</b>
CNW218	Daiwa Antenna Tuner incl. SWR/PWR Meter		<b>\$189</b>
CNW418	Daiwa Antenna Tuner - HF Bands		<b>\$219</b>
CNW518	Daiwa Antenna Tuner 2.5Kw PEP		<b>\$379</b>

Daiwa — Rotators:		Normally	Now
DR7500R	Daiwa Ant. Rotator, Medium Duty		<b>\$259</b>
DR7500X	Daiwa Ant. Rotator, Medium Duty, Pre-set		<b>\$249</b>
DR7600R	Daiwa Ant. Rotator, Heavy Duty		<b>\$369</b>
DR7600X	Daiwa Ant. Rotator, Heavy Duty Pre-set		<b>\$349</b>
PS-300	Daiwa Power Supply 22A, 9-15V X-needle		<b>\$399</b>
PS-106A	Daiwa Power Supply 13.8V 10 Amps		<b>\$237</b>
Cable/Rot	Daiwa Rotator Cable, 6 core		<b>\$1.40</b>

Daiwa — Linear Amplifiers:		Normally	Now
IA2030A	Daiwa Linear Amp. 3/30W 146MHz		<b>\$105</b>
IA2035	Daiwa Linear Amp. 2M FM/SSB/CW 3/30W		<b>\$99</b>
IA4015A	Daiwa Linear Amp. 15/15W 430-450MHz FM		<b>\$136</b>

Tono — RTTY		Normally	Now
550	Tono RTTY Terminal		<b>\$99</b>
CRT1200G	Tono Video Monitor 12"		<b>\$435</b>

All products are available from Vicom, Emtronics and participating Vicom dealers, while stocks last.



MELBOURNE:  
Vicom International Pty. Ltd.,  
57 City Road, South Melbourne, Victoria (03) 62 6931

SYDNEY:  
Emtronics, 649 George St., Sydney (02) 211 0531

WELLINGTON, N.Z.:  
Malvicom, 18 Raroa Road, Lower Hutt (4) 697 625

Dealer enquiries invited.

# a word from your EDITOR



## SELLING USED EQUIPMENT VIA HAMADS?

Having difficulty in moving some of that exotic gear? Have you considered the possibilities that you have overpriced that unit you want to update? Just what is the real value of used commercial equipment?

Some research over the past two years has shown that many sellers are not prepared to 'write off' the capital cost of their equipment. Amateur equipment is just like any other commodity, such as cars, TV sets, furniture etc. They all depreciate in value rather quickly, especially in the first twelve months, then settle to a small 'residual' value.

Most businesses amortise the capital cost of equipment over a period of five years, and are thus able to claim certain taxation benefits on its depreciation.

Amateur radio gear also depreciates at a fairly rapid rate, but unfortunately we are unable to claim any taxation benefits. So the capital depreciation value has to be borne by the purchaser.

One would expect a modern transceiver to last well over five years, however, each year new and 'up dated' equipment appears on the market, with the effect that used equipment, even only two or three years old, is almost 'obsolete'. What therefore is the real value?

Let us look at an ICOM IC720A purchased new in January 1982. The all up cost with power supply, external speaker, desk microphone was around \$1650. At the time of purchase, it was the 'top line' of amateur transceivers. Now in only a little over twelve months, at least two new models have come onto the market from the same manufacturer. Several factors to take into consideration are:—

The IC720A is 'used', and now out of warranty.

The second hand market is limited.

There are other comparable new transceivers on the market from the other manufacturers.

There is a negligible trade-in allowance available towards the cost of a new transceiver.

The current economic climate — (there is much buyer resistance at the present time, and many people including amateurs are just 'not spending').

How desperate am I for the money?

If I were to offer my 720A for sale, this is perhaps how I would look at its value.

Firstly, the set, being a little over twelve months old, I would reduce the initial purchase price immediately by twenty per cent, down to \$1320. Next I would look at what similar makes are selling for in advertisements (hamads etc.), and also look at prices for the new and comparable models, and those from other makers.

In this case, the new ICOM IC740 sells for around \$1250. Therefore my 720A is dearer than the new set, even though the 720A has a few more 'bells and whistles'. To ensure a sale, I would therefore have to reduce the price to be competitive with the IC740, so I would be thinking around \$1150.

I have seen some IC720A's being advertised for around \$950, so what hope have I in attracting a buyer at \$1150?

Not being 'desperate' for the cash, I would probably run an advert listing it at \$1350, to test the market. Then if no response, drop the price \$100 or so until a buyer was found. However, the disadvantage is that it may take four months or more to sell, and the advert also becomes 'stale'. Further, a new model may come onto the market in the meantime, thus reducing the chances of a sale at an acceptable price even further.

One is therefore in quite a dilemma!

Taking all of the above into consideration, I would be most lucky to attract a buyer at \$1000, so therefore in a little over twelve months and selling at \$1000, my initial purchase has depreciated by over thirty-nine per cent. This works out at \$12.50 per week.

I would expect after three years, and using the above criteria as a guide, the IC720A would probably be worth only \$500. However, this is possibly a little unrealistic and \$700 could be a more acceptable figure, and I would expect after five years, the value would be around \$400-\$500.

It is rather clear that to keep up with the 'state of the art', one must be prepared to:—

Amortise the total capital cost over no more than four years. Taking the above transceiver as a typical example, this works out at \$8.00 per week.

If desirous of disposing of the initial purchase between one and two years, an allowance for depreciation of approximately \$13.00 per week should be made.

One however cannot predict the mood of the second hand market, there are quite a number of other variables to be taken into account also. Among these are newcomer ignorance, condition of the equipment offered for sale, and the current inflation rate.

In my own personal case, I would probably be expecting to 'up date' my equipment after three years. Then I might also be thinking about a new linear, beam, VHF transceiver, meters, coax etc. Where does it all end?

Perhaps home brewing is the answer.

How much do I expect to get out of my hobby? Well two things are definite:—

- a. I intend to remain an amateur.
- b. I won't be showing this editorial to my wife.

VK3UV Editor.



# WIA NEWS

## INQUIRY INTO RADIO MASTS

The following item appeared in the Victorian Government Gazette on 8th December 1982. The Wireless Institute of Australia will be making a submission to the enquiry in due course. Further information will be published as it comes to hand and members will be advised of any action deemed necessary.

In the meantime it is important that all amateurs join the WIA to allow us to present a 100 per cent unified front. Please show this item to any non-member amateur stressing full support is needed NOW.

The outcome of this enquiry could have vast national consequences to the amateur service if not handled in a united fashion.

*Parliamentary Committees Act 1968, No 7727*

REFERENCE TO THE NATURAL RESOURCES AND ENVIRONMENT COMMITTEE

*At the Executive Council Chamber, Melbourne, the seventh day of December, 1982*

PRESENT

His Excellency the Governor of Victoria

Mr Roper

Mr Spyker

Mr Simpson

## INQUIRY INTO RADIO MASTS

Whereas section 4F (1) (a) (ii) of the *Parliamentary Committees Act 1968* provides (*inter alia*) that the Governor in Council by Order published in the *Government Gazette* may refer any proposal, matter or thing relevant to the functions of the Joint Investigatory Natural Resources and Environment Committee under the said Act for inquiry consideration and report to the Parliament.

Now therefore His Excellency the Governor of the State of Victoria, by and with the advice of the Executive Council thereof, and in the exercise of the powers conferred on him by the said Act, doth hereby refer to the said Committee the following matter, namely:

To inquire into, consider and report to Parliament, by 30 June 1983, whether the environmental impact of larger radio masts throughout the metropolitan area is of a degree of significance sufficient to justify municipal control over the appearance of such masts in residential areas.

And the Honourable John Cain, Her Majesty's Premier for the State of Victoria, shall give the necessary directions herein accordingly.

TOM FORRISTAL

Clerk of the Executive Council

## CABLE TV

The following letter was forwarded to the Queensland Division of the WIA by Mr David Jull MHR in response to a

query raised in respect of cable television.

This is the Minister of Communication's reply:

Dear Mr Jull,

I refer to your letter of 22 November 1982 in which you made personal representations on behalf of Mr Fred Saunders of the Queensland Division of the Wireless Institute of Australia. Mr Saunders is concerned that problems of electromagnetic compatibility (EMC) encountered overseas may be repeated here unless adequate planning takes place for the installation of cable television.

I am not yet in a position to give you a definitive answer regarding technical standards for cable television hardware. This is a complex issue which involves consideration of the recommendations in the Australian Broadcasting Tribunal Report as well as the report of the Committee of Inquiry into Telecommunications Services in Australia (the Davidson Report).

I would ask you to assure Mr Saunders, however, that I am fully aware of the implications of his question. I am concerned to protect the rights of existing users of telecommunications services and of the radio frequency spectrum. I am giving this matter careful attention in my evaluation of the recommendations of both reports.

Yours sincerely

N A Brown



# QSP



## ONE OR TWO ROTTEN APPLES

In any society, it is an accepted fact some people step outside of the guidelines of the establishment. The reasons for this could probably be summed up as follows:

1. ignorance of the rules
2. downright stupidity
3. personal selfish reasons

The amateur service as we all know, has some very strict rules, and if someone operates their equipment outside of the regulations, it casts doubt on our viability and may have repercussions which could affect us all.

The WIA has fought for many years to win the operating privileges we now possess. The WIA and the amateur service are held in very high regard in official circles, and for a hobby activity, this is no mean feat.

We have got where we are today the hard way, but there is still a lot more work to be done. We shall now allude to an area which is of immense concern to the WIA and the amateur service in general. The offenders are in the minority, but their actions can cause us all harm.

Recently a number of amateurs have expressed to the Federal Executive their concern at the on-air conduct of a small number of other amateurs. I believe these complaints are justified.

Because we believe that it is very important that so far as possible the amateur service is self-regulating, the executive has decided that I should remind all amateurs of their obligation to comply with the conditions of their amateur licence.

Currently, there is much debate in our country as to whether or not a dam should be built on the Franklin below Gordon River in Tasmania. I respect the fact that many

people hold very sincere and very strong views on that matter.

However, there is, in my view, no doubt that certain matter has been transmitted relating to this issue by some amateurs that can be described as information of a political character. That is contrary to the conditions under which amateurs are licensed. It also involves the amateur service in a controversy, whatever view one takes of the matter, that has no place in amateur radio. Other frequencies should be sought by those who wish to use radio for such purposes.

Offensive or obscene language is prohibited, yet we have heard such language on certain HF bands.

Radio amateurs have a privileged use of the radio spectrum for purposes that are responsible and non-commercial and non-political. I sincerely believe that if any of us, whether unthinkingly or because of strong and sincere convictions, use the amateur bands improperly, we prejudice all amateurs. We invite new and more restrictive regulations, and stringent policing of those regulations.

The Wireless Institute of Australia's most important role is to advance the interests of Australian amateurs. I would not like that role to become basically defensive.

Accordingly, I urge all amateurs, the divisions and other organizations to be conscious of the basis of our use of our bands and to encourage each other for all our benefit to use our bands only responsibly, non-politically and non-commercially.

Law abiding amateur operators must be continually alert for breaches of the regulations by others, and point out politely to offenders the errors of their ways. If difficulties arise your division should be advised immediately, so that proper action may be taken.

AR



## INTERNATIONAL NEWS

### NEWS FROM ARS — INDIA

The Government of India now permits each Indian Radio Amateur to obtain foreign exchange to the value of Rs 10,000/- (approx. \$US1000) each year to import amateur equipment.

During 1982 Yaesu offered 'rockbottom, slashed prices' for their equipment and as a result there is a sudden growth of VHF activity in India.

There is an IBP beacon operational, from New Delhi 'around-the-clock' on 28.295 MHz — call sign VU2BCN. QSL to VU2VIM.

The 80 metre band has been extended and VU amateurs may now operate 3.500-3.540 and 3.890-3.900 MHz. But the new 10, 18 and 24 MHz WARC bands are not yet allotted in India.

By the 1st January 1983 the number of valid amateur licences issued in VU-land was expected to be over 1100.

Over the past thirteen years have you worked an odd prefix emanating from India

and wondered 'why the change?'

Here is a list of the prefixes used, the times when operational and the reason.

- (A) Month of October 1969 . . . Call prefix VU0 instead of VU2 to mark the Ghandi Centenary Celebrations. The ARS of India issued Worked Republic of India (Ghandi Centenary Award).
- (B) Months of August to December 1972 . . . Call prefix VU25 instead of VU2 to mark the 25th Anniversary of Indian Independence.
- (C) Month of May 1979 . . . Call Sign VU25ARS instead of VU2ARS to mark the 25th Anniversary of the AMATEUR RADIO SOCIETY OF INDIA, New Delhi (ARSI was born on 14 May 1954 at New Delhi).
- (D) Month of November 1981 . . . Call sign AU2CD instead of VU2HV was allotted to mark the annual children's day

celebrations beginning every year on the birthday of late Jawharlal Nehru, the first Prime Minister of India. (14th November.)

- (E) Month of December 1981 . . . Call sign AU2SIF was issued to South Indian Fair at Hyderabad.
- (F) Months of August to 15 December 1982 . . . Call sign VU9 instead of VU2 to mark the 9th ASIAN GAMES being held in India at New Delhi, Bombay & Jaipur.
- (G) Months 14 Nov. '82 to 5th December '82 . . . Call sign VU82AG instead of VU2CJ/VU2ARD to begin on the annual children's day celebrations at the site of celebration and to continue till end of 1982 ASIAN GAMES.
- (H) Months of 24 Nov. '82 to 5th December '82 . . . Call sign AU9ASG instead of VU2APR (Hyderabad APARS) representing 9th ASIAN GAMES. A group of amateurs from South India, Hyderabad, maintained Communications on HF between Jawharlal Nehru Stadium, New Delhi and Asian Games stadium at Jaipur.

AR

# A "SQUARE-ONE" RECEIVER

## Part 3

Drew Diamond, VK3XU,  
43 Boyana Cres., Croydon, 3136

## CONSTRUCTION

For those with sheetmetal working facilities, a suggested form of construction was shown in Part 1. A chassis area of about 330 x 270mm, and front and rear panels of 330 x 155mm will be required. By placing the plane of the main chassis pan about 57mm from the bottom, it will be possible to accommodate the main receiver components upon the top side, and any converters underneath. If metalworking facilities are not available, there are several ready-made instrument cases available from several suppliers. One should be chosen with dimensions similar to those mentioned above.

The components for the RF amplifier, mixer/filter, IF amplifier, product detector/AF/AGC amplifier, VFO and calibrator are accommodated upon the copper side of home-made printed circuit boards. By using this method, considerable effort is saved in not having to drill the boards for components. Troubleshooting is made easier too, as tracks are easily traced, and components can be easily replaced. To delay temperature effects, the VFO circuit board and variable capacitor should be housed in a die-cast box measuring 65mmW x 120mmL x 40mmH, provided the variable capacitor can be fitted into the available space. The hole for the capacitor shaft must allow sufficient clearance so that the shaft does not touch at any point, otherwise annoying little variations in frequency can occur due to this noisy ground path. A 15pF capacitor may not be easy to obtain, so values have also been given on the circuit for the use of a more commonly available 100pF capacitor.

A simple Jabel dial may be used to display frequency. However, aside from a digital dial, a better approach may be in the method employed in the prototype: a 6:1 planetary reduction drive is fixed to a right-angled bracket as shown in the photo in Part 1, and connected to the VFO capacitor shaft via an insulated flexible coupler. A 140mm diameter disc is cut out from 18 gauge aluminium sheet, drilled, and sprayed with white undercoat paint. This will allow Letraset to be used marking the 10kHz dial divisions (resolution to 1kHz will be possible by interpolation). During final assembly, the disc is fixed to the raised boss with the screws supplied with the drive unit. A slot will have to be cut in the chassis to allow the disc to be positioned in the centre of the front panel. An arc shaped window must be cut in the front panel, the radius of which must be just less than that of the disc. The window should be covered by a piece of clear perspex, and held in place by three countersunk screws, two above and one below the window. It was found helpful to drill and tap the screw holes in the perspex to save the difficult job of placing nuts onto the fixing screws in the resultant tight space. The window is scribed down the centre with a vertical line to provide a pointer. A bush

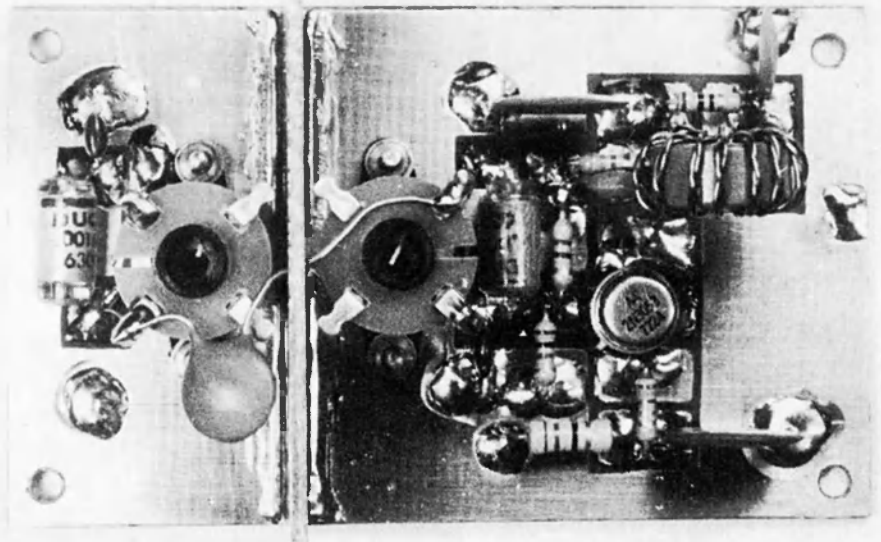

RF Amplifier

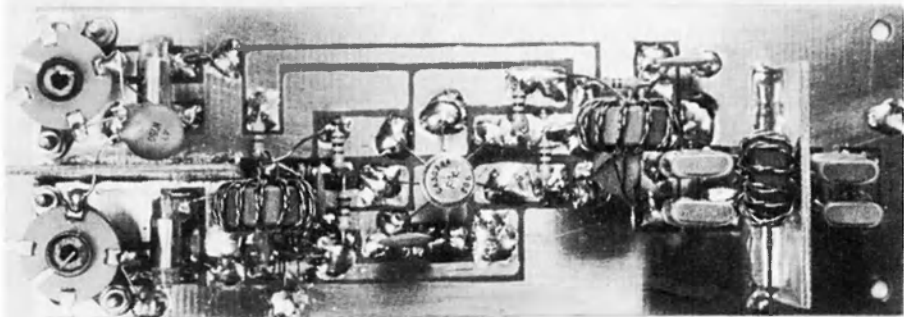

Mixer and 9 MHz Crystal Filter

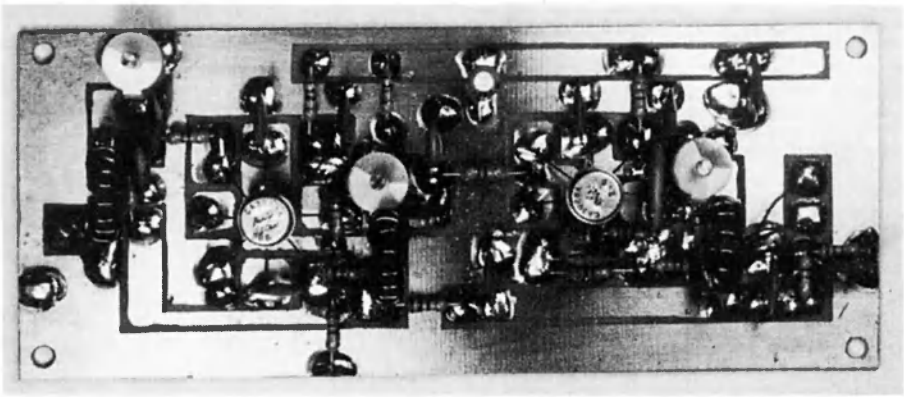

9 MHz IF Amplifier

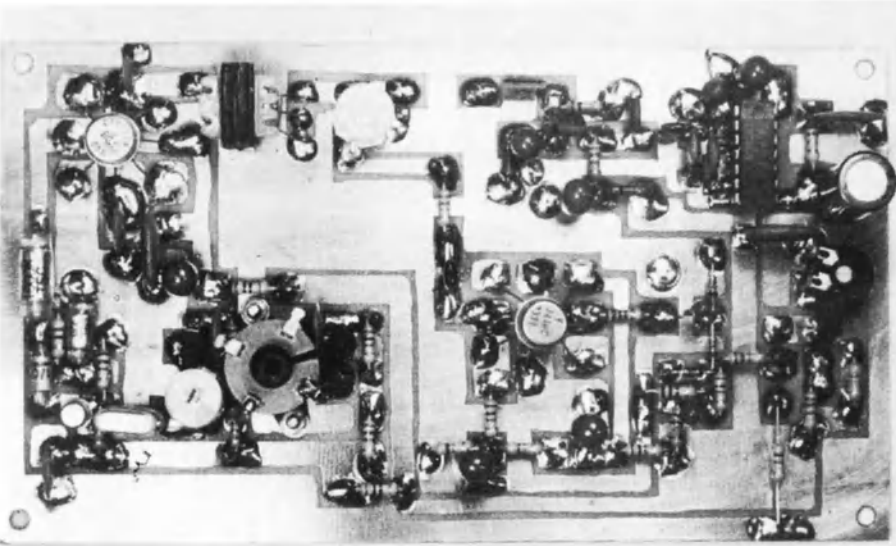

Product Detector, AF Amplifier and AGC Amplifier

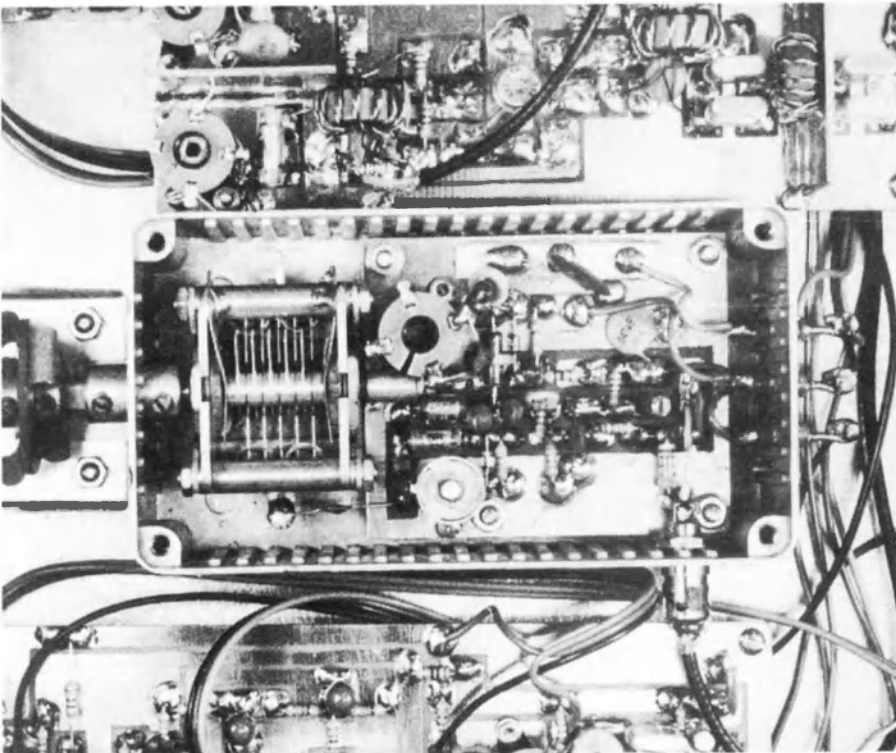

VFO (Crystal Oscillator)

bearing must be placed in the front panel where the spindle shaft emerges so that hand weight is not transmitted to the reduction drive.

An eleven position, 3-bank wafer switch should be incorporated in the receiver, preferably on the lower panel area so that other bands, ie converters, may be added later when required.

The trifilar broadband transformers T2 and T3 are made as follows: Take three 350mm lengths of 24 B&S enamel wire. Lay them parallel to each other, twist them together at one end, and place that end of the group in a vice. Starting at the vice end of the group, draw

a cloth through them to remove any wrinkles. Now twist the other ends together and fix them firmly in the chuck of a hand drill. Turn the drill whilst keeping the wires taut until there are about three twists per cm, then give the drill a tug to set the twists, and remove the twisted group. Carefully thread the group through a Neosid 4327/2/F25 core until there are about 11 loops. Leave about 2cm of wire at each end of the winding, and remove about 1cm of enamel from each lead. A multimeter (on ohms) can be used to identify the separate windings. It is essential that the end of one winding be connected to the start of another winding to form the centre tap for the secondary of T2, and the primary of T3.

T1 and T4 are made in a similar manner. Once again, it is essential that the end of one winding is connected to the start of the other winding to form the centre tap.

The single layer coils; L1, L2, L3, L4, L10 and L13 are wound upon Aegis 3510 coil formers. Shellac has been found to work well as a cement for this type of coil — even that in the VFO. It should be painted over the full length of the winding and allowed to dry before the ends are soldered to the tag ring provided. About 3cm of elastic (cotton removed) must be inserted with the slug to hold the slug in place.

## ADJUSTMENT

If a signal generator is available, many of the assemblies may be built and tested individually. The product detector/AF/AGC amplifier board may be made first. If a frequency counter is available, the BFO frequencies may be set to about 9005kHz with L10, and to 9008kHz with C56. If a counter is not available, the BFO frequencies can be set by ear on a CW or SSB signal when the receiver is complete.

The IF amplifier may be made next. Upon completion and connection to the product detector, a 9MHz signal from a signal generator may be applied to the input via L5. A fairly large signal will probably be necessary at first. With adjustment of C21, 25 and 32, the generator level should be decreased. With the IF amplifier tuned to 9MHz, it should be possible to hear a 1 microvolt signal.

If a generator is not available, the connection of an antenna via the filter to L5 will allow adjustment of C21, 25 and 32 using whatever signal or noise happens to be on 9MHz at that time.

A preliminary adjustment of AGC set pot R49 will be possible at this stage; R49 should be increased until AGC action just begins and no more. This point will probably occur about one-quarter travel from the ground end of R49. The AGC pot can be adjusted later to provide what the user feels is satisfactory AGC action. S-meter sensitivity pot R64 should be adjusted so that the meter does not pin violently upon reception of a strong signal.

Upon completion of the VFO, its tuning range can be set with C68 so that it covers 10.8 to 11.0MHz with a bit to spare at each end. If a frequency meter is not available, the range may be set later using the crystal calibrator. The front panel calibration pot allows about plus or minus 5kHz swing to correct for inaccuracies in the converter crystals and to align the VFO for USB/LSB reception. The remaining assemblies; balanced mixer, RF amp and crystal calibrator may be completed in that order.

If desired, it will now be possible to haywire the assemblies together upon a scrap of aluminium sheet and check that the receiver works as a whole before wiring them into the receiver chassis.

L1-L4 may be adjusted with the use of a signal generator, or with off-air signals from an





He is over 80 years old, of slight build but always very well groomed and dressed and he, without prompting, frequently took the part of host at Brisbane WIA meetings in the 1960s.

In the mid thirties he would sit in the vestibule of his workplace, Queen St Brisbane giving members lunchtime opportunity to collect and deliver QSL cards.

For many years he was a scoutmaster, and was also one of the most popular secretaries of the Queensland Division. In 1936 he was a Federal Councillor.

With Arthur, VK4AW and Pat VK4KB (Dec'd), he made the following Brisbane Telegraph headlines in February 1935. "Australian Wireless Record." "Shortwave Interplane Communication." "Success on 5 metre Band." "Early morning Experiments." Nearly two columns of story on this duplex radio telephony followed.

Recently he had the thrill of contacting Taupo, NZ, via the Brisbane 2 metre repeater from his room at Girraween Hostel Redcliffe with a 2 watt hand held.

He enjoys relatively good health and an occasional whisky. Yes he is Bill. VK4WX, VK4WT, 1932, and VK6WT.

AR

**Note**

John Moyle National Field Day Logs must be received by the Federal Contest Manager by the 23rd March, 1983, to qualify for any awards.

AR

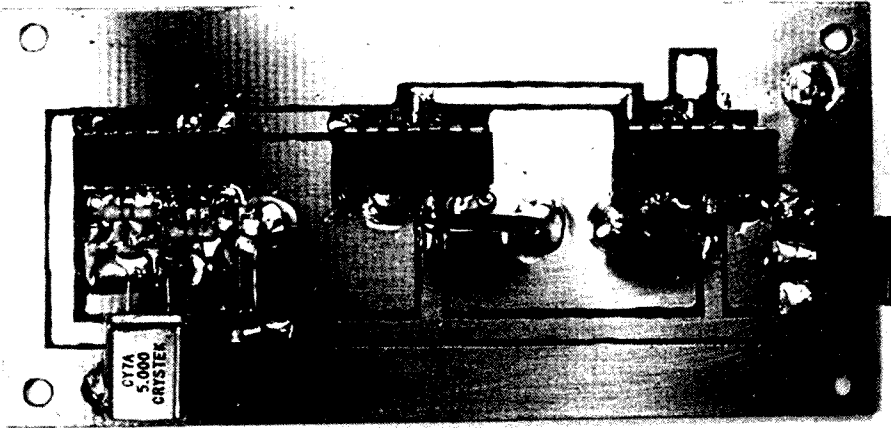

**Crystal Calibrator**



- L1, L2, L3, L4: 45 turns, 30 B&S enam. on Aegis 3510 coil assy.
- L13: 20 turns, 22 B&S enam. on Aegis 3510 coil assy. (no slug).
- L10: 20 turns, 28 B&S enam. on Aegis 3510 coil assy.
- L6, L7, L8: 12 turns, 22 B&S enam. on Neosid 4327R/1/P25 toroidal core. L5: 2 turns 22 B&S on earthy end of L6. L9: 4 turns ct 24 B&S on earthy end of L8.
- L1, L4: 13 to 14 loops, 24 B&S enam. twisted bifilar on Neosid 4327/2/P25 toroidal core.
- L7, L8: 11 loops, 24 B&S twisted trifilar on Neosid 4327/2/P25 toroidal core.

**Coils and Transformers**

antenna. Some compromise will probably be necessary in their adjustment so that a flat sensitivity response is obtained across the band.

When the tuning range of the VFO has been established, the calibrator may be used to find the 50kHz points on the dial. With the perspex removed, it will be possible to place Letraset sheet in position from above and behind the panel and rub the figures onto the dial through the window opening. If a stable calibrated signal source is available, such as a BC221 frequency meter, a known frequency can be introduced into the receiver input and used to supply the 10kHz spaced check points for

calibration. Send a large SAE to the author for a copy of the circuit board artwork and location diagrams.

Photos — Peter Dalliston.  
PARTS SOURCES

Coil formers, toroids, dial drive and many other parts: J H Magrath, 55 A'Beckett St., Melbourne, and Watkin Wynne, 32 Falcon St., Crows Nest.  
10k : 2k transformer, CA3028s, 5MHz crystal and many other parts : Ellistronics, 289 La Trobe St., Melbourne.  
27MHz CB crystals and many other parts: Tandy Electronics.

AR

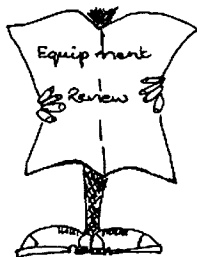

# EQUIPMENT REVIEW

Reviewed by, Bruce Bathols, VK3UV  
From an operators point of view only

## HAL CT2100 COMMUNICATIONS TERMINAL AND HAL KB2100 KEYBOARD

One of the latest pieces of equipment to pass across my bench was the HAL CT2100 Communications terminal and the HAL KB2100 matching keyboard.

Here are some of the specifications as taken from the leaflet accompanying the terminal.

- Send or receive ASCII, Baudot, or Morse code
- RTTY and Morse demodulators are built-in
- RTTY speeds of 45, 50, 74, 100, 110, 300, 600 and 1200 baud — ASCII or Baudot
- Four RTTY Modems: "high tones", "low tones", "103 Modem tones", and "202 Modem tones"
- Three shifts for high and low tones (170, 425 and 850 Hz)
- Crystal-synthesized transmit tones
- Send and receive Morse code at 1 to 100 WPM
- Characters displayed on 24 line screen
- Choose either 36 or 72 characters per line
- 2 pages of 72 character lines or 4 pages of 36 character lines
- Split-screen for pre-typing transmit text
- Audio, current loop, or RS 232 data I/O
- Printers available for hard-copy of all 3 codes
- On-screen RTTY tuning bar plus LED indicators
- ALL ASCII control characters; half or full duplex
- Brag-tape storage of 8-256 character messages in MSG2100 EPROM option
- Two programmable HERE IS messages

The station transceiver used for testing was the ICOM IC720A for HF, and the Icom IC290A for VHF. All tests were conducted using AFSK only, although it would have been a simple matter to wire up the FSK facility on the IC720A. Only the RTTY 45 Baudot and CW functions were tested, however other Baudot speeds and ASCII codes are an integral part of the terminal (see specs).

### RTTY REPORT

Having had some previous experience with RTTY computer terminals, it did not take long to interface the HAL terminal to the HF transceiver. As one would expect,

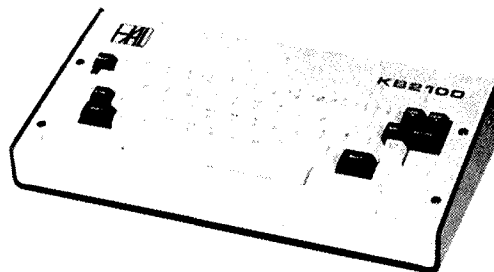
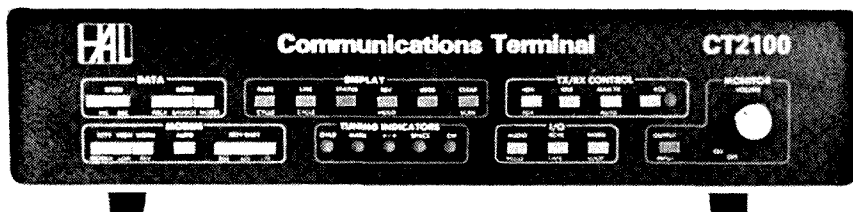

the terminal is no toy and care must be taken to ensure the correct connections are made.

A very comprehensive instruction manual gives explicit detail on the unit's operation and capabilities.

To the newcomer to this type of equipment, there is a special section in the manual for those that cannot wait to read the manual fully, and gives basic instructions for hooking up the terminal to receive signals in the interim.

After satisfying oneself that all appears to be in order initially, it is then strongly recommended that you sit down quietly for an hour or so and read the operations manual thoroughly. It is a bit like the old adage "If all else fails, read the instructions first". So HAL have included the initial

testing chapter for the impatient. Full marks to HAL for that facility.

After becoming fully accustomed with the terminal, and also soldering up the various connectors (supplied) required for the audio and switching functions, I started looking for weak RTTY signals on 20 metres. The terminal performed admirably and printed up 100 per cent copy from signals which were barely audible to the ear.

The built in tuning indicators were particularly sharp, and in conjunction with the passband tuning system of the transceiver, excellent rejection of adjacent interfering signals was made.

Signals well into the noise floor were printed perfectly and no copy was lost.

Hooking up an old Model 15 Teletype and loop supply to the loop keyer on the rear of the terminal, gave a hard copy of what was displayed on the screen. On transmit, the separate keyboard was most simple to use. The keyboard itself is lightweight and connected to the terminal by a length of 'curly' cord. This enabled operation in comfort with the keyboard resting on my knees. I could have placed the keyboard on the operating desk or any other convenient location.

As a fair majority of RTTY operators are two finger typists, the built in buffers of the terminal retained each word in memory until the space bar was activated. That means it does not matter what speed you are able to type at, the terminal would send each completed word at a preset rate, then wait for you to make up another word until the space bar was hit again. In the intervening periods, the terminal sent the 'letters' code. This facility makes a 'hunt and peck' typist look like a 60 WPM expert secretary.

Wrap around half screen facilities are included and enable the operator to commence typing a reply into the buffer memory while still receiving the other station. If a quick break was needed in response to a query while typing up the next reply, the buffer could be by-passed at the push of a button, the special query replied to, then back to receiving and

typing up the buffer again without disturbing the contents of the original buffer.

With such ease of operation and ability to receive RTTY signals under all conditions, I was able to spend many hours on this mode without feeling frustrated or tired.

To gain any satisfaction from RTTY you must possess a very stable receiver, as the passband in the RTTY terminal is very narrow, and a few hertz off the operating frequency will result in garbled or nil copy.

### CW TESTS

All of the functions applicable to the RTTY mode, is also applicable to the CW mode, so my comments here will be restricted to basic impressions only. After making the appropriate connections to the transceiver, I embarked on an expedition into the 40-50 WPM CW world.

I felt I was cheating myself as I normally have a little difficulty running 20 WPM CW on a hand key or electronic keyer. Tuning into a CQ call running 40 WPM on 20 metres, being able to read on screen every letter, and then reply at the same speed was an unusual feeling. However, the other operator was also using a 'computer' generated CW signal.

Coming back to reality for a while, and to the hand sent code showed up the usual faults with computers and CW reception. I have never been a great advocate for computers and CW reception, and unless

the CW is sent with the correct spacing, errors in reading on the screen will occur. However, the HAL terminal has built in provision for varying weight factors and automatic speed adjustment, and lessens the error rate on hand received morse considerably. There were no problems on the terminal's CW transmit mode.

### GENERAL

One item not included in this otherwise top line communications terminal was a TV modulator. The video output is designed to feed a direct monitor only and for use with a portable TV set as is the case with many other computerised RTTY/CW terminals, necessitates the extra purchase of that item. Never-the-less, my tests were conducted with BOTH a normal monitor and a modulated TV set on channel 1. The display on the monitor was far superior in clarity to a TV set using the special modulator.

### CONCLUSION

One would be hard pressed to find any fault with the HAL terminal and keyboard. Although not the cheapest unit on the market, the extra facilities it provides is more than justified. The test units were supplied by EMTRONICS, 649 George Street, Sydney NSW 2000, telephone (02) 211 0531, to whom enquiries regarding price and delivery should be made. **AR**

## The 22S . . . A Common Fault

Ian Jackson VK3BUF  
52 Virginia Street, Springvale 3171

From "Gateway" February 1982

The 22S is a very popular 2 metre transceiver, hundreds of them are used in Melbourne alone, their frequency control uses a diode matrix system to select a channel in a 25 kHz increment.

The printed circuit board is very susceptible to intermittent faults which produces an "out of lock" condition, these faults are annoying but can be repaired in time.

This article is not about the "out of lock" fault, but of a secondary fault that may arise from this condition . . . the frying of the voltage regulator.

The circuit Fig. 1 is of a voltage regulator that supplies half of the set with power, RF oscillators, mic. pre-amp stages and the PLL board.

The circuit is duplicated in Fig. 2 in a simplified form. It shows a typical zener reference assigning 9.6 volts to the base of a series regulating transistor via a diode. The transistor has full supply voltage (13.8 typ.) applied to the collector via a 15 ohm  $\frac{1}{4}W$  resistor and thus 9 volts regulated appears at the emitter.

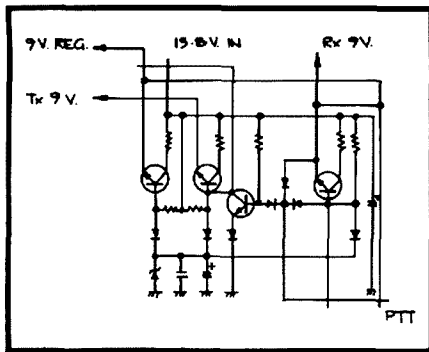

FIG. 1

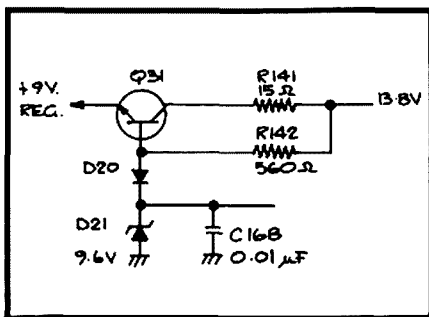

FIG. 2

Under normal operating conditions 86 milliamps is drawn through the regulator, there is an input-output voltage difference of approximately 4.8 volts, minus the 0.6 volt drop across Q21. There remains 4.2 volts across R141. The resistor therefore dissipates 360 milliwatts.

This means that the resistor in circuit is underrated and has on many occasions burnt out, though usually it just gets very hot. If the set goes out of lock either through a fault condition or if a channel position has been selected, that is vacant of diodes, the idle current shall rise from 86 to 100 milliamps. The extra current will in a very short interval cook the resistor, which shall rise in resistance and simulate many other faults, particularly in the phase-locked loop board by providing less than 9 volts.

This effect may occur more frequently to those who use an "external programmer" comprising eight switches as, through usage, they tend to fall out of lock more frequently.

It is therefore suggested that, whenever routine maintenance to the 22S is being done, that this resistor, R141, be replaced with a  $\frac{1}{2}W$  version of the same value. It's only a little modification but it could save some major headaches. **AR**



Graham Baker VK8GB  
74 Byrne Circuit, Moil NT. 5792

# NIGHT TIME VHF PROPAGATION

*A semi-theoretical assessment of the mechanisms involved with support from the author's experience over four years of operation in Darwin (a VHF DX'ers paradise!)*

## 1. THE NIGHT TIME IONOSPHERE

The ionosphere is generated by ultra violet radiation from the sun ionizing (or detaching electrons from) rarefied gases in the upper atmosphere. Because of the spectrum spread of the ultra violet radiation striking the upper atmosphere there is a tendency for ionization to occur in several different layers. The extent of the ionization is dependent upon the intensity of the incident radiation.

The ionosphere is also affected by charged particles generated in solar flares on the sun which arrive about a day after a major flare. These particles are deflected by the earth's magnetic field towards the poles and disturb the upper layers of the ionosphere.

Because of the sun being overhead the geographic equator at the equinoxes, it might be expected that the density of ionization would be at a maximum over the equator at these times. Actually two maxima occur and these are centred not about the geographic equator but over the line of zero magnetic dip, or the geomagnetic equator. These maxima begin to form in the morning and a pronounced valley between them becomes observable by noon and lasts till after midnight.

The maxima do not move north and south with the seasons, but with the migration of the sun in summer and winter the system becomes unbalanced with considerable differences between the high density areas which form in the regions approximately 10° to 15° from the geomagnetic equator.

The influence of the earth's magnetic field is marked. Not only are the maxima symmetrical about the magnetic equator, but the ionosphere is upset by magnetic storms and influenced by changes in the magnetic field. On magnetically disturbed days the high density areas tend to be closer to the magnetic equator.

The earth's magnetic field in space is not a neat dipole field but is compressed against the earth on the sunny side by the solar wind and is extended far into space on the side away from the sun. The earth and its ionosphere rotating within this field thus encounter a rapid change after sunset. The resultant dynamo action sets up strong electric fields, the lower levels of the ionosphere are sucked up, and the upper levels bulge outwards and reach a maximum about two hours after sunset. The turbulent regions then subside and high density irregularities then align themselves with the earth's magnetic field.

This phenomenon is observed on vertical incidence ionograms as "Spread F". The size of the irregularities is not accurately known but they are thought to be in the order of 10m wide and 1km along the magnetic field lines; larger areas may also exist at the same time.

## 2. 144 MHz PROPAGATION MODE

There has been much discussion recently about the propagation mode of VHF trans-equatorial signals and I am not in a position to comment on these theories but the following theory fits my experiences reasonably well.

Two aspects need consideration; one is the mode of propagation through the ionosphere and the second is access to or transition from this propagation medium.

### (a) Ionospheric Propagation

It is generally accepted that in the evening, VHF signals are propagated across the equatorial regions by guidance between field aligned irregularities along ducts.

This guidance across the equator can be likened to a "sheath" of fibre optic filaments extending to each side of the geomagnetic equator. The "sheath" terminates in a "transition zone" permitting access to the ends of the "fibres" by VHF signals. Once a signal is inside a "fibre" it is trapped until it comes to the other end. Access at intermediate points is prevented by the lack of a suitable "transition zone".

In real terms this guidance is probably in ducts, large waveguide-like structures created by the alignment of ionospheric irregularities by the earth's magnetic field. The requirement for guidance is related to specific ionization densities and abrupt changes in ionization density at the edges of the duct.

The path length depends upon the spread of these irregularities either side of the geomagnetic equator, the maximum propagated frequency on the ionization levels and the gradients present in the irregularities.

Seasonal variations in observed propagation would be due to a non symmetry of ionization on either side of the geomagnetic equator.

### (b) Transition Zone

In order to gain access to the ionospheric propagation medium across the equator, access to the ends of the ducts is required. It has been suggested that this transition is simply a matter of entering the ducts tangentially and this can be predicted

geometrically by the height of the F layer in which propagation takes place and the area in which a transition zone occurs.

The area in which a transition zone would occur is related to the spread of sufficiently dense ionospheric irregularities from the geomagnetic equator. It has been shown that on magnetically disturbed days the two "bulges" of ionization on either side of the geomagnetic equator are closer together. It can be assumed then that the transition zones in the evening move similarly in response to changes in magnetic disturbance.

The path length of propagation in the Darwin-Japan circuit is much less than the Athens-South Africa circuit and I assume that this can be related to both the spread of the two transition zones and the F layer height at which the ducting of signals occurs.

I do not rule out the possibility of another mechanism for accessing the ducts however.

## 3. DISCUSSION ON 144 MHz PROPAGATION

### (a) Limited area of Reception

The statistical base for determining the geographic limits of propagation of amateur signals from Japan to Darwin is very good because of the large number and distribution density of amateur operators in Japan. On the circuit described the maximum easterly deviation from north-south has been found to be 400 km over a path length of 5000km. Tests run with stations to the north west of Japan in Korea have failed to establish propagation and similar results to the south in Okinawa have also failed.

### (b) Focusing of Signals

On many occasions focusing of signals to very small areas within the overall geographical area has been observed. A general drift of focusing from east to centre has similarly been noticed with contact being established with the eastern most stations (in JA3) early in an opening.

### (c) SSB Signals

The doppler spread of signals experienced in the Africa/Europe sector is not as apparent in the Australia/Japan Circuit and almost all contacts were established using SSB at perfect readability.

On a small proportion of openings intelligibility at the beginning of an opening

was impaired by an "auroral like growl" rendering CW almost uncopyable but this abated after about 15 minutes and strong relatively stable conditions resulted. Marginal openings do not suffer this signal quality degradation, with SSB being copyable immediately.

#### **(d) 144 MHz Propagation without 50 MHz propagation.**

Propagation has been experienced on 144 MHz on a few occasions when signal levels on 50 MHz were severely reduced. However on these occasions amateur stations in southern Australia were always experiencing enhanced 50 MHz propagation at the time. I believe this to be the result of high ionization levels preventing access of 50 MHz signals to the transition zone while 144 MHz signals can penetrate the ionosphere. This I believe is a result of enhanced spread of the ionized areas on magnetically quiet days.

#### **(e) Variable Flutter on signals**

Prediction of an imminent opening at 144 MHz to Japan by means of the depth and level of flutter on 50 MHz signals received from stations in the 144 MHz propagation zone in Japan can be accomplished. Signals from other areas in Japan do not have the same flutter. This indicates to me that the propagation mode at 50 MHz is different to that for 144 MHz, and I suggest that there are in fact three forms of enhanced VHF ionospheric propagation observable in equatorial areas in the evenings.

#### **(i) Evening type TEP**

The propagation of 50 MHz signals from various parts of Australia to Japan in the evening at various angles to the magnetic field can be adequately described as evening type TEP.

#### **(ii) TEP Ducting**

The propagation of signals by means of ducts formed by field aligned irregularities (FAI) from 50 to above 144 MHz appears to be different from evening TEP propagation. The path geometry requirements are different, and different flutter characteristics occur on the received signals.

#### **(iii) Night time equatorial F2**

The existence of propagation with less flutter than that of normal evening type TEP signals, between Darwin and such places as Guam (KG6), Papua New Guinea (P29), Solomon Islands (H44), Indonesia (YB) Christmas and Cocos Islands (VK9) etc on a regular basis at extremely high signal levels, indicates F2 single hop propagation.

I will return to 50 MHz propagation later.

#### **(f) JA "Beacons"**

Many paging transmitters using continuous carrier and tone modulation are received in Darwin between 146.48 and

146.82 MHz coincident with JA amateur signals. In practice I always listen to a 146.810 MHz beacon to be aware of 144 MHz openings. These beacons are of high power level at good locations and are always observable shortly before and after JA amateur signals on 144 MHz. The beacons appear to be clustered about 146.5 and 146.8 MHz with as many as 30 different transmissions being observable.

#### **4. PREDICTION OF 144 MHz OPENINGS**

The criteria for 144 MHz propagation on the Australia — JA path are:—

- (1) geographical position with regard to the geomagnetic equator.
- (2) Seasonal variation, peak times March and September.
- (3) Daily time around 2100 local
- (4) Magnetically quiet day, K index less than 3 on the WWV solar/terrestrial indices report at 18 minutes past the hour.
- (5) Solar flux greater than 150.

A noticeable variation from normal 50 MHz TEP flutter rates would indicate the area of possible contact.

#### **5. 50 MHz EVENING PROPAGATION**

##### **(i) TEP RELATED F2**

The existence of VHF propagation at 50 MHz in the mid to late evening between stations located either side of the geomagnetic equator has been observed for many decades and is well known to VHF operators. Not so well known is the occurrence on a regular basis of night time F2 propagation in the tropical zone.

Propagation between stations in the equatorial zone, at various angles to the magnetic field including perpendicular, occurs regularly. In the Japan — Australia sector paths such as Guam — Japan, Hong Kong — Guam, Japan — Philippines, Japan — Malaysia, Australia — Guam, New Guinea, Indonesia, Solomon Islands, Malaysia, Cocos Island, Christmas Island exist from time to time.

The path from Darwin to Guam has very high reliability and occurs whenever evening type TEP to Japan is observed. Similarly the path from Darwin to Malaysia and the Philippines has high reliability.

These paths can exist without evening type TEP being observed particularly on magnetically disturbed days. This indicates the establishment of suitable TEP conditions in only the southern part of the TEP circuit.

Propagation to stations which lie nearer to perpendicular to the magnetic field at Darwin ie. New Guinea, Solomon Is., Indonesia and Cocos and Christmas Islands, occurs less regularly and is linked to the spread of high levels of ionization away from the geomagnetic equator.

Ionization can reach very high levels as is indicated by very short skip openings to West Irian from Darwin.

The propagation medium is identified as TEP related F2 by flutter which is less marked than normal evening type TEP to Japan and its correlation to evening type TEP by seasonal and diurnal occurrence.

I believe that this TEP related F2 propagation is linked more precisely with the formation of FAI ducting and the signals are in fact reflected back from the underside of this ducting.

Because of the westward extension of the night time TEP zone caused by the setting sun, propagation using multiple hops along this tropical band occurs. I have observed multiple hop F2 propagation to India and Nepal, Gibraltar and by coupling into the day time F2 ionization peak, to French Guyana in South America long path via the night side of the earth.

##### **(ii) Evening type TEP**

I have previously mentioned that I do not consider FAI to be responsible for night time TEP at 50 MHz. There is considerable evidence that large scale structures exist in the night time tropical ionosphere concurrent with the smaller FAI and I suggest that it is likely that these are responsible for evening type TEP at lower VHF frequencies.

#### **6. RELATIONSHIP BETWEEN THE GEOMAGNETIC EQUATOR AND DAYTIME F2 VHF PROPAGATION.**

As mentioned previously, in the morning of days during the sunspot cycle peaks, bands of enhanced ionization form at about 10 degrees either side of the geomagnetic equator. These bands of ionization form "freeways" which support 50 MHz propagation during the day. The paths between Europe and the Caribbean and Japan and South America follow these paths.

The night time path from Darwin to French Guyana follows this "freeway" from India over Israel, Italy, Gibraltar and across the Atlantic to South America. Propagation to India is by double hop TEP related F2.

Propagation from Southern Australia to the Caribbean and the United States uses these freeways but crosses them at an angle and requires additional F2 or Es reflections at either or both ends of the path.

It is a very interesting and worthwhile study to plot the geomagnetic equator on the globe and centre your own location on one axis and its antipodes on the other. By observing where paths follow a course parallel to the geomagnetic equator optimum VHF F2 paths can be determined.

#### **7. CONCLUSION**

This article is not meant to be a definitive scientific report but rather a summary of special VHF propagation I have observed while in Darwin for the last few years.

#### **8. REFERENCES USED**

1. KURIKI et al "Propagation mode deduced from signal strengths in the VHF band on the trans-equatorial path" Journal of the Radio Research Laboratories (Japan) No. 100 1972 pp 175-195.
2. L.F. McNAMARA "Evening — type trans-equatorial propagation on Japan — Australia Circuits" *Aust. Journal of Physics* 1973, 26 pp 521-543.
3. R. HARRISON "VHF Trans Equatorial Propagation" — *Amateur Radio* 1972 & *Electronics Today* June 1973 pp 88-97.
4. CRACKNELL et al "Twenty-one years of TE" *Radio Communications* June/July and August 1980.
5. CRACKNELL et al "The Euro-Asia to Africa VHF Trans-equatorial Circuit during Solar Cycle 21" *QST* November and December 1981.
6. *The Short wave Propagation Handbook* Jacobs and Cohen. Cowan Publishing 1979.

# TWO TONE TEST OSCILLATOR FOR SSB

A L BUTLER VK5BR

18 Ottawa Ave, Panorama, South Australia, 5041

**A two tone generator is a useful item to enable linearity and power output checks on the SSB transceiver and linear power amplifier. This article describes a two tone generator, built by the author, using tone generator devices FX205.**

The FX205 is a device which generates, digitally, a stable staircase waveform simulating a sine wave (refer Figure 1). Low distortion is achieved by the addition of a simple RC sine shaping filter. Performance tests carried out by the author on the FX205 have produced the following results:

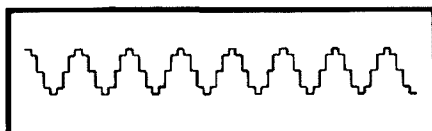

Fig. 1: Tone Generator FX-205 Output Waveform.

## FREQUENCY STABILITY

- (a) Less than 2% change over a temperature range of 20°C to 65°C.
- (b) Less than 2% change over a supply voltage range of 12 to 15V.

## OUTPUT VOLTAGE STABILITY

- (a) No noticeable change over a temperature range of 20°C to 65°C.
- (b) Output voltage is proportional to supply voltage, (ie output voltage stability is dependent on supply voltage stability).
- (c) Using frequency adjustment control (RV1 in Figure 2) over its full range, maximum output voltage change is within 0.5 dB.

(NOTE: This is without the filter which does not have a constant attenuation versus frequency characteristic.)

Using the FX205, as shown in the circuit of Figure 2, an output voltage range of 3.5 dB is provided by the adjustment of RV2 and a frequency range of 10 to 1 is provided by the adjustment of RV1.

Frequency range of the FX205 is 30 to 5,000 Hertz.

$$C_1 = \frac{0.82}{f \text{ 'LOW}}$$

$$f \text{ 'HIGH} = 10 f \text{ 'LOW}$$

where  $C_1$  is expressed in microfarads and  $f$  is expressed in hertz.

Frequency range of the RX205 is 30 to 5,000 Hertz.

## SINE SHAPING FILTER

The circuit of the complete two tone generator is shown by Figure 2. Sine shaping is achieved by the two filter sets labelled C2, C3, R4, C4, R5, C5. The filters

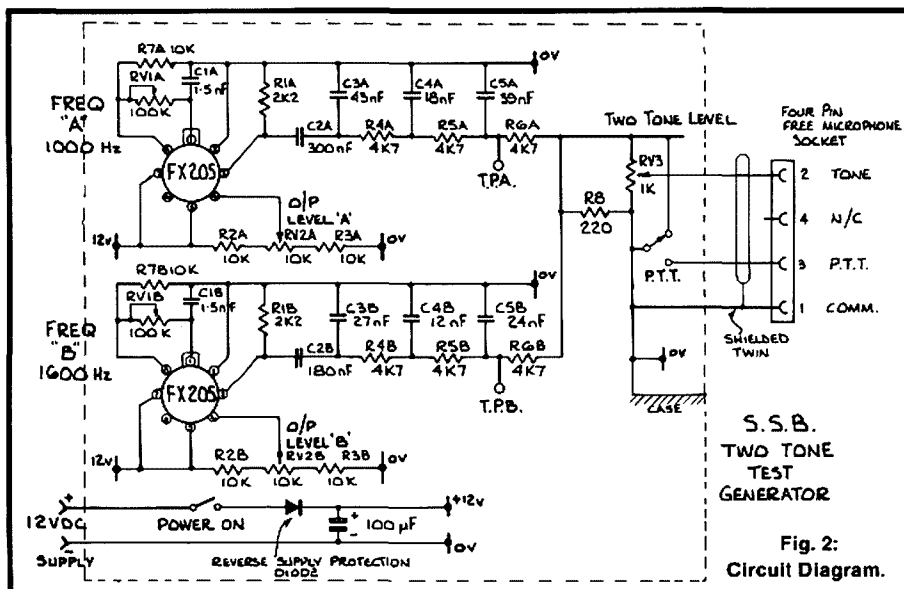

Fig. 2: Circuit Diagram.

are set for 1,000 Hz and 1,600 Hz respectively to give a distortion less than 1%. If different frequencies are required with similar performance, the following design criteria are applied:

$$C_2 = \frac{300}{f}, C_3 = \frac{42}{f}, C_4 = \frac{19}{f}, C_5 = \frac{38}{f}$$

where  $C$  is expressed in microfarads and  $f$  is expressed in hertz.

The values shown in Figure 2 are in nanofarads (nF) in case there is some confusion.

Note that each filter is designed for one frequency operation. If variable frequency operation is required, a low pass filter with constant attenuation in the passband is needed. The predominant harmonic is the seventh and hence the cut off frequency must be less than seven times the lowest frequency of operation with tuning frequency range restricted to about 6 to 1.

## ONE COMBINATION

The two tones are combined in R8 and RV3 and wired to a standard microphone free socket to replace the microphone feed to the transceiver. A switch to replace microphone press to talk is also provided. Two tone output level is set by RV3.

## ASSEMBLY

Layout of the generator unit is not critical but it is advisable to enclose the unit in a

metal box as a precaution against feedback from radiated RF. Furthermore, the output is at low microphone level and this should be shielded to prevent noise pick up.

The author assembled the components on a vero board and housed this in an inexpensive 13 cm x 8 cm x 5.5 cm aluminium box which was available at the local electronics store. RV1A-B and RV2A-B are trim pots mounted on the board. RV3 and the two switches (power and PTT) are fitted as external controls. The 12V supply shown in the circuit diagram is nominal. A supply between 10V and 15V is within the FX205 specified tolerance. (The unit constructed, actually worked well from a 9V battery.)

## ADJUSTMENT

The individual tones are monitored at TPA and TPB with the PTT switch set to short circuit RV3. Frequencies are set at 1,000 Hz and 1,600 Hz respectively by adjusting RV1A and RV1B and measuring at TPA and TPB with a frequency counter or reference oscillator and CRO. RV2A and RV2B are set for equal output voltages at TPA and TPB.

Frequency must be set before adjusting levels as the attenuation of the shaping networks varies with frequency.

Once set up, no further adjustment is necessary and two tone output level is set by RV3.

# THE CAMBRIDGE UNIVERSITY 600 kV HIGH RESOLUTION ELECTRON MICROSCOPE

Adapted from Cambridge Press Release  
Article courtesy Art & David Smith VK3UX & VK3ZSS

**A 600 kilovolt electron microscope, designed to provide image resolution to the atomic level, was opened by Sir James Menter on 18th May, 1979. It has been financed by the Science Research Council and the University of Cambridge.**

The main role of the new microscope is to examine a wide variety of crystalline and amorphous metals and semi-conductors, at sufficiently high magnification and resolution to make visible detail on the atomic scale.

Although this is not the first high voltage electron microscope to be designed for high resolution, it has several unique features which make it the most flexible and versatile. The electron gun employs a lanthanum hexaboride cathode which gives such a high brightness that images can be observed on the viewing screen even at a direct magnification of 500000 times, making focussing and correction of image astigmatism much easier. The microscope, which with the electron accelerator weighs some 7 tonnes, is supported on a three-point suspension system to reduce the

effect of site vibrations. The high voltage generator, supplied by the firm of Emile Haefely of Basel to a high specification, has been further stabilized to better than one part in a million by electronic means designed and constructed locally. The basis of the microscope proper consists of the column of electron lenses of the EM-7 microscope developed by AEI. That microscope was partly based on the original 750 kV microscope built in the Cavendish Laboratory in the 1960s. The most important lens, the high-power objective, has been modified to improve its imaging performance. Circuits of the extra high stability required for the lens current supplies have again been made on site.

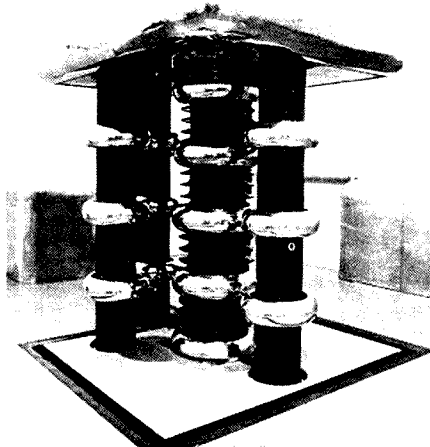

Cambridge University 600 kV High Resolution Electron Microscope High Voltage Accelerator.

Preliminary investigations, made by Dr D J Smith VK3ZSS in collaboration with specialists in Cambridge and elsewhere, have already demonstrated the potentialities of the new microscope in a range of problems of considerable scientific and technological importance. **AR**

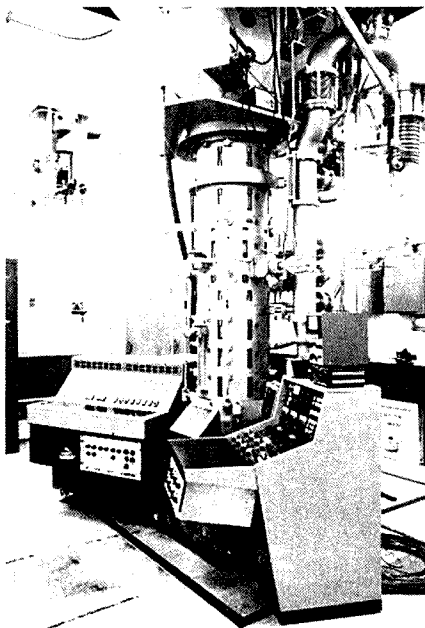

Cambridge University 600 kV High Resolution Electron Microscope.



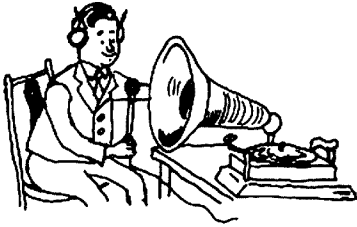

# NOVICE NOTES

## A JUNK-BOX ATU

As promised last month we have details of an ATU that you can build from your junk-box.

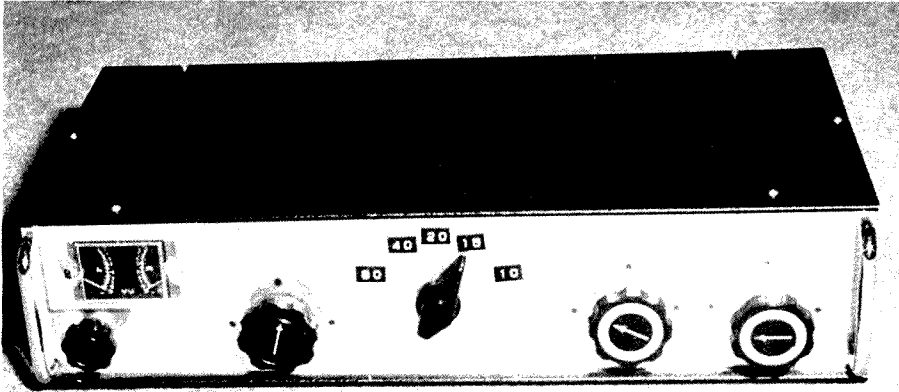

Once the optimum settings have been found for each band record them on a card and tape this card to the top of the ATU for future reference.

### THE VSWR METER

The VSWR meter is the transformer coupled type. All VSWR meters use a directional coupler usually one of two common configurations. The most common uses two parallel coupling lines. It is frequency sensitive.

That is for a given indication more power is required as the frequency is lowered. The coupler described here gives the same indication for the same power for frequencies from 3-30 MHz

Transformer T1 gives a voltage generated by the current in the line. Fig. 2 shows how

### Completed Junk-Box ATU.

Apart from a minimal price the ATU features a wide tuning and matching range and a frequency-independent VSWR and power meter that indicates forward and reverse power simultaneously.

### THE CIRCUIT

The tuner circuit is a pi coupler, made from the components of the PA circuit of an old valve AM transmitter, with an additional tuning capacitor in series with the antenna.

The large variable capacitor C1 allows the transceiver to be tapped up the tuned circuit. The tapping on L is set according to the band in use and C2 and/or C3 used to tune to resonance.

### TUNING-UP

To tune-up, select an unused frequency close to your desired operating frequency. Set L to the band in use. Turn C1 to half mesh and set C2 and C3 to minimum mesh. Apply 1 to 10 watts of CW and adjust the sensitivity control of the VSWR meter to indicate half scale. Tune C3 for minimum reflected power. Adjust C1 and C3 until reflected power indicates zero.

If a dip in reflected power is not found in the first instance set C1 to a different position (1/4 or 3/4 mesh) and tune C3 again. If no dip can be found set C3 to full mesh and adjust C2 and C1 for a dip. Sometimes changing the tap on L will give better tuning. For example when on 80 metres the tap may be set to 40 metres.

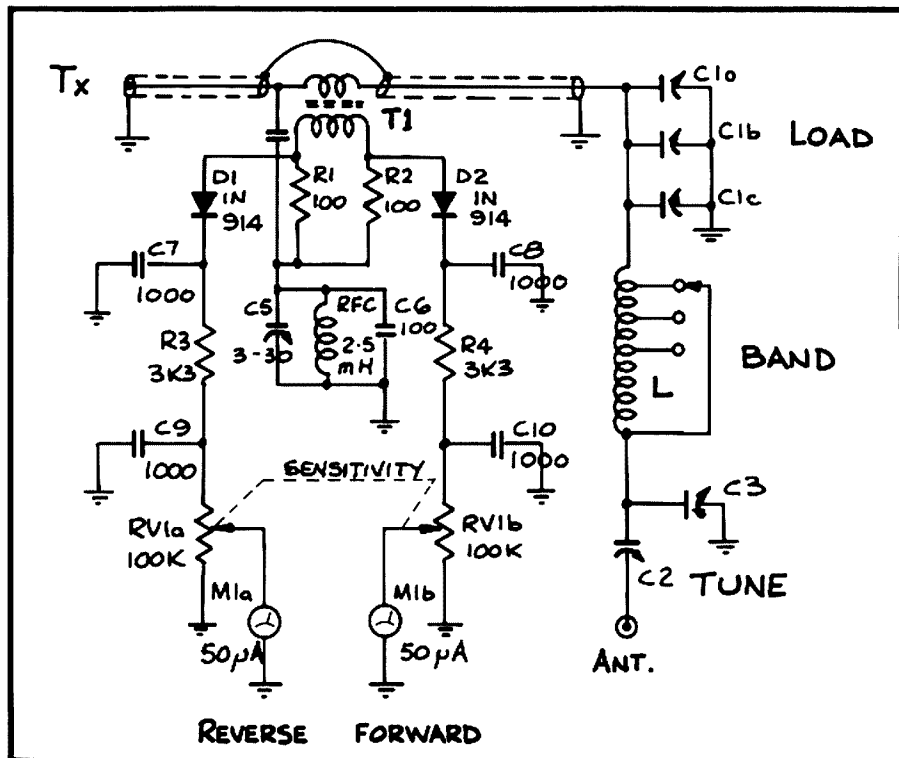
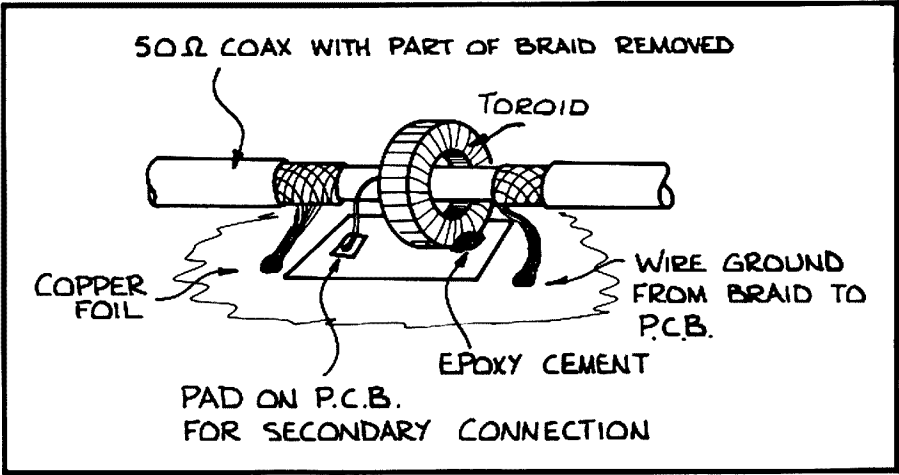

Fig. 1 — VERSATILE JUNK-BOX ATU

L — Gelsoso AM Tx Tank Coil; C1 — Three gang air-spaced tuning capacitor from valve radio 20-1050 pF; C2, C3 — Air-spaced valve transmitter PA tuning capacitors 270 pF 2kV minimum; R1, R2 — 100  $\Omega$  1 watt carbon resistors (or low inductance alternative); M1 — Twin VU meter, 50  $\mu$ A.





**Fig. 2 — DETAILS OF TRANSFORMER T1**  
 Torroid Core — Neosid 4327R/1/F25/EC; Primary — 1T made by coax.; Secondary — 40T #26 gauge enamelled copper wire.

the coaxial line is opened to form a 1 turn primary for T1. Capacitor C4 couples the line voltage to the detector circuit. D2 rectifies the combined signal producing a DC voltage proportional to forward power. C8, R4 and C10 form a filter circuit. A look linear potentiometer is used to set a convenient indication on the meter, M1(b).

If there is no reflected power the combined voltages from T1 and C4 applied to D1 is then zero. If there is some reflected power the diode D1 rectifies this, C7, R3 and C9 smooth this and the result is indicated on M1(a).

By using an inexpensive twin VU meter and a ganged potentiometer for RV1 both forward and reverse power are simultaneously displayed.

If the sensitivity control is graduated it can be calibrated to provide power measurements as well as VSWR measurements.

R1 and R2 provide terminations and DC returns for T1. A network consisting of an RFC and a shunt capacitor is used to adjust the frequency response of the system. To adjust C5 replace the ATU with a 50 ohm dummy load and with power applied at say 14 MHz (or 21 MHz if you can't produce 14 MHz energy), vary C5 for minimum reflected power indication. Check at 3.6 and 28 MHz and, if necessary, make any small compromise adjustment for equal (if not zero) reflected indications. Use the maximum sensitivity for final adjustments.

**CONSTRUCTION NOTES**

A metal case is recommended for housing the ATU components. The layout is not particularly critical. Note that C3 is mounted on a bracket and an insulating coupling used. This capacitor can be at a very high RF voltage. For RF powers above novice level C3 needs to be carefully chosen as the voltage across it can be many kV even at 100 watts of output. The photographs show the general arrangement I used. Other builders have used a square front panel and re-arranged the components accordingly.

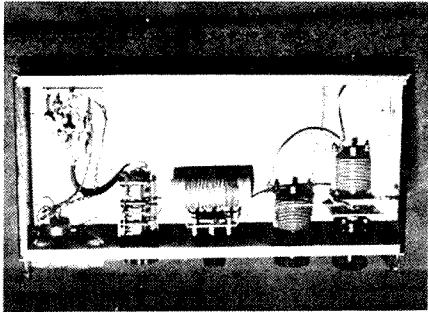

Inside the Junk-Box ATU.

of the ARRL *Radio Amateurs' Handbook*. The unit shown in Fig. 4 acts as a 1:1 balun but is in fact a means of preventing any current flowing down the outside of the braid by effectively adding series inductance in the outside of the braid. Currents flowing inside the co-axial cable are not affected.

The core is salvaged from an old TV set. Although the core has been designed for low losses only to a few MHz, negligible loss occurs at 30 MHz.

With this unit any piece of wire from a mattress to a fence becomes a potential antenna.

73 de VK3AFW  
AR

**USING OPEN WIRE FEEDERS**

In my unit I have left room for a balun to be installed at a later stage to allow balanced feeders to be used. For the present I prefer to put the balun at the antenna and use a coaxial feeder.

Two inexpensive baluns are shown in Figs. 3 and 4. The one shown in Fig. 3 is an air-cored unit described in the 1982 edition

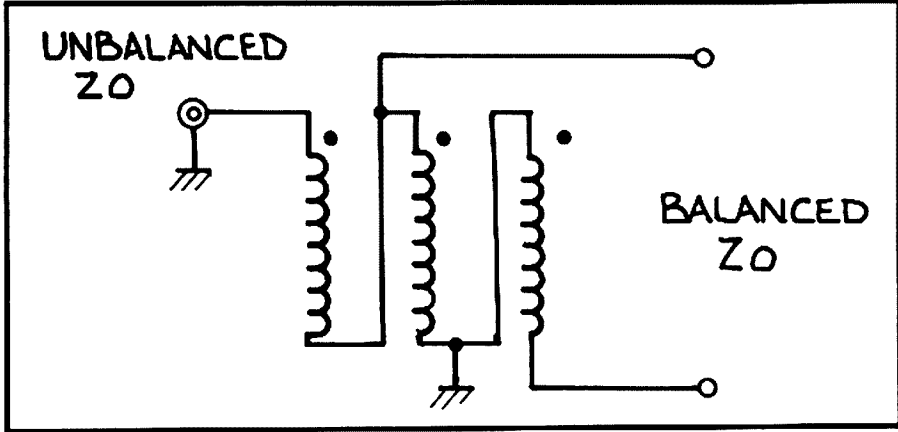

**Fig. 3 — HF BALUN TRANSFORMER**  
 Twelve turns number 12 formvar, (enamelled) wire, trifilar close wound solenoid on 25 mm OD PVC former.

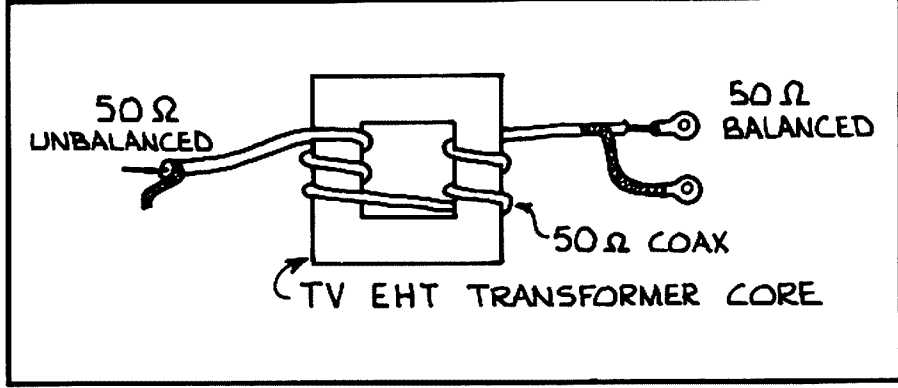

**Fig. 4 — ECONOMIC WIDE-BAND BALUN**  
 10 to 20 turns of RG 58 Cu type coax (for up to 100 watts).

# ADELAIDE'S PARTICIPATION IN THE DEPARTURE OF ANACONDA II

Ian Hunt VK5QX  
8 Dexter Drive, Salisbury East, SA 5109

*Preparation of a yacht for going to sea involves attention to a great many details, but just how much more detail is involved when that seagoing voyage is in connection with a major expedition to a small island over 4000 kilometres distant in Antarctic regions.*

In this article it is hoped to give you some idea as to the preparations made for the Adelaide departure of the Anaconda II on the first leg of it's trip from Adelaide to Perth prior to heading south west to Heard Island.



Preparing the Yacht

First there is the preparation of the yacht itself. With a myriad of ropes, tackle, winches etc , as well as such things as pumps, sails, engine, refrigerators, generating equipment and a host of other items to be taken care of. Most of this work was carried out by the yacht's 'crew' as distinct from either mountaineers or radio amateurs, however, when aboard it is certainly often a case of 'all hands on deck' and you work together even at dock-side for a common purpose.

The skipper of the Anaconda II, Josko Grubic supervised all activity in his inimitable way, answering questions from several different sources seemingly at the same time, bullying here, cajoling there to get the necessary work done in the most effective way. At the same time he was, no doubt, busy within his own mind planning for the whole of the voyage ahead and yet still so observant to detail that he picked up many little points which seemed to have been overlooked by others, even when they had been working on the very equipment referred to.

The amateurs first assignment was to check out the radio gear. This equipment comprised an Icom IC720A which fed via a Kenwood antenna coupler to an antenna which utilized a piece of solid wire running through the hull of the yacht to feed the base of a sixteen feet fibreglass whip, mounted at an angle of about 30 degrees



Josko Grubic, the Skipper

on the stern. A dummy load and power meter check soon showed that the output of the transceiver was up to par. A visual inspection of antenna connections indicated the expected type of corrosion which occurs in a salt air environment. At the same time the antenna systems for the marine radio equipment were inspected with similar problems noted. Quite some hours were spent to good effect cleaning up the offending connections and a definite improvement in operation was noted in each case. Carrying out of this work entailed some time spent down inside the hull of the yacht in a compartment in the stern where the antenna cables passed through and where remote couplers for the marine gear were located. Time was also spent making repairs to the DF equipment, fixing up and replacing various electrical leads, and assisting in the installation of a new radar and a second satellite navigation system. (It would appear that all the units have worked OK as at the time of writing this comes the news that the expedition

had landed and were operational from Heard and the radio gear for the amateur bands on the yacht had continued to keep the expedition in touch with the world on the voyage.)

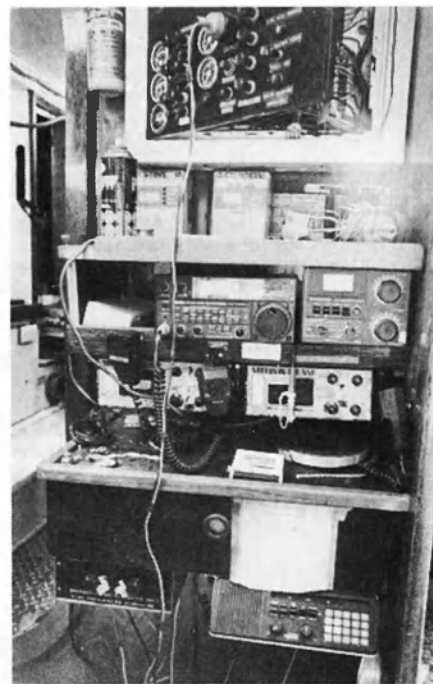

Radio Equipment on board Anaconda II

Whilst the electronic component was being taken care of much other activity was going on. Those members of the expedition who were embarking at Adelaide had arrived and were bringing aboard various items of personal gear, other equipment and large quantities of foodstuffs. One wondered where this mountain of a miscellaneous nature could possibly be put. The two 4 kVA diesel generators for powering the amateur station on the island were hoisted aboard and stowed on the floor adjacent to a set of sleeping bunks on the starboard side and lashed down. The bunks seemed to actually disappear amongst the load of equipment steadily coming aboard.

Gradually an appearance of tidiness began to take shape in the interior of the



**More Supplies arrive**

yacht and members of the expedition turned to checking their last minute personal preparedness and the purchasing of any extra items required for their first leg of the journey.



**Stowing Supplies in the Galley**

On deck Josco and his crew seemed to have the mess of ropes, tackle etc. fairly well under control, whilst all lent a hand to bring on board a massive sail to be bagged and stowed away in the sail locker. The sails are carried in huge canvas bags which are colour coded to indicate just which type of sail is contained therein. Above the entrance to the sail locker lists showing this coding are displayed. Slowly everything was falling into place!

On the night before departure a public presentation took place at a theatrette in the city. This presentation was very well



**The Sail Locker**

attended and allowed a last minute opportunity for the sale of Heard Island Expedition 1983 tee shirts and other mementoes. The presentation included an excellent static display of various items of survival gear, cold weather clothing, special tents, food packs etc., as well as a typical modern amateur radio transceiver and a collection of QSL cards. During an interval refreshments were taken and the South Australian WIA Divisional Council participated by helping with both supply and preparation of much of the supper provided.

During the course of preparations on the yacht there were visits by various representatives of the media including quite a few television cameramen. One visit of note was from the Mayor of Port Adelaide Mr Roy Martens from which port the yacht sailed. Mr Martens wished all members of the party well on their trip and presented the group with an official letter from himself, representing his council and constituents (see page 43, Feb AR). In return Mr Martens was presented with an expedition Associate Membership Certificate and some other items of interest.

Some of the last minute items to be taken care of were a quick taped interview with David VK3DHF for the VK5 Divisional broadcast and a fast run to the city to pick up the spares ordered for the Lombardini diesel engines which power the generators, and then it was time for departure.



**Navigation Room**

And so our part had been played, for now we were mere spectators, just waiting to hear word of how things were progressing. A regular radio schedule organized with Dave operating as VK3DHF Maritime Mobile was conducted and it was noted with some relief that the radio seemed to be operating as expected. And so a constant track of our adventurers was kept between Adelaide



**Bon Voyage**

and Perth. No problem was encountered with the radio schedules during this 'shake-down' part of the trip and these schedules were run completely in the clear so that others could follow the progress being made. No doubt as the story of the adventure of Heard Island Expedition 1983 unfolds, others who have been personally connected with later aspects of the expedition will put pen to paper and you may see it in the pages of Amateur Radio magazine.

Thank you to all those local people of Adelaide too numerous to mention individually for helping in so many ways with preparations prior to departure and also to local suppliers who provided donations of food and material towards the expedition. South Australia is of course proud that a South Australian yacht was chosen for this adventure, and are also happy to have been able to play at least some part in helping a well conceived plan to be brought to fruition. In the quieter moments it is often pondered just how did they manage to get all that extra gear aboard the yacht in Fremantle.

**Photos by — Warwick Kemp**

**YOU KNOW IT'S YOUR DAY FOR NET CONTROL WHEN . . .**

From Pike County ARC Capacitor

1. The weather forecast is for lightning storms all day.
2. Your wife/husband says, "Tonight, let's go out to eat."
3. You wake up and the power is off.
4. Your child has a special event that only you can help out.
5. Your auxiliary generator wasn't returned from a Field Day and the power is off.
6. You look for the rig that you took to the QSO party last night as you need it in 30 minutes.
7. The newspaper lists tonight as the last night to see the show you promised you'd take the family to see.
8. The pregnant dog starts to make a nest under the shack table.
9. The linking system to the repeaters suddenly starts malfunctioning.

Reprinted from: ARNS Bulletin — 8 '82

AR



# HOW'S DX

Ken McLachlan VK3AH  
Box 39, Mooroolbark,  
Vic. 3138

On reading the excellent column "POUNDING BRASS" in February's issue of AR, reminded me of the multiple calls made by various stations to contact a much wanted transceiver operator. Stations have been heard repetitively yodelling the DX station's call and transmitting their own call only ONCE.

A much wanted station is more than aware of his or her alphanumeric allocation and this habit causes considerable QRM, frayed tempers and places undue strain on the receiving operator. The caller suffers fatigue and also extreme frustration by adopting this practice. Short, precise, phonetically punctuated single calls enhance an operator's chances of making the log.

Short repeats of your allocated call sign with the emphasis on the VK generally brings expedient results. So in 1983 set an example and change your calling habits so that YOU may bring home that valued contact. If the DX station is handing out genuine reports of 5X9 and your reception of his signals are 3X3 signals, when his beam is in the other direction, your calls are QRMing valid contacts. ASK any station that you have a strong reception with, to make a QSP on your behalf, that a VK is hearing and is on frequency. Many stations will hear your request and most will QSP that a VK is on LINE. Please remember, the initial contact, brevity please, unless the other station is on for a chat, as many others are waiting and that amateur radio is a friendly hobby.

## YI1BGD

The complaint of extreme delays in the receipt of cards from YI1BGD as per January's column were numerous. A photostat of the notes concerning the article was forwarded to the club concerned in early December. No acknowledgement of receipt, except by coincidence, a flood of cards to VK amateurs over the last few weeks. The "too hard" basket apparently has been emptied.

## HOLIDAY DXING

A note from Bob, VK3AWN advises that he will be on holidays with his XYL, Mandy in the near future. Nothing really extraordinary about the holidays but the prefixes that Bob hopes to use will create much interest to many. Bob indicates that he will be looking for VK Novices from each QTH and hopes to check into the Carribean, ANZA and 14.322 MHz Open House Nets. The proposed itinerary is:

Call	Expected Operating Dates
3D2RR	8-17 March
T2AWN	18-26 March

T30 \* 26 March-8 April  
T32 \* 8-12 April  
5W5EB 12-18 April

This is an all band SSB and CW operation, 10 thru 80 metres and 160 metre operation from Kiribati. Six metre operations are dependant on the acquisition of suitable portable equipment and will be announced by Peter VK3AWY. Direct QSLs with return postage and envelope will be handled by Alan, VK3DAK, PO Box 6, Newport, 3015 or to Alan via the Bureau.

## NEW PREFIXES

Yet another new prefix to remember! The ITU have allocated T7 to the Republic of San Marino to replace the present 9A prefix. It is understood that the M1 will stay for the present.

The XO prefix heard around the bands last month is of VE origin and is to commemorate the "Jeu Canada Games" at Chicoutimi. QSLs to PO Box 212, Chicoutimi, Quebec, G7H 5B7, Canada.

Yet another group of changes come from Portugal. All CT operators may use optional prefix changes for the commemoration of World Communication Year and the following blocks have been allocated. January to March, CQ1 and CQ4, April to June CR1 and CR4, July to September, CS1 and CS4. October through to December will see the CU1 and CU4 prefixes being optionally used.

For prefix hunters, Alphabet Soup, as appeared in this column in December AR has had more taste added and will be very appetizing this year.

## EQUATORIAL GUINEA

That obliging and happy operator Alberto, is back on the bands again, still signing 3C1AB and using 10, 15 and 20 metres. QSLs EA1QF.

## DIRECT QSL INFORMATION

A number of requests for direct routes have been requested by VK DXers. Any information that is printed or given directly is checked from at least two different sources. All the information is given in good faith and no guarantee can be given as to its authenticity but it is worth a try to gain that valued card.

Please give QSL managers adequate time to reply, considering that they may have to wait for logs from countries that may have a very irregular mail service or in the case of the VK0HI operation the manager, VK6NE has to wait until the logs are returned at the end of the expedition. It is a help to all, if accurate UTC times and dates are used.

## ABU AIL

G5ACI/AA managed some 4000 QSOs in the forty hours of operation from Abu Ail. The operators were Iris W6QL, OM Lloyd W6KG, Christian F0ECV and Jean F6GBQ. QSLs will be 100% via YASME either direct or via the Bureau.

## ANTIGUA

Three operators from North America hope to operate in the ARRL SSB contest on the 5th and 6th March. They intend to be QRV for a few days both sides of the contest. QSLs will be to the operators KR4C, K4LTA and WA4CDH.

## NEW TEN METRE BEACON

Overseas news is that a beacon is due to be erected on Adelaide Island, using the call VP8ADE and should be commissioned in late March or early April. Frequency and technical details are unknown at present.

## WHAT PRICE DXCC

A VK5 correspondent, has kept records of all the QSLs sent with such details as the QTHs, managers (if applicable), and most importantly the cost.

Well, achieving DXCC in the CW mode turned out to quite expensive for this amateur. For the 40 cards received from 63 sent in 1982 directly to the stations or their managers, the IRC bill was not cheap. Forty x 3 IRCs at 65 cents each equals \$78.00, add to this the postage, card cost, envelopes etc. That is only for the cards received directly.

Now add the 23 cards that were sent, for the same period and no returns were forthcoming, the IRC cost was \$44.85. Some simple arithmetic gives the figure of \$122.85 without the extras. If you have kept accurate figures and they are similar, I am sure other readers would like to hear of your experiences or rather your costs.

To the newcomers of the "paperchase", take heart. If you are very patient, the WIA QSL Bureaux are very economical and it is one of the many benefits offered to members of the Institute.

## KERGUELEN ISLAND

Mike, FB8XAB, doing a stint at the weather station, offered his hospitality to the VK0HI expedition on the maxi yacht Anaconda II whilst enroute to Heard Island. This gesture allowed the party of eighteen to gain their "land legs" prior to the last leg of the voyage and the rigorous landing ahead. Mike's station should be active on ten metres in the near future.

## DX JAUNTS

Dieter, DK9KD, renowned for getting DXpeditions on the road has written to

advise of two expeditions scheduled for this month.

### ST PETER and ST PAUL ROCKS

In an effort to assist those that did not get in the log last time the Cologne DX-group will be activating this country from approximately the 4th to the 8th of March. Call signs on the trip include DK9KX, DJ9ON, DF9KH, DL8CM and one PY amateur. Watch for PY0S on the usual frequencies.

### SPRATLY ISLAND

DJ6SI and DJ3NG will try to activate this lonely area commencing around the 22nd or 23rd of March with activity for approximately five days.

### HONOURS

Tom, VR6TC, was awarded an MBE in the Queen's New Year Honours List. The citation was for his untiring efforts as the island's radio operator. Congratulations Tom.

### HEARD ISLAND

The Anaconda II successfully landed the VK0HI expedition at Atlas Cove on the island. All equipment was ashore on the 22nd of January and the first contact was made by Hugh VK6FS with AI VK6CW at 12:52 UTC, on twenty metres. I was lucky to follow with a QSO to Dave VK0HI, the leader of the radio component of the expedition, and be the first in his log at 12:58 UTC. They were, at this stage, running "barefoot" and using the vertical antenna. This did not preclude JY3ZH being next in line and the multitude following. This expedition's success so far, is a magnificent start to WCY 1983, and a tribute to the dedication shown by the organizers that burnt the "midnight oil" for most days of last year.

### UPDATING

Congratulations to David, VK3PBA who has contributed to these notes for a considerable period. David has upgraded and is now sporting the call VK3BY but is still contributing his novice news. Would any Novice operator like to contribute to the much read Worked on the Novice Bands segment of these notes to allow David more time to use his full call. Will someone please volunteer, so that other novice operators may benefit from your log?

### CORRECTION

An important correction is that on Page 42, of February's AR where Chuck Brady's call sign VK0MD magically got exchanged for AI Fischer's very active call VK0CW. Unfortunately Chuck never used his VK0 call sign, having to return to the United States. AI has used his VK0CW call sign notching up many thousands of contacts at the time of going to press. Both the VK0HI and VK0CW stations QSL arrangements are in the capable hands of Neil, VK6NE for all places except North America and Japan. A must for a prompt reply is a self addressed envelope with appropriate covering postage. Cards received without

return envelopes will be processed last due to the extra work involved.

Apologies to anyone who has been inconvenienced by the typographical error regarding AI's VK0CW call sign.

### ST. PETER & ST. PAUL ROCKS

This DX Country has eluded many VK's over the years and the last attempt in October was no exception. With hindsight it is probably easy to sit back in the comfort of the "shack" and expound as to how it should have been done and to criticise that such an operation should not be attempted without adequate research.

For an adventurous group to succeed with any expedition, they have before them a considerable amount of research to undertake including the absorbing and solving of problems that previous expeditions have faced and not to be overlooked are all allowances for the unpredictable "MURPHY'S" law that must be taken into account.

One such operation that took place in 1978 has been written up by Rolf Rasp, PY1RO. Actual excerpts from his lengthy and factual summary of the happenings of this trip are printed in the following paragraphs to give all VK DXer's an idea of some of the difficulties that can be encountered on such an expedition.

Rolf writes "I never really held much hope to ever go to this off the beaten track area of St Peter and St Paul Rocks until I ran across a marvellous group of French 'hippies' and their boat at Fernando de Noronha. During a chat with them and the usual questions regarding amateur radio such as 'Why do you come to this island to transmit?' — 'Because it is a separate country' — 'Are there any other such countries for amateurs around here?' — 'Yes St Peter and St Paul Rocks, but it is too difficult to get there.' — 'Why?' — 'Because there are no boats or aeroplanes going there regularly.' — 'Oh, in that case we can provide you with transport if you want.' It was that easy."

Rolf's experience, with these people who roam the worlds oceans, mainly existing by the collecting and selling of sea shells, is one of many that have been shared by amateurs world wide, as the simple honest answers to inquiring minds from all walks of life have brought the utmost and generally unsolicited assistance to help an adventurous hobbyist attain his ideals.

Rolf lost no time in getting together a group of participants who could assist with equipment and another operator. The size of the vessel limited the number of operators to two, Jim, PY7BXC and Rolf himself plus the minimum crew of three, Vincent, the captain, his girlfriend Nadine and the navigator, Max.

No time was lost in establishing the charter and making firm plans to take advantage of the offer to use the seventy year old French sailboat "Doudo Diop" by her generous owner. Firm dates were made to join the vessel at Recife (on the east coast of Brazil). This would allow heavy equipment to be loaded on board and save costly air charges in freighting to Noronha.

Rolf remarks that "this was our first trip in



L to R Rolf, PY1RO, Jim, PY7BXC, Vincent, the skipper, Nadine, Vincent's girl-friend, Max, the navigator, seated at the operating position.

a sailboat and our fears of seasickness and being exhausted by the trip were luckily unfounded even though we took two hourly turns at the rudder and were in excellent spirits throughout the voyage. The trip was relatively uneventful, even though it was soon realised, that the schedule was not going to be kept due to unfavourable winds. The amateur fraternity were given constant updates by the use of the FT101E which was set up under the deck and the makeshift antenna of an eight metre wire attached to the mast.

"Our navigator, Max, because of the expertise in his field and constant observations regularly corrected course each day by energising the diesel motor for a couple of hours and sailing into the wind. On the fifth day he announced that we were twelve miles from our goal. We were unable to see them from deck level at this distance due to their height of twenty metres above sea level but if we climbed to the top of the mast we could view our destination. Max, was correct and we were in the right direction.



St Peter and St Paul Rocks as viewed from the approach of the "DOUDO DIOP".

"As soon as we had a clear view of the rocky outcrop, we knew we were in trouble, because the lighthouse, in which we hoped to set up our station, as it has been done ten years previously, had completely collapsed and was definitely unusable for our purpose. We were worried, as we had not thought to bring a tent for an alternative operating location. Anyhow, we would think about this after landing.

"The final approach was made on diesel power into the wind. On arrival we found that about half of the fuel that was purchased on Noronha proved too dirty

and would have clogged the engine and thus had to be discarded. I'd hate to think what would have happened had we run out of fuel before our arrival.

"The first view of the rocks is true to their name, nothing but rocks. A few high spots, where water never reaches, are covered with white guano, looking almost like snow caps. There are four major rocks which, in a horseshoe fashion, form a crater, which is somewhat protected from the breakers rolling in with the wind from the east. This 'crater', about 50 metres wide, 90 metres long and 10 metres deep is a beautiful natural aquarium full of colourful fish, lobster and seaweed."

It was decided the safest anchorage would be at the entrance to the horseshoe and the vessel was tied equidistant to the rocks on either side with four ropes and the anchor thrown in for additional stability. The tying up and landing procedures were carried out with the aid of an inflatable rubber boat.

Unloading was completed before darkness, except for the second generator due to its weight of 60 kilograms. Rolf remarks that this operation went smoothly, considering the terrain and particularly the jagged rocks and was due to the French crews expertise.

The first "chore" for Jim and Rolf was to set up the vertical antennae and unpack the gear. In finding a place which was relatively flat for the operating table, that was thought to be above high tide, the boxes were moved to the vicinity. According to Rolfe's notes, "Murphy's" law struck and it was impossible to start the generator, the tide was rising fast and the gas lantern was found but no matches were brought ashore so with much difficulty some were secured from the vessel, not before a hurried transport of the equipment was made to higher "rock", just in case. A full moon assisted greatly.



Antenna Array

With the gas lamp now operational, Rolf attacked the 1.5 kW generator again, to no avail. Everyone very tired, partook of a seafood supper, caught by the crew and celebrated the landing by opening a bottle of 12 years old Chivas Regal.

Morning light saw the two amateurs assembling the station and being bothered by a small kind of seagull which didn't approve of the disturbance to their habitat. These birds would dive on the unwary visitors and on occasions drew "blood" from both the skipper and navigator. This was going to be another operating hazard but ingenuity, some scrap canvas from the



The remains of the Lighthouse at left, the operating position (lower centre) and the "DUODO DIOP" tied and anchored.

boat, and rope made a cover for the operating position.

The first QSO was made and the rigs as Rolf describes "Were my old DRAKE line and the KENWOOD 820 with remote VFO. Since there was no protection against the wind from the sides, it did not take long before the equipment was covered with saltspray which was being constantly blown into the rigs. The buttons were actually dripping with saltwater and we had to run our fingers across the dials at intervals to be able to read the frequency! By the evening the DRAKE started behaving erratically and by morning it was "dead" and we had to bring the FT101E from the boat. An SB200 linear drew too much current from the generator so that the Accu-keyer would reduce speed to half whenever the linear was transmitting, so we gave up that idea pretty soon."

Further troubles developed. The second keyer also stopped functioning and the two lone amateurs were soon reduced to minimum equipment to keep the two stations on the air at the one time. The large 1.5 kW generator had been unloaded and was pressed into service without any problems. After some use of alternating the two generators, the older one broke down for good. The group were left with one generator for at least another scheduled 48 hours of operating.

Propagation conditions were not the best and both operators had time to partake of the excellent cuisine offered by the French crew. The daily menu consisted mainly of lobster and occasionally fish. They consumed some 41 lobsters during their stay and the trip back and Rolf recalls that he was not aware how delicious bar-b-cue'd lobster was.

As previously mentioned, conditions were poor. At times virtually only one band was open at a time and it was futile trying to run two transmitters. Rolf recalls that openings to JA were by far the best in the early morning, from about 08:00 to 10:00 UTC on twenty metres and since signals were never really that strong they decided to restrict their operating to CW. This, Rolf says, caused "Some people to be probably mad at us because we did not work anything except JA and that general area as long as conditions lasted. Europe and North America could be worked around the clock."

"Most of the work was done split frequency and we had our share of those

who insisted on calling on our frequency. We tried our best to keep at least one station on the air at all times but as long as conditions were there this meant very little sleep. We had an average of three hours sleep per 24 hour period, since it was impossible to catch up on sleep during the day due to the lack of a place to lie down in the shade when the sun was out.

"In general it seems that everyone had a fair chance to work us and it looks like those that tried hard enough, really did. VK and ZL stations had a very hard time, since the band would not just open up to those areas with very few exceptions. Also, we worked a surprisingly small number of USSR stations. Our handicaps were the fact that we did not run any power and used "no gain" antennas, verticals, two of them, a 10-40 metre version, placed some thirty metres from the first one."

The whole trip took about two weeks, with three days of operating. The log had 5600 QSO's entered, not the number that was originally their goal, but quite a good effort considering the difficulties that were encountered.

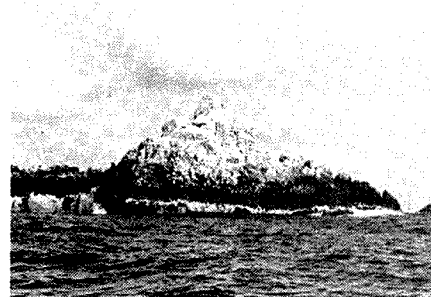

The largest rock with the derelict Lighthouse.

One has not got to use the imagination to consider the difficulties that lie ahead for future expeditions. The expedition late last year encountered severe difficulties and with the world wide escalation of fuel prices and the difficulties associated with chartering reliable seaworthy vessels that will get one to their destination and a reliable crew to man the vessel, any DXpedition, would have considerable research and planning ahead of them. This is without the problems of the workable area on the Rocks themselves, let alone the efforts of getting equipment ashore.

All amateurs, who need this rare country for a new one, when and if it does come up again, please think of the operators and the conditions that they are enduring to give you that contact. Then of course, there is the amateur who has it already confirmed, and just notches it up to "brag" about how good an operator he is. Fortunately, this type of operator is in the minority, as the majority of DXers are not selfish and do not indulge in the practice of depriving others from getting a new country to their score, in fact it is generally the opposite where they encourage and assist another operator, even if he is ahead of them on the DXCC ladder.

**QSLs RECEIVED (January)**

BY8AA, DU1REX, KH6OZ, KX6OB, VK9ZR (Willis Is.), VK9ZR (Mellish Reef), 5H3BH also for 10 MHz FK8EB, G2HW, KP4CKY, OZ7KV, 3X5DX.

**CW SWL-ING WITH ERIC L30042**

**28 MHz**  
DJ3XD (1000 UTC), HL2DAK, JH1KPL, VE7DRI.  
**21 MHz**  
CT2CB, DL6HAL, FK8KAA/P, KH6CP, LA3UL, LU4AC, PY3YUW, SM3BDP, UK0UAB, VK4VMB (XYL).  
**14 MHz**  
A35MJ, W6KG/A7 (XYL), NO20/DU2, EA9MG, F08FW, JX6RE, KV4CI, NP4BN, P29BR, UA0UAN, TL8ER, VE3DTL, VP9LB, XE1X, ZS6BUX, 457WP, 9V1TL.  
**10 MHz**  
DL8ZAJ, N7ET/DU6, DL7AD/EA8, F8VJ, FC9VN, HB9BXX, H18RPD (XYL), JA3SVG/MM, KP4CKY, XE2XW/1, YV5ANE (2030 UTC), 4Z4MK, 5Z4CS, 9J2B0.  
**7 MHz**  
DL6YU, F8VJ, G130QR, HB9CKF, LZ1BC, UA4FCM, EZ5IAN, UB5UKO, YU7NZR, 5Z4CV.  
**3.5 MHz**  
F6FAI, HA5KDO, OZ7YY, UK2GKW, UK2PCR, UK3AAO, YU3DBC

**CW WORKED ON THE WEST COAST**

**1.8 MHz**  
5N8RY, EA2OP, OH0W, T32AF, UA2GCN, UA9SAX, UA9ULC, UK2BAS/U6G.  
**3.5 MHz**  
5T5CJ, 5W1EH, H21AB, OH0W, RG6G, T32AF, UA0YAE, UK2BAS/U6G, UK2PCR/U6V, ZK2RU.  
**7 MHz**  
A4XJO, A71AE, AH0C, FROGGL, KV4SZ, UK2FAA.

**WORKED ON THE NOVICE BANDS**

**28 MHz**  
3D2DN, 5W1DW, A35TN, DU1EMC, T32AJ, T32AL, TG9HH, YV2BYT.

**21 MHz**  
3D2TN, 3D2WR, 6D5XMT, 9V1TL, A35TN, AP2AP, DU1CK, DF3SJ, F6BFC/FC, FG7XL, F08GT, GM4FNE, HB0BHA, HC2IX, HC8RS, HL1AID, KL7LF, OA4BUU, OK1AVD, P29JW, SM6GR, T30BY, TG4HH, TG9VT, T15KV, UK4NBM, YS1IX, ZC4NB, ZS5TE  
**3.5 MHz**  
3D2TN, A35TN.

**WORKED ON THE EAST COAST**

**28 MHz**  
HA7LM, LZ2VE\*, PA0DS\*, WH2ADE.  
**21 MHz**  
3B8FK\*, 3V8AA, 4U1VIC\*, A71AD, CE0AE, CR9CT, CT2QN\*, EI0CL, G13ZAD\*, HL5XF, K0CS/KH8, UA6HYL\*, VK0HI, VK0CW, VU2RAH\*, Y26SO\*.  
**14 MHz**  
\*EA3AKN, 9N1MM, A35MJ, A35PG, A4XJV, A71AD, AP2SO, BV2B, CE0AE, CE5SG, F88XAB, FC9UC, G4NMG, Beryl, GW2SB, H13ADI, HT1AGI, IK2ARP, JY4CB, KA6KL, KH7AA, M1V, OE3FS\*, OK3YX\*, OZ7YY, T30BY, T30CH, Vicki, T30DB, UK7PAL, UL7TBM\*, VK0HI, VK0CW, VU2KMK\*, VU2TLB, W6KG/A7, XE2BBD, Y11BGD, Y08CF\*, ZL3PA/C.  
\* Denotes CW operation.

**QSL ROUTES OF INTEREST**

A22CT, via G3HCT, J. Bazley, Ullenhall, Henle in Arden, Warwicks.  
5H3AA, to LA7FAA, PO Box 79, N9372, Gibostad, Norway.  
5Y4DA, PO Box 30137, Nairobi, Kenya.  
BV2A & BV2B, Tim Chen, PO Box 30457, Taipei, Taiwan 107.  
CQ60F, CT10F, R do Parque 46, 1500 Lisboa, Portugal.

FB8ZQ, via F6AJN, PO Box 88, Nancy, SV5OX, PO Box 157, Rhodes.  
TA1A0 to Box 167, Bakirkoy, Istanbul, Turkey.  
NO CALL SIGN ON ENVELOPE.  
T15BGA, PO Box 165, Grecia, Costa Rica.  
TL8ER, Chris, PO Box 1503, Banqui.

\* It is advisable in all cases with overseas QSLs to omit any mention of amateur radio from the envelopes.

**QSL MANAGERS OF INTEREST**

4N0SM (YU7JDE), 8U5JM (WA4VDE), 8Q7DL (DL9BAF), 9K2EK (JA2LZB), 9K2HE (DJ9ZB), 9N1WW (JA8BMK), 9Y0NP (W3Hnk), C30LM (EA3BKZ), C30MS (EA3MS), C30MK (EA3WZ), C30LG (EA3BOW), CE0ZAD (WB6WOD), C53DZ (DJ6SI), DA1WF/OHD (KN6G), FB8WG (F2CL), F00JO (K6HHd), F000J (W6GO), HH5CB (K9WUJ), HV2VO (I0GPY), KH6AC (WP2ACL), KK7K/17 (KJ7N), OX5RD (N9BEM), PY0RA (PY7YS), PY2ZFO (W7AMM), W4MNG (W4VOE).

**THANKS**

These notes wouldn't have been possible without the information gained from magazines such as BREAK IN, CQ, cqDX, DX NEWS SHEET, RADCOM, OST, WORLD RADIO, Overseas amateurs including EA1VG, G3NBC, I8SAT and ZL1AMM. VK amateurs VKs 1MM, 3FR, 3YJ (formerly VK3DFD), 5QX, 5AKH, 6IT, 6NE and Eric L30042. Thanks to one and all for your support.

**GEORGE HAM, 4GW 1929**

A well known and popular amateur of the 1920-30s, George was the country representative of Chandlers and travelled as far north as Mackay, and west on a Douglas motor cycle being away for weeks at a time.

George Ham's radio career started with self excited transmitters and direct coupled amplifiers using home made Reiss microphones. He experimented with scanning discs and neon tubes in Tom Elliot's TV days and with Arthur, 4AW, tuned the weird patterns from radio 4QG.

George was secretary of the Toombul Radio Club in 1930. May 24th 1931 saw the first recorded VK4 56 MHz (CW) contact, between George and Arthur, 4AW, prior to the introduction of super regenerative receivers and subsequently radio telephony on 56 MHz.

George retired from amateur radio in the mid 1930s and remained with Chandlers until his retirement from the wholesale division a few years ago.

George enjoys reasonably good health.

**THUMBNAIL SKETCHES**



**MAURIE BATT VK3XEX**

Maurie is a relative newcomer to the amateur radio transmitting fraternity, having gained his licence in 1982, however his interest in radio begins before WW2. As a boy he was interested in building model steam engines, photography and short wave listening.

He enlisted in the RAF at the outbreak of World War Two and served with Coastal Command in Beaufighters and later in Sunderland Flying Boats. He was later posted to Africa to serve as Flight Engineer on Sunderlands, Liberators and Douglas DC3's. His operational tour with the Emergency Operational Unit in Africa took him to just about every country on the west coast of the Dark Continent.

Maurie was demobilised in 1946 and went to work for the Lancashire Aircraft Corporation but the peacetime activities were not to last long. While with the LAC he flew on the Berlin air-lift for 22 months after which he joined British Airways European Branch.

Maurie and his wife Marge, along with their two daughters Sue and Hilary came to Australia in 1950 and first went to Bathurst NSW for 3 weeks. From there they came to

Ballarat for 7 weeks and then on to Rokewood Junction where they still live.

He joined the WIA soon after as an SWL and has been a member of the local radio club ever since, serving as QSL manager for all the local amateurs for most of that time. He has also found time in the past to bulk sort QSL cards for the VK3 bureau.

At the 1982 Annual General Meeting of the Ballarat Amateur Radio Group he was awarded Life Membership in recognition of his outstanding contribution to amateur radio.

He is shown in the photograph receiving his award from the outgoing President, Dick VK3AEX.

AR



AR

ANNEE MONDIALE DES  
COMMUNICATIONS  
WORLD COMMUNICATIONS  
YEAR  
AÑO MUNDIAL DE LAS  
COMUNICACIONES

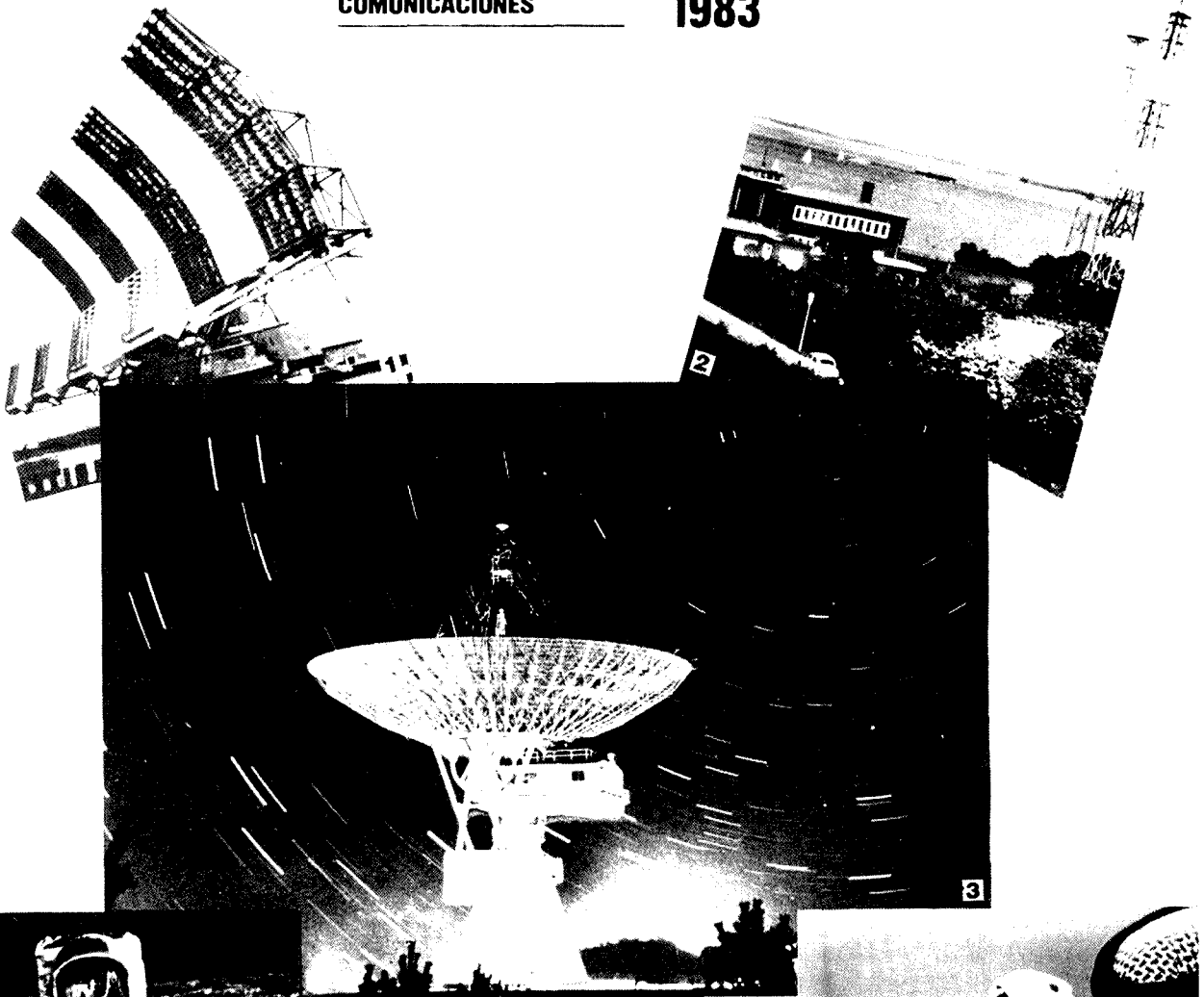

PHOTOGRAPHS  
FOR  
WORLD  
COMMUNICATIONS  
YEAR  
1983





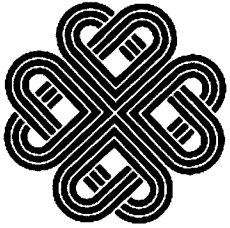

# WORLD COMMUNICATIONS YEAR: 1983



Roy Hartkopf VK3AOH  
34 Toolangi Road, Alphington, Vic. 3078.

## PUBLIC RELATIONS

John Hill VK3DKK  
Public Relations Co-ordinator

Although many of you may not have received the February issue of *AR*, at the time I am typing this column for the March issue, some interesting reactions have been received on my suggestions in February *AR* on the subject of WCY '83, public relations.

Firstly I would like to thank the VK5-Division for forwarding to me a promotion proposal, which is so professionally put together, that, apart from sending a full copy of this proposal to all divisional offices, it will also be used in this column for the use by clubs and individual members.

Our main target must be to improve the image of our amateur fraternity, on air as well as in our daily environment.

On air: by giving a good example to non-members and listeners (and you never know how many there are) by being polite and showing patience during a QSO.

By leaving openings during the overs for others to join in.

By welcoming and assisting "new calls" on the frequencies and introducing them to other amateurs in our QSOs.

Off air: by showing people all about your hobby, invite them to your shack and club meetings.

By explaining to your friends (and

neighbours) that we are not unqualified CBERs (with due regard to CBERs) but that we had to pass an exam (don't tell them how many times we sat) to become a licenced operator, be it novice, limited or full amateur.

By offering your services to your division and local clubs in any public activities (WICEN etc). If you feel good about your hobby, show it to others. Many of you have children at school and perhaps their teacher could be approached for a demonstration of amateur radio. Your division or club would only be too willing to assist you in such a promotion. Don't forget the children are the members of the future!

In fact, in any case contact your division and let them know what your plans and suggestions are.

Another point I would like to raise is QSL cards. How about having the WIA "diamond" logo printed on your QSL-cards and let the amateurs know that you are proud of your organization.

And ... talking about QSL-cards, if you promised to send one, please do so, and don't wait too long ...

That's all for now and don't forget ... try to enroll a new member ... after having paid your own subs for 1983.

AR

(G) General. (C) Constructional. (P) Practical without detailed constructional information. (T) Theoretical. (N) Of particular interest to the Novice.

This happens to be the twenty-fifth magazine review I have done since taking over the work. Apart from a couple of generally favourable comments there has been no feedback. I have tried to select material on the basis of usefulness to Australian amateurs, general interest, originality and information on the 'state of the art'. I have tried to avoid reprints and articles with attractive titles which do not come up to expectations. Any comments or suggestions would be very welcome. The apparently haphazard appearance of various issues of magazines is due to their spasmodic arrival from overseas.

**RADIO COMMUNICATION. Jan 1983.**  
1200 Baud Decoder for UOSAT Oscar 9. (P) Index to Vol 28. (G)

**QST. Nov 1982.** Field Day Results. (G) UOSAT Oscar 9 story. (G) Antennal Gain Measurements. (G)

**WORLD RADIO. Dec 1982. Year 12 Issue 6.** World Amateur news but mainly USA contests, conventions, DX. Profile of Percy Anderson. VK3PA. Heard Island Expedition. (G)

**SHORT WAVE MAGAZINE. Nov 1982.** Improved accuracy for SWR meters. (P)

**CQ-TV No 120 Nov 1982.** Filters etc. (P)

AR

Photo 1 — Radar Antenna at London Airport. (Photo: *Marconi, United Kingdom*)

Photo 2 — Coastal station Kiel-Radio: coastal stations keep ships all over the world in contact with land, and provide them with meteorological information necessary for the safety of life at sea, and aid maritime navigation. (Photo: *Deutsche Bundespost*)

Photo 3 — Parabolic antenna at the Kashima branch of Radio Research Laboratories: (Photo: *Ministry of Posts and Telecommunications, Japan*)

Photo 4 — Radio is the only moon to earth communication link for astronaut Edwin E. Aldrin Jnr walking near module during Apollo II extra vehicular activity. (Photo: *NASA*)

Photo 5 — Telecommunication testing laboratory in Saudi Arabia. (Photo: *Administration of Saudi Arabia*)

## SPECIAL EDUCATION QSP

Brenda VK3KT has available:

*Trial Exam Papers —  
Theory, Novice, AOC, Regulations.*

*Past CW Exams from DOC.*

*10 Exams at 5 w.p.m.*

*10 Exams at 10 w.p.m.*

*10 Exams fill a C60 tape. Send a tape and I will copy what you want onto it.*

*Complaints — or other comments —  
about Exam papers?*

*Make them known to your Federal  
Education Officer, VK3KT, QTHR, or  
on the Education Net, Wednesday  
evenings 12.00 UTC. 3.685 MHz±*

# AWARDS

Mike Bazley VK6HD  
Federal Awards Manager  
8 James Road, Kalamunda, WA 6076

Awards issued to the 5th January 1983 and amendments made up to 31st December 1982 are listed below. Because of the amount of paper work, I have decided that I will adjust totals, for

deletions, once a year. January the first seems to be a good time, at least for me, so the HKO, KS4 and 8Z4 deletions will be picked up in the next DXCC listings.

The number of stations in the DXCC top listings is growing and I notice that there are a number of stations that have not changed their score during the past two years. If you are interested in keeping your call in the lists, and you have not amended your totals during the past two years, could you please drop me a line.

## WAVKCA AWARD

CALL SIGN	CERT NO	CALL SIGN	CERT NO
JF2GIZ	1092	VK2AKP	1101
JA3BWK	1093	JA0SOD	1102
VK9ZA	1094	JH7XRG	1103
ZS2DK	1095	PZ9NCM	1104
DU1EH	1096	GW4KGR	1105
JA2FDC	1097	JH8MFS	1106
JA2MTM	1098	VE2IJ	1107
JH8CZB	1099	ZL4PX	1108
OK3TMF	1100		

## DXCC NEW MEMBERS

PHONE	CALL SIGN	CERT NO	TALLY
VK4NWH		303	100
VK6BA		304	103
VK2NYL		305	104/105
VK2VMX		306	105/106
VK2KCN		301	102/104
VK4AH		308	151
VK3CEW		309	105

CW	CALL SIGN	CERT NO	TALLY
VK5WO		119	135/140
VK5AKH		120	101

OPEN	CALL SIGN	CERT NO	TALLY
VK5GZ		212	112
VK1BB		213	112
VK5VV		214	304/316

## VHFCC AWARD

CERT NO	CALL SIGN
114	VK3XJA

## WAVKCA (VHF) AWARD

CERT NO	CALL SIGN
16	VK3AWY

## WAS (VHF) AWARD

CERT NO	CALL SIGN
128	VK3AWY (Amendment)
152	JA6RJK

## DXCC TOP LISTINGS

PHONE	CALL SIGN	TALLY	CALL SIGN	TALLY
VK6RU	317/362	VK4PX	297/312	
VK5MS	317/360	VK30T	295/296	
VK4KS	317/349	VK3AHO	293/326	
VK6MK	314/352	VK2APK	293/313	
VK5AB	314/345	VK4UC	293/306	
VK6LK	311/325	VK6FS	292/294	
VK7DK	308/323	VK5XN	289/302	
VK3JF	308/320	VK7AE	289/291	
VK4VC	308/319	VK3AWY	289/290	
VK6HD	307/314	VK5WO	286/308	
VK4FJ	306/343	VK3RF	286/288	
VK7LZ	306/323	VK3DV	284/284	
VK4RF	304/314	VK6YL	283/284	
VK4AK	304/313	VK2AHH	280/303	
VK5VV	303/315	VK7BC	280/283	
VK3AMX	302/312	VK3DU	273/275	
VK3AKK	300/302	VK4BG	272/282	
VK6NE	299/306	VK4DD	261/281	

## CW

VK2QL	310/350	VK3YD	281/313
VK2EO	308/346	VK4RF	277/298
VK3YL	308/336	VK6HD	270/281
VK4FJ	302/345	VK6RU	262/302
VK3AHO	298/331	VK3RJ	261/288
VK3XB	286/314	VK3NC	260/297
VK2APK	282/304	VK7LZ	253/283

## OPEN

VK6RU	317/363	VK30T	298/299
VK4KS	317/353	VK7BC	297/301
VK3YL	316/348	VK4UC	296/310
VK4SD	316/348	VK2SG	295/314
VK6MK	314/352	VK5WO	294/317
VK6HO	313/328	VK3AHO	293/326
VK4FJ	312/356	VK3XB	291/320
VK4RF	312/336	VK2AHH	287/313
VK3JF	311/332	VK5RX	281/313
VK3DU	309/324	VK4BG	279/292
VK7LZ	307/339	VK4OP	278/287
VK4PX	304/323	VK4DD	268/296



VK5WV	304/316	VK3JI	268/293
VK4AK	304/314	VK3NC	261/298
VK3AMK	302/312	VK5BO	254/286
VK2APK	300/329		
VK3AKK	300/302		



## INTRUDER WATCH

### DXCC AMENDMENTS

<b>PHONE</b>			
VK2AHH	280/303	VK4AK	304/312
VK3ABH	258/259	VK5BO	195
VK3AWY	289/290	VK5W0	286/308
VK3DFD	270/271	VK6HD	307/314
VK3RF	286/288	VK6LK	311/325
VK30T	295/296	VK6MK	314/352
VK3VU	260	VK6RU	317/362

<b>CW</b>			
VK2AHH	137/151	VK6HD	270/281
VK3ABH	138/144	VK6RU	262/302

<b>OPEN</b>			
VK2AHH	287/313	VK5W0	300/327
VK3ABH	266/272	VK6HD	313/328
VK30T	298/299	VK6MK	314/352
VK4AK	304/314	VK6RU	317/363
VK5BO	313/328		

### HAINAULT'S REWARD

The Goldfields Amateur Radio Group offer a very attractive award. The award shows the Hainault gold mine site against a setting sun and the main printing of the award is done, naturally enough, in gold. The award is available to all licenced amateurs and SWLs. All contacts made after January 1st 1982 count towards the award.

#### REQUIREMENTS

**VK/ZL** Work five resident goldfields amateurs, including two GARG members, within the 250 km radius of Kalgoorlie, including the town of Windarra.

**OVERSEAS** Work three resident goldfields amateurs, including one GARG member, within the 250 km radius of Kalgoorlie, including the town of Windarra.

**COST** \$3 Aust., or equivalent, or 8 IRCs.

**OVERSEAS** \$4 Aust., or equivalent, or 10 IRCs.

#### APPLICATION

QSLs not needed, send certified extract of log, signed by two other amateurs to: The Awards Manager, PO Box 463, Kalgoorlie, Western Australia 6430.

All contacts to be made in accordance with applicant's licence requirements.

No official GARG net contacts allowable. Contacts to be 2-way SSB, CW, FM or other recognised mode of transmission; no crossmode or crossband contacts except via satellite.

All contacts endorsed "mobile" or "portable" to be made from the same call area.

### HELVETIA AWARD

For this attractive award only contacts made after 1 January 1979 have validity.

Mail your list and the confirmations for each of the 26 cantons worked on CW and or phone, RTTY or SSTV to awards manager; Walter Blattner, HB9ALF, PO Box 450, Locarno 6601, Switzerland.

Bill Martin VK2EBM

FEDERAL INTRUDER WATCH CO-ORDINATOR

33 Somerville Rd, Hornsby Heights, NSW 2077

The listing of known intruders, from time to time, in this column should, I hope, be a help to those of us who wish to register their complaints of intrusions into the amateur bands by stations operated by Governmental, Military, and Commercial installations. This month we will deal with intruders employing the A3E mode, which is AM broadcasting. Look to future columns for details of known intruders using other modes of transmission.

### LIST OF KNOWN INTRUDERS USING A3E (AM) MODE

#### 80 METRE BAND. 3.500 MHz-3.700 MHz

This band in International Amateur Radio Union, Region 3 is NOT exclusive to amateur operators. Fixed and mobile services also are legal, and often appear using RTTY (F1B mode). HOWEVER, broadcasting stations heard between 3.5 and 3.7 MHz are intruders, and should be reported as such. Examples:

- 3.535 MHz Radio Peking China
- 3.560 MHz Pyongyang, North Korea
- 3.640 MHz Radio Peking China

#### 40 METRE BAND. 7.000 MHz-7.300 MHz

This band in IARU Region 3 is exclusive for amateur use only between 7.0 and 7.1 MHz. All intruders heard in this exclusive segment should be reported.

- 7.010 MHz Radio Peking China
- 7.025 MHz Peoples' Liberation Army Radio China
- 7.035 MHz Radio Peking China
- 7.055 MHz Radio Peking China
- 7.065 MHz Radio Tirana Albania
- 7.075 MHz Radio Tirana Albania
- 7.080 MHz Radio Tirana Albania
- 7.095 MHz Radio Peking China
- 7.099 MHz Radio Moscow Russia

#### 20 METRE BAND. 14.000 MHz-14.350 MHz

This band is exclusive to amateur operators from 14.0 MHz to 14.25 MHz. The segment 14.25 to 14.35 MHz has USSR

fixed stations operating. HOWEVER — AM broadcast stations heard in the exclusive amateur segment should be reported as intruders.

- 14.050 MHz PLA Radio Foochow, China (Harmonic of 7.025 MHz)
- 14.070 MHz Radio Peking China (Harmonic of 7.035 MHz)
- 14.320 MHz Radio Tirana Albania (In Mandarin Chinese)

#### 15 METRE BAND. 21.000 MHz-21.000 MHz

This band is for EXCLUSIVE amateur use.

- 21.121 MHz Radio Moscow Russia (Spurious of 21.529 MHz)
- 21.238 MHz Radio Moscow Russia (Spurious of 21.529 MHz)
- 21.356 MHz Radio Moscow Russia (Spurious of 21.529 MHz)

All amateur radio operators and short wave listeners are urged to send in reports of these intrusions to their Divisional Intruder Watch Co-ordinator, whose details appear in the call-book, or send reports care of your WIA division.

Next month we will deal with intruders using the A1A (CW) mode.

### PLEASE HELP THE INTRUDER WATCH.

#### COLLECTORS VINTAGE RADIO

Hugh Muggerridge of Little Oeo Rd, MANAIA, RD 28, TARANAKI, NZ, wants to contact collectors of Vintage Radios, so how about letting him know . . .

#### REMINDER

RAOTC QSO Party, 14 March. See February AR for details.

VK3ZC



# CONTESTS



## MARCH 1983 CONTEST CALENDAR

- 5-6 ARRL DX Phone Test
- 12-13 QCWA Phone QSO Party
- 12-13 YL/ISSB CW QSO Party
- 12-13 RSGB Commonwealth CW (See Feb AR for details)
- 19-20 BARTG Spring RTTY Test
- 19-20 Bermuda Test
- 19-20 G QRP Day
- 26-27 CQ WW WPX SSB Test

## APRIL

- 6-7 DX-YL to NA-YL CW Party
- 9-10 CARF Commonwealth SSB Test
- 13-14 DX-YL to NA-YL Phone Party
- 16-17 Polish Phone Test (Tentative Date)

## MAY

- 26-27 CO WW WPX CW Test

## CONTEST CHAMPION FOR 1982/83 CONTEST

The contests chosen for the VK Contest Champion were: John Moyle, VK/ZL, RD, and VK Novice.

The points awarded are as follows: first place equals 10 points, second 9 points, third 8 points and so on through to tenth position which equals 1 point.

An entrant must be included in three of the four contests. He/she may not score but must have entered.

To win the entrant must be a member of the WIA.

On the completion of all contests the highest points scorer wins the contest champion trophy for one year. The contests for the 1982 year have been completed and the available results are listed below. The results of the VK/ZL contest are not usually available until the June edition of AR. Therefore the trophy is awarded in the latter part of the year and held for the following year.

The contest for the 1983 year is now about to begin with the John Moyle National Field Day. To become eligible you must enter and to stand a chance of winning you should try for a high score (positions one to 10) in each of the contests. GOOD LUCK.

## THE RESULTS SO FAR FOR 1982

CALL-SIGN	J	M	VK/ZL	RD	VK Nov	TOTAL
3WP	10	—	10	18	38	
5QX	10	—	10	14	34	
4VIK	—	—	—	17	17	
2BQS	8	—	—	7	15	
5GZ	—	—	3	10	13	
3YIW	10	—	3	—	13	
3NZO	—	—	4	9	13	
3XB	—	—	3	8	11	
4LT	—	—	10	—	10	

The contests for 1983 are now about to start with the John Moyle and will be the same set of contests for this year. Be sure to have your entry in for a good position in all the contests for 1983.

## THE 27TH ANNUAL CQ WORLD WIDE WPX CONTEST

SSB: MARCH 26-27 1983

CW: MAY 28-29 1983

STARTS: 0000 UTC SATURDAY

ENDS: 2400 UTC SUNDAY

**CONTEST PERIOD:** Only 30 hours of the 48 hour contest period permitted for Single operator stations. The 18 hours of non-operating time may be taken in up to 5 periods anytime during the contest, and must be clearly indicated on the log. Multi-operator stations may operate the full 24 hours.

**OBJECTIVE:** Object of the contest is for amateurs around the world to contact as many amateurs in other parts of the world as possible during the contest period.

**BANDS:** The 1.8, 3.5, 7, 14, 21 and 28 MHz bands may be used.

**TYPE OF COMPETITION:** 1. Single Operator (a) All Band, (b) Single Band. 2. Multi-operator, All Band *only*. (a) Single Transmitter (only one transmitter and one band permitted during the same time period, defined as 10 minutes, no exception), (b) Multi-Transmitter (one signal per band permitted). **NOTE:** All transmitters must be located within a 500 metre diameter or within the property limits of the station licensee's address, whichever is greater. The antennas must be physically connected by wires to the transmitter.

**EXCHANGE:** RS(T) report plus a progressive three-digit contact number starting with 001 for the first contact. (Continue to four digits if past 1000.) Multi-transmitter stations use separate numbers for each band.

**POINTS:** Contacts between stations:

A) Contacts outside of own continent count 3 points on 28; 21, 14 MHz, and 6 points on 7, 3.5, 1.8 MHz.

B) Contacts with other countries on own continent count 1 point on 28, 21, 14 MHz, and 2 points on 7, 3.5, 1.8 MHz.

C) Contacts within own country count 0 points but are permitted for prefix multiplier credit.

**MULTIPLIER:** The multiplier is determined by the number of different prefixes worked. A "PREFIX" is counted once during the entire contest regardless of how many times the same prefix is worked.

A "PREFIX" is considered to be the three letter/number combination which forms the first part of an amateur radio call (N1, W2, WB3, K4, AA6, WD8, 4X4, DL7, G3, IT9, KH2, AL7, NP2, WP4, 9M2, CT9, 4J9, PY7, VK4, JE3,

VE3, Y32, Y33, Y45, AN8, AB8, H44, KT4, etc.). A station in a call area different than that indicated by its call-sign is required to sign portable. The portable prefix would be the multiplier. Example: W8IMZ/4 would count for prefix W4 only and W8IMZ/LX would count for prefix LX0 only.

Special event, commemorative, and other unique prefix stations are also encouraged to participate.

**Band Score,** total QSO points from all bands multiplied by the number of different Prefixes worked. (b) **Single Band score,** QSO points on the band multiplied by the number of different Prefixes worked.

**Multi-Operated stations.** Scoring in both these categories is the same as the All Band scoring for Single Operator.

A station may be worked once on each band for QSO point credit. However, prefix credit can be taken only once regardless of the number of different bands on which the same station and/or prefix has been worked during the entire contest.

**QRPP SECTION:** (Single Operator Only). Power must not exceed 5 watts output to qualify for QRPP section competition. You must denote QRPP on the summary sheet and state the actual maximum power output used for all claimed contacts. Results will be listed in a separate QRPP section and certificates will be awarded to each top scoring QRPP station in the order indicated in Section X. These certificates will be marked QRPP and will show your power output. QRPP stations will be competing only with other QRPP stations for awards. All other information contained in these rules is applicable to this section.

**AWARDS:** Certificates will be awarded to the highest scoring station in each category listed under Section IV.

1. In every participating country.
2. In each call area of the United States, Canada, Australia, and Asiatic USSR.

All scores will be published. However, to be eligible for an award, a Single Operator station must show a minimum of 12 hours of operation. Multi-operator stations must show a minimum of 24 hours.

A single band log is eligible for a single award only. If a log contains more than one band, it will be judged as an all band entry, unless specified otherwise. However, a 12 hour minimum is required on the single band.

In countries or sections where the returns justify, 2nd and 3rd place awards will be made.

**CLUB COMPETITION:** A trophy will be awarded each year to the club or group that has the highest aggregate score from logs submitted by members. The club must be a local group and not a national organization.

**LOG INSTRUCTIONS:** 1. All times must be in

# VHF UHF - an expanding world

## AMATEUR BAND BEACONS

Freq.	Call sign	Location
50.005	H44HIR	Honiara
50.008	JA2IGY	Mie
50.060	KH6EQI	Pearl Harbour (1)
50.075	VS6SIX	Hong Kong (2)
51.022	ZL1UHF	Auckland
52.008	VK0HI	Heard Island
52.013	P29SIX	New Guinea
52.100	VK0AP	Macquarie Island
52.200	VK8VF	Darwin
52.250	ZL2VHP	Palmerston North
52.300	VK6RTV	Perth
52.320	VK6RTT	Carnarvon
52.330	VK3RGG	Geelong
52.350	VK6RTU	New Guine
52.370	VK7RST	Hobart
52.400	VK7RNT	Launceston
52.420	VK2WI	Sydney
52.425	VK2RGB	Gunnedah
52.435	VK3RMV	Hamilton
52.440	VK4RTL	Townsville
52.500	VK2BNT	Newcastle
52.510	ZL2MHF	Mt Climie
53.000	VK5VF	Mount Lofty
144.400	VK4RTT	Mt Mowbull
144.420	VK2WI	Sydney
144.465	VK6RTW	Albany
144.475	VK1RTA	Canberra
144.480	VK8VF	Darwin
144.550	VK5RSE	Mount Gambier
144.600	VK6RTT	Carnarvon
144.800	VK5VF	Mount Lofty
144.900	VK7RTX	Ulverstone
145.000	VK6RTV	Perth
147.400	VK2RCW	Sydney
432.410	VK6RTT	Carnarvon
432.440	VK4RBB	Brisbane
432.450	VK3RMB	Mount Buninyong

There are quite a few changes to the beacons this month so they have been listed again. (1) and (2) are frequency changes for KH6EQI and VS6SIX. VK5KK (52.150) and VK3RTG (144.430) are not on the air.

Eric, temporarily indisposed, could not supply notes for this issue. Gil VK3AUI after a 'phone discussion with Eric, has put together some of the six metre happenings on Macquarie and Heard Islands over the last few weeks.

## HEARD ISLAND

Dave VK0HI and Al VK0CW of the Heard Island expedition set up the six metre keyer on Heard Island and had it operational on Saturday 29th of January.

The keyer on 52.008 MHz will run for the duration of their stay. The keyer is running 100 watts. As well as Dave's TS660 they have an FT 680, which was supplied by Yaesu to drive the 100 watt linear. The beam provided by Werner Wulf, VK3BWW went up without a hitch. If there is any propagation they will be able to exploit it.

Both Dave and Al had an excellent trip to Heard Island aboard the yacht Anaconda II. The Anaconda II made good time thanks to the seamanship of its owner/skipper

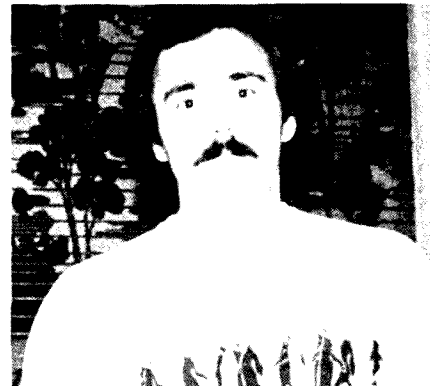

Dave, VK3DHF.

Josko Grubic and his crew. The DX-peditioners and the mountaineers made short work of setting up camp and VK0HI and VK0CW were soon handing out contacts. Maybe by now, they have worked someone on six metres.

## MACQUARIE ISLAND

Peter, VK0AC was worked by twenty six lucky VK2s, VK3s and VK7s on 18th December. Since then he has been QRT due to interference to a Riometer. Peter Barclay, VK3FR, has cards and will forward them by return mail. Efforts have been made to get Peter, VK0AP back on air. Filters for the Riometer were despatched on the supply vessel which arrived on Macquarie Island at the end of January. It is hoped that the filters will clear the problem. Peter is also looking at resiting the rig in the hope of reducing interference. Hopefully he will soon be back on air. Some more sporadic E contacts with a few F layer and TEP contacts would be a great achievement. Keep listening on 52.1 MHz, Peter will be back soon.



Peter, VK0AP.

International contacts to either VK0 call area on six metres would be a great achievement for World Communication Year.

UTC. The 18 hour non-operating periods must be clearly shown.

2. Prefix multipliers should be entered only the FIRST TIME they are contacted.

3. Logs must be checked for duplicate contacts and prefix multipliers. Recopied logs must be in their original form, with corrections clearly indicated.

4. An alphabetical/numerical check list of claimed PREFIX multipliers must be sent along with your contest log. (A prefix is counted one time only.)

5. Each entry must be accompanied by a Summary Sheet listing all scoring information, the category of competition, and the contestant's name and mailing address in BLOCK LETTERS.

Also submit a signed declaration that all contest rules and regulations for amateur radio in the country of the contestant have been observed.

6. Official log and sample summary sheets are available from CQ. A large self-addressed envelope with sufficient postage or IRCs must accompany your request.

If official forms are not available, you can make your own with 40 contacts to the page.

**DISQUALIFICATION:** Violation of amateur radio regulations in the country of the contestant, or the rules of the contest, unsportsmanlike conduct, taking credit for excessive duplicate contacts, unverifiable QSOs or multipliers will be deemed sufficient cause for disqualification. Actions and decisions of the CQ WPX Contest Committee are official and final.

**DEADLINE:** All entries must be postmarked no later than May 10, 1983 for the SSB section and July 10, 1983 for the CW section. Indicate SSB or CW on the envelope. From rare isolated areas the deadlines will be made more flexible. Your support is appreciated.

Logs go to: CQ Magazine, WPX Contest, 76 N. Broadway, Hicksville, NY 11801 or to the new WPX Contest Director: Steve Bolia N8BJQ, 7659 Stonesboro Dr., Huber Heights, OH 45424 USA.

## HELVETIA CONTEST

TIME — 23rd and 24th April 1983, 1300-1300 UTC.

**RULES**  
Use bands between 160 and 10 metres, less WARC-Bands. Mode CW and/or phone. Send RS(T) plus a three-figure serial starting with 001. Swiss stations will send an additional two-letter designation of their canton. Example: 57 (9) 001 BL. The abbreviations of the cantons are as follow:

ZH BE LU UR SZ OW NW GL ZG FR SO BS BL SH AR AI SG GR AG TG TI VD VS NE GE JU

Each contact with a HB-station counts 3 points. A station can be worked once per band (either CW or phone). The multiplier is the sum of Swiss cantons per band (a possible multiplier of 26 per band). Final score will be the sum of QSO points multiplied by the sum of cantons. Awards will be given to the highest entry from each country. USA and Canada call areas are considered as separate countries.

Logs postmarked not later than 30 days after contest should be sent to: G. Stalder, HB9ZY, Tellenhof, 6045 Meggen, Switzerland.

# AR SHOWCASE



## NEW MARITIME ELECTRONICS COURSE AT AMC

In the midst of a growing recession and widescale retrenchments, demand for trained personnel in one area cannot be lull met.

Classified advertisements in the daily papers reflect large numbers of vacancies both in Australia and overseas for electronics technical officers in a wide range of areas such as government departments — for example, Defence, Communications, Transport and Construction; the oil exploration and geophysical survey industries; and marine electronics companies. This shortage could well become more severe as the demand increases for personnel with knowledge of microprocessor technology. The starting salary for these positions is around \$16,000.

To help meet the demand for electronics technical officers, in February this year the School of Engineering at the Australian Maritime College in Launceston, Tasmania, is introducing a new, two-year full-time course — an Associate Diploma in Maritime Electronics.

The first year of the course runs in common with the existing Associate Diploma in Marine Radiocommunication. The second year emphasises areas such as instrumentation, digital and microprocessor systems, and advanced communication systems.

Entry to the course is by satisfactory completion of Year 12 or equivalent studies including mathematics and a science subject. Special consideration may be given to applicants aged over 21 who do not necessarily fulfil these requirements.

The Head of the School of Engineering, Dr John Cannell, says the school believes there are many people in the community with an appropriate work or educational background who would be eligible to apply for advanced standing to the course. Such people could complete the qualification in one year or 18 months. Those needing 18 months could begin study in July this year.

those requiring only one year of studies would be able to enrol in 1984 (the first time Year 2 of the course will be presented).

The type of people who would be eligible for advanced standing include the following —

- Ships' radio officers, other maritime, coast or land station radio officers or aviation communicators whose qualifications need updating;
- Certain experienced and capable radio amateurs who have a good grasp of basic mathematics and first-year Associate Diploma standard electrical and electronics principles;
- People holding a previous technical college certificate, eg electronics and communications certificates, either Australian or overseas;
- Various service or ex-service technical personnel with an appropriate background who wish to obtain more widely recognised qualifications for new jobs.

For enrolment or further information contact the Admissions Office (003) 260731 or the Course Leader, Mr E Mackinnon, (003) 26 0757.

## SEA SURVIVAL '83

Survival has often been described as man's strongest instinct, and the sea one of his greatest foes.

Modern technology has reduced many of the dangers of life at sea, and introduced others. Serious accidents and tragedies still occur.

An international seminar to be held at the Australian Maritime College in Launceston, Tasmania, on 17, 18 and 19 May this year, will examine new developments in survival technology and methods of improving standards of training and safety for survival at sea.

The seminar should appeal particularly to service personnel, airline operators, fishermen, yachtsmen, manufacturers of safety equipment, ship designers, water police, state emergency authorities, and shipping and offshore industry personnel.

Survival training experts from the UK, Norway, the USA and Australia will address the seminar on topics such as: Growth of the offshore industry and its future training demands; Mass evacuation systems — inflatable life chute and life raft development; Psychological and medical aspects of survival at sea; and Present and future uses of radio communication and radio location aids in distress, search and rescue operations.

The cost of the seminar including documents, luncheons, conference dinner and refreshments, but not accommodation, is

\$95 (less for full-time students). Accommodation will be available on campus or in the Launceston city centre. Early applications are advised.

For enrolment or further information, contact the Seminar Secretary, Australian Maritime College, PO Box 986, Launceston, Tasmania, 7250, telephone (003) 26 0711.



## FT-77 THRIFTY HF TRANSCEIVER

Utilizing the new CAD/CAM\* manufacturing techniques, Yaesu presents the FT-77 as the new milestone in reliability, simplicity and economy in HF communications.

Featuring efficient, all solid state, no tune circuitry, this unit offers a nominal 100 watts of RF output on all amateur bands between 3.5 and 30 MHz, including the three new WARC bands. The new CAD/CAM techniques plus the simple design add up to one of the smallest, lightest HF transceivers ever.

The front panel control layout and operation are actually simpler than some VHF FM transceivers, with only the essential operating controls; while the simple circuit design leaves fewer parts that could cause problems. Nevertheless, all of the essential modern operating features for HF SSB and CW are included, along with extras such as dual selectable noise blanker pulse widths (designed to blank the woodpecker or common impulse noise), full SWR metering, and capabilities for an optional internal fixed-frequency channel crystal, narrow CW filter and FM Unit.

Computer-aided design of the circuit boards ensures the most efficient component layout possible in the smallest space, while automatic parts insertion and soldering greatly diminish the chance for human error. Reliability and quality control are thus improved and simplified beyond the degree previously attainable in amateur equipment. This means longer equipment life with less chance of a breakdown.

The extremely compact size and simple control layout make the FT-77 ideal for mobile operation, or as the heart of a complete base station with the optional FP-700 AC Power Supply, FV-700DM Digital

Scanning VFO and Memory System, FTV-700 V/UHF Transverter and the FC-700 Antenna Tuner. The low price, coupled with the expansion capabilities presented by these accessories, make this transceiver the perfect choice for those new to amateur HF communication, or as a practical second rig for old timers.

All enquiries may be made to the Australian agents, Bail Electronic Services, 38 Faithfull Street, Wangaratta Vic. Phone (057) 21 6260,

\* Computer Aided Design/Computer Aided Manufacture.



### THE FT-980 ALL MODE HF CAT\*

This incredible new transceiver incorporates the highest level of microprocessor control ever offered in an HF all solid state radio. Including a general coverage (0.15-30 MHz) receiver with its own, separate front end, this amateur transceiver offers a new dimension in frequency control; whereby frequencies can be entered by either front panel keypad or tuning dial, and then scanned in selectable steps either freely or between any two programmable limits. Twelve memories include four with special protection, and two large digital displays allow full flexibility and control for split frequency operation, while two meters allow full transmitter information.

Additional controls include IF Width and Shift on concentric controls, AMGC (Automatic Mic Gain Control) to set microphone input threshold, RF Speech Processor, ALC Meter Hold function, IF Notch and Audio Peak filters, Transmit Monitor, Noise Blanker and CW Full Break-in. Controls are also provided for FM Squelch and CW Keyer Speed when the optional FM and Keyer Units are installed.

The most important feature of the FT-980 is that practically all of the above features can be controlled by the user's separate personal computer, when connected through an optional Interface, also available from Yaesu. Where up to now the few amateur transceivers that offered any kind of computer interfacing at all permitted only frequency control, the FT-980 permits almost total control of all functions from a separate microcomputer, including Mode; IF Width and Shift; Scanner Step, Speed and Limits; and switching of most other functions. Microcomputers are not available from Yaesu.

Further details may be obtained from Bail Electronic Services, 38 Faithful Street, Wangaratta Vic. Phone (057) 21 6260.

\* Computer-Aided Transceiver.

### YAESU YH-1

Yaesu has produced a new headset type YH-1 which include a light-weight head-phone and boom microphone. This headset

when used with the appropriate PTT Switch, can be used with FT207R, FT208R, FT780R, FT230R, FT290R, FT690R and FT790R.

For further information contact Bail Electronic Services.



### THE FT-726R V/UHF MULTIBANDER

Combining all of the best features from Yaesu HF and V/UHF transceivers, the FT-726R opens a new world of operating ease and flexibility for FM, SSB and CW on the 50\*, 144 and 430/440 MHz amateur bands. The design integrates the individual operating requirements of each of the three operating modes into one unit, and the user can then select which of the optional plug-in band modules he desires.

The VFO-A/B scheme has ten programmable memories, and can be tuned in 20 Hz steps for CW and SSB operation, or in selectable steps for FM. FM tuning is accomplished by an indented tuning knob. IF Width and Shift controls are provided for CW and SSB operation, while both preset standard and user programmable repeater offsets can be selected for all modes. An optional Satellite Unit makes the FT-726R into a full duplex cross-band satellite transceiver.

Further information may be obtained by contacting Bail Electronic Services. Phone (057) 21 6260.

\* 144 MHz Unit installed, other Units available as options according to local regulations.



## WHAT ARE YOU BUILDING?

*Please tell AR about it so we can tell others.*

**Amateur Radio is an experimental hobby — if you share your experiments with us you are enriching our hobby!!**

## “A VERSE FOR THOSE OVER THIRTY”

*Remember when hippie meant big in the hips  
And a trip involved travel in cars, planes or ships?  
When pot was a vessel for cooking things in  
And hooked is what grandmother's rugs might have been?  
When fix was a verb meaning mend or repair  
And be-in meant simply existing somewhere?  
When neat meant well-organized, tidy and clean  
And grass was a ground cover, usually green?  
When lights and not people were turned on and off  
And the pill was intended to help cure a cough?  
When groovy meant furrowed, with channels and hollows  
And birds were winged creatures like robins and swallows?  
When fuzz was a substance, all fluffy like lint  
And bread came from bakeries, not from the Mint?  
When a roll was a bun and a rock was a stone  
And hung-up was something you did to the phone?  
When chicken meant poultry and bag was a sack  
And junk was just cast-offs and old bric-a-brac?  
When cat was feline, a kitten grown up  
And tea was a liquid you drank from a cup?  
When swinger was someone who swung in a swing  
And pad was a sort of cushiony thing?  
When way-out meant distant and far, far away  
And man couldn't sue you for calling him "gay"?  
Words once so sensible, sober and serious  
Are making the scene man, like psycho-delerious  
It's groovy dad, groovy — but English, it's not  
Methinks that the language is going to pot.*

VK5XT  
AR

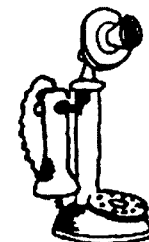

**Please remember your STD code when you advertise in HAMADS.**

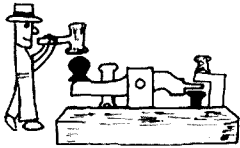

# POUNDRING BRASS

Marshall Emm VK5FN  
Box 389, GPO Adelaide SA 5001

## KEYS AND KEYSERS (Part II)

The ordinary manual key can't be beaten for simplicity and ease of operation, but there is still a lot of room for improvement. Some truly marvellous machines have been devised to simulate the actions of the hand in sending dots and dashes. Driven by springs and/or weights, they are all mechanically complex.

Basically, mechanical keys fall into two categories, semi-automatic and automatic. Either variety can be driven by a single paddle which is moved to one side for dots and to the opposite side for dashes, or by separate dot and dash paddles. The semi-auto variety will send a string of precise dots when the dot lever is actuated (or when the single paddle is swung to the dot side) but dashes are produced manually. There is often a problem in matching the speed of the dashes, or their spacing, to the mechanically generated dots, and if the dots are sent too quickly in relation to the dashes, the sending rhythm is distorted and the result can be very difficult to copy.

As a child of the semiconductor age, I have very little knowledge about mechanical keys. I have seen them in museums, and often recognized them on air, but have never used one. I would be grateful for any information readers can send me, particularly detailed descriptions or operating instructions.

I'm a lot more at home with electronic keyers, which are of three basic types — manual, single paddle (side-swiper) and dual paddle (the iambic, or squeeze keyer). Oddly enough, the "manual" electronic keyer is the most recent in development. I've designated it a manual keyer because it is driven by a straight key. Called the "Fist Fighter", it acts as an electronic interpreter; it receives sloppy signals you generate with a hand key, determines whether you intended to send a dot or dash, and generates a precise dot or dash for your transmitter, with appropriate spacing. I expect one would have to be reasonably consistent to make the thing work, so one would have to assume that if the "Fist Fighter" can read your sending, a human ear should have no trouble. "Fist" is usually defined as a distinctive sending style, and as such is something to be frowned on — every operator's goal should be to send "copper-plate" morse which is not distinguishable from perfect, computer generated morse, so this is the area where the "Fist Fighter" should be of most benefit. In other words it enforces a discipline on the user, and ultimately trains one to send code so well that aids are no longer needed.

The second level of electronic keyers generates strings of dots or dashes depending on whether the paddle is swung to right or left. The length of time the paddle is held over determines the number of dots or dashes generated.

The iambic keyer represents the state of the art at the present time. Any number of frills, bells and whistles are available, but as a keying method, iambic is of tremendous significance. The keyer is actuated by separate dot and dash paddles, but when both paddles are held over at the same time, the iambic keyer generates a pattern of alternating dots and dashes. That's where the name iambic comes from. It is a term used in poetry to describe a "meter" or rhythm consisting of a pair of syllables, the second of which is stressed. For the record, if iambic meter is reversed, with the first syllable stressed, it is dactylic, and an iambic keyer sends dactyls if the dash lever is actuated in advance of the dot lever! With a view towards making this all clearer, here is an example of iambic meter: "In days of old, when knights were bold . . ." A technique called scansion is used to analyze the meter, and the line breaks up like this: In days / of old / when knights / were bold . . . The rhythm is often described as "de dum de dum de dum de dum, or by extension, dit dah dit dah dit dah dit dah . . . get it?"

To send SK with a hand key requires twelve separate up or down movements. To send it iambically, the dot paddle is held over and the dash paddle is kicked in at the end — for a grand total of four movements:

1 2 3 4

1 — press dot 2 — press dash 3 — release dot 4 — release dash.

It sounds complicated, but the fewer the required movements, the easier the keying becomes, and great speeds are possible once you get the hang of it. Most people start off using an iambic keyer non-iambically (they depress one paddle at a time and don't use the combinations available with a squeeze) and then find their way into iambic keying as time goes by.

Now that you know all there is to know about iambic keying, we'll get down to cases next month and talk about paddles and keyers.

Till then — 73.

AM

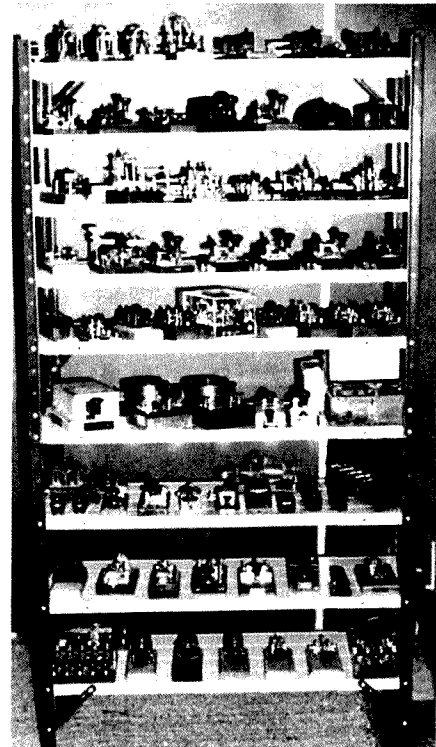

Part of David VK6WT's Morse Key Collection. David has more than 100 keys spanning 100 years from VK, ZL, G, W, UA3, DL and JA.

Photo by David Couch



## WATCH YOUR LANGUAGE PLEASE!!

A letter received from a VK5 amateur has brought our attention to possible breaches of the regulations in respect of unseemly language being used by some novice operators in the 80 metre nightly "Cocktail Net".

Our correspondent writes "... one particular 'N' call amateur leaves a lot to be desired, and whilst I believe I am fairly broadminded having served in three of HM forces in WW2, I really don't think the verbage used is in the best interests of amateur radio, and our image. Nor is it an example to be followed by newcomers to our bands ..."

Gentlemen, be warned "Public Bar talk" will not be tolerated on the amateur bands, and loss of your licence will result if it persists.

— VK3UV



**PLEASE HELP WITH INTRUDER WATCHING**

## EMC

(Electro Magnetic Compatibility)

If radio frequency interference is causing you a problem you are reminded that — "Advice on all types and aspects of interference (PLI, TVI, AFI, etc.) is available from the National EMC Advisory Service".

FORWARD DETAILS TO  
VK3QQ,  
Federal EMC Co-ordinator, QTHR.



# SPOTLIGHT

## ON S W L i n g

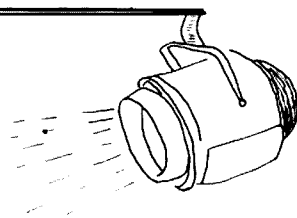
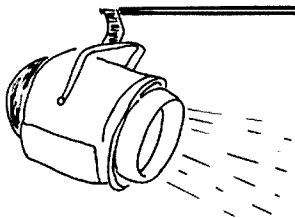

Robin Harwood VK7RH  
5 Helen Street, Launceston, Tas. 7250

### OVER THE HORIZON RADAR

My remarks in the January column, regarding the "Woodpecker" or Over the Horizon Radar, has elicited enquiries for the operating times and frequencies, together with the location of the various sites employing this mode. As I stated in my reply, it is virtually impossible to predict the times or frequency usage, as I have been unable to work out a pattern or organization to their operations. They just seemingly plonk down unexpectedly on any HF channel, whether it be occupied or not. Yet there appears to be an effort by all OTHR users to avoid using maritime and aviation HF allocations.

There are several known locations in the USSR and the North American continent, as well as one site pretty close to home. As the sunspot index is declining, the "Woodpeckers" will increasingly be observed on lower frequencies, although they have not been heard much below 5 MHz.

Have we seen the peak of operations of the "Woodpeckers"? They do seem to be dropping off, or alternatively their transmission time per channel is being reduced, in order to minimize communications disruption. With the rapid development of digital pulse transmission techniques, OTHR could be obsolete very quickly. As well, it does need quite a deal of energy. Let us hope that it can be reduced or refined so that HF communications can proceed.

### FREQUENCY ALLOCATIONS

As from the 16th of December, the allocations of 18.068 to 18.168 MHz and 24.89 to 24.99 MHz became available to full call amateurs. Both of these bands are shared with the fixed and commercial services, who are the primary service. Amateurs have only secondary rights and should not cause any harmful interference to primary service stations, nor are they protected from any interference from them.

### HOME AGAIN

Since my return from holidaying in Queensland, I have only briefly been able to listen on these new WARC allocations. Amateur activity on 18 MHz has been virtually nil, as there are plenty of commercial and fixed stations utilizing this band. And on 24 MHz, the only station I have heard and worked on CW has been Graham, VK6RZ in Perth. When overseas administrations do release these frequencies to amateurs, I expect that interest will pick up.

We are also permitted now on 40 metres to operate up to 7.3 MHz. This is to be

shared with the broadcasting service, and there are very few channels vacant in the evening hours. However, contacts are being made with Stateside stations for the first time on their own operating frequencies. The increased band also gives us more room for daytime QSOs.

Also permission has been given for Australian amateurs to operate between 3.794 and 3.800 MHz — the so-called "DX" window. I do believe that some very good contacts have taken place, yet it should be remembered that this, being a narrow allocation, should be kept clear for DX operators and not used as a local chatter channel. That can be easily done further down on the existing allocation.

### COMPARISONS

As mentioned previously, I spent the Christmas period vacationing in sunny Queensland. As I did not have much time to do any serious listening, what observations I was able to make, confirmed that there is a difference in propagation between Tasmania and Queensland. For example, signals from the Caribbean region were heard fairly well at 1200 UTC, yet there are signs of propagation to that region from this location. Naturally Asian signals were very strong, coming in a lot earlier than they do here. As well there was propagation on 11 and 15 MHz from SE Asia in daylight hours, plus some Pacific Island outlets on 9 MHz. These are rarely observed in Tasmania in daylight. Sometimes they are heard in the winter months in the late afternoon.

But I found that listening below 9 MHz in the evening hours is out of the question, because the incessant lightning crashes rendered the intelligibility of the signals to zero. As well, one has to be prepared to rapidly make sure that your antennas are thoroughly grounded, in semi-tropical or tropical regions such as Brisbane. Some of those spikes can do quite a lot of damage.

I was able to go to one of the local radio clubs whilst there. I attended the Gold Coast Radio Society and was invited by Ken VK4KD, the local President to speak about the Handicapped Aid Programme, of which I am the National Co-ordinator.

### CHANGE OF QTH

Radio Australia, the Overseas Service of the ABC recently moved its operations from Lonsdale Street to the outer Melbourne suburb of East Burwood. They were formerly cramped in an old building which, I believe, was at one time a biscuit factory. It now has modern, up to date studios from

where they can produce their programmes. As well, the Darwin Relay Site is likely to be re-commissioned in the near future, together with the up-grading of the existing transmitters at Shepparton (Vic) and Carnarvon (WA).

### RELAY TRANSMISSION

As you probably were aware, during the Commonwealth Games, Radio Australia transmitted special reports on the activities via the facilities of the BBC in the UK together with some of their relay bases. This could be done again in the future, on a shared basis with another international broadcaster, who would, presumably, gain access to use RA's transmitters to broadcast to the Pacific region. Such arrangements presently exist with Radio France International for them to send programming in French on a weekly basis. You can hear them on 6.045 MHz at 0945 UTC Fridays after Radio Australia concludes their special programmes directed to Antarctica.

### DXPOSITION

The Australian Radio DX Club is holding a DXposition on Easter Saturday, the 2nd of April. It is going to be held at the Radio Australia studios, which are approximately fifteen kilometres from the city centre. Highlight of the DXPO '83 will be the attendance of four DXers from the Japan BCL Federation — one of the leading SWL clubs in that country. For further details you should get a registration form from ARDXC DXPO '83, PO Box 300, Blackburn, Vic. 3130.

### SOVIET PROGRAMMES

In the course of listening around the bands, you have probably encountered SSB relays of Soviet Home Service programmes. These point to point transmissions are, presumably, designed for the Soviet Naval and Merchant Marine, or Soviet personnel working throughout the world, including the polar regions. The audio quality of these links is superior to that obtained from the normal AM channels, mainly due to good processing. All programmes are in Russian or other Soviet languages although the North American Service in English has been heard on SSB. One channel with excellent signals is 13.820 MHz at 1200 UTC, where they are strong and clear.

Well, that is all for this month. Until next time, the best of 73s and good DXing!

Robin VK7RH

AR

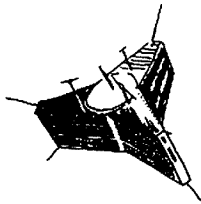

# AMSAT AUSTRALIA

Bob Arnold VK3ZBB  
41 Grammar St. Strathmore 3041

**NATIONAL CO-ORDINATOR**  
*Chas Robinson VK3ACR*

**INFORMATION NETS**  
**AMSAT AUSTRALIA**  
*Control: VK3ACR*  
*1000 UTC Sunday on 7.064 MHz.*

**AMSAT PACIFIC**  
*Control: JA1ANG*  
*1100 UTC Sunday on 14.305 MHz*

**AMSAT SW PACIFIC**  
*Control: W6CG*  
*2200 UTC Saturday on 28.880 MHz*

**ACKNOWLEDGEMENTS**  
AMSAT Satellite Report  
AMSAT UK  
VK5AGR

Basic Orbital Data can be obtained through the AMSAT Australia Net by both participating stations and listeners.

## UoSAT PAPERS

'The Radio and Electronic Engineer' is the journal of the Institution of Electronic and Radio Engineers (England). It has devoted its entire August/September 1982 issue (Vol 52 No 8/9) to "UoSAT — The University of Surrey's Satellite (an investigation into cost — effective spacecraft engineering). The journal carries about 100 pages and contains twelve papers by various authors associated with the project.

## OPERATING PROCEDURES FOR THE 'RS' SATELLITES

I am indebted to David Rankin 9V1RH/VK3QV for a translation of an article which originally appeared in the Russian amateur journal "RADIO" for July 1982.

The article is by Leonid Labutin UA3CR and has been translated from the Russian by Dexter Andersen W4KM. New information is contained in the text which should assist amateurs to make even more successful contacts with the RS group of satellites.

## "PARTICULARS OF QSO's VIA SATELLITES" by Leonid Labutin UA3CR

Some of the general recommendations and rules for conducting satellite QSOs given in

RADIO #1/1979 are repeated here:

- A lay-over (transparency) containing a path diagram should be prepared (RADIO #3/1982);
- A timetable of satellite passes over a specific geographical point should be drawn up;
- An overall evaluation should be made of reception conditions, and one should not go on the air if the signal level of the satellite is too low since this will only use up a communication channel for no good purpose;
- Both receiver and transmitter must have well-graduated scales, substantially reducing the time needed to search one's own signal;
- The receiver must have smooth tuning, permitting the tracking of frequency necessitated by the Doppler effect;
- The transmitter power must be able to be regulated over a broad range;
- Call CQ in 12 to 15 second bursts with pauses of the same length — in the majority of cases you will be called during your transmission since communication via satellite is duplex; on hearing a call you should stop transmitting.

There exist several specific particularities relating to operation via the "Radio-3" through "Radio-8" satellites, principally relating to the presence of regular signal fluctuations characterized by a period of 0.5-1 second and a dip of over 20 dB.

## WHEN TO OPERATE VIA THE SATELLITES

To select optimal conditions for satellite operation, one should monitor the regular fluctuations caused by the satellite's rotation around its own axis (in the course of which the directivity pattern as well as the receive and transmit antenna polarization planes rotate) and also by the rotation of the radiowave polarization plane in the ionosphere (the Faraday effect) and other factors. The rotation axis of the satellite maintains the same position over an extended period of time thanks to the gyroscope effect.

To get a clear idea of the phenomena governing the regular fluctuations in the radio signal, it is necessary to form a precise picture of the movement of the satellite around the Earth and its rotation around its own axis. Let us examine several possible combinations of the position of the satellite's own rotation axis and the orbital plane, and also examine how the receive signal level changes as a function of this. (We shall not for the time being consider the turning of the satellite's receiving antenna, which is legitimate in monitoring beacon signals. The turning of the satellite's receiving antenna will produce analogous changes in the signal

received by the satellite, and in the repeater mode fluctuations will be determined by the sum of the inequalities in the satellite's receiving and transmitting antenna patterns.) We shall assume that the satellite's transmitting antenna has a distant directional pattern similar to a toroid dipole, with minimum radiation along the axis of the dipole and maximum radiation perpendicular to it.

1. The satellite's own rotation axis coincides with the axis of the transmitting dipole and is perpendicular to the plane of the satellite's orbit. In this case regular changes in the signal are not observed, and the signal level mainly depends on the inclined distance (the straight distance between the Earth station and the satellite) and may vary within 9 dB in zenith orbits.

2. The satellite's own rotation axis coincides with the axis of the dipole and lies in the plane of the satellite's orbit. When the satellite passes through the communication zone the antenna turns continuously relative to an observer on Earth. A related phenomenon is that a minimum signal will be observed at every geographical point along the sub-satellite path, at a specific time.

3. The satellite's own rotation axis is perpendicular to the axis of the dipole and to the orbital plane. Given this arrangement, a change of signal level is observed with a frequency of twice that of the satellite's rotation about its own axis. The change in the signal is at a maximum along the subsatellite path and lessens as the distance from the path increases.

4. The satellite's own rotation axis is perpendicular to the dipole's axis, and lies in the satellite's orbital plane. Under these circumstances the amplitude of regular fluctuations varies continuously. If this is examined from the point of view of the receiving antenna on board the satellite, it becomes clear that precisely in this situation it is easiest of all to communicate with the robot and to record information on the bulletin board.

The above data are approximate only, having been gathered using simple antennas and receiving equipment. A multitude of possible intermediate situations exists, involving a more complicated calculation of signal-level changes. Deep and frequent fading occurs also as a result of the mechanism of radiowave propagation and the satellite's movement in orbit; here not only the amplitude of the fading changes but also the period, which differentiates this phenomenon from fading due to the rotation of the satellite.

A relatively stable and slowly changing signal level from the satellite beacons implies

that the satellite's own rotation axis is close to the axis of the transmitting dipole. Monitoring of signals that have passed through the repeater and of the robot's reaction to incoming signals are indications that the receiving antenna is rotating in a plane perpendicular to the satellite's own (as described in cases 3 and 4). The more such monitoring results are accumulated, the more precisely it will be possible to determine the interrelationship between the satellite's rotation axis, its antennas, and the orbital plane, and hence the most favourable orbits for radiocommunication.

#### OPERATION THROUGH THE REPEATER

Telegraph signals suffer least of all under conditions of deep fluctuations. Practice shows (and theory proves) that the stronger the fading and the weaker the signal, the slower the sending must be. A sending speed of 60-70 characters per minute may be considered normal, only occasionally increasing it to 100 CPM, and when working QRP dropping to 40-60 CPM.

The power radiated toward the satellite must be regulated in such a way as to avoid the peak level of the repeated signal from exceeding that of the telemetry beacon. When this is exceeded, the ARU system of the repeater begins to operate, and the signal level of the remaining station will "breathe" in synchrony with the turning of the satellite and with keying of the powerful station. The level of its own signal will change slightly.

Fluctuations affect the intelligibility of SSB signals substantially more. Sometimes whole words disappear. Hence when there are deep fluctuations it is advisable to pronounce words slowly, drawing them out as in a drawl, repeating the most important parts several times.

#### COMMUNICATION WITH THE ROBOT

Conducting a QSO with the robot is the most complicated procedure.

In order for an operator to have a QSO with it, all others must stand by patiently. The slightest interference can interrupt a QSO. Often operators create interference by tuning their transmitters on the robot's frequency. Correct operation presupposes the presence of a well calibrated transmitter exciter or a digital frequency meter and a table or graph showing the Doppler frequency shift. Variance from the calculated frequency should not exceed  $\pm 0.5$  kHz.

To make a contact with the robot, it is necessary to fulfill the following conditions:

- There must be no interference in the receive channel exceeding the threshold of the satellite receiver;
- the signal level from Earth must exceed the activation threshold of the satellite receiver;
- the signal's frequency must be situated in the passband of the satellite receiver;
- sending must be precise and without error.

If due to fluctuations the radiated power cannot compensate for dips in the antenna directivity diagram, it is necessary to stop trying to communicate with the robot in order not to bother others.

— it's necessary to observe the correct procedure for calling the robot; for example

"RS5 DE UA3XBU AR", and by the way the combination AR is sent together. If the call is received incorrectly by the robot, either no answer will follow or an answer will be given in the form of a coded phrase. If the robot received the call correctly, it answers, for example, thus: "UA3XBU DE RS5 UR QSO NR 012 UA3XBU DE RS5 NR 012 OP ROBOT TKS FR QSO 73 SK". With this the communication is ended, and you should not send the robot 73, thanks for the QSO, goodbye, etc, thereby occupying the channel and bothering others. The robot enters your call-sign in the on-board log, and during the regular "dumps" from the on-board log on command from Earth you may check on the correctness of the QSO. The capacity of the on-board log (its electrical memory) is 64 communications, and its memory capacity for numbers is 999. During the transmission by the robot of CQ don't tune in its receive channel, thus creating interference. During the robot's reply, its receive channel is switched off, so that tuning in this channel is all the more useless.

Communication with the robot may be conducted if the call-sign of the station calling consists of not less than four and not more than six characters.

The nominal input frequencies of the robots are 145.828 MHz for RS-5 and 145.836 MHz for RS-7.

#### SATELLITE STATUS REPORT

AMSAT Oscar 8 will celebrate the Fifth Anniversary of its launch on 5th March. At this time the satellite will have completed some 25 471 Earth orbits.

It has been reported that a problem may have developed with the battery charge, consequently the battery condition will have to be carefully monitored. Otherwise the satellite is working well and giving good service.

The AO8 Mode 'J' transponder is being used in a unique way to test the system for determining Phase IIIB orbital parameters from AMSATS own range measurements. The Phase IIIB command modem is operated through the AO8 transponder. The subsequent processing of the ranging signals is quite involved and is outlined in Edition 48/49 of ASR.

The RS series of satellites continue to operate satisfactorily in accordance with their previously advised schedules. It has been suggested that the beacon frequency of RS6 has moved on occasions but this report has not been officially confirmed. UOSAT Oscar 9 is still held under tight rein by its controllers. The satellite is now virtually at its planned attitude and its spin has been substantially reduced to a level where early deployment of the booms may be anticipated.

Telemetry transmissions have been restricted to weekends and since new year have been available during the Australian afternoons. An added bonus in recent weeks has been the synthesized speech experiment which has operated alternately with the ASCII.

Through a 120-word speech synthesizer telemetry, orbit ephemeris data and general

news can be encoded in 'English' and relayed via the general, engineering or 2.4 GHz beacons using nbfm. Although the satellite and its controllers are all European the synthesized speech signals have a distinct American accent; it seems that synthesizers are reared and educated in the USA. The SHF and microwave beacons aboard UO9 have recently been activated and found to be in good working order. These beacons operate on 2.401 GHz and 10.47 GHz respectively. The SHF beacon will transmit similar data to the VHF General Beacon on nbfm. The Microwave Beacon will transmit a steady tone.

#### NEW CONTRIBUTING EDITOR REQUIRED

After quite a few years of writing these notes I shall relinquish my position as Contributing Editor on satellites effective from the June edition.

This will give me an opportunity to write a series of in depth articles on the subject of satellites with, I hope, assistance from experts in specialized fields.

It will also, and perhaps more importantly, provide an opportunity for a younger enthusiast to make a tangible contribution to this interesting side of our hobby.

*If you are willing to assist please let the editor of 'AR' or myself know as soon as possible.*

AR

# BOOK REVIEW

## MINI/MICRO SOLDERING AND WIRE WRAPPING

Walk into any electronic parts distributor or computer store, and you can obtain books relating to almost any technical situation, from the simplest to the most complex subjects, and projects.

However, a book not usually found is how one actually goes about fastening individual components together, or how to remove them during repair and troubleshooting.

This book attempts to fill that void. Its four chapters cover information on the three methods of fastening, fastening new circuits, unfastening/refastening existing circuits, and some basic techniques for troubleshooting and repairing electronic equipment.

The book contains one hundred and twelve internal pages and is most descriptive with pictures and diagrams throughout.

A most useful addition for your amateur library.

Available from Stewart Electronics Components Pty Ltd, 44 Stafford Street, Huntingdale Vic. 3166. Cost is \$6.00, plus postage \$1.00.

VK3UV

AR



# HERE'S RTTY!

Bruce Hannaford VK5XI  
57 Haydown Road, Elizabeth Grove, SA 5112

## CHOICE OF RTTY GEAR

*Choosing the right RTTY gear is like choosing a wife. A lot of careful thought before hand can save much distress later. I don't intend to tell you what to do but will instead outline the main considerations in a non technical way.*

Firstly the choice of a suitable transmitter, receiver or transceiver. On the HF bands Frequency Shift Keying (FSK) is normally used. Some modern transceivers have an inbuilt FSK facility but many SSB transceivers lack this feature. With such SSB transceivers FSK can be generated by feeding pure audio frequency tones into the mic socket or phone patch connections. The result will be a true FSK transmission if no audio distortion is present in the tone oscillator or in the transceiver audio circuits.

When an "audio generated" FSK transmission is used the transceiver must, in addition to having low audio distortion, also have very good carrier and unwanted side band suppression. Most modern transceivers will meet this requirement and thus will be suitable for both SSB and RTTY.

In a transceiver having FSK fitted the carrier frequency will be keyed up and down slightly by the RTTY terminal equipment using DC pulses for this purpose. On HF bands this latter system is preferable as there is much less chance of spurious RF outputs.

In either case, when a basically SSB type of transceiver is used, the power output must be kept low because of the continuous carrier needed for RTTY. Usually the RTTY power output will be a little less than half the normal peak power of CW or SSB.

If you decide to use a linear to raise the transceiver power, remember that the distortion products will also be amplified and this is a most important consideration when using "audio generated" FSK. Personally I doubt if a linear should be used with "audio generated" FSK transmissions, much better to use a "DC switched" FSK system and largely avoid the problems of spurious outputs.

By the way "linears" don't have to work in a linear fashion when amplifying RTTY and it is a good idea to fit them with a bias switch giving extra bias for class C operation when using RTTY.

Before we leave the HF scene two more important points must be mentioned. Firstly

RTTY requires very high stability both in transmission and reception. Equipment considered perfectly stable for SSB or CW may not be good enough for RTTY. A frequency drift of say 50 Hz may be enough to lose a RTTY signal with some types of terminal equipment.

Secondly, although in reception RTTY audio tones are normally only 170 Hz apart CW filters may not be workable as the required RTTY tones are normally 2125 and 2295 Hz and most transceivers with the CW filter switched in produce beat notes of about 800 Hz! A transceiver with normal SSB pass band and IF shift may well be more useful than one with a CW filter.

On the VHF bands the situation is somewhat different as most RTTY is transmitted using FM transmissions. The audio tones remain at a constant pitch even when the receiver is well off tune and the volume is thus reduced. This system is called Audio Frequency Shift Keying (AFSK) and in passing you might note that this same type of RTTY and audio fed into a SSB transceiver produced FSK output.

With AFSK transmissions you need a tone oscillator that is keyed by the required RTTY code, however the keying is not on/off keying, it is change of pitch keying of the two audio tones used. At all times one or the other tone is present, the keying merely changes the pitch from one to the other.

Usually FM transceivers can be run at full power on RTTY as they are being used in their normal way, however RTTY overs tend to be longer than speech overs and in some transceivers this may cause overheating.

Because of the lack of drift problems using FM RTTY a signal once tuned stays that way. A receiver can be left running unattended tuned to a RTTY channel connected to printing equipment that will automatically start up when a signal is received.

This auto start system is used by many people who even leave equipment running

twenty-four hours a day. Messages can then be received even in the absence of the operator who, when he gets around to reading same, can reply in like manner even if the other operator is not available. This is a very interesting system that does not tie you down to exact times like a sked.

The information received can be recorded on paper, a magnetic tape recorder or in a computer memory. I note many people are using mechanical printers for this purpose.

Of course it is also possible to use FSK RTTY on VHF and a few are doing this mainly on 6 metres. If such a system is used it goes without saying exceptional stability is required and most other remarks made for HF FSK will also apply.

Let us now turn our attention to Terminal Equipment. Briefly this is those extra bits of gear needed to make your CW/SSB station a RTTY station.

Terminal equipment may be a single complete unit or a number of separate units. In receiving, the terminal equipment receives audio signals from the receiver voice coil or headphones jack, interprets these and passes them on to a paper printer or VDU screen. When transmitting a typewriter type keyboard is used to control the generation of coded signals that either finish up as two audio tones to modulate the transmitter or as DC pulses used to directly shift the transmitter carrier frequency.

Basically there are three types of terminals. A mechanical terminal, a communications computer terminal and a "home" computer terminal.

The mechanical terminal uses a teleprinter type machine such as have been used for many years in Post Offices and many of these are still giving good service in amateur stations. The machines were of course designed to work through land lines using a rather high current and voltage so some additional interface equipment is needed for radio use.

For transmission, a modulator is used for generating tones and for reception, a demodulator that converts the received

audio tones to DC pulses to work the printer is needed.

The mechanical printer is by far the cheapest and can give quite good results on a single RTTY speed.

The communications computer is a "dedicated" computer. That is it is dedicated to one task, namely that of sending and receiving RTTY or CW signals. Such a computer normally has all the necessary terminal equipment in the one package except that a VDU is often a separate item. The VDU most often used is a standard portable B/W TV receiver as these are cheaper than a normal VDU.

Comparing the mechanical gear with the computer the computer does offer much greater operating convenience and as a self-contained unit it requires a minimum of interconnecting wires and so is very easy to get going. It will normally operate on several RTTY, ASCII and CW speeds and has memory capacity which can be very useful.

Perhaps the greatest operating advantage of the computer is noted when sending mixed letters, figures and punctuation marks. Eg when using a mechanical system to send a figure in the middle of a group of letters you must first use the figures key then send the required figure and then use the letters key before continuing with more letters.

You will note three key tapping movements were required to send the one figure amongst a group of letters. With the computer there is a separate key for each figure and you simply tap the right key and the computer does the rest automatically. One movement instead of three! A time and motion study type would be ecstatic with delight at such saving of work movements.

The "home" computer does not really offer many advantages over the communications type as far as the actual sending and receiving of RTTY is concerned, however it will be useful in many other ways as well. If you have a use for a computer in its own right, quite apart from RTTY, it might then be well worthwhile considering as a reasonable proposition.

As a "home" computer is not normally intended for RTTY use it will need special interface equipment and a special programme for RTTY use.

In conclusion I trust this has been helpful to those who are considering using RTTY and also informative to other amateurs who like to be well informed concerning all modes available to them. The foregoing has been written in a non technical way using some very generalized statements that are normally true but perhaps omitting some details that my more technically minded friends, might regard as very important. I hope such will forgive me.

At the moment most material has been aimed at non RTTY operators, but it is my intention to become more technical after the ground work has been completed.

73 Bruce VK5XI

AR



## EDUCATION NOTES

Brenda Edmonds VK3KT  
Federal Education Officer  
56 Baden Powell Drive, Frankston, Vic. 3199

From time to time I overhear comments on air about education matters in general and exams in particular. Some of these come directly or indirectly from operators who have recently sat an exam, or from class instructors — others came from members with strong views on such matters. Some are criticism of particular exams or questions, others query the whole exam concept or techniques.

But in the time I have held this position I have had only half a dozen or so direct comments. PLEASE — don't just whinge on air. If you (or a friend) have a genuine complaint about a particular paper or question, let me know about it and I will make enquiries. Write down your complaint, or what you think the question said, tell me why you are complaining, and send it to me (QTHR).

The Wireless Institute has arranged with DOC for me to have access to copies of the exam papers used, so I can check on any that are queried. If there is genuine cause for complaint, the matter will be rectified. However we should all be aware that the recent examinee retains a very biased memory of the exam and questions — in many cases the recalled question is quite different from the original.

Of the papers I have seen so far, I do not think the average of 'doubtful' questions would be any more than two per paper.

If you have strong views about the direction education should be taking — again, please let me know.

The two syllabuses will shortly be undergoing revision — any input will be welcome. Alternatively you can forward your ideas to the executive via your local division. Does

your division have a defined policy on education and an active Education Officer? I have had little evidence of such from some states. Perhaps this could be considered before the next Federal Convention.

If I am to be of service to all VK amateurs (or potential amateurs) I need to know what the divisions are doing. One thing I particularly need to know is what classes are being run and where, so that I can direct enquiries to the right contact.

Please make sure that your club secretary or class co-ordinator lets me know if classes are planned or in operation.

I would also like to hear from those selfless souls who are running 'informal' classes for small groups, particularly in the country areas. There may be many ways I can help these enthusiasts.

Now that daylight saving has ended in Melbourne the Education net will run at 1100 UTC, Wednesday evenings about 3.685 MHz.

My idea of this net is to bring together class co-ordinators and education officers for sharing ideas about syllabus, teaching techniques and policies. It is not a 'Brainstrust' to answer or pass exam questions. Of course it is not restricted to those mentioned, all ideas and comments are welcomed.

It has been suggested that there is a place for a "Brainstrust" or an air class type of net in the Novice Bands. Who would be interested? How many would be willing to participate? Again, I would be interested to hear your ideas.

73  
Brenda VK3KT

AR



## QSP

### AMATEUR AUTOMATIC TELEGRAPH TRANSMISSIONS

As a result of decisions reached at WARC-79 and representations from amateur groups, DOC advise that the use of telephony or morse code will no longer be a mandatory requirement for identification purposes when using RTTY or ASCII transmissions.

In accordance with the provisions of Article 25 of the Radio Regulations of the ITU, identification may now be in any one of the following forms:

- speech, using simple amplitude or frequency modulation;
- international morse code transmitted at manual speed;
- a telegraph code compatible with conventional printing equipment;
- any other form recommended by the CCIR.

Accordingly, paragraphs 5.27 and 7.4 of the Amateur Operators Handbook will be amended to reflect these changes in due course.

AR

# NATIONAL EMC ADVISORY SERVICE



Tony Tregale VK3QQ  
National EMC Co-ordinator  
38 Wattle Drive, Watsonia, Vic. 3087

## UNITED STATES GOVERNMENT GIVES FCC POWER TO REGULATE EMI/RFI SUSCEPTIBILITY

House of Representatives Bill HR3239 (5008) Communications Technical Amendments Act of 1982 has been passed by the House, the Senate, and signed by the President — It is now Public Law 97-259. The Bill is similar to S929 the one introduced by Senator Barry Goldwater, K7UGA to amend the U S Communications Act of 1934. While the Bill contains several important provisions, one which is of special interest to the amateur service covers susceptibility. The FCC is given the authority to regulate the susceptibility/immunity of electronic equipment to EMI/RFI. This authority is required in order to stem the introduction of electronic devices which cannot function normally in the presence of EM/RF energy.

### UNITED STATES CONGRESSIONAL RECORD Proceedings and Debates of the 97th Congress, second session WASHINGTON, THURSDAY, AUGUST 19, 1982 HOUSE OF REPRESENTATIVES

The following extracts from the Congressional Record has the legislative history of Public Law 97-259. The legislation was passed by the U S Congress as HR Bill 3239, and when President Reagan signed it on September 13 it immediately became Public Law 97-259.

Conference report on HR 3239, Federal Communications Commission Authorization Act of 1981.

Mr Wirth submitted the following conference report and statement on the Bill (HR 3239) to amend the COMMUNICATIONS ACT of 1934 to authorize appropriations for the administration of such act, and for other purposes.

Short Title  
"COMMUNICATIONS AMENDMENTS  
ACT of 1982"

While the Communications Act of 1934 has been amended several times since its initial passage, it has never received a thorough technical overhaul and clean-up.

The Act still contains numerous instances of obsolete language, while imposing regulatory requirements and responsibilities upon the FCC which are no longer necessary in light of advancements in technology and changed circumstances.

#### INTERFERENCE WITH ELECTRONIC EQUIPMENT

Section 108(a)(1). The first sentence of section 302(a) of the Communications Act of 1934 (47 USC 302(a)) is amended by inserting "(1)" after "regulations", and by inserting before the period and at the end thereof the following: "and (2) establishing minimum performance standards for home electronic equipment and systems to reduce their susceptibility to interference from radio frequency energy".

(2) The last sentence of section 302(a) of the Communications Act of 1934 (47 USC 302(a)) is amended by striking out "shipment, or use of such devices" and inserting in lieu thereof "or shipment of such devices and home electronic equipment and systems, and to the use of such devices".

(3) Section 302(b) of the Communications Act of 1934 (47 USC 302(b)) is amended by striking out "ship, or use devices" and inserting in lieu thereof "or ship devices or home electronic equipment and systems, or use devices".

(4) Section 302(c) of the Communications Act of 1934 (47 USC 302(c)) is amended —

(A) in the first sentence thereof, by inserting

"or home electronic equipment and systems" after "devices" each place it appears therein; and

(B) in the last sentence thereof, by inserting "and home electronic equipment and systems" after "devices", by striking out "common objective" and inserting in lieu thereof "objectives", and by inserting "and to home electronic equipment and systems" after "reception".

(b) Any minimum performance standard established by the Federal Communications Commission under section 302(a)(2) of the Communications Act of 1934, as added by the amendment made in subsection (a)(1), shall not apply to any home electronic equipment or systems manufactured before the date of the enactment of this Act.

A. Amateur radio service — The amateur radio service is as old as radio itself. Every single one of the early radio pioneers, experimenters, and inventors was an amateur: commercial, military, and government radio was unknown. The zeal and dedication to the service of mankind of those early pioneers has provided the spiritual foundation for amateur radio over the years. The contributions of amateur radio operators to our present day communication techniques, facilities, and emergency communications have been invaluable.

In the early 1920s, amateurs were relegated to the portion of the radio frequency spectrum that was considered at that time to be virtually useless: the short-waves below 200 metres. These short-waves that once were considered

useless are now occupied by marine and aviation, police and public safety, television and FM broadcast, international broadcast, and amateur services, to name a few.

Amateurs are pioneering still today. Space or satellite communications are a most important part of amateur radio. Through Programme OSCAR (Orbiting Satellite Carrying Amateur Radio), amateurs have been utilizing advanced technology from their relatively simple, inexpensive ground stations. Seven amateur satellites have been built to date by amateurs at their expense. The amateur space activities are playing an important role in attracting the young people of America to scientific fields.

Almost every nation has amateurs who communicate each day with fellow amateurs in other countries and on other continents passing vital emergency message traffic and acting as ambassadors of international goodwill. The modes of communication include Morse code telegraphy, telephone, teletype or teleprinter, television and facsimile. Equipment ranges from home-built transmitters and receivers using parts from discarded radio and television receivers and costing only a few dollars, to the most sophisticated equipment manufactured for commercial, government, and military use costing many hundreds of dollars.

There are approximately 400 000 amateurs in the United States and almost 900 000 throughout the world. At any time of every day, thousands of amateurs scattered throughout the world are listening to and communicating with fellow amateurs over distances varying from only a few miles within a city to thousands of miles across the world. It is the large number of amateurs dispersed around the world operating in the five high frequency bands that has made it possible to provide the first, and for some time thereafter, the only communication links between areas devastated by natural disasters — earthquakes, tidal waves, hurricanes, tornadoes, blizzards and floods — and the outside world.

Every amateur has earned his licence by having demonstrated his knowledge of radio theory and application, International Morse Code, the Communications Act, and the regulations of the Federal Communications Commission. Entry into amateur radio usually is through the Novice Class. Amateurs are encouraged to increase their knowledge and skills by a series of five classes or grades of licence, all but one with limited operating privileges.

The Amateur Radio Service has been praised for being self-regulated. The Commission has reported that less time has been devoted to monitoring and regulating the Amateur Service than to any other service because of its self-policing and discipline.

One primary purpose of the Conference Substitute is to provide the Federal Communications Commission with the authority to implement various programmes which will result in improvements in administration of the amateur radio service and to cut the cost thereof. It will further allow the amateur radio service to continue its tradition as the most self-regulated radio service in the United States, and to become to some extent self-administered, requiring even less expenditure to government time and effort than in the past.

*D. Radio frequency interference rejection standards* — Radio frequency interference (RFI) arises when a signal radiated by a transmitter is

picked up by an electronic device in such a manner that it prevents the clear reception of another and desired signal or causes malfunction of some other electronic device (not simply a radio or television receiver). While almost any transmitter of any service is a potential interference source, Amateur or Citizens Band (CB) stations are very often associated with RFI problems involving electronic devices in the home.

Particularly since the advent of commercial television immediately following World War II, amateur radio operators have been active in interference control and elimination. The amateurs learned very early that the incorporation of good engineering practices in their transmitter construction, such as electrostatic shielding and filtering, minimized the possibility of interference by preventing the radiation of spurious signals. Such practices and techniques are well understood and are universally incorporated in transmitters manufactured and in use today, irrespective of the service. Appropriate rules of the Federal Communications Commission require all transmitters of all services, including the transmitting sections of transceivers, to suppress spurious radiation.

*It has become evident that many interference problems involving home electronic equipment and systems are not fully resolvable through taking protective steps with the transmitting equipment, but that resolution of some interference problems may require action with respect to receivers and other electronic devices picking up unwanted signals.*

Causes for interference to television reception, for example, can be divided into the following categories. First, although least common, is the pickup of a spurious (unwanted) signal having a frequency within or close to the band of frequencies occupied by the television signal. Such interference usually is caused by an interfering transmitter. In many instances, there is what is termed a harmonic relationship between the transmitter frequency and the television channel. That is particularly the case with the 27 Megahertz CB service: the second the third harmonics (multiples) of the 27 Megahertz CB signal fall in TV Channels 2 and 5 respectively. It is generally recognized that no TV design can eliminate susceptibility to harmonic interference. Second is the overloading of the input circuit of the television receiver by an undesired signal so strong that overloading, i.e. malfunctioning, of the circuits generates spurious signals within the television receiver that interferes with the desired signal. Such interference usually is more severe with transistorized receivers and may result from poor circuit design in the receiver. Third is the pickup of an undesired signal by circuits within the set or wiring leading to the set. Poor shielding or poor circuit design in the receiver is usually the culprit.

Interference to other electronic devices such as record players, hi-fi amplifiers, home burglar alarm and security systems, automatic garage door openers, electronic organs, and public address systems usually arises from the pickup of a relatively strong signal by the external wiring, such as the wires leading to the speakers or to the power source, followed by the rectification of the signal by a circuit, contact or component within the device.

The cures for most such interference have been well known for many years. Often an

inexpensive filter in the lead from the antenna to the television receiver will reduce the interference to an acceptable level or eliminate it entirely. For the other electronic devices, the judicious installation of inexpensive capacitors (devices which prevent wiring from picking up undesired signals) may suffice.

Even though the causes and cures of radio and television interference have been known for many years, the number of complaints received by the Commission has grown steadily each year. With the rapid, and indeed explosive, growth of the 27 MHz CB service in the mid-1970s, the probability of a home electronic device being located near a transmitter of some sort has increased substantially. The public's use of home electronic devices has grown, and continues to grow, at an exponential rate.

Many manufacturers of home electronic equipment and systems have been willing to provide, often free of charge, filters for electronic equipment when a particular interference problem is brought to their attention. *However, their efforts to voluntarily address the root problem by incorporating such RFI suppression techniques in the design and assembly-line stage have been less than adequate. This is true even though such filtering mechanisms and anti-interference design may only cost a few cents per unit.*

Many believe that the Commission does not now have authority to compel the use of protective devices in equipment which does not emit radio frequency energy sufficient in degree to cause harmful interference to radio communications. Manufacturers and retailers also believe that the Commission cannot require a label on equipment or the supplying of a pamphlet of the possibility of interference and outlining corrective measures. The Commission has thus far acted in consonance with this belief. *The Conference Substitute would thus give the FCC the authority to require that home electronic equipment and systems to be so designed and constructed as to meet minimum standards for protection against unwanted radio signals and energy.* Extensive amateur and Commission experience over the years with interference investigation and elimination supports the conclusion that, in most instances, satisfactory corrective measures can be simple and inexpensive. The Conferees by no means intends for major modifications and redesigns of equipment to be required, or that the Commission require steps to be taken which impose substantial additional costs or unnecessary burdens on equipment manufacturers. We do not believe that elaborate procedures will be necessary in order to achieve the desired result. Existing equipment and that manufactured prior to the date of enactment of this legislation will be exempt from any such standards as might be established by the FCC.

The millions of purchasers of television and radio receivers and other home electronic equipment and systems each year deserve protection from interference. Significant reduction of interference from the multitude of complaints received each year by the Commission should result from enactment of this provision, as should lawsuits against amateur and other radio operators in local jurisdictions based upon interference. Section 7 of the Conference Substitute is viewed by the Conferees as necessary to address adequately this in-

creasing problem, which plagues so many of the nation's consumers. Moreover, by virtue of this section, the Conferees wish to clarify that the exclusive jurisdiction over RFI incidents (including pre-emption of state and local regulation of such phenomena) lies with the FCC.

## INTERFERENCE WITH ELECTRONIC EQUIPMENT

### House bill

The house bill contained no provision.

### Senate amendment

The Senate amends Section 302(a) of the Communications Act of 1934 and authorizes the Commission to establish minimum performance standards for "home electronic equipment or systems" to take appropriate action in order to protect such equipment from radio frequency interference (RFI).

### Conference substitute

The conference substitute adopts the Senate provision.

For many years, public complaints have persisted about radio frequency interference to consumer electronic equipment, such as television sets and radio receivers. This interference has often been attributed to transmissions from the Amateur and Citizens Band (CB) radio services.

The Conferees wish to emphasize that it was its hope that voluntary efforts by manufacturers to reduce RFI when possible, as opposed to the use of government regulation, would be sufficient. Devices designed and marketed for use in a commercial environment normally include necessary protection against interference and do not require Commission regulation. In the market for home devices, however, good faith industry attempts to solve this interference problem have not always been as successful. Thus, in view of complaints regarding home devices, the Conferees believe that Commission authority to impose appropriate regulations on home electronic equipment and systems is now necessary to insure that consumers' home electronic equipment and systems will not be subject to malfunction due to RFI. However, the legislation does not mandate Commission exercise of this authority; that decision is well within the technical expertise of the agency.

The Conferees intend that the Commission's authority apply only to "home electronic equipment and systems" likely to be found in a private residence and intended for residential use, as distinguished from devices intended for office and business use. Radio and television sets would be typical examples of equipment subsumed under the term "home electronic equipment and systems". Other examples include home burglar alarm and security systems, automatic garage door openers, electronic organs, record turntables, and stereo/high fidelity amplifier systems. Although this legislation is aimed primarily at home equipment and systems, it is not intended to prevent the Commission from adopting standards for such devices which are also used outside the home. Portable TV receivers and radios as well as medical alert devices, for instance, are intended to be covered.

A number of alternatives are available to the Commission in exercising the authority granted hereunder. *The Commission could direct manufacturers of some types of home electronic equipment and systems to meet certain minimal*

*standards by incorporating an interference suppression capability into their devices before the equipment is offered for sale.* On the other hand, the Commission may choose to require only a warning label on those types of home electronic equipment and systems for which the installation of filtering, shielding or other interference suppression components would be unreasonably costly in relation to the total price of the device, or where such installation otherwise is unreasonable or impractical. Such a warning could be given in a pamphlet or tag accompanying the equipment, and marketplace forces would determine the success of particular competitors who chose to rely on such warnings instead of actually building in the filtering devices necessary to fully protect against the interference.

The Conferees expect the Commission to exercise the authority granted herein, as it has exercised the authority granted under section 302 of the Communications Act of 1934, by balancing the cost of improving the performance of a device to particular levels against the benefit to be gained from requiring manufacturers to meet standards of various levels of stringency. In so doing, the Conferees expect the number of interference complaints recorded and investigated by the Commission to be significantly reduced.

The Conference Substitute is further intended to clarify the reservation of exclusive jurisdiction to the Federal Communications Commission over matters involving RFI. Such matters shall not be regulated by local or state law, nor shall radio transmitting apparatus be subject to local or state regulation as part of any effort to resolve an RFI complaint. The Conferees believe that radio transmitter operators should not be subject to fines, forfeiture or other liability imposed by any local or state authority as a result of interference appearing in home electronic equipment or systems. Rather, the Conferees intend that regulation of RFI phenomena shall be imposed only by the Commission.

Amateur radio needed a solution to the problem of its being blamed for the inability of electronic devices to reject unwanted radio signals. Consumers found it difficult to accept the concept that a TV or stereo could be a "source" of interference. ARRL leaders monitoring the political and technological trends knew that, with time, the RFI situation would only get worse. Amateur radio operators would bear more and more of the undeserved blame for a growing RFI problem and local and state governments would bow to local political pressure and enact laws that would hamstring amateur operation. The FCC, however, did not have the authority to set minimum RFI-rejection standards for home electronic devices. Amateur radio needed a law that would amend the Communications Act to give the Commission this authority. Amateur radio also needed a law that would make it clear, once and for all, that matters involving RFI are preempted by the Federal Government and are not subject to regulation by state or local governments.

The ARRL wanted legislation, not compromises! "We know what the problem is; it's just the matter of doing something about it," they said.

And now something has been done! The FCC now has the authority to require that home electronics equipment will have to meet RFI susceptibility standards.

Congratulations to the ARRL and all those involved in this wonderful breakthrough for the Amateur Radio Service.

AR

## WHERE DO IDEAS COME FROM?

When you sit down to home brew something new, something that has never been built before, you force yourself to use more of your mind than if you were eating, sleeping or catching a train. Supposing you succeed, you construct a gizmo that has never been built before and it does marvellous things. Why was it not already built? Why did history wait until now for this device to exist when it could have been around fifty or a hundred years ago.

For most part this situation exists because new gadgets are not constructed until an immediate need occurs or an innovation is stumbled across. The limiting factor is the human mind, as our educational system impresses itself upon us over a period of time, fixed ideas develop about what is possible and what is sheer fantasy.

Consider a squid that can play a piano, you would probably think that this is not possible but has anyone ever placed a squid on a keyboard and shown it the keys? Personally I could not be bothered, but the first step is to ignore the fact that it cannot be done and take a trip to an aquarium.

This type of thinking should be applicable to any sort of problem; when faced with a dilemma forget half of what you have ever learned and try again. Is this what Tesla did when he drop-kicked the lead acid battery and invented three-phase power. Only the ability to forget that a thing is impossible enables you to do it. How else could it be that you can fly a jet around the equator or land on the moon; which is of course absurd as everyone knows, the world is flat.

Ian Jackson VK3BUF in 'Gateway'

AR

## THOUGHT FOR TODAY:

Low SWR is not proof of a good quality antenna system or that it is efficient. Lower than normal SWR exhibited over a frequency range by a straight dipole or a vertical over ground is a clue to trouble, in the form of undesired loss resistance.

## AND . . . A THOUGHT FOR TOMORROW:

The radiator of an antenna system need not be of self resonant length for maximum resonant current flow; the feed line need not be of any particular length and a substantial mismatch at the line antenna junction will not prevent the radiator from absorbing all real power available at the junction.

Ref: W Maxwell, QST June 1973

From Oxley Region Amateur Radio Club Magazine — "OXIALES" — Xmas 1981.

AR



## RON WILKINSON ACHIEVEMENT AWARD

Presented to  
in recognition of outstanding achievement in

This years recipient of the award is Dick Norman VK2BDN.

Proposed by the Executive for many years of activity on microwave experiments and a lifetime of dedication to VHF/UHF culminating in a 1296 MHz contact from NSW to ZL in January 1982.

Dick has had several articles published in the amateur press.

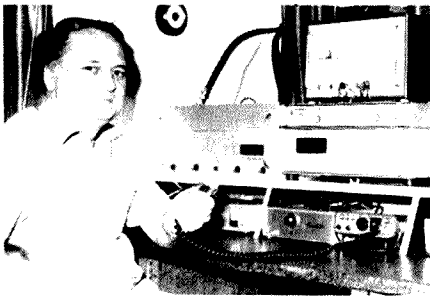

This Award was set up in March 1978 funded mainly from interest derived from the investment of \$1100 donated by Mrs Mary Wilkinson, widow of the late Ron Wilkinson VK3AKC, in his memory. The qualifications for the Award are as follows:

The Award is for special achievement in any facet of amateur radio. The following examples illustrate the level of achievement which will be taken into consideration in making the Award:

Outstanding communication achievement.

Article for Amateur Radio Magazine.  
Holder of Australian DXCC.  
Development of state of the art techniques.

Involvement in Institute affairs.  
Microwave activity.  
Involvement in WICEN, Education Clubs or similar.

Achievement in using amateur satellites.  
Notable Public Service.

These are only examples. As can be seen the Award is extended to cover the whole gamut of amateur radio activities.

(AR March 1978, page 17.)

## URGENT!

Please let us know of clubs and schools etc. starting theory classes.

Where, when, how much and whom to contact.

Contact Brenda QTHR



## COMMERCIAL CHATTER

### VICOM'S CHANGING BUSINESS

Vicom International, the company which has established the Icom name in Australia over a period of eight years will continue to be an Icom dealer, selling from its premises at 57 City Road, South Melbourne.

Vicom's Managing Director, Russell Kelly, said that Icom's decision to set up its own office in Australia would allow Vicom to concentrate on the products which have become more important to it over the last few years. Vicom will continue to ensure however that its amateur customers receive the high standard of service offered since Vicom survey has shown that amateurs are include maintaining the high standard of Icom service it has offered in the past.

Vicom has constantly examined the amateur market to decide where it should concentrate its attention. For example, a Vicom survey has shown that Amateurs are expanding their stations with new accessories rather than new transceivers. It has also found that not only is the number of new amateurs slowing dramatically, but that existing amateurs are not expanding their stations as eagerly as they have in the past. The decline in amateur radio activity in Australia is consistent with a world-wide trend, but also appears to be associated with the depressed Australian economy.

Vicom will continue to support amateurs, but is planning to emphasise the accessories in its range. Daiwa products, many of which feature a unique cross-needle meter, are proving to be of continued

importance to amateurs, along with Linear Amplifiers and RTTY equipment from Tono. Vicom is the exclusive Australian distributor for Tono and Daiwa.

Vicom's business has become increasingly concentrated in its professional division. For several years now, the product range has included a number of very successful products designed for government and commercial use and this has formed the majority of Vicom's business. Many government departments for example, rely on Vicom for sophisticated transmitting and receiving equipment and RF test equipment. Private industry finds Vicom invaluable because of its varied range of specialised test equipment.

Vicom's professional division supplies products from a number of overseas companies which Vicom represents exclusively in Australia. Companies represented range from IFR of the US which manufactures communication service monitors and avionics test equipment, to Adret and Giga of France, manufacturing signal and sweep generators. A number of other companies around the world have chosen Vicom to represent them in Australia. Vicom, for example, is also making moves into fibre optics and satellite communication.

The electronic communication industry is changing dramatically all the time, and Vicom attributes its own success to its constant review of the areas which are declining or expanding.



## QSP

### POWER LINE NOISE

OVERHEAD POWER LINES AND HIGH VOLTAGE EQUIPMENT

Strong USA representation on the sub-committee preparing the CISPR manual on, "INTERFERENCE FROM OVERHEAD POWER LINES AND HIGH-VOLTAGE EQUIPMENT" should result in the manual, particularly part two, being accepted by the United States electric supply utilities and by the FCC.

Canada is conducting interference measurements in the vertical direction over power lines using EMI measurement instruments in helicopters.

### MOTOR VEHICLE IGNITION SYSTEMS

Interference from motor vehicles and internal combustion engines is the subject of a report submitted to the CISPR in Stockholm by a Japanese delegation. The

report covers three to four years work on broadband antenna measurements.

Also being received by the CISPR is a report from the USA covering four years research on, "Interference to Mobile Radio Communications by Ignition Systems of Individual and Groups of Vehicles."

### CABLE TV CONFERENCE

Delegates at a recent two day conference organised by ACASCA (Australian Cable and Subscription Communication Association) in Canberra were surprised by the fact that the Minister for Communications, Mr Neil Brown did not give the green light to the early introduction of cable and RSIV (Radiated Subscription Television) as recommended in the report of the Australian Broadcasting Tribunal.

Mr Brown said that the public (and his government) had still to be sold on the benefits of introducing any new forms of communication systems.

So it seems that Cable Television will not begin as early as the recent Australian Broadcasting Tribunal's report led us to believe.

A key speaker at the conference — American newscaster Walter Cronkite, disappointed the delegates when he discussed the failure of Cable Television in the United States.

# KENWOOD

Take advantage of the Yen currency inflation Buy Kenwood now before the scales tip!



**NEW R-2000 RECEIVER WITH MEMORY SCAN, PROGRAMME SCAN & MEMORY MODE RETENTION**

**\$599** OPTIONAL VHF CONVERTER AVAILABLE EASTER '83



**TS-930S SOLID STATE HF TRANSCEIVER**

COMPLETE WITH FREE MC-42S UP/DOWN SCANNING MICROPHONE

**\$1,799** THE NEW PACESETTER IN HF TRANSCEIVERS



**TS-430S EXPORT MODEL**

INCLUDES UP/DOWN SCANNING MICROPHONE — MOBILE MOUNTING BRACKET — ORIGINAL "ENGLISH" INSTRUCTION MANUAL

**\$950** 12 MTH GUARANTEE

**7 ELEMENT YAGI**

KENWOOD ANNOUNCE THE RELEASE OF A NEW LOG PERIODIC!

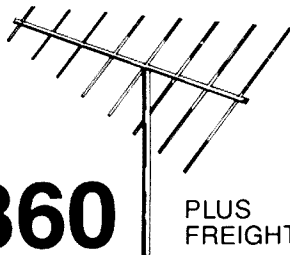

**\$360** PLUS FREIGHT

KENWOOD AUSTRALIA WAS HAPPY TO SUPPLY FREE OF CHARGE A TS-8305 STATION TO THE HEARD ISLAND EXPEDITION.

Dr. David Lewis leader of the 1982/83 Oceanic Research Antarctic Expedition has chosen Kenwood Communications Equipment on board the "Dick Smith Explorer". Where lives and safety are paramount and reliability is of prime importance — the professionals always choose **KENWOOD**

Frequency range 13 MHz to 30 MHz. Boom length 7.3 metres.. Longest element 11 metres. Average gain 10dB. Front to back ratio 19 dB. Maximum power 2kW. Shipping weight 18 kg.

**REMEMBER!** Get all Sydney items TRIO-KENWOOD (AUSTRALIA) PTY. LTD.

**TRIO-KENWOOD (AUSTRALIA) PTY. LTD.**  
(INCORPORATED IN N.S.W.)  
4E WOODCOCK PLACE, LANE COVE, SYDNEY, N.S.W. 2065. Ph. (02) 428 1455.

**NEW SOUTH WALES**

- SPRINGWOOD CAR RADIO — SPRINGWOOD (047) 51 4930
- UNIQUE ELECTRONICS — 383 MERRYLANDS ROAD MERRYLANDS (02) 682 3325
- WASSLEL ELECTRICAL — 10 McNAMARA STREET ORANGE (063) 62 6249
- STOCKMAN & HIGGINS — BYRON STREET INVERELL (067) 22 1300
- ELECTRON 2000 — 3 ELIZABETH STREET TIGHS HILL NEWCASTLE (049) 69 6399
- MACELEC PTY LTD — 99 KENNY STREET WOLLONGONG (042) 29 1455
- RADIO WORLD PTY LTD — 81 NEWCASTLE STREET Fyshwick (062) 80 6550
- OX ENGINEERING — 5 JASMINE STREET PORT MACQUARIE (065) 83 2175
- LAND LINK — MULLALEY ROAD GUNNEDAH (067) 42 2838
- LAND LINK — 61 BARNES STREET TAMWORTH (067) 65 4622
- FRANK BOUNDY — LISMORE (066) 569 7360

**INTERSTATE**

- VIC: EASTERN COMMUNICATIONS — 168 ELGAR ROAD BOX HILL (03) 288 3107
- BRIAN STARES — 11 MALMSBURY STREET BALLARAT (053) 39 2808
- SUMNER ELECTRONICS — 78 KING STREET BENDIGO (054) 43 1977
- CODLIN ELECTRONICS — MOE (051) 27 4516

- TAS: HOBBY ELECTRONICS — 83 CARELLA STREET HOWRAH HOBART (002) 47 6674
- GELSTON ELECTRONICS — 40 LAVENDER GROVE SUMMER HILL (003) 44 3882
- ADVANCED ELECTRONICS — 5A THE QUADRANT LAUNCESTON (003) 31 7075
- V.K. ELECTRONICS — 57 WEST PARK GROVE BURNIE (004) 31 1708
- DLD: MITCHELL RADIO CO — 59 ALBION ROAD ALBION (07) 57 6830
- S.A. & N.T.: INTERNATIONAL COMMUNICATIONS SYSTEMS PTY LTD — 8 MILE ST. PORT ADELAIDE (08) 47 3688
- W.A.: ARENA COMMUNICATIONS SERVICES — 642 ALBANY HWY. EAST VICTORIA PARK (09) 361 5422
- TRI-SALES — CNR NEWCASTLE & CHARLES STREETS PERTH (09) 328 4160
- WILLIS ELECTRONICS — 73 STERLING STREET, PERTH (09) 328 9229
- GRAHAM ROGERS — 18 BANKSIA STREET BUNBURY (097) 21 2236
- RON DENT — 115 PATON ROAD SOUTH HEADLAND (091) 72 1112



# VK4 WIA NOTES

## PRESIDENT'S REPORT 1982

For many years, amateur radio has been a growth industry. The magic milestones in VK4 of 500 members, 750, 1000, and now 1400 members have been reached and then left behind as more people join our Institute.

With this expansion, the administrative structure of the institute in Queensland has been stretched to the limit. At the 1980 AGM, it was recommended by some life members that members consider appointing a part time paid Secretary/Manager as the workload was too much for volunteers.

Since, council has tried to restructure our organization to avoid paid labour and to maximize the use of volunteer labour. So far we have been successful, and our membership fees as a result are by far the lowest in Australia. However, we will only be able to retain this volunteer status with the assistance of members throughout Queensland.

The institute affairs in VK4 are now divided into the running of the essential daily business and the policy making or management areas.

Council is ultimately responsible for both, but mainly concentrates on the policy areas and allows other volunteer workers to concentrate on chosen specialities.

## RETIREMENTS

1982 started with the retirement for a well earned rest for three members who have given their all to our hobby.

Alex McDonald VK4TE — the best treasurer this division has had — who guarded our finances and watched them grow ten times in eight years — our federal councillor for three years and a man who always urged us to think VK and not just VK4.

Tom Austin L40787 — our inwards QSL officer for four years, one of the most essential and yet most routine and time consuming tasks of any in our hobby.

Bill Gielis VK4ABG — Bill, transferred from Townsville to Brisbane, saw the Institute's critical need for assistance and took over as secretary. For several years he gave his all in almost singlehandedly running this division's administration.

## INWARDS QSL

In January, Dr Murray Kelly VK4AOK, his parents Pat and Melita Kelly and their devoted helpers took over the inwards QSL bureau. The sunspot cycle may be waning but with the natural lag in QSLing, over 80,000 cards were despatched to licencees throughout Queensland. Inwards QSL cards are sorted into callsign order and then distributed through our regional clubs, through the monthly general meetings in

Brisbane (if arranged) or through direct mailing where postage credit exists. Because of the vast size of VK4 individual mailing of cards must always be provided. About sixty voluntary hours per week are given to the inwards QSL bureau.

## OUTWARDS QSL

The outwards QSL bureau run by Mick and Chris Bently VK4AMB and VK4ABM despatched over 60,000 cards, including 3000 cards for AX4QCG. Thank you Mick and Chris for the fifteen hours a week you do not spend on air to ensure that VK4 cards go around the world.

## NEWS AND INFORMATION SERVICE

We are a communications hobby, yet one of the hardest things for us to do is to communicate. Communications is a two way process and like most amateurs we sure can transmit well!

Every week Bud Pounsett VK4QY and his XYL Bonnie collate the weekly broadcast from a variety of sources.

This broadcast service, on nine different frequencies would be impossible without the co-operation of our rebroadcasters both in Brisbane and throughout the state.

A new innovation has been the use of page 739 in BTQ Ch 7 Teletext service where items of amateur radio interest are displayed by courtesy of that channel's affiliated radio club, another first for VK4 using new technology to publicize our hobby!

The divisional insert QTC has been published since 1927 and is arguably the oldest continuing AR publication in the world.

About twenty-five hours a week spread among more than a dozen members is spent on this division's transmitting service.

The often forgotten but equally important area of communications, receiving, is catered for in four main ways:

1. Our annual Radio Club Workshop where delegates from affiliated clubs throughout VK4 express their club's viewpoint.
2. Our club net every Tuesday 1930 EST on 3.605 MHz allows club representatives to express opinions on current topics. The Queensland net on Thursdays 1930 EST on 3.605 MHz allows individual members to express their attitudes.
3. By mail directly from members and clubs, council is kept well informed.
4. By the weekly HF callbacks after the news broadcast.

A further twenty-five hours a week is spent in this area of the VK4 division's activities.

## PUBLICATIONS

Anne Minter VK4NRA has, with incredible efficiency, run the division's bookshop and a healthy profit of \$2,600 has resulted on a turnover of over \$13,500. Postage costs especially to the far flung areas of VK4 have risen significantly but as far as possible council is trying to provide equal services for our members wherever they live. About twenty hours per week of volunteer time are spent in running your bookshop.

## INTRUDER WATCH

Gordon Loveday VK4KAL of Rubyvale and his band of helpers have again kept to a minimum the activities of intruders. A common example is the Japanese fishermen on 80 metres. Has your club appointed an intruder co-ordinator?

## VHF ADVISORY COMMITTEE

Bill McDermott VK4AZM, for the second year, has ably led his committee, Brian Rickerby VK4RX, George McLucas VK4AMG, Paul Hayden VK4ZBV, Ed Roache VK4KAA.

Further repeaters are in the final planning stages for Weipa (146.800) Townsville (438.225), Rockhampton (438.025), Gladstone City (147.200), Gympie (147.100), Roma (146.700), and the Rum City Group's RTTY 2 m repeater at Bundaberg is receiving further consideration. Several beacons are under consideration including the Tropical Region VHF Group at Cairns proposed for 144.540, 432.540 and 1296.540 MHz.

The co-operation of the South East Queensland Teletype Group in the formulation of acceptable standards has been greatly appreciated and in this area much more work federally will be carried out in 1983.

## DISPOSALS

Dave Laurie VK4DT and more recently Bill Dagleish VK4UB have capably handled the profitable task of disposals.

About five hours a week are spent in collating, testing and packing these treasures.

## HISTORIAN

Peter Brown VK4PJ enjoyed a well earned holiday for part of this year but still has produced an amazing volume of historical notes from information sent to him.

Part of Australia's heritage, in the form of the memories and memorabilia of our early amateurs, is rapidly becoming lost. Please, all you pioneers of radio, ensure your stories are recorded on tape, your photographs labelled, your books stored, and above all, that your relatives know what items are of future historical interest.

## AWARDS MANAGER

John Moulder VK4YX and Trevor Knight VK4NLX of Warwick have quietly looked after this area of institute activities and several VK4 Award Certificates have been issued.

## CONTEST MANAGER

Bill Sebbens VK4XZ of Townsville has again capably looked after this task. Bill has activated many clubs into participating in the Jack Files Sunshine State Contest but has now relinquished this position.

## WICEN

Ken Ayers VK4KD has continued to co-ordinate WICEN activities throughout the State and the ever increasing activities of WICEN has provided invaluable publicity to our hobby. Congratulations Ken and to all the regional co-ordinators and WICEN officers throughout this cyclone-prone state. Countless numbers of hours are given to WICEN in VK4 and our image in the community has never been higher.

## SLOW MORSE

Phil Aldred VK4CA together with a few other dedicated souls have tapped out slow morse sessions in VK4 for many years. Following an offer by Townsville Amateur Radio Club to assist in this area, council voted \$400 for the design, assembly and testing of several interface units to enable any amateur to use computer generated tapes and transmit perfect morse. It is intended for clubs throughout VK4 to transmit on 3.535 MHz a half hour session at 19 30 EST every day of the week.

## MEMBERSHIP

Dave Richards VK4UG has, for many years, written to all new licencees inviting them to become part of the Institute. This year, Dave took over the full duties of membership secretary.

VK4 has for many years a membership percentage well above the VK average but until our percentage of members is 75% of the total of licenced amateurs in VK4 we will not be able to relax. Dave's efforts this year have shown pleasing results with our membership now being over 1400. Thanks for the twelve hours or so that each week you devote to this critical area of our activities.

## CONCLUSION

To serve over 1400 members nearly one hundred and fifty hours of volunteer work is given each week of the year and this massive workload is spread among about 50 members throughout VK4. How about offering your help in 1983 and spreading the load a little further?

## COUNCIL ACTIVITIES

Council has concentrated on being a management and policy making body.

## MEMBERS

The Annual General Meeting was held in February and only ten members had nominated for the council of twelve. These initial team members were Rod Taylor VK4NBD/YRT, Harold Bemerman VK4HB, Fred Saunders VK4AFJ, Ross Mutzelburg VK4AQK, Claude Singleton VK4UX, Ken Ayers VK4KD, Jack Gayton VK4AGY, John Aarsse VK4QA, Guy Minter VK4ZXZ and Ray Roche VK1ZJR. Of ten volunteers,

only five live in the Brisbane metropolitan area and the other five travelled at their own expense up to one hundred km each way every month to serve their hobby.

During the year, Barry Ker VK4BIK and Doug Charlton VK4JB joined the team and Ray VK1ZJR was transferred to VK3.

## HIGHLIGHTS OF THE YEAR INCLUDE

*Radio Club Workshop* — Delegates from every affiliated club in Queensland are invited to attend our annual Workshop in April, and in 1982, thirty-nine club delegates and observers attended the live-in weekend at Griffith University. Assistance is given with travelling expenses for delegates who travel long distances. The cost of nearly \$2300 represents \$1.65 a member but the benefits to council and to members are immense. In VK4, because of the feedback obtained at the Workshop and on the Club Net, our council makes decisions based on the expressed wants and needs of the members. At the Workshop, our federal delegates have a dress rehearsal for the Federal Convention held in Melbourne a fortnight later and this ensures that the voice of VK4 is heard loud and clear by the rest of VK.

*Ionospheric Prediction Service* — Division took the opportunity in May to stage a seminar by Dr Leo McNamara of the IPS on ionospheric predictions. Somewhat to our surprise in these days of failing sunspot activity, only twenty members attended the excellently prepared seminar. However, as the majority of our members live outside Brisbane, lecture notes were forwarded to clubs where they were well received. The monthly prediction service compiled by Nev Wright VK4ANW from IPS data is a monthly highlight of our news broadcast service.

*Federal Convention* — Dave Laurie VK4DT and Guy Minter VK4ZXZ attended and had been extremely well prepared by the Club Workshop. Because of prior discussions of the federal motions by VK4 clubs and the direct input available through the Workshop, VK4 members take an active interest in the Federal Convention and know that they play a vital part in THEIR convention.

*Education Seminar* — Ron Smith VK4AGS led this weekend seminar in July to "Educate the Educators" with the objective to improve instructional techniques in our clubs. Education is not just a matter of teaching theory to potential licencees but is a continuing process. Post licence education is essential.

Special congratulations must go to Rod Taylor VK4YRT/NBD for his efforts in the field of further education and we look forward to more seminars and a progressive uplift in standards generally.

*Club Visits* — Council members made themselves available wherever possible to visit clubs throughout the state. Clubs from Townsville to Roma had the opportunity to ask about the Institute directly from a member of council.

*AX4QCG* — The 12th Commonwealth Games were held in Brisbane from 30th September to 9th October. AX4QCG was

there and was heard all over the world. An incredible amount of organizing and preparing time was expended together with about \$2000 of the division's funds but immense goodwill was created for our hobby. Congratulations to David Jones VK4NLV and your band of thirty helpers.

*Hamfest/Convention November '82* — We decided to invite the Federal President to fly from Melbourne to Surfer's Paradise for the weekend of our Convention. Bruce Bathols VK3UV agreed to come and flew into Brisbane on Friday night. On Saturday, Bruce attended the Hamfest/Convention and circulated among over five hundred amateurs, spouses and harmonics who attended.

At the Convention Dinner, the attendance was disappointingly small, but fifty members who attended thoroughly enjoyed the evening. Bruce, was our guest speaker but we were also pleased to hear Art Burton VK4FE talk about his experiences on Heard Island in 1949. Unfortunately, that evening was Art's last outing. He became a silent key on 30th November.

*Political Lobbyists* — Council's greatest success story this year has been in our contacts with Australian politicians. In these times of complicated technology too often we, as technicians, get carried away with the undoubted attractions of an argument based on technical facts. However the majority of decisions in a democracy are made by politicians, and politicians are not technical people. Too many facts confuse people and politicians are no exception.

Using information given to us by the Honourable Mr David Jull MP, Chairman of the Parliamentary Backbench Committee for Communications, the VK4 Council has become a powerful lobby group for amateur radio. In June we arranged for copies of an "Amateur Radio" article on Electromagnetic Compatibility (EMC) to be sent to twenty-five selected Federal politicians. This initiative has now been adopted Federally. As the introduction of the long awaited (and still awaited) Radio Communications Act loomed near, we intensified our efforts to ensure that our hobby would benefit from any changes. Cable Television, a potential disaster area for us all, also received much attention.

However we have maintained constant liaison with Federal Executive so that any action of ours supplements discussions that they may be having with the Department of Communications.

*Conclusion* — This has been a hectic year with many new and useful activities commenced. I thank everyone associated with the Institute for the effort they have put into being part of the team here in VK4.

However, volunteers for the many aspects of running our hobby are required. If you feel you can be of any assistance, please contact your Institute and join the team of people who are making your hobby more rewarding.

Guy Minter VK4ZXZ  
VK4 DIVISION PRESIDENT

AR



# VK2 MINI BULLETIN

Athol Tilley VK2BAD  
PO Box 1066, Parramatta, NSW 2150

## ANNUAL GENERAL MEETING

All financial members of the WIA NSW Division will receive, in early March, notice and agenda of the Annual General Meeting of the division.

Please consider the items carefully and, if you are unable to attend, forward a proxy nominating either an Ordinary member or the meeting Chairman to act on your behalf. If a ballot is necessary for Council, papers will be included with the notice of the meeting. It is in your interests to carefully consider the candidates you wish to represent you on Council and to return a correctly completed ballot paper. Read the instructions carefully.

As the questions before the meeting are of importance to all members, you should attend the meeting if you are able.

## 8th CONFERENCE OF CLUBS

This conference will be held at the WIA office in Parramatta on Sunday, the 17th of April, commencing at 10 AM.

Agenda items will close in early March so ask what items your club is submitting. The agenda will be sent to all affiliated clubs about six weeks before the Conference so the items can be discussed at club meetings.

## COUNCIL REPORT

Divisional Council met on the 21st of January at the NSW WIA office at 109 Wigram Street, Parramatta.

A quote to produce WIA QSL cards for members was accepted, details appear elsewhere in this column.

Council decided to increase the Correspondence Course marking fees, as they had not been altered for several years.

Annual accounts for the financial year up to the 31st of December, 1982 were discussed and they were adopted. It was resolved that the division's fixed assets of furniture, fittings and radio equipment be revalued and that the Director's Statement be adopted. Purchase of a filing cabinet for storage of club newsletters and publications in the library was authorized.

Thirty one new applications for membership of the Division were accepted, a most gratifying total in view of current economic effects.

Federal Councillor Stephen Pall, VK2PS, presented a federal report. The use of AX2ITU during WCY-83 by the division awaited confirmation and it was decided to redraft the student uniform concession proposal for submission to the 1983 WIA Federal Convention.

Technical articles published in Amateur Radio by NSW members were judged and the best three articles selected for prizes (see AR Oct 82 p 48). This contest is to encourage submission of technical articles to AR by NSW members. The presentation

of prizes will occur at the Annual General Meeting of the division on the 26th of March.

The official opening of the Parramatta building was discussed and arrangements and duties were discussed. The Minister for Communications will be performing the opening ceremony and it is expected that amateur radio will receive considerable publicity during WCY-83 arising from this function.

An application by the Albert ARC to establish a repeater to cover the Condobolin area was discussed and approval was given for the application to be forwarded to DOC for processing. Irregularities in some repeater locations and infringements of regulations and conditions were discussed. Council is concerned that these operations will bring discredit upon the amateur movement. Groups operating repeaters and beacons are reminded that ALL conditions must be complied with and systems must not be placed on-air unless the licence has been received from DOC. T Mills is to present a report to council as to breaches of licence conditions and recommended action.

## QSL CARDS

Following a suggestion by the Goulburn ARS, council has decided to make a QSL card available for sale to WIA members. They will have the WIA badge on the right hand side and a block for standard QSL information across the bottom. Space will be available so members can arrange to have their cards overprinted with their own call sign and address or use a rubber stamp. As no reference is made to the NSW Division on the cards, they could be used by members in other divisions.

The price is 5¢ per card plus postage and they are available in white with blue or black print, blue with blue or black print, green with black print or yellow with blue or black print. Send orders to PO Box 1066, Parramatta, 2150.

## SLOW MORSE PRACTICE SESSIONS

These sessions are conducted by a panel of volunteer operators, on behalf of the NSW Division, every evening throughout the year on a frequency of 3.550 MHz for a period of one hour commencing at 0930 UTC. The call sign is VK2BWI.

The regular operators are:

Monday — Don VK3AKN at Hawkesdale  
Tuesday — Keith VK2NZM at Adamstown  
Wednesday — Ken VK2BKE at Lord Howe Island

Thursday — Lloyd VK2BLK at Oatley

Friday — Jim VK2NDI at Pymble

Saturday — Steve VK2ESG at Deniliquin

Sunday — David VK2NAW at Golspie

Relief operation was provided by David

VK2PRA from Goulburn, Ross VK2BRC from Orange and others.

Speeds commence at 4/5 WPM and increase to about 12/15 WPM. It should be noted that these sessions are primarily to assist those attempting the CW examinations at 5 and 10 WPM.

Panel operators welcome enquiries regarding the sessions, or on matters relating to acquiring skill and expertise in the CW mode. Practice cassettes are available to suit individual inquiries. Such enquiries can be directed through the Institute office at PO Box 1066, Parramatta, 2150 or to the Morse Practice Co-ordinator, Ross Wilson VK2BRC QTFR.

The Institute would like to thank all panel members for their perseverance and skill, throughout the past twelve months. These sessions are indeed a very great service to amateurs, and to those aspiring to the amateur ranks.

Bon Voyage also to Marshall VK5FN (ex VK2DXP), our former co-ordinator, who now resides in Adelaide.

Notes from Ross, VK2BRC

## HF SLOW MORSE BEACON

The Hornsby ADARC are interested in receiving comments to their proposal to establish a twenty-four hour automatic slow morse practice transmitter on HF.

The actual band has not been decided upon, but a suggestion made is possibly around 3.7 MHz.

Council proposes to place this question on the agenda of the AGM and has suggested that Hornsby present the matter to the WIA Federal Convention and the 8th Conference of Clubs.

Hornsby are interested in comments about their proposal and you can write to the club at PO Box 362, Hornsby, NSW, 2077.

## COFFS HARBOUR ADARC NEW OFFICERS

Following their AGM on the 17th November 1982, the club committee is as follows:

President — Max Francis VK2BMK

Vice-President — Harvey Ussher VK2DUJ

Secretary — David Harding VK2DUR

Treasurer — Percy Sara VK2QV

Publicity — Brian Lackie VK2DLM

Education — Rick Fletcher VK2BKV

## URUNGA CONVENTION

The annual Urunga Convention will again be conducted by the Coffs Harbour ADARC over Easter 1983.

Registrations will be held at 7.45 PM at the Ocean View Hotel, Urunga on Friday, the 1st of April. Cost is \$10 for OMs, \$8 for the wives and \$20 for a family for the weekend. For one day only, the fees are \$7,

\$5 and \$15 respectively.

A full programme of radio direction finding events, disposals, displays and quizzes is available.

**SATURDAY, 2.4.83 Urunga.**

10 to 11 AM, 7 MHz hidden TX.

11.30 to 12.00 noon, 2 m 2 transmitter mini mitter hunt.

12.30 to 1.30 PM, Lunch.

2 to 3 PM, 2 m 2 transmitter pedestrian.

3.30 to 4.30 PM, 80 m talkin.

7.45 PM, Social evening at School of Arts with films, supper, disposals table and possibly new gear for sale.

**SUNDAY, 3.4.83 at Bellingen Showground.**

9.30 to 10 AM, Urunga scramble, any power! Any location, any frequency. Most stations worked in time.

10.30 to 11 AM, 2 m 2 transmitter pedestrian. 11.30 to 12.30, 2 m 2 transmitter mobile hunt.

12.30 to 1.30 PM, Lunch of hot meal and sweets provided by club.

2 to 3 PM, 2m 2 transmitter pedestrian.

3.30 to 4.30 PM, open time, think of an event!

5 PM, Prize giving and finish of convention.

Cooking facilities available if you wish to cook tea at showground after convention, meat and supplies will be available.

Accommodation is available at the Ocean View Hotel. Bed and hot breakfast for \$16 single and \$26 double per day. Early booking essential. Caravan park opposite hotel at Urunga.

The club address for enquiries is: PO Box 655, Coffs Harbour, NSW 2450.

## COMING EVENTS

**OFFICIAL OPENING OF WIA PARRAMATTA OFFICE:** 2 PM Saturday 12th of March.

**ANNUAL GENERAL MEETING, WIA NSW DIVISION:** 2 PM Saturday the 26th of March at Granville.

**URUNGA CONVENTION:** 2nd and 3rd of April at Urunga/Bellingen.

**8th CONFERENCE OF CLUBS:** 17th of April at WIA Parramatta.

**LIVERPOOL FIELD DAY:** Sunday the 24th of April at Fairfield Showground.

**WIA FEDERAL CONVENTION:** 23rd, 24th and 25th of April in Melbourne.

*NSW members and clubs are invited to submit news items for inclusion in these notes to WIA NSW Division, PO Box 1066, Parramatta, 2150 and mark the items "for Mini bulletin". Items for May AR must reach us by the 23rd of March.*

Athol VK2BAD

AR

## NEW ITALIAN QSL BUREAU

ARI QSL Bureau

PO Box 6

I-28024 GOZZANO (NO)

Italy

This is the new address for all cards to the Italian QSL Bureau.



# QSP

## CARE WITH THOSE TOWERS!

The following item appeared in the Radio Bulletin (EMDR) Nov./Dec. '82.

*"Are you having tower problems? If so, consult the 'experts': Dan, VK3DAN, and Gray, VK3DMI. They will tell you how NOT to wind down towers.*

*Dan 'Quixote' Renfree tried to slow his down by showing his arm in the windmilling winch handle (broken in how many places Dan?), whilst Gray tried to plant his boom in the garden when the winch cable broke when tilting the tower over — stick to planting petunias Gray! Incidentally, both mishaps occurred on the same day.*

*Dan is using his enforced rest to work DXCC. Good luck, Dan."*

Although a humorous anecdote, the message behind it is serious. Crank up/tilt over towers can be dangerous!!

Always use BOTH hands, keep children, adults and animals away from the danger area whilst raising or lowering. Have a firm and steady grip on the winch. Ensure cables are regularly greased, inspect each three months for signs of corrosion, particularly the cables.

Prior to lowering the inner section, place a large piece of timber (at least 3" x 4") through the lattice work of the base section, at least eight feet above ground. This will break the 'fall' of the inner section should the cable snap and minimal damage will be caused.

If a mishap does occur, get out of its way quickly, do NOT attempt to stop the falling section by hand, or grasp the winch handle. Serious injury may result.

Editor

AR



## FIVE-EIGHTH WAVE

Jennifer Warrington VK5ANW

59 Albert Street, Clarence Gardens, SA 5039

It obviously pays to be persistent. For two years John Ingham, VK5KG on behalf of the SA ATV Group, has been lobbying the Department via the Federal Executive, for permission to cross-link the two SA ATV repeaters. Firstly permission was granted for WIA broadcasts and WICEN use only, but now permission has been received for open experimental use, until November, when a full report will be sent to DOC.

Wearing his other hat, that of Federal Video Tape Co-Ordinator, John also reports that all programmes held by him can now be copied onto Eumatic, VHS, and Philips N1500 formats. Apparently the saving on postage costs since using VHS is quite remarkable.

We are still looking for volunteers to help Dick Boxall VK5ARZ, with the equipment supplies, at the monthly meetings. You probably think of it as ESC but the 'C' stands for Committee and currently Dick is all the committee we have, and is currently doing the job which was at one stage done by FOUR men. Complaints have been heard about the non-appearance at some meetings of ESC but if Dick is unable to attend and there are no other volunteers, what is he supposed to do?

Tom Sears VK5NTJ, who was doing such an admirable job of canvassing advertisers for our journal, has unfortunately had a stay in hospital with a suspected heart attack. I hope that by the time you get to read this you will be well on the road to

recovery Tom (and for those of you who have, or were thinking of, nominating to stand for council election — this is not an indication of how hard we work our volunteers!)

We received a request that our local journal be sent to the federal councillors in each division. Currently a copy is sent to the secretary in each Division (alternate months Feb., April, etc.) so if you are not getting to see a copy, ask your secretary which WPB he filed it in.

As the theme for the year is communications, Staunton (Mac) McNamara VK5ZH our Programme Organizer has come up with a series of lectures on some of the things that amateurs get involved in, and all are aimed at 'getting started' in these other aspects. For example, our February meeting will be a lecture by Bill Simister VK5KTV on 'Getting started in ATV' (past tense by the time you read this!) Our March meeting will be by Graham Ratcliff VK5AGR on 'Getting Started in Satellite Communication' and in May we hope to have John Mitchell VK5JM on 'Getting started in RTTY'. One on Micro Processors has also been suggested.

## DIARY DATES:

22nd March Graham Ratcliff on 'Getting started in Satellites'.

29th March Buy and Sell.

26th April Annual General Meeting.

AR

## NOTICE OF AGM

Notice is hereby given that the AGM of the Western Australian Division of the Wireless Institute of Australia will be held on Tuesday 19th April 1983 at The Institute of Engineers, 712 Murray Street, West Perth on the conclusion of the General Meeting. Business to be transacted will be:

- 1 Consideration of Council's Annual Report and Balance Sheet.
- 2 Election of Office Bearers vis:
  - a President
  - b Vice President
  - c Seven Other Councillors
- 3 Election of two auditors.
- 4 Appointment of a Patron.
- 5 General Business which has been duly notified.

Agenda items will be advised on the Divisional Newsbroadcast on the three Sundays prior to the AGM.

Members unable to attend may appoint another member as their proxy in writing in the following form:

I ..... member of the Institute hereby appoint Mr/Mrs .....

also a member of the Institute to act for me as my proxy and in my name to do all things which I myself being present could do at the meeting of the Institute to be held at The Institute of Engineers, West Perth on the 19th April 1983.

Signature .....

Witness .....

Date .....

AR

## WIA INSERTS INTO AR



### NOTICE TO WIA ZONES, CLUBS AND GROUPS

WIA Zone, Club and other Group Secretaries are hereby notified that inserts into AR henceforward will be accepted **ONLY** direct from a Division and then only by prior arrangement with the Secretary.

All inserts must comply with Postal Regulations and must be received not later than the 26th of the month preceding publication date.

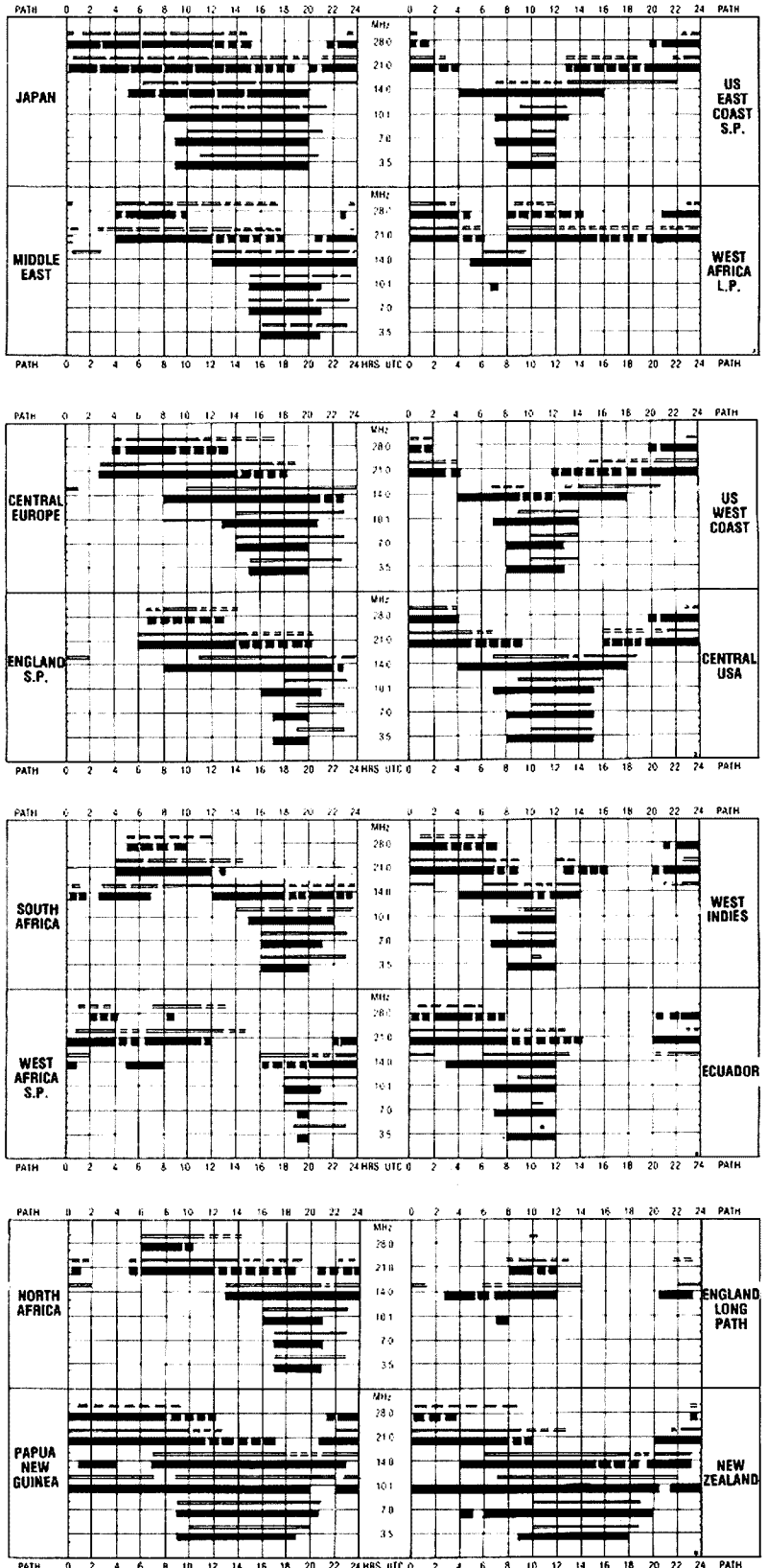



# LETTERS TO THE EDITOR

Any opinion expressed under this heading is the individual opinion of the writer and does not necessarily coincide with that of the publisher.



12 Lillian St.  
Cottesloe, WA

40 St Peters Terrace,  
Willunga 5172  
11th Jan 1983

The Editor,  
Dear Sir,

For some years I have been frustrated by the lack of availability of information on which consumers of amateur radio equipment can base their buying decisions.

In my case, this has proved a positive disincentive to buy.

I am a regular reader of Amateur Radio, the VK5 Journal and Electronics Australia. Occasionally I read Amateur Radio Action.

I want a tri-band beam. "KLM" and "Wilson" seem to be highly regarded. It took a visiting American amateur to inform me that "someone in Sydney" distributes KLM antennas, but I have no idea who it is, nor do I have any idea where I might find out about the Wilson range.

I would like to get into "glass RTTY". "HAL" is certainly advertised, but dear. "Xitex" seems to be popular, and cheaper, but I can't find information anywhere.

Looking for a 70 cm multi-mode transceiver, all I can find is "IC251A \$850", which doesn't mean a thing. Indeed, I suspect it may even be a 2 metre rig.

Perhaps these makers have advertised in some of the journals mentioned, but it is certainly not regular.

Yaesu equipment is reasonably well described, Kenwood is a poor second, and all other makes are a disaster.

I suppose to some extent it is a case of too much merchandise chasing too few amateurs, but I am sure that more gear would be sold if more amateurs were given more information.

Yours faithfully,  
Al Rechner VK5EK  
AR

Eugen-Huberstr 25  
8048 Zurich  
Switzerland  
24th December, 1982

Dear OMs,

Here I send my SA20 for 1983 "Amateur Radio". Thank you very much for sending me the "AR" during the past years.

I like to say your Journal is the best Amateur Radio Journal all over the world.

I made my licence this week, and hope to QSO with VK soon and come to Aussie-land.

With best wishes for 1983

Yours sincerely  
Fri Zwingli  
HE90ZH  
AR

57 Haydown Road  
Elizabeth Grove, SA 5112  
9/1/83

The Editor,  
Dear Sir,

I note many SSB operators don't know the frequency they are on, as they forget that the counter readout or dial frequency is the suppressed carrier frequency and NOT the radiated frequency.

Eg there are often SSB stations whose lower sidebands extend some 2 kHz into the CW only portion of 40 metres. Of course their read-outs show they are slightly higher than 7.030 MHz but they completely forget they are on LSB.

(VK3UV)

AR

I note the same problem in the recently issued new bands, some frequencies are to be kept clear but many SSB operators are forgetting their sidebands extend some 2.5 kHz from the indicated frequency.

Hopefully this letter will remind such SSB operators that when on LSB the indicated frequency is the high frequency limit of their radiated pass band and that the lower limit is about 2.5 kHz lower.

On USB the indicated frequency is the lower limit and the upper limit is some 2.5 kHz higher.

Thanking you  
Bruce Hannaford  
VK5XI  
AR

129 Coode Street  
South Perth, WA 6151  
12/12/82

The Editor AR,  
Dear Sir,

I have been noting with interest the appeals, both in AR and on federal news tapes, for us all to report intruders in our bands. In recent months the tone of desperation has increased almost to the point of hysteria. "For Pete's sake", the exhortations seem to say, "Don't you care? Can't you see how important it is? Please, please, report intruders!"

Despite this, it seems obvious that amateurs are turning a deaf ear — otherwise there would be no need to keep repeating the pleas.

Amateurs are not stupid. They can see the arguments in favour of reporting; and it is unlikely that they are too lazy to do it. Why, then, are they agog with indifference? As one who regularly reported intruders for a couple of years, and finally stopped doing so, I think I know the answer.

Bill Martin, the Federal Intruder Watch Coordinator, came near to it in his open letter (December AR, page 72) when he said that the results and satisfaction (of reporting) are not immediate. He is right. He also said, "When we eventually do manage to force an intruder to QSY, you can then derive some satisfaction in the knowledge that it was done with your assistance." Wrong! You never know. The simple fact is that there is little or no feedback. All the reports that I posted could have been sent straight round to the local rubbish tip for all I knew.

If a man joined a rifle club and simply blazed away at a distant target without ever being told what his score was — or whether he had even hit anything — his enthusiasm would gradually dissipate and he would give up. This is what happened in my case, and I suspect it has happened to others, too.

Why not use the time, space and effort currently wasted on futile appeals, to run a monthly column similar to "How's DX", listing intruders reported each month, asking for reports on certain stations and giving news of successful removals from our frequencies. Invite those useful people, short-wave listeners, to take part. Try to pack in as much information as possible to make it a really interesting department and give credit to the various reporters for their efforts. It may take a while to build up; to quote once more from the open letter: "the benefits may take some time to become apparent". Be that as it may, simple psychology will always get results where other methods have failed.

Yours cordially  
Jeff Jeffrey VK6AJ

The Editor,  
Dear Sir,

Having read your December issue of Amateur Radio I would like to make a few observations regarding its contents.

I am a recent qualifier in amateur radio but have read your magazine for some two years courtesy of a full call amateur.

During this period I have endeavoured to comprehend some of the articles, and there must be many of your readers who, (while not admitting to) would likewise be in the same category.

Listed below are a few of these:—

Ionospheric Predictions p 86

Intruder Watch p 72

Quick reference to Alpha Soup p 67

Unusual Prefix List

WICEN News p 87

Ionospheric Predictions — the top line of figures (barely readable) 0 to 24 is this a date?

Intruder Watch — the article invites other amateurs to report intruders. How does one know who or what an intruder is?

Quick reference to Alphabet Soup — what exactly does this mean?

WICEN News — I recently wrote to the organisation enquiring as to how one becomes a member (I am a current member of Sea Search & Rescue in WA) but have received no reply so must assume Novices are excluded.

From your perusal up to date it must appear obvious that a monthly article on each of these will help the recently initiated to become more enlightened and interested in joining the WIA and reading "Amateur Radio".

Finally have you noticed how measurements and details of circuits always appears barely discernable to the eyes of mature readers? (See pages 15, 18.)

QSP — The "Q" code says relay to...? How does this fit in with say "Nail polish in the Shack".

Curiously Yours  
R A Davey VK6NND

## EDITORS NOTE:—

Thankyou for your comments. I will briefly explain some details to you, and perhaps other newcomers may also benefit.

1. Ionospheric Predictions — 0-24 is the UTC period for the band opening. A new legend is in course of preparation to avoid confusion.
2. Intruder Watch — I am surprised at your comment, as this matter has been well publicised in the past. An intruder is any other station operating in the amateur bands which is not licensed to do so, eg Commercial broadcasting, pirate operations.
3. Alphabet soup — You haven't tried the Heinz variety yet? There have been many changes to several countries prefixes in recent times. It is almost like throwing letters into a pot, and drawing out a prefix as it suits!
4. WICEN — I suggest you write again to the VK6 WICEN Group, your letter may have gone astray. There is no restriction on Novices becoming involved. In fact Novice participation is more than welcomed.
5. Print size — yes other complaints have been made, we are endeavouring to enlarge same.

(VK3UV)

AR



**BILL VK2EBM WRITES IN REPLY TO JEFF VK6AJ —**

In any field of endeavour, when contributions are solicited, the resultant return is more often than not unsatisfactory. Mr Jeffrey is of the opinion that the continuing requests for more intruder reports ("bordering on the hysterical") stems from a lack of support for the Intruder Watch. This is not so. The ratio of reports received to the number of active amateurs is encouraging, and, of course, I realise that we will never receive reports from all amateurs. But how many reports would be received if none were solicited? Any at all, I wonder? I think it goes without saying that we must continue to ask for reports on intruders. Apparently, Mr Jeffrey sent in reports for a couple of years, and received little or no feedback. I am pleased that Mr Jeffrey is still aware of the existence of the Intruder Watch, and I think that he IS AWARE of it, because of the continuing requests for help.

However, on the feedback question, I think that most people would certainly realise that they can't expect a reply to every report that they submit, as the cost would be prohibitive. Even now, the cost is a major consideration. I think that Mr Jeffrey would find, on enquiring, that the regular intruder observers are quite happy with the situation as far as being kept informed is concerned.

During my short term (six months) as Federal Intruder Watch Co-ordinator, I have mentioned specific intruders in the columns of AD, and asked for reports on them. As VK2 Intruder Watch Co-ordinator, I send out regular IW Bulletins with new information on intruders to all WIA affiliated radio clubs. Perhaps Mr Jeffrey could contact his divisional IW Co-ordinator, and perhaps learn what is happening regarding intruders at the present moment.

As for his statement that the current appeals for reports are a waste of time, space and effort, and are futile, I suggest that possibly he would care to act as my assistant for a short while, and give me a hand to answer all the letters, etc, which arrive AS A RESULT OF THE FUTILE APPEALS. Mr Jeffrey suggests that better use could be made of the AR Intruder Watch column, for example: list all the current intruders reported for each month; give credit to the various reporters for their efforts, etc. Naturally, I must agree with Mr Jeffrey on this, as it is good constructive criticism — however, unfortunately, I would need about three pages each month of AR for this, and I don't think that the editor would be too pleased with me. Space does not permit the listing of all reported intruders. However, we do always ask for reports on specific intruders, and will continue to do so. Mr Jeffrey goes on to say, "Invite those useful people, SWLs to take part". I have done this many times, and DO receive reports from SWLs for which the Intruder Watch is very grateful. Mr Jeffrey's comments and suggestions are noted, and we are always ready to listen to ideas and suggestions to improve the effectiveness of the Intruder Watch.

However, as with any hobby, time is limited. Most of my leisure time is now accounted for due to the duties associated with the Intruder Watch, FOR WHICH I VOLUNTEERED, and certainly make no complaints about doing the duties. If I didn't want to be bothered with it all, I just have to say so. In short, the Intruder Watch is doing the best it can, with the resources at hand, and, at the risk of being accused of yet another near-hysterical outburst, I must say once again that the whole effectiveness of the Intruder Watch is SOLELY DEPENDENT on the average amateur letting us know what he hears in the way of intruders.

In closing, I think that the average Intruder Watch Observer knows that we are grateful for his/her report, and help, and when we do publicise the fact that such-and-such an intruder has disappeared from the Amateurs bands, then the reporter can say to himself, "well, I sent in some reports on that one, it must have done some good". I certainly hope that Mr Jeffrey will resume sending in his reports, and can assure him that they will be received most gratefully, and, of course, the writer is always standing by ready to answer any queries regarding intruders, or the Intruder Watch. Very 73

Bill Martin VK2EBM  
Federal/VK2  
Intruder Watch Co-ordinator  
AR

4/4 Talpa Cres  
Corio, 3214  
10 January 1983

The Editor,  
Dear Sir,

Might I enquire by what process are the rules of the WIA sponsored contests changed? I refer specifically to those of the John Moyle Memorial Contest as published in AR of January '83.

It appears that the rules are set and altered arbitrarily at the whims and fancies of the Federal Contest Manager or a very select and anonymous few without opportunity for prior comment by interested parties.

Furthermore, the actual changes are not necessarily to everyone's liking. For instance, why was the starting time for the contest brought forward by two hours into a period where propagation on the lower HF bands is marginal? What was wrong with the old starting time? Why was the X2 multiplier removed for CW-CW contacts? That certainly removes any incentive to operate CW. Why must we now allow a minimum of four hours to elapse between VHF contacts with portable stations? Originally the 2-hour rule for VHF was included to stimulate activity on these bands — particularly 6 and 2 metres SSB. It's hardly worth the effort of taking these two bands now.

Surely the sensible thing would be to inform readers of AR by publishing any proposed changes well in advance, by say May or June in the Contests department. This would allow an opportunity for discussion and comment by intending contestants.

Lastly, why is acknowledgement rarely made — and then selectively — of suggestions for changes to future contests? I can think of only one occasion when a suggestion was published for discussion — when a VK4 group wanted the date of the field weekend changed to late autumn or winter I believe. Whatever came of the suggestions which other entrants made? I know the contest group with which I participate regularly did, as we do every year, include with our log sheets a list of suggestions which we consider would improve the Field Weekend contest. I'm sure others do the same. It would of course be pretentious to expect these changes to be adopted out of hand, but what about discussing them, through AR?

The John Moyle contest is a great bun fight and I wouldn't miss it for the world; it's the only contest with a sensible multi-operator section. But I would like an opportunity to comment on rule changes before they are adopted, as would many others. I am firmly opposed to change for change's sake.

Charlie Graccarini  
VK3BRZ

**EDITOR'S NOTE:** Many thanks for your interesting comments, rule changes are made only by suggestion from a majority of participants, and agreed to by the executive. Only by trial and error can we sort out the bugs. I hope you enjoyed this year's contest, and would be pleased to receive further comments.

**FCM's COMMENTS ON CHANGES TO JOHN MOYLE CONTEST**

The rules of the John Moyle Contest are changed by the Federal Contest Manager as part of his duties.

Request for comment was published in AR, Aug 1981. On the date for the contest and for helpful comments. These comments were received over the following six months and collated. The rules now published are a submission from the VK4 WIA workshop 1982, which answered a great deal of the requests and suggestions put forward by the amateurs.

The starting time has been brought forward one hour not two. This will have only a marginal effect on the HF bands but

will assist the VHF band and above. The extra hour will also allow a little more time to pack up and get home before dark.

One point per contact CW is a trial, the comment being that only the very proficient CWer operates in this mode during contests and therefore he effectively excludes any person who is not fully proficient. The contact rate is 'similar' to the phone rate and therefore provides a vast advantage of scoring over the phone operator.

The one point per contact is also easier to check for my purposes.

Four hours between contacts VHF/portable stations is designed to encourage the use of better antenna systems and more bands. It also reduces the tendency of scheduling contacts.

Acknowledgements of comments for contests is usually made on a general basis. However the space allowed for contests in AR (for which is taken out of your subscriptions) is not unlimited and it is usually used for the more important subjects, such as rules and results.

Finally the date of the contest was left on the original date as the winter months in the southern states would preclude much of the activity of the contest. It is also the date of the NZART Field Day Contest who have included awards for the VKs in their rules.

Reg VK1BR  
FCM

W01105

## THE VK3BWW FORMULA FOR DX SUCCESS!!

### HIGH QUALITY AT LOW COST

<b>BEAMS</b>	
3 EL 10 & 11m .....	<b>\$75.00</b>
3 EL 15m .....	<b>\$83.00</b>
3 EL 20m .....	<b>\$158.00</b>
6 EL 6m .....	<b>\$108.00</b>
5 EL 2m .....	<b>\$36.00</b>
9 EL 2m .....	<b>\$59.00</b>

**DUOBANDER**  
3 EL 10m, 3 EL 15m **\$148.00**  
Prices include Gamma match

Our beams are easy to assemble and adjust. Entirely **NEW CONCEPT — NO NUTS OR BOLTS.**  
Spare parts, elements, booms and gamma matches available.  
**Plus Freight**

For further information  
**PLEASE RING (03) 366 7042**  
**VK3BWW**  
**WERNER & G. WULF**  
**92 LEONARD AVENUE**  
**ST. ALBANS, VICTORIA 3021**

# CUSTOM WOUND TRANSFORMERS

LOW COST  
HIGH QUALITY

Consult us about  
your special requirements  
in transformers,  
power chokes, r.f. chokes, etc.

240 V-29 V @ 100 VA  
\$23.40

240 V-20 V @ 400 VA  
\$53.00

Plus Sales Tax if  
applicable.

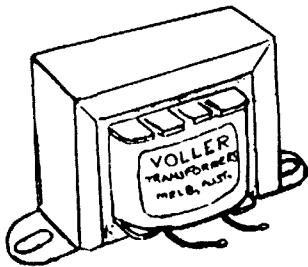

FREIGHT EXTRA

PLEASE RING (03) 551 1452  
VOLLER TRANSFORMERS  
PTY. LTD.

16 PIETRO RD.,  
HEATHERTON. 3202

For a BIG signal  
step up to a multiband  
CHIRNSIDE ANTENNA

CE-33 TRI-BAND	\$249.00
CE-42 DUO BAND	\$145.00
CE-5SS BASE VERTICAL	\$89.00

80-40-20-15-10 m  
Self supporting

AND MANY MORE  
Plus freight

Some items may be in short supply.

All mail orders to:

CHIRNSIDE ELECTRONICS  
PTY LTD

26 Edwards Rd, Lilydale,  
Vic. 3116. Phone: (03) 726 7353.

## Silent Keys

It is with deep regret we record  
the passing of—

RON JARDINE VK3PR  
H. R. G. MORRIS VK4VLM, G4ZMI

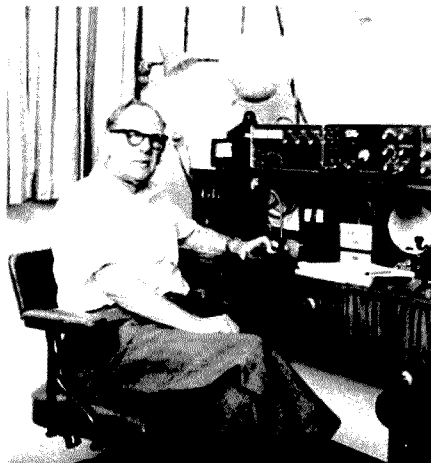

The late Ron Jardine VK3PR.

## Obituaries

KEN ALLEN

VK3UH

"How are those sheilas treating you?" — an opening query I shall miss from Ken Allen, VK3UH who became a silent key on 20th January 1983.

Ken was a country lad, born early in the century. He discovered the wonders of radio at a very early age, at times catching and selling rabbits to support the hobby.

It was through his early interest in radio which led him to a very worthy period of service as a radio operator in the RAN, mostly serving in "N" class destroyers, one of which was sunk under him in the Mediterranean.

He was a coot with a memory to match his wide experience, and an ability to discuss things in the finest detail (a very rare commodity in the world of today).

Ken was a reliable source of Australian culture and character anecdotes which he greatly enjoyed sharing. The type of bloke we can ill afford to lose — a gentleman who will be sadly missed.

Alan Heath VK3KZ  
AR

GERRY BAHRE VK4YB

It is with deep regret the passing of Gerry Bahre is recorded on the 11th January 1983 after a lengthy illness.

His passing is mourned by his XYL Ann, his daughter Johanna and sons Gerard and Tony and six grandchildren. Also many friends and acquaintances made "on air" over a period of twenty-six years.

A native of Holland, Gerry and his wife came to Australia in 1953 and first settled in Coolangatta, Queensland. After about three years he opened a radio repair business in Mareeba.

Having brought a PA0 callsign with him from Holland, he took out a call sign in Queensland which became widely known as VK4YB — phonetically "Yogi Bear". In 1959, when television was first introduced in Queensland, he and his wife and family came to Redcliffe and became firmly established as a radio and television repairer, relinquishing to his son only a short time before he died.

In 1967 he joined the Lions Club of Redcliffe Peninsula and in the intervening years he held many positions, including that of President, with an unblemished attendance record.

He was a founder member of the Redcliffe Radio Club and was a source of inspiration and practical guidance to many Club members. He will be sadly missed.

Dave VK4UG

AR

RON JARDINE

VK3PR

Ron Jardine of Leongatha, Vic. passed away suddenly on Friday 21.1.83.

Following a service in the packed Uniting Church on Jan 24, he was interred at Leongatha Lawn Cemetery.

The service was attended by Ron's very many friends including large groups of Church fellow members, Masonic Brethren and fellow amateurs.

He was a very well known popular amateur, active on air, in zone affairs, and with the Old

Timers club with fifty-three years of regular operating on most bands both phone and CW and setting an example of consistently good operating practices. He had filled over 30 large log books containing over 50,000 contacts with 167 countries.

One ambition was to work every DX country — obviously he nearly made it.

He is survived by his good wife Vernie, who was famous for her support of Ron's amateur activities, and especially the production of chocolate cream sponges, (known as Mrs Jardine's CCSs) which would invariably appear at zone get-togethers and conventions, and two sons. One, another Ron, is currently preparing to pass the AOCPE exam. We all hope he will secure the call sign VK3PR.

Amateurs who attended our last farewell were:

Harry	VK3HC	Harry	VK3GO
Cliff	3AJA	Mac	3RU
Keith	3IV	Ed	3EM
Keith	3SS	Jack	3AJK
George	3HV	Stewart	3BSM
Ossie	3AHK	Arch	3BW
Graham	3QZ	Charlie	3CMA
John	3BR	Len	3DLM
Fred	3QH	Peter	3DDL

My lasting memory of Ron was in 1937 when on a simple home brew, I first called CQ and was promptly answered by VK3PR. Years of ambition ended with this exciting first phone contact.

We will all remember the long friendship, technical exchanges, the pleasure of his company at amateur gatherings, the many photographs he took and presented to us all. I am requested to extend on behalf of the amateur fraternity our sincere sympathy to Vernie and sons.

May we all share your fond and happy memories.

#### ROSS TREHARNE VK5IQ

It is with deep regret that I report the passing of Ross VK5IQ at the age of sixty-three years, on the morning of 30th December 1982.

He attained his licence in Sydney at the age of fifteen years, and was the youngest to have done so at the time. He then held the call of VK2IQ and became very involved in the activities of the Zero Beat Radio Club, particularly their field day activities. One of his close associates at the time was the late Maurice Brown VK2QI.

Post war, Ross and his family moved to South Australia, in fact Adelaide, living for the first seven years at Plympton, then moving to live in Clearview until his passing.

Amateur wise, Ross was a solid supporter of Jamboree On The Air weekends, where he and his XYL Norma tried to satisfy the Cubs and Scouts seemingly unsatiable food and radio appetites.

Ross leaves many friends, both from his amateur radio activities, and his business world, Defence Research Centre Salisbury, from which he recently retired.

Our deepest sympathies go to his wife Norma, his four sons Douglas, Edward, Ian and David, and his brother Elgar VK5ED.

His son Douglas has taken over the call of VK5IQ to let it live on. Ross will be missed by many amateur friends both here and overseas.

John Butler VK5NX

A.R.



## 83/84 CALLBOOK

Work has commenced on the next edition!

Are your details correct in the last edition?

If not please notify the WIA Federal Office —

**PO Box 300  
South Caulfield  
Vic. 3162.**

## WARNING!!



Disposing of your old rig??

Please ensure it goes **ONLY** to someone licensed to use it on **YOUR** bands.

## HAMADS

**PLEASE NOTE:** If you are advertising items FOR SALE and WANTED please write on separate sheets, including ALL details, eg Name, Address, on both. Please write copy for your Hamad as clearly as possible, preferably typed.

\* Please insert STD code with phone numbers when you advertise.

- Eight lines free to all WIA members. \$9 per 10 words minimum for non-members.
- Copy in typescript please or in block letters double spaced to PO Box 300, Caulfield South 3162.
- Repeats may be charged at full rates.
- Closing date: 1st day of the month preceding publication. Cancellations received after about 12th of the month cannot be processed.
- QTHR means address is correct as set out in the WIA current Call Book.

Ordinary Hamads submitted from members who are deemed to be in the general electronics retail and wholesale distributive trades should be certified as referring only to private articles not being resold for merchandising purposes.

#### TRADE HAMADS

Conditions for commercial advertising are as follows: The rate is \$15 for 4 lines, plus \$2 per line (or pari thereof) minimum charge \$15 pre-payable. Copy is required by the first day of the month preceding publication.

**AMIDON FERROMAGNETIC CORES:** Large range for all receiver and transmitter applications. For data and price list send 105 x 220 SASE to: R. J. & U. S. Imports, Box 157, Mortdale, NSW 2223. (No enquiries at office: 11 Macken St. Oakley, 2223.)

**CB RADIOS \$69:** walkie talkies, short wave radios, military, outback, business, amateur, marine, repairs. RTTY Siemens 100A printer \$120; base mic., \$45; ultrasonic alarm, \$35; all ham bands on a single 6 ft. whip, 1.8 to 30 MHz, for base or mobile, \$300; aerials, installation, demonstrations, 40 ch. CB conversions, accessories, new rigs weekly. Bridge Disposals, 12 Old Town Plaza, opp. Bankstown Railway Station, NSW. Mail order service and all enquiries to 2 Griffith Avenue, Roseville 2069, or phone Sam VK2BVS, 7 pm to 9 pm only, on (02) 407 1066.

23 cm LOOP YAGI's and power meters, semi rigid coax, PTFE PC board, waveguide, flanges, Gunn and mixer diodes and our 3cm transceiver module are a few items from our lists. SAE to Microwave Developments, 6 Netley Rd, MI Barker, SA 5251.

#### WANTED — NSW

**CIRCUIT DIAGRAMS** or information on Hy-Gain "One-Arm Bandit" CB and "Nordmende Globe Trotter". VK2YXM QTHR.

**CIRCUIT DIAGRAM.** Good clear copy for Gemtronics GTX-2325 CB radio. VK2KBI QTHR.

**COLLINS TRC-75** transceiver. Must be complete and preferably with manual. Ph.: (02) 969 4539.

**MORSE KEY.** Small military type or old post office key. Pye Model ZA28656 preferred. VK2NSR. Ph.: (02) 588 3736.

#### WANTED — VIC

**CRYSTALS:** 4058.333 kHz and 4066.667 kHz for VHF TX. VK3TJ QTHR. Ph.: (03) 354 2401.

**FAIRCHILD TYPE 4710 CMOS** 16 x 4 RAM. Price and number available to Mike VK3ZCZ. Ph.: (03) 568 2224 (AH) or (03) 573 2463 (BH).

**KENWOOD BS5 PAN DISPLAY** wanted, will exchange with type BS8 in good condition, required for ZL1RC. DEN VK3DIS. Ph.: (03) 592 4093. Would also consider cash sale.

**MANUAL** — Loan of or buy B.41 receiver manual or any info please. Will pay costs. Also any valve receiver with LF and/or VLF bands. Condition unimportant. VK3DLJ QTHR. Ph.: (03) 528 3380.

**TRANSVERTER SSM** Europa for 6 metres Jim VK3AS QTHR. Ph.: (03) 277 1613.

**FOR SALE — VIC**

**FOR SALE — WA**

**WANTED — OLD**

**CIRCUIT DIAGRAM** and/or workshop manual for a Halicrafters Company Transmitter, model No. HT-37. Will pay necessary charges. VK4KEB QTHR. Ph.: (071) 72 3865 (AH).

**INSTRUCTION BOOK** and circuit diagram for Traeger Tcvrs 59SA, No. L766 & 3217. Len Saunders. PO Box 454 — Atherton Qld, 4883.

**Wanted — SA**

**ANTENNA TH3 MK3**. Secondhand in good order. Price and condition to South-East Radio Group Inc. VK5SR QTHR.

**FOR SALE — NSW**

**"ANCIENTS"** — Old Emmco parts and floor model receiver. Some old valves, barreters and a horse-shoe magnet speaker. VK2YXM QTHR.

**CRO. BWO 830 35 MHz** Oouble Beam as new in original packing. \$1,100 ONO. Claude VK2CD QTHR. Ph.: (02) 419 7283.

**CRO TRIO MODEL CO 1303A** never used \$110. VK2BQO QTHR. Ph.: 328 7892.

**KENWOOD TS180S SP180. PS30 S950.** Heathkit linear SB220 \$650. Homebrew 6 m transverter \$75. Swan 700 CX power transformers \$15. VK2AHK QTHR. Ph.: (045) 73 6215.

**MICROWAVE MODULES 432-28** transverter with extra crystal for 434-436 \$120.00. Yaesu FTV650. 6 m transverter with spare tubes \$145.00. VK2AJT QTHR. Ph: (044) 21 2786.

**MODEM 1200 BPS**, half duplex, SRT brand 2 wire or 4 wire operation, lull RS232 interface, TELECOM approved, tested OK \$50. VK2ZHM. Ph.: (02) 663 1097 (BH), (02) 406 5338 (AH).

**SX 59 MIZUHO PRESELECTOR** covers 3-30 MHz. With attenuator and internal power supply. Mint condition \$60. Jim VK2PTJ. Ph.: (02) 84 4610.

**TH3MK3 TRI-BAND BEAM** with BN-86 balun \$150. AWA SS70 solid state SSB 30 W PEP Tcvr. 2-10 MHz with service manuals \$120. VK2BSM QTHR. Ph.: (02) 869 2402.

**WIND UP TOWER**, commercial, galvanized, 4 by 16 ft. sections 12" triangle at base. Stolle rotator and control, coil of 5 core cable. New guys and hoist ropes. Complete unit \$250. VK2AEM QTHR. Ph.: (049) 81 3413.

**YAESU FT707** complete base station. Excellent condition. FT707, FP707, FV707DM, FC707, FTV707 with 6 m module. MR7 base rack, YM38 scanning desk mic, YM35 scanning hand mic. All owners manuals. Technical service manual for FT707 \$1200. Dennis VK2KVV QTHR. Ph.: (02) 645 3441 (AH).

**YAESU FT-8010** in good condition, including DC-DC converter and memory unit \$750 ONO. Also Kenwood AT180 ATU in good condition \$100. Brad VK2DBM. Ph.: 451 7257 (AH).

FT200 with match power supply and speaker, spare valves & manuals. No mods, low QSOs. Black panel reason for selling. Peter VK3BEJ QTHR or Ph.: (050) 24 5814.

**ICOM IC251A** 2 m All mode transceiver as new condition with book etc. \$625.00. Kenwood TS700A 2 m multimode transceiver good condition \$390. Mike VK3ASQ QTHR. Ph.: (052) 78 1043 (BH), (052) 48 1915 (AH).

**KENWOOD AT200** antenna tuner, SWR meter. Perfect order \$110. VK3DH. Ph: (03) 387 2531.

**KENWOOD TS-820S** As new \$600. VFO 820 \$100. Diawa RF440 speech processor \$75. Kenwood R1000 gen. cov. receiver, as new \$350. Icom IC-215 2m FM Portable, all 15 channels fitted. Nicads, flexi ant mobile mount. \$150. Icom IC-701 with power supply and desk Mic all as new \$625. Also many other bits and pieces. VK30M QTHR. Ph.: (03) 560 9215.

**LINEAR AMPLIFIER FL 2500** VGC with inst. manual and 5 new spare 6KD6 S300 ONO: Hamband only communications RX AX 190. Exc. with instr. manual \$150 ONO. Hans VK3DNS. Ph.: (03) 55 5866 BH.

**MONO BAND YAGI**, 4 elem, 20 m, 27 ft. boom, designed to same specs as Hy Gain 204BA using W. Wulf parts, machined Gamma match, h/duty and full size, no traps, exc. performer \$200. B. Bathols VK3UV QTHR. Ph.: (03) 580 6424 (AH). Will arrange freight FOB if required.

**OSCILLOSCOPE**: Solartron type CD 513.2 5 MHz bandwidth, 4 in. screen \$40. Mike VK3CZC. Ph.: (03) 568 2224 (AH) or (03) 573 2463 (BH).

**TELEREADER — CWR-685** communications computer. First class piece of equipment, near new — \$900; Tandy disc drive Mod:1 including TRSDOS & cable, brand new — \$350. Genuine reason for selling. Peter VK3BEJ QTHR or Ph: (050) 24 5814.

**YAESU FT101Z0**. Latest version with WARC, CW filter, fan and mic. EC \$700. Ext. scan VFO with 40 memories. FV901DM \$200. Both \$850. VK3AVK. Ph.: (03) 729 5414.

**YAESU FT200 TRANSCEIVER** with FP200 power supply/speaker. Top performer and unmarked condition. Handbook and spares \$325. Yaesu FTV650 Transverter 6 m, 50 W. Suitable for use with FT101, FT200 or similar. Handbook. Good condition \$100. VK3VF QTHR. Ph.: (059) 75 1475.

**YAESU FT707** with mic, 100 W all bands including WARC \$575. VK3DIP QTHR. Ph.: (03) 435 8363.

**FOR SALE — OLD**

**NATIONAL WV3030N** colour TV camera. Power zoom, new condition in leather case \$775. FT620B 6 m Tcvr, new condition \$350. VK4ZE0. Ph.: (07) 200 1406 after 6 pm.

**FOR SALE — SA**

FT101Z with OC/DC mic. and CW filter. No WARC. Swan SW120 Tcvr converted to 80 m and 40 m with AC and OC power supplies. John VK5ARK. Ph.: (085) 86 6127.

**RTTY EQUIPMENT**. Siemens model 100 with tape punch & reader ST5 demod. ST2 speed converter. Xtal type mod. The lot \$250. T/send tape reader. \$15. Siemens typing reperforator \$30. FT101E G/Con. with mike, h/book etc. \$500. Ray QTHR VK6XT. Ph.: (09) 447 4908.

**FOR SALE — NT**

**YAESU FT101 (MkII)** 160 m-10 m, AC/OC fan. Gd cond. \$450. Kenwood TS7010 2 m SSB/CW, 10 watts, mobile bracket, very gd cond. \$125. Delivery anywhere in Australia arranged. Wayne VK8AM, PO Box 116, Nhulunbuy, NT 5797. Ph.: (089) 87 1242.

## ADVERTISERS' INDEX

AGFA-GAVAERT LTD AUSTRALIA	3
BAIL ELECTRONIC SERVICES	1F
BRIGHT STAR CRYSTALS	6
CM CRYSTALS PTY LTD	5
CHIRNSIDE ELECTRONICS PTY LTD	54
DICK SMITH	4
ELECTROMARK PTY LTD	3
GFS ELECTRONIC IMPORTS	2
HAMRAD	6
ICOM AUSTRALIA PTY LTD	BC
IAN J TRUSCOTT ELECTRONICS	6
MAGPUBS	1B
NOVICE COURSE	3
PARLIAMENT OF VICTORIA	5
RF INDUSTRIES	5
TRIO-KENWOOD (AUSTRALIA) PTY LTD	46
VK2 NOVICE LICENCE	6
VICOM INTERNATIONAL PTY LTD	6
VOLLER TRANSFORMERS PTY LTD	54
WERNER & G WULF	53
WILLIAM WILLIS & CO PTY LTD	5

### RE: ADVERTISING ERROR

Vicom's recent advertisement for "Vicoms Christmas Stocking Sale" contained an error. It showed the price of the LA4015A (Daiwa Linear Amp 15/15W 430-450 MHz FM) as \$32 instead of \$132. Vicom sincerely apologises to its customers for any inconvenience caused by this error.

AR



# TIME ON YOUR HANDS?

Have you the desire to discover a little more about your hobby?

We'll **LOOK** at these!

## **THE GUNNPLEXER COOKBOOK — by Bob Richardson, W4UCH.**

This book is written for the VHF/UHF enthusiast with a modest experience assembling VHF converter or receiver kits. The only test equipment required to build the equipment described is a grid-dip meter, multimeter, standard broadcast FM receiver, ordinary TV set and a HF communications receiver that covers 400 kHz to 30 MHz. Chapters cover basic Gunn diode theory, Gunnplexer operation, IF amplifiers, communications systems and TV and Computer data links — to name a few.

335 pages published by The Ham Radio Publishing Group.



## **BEAM ANTENNA HANDBOOK — 5th Edition by William I. Orr, W6SAI and Stuart D. Cowan, W2LX.**

To the antenna experimenter, this book is a must. It has relevant information for the design, construction, adjustment and evaluation of parasitic arrays. Some designs will allow the builder to erect a rugged, high gain beam from material obtainable at the local hardware store for a fraction of the price of a commercial array.

198 pages published by Radio Publications, Inc.

## **SIMPLE, LOW COST WIRE ANTENNAS FOR RADIO AMATEURS — by William I. Orr, W6SAI and Stuart D. Cowan, W2LX.**

This handbook has been written for the amateurs who dream of a fifty acre "antenna farm" but are frustrated by a thin wallet, small suburban blocks, unsympathetic neighbours, and building inspectors who hamper "sky-wire" ambitions. Exact dimensions are given for antennas that are simple, inexpensive, yet they work, for bands 2 through to 160 metres. There are ground planes, dipoles, multiband antennas, a universal HF antenna which covers from 3.5 to 29.7 MHz, information on guys, baluns, coaxial cable, SWR meters and for the amateur with little space — an antenna which goes straight up.

191 pages published by Radio Publications, Inc.



## **THE SHORTWAVE PROPAGATION HANDBOOK — 2nd Edition, by George Jacobs, W3ASK & Theodore J. Cohen, N4XX.**

During the three years since the first publication there was a surprising burst of solar activity which drove the sunspot count to be the second on record since the Swiss Federal Observatory began keeping records in 1749. This made it necessary for the authors to rewrite the entire chapter on Sunspot Cycle Predictions.

There are many other changes with updates, expanded data and additional charts.

150 pages plus indexes published by CQ Publishing, Inc.

## **AMATEUR TELEVISION HANDBOOK — Volume 2 by Trevor Brown, G8CJS.**

As the demand for "The Amateur Television Handbook" was so great Volume 2 was written to supplement and extend it.

This book has been designed to start where the original Handbook finished and encompasses SSTV, microwave bands and Teletype.

98 pages published by British Amateur Television Club.



## **ELECTRONIC CIRCUITS HANDBOOK — Volume 2 by Tom Kneitel, K2AES.**

Due to the overwhelming demand for easy circuits this edition contains an entirely new assortment of circuits which it is hoped will satisfy the hunger of those who whetted their appetite on Volume 1.

There are 158 projects ranging from Transmitters, Receivers, Power Supplies, Modifications to Commercial Equipment to Test Gear and Operating Aids.

126 pages published by Cowan Publishing Corp.

**All books are available from your division or direct from MAGPUBS (publications department of the WIA) PO BOX 300, South Caulfield, Vic., 3162 or 3/105 Hawthorn Road, North Caulfield.**

# IC-R70

# NEW!

The Commercial Grade Communications Receiver that everyone has been asking for..... at a price you can afford!



## GENERAL COVERAGE RECEPTION AT ITS BEST

Listen to the world of HF with the R70, a 100kHz to 30MHz commercial grade receiver designed by ICOM Incorporated, the leader in advanced receiver design. Built from knowledge gained by designing receivers for commercial, marine, and amateur use, the R70 surpasses other receivers on the market... even receivers costing more than twice as much.

Utilizing ICOM's DFM (Direct Feed Mixer), the R70 is a receiver which in normal usage is virtually immune to intermodulation distortion or cross modulation, yet still maintains superior sensitivity. Whether you are a SWL (short wave listener), Ham (amateur radio operator), maritime operator or commercial user, the R70 provides the features you need.

## DESIGN

The R70 incorporates an UP conversion system, utilizing a direct feed mixer proven to be the best design for minimizing interference from strong adjacent signals. A preamp is provided for making the weakest

of signals readable. High grade filters in conjunction with the built-in PBT (pass band tuning) system and notch filter, provide the ultimate in interference rejection. Selectable AGC (fast/slow/off), noise blanker (wide or narrow), and rone control improve readability under the worst conditions. An AGC derived squelch, operative in all modes, adds to operating ease.

Dual VFOs with three tuning rates provide quick QSY (frequency change), memory for an important station, or by equalizing the VFOs (A=B), a digital RIT, 13.8 VDC operation is provided as an option. 230 VAC is standard.

## HAM'ING

The R70 is an ideal general coverage receiver to complement any ham shack. Use it with your existing transmitter or transceiver to provide dual receiver capability.

The R70's built-in monitor system lets you listen to your own transmitted audio and a mute input automatically projects the R70's receiver from your signal.

An option for FM allows listening to the 10 metre FM activity.

As an additional plus to ICOM IC-720A owners, the R70 has an optional interface

that will allow the R70 to control the transmit frequency of the 720A for the ultimate in handling versatility.

## SWLING

For the short wave listener, the readout section of the R70 gives all the information for logging a station to be returned to or a later time. Frequency, mode, VFO, signal strength are all displayed. A dial lock prevents accidental loss of a signal.

A front mounted speaker provides 3 watts of crisp clear audio. A record jack allows easy attachment of a tape recorder.

## ICOM SYSTEM

Like all ICOM HF products, the R70 fits into the ICOM system concept of accessories allowing you to use previously purchased accessories such as the HP1 headphone, SP3 external speaker, and AH1 auto bandswitching antenna.

## PRICE

Check with your local ICOM dealer for pricing on the R70. You will be amazed.

 **ICOM**  
The World System

ICOM AUSTRALIA PTY LTD

7 Duke Street, Windsor, Vic., 3181 Telephone 51 2284

# *Amateur Radio*

VOL. 51, No. 4 APRIL 1983

Registered by Australia Post — Publication No. VBH 0569



JOURNAL OF THE WIRELESS INSTITUTE OF AUSTRALIA



**BUSHFIRES RAVAGE TWO STATES  
NEW LIFE FOR TH6DXX  
SWLing RTTY**

**RF RADIATION — PART 1  
MILITARY SURPLUS — PART 1  
SENSITIVE SWR METER**



# Great Value! Books & Magazines.

- COLOUR COMPUTER NEWS • COLOUR COMPUTER NEWS
  - SYSTEM 68 - APPLICATIONS • 68 MICROJOURNAL
  - MICRO 80 • APPLE ORCHARD • CREATIVE COMPUTING
  - AUSTRALIAN PERSONAL COMPUTER
- WE ALSO HAVE A RANGE OF OTHER MAGAZINES IN STOCK!

FAIRCHILD		MOTOROLA	
Bipolar Memory Databook		CMOS Databook	\$9.00
	\$8.00	Schottky TTL Databook	\$8.00
CMOS Databook	\$9.00		
A Linear Databook	\$12.50		
MOS Memon. Databook	\$8.00		

PHILLIPS	
Building Hi-Fi Speaker Systems	\$6.50
Semiconductors Pt 2	\$10.00
Semiconductors Pt 3	\$10.00
General Catalogue 81 82	\$10.00

DATA BOOKS	
TEXAS INSTRUMENTS	
Software Design for Micro Processors	\$14.95
1981 Supplement - TI Data	\$6.25
Linear Control Circuits	\$3.90
Interface Circuits	\$16.00
MOS Memon.	\$8.35
Bipolar Microcomputer Components	\$9.99
TTL Data Book	\$12.50
Understanding Solid State Electronics	\$7.95
Understanding Computer Science	\$7.95
Understanding Communications Systems	\$7.95
Understanding Optronics	\$7.95
Beginners Basic TI-99 4A	\$14.95

NATIONAL SEMICONDUCTOR	
Audio Radio Handbook	\$6.50
Advanced Bipolar Logic	\$6.50
Linear Applications Handbook	\$18.00
Transistor Data Book	\$7.50
Voltage Regulator Handbook	\$8.00
Memory Data Book	\$7.00
Series 80 Board Level Computer	\$6.00
Hybrid Products Databook	\$9.00
Logic Data Book	\$9.00
MM 54HC 74HC High-Speed CMOS	\$2.50
The Reliability Handbook	\$16.00

All Publications Tax Code A

## Semiconductor Specials.

4001 23c	7411 30c	74LS11 23c	74LS83 75c
4002 30c	7413 45c	74LS12 23c	74LS85 30c
4007 23c	7414 45c	74LS14 55c	74LS90 30c
4013 30c	7420 23c	74LS15 23c	74LS93 30c
4015 55c	7430 23c	74LS20 23c	74LS123 30c
4042 45c	7432 23c	74LS27 23c	74LS157 30c
7400 23c	7442 45c	74LS30 23c	74LS174 30c
7402 23c	7444 45c	74LS32 23c	74LS240 75c
7403 30c	7474 30c	74LS42 30c	74LS245 90c
7404 30c	7475 45c	74LS43 30c	
7405 30c	7476 45c		
7406 30c	7490 45c		
7407 30c	7493 45c		
7408 30c	74121 45c		
7410 23c			

**SUPER BARGAINS AT MAGRATH'S**

### HILLS TV ANTENNAE

Designed to provide the best possible reception in your area. Built to highest electrical standards. Simple, lightweight, strong and easy to install.

EFC2 Metro Antenna **\$39.77**  
EFC3 Fringe area Antenna **\$66.81**  
FM3 Outdoor FM Antenna **\$23.35**

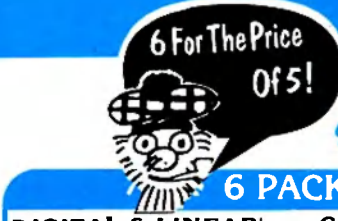

**SUPER LOW PRICES**

## 6 PACK SPECIALS

DIGITAL & LINEAR		CAPACITORS	
6x 4016B	\$1.50	Normal Price	Special Price Per Each Pack of 6
6x 4066B	\$2.40	50c	\$2.50
6x 4511B	\$3.45		
6x 74LS00	\$1.00		
6x 74LS04	\$1.00		
6x 74LS14	\$2.00		
6x 74LS90	\$2.10		
6x LM340KC 12	\$6.00		
6x LM3401 5	\$2.55		
6x UA317JC Regulator	\$6.00		
6x UA348PC Op Amp	\$4.25		
6x 74C00	\$1.00		
6x 74C107	\$1.50		
6x 74C04	\$1.00		
6x 74C02	\$1.00		

LEDs			
6x MV50535	35c		

BRIDGES			
6x KBPC602 6A 200V	\$5.00		

SCRs			
6x 60061 6A 600V	\$4.00		

TRANSISTORS			
6x PN2222A	25c		

BOURNS TRIM POTS 3006P			
\$5.16 - Tax Code C			

Standard Range 1000 - 1 MEGΩ			
3006P-101	3006P-201	3006P-501	
3006P-102	3006P-202	3006P-502	
3006P-103	3006P-203	3006P-503	
3006P-104	3006P-204	3006P-504	
3006P-105	3006P-205		

Ask about our other 6-Pack Specials There's lots more

### ARLEC PS493 KAPPAK

Multi-Voltage Car Adaptor Powers: Transistor Radios, Cassette Recorders, etc. from your Car Battery.

Suitable for 3V-4.5V-6V-7.5V-9V-12V equipment to 800mA

- Plugs into cigarette lighter socket
- 5-way plug connects to the majority of radios, recorders etc
- Includes polarity selector
- 12 months guarantee SEC Approved

**\$6.06** Plus Tax Code C

### VIDEO CABLES

VC1	BNC Plug to BNC Plug	3.20
VC2	BNC Plug to PL259 Plug	3.00
VC3	PL259 Plug to PL259 Plug	3.00
VC4	PL259 Plug to RCA Plug	2.32
VC5	RCA Plug to RCA Plug	1.60
VC6	BNC Plug to RCA Plug	2.61
VC8	6 Pin Dnt to 3.5mm, 2.5mm, RCA Plugs (for Sanyo)	4.60
VC9	3.5mm Plug, RCA Plug to 5 Pin Din, RCA Plug (for Akai)	5.15
VC11	2x RCA Plug - 2 RCA Plus (for JVC)	4.55

Plus Tax Code C

### ARLEC PS499 PLUG PACK BATTERY ELIMINATOR 6 VOLTAGE

Suitable for 3V 4.5V 6V 7.5V 9V 12V equipment to 800mA

- Flash Guns
- Electric Models
- Toys etc
- 12 months guarantee
- Cassette Recorders
- Calculators

**\$7.95** Plus Tax Code C

Eliminates batteries by running equipment direct from the mains electricity supply. SEC approved

### ARLEC 200H Mk 2 MULTIPURPOSE METER

for electrical testing.

Measures Voltage, Current and Resistance.

- SEC Approved
- 12 months Guarantee

**\$15.40** Plus Tax Code C

### MEMORY BARGAINS

HM6116P 3	\$5.99	250ns
MB2764 80	\$10.96	300ns 64K EPROM
MB8118	\$3.95	120ns 16384 X 1 RAM
MW2708Q	\$2.80	450ns 8K EPROM
MB8114 NLC	\$4.00	300ns CERAMIC
HN4625 X2G	\$7.00	450ns 32K EPROM
Sb834	\$13.30	512 X 8 EPROM
Sb835	\$4.70	128 X 10 RAM 450 NS
MC68000 L8	\$99.95	8 MHz CPU

PLUS TAX CODE C

### ARLEC SOLID STATE PLUG-IN LAMP DIMMER

Provides complete control over lamp brightness - saves money.

12 months guarantee

For table lamps, standard lamps, bedside lamps, etc...

- 500 watts output
- Includes Radio Interference Suppression
- SEC Approved

**\$9.57** Plus Tax

Made in Australia Code H

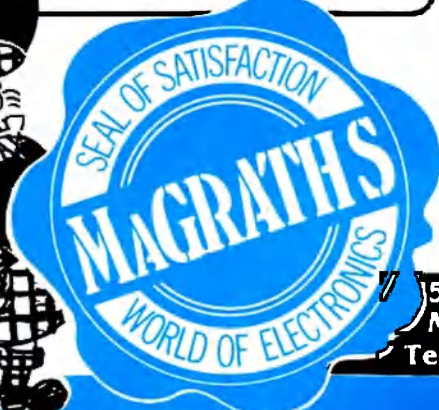

55 A'BECKETT STREET MELBOURNE, 3000. Tel (03) 347 1122 Telex AA31001



Registered Office:  
3/105 Hawthorn Road,  
Caulfield North 3161.  
Tel. (03) 528 5962



# amateur radio

## .. in this issue ..



On 15th February bushfires raged in VK5 and VK3. In this issue we feature WICEN involvement.

Photo: Greg Noakes — photographer for Southdown Press. Supplied Courtesy of: Dulcie Boling — Chairman and Chief Executive New Idea.

### ARTICLES

American OTHR—A New Woodpecker by Bill Martin VK2EBM .....	59
An Englishman in Australia by Deryck Buckley G3VLX/VK2EBZ .....	32
Anaconda Returns .....	49
Heard Island Expedition '83 by Neil Penfold VK6NE .....	50
Hints and Kinks for Contest Operating by Jack Swiney VK6JS .....	18
How Dangerous is RF Radiation — Part 1 Reprints from QST .....	26
Making the ICOM IC-551 Blanker Work by Andrew Martin VK3KAQ .....	24
Membership Form .....	43

Modern Military Surplus Equipment by Colin MacKinnon VK2DYM .....	29
New Life for the TH6DX by Jim Joyce VK3YJ .....	16
Publications Committee Field Day in Pictures .....	45
Radiation, Antennas, then what? Reprint from Gateway .....	51
Sensitive SWR Meter by Drew Diamond VK3XU .....	33
Simple External Freq Selection for ICOM IC-22S by Reg Fookes VK2AKY .....	22
SWLing on RTTY by Fred Robertson-Mudie VK1MM .....	20
VK/ZL/Oceania 1982 DX Contest Results by Jock White ZL2GX .....	62
VK7AMC — Australian Maritime College by Broder Tuff VK7XX .....	35
Who is this Amateur? by Peter Brown WK4PJ .....	48
WIA Directory .....	44
WICEN — The Test of Fire by Jim Linton VK3PC .....	12
World War II Military Sites by Peter Dermoudy .....	19

### DEPARTMENTS

A word from your EDITOR .....	9
Advertisers Index .....	80
ALARA .....	61
AMSAT Australia .....	66
Awards — Lake Goldsmith Steam Rally, NZ Rainbow Trout .....	54
Club Corner — Midland Zone & SERG Conventions .....	65

Commercial Chatter .....	69
Contests — VK/ZL/O 1983 RTTY & Sangster Shield Rules .....	64
Education Notes .....	57
Five-Eighth Wave .....	73
HAMADS .....	79
Here's RTTY .....	56
How's DX .....	46
International News — Soviet Diplomats .....	31
Ionospheric Predictions .....	74
Letters to the Editor .....	76
Magazine Review .....	48
Main QSP .....	10
National EMC Advisory Service — "A Fair Go" .....	60
Novice Notes — Are you ready for the AOCPE exam? .....	55
Obituary — VK4AYZ .....	79
Pounding Brass — Keys & Keyers Part 3 .....	58
QSP's .....	58, 72, 78
Silent Keys VK3XV, G6DW, VK7ZYL, VK4AYZ, VK6BB & VK4PR .....	79
Spotlight on SWLing .....	70
Thumbnail Sketches — Ralph Pepper, Jack Wooster & Vern Kenna .....	52
Try This — Cassette Player/Tcvt Interface Device by Stephen Gard VK2PMF .....	34
VHF UHF — an expanding world .....	67
VK2 Mini Bulletin .....	72
VK4 WIA Notes .....	73
WIA News .....	11
WICEN News — Review of past, look to future .....	71

**EDITOR**  
GIL SONES\* VK3AUI

**IMMEDIATE PAST EDITOR**  
BRUCE BATHOLS\* VK3UV

**TECHNICAL EDITORS**  
RON COOK\* VK3AFW  
EVAN JARMAN\* VK3ANI  
BILL RICE\* VK3ABP

**CONTRIBUTING EDITORS**  
BOB ARNOLD VK3ZBB  
MIKE BAZELY VK6HD  
REG DWYER VK1BR  
MARSHALL EMMS VK5FN  
RON FISHER\* VK3OM  
BRUCE HANNAFORD VK5XI  
ROY HARTKOPF\* VK3AOH  
ROBIN HARWOOD VK7RH  
ERIC JAMIESON VK5LP  
KEN McLACHLAN VK3AH  
LEN POYNTER\* VK3BYE

**DRAFTING**  
GEORGE BROOKS  
LIZZ KLINE

**BUSINESS MANAGER**  
REG MACEY

**ADVERTISING MANAGER**  
JOHN J. A. HILL VK3DKK

\*Member of Publications Committee

Enquiries and material to:  
The Editor  
PO Box 300, Caulfield South Vic. 3162

Copy is required the first of each month. Acknowledgement may not be made unless specially requested. All important items should be sent by certified mail. The editor reserves the right to edit all material, including Letters to the Editor and Hamads, and reserves the right to refuse acceptance of any material, without specifying a reason.

Material should be sent direct to PO Box 300, Caulfield South Vic. 3162, by the 25th of the second month preceding publication. Phone: (03) 528 5962. Hamads should be sent direct to the same address by the 1st of the month preceding publication.

Trade Practices Act: It is impossible for us to ensure that advertisements submitted for publication comply with the Trade Practices Act 1974. Therefore advertisers and advertising agents will appreciate the absolute need for themselves to ensure that the provisions of the Act are complied with strictly.

Victorian Consumer Affairs Act: All advertisers are advised that advertisements containing only a PO Box number as the address cannot be accepted without the addition of the business or residential address of the box-holder or seller of the goods.

Production: BETKEN PRODUCTIONS  
5 Masfield Avenue, Mooroolbark, 3138

Laser Scanned Colour Separations by:  
QUADRICOLOR INDUSTRIES PTY LTD,  
Graphic Division  
22-24 Glenvale Crescent, Mulgrave, 3170.  
Tel.: (03) 560 2222

Typesetting by: QUADRICOLOR INDUSTRIES PTY LTD,  
22-24 Glenvale Crescent, Mulgrave, 3170  
Tel.: (03) 560 2222

Photographic film and processing masters courtesy  
AGFA-GEVAERT LTD AUSTRALIA

Printers: WAVERLEY OFFSET PUBLISHING GROUP  
Geddes Street, Mulgrave, 3170  
Tel.: (03) 560 5111

\* Copy for June issue must  
arrive by 25th April 1983.

OVER 33,000  
CHANNELS

# J.I.L. SX-200



JIL  
REGD™

Monitor thousands  
of frequencies

NOW 32  
MEMORIES

FEATURING:

• Airband  
• Australian  
low-band



A range of accessories is available including Broadband or High Gain BASE Antennas.

## PROGRAMMABLE SCANNER DOES IT ALL. 26 - 180MHz, 380 - 514MHz.

### SPECIFICATIONS

- **Type:** FM & AM
- **Frequency Range:**
  - a) 26-57.995 MHz Space...5 kHz
  - b) 58-88 MHz Space...12.5 kHz
  - c) 108-180 MHz Space...5 kHz
  - d) 380-514 MHz Space...12.5 kHz
- **Sensitivity:**
  - FM...a) 26-180 MHz 0.4uV S/N 12 dB
  - b) 380-514 MHz 1.0uV S/N 12 dB
  - AM...a) 26-180 MHz 1.0uV S/N 12 dB
  - b) 380-514 MHz 2.0uV S/N 12 dB
- **Selectivity:**
  - FM.....More than 60 dB at -25 kHz
  - AM.....More than 60 dB at -10 kHz
- **Dimensions:** 210 (W) x 75 (H) x 235 (D) mm  
8-1/4 (W) x 3-1/4 (H) x 9-1/8 (D) in.
- **Weight:** 2.8 Kgs.
- **Clock Error:** Within 10 sec./month
- **Memory Channel:** 16 Channels
- **Scan Rate:**
  - Fast .....8 Channels/sec.
  - Slow .....4 Channels/sec.
- **Seek Rate:**
  - Fast .....10 Channels/sec.
  - Slow .....5 Channels/sec.
- **Scan Delay:** 0, 3 or 4 seconds
- **Audio Output:** 2 Watts
- **Ant Impedance:** 50-75 ohms  
Whip or External Antenna with LO/DX Control (20 dB ATT.)
- **Freq. Stability:**
  - 26-180 MHz ... Within 300 Hz
  - 380-514 MHz ... Within 1 KHz

The JIL SX-200 represents the latest **STATE-OF-THE-ART** technology in the development of Scanning Monitor Receivers. It has many features that previous have not been available on receivers of its type.

For example the tremendous frequency coverage, which encompasses all of the following bands:— HF & UHF CB, 27 & 155MHz MARINE, Australian LOW BAND, AIRCRAFT band, VHF SATELLITE band, 10Mx, 6Mx, 2Mx and 70CMx AMATEUR, VHF HIGH BAND and UHF TWO-WAY band — as well as many others. Other features include detection of AM or FM on all bands, Squelch Circuitry that can be used to **LOCK OUT** carrier only signals, Fine Tuning control for off channel stations, 240 VAC plus 12VDC operation, Squelch Operated Output that may be used to trigger a tape recorder or channel occupancy counter and accurate Quartz Clock.



\$599



\$8 P&P

### ACCESSORIES

Service Manual \$10 + \$1 P&P  
Scan-X Base Antenna \$62 + \$8 P&P

# JIL SX-200

## A BETTER SCANNING MONITOR RECEIVER

### HIGH QUALITY AND PERFORMANCE

JIL have designed the SX-200 as a high quality, high performance programmable scanning receiver at a realistic price, design criteria which are not born in many other receivers of its type.

### MECHANICALLY RUGGED

The JIL SX-200 is ruggedly built using EPOXY-GLASS printed circuit board and double sided through hole plating techniques. Easy access and servicability is maintained throughout its design.

### 4 BIT MICROPROCESSOR WITH ONBOARD ROM AND RAM

A powerful 4 Bit PMOS Microprocessor, the uPD553, is used as a controller in the SX-200. Its features include 2000 x 8 ROM and 96 x 4 RAM onboard as well as up to 80 instructions with a 3 level subroutine stack.

### EXTREMELY LOW SPURIOUS COUNT

Even though the SX-200 covers over 33,000 Channels JIL, through careful design, have been able to reduce the number of internally generated spurious signals to an extremely low level. Not the case in most other scanning receivers.



### FULLY TRACKED RF AMPLIFIERS

The SX-200 makes use of 3 separate RF Amplifier Stages. They are divided into 6 bands, each band having its own electronically switched coils which are fully tracked with the receiver frequency using Varicap Diodes. Maximum performance is thus gained over the entire operating range of the set.

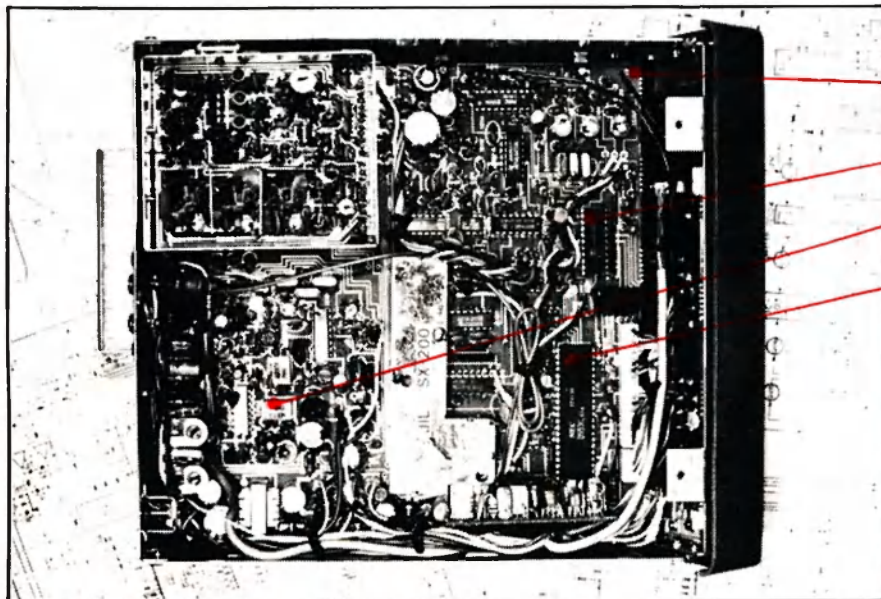

Rugged Double Sided Epoxy Glass Circuit Board

2K Cmos RAM

Crystal and ceramic I.F. filters.

4 Bit Microprocessor

Add an extra 16 memory channels

with the EXP-32 Memory Expander Kit.

- Total of 32 Memories
- Either Bank of 16 Can Be Scanned Separately.

PRICE \$53 + \$4 P&P

**SX-200, RUGGED CONSTRUCTION AND EASY SERVICABILITY.**

### AVAILABLE FROM

W.A.: Letco Trading Co. (09) 387 4966, N.S.W.: Emtronics (02) 211 0531, QLD: CW Electronics (07) 397 0808, S.A.: Jensen Intersound (08) 269 4744. Plus many other regional outlets, contact GFS for your nearest stockist.

AUSTRALIAN AGENT & DISTRIBUTOR

**GFS ELECTRONIC IMPORTS**

Division of GD & JA WILFER PTY. LTD

15 McKeon Road, Mitcham, Vic. 3132  
PO Box 97, Mitcham, Vic. 3132  
Telex: AA 38053 GFS  
Phone: (03) 873 3939, 873 2652



# NOVICE LICENCE

THE WHOLE FAMILY CAN GET ONE!

- \* THEORY BOOK \$7.50 incl. postage
- \* MORSE CODE TAPES \$5.00 incl. postage

Theory book: + covers whole syllabus  
 + simple text  
 + clear diagrams  
 + questions incl.

Morse tapes: + 5 WPM Novice  
 + 8/10/15 WPM  
 + 10 WPM exams  
 + 15 WPM

.....  
 Available from: G.Scott 11 Balmoral Cres.  
 Surrey Hills 3127 Vic.  
 or : A.Brucesmith.110 Rosemead  
 Rd. Hornsby 2077 NSW.

# CAMERAS & FILMS



## TO COLOUR YOUR LIFE... BEAUTIFULLY

## Crown remote control antenna rotator.

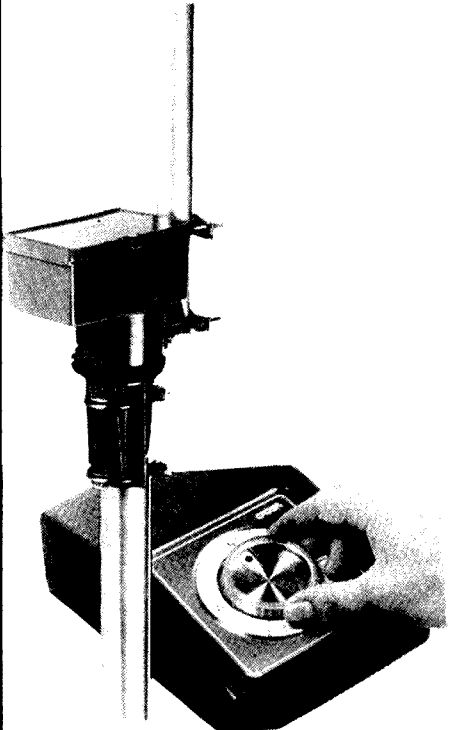

### IT'S EASY TO SEE WHY CROWN IS AUSTRALIA'S MOST POPULAR ROTATOR

#### ★ EASY INSTALLATION

Simply follow the instructions. Installation is a very easy Do-It-Yourself operation that requires no special Electronic or Electrical Skills.

#### ★ ALL BRACKETS AND MOUNTING HARDWARE SUPPLIED

Easy to follow instructions are included with the kit, together with Service, Parts and Wiring Diagrams. Nothing else to buy.

#### ★ COMPLETE WITH ALL CABLES

Full 70 feet of Harness supplied for Control Unit to Mast connection.

#### ★ FULLY APPROVED

By the Electricity Authority of NSW.

#### ★ INBUILT POWER SUPPLY

Control Unit just plugs into the mains and is ready to go.

#### ★ RUGGED DRIVE UNIT

Steel ball thrust bearing Rotor. Precision machined gears.

#### ★ STILL UNDER \$150

Vertical loading to 13.6 kg. Wind tested to 110 Kmh.

#### ★ WILL ROTATE A COMET

DISTRIBUTED  
BY



17 Sloane St,  
Marrickville, 2204.  
NSW Australia  
Phone: (02) 516 4500

Cables: 'MOBILEONE', Sydney  
Telex: AA27908, MOBILE  
PO Box 166, Randwick, NSW 2031.

### AVAILABLE ONLY FROM THE FINEST DEALERS — NATIONWIDE

# INCREDIBLE PRICE BREAKTHROUGH!

## YOUR CHANCE TO GO SCANNING

The Exciting New Hobby Sweeping Australia

**FAMOUS BEARCAT**

Latest Technology

The brilliant DICK SMITH

### PRO 40 SCANNER

Compare this superb Scanner with others of similar performance elsewhere at nearly twice the price! The new PRO 40 Scanner from Dick Smith represents the state-of-the-art in computerised scanning receivers! Completely solid state computer - controlled circuitry - no expensive crystals to buy - complete with backup battery for stored frequencies.

#### LOOK AT THESE SPECIAL FEATURES

Touch-type splash proof keyboards for direct entry of all operational commands, frequencies etc. Ideal as either a base or mobile scanner (operates 12V - beware of others that don't operate from 12V!) with its own self-contained whip antenna or external plug-in antenna. Also included is a specially prepared Australian instruction manual written and produced by our own engineers.

ALL FOR ONLY

**\$399**

65-520MHz Antenna specifically designed for scanners  
Cat D-4430 \$49.95

EXCLUSIVE

#### YOU CAN HEAR .....

Just about everything from harbour control nudging a supertanker into its berth, to telephone conversations from cars speeding along city streets! All the emergency services, authorities and forces ..... And of course there are thousands of business radio stations, amateur and CB radio operators.

Plus the thousands of stations in the band that we don't know about yet (we're waiting for you to tell us about them!) Cat D-2805

#### FREE THIS MONTH

This month 'Dick Smith's Australian Radio Frequency Handbook' (normally \$12.95) is yours free with every PRO 40 Scanner. (STOCKS LIMITED)

Or \$9.27 per week to approved customers.



## DICK SMITH ELECTRONICS

A405M/CT

NSW Auburn 648 0558 - Bankstown Sq. 707 4888 - Blakehurst 546 7744 - Bondi Jct. 387 1444 - Broadway 211 3777 - Brookvale 93 0441 - Chullora 642 8922 - Gore Hill 439 5311 - Liverpool 600 9888 - North Ryde 88 3855 - Parramatta 689 2188 - Sydney (Bridge St) 27 5051 - Sydney (York St) 290 3377 - Tamworth 66 1961 - Tighes Hill 61 1896 - Wollongong 28 3800 ACT Fyshwick 80 4944 VIC Coburg 383 4455 - Frankston 783 9144 - Geelong 78 6766 - Melbourne 67 9834 - Richmond 428 1614 QLD Brisbane 229 9377 - Buranda 391 6233 - Charmside 59 6255 SA Adelaide 212 1962 - Darlington 298 8977 - Enfield 260 6088 WA Perth (William St) 328 6944 - Perth (Hay Street) 321 4357 Cannington 451 8666 TAS Hobart 31 0800  
MAIL ORDER CENTRE: PO Box 321, North Ryde, NSW 2133. Phone: (02) 888 2105. Prices correct and stock available at press time



#### BEARCAT QUALITY - ECONOMY PRICE!

Amazing value - a quality micro-processor controlled scanner UNDER \$300! That's the superb Bearcat 150FB - the ideal monitor scanner for business, emergency services, news gathers, etc. With up to 15 channels programmable into its computer memory, with lockout and delay facilities available, you're ready to monitor a huge variety of special interest frequencies. At the touch of a button, you can lock any of them on so you won't miss any of the action. And changing the frequencies is as easy as punching in a few digits from the touch-sensitive keypad. If you're business depends on reliable monitoring, you need the Bearcat 150FB. 12V operated, (240V with optional adaptor). Cat. D-2800

That's the Bearcat 150FB ONLY \$285

#### A BRAND NEW BEARCAT

Introducing the all-new Bearcat 200 - a feature-packed scanner at a budget price.

With extended frequency range (covers up to 512MHz to include mobile telephones, etc) and splash-proof keypad, you'll be amazed at the Bearcat 200's versatility - especially at the low, low price.

Holds up to 16 channels in memory, with priority and lockout capabilities, delayed scanning, full band search facilities and direct channel access.

Ideal as a mobile scanner, too - operates from 12V DC - or use at home with an optional 240V mains adaptor. And no crystals to buy: everything is controlled by the inbuilt microprocessor!

Catch all the action with this superb new Bearcat 200. Cat D-2801

That's the Bearcat 200 ONLY \$349

#### FIND OUT WHERE AND WHO!

### DICK SMITH'S AUSTRALIAN RADIO FREQUENCY HANDBOOK

Up-to date and thorough listings of virtually all the VHF/UHF radio users we've been able to find. YES - find out who is where - and where to listen for all the excitement! PLUS: air band, marine band, and how to use a scanner, amateur radio and CB etc. Cat B-9600

VALUE AT \$12.95

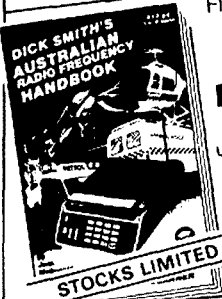

STOCKS LIMITED

# NEW CALLBOOKS NOW AVAILABLE

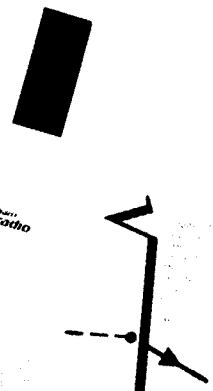
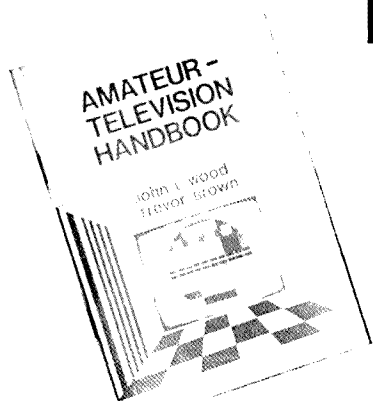

## WIA BOOK

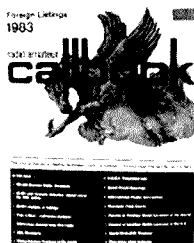

VOLUME 1

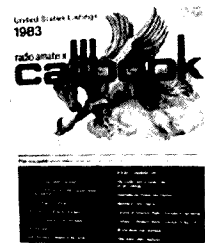

Have you a copy of the WIA Book yet?

In this book are 90 pages of VHF articles, projects and tables, Chronological Table of Radio Data from 1729 to 1925, Amateurs and Emergencies, Morse Code from Correspondent to Computer, Notes on QSLs and Callsigns, Ionosphere and Satellite information, IRU and ITU data, General Information of the WIA plus 16 magnificent reproductions of Historic Photographs.

Can you afford to miss this original production?

Hurry!! Limited Stocks now available.

### HAM HANDBOOK — Volume 2 edited by James R. Fisk, W1DTY.

This is a compilation of the many useful Circuits, Technical Tips or just practical approaches to solving odd problems which are contributed to the "Ham Notebook" column of Ham Radio Magazine.

This book has many practical, bench-tested circuits and construction ideas which covers amateur radio from low frequencies to microwave.

175 pages published by Communications Technology.

### AMATEUR TELEVISION HANDBOOK — by John L. Wood, G3YQC and Trevor Brown, G8CJS.

This is an amateur TV book with the emphasis on subjects such as Modern Receiving Systems, Electronic Video Sources, Vision Processing and Colour Television. There is a chapter for the newcomer and also guidance on aerials, feeders and simple receiving equipment.

93 pages published by British Amateur Television Club.

All books are available from your division or direct from MAGPUBS (publication department of the WIA) PO Box 300, South Caulfield, Vic 3162 or 3/105 Hawthorn Road, North Caulfield.

# THE CONVENIENCE REVOLUTION.



**A BRILLIANT LINEUP OF HIGH QUALITY AMATEUR RADIO ACCESSORIES.**

## ANTENNA ROTATORS

Round controller with world map indicator. DR7500R, DR7600R.

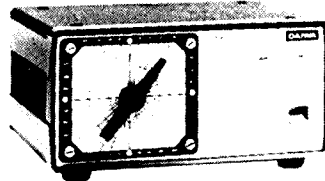
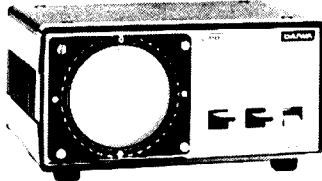

Pre-set controller. DR7500X, DR7600X.

Set your antenna with a choice of Daiwa Heavy Duty and Medium Duty Rotators. They'll get you going in the right direction. Type X allows you to pre-set the call area you want and Type R comes with Paddle Switch Control and world map display.

**DR7500R** Daiwa Ant. Rotator, Medium Duty. **DR7500X** Daiwa Ant. Rotator, Medium Duty, Pre-set. **DR7600R** Daiwa Ant. Rotator, Heavy Duty. **DR7600X** Daiwa Ant. Rotator, Heavy Duty, Pre-set.

## SWR/POWER METERS

Hands-off operation.

The famous cross-needle meter provides three measurements at the push of one PTT button. And their compact size means they fit into even the most crowded shack. There's a compact cross-needle meter to suit almost any need—choose the one that suits you.

**CN510** 1.8-60MHz. 200W/2kW. **CN520** 1.8-60MHz. 20W/200W. **CN540** 50-150MHz. 20W/200W. **CN550** 144-250MHz. 20W/200W. **CN620A** 1.8-150MHz. 20W/200W/1000W. **CN630/CN630N** 140-450MHz. 20W/200W. **CN650** 1.2-2.5GHz. 2W/20W. **CN720** 1.8-150MHz. 20W/200W/1kW.

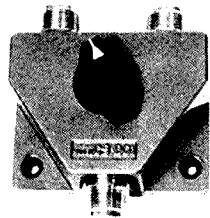

## COAXIAL SWITCHES

You get low-loss and good isolation with Daiwa's professional quality coaxial switches. They all complement Vicom's own unbeatable relays and operate from HF to 70cm. **CS201** Daiwa Coaxial Switch, 2 Pos. **CS201N** Daiwa Coaxial Switch, 2 Pos. "N" type. **CS401** Daiwa Coaxial Switch, 4 Pos.

## ANTENNA TUNERS

**AUTOMATIC** The **CNA1001** and the **CNA2002** are two of the most advanced antenna tuners on the market.

Both provide the convenience and accuracy of automatic tuning at the push of a button! The **CNA2002** is rated at 2.5kW PEP while the **CNA1001** is rated at 500 watts PEP. Both units auto tune within all HF bands 3.5-30MHz, including the new WARC bands. Both units incorporate the unique Daiwa cross-needle meter to indicate SWR and Power. A built-in dummy load is also included for preliminary tuning. **CNA1001** Daiwa Automatic Tuner 200W. **CNA2002** Daiwa Automatic Antenna Tuner 2.5kW.

**MANUAL** Daiwa has a superb range of Manual Antenna Tuners to ensure your station operates efficiently by getting maximum power to your antenna system. Rugged design and ease of operation make these tuners a must for any amateur station! **CNW518** Daiwa Manual Antenna Tuner 3.5-50MHz (including WARC). **CN418** Daiwa Manual Antenna Tuner 3.5-30MHz. **CNW218** Daiwa Manual Antenna Tuner 3.5-30MHz.

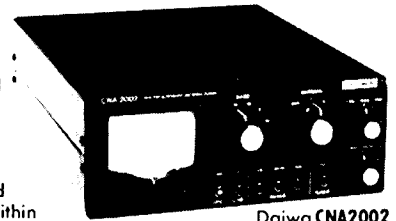

Daiwa CNA2002



Melbourne: Vicom International Pty. Ltd., 57 City Rd., Sth. Melb. (03) 62 6931.

Sydney: Emtronics, 649 George St., Sydney. (02) 211 0531. Wellington, N.Z.: Malvicom, 18 Raroa Rd., Lower Hutt. (4) 69 7625.

**Authorised Dealers N.S.W.:** Wagga: Rivercom 21 2125. Wollongong: Macelec 29 1455. Gunnedah: Landlink Communications 42 2838.

Springwood: Springwood Hi-Fi 51 3091. Tamworth: Independent Communication 65 6962. Inverell: Stockman & Higgins (067) 22 1300.

**Victoria:** Melbourne: Eastern Communications 288 3107. Bendigo: Sumner Wholesale 43 1977. Port Fairy: Ansonic Electronics 6 8113. Ballarat: John Lewis Electrical 31 3322. Wecom 39 2808. Cheltenham: Power Band Communications 584 7631. Frankston: Worldwide Radio 789 3412.

Moe: Codlin Communications 27 4516. Hamilton: Hamilton Electronics 72 3333.

**Western Australia:** Perth: Willis Trading 321 2207. Netronics 46 3232. Wormald Communications 277 8944. Kalgoorlie: Hocks TV 21 1906.

**Tasmania:** Launceston: Gelston 27 2256. Advanced Electronics 31 7075. Hobart: Harvey Skegg 23 6751. Burnie: VK Electronics 31 7733.

South Launceston: Graeme Thomson Electronics 44 4773.

**Northern Territory:** Darwin: Darwin Communications 85 3184.

**Queensland:** Brisbane: CW Electronics 397 0808. Gold Coast: Amateur's Paradise 32 2644. Townsville: Robco Equipment 72 2633.

Gladstone: Jones Communications 72 1116. Cairns: R. E. Hunter & Associates Pty. Ltd. 51 5092.

**South Australia:** Port Adelaide: International Communications 47 3688. Mt. Gambier: Set Services 25 2228. Whyalla: Gulf Communications 45 0208.



# YAESU'S NEW HF TRANSCEIVER

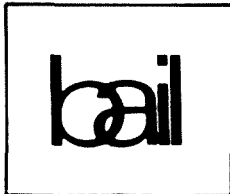

## FT-77

- ALL AMATEUR BANDS  
3.5 to 29.9 MHz (including WARC)
- CW, SSB MODES (FM optional)
- 100W OUTPUT
- WEIGHT: 6 kg
- SIZE: 240(W)x95(H)x300(D) mm,  
including heat sink

### FT-77 HF TRANSCEIVER

Featuring efficient, all solid state, no tune circuitry, the FT-77 offers a nominal 100 watts of RF output on all amateur bands between 3.5 and 29.9 MHz, including the three new WARC bands. The new CAD/CAM\* techniques plus the simple design of the FT-77 add up to one of the smallest, lightest HF transceivers ever, both in your hands, and on your wallet.

The front panel control layout and operation are actually simpler than some VHF FM transceivers, with only the essential operating controls. Nevertheless, all of the essential modern operating features for HF SSB and CW are included, along with extras such as dual selectable noise blanker

Computer-aided design of the circuit boards in the FT-77 ensures the most efficient component layout possible in the smallest space, while automatic parts insertion and soldering greatly diminish the chance of human error. Reliability and quality

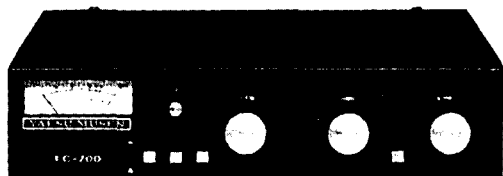

### FC-700 ANTENNA TUNER

pulse widths (designed to blank the woodpecker or common impulse noise), full SWR metering, and capabilities for an optional internal fixed-frequency channel crystal, narrow CW filter and FM Unit.

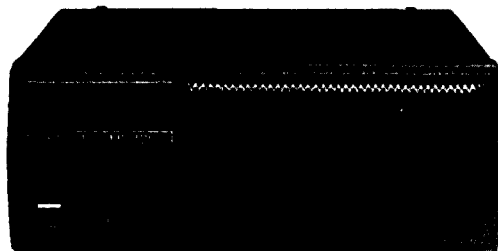

### FP-700 AC POWER SUPPLY

control are thus improved and simplified beyond the degree previously attainable in amateur equipment.

The extremely compact size and simple control layout make the FT-77 ideal for mobile operation, or as a complete base station with the optional FP-700 AC Power Supply, FV-700DM Digital Scanning VFO and Memory System, FTV-700 V/UHF Transverter and the FC-700 Antenna Tuner.

\* Computer-Aided Design/Computer-Aided Manufacture



## Bail Electronic Services

38 Faithful Street,  
Wangaratta 3677  
Telephone: (057) 21 6260 — Telex: 56880



Bankcard Welcome

Stan Roberts  
VK3BSR



---

*At the beginning of February Gil VK3AUI relieved Bruce VK3UV of the Editorship of AR to allow Bruce more time to devote to his position as Federal President of the WIA. Although Gil has been a member of the Publications Committee for many years this is his first contribution as Editor.*

---



## a word from your EDITOR

Taking over as editor of Amateur Radio is quite an experience. The computer which prints the labels chose the changeover as an ideal time to throw a tantrum. Schedules were thrown into disarray as data entries and programme were checked and rechecked.

Thanks to the good work of Reg, the office staff, Ken, Bett, and Automail, the March issue was mailed only a little later than usual. Amateur Radio follows a very tight schedule to reach you at the start of the month.

The whole production team will be working to get it out on time for the rest of the year.

During all this time disastrous bushfires were raging in South Australia and Victoria. Many amateurs have once again provided a much needed service setting up and maintaining emergency communications.

Amateur radio has had some favourable publicity as a result of this. We do not go and offer assistance and provide operators and equipment just for this publicity. The publicity comes from a job well done.

Many WICEN operators had only taken part in exercises such as the "Murray River Canoe Marathon" — see February AR.

When the real thing came the training helped in getting efficient nets into operation.

WICEN operators provided communications to relief organisations such as Red Cross, in addition to the upfront organisations fighting the fires.

Think also of the amateurs who have lost everything. Certainly insurance may help to re-establish a station but you can never replace the personal mementos, QSLs, logs and treasured equipment of sentimental value. Let us hope that the lost stations will be re-established, even though the past will be only memories.

On a happier note is the return of the Heard Island operators who have satisfied, for a while, the need for this rare one. Other expeditions will be needed in the future: The need for Heard Island — now satisfied — will be back in a few years.

Articles and photographs are always needed. Amateur Radio needs your contributions. Whenever you go on a field day, go to a convention, raise a new antenna farm send a photo to Amateur Radio.

*Gil Sones VK3AUI  
Editor  
AR*



**Devastation wreaked by the Bushfires on Ash Wednesday.**



# QSP



## **BUSHFIRE EMERGENCY "ASH WEDNESDAY"**

**WEDNESDAY 16th February, 1983**

The desk calendar informs me that this date is "Ash Wednesday". It would even appear that the people who printed the calendars may have been psychic. On that day, the southern part of Australia literally exploded into ash — from the foothills of Adelaide, through the coastal and forests regions of Victoria to the Victorian/New South Wales border in the east.

The cause — 'Bushfires'. With temperatures in the mid-forties and hot northerly winds exceeding 80 kph in places, the countryside tinder dry from a prolonged drought, the scene was set for a disaster — and it happened! — **THE DREADED BUSHFIRES** —

Seventy people dead, twelve hundred houses destroyed, thousands of hectares of prime land burnt and several towns wiped out. There is probably not one person reading this who is not already aware of the disaster that occurred.

Emergency services went into full swing and as can be imagined the task was formidable.

There are many stories of untold heroism, and I am proud to have been associated in some small way in assisting some of those who provided assistance to the Police, State Emergency Service, Country Fire Authority, Red Cross, Salvation Army and other community welfare groups.

What of the 'Amateur Radio Service'? You may ask, as only little publicity has been given.

No, we are not looking to pat ourselves on the back, we were just there, using our communications capabilities and expertise for those requiring it.

Victoria's WICEN was activated on the evening of the 16th of February, primarily to provide a back-up communications service to the State Emergency Service and Police.

Approximately two hundred amateurs became involved over a period of five days — during the initial disaster and in assisting mopping up operations.

Three VHF repeaters and 80 and 40 metre nets were used, using the WICEN call sign VK3AWI.

Volunteer operators were stationed at the WICEN Control Centre and at SES head office, Red Cross HQ, police stations and at over thirty locations in the disaster areas. All manned on a twenty four hour basis in eight to ten hour shifts. Some operators worked four and five shifts continuously and volunteers were not in short supply. It appeared that nearly every amateur operator in the state wanted to offer assistance. It was a very heartening and overwhelming response.

It would be unfair of me to single out any one particular person involved in the WICEN bushfire emergency communications, as there were many dozens of operators deeply involved in many aspects of the emergency — from the initial setting up, all providing expert and efficient service for the benefit of our community.

A debriefing session for all people concerned in the amateur operation was due to be held on the 5th March. There will be a further debriefing session of key personnel from various areas at a later date.

It will possibly take many months/years before those affected return to normal living. For some people, probably never, particularly the families who lost loved ones in this disaster.

The amateur service has once again done itself proud, and can hold it's head up high. It has proven its willingness and abilities in providing an expert and efficient communications service for the benefit of our community.

We do not look for disasters, we do not want them, but they happen anyway.

One thing is for certain, the amateur radio operator will always be ready if required.

I would like to convey my personal thanks to all amateur operators who rendered assistance in this tragedy.

Alan Noble VK3BBM  
PRESIDENT, VICTORIAN DIVISION, WIA  
AR



# WIA NEWS

## **DEPARTMENT TO END INVOLVEMENT IN BROADCASTING EXAMINATIONS**

The Minister for Communications, Mr Neil Brown, has announced that his Department's role in conducting two broadcasting technical examinations would end at the close of 1983.

"This is a further step in deregulating the industry and means that more responsibility will be placed on the industry itself to ensure a supply of competent technical operators," the Minister said.

The examinations were for certificates known as the Broadcasting Operator's Certificate of Performance (BOCP) and the Television Operator's Certificate of Performance (TVOCP).

Training arrangements would in future be left in the hands of the industry and appropriate tertiary institutions.

Mr Brown said that although the qualifications would be phased out at the end of 1983 persons responsible for transmitter performance would be required to have technical qualifications incorporating certain units specified by the Minister.

Candidates who passed BOCP and TVOCP examinations conducted by the Department before 1 January 1984 would be deemed to meet this requirement.

A number of tertiary institutions already conducted courses for technical operators. His Department would be consulting with the Broadcasting Council and various institutions concerning the suitability of their courses.

"The broadcasting industry will need to make training arrangements either in-house or in conjunction with the colleges to meet its needs," Mr Brown said. "My Department is ready to assist in establishing these."

## **STANDARDS ASSOCIATION OF AUSTRALIA: COMMITTEE ON ELECTROMAGNETIC INTERFERENCE**

The WIA now has a representative on the Standards Association of Australia, Committee TE/3: Electromagnetic Interference. He is Mr A Foxcroft, VK3AE, who has had wide experience in this field as a practising engineer.

The prime objective of the committee is to prepare Australian

Standards relating to appropriate levels of electromagnetic interference emanating from all types of electronic and electrical equipment such as electric machines, motors, welders, computers and a wide range of other industrial, scientific and medical equipment. It does not cover unwanted emissions from licensed radiocommunication transmitters such as harmonics, out-of-band intermodulation products, etc.

Of particular interest to amateurs are factors such as levels of radiated and mains-injected signals from TV and BC receivers and TV recording devices (line oscillator, beat frequency oscillator, etc), domestic and industrial motors, ignition interference from motor vehicles, radio diathermy equipment and the like.

This activity can, in some cases, have impact on the WIA EMC programme and therefore the WIA TE/3 committee representative works in conjunction with the Federal EMC Co-ordinator, VK3QQ, as well as the Federal Executive.

The SAA Committee provides guidance to the International Electrotechnical Commission (IEC) Special Committee on Radio Interference, (CISPR), where international standards are formulated on related subjects. Wherever possible these standards are adopted by Australia. The WIA has now, therefore a much enhanced capacity to contribute to work in the RFI/EMC standardisation area at both national and international levels.

## **1983 FEDERAL CONVENTION**

The Institute will be holding its forty-seventh Annual Convention on 23, 24, 25 April 1983.

Motions received to date are:

- Two items from VK1, that the Executive revise and promulgate all WIA band plans and that the Executive approach DOC again to obtain the issue of amateurs licences for longer periods of currency than one year.
- An item from VK2 requires that the concessional pensioner and student subscriptions be reviewed on a Federal basis rather than divisional.
- Items from VK5 require that the WIA involvement with WCY 83 and PR be discussed and that the Federal Executive be requested to change the words CW only to telegraphy only in all future gentlemen's agreement band plans.

AR

## **DEADLINE**

ALL copy for June AR must REACH  
PO Box 300, Caulfield South, 3162 no  
later than 25th April.



Photo courtesy State Electricity Commission of Victoria.

COCKATOO — Vic

# WICEN — THE



*The devastating bushfires which swept across South Australia and Victoria in mid-February saw the Wireless Institute Civil Emergency Network (WICEN) providing vital communication links.*

The fires began on Ash Wednesday 16 February, and reached their peak in Victoria that evening as strong northerly winds turned gale force southerly with the passage of a cold front.

On Wednesday night WICEN in Victoria swung into action as the extent of the fires and their destruction was becoming known. The worst damage and loss of life had not occurred at that time.

WIA Victorian president Alan Noble VK3BBM played a leading role in pulling the WICEN operation into shape and stayed with it during the disaster. Before the bushfires Alan had been given the job of examining WICEN's role and its long-term reorganisation in Victoria.

About 160 amateurs took part in the WICEN operation which ran from Wednesday night through until the following

Monday when it was scaled down. Another 150 amateurs had volunteered to help but were held in reserve.

WICEN covered the five major fire areas — the Southwest, the Otways, Macedon Ranges, Warburton, and the Dandenong ranges. The official WICEN callsign VK3AWI was used from the shack of Kevin VK3YPL in Melbourne's eastern suburb of Donvale. This was the initial command centre for the WICEN operation. Later a caravan was borrowed and stationed on a water tower hill in East Ringwood, and this remained WICEN control until the operation was scaled down.

Alan Noble made a telephone call to the Department of Communications asking for the allocation of callsigns from the suffix WIB-WIZ and these were "given on request". He said the use of these callsigns

greatly assisted in the running of the WICEN net and he thanked DOC for its help.

Apart from being in the fire areas amateurs manned VK3SES on a round-the-clock roster at the Melbourne headquarters of the State Emergency Service. VK3SES backed up the communications of the State Emergency Service and messages for SES were handled on 2 and 80 metres. Communications were also provided at Red Cross headquarters South Melbourne on a twenty four hours a day roster system which saw a large volume of traffic being handled. The Red Cross does not have its own communications and traditionally calls on WICEN.

Among the types of messages handled were the location of evacuees, missing persons, medical advice, and relief supplies.

# TEST OF FIRE

Jim Linton VK3PC  
4 Ansett Crescent, Forest Hills, Vic 3131

Photo courtesy Mike Thorne VK3BKK.



**WICEN co-ordinator Peter VK3ANX and Vic Div President Alan VK3BBM.**

Photo courtesy State Electricity Commission of Victoria.



**LORNE — Vic**

During the height of the bushfires some amateurs stayed at their QTHs in the Gembrook-Emerald area in the Dandenong Ranges at risk to their own safety to provide communications.

urgent medical advice and, expertise in the automotive trade was given when a mechanical breakdown occurred. Peter Mitchell said: "There were many lessons to be learned" from the bushfire disaster. One of them was that more training was needed to "verse amateurs in message and information handling". Peter said out of the operators involved only thirty would be from the hard-core of WICEN operators who regularly take part in exercises.



**Gwen VK3DYL operating in the WICEN control caravan with planning board in background.**



**WICEN control operating from a caravan atop a water tower hill.**

The exercises he's referring to are the annual Red Cross Murray River Canoe Marathon, the Alpine Rally, and fun runs. He said while the amateur fraternity really pitched in during the disaster he was hopeful it results in more amateurs becoming WICEN regulars.

WICEN co-ordinator Peter Mitchell VK3ANX said there was some initial reluctance in some quarters to use amateurs for communication, but in the main this soon disappeared when the worth of WICEN was recognised.

Apart from communications there were other skills supplied during the disaster by amateurs — which reflects the wide cross-section of the general community represented within the Amateur Radio Service. Through the WICEN net a doctor gave

"I hope those who were involved will continue an association with WICEN by participating in exercises," said Peter. "It was also under serious consideration to have local WICEN exercises with make-believe disasters and prepared messages for handling."

This would test the call out system of amateurs and give them experience in handling messages, and develop WICEN



Mopping up operations at Mt Macedon with Graham VK3YUI (centre) controlling operations. Photo courtesy — Bill Rose.



Debriefing after the fires.

Photo courtesy — Mike Thorne VK3BKK.

services have been upgraded must surely now be dispelled. The 1983 Victorian Bushfire Disaster clearly showed that amateurs are prepared and willing to serve their community in time of need.

#### AMATEURS LOSS IN THE FIRE

Among the approximately 2000 houses destroyed in Victoria some were the homes of amateur radio operators.

One of those was of 78-year-old Harry Duggan VK3XI who lost everything when his house was destroyed by flames in the south western district fires. Harry and his wife Clarice were lucky to escape with their lives. Apart from the Duggan's home and personal belongings, Harry lost extensive radio equipment including three transceivers and his antenna system. Their home was on the Garvoc-Laang Road, at Laang.



Photo courtesy — Keith Hill VK3ASS

Harry VK3XI and XYL Clarice.

Harry said on "Ash Wednesday" he saw the smoke to the north-west but did not believe the fire would reach his area. But the fire moved rapidly, and by the time he had gone inside to get his wife the fire had hit. Harry and Clarice got into their car and started heading south, driving through the fire. But after they had travelled about a kilometre the fire had cut the road in front of them and built up behind them. Harry said: "I made a wild swerve and went back through the fire that I had originally gone through. There was no visibility but I know the road so well I just kept going."

He said he got back to a cleared area, stopped and then found it was actually in front of his own home. A number of people had gathered in the dairy of Harry's neighbour's house, just across the road. The flames at the time were about 100 metres to the west and to the north of his home.

Harry and Clarice watched their home burn as the house exploded from the intense heat before the flames reached the building.

Despite the trauma and heartbreak suffered by Harry he said: "My loss was nothing when you see what has happened to others."

#### WICEN IN SA

In South Australia WICEN was called out by the Country Fire Service when local telephone exchanges became overloaded. VK5 WICEN co-ordinator Bill Mitchell VK5JM says communications were provided for CFS and an HF link was established between Mt Gambier and Adelaide on 7 MHz during the day and 3.6 MHz at

into a "proper telegram service". Another lesson learnt, according to the WICEN co-ordinator, is the need to have a pool of amateurs who can handle the administrative side as administration and management practices were needed to sort out rostering, and generally keep track of what is happening. While amateurs are keen to get out in the field and "do something" there's a real need for those to do the important behind the scenes jobs.

A part of the WICEN effort was the St John Ambulance Brigade which used its own callsigns VK3SJA and VK3SJB to great advantage through WICEN control. The Brigade's presence added an extra dimension to the WICEN net.

St John Brigade publicity officer Michael Bonacci VK3YZO said the Brigade's two UHF simplex channels were in heavy use and the ability to operate through WICEN control was extremely useful as it enabled the Brigade to "speak to a number of organisations direct" and provided extra safety for members in the field.

Michael wished to also thank those amateurs who manned the Brigade's communication centre during the disaster. A strong relationship has obviously developed between WICEN and the St John Ambulance Brigade, and moves are certain to be made so it can grow even stronger.

Michael was heard in high praise of WICEN while being interviewed about the Brigade's activities on a commercial radio station. In fact WICEN did very well on the publicity side with the Red Cross explaining often to the news media how amateur radio operators had served during the emergency and newspapers, radio and TV news bulletins carried mentions of operators playing their part during the emergency.

The worth of WICEN was proved by its overall performance under great pressure — and at the risk of a pun: "It passed the test of fire". The thoughts of some that the role of WICEN had been diminished because the communications of other

TELEGRAM TELEGRAM TELEGRAM

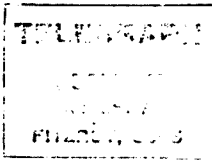

GRAM TELEGRAM TEL

FR 191- N22 =  
MELBOURNE TLX VIC 74/69 12.25P

MR ALAN NOBLE 12  
PRESIDENT WIRELESS INSTITUTE OF AUSTRALIA  
412 BRUNSWICK ST FITZROY

CONGRATULATIONS TO YOU AND THE MEMBERS OF THE CIVIL EMERGENCY NETWORK ON YOUR FINE PUBLIC SERVICE IN PROVIDING COMMUNICATION LINKS TO VICTIMS AND THEIR FAMILIES DURING THE DEVASTATING WEEK OF BUSHFIRES IN VICTORIA. I AM SURE IT WAS BOTH A GREAT COMFORT TO THOSE AFFECTED AND OF GREAT ASSISTANCE IN ORGANISING RELIEF  
NEIL BROWN MINISTER FOR COMMUNICATIONS

COL 412

night. Because of skip conditions the 40 metre operation had to be relayed through VK1 stations.  
Bill says about four hundred official messages were handled. He says the State Emergency Service asked for communications assistance when the fire operations began quieting down. WICEN was given a place at SES headquarters and a number of operators were sent into the field.

WICEN was commended for its effort by both CFS and SES and now has a permanent place at SES headquarters and amateur antennas are being installed.

Bill wishes to thank those amateurs who were not previously WICEN members but helped out during the emergency. A number of these have since become members of WICEN.

## A Call to all holders of a **NOVICE LICENCE**

Now you have joined the ranks of Amateur Radio, why not extend your activities?

**THE WIRELESS INSTITUTE OF AUSTRALIA (N.S.W. DIVISION)**

conducts a Bridging Correspondence Course for the AACP and LAACP Examinations.

**Throughout the Course, your papers are checked and commented upon to lead you to a SUCCESSFUL CONCLUSION.**

For further details write to:  
**THE COURSE SUPERVISOR, W.I.A.**  
P.O. BOX 1066,  
PARRAMATTA, NSW 2150

W01108

# ★ BRIGHT STAR CRYSTALS

*Specifications, Dimensions and data sheets available on request*

**BULK ORDERS:** In addition to our normal range we can supply quantity orders (100 up) at very competitive prices. All we ask is 50% of cost with order balance 30 days.

**DELIVERY:** 5-6 weeks from receipt of Order. Ring for quote: (03) 546 5076. Telex: AA 36004.

**NEW NSW AGENT:**  
**APP Master Communications,**  
**Sydney (02) 682 5044**

**BRIGHT STAR CRYSTALS**  
35 EILEEN RD., CLAYTON, VIC.  
ALL MAIL TO: PO BOX 42, SPRINGVALE 3171

Phone MELBOURNE (03) 546 5076

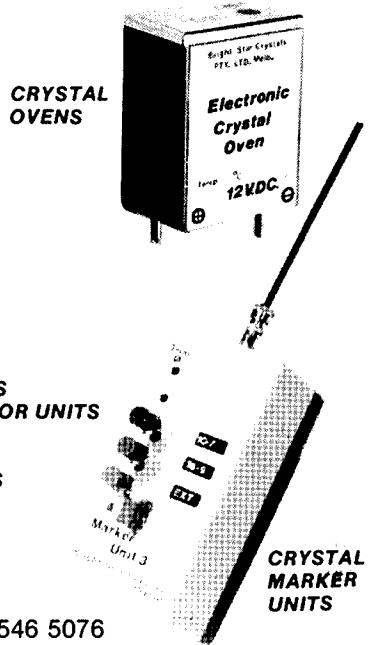

**WATCH CRYSTALS  
OVERN OSCILLATOR UNITS  
CRYSTAL UNITS  
FOR QUARTZ  
CRYSTAL CLOCKS**

**CRYSTAL  
MARKER  
UNITS**

# NEW LIFE FOR THE TH6DXX

Jim Joyce VK3YJ  
44 Wren St, Altona, 3018

From listening on air over the last few months, there seems to be some interest in the new HY-GAIN Antenna the TH7DX. However by the tone of most comments little is known about the technical side of the antenna, and very few are aware there is also a kit available to convert your existing TH6DXX into a TH7DX.

After losing my tower and TH6DXX in a storm (see article April 82 AR) I wrote to HY-GAIN in the States for a replacement price. They sent not only the data for the TH6DXX but also the technical data for the new TH7DX, plus the information that one may convert a TH6DXX with a kit (No 392s) into the new broadband version. Good points about the antenna or kit are the broadbanding without any apparent loss in gain, improved front to back, and in particular the fact that all the fittings are now stainless steel. Anyone who has had to hang by one leg and arm 30 ft up in the air like I have trying to undo rusted up fittings on a beam that had only been up eighteen months will know that zinc or cadmium plating leaves a lot to be desired, particularly in seaside locations! In my opinion the TH7DX is an expensive antenna landed in Australia (then what isn't expensive these days, unless you have a good tax dodge like some). But the kit could offer a viable alternative to the many TH6DXX owners in VK. The following are extracts from HY-GAIN'S form No 5314 which reports on both antennas. I leave it to you to decide.

## MULTI-BANDING TECHNIQUES:

There are two commonly used techniques for isolating sections of a multi-band antenna. One is the "lumped-constant" L/C circuit which is commonly known as a trap. Basically a trap is a parallel resonant circuit consisting of a capacitor and an inductor. The most common configuration of a trap is a wire coil enclosed within an aluminium tube. The capacitor is formed by the outer tube and the coil inside.

Other types of traps may use linear-loading techniques to replace the coil by a long length of rod or tubing. These traps result in the same amount of inductive loading as a conventional trap, since the shortening effect on the elements is the same. As a general rule-of-thumb for both driven and parasitic elements, the shorter the element is, the more loading and less efficient it is. The second technique is a circuit commonly known as "stub-decoupling". This circuit utilises  $\frac{1}{4}$  wave stubs to isolate certain portions of elements and is considered very efficient. In a multi-band parasitic array such as the TH7DX, the use of lumped-constant traps is the most desirable. Preassembled and tested traps substantially reduce on-site assembly time, which is a fact that all of us can appreciate. These traps allow half driven element lengths of 0.225 wavelength on 10 metres, 0.203 wavelength on 15 metres and 0.185 wavelength on 20 metres.

The TH7DX also features a combination of trapped and monoband parasitic

elements. Extensive research by HY-GAIN's engineering team indicated that a higher average front-to-back ratio could be maintained on each band by using this combination. Besides the two driven elements, there are two singly-trapped parasitics on 20 metres, one monoband director and one singly-trapped reflector on 15 metres, and one singly-trapped director as well as a monoband director and monoband reflector on 10 metres. Two of these singly-trapped parasitics are capacitively end-loaded to minimise the shortening effect and resulting in higher efficiency then would be possible with inductive loading.

## DUAL-DRIVEN ELEMENTS FOR LOW VSWR ON ALL THREE BANDS

The new TH7DX utilises a combination of two driven-elements, one resonant low in each band and the other resonant high, to produce VSWR less than 2:1 across each of the 10, 15 and 20 metre amateur bands. This dual driven element system uses a standard 50 ohm BN-86 balun and covers the entire 10-metre band from 28.0 to 29.7 MHz. These features are standard only on HY-GAIN's TH7DX. This makes the TH7DX ideal for OSCAR satellite reception when the other HF bands may be useless due to low sun spot numbers. The TH7DX is also ideal for "all-mode" operation, especially with the increasing popularity of RTTY terminals and code-readers in the CW band segments.

## GAIN AND RADIATION PATTERN MEASUREMENTS:

In the amateur radio service it is virtually impossible to measure HF antenna gain and defend your results. This is a highly controversial subject for most manufacturers, publishers and consumers in the amateur radio field. The problem stems from the fact that most amateur radio operators cannot afford the time and equipment necessary to individually verify the advertised gain specifications. Also, no amateur radio publication has the capability to measure and verify antenna gain.

In an effort to avoid controversy and still quantify the gain performance of the new TH7DX, it was decided to simply compare it to the best known high-performance tribander in the world — the TH6DXX. Both antennas were measured against the same reference dipoles using the same test setup, and under exactly the same conditions. The TH6DXX was selected at random from stock and assembled by an antenna technician. Standard assembly procedures were also used in assembling the new TH7DX. The test antennas were measured at 70 feet (23 metres) above ground and approximately 1500 feet from the transmitter. The gain figures stated for the TH7DX are the measured differences between it and the TH6DXX. "Average gain" numbers were obtained by averaging three measurements for each band — top, bottom and band-centre.

The antenna radiation patterns of the TH7DX and the TH6DXX were also



# FRONT-TO-BACK RATIOS:

## \*TH6DXX

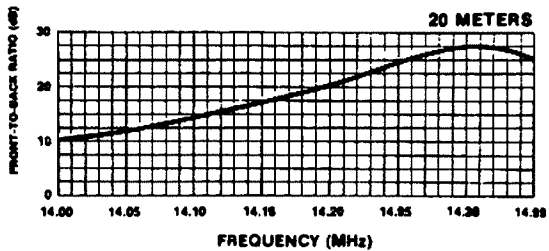
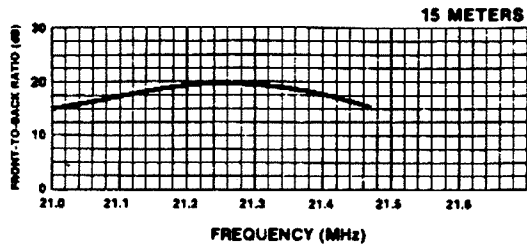
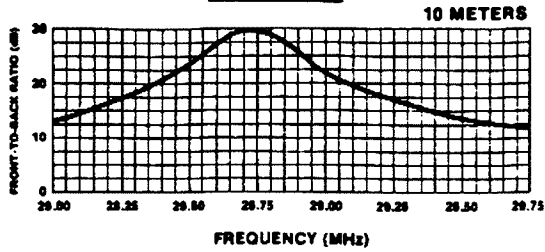

## TH7DX

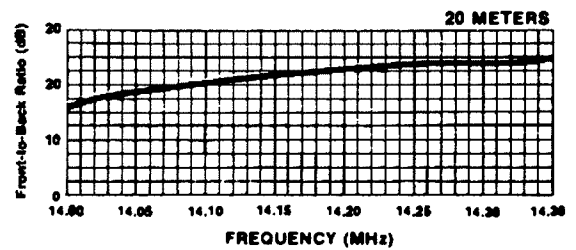
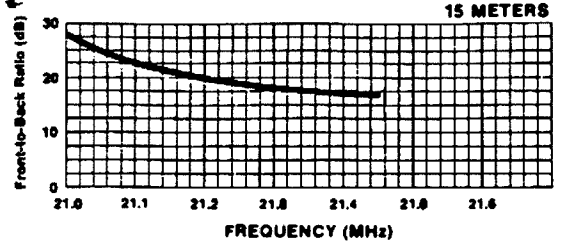
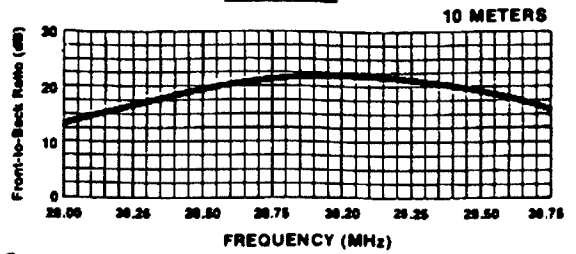

# VSWR:

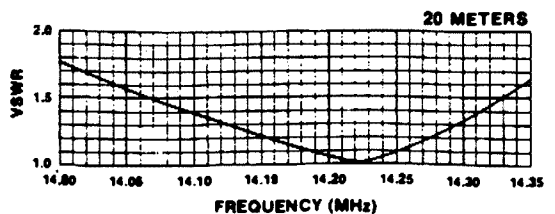
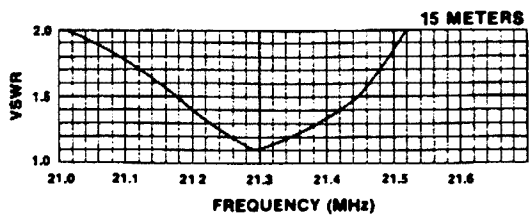
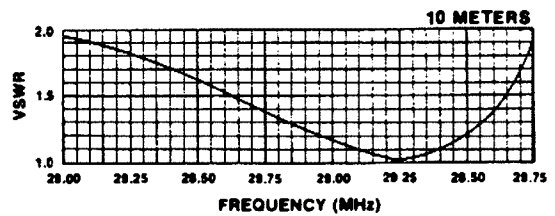
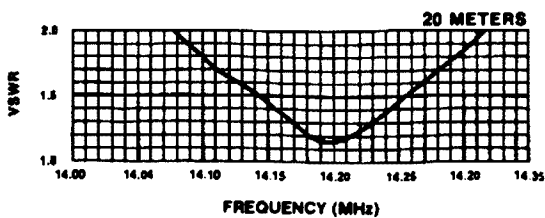
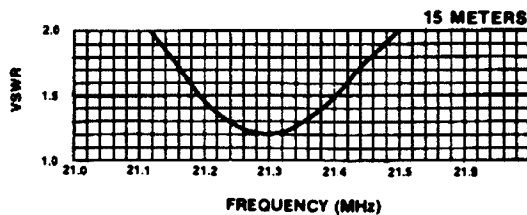
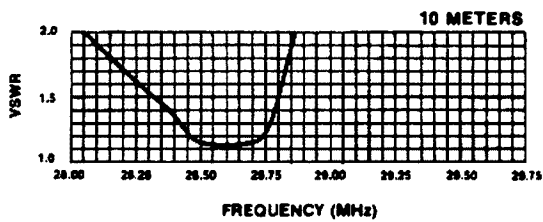

\* THE TH6DXX WAS ASSEMBLED TO THE "LOW PHONE" SETTING.

measured on the same test range under identical conditions. The test antennas were used as receiving antennas and were measured using a modern Scientific-Atlanta pattern recorder.

# HINTS AND KINKS FOR CONTEST OPERATING...

de Jack VK6JS

**DARKENED ELEMENTS ARE THE ACTIVE ELEMENTS FOR EACH BAND**

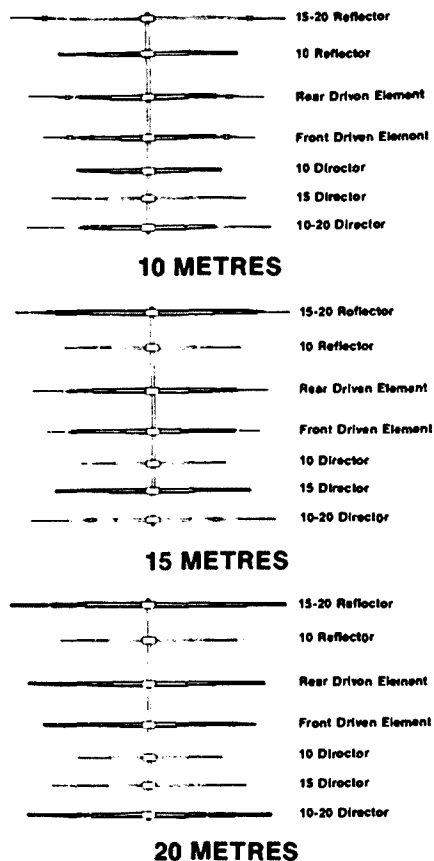

## PERFORMANCE COMPARISON — TH7DX TO TH6DXX:

ELECTRICAL:		TH6DXX	TH7DX
Power Gain	— Average (dB)	20M Reference	+0.3
		15M Reference	+1.4
	— Peak (dB)	10M Reference	+1.7
		20M Reference	+0.0
One-Half Power Beamwidth	— Average (degrees)	20M 65.0	65.7
		15M 68.0	63.3
		10M 59.0	63.0
Front-to-back Ratio	— Average (dB)	20M Reference	+4.0
		15M Reference	+5.8
		10M Reference	+0.0
2:1 VSWR Bandwidth	— (kHz)	20M 250	440
		15M 380	460
		10M 870	1710
Number of Active Elements	—	20M 3	4
		15M 3	4
		10M 4	5
		NO	YES

AR

Listening in on some of the "big gun" contests around the bands might deter some amateurs from becoming involved when they discover the overwhelming rapidity of callsign and report exchanges; a newcomer to the scene would perhaps describe it as "massive QRM"... let's admit it, during a big contest it ain't easy to find a clear spot for that weekly rag-chew with your old mate. Here's a little eavesdrop...

"I think you put it over to me, Joe, and I didn't hear a word you said on that last over... some KW guy came right over the top of you calling CQ Test but he's gone now... WHAT TEST?... Break, break."

"Well, Bill, it's one of them World versus The World contests this weekend so I guess we have to make the best of it... Hi!... By the way, I heard a JT0 out there just before you came up on frequency and I'd sure like to get him in the log for my DXCC... do you mind if I take off and hunt him down? Break."

"Not at all, Joe, go for your life... I think I'll track him down myself... I need JT0 too, as you know, and we might come across some more rare ones... see you later."

That's just one of the interesting aspects of contest operating... catching that rare one! Getting a QSL from him is usually no problem; he's in there either to give YOU a new country, zone, prefix or whatever or he's chasing you for his own reasons. He would obviously have considered and accepted the responsibility of QSL'ing... we hope! The name of the game is "grab him when you can!"

Of course, there's a bit more to contesting than just that. My personal approach is that it is foremost a "fun" activity... a good chance to meet old friends (no reason why you can't have a quick chat between contest numbers!)... a test of one's operating skills and the ability to put in a respectable score.

Preparation for the contest is all important. There's nothing worse, on switching the rig on, to find an interesting test underway. You vaguely recall having read about it somewhere as you glance up at the calendar and decide it's not too late to have a go. Now ensues a hurried attempt to locate the magazine that published the rules, grabbing a writing pad, tuning up the rig, checking the propagation charts, etc... all quite unnecessary if you had been ready for it in advance.

So let's summarize the basic requirements for an enjoyable and satisfying participation in a contest:

If you read of a contest that attracts your attention, write it down on a card showing dates and source to relocate the

rules... pin it up on the shack wall.

On the evening before the commencement of the test, prepare your blank "contest" log sheets... depending on the number of bands you intend to operate on, make up a separate one for each band.

Check your shack clock against WWV and adjust if necessary. Use of a digital type is recommended... it's much quicker to read and jot down. Mine is a "12-hour" displaying local time but this is altered to UTC when the faired copies are written up.

Have a couple of sharpened pencils handy at the operating table... breaking a point at a critical time could loose you a few vital points! And don't forget an eraser to correct those callsigns you hastily scribbled down that might be indecipherable later!

Check your manual key or auto-keyer... get that wrist flexing! I find that an auto-keyer with a multi-speed facility is very handy; in addition to the normal variable "Speed" pot. I have installed a four-position switch on mine for pre-set speeds of 12, 18, 24 and 30... the higher speeds for those UA stations who "send like the clappers!"

Pull out your latest propagation charts and map out your strategy. Pick the best start and finish times for each band, with beam headings, and tabulate them on a card. These don't always turn out to be quite correct but, at least, it gives you a chart to work from.

Now you should be ready to go! Make sure that you're tuned up and ATU'd about twenty minutes or so before the commencement of the test on the band of your first operation... tune around and listen to some of the signals... there's usually quite a few guys "flexing their muscles" with last-minute QSOs before the contest to give you a good idea of band conditions.

We're off... the shack clock shows the precise time of the start and all hell breaks loose! (This only applies to the "big gun" stuff, of course). DON'T call CQ at this point but tune slowly up the band from the lower end. Grab as many "CQ" stations as you can in the first ten minutes... by this time you've found that there are some vacant frequencies so get in on one and start calling "CQ TEST". But be prepared for a number of stations calling you at once... pick the strongest one or the "tail-ender" and work through the pile-up till the frequency is clear again. If there are no returns to your further CQs for the next three or four calls, give it up and go back to chasing those calling CQ as you did earlier. Repeat this process as often as you like.

From VKCW QRP Club Bulletin Nov '82.

AR

# WORLD WAR II MILITARY SITES SURVEY

## CAN ANYONE HELP?



Peter Dermoudy  
**MILITARY SITES CONSULTANT**  
 Northern Territory Museum of Arts & Sciences  
 Box 4646, Darwin NT 5794

We are conducting a survey of World War II Military Sites and have come up against a puzzle which can't be solved locally. We are hoping that you may be able to help us.

Printed are some photographs of a piece of equipment which obviously was housed inside a relatively small building when it was destroyed by fire. The equipment is now resting on its front face. The building was on raised piers with additional piers and strengthening to the floor beneath the equipment.

The photographs show a leaf spring suspension system below the cabinet, the top control panel which had a slight inclination from the horizontal and some (three) remaining condensers.

Adjacent to the building is what appears to be the concrete base of a tower.



The location of the installation in World War II parlance would be one (or all) of the following: — 10½ mile, 11 mile, Cemetery Plains, Knuckeys Lagoon or Knuckeys Siding. The mileages are the distances from Darwin.

We are hoping to identify the purpose the equipment served and which branch of the Services operated it and perhaps something about the equipment itself and when and for how long it was used.

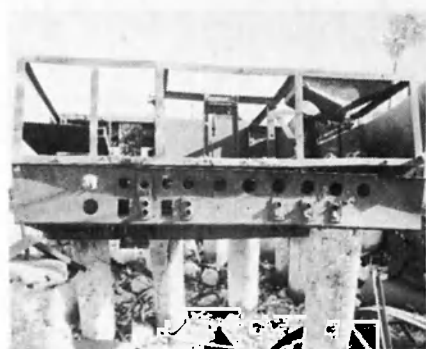

Incidentally the area in general appears to have had a multitude of radio installations. It is presently opposite the RAAF 11 mile Transmitting Station and adjacent to a recently abandoned DCA radio navigation aids site.

The photographs show aerial bases and the fallen masts which had a double taper with the thickest section being in the middle and flange bolted at that spot. The masts must have been approximately 22-25 metres high and were wire braced from the top and from an intermediate point.

AR

# SHORT-WAVE LISTENING ON RTTY

Fred Robertson-Mudie VK1MM and Forward Bias

*One of the interesting aspects of short-wave listening that was covered in 'Amateur Radio' (July '82) was that of monitoring HF Marine Communications stations. These Marine stations form a part of what is generally known as the utility services. The utility, or commercial services include fixed and mobile services, aeronautical, maritime, radio-navigation, standard time/frequency, point-to-point, meteorological, press etc, and occupy somewhere in the order of seventy five per cent of the HF spectrum. The utility stations use virtually every type of modulation technique, including radio-telephony, radio-telegraphy and radio-teletypewriter, as well as some of the more exotic formats such as facsimile, four-channel teletype and other multi-channel transmissions (though most of the latter are almost exclusively military).*

Whilst few, if any amateurs in Australia have the facilities to copy the more exotic formats, an increasing number are becoming involved in RTTY, making it probably the third most common form of amateur communication. This interest can be further enhanced by using the same equipment to monitor the utility RTTY stations on the short-wave bands, and it is an aspect of short-wave listening that can become quite absorbing. There are, for example, more than eighty press agencies using in excess of six hundred frequencies in the HF bands, and literally thousands of other types of utility stations using RTTY.

Not all the commercial/utility stations on the bands can be printed of course, a fact that will have been noticed by those amateurs already involved in this area. The stations which cannot be copied may, for example, be encrypted due to their traffic being of a military or diplomatic nature. Some, like the Arabs, whilst still using the standard CCITT2 five unit baudot code, have a quite different alphabet. Others, like the Russians and Greeks etc have, due to their somewhat larger alphabets, a 'third shift' on their machines allowing for the printing of 78 characters. The Japanese get round this problem by using a six unit RTTY code.

Other RTTY stations that cannot be printed on standard machines include, for example, VIS in Sydney which uses the CCIR seven unit SITOR code; the Australian Antarctic stations which use the CCITT3 seven unit ARQ code on their circuits; and the very few stations which use the CCITT5 eight unit ASCII code. The latter code is not very popular due to its high rate of data loss in QRM and QRN on HF circuits.

Most of the commercial traffic on HF uses the standard shifts of 170 Hz, 425 Hz, or 850 Hz, others are using odd shifts of up to 3 kHz. The speed of commercial traffic is not usually a problem as most

use either 50 or 75 baud. It is rare to find a station on HF using speeds in excess of 110 baud, again due to too high a data loss in QRM and QRN.

The monitoring of press agencies is possibly, the more interesting side of this aspect of the hobby. Some of these stations broadcast in French, Spanish etc. but the majority are in English (some things in life are meant to be easy). The quality of the material broadcast tends to vary considerably due to the fact that the greater majority of press agencies, ie those in the Communist bloc and in most of the developing countries, are owned and operated by their governments. This results in, for example, the somewhat biased news broadcast by the Telegraph Agency of the Soviet Union (TASS), and the rather crude propaganda broadcast by the (North) Korean Central News Agency (KCNA). However, the better known press agencies like Reuters and Associated Press (AP) broadcast the news that appears in the international pages of the daily newspapers, although it is surprising just how much of this news is either abbreviated or just not printed by the daily press. The advantage of printing the press agencies is that not only do you get 'all' the news, but it is a bit like getting the news before it happens!

Lists of frequencies, call-signs, schedules etc of many of the utility stations can be purchased from various outlets and can, in some cases, be quite comprehensive. However, you may prefer to save your money to purchase other things, including more amateur gear. To help you get started in this interesting aspect of amateur/SWL activity, I have compiled a list of 100 press agencies monitored during 1982. Whilst it is not intended to be comprehensive, and does not contain details of schedules, it could well form the basis of a detailed list of your own. Moreover, covering as it does a range of frequencies from 4 to 27 MHz, it

could also form the basis of an interesting study of HF propagation.

As can be seen, the list only covers the essentials (where known) of station name, call-sign(s), shift and speed. You will note that the most common shift and speed used by the press agencies is 425 Hz and 50 baud. A list of the acronyms of the various agencies included in the table is also given.

At this point, it might be a good idea to mention a few aspects of the practical side of monitoring commercial RTTY stations. It is, for example, essential to use a receiver with a high order of stability otherwise it will be almost impossible to copy these stations. However, most modern receivers are stable enough after a short warm-up period. If your demodulator cannot be switched for the various shifts, it is still possible to copy the different shifts by straddle tuning, particularly of a 425 Hz shift. If you cannot copy different speeds, I can only suggest that you get hold of one of the many technical articles on using a UART for speed changing.

The following table shows the 'normal' mark and space frequencies for both the high and low tones used for the more usual shifts:

HIGH TONES			LOW TONES	
SHIFT	MARK	SPACE	MARK	SPACE
170	2125	2295	1275	1445
425	2125	2550	1275	1700
850	2125	2975	1275	2125

Commercial stations do not necessarily comply with the norm, and may well have the mark and space tones inverted. If your demodulator cannot invert the tones for you, all you have to do is to change to the other side-band. If your demodulator can switch from high to low tones this is all to the good as commercial stations use both. However, many, if not most demodulators 'don't care' which tones are being used.

In addition to minor frequency variations by the stations themselves, it will be appreciated that there will be slight variations depending on the side-band and set of tones used for monitoring. Regardless of the method used, the stations in the table should all be within ±1 kHz of the listed frequency.

Of course, once you have your RTTY gear set up and running, you can start to monitor the many RTTY intruders that appear on the exclusive amateur bands. These intruders are mainly from Russia, China, East Germany and North Korea and can sometimes be copied and identified. However, even if you can't identify them, they should still be reported to your Divisional Intruder Watch Co-ordinator.

Finally, if there is sufficient interest, it is intended to publish, at a later date, a similar list of the other types of utility RTTY stations. It is also intended to publish, again if there is sufficient interest, details of international meteorological codes to enable you to use the data transmitted by the various meteorological stations. This utilisation could vary from a general interest in the weather in various parts of the globe to being able to draw up weather maps and plot temperature inversion data — a useful facility when trying to determine propagation in the VHF/UHF bands.

Frequency	Station	Call-Sign	Shift
4.525	BTA	LZI	425
4.804	ANSA	ISZ48	425
5.027	CETEK	DLC7	425
5.035	ANSA	IRC20	425
6.972	AGERPRES	YDG59	425
6.984	AP	GIC26B	425
7.542	AFP	ZEN33	425
7.577	CETEK	OLZ22	425
7.592	TANJUG	YZD6	425
7.658	TANJUG	YZD7	425
7.778	NDNA	ATP65/ATB68	425
7.800	IRNA	EPX9	425
7.806	TANJUG	YZD7	425
7.850	ATA	ZAA	425
7.960	IRNA	—	425
7.996	TANJUG	YZD9	425
8.020	TANJUG	—	425
8.022	AFP	FTI	425
8.140	TASS	RKA74	425
8.142	CETEK	OLX4	425
9.052	ANSA	ISY90	425
9.082	ANSA	IRG20	425
9.349	AP	GBU32/GBW34B GDW42A etc.	425
9.353	CETEK	OLX5	425
9.395	KCNA	HMK21	425
9.429	ATA	—	425
9.867	INA	YIZ74	170
10.258	TASS	RDZ71	425
10.270	TASS	—	425
10.319	AFP	—	425
10.407	ANSA	9VF63	850
10.434	ATA	ZAY	425
10.438	TANJUG	YZD7	425
10.465	TASS	RKA71/RNN51 RCB55	425
10.543	AON	Y2V54	425
10.558	AFP	FTK	425
10.580	KCNA	HML61/HMK25 HMR56/HME28	425
10.599	VNA	—	850

10.614	AFP	FTK	425
10.649	AP	GIC30B	425
10.730	AFP	ZEN49	425
10.809	ANSA	9VF	850
10.920	ADN	Y2V22	425
10.980	XINHUA BEIJING	BAP40	850
11.230	KCNA	HML61/HMK25	425
11.419	VNA	VNA86	425
11.502	BTA	LZH4	425
11.630	TASS	RPT38	425
11.695	SPA	—	425
12.128	ANSA	IRJ31	425
12.265	XINHUA BEIJING	BZB51/BZR62	425
13.410	TASS	RIF38	425
13.487	ANSA	ISX35	425
13.524	INA	YI071	170
13.579	KCNA	HMK25	425
13.625	REUTERS	GPP33	425
13.780	KCNA	HME28	425
13.876	KUNA	9KT32	425
13.890	PRENSA LATINA	YVV2	425
13.895	ADN	Y2V47	425
13.898	ANSA	IRK28	425
13.974	ANSA	ISX19	425
13.996	RFI	—	425
14.366	XINHUA BEIJING	BZP54/BZR66	425
14.373	INA	YIL71	170
14.460	ADN	Y7A57/71/76/ 89/62/91	425
14.465	TASS	RCT56/RTU44/ RKA74 etc.	425
14.470	TASS	as above	425
14.484	REUTERS	—	425
14.510	TASS	RIC75	425
14.514	REUTERS	GNP34	425
14.526	—	—	425
14.547	KYODO	JAL44/JUL82	850
14.566	PRENSA LATINA	CLN445	425
14.568	ADN	Y7A49/58/68	425
14.570	KCNA	—	425
14.630	ANSA	ISX46	425
14.700	TASS	REB24	425
14.760	XINHUA BEIJING	BAT93	425
14.784	NDNA	ATP65/ATB68	425
14.795	AFP	FTI2/H1	425
14.800	ADN	Y2V24	425
14.803	ANSA	—	850
14.825	ADN	Y2V25	425
14.830	KUNA	9KT33	425
14.845	UPI	—	425
14.922	—	—	850
14.928	PRENSA LATINA	XVF6	850
14.974	AP	GBW34B	425
15.022	ADN	—	425
15.462	JANA	—	425
15.633	KCNA	HMH21	425
15.651	—	—	425
15.977	AFP	—	425
15.978	AFP	FPP-97/F	425
16.184	AFP	FZF62	425
20.078	AFP	—	425
20.482	—	—	*425
22.812	ADN	—	425
27.027	ANSA	IRZ27	425

Note: All stations use 50 baud except those marked \* which use 75 baud.

## PRESS AGENCY ACRONYMS

ADN	East Germany News Agency
AFP	Agency France Press
AGERPRESS	Romanian Press Agency
ANSA	Italian Press Agency
AP	Associated Press (London)
ATA	Albanian Telegraph Agency
BTA	Bulgarian Telegraph Agency
CETEK	Czechoslovakian Telegraph Agency
INA	Iraqi News Agency
IRNA	Iranian News Agency
JANA	Jamahiraya News Agency (Libya)
KCNA	Korean Central News Agency
KUNA	Kuwaiti News Agency
KYODO	Japanese News Agency
MENA	Middle East News Agency
NDNA	New Delhi News Agency
PRENSA LATINA	South/Central American Pool
REUTERS	Reuters News Agency (London)
RFI	Radio France International(?)
SANA	Syrian News Agency
SPA	Saudi Press Agency
SUNA	Sudanese News Agency
TANJUG	Yugoslav News Agency
TAP	Tunis African Press
TASS	Telegraph Agency of the Soviet Union
UPI	United Press International
VOA	Voice of America
VNA	Vietnam News Agency
WAF	Palestine News Agency
XINHUA BEIJING	Chinese News Agency

Notes: Some agencies, like TANJUG, act as pool agencies for the smaller agencies such as WAF, JANA, TAP etc.

PRENSA LATINA acts as a pool for some of the South and Central American Countries.

Some of the larger agencies have overseas transmitters.

## MONEY WORRIES

It's difficult to save money when your neighbors keep buying something you can't afford.

Tall men can be just as short at the end of the month as anyone else.

Overheard: "We can stop worrying about keeping up with the Joneses — they've declared bankruptcy."

If you think you have no friends, just rent a cottage on the beach.

Inflation: A period when a man goes broke in a prosperous way.

High school girl to father, "You think you had it rough when you went to school. Some of the kids in my class had to park their cars four blocks away."

ARNS Bulletin Sept. 1982

# SIMPLE EXTERNAL FREQUENCY SELECTION FOR THE ICOM IC-22S

Reg Fookes VK2AKY  
Courtesy "DRAGNET" St George ARC

**Although the IC-22S is now "out of print" it is still a good, no-frills 2 m transceiver. Its PLL frequency synthesiser provides 144 channels between 144.4 and 147.975 MHz. By soldering diodes into an internal matrix board up to 22 of these channels can be selected by the front panel switch.**

This leaves 122 channels which can only be accessed by the rather laborious procedure of changing matrix diodes. A convenient method of selecting these other channels is needed. A published method, G Percy, VK3ZQP, (now VK3PE) Amateur Radio January 1978, p 9 is electronically elegant but complex and covers only 80 channels. The technique to be described is about as simple as possible. It is probably not new and no originality is claimed.

In the IC-22S channel selection is achieved by feeding +9 V through the selected row of matrix diodes to the appropriate inputs of the programmable divider of the PLL. One channel (eg No 22) is set aside for external programming by a series of 8 miniature toggle (or slide) switches and Si diodes. These are mounted in a small metal box mounted above the IC-22S on the plain face of the mounting bracket supplied with the rig, see Fig 1. Label the switches D7 to D0 and/or 128, 64, 32 . . . 1 to correspond with the handbook. In this configuration the bracket functions as a good tilting mount for table top use. As an optional extra a standard phone jack can also be mounted in the switch panel, connected by thin co-ax to a miniature plug for the "Ext Spkr" jack.

Electrical access to the interior of the transceiver is via the 9-pin socket on the rear panel. Disconnect the tuning meter lead, by-pass capacitor and earth connection. With ribbon cable or

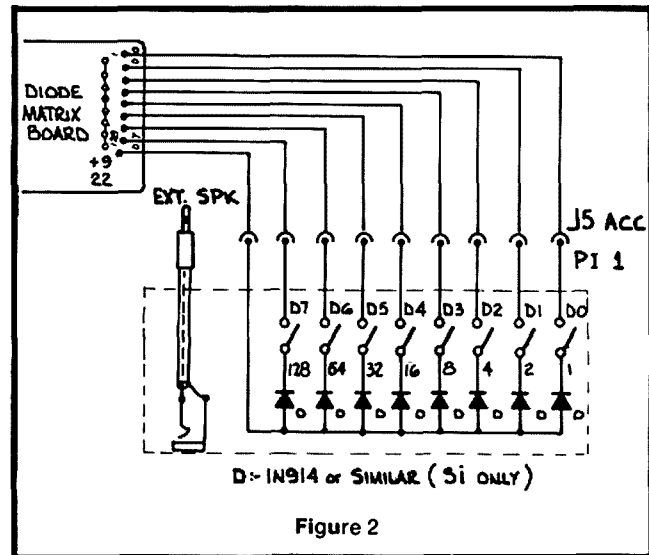

Figure 2

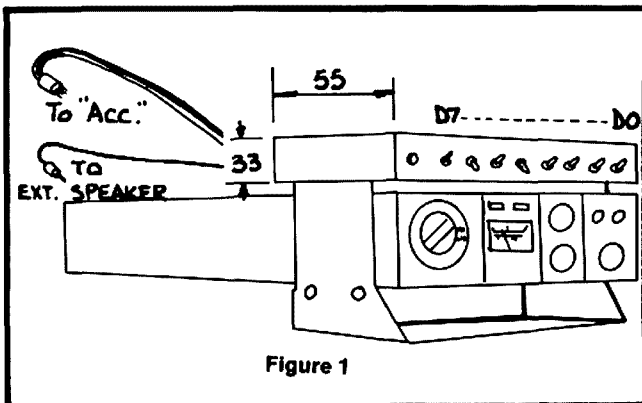

Figure 1

thin hook-up wire connect the socket to the channel No 22 row of holes in the diode matrix board, allowing sufficient length of wire to permit removal of the board for future changes in other channels. The circuit diagram is given in Fig 2. Be careful to keep track of each connection so the sequence of the switches will be covered.

To set up a channel not available with the main selector, turn the switch to Channel 22 and with the procedure given in the handbook, and with due regard for the requirements of simplex or repeater operations, set up the row of diode switches. Closing a switch is equivalent to inserting a diode in the matrix, and vice versa.

It works like a charm.

AR

# EASTERN

## COMMUNICATIONS PTY LTD

168 ELGAR ROAD, BOX HILL STH., VICTORIA 3128

PHONE

(03)

# 288 3107

ENQUIRIES

AUTHORISED  
**ICOM**  
DEALER



# ICOM

COMPUTER  
REPAIR CENTRE  
NOW  
OPEN

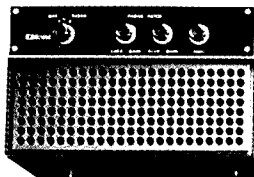

Phone Patch  
for IC-720A IC-740 IC-740

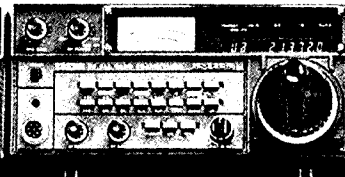

IC-720A HF Transceiver  
160-10 meter 100kHz - 30 MHz RCVR  
100W SSB CW AM RTTY

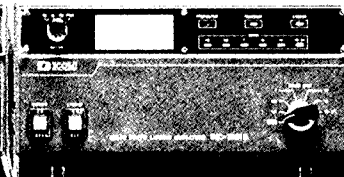

IC-2KL Linear Amplifier  
100-15 meter 80 W in 500 W out  
auto bandswitching

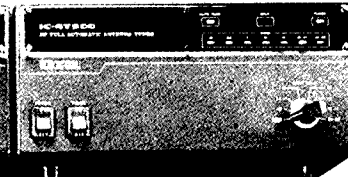

AT500 Automatic Antenna Tuner  
100-10 meters 500 W capacity

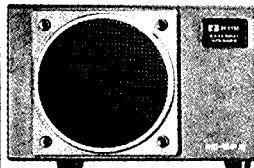

IC-SP3 External Speaker  
for IC-720A 740 740

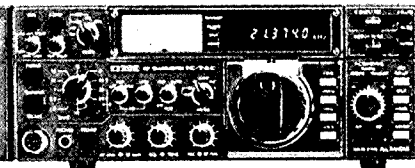

IC-740 HF Transceiver  
160-10 meters 100W SSB CW RTTY  
FM (option)

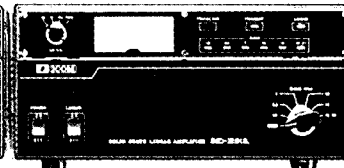

IC-2KL Linear Amplifier  
100-15 meter 80 W in 500 W out  
auto bandswitching

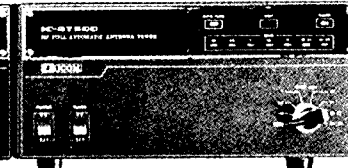

AT500 Automatic Antenna Tuner  
100-10 meter 500 W capacity

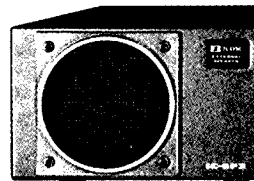

IC-SP3 External Speaker  
for IC-720A 740 740



IC-730 HF Transceiver  
80-10 meter Ham bands compact  
mobile 100W SSB CW AM

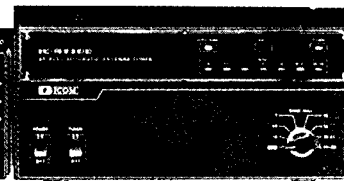

AT100 Automatic Antenna Tuner  
80-10 meter 100 Watt Capacity

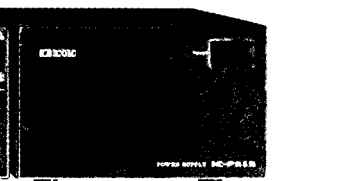

PS15 Power Supply  
12 VDC 20A Base AC Power for 720A 740 740

IC720A HF TRANSCEIVER . \$1060	IC290 2M x ALL MODE ... \$546	IC505 6M x PORTABLE ... \$383
IC730 HF TRANSCEIVER . \$725	IC2A 2M x HANDHELD .. \$250	IC-2KL LINEAR ..... \$1510
IC740 HF TRANSCEIVER . \$864	IC451A UHF ALL MODE .... \$840	ICAT500AUTO TUNER ..... \$438
IC-R70 HF RECEIVER ..... \$719	IC45A UHF MOBILE ..... \$380	IC-SP3 EXTERNAL SPEAKER \$58
IC251A 2M x ALL MODE ... \$718	IC4E UHF HANDHELD ... \$276	PS15 PWR SUPPLY ..... \$141
IC25A 2M x MOBILE ..... \$377	IC551D 6M x ALL MODE ... \$656	ICA5100 AUTO TUNER 100W . \$316

### EASTERN COMMUNICATIONS — LEADERS IN THE AMATEUR RADIO FIELD



SEE REVIEW ARA VOL 5 No 11  
100 KHz - 30 MHz GENERAL COVERAGE  
RECEIVER  
**ICOM ICR70 \$719**

**KENWOOD TS430S  
HF MOBILE TRANSCEIVER  
ONLY \$950<sup>00</sup>**

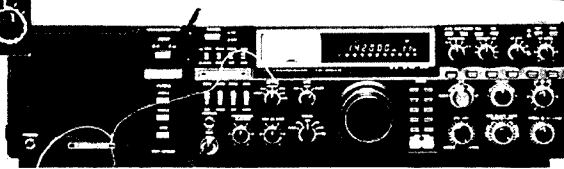

**KENWOOD TS930S  
THE ULTIMATE  
HF TRANSCEIVER  
ONLY \$1799<sup>00</sup>**

# HOW TO MAKE THE ICOM IC-551 NOISE BLANKER WORK ON LOW LEVEL IMPULSE NOISE

©1983

Andrew Martin VK3KAQ.  
Woodside, 14 School Road, Ferny Creek,  
Vic. 3786.

*The IC551 noise blanker suffers from having a very high blanking threshold and, consequently, only works on impulse noise that is generated next door. However, much of the impulse noise that is received on 6 metres is of a lower level where the IC551 noise blanker has no effect.*

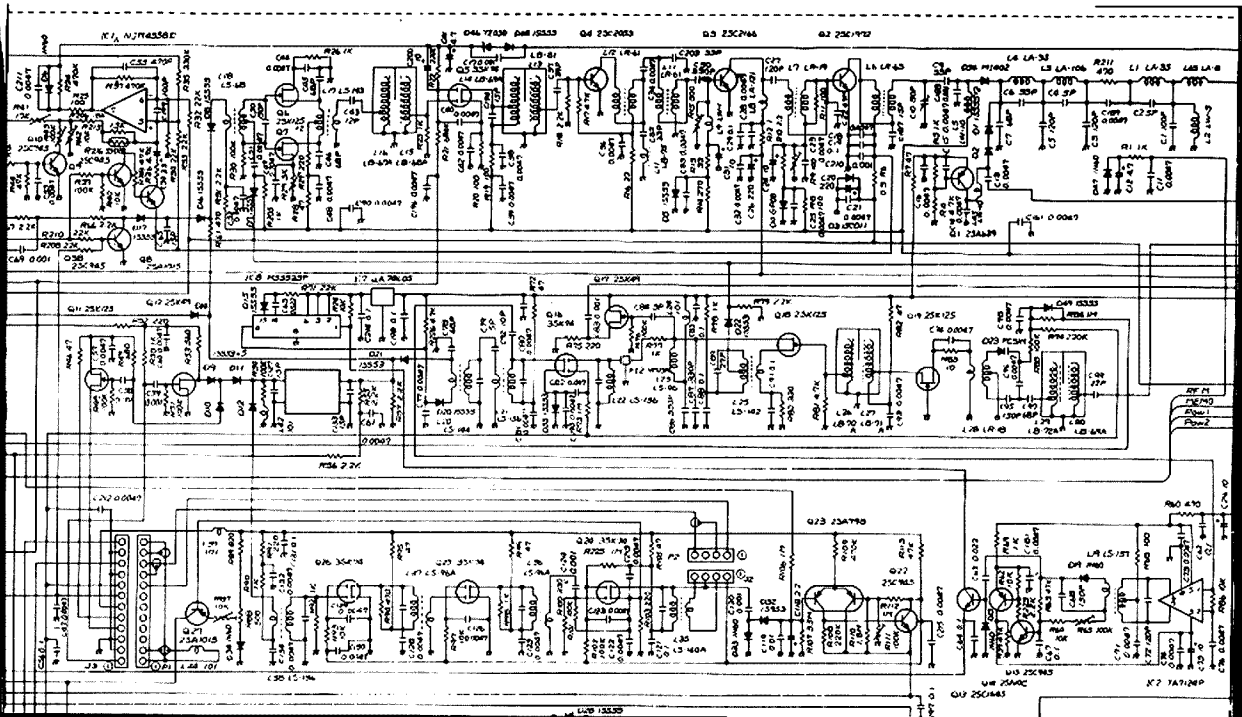



One way to make the IC551 blanker work more effectively is to use a receiver preamp with about 20dB of gain but this leads to a poorer receiver cross-mod performance. So, as I did not like the preamp idea, I began to wonder what other means could be used to improve the noise blanker performance.

While perusing the IC551 circuit it became apparent to me that when the pass-band-tuning unit is installed, the receiver IF strip of the main PC board is disconnected. My next thought was "why not use this redundant IF strip to obtain the necessary gain to make the noise blanker work at lower thresholds?"

This modification basically involves inserting the disused IF strip on the main PC board between the IF sampling point and the noise blanker amplifier. To complete this mod you must have installed the pass-band-tuning unit.

Carry out the mod as follows (reference to the IC551 schematic and board layout diagrams will help):

- 1 Remove the top cover.
- 2 Locate the IF strip which is up against the large tin box.
- 3 Cut R89. This disconnects the AGC drive to the "S meter" but note that the signal level is provided from the pass-band-tuning unit and we do not want the "S meter" being driven from two different sources. (The components to be cut form

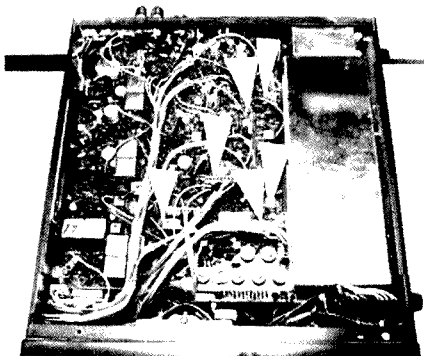

Key to photo — A-R89, B-D12, C-C92, D-L38, E-J2, F-J3.

an inverted "U" so when cutting just snip the bottom of the "U" leaving at least 2 mm of lead on the component and don't pull the component out.)

- 4 Cut D12. This is the input switching diode for the IF strip.
- 5 Cut C92 on the end towards the rear of the IC551 and lift C92 up to the vertical position. Be careful to leave enough lead on the PC board and C92 so that the input and output leads can be attached.
- 6 Install a shielded wire between the now free end of C92 and the now free end of D12. C92 is necessary for IF coupling and DC blocking. This now connects the input

to the IF amplifier. (Use the can of L38 for a ground.)

7 Install a 1/8 watt 100 k resistor between the junction of D12 with the input lead from C92 and ground. This allows D12 to be biased on.

8 Install a shielded wire between J2 pin 2 and the lead end of C92 that was left on the PC board. This connects the output of the IF amplifier back to the noise blanker input. The can of L35 can be used for a ground. Note that only one connection to J2 is required for the output.

9 Remove P1 (P1 goes to the pass-band-tuning unit) from J3 which is located about 25 mm towards the rear from the crystal filter.

10 Install a small wire link between pins 6 and 7 of J3 (on the PC board counting from the side nearest the IF strip). This applies the correct +9V supply to the IF strip.

11. Replace P1.

The modification is now complete. Now find some suitable impulse noise (preferably low level) and adjust R65 (threshold adjustment) to obtain optimum blanking. L19 may also require a small amount of adjustment. The AGC on the IF strip is still connected and serves to optimise the blanker input level.

This modification has successfully been applied to several IC551's in the Melbourne area and I hope you meet with equal success. Good luck and better DX.

AR

## WANTED TO BUY

Ham gear, CB equipment, Hi Fi, video, car stereo, large or small quantities.

WE BUY AND SELL  
ANYTHING ELECTRONIC  
ANY QUANTITY  
ANY CONDITION

# HAMRAD

104 Hightett Street,  
Richmond, Victoria.  
Phone: (03) 428 8136

## WIA BADGES

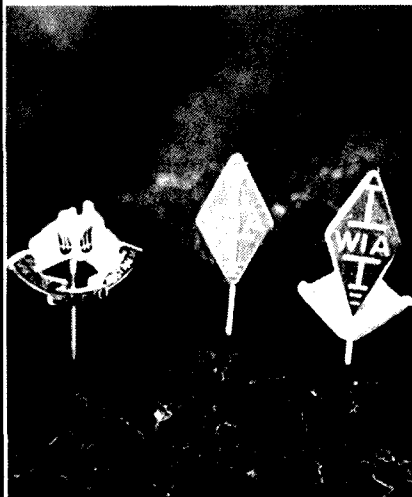

Stick Pins are now available  
Contact your division  
or  
Federal Office

## THE VK3BWW FORMULA FOR DX SUCCESS!!

HIGH QUALITY AT LOW COST

BEAMS	
3 EL 10 & 11m .....	\$75.00
3 EL 15m .....	\$83.00
3 EL 20m .....	\$158.00
6 EL 6m .....	\$108.00
5 EL 2m .....	\$36.00
9 EL 2m .....	\$59.00

**DUOBANDER**  
3 EL 10m, 3 EL 15m \$148.00  
Prices include Gamma match

Our beams are easy to assemble and adjust. Entirely **NEW CONCEPT** — NO NUTS OR BOLTS.

Spare parts, elements, booms and gamma matches available.  
Plus Freight

For further information  
PLEASE RING (03) 366 7042  
**VK3BWW**  
**WERNER & G. WULF**  
92 LEONARD AVENUE  
ST. ALBANS, VICTORIA 3021

# HOW DANGEROUS IS RF RADIATION?

## — Part One

From time to time, we receive requests from amateurs and even people in the commercial field, to give a view on the hazards of RF radiation. Of particular interest to radio amateurs are the VHF and UHF hand held transceivers. Newer models coming onto the market have the capacity to run up to ten watts of RF out.

The WIA is most interested in any reports in respect of RF radiation hazards. Microwave radiation is also a most important discussion area.

To give a fair view of what results have been ascertained in tests overseas, we have collated several articles from QST, and Radio Communication to help educate the Australian radio amateur in the possible hazards in the operation of VHF and above.

The articles are self explanatory, and the WIA or 'Amateur Radio' magazine assumes no responsibility for any of the statements made. The articles will be published as a series for the next three issues, and we would appreciate your thoughts on the matter when all of the articles have been published.

Here are the first of three articles in the series.

VK3UV

## RF HEATING IN THE AMATEUR BANDS

By A. Peter Ruderman, PhD, \*VE1PZ  
Reproduced from QST June 1978

An amateur licence is a licence to transmit RF energy. When you key your transmitter you generate electromagnetic and electrostatic fields around your antenna; when you receive you are tapping the far weaker fields that started at the output of someone else's transmitter. We are immersed all the time in the very weak fields of all the transmitters in operation anywhere in the community: those of other amateurs, commercial stations, CBers, airport control towers, paging systems, microwave ovens and even 60 Hz power transmission lines.

RF radiation is often referred to as non-ionising radiation in order to distinguish it from the ionising radiation that is associated with X-ray equipment and nuclear power plants. There are important differences: Ionising radiation, for example, can have a cumulative effect. (This is why atomic plant employees and uranium miners have a lifetime total safe dose to worry about.)

Non-ionising radiation can hurt people when it causes a build-up of heat by agitating the molecules in some part of the body. An increase of 2 degrees C in the temperature of the testicles can cause temporary sterility. An increase of 10 degrees C in the temperature of the eye can cause cataracts to form. This damage is permanent. Greater increases in temperature can be fatal by literally cooking your insides.

Normally, the effect of RF exposure is not cumulative unless tissue damage occurs, since whatever heats up can cool down. The damage caused by RF radiation depends on the amount of power, distance

of the individual from the power source, amount of shielding, and above all the frequency. The frequency determines how much heat will be generated in the body from a given amount of RF power. It takes only some simple commonsense precautions to protect amateurs from RF damage in most cases.

### A LOOK AT THE AMATEUR BANDS

From 1.8-30 MHz most of the radiation passes right through you without any after effects. Only a small amount is converted to heat. If you consider that a 1 degree C rise in temperature is tolerable (i.e., like the low fever of a mild cold), you might have to spend an hour or more just three feet away from the feed point of an antenna radiating 500 watts of power at 8 MHz to achieve this effect.

At 144 MHz enough energy is absorbed to cause more rapid heating, and a body close to the energy source at moderate power over a prolonged period can suffer harm.

At 420 MHz about half of the RF energy is converted to heat in the body. This is probably a real danger point.

From 1000-3000 MHz the RF energy is almost completely absorbed in the body. Microwave ovens fall in this range.

At 10 000 MHz we are back to half the energy being absorbed. Still higher frequencies tend to be reflected instead of passing through, as at communication frequencies. The wavelength is such that the energy can just hit the nerve endings in the skin and provide nature's warning signal of feeling the heat.

### SAFETY STANDARDS

If you are operating in the 10 metre band with 1 kW of radiated power, and the operating position is 10 metres from the antenna, the power density on the operator would be about 0.8 mW/cm<sup>2</sup>. This looks safe enough, and in fact the radiation pattern from the vertical, dipole or beam, would be such that an amateur 10 metres below the feed point would be receiving less than the theoretical radiation.

Unless there were serious leaks, poor shielding, lots of RF in the shack from radiating feed lines, unbypassed leads, etc., there does not seem to be much of a problem.

### 2 METRES AND UP

At 144 MHz and higher, the picture is quite different. First of all, more of the RF energy is converted to heat in the body. Second, although power is generally lower, a mobile antenna on the car roof is very close to the operator. And a handie-talkie with a built-in microphone brings the operator within a couple of inches of the antenna.

If a mobile operator were transmitting with 10 watts of radiated power, and the antenna was on the left (right in Australia -Ed.) front fender, less than one metre from the driver's seat, you could easily get a power density of 10 mW/cm<sup>2</sup>, which might be hazardous in the case of long uninterrupted transmissions. With a handie-talkie, a built-in microphone, and only one watt of radiated power, the density would be three or four times as great.

# HOW DANGEROUS IS RF RADIATION?

Reproduced from Technical Correspondence QST Sept. 1978

Workers at Motorola have recently conducted experiments of great interest to most amateurs. Their results have been published in several IEEE publications.

The experimenters constructed a simulated human head and torso and exposed it to the radiated fields from 150 and 450 MHz 6 watt, handheld transceivers. Both radios were equipped with helical or "rubber duck" antennas. In addition, tests were performed with a 1/4 wavelength antenna installed on the 450 MHz unit. A thermal probe was used to measure temperature rise due to exposure. These experiments were performed because of concern that the newer, high-power units might pose a health hazard. Previous measurements of the field strength surrounding these radios had indicated that an incident field intensity exceeding 10 mW/cm<sup>2</sup> might exist. This is a safety standard for human exposure to RF energy at higher frequencies.

Because the field would be concentrated by a probe causing nontypical localised heating, the probe was removed while the transmitter was operating. The "dummy" was exposed from 15 to 60 seconds. After power was removed, the probe was again inserted and the temperature change determined. Steps were taken to prevent thermal transients caused by insertion and removal of the probe. It would have been possible for heating to occur in small areas not being monitored by a probe. To look for

"hot spots", an IR (infrared) scanner was used to take thermograms of the dummy.

Assuming the transceiver was positioned as it would be during normal operation, no significant heating effects were noticed on either band. Even at 450 MHz, the temperature rise was slight. At a shallow probe depth (0.2 inch or 5 mm), the greatest temperature rise was less than 1°C. At deeper probe penetrations the temperature rise was less. Attempting to determine possible hazards from a measurement of radiated field intensity may cause misleading results. The low total energy and high field impedance which exist when such radios are brought in close proximity to the body will result in lower energy transfer than field-strength measurements alone would seem to infer. For example, at a point two inches (50 mm) from the helical antenna of the 150 MHz transmitter (Fig. 1), a Narda field probe measured a maximum field intensity of 168 mW/cm<sup>2</sup>. This value greatly exceeds the 10 mW/cm<sup>2</sup> exposure standard. Measurements based on the penetrating effects at the same point indicate a maximum power flow density in tissue of 2.8 mW/cm<sup>2</sup>. On 450 MHz, with the same spacing from the 1/4 wavelength whip antenna (Fig. 3), a maximum radiated intensity of 16 mW/cm<sup>2</sup> was found. Power flow density was only 2.5 mW/cm<sup>2</sup>. The radiation meter indicates a hazardous condition, while actual measurement of the

effects shows this is not the case. Power absorption in all cases was less than 1 mW/cm<sup>2</sup>.

IR thermograms did not detect any unusual hot spots. A health hazard exists when the tip of the antenna is close to the eye (within 0.2 inch or 5 mm) and the transmitter is operated. In this case, and RF burn will result on the cornea. The thick plastic cap on the tip of the antenna makes this unlikely to occur. When the radios are held in the normal position for use, no eye hazard exists.

While these tests were performed at 150 and 450 MHz, I think it is safe to assume we need not fear our portable 220 MHz rigs either. These tests point out the fallacy of using radiated field intensity as a criterion of safety. Some consumer publications have begun to measure the field strength radiated from CB radios. Consumers have been warned not to stand close to the mobile whip while a 5 watt CB transmitter is operating, due to the high field strength! These papers have shown that radiated power may greatly exceed that which is absorbed and converted into heat. Amateurs should continue to exercise prudence when using UHF and microwave equipment, of course. It does seem that our portable transceivers pose no threat to our health.

— J. E. Kearman, W1XZ, RFD, Collinsville, CT 06022.

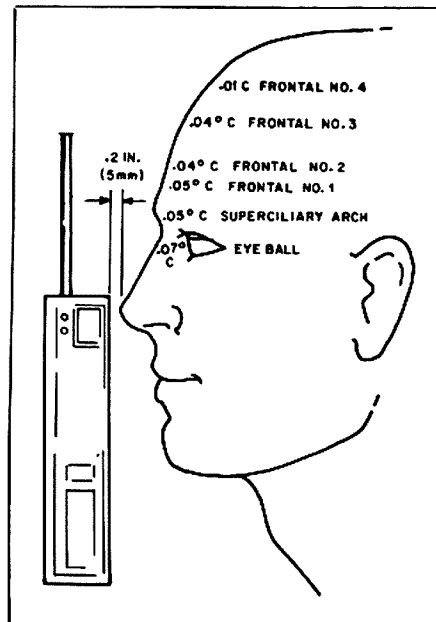
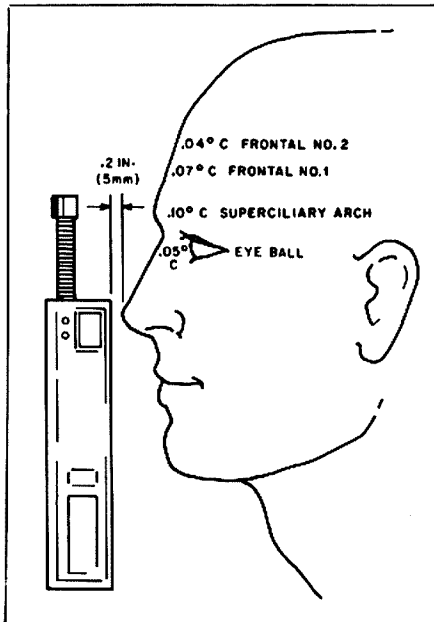
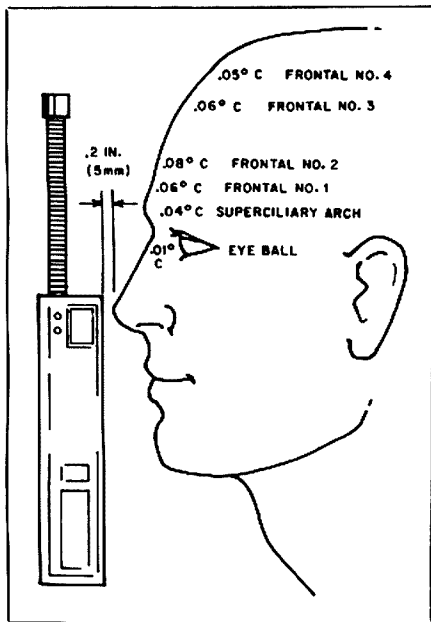

Fig. 1. This drawing shows the position of the 6 watt 150 MHz radio in relation to the head of the dummy. In this configuration, with the transmitter operated for 60 seconds, the temperature increases noted were observed.

Fig. 2. Position and thermal effects of a 6 watt, 450 MHz radio equipped with a helical or "rubber duck" antenna. A "hot spot" exists near the tip of this antenna. The eyeball is shadowed in its recess and receives very little exposure.

Fig. 3. The same 450 MHz rig, this time with a 1/4 wavelength whip installed. Power density in the eye is greater, but still very low.

## ANOTHER VIEW

The article, "RF Heating in the Amateur Bands", which appeared in *QST* for June, 1978, includes some statements which, in light of extensive experiments performed in our research laboratories, are not correct. Although Dr Ruderman properly warns amateurs to use caution to avoid unnecessary exposures, the power-density levels he quotes are too high to be realistic. At a distance of 10 metres from a half-wavelength 10 metre dipole connected to a one kilowatt output source, the power density in the horizontal direction is about  $0.08 \text{ mW/cm}^2$ , not  $0.8 \text{ mW/cm}^2$  as stated by the author. This last value would be found at a distance of 10 metres in the bore sight direction of a 10 dB-gain beam antenna.

Turning to the VHF bands, Dr Ruderman states that a mobile installation transmitting 10 watts effective radiated power (ERP) from an antenna mounted on the left fender, less than one metre from the driver (how much less isn't specified), could expose him to a power density of  $10 \text{ mW/cm}^2$ . This value is not corroborated by experimentation. Some research departments at Motorola Inc., have conducted careful measurements of power density inside the cabins of cars equipped with mobile transmitters. The Narda model 8310 radiation monitor, calibrated for VHF operation, was used. In the situation described by Dr Ruderman, at a distance of 1.1 m between driver and antenna, the maximum power density measured was  $0.05 \text{ mW/cm}^2$ , substantially lower (23 dB) than the  $10 \text{ mW/cm}^2$  level quoted by Ruderman. The  $0.05 \text{ mW/cm}^2$  level is slightly less than the power density one would find in free space (in the direction of

maximum gain) at about one metre from a VHF dipole connected to a 10 watt output source.

In the matter of portable transmitters, Dr Ruderman states that  $30\text{-}40 \text{ mW/cm}^2$  power densities exist in the immediate vicinity of a 144 MHz antenna connected to a 1 watt-output transmitter. These values are not supported by experimental evidence either. First of all, it is difficult to define, let alone measure, power density so close to an RF source. At a point near the radiator, different parts of an antenna contribute fields propagating in completely different directions, precluding any obvious definition of power flow. In these conditions, one can measure only energy density ( $\text{mJ/cm}^2$ ), by separately evaluating the E and H fields with appropriate instrumentation. In the near field, however, the electromagnetic energy density does not have a simple relationship to power flow. Unlike the far-field case, part of the energy is stationary (static type) and part is propagated. To avoid these difficulties, we measured power deposited in simulated humans, by operating 6 watt-output 150 MHz portable radios equipped with helical antennas. Helicals were selected because they caused much higher energy density readings in field probes than did quarter-wavelength telescopic antennas. The results of these measurements were presented in a recent paper.<sup>4</sup> The experiments have shown that, at VHF, electromagnetic energy in the immediate proximity of a portable radio antenna does not penetrate into muscle or brain tissue of the human body. There is energy deposition only in the very surface fatty layers. In addition, it was found that if

a user operates a 1 watt portable radio with the case 0.2 inch (5 mm) from his mouth, the maximum absorbed power density (which can be measured from heating effects) is less than  $0.2 \text{ mW/cm}^2$ . This value is much lower than the deposition levels ( $8\text{-}10 \text{ mW/cm}^2$ ), due to an incident power level of  $30\text{-}40 \text{ mW/cm}^2$  which, Dr Ruderman states, exist near a portable transceiver.

I would like to reassure radio amateurs of the absence of any detected thermal radiation hazard from commercially available mobile and portable radio transmitters, if such equipment is properly installed and operated in accordance with simple common sense.

— Quirino Balzano, PhD, Manager,  
Antenna Systems Research Laboratory,  
Communications Division, Motorola, Inc.,  
8000 West Sunrise Blvd,  
Ft Lauderdale, FL 33322.

## REFERENCES

1. Balzano, Garay and Steele. "Energy Deposition In Biological Tissue Near Radio Transmitters At VHF and UHF". *IEEE 1977 Conference Record of Vehicular Technology Group*, March, 1977. Experiments at 150 and 450 MHz.
2. Balzano, et al. "A Comparison Of The Energy Deposition Between Portable Radio Transmitters At 900 And 450 MHz". *IEEE 1978 Conference Record of Vehicular Technology Group*, March, 1978.
3. Balzano, et al. "Heating of Biological Tissue in the Induction Field of VHF Portable Radio Transmitters". *IEEE Transactions on Vehicular Technology*, May 1978. Results of experiments at 150 MHz.
4. Balzano, et al. "Heating of Biological Tissue in the Induction Field of VHF Portable Radio Transmitters". *IEEE Transactions on Vehicular Technology*, Vol. VT-27, No. 2, May, 1978.

# PROGRESS!!

Long, long ago in a land where steam power and stump-jump ploughs were at their height of creation a man sat blowing bubbles.

An observer would have seen a vast array of strangely grotesque measuring equipment lining the walls, a selection of rare metals and heating elements strewn across the bench and bits of molten glass in the carpet as the first ever electron tube was developed.

Within a decade the world had changed 'electronics' and 'amplifiers' became words and were put in dictionaries. Whole populations were astounded by the technological miracles they saw happening around them and gazed in awe at the people who made them happen. After a while the novelty wore off and almost everyone went back to what they were doing before.

As time meandered by the livelihood of more and more people became dependant upon these wireless wonders, 'triodes' and 'tetrodes' became as numerous as garden gnomes. Two world wars and the occasional skirmish boosted technology even further until entire communication net-

works were built in many countries. For engineers, TV repairmen and radio operators alike the mystique and complexity of wireless valve had diminished to the simplicity of a wheelbarrow.

One day catastrophe struck, someone had invented the silicon transistor.

For the second time in a century technology had spiralled along at a staggering rate, those who had a secure position in the past were forced to face a barrage of new terms and techniques to survive. As this pace accelerated even further slow learners who had just begun to grasp the secrets of the three legged wonder were dealt a further blow by the introduction of the digital integrated circuit, which had internals far beyond the comprehension of mere mortals.

Otherwise things were pretty good, the market was flooded with lots of neat gadgets like electronic calculators and space invader machines, even the pen being used to draft this article has a clock in it.

Only sixty years after the birth of an industry a major rift had appeared between old and new, the old scared to take their

eyes off an electronic circuit lest it grow smaller in their absence and the new conjuring up mental pictures of steam engines and stump-jump ploughs when words like 'pentode' creep into conversation.

It is a great pity this gap exists as the workings of modern electronics is simplicity itself, for the first time ever circuit design has been spared all of the complexities of component values and voltages so that greater effort may be directed to doing the job better.

These techniques enable the designer to draw a block diagram of a project and directly proceed to build it optimistic of success, very much like drawing a picture of a chocolate cake, then eating it.

As more people come to realise that a change in materials with which people work does not mean an early retirement but an opportunity to expand a field then the gap that presently exists will be seen to disappear.

by Ian Jackson VK3UBF  
Courtesy 'GATEWAY'

# MODERN MILITARY SURPLUS EQUIPMENT



Colin MacKinnon, VK2DYM  
PO Box 21, Pennant Hills, NSW 2120

*In the past couple of years some relatively modern military communications equipment has appeared on the local surplus market.*

*Over the next few issues I will describe this equipment and its adaptation for amateur use.*

*This instalment should enable you to recognise the various units and the accessories needed for operation. Future instalments will describe individual units and ways of getting them on air.*

## GENERAL INFORMATION

The equipment to be described is of English origin and was used by the Australian Army in a variety of transport vehicles and Armoured Fighting Vehicles (AFV). It was replaced several years ago by US designed radio equipment and now turns up in disposals throughout Australia.

The sets can be recognised by the dark green colour of the ribbed aluminium cases and the following nomenclature, generally shown on a tag on the front or top of the case:

NAME	FUNCTION	FREQUENCY
Wireless Set B47	low power FM Transceiver	38-56 MHz
Wireless Set C42	high power FM Transceiver	36-60 MHz
Wireless Set C45	high power FM Transceiver	23-38 MHz
Wireless Sender C11	high power AM, CW, FSK Transmitter	2-16 MHz
Reception Set R210	AM, CW, FSK Receiver	2-16 MHz
Supply Unit Vibratory No. 12	Power Supply Unit for C42 or C45	
Supply Unit Trans-former Rotary 24V	Power Supply Unit for C11	
Aerial Tuning Unit No. 8	Aerial Tuner	for B47
Aerial Tuning Unit No. 6	Aerial Tuner	for C45 & C42
Aerial Tuning Unit No. 7	Aerial Tuner	for C11

As you can see, this equipment can be quite useful on various amateur bands, particularly 6 metres FM.

The equipment was manufactured in 1959-60 and used miniature 6.3V valves with vibrator or dynamotor power supplies. It is obviously top quality and despite being a bit bulky and power hungry it gives a very reasonable performance even by today's standards.

The condition of the available sets varies from brand new in sealed cartons, to some that must have been in the Yarra! Normally the sets are sealed and could be under slight vacuum, so if you find one that has a small black metal cup covering the head of one of the Allen screws which hold the set in its case, and if, when you open the set, you hear an inrush of

air, you probably have a unit that has not been tampered with.

Because the sets (except C11) are virtually watertight the interiors are generally as new, even if the outer case is pretty grubby. The C11 and its PSU have vents that open for air circulation during operation. If the set has previously been opened, check for missing valves and crystals, particularly as all have 1 MHz/100 kHz crystal calibrators. Any mud, corrosion etc. inside is a big problem as the solder joints are probably affected and will break readily. The front panel knobs are a special collet type and should all be there. The dial scale is a photographic negative film with sprocket holes and is prone to damage and deterioration. Rotate the tuning knob while examining the dial scale and listen for noises which could indicate missing sprocket webs or damage.

The sets use a common connection method and even if you propose to deviate from this it is not a bad idea to acquire the basic connecting harnesses.

Vehicle installation required a two core power lead from a 24 volt battery to the Power Supply Unit PSU where used, or direct to the set. A short harness connected the PSU to the set. A control harness type A or B connected each set to a master control box known as the J1 box, or J2 or JD9. From there cables ran to each operator's station where headphones/microphones or handsets could be attached via individual small control boxes variously called CU30, CU31, CU34, JD8 or B, C, D, or R boxes, depending on facilities provided. Individual audio volume could be adjusted if the box included a low value pot off the audio output bus.

The correct plug and socket connectors and harnesses can be determined by examining the pin layout and shape but check that the threads on the connectors match as there are some harnesses around with non-compatible thread sizes.

The antenna was generally a 2.4 metre rod screwed into a base mounted onto the vehicle. 75 ohm coaxial cable with British Pattern, 4 sockets, not compatible with PL259/SO239, connected to the aerial tuner and to the set. Some vehicles also had a portable 8.7 metre telescopic mast with a variable length whip on top and used rope guys for support. This was fed with about 11 metres of smaller diameter co-ax (RG58/U size).

It is quite feasible to connect up and operate

the sets using the various harnesses and a J box and headset; however in the series I shall consider:

- Alternative power sources.
- A description of the circuitry so that troubleshooting, alignment or modification can be studied.
- Methods of getting the sets on air without the complexity of the harnesses etc.
- Modifications to improve performance. I will not give step by step details as there is often more than one way of achieving the end result.

## POWER SUPPLY ALTERNATIVES

All sets ran on 24V DC at currents ranging from 1.8 amps for the R210 up to a whopping 22 amps for the C11. They are tolerant of wide voltage fluctuations — from 20V to 30V input; although power output drops off at low voltage. All the power supplies have a relay which operates when low voltage is sensed and shorts out a resistance, or changes transformer taps, so increasing voltage into the sets.

There are a number of options for providing the required power:

- Buy an armoured car at a disposals auction. This gives you adequate 24V DC capacity and also commands a certain amount of respect when operating mobile.
- Use a 24V truck battery or connect two 12 volt car batteries in series. This method has the usual problems associated with lead/acid batteries.
- Build a 24V DC supply using commercial or junk box parts. This can be a very simple unit comprising a large transformer, diode rectifiers (perhaps auto alternator diodes?), and a large smoothing capacitor, say 10,000 microfarads at 40V DC. The vibrator or dynamotor are to a large extent self-regulating and will even run off raw unfiltered DC.
- Adapt one of the many ex-computer power supplies that are on the market. There are a few 240V units that give 24V and 32V outputs at adequate amperage but most seem to be 110V input. However, if the transformer is ferro-resonant, as evidenced by a winding connected to two capacitors rated at about 6 microfarads and 600V each, it can probably still be used. Disconnect the capacitors and feed 240V AC into the winding. Hopefully the 32V DC output circuit will show 24 to 28V DC. Take precautions

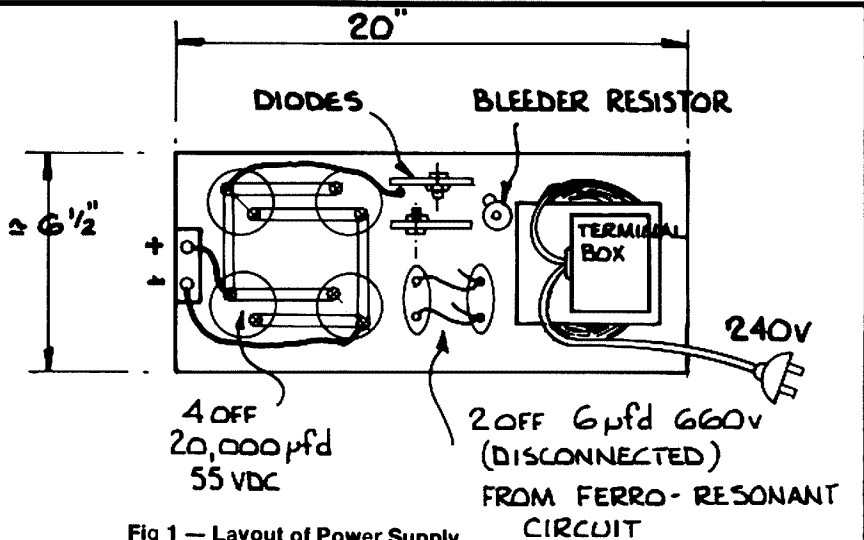
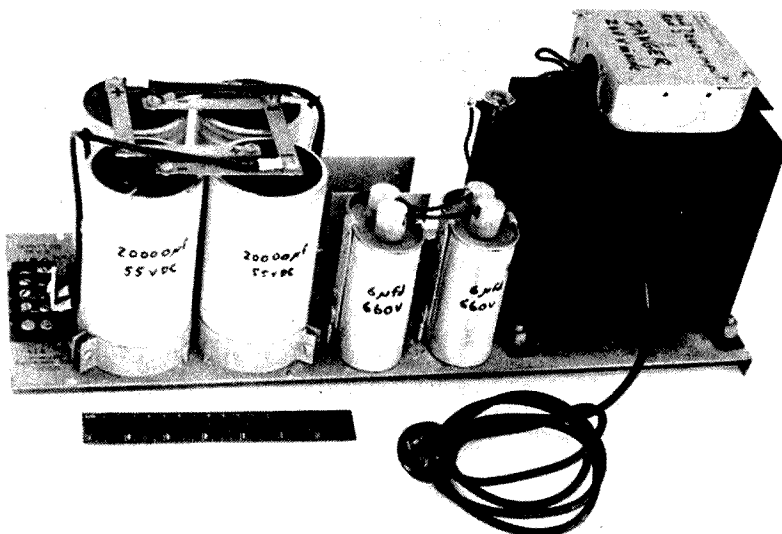

Fig 1 — Layout of Power Supply.



Power Supply — Typical 240 V to 24 VDC. Note — rule in foreground is seven inches long.

with the primary as it will have 80-90V induced in it. You should also check that the 24V wiring is large enough to carry the current. Some supplies provided 5V at heaps of amps but only low current to the 24 or 32V circuits.

See fig 1 and photo 1

- Dispense with the existing PSU circuit and build up a power supply for the necessary HT, filament and control voltages. This is more work but gets away from the vibrator noise and hash or the dynamotor's lack of efficiency. A large transformer from a valve type TV set, particularly one that has a valve rectifier would make a good start. Details of the voltages necessary will be given in the description of each set.
- For the R210 there is another neat alternative which I shall detail later.

#### MODIFICATIONS IN GENERAL

The circuitry of the sets is very conventional and consequently modifications suggested for other valve circuits will work equally well here. Some of my suggestions for one set will also apply to others in the series.

#### REMOVING FRONT PANEL KNOBS

The existing knobs are a collet type, called Boot-proof, but the potentiometers and switches have standard shafts. You may wish to fit normal knobs or change the pots or switches. The procedure to remove the knob assembly is:

- Remove the large centre screw and spring washer.
- Remove the knob and replace the centre screw 5-6 turns.
- Tap the screw gently and you will find the collet comes loose.
- Remove the large nut, sleeve, collet and washers, then remove the second large nut.
- You will now be able to get at the control.

#### DESICCANTS

All the sets have a quick-lime moisture absorber in a red tube of aluminium mesh. It cannot be recycled so can be discarded if you choose. As the coils and IFTS are not impregnated you should try to exclude moisture but do not use silica gel inside the set.

AR

## CUSTOM WOUND TRANSFORMERS

LOW COST  
HIGH QUALITY

Consult us about your special requirements in transformers, power chokes, r.f. chokes, etc.

240 V-29 V @ 100 VA \$23.40  
240 V-20 V @ 400 VA \$53.00  
Plus Sales Tax if applicable.

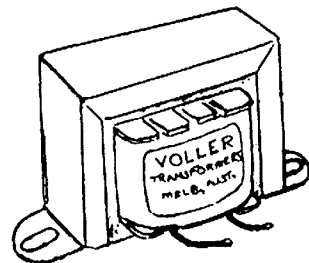

FREIGHT EXTRA

PLEASE RING (03) 551 1452  
VOLLER TRANSFORMERS  
PTY. LTD.

16 PIETRO RD.,  
HEATHERTON. 3202



## SOVIET RADIOAMATEUR DIPLOMAS<sup>1</sup>

*The name Vera Stepanovna Sviridova<sup>2</sup> is well known to Soviet radioamateurs. For almost two decades now she has headed the QSL Bureau and the Diploma Service of the Central Radio Club of the USSR named after<sup>3</sup> E T Krenkel'. 'Thousands of Soviet and foreign QSL cards and thousands of applications for radioamateur diplomas pass annually through her hands. Today Vera Stepanovna<sup>2</sup> is a writer for our magazine. In the article published here she acquaints readers with diplomas issued by the CRC of the USSR named after E T Krenkel'.*

In our country radioamateur diplomas were first established in 1949 by the Central Radio Club of the USSR. These were the diplomas R-100-0<sup>5</sup> and R-16-R (since 1957 R-15-R<sup>6</sup> first R-100-O diploma for CW operation was received in 1951 by Yu Prozorovskiy, UA3AW, and for 'phone operation by V Sheyko, UB5CI. V Zhelnov, UA4FE, became the owner of R-16-R No. 1 in 1955. In 1957 the CRC of the USSR established three more diplomas, R-150-S, R-10-R, and R-6-K. The first to fulfill the conditions for the R-150-S diploma were V Goncharovskiy, UB5WF (CW, 1958) and V Benzar', UC2AA ('phone 1959). R-10-R diploma No 1 was given in 1958 to G Pozdernik, UO5PK, and the R-6-K in 1958 to N Stromilov, UA3BN (CW) and V Glushkov, UO5AA ('phone), and in 1963 to V Kaplun, UA1CK (SSB).

In honor of the 100th anniversary of the birth of A S Popov, the inventor of radio, the diploma W-100-U<sup>9</sup> was established in 1959. In 1961, in connection with the first manned flight into space by a citizen of the USSR Yu A Gagarin, the first ultrashort-wave diploma was established — "Kosmos"/"Space"/. The RAEM diploma was created in 1972 in memory of the outstanding polar explorer and radioman and the first President of the Federation of Radio Sport of the USSR, E. T. Krenkel', Hero of the Soviet Union. Diplomas No. 1 were issued to N Stromilov, UA3BN (W-100-U), flyer-cosmonaut of the USSR Yu. A. Gagarin, Hero of the Soviet Union ("Kosmos"), and B Vil'pert, UA3BF ("RAEM"). The first radioamateur to fulfill the conditions for "Kosmos" was K Kallemaa, UR2BU, in 1963.

In the early seventies, endorsements/"stickers"/ began to be issued for the R-150-S, R-100-O, and W-100-U diplomas.

We briefly remind readers of the rules concerning diplomas issued by the Federation of Radio Sport of the USSR and the CRC of the USSR named after E. T. Krenkel' to Soviet and foreign radioamateurs.

The diplomas "RAEM", R-6-K, R-10-R, R-15-R, R-100-O, R-150-S, and W-100-U

are issued for radiocommunications carried out on any amateur bands (1.8, 3.6, 7, 14, 21, and 28 MHz) by telegraph or telephone separately (except for the "R-6-K" diploma, which is also issued for QSO's on SSB).

The "RAEM" Diploma is awarded for completing QSO's by telegraph, beginning 24 December 1972, with Soviet amateur radio stations located beyond the polar circles. To receive it, 68 points must be accumulated. For a QSO with radiostation RAEM (only with E T Krenkel'), 15 points are added, with radiostations in Antarctica and floating in the Arctic — 10; located on islands in the Arctic, on Cape Schmidt, Chelyuskin, Dikson, Pevek, Tiksi, Ust'-Olenek, and at points north of 70° north latitude — 5; located beyond the Arctic Circle — 2. For radioamateurs of South America, Oceania, and Africa points are doubled. With a given populated point only one radiocommunication is counted.

The R-6-K Diploma<sup>7</sup> is issued for QSO's completed since 7 May 1962<sup>8</sup> with amateur stations in the six continents of the world (Europe, Asia, Africa, North and Central America, South America, Australia and Oceania). In addition, it is necessary to complete QSO's with stations in the European and Asiatic parts of the USSR.

R-6-K has three levels: First — for QSO's on the 1.8 and 3.5 MHz bands, second — on 7 MHz, third — on any amateur bands.

To receive the R-10-R<sup>9</sup> and R-15-R<sup>10</sup> diplomas, it is necessary to complete, within 24 hours (for foreign radioamateurs within any period of time beginning 1 July 1958), QSO's with stations in the 10 radioamateur districts and the 15 union republics of the USSR, respectively.

The R-100-O Diploma is awarded for completing QSO's, beginning 1 January 1957, with amateur stations in 100 different oblasts of the USSR. It has three levels: The first for QSO's on the 1.8 and 3.5 MHz bands, second — on 7 MHz, third — on any amateur bands. For QSO's with 150 oblasts and with all oblasts existing at the present

time, "150" and "All Oblasts" endorsements are issued.

The R-150-S Diploma<sup>11</sup> is issued for QSO's completed beginning 1 June 1956 with amateur stations in 150 different countries or territories of the world (according to the list confirmed by the Federation of Radio Sport of the USSR), including stations in the 15 union republics of the USSR. For QSO's with each 50 new/additional/countries (territories of the world endorsements are issued). The last endorsement is "325".

The W-100-U Diploma<sup>12</sup> is awarded for completing QSO's, beginning 1 January 1959, with 100 amateur stations of the USSR, including five stations from the 9th radioamateur district — the birthplace of A S Popov. For QSO's with 300, 500, and 1000 radiostations (only those completed not earlier than 1 January 1974), endorsements "300", "500", and "1000", respectively, are issued.

The "Kosmos" Diploma is awarded for QSO's completed, starting 12 April 1961, with stations in the 144 MHz band. It has three levels: The first — for 30 QSO's with different radiostations, including 15 countries (territories) of the world (foreign radioamateurs must have 10 QSO's with different Soviet stations and five different territories), second — for 20 QSO's including 10 different countries (foreign radioamateurs must have 6 QSO's with Soviet stations and three with different countries), third — for 5 QSO's with different countries (foreign applicants must have two QSO's with Soviet stations and two with different countries). Special endorsements are issued for QSO's with each subsequent five countries (territories) of the world.

Article signed by V Sviridova.

### NUMBER CODE

1. Since *diploma* is the word used in Russian, we use it here rather than the more common English equivalent *certificate*.

2. Russian names have three elements — given (first) name, patronymic (middle) name, and family (last) name. The patronymic is derived from one's father's first name, to which is added -ovich/-evich for males and -ovna/-evna for females. Often (as at the beginning of the second introductory paragraph) the first and middle names are used and the last omitted. Many Russian last names end in -ov/-ev or -iy (males), -ova/-eva or -aya (females).
3. The single world *Imeni* sounds much more natural in Russian than does "named after" in English; an alternative translation would be "E T Krenkel' Central Radio Club of the USSR".
4. As noted later in the article, Ernst Teodorovich Krenkel' was a famous Soviet arctic explorer; he was also a philatelist and radio amateur. The Central Radio Club was named after him following his death in /I believe/ 1971. He held call-sign RAEM and, as an exception to the rules governing construction of amateur call-signs, used it on the amateur bands.
5. Most of the diplomas bear Cyrillic

(Russian) letters, but the "RAEM" and W-100-U use Latin letters. The fact that all of the Cyrillic letters used to designate the diplomas happen to be the same as Latin letters leads to possible confusion. The article does not say, but it is assumed that the abbreviations of the diplomas have the meanings given in subsequent footnotes.

6. In the early post World War II period Karelia was a separate Soviet Socialist Republic, of which there were 16, Karelia was then downgraded to an Autonomous SSR within the RSFSR, making the total 15 and explaining the redesignation of the diploma.
7. Possibly "Rabotal 6 Kontinentov" — "Worked 6 Continents".
8. Popov's birthdate, on which "Radio Day" is celebrated annually in the USSR.
9. Possibly "Rabotal 10 Rayonov" — "Worked 10 Districts". As used here, *rayon* refers to a call-sign district. A more common use by far is to designate a geographical and political unit into which oblasts and other larger units are

subdivided — something akin to our counties.

10. Possibly "Rabotal 15 Respublik" — "Worked 15 Republics". See footnote 6.
11. Possibly "Rabotal 150 Stran" — "Worked 150 Countries".
12. Possibly "Worked 100 U-stations". This is one of the diplomas whose abbreviation is expressed in Latin letters. (The other, "RAEM" is more easily explained, since as noted earlier this was Krenkel's call-sign and Soviet call-signs are usually expressed in Latin letters even in texts written otherwise in Cyrillic script.)

The foregoing article appeared on page 17 of the March 1981 issue of RADIO magazine, accompanied by a photo of Mme Sviridova. A briefer description of the diplomas was given in an article "Diplomas Await You" in the newspaper SOVETSKIY PATRIOT for 13 January 1982, in connection with the launching, on 17 December 1981, for six Soviet amateur satellites.

Translated by Dex Anderson K3KWJ/W4KM and published in Region 3 News, August 1982.

AR



## An Englishman in Australia

When I go abroad on holiday, I try to continue my hobby and get on the air, despite the (occasional) protests of the XYL. Sometimes this can be done by visiting a friend but it is usually more satisfactory to take some gear along. With a certain amount of planning, therefore, I have operated at various times as 40RV, GJ3VLX, PA9TO, G3VLX/DL and 9H3AM.

Deryck Buckley G3VLX/VK2EBZ  
16 Wood Ride, Petts Wood, Orpington, UK

With the departure of my son for New South Wales over two years ago and a month's holiday in VK planned, the chance to operate there seemed too good to miss. The first task was to organise the licence and eventually I was the proud holder of VK2EBZ.

I had already decided to take with me an Atlas 210X transceiver. This is a very small solid state rig capable of 100 W peak output when correctly matched, weighs only 3 kg, and would conveniently go into a suitcase with clothes packed round it. The home brew power pack weighs twice as much and I carried it with the hand luggage. I also packed several dipoles made of 24 gauge copper wire, one length of feeder and a very small SWR meter.

The operating site proved disappointing, half way up a hill facing south, and with numerous trees — too many for good propagation. With the help of my son, we slung a 7 MHz dipole between two trees at about 5 metres height and I set up my shack in the garage. The first QSO on 21 MHz with a JA encouraged me greatly — until I realised that the number of JAs on the band, and the favourable sea path make



Deryck, G3VLX/VK2EBZ and Len VK2API.

such contacts relatively easy. In the following three weeks I worked several JAs and a number of VKs but was unable to get into Europe as I had hoped. Although I had brought a key with me I could hear little CW and I realised too late that the Atlas has no sidetone facility which made sending difficult.

In UK most electricity distribution (apart from the 132/400 kV grid) is underground

but I was somewhat disappointed to find that most power lines in Australia are at roof height. This was undoubtedly responsible for most of the mush which masked the weaker signals.

Even so I had some interesting QSOs on phone and if we had more time would have been keen to accept some of the hospitality offered. Operating abroad is always an experience: one of the tasks I could not do without a struggle was to keep the log in UTC. (Do I take off eleven hours? If it's 0800 here what is it in London? Is the date different? I almost gave up.)

I think you are lucky to have the band up to 7.3 MHz. In Region 1 we are limited to 7.1 MHz and the phone section from 7.040 MHz to 7.100 MHz is nearly always crammed with QSOs — when it's not occupied by (illegal) broadcasters. If we want to work W on phone it has to be split frequency.

Despite the handicaps it was fascinating to work from VK and I am grateful to several VK stations who gave me encouragement. Next time I am able to activate VK2EBZ, the locals may be even kinder and lend me a trap vertical, or a three element beam!

AR



# A SENSITIVE SWR METER

Drew Diamond, VK3XU,  
43 Boyana Cres., CROYDON, 3136.

A low SWR is very important, particularly to the QRP operator, as high efficiency is one of our goals. Some transceivers have circuitry to reduce the output when a poorly matched load is used. SWR indicators normally available are quite insensitive at low frequencies, particularly 1.8MHz, and generally require in the order of 10 watts for a full-scale reading in the forward direction. The meter to be described requires only one watt on all HF bands for full-scale forward indication. The final circuit was derived after investigating several similar arrangements from various publications. Locally available components are used.

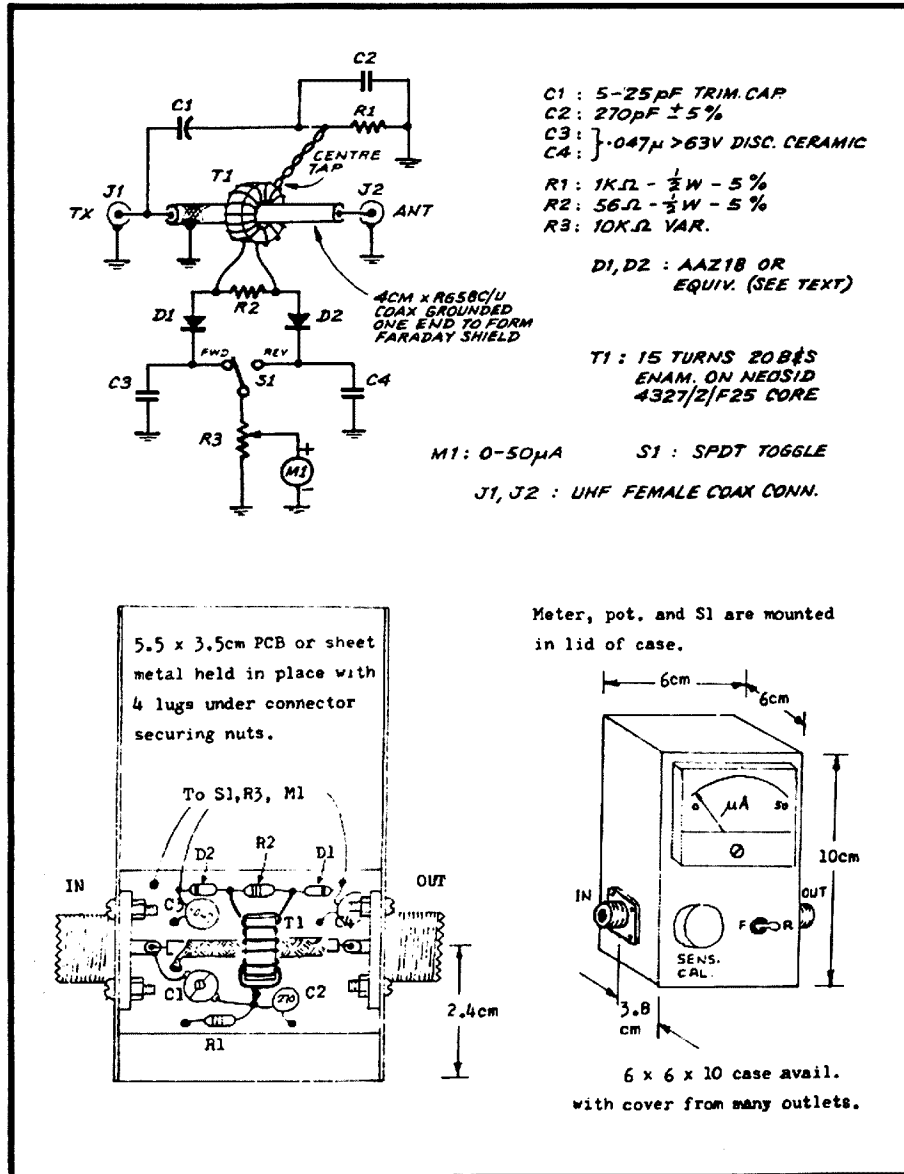

## Theory

The signal travelling from in (TX) to out (ANT) establishes an electric field between the inner and outer conductors, and a magnetic field around the conductors. The coax line forms the primary of transformer T1, and so the alternating magnetic field induces a voltage in the centre-tapped secondary winding, which is loaded by R2. C1 samples the electric field, and is so adjusted that when the load on the out side is 50 ohms resistive, the voltage injected into the tap of T1 aids the voltage in one half, and exactly cancels the voltage in the other half. Now, any load which departs from 50 ohms resistive will cause less cancellation of the voltage in the other half, and so an indication may be given as to the degree of mismatch. The remainder of the circuit is self explanatory.

**Construction**

The diagram and photograph show a suggested method of construction. The coax (jacket removed) fits snugly through T1 as shown. Care must be taken to ensure that the enamel on the secondary is not scratched by the coax braid. The components are self supporting, and may be accommodated upon a suitable piece of sheet-metal or PCB. AAZ18 diodes were found to yield the best sensitivity. Alternatively, OA91 or OA95 diodes may be used at slightly less sensitivity.

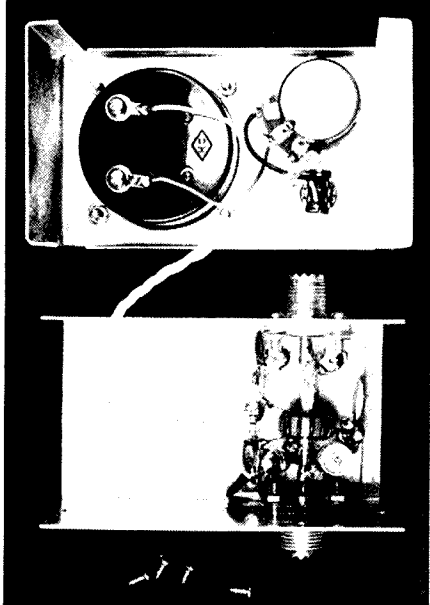

**Adjustment**

C1 is adjusted so that little or no reverse reading is obtained when the out connector is terminated with a purely resistive load. A satisfactory load may consist of two 100 ohm 1W Philips cracked carbon resistors in parallel, and soldered to a suitable connector. Apply about one watt of carrier on the highest HF frequency to be used, and adjust C1 for a null as indicated on M1 with S1 in the REV position. If the meter is to be calibrated, calculate the degree of mismatch for various terminations. e.g. 33 ohms or 75 ohms represents an SWR of 1.5. 25 or 100 is 2.0, 18 or 150 is 3.0 and so on. The sensitivity calibrate pot. must be adjusted so that a forward reading of full-scale (50 microamps) is obtained before checking the reverse reading. The sensitivity is quite constant from 1.8 to 30MHz, so the instrument may also be employed as an in-line wattmeter after appropriate calibration.

First Published in the VK CW QRPp Club Bulletin.  
Photos: Peter Dalliston.

AR



**TRY THIS**

Stephen Gard VK2PMF  
104 Hughes Street Deniliquin 2710

**A CASSETTE PLAYER/TRANSCIEVER INTERFACE DEVICE**

This simple circuit allows an ordinary cassette player which has an external speaker socket, to key a transmitter in its ICW mode. The idea comes from Don Smith, VK2BDU.

The small AC voltage from the player's speaker socket is stepped up, then rectified, and used to close a normally open reed-relay, across which is the transmitter's keying circuit, taken from the key socket at the rear of the transceiver.

The circuit is shown here;

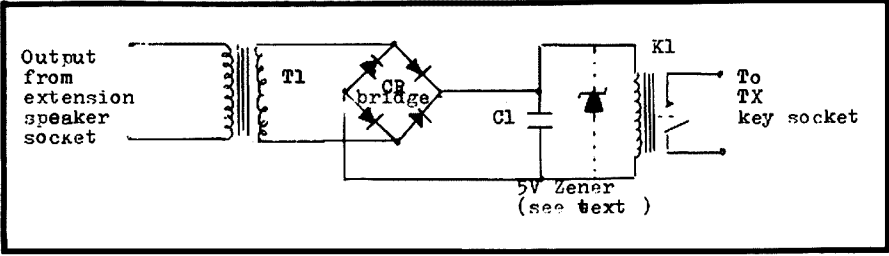

- T1: speaker transformer, primary approx. 7 kilohms secondary to match impedance of cassette player
  - CR 1-4: EM 401 or similar
  - C1: .1 mF polyester (at least 50VW)
  - K1: reed relay, normally open.
- (Zener diode BZXC51 or similar)

The transformer was salvaged from an old mantel radio, and should have an impedance to match the cassette player's output. The reed relay should be rated for the current in the transmitter's keying circuit.

The unit works well on 3.5, 7 and 14 MHz, but at higher frequencies, rectification in the audio circuits of the cassette player proved troublesome: the output was unusable.

An audio oscillator is used to prepare the message on the tape, but a high record level is advisable ("in the red"), and the audio output should be at a high level also (8/10).

The circuit can also be used with the Zener diode shown to provide input (from the transceiver's audio output) to a RTTY demodulation programme in a computer system.

AR

**The Radiocommunications Act**

*Communications and Electronics have progressed dramatically since the Wireless Telegraphy Act was written.*

*After many attempts to re-write the old Act, there is now every indication that the Bill for the new Act will be 'tabled' in Parliament.*

*The National EMC Advisory Service would like to remind all Amateurs of the importance of this — "Bill for the New Act" — and the direct effect this new Act could have on the Amateur Radio Service.*

*The "Bill" is the "Act" in draft form; therefore it can be*

*amended many times, before it becomes an Act . . . Copies of the Bill should become available at the Government Printer's Office.*

*If, after studying the contents of the Bill, you feel that you have a contribution, or may be in a position to assist the committee with any facet of this important response, please write to your Division, or direct to:*

*Chairman, Caspar,  
(Communications Act Special Planning and Response),  
Committee, PO. Box 300, Caulfield South, 3160.*

# VK7AMC – THE AUSTRALIAN MARITIME COLLEGE

Broder Tuff VK7XX  
C/- Australian Maritime College  
Launceston  
AR



The Australian Maritime College was established as a Commonwealth tertiary education institution in 1978 to cater for the education and training of personnel for the Australian shipping industry and the general maritime industry both ashore and afloat.

The main campus is situated at Launceston, Tasmania, with a Seamanship Centre at Beauty Point near the mouth of the River Tamar about 50 km north of Launceston.

The College's two training vessels are berthed at Beauty Point — 'Bluefin', a thirty-five metre purpose-built, fisheries training vessel which is the largest stern trawler in Australian waters and the 1300 ton, sixty-four metre navigation and seamanship training vessel 'Wyuna', the former Port Philip pilot vessel. 'Wyuna' (VKVS) has been completely refurbished and refitted by the College.

The School of Engineering, situated on the main campus at Launceston, is involved in many aspects of maritime related engineering education, including training radio officers for the shipping industry and technical officers for the wider field of maritime electronics.

At an early stage in the College's development it was felt that amateur radio had a role to play in the education of professional communicators and it was decided to install an amateur radio station, whose callsign became VK7AMC. Owing to the pressure of establishing a new College and new courses the amateur station was used only intermittently until recently and VK7AMC was a comparatively rare call to hear on the air.

During October 1982 lecturing staff and technical officers finally found time to organise a field trip for radio students. The location was a chalet 1200 m up Ben Lomond mountain. The party of about twenty people comprised several experienced radio officers attending a Radar Maintenance Course at the College, several members of the 1983 Antarctic Expedition attending a Communication Officers Course, students from the Associate Diploma Course in Marine Radiocommunication, College lecturers and the writer's family.

Among those present were Vince Kitney VK6VK, Peter Stickland VK6AST, both of

whom will be operating VK0 callsigns in 1983, Colin Whale VK4CU, Gio Donk VK7GO, Geoff Harrison VK7LA, Mike Collinson AMC Lecturer VK7MA, Broder Tuff VK7XX, Christine VK7CC and Stewart VK7II, Broder's wife and son.



The QTH on Ben Lomond.

The party arrived on site at 5.00 PM and promptly split into separate groups, one to wire up the chalet with power supplies, lights etc, from the 4.5 kilowatt generator we had brought along (the 600 watt standby was never used); another to erect aerials and a third to organise equipment.



VK6AST/OST studying RTTY screen whilst Simon Hood (student) operates 20 metres.

The aerial group erected a 7 m high TH5, rotated by two vice grips on the mast, a 220 m long wire from the top of a convenient mound of rocks about 40 m high (via the fork of two trees) to the chalet roof, an 8 element 2 m beam and a 14 element 70 cm beam, along with various dipoles, etc.

By 9.00 PM there were 3HF, a VHF and UHF stations established and on the air. The party operated continuously over forty-four hours and contacted over two hundred stations in thirty-two countries. Many of the QSO's were quite long and very interesting. During a brief interlude that weekend three separate parties climbed to the 1572 m summit of Ben Lomond and operated a two metre portable with some success.



Steve Burns, Andrew Tuff, Gio Donk, VK7GO and Broder Tuff, VK7XX working 2 metres.

The next opportunity to air the College callsign arose in December 1982. 'Wyuna' was scheduled to make a voyage to Lord Howe Island, Middleton Reef, Newcastle, Sydney and back to Launceston from 5 to 17 December.

Four radio students, an electronics technical officer and the writer participated on the voyage with twenty-seven Nautical Science cadets and members of the School



**VK7AMC/MM aboard the training vessel 'Wyuna'. Pictured are L to R — Robin VK7RA (student), Magella Robinson (student), Broder Tuff VK7XX (lecturer), Tony Robertson (technical officer) Nick Lindsay (student).**

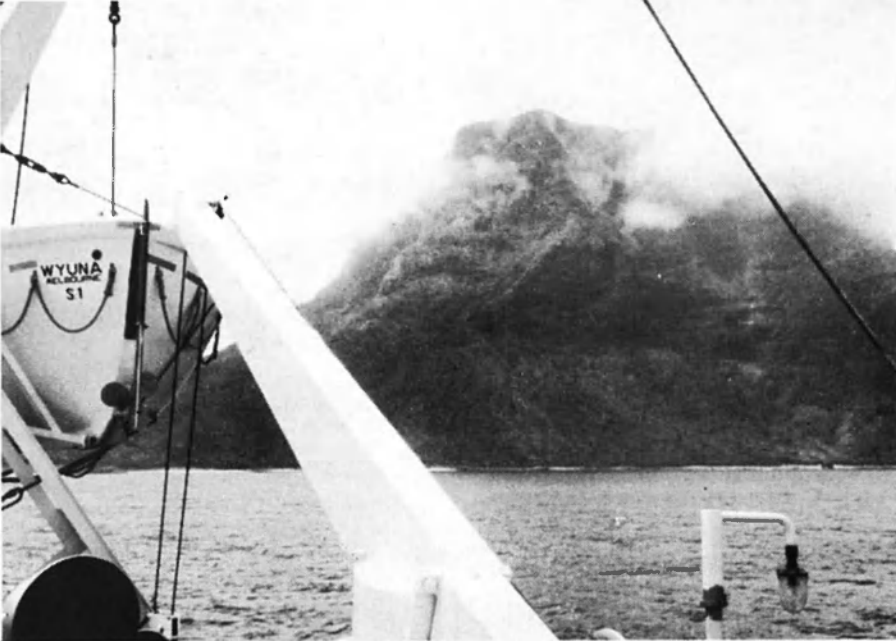

**Lord Howe Island as seen from the deck of the 'Wyuna'.**

of Nautical Science lecturing staff. It was decided that VK7AMC should go stroke MM. A trap dipole was hastily erected between the masts of the ship, the TS830S with ATU installed in the radio office, and VK7AMC/MM was on the air. Schedules were kept with the College station in Launceston and the writer's XYL four times a day throughout the trip and the station was operated when training schedules permitted. About three hundred stations were worked in sixteen countries and many of the QSO's lasted from half an

hour to an hour. During some of the schedules the spirit of amateur radio was very much to the forefront particularly when conditions were bad after the ship had passed through a very severe electrical storm. Noteworthy incidents included a VK2 station calling to ask if we knew there were coral outcrops at the entrance to Lord Howe Island lagoon which were unmarked on present charts; a VK6 'phoning a friend of the writer to bring him on air; a VK7 'phoning VK7CC, one night to get her to keep a schedule and the LA station who



**Students prepare to go ashore at Lord Howe Island.**

acted as a relay one evening. The spirit of amateur radio showed its very best in these and many more incidents including the patience and understanding of many operators with the inexperience of some of the students on the microphone and key. Thanks to all. You'll be happy to know that you really won a few converts to the ranks.

We were very pleased to have the opportunity to make all the contacts. The only frustrating part of the exercise was to lie at anchor half a mile off Lord Howe Island and not get ashore to use the VK2/LH call. Maybe another year the radio students will get put ashore for a few days with some equipment as a DX expedition.

Now that the installation of equipment and establishment of courses at the College has passed the initial hectic period, it is expected that VK7AMC, the Australian Maritime College, will be heard much more often on the radio amateur bands. We look forward to holding regular skeds and nets.



**83/84  
CALLBOOK**

**Work has commenced on  
the next edition!**

**Are your details correct  
in the last edition?**

**If not please notify the WIA  
Federal Office —**

**PO Box 300  
South Caulfield  
Vic. 3162.**

# END OF FINANCIAL YEAR AND STOCKTAKING SALE

KENWOOD

**TR-7800**  
25 WATT OUTPUT

PRE  
DEVALUATION  
PRICE

**\$380**

THIS UNIT AVAILABLE FROM  
TRIO-KENWOOD SYDNEY OFFICE ONLY



PRE  
DEVALUATION  
PRICE

**\$399**

**TR-7850**  
40 WATT OUTPUT

**\$135**

WITH FREE  
BATTERIES

**DM-81  
DIP METER**

The DM-81 dip meter is intended for adjustment of radio equipment and antennas.

It is self-excited oscillator designed for external coupling to the equipment being tested.

**FEATURES**

- Measurable frequency range of 700 kHz-250 MHz in seven bands
- Capacitive probe for measurements without removing coil shields
- Storage compartment for all seven dip meter coils, capacitive probe, earphone and ground clip lead
- Convenient for both indoor and outdoor measurements, all solid-state and built in battery

FREQUENCY SELECTION IS EASIER THAN EVER, AND THE TRANCEIVER INCORPORATES ADVANCED MEMORY DEVELOPMENTS FOR STORAGE AND RECALL OF REPEATER OFFSETS, PRIORITY AND SCAN.

## ATTENTION ALL SYDNEY HAMS

SYDNEY HAMS ARE INVITED TO WATCH THE KENWOOD CLUB'S REGULAR NIGHTLY BROADCAST ON TELEVISION UHF CHANNEL 34 FEATURING TECHNICAL AND INSTRUCTIONAL MATERIAL. THIS TRANSMISSION IS IN FULL COLOUR AND STEREO SOUND.

# KENWOOD

## TS-130SE

### HF SSB/CW TRANSCEIVER

The TS-130 Series is an incredibly compact, full-featured reasonably priced, all solid-state HF SSB/CW transceiver for both mobile and fixed operation. It covers 3.5 ~ 29.7 MHz (including the three amateur bands) and is loaded with optimum operating features.



**\$1,999**

**\$799**

## TS-930S SOLID STATE HF TRANSCEIVER

COMPLETE WITH FREE MC-42S  
UP/DOWN SCANNING MICROPHONE  
AND MC-60A BASE MICROPHONE  
TS-930S HAS AUTOMATIC  
ANTENNA TUNER

KENWOOD AUSTRALIA WAS HAPPY  
TO SUPPLY FREE OF CHARGE A  
TS-830S STATION TO THE  
HEARD ISLAND EXPEDITION.

**\$1,099**



## TS-430S EXPORT MODEL

INCLUDES UP/DOWN  
SCANNING MICROPHONE —  
MOBILE MOUNTING BRACKET —  
ORIGINAL "ENGLISH"  
INSTRUCTION MANUAL  
PLUS 5 BAND  
HELICAL ANTENNA

## RAIN CHECK POLICY

All items are available from stock at the time of preparing this catalogue. If during this offer period (1.4.83 to 1.6.83) we sell out and a firm order and deposit have been paid, the article or articles will be supplied to you at the prices shown in this catalogue. Except Models TR-7800, TR-7850, ST-1, SMC-24 and SC-3.

Further, all Kenwood articles imported and distributed by Kenwood Australia to the dealers listed in this catalogue are guaranteed for 12 months from date of original purchase. Beware of dealers not authorised to sell Kenwood offering dubious deals and service.

**\$30**

## RD-20 RF DUMMY LOAD

20 WATTS  
CONTINUOUS



# KENWOOD

## REMOTE VFO's

**VFO-120**  
TO SUITE MODELS  
TS-120/130/530/830



PRE  
DEVALUATION  
PRICE

**\$499**



## TS-660

15M-6M ALL-MODE TRANSCEIVER  
A must for Novice and  
Limited License operators.



PRE  
DEVALUATION  
PRICE

**\$140**



**\$135**

## HC-10 CLOCK

The HC-10 is a highly advanced world clock with dual display which can memorize 10 major world cities and two additional regions. This world clock incorporating a precise quartz and digital display system, as well as a built-in micro-computer, can also recall and display the starting time of QSO for logging purposes.



PRE  
DEVALUATION  
PRICE

**\$140**

**VFO-240**  
TO SUITE MODELS  
TS-120/130/530/830

PRE  
DEVALUATION  
PRICE

**\$99**



## PS-10 POWER SUPPLY

The model PS-10 is a regulated DC power supply and speaker designed to match the TR-8400 reliable fixed station operation.

**\$1,199**

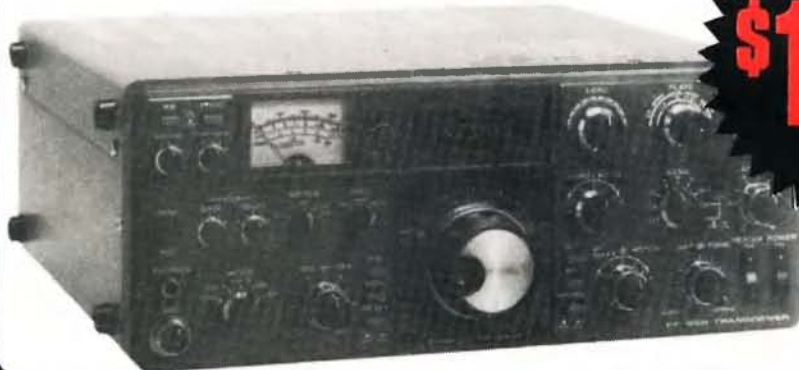

## TS-830S SOLID STATE HF TRANSCEIVER

The TS-830S is a high-performance, very affordable, HF SSB/CW transceiver with every conceivable operating feature built-in for 160 through 10 meters (including the three new bands).

COMPLETE  
WITH FREE  
MC-30  
MICROPHONE

# KENWOOD



**\$530**

**45W  
OUTPUT**

## TR-7950 2M FM TRANSCEIVER

- New, large, easy to-read LCD display
- New-21 multifunction memory channels
- Long life lithium battery memory back-up
- 45W and 25W versions
- Pre-programmed automatic offset
- Programmable priority alert
- Programmable memory scan lock-out
- Programmable band-scan width
- Center stop during band-scan, with indicator
- Scan resume selection
- Scan control using up/down microphone

THIS UNIT AVAILABLE  
FROM TRIO-KENWOOD  
SYDNEY OFFICE ONLY



**\$399**

## TR-7730 2M FM TRANSCEIVER

The KENWOOD TR-7730 is an incredibly compact, reasonably priced 25W, 2 meter FM mobile transceiver with plenty of convenient operating features such as five memories, memory scan, automatic band scan, UP/DOWN manual scan, etc.

THIS UNIT AVAILABLE  
FROM TRIO-KENWOOD  
SYDNEY OFFICE ONLY

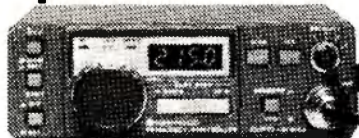

PRE  
DEVALUATION  
PRICE

**\$199**

## DFC-230 DIGITAL FREQUENCY CONTROLLER

**TDC-140  
DC CONVERTER  
24V INPUT  
13.8V OUTPUT**

**\$140**

Dr. David Lewis leader of the 1982/83 Oceanic Research Antarctic Expedition has chosen Kenwood Communications Equipment on board the "Dick Smith Explorer". Where lives and safety are paramount and reliability is of prime importance - the professionals always choose **KENWOOD**



**\$680**

## TR-9130 2M ALL-MODE TRANSCEIVER

The TR-9130 is a powerful, yet compact, 25 watt FM/USB/LSB/CW transceiver providing increased versatility of operation on the 2 meter band.



# KENWOOD

## REMOTE SPEAKER



ONLY  
AVAILABLE  
AT SYDNEY  
OFFICE

**\$18**

### SP-100

The SP-100 can be used in place of the receiver's built-in speaker for greater clarity and improved tone.

**\$670**



**NEW R-2000 RECEIVER**  
WITH MEMORY SCAN, PROGRAMME  
SCAN & MEMORY MODE RETENTION  
OPTIONAL VHF CONVERTER AVAILABLE



### R-600 RECEIVER

COMPLETE WITH SET OF  
HS-4 HEADPHONES

The R-600 is a high performance general coverage communications receiver covering 150 kHz to 30 MHz in 30 bands. Use of PLL synthesized circuitry provides highly accurate frequency control with maximum ease of operation.

**\$390**

**\$449**

**\$390**

**TR-3500**  
70CM FM  
HAND-HELD

**TR-2500**  
2M FM  
HAND-HELD



## TR-2400 OWNERS

**ST-1**  
AC/DC  
BASE STAND

**\$49**



SC-3 SOFT CASE ONLY \$20



**\$29**

**SMC-24**  
SPEAKER  
MICROPHONE

# ROTATORS

KR-400. Complete with top and bottom mast clamps plus 16 metres of 6 wire control cable. Usually sells for much more than this.

KR-250. Light duty for TV and FM aerials. Complete with top and bottom clamps and 16 metres of cable. Real value at this price.

KR-600RC. Complete with above fittings and cable. A must for all serious hams.

All Rotators purchased from Trio-Kenwood are fitted with approved 3 core AC lead and plug.

All units include Control Box and full Instructions.

**\$140**

**\$80**

**\$230**



# KENWOOD

## 7 ELEMENT YAGI

KENWOOD ANNOUNCE THE RELEASE OF A NEW LOG PERIODIC!

Frequency range 13 MHz to 30 MHz. Boom length 7.3 metres. Longest element 11 metres. Average gain 10dB. Front to back ratio 19 dB. Maximum power 2kW. Shipping weight 18 kg.

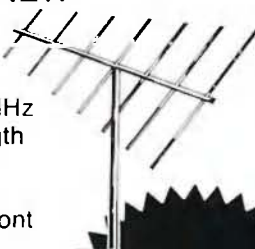

**\$370**

PLUS FREIGHT

## ANTENNA TUNERS

Don't fight with back yard home brew types!! Get the real thing — Commercially made, designed and resaleable with your Kenwood station.



**\$288**

### AT-230

The AT-230 antenna tuner includes the three new bands and functional features such as a through-line wattmeter, SWR meter and antenna selector switch.

The AT-130 is a compact and lightweight antenna tuner designed for base or mobile use (includes the three new bands).

**\$155**

### AT-130



## TRIO-KENWOOD (AUSTRALIA) PTY. LTD.

(INCORPORATED IN N.S.W.)

4E WOODCOCK PLACE, LANE COVE, SYDNEY, N.S.W. 2065. Ph. (02) 428 1455.

### NEW SOUTH WALES

TRIO-KENWOOD (AUST. I/P/L — 4E WOODCOCK PLACE, LANE COVE (02) 428 1455  
 SPRINGWOOD CAR RADIO — SPRINGWOOD (0471) 51 4930  
 UNIQUE ELECTRONICS — 416 OLD PROSPECT ROAD, WENTWORTHVILLE (02) 631 6689  
 WASSSELL ELECTRICAL — 10 McNAMARA STREET, ORANGE (063) 62 6249  
 STOCKMAN & HIGGINS — BYRON STREET, INVERELL (067) 22 1300  
 ELECTRON 2000 — 3 ELIZABETH STREET, TIGHS HILL, NEWCASTLE (049) 69 6399  
 MACELEC PTY. LTD — 99 KENNY STREET, WOLLONGONG (042) 29 1455  
 RADIO WORLD PTY. LTD — 81 NEWCASTLE STREET Fyshwick (067) 80 6550  
 DX ENGINEERING — 5 JASMINE STREET, PORT MACQUARIE (065) 83 2175  
 LAND LINK — MULLALEY ROAD, GUNNEDAH (067) 42 2838  
 LAND LINK — 61 BARNES STREET, TAMWORTH (0671) 65 4622  
 FRANK BOUNDY — LISMORE (066) 569 7360

### INTERSTATE

VIC: EASTERN COMMUNICATIONS — 166 ELGAR ROAD, BOX HILL (03) 288 3107  
 BRIAN STARES — 11 MALMSBURY STREET, BALLARAT (053) 39 2808  
 SUMNER ELECTRONICS — 78 KING STREET, BENDIGO (054) 43 1977  
 CODLIN ELECTRONICS — MOE (051) 27 4516  
 TAS: HOBBY ELECTRONICS — 83 CARELLA STREET, HOWRAH, HOBART (002) 47 6674  
 GELSTON ELECTRONICS — SUMMER HILL (003) 27 2256  
 ADVANCED ELECTRONICS — 5A THE QUADRANT, LAUNCESTON (003) 31 7075  
 V.K. ELECTRONICS — 57 WEST PARK GROVE, BURNIE (004) 31 1708  
 QLD: MITCHELL RADIO CO — 59 ALBION ROAD, ALBION (07) 57 6830  
 HOBBY ELECTRONICS — 477 NELSON ROAD, MT. NELSON (002) 43 6337  
 S.A. & N.T.: INTERNATIONAL COMMUNICATIONS SYSTEMS PTY. LTD — 8 NILE ST., PORT ADELAIDE (08) 47 3688  
 W.A.: ARENA COMMUNICATIONS SERVICES — 642 ALBANY HWY., EAST VICTORIA PARK (09) 361 5422  
 TRI-SALES — CNR NEWCASTLE & CHARLES STREETS, PERTH (09) 328 4160  
 WILLIS ELECTRONICS — 73 STERLING STREET, PERTH (09) 328 9229  
 BAY RADIO — 18 BANKSIA STREET, BUNBURY (097) 21 2236  
 RON DENT — 115 PATON ROAD, SOUTH HEADLAND (091) 72 1112

# JOIN A NEW MEMBER TODAY!!

Please pass this form to a non member so they may join the Institute.  
When completed this application should be sent complete with appropriate monies to the division representing the State in which you reside as per the directory overleaf.

## SUBS RATES AND JOINING FEES 1983

	ACT	NSW	VIC	QLD	SA	WA	TAS
	\$	\$	\$	\$	\$	\$	\$
Bona Fide Student	21	22	20	11	18	19	9.75
Pensioner	22	22	22	22	24	24	20
Associate Member (No Callsign)							
(a) Metropolitan	30	27	28	27	32	29	28.5
(b) Country	30	27	28	27	30	29	28.5
Full Member							
(a) Metropolitan	30	29	32	27	34	30	28.5
(b) Country	30	29	32	27	32	30	28.5
Plus Joining Fee	—	3	—	3	—	—	1

Family Member (eg wife) without AR — deduct \$12.15 from appropriate full or associate rate, except: —  
ACT — \$18, VIC — \$15, QLD — \$11, SA — \$17.

NOTE: A full member is an amateur holding a valid amateur call sign or possessing equivalent qualifications but awaiting the issue of a call sign. An associate is anyone else interested in amateur radio.

## THE WIRELESS INSTITUTE OF AUSTRALIA

### APPLICATION FOR MEMBERSHIP

To the Membership Secretary,  
..... DIVISION.

I hereby apply for membership  
and enclose \$ ..... Subscription

NAME .....

ADDRESS .....

CALLSIGN .....

I agree to be governed by the  
Memorandum and Articles of  
Association, Regulations and By-laws  
of the Institute now in force.

SIGNATURE .....



## WIA DIRECTORY

### FEDERAL PRESIDENT:

Mr Bruce R Bathols, VK3UV

### FEDERAL COUNCIL:

VK1: Mr Ron G Henderson, VK1RH

VK2: Mr Stephen Pall, VK2PS

VK3: Mr Alan R Noble, VK3BBM

VK4: Mr David T Laurie, VK4DT

VK5: Mrs Jenny M Warrington, VK5ANW

VK6: Mr Neil R. Penfold, VK6NE

VK7: Mr Peter Fudge, VK7BQ

### STAFF:

Mr Reg Macey, Secretary

Col C W (Wyk) Perry

Mr John J A Hill, VK3DKK, (Advertising)

Mrs Ann McCurdy •

### EXECUTIVE OFFICE:

3/105 Hawthorn Road, Caulfield North, Vic, Ph 528 5962.

### EXECUTIVE POSTAL ADDRESS:

PO Box 150, Toorak, Vic 3142.

### AUSTRALIAN CAPITAL TERRITORY:

President — Mr W R (Bill) Maxwell, VK1MX

Secretary — Mr Richard B Jenkins, VK1UE

Broadcasts — 3.570 MHz and 2 metre Channel 6950 at 20:00 hours.

General Meetings — Fourth Monday of the month.

### NEW SOUTH WALES

President — Ms Susan J Brown, VK2BSB

Secretary — Mr Athol D. Tilley, VK2BAD

Broadcasts — 11:00 and 19:30 hours.

Frequencies bracketed at 11:00 only.

Frequencies: (1.8125), 1.825, (3.585), 3.595, (7.146), 28.320, 52.120, 52.525, 144.120 MHz.

6850 Wollongong, 7000 Sydney, (7100 Westlakes), 8525 Sydney.

### VICTORIA:

President — Mr Alan R Noble, VK3BBM

Secretary — Mr Des J Clarke, VK3DES

Broadcasts — 1.840, 3.600, 7.135, 53.032 (AM), 144.2 (USB) MHz and 2 metre Channel 2 (5) repeater at 10:30 hours.

General Meetings — Second Wednesday of each month at 20:00 hours.

### QUEENSLAND:

President — Mr Guy D Minter, VK4ZXZ

Secretary — Mr Fred J Saunders, VK4AFJ

Broadcasts — 1.825, 3.580, 7.120, 14.342, 21.175, 28.400 MHz.

Repeaters: Channel 6700 and 7000 at 09:00 hours.

Re-broadcasts — 3.605 MHz on Mondays at 19:30 hours and 20 m RTTY at 20:00 hours.

General Meetings — Third Friday of each month at 19:30 hours.

### SOUTH AUSTRALIA:

President — Mr W M (Bill) Wardrop, VK5AWM.

Secretary — Mr David M Clegg, VK5AMK.

Broadcasts — 1.850, 3.550, 7.095, 14.175, 21.195, 28.470, 53.1 MHz.

Repeater: Channel 7000 at 09:00 hours.

General Meetings — Fourth Tuesday of each month at 19:30 hours.

### WESTERN AUSTRALIA:

President — Mr Bruce Hedland-Thomas, VK6OO

Secretary — Mr Fred Parsonage, VK6PF

Broadcasts — 3.560, 7.050, 14.100, 14.175, 28.470, 53.1 MHz. 2 metres: Channel 2 Perth, Channel 2 Wagin at 09:30 hours.

General Meetings — Third Tuesday of each month

### TASMANIA:

President — Mr Lloyd Cherry, VK7BF

Secretary — Mr Peter Clark, VK7PC

Broadcasts — 7.130 MHz SSB with relays on 6 and 2 metres Channel 2 (south), Channel 8 (north), Channel 3 (north-west), at 09:30 hours.

### NORTHERN TERRITORY:

President — Mr Terry A Hine, VK8NTA

Vice-President — Mr Barry Burns, VK8DI

Secretary — Mr Robert Miliken, VK8NRM

Broadcasts — Relay of VK5WL on 3.555 MHz and on 146.5 MHz at 09:30 hours. Slow morse transmission by VK8HA on 3.555 MHz at 10:00 hours almost every day.

### POSTAL INFORMATION:

VK1 — PO Box 46, Canberra, 2600. Phone (062) 41 3889

VK2 — PO Box 1066, Parramatta, 2150. 109 Wigram Street, Parramatta. Phone (02) 689 2417. Dural during B'casts only. Phone 651 1489.

VK3 — 412 Brunswick Street, Fitzroy, 3065. Phone (03) 417 3535 from 10:00 to 15:00 hours weekdays.

VK4 — GPO Box 638 Brisbane, 4001. Phone (07) 349 7768.

VK5 — GPO Box 1234, Adelaide 5001. West Thebarton Road, Thebarton. Phone (08) 352 3428.

VK6 — GPO Box 10, West Perth, 6005.

VK7 — PO Box 1010, Launceston, 7250.

VK8 — (included with VK5). Darwin Amateur Radio Club, PO Box 37317, Winnellie, Northern Territory, 5789.

### SLOW MORSE TRANSMISSIONS:

Most week day evenings from about 09:30 UTC onwards around 3.550 MHz.

### VK QSL BUREAUX:

The following official list of VK QSL Bureaux are all inwards and outwards unless otherwise stated.

VK1 — QSL Officer, GPO Box 46, Canberra, ACT 2600

VK2 — QSL Bureau, PO Box 73, Teralba, NSW 2284.

VK3 — Inwards QSL Bureau, Mrs Barbara Gray, VK3BYK, 1 Amery Street, Ashburton, Vic 3147.

VK3 — Outwards QSL Bureau, Mr Des Clark, VK3DES, C/o VK3 Rooms.

VK4 — QSL Officer, GPO Box 638, Brisbane, Qld 4001

VK5 — QSL Bureau, Mr Ray Dobson, VK5DI, 16 Howden Road, Fulham, SA 5024.

VK6 — QSL Bureau, Mr Jim Rumble, VK6RU, GPO Box F319, Perth WA 6001.

VK7 — QSL Bureau, GPO Box 371D, Hobart, Tas 7001.

VK8 — QSL Bureau, C/- VK8HA, PO Box 1418, Darwin, NT 5794.

VK9 & 0 — Federal QSL Bureau, Mr Neil Penfold, VK6NE, 388 Huntriss Road, Woodlands, WA 6018.

### MEMBERS OF EXECUTIVE:

Mr Bruce R Bathols, VK3UV. Federal President.

Mr Peter A Wolfenden, VK3KAU. Member.

Mr Harold L Hepburn, VK3AFQ. Member.

Mr Courtney D H Scott, VK3BNG. Honorary Treasurer.

Mr Ken C Seddon, VK3ACS. Member.

Mr Earl R Russell, VK3BER. Member.

Mr Reg Macey. Secretary.

### PAST FEDERAL PRESIDENT AND JOINT IARU

#### LIAISON OFFICER

Dr David A Wardlaw, VK3ADW

#### IARU LIAISON OFFICER

Mr Michael J Owen, VK3KI

#### INTRUDER WATCH CO-ORDINATOR

Mr R W (Bill) Martin, VK2EBM

#### EDITOR AND CHAIRMAN OF PUBLICATIONS COMMITTEE

GIL SONES VK3AUI

#### FEDERAL BROADCAST TAPE CO-ORDINATORS

Mr Ron Fisher, VK3OM

Mr Bill Roper, VK3ARZ

#### FEDERAL EDUCATION CO-ORDINATOR

Mrs Brenda Edmonds, VK3KT

#### FEDERAL HISTORIAN

Mr G M (Max) Hull, VK3ZS

#### FEDERAL CONTESTS MANAGER

Mr Reg Dwyer, VK1BR

#### FEDERAL AWARDS MANAGER

Mr Mike E Bazley, VK6HD

#### FEDERAL TECHNICAL ADVISORY COMMITTEE

Mr W M (Bill) Rice, VK3ABP

Mr Ken C Seddon, VK3ACS

Mr Peter A Wolfenden, VK3KAU

Mr Ian W Cowan, VK3BGH

Mr Les Janes, VK3BKF

Mr John J L Martin, VK3ZJC

Mr Kevin L Phillips, VK3AUQ

Mr Martin F M Tuck, VK3ZOV

Mr Peter B Mill, VK3ZPP

Mr Peter L Freeman, VK3KAI

#### AMSAT AUSTRALIA

Mr Chas J Robinson, VK3ACR

Mr R C (Bob) Arnold, VK3ZBB

#### FEDERAL WICEN CO-ORDINATOR

Mr Ron G Henderson, VK1RH

#### FEDERAL EMC CO-ORDINATOR

Mr A (Tony) Tregale, VK3QQ

#### VK/ZL/O CONTEST MANAGER (VK)

Mr Neil R Penfold, VK6NE

#### FEDERAL VIDEOTAPE CO-ORDINATOR

Mr John F Ingham, VK5KG

#### ALTERNATE FEDERAL COUNCILLORS

VK1 — Mr Fred Robertson-Mudie, VK1MM

VK2 — Mr Wally A Watkins, VK2DEW & Mr Tim Mills VK2ZTM

VK3 — Mr Des J Clarke, VK3DES

VK4 — Mr Guy D Minter, VK4ZXZ

VK5 — Mr David M Clegg, VK5AMK

VK6 — Mr Bruce Hedland-Thomas, VK6OO

VK7 — Mr Ivan Ling, VK7XL



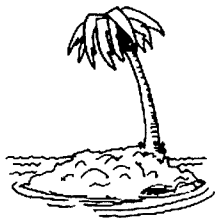

# HOW'S DX

Ken J McLachlan VK3AH  
PO Box 39, Mooroolbark 3138

This month, to provide the opening remarks to this column, Ken G3NBC, has submitted the following observations by invitation. Ken G3NBC, has been an amateur and member of the RSGB for nearly a quarter of a century, and past Certificate Manager for the RSGB in the 1960s. Ken has a DXCC score in excess of 326 countries confirmed and has entitled his remarks "THE OTHER END OF THE QSO".

"For almost a quarter of a century of amateur radio operating I have always had a considerable interest in finding out a bit about the other end of a DX contact, either by radio or occasionally when one has the opportunity of a personal contact with an overseas amateur.

Through our hobby, we are able to gain much knowledge of the world in which we find ourselves, its geography, its history, its people, etc. . . A great deal may also be learned about aspects of amateur radio as seen from the distant operators point of view.

Unless one is fortunate enough to be able to travel and operate from various parts of the world it is unusual for us to regard operating conditions in any other way than it is known from our particular location. This of course is far from the case and what is one operators DX may be another's QRM. Therefore a little knowledge of how things are, radio wise, may help when wishing to work into that part of the globe.

"With this in mind an attempt will be made to provide a picture of how the DX bands are seen (or heard) from here in the UK. As my own activity and interest is mainly confined to the 10, 15, and 20 metre bands. These will be considered in this illustration with just a brief look at 40 metres.

## TEN METRES

Very little activity during our summer months is usual, apart from the occasional European short skip, although sometimes South America and Southern Africa may come through. With the exception of the in between years, the period from September to April can produce some exotic and interesting results.

There is however, a usual pattern of day-to-day propagation with the opening of the band shortly after 0800 UTC until it closes with the coming of darkness in the early evening. The morning, until about 1200/1300 UTC sees easterly propagation from north to south permitting communication (depending on how good the conditions are) with JA, ZL, UA0, KH2, VK, VS6, P29, H44 etc. . . Africa and the Middle East may

also be worked. At the same time very strong single skip signals from Europe UA, UB5 and YU stations are normal. Such signals are numerous, and often S9 plus, creating considerable problems when one is trying to work a DX station.

After 1300 UTC propagation rapidly changes to the west with activity from North America and Canada followed closely by South America until the closing of the band. Contacts into the Pacific area are fairly rare, but an interesting condition sometimes occurs, when the long path opens to VK and ZL around 2200 UTC from an otherwise dead band. This is, however, a short lived condition. Propagation on the 10 metre band is invariably on the short path.

## FIFTEEN METRES

This is a very interesting band with generally all year DX propagation although often closing in mid evening (1900-2000 UTC) during the winter months. The paths that are open from the UK can be very varied throughout the day and sometimes all parts from all Continents may be heard simultaneously. There is, however, a pattern of propagation which usually provides contact with ZL, VK, UA0 and the Pacific area until 1300 UTC. Asia and Africa 1500 to 1700 UTC, North and South America hold from early evening until the band closes. QRM due to strong short skip signals is far less of a problem on this band, making DX working easier.

The best time for VK/G station QSO's would seem to be between 0700-1200 UTC and maybe sometimes on either path. During the summer months very good openings occur to the south and south west with ZL possible at that time.

## TWENTY METRES

The 20 metre band carries most of the DX traffic throughout the year and except for a period during the winter months is often open 24 hours per day. A propagation pattern is very noticeable making the winter-time doldrums, early morning (up to around 0930/1000 UTC) working in a westerly direction from north to south which includes the long path to VK and the direct paths to the South and Central Pacific area. During the larger part of the day DX working is very difficult as the longer distance paths are usually poor and short skip conditions predominate until 1700/1800 UTC. The evening often opens the short path to VK and sometimes ZL, FK8 and the Pacific Ocean, and of course North and South America.

The 20 metre band in this part of the world is very heavily congested, QRM can be unbelievable and behaviour of some

operators leaves a lot to be desired. One often has to attempt to hear a DX station with an S9 + 20/40dB signal a few kilohertz away, or be tuned up on in the middle of a contact if one is lucky enough to make themselves heard. Many European stations are permitted to run a much higher power limit that is permitted in the UK and antenna planning constraints are not so rigorously applied. These factors leave the "G" stations with a disadvantage in the competition for DX contacts. So an appeal to all DX stations, if you have a pile up, please listen carefully as there may be "G" stations calling from a few layers down.

## FORTY METRE OPERATION

The activity from this QTH, on this band, is limited by the use of only a dipole antenna at present which is, of course, very useful for working around the UK and Europe but from time to time has brought some DX results, UA0, YB0, PY, EA8, EA9, VP2, VP8, etc having been entered in the log.

Many DX signals may be heard in the early morning hours until about 0900 UTC and again in the evening after 2000 UTC although they have to be found among the highpowered broadcast stations which plague the band until the early morning hours. Throughout the daytime, big signals from within a few hundred kilometres occupy the band.

UK operators are always very glad to have contacts with VK and it is obvious that many good and long lasting friendships have resulted from our hobby. It is hoped that the above notes will give the VK amateur an insight as to the state of the bands in this country and will be of interest to any amateur wishing to make contacts with this country.

Please remember that operating with the ORM often experienced in this part of the world is not always easy, so PLEASE, have patience with the "G" who may be struggling with all kinds of noise to hear his DX contact."

Have you heard Heard? This was the cry of the multitude from all continents when one swung across twenty metres at any hour of the day or night when the band was open. Fifteen metres didn't give many a chance and ten does not even rate a mention as the monitoring at this QTH drew a complete blank on signals from anywhere.

Perhaps it is one of "MURPHY'S LAWS" that intervened when the most wanted country on the DXCC lists was activated by two DXpeditions. Anything from massive solar flares and total radio "blackouts" to

sheer deliberate QRM marred many more contacts being made by both groups.

The antenna at this QTH spent most of its time looking at VK0 Heard, except, when serious local wind storms by our standards were forecast and there were a few. Many hours were spent monitoring the excellent operating of both Dave VK0HI and Al VK0CW whilst engaging myself in other chores. It was interesting to note, the number of stations who had previously "boasted" that they had Heard Island confirmed and then lined up for a contact prior to the stations who needed it for a "new" one, not only once, but a number of times. Some people really take "safety in numbers" too far!

Full marks must be given to the operators on the island for their patience, reliability and dedication to assist those that do not possess the luxury of "split operation" facilities, also for their assistance to the Australian Novice in allowing them to participate and gain a new country. Many novice operators have indicated their appreciation of the courtesy shown.

Apparently the new inhabitants of Heard Island had their problems with the weather which destroyed some of the property and sand blasted everything in sight. Most stations, after they have worked an expedition, have only the thought of when they are going to receive the card. Very little thought is given to the safety and safe return of the people that have taken innumerable risks and spent their saved up holiday time or taken leave of absence from their daily chores to give the DXer a new country. Think, have patience and please don't publicly criticise, particularly on air, leaving many to add their own connotations to the story and start unnecessary rumours.

With this Australian possession now down the list of much wanted countries, will the number of BY stations active on CW, as promised, use the sideband mode in the near future and will such rarities as S9, YA and ZA grace the current log books this year? Let us all hope so.

Tom, VE7BC is planning to return to BY land next month on business and it is hoped that the relocation of BY1PKs antennae to a higher location has been completed. This, it is envisaged, will eliminate some of the TVI problems encountered on the last visit when Tom had the problem of modulating all TV sets in the near vicinity.

It has been stated from reliable sources that other stations may soon appear from BV. This area has been ably taken care of by Tim BV2A and BV2B who was first licensed in 1939 and his hobby is interspersed with his occupation as a Director of Columbia Chinese Pictures in Taipei. Let us, as DXers, hope that the scope of the hobby will be promoted beyond our wildest expectations in WCY 1983.

### CROZET

A much wanted country until Georges took it off the high priority list of most keen DXers last year. This year two amateurs are very active. Look for FB8ZP and FB8ZQ in the French "area" of the band (below 14.120 MHz). If you are successful the QSL route is via F6KNO.

### SUDAN

Roger, who has been operating 9Y4RD/SU, anticipates being in ST towards the end of March for a few weeks. If you catch Roger, who hopes to operate when time is available, QSL to Roger's home call.

### HARD WORKED

The ARRL in their DX awards system have, since 1947, issued a mammoth number of 39,291 certificates. In 1981, alone 3,527 new certificates were issued and 7,159 endorsements went through the doors. In the 1981 period five amateurs were disqualified for submitting "altered, phony or counterfeit cards". One amateur who was almost on the Honour Roll, was disqualified for altering cards to suit the mode or class he was applying for.

The total cards handled at Newington, as one can imagine, is astronomical and can be understood when there was in excess of ten thousand applications in 1981.

It is interesting to note, that the ARRL DXCC rules allow any one who is disqualified, to commence all over again after a five year period by submitting all new cards.

Would the alteration of cards to obtain that valued certificate be worth all that trouble and the embarrassment of disqualification plus the monetary loss of starting again? I personally don't think so.

### INACTIVITY

The amateur who has recently attained his licence will probably be interested in the following inactivity list which was compiled by Denny K8DB in a submission to the Northern Ohio Amateur Radio Society, of which he is a member. The submission concerned Honour Roll status but the activity list is of interest.

XZ	1965	70	1970
VU7	1971	*CEOX	1972
YA	1974	XU	1975
XV	1975	4W	1975
*C9	1976	*HK0	1977
5A	1977	*ZL/K	1977
VU7	1978	FO0	1978
A6	1979	*IS	1979
D2A	1979	YV0	1980
*TT8	1980	*3Y	1980

The above list is in order of prefixes and last authentic operation and spans some twelve years. The current DXCC list now stands at 315 countries and it is going to be a miracle for some of the newcomers over the last five years to attain the 300 figure yet attain the Honour Roll figure of 305 current countries which is determined as being ten countries less than the maximum attainable. Asterisks denote probable operation in the future.

Of course there are others where there is little hope held for a fully fledged operation to be launched from their boundaries and these include some of the remote areas which will cost a small fortune to activate considering the world wide escalation of fuel and charter expenses.

Two groups of amateurs could gain access to a number of the much wanted areas. Namely the "Globetrotting" Colvins with their persuasiveness and track record and Erik, SM0AGD with his connections.

Both would, it is sure, have the blessing of the ARRL DXCC committee in their submissions for the validity of an operation.

### SP BACK ON THE AIR

Legitimate SP stations may soon be on the airways again in the near future. Mail is coming out of this country with no problems and all persons who held a call sign prior to the enforcement of martial law are to submit applications through a complicated system.

This system commences with the local radio club and ends up with the Inspectorate of the Military for Communications for final approval. It is understood that former calls will still be retained and will not be reallocated to other individuals.

### PHONY CARDS

Received a lot of cards from the Bureau and one or two in the mail from SWLers generally with an airmail envelope and one IRC if you are lucky? Then beware. As with all cards they need particularly careful checking against the log as the "unscrupulous" are around.

Collection of awards for amateurs and short wave listeners is big business and if you don't meticulously check your log you could be aiding the issue of a certificate that has not been gained in the spirit of the hobby.

One method that seems to work, though it is time consuming, is on the receipt of cards from the Bureau (after looking for any new or rare countries) is to sort them into year/month/date/time order and then make an onslaught on the logs. A hint, our children are now expert at sorting cards.

### SAN MARINO PREFIXES

From April 83 the radio amateurs of San Marino will change their prefixes. M1 and 9A1 will not exist, but the new prefixes are: T77A to T77Z (First class licence) T72A to T72Z (Second class licence VHF and above only) T70A (Radio Club Station "Corrado Francini" Silent Key M1A) T71A to T71Z (Special prefix only First class)

The stations QRV at present time will change their calls in this way:  
 M1B will be T77B, QSL Via WA3HUP.  
 M1BS will be T77S, QSL Via Call Book address.  
 M1C will be T77C, QSL Via Call Book address.  
 M1D will be T77D, QSL Via Call Book address.  
 M1H will be T77H, QSL Via Call Book address.  
 M1I will be T77I, QSL Via Call Book address.  
 M1J will be T77J, QSL Via Box 1, Dogana 47031 Rep San Marino.  
 M1V will be T77V, QSL Via Box 1, San Marino City or Call Book address.  
 M1Y will be T77Y, QSL Via 10MWI.  
 M1W will be T77W, QSL Via Call Book address.

T70A QSL Via Box 1 San Marino City 47031 Rep San Marino Europe.

The 20th April will start the first operation with T70A station beginning from 1300 to 1300 UTC of the day after two way SSB,

CW, RTTY. A special card with first day stamps of World Communication Year will be obtainable with one contact on any band and mode. For any other information write to ARRSM Box 1, Rep San Marino 47031.

#### QTHs YOU MAY NEED

A71AD PO Box 4747, Doha, Qatar.  
 A92NH Nabeel, PO Box 752, Bahrain.  
 C53CR PO Box 2282, Serekunda, Banjul.  
 EA9JV PO Box 100, Melilla, North of Africa, Spain.  
 J88AR PO Box 106, St Vincent.  
 J88BC PO Box 853, St Vincent.  
 JT0LAJ PO Box 180, Ulan Bator, Mongolia.  
 HV2VO G. Gotnich, IOGPY, V Vigne Morena, 90, 00040 Roma.  
 JT60AB PO Box 844, Ulan Bator.  
 KX6PO PO Box 915, Majura, Republic Marshall Islands, 96960.  
 M1V PO Box 1, San Marino.  
 PYOSJ.  
 PYOSP.

to N6CW 4639 Katherine Pl, La Mesa, CA 92041 USA

SU1AA PO Box 109, Giza, Egypt.  
 SU1ER PO Box 33, Int. Airport, Cairo, Egypt.  
 T2GSH Gordon, C/- PO Tuvalu, Central Pacific.

ZD7BW G Smillie, St Helena Island, Sth Atlantic Ocean.

5V7HL PO Box 8072, Lome.  
 6W8CC PO Box 1258, Dakar, Senegal.  
 7P8CR PO Box 212, Maseru, Lesotho.

9Y4RD/  
 SU Roger de Weeveer, UNTSO, PO Box 20, Grand Central Station NY, NY 10163.

#### QSL MANAGERS

C300H — DL80H, CE0ZAD — WB6WOD, CN8AT — OE3NH, C02HS — WB6QPG, C02PY — KB7SB, CT2DL — G4KJF, DF1MM/C6A — DJ2BW, EA4LH/CE3 — EA4JF, ED9CM — EA9JV, DK7PE/HB0 — DK7PE, EN6A — UK6AAJ, HH2CB — K9WJU, HH2CQ — K4JPD, PYOCW — PY7CW, PYOZZ — PY7ZZ, V2AU — OE3ALW, V2AZL — W2HMS, VKOCW — VK6NE, VK0HI — VK6NE, ZK1XX — K6OZL, 5H3MI — SM5KDK, 5H3YL — SM6BOW, 5T5TO — F6BUM, 5W1DW — VK3VU, 5Z4CS — JI1VLV, 7X4BL — DF9EP, 7Z2AP — I8YCP, 8P6J — N6TJ, 9X5SL — DL8DF, 9Y50JW — K2QIE.

#### CW WORKED ON THE WEST COAST

5Z4CP+, 5Z4CS, A4XJ0\*, A4XJ0+, DL1RK, F8VJ, FB8ZQ\*, FB8ZQ+, GD4BEG, GM3ZSP, J28DP\*, OH1XX, OK1DXS/A, SM5DGA, UA3PFN, UK2RDX, UK50B0, UQ2GKM, VE1BVL, VK0JS\*, VK0JS+, VS6D0, XT2AW\*, YB5AES, ZC4BI\*.

\* Denotes 3.5 MHz

+ Denotes 7 MHz

All others 1.8 MHz

#### SSB WORKED ON THE EAST COAST

3A2EE, 3A2LF, 3B8DA/3B9, 4S7EA, 4Z4JS, 5H3BH, 5N0ATW, 5Z4DA, 807AZ, 9G1HT, 9H1U, 9K2KA, 9N38, C21BK, C21EF, CE0AE, CE0ZAD, CE3BII, CE5SG, CP1FQ, CP8ADE, CQ4UA, DL80B, DU7RLC, E14A, E16BA, F6KHL, FB8WH, FB8WI\*, FB8XAB, FB8ZQ, FB8ZR, FR7ZS, G3NBC, G4RTI, GW2SB, H44AK, HB9CV, HC1HC, I2JHF, I8SAT, J28AZ, JY5RBM, KG6JJH, KX6PO, KX6QM, QZ7B, PAOPN, SM4GFL, T2GSH, T3OCH, TA1MO, T1ZEWL, TT8BC, UA0BDA, UA9UKA, UK2BBX, UP2BGK, VK0CW, VK0HI, VQ9CI, VS5OX, VS6EL, WK4I, YK1A0, YQ3QK, YV5AK, Z21GJ, ZS2HP.

\* Denotes 7 MHz

All others 14 MHz

#### CW SWLING WITH ERIC L30042

28 MHz  
 OJ6RX, G3KHZ, JH0WGN, UK5DAC.

21 MHz  
 CX1DZ, FK8CE, HL5MC, OH4ML, PY7YS, UK7PAL, UL7XE, UK9HAC, VE7IN, XE2XX, YC1CPG, 5B4LY.

14 MHz  
 CQ1CBU, CT2QN, G6ZY/EA6, FB8ZQ, FK8EJ, FK0AN, FM7WA, F08IU, GD4AM, HK0BKX, HL1CX, KV4CI, T30AC, T12PI, VK0HI, VK0NL, VU2KMK, XE3LPV, YB30N, YV1AD, DL0GD/ZL5, 3D2ER, 5B4LY, 9M20K.

10 MHz  
 C31IU, DK6PB, EA3EF, F2PC, G6HL, GI3CVH, JE1SPY, KH6AT, KV4CI, PA3BTH, T08RU.

7 MHz  
 DL3ZI, E19Q, F8VN, G3BDQ, F08BI, HB9APJ, HZ1AB, IOHCJ, LZ1RU, KG6RT, OE300G, OK1KQJ, ON5NT, T32AF, T12BEV, UA9KAI, UD6CN, UH8EAA, UO5OWN, UR2REE, VP5FUX, VU2TTC, Y27QO, YU1RL, ZK2BGD, 4N9YU, 4X4WF.

3.5 MHz  
 DJ9GW, HA9RT, HA9RU, JA1KYE, OH2VD, YU1FU.

#### QSLs received (Feb)

C2INI, AM01BAD (Spain), G3FJQ (10 MHz), FWOAG, PA3BTH (10 MHz), T2AGD, T30CB, VP2MIX, K2NY (10 MHz) 6Y5AG.

#### THANKS

To the magazines cqDX, DX NEWS SHEET, DX NEWS, RADCOM, QST, SHORT WAVE MAGAZINE, WORLD RADIO and the QSL MANAGERS GUIDE, grateful thanks for interesting reading. Amateurs including DK9KD, G3NBC, I8SAT and VKs 1MM, 3UX, 2EBX, 2PS, 3YJ, 3YL, 4KA, 6NE and L30042. Sincere thanks for making the column possible. Good DXing and a happy Easter to all.



Mike VK9ZYX of Cocos-Keeling Island.

Photo — Neil Penfold VK6NE.

# MAGAZINE REVIEW



Roy Hartkopf VK3AOH  
 34 Toolangi Road, Alphington, Vic 3078

(G) General. (C) Constructional. (P) Practical without detailed constructional information. (T) Theoretical. (N) Of particular interest to the Novice.

#### RADIO COMMUNICATION February 1983

Slow to fast SSTV converter. (P) Elliptical Filters. (T) VHF Propagation over Snowdon. (G)

#### QST December 1982

Annual Index. (G) The Ultimate QSO. (G) Effect of towers on your antenna. (T) 73 January 1983

Narrow band ATV. (T) Reclaiming silver from fixer solution. (P) The BBC. (G) Computer designed filters. (P)

#### 73 February 1983

2 metre to HF transverter. (P) Direct Broadcast Satellites. (G) Mobile Noise. (P) Russian Satellites. (G)

AR

## WHO IS THIS AMATEUR?



Because of ill health he has not been seen at a radio meeting since those held at Celtic Chambers, George St, Brisbane and he has had little to say at anytime.

However he is very well known for his writing on subjects generally related to amateur radio as he contributes to several journals including AR (see Dec. p. 28).

In 1937 he commenced as a broadcast technician with the ABC. For most of his early amateur radio career he was a dedicated morse operator but of latter years he may sometimes be heard on SSB.

His operating activity may be measured by the number of certificates that he has earned, in fact few operators in VK would have more. Apart from writing he is well known for his comparatively extensive collection of early radio artifacts, including a fine collection of morse keys.

His call sign is sweetness itself.  
 Yes he is AI VK4 Sugar Sugar.

AR



# ANACONDA RETURNS

NEIL PENFOLD VK6NE  
VK6 DX Group

*After one of the most successful voyages of her career, Anaconda returned to Australia on Wednesday, 9th March. Aboard were a jubilant group of men and women returning from an adventure of a lifetime; VK0HI and VK0CW with over 30,000 DX contacts to their credit, and the second successful ascent of Mawson's Peak to the mountaineering party. Photographs and film footage yet to be viewed, should have remarkable and beautiful scenes to behold.*



The voyage home was without incident, except for the exhilaration caused by some speedy sailing. Anaconda clocked eighteen knots for some parts of the trip, when helped along by the waves and wind. It must have known that it was homeward bound.



In Adelaide, many excited friends and relatives greeted the expeditioners. The young women aboard were easily recognised, but most of the men were hidden behind great clumps of facial fungus. This is an Antarctic Region disease that most



males catch when working in these very cold latitudes.



Amateur radio played its part exceedingly well for the duration of the expedition. From leaving Adelaide till the return, contact was maintained almost daily, only missing out during the solar disturbances. From the feedback received, people at both ends of the link are grateful. This includes the link to America, for our friend Al was able to keep in contact, and his call VK0CW was regularly received by his liaison people. Having only married just prior to leaving for the expedition from America his wife was re-assured almost daily of his location and health.

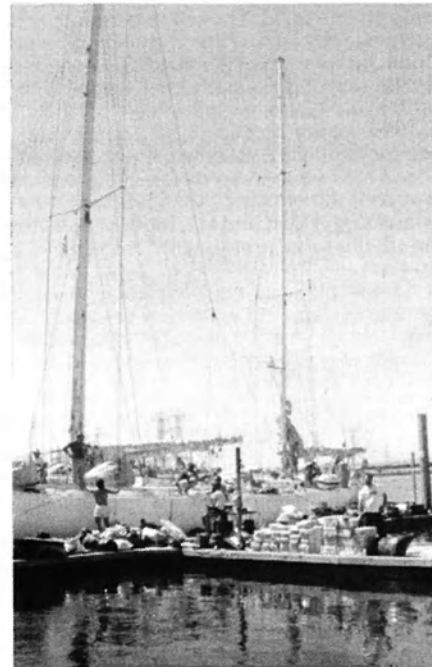

The sked frequency of 14.110 MHz became well known right from the start of the expedition. And almost without exception, the skeds were maintained without interference. This was greatly appreciated by all concerned with the safety and well being of the group.

We knew many were waiting, as when the skeds were finished, VK0HI would then be "fair game" and the numbers who then called, gave an indication as to how many waited in silence before VK0HI called "QRZ".

AR

For QSL's —  
NORTH AMERICA — N2DT  
— JAPAN — The DX Family  
Foundation PO Box 12, Shinjuku-  
Kita, Ochiai, Tokyo 161 Japan  
REST OF WORLD — VK6NE



# HEARD ISLAND EXPEDITION '83

Neil Penfold VK6NE  
VK6 DX Group

*By now the world of DX should be happy with the efforts of Dave VK0HI and Al VK0CW. Despite solar disturbances, which reduced their operating time, approx thirty thousand contacts were made, world-wide.*

Propagation was generally as predicted with some parts of the world receiving only very short openings to the island, and then only on one band. The teflon bearings and guys stood up to the high winds and constant rotating of the mast and antenna, as the search for a path to any part of the world was a constant practice.

After the first frantic days of the clamouring for contacts died down, it was heartening to hear the "little pistols", being picked up. With the efforts of the stations on the island to work VK and NZ, there should not be anyone who has tried that didn't make a contact.

Of interest, was the behaviour of some operators, who did what now seems to be the normal for DXpedition operations. Long calls, tailgating, shout abuse at each other etc, etc, trying to attract the operators of the DX station. During one particularly unpleasant period, Al the operator at the time, was heard to say "OK you lids, on goes the tape recorder and all your callsigns and smart remarks, will be heard when I play the tape at the conventions and hamfests I will attend on my return home." For a while after that you could hear the proverbial pin drop.

Towards the 5th of February a noticeable change began in propagation leading up to a total blackout over the weekend and almost up to the 7th, when signals began to come through again. As the openings began, the operators gathered up any contact that appeared, but it was slow going.

The continual request, to "please QSY to" 80 or 40 or 15 or 10, tried their patience, especially as they were often then working their way through a pile-up.

There has been some question of Al using the callsign of VK0HI for long periods. This has been authorised in writing by the DOC. After the departure of Chuck Brady back to the USA, Dave and Al decided to use 0CW on CW and 0HI on SSB. However there was a little rivalry between them, as to who would work the most countries, so from time to time, suddenly 0CW would appear to catch a new one. The result has yet to be determined.

The deluge of QSL mail has yet to arrive, but with the early arrivals are many with comments. These range from "thanks", to, "at last after chasing VK0HI for 19 days, taking two days off work, finally got it".

As one of the team who put the expedition together, and now opening the incoming mail it is with satisfaction to read the notes on the QSL cards. The QSLing is being handled by three organisations so the project should not be too onerous. But please, do include a SELF ADDRESSED ENVELOPE with your card. The process of replying will be done on return of the logs, around 15th March, and the entries counted. N2DT will handle North America, The JA DX family Foundation for Japan, and VK6NE, the rest of the world.

Communications with the advance camp at Spit Bay were tenuous at the best of times, even though they were only thirty kilometres away. The NZ radios used successfully on NZ mountains seemed to object to being away from home. Fortunately the operations at the advance camp and the climb up Big Ben went as planned and no problems were encountered that were not surmountable.

At base camp in Atlas Cove, on the 5th Feb, our men welcomed the arrival of the Cheynes II, which was carrying a group of people with similar aims to our expedition. They set up operations, two hundred metres away but mutual interference took place, till the 15th of March when the ex whalechaser departed for Hobart via Albany. Their arrival had been delayed by weather off southern Tasmania, and at the second attempt, a stop at Albany was made for refuelling. This was due to excessive fuel consumption, which was cured before it left Albany in West Australia. Then a stop at Kerguelen was made for water, finally arriving just as a solar flare caused a weekend blackout of propagation.

Conditions for living and operating were as expected. The old French huts were in reasonable condition. The steel and timber construction has withstood the onslaught of time and weather. The furniture was adequate, but housekeeping was a chore. The grit was continually being blown into the hut through any crevice it could find, and also it filtered down from the roof timbers. It covered everything, people, equipment, sleeping bags and proved a constant problem.

Some days of no propagation and the weather allowed, exploratory walks were taken with care. Searching for tags on the tails of leopard seals produced some hair raising moments. Not all seals like having their tails lifted to see what's under them. A

note for further use is to take motorcycle full face helmets for walking about where the skua birds abound. They are a formidable hazard, diving and swooping at you as you walk along.

There was a report of rumblings from the vicinity of the mountain, but as to their origin that has yet to be determined.

The return of the expedition to Australia is expected to be around 15th March, and at the time of writing, whether it returns to Adelaide or Perth is unknown.

And so now comes to an end, an amateur expedition which many organisations and amateurs may regard with some pride, as once again amateur radio shows that it could be done.

## DONATIONS WHICH HAVE NOT BEEN PUBLISHED IN AMATEUR RADIO TO THE DECEMBER ISSUE.

CALLSIGN	\$	CURRENCY
VK2XT	10	AUST
VK40X	5	AUST
VK61W	15	AUST (second donation)
VK6AJW	20	AUST
DJ8NKA	50	DM
G3NOF	9	AUST
DUTCH AMATEURS	105	AUST (via PA0ALO)
PA0HVF	5	US
VE7BIP	10	AUST
J DE LORENZO	25	?
MUNCIE AREA ARC	50	US (via KB9UV)
KA2DIV	10	US
WA3HUP	100	US
K4GDE	5	US
WB4OSN	20	US
KA4EQW	5	US
N4TL	5	US
W4WJ	10	US
K4CEF	10	US
K4KUZ	20	US
W5DZF	10	US
N5AN	200	US
W7QK	5	US
W7YF	10	US
K8PXG	15	US
W9KA	5	US
VE3DZV	10	US
JH5ECN	33	US
DXFF (Japanese)	20	US
VK2XT	10	AUST
WESTERN PA DX ASS US	25	US
W2FTV	5	US
JH8GWW	10	US
VK6PY	25	AUST

**ASSOCIATE MEMBERS FROM COMPLETE LIST SUPPLIED BY MRS BLUNT DATED 2nd JANUARY 1983**

LETTER P: DENOTES ALREADY PUBLISHED IN AMATEUR RADIO, ALL OTHERS YET TO BE PUBLISHED.

VK2		VK3	
QC	P	DKH	P
AYF	P	YIP	P
OI	P	KAR	P
KKK	P	DBQ	P
BIX	P	BH	P
DBH	P	ZIT	P
KNR	P	BFP	P
ZK	P	DRH	P
NKN	P	PDX	P
KNG		AQG	P
DPN		AVY	P
EQC		AET	P
DDW		AXQ	P
ECN		AGH	P
WN		BFN	P
NFZ		YXK	P
CJD		L30253	P
AVG		ADN	
AYJ		BTK	
D. STONIE		DU	

NJM		WO	
VIK		AFZ	
VQ		LO	
VNG		NKY	
OT		ZLH	
AUI		CCT	
UX		L50122	
DXE		L50037	
L30546		L50038	
AGO		AAM	
PH		VK6	
VK4		FS	
KSF	P	YL	P
CB	P	ZGA	P
YX	P	OV	P
BTX	P	CU	P
WIA	P	DQ	P
WJJ		JP	P
AGW		RU	P
OZ		KG	P
QA		AWJ	P
NEL		FY	P
ASI		MM	P
ABX		NGG	P
AFA		YD	P
VK5		KBW	P
L50545	P	WT	P
AHP	P	L60136	P
		OF	
		IW	

ACP		WORLD	
NEB		A4XYF	P
MKI		PAOGAM	P
ALP		PE1AAN	
ALK		OJ9ZB	
DYP		WB4UBD	
NID		KK5P	
AST		W6ILH	
NLZ		W7CNL	
OO		K5KSY	
NVJ		WA3DMH	
NXX		PA7479	
AH		KJ7B	
ART		ZL480	
ARC		WA2WGS	
RG		EASZA	
NMR		ON5FD	
SX		ISVNY	
AE		KD3T	
IT		B. DREWETT	
L60089		W6RDL	
AL		K0BJ	
VK7		VE7BIP	
ZAE		VS6CT	P
G. ROBSON		NK6F	
VK8DI		PY2XOI	
VK9NYG	P	L8BDY	
VK0AB		G3NBC.	

**Radiation, Antennas, then what?**



One of the first things that a radio operator is likely to notice after picking up a microphone is that the further away the other operator is the weaker his signal becomes. This startling revelation is due to the effect of a phenomenon known as 'the inverse square law'.

At some point in time the concept of the 'isotropic radiator' was thought up, which as theory goes, is an antenna that radiates equally in all directions simultaneously. Two examples of this that can be readily observed are the sun, around which our planet revolves and fresh lemon being squeezed on fish. In each case the radiation effect is reduced to one quarter of the original every time the distance from the source is doubled. (In the case of the lemon it is easier to keep both eyes closed until the immediate threat has passed.)

Most radio transmissions operate with a concession in performance between a truly omnidirectional signal and one which operates on a tight beam in one direction only. Omnidirectional transmissions are great, you can hear them anywhere with the distinct limitation that at some finite point distant from the transmitter the signal will fade into uselessness. Unidirectional transmissions are pretty good too, you can hear them at an infinite distance away with power levels approaching zero. Here the difficulty arises when the transmitting point may have no idea where the receiving end is and vice-versa, a bit like two yabbies in a dam looking for each other. The nearest practical application yet of a device built for unidirectional transmissions is the laser beam, a marvellous device almost totally useless when it is raining.

With these sorts of conditions limiting the range of our radio contacts it seems surprising that we ever get over our own back fence. In reality there are lots of other variables at work to assist us like bouncing of signals off the ionosphere with all the seasonal and temperature variations that go with it to determine how strong a signal will be between two points.

Will there be any marked changes in communications in the future? If radio waves are still fashionable we may find everybody linked to each other via some gigantic telephone network controlled by four or more huge geo-stationary satellites hovering over strategic points of the globe. This would certainly make amateur radio obsolete, the nearest thing to exotic 'DX' may be dialing phone numbers at random.

How a signal radiates depends on what sort of antenna is being used. There are dozens of different designs and variations of antennas for different bands, and what they all have in common is the more aluminium there is in the air the more directional and less inefficient they become. The field of radio has got to the stage where only minor refinements have been made in the past twenty years and probably even fewer shall be made in the next twenty. However, what could happen is that an entirely new field may develop that could render the latest solid state UHF transceiver as obsolete as plaster flying ducks. This would be a shame, as antiquated as our present technology may seem to future generations, it still works.

Buffy's Bull in 'Gateway' Sept/Oct 82. **AR**



**ELECTRONIC HOBBYIST!**

DO YOU LIVE IN . . .  
Ringwood, Lilydale,  
Boronia, Wantirna,  
Bayswater, Mooroolbark etc? . . .

We carry a comprehensive range of electronic components at very keen prices.

**Ian J. TRUSCOTT  
ELECTRONICS  
CNR EASTFIELD  
& BAYSWATER ROADS,  
SOUTH CROYDON,  
VIC.  
TELEPHONE  
(03) 723 3860**



## THUMBNAIL SKETCHES

Peter Brown VK4PJ  
16 Bede Street, Balmoral, Qld 4171

### Ralph Pepper. N742, 2VH, 1922.

Ralph's interest in radio began in Tamworth in 1922 when a PMG technician, Lionel V G Todd, who operated 2CR, taught him CW to pass the test with the local postmaster at 12 WPM, and an application for a "Wireless Experimenters Licence", N742, was granted.

The renewal, roneo Form "F", on 23/8/1923, cost ten shillings and came from Melbourne signed by J Malone, Chief Manager, Telegraph and Wireless. At this time Ralph used receiving equipment only, all parts of which were "homebrew" only, and crystals used were the best of experiments with minerals brought from various areas by his father. The best combination was "zincite" with "bornite".

Ralph and Lionel used "wireless" to time motor cycle races at Tamworth, possibly for the first time in Australia, in 1923.

One evening Ralph heard an "SOS" from the "Stirling", off NZ, a ship which eventually sank.

A bad shock from a "B" battery ended Ralph's wireless experiments.

Ralph was a RAAF photographer during WW2, and became Photo Intelligence Officer at McArthur's Headquarters.

Post war Ralph has been overseas forty five times, mainly as tour escort, and has a fine collection of slides. Brisbane has been Ralph's home for some thirty three years.

AR



### JACK WOOSTER VK4VH 1930

One of the younger pre 1930 amateurs, born 1909, Jack spent his early days

around the shacks of Norm Odger and Norm Husband at Charters Towers from whence came many fine technical men.

As a railway telegraphist, radio came easily to Jack and in the 1930s he and Andy Couper provided the two Willis Island staff with a regular mail service.

Commissioned as a Signals Officer in 1930, and later Captain, Jack had five and a half years of active service, also serving with Movement Control. Lae, Aitape, Hollandia and Nadzab were areas in which he served.

When in Townsville, with Leo Woolley, VK4FW, he pioneered broadcasting being licensed for 204.7 kHz experiments.

After the war, 1946, Jack returned to the Main Roads Department, where he started in 1933, and retired some years ago.

Jack keeps himself busy with family, electronics and some radio.

AR



### VERN FRANCIS KENNA VK2JRW, 4FK 1926.

One of the best known and most respected amateurs of the 1920/30s Vern was at that time referred to as "brilliant" and nicknamed "Marconi" by his friends. As he lived up to this description there is insufficient space in this sketch to give more than a few highlights.

Born year 1908, he joined PMG in 1924, passed his AOC in 1926, a keen student, he was behind treasure hunts, field days, etc, and invariably took portable equipment on camping holidays and on his yacht "June".

Vern was President of the Queensland Division in 1933 and Federal President of the IRE in 1968-9. At 4QG 1931-4, Melbourne research 1934, in 1935 qualified as an engineer and posted to Rockhampton.



AR

## WIA INSERTS INTO AR



### NOTICE TO WIA ZONES, CLUBS AND GROUPS

WIA Zone, Club and other Group Secretaries are hereby notified that inserts into AR henceforward will be accepted ONLY direct from a Division and then only by prior arrangement with the Secretary.

All inserts must comply with Postal Regulations and must be received not later than the 26th of the month preceding publication date.

**COUNCIL PROBLEMS?  
THE ANSWER TO LIMITED SPACE**

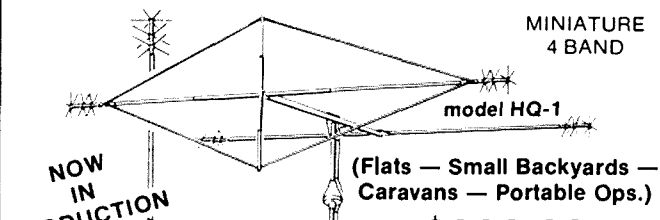

**NOW  
IN  
PRODUCTION**

(Flats — Small Backyards —  
Caravans — Portable Ops.)

**\$222.00**  
(Freight Extra)

**EFFICIENT ANTENNA FOR LIMITED SPACE**

10, 15, 20 & 6 metres. 1350 mm boom,  
3350 mm elements.

For 6, 10, 15 & 20 metres.  
NO GROUND RADIALS NEEDED  
Lightweight yet rugged  
3350 mm long

**MIKE KILPATRICK  
VK2DJP**

Miniature  
Band  
Coaxial Vertical

**\$116**  
(Freight  
Extra)



**WATCHMAN  
ELECTRONICS**

**28 Elouera Cres, Woodbine, NSW 2560  
Phone (046)26 6101**

For a **BIG** signal  
step up to a multiband  
**CHIRNSIDE ANTENNA**

CE-33 TRI-BAND	\$249.00
CE-42 DUO BAND	\$145.00
CE-5SS BASE VERTICAL	\$89.00

80-40-20-15-10 m  
Self supporting

**AND MANY MORE**  
Plus freight

Some items may be in short supply.

All mail orders to:

**CHIRNSIDE ELECTRONICS  
PTY LTD**

26 Edwards Rd, Lilydale,  
Vic. 3116. Phone: (03) 726 7353.

**FAMOUS AMATEUR MICROPHONE  
DUAL IMPEDANCE SUITS ANY "RIG"  
SHURE MODEL 444-D**

**SHURE**



**Microphone Features:**

- High-output, durable, totally reliable CONTROLLED MAGNETIC cartridge.
- Response tailored for speech intelligibility.
- Switch selectable high or low impedance.
- Normal/VOX switch on microphone.
- Double-pole, double-throw, Million-Cycle leaf-type push-to-talk switch with momentary or locking switch bar.
- Three-conductor, one-conductor shielded coiled cable.
- Cable and switch arranged for instant connection to grounded or isolated transmitter keying.
- Rubber feet keep microphone from slipping.
- Height adjustment for operator comfort.
- Strong ARMO-DUR case impervious to rust and corrosion.

PRICE \$136.00  
(\$4.00 Post & Packing)

**WILLIAM WILLIS & Co. Pty. Ltd.**

PHONE: (03) 836 0707 W0809  
98 CANTERBURY ROAD, CANTERBURY, VIC., 3216

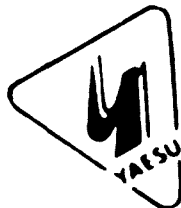

**THREE  
BIG  
NAMES**

**ICOM**  
**ATN ANTENNAS**

**AT  
ONE  
GREAT  
STORE**



PLUS MUCH  
MUCH MORE

**ELECTRONICS**

CW Electronics is the communication centre of Queensland.  
Innovators and pioneers of computer/RTTY/ASCII/CW/radio  
interface in Australia.

Come in and see our range

416 LOGAN ROAD STONES CORNER BRISBANE  
PHN: (07) 397 0808 397 0888

MBS

P.O. BOX 274 SUNNYBANK QLD. 4109

**RTTY  
THE EASY WAY**

**AFSK MOD-DEMOD FOR RTTY,  
ASCII, 45 to 1200 BAUD**

**MODEL MDK-17 KIT**

- \* Interfaces directly to baudot Type Machines.
- \* Provides for all Combinations of TTL or high voltage send-receive systems. \* Only single +12V Supply required. A high Gain Amp/Limiter and active band pass filter precede an XR2211 Demod I.C. \* Good Data recovery is assured, even under difficult conditions \*
- Excellent temperature stability is provided by an XR2206 I.C. in the tone generator. \* Sense invert capability \* LED indication of transmit tones, receiver tuning and valid signal. \* Auto start output available (TTL). \* Supplied with comprehensive documentation.

**MDK-17 Kit \$106 Plus \$10 Airmail,  
Assembled and Tested \$161**

GFS Electronic Imports,  
15 McKeon Road, Mitcham, 3132, Victoria,  
Australia. Ph. 61 3 873 3939. Telex 38053 GFS

# AWARDS

Mike Bazley VK6HD  
FEDERAL AWARDS MANAGER  
8 James Road, Kalamunda WA 6076

Many thanks to those readers who send me details of awards they receive on QSLs or over the air. My policy in selecting awards for this column is to give first priority to any Australian award. For overseas awards, I try to check whether the club issuing an award is affiliated to its National Society and that this National body is a member of the International Amateur Radio Union. Hope-fully by following this policy, if things do go wrong, one should be able to get problems resolved. Generally, difficulties arise over awards issued by non affiliated overseas bodies.

## LAKE GOLDSMITH STEAM RALLY AWARD

The Western Zone of the Victorian Division of the WIA will be operating from the Lake Goldsmith Rally using the call VK3BWZ. Power for the station will be obtained from a steam driven generator and an exhibition of old time radio equipment will be held.

WHEN: 0200 UTC 30th April to 0200 UTC 1st May.

REQUIREMENTS: One contact with VK3BWZ on any mode band.

FREQUENCIES: 1.823 AM/SSB, 3.585 CW/SSB, 7.090 CW/SSB, 14.280 CW/SSB, 21.180 CW/SSB, 28.580 CW/SSB MHz.

SSTV frequencies are: 7.103 and 14.230 MHz.

The cost of the award is \$2.00 or equivalent and applications should be sent to: Maurice Batt, VK3XEX, RSD, Rokewood Junction, Victoria 3351.

The following award information has been received from Jim Hogan ZL1AJQ.

## THE INTRODUCTION OF RAINBOW TROUT TO NEW ZEALAND CENTENNIAL AWARD

The Rainbow Trout (*Salmo gairdneri*) was transported to New Zealand from the Sonoma River (California) and arrived in New Zealand early April 1883. Since then this species has become well adapted to New Zealand conditions and world famous as a sporting fish as well.

During 16-23 April 1983 Taupo will be

host to guests from all over the world to celebrate the event with processions, beer fest, fishing contest, golf, art fairs, country and western events etc. etc.

NZART Branch 60 sponsors the Centennial Award. The Award is an attractive colour picture on card suitable for desk stand or wall mount. Well worth the effort to get the Award.

### RULES:

- 1 Contacts with stations in the vicinity of Lake Taupo between and including the dates 13th April to 23rd April 1983.
- 2 Same station on different day is a new contact.
- 3 Same station on a different band or using a different mode on the same day is a new contact.
- 4 Use of repeater(s) is allowed but counts as one band.
- 5 Have to say the name of the Award during the contact.

- 6 Basic Award is ten contacts. Gold stars for every ten after that.
- 7 Overseas Awards, three contacts.
- 8 Enclose \$1.00 with copy of log to Centennial Award, Box 910, Taupo.

Branch 60 members will be active in all bands, all modes, and intend to cover the ten days.

## THE WORKED AUSTRALIAN STATE POLICE AWARD

A request for information from any reader who knows where to apply for this award. It appears that applicants, to an address given in 1981, are not receiving replies. If anyone knows anything about this award I would be grateful if details could be sent to me.

Until next month Happy Hunting, 73 es  
DX, Mike VK6HD.

AR

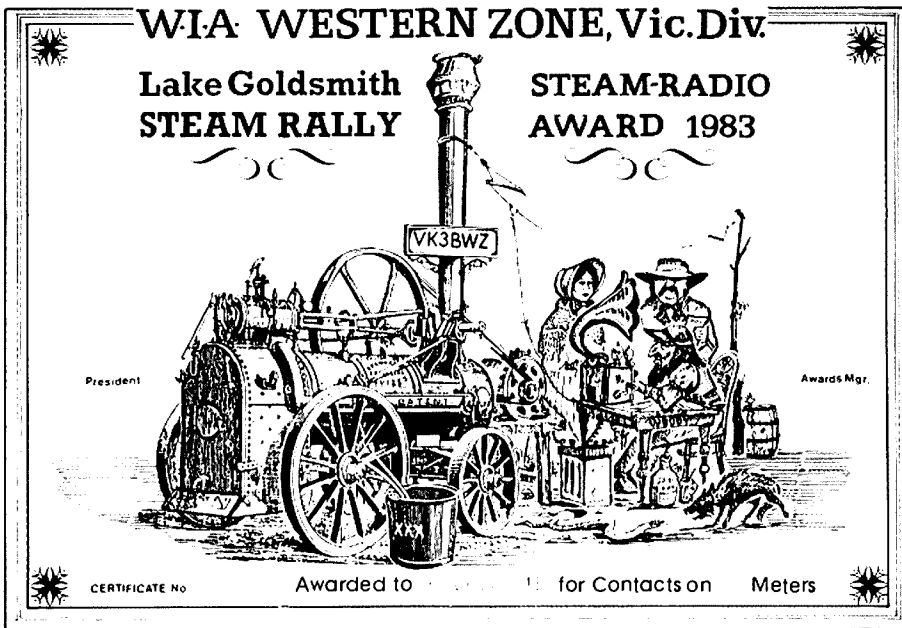

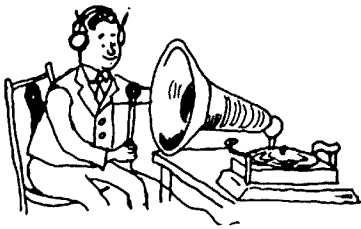

# NOVICE NOTES

Ron Cook VK3AFW  
7 Dallas Avenue, Oakleigh, Vic. 3166

**So you are considering sitting for your AOCP soon. Just to see how your study is going why not try to answer the following questions. Some questions have two correct answers and both are required.**

1. The peak value of an AC voltage may be determined by:

- (a) The RMS value  $\times 1.414$ .
- (b) The RMS value  $\times 0.707$ .
- (c) The RMS value  $\times 2$ .

2. When an alternating EMF is applied across an ideal capacitor the current will:

- (a) lag on the applied EMF.
- (b) lead on the applied EMF.
- (c) differ in phase by  $90^\circ$  from the applied EMF.
- (d) differ in phase according to the magnitude of the applied EMF.

3. The inductance of an inductor is 1 henry if:

- (a) a voltage change of 1 amp/second produces a back EMF of 1 volt.
- (b) a change of current of 1 amp/second causes back EMF of 1 volt.
- (c) a current of 1 amp is produced in the circuit by a potential of 1 volt/second.

4. In radio frequency tuned circuits:

- (a) the impedance of a series tuned circuit is minimum at resonance.
- (b) the current in a series tuned circuit at

resonance is maximum.

- (c) the current in a parallel tuned circuit at resonance is maximum.
- (d) the current and voltage in a resonant parallel tuned circuit are in phase.

5. Indicate which of the following statements are true:

- (a) a forward biased junction diode has a negative temperature coefficient of resistance.
- (b) the currents and voltages developed in a temperature stabilized transistor amplifier can be used to temperature stabilize other transistors.
- (c) an emitter swamping resistor minimizes variations in emitter current caused by variations in the emitter-base resistance.
- (d) emitter-base junction resistance increases with increasing temperature and causes increased emitter current.

6. Silicon diode type rectifiers for power supply use have the following advantages compared with valve rectifiers of comparable power rating:

- (a) internal resistance is very low.

- (b) peak inverse rating are very much higher.
- (c) only a small amount of heat is generated.
- (d) they easily withstand transient voltage peaks.

7. Class A amplifiers are commonly used as:

- (a) low power linear amplifiers in transmitters.
- (b) audio and radio frequency amplifiers in receivers.
- (c) oscillators in receivers.
- (d) frequency multipliers.

8. The primary purpose of a buffer stage in a transmitter is:

- (a) to isolate the final stage from the aerial.
- (b) to increase the frequency.
- (c) to isolate the oscillator from the modulated or keyed stage.
- (d) to increase the audio voltage input to the modulating stage.

(From Westlakes Radio Club Monthly Newsletter, May 1980)

The answers are on page 78



All correspondence to Amateur Radio magazine and the Federal Office of the Wireless Institute of Australia should now be addressed to Post Office Box 300 Caulfield South, Victoria 3162.

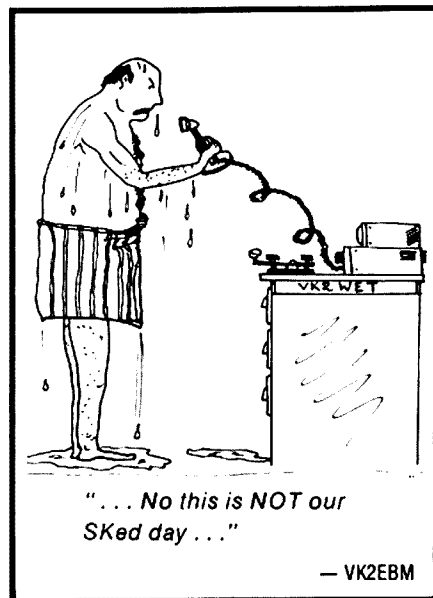

# HERE'S RTTY!

Bruce Hannaford VK5XI  
57 Haydown Road, Elizabeth Grove, SA 5112

and this is why low tones were first introduced. However as amateur shift soon after became 170 Hz there is now little reason for using low tones as high tones 2125 and 2295 Hz are well within the pass band of typical SSB filters.

Looking at all the odd figures for mark, space and shift frequencies I decided there must be some reason for using these odd values and sought to find it. I discovered that each frequency is a multiple of 85 Hz, in other words 85 Hz can be regarded as an unused fundamental and then all RTTY audio frequencies are harmonics of this frequency.

On the HF bands using an SSB transceiver with "audio generated" FSK it does not matter much what tones are used provided the shift is correct. This is so because the receiving station can tune to get any desired beat note but of course this will not change the shift in the original signal transmitted. A transceiver using low tones equipment sending to a receiving station using high tones equipment will have no difficulty as both have the same shift. Of course this is not the case with Audio Frequency Shift Keying (AFSK) where the tones are used to modulate a FM or AM transmitter.

When this is done it is obvious that both sets of equipment need to be using the same audio frequencies.

The normal frequencies used for VHF/UHF are high tones 2125 mark and 2295 space. If you want to use the same RTTY equipment on HF and VHF you need high tones equipment.

A RTTY AFSK signal consists of a single FM or AM carrier alternately modulated by two audio tones that are arranged according to the RTTY code.

## HOW CAN I IDENTIFY RTTY COMMERCIALS?

Amateurs without RTTY equipment often wonder if this is possible on the HF bands and I give the following tips. Firstly commercial stations usually send very long messages without a break, often thirty or more minutes in length, on the other hand amateurs rarely use overs longer than about five to ten minutes in length.

Commercial stations often send RTTY at faster speeds than amateurs and commercials rarely use hand sent RTTY as they normally pre-record their messages to save valuable transmission time. Amateurs may also pre-record part of their overs but if you keep listening you will note that some parts of it are at a slow hand typing speed. With hand typing you will at times hear a continuous tone as the operator pauses to think what he will say next etc but this rarely happens with commercial RTTY.

to the frequency difference between the two carrier frequencies. Listening to either one of the keyed carriers you will note it is CW on off keying but not using the Morse code. However even if you have memorised the RTTY code you would not have much success reading it as it is normally at 60 wpm or one word per second.

Each RTTY character that is sent (letters, figures, punctuation marks etc) are all the same length, all have seven parts, all start with what is in effect a synchronising start pulse and conclude with a stop pulse. All the parts are equal in length except that the stop pulse is often slightly longer. The five parts between the start and stop pulses are used in the form of a code to represent the different letters and figures etc. All seven parts are either one of two states or conditions eg plus or minus, on or off, current flowing or not flowing, a high pitch or a low pitch audio tone or a high or low RF frequency etc.

The change from one state to the other is nearly instantaneous, there is no appreciable delay or gap between parts of a character or between letters in a word (if you can type fast enough). These alternate states are called mark and space, this coming from the early days of recording telegraphy on paper when a pen moving across the paper marked it when current flowed and left a space when there was no current flowing.

Nowadays normal amateur convention is mark means circuit closed, current flowing, a low pitch audio tone or the higher of the two RF carrier frequencies. Space means circuit open, no current flowing, a high pitch audio tone or the lower of two RF carrier frequencies. It is rather unfortunate that the high/low audio and RF frequencies are at cross purposes but that is the present convention and we have to live with it.

The difference between the two audio tones or the two RF carriers is known as the shift frequency and in present amateur use is normally 170 Hz, a decade or so ago it was normally 850 Hz but this is very rarely used today. Many commercial stations use a shift of 425 Hz and a few use 170 Hz. The normal tones used by amateurs are 2125 mark and 2295 space, sometimes a second set of tones are used and these are 1275 mark and 1445 space. You will note that in both cases the shift is 170 Hz. The first set of tones are known as high tones and the second set as low tones.

If a different shift is used it is normal practice to leave the mark frequency unchanged and to change the space frequency according to the shift, eg high tones at 850 Hz shift would be 2125 mark and 2975 space. Please note that 2975 Hz is beyond the pass band of many SSB filters

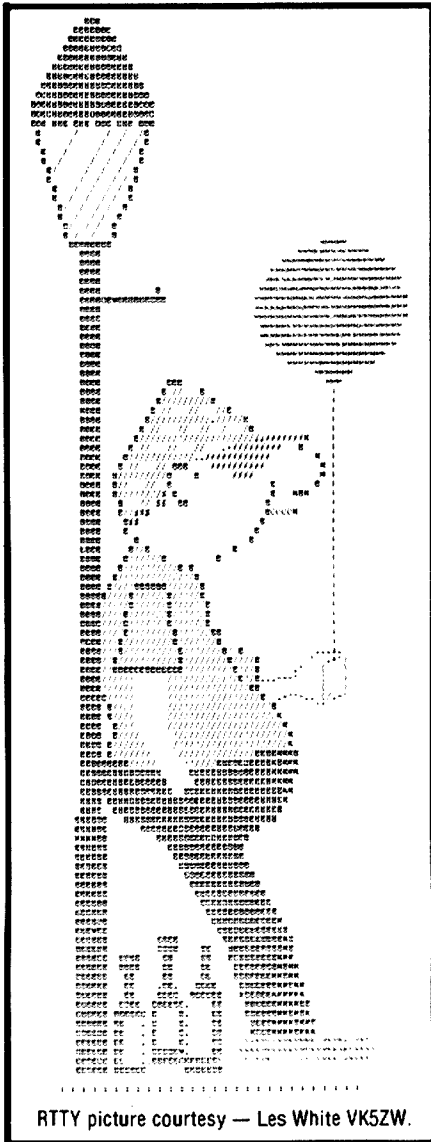

RTTY picture courtesy — Les White VK5ZW.

## WHAT IS A RTTY SIGNAL?

Many non RTTY operators who have tuned in a RTTY signal and listened for a while to the two tones warbling from one pitch to the other have asked themselves this question.

The signal sounds rather like someone with their first and second fingers on two adjacent organ note keys rapidly changing pressure from one finger to the other.

On the HF bands RTTY is normally Frequency Shift Keying (FSK) and as such it is actually the alternate radiation of two unmodulated carriers of slightly different frequencies. To receive such signals the BFO must be on to produce two beat notes when slightly off tune to both carriers. As there are two carriers alternately present there will be two beat notes (unless one carrier is tuned to zero beat) in practice rather high pitched beat notes are normally used to work with RTTY equipment.

By tuning first one then the other of the separate carriers to zero beat you can then listen to the keying of the other one and also the beat note remaining will be equal



Commercials often use 425 Hz shift and amateurs normally use 170 Hz, you can check the shift by tuning one of the two RTTY carriers to zero beat and listening to the pitch of the remaining beat note this would normally be 425 Hz for a commercial and 170 Hz for an amateur station.

It is possible to educate your ears to detect the difference between amateur and commercial RTTY by listening and comparing them. Tune commercial RTTY outside the amateur bands and compare with amateur RTTY on about 14.090 MHz (seldom any commercials there).

Of course these tests are not infallible but if a RTTY station sends for hours on end using no hand typing and using 425 Hz shift you can be 99% sure it is a commercial.

### A RTTY PIRATE

There is a RTTY Pirate active on 80 metres and sometimes on 40 metres as well. I call him a pirate as he never gives a call sign even when asked to do so. He comes on using RTTY and complains about RTTY being used in the Gentlemen's Agreement CW Only portion of the bands.

When the Pirate confronted me with his

usual question "Why are you using RTTY in the Gentlemen's Agreement CW Only Portion of the band?" I answered "If you give me your call sign I will tell you". However as usual he declined to do this. In the hope that this "Gentleman" reads this article I will now tell him and others that also think this way why I sometimes use RTTY in the CW Only portion of amateur bands.

*VK RTTY presently has no Gentlemen's Agreement allocated band segments in which to operate as up to the present time the WIA has not seen fit to allocate an RTTY segment.*

*RTTY is a form of telegraphy closely akin to CW Morse telegraphy, it can even be sent as CW using a single keyed carrier. In a recent Sunday morning WIA broadcast (22/8/82) a Federal WIA representative said "RTTY would usually be found in the CW only portion of the bands."*

*Although commonly used amateur band RTTY frequencies were listed in the 81/82 WIA Call Book to the best of my knowledge the WIA has never asked amateurs to keep these frequencies clear for RTTY and generally speaking this is very seldom*

*done by other mode users. As RTTY operators are often denied the use of their commonly used frequencies by other mode users and are presently receiving no guidance from the WIA re where they are expected to operate they then do the best they can under these circumstances.*

In conclusion RTTY operators are just as much amateurs, WIA members and gentlemen as other mode users and until the WIA gives definite guidance to all amateurs as to what part of the bands they want set apart for RTTY it seems a perfectly gentlemanly thing to put our RTTY telegraphy in the telegraphy portion of the amateur bands. In fairness to the WIA I must add that the Federal Technical Advisory Committee (FTAC) are presently considering these matters and perhaps might even have made a decision by the time these words are published.

As most elementary subjects have now been covered I plan to make future articles somewhat more technical thus better serving those already using RTTY.

73  
Bruce VK5XI  
AR



## EDUCATION NOTES

Brenda Edmunds VK3KT  
FEDERAL EDUCATION OFFICER  
56 Baden Powell Drive, Frankston, Vic. 3199

I have not yet had a lot of response to the request for information about classes planned or in progress. If you know of any classes about which I have not been notified, please forward details to me or the Executive as we do get requests for information about availability of classes in particular areas.

I would also like to build up a list of schools where some radio theory is being taught or some radio operating is carried out. I know there are many schools with licences and call signs, but do not know how active they are.

I wonder if this is an area where we could do a little more recruiting.

Amateur radio activity in schools seems to depend on the presence of an enthusiastic licensed operator on the staff. If that staff member transfers, becomes too busy, or loses interest, a group of potential amateurs is lost. I wonder if it would be possible to involve non-school amateurs in activities of this sort. I know of a couple of amateurs who regularly give some of their time to a school or group of children. I'm sure there are others as well that I do not know about, but I think there is probably scope for many more.

Many secondary and technical schools introduce electronics and computer technology at a fairly early stage, and many students would appreciate the opportunity to see some of the theory put into practice. Many schools also have a weekly 'activities' session where a visiting amateur could be fitted in with a small group of students.

At the more senior level there is also the possibility of involving the students in some experimental activities which may be accepted as part of a Senior Certificate course.

Even in the primary schools there are opportunities to offer an occasional or regular visit. Even if the only contact is with a station a few streets away, it is an experience which the children will remember. We all know the enthusiasm which the Jamboree on the Air generates. Perhaps there is room for something of the sort in the schools even just on a local basis, or organised by a club within its own area.

Many schools now have licensed operators among their students. These students may need the support and assistance of older amateurs to maintain their interest and make use of any gear which the school may have. In many cases, the school principal and staff may be completely unaware of the potential value of amateur radio, and may not even know that they have novices among their students. They will certainly not have given much thought to the possibilities of using radio to broaden the scope and effectiveness of the existing curriculum. Perhaps we can help expand a few horizons.

I would be interested to hear readers views on this matter especially from any amateurs who have tried to establish some such programme. It could be an interesting project for World Communications Year.

Finally I would like to repeat my plea from last month. If you have a complaint

about exam procedures, questions, or results, PLEASE bring it to me instead of just complaining on air. I cannot act on third hand or overheard information.

73  
Brenda VK3KT  
AR



### URGENT!

Please let us know of clubs and schools etc. starting theory classes.

Where, when, how much and whom to contact.

Contact Brenda QTNR

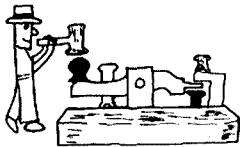

# POUNDRING BRASS

Marshall Emm VK5FN  
Box 389, GPO Adelaide SA 5001

## KEYS AND KEYERS (Part III)

An iambic keyer is driven by dual paddles, and there are various ways to go about engineering them. The simplest consists of two paddles which are held by spring tension so that they can be swung inwards against a common centre post.

This principle is used in paddles such as the HK1, which is used external to the keyer, and the same principle is used in less rugged paddles which are often used where paddles are built into the keyer.

More esoteric, but a delight to use, is the Bencher paddle. Each of the two paddles has its own post, so the contacts meet flush, rather than a flat contact meeting a round centre post, and they are capable of very fine adjustment. The arrangement looks something like this:

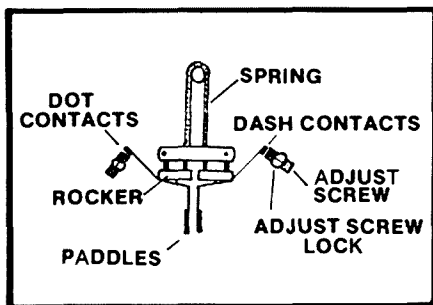

The Bencher is not cheap, but then again it is not a lot more expensive than the others, and you get what you pay for.

As far as the keyer itself is concerned, the

best introduction is to build one. There is a Heathkit keyer, but a less expensive alternative is based on the kit marketed by Dick Smith some years ago (it originated with WB4VVF in QST and was later published in Electronics Australia). Unfortunately, the kit as such is no longer available, but Mr Smith still has the circuit board, the Galbraith paddle (GK11) and, I presume, the instructions. The IC's and other components are readily available. In the original design the paddle was built into the keyer, but I prefer a separate paddle, so was able to put all the controls on the front panel, and jacks for all the externals on the back. I modified the design to use a plug-pack for power, and put in a switch for speed control rather than a pot, so selected speeds could be set quickly. It was also simple to add a rectifier circuit so the keyer can be driven by a cassette recorder — an alternative which seemed easier than building a memory for it. The paddle would be by far the most expensive part — other than that, the whole thing should cost less than \$20 and a few hours to knock it together.

If you are thinking of buying a keyer ready-made, there are dozens on the market to choose from. The basic iambic keyer circuitry has been reduced to one IC now (the Curtis 8044) and there is a Vibroplex paddle with a complete keyer built into the base! There is another, the name of which could be misconstrued, which has the keyer attached to a Bencher paddle.

Beyond the basic keyer circuit, which gives you dot and dash memory, automatic

spaces, and variable speed and weight, the main attraction of more advanced keyers is memory. A memory is very handy during ordinary operations, but for contesting it is almost mandatory. In choosing a memory keyer, you need to work out the size of the messages to be stored, and the ease of storing, editing, and using them.

Perhaps the most advanced line of keyers on the market today is produced by Advanced Electronic Applications, of PO Box 2160, Lynnwood, WA 98036 USA. Their top-of-the-line "Morsematic MM2" keyer has to be seen to be believed. Featuring two micro-computers, the MM2 will act as a contest keyer (automatically generating serial numbers), a beacon (sending a programmed message at programmed intervals), and a trainer, in addition to "ordinary" keyer functions. In trainer mode, MM2 can be programmed to start at any speed between 2 and 98 WPM, and, after an elapsed time of 0.1 to 59.9 minutes, it will have increased to any higher speed between 2 and 98 WPM. It will generate random characters or words, but if you want to check progress, you can select one of ten starting positions for use with an Answer Book. The prices for these keyers are amazingly low if you can get them from the US. If you get one from the Australian agents, you will pay the exporter's mark-up, the importer's mark-up and sales tax — you will pay almost twice the US price, but you'll still be getting a bargain.

Next month's column will be about signal reporting, and I promise some real food for thought. Till then, 73 and keep pounding.

AR



## QSP

### EXPLODING INTRUDER

In May 1978 the Soviets concluded the third of a series of killer satellite trials. They had tested slow, similar orbit, interceptions, fast bob down from above, and finally the very efficient fast pop up interceptions from below.

For four years European observers have waited for the next step and early in March 82 the familiar spread spectrum test signals with their covert telemetry were heard around 144.3 MHz.

As in previous tests things went slowly for a while and there was a break while the observing satellite changed from afternoon descending to afternoon ascending. Then after an isolated test on 25 May 82, tests proper began on 6 June. From then until 18 June 82 a series of about ten test runs were carried out culminating in two tests where target telemetry ceased abruptly (a point subsequently confirmed by US Secretary Haig).

There is a possibility that there may now be a continuous series of tests at intervals of two or three months. Observers should listen for wide band spread spectrum FM multi carrier signals centred on 144.3 MHz and extending up to 1.5 MHz either side of that frequency, on orbits transmitting azimuths 010 to 090° from UK. Orbital parameters are altered in flight and periods range from 100 to 110 minutes with targets usually at the higher period. Most tests are afternoon UTC Wednesdays, Thursdays and Fridays. Clocking pulses are superimposed on some telemetry.

Reprinted courtesy: OSCAR News, January 1983

AR



# AMERICAN OVER-THE-HORIZON RADAR: A NEW WOODPECKER?

Bill Martin, VK2EBM  
33 Somerville Rd, Hornsby Heights, NSW, 2077

***The idea of over-the-horizon radar was first conceived in 1946. However, as every radio amateur knows, the idea is in fact now a reality, with evidence appearing daily on the amateur band of frequencies, and formerly all were originating from the USSR.***

However, we must now steel ourselves for possible evidence of a new source of radio interference emanating from the United States of America. Conventional line-of-sight radar uses frequencies in the gigahertz bands, and the radiation passes largely unimpeded through the ionosphere into outer space. With the OTHR system, which employs HF frequencies, a significant part of the much lower frequency is reflected down towards the earth's surface, reaching it at a distance well beyond the visual horizon. Hence the title, 'Over-The-Horizon Radar'.

The radar system is called a 'backscatter' system, meaning that the radar return pulse is reflected back to a receiving antenna reasonably close to the transmitting source. In this case, 110 miles. A certain portion of the transmitted energy is not backscattered towards the receive antenna (via the ionosphere) but is rather reflected 'downrange' for a further 'up-down' hop. Whilst theoretically this could be used to extend the range of the system to something like 3,600 nautical miles, the contractors describe the reliability of signals beyond the first hop zone as 'marginal'.

Skywave OTH radar has MINIMUM detection range of 400 nautical miles. Experimentation and feasibility testing began in June, 1980, and recently a \$US66.7 million contract was awarded to the General Electric Co, to begin a full-scale development of the project. The transmitter is situated at the Moscow Air Force Station, in Maine, USA.

The full range of the frequency bands will be:

BAND A: 5.00 — 6.74 MHz  
BAND B: 6.74 — 9.09 MHz  
BAND C: 9.09 — 12.25 MHz  
BAND D: 12.25 — 16.50 MHz  
BAND E: 16.50 — 22.25 MHz  
BAND F: 22.25 — 28.00 MHz

The range of the system is from 500 to 1800 nautical miles. The operating range 6.7-22.25 MHz is selectable in 1 Hz segments. An FM/CW waveform is used, and bandwidths of 2.5, 5, 10, 50, and 100 kHz can be selected, as well as waveform repetition frequencies of 20, 30, 45 and 60 Hz.

A Hewlett-Packard 141T spectrum analyser is used in the transmitting control room to aid in the selection of frequencies THAT NO-ONE IS USING. (We hope that this is efficient.) If a channel is clear, the radar system is brought up to power. Operators have a priority list of "most useable" frequencies for signal propagation.

Transmitter engineers use a 5 kW ionosphere sounder, excited by a computer-controlled signal generator, as a check on the ionosphere, the sounder sweeping from 2-30 MHz at a 100 kHz sweep rate. It returns from the ionosphere and is evaluated at the operations site. The main transmitters have a self-calibration check mode that requires about eight seconds to complete a calibration routine. A performance assessment operator is provided with a CRT display of range and amplitude, enabling him to compare the amplitude, of radar returns with the noise floor. This ratio provides an instant assessment of radar performance. Target lines on the display appear as verticals when the return maintains a constant doppler frequency; the upper portion of the line slopes to the left if the target is accelerating, and to the right if the target is slowing. The FET receiver front-ends are digitally tuned by means of mercury-wetted reed relays and provide a dynamic range of 114-124 dB.

## THE ANTENNA SYSTEM

The transmit antenna, situated at Moscow Air Force Station, Maine, (not USSR), currently consists of four separate 12-element sub-arrays, each designed to cover a different band of frequencies between 6.74 and 22.5 MHz. The radiating element consists of 'T' shaped dipoles, either vertical or canted 45 degrees with a length varying between 24 and 60 feet, according to the frequency band. The transmit arrays have a common mesh backscreen ranging in height from 45 to 100 feet, and a common groundscreen extending out some seven hundred and fifty feet in front of the arrays. Total transmit array length in the experimental installation is 2,265 feet. This will be extended to 3,630 feet in the full-scale system.

The new system will give uninterrupted coverage (apart from guarded frequencies) from five to 28 MHz. At the Moscow (Maine) Air Force Base, the station has it's own 7.5 MW power sub-station. The 12 elements of each sub-array are fed simultaneously by 12 Continental Electronics transmitters, each capable of producing up to 100 kW average power. Total effective power delivered from the array is up to 100 MW.

The receive antenna site at Columbus Falls Air Force Station, Maine, contains an experimental receive array presently consisting of 137 triangular elements, each 17 feet high. The receive antenna has both a backscreen 50 feet high, and 750 feet wide groundscreen. Total length of the experimental receive array is 3,906 feet, with planned extensions to 5,230 feet. The received signals are digitised and formed into four simultaneous beams covering the same area as the range-azimuth sector illuminated by the transmitter. The four beams are processed almost simultaneously by the signal processor, which resolves each beam into 4,096 time delay (range) and Doppler frequency (radial velocity) cells. Processor functions include interference suppression and clutter blanking, peak detection and integration over a period of time. After processing, target 'hits' are passed to the operations processor which initiates and maintains tracks, registers them with geographical coordinates, formats the information for display and assesses the significance of the radar data, besides providing the operator with a variety of automatically-processed data-bases.

No north-looking radar is planned, due to ionospheric irregularities centred on the North Magnetic Pole. Longer-term plans, however, call for an installation looking south. Radio amateurs will be looking with interest at the development of this project.

Acknowledgement:  
Interavia, 1982, and  
Aviation Week and Space  
Technology, 1982

AR

# NATIONAL EMC ADVISORY SERVICE

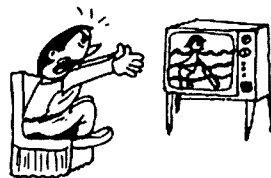

## "A FAIR GO!"

Tony Tregale VK3QQ  
FEDERAL EMC CO-ORDINATOR  
38 Wattle Drive, Watsonia, Vic. 3087

Communications is what the Amateur Radio Service is all about. Communicating by use of electromagnetic energy has its problems. One problem is simply that all radio receivers and all radio transmitters are potential sources and victims of interference for many reasons. When it comes to interference the average radio amateur just wants a fair go.

Over the years in almost all countries of the world radio amateurs have been blamed for causing interference to everything from television to garden mowers.

With the advent of television the general public became most critical of interference. Anything which, even in a minor way, disturbed their viewing ritual was sure to be given the 'twelve gauge shotgun' treatment.

Television receiver manufacturers had little difficulty convincing the general public that any interference experienced must be due to an external source rather than their product, because if you turn off the external source, the interference is removed — anyone could see this. What the manufacturers did not wish to make too public was that their equipment was very capable of receiving signals which were well outside its licensed operating bands with just as much clarity as those signals to which the equipment was intended to receive.

From time to time owners of record players, audio amplifiers and the like have complained about the reception of radio signals on these devices, usually from nearby radio transmitters. Devices of this nature are, or should be, designed to amplify audio signals such as music and speech and not respond to radio signals.

Again, manufacturers of such equipment can fob off complaints of interference by saying that if the radio transmitter is turned off, and the interference disappears, any interference must be the fault of the radio transmitter. The general public find this answer easy to understand. The truth is, of course, the audio equipment should not respond to radio frequency signals, if it does, then it should be licensed as a radio receiver.

Domestic equipment manufacturers were, and to a certain extent still are able to get away with the production of equipment which works well in a hostile free environment.

With the growing world of electronic gadgets the hostile free world is becoming smaller and smaller, to the extent that one piece of domestic equipment can, and quite often does, interfere with another.

In the early days when television was a new and novel form of home entertainment, government authorities had very little information or political power to deal effectively with the real cause of the interference problem. It was much easier and less controversial to close down the amateur station or to restrict its operations to outside TV hours.

Government action, or lack of it, has done little more than sweep the problem under the carpet. With the growing world of electronics the 'buck' has to stop somewhere, and soon!

Fortunately a number of countries have seen the 'light' and have embarked on a full programme of standards, regulations and mandatory legislation to cover the design, production, operation and import of domestic entertainment equipment and consumer products in respect of EMC and EMI.

In CANADA the steering committee on electromagnetic interference and electromagnetic compatibility of the Canadian Standards Association produced an in-depth study of radio interference and its impact on Canadian use of sensitive electronic and electrical equipment has concluded that standards are needed incorporating guideline limits both as to levels of radio interference which are tolerable and the levels of immunity which must be built into electrical/electronic systems. The committee has concluded that failure to develop and apply appropriate technical standards could result in a serious deterioration in most Canadian electronic systems and could increasingly threaten Canada's position in the domestic and world markets.

NORWAY insists that equipment showing insufficient immunity be modified by the manufacturers or importers — fitting any necessary filters.

SWEDISH manufacturers supply free upon request high pass filters and/or mains filters; radio dealers are authorised

by the Swedish Electrical Testing Authority (SEMKO) to make minor modifications to equipment to increase its immunity to electromagnetic interference.

WEST GERMANY has perhaps the most positive control of all forms of interference problems. The very involved and complex DIN/VDE Standards and Regulations seem to cover almost all situations, including being retrospective.

The West German Law requires that an EMC information sheet be included with the instruction manual of all radio and television receivers, also audio and Hi Fi equipment.

The instruction sheet informs the purchaser that the equipment has been approved by the German Post Office as a sound radio\*/audio system\*/television receiver\* and complies with the current regulations of the German Post Office . . .

*"see FTZ test number attached to the equipment".*

*"The FTZ number is your insurance that this equipment will not cause interference to other telecommunications services. The suffix letter S or SK indicates that the equipment has a high degree of immunity to unwanted signals (amateur, CB, etc.). Should interference be experienced please contact your local interference measuring service office."*

In last month's Amateur Radio we reported on one of the latest countries to tackle the EMC problem . . . The United States Government has given the FCC power to control susceptibility/immunity.

The United States Communications Act of 1934 has been amended by Public Law 97-259, 1982, to read as follows:

### Communications Act of 1934, as amended by Public Law 97-259, 1982

§302(a) The Commission may, consistent with the public interest, convenience, and necessity, make reasonable regulations (1) governing the interference potential of devices which in their operation are capable of emitting radio frequency energy by radiation, conduction, or other means

in sufficient degree to cause harmful interference to radio communications; (2) establishing minimum performance standards for home electronic equipment and systems to reduce their susceptibility to interference from radio frequency energy. Such regulations shall be applicable to the manufacture, import, sale, offer for sale, or shipment of such devices and home electronic equipment and systems, and to the use of such devices.

(b) No person shall manufacture, import, sell, offer for sale, or ship devices or home electronic equipment and systems, or use devices which fail to comply with regulations promulgated pursuant to this section.

(c) The provisions of this section shall not be applicable to carriers transporting such devices or home electronic equipment and systems without trading in them, to devices or home electronic equipment and systems manufactured solely for export, to the manufacture, assembly, or installation of devices or home electronic equipment and systems for its own use by a public utility engaged in providing electric service, or to devices or home electronic equipment and systems for use by the Government of the United States or any agency thereof.

Devices and home electronic equipment and systems for use by the Government of the United States or an agency thereof shall be developed, procured, or otherwise acquired, including offshore procurement, under United States Government criteria, standards or specifications designed to achieve the objectives of reducing interference to radio reception and to home electronic equipment and systems, taking into account the unique needs of national defence and security.

Note: Any minimum performance standard established by the Federal Communications Commission under section 302 (a)(2) of the Communications Act of 1934, as added by the amendment made in subsection (a)(1), shall not apply to any home electronic equipment or systems manufactured before the date of the enactment of this Act.

In Australia we ask our Department of Communications to look after the radio frequency spectrum with their hands tied behind their backs.

With the proposed new Radiocommunications Bill (Telecommunications Bill) in the pipeline, isn't it time that the Australian Government gave our Department of Communications the power and the staff to do the job for which they were appointed.

AR

## EMC

(Electro Magnetic Compatibility)

If radio frequency interference is causing you a problem you are reminded that — "Advice on all types and aspects of interference (PLI, TVI, AFI, etc.) is available from the National EMC Advisory Service".

FORWARD DETAILS TO

VK3QQ,  
Federal EMC Co-ordinator, QTHR.



AUSTRALIAN LADIES AMATEUR  
ASSOCIATION

# ALARA

Margaret Loft VK3DML  
28 Lawrence St, Castlemaine 3450.



L to R Alma ZL2AWP/VK3DFU; Mavis VK3KS; Bobby VE7CBK/VK4BRU; Margaret VK3DML; Jessie VK3VAN.

As we all know this is World Communications Year (WCY '83) and the editorial in January AR asked us all to make some small contribution to ensure it's every success. Last week the members of WICEN made a very large contribution to help those involved in the bushfire areas in VK3 and VK5. Some of our members live in these areas and I would like to publicly thank all WICEN operators for their time and efforts on behalf of all ALARA members.

This has shown how very necessary and valuable amateur radio can be.

### WELCOME TO NEW MEMBERS

Suzanne VK2PSC joined 20.10.82  
Lorraine VK4KLJ joined 20.11.82  
Bron VK3NTD joined 6.11.82  
Dale VK3PEH joined 26.11.82 (100th VK-YL)

### Sponsored Members

Joanie KA6V joined 16.10.82  
Cathy ZL2ADK joined 30.10.82  
Christel DF1LV joined 11.12.82  
Jeanne ZL2BOD joined 26.12.82  
Kazuko JD1BBH joined 20.10.82  
Denise WH2ADG joined 22.11.82  
Lynn ZL2PQ joined 25.12.82  
Maxine N6GGR joined 28.12.82

### Subscriber:

Jack VK3NTR joined 6.11.82

### CONGRATULATIONS

Congratulations to Margaret VK3NZD; a member of ALARA since 1981 and is the XYL of VK3DBJ.

And to Joy VK2EBX previously VK2VJV and 2KJC. Sorry about the error in the list in AR. I will compile a complete and up to date list and publish it again, apologies to those I omitted and for the errors.

Thank you to all who have sent me photos and news. It does make my column easier.

Nice to meet some of the OMs and their XYLS at the Midland Zone Convention on Sunday 20th February at Strathfieldsaye. We felt it was very successful and hope you all enjoyed the day.

Mavis VK3KS is waiting for your application for the award, so look through your log book and see if you have talked to enough members to send for one. Rules are on page 40 June 1982 AR.

Until next month 33/73/88s to all.

Margaret VK3DML

AR



## 1982 VK/ZL/OCEANIA DX CONTEST

Jock White ZL2GX  
CONTEST MANAGER

Many thanks to all who submitted logs. Compiling these is time consuming and no easy task. NZART does not ask for logs to be "re-written" — carbon copies of an operating log are sufficient — but of course, legibility must play a part too.

Only one problem developed from the rules — the *summary* requires "prefixes worked on that band". This is an integral part of the *summary* and is of importance in log checking. Too many merely indicated the new prefix in the log. Maybe the listing in the *summary* is superfluous — even though it helps in checking — both for the operator and for the contest manager!!

Logs from VK/ZL arrived in good time, as have most, but Eastern Europe presents a problem. To delay the receipt date presents further problems. It is important to promulgate the results as soon as possible.

The scoring system with a differential for different bands (introduced by NZART some time ago) once again received favourable comment. It must be stressed that with such a system (already giving full credit to users of different bands) that any multiplier system is quite out of order and can only provide distorted results.

The points allocated for operation on different bands might well be investigated however. Are the ratios reasonable when one compares the QSO rate on say 15 metres with that on 80! It must be kept in mind however that these "ratios" could vary from "year" (or group of years) to "year" depending on conditions.

Results are tabulated in "scoring areas" as this is the basis of the awards programme and so is logical. Additionally, individual band scores are tabled and certificates will be issued to these place winners too.

Rule 8 (begin with any serial number between 001 and 100) is a "hangover" from the "good old days". Maybe we could all start at 001! Does it *really* matter?

The "all band" situation is covered elsewhere.

Clashes with other contests is always a problem and will get worse before it gets better! There seems to be more and more "international" contests — some of which fill roles which are difficult to understand.

A growing problem could be that of stations operating in an area which is different to the prefix! At present, NZART policy accepts the PREFIX for ZLs and not the location for the VK/ZL/O.

In many countries the prefix is no longer changed when a physical move is made.

This and that — "my first DX Contest — GREAT! . . . plenty of prefixes but many that I missed . . . ZL2SQ has lost none of his EP2BQ prowess! . . . model logs from youngest competitor Charlene VK1NEJ and from contest doyen AX4XA.

Finally . . . thanks to so many for the personal notes with logs — much appreciated.

A final final — the certificates which are typical and appropriate have presented a typing problem. I hope all concerned will understand.

### SOMETHING TO TALK ABOUT . . .

What constitutes an "Open Section" entry in the VK/ZL/O? For years this has been accepted as the "highest score" and there is much to support such an opinion. It could be debated that the manner in which you make your points is your own affair — no one else's. Let's be fair and admit that this is a simplistic attitude nevertheless. Now we *are* in trouble. Should then a contestant in the "Open Section" operate on say two bands? — or on four? — or five? If on four — which four?; or if on five — which five? I don't think it would be fair to say 10, 15, 20, 40, and 80 — any more than 15, 20, 40, 80, and 160 would be fair. So where are we? I'm quite sure that most — if not all — so called "All Band" scores in the major DX Contests are NOT "all band" scores at all. Undoubtedly they will be more than "one band" — but ALL BAND, I'm sure NOT! Interesting isn't it. I'd like some opinions . . .

### RESULTS . . .

Full VK and ZL results will be mailed to all award winners in VK and ZL. These results as well as "Overseas" results will be published in "Amateur Radio" and in "Break-In".

Trophies are the responsibility of WIA for VKs and NZART for ZLs. (NB — certificates will be mailed by NZART to all concerned — both VK and ZL — as well as overseas winners.)

- \*\*\* Suggested change in rules for OVERSEAS STATIONS: In addition to VK and ZL prefixes, to include ALL Oceania prefixes as multipliers.
- \*\*\* WIA will organise the VK/ZL/O in 1983 and in 1984.





# CONTESTS



Reg Dwyer VK1BR  
FEDERAL CONTEST MANAGER  
Box 236, Jamison, ACT 2614

## CONTEST CALENDAR

### APRIL

- 6-7 DX-YL to NA-YL CW Party
- 9-10 CARF Commonwealth SSB Test
- 13-14 DX-YL to NA-YL Phone Party
- 16-17 Polish Phone Test (tentative date)

### MAY

- 7-8 CQ M Russian Test\*\*\*
- 7-8 World Telecom Phone Test\*\*\*
- 14-15 World Telecom CW Test\*\*\*
- 14-15 Sangster Shield Test
- 17 World Telecommunications Day
- 28-29 CQ WW WPX CW Test

### JUNE

- 11-12 6th VK/ZL Oceania RTTY Test
- 11-12 ARRL VHF Test\*\*\*
- 18-19 All Asian Phone\*\*\*
- 25-26 ARRL Field Day\*\*\*

### JULY

- 2-3 Venezuela Phone Test\*\*\*
- 9-10 NZART Memorial Test (June AR)
- 16-17 International QRP Test\*\*\*
- 23-24 Venezuela CW Test\*\*\*

*The contests marked with \*\*\* are not yet confirmed . . .*

## 6TH VK/ZL/OCEANIA 1983 RTTY DX CONTEST

- DATE: 11th to 13th June, 1983
- TIME: 0000-0800 UTC Saturday 11th June 1983
- 1600-2400 UTC Saturday 11th June 1983, and
- 0800-1600 UTC Sunday 12th June 1983

- CLASSES: Three classes: (a) single operator, (b) Multi-operator, and (c) SWL operators.
- Note: Logs of Multi-operators must be signed by all operators, together with a list of their call-signs. Incomplete loggings are not eligible for scoring.

- BANDS: All Amateur Bands. 3.5-28 MHz.
- NUMBER EXCHANGE: Serial number will consist of (a) RST, (b) Zone Number, and (c) Time in UTC.

- SCORING: As per CARTG Zone Chart, multiplied by the number of countries worked, multiplied by the number of continents worked (maximum six).

After the above calculations, world stations add 100 points for each VK/ZL station worked on 14 MHz, 200 points for each VK/ZL station worked on 21 MHz, and 300 points for each VK/ZL station worked on 28 MHz. (EXAMPLE: 720 points from zone chart x 29 countries worked x 5 continents worked = 104,400 points, plus (+) 6 VK/ZL stations worked on 14 MHz (that is 600 points) giving a total of 105,000 points.

A station may be worked only once on each band, but may be worked on another band for further multipliers.

**COUNTRIES:** Country count as per ARRL list of countries, except that each VK, ZL, JA, VE, VO, W/K districts count as separate countries. Contact with one's own country count as zero points for multipliers.

**LOGS:** Logs must show in this order: 1 Date, 2 Time (UTC), 3 Callsign of station worked, 4 Serial number sent, 5 Serial number received, and 6 Points claimed.

**CLOSING DATE:** Logs must be received by the Contest Committee by 1st October 1983. The address for logs is: W J (Bill) Storer, VK2EG, 55 Prince Charles Rd, Frenchs Forest, 2086, NSW, Australia.

**SUMMARY SHEET:** Summary sheet must show, call-sign of station, name of operator/s, and address of same, bands used (a separate log sheet is required for each band), the points claimed for each band, number of VK/ZL, stations worked, total points claimed and signature/s. Multi-operator station logs must contain the signatures and callsign of each operator.

**AWARDS:** Awards will be issued for 1st, 2nd and 3rd on a world basis and also on a country basis.

The judges decision regarding the placings in the contest will be final and no correspondence will be entered into regarding the same. The logs become the property of the Contest Committee on completion of checking.

This contest is organised and conducted by the Australian Amateur Radio Teleprinter Society, PO Box 860, Crows Nest, NSW. (Official club station is VK2TTY.)

## SANGSTER SHIELD CONTEST

Presented to the amateurs of New Zealand by Mr Ralph Sangster in 1927, the Sangster Shield is for annual competition to be won by the most efficient station. In this respect it should be pointed out that in addition to the efficiency of the transmitter itself, the efficiency of the operator is of the utmost importance. To win this contest marks an operator as one who not only knows how to obtain the most output from low power but also as one who is most proficient in the art of telegraphic communication.

## RULES

**1 WHEN?** 14-15 May 1983, between the hours of 8 PM and midnight on each day. The maximum period of operation will be *eight* hours.

**2 POWER?** To compete for the Sangster Shield the input to the anode of the final amplifier and/or any other stage in the transmitter must not exceed 5 watts.

3 CW to CW contacts only are permitted.  
4 All operation must be in the 80 metre band.

5 (a) Contacts with any one station permitted *each hour*, based on the "even hour" basis — e.g. 2000 to 2100; to 2200 etc etc.

(b) It is *not permissible* to QSO the same station "twice running" eg at the end of one hourly period and at the beginning of the next. A different station must be contacted before the "same" station is contacted again.

(c) *Except that* this is permissible when *one* of the two stations concerned has contacted a different station between QSOs concerned or when there is a time delay of at least five minutes between the contacts.

6 All ZL entrants must be financial members of NZART.

7 All radio regulations must be observed.

8 In the event of any dispute, the ruling of the Executive Council will be final.

9 LOGS: (a) On QUARTO size paper — preferably NZART log sheets.

(b) Data in this order: date, time, call of station contacted; serial sent, serial received, points, claimed.

(c) ON SEPARATE SHEET a summary to show —

(1) Call sign, name and address in BLOCK LETTERS.

(2) Number of contacts with stations using 5 watts or less.

(3) Number of contacts with stations using 6 watts or more.

(4) Number of contacts with overseas stations.

(5) List of different Branches worked with number and name of the Branch in order as given in the Call Book, together with the *callsign* of the station



claimed as a multiplier for that Branch.

(6) Total Score — (total points multiplied by different Branches).

(7) Description of equipment used and POWER used.

(8) Declaration that all contest rules have been observed.

(d) UNDERLINE each new Branch claimed as a multiplier. (Underline all entries for that QSO.)

10. CYPHER SYSTEM: (a) RST followed by Branch Number followed by Power input — eg 569/11/04. This would indicate a 569 report; Branch 11 and Power of 4 watts. Power will always be given as TWO figures — over 100 watts will be given as 99 while below 10 watts will be preceded by 0.

(b) Overseas stations need give RST only but must receive the full cypher from the ZL station.

11. SCORING: (a) All Overseas Contacts — 10 points.

(b) ZL contacts with power given as 5 watts or less — 5 pts.

(c) ZL contacts with power given as over 5 watts — 1 point.

FINAL SCORE is total of points multiplied by number of different NZART Branches contacted.

NOTE: Contacts with a contestant's OWN Branch are OK for QSO points but NOT as a multiplier.

12. Mobile or Mobile/Portable operation is not permitted. The station must be operated from a *fixed location* for the duration of the contest.

13. AWARDS: (a) *Sangster Shield* to the highest scorer using 5 watts or less.

(b) *Transistor Trophy* to the highest scorer observing the rules as enumerated, but in addition who has been licensed for 12 months or less. Entrants must give Operator's Certificate number together with the date of issue.

(c) Certificates to the first three contestants using 5 watts or less, similarly to "newly licensed" entrants.

(d) Certificate to the contestant using

over 5 watts with the highest score made from QSOs with stations using 5 watts or less.

(e) Certificates to Overseas Stations to the highest scorer in any call area.

14. Logs must be posted to REACH the Contest Manager ZL2GX, 152 Lytton Road, Gisbourne, New Zealand, on or before 2 June 1983.

15. To give QRP Contestants a fair chance (particularly with DX stations) higher power stations are requested to operate ABOVE 3.530 MHz.

This contest has been opened to entrants from VK, with certificates to the highest scorer. The NZART welcomes all entrants from the VK areas and a good turnout is expected. Information on the other awards is available from the NZART Contest Manager, ZL2GX 152 Lytton St, Gisbourne, NZ. Please note the date for logs to be posted.

AR

# CLUB CORNER



## MIDLAND ZONE CONVENTION

The executive and committee of the Midland Zone would like to thank everyone who attended their annual convention at Strathfieldsaye on Sunday 20th February.

From reports heard all who attended had an enjoyable day and we look forward to your attendance again next year.

Special thank yous to Stan Roberts of Bail Electronics, George Sumner of Sumner Electronics, Keith Haslem of Eastern Communications and the boys from Ballarat Amateur Radio Group for their attendance and providing interest for our visitors.

Thank you to Bail Electronics, Scalar, Milnes (Bendigo) for prizes and to GFS and the Bendigo Premier Town committee for literature provided.

Thank you also to the ladies of the zone who helped with the catering both in providing food and helping in the kitchen on Sunday.

At the meeting on Friday night Ross VK3YXR gave an interesting talk on the ATV repeater in Bendigo and answered numerous questions from members. The repeater is working well and is being watched by a number of people in the Bendigo area.

Next meeting of the Zone is on Friday 18th March at the Eaglehawk and Long Gully Community Centre and guest speaker will be Fred Toliver VK3DTG/KL7HM and the topic is "Ham Radio in Alaska". All welcome at 8 PM.

On Sunday 10th April a family day barbecue lunch has been arranged at "Burnewang House" Elmore out near the field day site. Directions on the day via ch 11 147.150 MHz.

All welcome, BYO.

Friday 15th April meeting; guest speaker Neville VK3ACN — "More handy hints".

Friday 20th May meeting; guest speaker George VK3AGM — Digital readouts.

Friday 17th June Annual Dinner at Bendigo Club.

73/88 Margaret VK3DML

Secretary

AR

## MOUNT GAMBIER CONVENTION

The South East Radio Group Inc in Mount Gambier will be holding its 19th Annual Convention on the Queen's birthday weekend the 11th, 12th and 13th of June.

To maintain the popularity of this convention the South East Radio group is scheduling some new events which should prove interesting to all who attend. As was the case last year the events will start on Saturday afternoon to be followed by the excellent SERG dinner which will be followed by a night fox hunt and some terrific entertainment.

The Sunday of the convention will be filled with many scrambles, fox hunts, sniffer hunts, beam heading competitions and hidden transmitter hunt. The prizes will as usual be of excellent standard with an aggregate prize and trophy to be kept by the person who turns in the best overall performance. Another new innovation this year will be the encouragement of club participation. Every person who wins an event will not only score personal points and prizes but will also accrue points for his or her club. The best club performance at the end of the convention will gain them a trophy to take home.

Trade exhibits in the past have been

excellent and have attracted much interest. This year will be no exception, and any one requiring trade space should let the Convention Registrar know as soon as possible at the address below.

The catering will, as usual be terrific.

Convention registration forms will be available from most VK5 and VK3 clubs or from the Convention Registrar by sending a SAE to PO Box 1103, Mt Gambier, SA 5290. Any enquiries can be made by checking into the SERG Net, Monday nights at 1000 UTC on 3.585 MHz.

D Edwards VK5FF  
PUBLICITY OFFICER

AR

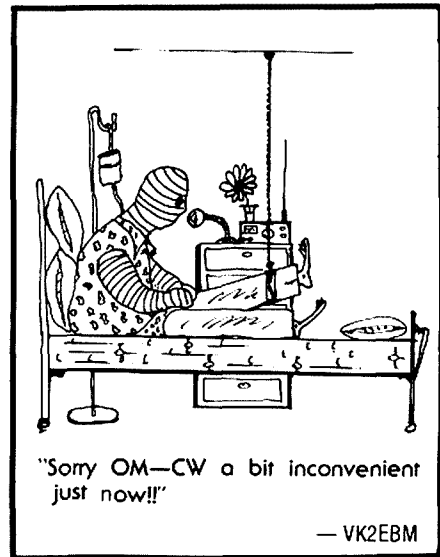

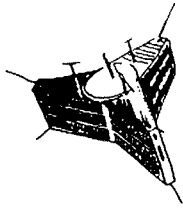

# AMSAT AUSTRALIA

Bob Arnold VK3ZBB  
41 Grammar Street, Strathmore, 3041

## NATIONAL CO-ORDINATOR

Chas Robinson VK3ACR

## INFORMATION NETS:

### AMSAT AUSTRALIA

Control: VK3ACR  
Time: 1000 UTC Sunday  
Frequency: 7.064 MHz Summer  
3.680 MHz Winter

### AMSAT PACIFIC

Control: JA1ANG  
Time: 1100 UTC Sunday  
Frequency: 14.305 MHz.

### AMSAT SW PACIFIC

Control: W6CG  
Time: 2200 UTC Saturday  
Frequency: 28.880 MHz.

Acknowledgements for information are extended to:

Graham VK5AGR, Ed VK2ADJ  
AMSAT Satellite Report

## PUBLICATIONS

In February I included in these notes a review of the AMSAT-UK publication "Satellite Tracking Software for the Radio Amateur" by John Branegan.

It is understood that some additions are now available and that these cover the requirements of users in the Southern Hemisphere. The cost of the additional pages is 40 p plus postage.

By the way, the weight of the original book is 280 grams and the amendments 25 grams; so, send lots of money for postal charges if you want the book by airmail! In fact, send £6.50 in total.

Despite repeated requests to send only English currency AMSAT-UK continues to receive all types of notes and even Australian postage stamps; in future any orders which are not properly serviced will be returned as received by sea mail. If you don't know what to do to obtain a draft in English pounds speak to your bank.

## OPERATIONAL UPDATE

### AMSAT OSCAR 8

The telemetry from A08 indicates that all is not well with the battery voltage, possibly due to excessive temperatures experienced during the past twelve months. In order to conserve power and to assist in the normalisation of the battery voltage the satellite transponders are operating on one mode only each day; the present sequence is Mode A on Sunday, Monday and Tuesday and Mode J on Thursday, Friday and

Saturday. Wednesday is a non-operating day.

### AMSAT OSCAR 7 and RS 1 and 2

Following reports that these satellites had been heard again after a long period of silence, a careful watch has been maintained in both the northern and southern hemispheres. Unfortunately no reports of activity have come forward but should anyone have information, supported by suitable evidence such as tape recording, please let VK3ACR know without delay.

### UOSAT U09

Early in February the 'tip — mass release pyros' (explosive bolts) were fired without disturbing the satellite and in preparation for boom deployment; this step appears to be taking longer than anticipated.

The Navigation Magnetometer is out of calibration and once this has been recalibrated a complete list of equations will be issued. For the information of those decoding the telemetry it should be noted that Channels 5 and 6 with Channels 15 and 16 are reversed ie Ch 5 is HY-Coarse, Ch 6 is HX-Coarse, CH 15 is Hy-Fine and Ch 16 is HX-Fine.

## ORBITAL INFORMATION

Far more people use the Orbit Period and Longitude Increment figures to predict satellite passes than the more accurate Keplerian elements. However we have a problem as so many authorities publish their own unique figures; for instance in the current edition of Amateur Satellite Report no less than three different figures are quoted for two of our satellites! What is the simple amateur to do when bemused by the experts? In traditional Aussie fashion we will take a bet both ways by shooting down the middle and give the following figures with thanks to KA9Q.

SATELLITE	NODAL PERIOD Minutes	LONGITUDE INCREMENT Deg West/Orbit
OSCAR — 8	103.16911	25.794574
UOSAT — 9	94.76881	23.691313
RS — 3	118.51867	29.756458
RS — 4	119.39409	29.975570
RS — 5	119.55500	30.015748
RS — 6	118.71619	29.805877
RS — 7	119.19495	29.925660
RS — 8	119.76366	30.068025

## FUTURE PROJECTS

No positive indications have been forthcoming on future amateur satellite operations which may include:

- The ARNET proposal for two geosynchronous satellites.
- Amateur operation by W5LFL during the flight of the Shuttle 'Challenger'.

The whole project may be delayed due to the problem of hydrogen leaks on Challenger.

- The proposal to launch Phase IIIC with a DSCS satellite of the USAF.  
The launch of Phase IIIB is now believed to be scheduled for 27 May 1983.

## THE RISE AND FALL OF ISKRA 3

Russian Amateur Spacecraft ISKRA3, also known as RK03, was launched from spacelab SALYUT 7 at 0756 UTC on 18 November 1982, see Amateur Radio, January 1983.

The satellite was at the relatively low height of 364 km at launch and without onboard boosters was destined to have a short life. This situation was ideal to study the decay characteristics of the satellite and consequently every effort was made to determine regular orbital times and to plot this parameter against the day of the year.

Initially orbit times were measured every three or four days ie whilst the rate of decay was fairly steady, but when the orbit time became less than 90.5 minutes and the rate of decay increased substantially observations were recorded two or more times each day.

Contact was lost on day 350 (16th December) and I understand that this is the day of re-entry recorded by NASA. However some authorities claim that the satellite was heard on orbits up to 25th December.

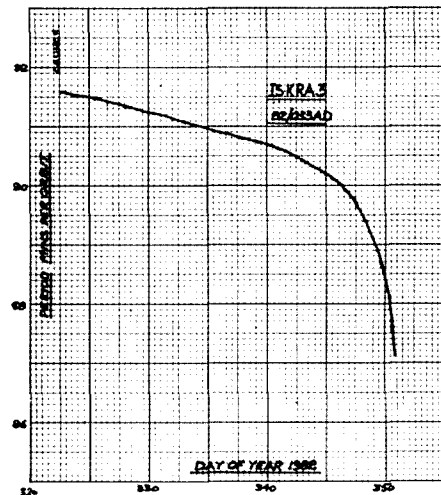

The data recorded is shown on the graph; it is interesting to observe how quickly a satellite of this type decays once its orbital time falls below 90 minutes.

AR



# VHF UHF - an expanding world

Eric Jamieson VK5LP  
1 Quinns Road, Forreston, SA 5233.

All times are Universal Co-ordinated Time, indicated as UTC.

## AMATEUR BAND BEACONS

### FREQ. CALLSIGN LOCATION

50.005	H44HIR	Honiara
50.008	JA2IGY	Mie
50.060	KH6EQI	Pearl Harbour
50.075	VS6SIX	Hong Kong
51.022	ZL1UHF	Auckland
52.013	P29SIX	New Guinea
52.100	VK0AP	Macquarie Island
52.200	VK8VF	Darwin
52.250	ZL2VHP	Palmerston North
52.300	VK6RTV	Perth
52.320	VK6RTT	Carnarvon
52.350	VK6RTU	Kalgoorlie
52.370	VK7RST	Hobart
52.400	VK7RNT	Launceston
52.420	VK2WI	Sydney
52.425	VK2RGB	Gunnedah
52.435	VK3RMV	Hamilton
52.440	VK4RTL	Townsville
52.510	ZL2MHF	Mt Climie
144.400	VK4RTT	Mt Mowbullian
144.420	VK2WI	Sydney
144.465	VK6RTW	Albany
144.475	VK1RTA	Canberra
144.480	VK8VF	Darwin
144.550	VK5RSE	Mt Gambier
144.600	VK6RTT	Carnarvon
144.900	VK7RTX	Ulverstone
145.000	VK6RTV	Perth
147.400	VK2RCW	Sydney
432.410	VK6RTT	Carnarvon
432.440	VK4RBB	Brisbane
432.450	VK3RMB	Mt Buninyong

There have been a number of deletions from the beacon list this month. First is VK3RGG at Geelong now off due to problems with the co-sited 2 metre repeater. VK2BNT on 52.500 apparently is not yet on the air, so we jumped the gun on that one. VK5VF on 53.000 and 144.800 are both off the air due to bushfire damage.

## THE SAD STORY OF VK5VF

Ash Wednesday 11 will long be remembered in VK5 and VK3 for the terrible destruction of major bushfires in both States. The 16th of February will be looked upon with some foreboding each year in future. For those not accustomed to the ravages of bushfires, the results have to be seen to be believed. The destruction is usually so total, so frightening for those involved, it is hard to comprehend. Even after nearly thirty years as a Fire Control Officer I still find major bushfires a very traumatic experience, and are to be feared.

To view the absolutely total destruction around the summit of Mount Lofty is a terrible spectacle, and this is the area where the VK5VF 6 and 2 metre beacons were installed. The flames passed through the towers of the transmitters of the television stations on Mount Lofty, and in so doing, destroyed a building which supplied power to the beacons, so putting them off the air. I went to the beacon site today (22/2) but didn't have the heart to wander amongst those people who were cleaning up the site (I would never want to be classed as a sightseer!). However, looking from the outside it appears the two antennae are gone, and probably the transmitters would have been roasted in their cubicle, so that's the end of that story!

Fortunately, Mark VK5AVQ had taken the new solid state beacons back to his QTH previously after testing, so at least we still have something, but a lot of work will now be needed to get the beacons back on the air, a new tower, two antennae, feedlines, power supplies, together with a source of power etc. However, they will go back!

At this stage I have not heard of losses sustained by amateurs in the bushfires, other than an unconfirmed report of VK3XI losing all his antennae; but there must be some who have suffered severely in the two southern States. Maybe we could help if we knew.

## BEACONS IN VK2

Tim Mills VK2ZTM, the State Repeater Co-ordinator, has written advising VK2BNT (mentioned above) was not yet on the air, with the sponsoring group, Hunter Branch Radio Group, in the final stages of submitting the various required details preparatory to licencing.

Tim also mentions the beacons VK2WI at Dural use a common callsign generator, and to date there are three bands covered, 10, 6 and 2 metres. Jeff VK2BYY is waiting for the licence for 70 cm to come through. Later in the year it is planned to change the callsign to one from the "R" series which will be in line with identification requirements.

## BEACONS IN VK1

A letter from Ron VK1RH advises it is proposed to change the frequency of the VK1 2 metre beacon to conform to WIA beacon band plan. The crystal for 144.410 has been purchased, but it is necessary to wait until the Department of aviation radar on Mt Majura is switched off for maintenance before changes involving aerials

and swapping the crystal can be made. The work involved is to change the antenna boom and replace the 2 metre vertically polarised omni-directional antenna (which used to be part of the VK1RAC repeater set-up) with 2 and 6 metre horizontally polarised omni-directional antennae.

These changes should allow the present 2 metre beacon to be heard much further afield, and ultimately lead to the establishment of the 6 metre beacon, a licence for which has been held for several years, but equipment is mostly in the design stages.

## VK1 REPEATERS

Ron also mentions VK1RGI on Mt Ginini continues to give faithful service, no changes are proposed at the moment except perhaps cross linking to the 70 cm unit when it gets to Ginini. VK1RAC on Black Hill also continues with reliable service although its antenna took a lightning strike a few months ago which called for repairs. VK1RUC, the 70 cm repeater is to be located on Mt Ginini shortly, testing having already been undertaken in Canberra by Eddie VK1VP.

There is an active ATV interest group in Canberra and they propose to construct and operate a 70 cm to 50 cm ATV repeater, to be sited at Black Hill. Enquiries have been made to the VK5ATV people regarding repeaters, particularly the mid-north repeater which has a level of sophistication the Canberra group would like to achieve also.

## FORWARD PLANNING

Ron VK1RH draws my attention to a short article a couple of years ago in "AR" in which he proposed that the VHF bands be progressively "opened up" by first installing beacons as standard signal sources then progress first to wide band modes (FM) repeaters as necessary then to narrow band modes and linear translators (repeaters in the true sense). Coupled with this would be a progressive policy of curtailing outmoded facilities, with suggestions that no more 2 metre FM repeaters be sited in cities, and in five years no more in the country areas. Ron says the article largely fell on deaf ears, but he would still like the principle applied wherever possible. He has looked into the matter of 1296 MHz beacons and would like to see something along these lines in service in Canberra and other places in the future. There's only one way to go — and that's up in frequency!

## THE SIX METRE SCENE

Six metres continues to provide a few

surprises. It is quite surprising the number of times JA stations are heard, mostly on 50 MHz of course, but occasionally the band opens to 52 MHz. Bob VK5ZRO has again filled in the gaps in my log book, which together shows what has been happening in VK5.

4/1: 0910 VK6KZ, VK6YU. 6/1: 0932 VK3CGH, VK2BHO, VK2ZIR, VK1CJ, VK1VP. 7/1: 0640 VK2VC, 2ZNS, 2ZDH, 2BKL, 2BQN, 2BOD, 2DDG, 2AYF, 2ZIR, 2EDB, 2ASZ, VK3ZQS, 3YRP, 3ZLD, 3CGH and VK1CJ. 10/1: 0830 VK2ZNS, 2ZIR, 2BXT, 2BKL, 2ZGB, then at 1200 VK2ZZV, 2ASZ, VK6XW, 6KRC. 11/1 0945 VK4QO.

13/1: 0915 VK6RO, 6XW, 6ZDR, 6SM, 6ZDY. 15/1: 0855 VK4D0, VK2ZMG, VK6ZDY. 16/1: 0444 VK6AUS/7, VK7ZIF, VK2BKL, 2ZGB. 22/1: 0820 VK6ZDY, 6ZPG, 6RO, 6AKT. 23/1: 0600 VK4TZ, 4RO, 4ZYA, 4JH; 1120 VK6ZPG, 6RO, 6GL. 24/1: 0715 VK2ZIR. 25/1: 0925 VK2ZMG. 26/1: 0830 VK4QO, 4RO; 1158 VK7ZIF. 27/1: 0945 VK6RO, 6ZWH. 28/1: 1040 VK7ZAR. 29/1: 0625 VK2ARA, 2ZQX, 2ZFS, VK4KHZ; 1155 VK2ASZ, 2ARA; 2337 VK2ZQX. 30/1: 0125 VK6ZDY; 0608 VK6RO.

3/2: 0345 VK6ZPG. 6/2: 0100 VK4ZHO, 4ANR and others. 9/2: 0720 VK4PZ, 4ZDK, ZL3ADT, ZL3TIC. 10/2: 0920 VK4RO, VK4TZ. 13/2: 0005 VK4WIM, 4ABP, 4ZYA, 4ZRK, 4WIT, 4RO; 0220 to 0445 JA1, 2, 3, 4, 7, 8, 9 and 0, quite a big opening with signals to 5 x 9 both ways. 18/2: 1035 VK2ASZ, 2ZIR, 2BHO.

Whilst on the 6 metre scene Gil VK3AUI sends some details on what has been heard in Melbourne, adding that there are other contacts which have been made but details are sketchy. 18/12: VKOAP, ZL3ADT. 24/12: ZL3TIB, ZL3HB. 30/12: Heard VK4D0 whilst mobile on the River Murray! 2/1: VK2BA, 2ZIR, ZL1TOP. 3/1: VK5ZDR, VK6GU, VK4NL, 4KJL, VK2ZFS, 2ZZV/2, VK3AZ. 6/1: VK5ZDR, 5AIM, 5ATN, VK3NM/5. 7/1: VK4D0, 4KAA, 4QR, VK5AGM, 5RO, VK3NM/5. 11/1: ZL4AS, ZL4HR. 13/1: VK6ZPG, 6OX, 6ZTT, 6ZH, 6VP, 6ZDY, VK5LA. 15/1: VK400, 4KHZ. 16/1: VK4D0, VK2ARA, VK5KMW. 17/1: VK4KJL, VK2ZQX. 18/1: VK4ABV. 19/1: VK4. 22/1: VK4D0. 30/1: VK6RO. JA7 also heard by VK3AMK. 7/2: Reports of JA, KH6 and P29 being heard during the day. 13/2: Whilst operating as VK3WIA during John Moyie Memorial Field Day the band was open to VK4, VK8GF and JA.

Gil also mentions preliminary reports indicate the VK0HI operation appears not to have worked anyone in Australia or Japan on VHF, although it appears possible VK TV sound was heard on one occasion. Other signals have been heard in the 0300 to 0400 time slot, one had the letters "DA" and one other undecipherable signal, all occurring between 6th and 10th February. No doubt most disappointing for the operators, but I am sure we will hear the full story in due course.

VK0AP appears to be a sad story in spite of all efforts. Communication is difficult as Peter has not been able to get his HF rig going yet (at 14/2). The lucky 26 who have worked him on 6 metres should send their cards to Peter Barclay VK3FR who is Peter VK0AP's manager. He will return by post all cards accompanied by an SASE. Cards via the Bureau will be answered the same way.

Signals were first heard from VK0AP in Melbourne by Geoff VK3AMK at 0030 on 18/12/82. First Melbourne station worked was Andrew VK3KAQ at 0051. During a

series of openings Peter VK0AP worked twenty six stations in VK3, VK2 and VK7. Thanks Gil.

### WHAT'S ON TWO METRES AND ABOVE

Gordon VK2ZAB has written an interesting letter from Berowra Heights, a northern Sydney Suburb, and all concerns 2 metres SSB, and from that scarce news State, VK2! 2/2/83: For some weeks now I have been running skeds to make contact with Bill VK4LC at Eagle Heights, inland from Queensland's Gold Coast, using SSB on 144.015 MHz.

"We have now managed to make contact on three separate occasions, viz: 1011 on 26/1/83, when Bill gave me 5 x 3 and I gave him 4 x 1; at 2025 on 29/1 with 5 x 4 and 5 x 1; and 2/2/83 at 1000 with 5 x 3 and 5 x 2. The first two contacts were made with the assistance of Bill VK2ZCV at Port Macquarie who can always work both of us, and who was able to switch between two antennas — one facing north and the other south specially for the purpose.

"The best contact was on 2/2 and made without the assistance of VK2ZCV. I don't know when the last 2 metre contact between Queensland and Sydney occurred, but it must have been a long time ago.

"I also believe the propagation medium is tropospheric scatter with possibly some tropospheric refraction assisting, although at times there is a hint of some elevation in the arrival of Bill's signals — suggesting an ionospheric path. Distance about 650 km.

"Bill runs 75 watts PEP to 2 x 19 element yagis, and I run 400 watts PEP to 4 x 9 element yagis, all horizontally polarised.

"Also worked from this QTH recently was Tom VK2DDG at Byron Bay (almost in Qld) Tom was 5 x 3 here at 1018 on 17/1/83 and he gave me 5 x 7, on 144.010 MHz SSB. That contact was as rare as the Sydney/VK4 one.

"There was a small opening to ZL at 0610 on 31/1 when ZL1BHX was worked for about five minutes, 5 x 2 in Sydney and 5 x 3 in New Zealand. Tony ZL1BHX was running 100 watts PEP to a 13 element 'flat top beam'. Everyone around here had been expecting an opening, and there were signs of it the day before, but the large scale opening did not eventuate. No concrete reports as yet on who worked who!

"Finally, there is continuous long distance activity on 2 metres SSB in NSW. Several stations including Jock VK2ZQX, Barry VK2KAY (both near Gunnedah), VK2DAU and VK2ADY (Peter and Don at Tamworth), Brian VK2AKU and occasionally Chick VK2DK near Narrabri, are on 144.200 almost every night and can be worked from Sydney at 1030. John VK2MX at Cooma, and several VK1s, Eddie VK1VP, Ralph VK1RK, Glen VK1KAA to name a few can and do work into Sydney at any time of the day or night. The same applies to stations in Wagga, Griffith, Cootamundra, Orange, Bathurst, and elsewhere. Coastal ducts enable SSB contacts between the extreme south and the far north of NSW frequently — on the coast that is, not much inland.

"The reason why these contacts are not reported more whilst contacts of similar distances in other States are, is simply that they are so commonplace that they are not news! In fact, it is a mystery to me why so much trouble is taken to erect repeaters because anywhere you can get via repeaters,

can be covered directly on SSB most times! Nevertheless, it is true that the real 2 metre band is alive and well in VK2.

"Incidentally, Bill VK4LC was formerly VK1BH."

Thank you for writing Gordon. I am so pleased you did because whilst you may see your contacts as commonplace, we in other areas have no idea what degree of activity may exist in other places unless we hear about it, and there are plenty of people very interested in what you are doing, and would be pleased to hear about it from time to time. If for no other reason, the fact that such contacts are possible helps to convince some other operators of the need to upgrade their stations to share in such contacts, either with you and your group or in other areas.

Another paragraph in your letter which I did not include asks me to publish more information on 2 metre activity, and above. Sure, I would be most happy to do so, but very few people ever write to me to tell me what they are doing, that's why you hear so much about the Adelaide to Albany path, it's here to be reported! Six metres gets more airing because I can hear for myself what is going on in lots of other places, but that is generally not possible on 2 metres, so we have to rely on people like yourself to write and say what is happening — this alone might help to get others to write and so the news is spread!

### TWO METRES AND ABOVE IN VK5

Bob VK5ZRO continues with his nightly 144 and 432 MHz contacts to Don VK5ZRG at Whyalla over the 220 km path. Signals vary at times but are often 5 x 9 on both bands. 21/2 was a particularly good night, the 70 cm signals being 5 x 9 + 20 at VK5ZRO. Bob phoned me and suggested the signals might be strong enough for me to hear Don through my 60 dB attenuator (hill), as he was able to maintain good contact running 5 mW! VK5LP therefore fired up with 100 watts SSB on 70 cm and the first two-way contact for me with Don resulted, signals being about 5 x 2. After trying for many months, the path was finally bridged! Don VK5ZRG reported picking up the Adelaide ATV repeater on 579 MHz in colour, so conditions were good. Incidentally, a relatively new station in Ridgehaven, an Adelaide suburb, Bob VK5KRA has been working VK5ZRG on 144 with an 11 element yagi, and on 70 cm with a 14 element yagi, running 10 watts to both antenna.

5/1: 1255 VK6WG; 2200 VK6KJ; both on 144 and 432 MHz. Neil, VK5ZEE normally resides at Woomera, but came a bit closer and stayed for a while at Hesso between Port Augusta and Woomera recently, and worked a number of Adelaide stations on 144 and 432, on 12/1, 14/1, 16/1 and others. On 29/1 VK5ZRO, VK5ZDR and others worked VK6XY on 432 at 1230; VK6BE on 144 at 1240; and VK6WG on 144 and 432 at 1255, all in Albany.

### NEWS FROM WESTERN AUSTRALIA

Wally VK6KZ has sent a very interesting letter and I am sure readers will be interested in the following extracts from the letter.

"The Ross Hull Contest was an intense period of operating for me, using up to seven

bands. 52, 144, 432, 576, 1296, 2304 and 3456 MHz.

"The most dramatic DX was the establishment of the Perth to Exmouth (North West Cape) path of 1130 km on 144 MHz as a regular part of our summer pattern. Steve VK6ASF previously active on FM put up a beam and operated SSB. I worked him on SSB for the first time on 11/11/82 and then during the Ross Hull Contest at 1547 on 4/12, 1348 on 15/12 and 2228 on 20/12, and on 24/12 at 2122 on FM via the Bunbury Repeater which is 100 km south of me! Steve replaced his yagi on 144 just before Christmas and reverted to two 5/8 wavelength verticals in phase for FM operation. Earlier that UTC day (the previous evening) Steve could not avoid triggering simultaneously repeaters along the north west coast to Karratha (310 km) and Port Hedland (500 km) as well as those to the south such as Geraldton (760 km).

"Other stations worked to the north from here included Andy VK6OX on both 144 and 432 at 1311 on 11/11, 1412 on 15/12, 1340 on 23/12, and on 144 only at 1338 on 16/12 and 1309 on 24/12.

"Country activity during the Ross Hull Contest was good. Regulars on 144 and 432 were Tony VK6BV at Northam (85 km), Max VK6FN Manjimup (250 km), Alan VK6ZWH Busselton (200 km), Beth VK6EL Busselton, and Wally VK6WG Albany (380 km). Others who appeared on 144 SSB included Wally VK6ZWO Mullewa (390 km), Ken VK6AKT Katanning (240 km) and Laurie VK6GL, John VK6IM and Doug VK6ZDR, all at Bunbury (140 km).

"Apart from a good opening to Japan on 4/12 from 0500 to 0700, 52 MHz was relatively quiet as far as DX was concerned. My best day was on 28/12 when VK1, 2, 3, 5, 6 and 7 were worked. It was a big disappointment as far as Ross Hull points were concerned.

"My portable work this summer was limited to a brief holiday period in Busselton (200 km south of Perth) and the best DX on 144 and 432 was to Andy VK6OX in Carnarvon (988 km). On 576 and 1296 MHz I worked Don VK6HK over a 193 km path. This contact on 576 MHz will be the basis of a claim for a new Western Australian DX record.

"Wally VK6WG tells me that the Albany/Adelaide path has been very poor and that the Albany to Melbourne path almost non-existent on 144 MHz this season

"By the way, the Indonesian to VK6 path on 144 MHz has frequently allowed stations along the north west coast to work on FM some Indonesian stations. I haven't many details. Maybe your column could seek out reports from stations such as VK6AIH in Port Hedland. As of 4/12/82 Steve VK6ASF in Exmouth had had one contact on 22/10/82. It is possible language is a formidable barrier. (If anyone who has knowledge of these contacts would like to write to me with details I will be pleased to pass it on for others to read... VK5LP).

"During my overseas trip I visited the 1296 MHz beacon site on Mauna Loa in Hawaii thanks to Paul KH6HME, the beacon keeper. It was built by Chip N6CA in Los Angeles, and runs 25 watts to an antenna system of four 25 element loop yagis mounted one above the other. The takeoff at the 2400 metre level is fantastic. Later again in the company of Paul I visited the Los Angeles end of the 1296 MHz

path from where Chip had heard that beacon. The beacon has an inbuilt receiver and the idea is to disable the transmitter to receive. Frequency is 1296.000 and CW keying. I listened to the Chip N6CA recording of the beacon signal and there is no doubt in my mind that the world record on 1296 MHz between Chris VK5MC and myself (VK6KZ) will eventually be extended in excess of 3980 km! New Zealanders please take note and look out for VK6!!

"The Central States VHF Conference in Louisiana was tremendous with about a hundred and seventy fanatics attending. However, the conference opened my eyes to the strong role played by that simple challenge of 'Worked All States'. This achievement has resulted in stations gradually improving their gear and operating habits. Firstly, tropospheric conditions provide the nearby States. Then comes aurora and then meteor scatter and maybe Es. Then comes a stage when further States can only be added to the tally by moving to moonbounce. This requires better receivers and higher power transmitters. The serious operator is now using gAs FET preamplifiers with noise figures on 144 MHz well below 1 dB and below 1 dB on 432 and 1296 as well. Both USA and Japanese devices are common. This interest in EME explains why two major activities at most VHF conferences are noise figure measurements of preamplifiers and antenna gains. One of the fascinating antennas had a 26 foot boom, and it was one of 16 in the operators array! No wonder 'QST' talks of antennas being damaged by wind and snow and the motto 'if it didn't blow down it wasn't large enough!'

"More than half of those attending the conference had, or were working EME. International participants were G3POI, LU3DCA, VE7CRU, ZS1FE, ZS1KE and VK6KZ. ZS1FE/KE had been working with AMSAT on Phase 3B and Tom Clark W3IWI President of AMSAT was there too.

"I found little or no activity on 2304 MHz and higher, but interest in 2304 was emerging. At present the activity was linked to 'Amateur TV' ie reception of 'cable TV' being distributed between 2000 and 2300 MHz! There was legal action in Los Angeles when I was there with private individuals being accused of 'stealing' pay TV.

"All in all, I felt we have much to be proud of in Australia with some remarkable achievements accomplished without easy access to new components, 'engineering samples' and surplus components ex manufacturers and military. Certainly they have some sophisticated repeaters and phone patch arrangements through them with appropriate codes.

"I was in Tokyo for two full days and spent a lot of time in the suburb of Akihabara. This has many electronic/electrical outlets. Impressions were very favourable! Components were readily available from hosts of 'cubicles', about 2 metres deep and 2½ metres wide and loaded with items from the side and back walls plus ceiling. There were many of these in the one building and similar buildings were adjacent eg one four storey building had these arranged around a U-shaped aisle, each cubicle had a different entrepreneur and many specialised in a particular area, eg transformers or hardware or instruments or computer chips etc, etc. And there were many

customers. Either there is a strong cottage industry or some very active home hobbyists!

"The amateur radio stores in Akihabara had a fantastic range of equipment. The most dramatic to me was the availability of 1296, 2304 and 5760 transverters! And loop yagi antennae for 1295 and 2304 MHz! The 1296 and 2304 transverters were all mode devices, the 5760 MHz FM and not on display. With the recent licensing of repeaters for the 430 to 440 MHz and 1.3 GHz band in Japan I guess we will see more commercial equipment for those bands, plus Phase 3B for 1.3 GHz.

"The 144 to 146 MHz region was crammed with JAs on SSB and FM and the paging systems above 146 MHz certainly provide good beacons for those in northern Australia and elsewhere.

"If the language barrier was not so great I am sure I could have learnt a lot about the state of the art for 1.3 GHz and above!

"Well, there are some observations. I could go on for a long time. Clearly I enjoyed myself and learnt a lot but still think VK is the best!"

Thank you Wally for allowing us to share in your experiences, I am sure there will be something of interest for most in your letter, and many would have liked to accompany you!

Wally also enclosed details of the equipment used for the reception of the 1296 MHz signal from Hawaii, and next month I hope to find enough room in this column to give you all some details.

## CONCLUSION

Sorry about the lack of VHF notes last month. It takes a lot to knock me down but the throat infection which went through my whole system certainly made life difficult for five weeks. Not even the clacking of the typewriter could be tolerated at the critical time! However, I have survived and managed to turn the transmitters on once again!

*Thought for the month: "In the good old days, the man who saved money was a miser; nowadays he's a wonder!" 73. The Voice in the Hills.*

AR

## COMMERCIAL CHATTER

### VK2DIK HELICOPTER MOBILE

Dick Smith is off on the next leg of his around the world helicopter adventurer.

He hopes to leave Sydney on the 1st June 1983 and head to North Queensland around the 2nd to 5th June. Then it will be off to Indonesia 6-12 June, Phillipines 13-17 June, China 18-28 June, Japan 28 June-4 July, North Pacific 4-9 July, Alaska 9-17 July, Canada 17-19 July and finally back to the USA on 19-22 July.

Equipment aboard is a Collins HF220 rig using upper sideband only. Frequencies will be 3.797, 7.225, 14.285, 14.146, 21.385 and 21.185 MHz.

Note: Normally operating on 21.385 or 14.285 MHz.

AR

# SPOTLIGHT

## ON

## SWLING

Robin Harwood VK7RH

5 Helen Street, Launceston, Tas 7250

Canada and the United States. The BBC have for many years also retransmitted Radio Canada International from their Davenport site for European listeners.

### NEW AMERICAN STATION

The new American commercial station located at Saipan in the Marianas, KYOI "Super Rock". I heard it on 15.190 MHz and it has continuous "rock" music with the occasional I/D in either Japanese or English. It appears to me that the same tapes are being used repeatedly, and there appears to be a lack of commercial advertising.

This compares with WRNO in New Orleans, the other American commercial station, although on weekends it is virtually indistinguishable from one of the many religious broadcasters that are about. For KYOI suggest you try either 15.190 MHz at 0500 UTC or 11.900 MHz at 1200 hours UTC.

### COMMERCIALS

Speaking of commercials, recently I got a shock listening to the Chinese Second Network on 8.320 MHz one night, when I heard Chinese ads for various goods and services manufactured in the PRC and available throughout SE Asia. This is certainly a change from hearing quotations ad nauseum during the Cultural Revolution of 1966-76. Listen at 1145 UTC on either 8.320 or 9.020 MHz and you might just hear what I heard. It could be possibly on a Monday only.

Incidentally as from 1st January, Radio Peking has changed its call to Radio Beijing. This has now brought it into line with the Chinese spelling, which reflects more accurately the Chinese pronunciation. Other place names have also altered their spelling for example Guangdong (Canton), Fujian (Fochow) etc. However, Shanghai the largest city in China is unaltered. It has twelve million inhabitants.

Well that is all for this month. Until next time, the best of 73 and good DXing!

Robin VK7RH

AR

is very difficult to hear ordinarily, it is a pity that they are operating and intruding on the amateurs' allocated frequencies. Other nations known to operate on these frequencies are, besides Laos, China, Albania, Indonesia, Egypt and North Korea.

### HELP INTRUDER WATCH

Recently, Bill Martin VK2EBM, our Federal IW Co-ordinator wrote to me, asking for help from SWLs in identifying and reporting intruders in the amateur bands. Some SWLs would have experience in identification of some of the broadcasters, and I personally feel that they could contribute to Intruder Watch. I recommend that they contact their State IW Co-ordinator (from the latest Callbook) and obtain some observer log sheets and forward them monthly.

One intruder I heard and logged recently on 14 MHz, was the Vietnamese News-agency on CW. On the 23rd of February, it was heard on 14.070 MHz at 1130 approximately with copy in English about possible troop withdrawals from Kampuchea (Cambodia). This station has been observed previously on 14 MHz with copy in Vietnamese and French. Its operational frequency does seemingly vary, due to how occupied the CW portion of 20 metres allocation is.

Incidentally, the Voice of the Khmer Rouge guerillas is easily observed here on 15.165 MHz and 11.680 MHz approximately at about 1030 UTC. The programmes emanate from Chinese transmitters and are quite loud. Naturally they broadcast in Khmer, the language of Kampuchea.

The station in Phnomh Penh is very difficult to hear and the Voice of Vietnam is quite happy to put its point of view. They are easily heard here just above WWV on several 10 MHz channels. On 10.060 MHz, there is a relay of the Domestic service in Vietnamese, and 10.040 and 10.080 MHz carry Foreign Service programmes. English can be heard on the latter channel at 1000, 1100 and 1200 hours UTC and also on 12.030 MHz. However, I do find the announcers' diction very hard to follow at times.

### REBROADCASTS

Recently, I made the observation that the BBC Caribbean Relay was being heard at 1200 UTC on 9.510. Well, I was right about the hemisphere but wrong on location. These programmes are being re-transmitted from the CBC transmitters at Sackville, New Brunswick and are on between 1100 and 1330 hours UTC for listeners in

Well, a quarter of the year has passed and it is already apparent that HF conditions have deteriorated rather markedly. Propagation has been very poor on some long distance routes, mainly the east-west path. Some of the weaker stations closer to home, that are not normally observed because they are drowned out by the higher powered outlets from Europe or America, have been noticed, particularly on the 41 and 49 metre bands. The lower frequencies are also improving gradually, with the disappearance of the atmospheric electrical activity. Signals from the Latin American regions should be making their presence felt on the 60 and 90 metre band allocations by now.

One interesting trend I noticed this summer, was Asian signals coming in much earlier, presumably because signals from Europe were down from normal. For instance, the Home Service from Pyongyang (North Korea) was monitored here as early as 0700 UTC on 11.350 MHz. Several Chinese outlets of their domestic and foreign services were also noticed, but not at the same strength, peaking a little later at about 0800 UTC. On a lower frequency, a Soviet station with Domestic programming has been heard on 4.485 MHz as early as 0900 UTC. It is located in the Petrov-pavlovsk region. I expect that this propagation will not continue, as the days lengthen in the northern hemisphere.

### INDOCHINA

Those interested in trying to receive several low-powered stations in the Indochina region might give the range of 6.3 and 7.1 MHz a thorough scan. The best time to listen is between 1100 and 1300 hours UTC. One noticeable characteristic is the lack of stability on their transmitting frequencies, and have been drifting over 30 kHz or so. For example, Radio Vietiane in Laos has been logged between 7.035 and 7.050 MHz in Laotian and at 1200 UTC in English. Several provincial Lao and Vietnamese stations have also been heard about 6.5 MHz. However, don't get confused with several powerful Chinese stations also around these frequencies. Their transmissions are extremely stable. One aid in identification of Vietnamese stations, is to check Hanoi on 10.060 MHz, very often the provincial stations carry programming from Hanoi.

### IN THE AMATEUR BANDS

There is an increasing trend for stations to utilise the exclusively amateur allocation between 7.000 and 7.100 MHz. While Laos

**JOIN A NEW  
MEMBER  
NOW**

# WICEN NEWS

Ron Henderson  
FEDERAL WICEN CO-ORDINATOR  
171 Kingsford Smith Drive, Melba, ACT 2615

## **A REVIEW OF THE PAST AND A LOOK AT THE FUTURE FOR WICEN**

### **ORGANISATION**

WICEN has come a long way organisationally over the past few years, principally because of closer and continuing liaison with the disaster control agencies in each state. Matters such as accreditation, insurance and compensation have been taken up mostly with acceptable results. Divisional activities have fallen into clear levels of responsibility and duties of co-ordinators established at local, regional and state levels.

Future organisational objectives must address simple state chains of command and insurance/compensation coverage for small groups and single amateurs who don't feel they have to belong now that third party traffic is authorised.

### **ACCEPTANCE**

Whilst there is no denying that acceptance of amateur radio by disaster control agencies has improved due to the efforts and liaison of WICEN, that acceptance is very fluid and frequently heavily dependent upon personalities on both sides.

Our objective here is to formally record that acceptance in some detail in the relevant state disaster plans and make it more independent of personalities of the day. Ideally it should be possible to initiate WICEN involvement from that plan and its contact lists.

Human nature being what it is we amateurs will only be called upon for help when other resources are exhausted and things look desperate. Then we will be expected to step in at full speed to stop the gap in a professional way and that's the challenge facing WICEN.

### **ACTIVATIONS**

With any volunteer organisation it's difficult to achieve a balance of activity and effort. Some operators will answer all and every call for assistance and do it for years (or until divorce strikes!) others will respond to real emergencies, still others can only "monitor the repeater from home for a couple of hours". A small turnover of members prevents stagnation but on the other hand providing exercise communications for everyone soon leads to cries of overwork and underpayment. Besides, should many civic organisations get free communications whilst so many of our numbers are unemployed?

Our future objectives here are to know our operators and their availabilities and select civic aid exercises with care so that they do have training, PR or public exposure value. A guide is not to be interested in groups who are not genuinely interested in us.

### **CAPABILITIES**

The capabilities of WICEN have changed over the years, keeping pace with advances in communications. The HF crystal locked, valve, battery powered equipment of the 50s has been replaced progressively by SSB transceivers and crystal locked FM gear which has itself been replaced by synthesised equipment. The use of repeaters has also enhanced capabilities. However old skills have been lost, such as CW message handling, filling the gap from the extremes of VHF FM repeater range to the first HF skip distance and working through interference both man made and natural.

For the future our capabilities/objectives must include matching current capabilities to disaster plan needs then testing and proving new techniques eg RTTY, portable repeaters, field antennas, field power supplies to name a few. In a phrase be progressive and not stagnate — remember our strength is our flexibility both equipment and frequency wise. Here's a thought to bring you down to earth, "how much traffic could be passed from Sydney to Melbourne on HF SSB should the public circuits be disrupted?"

### **PURPOSE**

Coupled closely with capabilities, which are really the response, is purpose or demand. Rather than tell the authorities what we can do and leave them to fit it into their plan, an approach which was used frequently in the past, let's be more progressive and see if we can solve their communications problems. To do this it's necessary to analyse the disaster plan, or if one does not exist, carry out a threat analysis, grouping threats into probability of occurrence and severity of disaster effect classes. Then we must aim to satisfy the most likely or frequent occurrences whilst still retaining some ability to meet the rarer circumstances. Such an approach perhaps conducted as a "think tank" of members retains their interest and sense of purpose in WICEN.

### **AWARENESS & TRAINING**

Historically, semi-closed groups went about training and provided WICEN communications in some isolation but in recent times the need for awareness and recruiting has led to a greater openness and exposure. Some training activities, both civic aid exercises and WICEN only sessions can be used to provide on-air awareness and for recruiting of new operators. Training in the past has been in voice procedure and message handling whilst neglecting our two great assets, flexibility of frequency and equipment.

Future awareness objectives must be targeted to get every Australian amateur aware of the existence and need for emergency communications, the role of WICEN, the existence of WICEN calling

frequencies, net discipline and how to use basic voice procedure.

Training objectives for WICEN operators will need to be expanded into frequency management considerations and into field operations. The first can be associated with IPS instruction, interstate nets and DX hunting whilst the latter can be achieved through field day and public display stations.

### **COMMUNICATIONS**

A never ending challenge, accomplished in the past through close-knit groups, printed news sheets and personal liaison. Regrettably printing and postage costs have taken their toll of late so our communications objectives must be to achieve amateur awareness through our magazine Amateur Radio, divisional broadcast items and regular WICEN networks supplemented by divisional and club meetings. But are you aware that only half the Australian amateurs belong to the WIA and receive AR, and a lesser number listen to broadcasts. The challenge then is to make them all aware of our existence and activities and perhaps reduce the on-air tuning up on working emergency networks.

### **THIRD PARTY TRAFFIC**

What has been the impact of third party traffic privileges? Not to fill all our bands each night with networks passing amateurgrams of trivia around the nation as some diehards feared and predicted. Sadly perhaps it's been the opposite as the amateur movement could easily sustain a basic traffic framework, particularly to isolated islands (I am aware of the useful VK0 traffic). Some have suggested that WICEN could become the framework for a national traffic network system whilst others have decried its lack of SES standard operating procedure. Personally I feel it's too soon to know just what will happen, perhaps the WIA missed the bus by not appointing a national traffic manager however they did produce a Policy Statement and operators' guide lines in keeping with their low key approach.

The effects on WICEN have been generally good, for despite the lack of formal changes to the regulations, far more civic aid exercises have been conducted. On the negative side however are the lost WICEN members who have seen no need to continue their affiliation and are now potentially exposed to personal risk liabilities whenever they become involved in emergency communications.

This gives rise to the last objective; to make membership of WICEN attractive and advantageous to the civic minded amateur who is willing to assist with communications in emergencies.

AR



# VK2 MINI BULLETIN

Athol Tilley VK2BAD  
Box 1066, Parramatta, NSW 2150



## COUNCIL REPORT

Divisional Council met on the 11th of February 1983 at the WIA Parramatta building.

The motion carried at the December meeting to invest \$5,000 in AGC debentures was rescinded as they had been suddenly withdrawn from the market. Other investments will now be considered.

A Yaesu FT107 was purchased to replace the existing HF transceiver at Dural. This will provide greater reliability for HF broadcasts and callbacks.

Fourteen new applications for membership for February were accepted.

Federal Councillor Stephen Pall, VK2PS, presented a report on WCY-83, identification changes for RTTY and ASCII transmissions, Melbourne mast enquiry, callbook entries, VK/ZL Contest Manager, 1983 WIA Federal Convention and subscription renewals. Five federal convention agenda items from VK2 were discussed; uniform concessions for students and pensioners, discounts for students and pensioners and voting representation at conventions. It was decided that this division would be represented by the Federal Councillor, Stephen Pall VK2PS and Alternate Councillors Wally Watkins VK2DEW and Tim Mills VK2ZTM.

Tim Mills presented a report on repeater applications, interference and breaches of regulations. It was noted that four Sydney repeaters had no identification, others had inadequate identification and four country repeaters were not at the site for which they were licensed. Council resolved that a letter be sent to each club involved advising them of their breach of regulations.

All amateurs should be aware of the need to observe regulations as breaches detract from the image of the Amateur Radio Service being responsible and self policing. Investigating the above breaches involves the DOC in considerable time and increases their costs, with a consequent rise in licence fees.

It was decided to reschedule the official opening of the WIA building at Parramatta to the 28th of May, 1983. Due to uncertainties as to the Minister for Communication's attendance, no other alternative was possible. When the Federal Election has been decided, new arrangements will be made and members advised.

## LIVERPOOL FIELD DAY

The Liverpool & Districts Amateur Radio Club will be holding its field day on the 24th of April, 1983 at the Fairfield Showground.

The programme of events is:

8.45 to 9 AM — HF all band scramble.

9 AM — start of observation trial.

9.30 to 10 AM — 10/2 m DF foxhunt.

10.30 to 10.45 AM — VHF/UHF scramble, repeaters can be used.

11 AM — disposals open.

11 to 11.30 AM — audible children's beeper hunts.

11 to 11.30 AM — junior (under 17) 2 m pedestrian foxhunts.

11.30 to 12 noon — senior (over 17) 2 m pedestrian foxhunts.

12 to 1.30 PM — lunch.

12.15 to 12.30 PM — meet the people contest.

1.30 to 2.30 PM — 2/10 m 2 transmitter DF foxhunts.

3 to 3.30 PM — talkin foxhunts on 2 m, 10 m, 70 cm (minimum of two starters needed for each band).

3.45 to 4 PM — 2 m pedestrian talkin hunt.

All 10 m events are on 28.47 MHz; all 2 m mobile, talkin, pedestrian talkin events are on 146.55 MHz; 2 m pedestrian events on 144.475 MHz; 70 cm talkin event on 439 MHz.

A grand raffle with the prize being a Commodore VIC-20 computer with cassette and game joystick (value \$412) will be held. Tickets are \$1 each or 3 for \$2.

Entry fees for the field day are; adults \$3, children attending school over 12 years \$0.50, families \$5.

Trade displays of amateur gear and home computers will be held and there will be technical and general interest quizzes, children's crossword and coloring competitions and other attractions. Food and drink will be on sale.

For advance purchase of raffle tickets or enquiries about the club or field day, write to PO Box 690, Liverpool, NSW, 2170.

## PUBLICATIONS

A new publications price list was included in the AGM booklet posted to all financial members. Please be sure to refer to it for your purchases.

## 8TH CONFERENCE OF CLUBS

The next Conference of Clubs will be held at the Parramatta WIA building at 109 Wigram Street, Parramatta commencing at 10 AM on Sunday, the 17th of April.

Agenda for the meeting has been sent to all VK2 Affiliated Clubs so that they can discuss the motions with club members as a guide for their delegate. Agenda items for the 1983 WIA Federal Convention will be discussed under General Business and the VK2 Federal Councillor, Stephen Pall VK2PS, will note members' views as a guide to his vote at the convention.

These Conferences of Clubs are an advisory policy making body of this division and all affiliated clubs should obtain the views of their members on agenda items and attend the Conference of Clubs.

Any member is entitled to attend as a spectator and you would certainly gain an insight as to the workings of the conferences and the important place they occupy in the operation of this division.

Confirming contact/report

DATE	UT	TO	RST	MHZ	2 Way	QSL
						PSE TNX



Rig

Ant

73's

## WIA QSL CARDS

As you will see from the sample, WIA QSL cards are now available from this division. You can arrange with your local printer to have the cards overprinted with your own call sign or you can use a rubber stamp as the cards are a smooth non glossy finish. They are available from the office in lots of one hundred for \$5 or \$6 posted.

Card colors are white with either black, blue or red print; blue with black or blue print; green with black print; yellow with black or red print.

Please indicate a second card color/print preference as some combinations may sell out. Send orders and cheque to PO Box 1066, Parramatta, NSW, 2150.

## COMING EVENTS

8th Conference of Clubs: 17th April at WIA Parramatta.

Liverpool Field Day: Sunday the 24th April at Fairfield.

WIA Federal Convention: 23 to 25th April in Melbourne.

NSW members and clubs are invited to submit news items for inclusion in these notes to WIA NSW Division, PO Box 1066, Parramatta, 2150 and mark the items "For Mini Bulletin". Items for June AR must reach us by the 22nd of April.

Athol VK2BAD  
AR



# QSP

## KEEP THAT NOSE TO THE GRINDSTONE

The longer you work, the longer you live, suggests a study by the US Social Security Service. It found that among men who retired at 62, some 81 per cent were alive six years later. But among those who kept on working, 86 per cent survived for at least six years.

Business Review Weekly  
AR





# VK4 WIA NOTES

Bud Pounsett VK4QY  
33 Lasseter Street, Kedron, Qld 4031

April is Radio Club Workshop Month in Queensland. On the weekend of the 9th and 10th, delegates from many parts of the state will assemble at Griffith University, where they will stay until Sunday afternoon. They will eat, sleep and work at the university for something like 20 hours of work time.

Griffith University, not far from the famous QEII stadium, was the Games Village last year and only ten minutes on the Freeway from downtown Brisbane. It is the perfect location for our Radio Club Workshop.

The Radio Club Workshop is an expensive exercise, but it is money very well spent. The total cost is estimated to run to about \$2.00 per member of our total membership of some 1200 or so members. The workshop is the forum where clubs, affiliated with the division, can convey the views of a large proportion of the amateurs of Queensland to our state council. The discussions have a large bearing on decisions made by council, not just for one year, but well into the future. It also briefs our federal councillors in preparation for the forthcoming Federal Convention.

It is a two-way affair, the delegates take back a wealth of information regarding the council, the services offered members of the division and most important, the fact that council is a body of amateurs, ordinary amateurs, just like themselves. Some time back a very popular slogan was "BREAK

DOWN THE BARRIERS". This is just what the Queensland Radio Club Workshop does.

In a letter to Queensland Club Secretaries recently, David Jones, VK4NLV, had this to say:

*"It should be noted that the highly successful concept of policy-investigating committees will be continued with this year's Workshop. Federal Executive has taken great notice of the policies developed by last year's Workshop, and we are certain that they are eagerly awaiting this year's results. That the Federal Executive are now reviewing basic Federal Policies in so many areas is a direct result of the input of your delegate at last year's Workshop."*

Some of the club motions to be debated will be:

That RTTY segments be proposed on the HF bands as follows: 3.545 ± 5 kHz, 7.045 ± 5 kHz, 14.090 ± 10 kHz, 21.090 ± 5 kHz, 28.090 ± 10 kHz, 28.490 ± 10 kHz.

That training kits be made up to assist the uniformity and quality of training by club instructors in the amateur operator licence courses.

It is interesting to note that two clubs, Mackay and Gold Coast have similar motions restricting frequencies within bands for all contests.

There is also the perennial proposal regarding the expansion of novice bands. There will be some very lively debating!

The NSW Division has expressed some interest in a similar workshop in that state.

The Queensland Council has invited an observer from VK2 and it is pleasing to note that this has been accepted. Guest speakers at the workshop will be Mr David Jull, MHR; Mr Sam Voron, VK2BVS; Mr Kev Whiting, the State SES Director and an officer from DOC.

A report on the 1983 Radio Club Workshop will appear at a later date.

## IT'S HISTORICAL

Peter Brown, VK4PJ, VK4 Division Historical Officer hosted another successful luncheon at Coorparoo RSL in February. Included were Perc Wood, Ex 4RO, 1927 from Benora Point, NSW; Steve Fittell, VK4YF, 1929, Gympie; Alf Bauer, 4AT, 1926; Arther Walz, VK4AW, 1926; Ralph Pepper, 2VH, 1922; Jack Wooster, VK4VH, 1930; and Norm Odgers, VK4ANO, 1924. Many were the stories told by all these "OLD TIMERS" and a lot more material was gathered by Peter.

Do any of you living in other states have memories of incidents of historical value to Queensland. Maybe you lived here in the 20s and 30s and can contribute to Peter's files. Peter Brown, VK4PJ, is QTHR or: Via Box 638, GPO, Brisbane, Qld 4001.

Bud VK4QY  
AR



# FIVE-EIGHTH WAVE

Jennifer Warrington VK5ANW  
59 Albert Street, Clarence Gardens, SA 5039

As I am writing this it is exactly a week after Ash Wednesday, and the dreadful devastation done by the bushfires is still upper-most in everyone's minds. To date I have not heard of any South Australian amateurs who have lost homes or lives, but I gather that there were at least three VK3s who were affected, to them we send our deepest sympathies and the hope that the legalities will be expedited quickly so that you can start rebuilding your lives.

The closest 'shave' that I have heard of over here, was that of Marlene and Brian Austin (VK5QO and VK5CA respectively) who lost everything outside the house — the fire coming to within two feet of the house! I think that the sprinkler system, on the roof, and the fact that they had spent many hours during winter and spring cutting back and clearing the under-

growth, possibly saved them.

I am sure that a full report on the activities of WICEN over the last week will appear on these pages in the near future.

For now, let me just say, a very heartfelt 'Well done and Thankyou' to John Mitchell VK5JM, our WICEN controller, and all the volunteers who worked many long hours in difficult and sometimes hazardous conditions. I hope that the 'Knockers' and 'Button-pushers' on the repeater never need the help of WICEN, but if they were in that position perhaps they would be a little more considerate.

I am currently playing host to five members of my family who are spending seven weeks holiday with us, from England. Not only have they been horrified by the devastation, which has wiped out many of the beauty spots which they had visited

only days before, but also the inaccuracies in the reporting of the bushfires in the British press, which reported that Adelaide was ringed by fire, and 80% wiped out! We have had phone calls from worried relatives and friends including amateurs that I talk to on a fairly regular basis.

A very pleasant surprise at our February meeting was a picture of the Burley Griffin Building done in poker-work by Pete VK6NOD (Noddy, as he likes to be called). We thank you, Pete, and it will be hung in the building for all to admire.

## DIARY DATES

23-25th April Federal Convention  
26th April Annual General Meeting  
24th May Getting Started in RTTY  
— John Mitchell VK5JM  
31st May Buy and Sell

AR

# IONOSPHERIC PREDICTIONS

Len Poynter VK3BYE

## NOTES ON THE PREDICTIONS

The mode of propagation used by IPS in compiling their predictions are reflected in the bar charts used to convert the Graflex symbols into a graphic picture.

When generating the Graflex charts (reproduced in a number of publications) the following symbols are used.

- 1 "·" — Propagation is possible but probably less than 50% of the days of the month.
- 2 "%" — Propagation is possible between 50% and 90% of the days of the month.
- 3 "F" — Propagation is possible by the first F mode on at least 90% of the days of the month unless there is a severe ionospheric disturbance.
- 4 "M" — Propagation is possible by both first and second F modes. The strongest mode is normally the first mode, but the vertical aerial pattern may influence the mode received.
- 5 "A" — High absorption, ie above the absorption limiting frequency but probably too close to it for good communication.
- 6 "X" — Complex mixtures of modes including the second E mode.

These are the most significant types we encounter. The full lines or bars on the chart cover 2, 3, 4 taking 5 into account. The broken lines or bars are depicted by 1. 6 is extremely hard to verify and is not taken into account.

The paths from Eastern Australia are based on Canberra. The paths from West Australia are from Perth. Suitable allowance should be made on Eastern paths for geographical differences. Times, as such as 1 hour difference between Victoria and Queensland in band openings occur. Often there is no signal available in one State, whereas the opposite effect occurs in the other State, they get the lot. Marginal differences produced by layer tilt and varying degrees of ionisation can be very frustrating.

Generally the predictions show that time of day when the path should be open between the two areas. All other factors notwithstanding.

### LEGEND

-  FROM WESTERN AUSTRALIA
-  FROM EASTERN AUSTRALIA
-  BETTER THAN 50% OF THE MONTH, BUT NOT EVERYDAY
-  SP SHORT PATH
-  LESS THAN 50% OF THE MONTH.

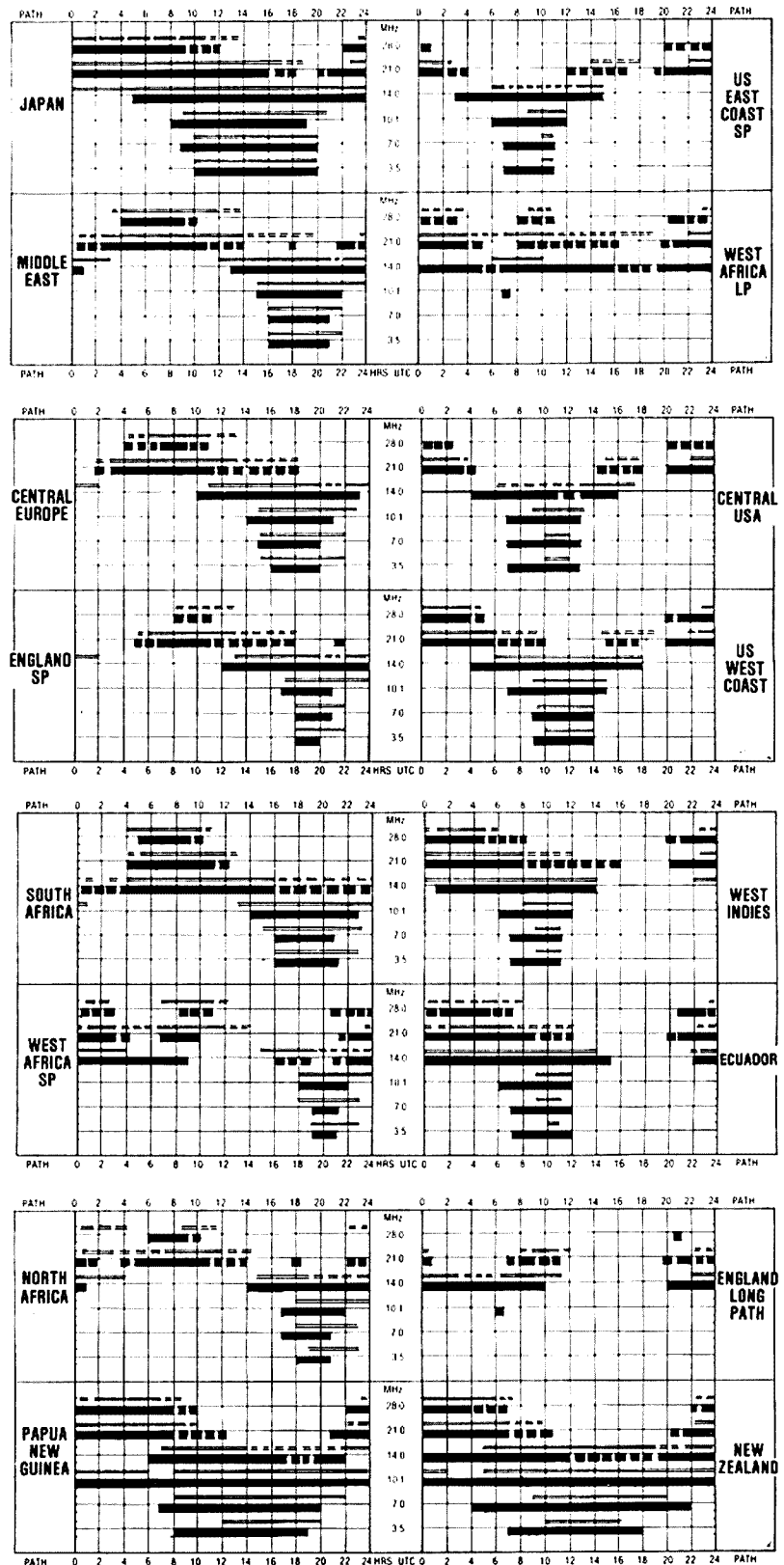

Predictions courtesy Department of Science and Environment IPS Sydney.  
All times universal UTC.

# Andrews Communications Systems

## "STATE OF THE ART" IN SCANNERS!

### SAIKO SC-7000

#### INCREDIBLE 70 CH SCANNER

ONLY

**\$449**



**LATEST MODEL JUST ARRIVED** Sole Australian Distributors

Why pay more for a lesser scanner? **BUY THE BEST!**

**AMAZING 2.5 kHz STEPS ON AUSTRALIAN LOW BAND AND HIGH BAND, NOT 12.5 kHz!**

Scans & searches Australian low band, high band, UHF & aircraft with up and down searching. Genuine lock out, AM/FM, AC/DC. Direct channel access, priority delay. Message counter, digital clock. Auxiliary output for tape recorder, Scan 20, 30 ... or all 70 ch as you wish.

**SENSITIVITY:**

0.4uV on VHF FM for 10dB S/N

0.8uV on UHF for 10dB S/N

1.0uV on AM Aircraft for 10dB S/N

**FREQUENCY RANGE:** 60-90, 108-136, 140-180, 380-520 MHz.

## CALL (02) 349 5792 or 344 7880 NOW!

### SHOP 7, GARDEN ST, MAROUBRA JUNCTION, SYDNEY NSW

Call For Closest Authorised Dealer To You!

THE MAIL ORDER SPECIALISTS Write to: PO BOX 33, KENSINGTON NSW 2033

## WIDEST OPTIONS AVAILABLE

Everything you ever wanted in Antennas and Antenna Accessories are Now Available including:

**"Antenna Specialists"**  
and  
**"Avanti"**

Our range optimises your range.

Call us Now:

### R. F. Industries

219 Warrigal Road  
Oakleigh 3166

**Melbourne (03) 570 1698**  
**Sydney (02) 519 5188**  
**Brisbane (07) 52 7600**

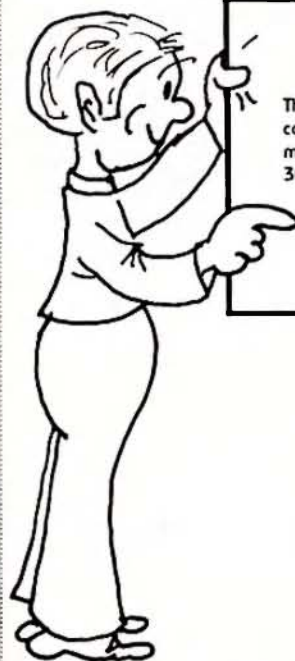

The 1983-84 Call Book is now being compiled. If you have relevant information for inclusion — Rush it to Box 300, Caulfield South Vic 3162 NOW.



# LETTERS TO THE EDITOR

Any opinion expressed under this heading is the individual opinion of the writer and does not necessarily coincide with that of the publisher.



1/138 Bluff Road,  
Black Rock, Vic 3193  
23.2.83

## Editors Note:

If any reader needs a copy of the QST cutting please send an SASE and a donation to cover photocopying costs to PO Box 300, Caulfield South, Vic 3162.

AR

PO Box 93, Toongabbie, NSW 2146  
8-2-83

Dear Sir,

Congratulations on the "new-look" AR. I am finding every issue of great interest and look forward to receiving my copy each month, in fact I make distinct mumbling sounds if it is delayed in the post.

73

Yours faithfully,  
Jim Swan, VK2BQS

AR

Hughesdale 3166  
2-3-83

The Editor,

Dear Sir,

So everything's up to date in Latrobe City. (VK7OW p 20 AR Feb 1983) Does the "improved Mark II G5RV" really sparkle?

Metinks something is wrong. Here in downtown Hughesdale we haven't seen a horseless carriage for sixty years. Modern automobiles purr rather than chuff along the sealed streets.

The length of the flat-top and the 300 ohm feeder, using a velocity factor of 0.85, is equivalent to 98.5 feet. Referring to the RSGB Amateur Radio Handbook (fig 13 p 361 3rd Ed) we find that at the feed point for the coax we have:

- on 3.5 MHz — a fairly large inductive impedance
- on 7.0 MHz — a low capacitive impedance
- on 14.0 MHz — a high inductive impedance
- on 21.0 MHz — a high capacitive impedance
- on 28.0 MHz — a low slightly inductive impedance

For the original genuine G5RV design the combined feeder and half flat-top length is 85 feet for which the same fig 13 gives:

- on 3.5 MHz — a low inductive impedance
- on 7.0 MHz — a high capacitive impedance
- on 14.0 MHz — a low capacitive impedance
- on 21.0 MHz — a low inductive impedance
- on 28.0 MHz — a high inductive impedance

Hence the "original" appears to present high VSWR for 7 and 28 MHz while the "improved Mk II" appears to present high VSWR for 14 and 21 MHz and a worse (compared to the original) VSWR on 3.5 MHz.

I do not think I want to buy the new "improved Mk II" version. Altering the feed line lengths from the original can improve the matching on some bands at the expense of others. If VK7MS is in the business of selling (and delivering and installing) 70 foot pine trees then I should be glad to receive a price list. Nothing makes an aerial system work better than putting it up higher.

Yours sincerely  
Ronald Roy

AR

61 Ashwood Dve,  
Ashwood 3147  
31-1-83

Dear Sir,

Reference the cover photograph of AR Feb 1983. What on earth is the soldering iron wielding male doing to the receiver? Is he soldering a component to the board? Could not be as all component leads

are on the other side of the board. Is he soldering a connecting lead? No, there are no leads visible under the iron. The iron appears to be just for some sort of show. If this be true then the magazine is treating readers amateurishly. Further, the cover photo shows an apparently finished receiver, yet I see a few components lying in front of the set? Some toroids which appear to be front end coils are shown soldered in place yet there are two toroids spare? While I cannot see a mains cord connected, I can see that the mains switch is on. And this, while the operator is soldering?

Surely the use of the depicted mains operated soldering iron went out with valve receivers? Why could not a more suitable iron for the task, such as a temperature controlled iron, have been shown. And, is that a piece of grass I see at the top right of the picture? Tch, Tch, what an odd workbench. And look at that length of solder from the tip of the iron to the solder spool. What a waste of solder, surely no amateur would do that in these hard times.

However I do like the piece of packing used for the top of the bench upon which the receiver is resting. The piece would really stand up well to the average amateur's work shop use. Especially if he smokes.

After all that, I read the article on the receiver and found it excellent. Keep up the good work and let's see more of these articles and perhaps less of the amateur pictures.

Peter Frederick  
VK3BSF

## Editors Note:

Many thanks for your comments, Peter, but the chap I am more concerned about is the photographer who used 240 V flood lighting whilst standing barefoot on the wet grass.

AR

88 New North Rocks Road,  
North Rocks 2151  
1-2-83

The Editor,

Dear Sir,

When I obtained my licence, I was grateful to the WIA who printed some of the books I read. I knew nothing of it other than that, I asked many people, most of whom said they knew as little of the WIA as I did.

I was about to write to the WIA and ask questions, when I received the answers and an invitation to join, from the WIA, with a sample copy of AR.

I have not met a great number of amateurs yet, but most I have found friendly, courteous and helpful. The odd "old spark" who may have even started the WIA told me that I was not doing my "patriotic duty", etc. unless I joined, plus various other comments.

I have made some friends amongst the early amateurs already and I am writing to ask of all experienced amateurs, their patience, indulgence and advice.

Please forgive us for not knowing what was in AR in 1979 or those many unwritten conventions. Just be patient with us and in forty years, we may be as good at it as you are now.

TNKS FR YR HLP!  
Noel, VK2YXM

AR

25 Beecroft Pde, Currarong 2540  
1-2-83

The Editor,

Dear OM,

I was indeed pleased to discover that my letter to you (15th Nov 82) concerning the distress call by

The Editor,

Dear Sir,

I have written a computer programme for my TRS-80 which sends and receives Morse Code.

My FT 101 transceiver has been keyed by the computer which can send at virtually any speed. On air reports have been good.

However, while the computer prints on the screen, anything that I send to it through a hand keyed audio oscillator — I have not had much success in decoding signals off air.

There appear to be two problems. One is that the received Morse needs to be pretty well perfect to be decoded — and there's not a lot of that about. The other is that the computer appears not to be able to differentiate between Morse signals and random noise and static.

Perhaps the first problem could be solved by having the Morse sent by another computer using my programme — but the second probably needs a good filter which removes, from the signal, everything but the Morse.

I wonder if there is anybody who would like to get together with me and help solve my two problems.

I would also be interested to have contact with anyone who could assist me to get the computer going on RTTY.

If anyone is interested — I'd be glad to hear from them at the above address or by phone on (03) 598 9467.

Yours etc,

Alan Maclean VK3ASL

AR

562 Koorringal Road,  
Wagga Wagga, 2650  
5.1.83

The Editor,

Dear Sir,

I enclose a cutting from "QST" of December, 1953 issue, with an estimation of the Novice situation in USA after two years of experience with this class of licence. While the Novice experience in USA may be somewhat different from the Australian situation, there are sufficient points of major benefit and interest common to both national areas to justify a request that you might publish some or all of the "QST" article for benefit of the Australian Amateur Service.

I realise that in the USA the Novice class was introduced prior to the CB "explosion", which had severely detrimental effects on the American Amateur development. Here we had the CB and pirate invasion BEFORE the Novice Licence was introduced to counter the massive unlicensed operations of the so-called CB movement. There were some benefits from the CB invasion in that CB and pirate usage provided a certain number of recruits to amateur radio and an increase in the Institute membership. However, we DID lose an entire HF band without compensation by invasion and the subsequent condoning of such reprehensible action by the Federal Government. Since then, other services have been ejected from their allocations to make room for the insatiable demands of the local CBRS and its big PIRATE brother, under the leadership of BIG BUSINESS interests for whose benefit the radio spectrum appears to be an area for exploitation to ensure that "already wealthy" citizens are made "still wealthier".

Yours faithfully,  
Rex Black VK2YA

HP2XBP/MM was of sufficient interest to warrant publication (Page 60).

Additionally the article "Emergency and Oistress Calls" on Page 36 is absolutely first class.

However, one minor error, in the publication of my letter was the callsign which was shown as VK2AEX — my call is 2AEV. Only a minor thing, but may cause embarrassment to 2AEX. (I guess it's my poor handwriting.)

73  
Yours faithfully,  
Alex McMurray, VK2AEV

Sorry for the unfortunate error Alex.

Gil Sones, VK3AUI  
Editor AR

AR  
10 Moorabinda Street,  
Buderim, Qld, 4556  
28-1-83

The Editor,  
Dear Sir,

The WIA has always urged members to "use your bands or lose them". Do you know, sir, that there is 25 kHz of the 15 metre band virtually never used by VKs?

I wish to make a plea on behalf of the Novice CW operators, that the WIA endeavour to get this segment — 21.100 MHz to 21.125 MHz — allocated for Novice CW operators — CW only — and I would back my submissions up with the following points.

1 This 25 MHz segment is rarely used by VKs. I have monitored this segment of the band over the years and can only once recall hearing a VK being called. At my radio club of some 45 members not one used this segment. Therefore, it is not being utilised to the full by Australian amateurs.

2 When the band is open the present 25 kHz novice segment is always very crowded. Overseas stations know it is the VK novice portion and know that they will always find VKs there. The JAs and KAs who call CQ VK for hours on 21.100-21.125 MHz and don't get answered are the newcomers who have not learnt of the VK frequency allocations.

3 Despite the "Gentleman's Agreement" there are still SSB operators in the CW segment. And, regretfully some of these offenders are full call operators.

4 The Woodpecker seems to have a particular liking for the CW segment too — many evenings there is barely 5 kHz clear for CW operation. Oddly he is not often on 21.100 to 21.125 MHz.

5 When rare DX appears in the Novice segment, full call operators soon appear — quite rightly so — so why not allow the full 50 kHz to Novice CW?

6 The American Novice CW operators appear to go down to 21.100 MHz.

I know many Novice CW operators share my views but there must be many more so please speak up or let me hear your views.

In conclusion, sir, I would like to reiterate my findings, that is, that there is 25 kHz of our valuable 15 metre band NOT being used by VK stations.

73  
Tom Dowling, VK4NUN  
AR

PO Box 109, Mt Druitt  
NSW 2770  
1-2-83

The Editor,

In reply to statements made by Bruce VK5XI in his article 'HERE'S RTTY' — February issue AR.

It is my understanding that the '-TY' in RTTY, was an abbreviation of the word 'TELEGRAPHY' or has it been changed mysteriously? CW or carrier-wave became 'telegraphy' when interrupted in a recognisable form, ie the Morse code or Continental code etc. Thus the two, CW and telegraphy, are widely used in an interchangeable role, and recognised officially in both 'forms'.

Rather than dither over a technicality, it would have been better had Bruce directed his energies towards a sensible agreement for the co-called 'gentlemen' in the amateur service. Many SSB

operators share the bands with the narrow band boys without any hassles, yet there are the odd few that make life difficult by using the recognised 'telegraphy' allocations' for their local ragchews when the DX is running etc.

The strange thing is, that these people had to learn the code, yet seem bent on taking their spite out on their fraternity for having had to do so. So I suggest that the 'agreements' be made more amicable, or that they be scrubbed altogether and fixed frequencies be allocated for the use of telegraphy (whatever form) and phone operations. Perhaps his influence with the WIA and DOC may help those of us who suffer silently? ... and long!

As far as the statistics on CW operators. My statistics of a particular competition show that CW outnumbered phone operations by 100 per cent! In other words the number of operators using the narrow band mode who shared the bands with the medium band folk are undisputably the MAJORITY USERS.

I would support your 'idea' then Bruce, of the greatest benefit for the greatest number of people, but please use my contest figures. It is this sort of thinking that will erode the foundations of what could be one of the finest amateur radio associations in the world.

Yours fraternally,  
Colin Stevenson, VK2VVA  
AR

11 Kyle St, Wembley Downs, WA 6019

The Editor,

I would like to enter a plea for LARGER circuit diagrams in AR technical articles.

As an example, please see Page 15 of Feb 83 AR. I have excellent eyesight but I consider that each of the circuits on this page could easily and profitably be enlarged x 2 in horizontal and vertical dimensions.

I would hasten to mention that the drafting (in this case by Lizz Kline) is immaculate and that SIZE is the issue at present.

Considering that the Feb issue of AR contained 64 pages and only four involve technical construction I feel it is not unreasonable to expand this aspect of AR.

If I were VK3XU, the author of the article "a Square One Receiver", I would certainly feel insulted in seeing my article presented in such a way.

As a different issue, I would like to point out that AR is the only magazine I know of that makes no payment for technical articles.

With the cost of components and test gear being what it is and considering the cost of producing photographs of the completed project, it is only natural that authors would send their better projects to magazines which will help to defray some of these costs.

I would suggest about \$30 per page subject to the editor's discretion if it is considered that an article has been padded out to fill extra pages or was considered to be too trivial to be paid for at this rate.

At \$30 per page you would still be getting many hours of research at a bargain price. If someone was likely to be insulted by being paid(!) they could always say so when submitting the article. Maybe we could end up with 8 or 10 technical articles per month?

Hope you can find time to consider implementing the above items. I'm sure the magazine would benefit from them.

Best wishes,  
Mike Murphy, VK6KRO/CXC

Amateur Radio does not normally pay for articles. However payment has been made for specially commissioned articles.

Editor  
AR  
Southport Avenue, Eagle Heights, Qld 4271  
31-1-83

Editor,  
Dear Sir,

I have, under a separate letter, just made a claim

for a VK4 record on 432 for a QSO on 432.1 MHz, 2 x SSB with ZL2TAL on 24/11/82 at 1220 UTC.

Recent QSOs have been, ZL2TAL on 144, also 2 x SSB ZL1BHX, ZL2VHT, ZL2UEC, ZL1TWR.

VK4TL on 10-1-83 2 x SSB 144.100 MHz  
VK2ZAB on 26-1-83 2 x SSB 144.015 MHz Iz  
I also have regular QSOs at 1000 UTC on 144.100 MHz with VK4ZWH at Bundaberg.

73  
Bill Hempel, VK4LC  
ex VK1BH,  
VK3AHO  
AR

10 Poulter St, Ashburton 3147  
7-2-83

The Editor,  
Dear OM,

I read with interest the letter from John Stone VK4NZ, regarding the colour of the AR cover and I had intended to comment on this since the latest change was introduced.

I have all copies of AR from March 1946 and see that there was no uniformity of colour for each volume until 1962. From then, until the recent change, each volume had a distinctive colour except for special issues like the Silver Jubilee.

For the convenience of "filing and finding" I suggest that the green background at the top of the cover be retained for 1983.

As a matter of historical interest the May 1946 copy cost sixpence at D J Collins, 400 Lonsdale St, Melbourne.

73  
C N Pickering, VK3ATP

A colour strip has been placed on the spine of the 1983 issues of Amateur Radio. Colour on the cover however is chosen to compliment the cover photograph.

Editor  
AR

12 Turner St,  
Thirlmere 2572  
14-2-83

The Editor,

The following advertisement appeared in our local rag, and gave my day a real lift:

CB Radio, 18 channel, \$40; 15 ft cable, \$7; TV Eye filter, \$3 etc

Now, with the standard of BCTV programmes, an eye filler must be a necessity — and cheap at the price. God Bless the phone-in classified ad. Lewis Carroll has nothing on them.

Regards,  
Stephen Gard, VK2ESG  
AR

50 Lenna St,  
Burwood East 3151, Vic.

Dear Sir,

I would be grateful if an officer from the WIA or the repeater committee would clarify the current problem with VK3RMM, the Mount Macedon repeater. I have heard many stories that mention interference caused by VK3RMM, or interference to RMM by other services.

More seriously, I have heard there is a chance that the repeater may never be restored to normal use. If this is true, it will be of grave concern to many amateurs who rely on this repeater for communication, especially those in country areas.

While none of this information may, in fact be true, I ask the WIA to make a statement as the amateur service is not benefited by erroneous stories floating around about the future of the repeater.

Yours faithfully,  
Terry Fraser VK3RT

The VK3RMM repeater has been voluntarily turned off in the interests of good public relations with the Victoria Police whose site we share by grace and favour. There are currently some co-siting problems which will be resolved as soon as possible.

An explanation has been given on divisional broadcasts.  
Victorian Division  
AR



# QSP

## PLEASE NOTE

Letters to the Editor should be short and to the point. They will be easier to read and will not require shortening or summarising.

Amateur Radio is produced under a very tight budget. Space for each item printed in the magazine is at a premium.

AR

## Editors Note

Correspondents should note that letters requiring local divisional attention or federal policy are more effectively dealt with when addressed to their local division.

Federal Policy is formulated after discussions by divisions and by the agreement of divisions. See Amateur Radio, February 1983, page 11.

The WIA Directory in Amateur Radio, December 1982, page 4 lists divisional office bearers and divisional addresses.

AR

## Answers to Novice Notes AOCF Test

Score 10 points for each correct answer, subtract 10 points for each question not answered and subtract 10 points for each incorrect answer.

1 (a), 2 (b) & (c), 3 (b), 4 (a), 5 (a), 6 (a) & (c), 7 (a) & (b), 8 (c).

If you scored less than 80 — back to the text books.

AR

## AGFA-GEVAERT LIMITED COMPETITION

will be announced  
next month

The winner will receive this  
camera

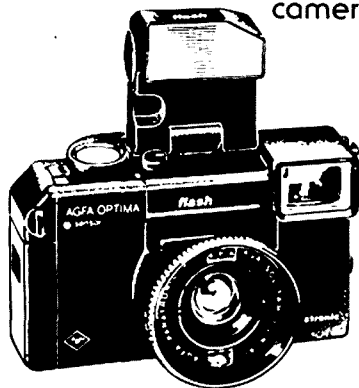

## Advanced Electronic Applications, Inc.

### CK-2

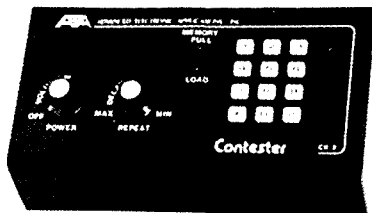

#### Contest Keyer

Speed Range (WPM)	1.99
Memory Capacity (Total Characters)	500
Message Partitioning	Soft
Automatic Contest Serial Number	Yes
Selectable Dot and Dash Memory	Yes
Independent Dot & Dash (Full) Weighting	Yes
Calibrated Speed. 1 WPM Resolution	Yes
Calibrated Beacon Mode	No
Repeat Message Mode	Yes
Front Panel Variable Monitor Frequency	Yes
Message Resume After Paddle Interrupt	Yes
Semi-Automatic (Bug) Mode	Yes
Real-Time Memory Loading Mode	Yes
Automatic Word Space Memory Load	Yes
Instant Start From Memory	Yes
Message Editing	Yes
Automatic Stepped Variable Speed	Yes
2 Presettable Speeds. Instant Recall	Yes

Price \$186.76 (includes ST)  
Plus P&P

### HY-TECH DISTRIBUTORS

Building 51,  
Archerfield Aerodrome, Q 4108  
Tel: (07) 277 5624  
Telex 43318

#### This month's specials:

Isopole Antenna 144 Junior — \$45.  
Superseded demonstration Model  
Morsematic MM-1 was \$269 — now  
\$198

## 1 KILOWATT RATED



## “MOBILE ONE”

Quality Communications  
Ask for it by name:  
“HAMTANNAE” or  
“Bush Bandit”

## ‘THE’ ANTENNAE

that has taken  
the 10 mtr band  
into the 80s.  
The ONLY  
Mobile Whip to  
cover the  
WHOLE Band  
allocation.  
Under 1.5:1  
VSWR.  
Available in 60”  
and 40” sizes.

HAMTANNAE™

MODEL: M10-1

MOBILE ONE AUSTRALIA

© Copyright Mobile One

# Silent Keys

It is with deep regret we record the passing of —

COLIN ANDERSON	VK3XV
JOAN FUDGE	VK7ZY
DOUGLAN JOHNSON	G6DW
R McFARLANE	VK4AYZ
J C PARK (Life Member)	VK6BB
W J RAFTER	VK4PR

# Obituaries

Richard McFarlane VK4AYZ

It is with deep regret that we advise the passing of Richard McFarlane, of Mount Isa, on the 19th of January, 1983. He was thirty-six years old.

Richard's interest in electronics and radio dated back to his school years in Perth, but it wasn't until he was settled in Mount Isa that we talked each other into sitting the Novice Exam. Richard's callsign VK4NYZ/ZSR came from the August 1979 exam with VK4AYZ the following year.

Richard's interest in computers inspired others of our community along the same path, and he was always ready to help and advise when needed. Likewise, his enthusiasm for 2 metres helped the repeater project.

Richard was a quiet, unassuming person and wasn't heard 'on air' very often; his interests were on the work bench experimenting and building, but everyone was welcome in his shack.

Our sympathies go to his wife Claire and young daughter Alice and also to his parents Dixie and Val.

Richard was a true gentleman and he will be missed by his many friends.

Roger Wood VK4ARZ  
Sharen Wood VK4AW

AR

# WARNING!!



Disposing of your old rig??

Please ensure it goes **ONLY** to someone licensed to use it on **YOUR** bands.

# HAMADS

**PLEASE NOTE:** If you are advertising items FOR SALE and WANTED please write on separate sheets, including ALL details, eg Name, Address, on both. Please write copy for your Hamad as clearly as possible, preferably typed.

\* Please insert **STO** code with phone numbers when you advertise.

- Eight lines free to all WIA members. \$9 per 10 words minimum for non-members.
- Copy in typescript please or in block letters double spaced to PO Box 300, Caulfield South 3162.
- Repeats may be charged at full rates.
- Closing date: 1st day of the month preceding publication.
- QTHR means address is correct as set out in the WIA current Call Book.

Ordinary Hamads submitted from members who are deemed to be in the general electronics retail and wholesale distributive trades should be certified as referring only to private articles not being resold for merchandising purposes.

## TRADE HAMADS

Conditions for commercial advertising are as follows: The rate is \$15 for 4 lines, plus \$2 per line (or part thereof) minimum charge \$15 pre-payable. Copy is required by the first day of the month preceding publication.

**AMIDON FERROMAGNETIC CORES:** Large range for all receiver and transmitter applications. For data and price list send 105 x 220 SASE to: R. J. & U. S. Imports, Box 157, Mordale, NSW 2223. (No enquiries at office: 11 Macken St, Oakley, 2223.)

**CB RADIOS** \$69; walkie talkies, short wave radios, military, outback, business, amateur, marine, repairs, RTTY Siemens 100A printer \$120; base mic., \$45; ultrasonic alarm, \$35; all ham bands on a single 6 ft. whip, 1.8 to 30 MHz, for base or mobile, \$300; aeriels, installation, demonstrations, 40 ch. CB conversions, accessories, new rigs weekly. Bridge Disposals, 12 Old Town Plaza, opp. Bankstown Railway Station, NSW. Mail order service and all enquiries to 2 Griffith Avenue, Roseville 2069, or phone Sam VK2BVS, 7 pm to 9 pm only. on (02) 407 1066.

**DIGITAL LOGIC:** Hands-on, teach-yourself module which combines theory with experiments on Digital Circuits Board. Manual of 117 pages by experienced teacher. Gentle entry into world of logic gates, flip-flops, counters, with challenge to go further into very basic computer electronics. Parts kit \$34, assembled in box \$46, plus P & P. CYRIL VK2ACO. Marist Brothers, 44 Langdon Rd, Winston Hills 2153. Ph: (02) 624 5545.

**OWNERS OF MOD I, MOD III, & SYSTEM 80 COMPUTERS.** Use your computer to transmit and receive Morse, RTTY & ASCII. Programmers delve into the secrets of your ROM. Amateurs. The RICH CRAFT books are the least expensive way of using your computer in these modes. Disks also available. Send SASE for full details. NORTHERN DIGITAL, BOX 333, CHARLESTOWN 2290. Ph: (049) 43 8981.

## WANTED — NSW

**CRO TUBE,** 9 pin loctal and/or circuit diagram for the Cossor Miniscope CRO. VK2BGL QTHR. Ph: (047) 54 1096.

**CW TRANSMITTER.** High Power. VK2BOA QTHR or Ph: (049) 43 8981 AH.

**LINEAR RF POWER AMPLIFIER** HF 80-10 m, capable of maximum legal power. USA manufactured preferred, by genuine cash buyer, all offers to PO Box 120, Vaucluse, NSW 2030 or Ph: (02) 371 8854.

## WANTED — VIC

**COLLECTOR** — Historian requires any old Morse keys or bugs (semi-auto devices). Ex-services, PMG etc. Will pay cash. Maurie, VK3CWB. PH: (03) 49 4167. PO Box 115, Fairfield 3078.

**HEAVY DUTY ROTATOR** — Emotator or similar. Enquiries to Trevor VK3KEG. Ph: (03) 789 4911.

**MAGAZINES** — ARs containing operating procedure incl CW. Portable, Mobile operation, QRP and HF antennas for limited space. G FHarris, 9 Lomas St, Ringwood East 3135.

## WANTED — QLD

**HALLICRAFTERS TX/RX.** Also Hallicrafters general coverage RX, SX-71 or earlier. Roland Clark VK4EG. QTHR. Ph: (079) 54 6631.

**RTTY ART:** Copies of pictures or tapes of RTTY art. Also circuits of CW and Baudot idents, EPROM or Diode Matrix. To suit RTTY ident. Contact Col VK4BCP QTHR.

**VALVES NEW** 6AK5, 5Z4G, OA2, OB2, 6080, 6X5, 7360, ECC88, 6C4, QV04/7, TT15, 2-01C (AC probe diode for HP VTVM). New 7 pin & 9 pin valve sockets. VK4JZ QTHR. Ph (07) 44 7980 AH (not weekends).

## FOR SALE — NSW

**ANADIX DP8000** fast dot matrix line printer serial RS 232/current loop or parallel \$375. OST back issues 1960 to 1981 about six issues missing. Also Electronics Australia 1968 to 1982 nearly complete. First reasonable offer. Mark Webster VK2BAK 1 Fisher Ave. Wahroonga, NSW 2076. Ph: (02) 487 1299.

**COMPUTERS SBC 2650, SCVT 100, 32K-2K EPROM, 6K CMOS RAM, KT1500, 8K.** Lots software, Xitex TTY — ASCII board, Creek Mod75 Printers, 240 V synch, 50 baud, small, golfball \$25. Take the 4 and incl manual, 75 baud, gears, spares, Klienschmidt TTY RePerf-TD \$30. Pye overland FM lo-band, solid st. Rx, 6146. Tx \$25. VK2MJ QTHR. Ph: (0649) 51624.

**CALLBOOK 1982 Foreign \$10.** Spider quad hub W6SAI design strong construction \$30. VK2DET Blackheath NSW QTHR. Ph: (047) 87 7003.

**FT-7,** no mods, xtals for 10 m, mobile bracket \$350 or xchge for 2 m handheld plus cash adjust. Also Yaesu mobile whip system for 80, 15, 10m \$75 complete. Stephen, VK2ESG. Ph: (046) 81 9675 AH.

**HF LINEAR AMPLIFIER,** over 100 W O/P, broadband, rugged Philips transistors, as new, commercial unit, ideal for FT7 or TS120V. \$100 VK2BGL QTHR. Ph: (047) 54 1096.

**ICOM 701 HF Txcvr,** with power supply and desk mic, bought from Vicom. Excellent condition \$730 — Mike VK2BMR QTHR. Ph: (02) 639 8643.

**ICOM IC740** under warranty \$750. TS8205 two months use as Rx. New condition with workshop manual etc \$650. Ph: (02) 467 2354.

**KENWOOD TR7400A** 2 m Tcvt, 25 W, 800 ch. Perfect cond. Covers never been off used only as base station \$295. Max VK2GE. Ph: (043) 92 4900.

**KENWOOD TS-120V TRANSCEIVER.** Mint condition. MB-100 mobile bracket. 26.5-28.0 MHz. Operators

manual \$450. ATN 28-30-5 five element beam \$100. Charles VK2VSH QTHR. Ph: (067) 54 9328.

**KENWOOD TS520S** Tcvr, CW filter, remote VFO 520 S, SP520 spkr with spare set tubes, manual, immac cond in orig box \$650; Shure 444 SSB mic new cond \$65; 2 x Orake TV 3300LP TVI filters \$30 ea. Oskerblock SWR 200 \$50; Ham III rotator \$100; Rak balun \$10; 5 new 6146B \$8 ea; 2 new 572B \$15 ea; 10 new 6DQ5 \$2 ea; 2 x 811; SCR 211 freq meter \$45. Geoff VK2FY QTHR. Ph: (02) 602 9043.

**KENWOOD TS820S** with MC50 mic, DC option, manual and remote VFO in original cartons. Excellent condition \$700. Greg VK2KEO. Ph: (02) 982 3827 AH.

**KENWOOD TS830S** with MC50 S800. Kenwood VFO digital \$270. Kenwood SM220 monitor with DG8 \$370. Kenwood speaker \$30. Kenwood tuner-antenna \$170. All equipment very little use. 4 months old. Excellent condition. Herman Feige VK2EHF. Wollar Rd. Cooyal via Mudgee, NSW 2850.

**REALISTIC PRD-2002**, 50 ch scanner as new. The best on the market \$430 ONO. Sony ICF 2001 fully synthesised HF portable Rx with mains pwr supply \$250 ONO. Philip VK2DPN QTHR. Ph: (049) 43 4220.

**UNIDEN 2020 HF** Txcvr complete with ext VFO, matching speaker, manuals, connectors, mic \$375. VK2BOA QTHR or Ph: (049) 43 8981 AH.

**YAESU FT101E** SSB AC/OC mic manual & 4 x 6JS6C \$550. Yaesu FL50 80 m-10 m HF, 50 W transceiver \$130. Grundig GDO 240 V 6 coils 1.7 MHz-250 MHz \$50. Kyoritzu SWR bridge 109 \$10. CR impedance bridge \$10. The lot \$700 ONO. Deceased estate of VK2ABT. Ph: (02) 858 1897.

**YAESU FV9010M** scanning VFO 40 mem \$355. Yaesu FP12 power supply with speak \$125, Oskerblock 300 SWR and power meter — HF, VHF and UHF metering \$85. Shure 444 base mic \$65, EA-Dick Smith freq counter \$85, Sony AM/FM and BFO 150 kHz to 136 MHz G band Rx \$430. Other bits and pieces, panel meters etc. All items ONO and in as new cond. Craig VK2PLF. Ph: (049) 43 9996.

**FOR SALE — VIC**

**ANTENNA CE35DX** 5 el triband Yagi, 3 el 20 m and 15 m, 4 el 10 m comes with balun and 10 m RG8 coax GC with instructions \$200. Also, Pye Victor and AWA car phone MR15A. No crystals \$10 each. TE20D RF sig gen 120 kHz to 500 MHz in 6 bands \$40. Cash only, all prices firm. Contact Phil VK3DCZ. Ph: (03) 723 1669.

**DECEASED ESTATE** of Dick VK3DG, late of Lancefield. Yaesu FT101E CW filter \$650. FT620 6 m \$250. Swan 350 \$250. Hygain ant TH6 \$200. Hygain 14 el 2 m ant \$50. KW107 ant tuner \$100. VTVM 2 of \$30 ea. Prop pitch Motor \$20. 2 m Rx converter \$20. Amount of disposal and vintage bits. What offers. Boxes of books and mags 1937 and on. Offers. Enquiries to VK3AMW. Ph: (054) 29 1247. QTHR.

**FT101E** with opt novice mod. AC/DC full manual, mike, fan AC/DC \$425. VK3DSP. Ph: 509 8216 or (059) 85 4185 (AH).

**FT200** with match power supply and speaker, spare valves & manuals. No mods, low QSOs. Black panel \$380. MFJ 941B 300 W ant. tuner \$85. DX 160 Realistic Communication RX \$110. All excellent cond. VK3ALT QTHR. Ph: (03) 277 2337.

**KENWOOD TS120S** 100W transceiver, late model, mint condition in carton, complete with noise cancelling mic, operator and workshop manuals. \$450 ONO. VK3ARZ QTHR. Ph: (03) 584 9512.

**KENWOOD TS520** Txcvr C/W, AC/DC cables and spares including 6146 Bs unmarked in original carton. \$450 ONO. VK3NV QTHR. Ph: (03) 578 6866.

**KENWOOD TS520S** with 500 Hz CW filter plus VC-2 SWR/power meter and Daiwa LP filter, \$520. Also FOK Multipalm II 2 m HH with R 2, 4, 5, 8, CH 49, 50 crystals \$100. VK3DRU. Ph: (03) 846 1259.

**NALLY TOWER** 64 ft inc extension \$650. Emotator 502 Cxx — complete control and cables plus Swiss Quad 10 & 15 m with RG8 cable \$450. On site Preston. All EC. Urgent sale — moving QTH. VK3NAJ QTHR or Ph: (03) 44 6803.

**TRANSFORMER** — 230 V to 110 V. Suitable for teleprinter \$20. Interface from TRS-80 computer to ASR 38 teleprinter \$15. Typewheel for ASR38 teleprinter. Slight damage \$10. VK3ASL. QTHR. Ph: (03) 598 9467.

**YAESU FT101E** includes 10 MHz with manual \$550. Yaesu FL2277B 1200 watt linear with manual \$450. Yaesu YD884 desk mike \$30. All units mint cond. Rod VK3JS. Ph: (03) 551 1367.

**YAESU FT227RB** \$300 ONO. Would consider suitable 2 m handheld as part exchange. VK3KQR. Ph: 25 8255.

**YAESU FT227R** memoriser 2 m FM txcvr, little use, immaculate condition in original carton, complete with AED scanner, mic, handbook, mobile mount (unused). \$225 ONO. VK3ARZ. Ph: (03) 584 9512.

**YAESU RSM2** plus loading coils for 80-10 m, gutter mount HF mobile aerials complete with coax \$100 ONO. \$153 new price. Lionel VK3NM QTHR. Ph: (03) 568 2733 BH or (03) 88 3710 AH.

**FOR SALE — QLD**

**FT101E** complete with all accessories and handbook. No mods. Includes 12 BY7 and two P/A 6JS6C. All good condition, as new \$400. Ph: (071) 43 5853. Maroochydoore.

**KENWOOD TS830S**, 12 mths old in top condition \$850. Contact Mick Haagsma. Ph: (07) 284 7739.

**YAESU FT101ZD**, not WARC bands, with NCW filter, fan, spare fan, DC-DC supply and mic \$450. YAESU FV901 DM external VFO with NiCad battery memory back-up \$150. VK4AJI QTHR.

**YAESU FT 207-NC3** fast charger \$50, 2 m Amps 2N6084, 10-40 W \$40, 2N5590 2-10 W \$35, 1296 MHz microwave modules 432-1296 varacter \$70, 1296-144 Rx converter \$60, 1296 pre-amp \$55 Kevin VK4ZKE. Ph: (07) 377 3785 BH or (07) 201 3006 AH.

**FOR SALE — SA**

**KENWOOD R1000** mint cond, orig packing \$350. Dentron Clipperton-I, HF linear, hi-lo power to 2 kW input, unused, orig packing \$550. Hans VK5YX. Ph: (08) 271 5350. QTHR.

**PRC/1038/55 MHz FM** Txcvr with AC power supply. What offers? ICOM 251A/2 m all mode Txcvr \$600. Icom 551/6 m all mode Txcvr, with P/band, VOC, FM, fitted \$600. Byer model 66 reel to reel taperecorder. What offers? Both ICOM transceivers are in excellent condition, with original packing. Don VK5ADT. Ph: (085) 64 2159.

**YAESU FT200** Txcvr and power supply. Mint condition. No mods. Original packaging, instruction manual and spare valves \$320. VK50B QTHR. Ph: 276 6124 AH.

**FOR SALE — WA**

**FTDX560 TRANSCEIVER** with outboard VFO and spare tubes, 560 W input; also FT301D, all solid state, 200 W with mains power supply, both mint condition. What offers? VK6VW QTHR. Ph: (09) 387 1269.

**YAESU FT101ZD** 160-10 m with handbook and mic \$600. Astatic D104 mic on UG8 stand \$105. Datong active antenna AD170 and interlace unit IB2 complete \$80. Daiwa auto tuner CNA2002 \$380. Offers considered. Neil VK6NE QTHR.

**FOR SALE — TAS**

**DUO BAND BEAM**, 15 m and 10 m with separate gamma matches. W Wulf design \$100. VK7KWC. Ph: (002) 44 1268.

**FOR SALE — NT**

**YAESU FT101 Mk II** (late model, 160-10 m). CW filter, fan, mic. FV101B remote VFO. Very clean. Spare finals. Service manual \$500 for all. Nick VK8DE, 57 Memorial Avenue, Alice Springs, NT 5750. Ph: (089) 52 3692.



**ADVERTISERS' INDEX**

AGFA-GEVAERT LIMITED .....	4
ANDREWS COMMUNICATIONS SYSTEMS .....	75
BAIL ELECTRONIC SERVICES .....	8
BRIGHT STAR CRYSTALS .....	15
CHIRNSIDE ELECTRONICS PTY LTD ..	53
CW ELECTRONICS .....	53
DICK SMITH ELECTRONICS .....	5
EASTERN COMMUNICATION CENTRE PTY LTD .....	23
EMTRONICS .....	IBC
GFS ELECTRONIC IMPORTS .....	2, 3 & 53
HAMRAD .....	25
HY-TECH DISTRIBUTORS .....	78
IAN J TRUSCOTT ELECTRONICS .....	51
ICOM AUSTRALIA PTY LTD .....	BC
MAGPUBS .....	6
MAGRATHS .....	IFC
MOBILE ONE .....	4 & 78
NOVICE LICENCE — G Scott & A Brucesmith .....	4
RF INDUSTRIES .....	75
TRIO-KENWOOD (AUSTRALIA) PTY LTD) .....	37 to 42
VICOM INTERNATIONAL .....	7
VK2 WIA NOVICE LICENCE .....	15
VOLLER TRANSFORMERS .....	30
WATCHMAN ELECTRONICS .....	53
WERNER & G WULF .....	25
WIA BADGES .....	25
WILLIAM WILLIS & CO PTY LTD .....	53







# EMTRONICS

Retail Division of EMONA ELECTRONICS P/L

649 George St., Sydney, NSW, 2000. Phone: 211-0531.

**CORRESPONDENCE & MAIL  
ORDERS:**

Box K21, Haymarket  
NSW, 2000, Australia

**WRITE, PHONE OR CALL IN!**

## !!!AUTUMN SPECIAL!!!

### ICOM:

FANTASTIC NEW  
PRICES

IC-720A — HF TRANS.	\$1060
IC-730 — HF MOBIL TRANS.	\$725
IC-740 — HF TRANSCEIVER	\$864
IC-R70 — RECEIVER	\$719
IC-505 — 6M TRANSCEIVER	\$383
IC-2A — HAND HELD 2M	\$250
IC-4A — HAND HELD 70 CM	\$276

## WRITE FOR OUR NEW 1983 CATALOG

SEND 80c for P&P

### HAL:

BRAND NEW ST-5 & ST-6  
DEMODULATOR KIT. RECOMMENDED  
FOR THE EXPERIENCED HAM

ST6 — ~~\$366~~ NOW \$250

ST5 — ~~\$174~~ NOW \$115

### JRC — NRD515 SYSTEM

1 only NRD515 famous  
COMMUNICATIONS  
RECEIVER

1 only NDH515 MEMORY  
UNIT

1 only NVA SPEAKER

TOTAL ~~\$1949~~

Package SPECIAL \$1600

### TELEREADER CWR 610



See What You've Been Missing!

Stay in touch with world events, monitor weather, press, ship traffic, and radio amateurs. Connect to your receiver and display shortwave radio teleprinter and Morse code transmissions with the new receive-only.

Telereader CWR-610 Code Master

NEW ECONOMY DECODER-CONVERTER

~~\$247~~ NOW \$199



SWR & POWER METER FOR HF/VHF BAND  
MODEL PM-4HV

Compact and light weight SWR/Watt meter designed for mobile operation as well as base station use.

~~\$38~~ NOW \$29

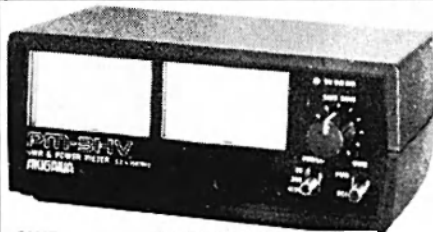

SWR & POWER METER FOR HF/VHF  
BAND MODEL PM-3HV

High quality SWR/Watt meter designed as SWR and power can be measured independently at a time. With meter illumination and "On-the-Air" indicator lamp.

~~\$65~~ NOW \$45



SWR & POWER METER FOR VHF BAND  
MODEL PM-5V

PM-5V is designed to cover VHF band. Illuminated meter is convenient to the use in mobile operation. A complete set to be in display carton.

~~\$56~~ NOW \$39



MIKE COMPRESSOR WITH LINEAR  
AMPLIFIER  
MODEL MCLA-1

The MCLA-1 incorporates both a Mike Compressor and Linear Amplifier.

~~\$95~~ NOW \$68



ACTIVE AUDIO FILTER MODEL AAF-1

By connecting the AAF-1 between a receiver and an external speaker (or earphones), you can reduce unnecessary or undesired audio signals from your receiver.

~~\$98~~ NOW \$68

### ROBOT 800 COMMUNICATION TERMINAL

MODEL 800

FOUR MODE SUPER TERMINAL  
Baudot, ASCII, MORSE, SSTV.

SUPER TERMINAL HAS THEM ALL!!

#### FEATURES

\* Split screen display \* Word mode \* Line mode  
\* Autostart \* Programmable WRU \* Here is messages \* Automatic CR, LF \* USOS — Unshift on space \* Keyboard station control \* On screen status indicator \* On screen tuning indicator \* Current loop keyer \* Programmable narrow shift \* Demodulator \* Limitless RTTY operation \* Morse autotrack \* Side tone oscillator \* Morse code trimer \* Speed indicator  
SSTV alphanumeric and many other features

~~\$1150~~ NOW \$700

MULTIMETER  
WITH  
SWR/POWER  
METER  
MODEL MM-1

The MM-1 is high quality 20K-ohm/VDC Multimeter usable as the SWR/Power Meter as well by connecting with the directional coupler unit included.

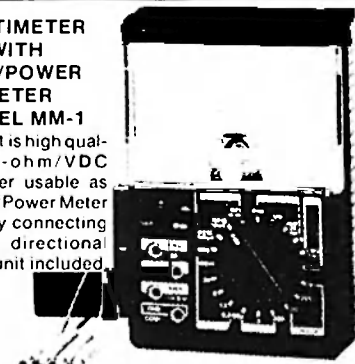

~~\$55~~ NOW \$28

# IC-740

## *The Inflation Beater...*



The IC-740 from ICOM offers extensive versatility for the serious operator at a realistic price, contains all of the most asked for features, in the most advanced solidstate HF base station on the amateur market... performing to the delight of the most discerning operator.

Study the front panel controls of the ICOM IC-740. You will see that it has all of the functions to give maximum versatility to tailor the receiver and transmitter performance to each individual operator's requirements. Features of the IC-740 receiver include variable width and continuously adjustable noise, blanker, continuous, adjustable speed AGC, adjustable IF shift and variable passband tuning built in. In addition, an adjustable notch filter for maximum receiver performance, along

with switchable receiver preamp, and a selection of SSB and CW filters. Squelch on SSB Receive and all mode capability, including optional FM mode. Split frequency operation with two built in VTOs for the serious DX'er.

The IC-740 allows maximum transmit flexibility with front panel adjustment of VOX gain, and VOX delay along with ICOM's unique synthesized three speed tuning system and rock solid stability with electronic frequency lock.

Maximum versatility with 2 built in as standard, plus 9 memories of frequency selection, one per band, including the new WARC bands.

With 10 independent receiver and 6 transmitter front panel adjustments, the IC-740 operator has full control of his station's operating requirements.

See and operate the versatile and full

featured IC-740 at your authorized ICOM dealer.

#### Options include:

- FM Module
- Marker Module
- Electronic Keyer
- 2-9MHz IF Filters for CW
- 3-455KHz Filters for CW
- Internal AC Power Supply

#### Accessories:

- SM5 Desk Microphone
- UP/DWN Microphone
- Linear Amplifier
- Autobandswitching Mobile Antenna
- Headphones
- External Speaker
- Memory Backup Supply
- Automatic Antenna Tuner

**Discover a new deal with  
ICOM AUSTRALIA PTY. LTD.**

7 DUKE STREET, WINDSOR, 3181, VICTORIA, AUSTRALIA

FOR FURTHER INFORMATION TELEPHONE (03) 51 2284.



**The World System**

# Amateur Radio

VOL. 51, No. 5 MAY 1983

Registered by Australia Post — Publication No. VBH 0569



JOURNAL OF THE WIRELESS INSTITUTE OF AUSTRALIA

CONSTRUCT A 13.8V REGULATED SUPPLY

EQUIPMENT REVIEW — VoCam 2m ANTENNA

EXCLUSIVE HEARD ISLAND STORY

WIN AN AGFA OPTIMA FLASH CAMERA

RF RADIATION — Part 2

MILITARY SURPLUS — Part 2

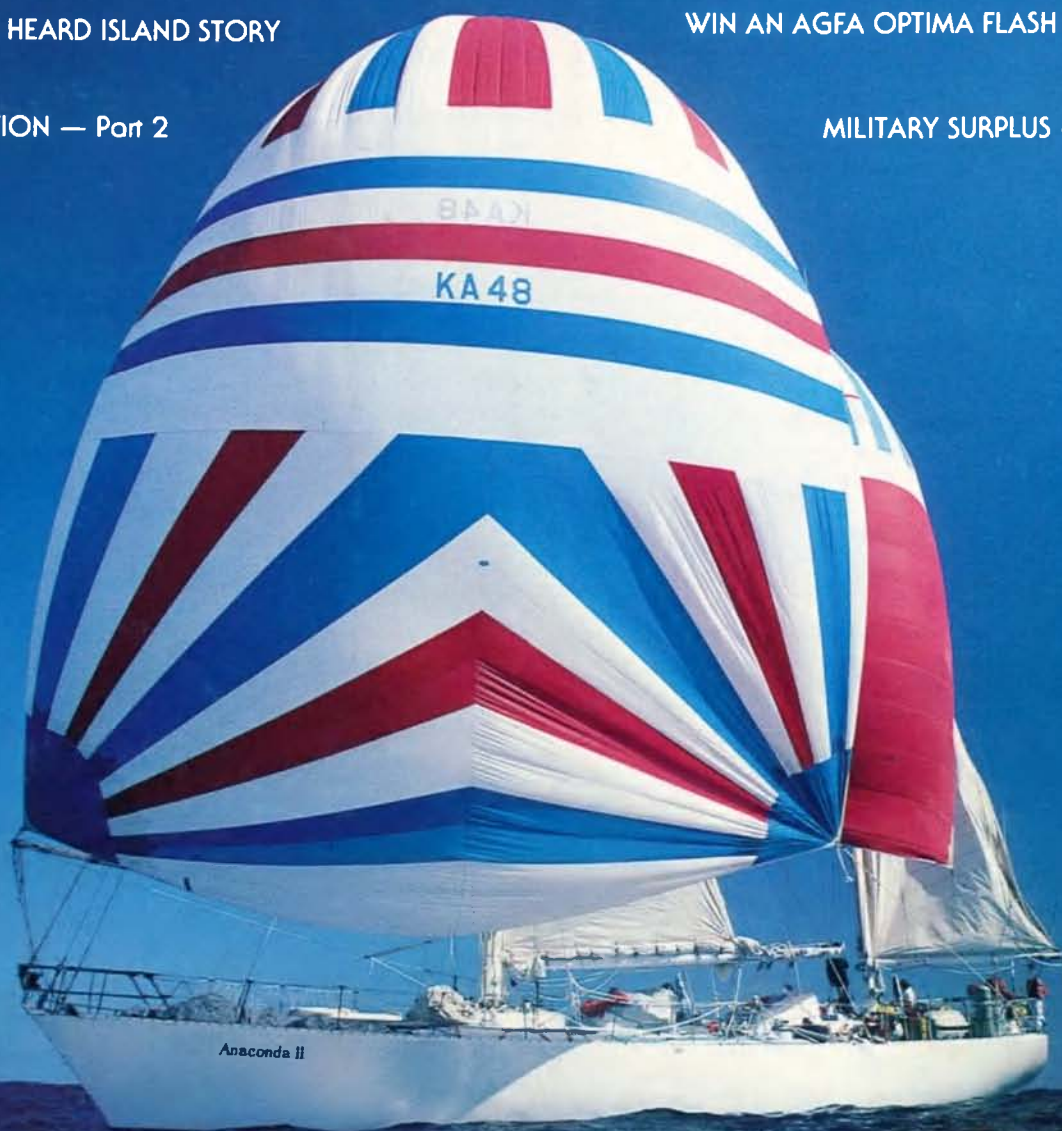



# THE YAESU SPECIALISTS

**Bail Electronics have the largest range of Yaesu Amateur Radio equipment in Australia.**



**FT-ONE** the ultimate HF rig for SSB, CW, FSK, AM, FM.

General coverage receiver 150 kHz to 30 MHz



**FT-102** the DXer's dream. All mode with 100db Rx dynamic range. Accessories FC-102 antenna tuner 1.2Kw; FV-102DM Ext. VFO; SP-102 Ext. speaker with audio filter.

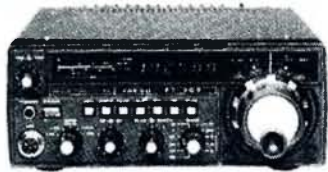

**FT-707** the ideal mobile HF rig - can be used as base station transceiver with optional power supply, accessories - FC-707 Antenna Tuner, FV-707DM Ext. VFO.



**FL-2100Z** Linear Amplifier 1.8 - 30MHz — coasts along at full legal power.



**FT-208 — FT-708.** Handhelds for 2m and 70cm.

- Fully synthesised
- 10 memories
- Keyboard entry



**FT-290, FT-690, FT-790.** All mode portable/mobile rigs for 2m, 6m, 70cm. The "go anywhere" rigs.

FL-2010 (2m), FL-6010 (6m), and FL-7010 (70cm) Linears for the FT-208, FT-290 series.

**FT-480, FT-680, FT-780**  
The popular all-mode Mobile or base Station transceivers for 2m, 6m, 70cm.



Boost your output to 70 W with the FL-2050 2m Linear Amplifier (12db Rx amp inbuilt.)



**FT-230** the compact 2m mobile with 25 W output

- 10 memories
- Dual VFO

Stop Press — FT730 70cm 10W due soon.



**FRG-7700**

Listen to the world with the professional all mode Communications Receiver 150 kHz to 30 MHz. Accessories include FRA-7700 Active Antenna, FRT-7700 Antenna Tuner, FRV-7700 VHF Converters (for listening to hams, aircraft etc.)

- Bail — gives full Yaesu 12 month guarantee.
- Bail — carries a range of Yaesu spares and Yaesu antennas
- Bail — provides expert repair service
- Bail — offers friendly advice to hams and hams-to-be.
- Bail — gives prompt attention to your mail orders.



## Bail Electronic Services

38 Faithful Street,  
Wangaratta 3677  
Telephone: (057) 21 6260 — Telex: 56880



**Bankcard Welcome**

Stan Roberts  
VK3BSR

Registered Office:  
3/105 Hawthorn Road,  
Caulfield North 3161.  
Tel. (03) 528 5962



# amateur radio

## .. in this issue ..

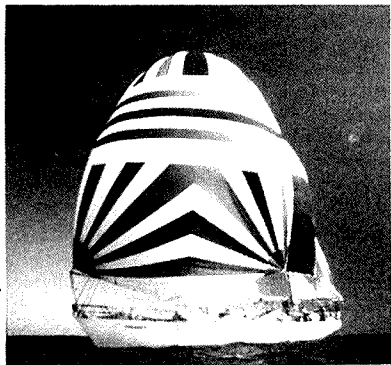

Photo by Jonathon Chester.

Anaconda II Under Full Sail.  
See story p 10.

### ARTICLES

Bill Blitheringtwit Goes on Air by Ted Holmes VK3DEH .....	16
History of RAAF Wireless Reserve by Bob Cunningham VK3ML .....	43
How Dangerous is RF Radiation? — Part 2 Reprint from RadCom .....	7
How Much Can a 290R Take? .....	16
Increasing the Sensitivity of Trio Dip Meter DM-800 by P J Grigg VK3APG .....	17

Modern Military Surplus Equipment — Part 2 — The R210 by Colin MacKinnon VK2DYM .....	28
Photo Competition .....	6
Regulated Power Supply for 13.8 Volts by Des Greenham VK3CO .....	14
Stolen Equipment .....	47
To Heard and Back by Dave Shaw VK3DHF/ VK0HI .....	10
VK/ZL/Oceania OX Contest 1982 Overseas Results by Jock White ZL2GX .....	40
Who Is This Amateur? by Peter Brown VK4PJ World Communications Year by John Hill VK3DKK .....	24

### DEPARTMENTS

Advertisers Index .....	56
ALARA .....	30
AMSAT Australia .....	31
Awards — Brazil DX, 3 Nigerian Awards, DUF & Diploma del Millenario .....	42
Book Review — 100 Basic Projects, Microcomputers in Amateur Radio .....	39
Contests — Asian DX (Rules of 24th, Results of 23rd), European DX, Ross Hull '82 ..	37
Education Notes .....	41
Equipment Review — VoCom Telescopic 2m Antenna .....	27
Five-Eighth Wave .....	49
HAMADS .....	55
Here's RTTY — Mechanical Generation of	

RTTY .....	26
How's DX .....	20
International News — New Focus for 73 Journal, ARRL National Convention '84 .....	9
Intruder Watch .....	24
Ionospheric Predictions & Geomagnetic Activity 1982 .....	52
Letters to the Editor .....	50
Listening Around .....	18
Magazine Review .....	46
Main QSP .....	5
National EMC Advisory Service — Radio- communications Bill .....	44
Obituaries — G3TR & VK3IE .....	55
Pounding Brass — Signal Reporting .....	25
Silent Keys — VK3PW .....	55
Spotlight on SWLing .....	46
Technical Correspondence — Static Charges .....	43
VHF UHF — an expanding world .....	32
VK2 Mini Bulletin .....	48
VK4 WIA Notes .....	47
WIA News .....	6
WICEN News .....	22

### DEADLINE

**ALL copy for July AR must REACH  
PO Box 300, Caulfield South, 3162 no  
later than 25th May.**

**EDITOR**  
GIL SONES\* VK3AUI

**TECHNICAL EDITORS**  
RON COOK\* VK3AFW  
PETER GAMBLE\* VK3YRP  
EVAN JARMAN\* VK3ANI  
BILL RICE\* VK3ABP

**CONTRIBUTING EDITORS**  
BOB ARNOLD VK3ZBB  
MIKE BAZELY VK6HD  
RON COOK\* VK3AFW  
REG DWYER VK1BR  
BRENDA EDMUNDS VK3KT  
MARSHALL EMMS VK5FN  
RON FISHER VK3OM  
BRUCE HANNAFORD VK5XI  
ROY HARTKOPF\* VK3AOH  
ROBIN HARWOOD VK7RH  
ERIC JAMIESON VK5LP  
MARGARET LOFT VK3DML  
KEN MCLACHLAN VK3AH  
LEN POYNTER\* VK3BYE  
TONY TREGALE VK3QQ

**DRAFTING**  
GEORGE BROOKS  
LIZZ KLINE

**BUSINESS MANAGER & SECRETARY**  
REG MACEY

**ADVERTISING MANAGER**  
JOHN J A HILL VK3DKK

\*Member of Publications Committee

Enquiries and material to:  
The Editor  
PO Box 300, Caulfield South Vic. 3162

Copy is required the first of each month. Acknowledgement may not be made unless specially requested. All important items should be sent by certified mail. The editor reserves the right to edit all material, including Letters to the Editor and Hamads, and reserves the right to refuse acceptance of any material, without specifying a reason.

Material should be sent direct to PO Box 300, Caulfield South Vic. 3162 by the 25th of the second month preceding publication. Phone: (03) 528 5962. Hamads should be sent direct to the same address by the 1st of the month preceding publication.

Trade Practices Act: It is impossible for us to ensure that advertisements submitted for publication comply with the Trade Practices Act 1974. Therefore advertisers and

advertising agents will appreciate the absolute need for themselves to ensure that the provisions of the Act are complied with strictly.

Victorian Consumer Affairs Act: All advertisers are advised that advertisements containing only a PO Box number as the address cannot be accepted without the addition of the business or residential address of the box-holder or seller of the goods.

Production: BETKEN PRODUCTIONS  
5 Masfield Avenue, Mooroolbark, 3138.

Laser Scanned Colour Separations by:  
QUAORICOLOR INDUSTRIES PTY LTD.  
Graphic Division  
22-24 Glenvale Crescent, Mulgrave, 3170.  
Tel.: (03) 560 2222

Typesetting by: QUAORICOLOR INDUSTRIES PTY LTD.  
22-24 Glenvale Crescent, Mulgrave, 3170.  
Tel.: (03) 560 2222

Photographic film and processing material courtesy  
AGFA-GEVAERT LTD AUSTRALIA

Printers: WAVERLEY OFFSET PUBLISHING GROUP  
Geddes Street, Mulgrave, 3170  
Tel.: (03) 560 5111

**BILL EDGE'S**

# ELECTRONIC AGENCIES

115-117 Parramatta Rd. Concord 2137  
(Corner Parramatta Rd & Lloyd George Ave)  
Telephone (02) 745 3077 (two lines)  
117 York St. Sydney Phone 29 2098

**Mail Orders:**  
PO Box 185  
Concord  
2137

NSW & ACT ONLY	VIC. SA. QLD. TAS. WA. NT
\$1 - \$ 9.99 \$1.50	\$1 - \$ 9.99 \$2.00
\$20 - \$24.99 \$3.50	\$20 - \$24.99 \$4.00
\$25 - \$49.99 \$3.50	\$25 - \$49.99 \$4.00
\$50 - \$99.99 \$4.50	\$50 - \$99.99 \$5.00
\$100 or more \$5.50	\$100 or more \$7.50



**TRADING HOURS**  
BOTH STORES  
Mon-Fri 9 am-5:30 pm  
York St. Thursday 8 pm  
Saturday 9 am-12 pm

All heavy or bulky items (over 20kg) sent Comet Road Freight \$12.00 anywhere in Australia.

**COMPARE THE VALUE OF THIS KIT WITH OTHERS ADVERTISING SPECIAL FEATURES**

## MICROBEE

XE5000 16k PLUS \$449  
XE5100 32k PLUS \$549

## NEW SOFTWARE

XE6700 CAR RACE \$11.95  
XE6705 DEATH TRAP \$11.95  
XE6710 BREAKTHROUGH \$11.95  
XE6715 WORMSQUIRM \$11.95  
XE6720 EXTENDED BASIC \$11.95  
XE6725 PRINTER GRAPHICS \$11.95  
XE6730 GRAPHICS GAME TOOL \$14.95  
XE6735 EUCHRE \$11.95  
XE6740 OTHELLO \$11.95  
XE6205 WORK-A-BEE \$14.75  
XE6210 TURTLE GRAPHICS \$14.75



## EPROM PROGRAMMER KIT FOR MICROBEE

All the components supplied plus the usual extra parts which keeps Electronic Agencies on top of the kit market.

- 24 pin ZIF socket **included**
- 5 dip header plugs **included**
- 15 pin parallel plug **included**

KE7003 \$46.50

## MONITORS FOR MICROBEE

XE1186 12" MICRON GREEN MONITOR \$199.50  
XE1188 12" KAGA DENSHI ORANGE MONITOR \$325.00  
XE1190 12" KAGA DENSHI GREEN MONITOR \$325.00  
XE1192 12" BLACK & WHITE \$129.00



MICROBEE PHONE ORDERS (02) 29 2098

## MOTOR SPEED CONTROLLER KIT

See ETI Apr. 83.  
KE7006  
\$19.95



## TOUCH LIGHT DIMMER KIT

See EA Apr. 83  
Complete kit including all hardware. KE7007  
\$19.95



## STEREO SIMULATOR KIT

See EA Apr. 83  
All parts supplied including box, front panel, etc, but excluding plug pack.  
Plug Pack \$9.95. Cat ME7721.  
KE7008 \$19.95

# ★ BRIGHT STAR CRYSTALS

*Specifications, Dimensions and data sheets available on request*

**BULK ORDERS:** In addition to our normal range we can supply quantity orders (100 up) at very competitive prices. All we ask is 50% of cost with order balance 30 days.

**DELIVERY:** 5-6 weeks from receipt of Order. Ring for quote: (03) 546 5076. Telex: AA 36004.

**NEW NSW AGENT:**  
APP Master Communications,  
Sydney (02) 682 5044

## BRIGHT STAR CRYSTALS

35 EILEEN RD., CLAYTON, VIC.  
ALL MAIL TO: PO BOX 42, SPRINGVALE 3171

WATCH CRYSTALS  
OVERN OSCILLATOR UNITS  
CRYSTAL UNITS  
FOR QUARTZ  
CRYSTAL CLOCKS

CRYSTAL OVENS

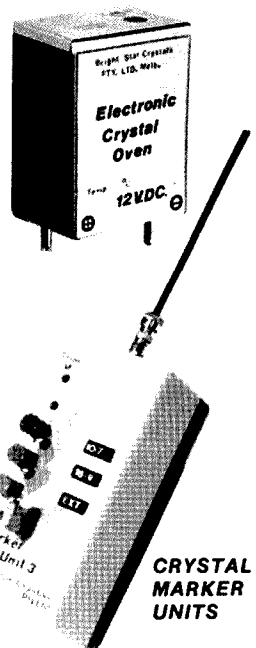

CRYSTAL MARKER UNITS

Phone MELBOURNE (03) 546 5076

# NOVICE THEORY

## NOVICE THEORY COURSE BOOK

- \* Covers the whole theory course
- \* Simple text, Copious diagrams
- \* Includes multiple choice questions
- \* Used by many clubs & schools

## MORSE CODE TAPES

- \* Novice... 5 Word/Min.
  - \* 8/10/15 Word/min.
  - \* 10 WPM exams
  - \* 15 WPM
  - \* 20 WPM
- Tapes: \$5.00 ea.  
Books: \$7.50 ea.

Available from: G Scott 11 Balmoral Cres.  
Surrey Hills 3127 Vic.  
or.. A. Bruce Smith 110 Rosemead Rd.  
Hornsby NSW 2077.

# THE CONVENIENCE REVOLUTION



Daiwa CNA-1001

A brilliant line-up of high quality Amateur radio accessories from Daiwa.

Daiwa specialises in providing the very best in Amateur radio accessories.

You can set your antenna with a choice of Daiwa Heavy Duty and Medium Duty Rotators. They'll get you going in the right direction. Type X allows you to pre-set the call area you want and Type R comes with Paddle Switch control and world map display.

Daiwa Coaxial Switches give you low loss and good isolation. They all complement Vicom's own unbeatable relays and operate from HF to 70cm.

For hands off operation, the famous Daiwa cross-needle meters are ideal. They provide three measurements with the press of one PTT button. And their compact size means they'll fit into even the most crowded shack.

Daiwa make some of the most advanced Antenna Tuners on the market. both Automatic and Manual models are available. Their rugged design and ease of operation makes them a must for any Amateur station!

See the complete range of Daiwa accessories at Vicom's showroom in Melbourne. Alternatively, most reputable dealers stock Vicom products.

# VICOM

People to People.

MELBOURNE:  
Vicom International Pty. Ltd.,  
57 City Road, South Melbourne, Victoria (03) 62 6931

SYDNEY:  
Emtronic, 649 George St., Sydney (02) 211 0531  
WELLINGTON, N.Z.:  
Malvicom, 18 Rarua Road, Lower Hutt (4) 697625

Dealer enquiries invited.

## THREE BIG NAMES

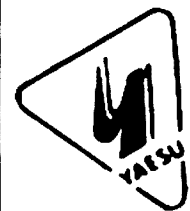

# ICOM

# ATN ANTENNAS

## AT ONE GREAT STORE

## CW ELECTRONICS

PLUS MUCH  
MUCH MORE

CW Electronics is the communication centre of Queensland.  
Innovators and pioneers of computer/RTTY/ASCII/CW/radio  
interface in Australia.

Come in and see our range

416 LOGAN ROAD STONES CORNER BRISBANE  
PHN: (07) 397 0808 397 0888

P.O. BOX 274 SUNNYBANK QLD. 4109

# NEW MODELS DUE FOR RELEASE MAY-JUNE '83

## 2 FM MOBILE TRANSCEIVERS



TM-201. 144 MHz

TM-401  
430 MHz



TW-4000A  
UHF-VHF DUAL BANDER  
TRANSCEIVER

## NEW RANGE SWR METERS

SW-200 A/B

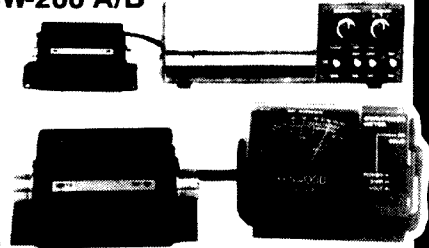

SW-100 A/B

## GREAT VALUE IN STORE — SEE YOUR DEALER FOR YOUR SPECIAL PRICE

TS-830S  
SOLID STATE  
HF TRANSCEIVER

NEW R-2000 RECEIVER  
WITH MEMORY SCAN, PROGRAMME  
SCAN & MEMORY MODE RETENTION  
OPTIONAL VHF CONVERTER AVAIL. SOON.



TS-130SE  
HF SSB/CW TRANSCEIVER



## TRIO-KENWOOD (AUSTRALIA) PTY. LTD.

(INCORPORATED IN N.S.W.)  
4E WOODCOCK PLACE, LANE COVE, SYDNEY, N.S.W. 2065.  
Ph. (02) 428 1455.

### NEW SOUTH WALES

TRIO-KENWOOD (AUST.) P/L — 4E WOODCOCK PLACE, LANE COVE (02) 428 1455  
SPRINGWOOD CAR RADIO — SPRINGWOOD (047) 51 4930  
UNIQUE ELECTRONICS — 41B OLD PROSPECT ROAD STH. WENTWORTHVILLE (02) 631 6689  
WASSELL ELECTRICAL — 10 McNAMARA STREET, ORANGE (063) 62 6249  
STOCKMAN & HIGGINS — BYRON STREET, INVERELL (067) 22 1300  
ELECTRON 2000 — 3 ELIZABETH STREET, TIGHES HILL, NEWCASTLE (049) 69 6399  
MACELEC PTY. LTD. — 99 KENNY STREET, WOLLONGONG (042) 29 1455  
RADIO WORLD PTY. LTD. — 81 NEWCASTLE STREET, Fyshwick (062) 80 6550  
DX ENGINEERING — 5 JASMINE STREET, PORT MACQUARIE (065) 83 2175  
LAND LINK — MULLALEY ROAD, GUNNDAH (067) 42 2838  
LAND LINK — 61 BARNES STREET, TAMWORTH (067) 65 4622  
FRANK BOUNDY — LISMORE (066) 86 2145

### INTERSTATE

VIC: EASTERN COMMUNICATIONS — 168 ELGAR ROAD, BOX HILL (03) 288 3107  
BRIAN STARES — 11 MALMSBURY STREET, BALLARAT (053) 39 2808  
SUMNER ELECTRONICS — 78 KING STREET, BENDIGO (054) 43 1977  
CODLIN ELECTRONICS — MOE (051) 27 4516  
TAS: HOBBY ELECTRONICS — 477 NELSON ROAD, MT. NELSON (002) 23 6751  
GELSTON ELECTRONICS — SUMNER HILL (003) 27 2256  
ADVANCED ELECTRONICS — 5A THE QUADRANT, LAUNCESTON (003) 31 7075  
V.K. ELECTRONICS — 57 WEST PARK GROVE, BURNIE (004) 31 1708  
QLD: MITCHELL RADIO CO — 59 ALBION ROAD, ALBION (07) 57 6830  
S.A. &  
N.T.: INTERNATIONAL COMMUNICATIONS SYSTEMS PTY. LTD. — 8 NILE ST. PORT ADELAIDE (08) 47 3688  
W.A.: ARENA COMMUNICATIONS SERVICES — 642 ALBANY HWY. EAST VICTORIA PARK (09) 361 5422  
TRI-SALES — CNR NEWCASTLE & CHARLES STREETS, PERTH (09) 328 4160  
WILLIS ELECTRONICS — 445 MURRAY STREET, PERTH (09) 321 2207  
BAY RADIO — 18 BANKSIA STREET, BUNBURY (097) 21 2236  
RON DENT — 115 PATON ROAD, SOUTH HEADLAND (091) 72 1112  
SELECT TRONIX — TOM PRICE (091) 89 1564





# QSP



## PIE GRAPHS for 1982

Expenditure — as a percentage of Income.

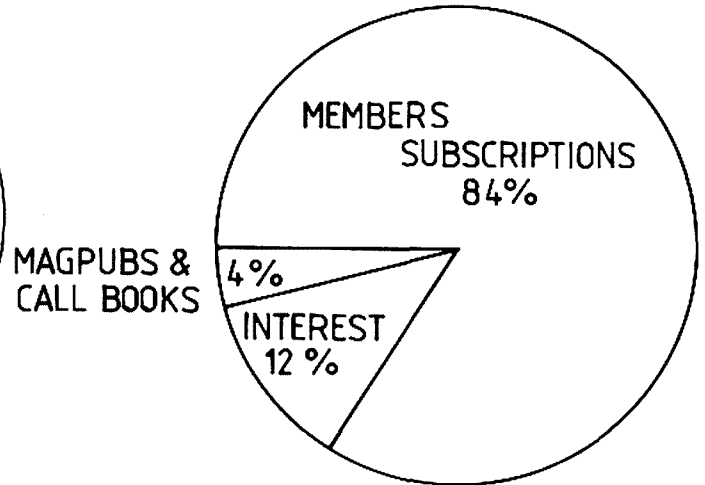
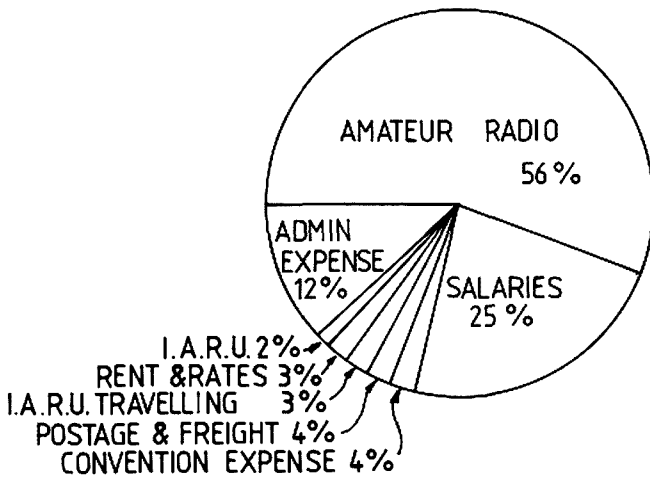

## WIDEST OPTIONS AVAILABLE

Everything you ever wanted in Antennas and Antenna Accessories are Now Available including:

**“Antenna Specialists”  
and  
“Avanti”**

Our range optimises your range.  
Call us Now:

**R. F. Industries**

219 Warrigal Road  
Oakleigh 3166

**Melbourne (03) 570 1698**  
**Sydney (02) 519 5188**  
**Brisbane (07) 52 7600**

## COUNCIL PROBLEMS? THE ANSWER TO LIMITED SPACE

MINIATURE 4 BAND  
model HQ-1

(Flats — Small Backyards — Caravans — Portable Ops.)

**\$222.00**  
(Freight Extra)

**EFFICIENT ANTENNA FOR LIMITED SPACE**  
10, 15, 20 & 6 metres. 1350 mm boom, 3350 mm elements.

For 6, 10, 15 & 20 metres.  
NO GROUND RADIALS NEEDED  
Lightweight yet rugged  
3350 mm long

MIKE KILPATRICK  
VK2DJP

NOW IN PRODUCTION

Miniature Band Coaxial Vertical

**\$116**  
(Freight Extra)

**WATCHMAN ELECTRONICS**  
28 Elouera Cres, Woodbine, NSW 2560  
Phone (046)26 6101



# WIA NEWS

Department of Communications has granted the use of the special AX prefix and ITU suffix on the occasion of the World Telecommunication Day Contest.

Approval is given to the WIA to employ one station per division using the AX prefix and ITU suffix on 17 May 1983. No objection is seen to the use of the AX prefix by all amateur stations on this day.

## RADIO COMMUNICATIONS BILL 1983

The CASPAR Committee has studied the new Bill in detail, input has been received from several divisions and interested individuals.

By the time that you read this, CASPAR's report will be with the Federal Executive to form part of the WIA submission to the Department of Communications.

Following on from this, Michael Owen, VK3KI will present a paper at the IREE Radiocommunications Workshop, on behalf of the Wireless Institute, in Sydney on 26th and 27th April.

## SCRAMBLERS

Amateurs may have noticed that Scramblers have been advertised in a number of magazines. This equipment may be totally acceptable on frequencies allocated to some services,

however both International Regulations of the ITU and the Australian Regulations require all transmissions by amateur stations to be in plain language.

It is our understanding that the utilisation of a scrambler by amateur stations would be in breach of these regulations and amateurs are advised not to use scrambler devices in the amateur bands.

## 50-50.15 MHz

The Institute has replied to the Department of Communications request for comments on three options of amateur use of the 50-50.15 MHz segment.

The Institute has opted for option one with reservations and observations in an effort to get amateurs on the air and then continue negotiating.

## DOC MEETING

A joint DOC/WIA meeting was held on the 30th March and the following items were discussed. Visitor's call signs, 50-50.15 MHz, Chess-on-the Air, Age limits, Examinations, Amateur Operators Handbook, Radio Communication's Bill 1983, 12/14 WPM Morse tests, ATV and Reciprocal Licensing.

AR

## PHOTO COMPETITION

To increase the interest and participation of members of the Wireless Institute of Australia in AMATEUR RADIO and through the courtesy of AGFA GEVAERT LIMITED, a competition with a difference will commence in the July issue of AMATEUR RADIO and run through to the June issue of 1984.

The competition is based on the best photograph that is reproduced in the magazine for this period pertaining to the hobby and may be a front cover, a photograph included with a story or technical article, or just a photograph of interest, suitably captioned.

The basic rules for this competition which will be known as the AGFA COMPETITION are:

1. Only financial members of the WIA and their immediate families are eligible.
2. Professional photographers, members of Federal Executive, the Publications

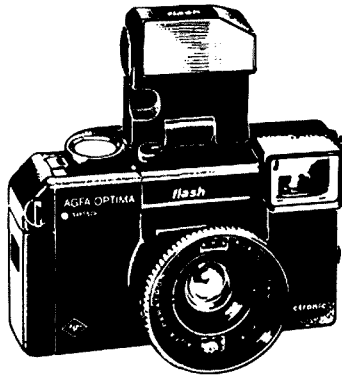

Committee, employees of the Wireless Institute of Australia, Agfa Gevaert Limited, Waverley Offset Printing Group and Quadricolor Industries and their immediate families are precluded from entering the contest.

3. Only photographs submitted in the form of colour transparencies, colour

prints, B&W prints or negatives taken after the 1st March 1983 are eligible.

4. The prize, a superb Agfa Optima Flash camera that has been kindly donated by Agfa Gevaert Limited, will be awarded to the entry judged from the best photograph in each issue by the management of Agfa Gevaert Limited, Waverley Offset Publishing Group and Quadricolor Industries in July 1984. The lucky winner will be announced in the September 1984 edition of AMATEUR RADIO.

5. No correspondence will be entered into by the judges or the editor of the magazine regarding the competition at any time.

6. All transparencies, negatives and prints whether printed in the magazine or held in abeyance will be returned to the sender if suitably identified and marked.

AR

# HOW DANGEROUS IS RF RADIATION?

## — Part Two

*Here is the second in our series of articles on this most important subject. It is reproduced from Radio Communication February 1982 and is printed in its entirety. Next month we will publish the final item in this series covering Microwave RF hazards.*

### RF HAZARDS AND THE RADIO AMATEUR

by Roger P Blackwell, BSc, G8IZV\*, and Ian F White, MA, PhD, G3SEK\*  
Reproduced from Radio Communication February 1982

The biological effects of RF radiation and their practical implications have received a great deal of attention in recent years. Papers on these subjects in professional and scientific journals abound. Unfortunately the echoes of these papers in the amateur radio press have often been ill-informed and in some cases sensationalised. The average radio amateur is left wondering whether RF hazards are truly a cause for concern and, if so, what to do about them.

The authors are radio amateurs who are professionally involved in radiological protection, one being a biologist and the other an environmental scientist. In this article they examine the potential hazards of amateur radio from the viewpoints of radiation biology, RF engineering and commonsense.

Normal good RF engineering practice automatically tends to control potential hazards to the station operator. At fixed stations the normal use of high antennas leads to very low environmental RF power densities in accessible places. Even in the less common cases where areas of relatively high RF power density are potentially accessible, the operator can still control the hazard by preventing access. The authors see no reason for treating RF hazards any differently from other hazards of amateur radio that are better-known, accepted and controlled.

#### EFFECTS OF RF RADIATION

The quantum energy of RF radiation, which determines what manner of interaction with matter takes place, is very low; orders of magnitude smaller than that required to cause ionisation of atoms or molecules. RF radiation is thus totally different in properties from the ionizing radiations such as gamma and X-rays. The most important effect of RF radiation on biological materials is the induction of rotation of electrically-polarised molecules, such as water. This rotational energy manifests itself as heat. This principle is employed in medical diathermy and the microwave oven.

A great deal of research effort is currently directed towards understanding the biological effects of RF. While the authors would not wish to discourage anyone from taking an interest in this work, they must emphasise that the interpretation of the experimental results is difficult for the layman, and that it is all too easy to jump to the wrong conclusions. The view of the overwhelming majority of Western scien-

tists working on this topic is that heating is the *only* biologically significant effect of RF. There are often reports, mostly emanating from Eastern Europe, of "non-thermal" effects occurring at extremely low power densities. Such reports must be regarded with suspicion, for they fail the basic test of scientific credibility: when independent workers have repeated the experiments the claimed results have not been observed. More credible effects have indeed been observed at RF power densities which, while not extremely low, seem low enough to suggest "non-thermal" origins; but closer examination has shown that they too can be explained by heating, and that what has been detected is the body's reaction to compensate for a very small thermal change induced by the RF field. Although such effects are of scientific interest, they have not been shown to be hazardous, bearing in mind that a "hazard" is a risk of *harm*.

Heating of a part of the body can be considered a hazard if the heat cannot be removed by the body's normal temperature-

regulating mechanisms quickly enough to prevent a temperature rise sufficient to damage tissue. Perhaps the most critical organ in this respect is the lens of the eye, because it is near the surface of the body, has no blood supply to remove heat, and has no capacity for repairing damage. Hence the oft-repeated warning about looking down waveguide. There is no evidence whatsoever that RF radiation produces long-term damage of the kind associated with ionising radiations, i.e. cancer or genetic damage.

#### RF EXPOSURE LIMITS

The Home Office and the Medical Research Council recommend that the maximum for continuous exposure is a power density of 10 mW/cm<sup>2</sup>; this limit may also soon appear in the form of a European Community (CEC) Directive. The figure of 10 mW/cm<sup>2</sup> was arrived at over 20 years ago<sup>1</sup> and remains essentially valid today, despite close examination in recent years. Very similar limits are used in the USA and some other countries. Eastern Europe and

Russia have somewhat tighter standards — for example,  $10 \mu\text{W}/\text{cm}^2$  — but there is no valid reason for these from the Western viewpoint.<sup>2</sup>

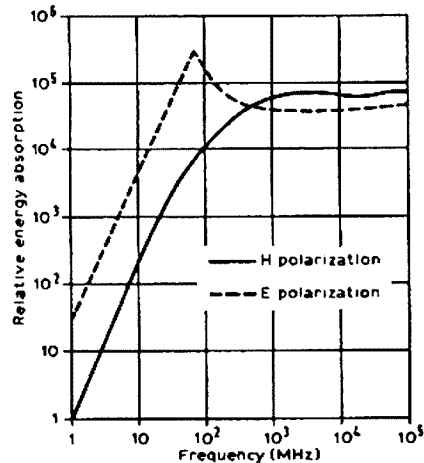

Fig. 1. Relative energy absorption versus frequency for E and H field orientations of an "average man".

Recent work has substantially confirmed the validity of the UK limit over the majority of the RF spectrum.<sup>2</sup> The absorption of energy by a given object depends on several variables, such as the frequency of the radiation, size of the object and the materials of which it is made. For frequencies above 500 MHz the amount of energy absorbed by, for example, an "average man" is relatively independent of frequency. At about 65-70 MHz man is more or less resonant, because his height is approximately half a wavelength; absorption of RF energy, if the subject is oriented parallel with the E-field, is therefore at a maximum and may be possibly 10 times that at 500 MHz. Absorption then falls off rapidly with decreasing frequency, at 10 MHz being less than 10 per cent of that at 500 MHz (Fig. 1). There would therefore appear to be much less of a problem with HF exposures. The  $10 \text{ mW}/\text{cm}^2$  limit remains equally valid at all frequencies, although the "built-in" safety margins are less around the frequencies at which man is resonant.

#### DETERMINING RF POWER DENSITY

It is very difficult to predict RF power densities in real-life situations, and none too easy to measure them. The reason for these difficulties is that power densities are likely to be highest close to the source, which is where the electric (E) and magnetic (H) components of the field are not at right-angles as they would be in the "far-field". The difficulty in measuring RF power density when the E-field and the H-field are not at right-angles is rather like that in measuring power in a reactive AC circuit, where the E and I vectors are not in phase. Just as one cannot determine power in the AC circuit by measuring E and/or I separately, one cannot determine RF power density in the near-field region by measuring the E-field and/or the H-field separately.

Very sensitive measurements can be made of the E-field (or less commonly of the H-field) but their interpretation is ambiguous. If one assumes that the two components are at right-angles the power density is simply calculated from the equation

$$W = E^2/Z \quad \text{W/m}^2$$

where E is the E-field in V/m and Z is the "impedance of free space" ( $377\Omega$ ). Although this represents the maximum possible value of W, and may be a considerable overestimate in the near-field region, "derived standards" of the maximum permissible E-field for particular circumstances can be calculated on this conservative basis.

A less ambiguous measurement of RF power density is based on direct detection of the heating effect, but instruments employing this principle are not very sensitive owing to the difficulty of measuring the very small temperature rises involved.

Even under laboratory conditions, accurate measurements of RF power density call for specialised instruments and great care. It is not possible for amateurs (or indeed professionals) to measure near-field RF power density with normal communications test equipment.

However, commonsense suggests that situations in which RF power density may be high are best avoided as a matter of principle, even if they may not prove unduly hazardous in practice. Generally speaking, the larger the quantity of RF energy and the smaller the area in which it is confined, the higher the RF power density. Fortunately most of the undesirable situations represent bad engineering practice for other reasons, and some of the authors' strictures are as much against the bad practice as against the RF hazards that might result.

#### SITUATIONS TO AVOID

**1. RF exposures leading to an actual sensation of heating are far in excess of  $10 \text{ mW}/\text{cm}^2$ , and are definitely to be avoided!**

**2. Looking down a waveguide**

The classic example in which RF energy is confined into a small area (about  $3 \text{ cm}^2$  for WG16), and applied to sensitive tissues (the lens of the eye). NEVER look down a wave guide unless you are quite sure there is no RF source at the other end!

There is a tendency to single-out microwave radiation as being especially hazardous. This is not correct, as Fig. 1 shows, though the practical situations in which high RF power densities could occur may not readily be anticipated by beginners who are unfamiliar with microwave technology. However, the level of skill required to generate large amounts of microwave power should be more than sufficient to anticipate and avoid the potential hazards.

**3. Working on high power VHF/UHF amplifiers with the covers off**

Quite apart from the potential RF and high voltage hazards, testing an amplifier with a cover off the anode circuit is unlikely to be useful, for the patterns of circulating RF currents may be entirely changed.

Sadly there is no substitute for the use of a large number of securing screws, or for

the tedium of removing and retightening them all, each time a change is made. Note that even a narrow gap between two covers can make an effective slot radiator if it is an appreciable fraction of a wavelength long; never peer through such a gap. If access or viewing ports are essential, round holes are best; for example, a hole of about 2 cm diameter results in very little RF leakage at 144 MHz.

**4. Using a small antenna in the shack as a dummy load**

This is very bad practice; the use of a proper screened dummy load is essential. Quite high RF power densities can be achieved close to small antennas such as VHF/UHF dipoles if the RF power level is a few tens of watts or more.

**5. Adjusting energised antennas**

This is also bad practice. "Live" adjustment is very convenient, but it can and should be done at very low power levels.

**6. Using handy-talkies with "rubber duck" antennas**

This is not necessarily to be avoided as being unduly hazardous, but it does lead to higher RF power densities in sensitive tissue (the eye) than almost any other activity in amateur radio<sup>3,4</sup> and it is of course a very common practice.

The E-field at the end of a foreshortened antenna such as the "rubber duck" (or normal-mode helix, to give it its proper name) is greater than that at the end of a full quarter-wave, and on a handy-talky the end-cap of the "rubber duck" can come quite close to the eyes and face. Extremely close contact with the end of the antenna is usually prevented by a very thick insulating end-cap on commercial antennas of this type. The authors strongly recommend amateur constructors to take similar precautions, for direct contact with the un-insulated end of a "rubber duck" could cause a corneal burn at power levels of only 1-2 W.

#### ENVIRONMENTAL RF FIELDS

So far in this article the authors have concentrated mainly on potential RF hazards to the station operator. In order to obtain some indication of typical RF power densities generated in the environment of amateur radio stations, they also made a limited survey of fixed stations.

**STATION A.** 300 W PEP RF output on 144 MHz, to a 16-element Yagi on an 11 m mast beside the house. Maximum power density near ground level occurred at 35 m from the base of the mast in the direction of the main beam, and was  $0.03 \text{ mW}/\text{cm}^2$ ; at a distance of 60 m the power density had fallen to  $0.0003 \text{ mW}/\text{cm}^2$ , the detection limit of the instrument in use. No fields could be detected at the base of the mast or in the shack or the rest of the house.

**STATION B.** 400 W PEP RF output on 144 MHz, to a 16-element Yagi 3 m above the centre of the roof. Inside the loft, at the peak of the ridge directly below the antenna, the indicated RF power density was  $0.2 \text{ mW}/\text{cm}^2$ . Otherwise the results were very similar to those for station A.

**STATION C.** 400 W PEP RF output on 432 MHz, to a 20-element loop Yagi on an 11 m mast beside the house. No RF field was indicated (ie less than  $0.0003 \text{ mW}/\text{cm}^2$ )

in the shack, anywhere outside near ground level, or even when leaning out of the bedroom window.

**STATION D.** 400 W PEP RF output on 28 MHz to a TH6DXX multiband beam, which behaves as a four-element Yagi on 28 MHz. The beam is mounted on a crankup tower, 20 m from the house. With the beam at a height of 11 m, pointed at the house, the power density at the nearest upstairs bedroom window, 7 m below the plane of the beam, was 0.01 mW/cm<sup>2</sup>. The greatest power density observed outside, close to ground level, was 0.06 mW/cm<sup>2</sup> at the foot of the tower.

Although the above information is circumstantial, and could not be used to accurately predict RF power densities at other locations, the general conclusions are clear enough. In all cases the measured power densities were very much less than 10 mW/cm<sup>2</sup>, even though the stations concerned were using powers up to the UK legal limit. Two of the stations had kilowatt permits for experimental work, and it is clear that the increase in power beyond the normal limit would introduce no appreciable hazard. In this survey the highest RF power densities encountered were where the height differences were small: in the loft at station B, and upstairs at station D when the tower was retracted.

In order to obtain any appreciable environmental RF power density, therefore one needs the rather unusual combination of high RF power but a low antenna. Virtually all fixed stations have antennas high enough to preclude the possibility of anyone approaching them closely; this is another example of the way that normal good practice tends to control potential RF hazards without any special precautions to that end.

One possible exception to this general rule is the ground-mounted  $\lambda/4$  vertical

antenna, especially on 28 MHz. A recent calculation<sup>5</sup> has shown that standing very close (20 cm) to a 27 MHz ground-mounted  $\lambda/4$  vertical fed with 140 W of RF can lead to the same energy absorption as would standing in a 10 mW/cm<sup>2</sup> plane-wave field. However, the energy absorption is considerably reduced if the subject is not perfectly grounded.

### MOBILE OPERATION

In mobile operation the antenna is low, but in most cases the RF power is also low. There is an effective limit of about 100 W RF output because of the drain on the battery while stationary, and in the UK the legal power limits are only a little above this level. Even when using such power levels, the operator can still control any RF hazards simply by making sure that nobody remains close to the antenna while the transmitter is in use, or by refraining from transmitting high power if anyone is close by; and of course the problem disappears when the car is in motion.

### CONCLUSIONS

Heating appears to be the *only* biologically-significant property of RF energy, and is only a hazard if the heat cannot be removed quickly enough by the body's thermostatic mechanisms.

Absorption of RF energy by the human body diminishes rapidly with frequency in the HF region, and is relatively constant in the microwave region. The slightly enhanced absorption occurring near the resonant frequency of the human body is not a major cause for concern.

Normal good RF engineering practice automatically tends to control any potential hazards to the station operator. However, commonsense suggests that situations in which RF power densities *may* be high are best avoided as a matter of principle, even if they may not prove unduly hazardous in practice.

At fixed stations the normal use of high antennas tends to reduce the environmental RF power density in accessible places to very much less than the maximum levels considered acceptable.

Even if areas of relatively high RF power density are potentially accessible, the operator can still control any hazard by preventing access or by not transmitting when anybody is in such an area.

The authors see no reason whatever for treating RF hazards any differently from other hazards of amateur radio that are better known, accepted and controlled, eg high voltages or falling antennas. There is no case for introducing any special regulations, on any amateur band, aimed at controlling RF hazards due to amateur radio.

### REFERENCES

1. *Safety Precautions Relating to Intense Radio-Frequency Radiation*. HMSO, 1960.
2. "A Review of Selected Biological Effects and Dosimetric Data Useful for Development of Radio-Frequency Safety Standards for Human Exposure". R. A. Tell and F. Harlen. *J. Microwave Power* 14 (4) 1979.
3. Technical correspondence. *QST* September 1978.
4. "Energy Deposition in Biological Tissue Near Portable Radio Transmitters at VHF and UHF". Q. Balzano *et al.* *IEEE 1977 Conference Record of Vehicular Technology Group*, March 1977.
5. "Electromagnetic Coupling Between a Thin-Wire Antenna and a Neighboring Biological Body: Theory and Experiment". K. Karimullah, K-M Chen and D. P. Nyquist. *IEEE Transactions on Microwave Theory and Techniques*, Vol. MTT-28 (11) 1218, November 1980.

©1981 R. P. Blackwell and I. F. White. Permission is hereby given for any bona-fide amateur radio publication to reproduce this article, provided that it is reproduced in full and without alteration, and that due acknowledgement is made.

Published by permission of the National Radiological Protection Board.



## INTERNATIONAL NEWS

### NEW INTERNATIONAL FOCUS FOR 73 JOURNAL

Beginning with its April issue, *73: Amateur Radio's Technical Journal* will be offering a new column, "73 International".

Written by columnists from around the globe, "73 International" will offer its readers a broader knowledge of amateur radio activity throughout the world and provide foreign amateurs with an international outlet through which they can publicise their operations.

The April issue will include columns from India, Hong Kong, Taiwan, Korea and Papua New Guinea, Guam, New Zealand, Chile, Brazil, Switzerland, Austria, Sweden and West Germany will also be represented in that issue.

By fostering an international forum for amateurs, *73* hopes to encourage the growth of amateur radio worldwide and to cross the

traditional boundaries of technological co-operation. Further information is available from Avery L Jenkins WB8JLG.

### AMERICAN RADIO RELAY LEAGUE NATIONAL CONVENTION

The 1984 ARRL National Convention will be hosted by the Hudson Division at the New York Statler, on the weekend of 20-22 July. The popular event, which usually attracts amateurs from every one of the fifty United States, all Canadian provinces and many countries abroad, is scheduled to feature numerous activities including technical and operating seminars, social events, banquets, DX meetings, manufacturer's displays showing the latest equipment designs and unlimited activities for non-amateur spouses.

The New York Statler is situated in the heart of the city, which provides visiting amateurs and their families easy access to its many cultural attractions. Broadway's famous theatre district, the Empire State Building, the World Trade Centre's twin towers, the bohemian Greenwich Village artists' colony, plus opera houses, museums and numerous restaurants featuring cuisine from nearly every nation, are all within minutes of the hotel via taxi, bus or subway. The hotel itself offers every amenity of a cosmopolitan inn, including dining rooms, conference rooms, lounges and a Grand Ballroom which can accommodate up to 2000 people.

Detailed information and registration forms may be obtained by writing to Mike Troy, AJ1J, R.R. 4—Box 19C, Pound Ridge, New York 10576, USA.

AR

# To Heard and Back

Dave Shaw VK3DHF/VK0HI,  
9 Milton Street, Heathmont 3135

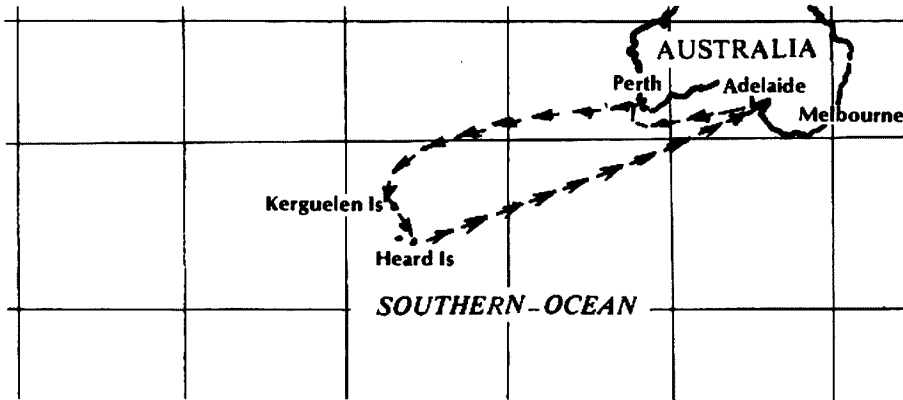

In December 1982 a group of mountaineers, scientists and radio amateurs sailed aboard the maxi-yacht *Anaconda II* to the Antarctic wastelands.

This month we begin a two-part story by Dave Shaw VK3DHF, the leader of the radio component of the successful operation of VK0HI and VKOCW and the triumphant ascent of Big Ben, the highest mountain in Australia and its territories by the mountain climbers. As there is a high pictorial content it was decided to run this article over two issues.

My journey began on a warm night in Melbourne with a bus trip to Adelaide, the port from which the *Anaconda II* was going to depart. As I was carrying half of the display material for our Audio Visual the next night it was fortunate that the service was new with few people travelling and plenty of room for my gear. It was thought this would be the most uncomfortable part of the trip, but with twenty people to embark on *Anaconda II* in Perth, I was quite wrong.

This story starts in early March 1982 with a telephone call from Perth when Nick VK6XI rang and without introduction asked if I was about twenty eight and reasonably fit. With an affirmative answer, he continued by asking if I would like to go to Heard Island. This was reasonably startling and one couldn't help wondering if it were a joke.

Nick probably realised this and gave me his telephone number and asked me to call him if I was interested. It took me approximately ten minutes to return his call saying that I would accept the invitation.

From my side things moved very slowly. All my questions and fears were allayed continually with regular reports from the VK6 DX Chasers Club (VK6DXCC) through Nick and Neil VK6NE.

*This exercise turned out to be the most damaging.*

A meeting with the organisers of the trip, the mountaineers, in August firmed arrangements and I was convinced that the trip was feasible and safe!

Word from Perth about equipment and other operators was also very promising and other than the canvassing of friends and acquaintances for associate membership the worry, frustration and work of putting the expedition together was in the hands of the VK6 DXCC and the mountaineering group in Sydney.

My responsibilities consisted of physical training and also an exercise on the inflatable rubber boats (IRBs) at Portsea

Surf Lifesaving Club, which is located south of Melbourne. This exercise turned out to be the most damaging and demanding part of the whole trip.

The surf endured at Portsea during the training turned out to be at least twice as large as that encountered at Heard Island, therefore valuable experience and confidence in handling of the boats was obtained. Due to mishaps during training, swimming in the cold rough surf became a necessity and the fear of drowning and being rescued from the sea was eliminated.

My interest in six metre operation saw the assembly and testing of a complete VHF installation. This was done in Melbourne with the help of Gil VK3AUI and Lionel VK3NM, both dedicated VHF enthusiasts, and a beam to complement the station was manufactured and loaned by Werner VK3BWW.

With the VHF equipment taken care of, a trip to Sydney in early December was necessary. The main object of this trip was to meet other members of the expedition

and assist with the packing of rations and sorting of clothing and all the other necessities so that it would be ready for despatch to Adelaide for an anticipated departure date of mid December.

During this period other members of the expedition were involved in Audio Visual lectures around Australia in efforts to canvass more support and give the public a picture of the broad spectrum of activities to be carried out whilst on the island.

On arrival in Adelaide, it was off to the boat to start packing and get my first view of "home" for the majority of the expedition. The Anaconda II is reasonably easy to pick out at any wharf with a length of 25 metres and its 28 metre mast plus towering above other yachts in the vicinity.

The packing and stowage of food and supplies for the voyage was to take the next four days. With twenty people to be on board, approximately five tonnes of provisions and equipment had to be safely stored.

### *Leaky fuel line did contaminate some food.*

As most of the food had to be stored in the bilges, that are located under the floor of the boat, it was necessary to pack it into large plastic garbage bags. This was to reduce the amount of salt water ingress and, in the case of cans, to eliminate any small amount of rust getting back into the bilges.

It was an effective method for sea water, its usefulness for diesel fuel was strictly limited as we found out when a leaky fuel line did contaminate some of the food and with so many nooks and crannies filled with food it was sometimes hard, with the continual pitching of the vessel, to raise the floor and utilise the stocks fully.

With the majority of our food supplies aboard (fresh vegetables and meat were to be loaded before we departed from Perth, our last Australian port of call), we departed from Adelaide for the west to pick up the rest of the expeditioners. Only five expeditioners did this part of the trip, as the rest headed for Perth to organise the last Audio Visual, and the remainder of the equipment needed for the trip.

This was a wise move as most of us had very little sailing experience and with only five on board for this leg of the trip it allowed the skipper and crew time to teach us a little of what would be expected of us on the journey.

For the captain and crew of the Anaconda II, this was the true beginning of the voyage, Adelaide being Anaconda's home port. There were many relatives, friends and well wishers for our send off including the Mayor of Port Adelaide, Mr Roy Martens. His interest, as well as many others in Port Adelaide, in the expedition showed itself on our return.

Sailing the Anaconda is a very involved business, especially when considering that for the first few days on board the inexperienced were hanging over the side. The trip to Perth and subsequently to the island all on board had to do their shifts to keep the boat on tack. We were divided into two watches — one watch on deck at all times in three hour rotating shifts. This was compulsory and no one missed out.

Even now with two months of sailing behind me, getting to the right winch or halyard still cannot be done without a bit of thought first. Fortunately Josko Grubic, the skipper, allowed quite a bit of leeway when he built the Anaconda with extra stays and heavy rigging for a crew of raw recruits such as ourselves.

Communication during this part of the voyage was maintained with a daily sched to VK6NE and VK5QX, with no problems encountered on forty and twenty metres. This was in contrast to the commercial scheds which were sometimes not so fruitful.

Equipment on this well designed vessel, consisted of two commercial crystal locked transceivers using the backstay as an aerial. A VHF marine band transceiver and an Icom 720A with antennae matching unit operating into a vertical on the stern of the boat, comprised the other communications equipment.

This radio equipment was all battery powered from the ship's supply and its drain and that of the satellite receivers, other navigation instruments and internal lighting, meant that to operate for long periods required excessive generating times from the ship's alternator which was not practicable.

Our training period on the first leg of the trip, although nothing like what we were to encounter in the southern latitudes, did serve to give us a bit of confidence on the boat, and the knowledge of where to run to when our muscle was required.

Most of the Adelaide-Perth trip was a relatively cosy time. The vessel was becalmed for two days and had light winds for most of the voyage and if the rest of the journey was to have been like this, we would indeed have been suntanned, healthy, happy and fit.

After nine days, we tied up at the Port of Fremantle, the port which services Perth, to be greeted by some of the amateurs who had donated so much time, money and effort to make the trip possible. These included Neil VK6NE, Don VK6DY, Nano VK6UN.



*Anaconda II en route to Perth.*

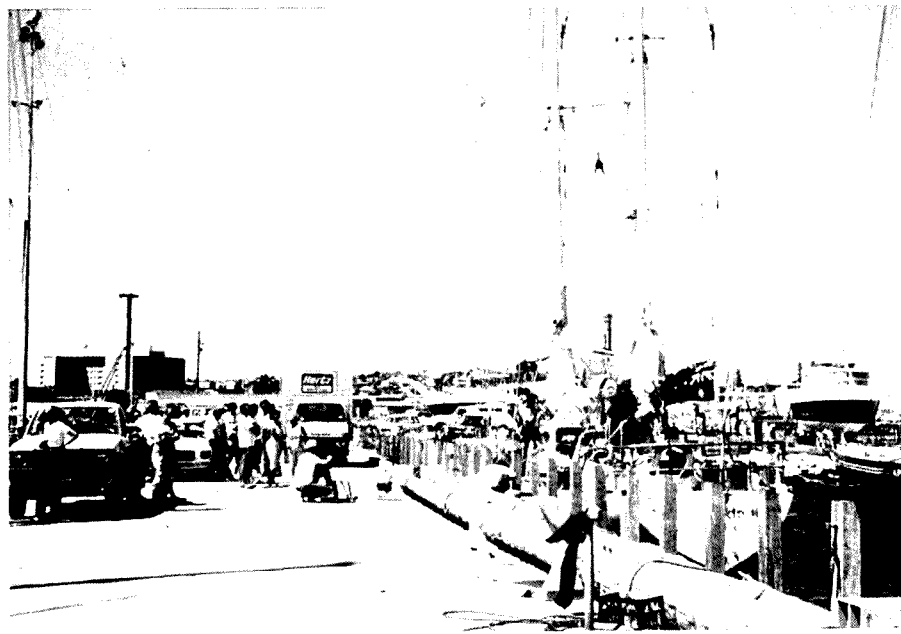

*Arrival at the Port of Fremantle.*

The boat's arrival at Fremantle caused quite a bit of interest, because of the VK6's involvement in the DXpedition and it is hard now to recall the names and callsigns of all those well wishers who arrived and looked over the Anaconda.

Soon after landing, I was whisked away by Don VK6DY for a much needed shower (there are no mod cons such as showering facilities on board the yacht) and get a bit of washing done before meeting the rest of the DX Chasers Club and the two other operators who had arrived from the United States a couple of days previously.

Meeting all the members of the VK6 DXCC and seeing the assembled equipment was a pleasant surprise. The group in Perth had organised all of the HF amateur radio aspect of the trip and now seeing them and meeting Al VK6AHI/VK0CW and Chuck VK0MD, the American operators, it felt good to be an integral part of this expedition. It is regrettable that Chuck had to pull out of the group at the last moment due to personal problems back in America.

### *Everyone tried to get the maximum gear aboard*

As we were going through the amateur equipment, preparations with the mountain climbers and at the boat were also moving along rapidly.

The amount of gear to be taken on board now started to assume very large proportions with everyone trying to get the maximum amount of gear on board. I am certain the captain would have had a "heart attack" if he could have seen everything assembled on the wharf, but secreted away on board the gear was acceptably unobtrusive.

One or two days was the expected stay over in Fremantle, but this stretched to eight days as so much gear was assembled in Perth it was not possible to take it all and much reshuffling took place. Also some work on the Anaconda had to be done, which showed up on the trip across the Bight. Unfortunately arriving on Christmas Day did not help to get this work done expeditiously.

With the whole expedition assembled and the keel lying a few more centimetres in the water, we departed on the last day of

the year for our destination, Heard Island.

Now we settled down to sailing and learning more about the yacht. Al VK6AHI/VK0CW and I saw each other at watch change during the voyage down, with the scheds to Australia being taken care of by the one on duty at the time. Al and I shared the same bunk, as with only sixteen bunks and twenty people on board most people had to "HOT BUNK", which is, two people use the same bunk and when one is on watch the other is in the bunk, sleeping.



*Anaconda beating through heavy seas in the Southern Ocean.*

Photograph — Ross Vining.



*Some of the supplies ready to be loaded in Perth. A mountaineering tent is in the right foreground.*

Sleep became an important commodity during the eighteen day voyage to Kerguelen Island and it became increasingly difficult to wake people for the next watch.

This was not only due to the lack of sleep but with no heating, a nice warm sleeping bag and the gentle rolling of the boat became an exclusive respite.



*Tacking the boat.*

Life on deck, as we approached the southern latitudes, changed from relaxed cruising to cold hard work. Changing sails with half a metre of water continually





*Entering Kerguelen Bay as a Russian Trawler departs.*

The seas south to Heard Island were the largest we were to encounter with about a twelve to fifteen metre swell whipped up with up to about fifty five knot winds. This could not dampen our enthusiasm however and after a day we sighted the McDonald Islands followed that afternoon by our first glimpse of cloud covered Heard Island.



*DAVE VK0HI*



*Al VK0CW*

Photography unless noted by Dave Shaw VK3DHF.

⊗ This article may not be printed in part or whole without the prior written permission of the Editor of Amateur Radio.

*To be concluded in June issue.*

washing across the deck with thirty and forty knots of wind is not something to look forward to. Whereas thirty minutes at the helm, with the wind and swell trying to push us all about the ocean, had one sweating and exhausted.

After eighteen days on board it was a welcome relief to have a couple of days rest at the French base on Kerguelen Island. Here we were made very welcome, firstly with showers for all those on board and a relaxed dinner in the island's mess.

Kerguelen is a large sub antarctic island about two days sailing from Heard, with a large French scientific base. There are about one hundred people on the base for the winter period.

One of the first people to meet us was Michel FB8XAB, home call F6GVH, who was on the base for the summer period. He showed both Al and myself around the base, arranged for our accommodation, shower and washing needs. Then refreshed we operated FB8XAB for the rest of the night. This caused some confusion on the bands. Most of the Europeans did not expect FB8XAB to come on the air with either an American or Australian accent.

*Good French food  
and wine occupied  
our stay*

Al and myself were keen to get some operating in before the onslaught at Heard and Michel gave us this opportunity over the couple of days we were there. Between both of us we managed several hundred contacts considering the restricted amateur operating times that the French authorities have imposed on amateurs at Kerguelen due to the commercial daily traffic between 0900 and 1400 UTC.

Filling ourselves with good French food

and wines also occupied much of our stay. The inhabitants of the island showed the whole group great hospitality and after a few after dinner drinks the language difference did not pose many problems.

We were sad to leave the French base and the new friends we would probably never meet again, but our destination was still several hundred kilometres to the south, so we departed on the 20th January on the final leg.

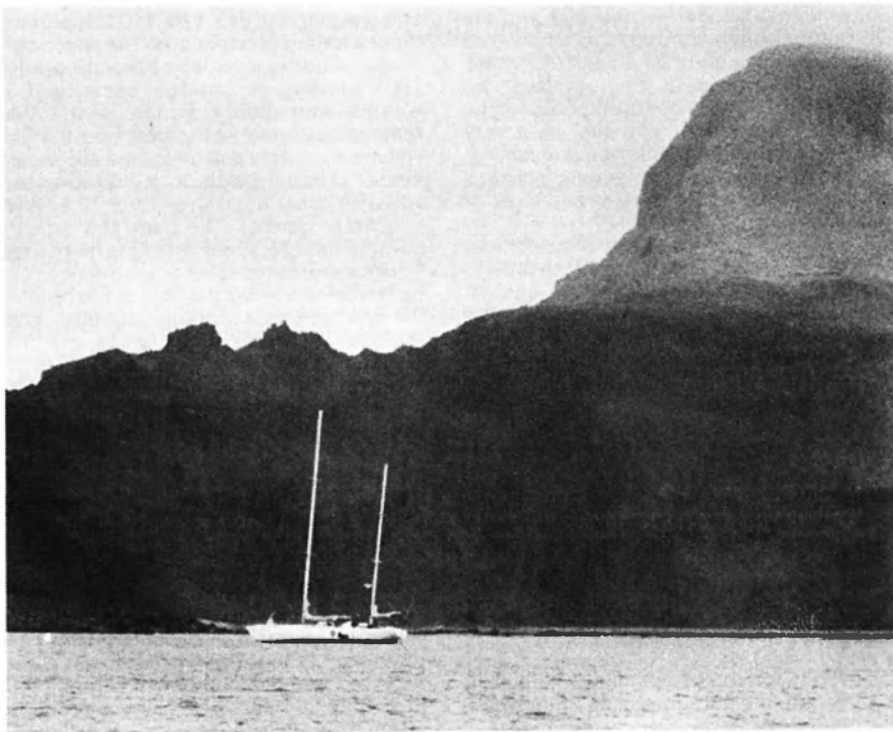

*Safely anchored in Atlas Cove — Heard Island.*

# 13.8V REGULATED POWER SUPPLY

Des Greenham VK3CO  
23 Stewart Street, Seymour Vic 3660

*In these days of "black box" operation, it can be refreshing and rewarding to actually build something that works, especially when the cost is minimal. After all, most amateurs seek the "best" at the lowest possible cost. The power supply to be described has a regulated output of 13.8 volts DC adjustable, with a maximum load of around 10 amps. This is more than enough to drive the average 2 metre FM unit with an output of 25 watts.*

## GENERAL DESCRIPTION

The actual layout and construction details will be left to the constructor as they are not critical. The heart of any power supply is the transformer and this can be quite a costly item. In this case the transformer is one recovered from an old B & W television set, many of which are resting as junk in sheds or even obtainable from the local "tip". The transformer is partly rewound by stripping away the original secondary winding and replacing with a heavy duty 18 volt winding. This operation, whilst time consuming, is interesting and certainly not difficult.

The 18 volt winding is fed into a conventional bridge rectifier unit and the DC output is then controlled by a UA78HG regulator which controls a bank of 2N3055 transistors. These of course, must be mounted on a heavy heat sink. This can be either a commercial type sink or a very heavy piece of aluminium or copper "U" section material. This sink is best mounted on the outside of the case to allow better heat dissipation.

Components these days are most reliable. However, should one of the regulating transistors develop a "short circuit" then the output voltage would instantly rise to a dangerous level, causing damage to valuable equipment. Most 12 volt units can only stand a maximum of 15 volts before damage occurs. It is desirable therefore that there be some form of protection against high voltage. Many power supplies have the popular "crowbar" protection, in which, when the voltage exceeds a set value, a Zener diode conducts and "fires" a SCR which in turn short circuits the output and blows a fuse.

In this supply, the cost of protection has been cut by fitting a 15V Zener diode across the output. In the event of the voltage rising above 15 volts, the Zener diode will conduct and "short" the output thus protecting the equipment. The current carried by the Zener diode is far in excess of its rated current and therefore the diode is destroyed. When the Zener diode is

destroyed, it invariably becomes short circuit and the DC fuse will be blown thus completely isolating the equipment. The only cost for repair would be the faulty regulating transistor and a Zener diode. However, this is a remote risk and may never happen. It is re-assuring to know, nevertheless, that there is some form of over-voltage protection for valuable equipment.

## CONSTRUCTION DETAILS — TRANSFORMER

The TV power transformer should be carefully examined for any damage. It should be removed from the chassis noting and marking the 240, 220, 210 volt primary input winding connections. The secondary heater winding is usually 6.3 or 12.6 volts. This winding is obvious because it is wound with heavy gauge wire. After removal, connect the primary to the 240 volt mains supply and check the secondary heater winding with a multimeter (AC volts) to ascertain if it is 6.3 or 12.6. After checking, carefully tie back the primary connections to avoid breaking the wires. The transformer should now be dismantled by firstly removing the four bolts holding the laminations and frame together. After removal of frame and clamps the first lamination should be removed. This is the most difficult part of the entire project as these are usually pressed in by machine and difficult to remove. A thin bladed screwdriver driven in between laminations can frequently enable one lamination to be gripped by long nosed pliers and removed. The laminations are usually in an "E" and "I" shape configuration and should be completely removed and stacked.

The heater winding is on the outside, and should now be carefully unwound making sure to **count the turns as they are removed**. When this winding has been removed and the number of turns noted, the remaining secondary winding can be stripped either by unwinding or careful use of a hacksaw remembering that the primary winding underneath is to be re-used. Some

transformers from Astor and AWA sets have a double bobbin winding with primary on one side and secondary on the other. These are particularly easy to rewind. The more usual type have the primary against the core, then the high voltage secondary and finally the heater winding on the outside.

Having stripped the bobbin down to its basic primary winding, the turns ratio of the transformer must be calculated. The "turns per volt" figure is found by dividing the turns counted by the heater winding voltage. This is nominally 6.3 or 12.6 volts. However most manufacturers wind transformers for 6.5 or 13 volts to allow for a voltage drop. It is common to find that the 12.6 volt winding has 39 turns. The "turns per volt" figure would be

$$\frac{39}{13} = 3$$

This means we need 3 turns on the secondary for each volt of secondary output. In our case we need 18 volts, therefore we would need  $3 \times 18 = 54$  turns. This is only an example and you must calculate for your particular transformer to obtain 18 volts output.

To rewind the secondary we need wire that will supply 10 amps without overheating, 14 Gauge B & S is adequate and can be purchased from retailers or automotive electricians. A length of 10 metres should be enough for an average transformer. The winding is wound on carefully layer by layer, although it can be "jumble" wound if there is enough space.

The turns must be carefully counted on and when the winding is complete a layer of PVC tape should be wound around it. The ends should be covered with spaghetti and extended out in a similar way to the original heater winding. Now the core must be replaced by fitting the laminations back into the bobbin. If the laminations are the "E & I" type, it is easier to fit 3 "E" sections at a time alternating the direction. The "I" pieces can be fitted later.

It is part of "Murphy's Law" that all the laminations removed will never be re-

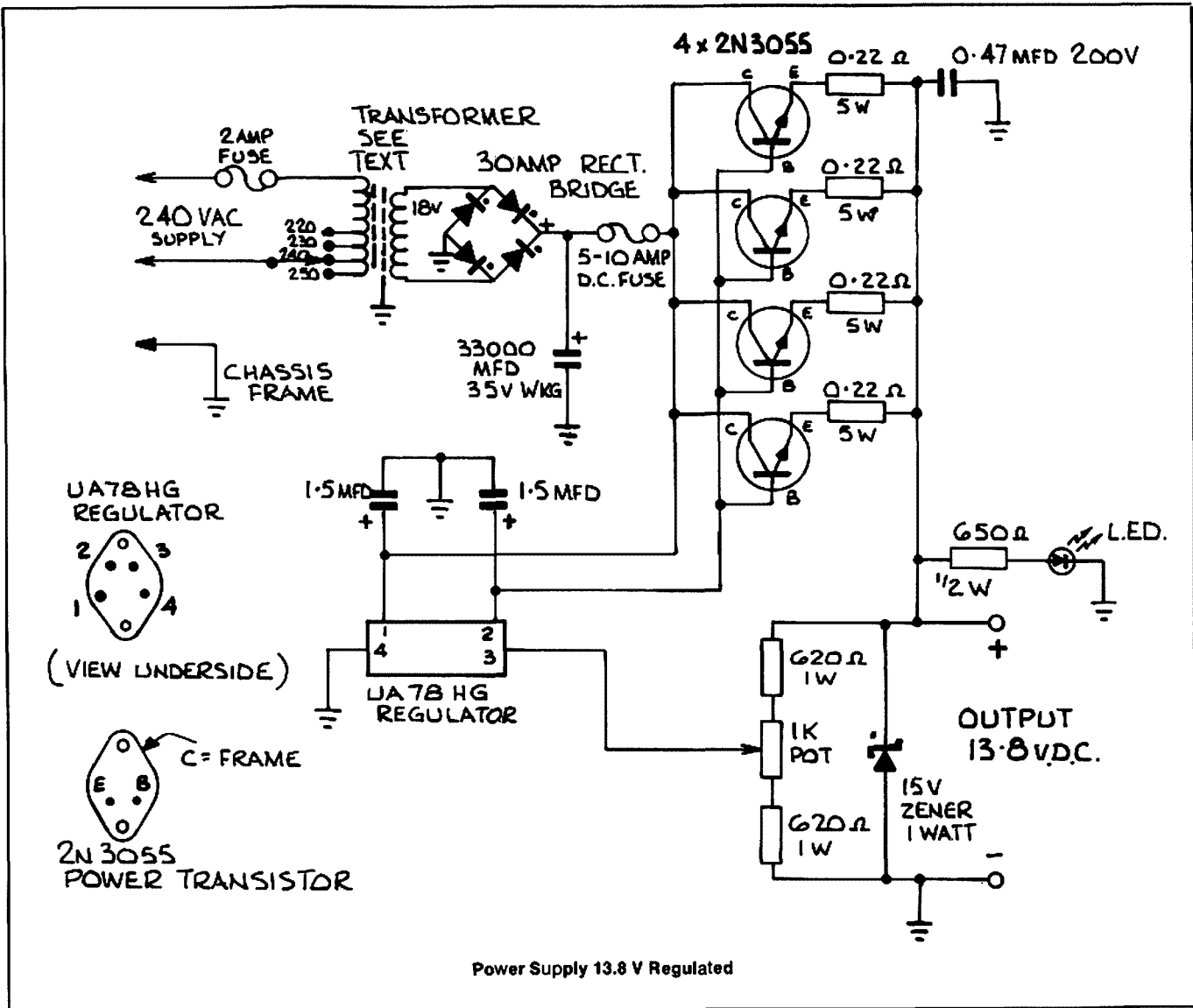

placed, so do your best. The last few will be difficult to fit and careful use of a small hammer will assist. The assembly should be tapped into square shape with the hammer and the 4 bolts and mounting plates fitted. When finally together and looking like original, connect 240 AC to the primary and check the secondary voltage. If your calculations have been correct and all care taken your meter will read 18 volts. If your reading is not exactly 18 volts, you can adjust by changing the primary tapping. By connecting 240 volt mains to the 250 volt tapping, the output will be dropped and similarly connecting to the 230 volt tapping will increase the output.

#### CONSTRUCTION — GENERAL

The general assembly of the power supply will be left to the constructor. The transformer should be well mounted and all bolts tightened to prevent "buzz". The regulator can be mounted in any position and does not require any heat sink. It can be mounted on a small piece of aluminium

formed into a bracket. It is important that the 1.5 µF bypass capacitors be mounted directly on the regulator itself and not wired away. The output fuse should be rated only marginally higher than the maximum load expected. To operate a set such as the IC22S a fuse rating of 5 amps would be adequate. The main filter capacitor, shown as 33,000 µF, is from a disposal computer power supply.

Any value larger than 25,000 µF would be acceptable and this could be made up from several smaller capacitors wired in parallel. An example could be 5 capacitors, each of 5000 µF, wired in parallel. Be sure the voltage rating is adequate. Any rating higher than 30 volts working is sufficient.

After completion of wiring and circuit check, set the voltage adjustment potentiometer to the "low" end (earthy side). This will protect the Zener diode in the event that the output voltage is in excess of 15 volts. Connect an accurate voltmeter or multimeter to the output and switch on AC supply. Carefully adjust the potentiometer

until 13.8 volts is noted. The LED should be glowing. When satisfied that all is well, connect transceiver and check with another station for any noise or hum. The supply is clean and hum is not discernible. Check the voltage reading when the transmitter is operated. The drop should be barely noticeable. With the values shown and a transformer of the TV type, an output of 10 amperes, well regulated, will be available and there will not be too big a dent in your domestic budget.



**Please remember your STD code when you advertise in HAMADS.**

# How much can a 290R take?

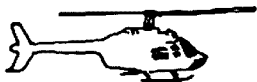

**Recently, whilst on a working assignment, two amateurs and two of their workmates had a miraculous escape from a helicopter crash. Along with the lucky survivors was a much loved Yaesu 290R.**

Most amateurs take great care of their rigs, certainly they make sure they don't drop them.

Dale VK3DXB is meticulous about his Yaesu 290R. He even made a special leather cover for it, but he recently dropped his from 500 feet. His second problem was that he fell with the 290 — fortunately both survived and both are in good working condition. Not a scratch on either.

Dale and Chris VK3VYS, along with a stills photographer, were filming the low water levels in the Eildon dam for the Victorian State Electricity Commission when the Bell 206 helicopter they were using suddenly lost power and crashed from 500 feet.

Both Dale and Chris work with the SEC Film Unit which early this year won a national award for one of their films (AR, February 1983).

Dale had taken his 290R on the assignment to see how far he would be able to work RML, the Melbourne two metre repeater, from the air.

"I thought it would be interesting to test the range of the 290 during the trip home from our assignment which was to film four

of the water storages in north-eastern Victoria — unfortunately I didn't get the chance," Dale said.

"We had just finished shooting a sequence at Eildon when the helicopter went into an uncontrollable spin and crashed into the dry bed of the dam.

"The helicopter flipped as we hit the ground and one of the rotors crashed through the cabin. The pilot really did an amazing job getting us down as well as he did.

"The four of us scrambled out of the wreckage and run away from the helicopter as there was aviation fuel everywhere and we expected the whole thing to catch fire.

"While we sat and tried to recover our senses and waited for the wreckage to cool down and help to arrive, I could see the 290 swinging from its strap. Later we were able to remove our gear from the wreckage."

Later on his way home, Dale was able to prove the value of amateur radio and the reliability of modern equipment, when he used the 290R to call RML and ask another station to pass a message to his wife that all were safe and were on their home — by car.

AR

## Bill Blitheringwit goes on Air

A continuing saga by

Ted Holmes VK3DEH.  
20 Edmund Street, Parkdale, Vic 3195



His hand stretched out and switched on the ancient power supply. Bill Blitheringwit was about to go on air using one of those new fangled black boxes: an all solid state multiband transceiver, complete with LED frequency readout and a variety of knobs for many and varied functions. He had purchased the rig that morning and just couldn't wait to try it out.

His old rig had died rather suddenly the previous day, owing to years of tuning through a defective ATU into a primitive antenna system. The glass envelopes of the finals had melted and were now a ¼ inch high. It had been a spectacular effect, added to by the generous sparking created when Bill aimed a soda syphon at the blazing rig, without first disconnecting the power system from the mains.

Bill then turned on the new black box. Unfortunately, his power supply was not the best and, of course, he had not checked it first. At switch on, the voltage immediately shot up and the lights in the black box grew bright, then died. Despite all Bill's efforts — which included switching the power supply on and off again several times — the brand new black box refused to come to life again. He signed and made a mental note to return the unit to the suppliers. He could always have it fixed under warranty. . . .

He reached for his old and trusted ex-Army unit. No matter what he did, he had been unable to destroy that! So far, that is. He plugged it in and switched on. This was beautiful! He could hear a QSO in progress on 20 metres and decided to try to get into it. Locating the analog exactly on the frequency, he started to tune.

Doing this, he almost destroyed the QSO which was going on but, undeterred, he waited. At a suitable time he inserted his call sign. There was a pause and the QSO resumed. He called again. No reply. The voices disappeared but he found them about 20 kHz up. Not understanding all this, Bill decided that some people were not very friendly.

—oOo—



LtoR — Dale VK3DXB, Chris VK3VYS and Ern Ward, stills photographer after their lucky escape.

Photograph — Alan Weekes.

# INCREASING THE SENSITIVITY OF TRIO DIP METER DM-800

P J Grigg VK3APG  
Lot 44 Glenburn Street, Newcomb Vic 3219

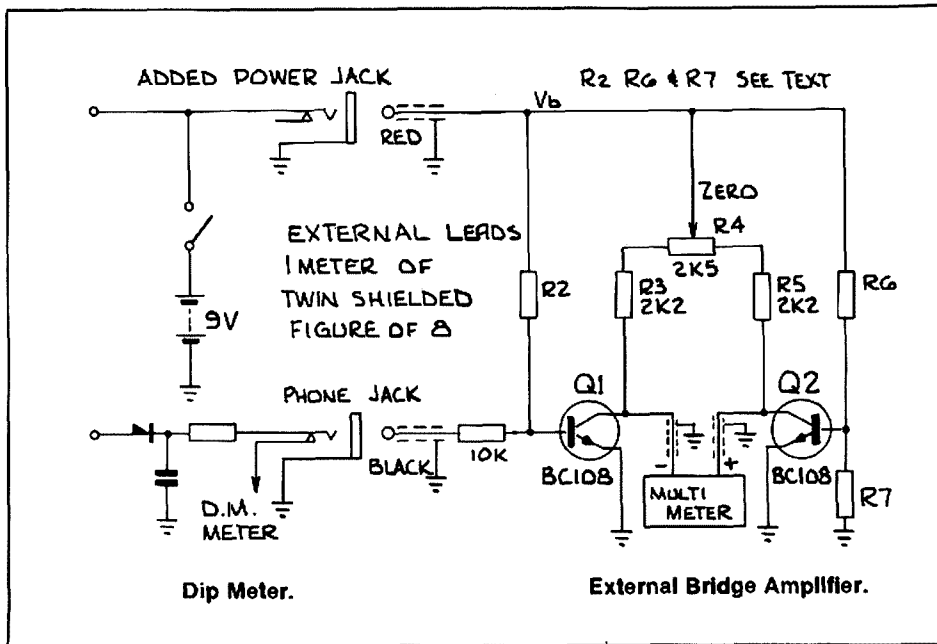

With some circuits the dip on the Trio DM-800 was found to be only just perceptible. It was much improved by the addition of the following differential amplifier. The amplifier was built into a separate small metal box, suitably spray painted and labelled with rub down lettering. The only modification to the dip meter itself was the addition of a 3.5 mm jack, to supply 9 volts to the amplifier.

## DIP METER

Remove the metal cover on the phone jack side and enlarge the nearby cover fixing screw hole to match that of the phone jack. Drill a corresponding screw hole on the chassis to accommodate a 3.5 mm jack. Fit the jack, wire to the positive 9 volt rail and test. Re-locate the cover fixing screw a little lower, towards the edge of the chassis and replace the cover.

## AMPLIFIER

Build up the circuit except for R2, R6 and R7 and connect to dip meter; turn power on, set sensitivity at minimum and R4 to mid range. Select R2 so that  $Q1 V_c = 1/3$  to  $2/3$  of  $V_b$ . Make R6 the same as R2 and select R7 so that  $Q2 V_c$  is very close to that of Q1. Now connect a multimeter to bridge (on a suitable low volts range). Zero the meter and increase dip meter sensitivity for a convenient reading. The device is now ready for use. To use the DM-800 as a wave meter, disconnect the amplifier plugs.

**NOISE BRIDGE**  
\$60 POST PAID

Adjust your antenna for maximum performance. Measure resonant frequency, radiation resistance and reactance. Better than an SWR meter. Operates over 100 MHz. Most useful test unit in your shack.

**ANTENNA BALUNS**  
3 to 30 MHz.  
Maximum Power 300 Watts.  
Centre support.  
Ideal for Dipoles, Beams, Quads.  
S0239 connector.  
**\$26**

**POWER LINE FILTER**  
240 Volt @ 10 Amp  
**\$14**

1000's of Transistors — Ferrites — Hobby Kits — Tag Strips — Switches etc. Send stamped addressed envelope for full list.

**K. BRUCE SMITH**  
110 Rosemead Road  
Hornsby N.S.W. 2077

# LISTENING AROUND



Joe Baker VK2BJX  
Box 2121, Mildura, Vic 3500

By a perusal of the VK2 section of the 1982/83 call book, I am more than convinced that Uncle Sam must have packed his flag in his bag and hi-tailed it for VK2. Look through other sections of the call book and you won't find as many VK2 American amateurs as there appear to be in NSW. A study of the addresses in this section of the call book is very interesting indeed. NSW appears to have a larger population of Americans with VK2 calls than the other states.

The "rough" for this article was being prepared just after the massive bushfires in Victoria and South Australia, and tributes to the work of amateurs who helped out are still being heard. The other night, VK2PBX John of Sunbury — a very good friend of mine from CB days — told me of a tribute to WICEN paid by Paul Welsh of the Victorian State Emergency Service.

When I heard that the fires had come within visual distance of Sunbury and not finding John on the air, I phoned his home to ensure that all was well. John later thanked me for doing this, but it was the least that I could do and the sort of thing that any other person would do.

Just before speaking with John on air on 1.3.83 I happened to come across the Tasmanian Devil Net conducted by Don, VK7NBF. What attracted me to pause on their frequency as I panned across the 80 m band was the very obvious interference to this net that was being done deliberately by some irresponsible person. A transmitter was being deliberately overmodulated to the point of distortion while the Tasmanian Devils were doing their best to ignore the disrupter as they conducted a contest. When VK3PBX and I later came up on a nearby frequency the disrupter jammed us to the extent that we were eventually forced to close down. While we could hear him, despite the heavily distorted transmitter, the disrupter, who used no call sign, was boasting of the fact that he had been able to force others to close down also. Although I know we are supposed to try and ignore such idiots, my feelings got the better of me at one stage and I told him he ought to go.

Word has reached me that one amateur radio operator (mobile) who volunteered to go to an area where many of the survivors of the bushfire were assembled for safety on a football oval, was prevented from doing so by some over-zealous civic authorities.

This was at a point in time when existing telephone lines were overloaded. He said

that had he been permitted to get to this area with his equipment he could have relieved some of the trauma of that time by passing traffic for people who wanted to contact relatives. He was bitterly disappointed at being prevented from rendering this service and said that some of these officials ought to be educated in the very useful work that even one amateur can do.

During the emergency, ABC radio 3LO remained on the air all one night and for a while maintained a talk-back programme during which I heard some caller named Anne ask for any information about "Digger Smith of Naringal who is believed to be a radio amateur". Digger is indeed a radio amateur to whom I have spoken often but I had no news of him at this time so I did not ring the number given by Anne. However, the following night I mentioned this to all on the Cocktail net, and I understand that a member of this net was able to ring Anne and supply the information re Digger. During this time also, Radio 3AW Melbourne did a wonderful job of bringing us up-to-the minute reports of the fires from their on-the-spot reporters. At the time of writing, I know of at least four amateurs who lost much gear during the bushfires.

A South Australian amateur tried in vain to get a message through by phone to his son in Perth to let him know that Dad was OK. On air, he finally got through to a VK6 who offered to relay the reassuring message on by phone.

Although I was far from the disaster area of the Ash Wednesday fires, I know what bushfires are all about. About seven or eight years ago the whole of the western half of New South Wales was on fire and there were many fires raging on both sides of the Murray River in this Sunraysia area. To assist local volunteer and professional brigades, many appliances with their complete crews journeyed from as far away as Sydney, and thus it was not uncommon during that terrible fortnight, to see fire engines bearing the names of many Sydney suburbs cruising this area. At one point in time there were about sixteen or seventeen separate fires burning simultaneously and there was strong suspicion that some were deliberately lit.

This was long before I got my amateur ticket and before the CB craze hit this area, which means that I couldn't assist in the vital matter of communications. And although much valuable communications equipment was being used by fire officials, it was found that much of the gear could

not be used on a common frequency. I am told that the situation re message-passing was more than chaotic and the need for standardisation of nets was patently obvious. Nevertheless local people appreciated the valuable work done by the hundreds of volunteers who travelled 700 miles to assist us during that unforgettable period. Helicopters, operating out of Buronga Public school yard were used for fire spotting, and my receiver on the spot in the schoolyard enabled police and other authorities to hear messages direct, saving time before they arrived by other means.

So much for bushfires. What a land of contrasts we live in. I happened to be writing the original draft for this article on a day when the much needed rain seems to have arrived. To the west, the sky became darkened with a mixture of water vapor and Mallee dust, then was joined by thunder and lightning as all hell was let loose. A local radio station went off the air for about twenty five minutes, then returned with the announcer apologising for the blackout and bleating about his total inability to give the time, because with everything powered from the AC mains, the studio clocks had stopped also, and even the telephones were out of action.

I wonder is it a reflection of the times that we are so heavily dependent on the seemingly inexhaustible AC mains supply, and not even a commercial radio station has thought of using a battery operated kitchen clock, or one of the old fashioned wind-up variety. And as to why nobody was using a back-up power supply I can't even guess.

A few weeks ago, when there was a similar major disruption to the power supply the cry went out for everyone to stop watering their gardens with hand held hoses, as we were told by the radio that due to the interruption to the power supply, the pumps to the big city tank had ceased to function, and there was only one hour's water left in the tank. Now, why has not somebody thought of having auxiliary generators to power the water pumps? I wonder what will happen if World War Three gets going? I reckon that with our total dependence on generators located hundreds of miles away — with all that wire strung across the country, it will be child's play for the enemy to dislocate our big centres of population.

73 Joe VK2BJX

AM



# WORLD COMMUNICATIONS YEAR

## Public Relations

John Hill, VK3DKK,  
PR CO-ORDINATOR

17 MAY 1983

### WORLD TELECOMMUNICATION DAY

*One World One Network*

"One world, one network" is the theme for the 15th World Communication Day, which — following a long standing practice — will take place on the 17th May, the anniversary of the founding of the oldest intergovernmental organisation in the United Nations System, the International Telecommunication Union (ITU) 118 years ago in Paris on the 17th May 1865. In his message, Mr R E Butler, the Secretary-General of the ITU, stresses that the development of the infrastructures is essential for the harmonious operation of the world network.

World Communication Day 1983 is of particular significance in that it falls within World Communications Year, proclaimed by the General Assembly, with the purpose of promoting the development of communications infrastructures throughout the world.

### WCY STAMPS

To celebrate World Communications Year, Australia Post will issue a 27 cent commemorative stamp on 16th May 1983. A First Day Cover will be issued around the same time.

### AX PREFIX

Word has been received from the Department of Communications that approval is given to the WIA to employ one station per division using the AX prefix and ITU suffix on the 17th May 1983 on the occasion of the World Telecommunication Day Contest.

No objection is seen to the use of the AX prefix by all amateur stations on this day.

### A WEEKEND WITH OE AND DL's

A "World Communication Tour" was organised by a number of German and Austrian Amateurs with wives and friends. The countries visited were Australia and New Zealand. After having visited ZL and VK2 the group flew to Melbourne where Walter VK3DFO acted as host during their stay over the weekend 26/27 March.

Highlights of the Melbourne stopover were a visit to the Science Museum, attending the WIA Broadcast, walk through the Botanical Gardens and a ride on the

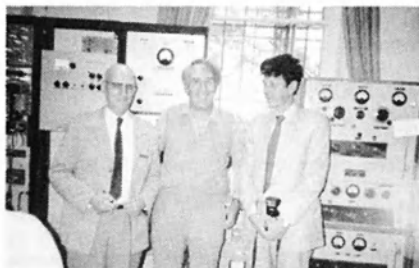

Hans OE2UE, John VK3DKK and Ruprecht DF3CZ during WIA Broadcast.



L to R: Walter VK3DFO, Hans OE2UE, Ruprecht DF3CZ and Franz DJ9EO, ready to board "Puffing Billy"



Peter VK3AVE and Fred VK3BOU during WIA broadcast.



Ruprecht DF3CZ and Heinz DL6RB (standing) at VK3 radiorooms.

famous "Puffing Billy". Peter VK3AVE and Fred VK3BOU welcomed the guests at the "studio", whilst Walter VK3DFO and his wife Maria contributed with a barbecue at their home, attended by many VK friends. The visitors were Ruprecht DF3CZ (tour leader), Hans OE2UE, Franz DJ9EO and Heinz DL6RB.

### VK2 WCY PR

VK2 Federal Councillor, Stephen Pall VK2PS and Athol Tilley VK2BAD, Secretary of the WIA New South Wales Division, were the guest speakers at the Monday 28th February, 1983 meeting of the Rotary Club of Fairfield, NSW, Rotary District 969.

Before a well attended meeting Stephen introduced the concept of amateur radio, its meaning and standing in the community. It traced its history from the turn of the century to present day and practical information was given of what to do to become a radio amateur. Old copies of "Amateur Radio" and copies of the WIA pamphlet "A-Z" were distributed. A video tape presentation about "Amateur Radio", using copies of the federal video library, was made by Athol.

At the end of the Rotary meeting a practical demonstration how amateur radio works was made, using a hand held two metre set working via the Dural repeater, and a QSO with a NZ amateur (ZL2MBC) was conducted on twenty metres with the help of Stephen's rig which was, at the meeting, set up as an amateur station. An endfed random wire antenna was tuned with an AT unit.

from Stephen Pall VK2PS

AR

## ADDRESS UNKNOWN



Would Blake Taylor of Lynwood WA please contact Amateur Radio and let the Editor know your current address.

Australia Post have returned a letter as address unknown.

The address for AR is PO Box 300, Caulfield South, Vic, 3162.

AR

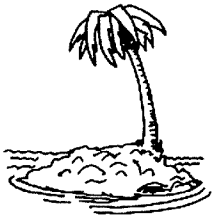

# HOW'S DX

Ken McLachlan VK3AH,  
PO Box 39 Mooroolbark Vic. 3138.

April Fools Day is the day when you are wary of what you hear but Bouvet was the area the DXers concentrated on this year. The world amateurs had the opportunity and the dubious "honour" of working the station 3Y1A who claimed to be on the island. This station was very explicit in his QSL arrangements, that all cards go to LA3DA. What a busy time his postman is going to have and Nils is going to have to do a lot of explaining to the multitudes if this station was not genuine.

Still on Bouvet, still 1st April, was the rumour that this much wanted and inaccessible outcrop would be activated in late 1983 or early 1984 by an Australian expedition. The only known activity that is planned is a Scientific Expedition from LA in 1984/85.

## 1983 CQ WW WPX CONTEST

The 1983 CQ WW WPX Contest, commenced as a disaster in VK3, with the bands misbehaving to the extent that very few QSO's of any note were made on the first day of the contest. Anticipated large ruled up log sheets will have to wait to be filled maybe next year.

When the band did eventually open, on twenty metres, the European QRM built up to the impossible and the easiest way to gain points was to turn the beam north and work the well disciplined operators in Asia. It was a pleasure to call one station and for that station to come back and give a report. This was consistent for the whole time the band was open to the north.

The VK novice had little show of making a reasonable number of contacts as both ten and fifteen metres were not kind and hardly opened at all. If there was much action it was generally outside the segment of the novice allocation. A number of amateurs still flaunt the "gentlemen's" agreement and selfishly operate on SSB under 21.150 MHz, in a narrow segment, that novice operators have to increase their CW prowess. These surreptitious operations are equally carried out by amateurs holding limited and unlimited privileges.

Many exotic prefixes were heard and worked, including XF0MDX/ on Revilla Gigedo who, when last heard, had in excess of 2900 contacts to their credit. Closer to home, Bob ZK1CG, was doing excellent business and towards the end of the contest sounded that some throat jubes would be of great assistance.

Perhaps propagation next year may be better and allow more VK participation in this, my favourite overseas contest.

## FRANZ JOSEF LAND

Chris VK3QG, had the pleasure of working UK1PGO recently and reports that this station has had very few VK's in the log over the last few months. The operators of this still rare country do have scheds on Mondays at 1300 UTC on 14.150 MHz.

## HOLIDAY DXING

Jan and Jay, K6HHD/FO0OJ and W6GO/FO0JO, took a break from the chores of producing their QSL Manager List, which is a must for any serious DXer, and ventured to French Polynesia for a mini DXpedition which was sponsored by the International DX Foundation. It was coincidental that such a trip would enable them to partake in the CQ WW DX Phone Contest.



Jan FO0OJ operating.

The breakdown of 8915 QSO's during the period of 22 October to 4 November, 1982 shows that 128 different countries were worked by both operators with VK getting 3% of the action and ZL and VE 2% each. The operators in the USA fared well with 58% followed by JA with 26%. Europeans gained a 1% success rate.



Jay FO0JO at "work".

The breakdown of the QSO's per band given by the happy twosome is as follows:

3.5	7	14	21	28 MHz
5	7	20	24	44%

Jan writes that 2285 cards are now in the mail and the sample supplied would rate it as one of the nicest multi coloured cards that has been seen at this QTH in many years.

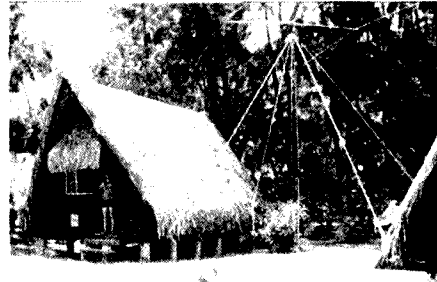

The Residence at Moorea.

## TWO HUNDRED PLUS

Diana G4EZI, by working PY0ZSF, notched up YL country 205. Considering the difficulty in finding that elusive DX country is a big enough challenge, yet alone to achieve 205 YL countries since being licensed. What's the secret, Diana?

## MOZAMBIQUE

Jane ON7WW, writes to say that conditions have not been very good and short skip QRM has not been conducive to good DX QSO's. Jane also mentions that Jack ON6BC/C9 is back home and was unable to obtain the correct documentation to satisfy the ARRL scrutineers. Quite a pity as this is a much needed country.

## UNUSUAL PREFIX

Selected Yugoslavian amateurs are using their alternative 4N and 40 prefix allocation for the 1984 Winter Olympics to be held in Sarajevo. It has been intimated that quite a few calls will be on the bands over the next twelve months from this country. The operators from Sarajevo will see a lot of Willy, in green and gold, a creative koala, the first official mascot ever to represent Australia in an Olympiad.

## WARC BANDS

The latest known "stocktake" of countries that have been granted the WARC bands lists the following.

10 MHz has been granted to A2, A3, DL, DU, EA, F, G, H4, HB, J2, JA, LA, LX, OA, OY, OZ, P2, PA, PJ, PZ, VE, VK, W, XE, YB, YK, ZF, ZL, ZS, 4X, 5N, 7X, 9H, 9L and 9M.

18 and 24 MHz activity is now allowed from A2, A3, A4, DL, F, G, HB, J2, LA, OA, OY, OZ, PA, VK, YB, ZF, ZS, 4X, 5N, 7X and 9L.

Quite an impressive list for the SWLer and the dedicated amateur to look for.



Though not acceptable for DXCC, they should create quite a lot of interest.

### JY ACTIVITY

The "globetrotting" Colvins, after making quite an impact from 9K2 on the waiting multitudes, moved on as predicted to JY. Iris was giving many a new YL country when she was signing as JY8KG and operating from JY3ZH's QTH. The deliberate QRM everyone could have done without but Zedan's transmitters have a way of getting out from that QTH overlooking Amman. QSL's are assured from YASME.

### MALAGASY REPUBLIC

Paul, F6EXV now signing TO6EXV, a special prefix to commemorate WCY, has had to cancel his arrangements to visit Alain 5R8AL and assist him in some serious operating from the rather "unheard-of-on-the-bands" QTH. One reason that Paul put forth was that he has been conscripted into military training for a period and this was going to alter his operating habits.

In the meantime Alain 5R8AL can be heard occasionally on the low end of the twenty metre phone segment speaking to his friends back home.

### BANGLADESH

Peter S2BTF, is active from this rare area on SSB. In a brief QSO with Peter he indicated that he would be QRV until mid July. QSL's, if you are lucky enough to catch him on SEA Net on 14.320 MHz at 1200 UTC, should go to LA5NM.

Two JA operators hoped to assist in taking S2 off the rarity list as a gesture for WCY in late March and early April. This period was to take in the WPX contest of course.

### 1Z9A

Will it or won't it is the question? The answer is not known but it is another attempt to get recognition of the operators from the State of Kawthoolei who have formerly operated under the "prefix" XZ9.

One wonders if this "allocation" is genuine or the results of someone's dream. Is it another ploy to be accepted by the ARRL and consequently increase the diminishing flow of IRC's and "greenbacks" in to the "kitty"? Recommend that you work it as I have done and sit back and wait for a decision as to its acceptance by the ARRL committee.

### COCOS KEELING

Paul VK9YB, had a lengthy stopover on the island recently and was set to outdo Neil's VK9YE QSO rate in his Mini "DXpedition" last year. Paul's QSL arrangements are via VK5QX.

### TOGO REPUBLIC

Ted 5V7HL, is to be shortly joined by another missionary who will become active on the bands. Ted has given many a DXer this rare country in the limited operating time that he has available. Ted has never appointed a manager mainly due to the fact that he says that he doesn't have the time to operate and swell the log book that would justify one's existence.

### DAYTON

Ian VK5QX, reports that VK5CCT/VK9YA will be definitely attending the Dayton convention this year. Many amateurs have made their intention known of attending this world renowned convention over the past few months but Alec is the first definite starter that is known at the present.

### BEACONS

A group of interested North American amateurs have funded a chain of eight beacons which will operate sequentially on 14.100 MHz. The beacons are as follows:

TIME	CALLSIGN	LOCATION
***:00	4U1UN/B	New York
***:01	K6OBO/B	Stanford, CA
***:02	KH6O/B	Honolulu, HI
***:03	JA2IGY	Tokyo
***:04	4X4TU/B	Tel Aviv
***:05	OH2B	Espo
***:06	CT3B	Madeira
***:07	ZS6DN/B	Transvaal

Each beacon transmits in sequence for one minute every ten minutes. The message sequence is as follows: (100W) "QST de (callsign) beacon", (100W) nine second dash, (10W) nine second dash, (1W) nine second dash, (0.1W) nine second dash, (100W) "SK (callsign)". All beacons should now be operational using single element quad loops for antennae.

### MODEL STATION

The ultimate in operational comfort is what all amateurs strive to achieve. Glyn VK3VQX, has constructed this magnificent station, which has all "mod cons" at one's fingertips, for ease of operation. Glyn is fairly new to the bands and one must think that it will not be long before that back wall is filled with overseas certificates.

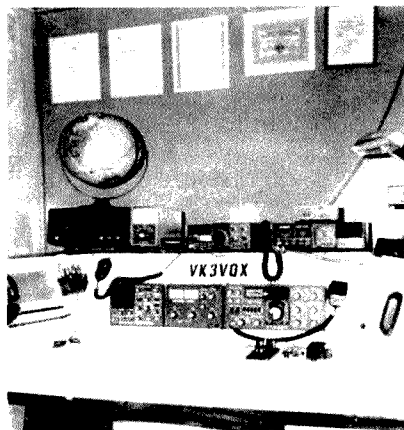

Glyn VK3VQX's operating console.

### ARRL MICROSCOPE

Erik SM0AGD/KH1 and T31AE was a little slow in submitting verification of his successful visit to this area. In fact some of the cards that were sent out were on the DXCC desk for updating amateurs standings before the paper work was received from Sweden. The result, returned cards with no credit. This anomaly was soon rectified and all cards from this area are now acceptable.

### RECIPROCAL LICENCE

It is believed that the negotiations between G and JA are closer to a reciprocal agreement. A number of 9V and VS amateurs are dwelling on such an agreement which would allow them a licence whilst on holidays in this area.

### CW SWL-ING WITH ERIC L30042

28MHz

FK8DZ, JA, 8J5SUN, UA0CBE, UA0LFI, UI80AA, VE5RA, VE6WQ, VE7UZ, X07CC, X07SR, VK8HA, KA6EAS, W7WHO.

21MHz

BY1PK (0715UTC), DU1CK, FK8CE, FK8KAA/P, HL4VM, ISONZA, JT1A0, OK1APJ, UA0SAB, UR2RKS, VK8HA, 9M6YY.

14MHz

A35XX, CE3AA, CM8JC, CR9T, N0Z0/0U2, FG7CC, FK8BU, FM0AX, F08DR, F08IV, HK0BKX, JD1ABZ, KP4V, KH6O/B (Beacon), OK30M, W2BBK/PJ7, PY1ZAE, KD4LI/TI2, T30AT, SV1NY, UL7FCG 4K1A, VK9YB, VP5SSX, VP9DR, X07CC, W6WX/B (Beacon), YV4AU, ZK1AA, ZK2BW, ZL3TZ/C, DK0GDA/ZL5, 4S7EC, 6Y5HN, 9V1TL.

10MHz

A35MS, DL8MM, EA1BSU, F3NB, G2BY, HB9BEG, JA, KV4CI, O2ZRH, PA3BTH, VK8OB, W9UZL, ZL1BXW.

7MHz

EW2A, F9XL, FC9VN, FK80Z, G3LNS, FM7BZ, HL5BBM, IT9TQH, JA, HB9G, HL9KT, I3LJE/KP4, LZ1KAB, X07CC, VK9YC, VP9JR, VS6D0, VU2TTC, Y03AWC, 4N90LY.

3.5MHz

YU2DAM/M.

### QSL MANAGERS

3A3LT (3A2ARM), 4K1G (UA0UCV), 4K1H (UA1CJD), 4Y9YU (YU4FRS), 5N7HKR (OE5RI), 6Y5MJ (K8ZBY), 7P8CG (KCOFH), 9U5DSD (WA4WPO), A22CT (G3HCT), A22DC (G4KJF), C31SZ (G4HYQ), CE9AT (WB6WOD), CO2HQ (WB6QPG), CO2PY (KB7SB), CO1CAK (CT1CAK), CR9BK (JA1HGY), EK9D/D (UK9CAA), EL2AD (WA3HUP), EW2A (UK2AAB), F6FGW/5V7 (F6FGW), FOBLZ/FC (I4BFY), FK8CR (F6EWK), GU5CIA (N6MA), HB0BHA (DK6NN), HK0BXX (WB4QFH), J20BL (F6BFN), J20DU (W6RGG), J28DP (F2GA), JD1FHL (JM1FHL), VP2MKD (N0DH), VU2JXO (WA3TLB), VU2TLB (WA3TLB), ZD7WT (Z08TM), ZP5PX (W3HKN).

### THANKS

These notes have been made possible by information from such magazines as CqDX, WORLD RADIO RADCOM, CQ, QST, HOW'S DX, DX NEWS, QTC, BREAK IN and amateurs including DK2OC, DK9KD, G3NBC, IBSAT, K6HHD, ON7WW and VK's 1MM, 2PS, 3BY, FR, UX, YJ, YL, DHF, VOX, 4YX, 5QX, 6FS, HD, IH, NE and Eric L30042. Sincere thanks to one and all.

**JOIN A NEW  
MEMBER  
NOW**

# WICEN NEWS

Ron Henderson VK1RH  
FEDERAL WICEN CO-ORDINATOR  
171 Kingsford Smith Drive, Melba, ACT 2615



## COUNTER DISASTER COMMUNICATIONS STUDY

WICEN has received an invitation to be represented at a Counter Disaster Communications Study jointly sponsored by Department of Communications and Natural Disasters Organisation, to be held at the Australian Counter Disaster College, Mt Macedon from 24 to 27 July, 1983. With the concurrence of the Federal Executive, I, as Federal WICEN Co-ordinator, have been nominated to attend.

A suitable scenario, which includes bush fires and cyclones, has been proposed as a basis of the study and representation has been invited from a wide range of Commonwealth Departments, State Emergency Services, TV and Broadcasting Federations and the Royal Flying Doctor Service.

The scope of the Study will include:

- (a) *The extent of the Australian disaster problem.*
- (b) *The general requirements for effective response to disaster, with particular reference to communications.*
- (c) *Briefings on current and planned future Australian communications capability in relation to the requirements for effective response to disaster.*
- (d) *Identification of communications requirements for effective response to disasters with particular reference to Australian (including external territory) circumstances.*
- (e) *Review of Australia's communications capability in relation to the identified requirements.*
- (f) *Suggestions for the improvement of Australia's capability*  
— *in the immediate short term; and*  
— *in the long term.*
- (g) *Identification of training needs.*

I will be contacting state co-ordinators separately but if there is anything you personally would wish me to be aware of please write to me at the above address. Now is the time to debrief and review the activities of the recent summer.

## QUEENSLAND WICEN QUESTIONNAIRE

I am indebted to Ken Ayers, VK4KD, the Queensland WICEN co-ordinator for the following questionnaire which is reproduced as received. This is part of Ken's dynamic approach to WICEN awareness and passage of information within his division. Keep up the good work Ken!

### HOW DO YOU RATE AS A QUEENSLAND WICEN OFFICER?

ANSWER TRUTHFULLY AND CHECK YOUR SCORE

#### QUESTION

#### TICK YOUR SCORE

- |  |  |
|--|--|
| 1) Do most of the local amateurs know you are a WICEN Officer?   | (10) YES<br>(0) NO                         |
| 2) Have you given a talk at your local radio club on WICEN?  | (10) YES<br>(0) NO                         |
| 3) Have you organised a local WICEN net in your area?  | (10) YES<br>(0) NO                         |
| 4) Are you registered with the local SES as a member?  | (5) YES<br>(0) NO                          |
| 5) Do you know the name of your local SES Group Leader?  | (10) YES<br>(0) NO                         |
| 6) Do you know the name of the SES area Controller.  | (5) YES<br>(0) NO                          |
| 7) In an emergency with no telephone, could you get a message to your local SES headquarters within five minutes?  | (10) YES<br>(0) NO                         |
| 8) Do you check into the weekly 7050 state network?  | (10) ALWAYS<br>(5) SOMETIMES<br>(2) RARELY |
| 9) Can you recite the PHONETIC ALPHABETIC accurately?  | (10) YES<br>(5) MOSTLY<br>(0) NO           |
| 10) Are you familiar with the WICEN PROWORDS?  | (10) YES<br>(5) MOSTLY<br>(0) NO           |
| 11) Do you know how to give or take a map reference?   | (5) YES<br>(0) NO                          |
| 12) Have you emergency power and can get on air without mains?   | (10) YES<br>(5) NO                         |
| 13) In an emergency, after family and immediate house damage assessment, would you go on air immediately to help other WICEN stations and the authorities? | (10) YES<br>(0) PROBABLY                   |
| 14) Have you a telephone?  | (5) YES<br>(0) NO                          |
| 15) Are you emergency minded and a survivalist?  | (5) YES<br>(0) NO                          |
| 16) Could you erect an emergency antenna within half an hour?  | (5) YES<br>(0) NO                          |
| 17) Have you a fully stocked first aid kit?  | (5) YES<br>(0) NO                          |
| 18) Have you a survival kit or emergency rations available?  | (5) YES<br>(0) NO                          |
| 19) Have you a fire extinguisher in the house or car?  | (10) YES<br>(0) NO                         |

SCORING: 120 to 150 — You are a good amateur dedicated to WICEN.

80 to 120 — You are a good WICEN Officer but you should seriously consider the answers where you didn't get top marks.

25 to 80 — You are not taking your important job as WICEN Officer seriously enough.

Under 25 — Please resign, you are letting the team down.



# EMTRONICS

Retail Division of EMONA ELECTRONICS P/L

649 George St., Sydney, NSW. 2000. Phone: 211-0531.

## CORRESPONDENCE & MAIL ORDERS:

Box K21, Haymarket  
NSW, 2000, Australia

WRITE, PHONE OR CALL IN!

### FROM SYDNEY'S NEWEST ICOM CENTRE!

IC-R70 COMM RECEIVER.....	\$789
IC-720A HF TRANSCEIVER.....	\$1189
IC-730 HF TRANSCEIVER.....	\$819
IC-740 HF TRANSCEIVER.....	\$969
IC-505 6m ALL MODE TRX.....	\$433
IC-2A 2m FM HAND HELD.....	\$289
IC-25A 2m FM MOBILE TRX.....	\$395
IC-290 2m ALL MODE TRX.....	\$617
IC-4E 70cm FM HAND HELD.....	\$320
IC-45A 70cm FM MOBILE.....	\$429
IC-490A 70cm ALL MODE.....	\$689
IC-2KL WITH PS.....	\$1689
IC-AT 100 AUTO TUNER.....	\$357
IC-AT 500 AUTO TUNER.....	\$495
IC-PS 15 POWER SUPPLY.....	\$189
IC-PS20 POWER SUPPLY.....	\$279
IC-PS 740 POWER SUPPLY.....	\$235

### FROM SYDNEY'S OLDEST KENWOOD CENTRE

R-2000 Comm Receiver.....	\$655
TS-930S with tuner HF TRX.....	\$1935
TS-430S HF TRX.....	\$1055
TL-922 2KW Lin ampl.....	\$1380
PS-430 power supply for TS-430.....	\$189
HC-10 world clock.....	\$125
DM-81 Grid Dip Oscillator.....	\$119



## FROM AUSTRALIA'S LARGEST HAM RADIO CENTRE.

### AZDEN the FM KING PCS-4000 \$459



- 8 MHz COVERAGE, CAP/MARS BUILT IN: 142,000-149,995 MHz in selectable steps of 5 or 10 kHz COMPARE!
- TINY SIZE: Only 2" Hx5.5" Wx6.6" D. COMPARE!
- MICROCOMPUTER CONTROL: At the forefront of technology
- UP TO 8 NON-STANDARD SPLITS: Ultimate versatility for CAP/MARS. COMPARE!
- 16-CHANNEL MEMORY IN TWO 8-CHANNEL BANKS: Retains frequency and standard offset.
- DUAL MEMORY SCAN: Scan memory banks either separately or together. COMPARE!
- TWO RANGES OF PROGRAMMABLE BAND SCANNING: Units are quickly reset. Scan the two segments either separately or together. COMPARE!
- FREE AND VACANT SCAN MODES: Free scanning steps 5 seconds on a busy channel. Vacant scanning stops on unoccupied frequencies.
- DISCRIMINATOR SCAN CENTERING (AZDEN EXCLUSIVE PATENT): Always stops on frequency.
- TWO PRIORITY MEMORIES: Either may be instantly recalled at any time. COMPARE!

### JRC:JST-100 Only After You Have Seen Everything Else — Come and See the Fantastic JST!

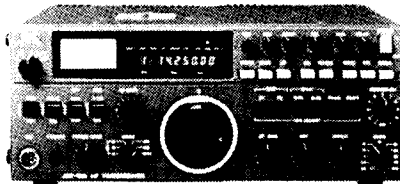

## \$1745

The JRS Model JST-100 HF transceiver is a new digitally synthesized, micro-computer based transmitter/receiver. It incorporates an 11-channel memory and two digital variable frequency oscillators, allowing various types of operation in all amateur bands in the emission modes of A3J, A1 and F1. The JST-100 is designed for compact and lightweight construction and ease of operation.

Write For Brochure

### EXCITING NEW ANTENNA TUNER EMTRON EAT-300



## \$159

MARINE — AMATEUR — COMMERCIAL APPLICATIONS

The Best 300W Antenna Tuner on The Market. The finest American Components Give You Quality Performance and Satisfaction.

- ★ Built-in sensitive SWR meter
- ★ Handles up to 300 watts RF output
- ★ Matches everything from 1.8-30 MHz
- ★ Size 190mm wide x 85mm high 150mm deep.
- ★ Use with: coax, random wires, balanced lines
- ★ 4:1 Balun for balanced lines, 1000V capacitors.
- ★ Large efficient airwound inductor gives lower losses
- ★ A negligible insertion loss of 0.25 dB
- ★ Size 190mm wide x 65mm high x 150 mm deep.
- ★ Built-in heavy duty 2mm aluminum case.

### PCS-300 — The Standard For Comparison \$359



- 8 MHz Coverage
- Ideal size & weight distribution
- LCD Display with timed lamp
- 16 Key Autopatch
- PL Tone switch
- Programmable "odd splits"
- 9 Channel memory with scan
- Automatic inclusive or exclusive programmable band scan
- Busy and vacant scan modes
- Keyboard lock
- Transmit lock
- Digital S/R/F and memory address meter.
- High or low power
- True FM
- Automatic front end tuning
- Rugged commercial-grade modular construction
- Superior receiver
- BNC Antenna connector

### RTTY EQUIPMENT

#### TELEREADER:

CWR685E Comm. Terminal.....	\$1289
CWR670E Receive Conv.....	\$487
CWR-610E Receive Conv.....	\$247

#### HAL:

CT-2100 } comm.....	\$1654
KB-2100 } Terminal.....	

#### ALINCO SSTV:

EC-720 SSTV Conv.....	\$778
-----------------------	-------

See us for a Complete Range of HF, VHF & UHF Linear Amplifiers

### DATONG PRODUCTS

D.70, Morse Trainer.....	\$159
ASP, Automatic Speech Processor.....	\$235
FL-3 Frequency Agile Filter.....	\$299
AD270 Active Antenna.....	\$129
AD370 Active Antenna.....	\$199
RC, Universal Speech Clipper.....	\$199
RFA Broadband Pre-amp.....	\$79
Code Call 4096.....	\$79
RF Direction Indicator.....	\$360
VL Converter.....	\$79
NFA Notch filter.....	\$89

Write For Full Specs On All Items

SEND 60c FOR OUR LATEST 1983 PRODUCT CATALOGUE

# INTRUDER WATCH



Bill Martin, VK2EBM,  
FEDERAL INTRUDER WATCH  
CO-ORDINATOR

33 Somerville Rd, Hornsby Heights, NSW, 2077.

This month, we continue with a short list of known intruders using the A1A (CW) and F1B (RTTY) modes of emission. The A1A intruders can be difficult to monitor, as often the sending speed is very fast, and they don't identify as frequently as we would like. Often, also, they are listening on other frequencies, so we don't hear any replies, and don't always know the identity of the station they are working.

FREQUENCY:	CALL-SIGN:
7012	HY8J
7013	LNV
7060	SGJ
14015	6VWG
14040	MS2T
	XBMC
14079	VRQ. VHL
14141	ULY4, UIJ2, UWX2
14198	7HKM, PAA, AF
14199	QRB5
14244	QSA
21032	UMS (USSR Naval)
21115	F9T (Diplomatic)

Intruder reports on these, and any other intruders are sought by the Intruder Watch. For the statistically-minded, here are a few facts on the Intruder Watch from June to December, 1982.

Number of Intruders reported: 1705  
 Number of Intruders using RTTY: 439  
 Number of Intruders using AM: 405  
 Number of Intruders using CW: 48  
 Number of Intruders who identified: 222  
 And finally, thanks to the following amateurs who sent in reports of intruders in this period:

- VK1 MM NEB DC GD NBS NET UE JO.
- VK2 DAT PS VYI BQS QL NSR PEJ ARR AZR
- VK3 LC XB AMD DMP DBB
- VK4 BG VFG AFA KAL AKX FB YX
- VK5 RM

Now that intruders using the A3E (AM) (see March issue), and A1A (CW) modes have been discussed, let us turn our attention to those intruders who employ the F1B (RTTY) mode of transmission. This is the most prevalent mode employed by intruders, and can be heard virtually at any time on the amateur bands. Bear in mind that amateur operators NEED NO LONGER IDENTIFY IN CW OR PHONE if they are transmitting RTTY signals. They can now identify only in the mode of transmission, if they wish, and this makes the task of separating intruders from amateurs using RTTY more difficult.

If you have RTTY capabilities, well and good. If not, at least you can still measure the shift of the transmission, and any shift over 850 Hz IS DEFINITELY AN INTRUDER. Amateurs can use shifts only upon to

850 Hz. Intruders use shifts of 170, 250, 425, 500, 850, 1000, 2000 Hz, etc, and this makes things difficult. If you hear a RTTY transmission you suspect as being that of an intruder, measure his shift by first zero-beating the mark frequency, and then the space frequency. The difference is the shift, and the point midway between the two is the frequency of transmission. If your rig has a digital read-out, this is comparatively easy.

If the mark frequency zero-beats on a frequency 1000 Hz away from the zero-beat of the space frequency, then the shift is 1000 Hz, and if the two frequencies in question are, say, 14.141, and 14.140, then the frequency of transmission is 14.140.5 MHz.

Now to the more common intruders using RTTY:

Frequency Station	Details
7.048 UHR3	USSR
14.025 HML61, HMR56,	KCNA-(Korean Central
HME28, HMH32,	News Agency)
HMH28, HMK21,	Find more on 21.056 MHz
HMK25.	
14.071 VNA	Vietnam News Agency.
	Also on 21.199
14.101 BXT1	China
BXT43	China
14.115 Y5K	East Germany. Also
	14.145, 14.163 MHz
14.131 Z3N	Thought to be Diplo-
	matic
14.141 UMS	USSR Naval station
14.154 BXT21	China
14.218 QLK	Uses FSK Morse
14.248 BXT17	China
21.032 UMS	USSR Naval station

These above details will give you some idea of the abundance of intruders to be found on our bands. But what happens to the intruders who slip up? *Read on...*

To circumvent the International Telecommunications network, and to ensure industrial secrecy, a Sydney-based company recently got up to some funny business on the HF bands. They were using a VK2 call-sign, and working to the Pacific Islands to an H44 call-sign (neither of which, of course, were amateur operators), using two FT 707's. Power in use was 1.5 KW, and antennas were two log-periodics. Amplifiers were in use, of course. This company was working on the 40, 20, 15, and 10 metre amateur bands, as well as other frequencies. Modes were RTTY, using unusual shifts and speeds, and SSB. Unfortunately for them, they out-smarted themselves, and had \$15,000 worth of equipment seized; had their antennae dismantled, and of course, charges were laid under the Wireless Telegraphy Act. Also found on the premises were three unauthorised UHF rigs.

I have no sympathy for these type of offenders, and the sooner we can report more results like this with regard to other Commercial, Governmental or Military Intruders, the better.

You can help by telling us what you hear. Send any Intruder reports to your Divisional Intruder Watch Co-ordinator, whose details can be found by contacting your Divisional Office. See you next month.

AR

## WHO IS THIS AMATEUR?

Peter Brown VK4PJ

16 Bede Street, Balmoral, Qld 4171

He was born in Sydney in 1872 and passed on in 1928. It is doubtful that he had an amateur radio licence. He commenced his working life apprenticed to an architect but mastered many other callings ranging from engineering to art and writing.

He formed the "Association for Developing Wireless in Australia, New Zealand and Fiji" and was Honorary Secretary. The formation of the Wireless Institute of Australia was credited to him along with many other organisations of note.

He was honoured by the Royal Geographic Society, Royal Astronomical Society and Institution of Engineers, Australia.

In 1911 he established wireless communication between interstate express trains, directed a model and fired a gun by radio. A Memorial Lectureship in Aeronautics was established at Sydney University to recognise his efforts in Aviation, Wireless and Building Construction. This man built and flew gliders in 1909.

His life work is best described in a biography by J M Giles published in a supplement to "Construction" 11/12/1957, and some mention is made of him in WIA Book 1.

On Wednesday 27th October, 1925, he addressed a meeting of the WIA Queensland Division on "Wireless — Today and Tomorrow", and correctly predicted the form that present day television would take. "He has a great reputation for good work: the best of that reputation having been won for services rendered to others". Yes he was George Augustine Taylor. Who has his photograph?

AR

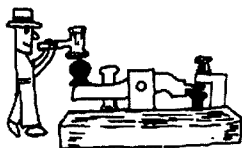

# POUNDRING BRASS

Marshall Emm VK5FN  
GPO Box 389, Adelaide, SA 5001

## SIGNAL REPORTING

*One of the oldest traditions of amateur radio, and the subject of an incredible amount of controversy, is the Signal Report. It is important to all of us to know how "good" a signal we are putting out, yet in the first place a signal report is merely someone's opinion and, secondly, there is seldom anything we can do about a "bad" report. At best a report gives us some idea of "how we are getting out"; at worst it can make us suspect problems which have absolutely nothing to do with our own equipment. Of course reports are VERY useful during contests, when the organizers have said that signal reports WILL be exchanged.*

The basic problem is that a signal report is determined by an operator's ability to hear the signal, and his ability is determined by the quality of his receiver and antenna, the state of his hearing, and his understanding of the business, among other factors INCLUDING the sort of signal you are transmitting and how well it has propagated to the listener's part of the world. All you can reasonably expect is a report of how it sounds to him, in comparison with other signals on the band or which he has evaluated in the past. He may make use of an S-meter, which makes him reliant on the equipment manufacturer's opinion as well as his own.

Given that the whole business is pretty unscientific, we owe it to our fellow amateurs to give as accurate an assessment as possible in accordance with the standard reporting system.

In the case of CW, the standard report format is called the "RST Report", which consists of a three digit number representing an appraisal of Readability (R), Strength (S), and Tone (T), in that order.

**READABILITY.** Reported on a scale of 1 to 5, where 1 represents *no* readability and 5 equals perfect copy. Assuming that "copy" is our ability to derive intelligence from a received signal, perfect copy would represent 100% reception with no difficulty. For the record, the scale is:

- R1 No readability
- R2 Barely readable (only occasional words)
- R3 Readable with difficulty
- R4 Readable with practically no difficulty
- R5 Perfectly readable.

The word "difficulty" as used above

presents some problems. Keeping in mind that we are talking about actual signals here, you should ignore "difficulty" that you might experience due to your own copying ability or the other station's sending speed.

**Note that there is no provision for a report of Readability 0 — R1 means *no* readability, and you can't get any lower than none!**

**STRENGTH.** Reported on a scale of 1 to 9, where 1 represents faint signals and 9 represents extremely strong ones:

- |                              |                      |
|------------------------------|----------------------|
| S1 Faint, barely perceptible | S6 Good              |
| S2 Very weak                 | S7 Moderately strong |
| S3 Weak                      | S8 Strong            |
| S4 Fair                      | S9 Extremely strong  |
| S5 Fairly good               |                      |

A great degree of judgement is called for in giving a strength report. "S-points" cannot be measured objectively outside a laboratory, so meter deflection should be taken as a relative indication only. For example, my own S-meter rarely moves at all on 10 metres — if it twitches the received signal must be at least 8! As far as possible, give a report which indicates the strength relative to other signals on the band. It may seem strange to give an S9 report when the static noise level is S9 + 3 dB, but there is scope in the report amplifications to explain that one, as we shall see next month.

**Never, never, never give a report of S0. It just makes you look silly, because if there is no signal strength at all, there is no signal — and nothing for you to report on in the first place.**

For practical purposes, readability can give a clue to the appropriate strength report, at least to this extent — if readability

is 5, Strength can't be less than 3. Look at the tables again and think about it.

**TONE.** Yes, tone . . . Well, what can we say about tone? This report must go back to the days of spark. T1 is defined as a rough, hissing note, while T9 is defined as a pure DC note with no trace of ripple. I think in technical terms a report of less than T9 would have to represent some form of modulation, but I'm damned if I've ever heard it.

**Note: Technical faults such as Chirp, Drift and Clicks do *not* mean sub-standard tone. They will be covered separately next month.**

I once got a report of 5/9/8 and I was so shocked I nearly broke the paddles going back with "WHY T8? WHY T8?" The answer I got was "SRI OM RCVR HR NOT VY GUD". He knew the fault was in his receiver, but he still wouldn't change my report. Oh, well . . .

Ultimately the tone report will go the way of the dinosaurs. Good riddance, and perhaps we can speed it on its way. As an experiment, once this has appeared in print and I can hope for some support, I will stop giving tone reports and just give readability and strength, with any amplification which might be called for (X, C, D, K, QRM, QRN). If anybody demands a tone report, I'll go back with "T9 OF COURSE OM T9". Well you have to start somewhere, so wish me luck and why not try it yourself? Who knows, maybe we can start something worthwhile in this staid old hobby of ours. If you agree with the idea, why not drop us a line, direct or via the editor, and of course if you know of a good reason for keeping the T report, I'd sure love to hear it!

Till next month, keep pounding ES 73.



## HERE'S RTTY!

Bruce Hannaford VK5XI  
57 Haydown Road, Elizabeth Grove, SA 5112

### MECHANICAL GENERATION OF RTTY SIGNALS

*If you were a very exceptional CW operator with the dexterity and sense of rhythm of a jazz band drummer and had learnt the RTTY code perfectly then you could send RTTY with a morse key.*

RTTY picture courtesy Les White VK5ZW.

However I certainly do not recommend that you attempt this and I only mention it to underline that the mechanical generation of RTTY is as simple as the opening and closing of a circuit according to the RTTY code. The normal amateur RTTY sending speed is 45.45 Bauds and at this 60 WPM speed the shortest part of a RTTY signal is 22 milliseconds (just a little shorter than a 60 WPM morse dot). In a RTTY signal there are seven parts the total length of the 45.45 Baud. The RTTY signal is 163 milliseconds. The first six parts are all 22 milliseconds each and the last part 31 milliseconds long. The first part is always space or off and the last part always mark or on.

To generate a RTTY signal we need a rapid system of on/off switching that gives accurate time lengths of on and off as needed for the various letters etc. The five coded parts of the signal are changeable and the start and stop parts of the signal are always the same. By the way these parts are called bits in computer jargon.

The help explain what is involved in a simple way I will, as a teaching aid, describe a very simple mechanical system. RTTY sending can be done with a rotary switch having seven segments, the rotary arm being motor driven to do one revolution every 163 milliseconds.

*At this stage please study the diagrams and continue to do this as necessary while you read the remainder of this explanation.*

Six of the switch segments are arranged so the moving switch arm takes 22 milliseconds to sweep over each one in turn, the seventh one is slightly longer and the arm takes 31 milliseconds to pass over it.

The longer segment is the stop pulse segment and considering the direction of rotation the next one contacted by the arm is the start pulse contact. As the start pulse is always a space or open circuit condition nothing is connected to this segment of the switch and we will call it the S segment, the next segment is the first of the code segments so we will call it No. 1 the next No. 2 and so on up to code segment No. 5, the stop segment we will call F (F for finish).

There is little insulating space between segments and the switch arm is wide enough to bridge the insulation gap (make

before break). Segments 1 to 5 have a push button hold on switch in series with each one so according to what buttons are pressed the five code segments can be made either mark or space. Holding down a button will make that segment mark and all buttons not held down will make their segments space. The F segment is always a stop pulse (mark) so will always be connected needing no push button switch in series with it.

If the switch arm is rotating at the correct speed and the No. 1 push button is pressed while the arm is over the F or S segments and held down until the arm returns to the F segment and then released the letter E will be sent assuming the receiving equipment is in the letters printing condition. NOTE: In a teleprinter there are less typing keys than a typewriter and letters and figures are combined on the same keys so a special signal is sent to make the receiving machine print either letters or figures and the machine thus operated will stay that way until another signal is sent to change it back again. If the receiving machine was in the figures printing condition the figure 3 would have been sent. If the button is held down for several revs of the switch arm several E or 3s will be sent. If no push buttons are pressed the rotating arm will send start and stop pulses with five space signals for the coded positions, this combination of five spaces is normally not used to print anything and although it has a key on the teleprinter keyboard the key is blank as it prints nothing and normally does nothing at the receiving end.

Sometimes this signal is used to control something at the receiving end however its use is limited as it is an error prone signal because a break in the transmitting to receiving circuit also gives the same signal. As far as our simple sending device is concerned we can simply assume no buttons pressed mean nothing printed at the receiving end.

Now as mentioned before the changing of button positions should be done while the switch arm is over the F or S segments and never while the arm is over the coded segments portion of the switch. Failure to observe this will normally mean various unwanted character signals will be sent.

Because of the rapid rotation of the switch arm it is very difficult to press the buttons at the exact right time so it is desirable to have a one turn clutch that, when engaged, starts the switch arm revolving and stops it after one turn, also the start and stop positions are always at the same point, namely at the end of the stop segment.

With such a clutch in operation press the clutch starting key and you always get one turn even if you hold the key down long enough for several turns.

As an experiment I have made and tried this system on air and I can assure you it does indeed work, the main problem being to quickly remember the RTTY code and decide on the right buttons to press. I found it was best to have the five buttons one under each finger of the right hand and the print or start key under the first finger of the left hand. As the buttons are always there under the correct fingers there is no need to keep looking at your simple keyboard and instead you can watch what is printed, as it is printed. All very interesting, but I repeat I only recommend this system as a teaching experiment and not as a permanent RTTY sending device.

In a normal teleprinter machine you need not know the RTTY code as pressing the desired letter key etc automatically sets the code switches into the correct position and the pressing of any of the keys also sets the one turn clutch into operation at the same time. Additionally when the clutch engages, the switch setting mechanism is locked so a second key cannot be pressed until the first signal has finished.

In our simple sending device a single rotary switch was used but in normal teleprinters each of the five code switches are controlled by a separate cam mounted at different spots on the same shaft. As each cam portion is arranged to come into action consecutively the result is much the same except it is a more compact system that provides easier keyboard control of the switching mechanism.

Well so much for this simple explanation of the mechanical generation of RTTY signals. What has been explained should start beginners along the right road and

help when, for the first time, they are confronted with the complexity of a teleprinter service handbook.

At a later date we will deal with the mechanical reception of RTTY signals.

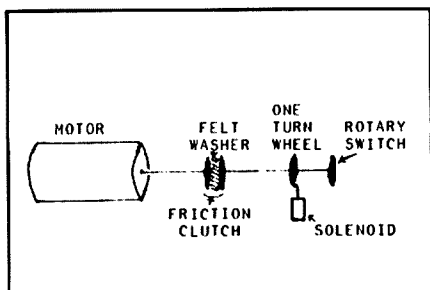

#### RTTY SENDING DEVICE (45.45 Bauds)

The motor drives the rotary switch through a friction clutch, the driving shaft being broken at this point. 368 RPM — one turn per 163 milliseconds.

In the above diagram the one turn wheel that is attached to the rotary switch shaft has a single projecting tooth that comes to rest against the solenoid armature pin in its extended no current position. While in this condition the motor is turning and the clutch is slipping and the rotary switch is stationary at its' stop position.

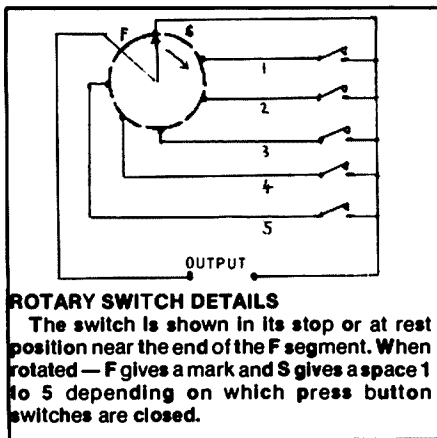

#### ROTARY SWITCH DETAILS

The switch is shown in its stop or at rest position near the end of the F segment. When rotated — F gives a mark and S gives a space 1 to 5 depending on which press button switches are closed.

When the solenoid is briefly energised its armature pin is withdrawn allowing the switch shaft to rotate for only one turn as the armature pin has returned to its at rest extended position before the tooth comes around again.

#### 1983 RD CONTEST

As RTTY participation in the 1982 contest was almost negligible I intend to do all I can to reverse this in 1983.

1. I am endeavouring to have the rules changed so telegraphy contacts receive double points.
2. I am asking the WIA to recommend what

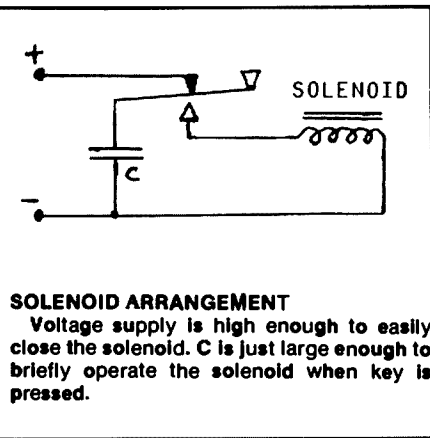

#### SOLENOID ARRANGEMENT

Voltage supply is high enough to easily close the solenoid. C is just large enough to briefly operate the solenoid when key is pressed.

frequencies should be used by RTTY stations during the contest.

3. I am trying to organise some special RTTY awards for those with the highest RTTY contacts score.

4. I am compiling a list of RTTY stations that intend to participate on HF bands and will publicise this just before the contest.

All the above statements have a monotonous repetition of the word I and it should not be that way, how about YOU getting into the act and helping in this effort.

73 From Bruce VK5XJ

AR

## EQUIPMENT REVIEW

### VoCom TELESCOPIC TWO METRE ANTENNA

*Perhaps one of the best pieces of gear I've bought is my two metre "handheld". I'm onto my second one, synthesised of course, but it has the same limitations as the first — an inability to reliably raise two out of the three local repeaters.*

Fortunately a solution was available from GFS, (an AR advertiser of course) — the VoCom telescopic antenna.

As the photograph shows the antenna telescopes down to almost the same size as the "rubber ducky". This is an advantage when you are moving about with the rig either in your hand or hanging from your belt and you want to monitor a channel or two. In this position the received signal is indistinguishable from the "rubber ducky".

When you want to reply to a call it is only a two second task to extend the antenna to its full 1.2 metre length. The effect is as adding a linear. Where once only a thin and noisy unreadable signal might have resulted on the "rubber ducky" the VoCom five-eighth gives a good strong, virtually noise free signal.

I have used this antenna in locations from mountain tops to motel rooms, around Australia and New Zealand with excellent results.

So much for the users report, now for the technical details.

**Connector:** BNC  
**Length:** 210 mm telescoped  
 1215 mm extended  
 (Both lengths include the connector and loading coil)  
**Impedance:** 50 ohms nominal

On test the VSWR was about 2:1 over most of the band, rising slightly at the low frequency end. Measurement of the length of the radiator revealed that it was about sixty four mm (2½") shorter than the recommended length.

Comparative tests were made against a carefully resonated and matched half-wave. It could be expected that the half-wave may out perform the five-eighth wave when either were mounted on the hand-held without resonant radials. The small gain of the five-eighth over the half-wave might be expected to be more than lost due to the poor ground plane.

In practice there was a barely perceptible difference, in favour of the half-wave,

between either antenna on transmission or reception, a very satisfactory result.

Extending the radiator to the full five-eighth wavelength by adding a length of thin brazing rod may improve the match to 50 ohms. I haven't bothered because the operational improvement would be slight and the telescoped length would be longer.

The appearance isn't very exciting. The finish is chrome and black and white plastic.

Nevertheless, when I sell the hand-held I'll be keeping the VoCom.

The VoCom five-eighth 2 m antenna is available from GFS Electronic Imports, PO Box 97, Mitcham, Vic 3132 for around \$35.

#### AT A GLANCE

PARAMETER	RATING
Size	....
Performance	....
Appearance	...
Construction	....
Matching	..

AR

# MODERN MILITARY SURPLUS EQUIPMENT



Colin MacKinnon, VK2DYM  
PO Box 21, Pennant Hills, NSW, 2120

## Reception Set R210

*The R210 is a seven band single superheterodyne communications receiver normally used in conjunction with the Wireless Sender C11. It can be used with longwire or coax cable input, and has facilities for AM and CW; a switchable noise limiter and audio filter.*

### SPECIFICATIONS

Power requirements: 24V DC at 1.8 amps

Frequency coverage:

Band 1	2.0-3.0 MHz
2	3.0-4.5
3	4.5-6.8
4	6.8-9.1
5	9.1-11.4
6	11.4-13.7
7	13.7-16.0

Mode of operation:

Reception of AM, CW and FSK. SSB possible using inbuilt variable BFO.

Sensitivity:

AM-5 microvolts for full audio output

Signal to noise ratio:

AM 6.5 microvolts for 20 dB

Selectivity:

AM-5 kHz-7 kHz at 6 dB

less than 12 kHz at 60 dB

CW-150 Hz at 3 dB

600 to 1000 Hz at 20 dB

Antenna:

1-long wire

2-80 ohm via a BNC socket

IF Frequency:

460 kHz

Stability after 15 minute warm up:

50 Hz per MHz

Dial Calibration:

5 kHz per division, 40:1 reduction ratio of tuning dial.

AF output:

150 mW into 50 ohms.

Weight:

approx 17kg

Valve line up:

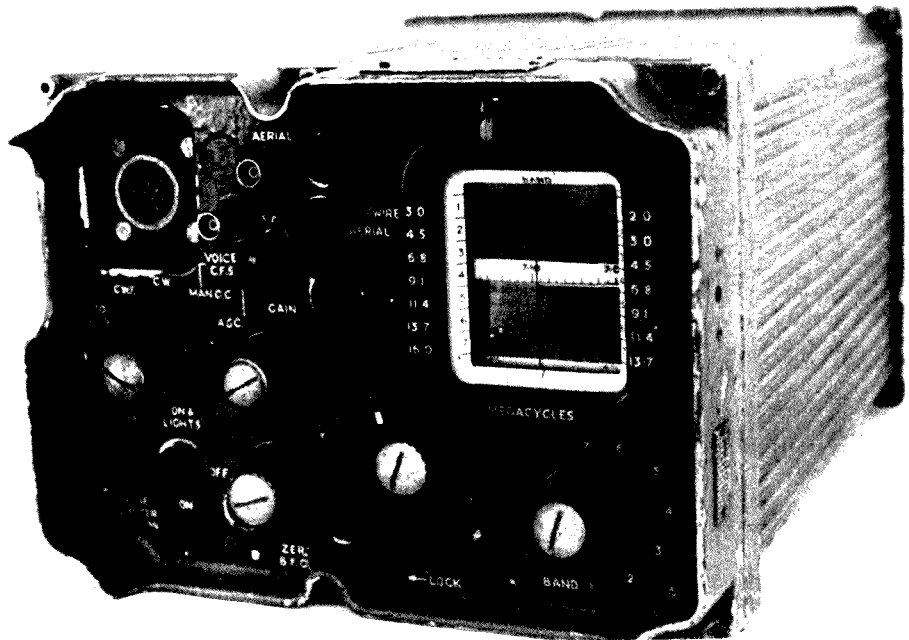

SERIAL NO.	TYPE	FUNCTION	EQUIVALENT
V1	CV4015, CV131	RF amp	6065, EF92
V2	CV4012, CV453	Mixer	68E6
V3	CV4015, CV131	1st IF amp	6065, EF92
V4	CV4015, CV131	2nd IF amp	6065, EF92
V5	CV4015, CV131	3rd IF amp	6065, EF92
V6	CV4025, CV140	AGC Rectifier/detector	6058, EB91
V7	CV4010, CV 850	1st AF amp	6AK5, EF95
V8	CV4010, CV850	2nd AF amp	6AK5, EF95
V9	CV4003, CV491	10 kHz multivibrator	12AU7, ECC82
V10	CV4010, CV850	100 kHz crystal oscillator	6AK5, EF95
V11	CV4010, CV850	Local Oscillator	6AK5, EF95
V12	CV4010, CV850	BFO	6AK5, EF95
V13	CV4010, CV850	IF cathode follower	6AK5, EF95
V14	CV4025, CV140	Noise Limiter	6058, EB91
V15	CV286	95V Stabiliser	95A1

In the above list the valve type numbers are given for the high reliability version e.g. CV4015 and the standard version e.g. CV131. Equivalents are given for US and English commercial valves.

### PRINCIPLE OF OPERATION

RF signals are fed through the appropriate aerial circuit via Band Switch SWB to the RF amplifier V1. The signal is mixed in V2 with the local oscillator, V11, output; operating 460kHz above the signal frequency. Three IF stages, V3, V4 and V5, amplify the signal at 460 kHz. V6 detects the audio in one half and acts as the AGC rectifier in the other diode half. V7 and V8 are audio amplifiers.



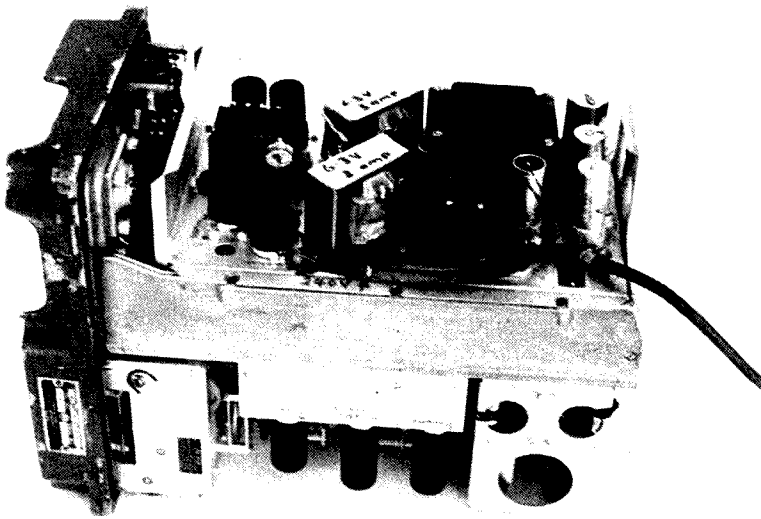

Internal View Showing Mod 4.

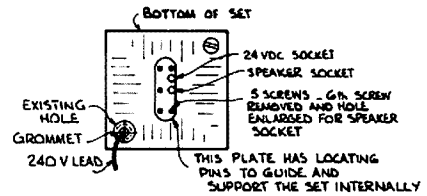

Rear View Showing Mod 3.

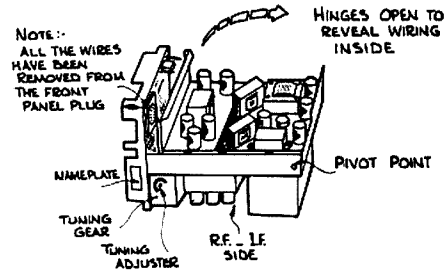

Figure 1 — Rear View.

Output is via a transformer matching to 50 or 150 ohms. The BFO V12 is variable from the front panel about  $\pm 5$  kHz. V13 provides an 80 ohm IF output on the front panel for FSK, or as the army call it, CFS, Carrier Frequency Shift. The double diode V14 operates as an audio noise limiter switchable from the front panel.

A 100 kHz crystal oscillator V10 is switched on for calibration and V9, a double triode connected as a multivibrator gives 10 kHz calibration signals. A 1 kHz audio filter, L12 and C99, is switched in on the CWF switch position. AGC is applied to V1, V2 and V3, in the Cal 10 kc/s, Cal 100 kc/s and AGC switch positions but in the CWF, CW and Man GC positions a 1 meg ohm pot ganged with the 0.5 meg ohm audio gain control is brought into the AGC line and supplied with  $-30V$ . The audio gain pot is then inoperative.

### POWER SUPPLY

The power supply uses a self-rectifying vibrator and a transformer, with a choke and capacitor for HT output. Separate windings give filament and bias voltages. V15 is a 95V stabiliser feeding the local oscillator and mixer. Voltages required in the set are:

- HT1 +175VDC at about 150 mA
- HT2 +95VDC at about 50 mA
- Filaments 6.3VAC at about 2.5 A
- Bias  $-30VDC$

An interesting feature of the power supplies for the various units is a relay which switches out resistance, or in the R210, switches transformer tappings to maintain HT voltages when the input voltage drops below 23.5V. In the R210 this is relay RL4/4 which can be permanently energised if the input voltage is less than 30V.

### FRONT PANEL INTERCONNECTION PLUG — PLA

If you examine this plug you will see it has a letter beside each pin. The significance of each is:

- A — 24VDC input positive
- B — 24VDC input earth
- C — HT1 (+175V) output from PSU
- D — to HT1 input to set
- E — 6.3V heater output from PSU
- F — to valve heaters
- G — earth same as B
- H — 30V input from C11 (in parallel with PSU supplied  $-30V$ )

### HASHBOX VIBRATOR

THIS IS THE LEFTHAND SIDE OF THE SET

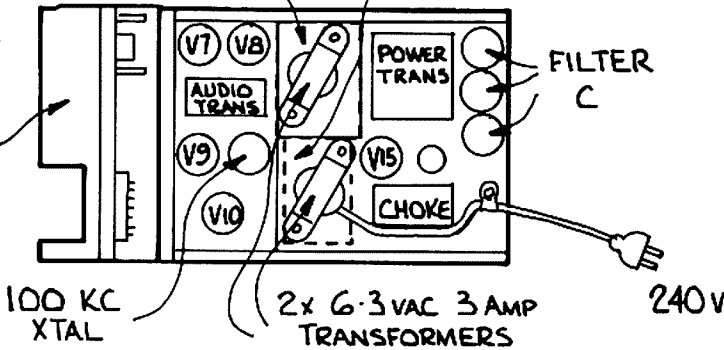

Figure 2.

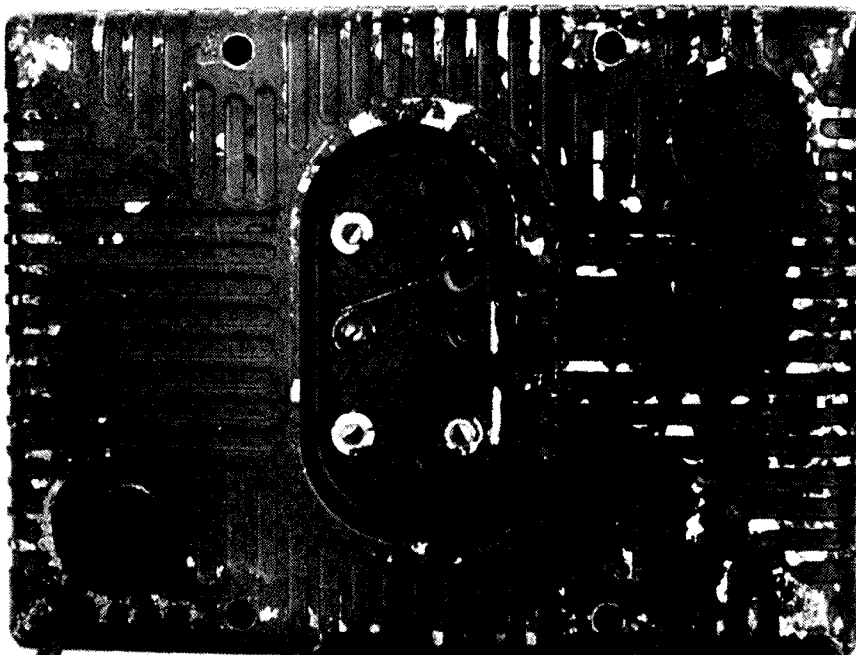

Figure 3.

J — voltage control relay RLA/4  
 K — Audio Output — 50 to 150 ohm  
 L — Audio Output — 50 to 150 ohm  
 M — 24VDC switched output

## MODIFICATIONS

- (1) To operate the R210 alone you need to make the following connections:  
 + 24VDC to pin A  
 earth to pin B  
 pin C to D  
 pin E to F  
 pin J to M if input voltage is less than 30V  
 Headphones, Low impedance, or a speaker to pins K and L. An 8 ohm speaker works OK.  
 Antenna to front panel.
- (2) One way to accomplish these connections is to remove the front panel connection plug and replace it with an aluminium plate. Onto this plate fit an earphone socket eg Dick Smith P-1231 and a DC power socket eg Dick Smith P-1665.  
 The other wires can be soldered together as required and taped.
- (3) Another way of making a neat installation is to remove the centre bolt securing an aluminium plate with alignment pins that is bolted to the back of the case. Enlarge the hole to about 12 mm diameter to clear an earphone plug and drill a similar sized hole next to it. Mount a small aluminium plate to the RF/IF sub-assembly chassis and on this, in line with the holes in the case, fit an earphone socket and a DC power

socket. (see photo No. 3) The existing wiring can be left as is and new audio and 24V wiring connected in parallel, or it can be disconnected from the front connector and run to the new sockets. If you choose to leave the existing wiring be aware that there is unguarded 175V on the front connector.

- (4) A worthwhile modification involves fitting a 240V to 6.3V 7 amp transformer onto the power supply chassis and connecting it to the heater wiring. The vibrator is removed and two rectifier diodes connected in the 175V secondary of the set transformer. Note that they are connected in opposite polarity to a conventional full-wave, centre tap circuit. There is room for two transformers on the chassis if you can't find one with sufficient current rating. The mains lead can conveniently be routed through a large plug hole in a rear corner of the case. Do not use the existing ON-OFF switch for the 240 volt input as it's only rated for low voltage.
- (5) If you can find a dual concentric pot with one 1 megohm and one 0.5 megohm values or similar, you can replace the existing gain control and obtain independent control of RF and AF gain. You must move a brown wire from VR2 terminal with shielded connection to the VR2 centre terminal. This is helpful when resolving SSB signals.
- (6) Better performance on SSB can be obtained by converting V13 and FSK IF output, to a product detector.
- (7) Although I haven't tried it, it would not be too hard to change the BFO variable capacitor to a switch connecting one of

- (8) two trimmer capacitors for USB or LSB. You can retune the IF to 455 kHz, from the 460 kHz, if you wish to fit a crystal or ceramic filter for better selectivity. Local oscillator frequency will have to be adjusted.
- (9) If you carried out modifications to provide alternative connections to the front panel interconnection plug PLA then you can remove the front panel connection plug altogether and fit an S-meter in its place. You may have to enlarge the hole to suit. I haven't detailed any circuit as there are plenty of S-meter circuits in the technical literature.
- (10) On the cosmetic side; if you carefully scrape the paint off the raised lettering on the front panel you highlight them in silver on a green background.
- (11) On many sets the tuning is inoperative. I don't know how this came about but invariably a small ball on the end of a worm shaft in the tuning gearing has been dislodged. You usually find the ball somewhere in the case and it only requires infinite patience to replace it. There is supposed to be a ball at each end of the shaft, held under tension by screwed adjusters sealed with red paint. Undo one of the adjusters and fit the missing ball back by whatever means you can. (see fig 3) I have found that a dab of grease on a toothpick will hold the ball whilst you juggle it in. Tighten up the adjuster just enough to eliminate end play and lock it up again. If you choose to fiddle with the rest of the tuning gearing — best of luck!

AR



AUSTRALIAN LADIES AMATEUR  
 ASSOCIATION

# ALARA

Margaret Loft VK3DML  
 28 Lawrence Street, Castlemaine, Vic. 3450



## 83/84 CALLBOOK

Work has commenced on  
 the next edition!

Are your details correct  
 in the last edition?

If not please notify the UIFA  
 Federal Office —

**PO Box 300  
 South Caulfield  
 Vic. 3162.**

Hello again to all. The months are rolling on very quickly. The good news this month is the rain we have been enjoying this week, do hope the drought really has broken and all the water related problems are over.

Haven't heard any new call signs from the last exam but do hope some are about to appear on the bands.

Our secretary Jessie VK3VAN and OM Gordon VK3BGB are on the move, hope you both enjoy suburbia after the country life. Good luck to you both from us all in ALARA.

If you want to join ALARA please write to Valda VK3DVT, Post Office Box 4, Church St, Brighton 3186, for details, she will be very pleased to hear from new YL's.

Annual meeting will be on Monday 25th July at 1030 UTC. Some of our office bearers have indicated they will not be available for re-nomination so please give some thought to whether you have the time to help in the Administration of ALARA in the next twelve months. Nomination forms

will appear in April newsletter. If you feel able to assist, please offer to help in the capacity you prefer and this will ensure the continuity of our group in the future.

ALARA nets on Monday nights for the first ½ to 1 hour (at discretion of net control) are for YL's only. After this the OM's are very welcome to join in, either for contacts for the award or just to chat. If you want to get a message through for one of the girls on the net indicate this to net control when you call in. We have acted as liaisons at times and also in emergency situations. So please call in any Monday night, when you have time.

Margaret VK4AOE invites all YL's to join in on Wednesday nights at 1000 UTC on 3563 MHz ± GRM. I called in one night but band conditions weren't favourable, so better luck next time.

Until next month all the best to you all, hope you all had a pleasant Easter break. 33/73/88 to all.

AR

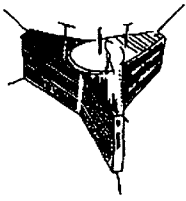

# AMSAT AUSTRALIA

Bob Arnold VK3ZBB  
41 Grammar Street, Strathmore Vic 3041

## NATIONAL CO-ORDINATOR

Chas Robinson VK3ACR

## INFORMATION NETS

AMSAT AUSTRALIA

Control: VK3ACR

1000 UTC Sunday

7.064 MHz in Summer

3.680 MHz in Winter

AMSAT PACIFIC

Control: JA1ANG

1100 UTC Sunday

14.305 MHz

AMSAT SW PACIFIC

Control: W6CG

2200 UTC Saturday

28.880 MHz

Participating stations and listeners are able to obtain Basic Orbital Data including Keplerian Elements, from the Amsat Australia Net. This information is also included in some WIA Divisional Broadcasts.

## OPERATIONAL UPDATE

AMSAT OSCAR 8

The operating schedule of Mode 'A' on Sunday, Monday and Tuesday; Wednesday rest day and Mode 'J' on Thursday, Friday

and Saturday continues to apply and will so for the foreseeable future. The possibility of severe battery problems appears to have been averted as operation of the transmitters on both modes is now quite normal.

Information from Ed VK2ADJ indicates that the battery voltage and spacecraft temperature are now normal.

### THE RS SERIES

All RS satellites are working normally. Some slight deviation to the RS5 telemetry on 29.452 MHz has been observed and this is understood to be connected with the use of RS5 codestore by the Soviet Antarctic Expedition.

Leo Labutin UA3CR heads up the communications section of the Expedition using the call sign 4K1CR. With the RS5 transponder off the Robot-Codestore channel on 29.330 MHz is used to store and exchange messages between the Antarctic and Moscow.

### UOSAT OSCAR 9

After a protracted period of analysis and manoeuvring the UO9 spacecraft was stabilised early in March and deployment of the Boom commenced. Extension proceeded satisfactorily for the first metre of

the fourteen metre total length but at one point the boom became snagged with the cables connecting it to the spacecraft. The situation was analysed and it was hoped to free the boom by 'rocking' it to and fro.

The boom is important to the overall success of the UOSAT project as it acts as an antenna for the HF Beacons and carries other experiments — see the UOSAT Technical Handbook (obtainable from AMSAT-UK) for further details.

## 1983 ORBITAL DATA

	ORBITAL PERIOD MINUTES	INCREMENT DEGREES WEST
Oscar 8	103.1676	25.7943
UOSAT 9	94.7095	23.6763
RS 3	118.5196	29.7567
RS 4	119.3930	29.9754
RS 5	119.5547	30.0155
RS 6	118.7168	29.8060
RS 7	119.1949	29.9256
RS 8	119.7622	30.0676

The Orbital Period and Increment are estimated figures for 1st May 1983.

## SATELLITE ORBITAL DETAILS FOR 1983

SATELLITE	OSCAR 8	UOSAT 9	RS 3	RS 4	SATELLITE	RS 5	RS 6	RS 7	RS 8
Epoch	78.43168648	79.36845551	78.48020060	49.18893777	Epoch	79.07073722	49.15195035	80.34568084	80.03962658
Decay	1.36e-6	55.51e-6	4e-8	1.12e-6	Decay	11e-8	21e-8	-7e-8	2.01e-6
Inclination	98.7644	97.5327	82.9581	82.9499	Inclination	82.9599	82.9567	82.9577	82.9420
RAAN	95.4240	45.3113	25.7519	46.1033	RAAN	30.5515	42.9474	28.0496	30.9627
Eccentricity	.0006262	.0001214	.0057404	.0018223	Eccentricity	.0009657	.0049012	.0020583	.0021866
Arg Perigee	198.7280	273.6305	221.1520	353.2768	Arg Perigee	326.1409	299.0670	247.4133	4.0044
Mean Anomaly	161.3667	86.4783	138.5206	6.8045	Mean Anomaly	33.9068	60.5489	112.4729	356.1061
Mean Motion	13.96548127	15.21124015	12.15575695	12.06661508	Mean Motion	12.05039402	12.13552541	12.08674848	12.02935935
Orbit No	25671	8029	5553	5159	Orbit No	5512	5188	5544	5514
Element Set	741	439	52	85	Element Set	78	49	94	202

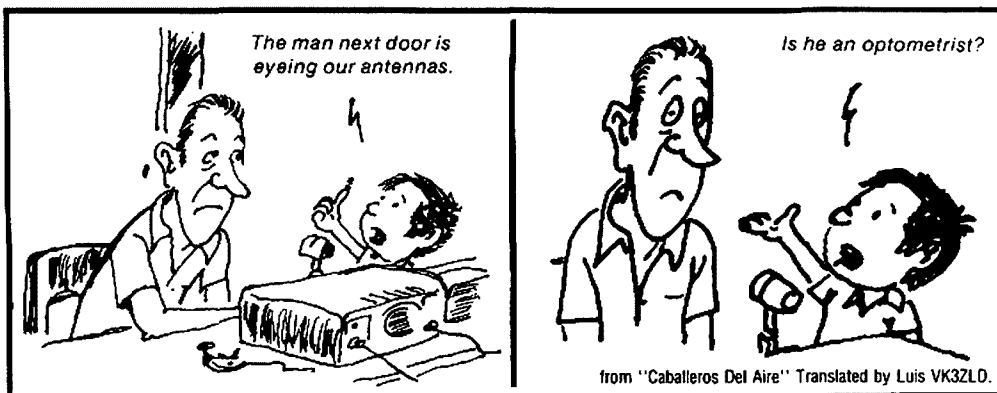



# VHF UHF - an expanding world

Eric Jamleson VK5LP  
1 Quinns Road, Forrester, SA 5233

All times are Universal Co-ordinated Time, indicated as UTC.

## AMATEUR BAND BEACONS

FREQ	CALL SIGN	LOCATION
50.005	H44HIR	Honiara
50.008	JA2IGY	Mie
50.020	GB3SIX	Anglesey (1)
50.060	KH6EQI	Pearl Harbour (2)
50.075	VS6SIX	Hong Kong
51.020	ZL1UHF	Auckland (3)
52.013	P29SIX	New Guinea
52.100	VK0AP	Macquarie Island
52.200	VK8VF	Darwin
52.250	ZL2VHP	Palmerston North
52.300	VK6RTV	Perth
52.320	VK6RTT	Carnarvon
52.350	VK6RTU	Kalgoorlie
52.370	VK7RST	Hobart
52.400	VK7RNT	Launceston
52.420	VK2WI	Sydney
52.425	VK2RGB	Gunnedah
52.435	VK3RMV	Hamilton
52.440	VK4RTL	Townsville
52.510	ZL2MHH	Mt Climie
144.400	VK4RTT	Mt Mowbrall
144.420	VK2WI	Sydney
144.465	VK6RTW	Albany
144.475	VK1RTA	Canberra
144.480	VK8VF	Darwin
144.550	VK5RSE	Mt Gambier
144.600	VK6RTT	Carnarvon
144.900	VK7RTX	Ulverstone
145.000	VK6RTV	Perth
147.400	VK2RCW	Sydney
432.410	VK6RTT	Carnarvon
432.440	VK4RBB	Brisbane
432.450	VK3RMB	Mt. Buninyong

- (1) Confirmation to hand that this beacon is operating with 100 watts ERP to a three element yagi beaming west, and an invitation to list it. (The days are gone when one can safely say it may never be heard, that statement disproved regarding lots of stations in Cycle 21, also contacts between G land and VK6 have been made on 6 metres, so let's be adventurous and include it . . . VK5LP)
- (2) "Break In" magazine from NZART says this beacon is now on 50.064, and they are closer than we are and have probably heard it lately. Can anyone confirm frequency from VK?
- (3) ZL1UHF now operating on 51.020 in lieu of former 51.022.

## SIX METRES IN THE UNITED KINGDOM

Norman Fitch, G3FPK, is the Editor "VHF Bands" for the "Shortwave Magazine" published in the UK, and has written to say that "Following negotiations between the RSGB and the Home Office, forty UK radio amateurs now have permission to operate in the 6 metre band. Now we have a domestic TV service in Band 1 but the vast majority of

viewers receive the 625 line colour service in Bands 4 and 5 now. So there are still restrictions as to when we can operate.

"The band is from 50.0 to 52.0 MHz. The powers: A1A (CW) 16 dBW carrier power at the antenna; J3E (SSB) 22 dBW at the antenna. Operation times are outside Band 1 TV transmission hours, normally from about 0000 through 0900.

"G — England — nineteen stations licensed to operate; GI — Ulster — three stations; GJ — Jersey — three stations; GM — Scotland — ten stations; GW — Wales — five stations. Only full, Class A licensees are included, no Class B, VHF only folk.

"As to the future, by Act of Parliament, as TV in Band 1 must close down by the end of 1986. However, the BBC would like to close down all the transmitters much earlier as they are costly to maintain. Lately, there has been published the Merriman Report concerned with the development of the VHF spectrum in general, and it recommended that all UK Band 1 TV be closed down by the end of 1984. Therefore, we expect that 6 metres will be available to all in the not-too-distant future. So, by the time the next sunspot cycle allows F-layer DX, we should be working VK!"

So that's the position in the UK and the forty licences so far granted is at least a start in the right direction. It will be of tremendous interest and benefit to Northern Hemisphere operators in particular, and hopefully we can eventually share in the contacts. It will be of even greater interest to us if we too can operate on 50 MHz and so place the DX operators at least in a position to work on a more world wide basis than at present.

Steve VK5AIM has sent some more pages from "The Short Wave Magazine" (mentioned above) and a plea for more adherence to the 2 metre band-plan for Region 1. It may interest you to know 144.000 to 144.150 is exclusively CW, with the first 10 kHz for EME. 144.050 is the calling frequency, 144.100 the random, ie non-scheduled — MS frequency. 144.150 to 144.499 is SSB and CW, though little CW occurs in this part. 144.300 is the SSB calling frequency, and 144.400 the calling frequency for random SSB, although 144.200 is very much in use too. 144.500 to 144.849 is basically all-mode DX operation, with 144.500 for SSTV calling, 144.600 for FSK RTTY calling, 144.700 for FAX calling, and 144.750 for ATV talkback. 144.850 to 144.990 is the beacon band. The FM band for repeaters with 600 kHz spacing input/output is from 145.000 to 145.800, with 145.300 AFSK RTTY calling frequency and 145.500 the general calling frequency. The section 145.800 to 146.000 is for

satellite communications. Reading through the notes one gets the impression there must be so many stations on the band that QRM is always a problem, especially as all of Europe is within range from time to time.

DX records in the UK are interesting. John G4BYV has had his previous 464 KM record on 9 cm broken by PA2DOL who worked over 500 km. G3AUS worked on OK station on 30/10/82 to create a new 23 cm record of 1576 km. On 13 cm the record is held by G4BYV and OK1AIY with 1027 km.

GB3CEM is a microwave beacon operating on 10.36888 GHz with 3 mW to an omnidirectional aerial, while GB3GBY is another beacon with 10 mW to a slotted waveguide, with a sixteen element beam pointing south. On 23 cm the Kent beacon GB3NWK has an ERP of 100 watts.

## NEW 1296 RECORD — HAWAII TO CALIFORNIA

That's what the headline read in the American publication. But there was one catch. It was one way only over the path of almost 2500 miles, almost double the present Australian record.

One could say it was very unfortunate that the beacon operator, Paul Lieb, KH6HME, was actually in California on business at the time the signal was received.

I am indebted to Wally VK6KZ for further fill in on the 1296 MHz scene in California, as he has recently returned from a trip to the USA, and has actually spoken to some of these operators. A group of dedicated 1296 MHz operators in Southern California are led by Chip N6CA, others include Paul KH6HME, Ed W6NGN, Garry WA6MEM, Joe K6ZMW, Robert W6PJA and Lynn W6KGS. They are anxious to make two-way communication between Hawaii and California, and keep a close watch on the weather conditions between the above two locations as well as those fronting on to Mexico.

It appears the tropospheric duct occurs around 8000 feet in Hawaii and 1000 feet in California, and often hurricanes are present in the Gulf of Mexico at the time the duct is formed as a result of rapid changes in temperature, air pressure and water vapour or moisture in the atmosphere.

Normally the KH6HME beacon runs on three bands, 144, 432 and 1296 MHz, but recently the 2 metre beacon has been withdrawn because the 2 metre path has been worked so often there seems little purpose in continuing a beacon on that band. However, on 432 and 1296 MHz the beacon mostly operates during the summer months when the formerly mentioned

rapid changes to pressure gradients etc are most likely to occur. N6CA even has a mobile 1296 MHz station and drives around the hills in his location looking for the right spot from which to work long distance signals. His mobile rig includes 144 MHz and HF gear for local contacts and general co-ordination, plus his 1296 MHz receiver with extremely low noise figure for mobile monitoring, apparently this is necessary as the end of the duct can be any height from the former 1000 feet to near ground level. Once having found the right spot, Chip can fire up a 500 watt transmitter which can be powered either from the AC mains if they are handy or a portable alternator. That must be dedication to the extreme, but it is certainly starting to pay off!

The signals in question were originally heard on 30/7/82 on 432.075, weakly at first until peaking to S9. They didn't last long enough for Paul KH6HME to get back to Hawaii from California and make it a two-way contact, as signals faded out the next day.

The California 1296 MHz operators seem to favour the loop type yagi, and a 44 element yagi with a boom length of twelve feet can be used for mobile operation. These operators favour the loop yagis due to much less wind loading than with a six to eight foot dish to give similar gain, and are easier to feed than a dish.

Chip, N6CA, has ensured the best possible set-up for the Hawaiian end of the circuit by constructing most of the equipment being used, himself. Four 25 element loop yagis vertically mounted one above the other give about 24 dBI gain, are fed with heliax from a 30 watt transmitter, and the beacon is located on Mauna Loa, an active volcano, at about 8000 feet ASL, and it takes Paul KH6HME about three quarters of an hour to get there from his home after being alerted the band is open. Wally says its some drive too, through lava flows which are black in colour, and the road would be hard to see at night as it is just bulldozed through the lava!

Whatever the outcome of the signals on 30th July, it would be remiss of us in Australia if we didn't say well done to the USA operators who have put so much time and effort into trying to span such a distance, and we wish them well in the future, knowing it is only a matter of time before the crossing becomes two-way. We all await that time with interest. Perhaps to keep the world record in Australia we should be striving to span the distance between VK6 and New Zealand, and I see no reason why it should not be done eventually if there are similar dedicated operators at both ends of the circuit here. Who is going to be first?

### LOW NOISE FIGURES

Whilst still concerned with the American scene, I have to hand, from Wally VK6KZ, some interesting figures on a pre-amp noise figure measuring contest held recently at the 1982 Central States VHF Society Conference. You may find the following figures a fair indicator of how far the "state of the art" has progressed recently.

50 MHz: WA5VJB using 3SK97 returned 0.59

dB; WB5CHW 3N204 1.25 dB.

144 MHz: VE3CRU MGF 1200 0.12 dB; K7KOT D432 0.18 dB; W5UN MGF1200 0.27 dB; WA5VJB MGF1200 0.42 dB; K89NM MGF1402 0.42 dB; KB9NM MGF1200 0.48 dB; WB5GHW BF981 0.73 dB; WA5IED Janel 3N204 2.99 dB.

432 MHz: WBOTEM MGF1402 0.40 dB; WD4MBK MGF1402 0.58 dB; WA5HMK MGF466 0.98 dB; W5UKQ PAG432 (Lunar) 1.12 dB; KR5F DXL3501 1.16 dB; KL7WE PAG432 (Lunar) 1.20 dB; WA5HMK NE64535 1.49 dB; KR5F DXL 3501 1.96 dB.

902 MHz: KCOW MGF1402 0.82 dB; WB5GHW MGF1400 2.50 dB; WA5VJB MRF902 2.56 dB.

1296 MHz: WBOTEM MGF1402 0.68 dB; K9KFR MGF1400 0.99 dB; WD4MBK NE72089 1.12 dB; WB5GHW MGF1400 1.20 dB; W6PO DXL3501 1.47 dB; W1UHE PAG432 1.71 dB.

2304 MHz: K9KFR NE24483 0.90 dB; WA5VJB NE64535 (1) 2.50 dB; WA5VJB NE64535 (2) 3.00 dB.

There were a number of other pre-amplifiers in each range except 50 MHz which were not as good as those listed, but still very satisfactory by ordinary standards.

In the Antenna Gain Measuring Contest conducted at the same venue, on 144 MHz K5RF had an eleven element quad eighteen feet long giving 13.5 dB gain, a nine element quad thirteen feet long gave 13.2 dB and a nine element wide spaced quad sixteen feet long 12.5 dB. W5UN submitted a home brew twenty-six foot long quagi with 12.5 dB gain.

On 432 MHz: K5GW submitted a twenty-four element Cushcraft yagi with 14.5 dB gain. WD4MBK submitted three, nineteen element home brew yagis to the RIW design producing 13.9, 13.9 and 13.5 dB respectively, W3XO submitted a sixteen element yagi with 12 dB gain.

On 1296 MHz: W5UPR obtained 17.2 dB gain with a Tonna yagi; WA5TKU 16.0 dB loop yagi; K5FN 15.5 loop yagi; W5DC 14.5 dB yagi.

On 2304 MHz: WA5VJB 19.5 dB with forty-one element loop yagi; WB5LUA 8 dB with a one pound coffee can dish feed antenna, and his reference dipole naturally gave 0.0 dB!

So all you home builders will now have some specifications to attempt in both preamplifiers and antennas, so I expect soon to be hearing reports of improved signals on all bands!

### EME EXPERIMENT

Wally, VK6KZ, has kindly telephoned me with information on forthcoming EME experiment on 14/5, 15/5 and 16/5/83 which could promote quite a degree of interest for those 70 cm stations having a reasonable degree of DX capability.

Callsign to be used is K8HUH and will be operating from Greenbank, West Virginia, and running 150 watts to a 150 foot dish, which should have a gain around 44 dB giving 3.86 megawatts ERP! Transmitting frequency will be 432.100 and they will be tuning for replies fairly widely both above

and below that frequency, so it may be preferable for those replying to spread out a bit to reduce the possibility of being clobbered by someone more powerful.

Stations at this end, it is considered, will need about 1 kW ERP, which can be obtained from 100 watts to a 10 dB gain antenna (but remember to allow for cable losses when making your calculations!). It is likely most contacts will be made with CW but if everything is just right it might be possible for some SSB contacts to be made.

On the receiving side a masthead amplifier would be very desirable, preferably of the GaAs FET variety. As the new moon and the sun will both be in the same quadrant during the experiments, it is likely the level of sun noise will be increased, hence the better the antenna the less noise.

The window for Perth is from 50 to 60 degrees, and elevation will be just above the horizon, so your horizontal beams will be at about the right elevation.

Times for Perth are: 14/5 0020 to 0110 UTC; 15/5 0130 to 0210 UTC; 16/5 0240 to 0330 UTC. Due adjustments from these times will need to be made depending on moonrise and where you live.

Good luck with the experiment to those who have the right equipment, but remember, don't transmit on 432.100 because you could block out the signals from K8HUH to someone who is actually copying him and this would be a pity. Certainly there is no point in putting your transmitter on the air unless you can actually hear K8HUH. Whilst he might hear your transmitter if you have enough ERP, unless you can HEAR HIM then no contact will result! Doppler shift will also make it necessary for you to track his signal as he is transmitting, so you are going to be busy. Those with some of the more recent gear with twin VFO capability will have a head start in any case.

More information will probably be available as the time approaches. If you are serious then perhaps a brief few words with EMEers such as VK5MC and VK6ZT could provide you with additional information, but don't overload them, they will probably be very busy themselves at the time, or leading up to the experiments.

### NEW 10 GHz EUROPEAN DX RECORD

"Break In" for February 1983 gives evidence of "a new record has been established on 10 GHz of 1166 km between I0SNY/EA5 located near Valencia, Spain, who worked back to Italy to IW0BFZ near Rome. This sea path across the Adriatic Sea was achieved on 10th July 1982 on 10.525 GHz. Equipment in use is believed to be 30 milliwatt Gunnplexers to one metre dishes at both ends.

"Nicola Sanna I0SNY has over the last few years been investigating enhanced propagation across the Adriatic Sea (off the east coast of Italy) and has held the world DX record twice on 10 GHz work, over this same path, once at 757 km and once at 860 km. This path is geographically interesting in that it is well sheltered by land masses and together with mid summer temperatures and calm weather conditions

has led to a high incidence of tropospheric ducting propagation.

"In addition to his 10 GHz work, Nicola was active on 1296 MHz and amongst other DX contacts worked I2K5X/8 in Calabria (southern Italy) at a distance of 1396 km thus creating a new European DX record on this band; he was using only 4 watts to a 17 element yagi. Thanks to QST for the report."

### VK0AP — MACQUARIE ISLAND from GII VK3AUI

A number of problems have arisen with this operation by Peter McLennan.

1. *Liaison on 14 MHz. Due to the small size of the base there have been EMC problems with the station radio equipment.*

2. *The six metre equipment has an EMC problem with a scientific instrument called a Riometer. This equipment is very sensitive and is used to listen to cosmic radio noise. It consists of two receiver chains. The equipment operates on a frequency of 35 to 40 MHz with a local oscillator of 43 MHz and an IF of 3 to 8 MHz. The input filtering is not sharp.*

Filters have been sent to Peter for the Riometer but it is up to the operator of the Riometer to fit them. Approval in principle for their use, has been obtained, but it is up to the people on the island.

Peter has been looking at the alternatives listed.

a. *Resiting amateur gear as far as possible from the equipment affected.*

b. *Using antenna polarisation changes to reduce the signal at the Riometer.*

c. *Using the antenna beam pattern nulls to reduce the signal at the Riometer.*

d. *Filters on the Riometer but this requires fitting by a third party.*

e. *Reduction of power from 100 W to 10 W as a last resort.*

Unfortunately the deteriorating weather, as winter approaches, and also Peter's work commitments may preclude opera-

tion. Operation will only be permitted when all EMC problems have been resolved to the satisfaction of all parties.

There is still hope of further six metre operation before Peter leaves the island in November.

From Paul ZS1BR in Cape Town comes news of the VHF amateur radio beacon which has been established for the benefit of the radio amateurs in the Western Cape Province and hopefully the international community under good propagation conditions.

The beacon transmits continuously as follows: firstly, in frequency shift keying CQ DE ZS1SIX QTH PIKETBERG SA FSK MODE PSE QSL TO ZS1CT 73. The beacon then changes mode and transmits using FM with an audio tone of approximately 1 kHz and constant carrier CQ DE ZS1SIX QTH PIKETBERG RSA FM MODE PSE QSL TO ZS1CT 73.

The output power is 16 watts, feeding a vertically polarised ground plane antenna. The crystal-controlled frequency is 50.945 MHz.

The location of the beacon is Aasvöelskop 32° 54' 57" S, 18° 44' 20" E at an altitude of 807 m ASL above the town of Piketberg.

The beacon was built up by ZS1SG and ZS1BR, and all reception reports and QSL cards should go to ZS1CT.

### GENERAL NEWS

I wonder what that is? It's very scarce this month, the bands here have been very quiet. Still the occasional JA contacts on 6 metres, a few weak signals across "The Bight" to and from Albany on 2 metres. Bob VK5ZRO and his group continue to work 144 and 432 MHz up and down Eyre Peninsula and to Woomera, whilst others must have got out their knitting and are relaxing!

Eric Trebilcock L3-0042 sends a short note to advise that my statement re Chatham Island being south of New Zealand (Feb "AR") was wrong, and that the island is actually east of New Zealand, with people living in Christchurch saying "its out there" and pointing east. Thanks for putting the record straight Eric, my maps didn't show the island and the fact that it was to have a station signing ZL4OY/C I took a punt on its position, and of course I was wrong!

I wonder if April 1983 will bring any exotic DX across the Pacific Ocean? April 1982 didn't cause a great deal of excitement on 6 metres. My next set of notes will probably tell the story.

Closing with the thought for the month: "If you realise that you are not as wise today as you thought you were yesterday, you're wiser today." 73. The Voice in the Hills. AR

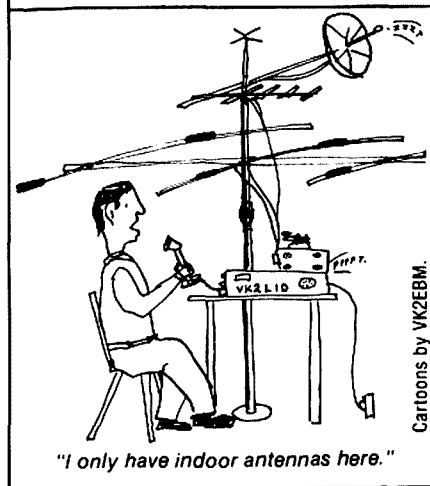
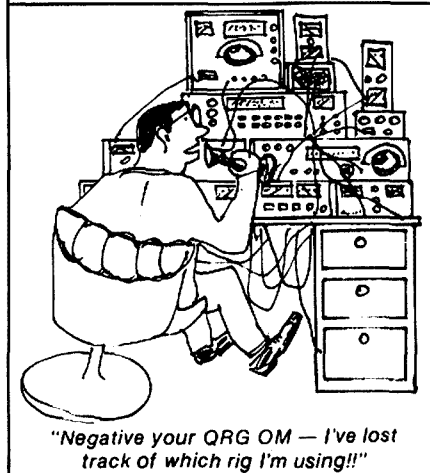
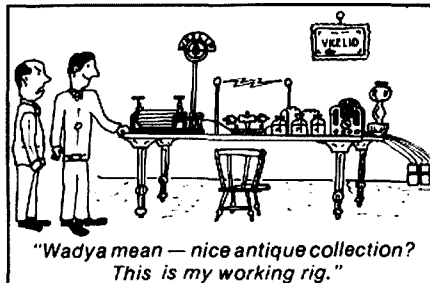

Cartoons by VK2EBM.



Lior: GII VK3AUI, AI VK0CW and Lionel VK3NM in GII's shack discussing Heard Island 6m activity during AI's visit to Melbourne enroute back to America after the Heard Island Expedition.

**WE HANDLE ALL COMPUTER REPAIRS**



**\$670**

The R-2000 provides outstanding performance through use of microprocessor controlled operating functions, allowing maximum flexibility and ease of operation throughout its operating range. An all mode receiver, it covers 150 kHz-30 MHz in 30 bands, on SSB, CW, AM, and FM. Key features include digital VFO's, ten memories that store frequency, band, and mode information, memory scan, programmable band scan, digital display with 24 hour dual clock, plus timer, and a host of other features to enhance the excitement of listening stations around the world.

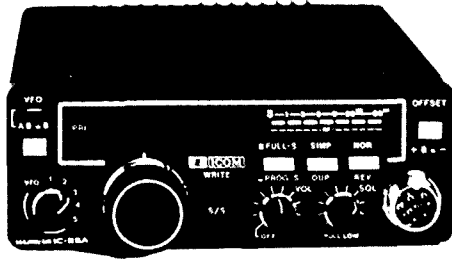

**2 Metre/FM \$395**

*Now with green display.*

Try to imagine 25 watts, 5 memories and 2 scanner systems in a 2" high, 5 1/2" wide and 7" deep 2-metre transceiver! The IC-25A is a full-featured FM transceiver for the space conscious operator.

The IC-25A is no lightweight when it comes to features: 5 memories... Priority channel... 25 watts high... 1 watt battery saving.



**\$1999**

The TS-930S is a superlative, high performance, all solid-state, HF transceiver capable of operation in the SSB, CW, FSK, and AM modes on all Amateur 160 through 10 meter bands. It incorporates an excellent general coverage receiver with an exceptionally high dynamic range (100dB typical on 20 m, CW bandwidth) having continuous coverage of all frequencies from 150 kHz through 30 MHz.

Keyed to the exacting requirements of the DX and contest operator, the TS-930S provides a variety of the most useful performance features, including new, innovative, interference rejection circuits, such as SSB slope tuning, CW VBT (variable bandwidth tuning), IF notch filter, CW pitch control, and audio peak-tuned CW filter. Equally important, the TS-930S design includes dual digital VFO's, eight memory channels, CW full break-in switchable to semi break-in, a unique built-in automatic antenna tuner, and a new higher voltage operated solid-state final amplifier that provides the ultimate in reduction of IM and spurious emissions.

**Dip Meter \$135**

The DM-81 dip meter is intended for adjustment of radio equipment and antennas.

It is a self-excited oscillator designed for external coupling to the equipment being tested.

**FEATURES**

- Measurable frequency range of 700 kHz-250 MHz in seven bands
- Capacitive Probe for measurements without removing coil shields
- Storage compartment for all seven dip meter calls, capacitive probe, earphone and ground clip lead
- Convenient for both in indoor and outdoor measurements, all solid-state with built-in battery.

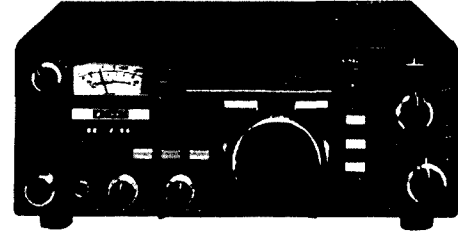

**HF Transceiver \$819**

ICOM's IC-730 is the "go anywhere HF rig for everyone's pocketbook". This compact size HF transceiver for the amateur band will fit in extremely small spaces, measuring only 3.7" x 7 1/2" x 10.8" deep, the unit is perfect for car, airplane, boat or suitcase portable operation. Convenient to use features such as 3-speed tuning with tuning rates of 1 KHz, 100 Hz or 10 Hz, electronic dial lock, 1 memory per band, and dual VFO's are built in at no extra cost.

The IC-730 is full featured: 200 watts PEP input, receiver pre-amp, VOX, noise blanker, large RIT knob, speech processor, IF tuning standard, fully solidstate broadbanded tuning.



**\$1199**

The TS-830S is a high-performance, HF SSB/CW transceiver with every conceivable operating feature built-in for 160 through 10 metres (including the three new bands). The TS-830S combines a high dynamic range with variable bandwidth tuning, IF shift, and an IF notch filter, as well as very sharp filters in the 455 kHz second IF. Its optional VFO-230 digital VFO provides five memories. The TS-830M includes AM mode built in.



**\$495**

**Automatic HF Antenna Tuners 500 and 100 Watt Models**

The IC-AT500 and the IC-AT100 Automatic Antenna Tuners provide automatic adjustment of the ICOM HF transceivers to the transmission line. Working at 500 and 100 watt levels respectively, the IC-AT500/100 detects the resistance and reactance of the load presented by the transmission line. Powerful motors tune the two variable capacitors, so that the tuner presents a 50 ohm nonreactive load to the transceiver.

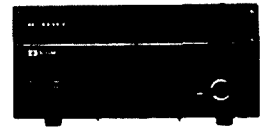

**\$357**



ANTENNA SCIENCE & ENGINEERING

**HOXIN**

- HF-5DX \$187** 3.5 to 30 MHz trapped vertical antenna which is completely self-supporting, no guys are necessary. Height 6.6 metres.
- G-SS \$15** Heavy duty die-cast gutter mount.
- RINGO \$60** 2 metre high gain vertical 9 dB gain
- RK-1 \$18** Radial kit for Ringo.
- F-1E \$15** 2 metre Rubber Duck with PL-259 base.
- SCAN-X \$62** Broadband receiving discone antenna 65 to 520 MHz for use on Scanning Receivers.
- GDX-1 \$98** Transmitting discone antenna. 80-480 MHz.

HF5-DX

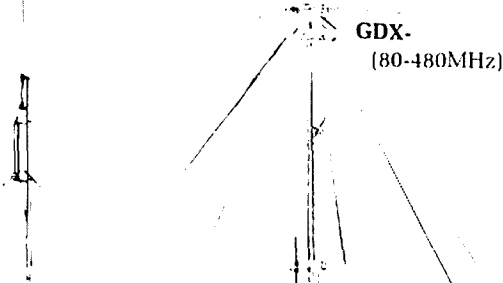

GDX-1 (80-480MHz)

**VoCom**

**VOCOM G-58 \$42**

Telescopic 2m x 5/8 wave antenna to suit all hand helds. Up to 7 dB over a rubber ducky.

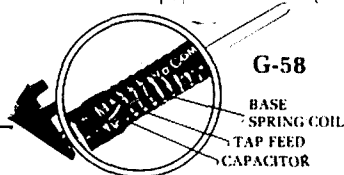

**UM PRODUCTS**

- A-248D \$93** Triband trapped dipole for 80, 40 and 20 metres. Overall length is 60 feet. Maximum power 500 W. Ideal 80 Mx antenna for small backyards.



- \* 4 KHz BW at -6 dB on SSB.
- \* Size 325 W x 230 D x 140 Hmm.

**\$425**

**AMATEUR AND COMMERCIAL ANTENNAS, HELICAL MOBILE ANTENNAS**

The ASE range of HF Helical Mobile antennas is designed to give you a signal to be proud of and get it further out because each antenna uses every known method to increase mobile efficiency.

- \* Thick wire (0.6 mm) to decrease resistive losses.
- \* Top winding—to increase current-length product.
- \* Top loading—large brass mass to act as capacity hat.
- \* Parallel former—allows top winding to be smaller in length producing a longer radiating part.

In addition you get top quality chrome plating, 3/16 stainless steel grub screw and adjustable sliding tuning tip and Allen key. Plus extra thick heat shrink to minimize impact trauma.

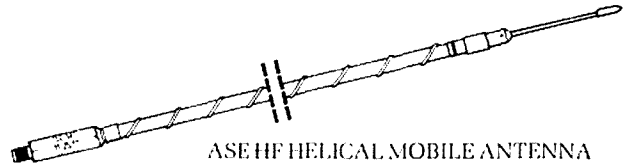

ASE HF HELICAL MOBILE ANTENNA

**Super G-80/15/10 \$71** Triband helical covering 80, 15 and 10 meters, overall height on 80 meter is 7 feet.

**G-80 \$46** 80 meter heavy duty helical, 6 feet long.

**G40 to G-10 \$40** 40, 20, 15 and 10 meter helicals, 5 feet long

**G-BM \$26** Stainless Steel bumper mount to suit the ASE Helicals, female, 3/8 x 24 thread.

**J.I.L.**

**JIL MODEL SX-200 HF/VHF/UHF PROGRAMMABLE SCANNING RECEIVER**

THE SX-200 includes many unique features not provided on any other scanner. For example, its wide frequency coverage of 25 to 88, 108 to 180 and 380 to 514 MHz. Its capability of receiving over 33,000 channels, 3 mode squelch that can be set to only allow the SX-200 to stop on carrier with modulation signals, 16 Memory channels that can be expanded to 32 with the EXP-32 kit. AM and FM detection on all bands. For full details write or call us.

**\$599**

**SX-200 HF/VHF/UHF 33,000 CHANNELS**

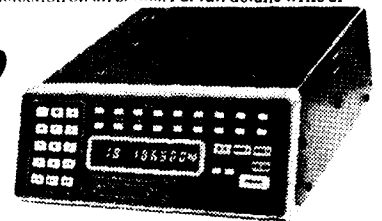

**EXP-32 \$53**

Memory Expander kit increases memory channels in SX-200 from 16 to 32 channels.

**A-4AM \$32**

Air Band Auto AM Kit.

**SEIKI ELECTRONICS**

Century 21D Digital HF Communications receiver is designed for the keen SWL who desires a quality digital HF Receiver at a reasonable price. The Wadley loop combined with a 5 digit orange LED display makes operation of this new receiver a breeze. Some important features include:-

- \* 0.5 to 30 MHz
- \* 0.3 uV on SSB
- \* CW, USB, LSB, & AM.
- \* 1 uV on AM

AUSTRALIAN AGENT & DISTRIBUTOR

**GFS ELECTRONIC IMPORTS**

Division of GD & JA WHITER PTY. LTD

15 McKeon Road, Mitcham, Vic 3113  
 PO Box 97, Mitcham, Vic 3112  
 Telex: AA 38053 GFS  
 Phone: (03) 873 3939, 873 2652





# CONTESTS



Reg Dwyer VK1BR  
FEDERAL CONTEST MANAGER  
Box 236, Jamison ACT 2614

## CONTEST CALENDAR

- MAY**  
 7-8 Florida QSO Party  
 7-8 G-QRP Day  
 7-8 CQ M Russian Test  
 7-8 World Telecom Phone Test  
 14-15 World Telecom CW Test  
 14-15 Sangster Shield Test  
 17 World Telecommunications Day  
 28-29 CQ WW WPX CW Test

- JUNE**  
 4-5 RSGB National Field Day  
 11-12 South American CW Test  
 11-13 6th VK/ZL Oceania WCY RTTY Test  
 11-12 ARRL VHF Test +++  
 18-19 All Asian Phone (Log available FCM)  
 18-19 Nine Lands CW Test  
 25-26 ARRL Field Day

- JULY**  
 2-3 Venezuela Phone Test +++  
 9-10 NZART Memorial Test (June AR)  
 9-10 IARU Radiosport Test  
 16-17 International QRP Test +++  
 16-17 SEANET CW Test  
 23-24 Venezuela CW Test +++

- AUGUST**  
 6-7 DARC WAE CW Test  
 13-14 SEANET Phone Test  
 20-21 SARTG RTTY Test  
 27-28 All Asian CW Test

The contests marked with +++ are not yet confirmed.

## WCY COMMEMORATION, THE 24th ALL ASIAN DX CONTEST

### 1 CONTEST PERIOD:

- Phone: 48 hours from 0000 UTC 18 June, 1983 to 2400 UTC 19 June, 1983
- CW: 48 hours from 0000 UTC 27 August, 1983 to 2400 UTC 28 August, 1983

### 2 BANDS:

Amateurs bands under 30 MHz.

### 3 ENTRY CLASSIFICATIONS:

- Single operator, 1.9 MHz band (CW only)
- Single operator, 3.5 MHz band
- Single operator, 7 MHz band
- Single operator, 14 MHz band
- Single operator, 21 MHz band
- Single operator, 28 MHz band
- Single operator, Multi band
- Multi operator, Multi band

### 4 POWER, TYPE OF EMISSION and FREQUENCIES:

Within the limits of own station licence.

### 5 CONTEST CALL:

- For Asian stations:
  - Phone . . . "CQ contest"
  - CW "CQ test"
- For non-Asian stations:
  - Phone . . . "CQ Asia"
  - CW . . . "CQ AA"

### 6 EXCHANGE:

- For OM stations: RS(T) report plus two figures denoting operator's age
- For YL stations: RS(T) report plus two figures "00 (zero zero)"

### 7 RESTRICTIONS ON THE CONTEST:

- No contact on cross band
- For participants of single operator's entry: Transmitting two signals or more at the same time including cases of different bands is not permitted.
- For participants of multi operator's entry: Transmitting two signals or more at the same time within the same band, except in case of different bands, is not permitted.

### 8 POINT AND MULTIPLIER:

- For Asian stations
  - Point . . . Perfect contact with non-Asian stations will be scored as follows:
    - 1.9 MHz band . . . . . 3 points
    - 3.5/3.8 MHz bands . . . . . 2 points
    - Other bands . . . . . 1 point
  - Multiplier . . . The number of different countries in the world worked on each band. According to the DXCC countries list.

### (2) For non-Asian stations

- Point . . . Perfect contact with Asian stations (excluding US auxiliary military radio stations in the Far East, Japan: KA stations) will be counted as follows:
  - 1.9 MHz band . . . . . 3 points
  - 3.5/3.8 MHz bands . . . . . 2 points
  - Other bands . . . . . 1 point
- Multiplier . . . The number of different Asian Prefixes worked on each band. According to the WPX rules.

### (3) JD1 stations

- JD1 stations on Ogasawara (Bonin and Volcano) Islands belong to Asia.
- JD1 stations on Minamitori Shima (Marcus) Island belong to Oceania.

- Contacts among Asian stations and among non-Asian stations will neither count as a point nor multiplier.

### 9 SCORING:

(The sum of the contact points on each band) times (The sum of the multipliers on each band).

### 10 INSTRUCTIONS ON THE SUMMARY AND LOG SHEET:

Please keep all times in UTC. Please fill in the blanks of "multiplier" by countries or prefixes, only the first time on each band.

### 11 AWARDS:

- For both phone and CW, certificates will be awarded to those having the highest score in each entry in proportion to the number of participants from each country and also those from each call area in the United States.
  - The number of participants under 10 . . Award only to the highest scorer.
  - From 11 to 20 . . . Award up to the runner-up.

(c) From 21 to 30 . . . Award up to the top third.

(d) From 31 or more . . . Award up to the top fifth.

- The highest scorer in each Continent of the single operator multi band entry will receive a medal and certificate from the Minister of Posts and Telecommunications of Japan.
- The highest scorer of the multi operator multi band entry in each Continent will receive a medal.

### 12 REPORTING:

- Submit a summary sheet and logs of only one classification.
- Both log and summary sheet must arrive in JARL, PO Box 377, Tokyo Central, Japan on or before the following dates
  - Phone . . . . . September 30, 1983
  - CW . . . . . November 30, 1983

### 13 DISQUALIFICATION:

- Violation of the contest rules
- False statement in the report
- Taking points from duplicate contact on the same band in excess of 2% by the total.

### 14 ANNOUNCEMENT OF THE RESULT:

- Phone . . . . . About February 1984
- CW . . . . . About April 1984

### 15 COUNTRIES LIST OF ASIA:

A4, A5, A6, A7, A9, AP, BV, BY, CR9, EP, HL/HM, HS, HZ/7Z, JA-JR, JD1 (Ogasawara Is), JT, JY, OD, S2, TA, UA/UK/UV/UW9-0, UD6/UK6C, D, K., UF6/UK6F, O, Q, V., UG6/UK6G, UH8/UK8H, U18/UK8A.G.I.L.O.T-Z, UJ8/UK8J, R., UL7/UK7, UM8/UK8M.N., VS6, VS9M/8Q, VU, VU (Andaman & Nicobar Is), VU (Laccadive I), XU, XV, 3W, XW, XZ, YA, YI, YK, ZC4/5B4, IS (Spratly I), 4S, 4W, 4X/4Z, 7D (S. Yemen), 9K, 9M2 (West Malaysia), 9N, 9V (Singapore), (AbuAil).

## RESULTS OF THE 23RD ALL ASIAN TEST (82) FOR AUSTRALIA

CALL	FINAL SCORE
VK2XT	61506 *
VK6NSD	25434 *
VK2DVU	20473
VK2PFO	15132
VK2NHV	6440
VK2DEW	3636
VK3VAB	3135
VK5NWS	220
VK6JS	36064 *
VK4AIX	5757

Congratulations to all those who entered the contest and represented Australia in this very popular contest, especially those who have won a certificate (\*) and all the novices who have shown us all, the way.

## EUROPEAN DX-CONTEST

- Contest periods: CW: 13/14 August, Phone: 10/11 September, RTTY: 12/13 November. All from 0000 UTC Saturday to 2400 UTC Sunday.
- Bands: 3.5 - 7 - 14 - 21 - 28 MHz.
- Classifications: Single Operator — all band;

Multi Operator — Single transmitter. Multi-operator/Single transmitter stations are only allowed to change band one time within a period of fifteen minutes. A quick band-change and return for working new multipliers is allowed.

4 Rest period: only thirty six hours of operation out of the forty eight hours are permitted for single operator stations. The twelve hours of non operation may be taken in one, but no more than three periods at any time during the contest and have to be marked in the log.

5 Exchange: A contest QSO can only be established between a non-European and a European station. Exchange the usual five or six digit serial number RTS/RS report plus a progressive QSO number starting with 001. W/K stations in addition give their state (eg 599011 MA).

6 Points: Each QSO counts one point. A station may be worked once per band. Each confirmed QTC — given or received — counts one point (see below).

7 Multipliers: The multiplier for non-European stations is determined by the number of European countries worked on each band. Europeans will use the last ARRL countries list. In addition each call area in the following countries will be considered a multiplier: JA, PY, VE, VO, VK, ZL, ZS, UA90. (See special regulations for RTTY Fig 13). Each W/K state will be considered a multiplier.

The multiplier on 3.5 MHz may be multiplied by four.

The multiplier on 7 MHz may be multiplied by three.

The multiplier on 14/21/28 MHz may be multiplied by two.

8 Scoring: The final score is the total QSO points plus QTC points multiplied by the sum total multipliers from all bands.

9 QTC-Traffic: Additional point credit can be realised by making use of the QTC traffic feature. A QTC is a report of a confirmed QSO that has taken place earlier in the contest and later sent back to a European station. It can only be sent from a non-European station to a European station. The general idea being that after a number of European stations have been worked, a list of these stations can be reported back during a QSO with another station. An additional one point credit can be claimed for each station reported. (Note special regulation for RTTY see 13.)

a) A QTC contains the time, call and QSO number of the station being reported, ie: 1300/DA 1AA/134. This means that at 1300 GMT you worked DA1AA and received number 134.

b) A QSO can be reported only once and not back to the originating station.

c) Only a maximum of 10 QTCs to a station is permitted. You may work the same station several times to complete this quota. Only the original contact, however, has QSO point value.

d) Keep a uniform list of QTCs sent. QTC 3/7 indicates that this is the third series of QTCs sent and that seven QSOs are reported.

Europeans may keep the list of the received QTCs on a separate sheet if they clearly indicate the station who sent the QTCs.

10 Contest Awards: Certificates to highest scorer in each classification in each country, reasonable score provided. Continental

leaders will be honoured. Certificates will also be given to stations with at least half the score of the continental leader.

11 Disqualifications: Violation of the rules of this contest, or unsportsmanlike conduct, or taking credit for excessive duplicate contacts will be deemed sufficient cause for disqualification. The decisions of the Contest Committee are final.

12 Logs: It is suggested to use the log sheets of the OARC or equivalent. Send large size SASE to get the wanted number of log and summary sheets (forty QSOs or QTCs per sheet). Use a separate sheet for each band. All entrants are required to submit cross-check (dupe) sheets for each band on which they worked more than 200 QSOs. For each duplicate contact, that is removed from a log by the checker, a penalty of three additional contacts will be crossed out.

13 Special regulations for RTTY: In the RTTY Section of the EUROPEAN DX CONTEST also contacts between all continents and also one's own continent are permitted. Multipliers will be counted according to the EUROPEAN and ARRL countries list. QSO as well as QTC traffic with one's own country (district) is NOT allowed. SWLs apply to the rules accordingly.

14 Deadline: CW: September 15th; Phone: October 15th; RTTY: December 15th.

#### EUROPEAN COUNTRY LIST

C31 - CT1 - CT2 - DL - EA - EA6 - EI - F - FC - G - GD - GI - GJ - GM - GM Shetland - GU - GW - HA - HB9 - HB0 - HV - 1 - IS - IT - JW Bear - JW - JX - LA - LX - LZ - M1 - OE - OH - OH0 - OJ0 - OK - ON - OY - OZ - PA - SM - SP - SV - SV Crete - SV Rhodes - SV Athos - TA1 - TF - UA1346 - UA2 - UA Franz Josef Land - UB5 - UC2 - UN1 - UO5 - UP2 - UQ2 - UR2 - Y2 - YO - YU - ZA - ZB2 - 1A0 - 3A - 4U1 - 9H1.

Criteria for the awarding of certificates and trophies in the WAEDC. Minimal requirements for a certificate or a trophy are 100 QSOs or 10 000 points.

Mailing Address: WAEDC Committee Postbox 1328, D-895 Kaufbeuren, Germany.

#### THE ROSS HULL CONTEST 1982

The contest this year (1982) was entered by only twenty odd contestants, three of those were overseas.

The entries all were particularly well presented and most gratefully received because of the trouble and obvious care taken by the entrants.

Although there were only a 'few' entrants those who did enter were there to make a point through the contest and most carried the same general suggestions for a change of the rules. I will make these comments public and ask for your advice on the alterations to the rules for the future contests.

Anyway, on to the results for the contest and my sincere congratulations to the winners for an excellent effort in a very difficult area of specialty.

#### COMMENTS

These comments have been received from entrants' letters and reproduced here for your advice.

From a lengthy letter from Victoria here condensed with literal licence, for the purpose

of publicity.

*"This entry is sent with the purpose of showing the impossibility of an eastern state winning the contest against the bonus scheme of VK6."*

*"It became necessary to seek other bands to increase the score over other active locals."*  
*"It was necessary to design and construct equipment for 576 and 2304 MHz during the contest activity."*

*"The contribution of long distance DX would be an important part of the scoring. We note these contacts are based on normal nightly contacts and are not dependent on propagation enhancement. This is surely what Ross Hull is all about."*

*"The attitude of operators is to give the contest a 'BIG MISS' which is not in the best interests of amateur radio."*

*"The end event of the present scoring scheme is 'WHY BOTHER'," from WA.*

*"I am not a rabid contest operator, but this is one event that has a positive aspect of encouraging the extension of activity to otherwise neglected bits of the spectrum and so must not be allowed to lapse."*

*"The times two multiplier for VK6 may need some revision," from WA again.*

*"Are mobile contacts valid?" Answer yes.*  
*"If the rules as to the multipliers changes then some incentive for national and state winners for each frequency band," from VK4.*

*"Conditions very poor over the whole period. For several days on end never heard a signal from outside Rockhampton. Worst conditions for many years."*

From these comments I can draw the following tentative conclusions.

1 The VK6 bonus of doubling the score should be dropped.

2 An additional incentive for each div/state for each winner of each band.

3 The distance and multipliers should remain the same.

4 Each state should compete on an even footing and scoring basis.

The next Ross Hull Test is December this year (1983) and the same rules will apply unless you consolidate your thoughts for a change.

FCM comments. With the ever-increasing pressure of commercial stations requiring band space we are in the unenviable position of having to 'show' that we are using the bands that have been allocated and that we are using them to the advantage of the general population. We are doing this very well in the HF spectrum and have been allocated additional spectrum space at WARC79. However this is not the case in these higher frequencies. The 'few' are again expected to maintain the status quo for all the rest of us and for the future amateurs (your descendants).

It would be of great assistance if all the amateurs of VK showed some interest in the future of the sport and very valuable activity of amateur radio. All the best.

The winners of the 1982 Ross Hull VHF Contest are:  
Walter House VK6KZ, Seven Day Phone Section  
S Blanche, VK2KFJ, Seven Day CW Section  
Hideo Kirii JA2DDN, O/seas Seven Day Phone Japan

Yutaka Kato JH1WHS, O/seas Two Day  
Phone Japan  
W R Hamer ZL2CD, O/seas Seven Day  
Phone NZ  
G L C Jenkins VK3ZBJ, Two Day Phone  
Section  
A Van Derbyl VK2EDB, Two Day CW  
Section

As the number of overseas entries were few all overseas entries will receive a certificate.

### RESULTS OF 1982 ROSS HULL CONTEST

CALLSIGN	7 DAY		2 DAY	
	PHONE	CW	PHONE	CW
VK6KZ	76714	0	22330	0
VK3ZBJ	57060	0	19326	0
VK6HK	38928	0	11396	0
VK3YY	35905	0	10405	0
VK3ZHP	29976	0	8848	0
VK2BA	10628	0	3368	0
VK6OX	10198	0	3560	0
VK1VP	8490	0	3240	0
VK8GB	6044	0	3944	0
VK2EDB	5444	0	1812	970
VK4DO	4204	0	1218	0
VK6SM	3960	0	892	44
VK3VF	3420	0	1047	0
VK5KMW	2670	0	1200	0
VK3YRP	2384	0	1520	0
VK4ZTV	1594	0	544	0
VK2ZQX	1577	0	500	0
VK2KFJ	863	117	730	51
VK3ZHQ	187	0	0	0

OVERSEAS			
JH1WHS	0	0	1350
JA2DDN	1800	0	0
ZL2CD	3500	0	0

### 1983 RTTY CONTEST

Further to the contest rules — page 64 April AR — Copies of Exchange Points Table are available from FCM at above address. Please enclose SSAE.

Reg VK1BR  
AR

## SPACE

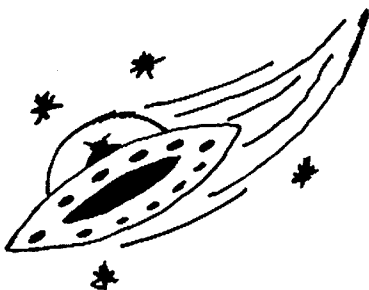

This space is reserved for YOUR advertisement.

Please contact the advertising manager at Box 300, Caulfield South Vic 3162 for price list and further information.

# BOOK REVIEW

Ron Cook VK3AFW  
7 Dallas Avenue, Oakleigh, Vic 3166

## 100 BASIC ELECTRONIC PROJECTS

### First Edition

This interesting book is published by the WIA (NSW Division) Education Service. It is based on an earlier book by Dave Wilson, VK2KDW, and incorporates additional material by Ian Hook.

Although it is a how-to-do-it rather than a who-done-it, I found it hard to put down until I had read it all. This is in spite of the title giving away the whole plot. Yes there are one hundred projects and although they are basic, they offer enjoyment and some education, I am sure, for all amateurs and short-wave listeners as well as all others, interested in electronics, aged from nine to ninety years.

Every project has a circuit diagram, a parts list, an explanation on what it does and how it does it and, where appropriate, sketches and descriptive information on construction. Some projects do not even need a soldering iron.

Just to whet your appetite here are the names of ten of the projects.

*Dr Who Maze*  
*Transistor Tester*  
*Dalek Bomb*  
*Electronic Thermometer*  
*One Transistor Receiver*  
*Hazard Warning Light*  
*144 MHz Sniffer*  
*BFO*  
*Metal Detector*  
*Brake Fluid Monitor*

And the best news is that the price is only \$3.00, yes 3¢ per circuit!

I strongly recommend this book and suggest you enquire at your local Divisional Office or Mag Pubs.

The review copy was provided by the WIA NSW Education Service. Their address is PO Box 262, RYDALMERE, NSW 2116 and copies could be obtained from them but don't forget the postage.

## MICROCOMPUTERS IN AMATEUR RADIO

By Joe Kasser, G3ZCZ

This is a sturdy paper-back book of over 300 pages. It is intended to show the amateur how he can use a mini-computer, based on a microprocessor, as a station accessory for receiving and sending Morse and/or RTTY, and for such operating assistance as log and record keeping.

Inevitably any such book must be heavily biased toward a particular microcomputer. Apart from the popular Apple, Tandy and Commodore, there are some one hundred commercially produced inexpensive microcomputers. This book is based on the GOLEM-80, an 8080, 8085 or Z80 based system using the AMS-80 monitor and an S-100 bus. The beginner will be relieved to learn that most of the buzz-words are explained in the early chapters.

Obviously if you build the GOLEM-80 Project you will want this book to get the most out of the beast.

As far as I can ascertain the programmes given in the book will run on most Tandy machines with an S-100 bus. Some modification to the software would be inevitable but there should be no problems with the hardware. Full software/programme listings are given at the rear of the book.

Even if you do not have an 8080 or Z80 based system this book should provide you with some good ideas.

Although the 100 plus pages of programme listings may take you a considerable time to type in, the cost of the book is much less than current prices for equivalent software packages.

If you are "into" microprocessors, or about to take the plunge, then this book is certainly worth considering.

By the way does anyone have any ideas on an S-100 bus for a ZX80/8k ROM?

The review copy was provided by Australian and New Zealand Book Co Pty Ltd, PO Box 459, Brookvale, NSW 2000. List price is \$15.95.

VK3AFW  
AR

## EMC (Electro Magnetic Compatibility)



If radio frequency interference is causing you a problem you are reminded that — "Advice on all types and aspects of interference (PLI, TVI, AFI, etc.) is available from the National EMC Advisory Service".

FORWARD DETAILS TO  
VK3QQ,  
Federal EMC Co-ordinator, QTHR.

# 1982 VK/ZL/OCEANIA DX CONTEST

Jock White ZL2GX  
NZART Contest & Awards Manager

## OVERSEAS RESULTS

### PHONE

ASIA				STH AMERICA				CW ASIA							
JA1UQP	22050	JA6IP	6660	HK3NBB	1738	JA1CJQ	8811	JA0DNS	40	GW3MPB	649				
JATAOD	1738	JA6GGD	3250	YV3BRF	11448	JG1IMM	8466	JA0TMF	27	HA5LZ	1805				
JM1AFK	1644	JA6EFT	1248	YV21F	1220	JR1UIO	4088	JAONCE	12	HA0KDA	1300				
JF1JLW	1630	JR6PGB	1030					JA1HGY	1140	HA8KAZ	600				
JA1BN	1620	JA6CNL	585					JA1PS	950	HA3HZ	196				
JR2VLS/1	1386	JA6JNG	580					JA1UPO	760	VE3VC	3360				
JH1PMH	1344	JR6DVO	280					JA10HP	640	VE4MF	702				
JN1NDY	1330	JE6XDT	252					JH1LME	600	KF1Z	8280				
JE1PJR	1140	JA6VVS	217					JE1PGW	594	WA1FCN	816				
JK1TXS	1133	JA6QOU	198					JH1MTR	494	W1END	420				
J11QLB	1092	JA6PBO	125					JN1WFF	352	N2LT	4205				
JATAFF	1032	JH7ONO	20736					JA1AOD	324	K2SX	1694				
JO1LDY	968	JA7FFY	2280					JL1LUIY	287	KW2J	572				
JH1QFA	836	JA7VSO	1422					JJ10SP	280	KC2X	336				
JATAAV	708	JA7XBG	858					JL1EEF	266	W31CM	243				
JA7ARW/1	650	JH7XGN	690					JP1BJR	120	WA3DMH	203				
JA1DCO	648	JA7FAS	400					JA1BSU	115	AG5C	2756				
JE1GBI	585	JR7AMZ	210					JA1RWI	75	W5PWG	1200				
JN1QWG	252	JA7RXU	130					JA2SAP/1	30	W6UA	8132				
JA1AAT	224	JR7RHR	24					JL1EJO	24	AA6EE	1764				
JA1JGP	208	JH7PWS	check					JA1BNW	12	N6ZZ	1474				
JA1OHP	175	JA8SW	1479					JN1ENK	10	A1GZ	1407				
JA1FO	80	JH8BJG	1404					JA1AAT	3	K6VL	check				
JA1PUK	72	JH8GQZ	1152					JA1AFF	2	W7QK	2900				
JL1EJO	56	JH8NYK	957					JH2WMN	5611	KA7FEF	456				
JA1UPO	12	JH8REF	800					JA2WB	2438	K7SS	160				
JO1RUB	2	JA8UJY	711					JA2KPV	486	W7DRA	2				
JH1KRC	check	JH8JYV	68					JA2RJV	400	W8UVZ	930				
JR2BPV	13440	JA9YBA	25756					JA2FXV	396	WA9TZE	50				
JA2BNN	7208	JA9YE	4480					JE2KEB	162	WOKEA*	12257				
JA2APA	4416	JH9GAT	2016					JE1EQ	138						
JA2WB	4030	JA9AA Y	1000					JR2AQP	60						
JA2YKA	3978	JA9RYL	216					JA2YKA	44						
JR2TRZ	1968	JH9FQI	3					JR3WXA	3792						
JA2YKR	1884	JA0VHI	8745					JA3UCO	342						
JE2IEQ	549	JA0COL	5236					JG3VKW	76						
JE2KEB	200	JH0LFE	1860					JA3BCT	24						
JR2AQP	152	JA0FMB	1649					JA4ESR	6538						
JH2XTV	90	JR0AFG	940					JA4MES	376						
JA2RJV	18	JA0TPE	730					JR4ISK	70						
JH3YJM	17240	JH0PIA	301					JA4AQR	30						
JA3HTT	14910	JA0BFA	84					JH5MVR	260						
JE3DYW	14440	JA0DNS	12					JA5SIX	36						
JR3SOT	4320	<b>NTH AMERICA</b>						JH5OXF	12						
JA3BLN	4224	OX3ZM	check					JA5DQH	4						
JE3KAM	2535	VE4RP	3595					JA5BLF	2						
JR3WXA	2160	VE1YX	600					JA6GU	5684						
JA3UCO	1391	VE3FEA	280					JA6BIF	5134						
JR3CVJ	1150	W1BIL	2046					JA6LLD	4960						
JA3GCM	423	N2LT	1880					JR6LJO	1070						
JF3EGT	360	KC2X	710					JA6CNL	533						
JA3HUL	180	W2KZE	84					JA6GGD	65						
JH3SBL	23	YU1NR	1216					JA7GLB	7665						
JR4BYH	4806	YU7ADA	300					JH7ONO	6501						
JA4KWU	1236	YU2KDE	30					JA7XBG	760						
JA4ESR	480	YU1RA	22					JH7NAB	594						
JA4NZ	363	YU2LM	18					JA7KM	328						
JA4DEI	200	Y37XJ	1512					JA7FAS	246						
JH4QJT	115	Y34YC	882					JR7AMZ	222						
JE4GNF	80	Y22WF	572					JR7XBN	48						
JR4ISK	72	Y24LA/a	240					JH7HLD	12						
JA4AQR	36	Y24XJ/p	135					JH8JYV	2400						
JA5CPO	4775	Y25HL	120					JA9YBA	11634						
JA5BSQ	3081	Y23DG	80					JA9KHU	32						
JH5EVO	1089	Y21YK*	15228					JA0DAI	12240						
JH5CKV	910	Y22HF	check					JH0BVA	680						
JA5UIM	781	Y22TO	check					JH0ORW	400						
JA5DFY	610	Y34RI	check					JH0LFE	351						
JH5OXF	384	Y38YE	check					JH0PIA	60						
JA5XRF	198														
JA6YAI	15504	W8UVZ	5797												
JA6LDD	12259	K8VIR	860												
JA6BIF	9835	W8VEN	217												
		WOKEA*	27552												

Check Logs from: Y21FA, Y23CM, Y23TF, Y38VL, Y38YE, Y38ZF, Y42YG, Y47ZG, Y54UA, Y56XM, Y56ZM.

SWL

<b>EUROPE</b>		Y2-8983/P	2600
BRS31976	5700	Y2-11030/F	1500
BRS25429	2730	Y2-4406/G	952
HA2-013	1696	Y2-11148/F	374
HE9EVI	2070	Y2-16835/G	112
ONL-383	834	Y2-11153/F	2
		Y2-16841/G	2
NL4276	3144		
OE1-109976	384	<b>NTH AMERICA</b>	
OH6-401	1200	WDX9 IIK	1500
OK1-22309	6032	<b>ASIA</b>	
OK3-26694	2176	JA6-9330/1	19800
OK1-11861	1962	JA1-24432	7704
OK2-19826	500	JA3-32103	3496
Y08-18318	546	JA3-9344	456
		JA4-30124	11088
YU2-644	2832	JA6-MT	4644
YU7-713	960	JA7-8347	5046
YU7-606	912	JA8-3759	3250



# EDUCATION NOTES

Brenda Edmonds VK3KT  
 FEDERAL EDUCATION OFFICER  
 56 Baden Powell Drive, Frankston, Vic 3199

**NOTES:**

1 Certificates will be posted to top scorer in each scoring area (as per rules) and additionally to second and third place winners where activity warrants as well as band winner certificates where necessary. All certificate winners will receive this result sheet.

2 NZART expresses gratitude to all who submitted logs — sometimes even with quite a small score — thank you.

3 The certificates — showing a typical New Zealand bush scene, provided a difficulty with typing. Our apologies — a magnifying glass is desirable. I hope other factors will help to overcome this problem.

4 VK/ZL/Oceania DX Contest 1983 will be organised by WIA — the first two weekends in October as usual.

5 A reminder . . . NZART has a very comprehensive awards programme from the prestigious five band "5 x 5" award to WAP (Worked All Pacific) and many awards for contacts with ZLs such as NZ Counties Award etc.

AR



I have received an interesting collection of letters in response to recent columns. These will be answered individually, but at the risk of repeating myself there are a few comments I would like to make.

To those who are simply critical of the system — there are moves afoot to try to improve it — but I have had few useful suggestions from correspondents. On a cost basis alone, the Institute would find it difficult to maintain the examination system, regardless of the other difficulties involved. I do not believe that the Department of Communications is deliberately trying to prevent candidates passing. The amateur exams are a very small section of the work handled by the Examinations Branch but I think we would be much worse off under any other system.

Pass rates for AOCPP Theory exams have changed little from the days of the essay type answer. When the statistics for the February exams are available, I will publish them in full, but what information I have suggests that usual pass rate figures were maintained. The paper which collected most complaints in February was one that had previously been used in other centres without complaint. Surely the recycling of papers and questions is the best way of ensuring that the papers do not become 'harder'. However, it is also important that there is provision for new questions to be added occasionally, otherwise the exam becomes a test of how well the candidate remembers the questions, not how much Radio Theory he knows.

I do not publish copies of the papers I see, — nor do I intend to. I do not even quote questions to my classes, or use DOC questions in our sample papers — although it is hard to be sure that a question I write as 'new' is not just a remembered one resurfacing.

It seems to me important to retain the

privilege of viewing and criticising as a way of checking the standard. Where I have been able to find fault, those faults have been rectified before the paper was reused.

On the idea of 'standard' — I look for questions that I would expect an average candidate to be able to answer after some thought. It is reasonable to expect that questions for AOCPP exams require more knowledge than those for Novice exams. This may make them more complex questions, and it is probably these that the candidate remembers as 'trick' questions. There is a pattern to the exam paper — so many questions from each section of the syllabus — but at AOCPP level I think it is fair to have some that connect two or three sections of the syllabus. For example, a question on TVI could be related to the syllabus sections Interference, VHF, ATV, Filters and possibly even Harmonics. This is one reason why a well prepared multiple-choice paper is much more searching than an essay type exam.

To those sitting for the May Novice exam — best of luck — but READ THE QUESTIONS — and take care when filling in the answer sheets. Also make sure that your answer sheet has your number on it.

For those of you who feel you have a genuine complaint about an exam, let me know the exam for which you sat, and the exam centre, and the reason for the complaint. Don't just say — 'it was a hopeless paper' see if you can specify the problem so I can check on it.

To those who again missed out in February, keep trying, many people have made several attempts and still got there.

I am trying to produce a sample paper about a month before each exam — let me know if you need a copy. The May paper is hot off the press.

73  
 Brenda VK3KT  
 AR

## SPECIAL EDUCATION QSP



Brenda VK3KT has available:  
 Trial Exam Papers —  
 Theory, Novice, AOCPP, Regulations.  
 Past CW Exams from DOC.  
 10 Exams at 5 w.p.m.  
 10 Exams at 10 w.p.m.  
 10 Exams fill a C60 tape. Send a tape and I will copy what you want onto it.  
 Complaints — or other comments — about Exam papers?

Make them known to your Federal Education Officer, VK3KT, QTHR, or on the Education Net, Wednesday evenings 12.00 UTC. 3.685 MHz±

# AWARDS

Mike Bazley VK6HD  
FEDERAL AWARDS  
MANAGER

8 James Road, Kalamunda, WA 6076

Once again the gremlins crept into the half yearly DXCC listings. Apologies to VK3DU who should have shown with a phone total of 282/284. Several awards this month to tempt the award hunter's appetite. These come from Brazil, Nigeria, France and Italy.

## DIPLOMA BRASILEIRO DE DX AWARD (DBDX)

### RULES

- 1 The DBDX award for confirmed contacts with a minimum of twenty different countries (one of them has to be Brazil), as shown on the Official DXCC List, is available to amateurs anywhere in the world.
- 2 Special stickers for additional countries, in groups of ten, will be available.
- 3 All contacts must be made on the 160, 80 and 40 metre bands. No cross-band or phone to CW contacts are allowed.
- 4 There will be two certificates; one for phone-CW operation and one for phone operation.
- 5 All stations must be contacted from the same call area, where such areas exist, or from the same country in cases where there are no call areas. One exception is allowed to this rule: where a station is moved from one call area to another, all contacts must be made from within a radius of 150 miles (240 kilometres) of the initial location.
- 6 All contacts must be "land stations". Contacts with ships, anchored or otherwise, and aircraft, cannot be counted.
- 7 Contacts may be made over any period of years from 15 November, 1945.
- 8 All confirmations must be submitted exactly as received from the stations worked, and minimum reports are: RS-33 for phone and RST-338 for CW.
- 9 The DBDX secretary will keep an honor roll showing all awards issued and consecutively numbered.
- 10 Applications must be submitted to:  
"LABRE Awards Manager — DBDX  
PO Box 07-0004  
Brasilia — Distrito Federal — Brazil  
— 70.000
- 11 Decisions of the LABRE Awards Commission regarding interpretation of the rules as here printed or later amended shall be final.
- 12 Sufficient postage for return of confirmations must be forwarded with the application — US\$2.00 or 10 IRCs.

## WORKED ALL NIGERIA STATES AWARD — WNS

### CONDITIONS FOR THE AWARD:

Work ONE amateur radio station from EACH of the states of the Federal Republic of Nigeria. There are nineteen states in the

Federal Republic of Nigeria. These are:

<i>Lagos State and Federal Territory</i>	
<i>Abuja</i>	5N0
<i>Ogun State and Oyo State</i>	5N1
<i>Kwara State and Niger State</i>	5N2
<i>Ondo State and Bendel State</i>	5N3
<i>Anambra State and Rivers State</i>	5N4
<i>Imo State and Cross River State</i>	5N5
<i>Benue State and Plateau State</i>	5N6
<i>Bauchi State and Gongoi State</i>	5N7
<i>Bornu State and Kano State</i>	5N8
<i>Kaduna State and Sokoto State</i>	5N9

## WORKED ALL NIGERIA ZONES AWARD — WNZ

### CONDITIONS FOR THE AWARD:

Work ONE amateur radio station from each of the ten call areas in Nigeria.

## OUTSTANDING NIGERIA DX AWARD — 5NDX

There are three classes for this Award:  
*First Class: Worked 100 amateur radio stations.*  
*Second Class: Worked 50 amateur radio stations.*  
*Third Class: Worked 20 amateur radio stations.*  
*Multipliers — NARS, President's Station (5N0AAJ), counts as five stations.*  
*— XYL Stations, count as two stations.*  
*— Club Stations, count as two stations.*

For the three above awards all QSOs need to have been made after 1st January 1980. The Fee for each award is 10 IRCs or \$4.00. For each award, full QSO details are required and in lieu of the QSLs the log extract can be certified by the Federal Awards Manager. (This means that applicants forward a log extract, together with the QSLs to me — do not forget to include return postage for your QSLs — I will certify the list as being correct and this is then returned to the applicant who claims the certificate direct from the issuing society).

Applications for these awards should be sent to:

*Awards Manager  
PO Box 2873  
Lagos  
Nigeria.*

## DIPLOMA DE L'UNIVERS FRANCOPHONE (DUF)

This award may be claimed for having contacted (heard) and received QSLs from the DUF countries list.

There are several categories of this award.

*DUF1: awarded for contacting five different DUF countries in three continents (five QSL cards). Fee — 7 IRCs.*

*DUF2: awarded for contacting eight different DUF countries in four continents (eight QSL cards). Fee — 9 IRCs.*

*DUF3: awarded for contacting ten different DUF countries in five continents (ten QSL cards). Fee — 12 IRCs.*

*DUF4: awarded for contacting twenty different DUF countries in six continents (twenty QSL cards). Fee — 15 IRCs.*

*DUF Medal: a very nice medal which can be claimed by the proud recipients of the DUF4. Fee — 20 IRCs.*

*All endorsements — 6 IRCs.*

### DUF COUNTRIES LIST

#### EUROPE:

France  
Corsica  
Monaco  
Andorra  
French Army in Federal Republic of Germany

#### AFRICA:

Algeria	after 1 July 1962
Tunisia	
Morocco	
Central African Republic	after 13 August 1960
Congo	after 15 June 1960
Ivory Coast	after 7 August 1960
Benin	after 1 August 1960
Gabon	after 17 August 1960
Republic of Guinea	after 1 October 1958
Mali	after 20 June 1960
Mauritania	after 20 June 1960
Niger	after 3 August 1960
Senegal	after 20 June 1960
Chad	after 11 August 1960
Upper Volta	after 5 August 1960
Cameroon	after 1 January 1960
Togo	after 27 April 1960
Djibouti	
Malagasy Republic	after 14 October 1958
Mayotte	after 5 July 1975
Comoros	after 5 July 1975
Reunion	
Glorioso Island	after 25 June 1960
Tromelin	after 25 June 1960
Europa	after 1 August 1968
Juan De Nova	after 25 June 1960

#### SOUTH AMERICA:

French Guiana

#### NORTH AMERICA:

St Pierre — Miquelon  
Mauritiquie  
Guadeloupe

Saint-Martin  
Saint-Barthelemy  
Clipperton  
Vietnam  
Khmer Republic  
Laos People's Democratic Republic

OCEANIA:  
New Caledonia  
Loyalty, Belep, Huon, Pins Islands  
Cherterfield, Walpole, Hunter, Matthew  
Wallis  
Futuna  
Vanuatu  
Windward Group (Tahiti)  
Leeward Group (Utorea)  
Australia (Tubuai)  
Australia (Rapa)  
Marquesas  
Gambier  
Tuamotu

AUSTRAL AND ANTARCTICA:  
Adely Land  
Kerguelen  
St Paul-Amsterdam  
Crozet

The usual certification rules apply (detailed in the Nigerian award above) and application should be sent to:

Mr Edmond DuBOIS, F9IL  
BP 7  
Aubenchoul Au Bac  
F.59265 Aubigny Au Bac  
France

### DIPLOMA DEL MILLENARIO

On the occasion of the Millenary of the foundation of the city of Udine, the Committee responsible for the organisation of the Electronic Exhibition EHS in collaboration with the ARI Section of Udine, institutes certificate "Diploma Del Millenario".

The certificate is granted to all OMs, YLs and SWLs all over the world who, in the course of 1983 will score at least thirty points according to the following regulations:

- 1 Each QSO/HRD with stations located in Friuli Venezia Giulia region (IV3 prefix) will count one point.
- 2 Each QSO/HRD with stations of members of ARI Section of Udine will count three points.
- 3 Each QSO/HRD with stations located in Udine, Buia, Fagagna, Brazzacco, S Margherita del Grugno will count six points.
- 4 Each QSO/HRD with the special station operating on the premises of

the sixth EHS exhibition on 8th and 9th October, 1983 will count ten points.

One station cannot be worked more than once on the same band, and contacts via transponders, repeater, and mixed mode are not considered valid. The operating modes are: SSB, CW RTTY, SSTV and shall be made on all the authorised bands, between 1st January and 31st December, 1983.

A special classification will be reserved for the OMs all over the world (excluding IV3 call signs), whose original, direct or indirect is Friuli, who score the most points. All the operators outside the IV3 call area will indicate on the log, the name of their original village in Friuli region.

A copy of the log with all QSO/HRD details to ARI Udine Diploma del Millenario PO Box 23-33100 UDINE, ITALY before 29th February, 1984. The award is free of charge. All participants will be sent a small flag as a keepsake of the competition. The decision of the jury will be final.

Well that's it for this month.  
73 es DX, Good Hunting de Mike, VK6HD.

AR

## TECHNICAL CORRESPONDENCE

### STATIC CHARGES

25/3/83

The Editor,  
Dear Sir,

Reading the letter by P Christie (VK2ATE — AR, Vol 50, No 1, Page 41) and the column "When is a static charge present" (AR, Vol 50, No 10, Page 49) prompted me to write this letter concerning my own experiences with static charge.

These occurred during 1982 whilst I was stationed at Mawson base in Antarctica. I found that it was sometimes fatal to leave solid state receiving equipment connected to antennas during blizzards which occur frequently in Antarctica.

This was exemplified by operating a satellite navigation unit during such a time. The 400 MHz antenna assembly unit about one metre in height was located about five metres above ground. After several weeks of successful operation, the console unit failed only a couple of hours after the commencement of a blizzard.

Subsequent examination showed that the switching power supply board ceased to function. In order to run system self diagnostic routines to check the receiver board, signal processing board etc a temporary external power supply had to be bootstrapped to the system.

The diagnostics indicated faults on the CPU board (which contains many CMOS ICs) which in retrospect was not surprising since these chips have ESD susceptibility ratings of only 250 to 300 volts. The actual voltages on the coaxial cable connecting the console unit to the antenna must have

been in excess of 5000 volts since sparks could be seen when placing the cables coaxial connector near a grounded object (ref AR, Vol 50, No 10, Page 49). I was somewhat surprised however that the RF front end section did not fail also. At \$1700 for two replacement circuit boards this is not an exercise to be repeated!

A second example of the high static charge buildup on antennas was observed between the mounting brackets of a 600 to 50 ohm balun mounted on a wall in the amateur shack at Mawson about 5 mm from an earthed copper pipe nearby. With a frequency of about 1 Hz, large blue-green sparks were clearly seen jumping between the balun and the pipe. A sharp cracking sound was also evident coincident with the sparks. A fluorescent tube held close to the arcing was also seen to illuminate.

Other cases of electronic component failure during blizzards which were connected to the outside world by wires or antennas were also reported during the year. The QRN levels are typically S9 or larger during blizzards, effectively making radio operating impossible.

I believe that the effect Mr Christie and myself have observed results from the action of rapidly moving dry particles colliding with antenna wires, leaving the wire charged. In our cases it was dust and snow respectively.

The same physical process occurs when a comb is brushed through dry hair.

Yours faithfully,  
Brian Jarvis VKODX/VK7XD



### HISTORY OF THE RAAF WIRELESS RESERVE

The RAAF Wireless Reserve was created about 1931 by Howard Love (then VK3BM), President of the WIA Victorian Division and the Air Board of the RAAF.

It was realised that the radio amateurs of Australia represented a great potential of emergency communications to the RAAF in providing a group of trained signals operators. At the outbreak of the 1939/45 war some 200 operators were called up for full time active service from all States.

The Air Force appointed Bob Cunningham VK3ML, with the rank of Pilot Officer to command and organise this Reserve. Bob now wishes to write a history of the RAAF Wireless Reserve from information available. Unfortunately there are many missing gaps in the 1931-1939 years where records of members and their activities are unavailable. He would therefore be grateful if former members of the Reserve would provide him with known lists of members and any items of interesting activities worth recording in the proposed history.

Please forward any such information to VK3ML at 384 Glenferrie Road, Malvern, Vic 3144.

AR

# NATIONAL EMC ADVISORY SERVICE



Tony Tregale VK3QQ  
FEDERAL EMC CO-ORDINATOR  
38 Wattle Drive, Watsonia, Vic. 3087

## THE RADIOCOMMUNICATIONS BILL — EMC COMMENT

The Radiocommunications Bill has at last seen the light of day; for how long — who knows! Governments consider electronic communications to be very low priority. This is rather surprising considering they use the electronic form of communication to conduct a large percentage of their everyday business.

The draft Bill has given a great deal of general attention to the problems of interference. Unfortunately it appears to be written in a form which is not too helpful in respect of the major interference problems affecting the Amateur Radio Service.

There are many members of amateur service who can boast that they have never received a complaint of interference, however I guess there are few members who boast that they have never been troubled with interference to their reception.

Those members of the amateur service who have never received a complaint of interference — excellent! They should consider themselves very lucky in this fast expanding world of electronic gadgets. However, because the Amateur Radio Service has always kept well ahead in modern technology the lack of interference complaints can mean only one of two things:

- (a) *the Station is separated from other radio and electronic equipment by a large amount of real estate, or*
- (b) *other radio and/or electronic equipment which is in close proximity to the station has, by good luck or design, a reasonable immunity factor.*

Most amateur stations have installed equipment which uses the most modern communications techniques, equipment which meets high standards for transmission and reception of electromagnetic energy.

The same cannot be said for manufacturers of domestic entertainment equipment and consumer products where the object is to produce a product as cheaply as possible, to ensure a large turnover with as much profit as possible with little regard to how it will operate when it is in close proximity to other equipment — which of course is the case in the majority of domestic situations.

This lack of regard for how and where the equipment will be used is reflected in the fact that a large percentage of domestic entertainment equipment and consumer product is manufactured in overseas countries and dumped on the Australian market by profit orientated entrepreneurs.

The majority of radio amateurs are not in

the fortunate situation where they can isolate themselves with large amounts of real estate. For most of us 'luck' runs out and we receive a complaint of interference or suffer interference soon after receiving our hard earned licence.

Quite often there is no simple answer — except to completely redesign the domestic equipment so it has a reasonable immunity factor and does not produce incidental radiation. Also, redesign the electrical power distribution so this does not produce incidental radiation.

No member of the Amateur Radio Service can, with respect, sit back and ignore the ever growing threat to our service by interference problems which are not of our making, in many cases are beyond our control and, are outside the law as it stands at present.

The draft Radiocommunications Bill goes some way towards dealing with the problems of IMMUNITY/SUSCEPTIBILITY and INCIDENTAL RADIATION. However, much work will be required before full and proper control is able to be exercised over these problem areas.

Before commenting on the interference sections of the Bill perhaps we should outline a few items from some of the original material.

The Draft Principles of Proposed Radiocommunications Legislation by the Department of Communications dated January 6, 1981 stated: "*Control of interference should be possible including incidental emissions from non-communications sources such as radio frequency, heaters and power lines.*"

"*Standards: The Minister could be empowered to adopt standards relevant to use and technical factors.*"

"*Radio equipment should be subject to technical standards.*"

"*Restrictions should be imposed, to the limits of Commonwealth legislative power, to control manufacture, importation and sale of equipment which fails to meet those standards.*"

The Institute responded with a twenty two page document entitled, "Proposed Radio Communications Act — Comments submitted on behalf of the Wireless Institute of Australia".

### STANDARDS

It is noted that the draft principles include the suggestion that the Minister could be empowered to adopt standards "relevant to use and technical factors". It is not clear what that phrase means.

In general, such a provision is supported. However, two observations are made. Firstly, it is suggested that this power should not reside in the hands of the Minister. It would be more appropriate for standards to be prescribed by regulation. The prescription of standards by regulation is provided for by the Trade Practices Act 1974 and such a course has considerable advantage. A standard promulgated by regulation, or identified by regulation, is far more accessible than what really amounts to an internal administrative Act. Secondly, a regulation is necessarily more formal and there is thus less chance of an inappropriately worded standard being promulgated. Finally, a Regulation is subject to review, and may be disallowed. It should be noted, in the context of standards, that type approval is presently not required in respect of equipment used by the Amateur Service. As is demonstrated at the outset of this paper, the essential characteristics of the Amateur Service that distinguish it from other Services, certainly would make the application of such standards to that service totally inappropriate.

Insofar as the provision relates to standards relevant to use, the Amateur Service has proved its own capacity to determine its own usage of its bands through its own organisations and by the achievement of consensus. It is essential that any power (as here suggested to make Regulations) should be expressed in terms that clearly enable all standards to exempt stations in a particular Service or particular classes of stations in a particular Service.

It is also noted that a suggestion is incorporated in the draft principle paper to the effect that public comment on drafts should be sought except in cases of urgency. This is seen as a very constructive and worthwhile proposal and indeed it is suggested that this proposal could be taken further. Not only standards but regulations affect investment decisions and individuals. The regulation of radio communication is necessarily complex. The WIA favours the



public exposure of not only draft standards but also draft regulations prior to their promulgation.

An interesting precedent is to be found in Section 70 of the New Zealand Commerce Act. Under the legislation regulations will, in the normal course, be exposed for comment though a discretion is given to bypass the public exposure route where it is urgent for a move to be made quickly.

Because of the importance of this area, it is worth quoting an extract from the New Zealand Securities Act. Section 70 of that Act gives to the Governor-General power, by Order in Council, "in accordance with the recommendations of the Commission," to make regulations for certain specified purposes and provides by sub-section (3): "before making any recommendation for the purposes of" this Section "the Commission shall —

- (a) do everything reasonably possible on its part to advise all persons and organisations, who in its opinion will be affected by any order in council made in accordance with the recommendation, of the proposed term thereof, and give such persons and organisations a reasonable opportunity to make submissions thereon to the Commission; and
- (b) give notice in the Gazette, not less than fourteen days before making the recommendation, of its intention to make the recommendation and state briefly in the notice the matters to which the recommendation relates; and
- (c) make copies of the recommendation available for inspection by any person who so requests before an order in council is made in accordance therewith;

provided that this sub-section shall not apply in respect of any particular recommendation if the Commission considers that it is desirable in the public interest that the recommendation be made urgently; provided also that failure to comply with this sub-section shall in no way affect the validity of any order in council made under this Section."

The Wireless Institute of Australia regards the inclusion of such a provision, appropriately modified, as highly desirable.

At present the Amateur Service is subject to the provisions of any condition imposed by way of licence, the provisions of a Handbook which purports to interpret the Regulations made under the Wireless Telegraphy Act (though not necessarily consistently in all cases), the Regulations themselves and finally the Act. The present inconsistencies and inadequacies have resulted in the expenditure of an enormous amount of departmental and individual time in the resolution of various problems that arise. Many of these difficulties would never have arisen had there been proper consultation before the promulgation of the relevant Regulation. Certainly the "Handbook" has been the subject of close co-operation between the Department and representatives of the Amateur Service and experience of this co-operation is clear evidence of the desirability of prior consultation. No doubt other users of the radio frequency spectrum would take a similar view.

## Interference

It is noted amongst the principles annunciated in general in the paper prepared by the Department it is suggested that control of interference should be possible, including incidental emissions from non-communication sources such as radio frequency, heaters and power lines.

The power to control interference may be regarded as an essential aspect of the control of radiocommunications. However, there are considerable difficulties in the establishment of appropriate principles and in the definition of powers that are appropriate. Two broadly based principles can be identified and may be summarized as follows:

- (a) *A sub-standard, improperly operated, or defective, or inadequately designed receiver, entertainment device, or other device susceptible to RF interference should not be protected from a transmitter that is correctly operated, correctly adjusted, and meets a reasonable harmonic and spurious emission standard,*
- (b) *Radiocommunications Services should be protected from interference and from unnecessary electromagnetic radiation emissions of any source.*

A blanket prohibition against causing interference imposed on particular stations, classes of stations, or stations in a particular Service, must be rejected. The formulation of principles must necessarily have regard to the fact that the removal of interference may be only possible at the receiver or device suffering the interference. This may involve some expenditure and it should be clearly established how that cost is to be borne.

It must be recognized that in some cases interference cannot be remedied at the transmitter. For example, a transmitter correctly operated, and of a high standard, may cause inevitable interference to a broad band device in the immediate vicinity, even though that device is (by ordinary standards) reasonably protected against RF interference. Where special measures are necessary in such cases, the question as to who is to bear the cost may give rise to a different answer. At least it should be made clear, in such cases, that a person who complains and then unreasonably refuses to allow the necessary measure to be taken, can preserve no rights.

It is considered that the legislation should establish certain broadly based principles to deal with these situations.

So far as a power of general control is concerned, it is noted that in the United States the Federal Communications Commission is, by Section 302 of the Communications Act 1934, given the following power:

- "(a) *The Commission may . . . make reasonable regulations governing the interference potential of devices which, in their operation, are capable of emitting radio frequency energy . . . in sufficient degree to cause harmful interference to radio communications. Such regulations shall be applicable to the manufacture, import, sale, offer for sale, shipment or use of such devices.*
- (b) *No person shall manufacture, import, sell, offer for sale, ship or use devices which fail to comply with regulations promulgated pursuant to this Section . . ."*

The Institute is of the view that this is an area where regulations (of the kind discussed in the context of standards) are appropriate and the effectiveness of such regulations would be bolstered by the provisions of the Trade Practices Act 1974. Recourse to heads of Commonwealth constitutional power such as the corporation power and the customs power as well as the postal, telegraphic, telephonic and like services power, may be necessary to make Commonwealth legislation in this area effective.

-----

There are many EMC areas within the new draft Bill which have been considered by the CASPAR Committee and are now contained within the CASPAR Report. This report will assist the Federal Executive with the production of the Institute's official response to the Bill.

However, perhaps the most important outstanding omission in the EMC area is that the Bill refers only to receivers, it is by no means clear that the Federal Parliament would have the power to legislate for standards of immunity from the electromagnetic energy in items like audio systems, video systems, intruder alarms, intercoms, and other sundry consumer products.

This appears to be a most difficult area from the legal viewpoint. There seems no way in which radiocommunications legislation can cover non-communications equipment, even though this type of equipment and its problems are related through electromagnetic energy.

Unlike many other countries who have managed to deal effectively with equipment which is not intended to receive electromagnetic energy, it seems the Australian Federal Legal system (under which the DOC operates) is unable to cope with this situation and must, for the legislation to go through, involve the States' legal system — and all the problems this could involve.

So, unless some of our smart lawyers can think up an easy way around this difficult and growing problem area we will all continue to suffer the crazy situation where domestic entertainment and consumer products, which for economic reasons, come with built-in poor immunity factors and cause so much trouble to the Amateur Radio Service.

In respect to Standards the Bill indicates it should be the radiocommunications *equipment* which should meet specific standards. This is of course against the whole concept of the Amateur Radio Service.

In contrast to the field of business and commercial (taxi, fire, Police, and general business) communications; with amateur radio it is the operator who is technically qualified and licensed on those technical qualifications.

With business and commercial communications services it is necessary for the equipment to meet specific standards because, in the main, the operators are unqualified and do not hold licences based on any technical qualifications.

In conclusion it would seem the most obvious answer which would solve the Standards situation for both Services would be for the basic requirement of Standards to cover EME (electromagnetic emission): A Standard to cover the transmission or recep-

tion of a specific class of emission (this would need to be little more than we have now). However, the advantage to the amateur service would be that television receivers and the like would be required to meet an emission receiving standard for their class. As with business and commercial communications the television receiver is operated by non technical or qualified operators; therefore it would be the responsibility of the manufacturer or importer to ensure that the equipment would meet these emission standards. The technically qualified and licensed operators within the amateur service would, of course, be personally responsible for their emission standards. Therefore there would be no question of equipment standards or type approval of any equipment used within the Amateur Radio Service.

AR

## MAGAZINE REVIEW

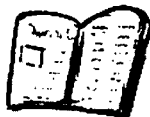

**CQ JANUARY 1983.** New York City Marathon (G). Experimental antennas for fifteen metres (P).

**RADIO COMMUNICATION MARCH 1983.** Portable two metre J pole (P). RSGB General Meeting (G). CW Filter (P). 3.4 GHz Preamp (C).

**73 MAGAZINE MARCH 1983.** RTTY Tuning Indicator (C). Adventure in Sarawak (G). Oscar 8 Telemetry (T). High Q cavity filter (C).

**73 MAGAZINE APRIL 1983.** Electronic Mailboxes, Amateur radio's new method of

Roy Hartkopf VK3AOH  
34 Toolangi Road, Alphington Vic 3078

communication (P). Suppressing alternator whine (P). Mount for a mobile rig (P).

**HAM RADIO FEBRUARY 1983.** Panoramic Adaptor design notes (G). Bragg Cell Receiver (G). 2304 MHz Low Noise Preamp (P).

**QST JANUARY 1983.** Modern Receivers and Transceivers (G). Beverage antennas (T). Century Club Awards (G).

(G) General. (C) Constructional. (P) Practical without detailed constructional information. (T) Theoretical.

AR

## SPOTLIGHT

ON

SWLING

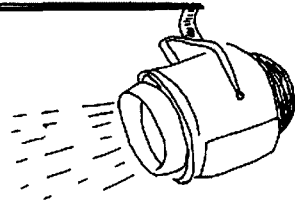
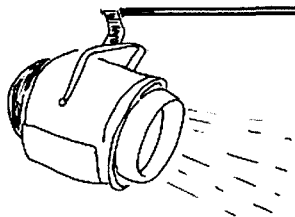

Robin Harwood VK7RH  
5 Helen Street, Launceston Tas 7250

Recently, I was present at a Launceston SWL's QTH, after we received a tip-off from some DXer's in New Zealand, when we heard one of the rarest stations in the world — the Falkland Islands Broadcasting Station. One moment, the channel was quiet, then popped up some very weak audio, indistinct, with quite an amount of flutter. The programme consisted of mainly "pop" and disco music, although we recorded the audio to get the announcements, which were clearer on playback.

Ordinarily very difficult to hear in Australia, across the Tasman they seemingly have better propagation than we do. However, many SWLs in southern Australia were indeed very fortunate to intercept the FIBS. After the tip-off, many commenced monitoring 3.958 MHz, which appears to be the main operational frequency, and the signals faded in at about 0900 UTC. The phenomenon of hearing signals from this region only occurs at the Autumn equinox of March, when the Sunrise/ Sunset is roughly parallel, although the Spring equinox does not propagate as well. Signals come over the South Polar region, hence the flutter which usually is present from the Antarctic region. By the time you will be reading this, the peak will have well and truly passed. In fact, they went off Daylight Saving the same weekend as we did here in Tasmania, which means they would open one hour later at 1000 UTC, when signals from Asia commence to come in.

I believe that the MW as well as the transmitter formerly on 2.370 MHz were either destroyed or damaged during the war last year. One interesting observation is that they are using SSB with carrier, as the audio is present on the upper sideband, but not on the lower. This could be indicative of a Services' transmitter being

used. As well, a lot of the programming is from the British Forces' Broadcasting Service, serving the British garrison which now makes up two thirds of the population. There is reportedly an FM transmitter operational too.

Congratulations to those fortunate in hearing the FIBS and many reports from Australia and NZ have gone in, judging by some cheerios I heard from the DJ. It is unfortunate that listeners in WA and further north in NSW would have missed out hearing this station, because the difference in propagation makes it highly improbable.

Recently, I accidentally came across some cordless telephone outlets between 1.7 and 1.9 MHz. Now I don't have anything against these devices, but am somewhat concerned that one could lose contact on 1.810 MHz CW because a local cordless 'phone will suddenly plop on to the channel out of nowhere. Surely other frequencies exist for these devices to operate without causing harmful interference. They state on the commercials they are Telecom approved but surely the user would have to apply to DOC for permission to operate. If any cordless systems are heard within our primary allocation on 1.8 MHz I shall be reporting them to the Intruder Watch. It does appear to be one model of these devices that could cause problems.

Listening on 6.095 MHz recently, I thought I had come across a new frequency of a Chinese domestic network. However, I was puzzled because the music choice didn't follow the normal pattern of what one hears from the Central Peoples' Broadcasting Station (CPBS). The identification and the time signal were similar to that on the CPBS. Yet it eventually dawned on me, after listening for a while, that it was

Taiwan. The signals are directed to the Chinese mainland, and it is naturally in that language. There doesn't appear to be any jamming yet. Listen at 1100 UTC and see for yourself.

And talking of new channels, both Radio 3RPH and VL2UV altered their operational frequencies in the second week of March. The Radio Print for the Handicapped Station 3RPH, formerly on 1.705 MHz, can now be heard on 1.629 MHz. The University of NSW station, VL2UV, has now gone to 1.692 MHz from 1.750 MHz.

Those interested in shortwave listening may not know that there is a regular weekly amateur radio net devoted to this. It is on Thursday evenings at 1030 UTC on 3.565 MHz  $\mp$  QRM LSB. Net Control is either Don VK3BMB, Tony VK2ECB, or myself VK7RH.

Don't forget that the "J" period commenced on Sunday 1st May. On this date, international broadcasting stations occasionally alter their frequencies to take account of seasonal variations in propagation. This period will be in effect until the first weekend in September, when it becomes the "S" period. Also winter time propagation will be in effect now. Many signals will be heard during daylight hours, especially on 25 and 31 metres, which should have twenty four hour propagation.

Also take note of signals coming across the South Polar regions, emanating from Europe. Listen on 41 and 49 metre bands at 0200 UTC for DW, Radio Berlin International and the BBC, mainly in Spanish. Those in the southern states again have the advantage over those further north in observing these.

Well, that is all for this month. Until next time, the best of 73's and good DXing!

— Robin  
AR



# VK4 WIA NOTES

Bud Pounsett VK4QY  
33 Lasseter Street, Kedron, QLD 4031

## Geoff Adcock, VK4AG — MERIT BADGE AWARD

That very popular amateur, Geoff, VK4AG, has been in the limelight again. It was president, Guy Minter's, VK4ZXZ, pleasure to present a merit badge and certificate to Geoff for his untiring work and many achievements in furthering the cause of amateur radio in Queensland. The merit badge is an award not lightly given and does not happen very often. Geoff is always there to assist his fellow amateur in any way that he can. He is very active in WICEN and has built a couple of VHF repeaters for portable use. Geoff was largely responsible for the technical side of one our state's greatest achievements, that of putting on the air, the games station, VK4QCG. He is active in the amateur radio side of scouting, not only at JOTA time, but at many other times throughout the year. Geoff also takes an active part in the broadcast on Sunday mornings relaying VK4WIA on ten metres. Geoff, VK4AG, can wear his merit badge with pride, Queensland is justifiably proud to honour VK4AG in this way.

to commission new equipment for their repeater, VK4RDD. This equipment was made possible by a legacy from Arch Marshall, VK4AF, 1907-1982, late of Clifton. It will be known as the Arch Marshall Memorial Repeater and will carry a plaque commemorating Arch's generous bequest.

Plans are well advanced for a repeater on a mountain top north of Roma. It is anticipated that the site will afford a very wide coverage. "On the Air" day is not yet available but this repeater is not too far off.

## EDUCATION

We have already had one "Educating the Educators" seminar in Queensland, last year in Toowoomba on the Darling Downs. This year two more are planned. Ron Smith, VK4AGS, from Dalby will be teaching the teachers the finer points of teaching. At presstime, nothing is definite, but it is hoped to hold one in Townsville on the weekend of 28/29 May, to be followed by one in Central Queensland, probably Rockhampton, on 10/11 September.

Peter Brown, VK4PJ, has been collecting history up to 1930 for some time. Now Al Shaw smith, VK4SS, (Thumbnail Sketch, April AR) has taken on the task of recording events and personalities of the 1930 to 1939 years. Al has set out to document all those with VK4 call signs in that decade. Maybe you can help, both Peter and Al would appreciate any help that they can get, both are QTHR.

## THE QUEENSLAND AWARD

The VK4 Council have decided at the last council meeting to delete two shires from this award. These are Mornington and Arakun Shires. Both are aboriginal reserves and not accessible without special permission from the appropriate government department. So that you can advance your score towards claiming the Queensland Award, the Queensland net operates each Thursday evening on 3.605 MHz, 0930 UTC. You do not have to operate from the Sunshine State to join the net, others less fortunate than we Queenslanders are very welcome.

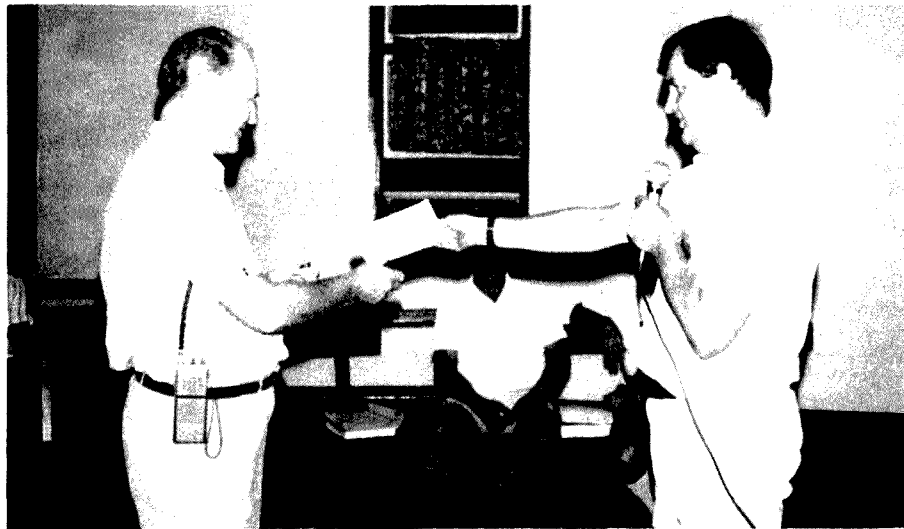

Guy Minter, VK4ZXZ, Queensland State President, presents the Merit Badge and Certificate to Geoff Adcock, VK4AG, at the February General Meeting in Brisbane.

## REPEATERS

Gladstone Amateur Radio Club have officially opened their 2 metre repeater on CH6900. This repeater, situated on Amy's Peak some 1000 metres ASL, has a range of about 150 km. It covers Highways 1, 17 and 39, the Capricorn Coast, many off shore Barrier Reef Islands, Gladstone, Rockhampton, Biloela, Monto, Moura. The repeater, completely solar powered, is located about 25 metres above ground, some 60 km south west of Gladstone on the Calliope Range.

The Darling Downs Radio Club are about

## RTTY NEWS

More and more stations are becoming active on RTTY, particularly in south east Queensland. The SEQ Teletype Group now have a news broadcast on Monday evenings on 10.120 MHz at 1000 UTC. The Bulletin is also carried by the group's Mt Cotton 2 metre repeater near Brisbane. The group would welcome reports on the 30 m transmission.

## HISTORY

There are two historians in Queensland.



## STOLEN EQUIPMENT

Recently GFS Electronic Imports in Mitcham, Vic were the victims of a burglary — their second in as many months.

Equipment taken in these robberies were:

- A PCS-3000 Azden two metre FM rig — serial number 80256
- A Standard C58E two metre portable rig — serial number E030036
- A JIL-SX200 scanner — serial number 10740326
- FS10 pocket scanner — no serial number
- C800 pocket scanner — serial number F050332
- Sky Ace R517 pocket receiver — no serial number.

Anyone offered equipment similar to that described above are advised to carefully check the serial number and if the serial number is the same or has been erased, contact Greg Whiter of GFS or your nearest Police station.

Apparently other traders in the same area have had similar experiences and as a result of these burglaries Greg has improved security at his premises.



# VK2 MINI BULLETIN

Athol Tilley VK2BAD  
VK2 MINI BULLETIN EDITOR  
PO Box 1066, Parramatta, NSW 2150

## COUNCIL REPORT

The VK2 Divisional Council met on the 11th of March at the WIA Parramatta office.

An Invitation from the Queensland Division for a VK2 representative to attend the VK4 Radio Club Workshop in April was accepted. Councillor Peter Jeremy, VK2PJ, will attend so he can observe the operation of the workshop system. An agenda item carried at the 7th Conference of Clubs requested the VK2 Council to investigate the radio workshop system with a view of changing the twice yearly conference to an annual meeting along the lines of the VK4 club workshop system. The division appreciates the generous offer by the Queensland Division to arrange the accommodation and meals of the VK2 delegate.

Twenty-five new applications for membership were received and accepted.

The official opening of the Parramatta office was discussed and the date confirmed as being the 28th of May at 2 PM.

A report was presented on preparations for the Annual General Meeting. Special thanks are due to Bob Clark VK2YOD, Bruce Miller VK2VRG, Tom Delandre VK2PDT and Jim Swan VK2BQS who answered a call on the broadcasts and assisted councillors in inserting and posting the notice for the AGM.

Eight agenda items were received for the 8th Conference of Clubs. A report of the Conference will be included in the next VK2 Mini Bulletin.

Federal Councillor Stephen Pail VK2PS presented a report on WIA Federal matters and correspondence. It was resolved that the division pay the air fare of the Federal President so he could attend our official opening.

## REPORT ON 1983 ANNUAL GENERAL MEETING

The Annual General Meeting of the division was held on the 26th of March in the auditorium of the Granville RSL Club. Fifty-eight members and two visitors attended the meeting commenced at 2 PM.

The minutes of the 1982 AGM, President's Report and Annual Accounts were all received and adopted by the meeting as circulated. A motion of special thanks to retiring members of council, Athol Tilley VK2BAD and Stephen Pail VK2PS was carried by acclamation.

Awards were then presented to winners of the 1982 Homebrew Competition. Winner of Completely Home Designed and Built section, Graeme Dowse VK2CAG, was presented with an engraved trophy, a cheque for \$100 and an open order on the division for \$50 for his fine entry of a 2 metre repeater. Geoff Campbell VK2ZQC was presented with a merit certificate and a \$25 open order for his entry of a 6 metre power amplifier in the home built from a

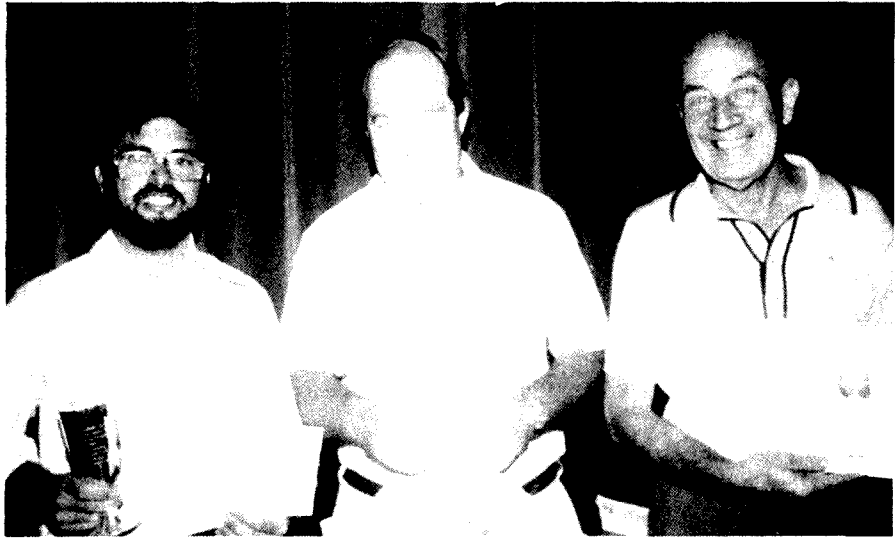

L to R: Graeme Dowse VK2CAG, Geoff Campbell VK2ZQC and Tom Taylor VK2DTB.

published design section. The awards for Mike McDonnell VK2DAI and Rod Pym VK2DNP will be posted to them as they were unable to attend the meeting.

Presentations were also made to winners of the 'Amateur Radio' Technical Articles Award, these being judged from articles from VK2 members published in Amateur Radio magazine during 1982. First was Bruce Henderson VK2DFH for his article "Antenna Tuner Adjustment" published in March 82 AR. Bruce's award of a cheque for \$200 and a merit certificate was accepted on his behalf by Tom Taylor VK2DTB who has assisted with the development of the tuner described in the article. Second prize of a cheque for \$100 and a merit certificate will be posted to Terry Clark VK2ALG for his article on a CMOS bug published in February 82 AR.

Third prize was awarded to Gordon McDonald VK2ZAB for his article "Staggered Stacking" published in the June 82 AR, and his cheque for \$50 and a merit certificate will be posted to him as he was unable to attend the meeting. Rod Pym was highly commended for his article on "Another 2 metre amplifier".

The Returning Officer, Roger Henley VK2ZIG, then announced the members of the 1983/84 Council. As there were only six nominations, no ballot was required, and the new council members are Susan Brown VK2BSB, Bob Clark VK2YOD, Peter Jeremy VK2PJ, Tim Mills VK2ZTM, Jeff Pages VK2BYY and David Walters VK2AYO.

The meeting then debated and voted on the four notices of motion as sent to all members of the division. The two special resolutions to change Articles 93 and 96 were carried without dissent by the meeting and are now in effect as prior approval from

the Attorney-General had been received for the changes. The third motion asking that the Administrative Secretary check whether QSL cards are awaiting members at the office was lost. The final motion requesting that divisional premises at Wigram Street, Parramatta be made available for meetings by bodies of kindred interest to the Institute was lost.

Roger Henley VK2ZIG was reappointed as the Division's Returning Officer for 1983/84 and the meeting then closed at 3.23 PM.

The following articles (93 & 96), as accepted at the 1983 AGM are now in effect. Please amend your copy of the Articles of Association.

*"Article 93. Each delegate shall, at any such Conference, have voting rights on behalf of his club, in respect only of those members of his club who are also Ordinary Members of this Division, in accordance with the following scale:*

- (a) For any number of Ordinary Members of this Division from five (5) to ten (10) inclusive — one (1) vote.*
- (b) Thereafter, for each subsequent group, or part thereof, of ten (10) Ordinary Members of this Division — one (1) vote.*

*In calculating the number of votes to be exercised by a delegate at any Conference, any Ordinary Member of the Division who is a member of more than one club shall be counted in respect of one club only for the purpose of calculating the voting rights of a delegate. Where an Ordinary Member of the Division holds membership in more than one club, such member shall be deemed to have assigned his voting rights to the club nearest his home address unless he advises the secretary of the Division and the clubs involved of his contrary wishes in writing. The secretary of the Division*

shall keep a file of such members which shall include the club to which the member is assigned for the purposes of voting rights."

"Article 96. A Conference may not transact any business unless a quorum of no less than twenty five (25) per cent of the total clubs affiliated is represented by delegates entitled to vote".

(Prior approval for changes to Articles 93 and 96 has been obtained from the Attorney-General and the Corporate Affairs Commission.)

## REPEATER REPORT

There has been considerable activity during the last few months in developing new repeater systems in VK2.

A few weeks ago eleven new licences were issued by the Department of Communications. Expanded details will be given on future divisional broadcasts and in the MINI BULLETIN. Some of the new systems included VK2RRR (6900) in the Condobolin region, VK2RCC (6800) at Dubbo and VK2RNE (6950) at Glen Innes. To provide a channel for Glen Innes, the existing Moree-Inverell service VK2RMI will change from channel 6950 to 6650.

In Sydney, VK2ROT which is sponsored by the OTC (A) Amateur Radio Club, was installed in the Eastern Suburbs on channel 7075. A new paging system has been installed in Sydney just above 148 MHz and this appears to be interfering with this new repeater. When a solution to the problem is found, VK2ROT will be placed in service again.

The morse practice beacon VK2RCW (7400) has been relocated to a new site which is giving a much larger service area. Later this year the northern beaches repeater VK2RMB (6875) will be relocated at Terry Hills. The Liverpool Club has plans to develop VHF and UHF systems.

Other developments include establishing a repeater at Grenfell. This was the system previously proposed for Cootamundra by SWARS. Wagga is working on an ATV repeater for that city. In Sydney, an ATV signal on UHF channel 34 is transmitted by VK2DTK on most week nights from Lane Cove. At Wollongong, there is a new VHF repeater VK2RIL (7275) which covers their northern suburbs and a new UHF repeater on channel 8725 is proposed at the same site.

There are additional UHF systems licensed with VK2RUH (8425) in the Sydney southern suburbs, VK2RUT (8375) in the Blue Mountains and VK2RTK (8025) at High Range, south west of Sydney.

It is now time to compile the repeater listings for the next callbook. There are a few repeater systems observed as not having the official records up to date. The problem mostly concerns the site of these systems and those system operators have been advised accordingly. If you have not returned a repeater questionnaire, would you please complete the information requested and return the form to the State Repeater Committee.

There are now thirty four VHF and twelve UHF repeaters licensed in VK2.

Notes from Tim Mills, VK2ZTM, VK2 State Repeater Committee Chairman.

## VK2BWI SLOW MORSE SESSIONS

David Bell VK2NAW is taking a well earned vacation from the Sunday night slow morse practice sessions after four years of service. David is very well known on air not only for his fine CW but also for his consistently strong signal from Golspie, and his cliff-hanger stories in the CW text where aircraft are regularly plunging out of control or ships sinking in giant seas. Listeners were literally in suspense from week to week as David used to run his programme in the form of an ongoing serial. All good stuff and certainly designed to ensure the sweating listener had to jolly well keep up to find out what was happening next. Thank you David for a job enthusiastically and colourfully well done. We hope you will still find the time to do the occasional session for us.

We welcome to the Sunday session Doug, VK2NBC, an operator of wide experience who many will remember from some years past as a panel member. Thank you Doug for your interest and for dropping into David's shoes so keenly. The division and listeners are grateful to you for offering these skills for the benefit of so many and a warm welcome is extended to you Doug from all of us at VK2BWI.

The VK2BWI Slow Morse sessions are conducted by volunteers of the division each night, commencing at 0930 UTC using 3.550 MHz. You can assist by keeping clear of the frequency during these periods.

Notes from Ross Wilson VK2BRC, VK2 Slow Morse Co-ordinator.

## TAREE AMATEUR RADIO CLUB

The club held its AGM on the 8th of February and the following officers were elected.

President — Geoff Hunziker, Vice Presidents — Chas Withers and George Baker, Secretary — Mike Richardson, Treasurer — Trevor Clarke, WICEN Co-ordinator — Chas Withers, QSL Officer — Trevor Clarke, Social Committee — Bruce Cross and Wayne Eckert, Repeater Committee — Ted Eckert, John Farley, Geoff Hunziker, Chas Withers, Trevor Clark, Broadcast Officer — Bruce Cross.

The Club address is PO Box 712 Taree, 2430.

## COMING EVENTS

Official Opening, WIA Parramatta; 28th May at 2 PM. Port Macquarie Field Day; 11/12th June.

NSW members and clubs are invited to submit news items for inclusion in these notes to WIA NSW Division at PO Box 1066, Parramatta, 2150, marking the copy and envelope "For Mini Bulletin". Items for July AR must reach us by the 23rd of May.

Athol VK2BAD

AR



## FIVE-EIGHTH WAVE

Jennifer Warrington — VK5ANW  
59 Albert Street, Clarence Gardens SA 5039

At the Divisional Council meeting held on the 18th of March, John Mitchell VK5JM gave a detailed report on the WICEN involvement in the Ash Wednesday bushfires. One good thing that has emerged as far as WICEN is concerned, is that the Director of State Emergency Services has provided permanent facilities and antennas for WICEN use at SES Headquarters, for any future emergencies. This recognition of WICEN's usefulness has been hard won by John and his officers, and it only takes one act of stupidity to undo months or years of work. It was a couple of incidents like this, which has caused John to draw up a paper on the terms of reference of the Director. Council has moved that this be adopted.

Council has authorised the purchase of an Olivetti Praxcis 35 and additional inter-face, so that we can do our own typesetting of the 'Journal'. Although this is initially a large cost, it is envisaged that we will recoup this within the next year, and that after this it will represent quite a saving on what we would be paying elsewhere.

The Kenwood Trophy for this quarter was presented to John Mount VK5EV for his services to the division as publications officer. Although John no longer appears at the monthly meetings, he still takes care of the ordering and postal requests. Our steep stairs, the weighty parcels, and his XYL Eleanor's poor health are the main reasons that John no longer attends the meetings. His stalwart helpers, Max VK5NMX and Archie L50014, still keep up the standard of service that John has set. I'm sure that everyone would agree with Council that John is a most worthy recipient of the voucher from ICS.

Sam VK5TZ has resigned as Co-ordinator of the panel of Morse Code Practice volunteers. We can't really complain though, seeing that he only took over in a temporary capacity a couple of years ago! Our thanks for your past efforts in this capacity Sam, and for the work that you continue to do for the division.

Dick Boxall VK5ARZ, our equipment supplies COMMITTEE, was conspicuous by his absence at the last meeting, due to an attack of shingles. We hope that you are now fully recovered Dick, and thank David VK5AMK and Graham VK5AGR for ensuring that parts were available at the meeting.

## DIARY DATES

24th May 'Getting started in RTTY' speaker John Mitchell VK5JM.

31st May 'Buy and Sell' starts at 7.30 PM.

AR



# LETTERS TO THE EDITOR

Any opinion expressed under this heading is the individual opinion of the writer and does not necessarily coincide with that of the publisher.



## ODES OF THANKS

7 Grimes Street,  
Auchenflower, 4066.  
7.2.83

Dear Sir,

Quite a number of VK4's owe thanks to Roy O'Malley (VK4ZQ) for carefully guiding them through a TAFE course for the AOCF theory.

Roy took raw recruits in hand and in just twenty four weeks at two hours per week (7-9 pm) he had us reading Yaesu circuits component by component. His class of 1982 was a success story of nearly 50 percent pass.

Midway through the course the ditty "To VK4ZQ" was written to show we supported his efforts. At the course end "Again to VK4ZQ" was written to thank Roy for his efforts. Both were of course signed ANON.

I thought you might be interested in seeing proof that all are appreciative of the fine work done by Roy and all like him. Their interest in amateur radio is infectious.

Yours sincerely,  
Edward Seabrook VK4YAS  
(of the class of '82)

## TO VK4ZQ

In the depths of the AOCF  
Some wondrous creatures lurk  
Such marvels as I and V  
With the watts doing all the work

The Wizard O'Malley pores  
Over huge and dusty tomes  
Cooking up Kirchoff's Laws  
And muttering "Ohms, boys, Ohms"

He'll boil up a complex circuit  
With voltages tossed all around  
And, somehow, mysteriously work it  
So amplification is found

The apprentices scribble — if only they knew  
(Though most of them try to ignore)  
That dipoles, receivers, transmitters and O  
Are dubious pleasures in store

At nine we release our attention  
Such relief is an amateur's joy  
But we'll master Marconi's invention  
And see you on two metres, Roy!

## AGAIN TO VK4ZQ

It comes to us all in the end  
The circuits are coming alive  
Connections are humming, the students buzzing  
O'Malley's class will survive

Our dipoles are all radiating  
All vertically polarized  
Yet it's a wonder we tuned to his circuits  
For we all appeared mesmerized

Roy's badgered us all the semester  
He wants to see more on air  
I've Voltaire and Hertz in my corner  
So please Roy do not despair

The Yaesu and Kenwood are ready  
The antenna is swung and aligned  
It's a matter of switching the mic. on  
And beaming in strength 5 and 9

So thanks for the titanic effort  
To make us all amateurs new  
We'll owe it to your dedication  
To O'Malley VK4ZQ

AR

## EXPERIMENTAL TRANSMISSIONS ON A LOW FREQUENCY

12 Albert Street,  
Oak Park, 3046  
16-2-83

The Editor,  
Dear Sir,

I would like to thank all those who gave assistance and reports on experimental low frequency transmissions following my letter in September 1982. Amateur Radio. The experiments were terminated with the start of daylight savings because of the increased summer noise level. The experiments will recommence shortly. I intend to contact all volunteer listeners before recommencing experimental transmissions.

Although the response from volunteer listeners was very good inside the ground wave range, approximately 370 km, we have few volunteers outside this range.

We would like to hear from anyone who has receiving equipment with low noise level, freedom from spurious and capable of receiving below 200 kHz who live in a radius of from 350 to 1500 km from Melbourne. It would be an advantage if the listener has operating facilities on 80 and 40 metres for the purpose of reporting.

For anyone interested in participating in these experiments, we would arrange listening times and call back frequencies for reports. Interested persons please contact J A ADCOCK, (03) 306 2069 QTHR.

There will be a full report of the technical aspects of the activity published when complete.

Yours faithfully,  
John A Adcock  
VK3ACA

AR

## ITEM OF VALUE

The Editor,  
Dear OM,

May I reply to the sincere concern expressed by Alex McMurray VK2AEV in AR February 83 re a medical emergency he handled on amateur radio.

I think that Alex, with no marine background handled the situation very well. Commonsense is the basic essential and by phoning HMAS Albatross he had the experts involved immediately.

73  
Don Hopper VK4NN

## THANKS

Dear Sir,

This club expresses its appreciation of the fine work done by the Wireless Institute Civil Emergency Network (WICEN), and the State Emergency Service (SES), in providing communications during the recent tragic bushfires in South Australia and Victoria.

We congratulate all operators on the discipline, and high standard of operating displayed in supplying these essential communications.

Once again it has been shown that the amateur service, its operators, and their equipment can play a valuable part in any local, state, or national emergency.

We are sure that the State, and Federal governments will be ready to publicly acknowledge these facts, and express their official appreciation of the work done, and so encourage the many persons involved in this valuable service.

Yours sincerely,  
Warren  
Secretary,  
Moorabbin and District  
Radio Club (VK3APC)

PO Box 123  
Sandy Bay  
5/3/1983

The Editor,  
Dear Editor,

The members of the Southern Branch, Tasmanian Division, of the WIA wish to commend you on the new format of the Amateur Radio Journal.

At each meeting the members always remark on the amount of content in your journal, and its presentation.

Yours faithfully,  
Ian Hill  
Secretary, Southern Branch, WIA

AR

## CABLE TV TRANSMISSION BEARERS

18 Ottawa Avenue,  
Panorama SA 5041  
16/3/83

The Editor,

WIA is currently making representations to ensure that amateur radio is not affected by the introduction of cable TV in Australia. In making these representations, some important comparisons between coaxial cable and optical fibre as a transmission bearer could be stressed.

Polyethylene dielectric coaxial cables, in diameters ranging from 5 to 10 mm, have attenuation constants ranging from 20 to 40 dB/Km at 10 MHz and from 60 to 150 dB/Km at 100 MHz.

Compare these coaxial cable figures to optical fibres, operating in the 1.3 to 1.6 micrometre wavelength region, which can now be made with attenuation constants of less than 1 dB/Km and which can support signal bandwidths up to 1000 MHz. Such fibres, complete with protective sheath, have diameters less than 1 mm and hence take up less space in cable ducts than coaxial cable. Furthermore, as optical fibre systems are expanded in development, installation costs are expected to fall to a fraction of those for coaxial cable systems.

As far as amateur radio is concerned, optical fibres have the important advantages that they do not generate electromagnetic fields and are immune to interference from electromagnetic fields.

Clearly, optical fibre is destined to beat coaxial cable as a transmission bearer, hands down. It would seem to be a lack of foresight if Australia allows yesterday's technology, of a coaxial cable television system, to be introduced. Optical fibre technology is already here and Australian industry could well do with a programme to develop it for national cable TV.

It is not the prerogative of WIA to recommend whether cable TV is needed in Australia or

otherwise, but if it is to be introduced, WIA must encourage a system which does not interfere with amateur radio reception and is immune to fields from amateur radio transmitters. It is therefore in the interests of amateur radio to encourage optical fibre as the transmission bearer. Fortunately, optical fibre has advantages on all counts and WIA should stress these advantages to those authorities delegated to make the decision.

Lloyd Butler VK5BR

AR

## SEARCH AND RESCUE

The Editor,  
Dear Sir,

I refer to the letter from Alex McMurray (VK2AEV) in your magazine's February 1983 edition and would like to thank the writer for his kind remarks.

This centre often becomes involved in Marine Search and Rescue (SAR) incidents where the only communication with the scene is through Amateur Operators. As the Australian Marine Search and Rescue authority, we maintain a continuous operations centre to coordinate assistance to those that need it.

Your readers may have cause to report incidents such as that outlined in Mr McMurray's letter and a reverse charge telephone call to us will ensure early action to alleviate the distress. Our number is Canberra (062) 47 5244.

We have worldwide contact with other SAR authorities who are notified if their assistance is required.

Yours faithfully,

H. K. Duncan,

Director Operations,

Australian Coastal Surveillance Centre

10 March, 1983.

AR

## ASH WEDNESDAY

46 Fore Street,  
Whittlesea 3757  
28/3/1983

The Editor,  
Dear Sir,

Although the devastating results of "Ash Wednesday" are slowly fading in physical terms, many amateurs will not forget the chaos and confusion that reigned during that day.

Amateurs throughout Victoria and South Australia have been praised, and rightly so, for their excellent service in handling communications, for and on behalf of other services.

But let us, as amateur radio operators, be wary of sitting back on our haunches until the next time our services are required. Although our operations were classed as "excellent", one must clarify this description and say that they were "adequate".

The regular Victorian WICEN members, totalling about thirty at the best of times, were indebted to Peter Mitchell VK3ANX and Colin Pomroy VK3BLE for advice and instruction on message handling for years prior to the "Ash Wednesday" incident. Operators who for many years had not involved themselves in WICEN directly appeared "out of the woodwork", and thankfully provided enormous support to the thin core of WICEN.

Now that the circumstances have reverted back to normal, let us hope the majority of amateur operators do not "go back into the woodwork", and see fit to join WICEN, participate in exercises, learn proper message handling techniques and logging, and ensure categorically the acceptance of the term "EXCELLENT" for our service.

Yours fraternally,  
Mark J Stephenson VK3PI

AR

## TECHNICAL CORRESPONDENCE

28 Immarna Avenue,  
Woolongong, 2500  
23-2-83

The Editor,  
Dear Sir,

With reference to Theo Vidler's (VK1KV) comments on 290R mods to stop the battery "blow ups", I would like to make the following points.

Upon inspection of my 290H I found a diode already soldered from the ext DC jack to ground. As pointed out this will provide protection except when used with (-) earth vech AC with the co-ax braid earthed. I consider this to be unacceptable and also VK1KV's mod to exacerbate an already over-taxed battery system.

Battery volts =  $8 \times 1.5 = 12$  volts from dry cells

Battery volts =  $8 \times 1.2 = 9.6$  volts from NiCADs

Total Drop =  $12 - 9.6 = 2.4$  volts

Add 0.6 volt for diode fwd volt drop  
=  $2.4 + 0.6 = 3$  volts

This causes a dramatic reduction in output power whilst portable.

A better solution is a small slide switch. The noise blanker switch on my R16 is usually left on so this would appear to be a suitable switch. Just connect in series with the batteries.

No damage to the set can occur if you switch it on with the batteries isolated. It just will not work.

In my view, the added inconvenience is justified by having full power available. Sure, you can forget to turn it off; but as I use my rig only occasionally portable this does not matter.

Yours faithfully,  
Peter Laughton,  
VK2XAN

AR

## ELECTRONIC HOBBYIST!

DO YOU LIVE IN . . .  
Ringwood, Lilydale,  
Boronia, Wantirna,  
Bayswater, Mooroolbark etc? . . .

We carry a comprehensive range of electronic components at very keen prices.

## Ian J. TRUSCOTT ELECTRONICS

CNR EASTFIELD  
& BAYSWATER ROADS,  
SOUTH CROYDON,  
VIC.  
TELEPHONE  
(03) 723 3860

## THE VK3BWW FORMULA FOR DX SUCCESS!!

W01105

### HIGH QUALITY AT LOW COST

#### BEAMS

3 EL 10 & 11m	\$75.00
3 EL 15m	\$83.00
3 EL 20m	\$158.00
6 EL 6m	\$108.00
5 EL 2m	\$36.00
9 EL 2m	\$59.00

#### DUOBANDER

3 EL 10m, 3 EL 15m \$148.00

Prices include Gamma match

Our beams are easy to assemble and adjust. Entirely **NEW CONCEPT** — NO NUTS OR BOLTS.

Spare parts, elements, booms and gamma matches available. Plus Freight

For further information  
PLEASE RING (03) 366 7042  
VK3BWW  
WERNER & G. WULF  
92 LEONARD AVENUE  
ST. ALBANS, VICTORIA 3021

## WANTED TO BUY

Ham gear, CB equipment, Hi Fi, video, car stereo, large or small quantities.

WE BUY AND SELL

ANYTHING ELECTRONIC

ANY QUANTITY

ANY CONDITION

## HAMRAD

104 Hightett Street,  
Richmond, Victoria.  
Phone: (03) 428 8136

# IONOSPHERIC PREDICTIONS

Len Poynter VK3BYE

## NOTES ON THE PREDICTIONS

The mode of propagation used by IPS in compiling their predictions are reflected in the bar charts used to convert the Graflex symbols into a graphic picture.

When generating the Graflex charts (reproduced in a number of publications) the following symbols are used.





- 1 "." — Propagation is possible but probably less than 50% of the days of the month.
- 2 "%" — Propagation is possible between 50% and 90% of the days of the month.
- 3 "F" — Propagation is possible by the first F mode on at least 90% of the days of the month unless there is a severe ionospheric disturbance.
- 4 "M" — Propagation is possible by both first and second F modes. The strongest mode is normally the first mode, but the vertical aerial pattern may influence the mode received.
- 5 "A" — High absorption, ie above the absorption limiting frequency but probably too close to it for good communication.
- 6 "X" — Complex mixtures of modes including the second E mode.

These are the most significant types we encounter. The full lines or bars on the chart cover 2, 3, 4 taking 5 into account. The broken lines or bars are depicted by 1. 6 is extremely hard to verify and is not taken into account.

The paths from Eastern Australia are based on Canberra. The paths from West Australia are from Perth. Suitable allowance should be made on Eastern paths for geographical differences. Times, as much as 1 hour difference between Victoria and Queensland in band openings occur. Often there is no signal available in one State, whereas the opposite effect occurs in the other State, they get the lot. Marginal differences produced by layer tilt and varying degrees of ionisation can be very frustrating.

Generally the predictions show that time of day when the path should be open between the two areas. All other factors notwithstanding.

### LEGEND

-  FROM WESTERN AUSTRALIA
-  FROM EASTERN AUSTRALIA
-  BETTER THAN 50% OF THE MONTH, BUT NOT EVERYDAY
-  LESS THAN 50% OF THE MONTH.

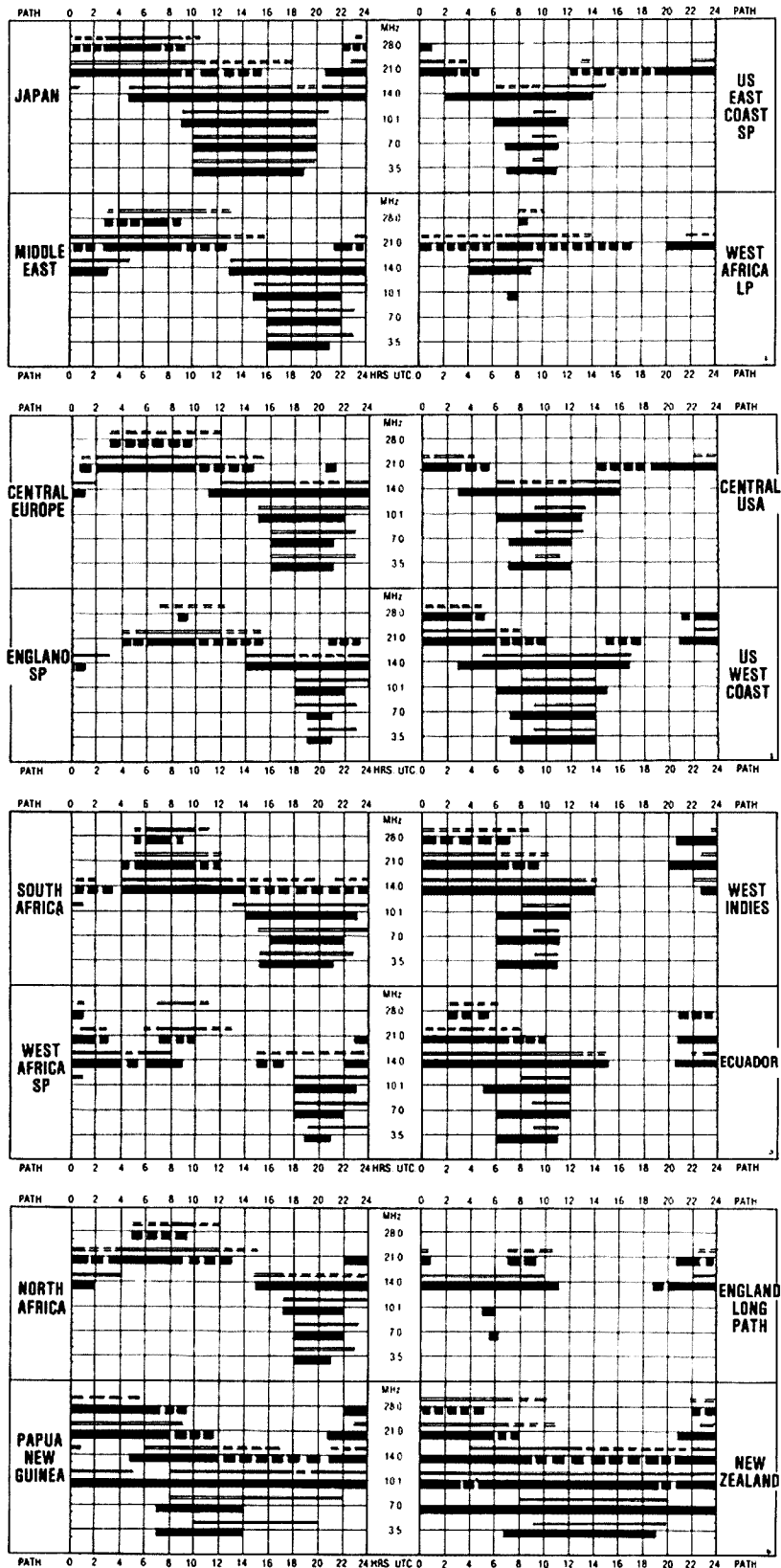

**PATHS** — Unless otherwise indicated (ie LP = Long Path) all paths are Short Path.

Predictions courtesy Department of Science and Environment IPS Sydney.  
All times universal UTC.



## GEOMAGNETIC ACTIVITY FOR YEAR 1982

### Ap — PLANETARY INDICES

MONTHLY	MEANS	HIGHEST	DAILY	LOWEST	DAILY	MOST DISTURBED DAY	DAYS OVER Ap 15
1/82	12	34	31/1	3	14/1	31/3	8
2/82	33	60	2/2	6	16/6	2/2	25
3/82	18	107	2/3	3	6/3	2/2	11
4/82	22	61	10/4	6	14/4	10/4	19
5/82	17	56	28/5	2	23/5	28/5	12
6/82	22	62	13/6	6	5/6	13/6	20
7/82	30	153	14/7	2	4/7	14/7	23
8/82	21	107	7/8	3	15/8	7/8	21
9/82	36	199	6/9	9	29/9	6/9	16
10/82	18	35	29/10	5	24/10	29/10	16
11/82	21	83	24/11	4	7/12	24/11	15
12/82	21	62	17/12	2	1/12	20/12	18

### CYCLE 21 RUNNING SMOOTHED NUMBERS TO DATE:

	1976	1977	1978	1979	1980	1981	1982
JAN		16.8	61.3	123.7	163.8	140.2	136.7
FEB		18.2	64.5	130.9	162.6	141.6	132.8
MAR		20.0	69.6	136.5	161.0	143.0	128.6
APR		22.2	76.9	141.2	158.7	143.4	123.8
MAY		24.2	83.2	147.2	156.3	142.9	119.3
JUN		26.4	89.4	153.0	154.7	141.4	116.7
JUL	13 min	29.0	97.4	155.0	152.7	139.8	
AUG	14	33.4	104.0	155.4	150.2	141.1	
SEPT	14	39.2	108.4	155.7	150.1	142.8	
OCT	14	45.6	111.1	157.8	150.2	142.0	
NOV	14	51.8	113.4	162.3	147.6	138.7	
DEC	15	56.9	117.8	164.5 max	142.7	137.6	

### SUNSPOT

MONTHLY	MEANS	HIGHEST	DAILY	LOWEST	DAILY
1/82	110.7	237	31/1	46	11/1
2/82	162.6	258	1/2	97	23/2
3/82	153.7	182	27/3	116	9/3
4/82	122.5	152	12/4	75	30/4
5/82	81.4	130	27/5	46	3/5
6/82	110.4	147	10/6	32	29/6
7/82	102.6	272	17/7	19	28/7
8/82	105.9	161	9/8	55	1/8
9/82	119.2	176	4/9	78	12/9
10/82	94.3	164	2/10	39	18/10
11/82	98.5	141	22/11	71	27, 29/11
12/82	126.4	194	12/12	62	31/12

ACKNOWLEDGEMENTS: Sunspot Data, Sunspot Index Data Center, Brussels.  
Geomagnetic Data, IUGG Assoc. of Geomagnetism and Aeronomy, Gottingen.

# CUSTOM WOUND TRANSFORMERS

**LOW COST  
HIGH QUALITY**

Consult us about  
your special requirements  
in transformers,  
power chokes, r.f. chokes, etc.

**240 V-29 V @ 100 VA**  
**\$23.40**  
**240 V-20 V @ 400 VA**  
**\$53.00**  
**Plus Sales Tax if  
applicable.**

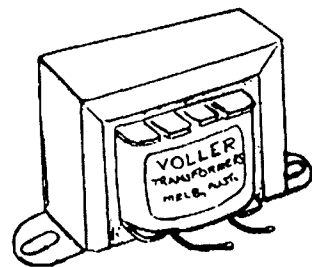

**FREIGHT EXTRA**

**PLEASE RING (03) 551 1452  
VOLLER TRANSFORMERS  
PTY. LTD.**

**16 PIETRO RD.,  
HEATHERTON. 3202**

**A Call to all holders of a  
*NOVICE LICENCE***

Now you have joined the ranks of Amateur Radio, why not extend your activities?

**THE WIRELESS INSTITUTE OF AUSTRALIA (N.S.W. DIVISION)**

conducts a Bridging Correspondence Course for the ACP and LAACP Examinations.

Throughout the Course, your papers are checked and commented upon to lead you to a **SUCCESSFUL CONCLUSION.**

For further details write to:  
**THE COURSE SUPERVISOR, W.I.A.**

P.O. BOX 1066,  
PARRAMATTA, NSW 2150

**AIR-WOUND INDUCTANCES**

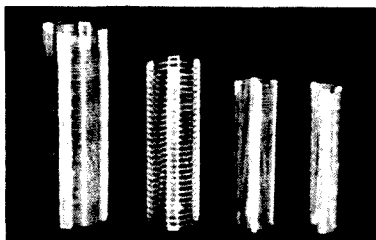

No	Diam	Turns per		B & W Equiv	Price
		Inch	Length		
1-08	1/2"	8	3"	No 3002	\$1.60
1-16	1/2"	16	3"	No 3003	\$1.60
2-08	3/8"	8	3"	No 3006	\$1.90
2-16	3/8"	16	3"	No 3007	\$1.90
3-08	3/4"	8	3"	No 3010	\$2.30
3-16	3/4"	16	3"	No 3011	\$2.30
4-08	1"	8	3"	No 3014	\$2.60
4-16	1"	16	3"	No 3015	\$2.60
5-08	1 1/4"	8	4"	No 3018	\$2.90
5-16	1 1/4"	16	4"	No 3019	\$2.90
8-10	2"	10	4"	No 3907	\$4.20
8-10/7	2"	10	7"	No 3907	\$7.20

Take the hard work out of Coil Winding — use "WILLIS" AIR-WOUND INDUCTANCES

**WILLIAM WILLIS & Co. Pty. Ltd.**

98 Canterbury Road, Canterbury, Vic. 3126  
PHONE: 836 0707

**RTTY/CW**

Advanced split-screen ASCII, BAUDOT, CW software for Commodore computers . . . \$59

VIC 20 computer — 5K RAM, 8 colours, hi-res 176\*200 pixel graphics, 4 voice sound generator . . . \$299

Commodore 64 computer — 64K RAM, 16 colours, hi-res 320\*200 pixel graphics, sprites, sound synthesizer . . . \$699

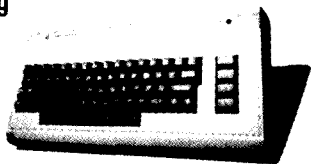

Both computers feature 20K BASIC & operating system, RS 232, parallel user port — disc drives, printers, joysticks, paddles, light pens, games, utilities etc available.

Versions also available for PET/CBM 3000, 4000 and 8000 series (includes SSTV send) — POA.

**HIGH TECHNOLOGY COMPUTER SYSTEMS PTY LTD**

87 Swan Street, Richmond, Vic 3121 ph (03)  
429 1966 ask for Mike VK3BHM or Joel VK3ZKE

**Chirnside Antennas**

For a **BIG** Signal

**CE-5SS**  
**80-40-20-15-10 m**  
**Trapped Vertical**

**Base or Portable**  
**Self Supporting**  
**Still Only \$89**

**Why pay approx**  
**\$160 for**  
**imported types?**

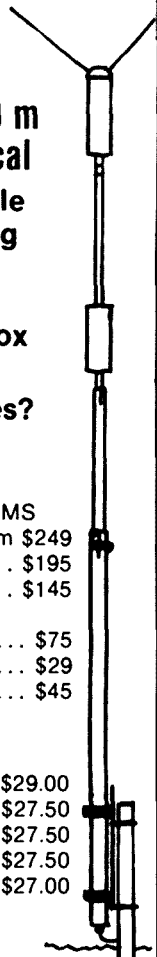

**MULTIBAND BEAMS**

- CE-33 3 el 20-15-10 m \$249
- CE-52 5 el 15-10 m . . . \$195
- CE-42 4 el 15-10 m . . . \$145
- CE3-11/10 3 el
- 10 or 11 m . . . . . \$75
- CE2-5 el 2 m yagi . . . . . \$29
- CE2-8 el 2 m yagi . . . . . \$45

**Mobile Helicals**

- 80 m 6'6" long . . . . . \$29.00
- 40 m 6'6" long . . . . . \$27.50
- 20 m 6'6" long . . . . . \$27.50
- 15 m 6'6" long . . . . . \$27.50
- 10/11 m 6'6" long . . . \$27.00

We use only high quality components. .71 m wire, top loading, solid brass fittings with adjustable stainless steel tip and heavy wall heat-shrink tubing.

All available by mail order from:—

**Chirnside Electronics Pty Ltd**

26 Edwards Rd, Chirnside Park Vic  
3116. Phone (03) 726 7353

Please allow sufficient for freight and insurance.

# Obituaries

## JOHN CRITCHLEY GRAHAM G3TR

His many friends in VK/ZL will be saddened to hear of the passing, whilst on holiday in Tenerife, of John Graham, G3TR.

For many years John has been one of the outstanding UK signals on 20m, resulting in thousands of VK/ZL contacts.

John started a long association with amateur radio with the artificial aerial call sign of 2BQR, first obtained in the mid 20s. G3TR first came to air in 1936 and has been regularly heard, apart from the war years, ever since, passing through all British call areas as he moved around with his work.

John's many hobbies in earlier years included fishing and a long association with motor racing. Indeed he used to drive Riley cars at Brooklands in the heyday of that particular track. His other interests included ballroom dancing and a lifetime interest in everything connected with aviation.

John became associated with Air Traffic Control in the very early days and in fact held Licence No 13, finishing his career as Air Traffic Control Officer in Charge of London Gatwick Airport prior to his retirement some fifteen years ago.

Following retirement John had more time to become involved in the administrative side of amateur radio and served on many RSGB committees, finally being elected President during 1968.

More recently, John was heard daily on the 20m band where he particularly sought out VK/ZL contacts.

John is survived by his wife Else, son Eric and daughter Britt to whom we offer sincere condolences. 20m is just not the same without his voice.

Ron VK6RV

## ALF SEEDSMAN VK3IE

All was born in 1904 and passed away 8 January 83. He was educated as a Civil Engineer at Melbourne University, and experimented since his late teens with spark transmitter and later with single valve sets and mainly hand built components. Licensed in 1947 as VK3IE (succeeding the late Jack Mann as call holder), he was well known on 80, 40 and 20 with his Type 3 Mark 2 (and occasionally an 'A' Mk3). Always a 'home-brew' amateur, he converted to OSB when the move away from AM set in. It was only in his last three years of operating that he used a commercial unit.

Some of his fondest memories were the 80 metre transmitter hunts when hidden by the late Col Gibson (3FO), teaming up with the late Jack Ouncan (3VZ) trying to beat Len Moncur's VK3LN family to the transmitter site.

He often recalled two TV demonstrations he had seen, one by 3LN and 3VZ at a Hobbies Exhibition in the early 1950s, and a special one by Peter 3BX later in the 1950s; and his respect for the magnificent equipment assembled by Joe Rogers (ex 3TO).

He served as a WIA Victorian Division broadcast announcer in the late 1940s, on Divisional Council, and later on the Federal executive.

He was well known to the VKO fraternity in the 1980s as his son Don (ODS) spent two separate years on the Antarctic Continent.

To the many friends, too numerous to mention that he made in his 38 years of operating, I am sure he is sorry that he could not have that one last contact to say goodbye.

Don Seedsman VK3ZIE  
AR

# Silent Keys

*It is with deep regret we record the passing of —*

HAROLD WEBBER VK3PW

## HAMADS

**PLEASE NOTE:** If you are advertising items FOR SALE and WANTED please write on separate sheets, including ALL details, eg Name, Address, on both. Please write copy for your Hamad as clearly as possible, preferably typed.

\* Please insert STD code with phone numbers when you advertise.

- Eight lines free to all WIA members. \$9 per 10 words minimum for non-members.
- Copy in typescript please or in block letters double spaced to PO Box 300, Caulfield South 3162.
- Repeats may be charged at full rates.
- Closing date: 1st day of the month preceding publication.
- QTHR means address is correct as set out in the WIA current Call Book.

Ordinary Hamads submitted from members who are deemed to be in the general electronics retail and wholesale distributive trades should be certified as referring only to private articles not being resold for merchandising purposes.

## TRADE HAMADS

Conditions for commercial advertising are as follows: The rate is \$15 for 4 lines, plus \$2 per line (or part thereof) minimum charge \$15 pre-payable. Copy is required by the first day of the month preceding publication.

**AMIQON FERROMAGNETIC CORES:** Large range for all receiver and transmitter applications. For data and price list send 105 x 220 SASE to: R. J. & U. S. Imports, Box 157, Mordial, NSW 2223. (No enquiries at office: 11 Macken St, Oakley, 2223.)

**CB RADIOS \$69;** walkie talkies, short wave radios, military, outback, business, amateur, marine, repairs, RTTY Siemens 100A printer \$120; base mic., \$45; ultrasonic alarm, \$35; all ham bands on a single 6 ft. whip, 1.8 to 30 MHz, for base or mobile, \$300; aeriels, installation, demonstrations, 40 ch. CB conversions, accessories, new rigs weekly. Bridge Disposals, 12 Old Town Plaza, opp. Bankstown Railway Station, NSW. Mail order service and all enquiries to 2 Griffith Avenue, Roseville 2069, or phone Sam VK2BVS, 7 pm to 9 pm only, on (02) 407 1066.

23 cm LOOP YAGIs and Power Meters, Semi Rigid Coax, PTFE PC Board, Waveguide, Flanges, Gunn and Mixer Diodes and our 3 cm Transceiver Module are a few items from our lists. SAE to Microwave Developments, 6 Netley Rd, Mount Barker, SA 5251.

## TAKE AWAY

RAAF AR14 RX circa 1940. Complete with coils. May interest collector. Take away. ARs in sequence since 1977. May suit club. VK3MU, QTHR. Ph: (03) 82 2747.

## WANTED

Due to the imminent retirement of Bob Arnold VK3ZBB a Contributing Editor for the AMSAT Australia column is required.

## WANTED — NSW

**TRANSCEIVER** — AM only needed by student for experiments. Will pay any realistic price — 6 or 2 metres only. Prefer commercially built VFO tuned superhet with circuit diagrams. John VK2DVM, PO Box 57, Bexley North 2207 or Ph: (02) 57 6567 AH.

**YAESU FRG 7700** — If it can be done, I would like information on how to convert the clock of the Yaesu FRG 7700 to a 24-hour clock. Prepared to pay. Paul Casotti, L20173, Box M60, Post Office, Newtown South, 2042, NSW.

**YAESU FT-7B** in good condition, preferably with a mobile mount and owners manual. John VK2DFC QTHR or Ph: (069) 62 5547.

## WANTED — VIC

**CONVERSION DETAILS** of FL2000 Linear Amp for 160 Metres. VK3BAX QTHR.

**MOTOROLA MPU CLOCK** type MC6871, frequency 614.4 kHz as used in D2 evaluation kit. VK3ALY QTHR. Ph: (03) 589 4275.

**RADIO COMPONENTS** — WWII vintage. Command Tx & Rx units pref unmodified. Controllers both Tx & Rx, modulators, RF output metres, plugs, sockets, top & bottom covers, inc inspection covers over valves and Bowden cables and fuse covers. Radar sets, Rebecca, Eureka, Walthar, TPS, H2S, APS2, APS4, APS13, Aust & US brands. Indicators, Tx's and access, test gear, handbooks and antenna systems. W. Babb, VK3AQB. Ph: (03) 337 4902.

**V F O TO SUIT FT-75B ALL BANDS.** Contact John VK3VGP QTHR or Ph: (03) 398 1564 AH.

## WANTED — QLD

**LINEAR AMPLIFIER,** Drake L4B or similar. Details to VK4SZ (John) PO Box 26, Innisfail. Ph: (070) 61 3286.

**YAESU FTV-107R,** 430 MHz unit, working or not, any reasonable price paid. Noel VK4BTX. Ph: (074) 22 2533 BH (074) 22 1959 AH.

## WANTED — WA

**824 AWA** power supply and receiver circuit diagrams. Uniden VFO 8010, ext spkr 8120, DC cord and plug. Must be good condition all letters answered. C Chew, PO Kirup 6251.

## FOR SALE — ACT

**ICOM 551 Tcvr** 6 m all mode 10 W with FM board \$500. Icom 260A 2 m all mode 10 W \$250. Glen VK1KAA QTHR. Ph: (062) 54 8002.

**FT101B** good cond \$450 ONO. FT650B, T/V, good cond \$120 ONO. VK1EP QTHR. Ph: 49 6437.

**FOR SALE — NSW**

**HY-GAIN TRI-BAND ANTENNA** type TH3 MK3 in good condition with BN-86 balun and manuals \$160. VK2BX QTHR. Ph: (045) 67 7157.

**KENWOOD 820S TRANSCEIVER**, digital readout. CW filter, DC-DC converter, service manual and handbook, recent dealer alignment and service, \$600 ONO. With matching VFO \$700. Barrie, VK2DWC. Ph: (02) 44 3787.

**SHACK CLEANOUT** — Yaesu FT101E Txcvr \$525, Yaesu FTV250 2 m transverter \$165, Yaesu FT227R 2 m Txcvr \$225, Higan TH3 MK3 triband yagi (heavy duty) \$225, all excellent condx in orig cartons with books. John VK2DXA, Box 750, Tamworth. Ph: (067) 65 7100 BH or (067) 65 4226 AH.

**TEN TEC TRITON IV TRANSCEIVER**, 5 HF bands, CW, SSB, lull break in. Output 85-100 W, good condition and complete with ceramic mic and service manual \$320. Ted VK2KEM QTHR. Ph: (02) 913 9649.

**YAESU FT101E \$450, FT7 \$350, FL110 linear amp \$200, Philips FM 321 Txcvr \$200, VK2DKP QTHR. Ph: (049) 94 9267 AH.**

**YAESU FT102**, All mode transceiver recently purchased new, has had very little use. In excellent condition, one mod completed by dealer when purchased \$875 plus freight. Owen VK2PCJ QTHR. Ph: (0649) 21 555, Ext 12 BH.

**YAGI 3 EL MONOBAND** beam for 20 m VK3BWW design brand new \$100. Palomar IC keyer \$80. Dentron jr monitor ATU \$50. Kenwood low pass filter LF30A \$10. Beam antenna handbook Orr \$3. All about cubical quad antennas Orr \$3. All prices firm. VK2DET QTHR, Blackheath, NSW. Ph: (047) 87 7003.

**FOR SALE — VIC**

**ANTENNA**, 18AVT Vertical \$50. Freq Meter BC221 C/W AC supply \$25. Marconi Video Osc 50 Hz-12 MHz. TF885A/1 \$50. Audio Filter. Technical Materiel Corp Model 466 Hi-Lo 1-2.5 khz \$30. Decade Cap Box. AWA Type A8297. \$20. Command Trans 6.0 — 9.1 MHz \$5. Three meters 0-7/0-15/0-25 volts, 0-10 volts, 0-5/0-250 volts \$6. Two meters 0-100 mA, 0-200 mA \$6. Model 310 Pwr-SWR meter \$20. CRO 3" to 50 kHz \$50. AWA mic DM47 (50 k-ohms) \$25. Dan VK3BCD. Ph: (03) 80 5354.

**COMPUTER SYS 80**, 16 k U/LC, sound, video monitor, utility programmes inc Morse send, rec \$575. Exp interface (new series) 32 k \$320. Two MPI disk power supplies & cases as new \$50 each. Kenwood station monitor SM 220, Pan display inc, as new \$250. VK3BZC QTHR. Ph: (052) 63 1981.

**FT290R**, under 12 mths old, as new cond complete with carrying case, Ni-Cad batteries and charger, 'no mods'. Suit new 2 m rig buyer \$295. Selling due to lack of interest. VK3KVT QTHR. Ph: (03) 754 4860.

**ICOM IC-701** transceiver with IC-RM3 computerised remote controller, IC-701PS power supply and IC-SM2 desk mic. Complete with handbooks, cables etc \$750. VK3ARY QTHR. Ph: (03) 277 4798.

**ICOM IC730** HF transceiver, 12 mths old. Excellent condition \$600. Ph: (03) 723 3717 AH.

**KENWOOD TR2400** 2 m tcvr 800 channel handheld in perfect order & condition. Complete with charger, manual & soft carry case with belt clip \$200. Harry VK3ASI QTHR. Ph: (052) 43 1831.

**LINEAR FL 2500** VGC incl spare set of new valves and inst manual \$300 ONO. Amateur band only communications Rx AX190 mint cond in original carton and owner's manual \$150 ONO. General communications Rx DX300 digital read out incl owner's manual VGC \$200 ONO. Hans VK3DNS QTHR. Ph: (03) 557 5795 (BH), (03) 555 8666 AH.

**MULTIBAND TRAP DIPOLE**, 10 thru 80 m, RAK MIDY-VN, alloy wire, 1.5 kW PEP, 52 Ω single feed, 23 m long, completely assembled and adjusted, original box with instructions, EC \$25. VK3K0A QTHR. Ph: (03) 45 1731.

**NALLY TILT-TOWER COR AR22** rotator, approx 25 m low-loss coax. Imperial calcs \$520, including dismantle, transport & re-erect in metro area. VK3MU QTHR. Ph: (03) 82 2747.

**SHACK CLEARANCE** — Yaesu FT 501 transceiver, digi readout, 560 watts, 80-10 m, \$450 ONO. Waterman miniature oscilloscope \$75. HP 523B counter \$50. 15-400 MHz sweeper/display unit \$40. Advance pulse generator \$40. HP 403A millivoltmeter \$30. Miniature pen recorder \$30. Philips GM 4249 resistance bridge \$25. Rod VK3AAR QTHR. Ph: (03) 836 4279 AH.

**VIDEO RECORDER** — JVC Umatic, black and white vidicon camera, six one hour tapes, head cleaning tape, full service manual, dust cover \$550 the lot. VK3DNE. Ph: (03) 336 7815 BH, (03) 337 7210 AH.

**YAESU FT101ZD** with WARC, CW filter fan and mic late model in mint condition \$600. VK3AVK. Ph: (03) 729 5414.

**YAESU FT480R 2 M TCVR** unit is as new in original packing with instruction manuals, mobile mount etc. Full workshop service manual available if reqd. Surplus to requirement \$350. VK3YXX QTHR or Ph: (03) 527 4029 AH, (03) 697 6230 BH.

**YAESU FT707**, All bands including WARC \$599. VK3DAW. Ph: (03) 874 7270 AH or (03) 41 5249 BH.

**YAESU FT-7**, HF txcvr, 80 thru 10 m, also FL-110 linear amp to suit, 200 W input; both with box, manual and mobile mount — \$350 and \$200 resp — or \$500 for both. Michael VK3AGR QTHR. Ph: (03) 528 5063.

**FOR SALE — QLD**

**RADIOTRON DESIGNER'S HANDBOOK** by Langford Smith, 4th ed (latest) fair cond, WT 2 kg, \$10 & post. P Hadgraft, 17 Paxton St, Holland Park, Q4121. Ph: (07) 397 3751.

**SHACK SELLOUT**, Yaesu FT-107 QMS, FC-107 ATU WARC, TRS-80 Mod 1 Level II, green screen monitor, Macrotronics M80 CW RTTY interface, AFSK generator, excellent performance, many extras \$1900 ONO. Ph: Noel (074) 22 2533 BH.

**TEKTRONIX 561A** oscilloscope. Dual trace. Delayed sweep time base. Calibrator. One X1 probe plus one X10 probe. Manuals included. Excellent condition \$150. John VK4ZJW Strathpine. Ph: (07) 205 4512 AH.

**YAESU FT101 TRANSCEIVER** complete with mike and instruction book \$350. Icom 202 SSB 2 m with Oscar xtal fitted \$100 VK4CJ QTHR. Ph: (07) 343 2235.

**YAESU FV401** external VFO. In as new condition with handbook, and original carton \$95. Fred VK4RF. Ph: (07) 200 7916 QTHR.

**FOR SALE — SA**

**KENWOOD TS-820** with digi display and DC-DC inverter \$750. SP-820 speaker with 3 switchable filters \$40, Kenwood LF-30A low pass filters X2 \$20 each, Shure 444 high impeded mic \$45, Emotator 103LBX Medium Duty rotator inc cable \$90, Hidaka VS-33 3 el tri-band Yagi 14 ft boom inc balun \$200, 30 ft free standing tower with 1 1/2 ins water pipe extension 10 ft long \$60, transistorised sig gen 400 kHz-30 MHz \$15, partially complete HF Linear designed around two 3-500Z, includes blower and separate HV 3000 V 1 amp power supply \$100, photographic enlarger LPL-35 with 50 mm f3.5 lens inc 8 x 10 easel \$60. Apply VK5FF. Ph: (087) 25 4248 or QTHR.

**MODEL 15 TELETYPE**. Requires extensive cleanup before attempting to operate. Also a large number of spares for this machine. Machine plus spares \$20. Buyer must pay freight. G Moore VK5AGL. Ph: (085) 84 6260.

**ADVERTISERS' INDEX**

BAIL ELECTRONIC SERVICES ..... IFC  
 BILL EDGE'S ELECTRONIC AGENCIES 2  
 BRIGHT STAR CRYSTALS ..... 2  
 C W ELECTRONICS ..... 3  
 CHIRNSIDE ELECTRONICS PTY LTD 54  
 EASTERN COMMUNICATION CENTRE 35  
 EMTRONICS ..... 23  
 GFS ELECTRONIC IMPORTS ..... 36  
 HAMRAD ..... 51  
 HIGH TECHNOLOGY COMPUTER SYSTEMS PTY LTD ..... 54  
 IAN J TRUSCOTT ELECTRONICS ..... 51  
 ICOM AUSTRALIA PTY LTD ..... BC  
 NOVICE THEORY — G Scott & A Brucesmith ..... 3  
 R F INDUSTRIES ..... 5  
 SCALAR GROUP ..... IBC  
 TRIO-KENWOOD (AUSTRALIA) PTY LTD ..... 4 & 17  
 VICOM INTERNATIONAL PTY LTD .... 3  
 VK2 WIA NOVICE LICENCE ..... 54  
 VOLLER TRANSFORMERS PTY LTD 53  
 WATCHMAN ELECTRONICS ..... 5  
 WERNER & G WULF ..... 51  
 WILLIAM WILLIS & CO PTY LTD ..... 54



# YAESU'S NEW HF TRANSCEIVER



## FT-77

- ALL AMATEUR BANDS  
3.5 to 29.9 MHz (including WARC)
- CW, SSB MODES (FM optional)
- 100W OUTPUT
- WEIGHT: 6 kg
- SIZE: 240(W)x95(H)x300(D) mm,  
including heat sink

### FT-77 HF TRANSCEIVER

Featuring efficient, all solid state, no tune circuitry, the FT-77 offers a nominal 100 watts of RF output on all amateur bands between 3.5 and 29.9 MHz, including the three new WARC bands. The new CAD/CAM\* techniques plus the simple design of the FT-77 add up to one of the smallest, lightest HF transceivers ever, both in your hands, and on your wallet.

The front panel control layout and operation are actually simpler than some VHF FM transceivers, with only the essential operating controls. Nevertheless, all of the essential modern operating features for HF SSB and CW are included, along with extras such as dual selectable noise blanker

Computer-aided design of the circuit boards in the FT-77 ensures the most efficient component layout possible in the smallest space, while automatic parts insertion and soldering greatly diminish the chance of human error. Reliability and quality



### FP-700 AC POWER SUPPLY

control are thus improved and simplified beyond the degree previously attainable in amateur equipment.

The extremely compact size and simple control layout make the FT-77 ideal for mobile operation, or as a complete base station with the optional FP-700 AC Power Supply, FV-700DM Digital Scanning VFO and Memory System, FTV-700 V/UHF Transverter and the FC-700 Antenna Tuner.

\* Computer-Aided Design/Computer-Aided Manufacture



### FC-700 ANTENNA TUNER

pulse widths (designed to blank the woodpecker or common impulse noise), full SWR metering, and capabilities for an optional internal fixed-frequency channel crystal, narrow CW filter and FM Unit.



## Bail Electronic Services

38 Faithful Street,  
Wangaratta 3677  
Telephone: (057) 21 6260 — Telex: 56880



Bankcard Welcome

Stan Roberts  
VK3BSR

# ICOM IC-730

ICOM's Go Anywhere HF Rig for Everyone's Pocketbook



## Compact.

Only 3.7 in (H) x 9.5 in (W) x 10.8 in (D) will fit into most mobile operations (compact car, airplane, boat, or suitcase)

## Affordable.

Priced right to meet your budget as your main HF rig or as a second rig for mobile/portable operation.

## Convenient.

- Unique tuning speed selection for quick and precise QSY, choice of 1 KHz, 100 Hz or 10 Hz tuning.
- Electronic dial lock, deactivates tuning knob for lock on, stay on frequency operation.
- One memory per band, for storage of your favorite frequency on each band.
- Dual VFO system built in standard at no extra cost.

## Full Featured.

- 200W PEP input—powerful punch on SSB/CW (40 W out on AM)
- Receiver preamp built-in • VOX built-in
- Noise blanker (selectable time constant) standard
- Large RIT knob for easy mobile operation
- Amateur band coverage 10-80M including the new WARC bands
- Speech processor—built-in, standard (no extra cost)
- IF shift slide tuning standard (pass band tuning optional)
- Fully solid state for lower current drain
- Automatic protection circuit for finals under high SWR conditions
- Digital readout • Receives WWV • Selectable AGC
- Up/down tuning from optional microphone
- Handheld microphone standard (no extra cost)
- Optional mobile mount available



ICOM AUSTRALIA PTY. LTD.

7 DUKE STREET, WINDSOR, 3181, VICTORIA, AUSTRALIA  
TELEPHONE (03) 51 2284.

# *Amateur Radio*

VOL. 51. NO. 6 JUNE 1983

Registered by Australia Post — Publication No. VBH 0569



JOURNAL OF THE WIRELESS INSTITUTE OF AUSTRALIA

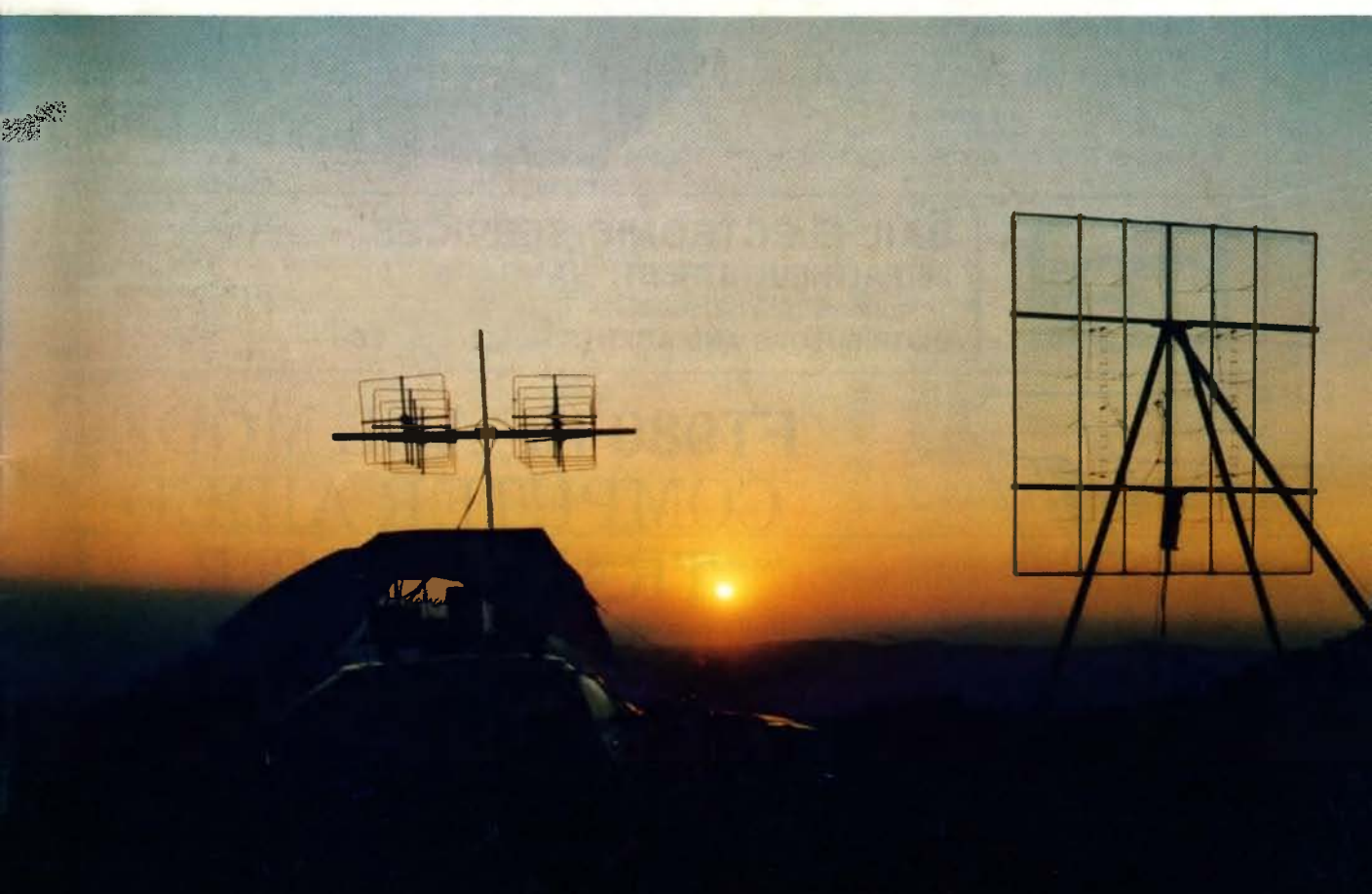

Concluding — TO HEARD & BACK  
— RF RADIATION

Mini Report — 47th CONVENTION  
AMATEUR TV goes Bush

Rules for 1983 RD CONTEST

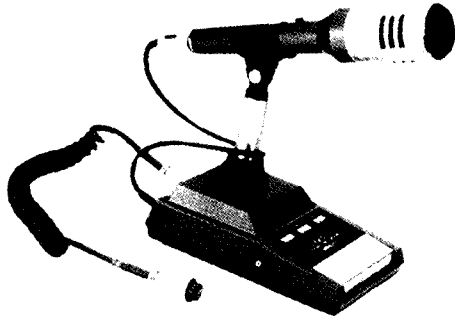

# FT726 V/UHF ALL MODE TRIBANDER

- USB, LSB, FM, CW modes
- 10 watt RF output on two metre (6 metre, 70 centimetre units optional)
- 11 memories store mode as well as band
- Programmable limited band seen between memories
- Satellite I.F. unit (optional) for full duplex cross-band
- Squelch on all modes
- GaAs FET RX pre-amp in 70 centimetre unit

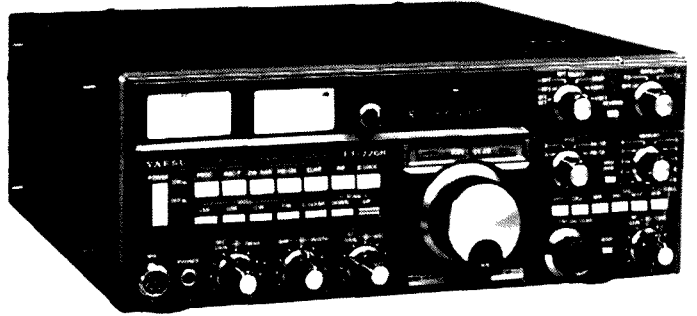

**BAIL ELECTRONIC SERVICES**  
**38 FAITHFUL STREET, WANGARATTA 3677**  
 Telephone: (057) 21 6260 — Telex: 56880  
**DISTRIBUTORS AND AGENTS IN ALL STATES**

Stan Roberts  
 and Staff —  
 VK3BSR

# FT980 HF ALL MODE COMPUTER AIDED TRANSCEIVER

Built-in computer control using 8-bit microprocessor  
 (80C85)



- General coverage RX 150KHz-29.99MHz
- Power output 100 watt SSB, CW; 25 watt AM; FSK
- Two independent RX front-ends using JFets
- 12 memory channels storing mode and frequency
- Rear panel connections for transverter, linear amplifier and external microcomputer interface

**BAIL ELECTRONIC SERVICES**  
**38 FAITHFUL STREET, WANGARATTA 3677**  
 Telephone: (057) 21 6260 — Telex: 56880  
**DISTRIBUTORS AND AGENTS IN ALL STATES**

Stan Roberts  
 and Staff —  
 VK3BSR





.. in this issue ..

# amateur radio

Photo by Bill Magnusson VK3JT



A 430 MHz phased array with screen reflector used for last scan TV and a pair of 4 el quads for VHF. (See story page 14.)

A Birds Eye View of the 47th WIA Convention	10
Amateur Television Goes Bush by Dick Robbins VK3ARR/W8VNE	12
Another Useful Multiband Antenna — The Delta Loop by Guy Fletcher VK2BBF	11
Award for 1982 Presentation	56
Heard Island Competition Winner	17
How Dangerous is Radiation? Concluding — Reprinted from RadCom	20
Modern Military Surplus Equipment — Part 3 — The B47 by Colin MacKinnon VK2DYM	18

Murphy Strikes	53
Old Timers Meet Again	37
Radio Amateur Old Timers Club by John Tutton VK3ZC	25
The Fisk Trophy by Peter Brown VK4PJ	46
To Heard and Back by Dave Shaw VK3DHF/VK0HI conclusion	14
Update on Stolen Equipment	55
WCY Celebrations in VK4 Who is this Amateur? by Peter Brown VK4PJ	40
A word from your EDITOR	9
Advertisers Index	64
ALARA	45
AMSAT Australia	52
Awards — Aust Amendments & Frankston and Mornington Peninsula Award	34
Club Corner — Repeater Group	24
Contests — Rules for 1983 RD, NZART Memorial, Results Asian & John Moyle	42
Education Notes	48
Five-Eighth Wave	56
Forward Bias	56
HAMADS	63
Here's RTTY — Mechanical Reception of RTTY	36

How's DX	28
International News	9
Intruder Watch	25
Ionospheric Predictions	62
Letters to the Editor	60
Listening Around	26
National EMC Advisory Service	54
Novice Notes — Sticky End for COAX??	51
Obituaries — VK2BTO, VK4PR, VK6NM & VK7ZYL	63
Pounding Brass — Signal Report Amplification	47
Silent Keys — VK2BTO, VK3HE, VK6NM, VK6BB & VK6KLA	63
Spotlight on SWLing	49
Thumbnail Sketches — Percy Wood and A. T. Bauer	13
Try This — Coaxial Cable Braid Preparation	35
VHF UHF — an expanding world	38
VK2 Mini Bulletin	57
VK3 WIA Notes	59
VK4 WIA Notes	58
WIA News	9

## DEADLINE

All copy for August RA must ACACH PO Box 300, Caulfield South, 3162 no later than 24th June.

**EDITOR**  
GIL SONES\* VK3AUI

**TECHNICAL EDITORS**  
RON COOK\* VK3AFW  
PETER GAMBLE\* VK3YRP  
EVAN JARMAN\* VK3ANI  
BILL RICE\* VK3ABP

**CONTRIBUTING EDITORS**  
BOB ARNOLD VK3ZBB  
MIKE BAZELY VK6HD  
RON COOK\* VK3AFW  
REG DWYER VK1BR  
BRENDA EDMUNDS VK3KT  
MARSHALL EMMS VK5FN  
RON FISHER\* VK3OM  
BRUCE HANNAFORD VK5XI  
ROY HARTKOPF\* VK3AOH  
ROBIN HARWOOD VK7RH  
ERIC JAMIESON VK5LP  
MARGARET LOFT VK3DML  
KEN McLACHLAN VK3AH  
LEN POYNTER\* VK3BYE  
TONY TREGALE VK3QQ

**DRAFTING**  
GEORGE BROOKS  
LIZZ KLINE

**BUSINESS MANAGER & SECRETARY**  
REG MACEY

**ADVERTISING MANAGER**  
JOHN J A HILL VK3DKK

\*Member of Publications Committee

Enquiries and material to:  
The Editor  
PO Box 300, Caulfield South Vic. 3162

Material should be sent direct to PO Box 300, Caulfield South Vic., 3162, by the 25th of the second month preceding publication. Phone: (03) 528 5962. Hamads should be sent direct to the same address.

Acknowledgement may not be made unless specially requested. All important items should be sent by certified mail. The editor reserves the right to edit all material, including Letters to the Editor and Hamads, and reserves the right to refuse acceptance of any material, without specifying a reason.

Trade Practices Act: It is impossible for us to ensure that advertisements submitted for publication comply with the Trade Practices Act 1974. Therefore advertisers and

advertising agents will appreciate the absolute need for themselves to ensure that the provisions of the Act are complied with strictly.

Victorian Consumer Affairs Act: All advertisers are advised that advertisements containing only a PO Box number as the address cannot be accepted without the addition of the business or residential address of the box-holder or seller of the goods.

Production: BETKEN PRODUCTIONS  
5 Masfield Avenue, Mooroolbark, 3138.

Laser Scanned Colour Separations by:  
QUADRICOLOR INDUSTRIES PTY LTD.  
Graphic Division  
22-24 Glenvale Crescent, Mulgrave, 3170.  
Tel.: (03) 560 2222

Typesetting by: QUADRICOLOR INDUSTRIES PTY LTD.  
22-24 Glenvale Crescent, Mulgrave, 3170.  
Tel.: (03) 560 2222

Photographic film and processing material courtesy  
AGFA-GEVAERT LTD AUSTRALIA

Printers: WAVEBLEY OFFSET PUBLISHING GROUP  
Geddes Street, Mulgrave, 3170  
Tel.: (03) 560 5111



# ILP TOROIDALS — UNBEATABLE VALUE

ILP toroidal transformers meet modern day requirements for a smaller size, low magnetic interference field transformer. Featuring a nearly ideal physical construction, one can expect excellent performance. Small size and weight (approximately 50% of conventional transformers), extremely low noise and low magnetic interference field make the toroidal transformer ideal for compact power supplies.



110 V Primary 0 instead of x  
220 V Primary 1 instead of x  
240 V Primary 2 instead of x

TYPE	SERIES	SECONDARY RMS No. Volts Current																						
30 VA 70x30mm 0.45Kg	1X	1X010	6.6	2.50	80 VA	3X010	6.6	6.64	160 VA	5X011	9.9	8.89	300 VA	7X014	18.18	8.33	625 VA	9X017	30.30	10.41				
		1X011	9.9	1.66		3X011	9.9	4.44		5X012	12.12	6.66		7X015	22.22	6.82		9X018	35.35	8.92				
		1X012	12.12	1.25		3X012	12.12	3.33		5X013	15.15	5.33		7X016	25.25	6.00		9X026	40.40	7.81				
		1X013	15.15	1.00		3X013	15.15	2.66		5X014	18.18	4.44		7X017	30.30	5.00		9X025	45.45	6.94				
		1X014	18.18	0.83		3X014	18.18	2.22		5X015	22.22	3.63		7X018	35.35	4.28		9X033	50.50	6.25				
		1X015	22.22	0.68		3X015	22.22	1.81		5X016	25.25	3.20		7X026	40.40	3.75		9X042	55.55	5.68				
		1X016	25.25	0.60		3X016	25.25	1.60		5X017	30.30	2.66		7X025	45.45	3.33		9X028	110	5.68				
		1X017	30.30	0.50		3X017	30.30	1.33		5X018	35.35	2.28		7X033	50.50	3.00		9X029	220	2.84				
						3X018	40.40	1.00		5X028	110	1.45		7X028	110	2.72		9X030	240	2.60				
						3X029	220	0.36		5X029	220	0.72		7X029	220	1.36								
			3X030	240	0.33	5X030	240	0.66	7X030	240	1.25													
50VA 80x35mm 0.9 Kg	2X	2X010	6.6	4.16	120 VA	4X010	6.6	10.00	225 VA	6X012	12.12	9.38	500 VA	8X017	30.30	8.33	Rating	List Rating	List					
		2X011	9.9	2.77		4X011	9.9	6.66		6X013	15.15	7.50		8X018	35.35	7.14				30 VA	\$24.38	225 VA	\$ 55.43	
		2X012	12.12	2.08		4X012	12.12	5.00		6X014	18.18	6.25		8X026	40.40	6.25				50 VA	30.59	300 VA	64.28	
		2X013	15.15	1.66		4X013	15.15	4.00		6X015	22.22	5.11		8X025	45.45	5.55				80 VA	33.58	500 VA	88.89	
		2X014	18.18	1.38		4X014	18.18	3.33		6X016	25.25	4.50		8X033	50.50	5.00				120 VA	37.96	625 VA	108.09	
		2X015	22.22	1.13		4X015	22.22	2.72		6X017	30.30	3.75		8X042	55.55	4.54				160 VA	45.99			
		2X016	25.25	1.00		4X016	25.25	2.40		6X018	35.35	3.21		Regulation	6X025	45.45				2.50				
		2X017	30.30	0.83		4X017	30.30	2.00		6X026	40.40	2.81		7%	6X028	110				2.04				
		2X028	110	0.45		4X018	35.35	1.71		6X029	220	1.02			6X030	240				0.93				
		2X029	220	0.22		4X028	110	1.09		Regulation	4X029	220		0.54										
2X030	240	0.20	4X030	240	0.50		4X030	240	0.50															

**IMPORTANT.** Regulator references - All voltages quoted are FULL LOAD. Please add regulation figure to secondary voltage to obtain off load voltage

Rating	List Rating	List
30 VA	\$24.38	225 VA \$ 55.43
50 VA	30.59	300 VA 64.28
80 VA	33.58	500 VA 88.89
120 VA	37.96	625 VA 108.09
160 VA	45.99	

All prices. Sales Tax incl.

To order or for further information please contact:

**ELECTROMARK Pty Ltd**

40 Barry Avenue,  
Mortdale N.S.W. 2223  
Telephone (02) 533 4896

**BANKCARD ACCEPTED**

# ★ BRIGHT STAR CRYSTALS

*Specifications, Dimensions and data sheets available on request*

**BULK ORDERS:** In addition to our normal range we can supply quantity orders (100 up) at very competitive prices. All we ask is 50% of cost with order balance 30 days.

**DELIVERY:** 5-6 weeks from receipt of Order. Ring for quote: (03) 546 5076. Telex: AA 36004.

**NEW NSW AGENT:**  
**APP Master Communications,**  
**Sydney (02) 682 5044**

## BRIGHT STAR CRYSTALS

35 EILEEN RD., CLAYTON, VIC.  
ALL MAIL TO: PO BOX 42, SPRINGVALE 3171

**WATCH CRYSTALS  
OVERN OSCILLATOR UNITS  
CRYSTAL UNITS  
FOR QUARTZ  
CRYSTAL CLOCKS**

**CRYSTAL OVENS**

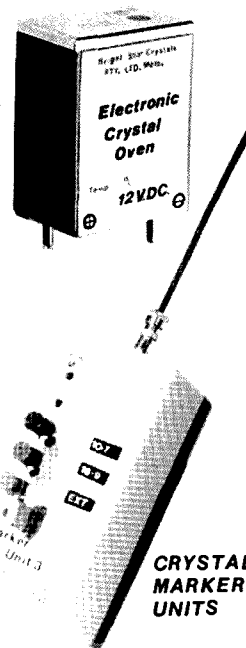

**CRYSTAL MARKER UNITS**

Phone MELBOURNE (03) 546 5076

# EASTERN

## COMMUNICATION CENTRE

COMMUNICATIONS, ELECTRONICS AND COMPUTERS

168 ELGAR ROAD, BOX HILL SOUTH, 3128

Phone enquiries: 288 3107

HOURS: Mon-Fri 9-5.30, Sat: 9-12.

BANKCARD WELCOME OR WE CAN  
ARRANGE FINANCE.

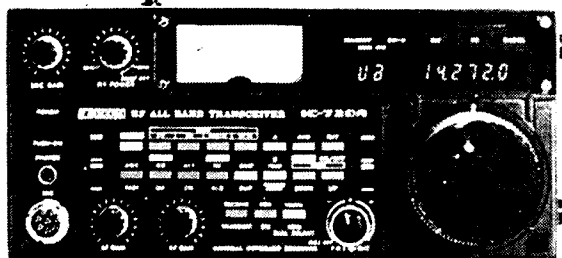

### HF TRANSCEIVER/GENERAL COVERAGE RECEIVER

ICOM's IC-720A is a superior quality HF transceiver. Whether you are a radio amateur, a shortwave listener, or a mariner, you will find the IC-720A has features that no other transceiver offers in such a small, compact size.

Built into the IC-720A are CW, AM, single sideband, and RTTY modes. Two VFO's, data transfer between the modes, receiver incremental tuning, selectable AGC, capability for Simplex or Duplex operation between the VFO's and pushbutton control of the band in use, plus general coverage reception of 0.1MHz to 30MHz.

ICOM's digital tuning system gives the IC-720A a choice of three tuning speeds, 1 KHz per increment, 100 Hz per increment, and 10Hz. This corresponds to dial rotations of 100KHz, 10KHz, 1KHz.

**ONLY \$1199**



### HF GENERAL COVERAGE RECEIVER \$799

Listen to the world of HF with the R70, a 100KHz to 30MHz commercial grade receiver designed by ICOM Incorporated, the leader in advanced receiver design. Built from knowledge gained by designing receivers for commercial, marine, and amateur use, the R70 surpasses other receivers on the market... even receivers costing more than twice as much.

Utilizing ICOM's DFM (Direct Feed Mixer), the R70 is a receiver which in normal usage is virtually immune to intermodulation distortion or cross modulation, yet still maintains superior sensitivity. Whether you are a SWL (short wave listener), Ham (amateur radio operator), maritime operator or commercial user, the R70 provides the features you need.

The R70 is an ideal general coverage receiver to complement any ham shack. Use it with your existing transmitter or transceiver to provide dual receiver capability.

The R70's built-in monitor system lets you listen to your own transmitted audio and a mute input automatically protects the R70's receiver from your signal.

An option for FM allows listening to the 10 meter FM activity.

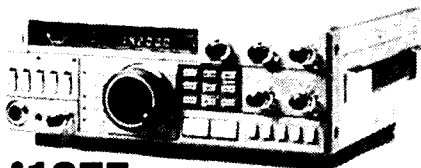

**\$1075**

The TS-430S combines the ultimate in compact styling with its counterparts in advanced circuit design and performance. An all solid-state SSB, CW, and AM transceiver, with FM optional, covering the 160 - 10 meter Amateur bands including the new WARC bands, this remarkable radio also incorporates a 150 kHz - 30 MHz general coverage receiver having an extra wide dynamic range. Key features include dual digital VFO's, eight memory channels, memory scan.



**\$390**

The TR-2500 is a compact, designed for tomorrow, 2 meter FM handheld transceiver, incorporating the latest in electronic technology, including LCD read-out, 10 channel memory with improved memory back up, memory scan, programmable automatic band scan, keyboard channel selection, and improved flexibility with a variety of new accessories. Big in features, big in performances, the TR-2500 will surprise you with its small size.

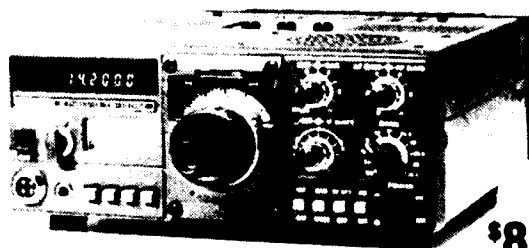

**\$800**

The TS-130 Series is an incredibly compact, full-featured reasonably priced, all solid-state HF SSB/CW transceiver for both mobile and fixed operation. It covers 3.5-29.7 MHz (including the three new amateur bands) and is loaded with optimum operating features such as digital display, IF shift, speech processor, narrow/wide filter selection (for both SSB and CW modes), and optional (DFC-230) digital frequency controller.

The TS-130S and TS-130SE run high power, and the TS-130V is a low-power version for ORP operation.

**SPECIFICATIONS (GENERAL)** • Mode: SSB/CW • Power requirement: TS-130S/130SE = RX: 0.7A 13.8V DC, TX: 1.9A 13.8V DC, TS-130V = RX: 0.7A 13.8V DC, TX = 4A 13.8V DC • Dimensions: TS-130S/130SE = 241 (9.6)W x 94 (3.8)H x 293 (11.7)D mm (inch).

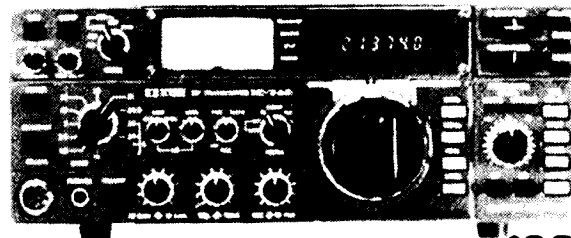

### HF TRANSCEIVER

**\$969**

ICOM's IC-740 has features desired by serious operators to fine tune the received signal and ignore interference. ICOM delivers 100dB dynamic range plus these standard features:

- All Solid State
- Dual VFO's/Split Operation
- Adjustable Noise Blanker
- Adjustable AGC With OFF
- Squelch on FM/SSB/CW (FM Optional)
- IF Shift and Passband Tuning
- Notch Filter
- Automatic Sideband Selection
- Speech Processor

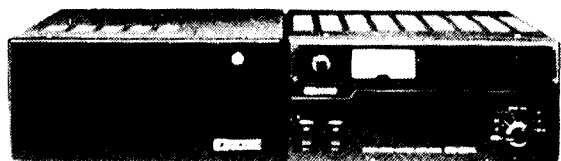

### HF 500 WATT LINEAR

**\$1699**

IC-2KL solidstate amplifier by ICOM features all solidstate broadband tuning with fully protected finals and automatic band switching, when used with the IC-701, IC-720A, or IC-730, plus full metering.

500 watts of output power give the needed punch, in a small package, to make those QSO's when the going really gets rough. ICOM's exclusive heat pipe cooling system allows smaller construction.

### FIVE BAND HELICAL-TYPE HF MOBILE ANTENNA

**\$133**



The MA-5 is a multi-purpose HF antenna for mobile operation.

- Mounts on car bumper with VP-1
- Suitable for field operation and marine mobile operation
- 5 band operation with supplied elements (80, 40, 20, 15 and 10 meter bands)
- Easily adjustable center frequencies
- FRP (fiberglass reinforced plastic) covered antenna elements

MOBILE ONE  
COMMERCIAL SYSTEMS

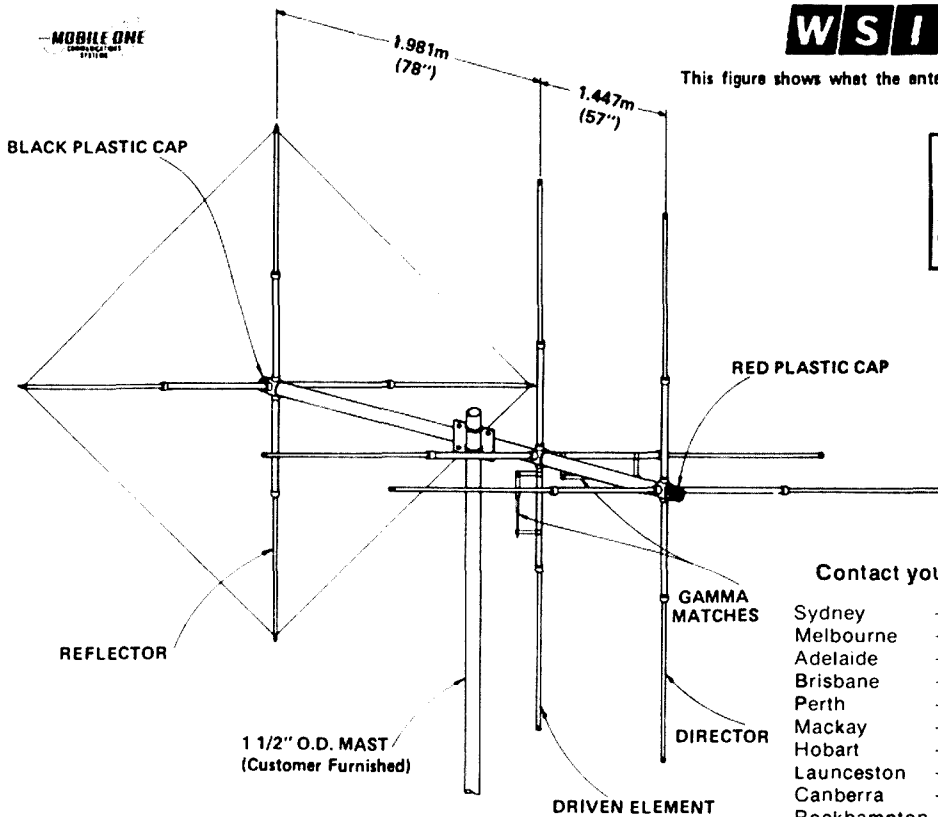

**W S I WILSON**  
SYSTEMS, INC.

This figure shows what the antenna should look like when assembled.

**6 Element  
26-28 MHz**

**COMET**

**Switchable  
Polarity**

Contact your nearest dealer at:

- |             |                                       |
|-------------|---------------------------------------|
| Sydney      | — 349 5792/671 3461/516 4500          |
| Melbourne   | — 380 4942/579 4758/318 2674/584 7631 |
| Adelaide    | — 46 9234/269 4744                    |
| Brisbane    | — 44 4707/393 3810                    |
| Perth       | — 387 4966/328 6254                   |
| Mackay      | — 51 1723                             |
| Hobart      | — 34 6944                             |
| Launceston  | — 31 7075                             |
| Canberra    | — 80 4339                             |
| Rockhampton | — 2 1058                              |

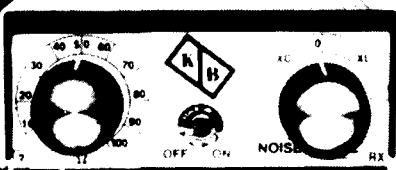

**NOISE  
BRIDGE**  
**\$60** POST  
PAID

Adjust your antenna for maximum performance. Measure resonant frequency, radiation resistance and reactance. Better than an SWR meter. Operates over 100 MHz. Most useful test unit in your shack.

**ANTENNA BALUNS**

3 to 30 MHz.  
Maximum Power 300 Watts.  
Centre support.  
Ideal for Dipoles, Beams, Quads.  
S0239 connector.

**\$26**

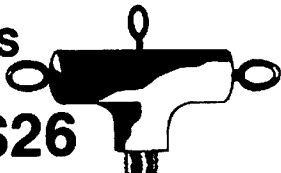

**POWER LINE  
FILTER**

240 Volt @ 10 Amp

**\$14**



1000's of Transistors — Ferrites — Hobby  
Kits — Tag Strips — Switches etc. Send  
stamped addressed envelope for full list.



**K. BRUCESMITH**  
110 Rosemead Road  
Hornsby N.S.W. 2077



**NOVICE  
LICENCE**

THE WHOLE FAMILY CAN GET ONE!

- \* THEORY BOOK \$7.50 incl. postage
- \* MORSE CODE TAPES \$5.00 incl. postage

Theory book: + covers whole syllabus  
+ simple text  
+ clear diagrams  
+ questions incl.

Morse tapes: + 5 WPM Novice  
+ 8/10/15 WPM  
+ 10 WPM exams  
+ 15 WPM

Available from: G.Scott 11 Balmoral Cres.  
Surrey Hills 3127 Vic.  
or : A.Brucsmith.110 Rosemead  
Rd. Hornsby 2077 NSW.

# CAUTION! CAUTION!

# DON'T TAKE CHANCES WITH BACKYARDERS You Could be sorry!

Buying amateur radio equipment?

If you don't deal with the factory authorised distributors, you could be buying trouble!

Everyone knows of the 'backyarder' - the wheeler dealer who can offer you a discount on just about anything. Amateur radio has them just as much as any other field.

But there's a difference: most backyarders sell the 'genuine' article, complete with manufacturer's guarantee, etc, at a discount. Amateur backyarders? That's a different story!

Chances are, what you order won't even be in stock. And when it does finally arrive, you'll get a piece of equipment never even intended for Australia. It could have different bands, the wrong power supply, wrong plugs . . . even Japanese instruction manuals!

And as for service back up . . .

And spare parts back up . . .

Etc. etc. etc.

When you deal with the factory authorised Yaesu distributors, you know you're getting the genuine article.

You know that if it is advertised, we have stock (assuming it hasn't sold out because of popularity!)

You know that if something goes wrong, there is full service back-up available.

You know that we have an enormous inventory of spare parts that are held in stock.

And you know that we'll still be here tomorrow to help you out. (Think of the number of 'backyarders' of yesterday who aren't around now!) Trust Yaesu. Trust Dick Smith for your Yaesu.

All Yaesu products from Dick Smith Electronics are fully guaranteed for 12 months with full back-up.



## The brilliant FRG 7700/SW

For the professional monitor or serious SWL! If you want the best, you want the Yaesu FRG 7700 SW. Complete shortwave coverage with ease of operation the others only dream about. Just look at these features:

- 2MHz - 30MHz continuous
- ALL Mode - including FM (great for working with converters!)
- Digital frequency readout, with digital clock.
- Timer for turning receiver on/off plus control of external equipment (such as a tape recorder).

Ask for a copy of our brochure showing you what the FRG 7700 SW can do for you.



Cat D-2841

All this **\$519**  
for only

FRG 7700 HF 150kHz - 30MHz version also available. Cat D-2840 **\$549<sup>50</sup>**

## Accessories to suit:



**\$144<sup>50</sup>**

### VHF CONVERTER

There's a lot more to listening pleasure than just the HF bands! Listen in to the exciting world of VHF radio: all the services, amateurs etc, etc. 50-59, 118-130, 140-150kHz. Cat D-2844



**\$89<sup>95</sup>**

### ANTENNA COUPLER

The FRG 7700 works with many types of antennas, but best with a low impedance one. This coupler ensures optimum performance always. Cat D-2843



**\$89<sup>50</sup>**

### ACTIVE ANTENNA

Don't want to string up an antenna outside? Use the active antenna - powerful preamplifier plus a whip antenna will pull in stations you didn't think possible. Cat D-2845

OPTIONAL MEMORY UNIT **\$129<sup>50</sup>**  
Gives you single button re-call of any of 12 chosen frequencies. Simple connection, instructions included. Cat D-2842 **WAS \$149.50**



## FT 707 SERIES

SAVE NEAR  
**\$100<sup>00</sup>**

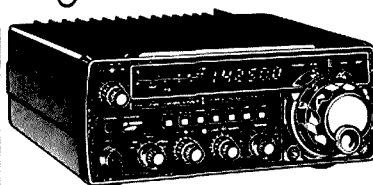

The FT 707 is a full HF band (including WARC) multi-mode transceiver not much bigger than an average 2 metre mobile! And you get digital display as well, LED S/power meter, push button operation . . . all the things the amateur needs for safe, and yet reliable mobile operation. But it's more than that: team it up with a power supply and it's a superb base station, too. Cat D-2869

WAS **\$795<sup>00</sup>** NOW ONLY **\$699<sup>00</sup>**



## FT 102 HF Transceiver

SAVE  
**\$176**

A fantastic new, super high performance HF transceiver has arrived. The FT-102 has all the amateur bands PLUS the new WARC bands. Special high voltage JFET RF amplifier provides exceptional dynamic range - well beyond 100dB. Adjustable Noise Blanking even works on 'the Woodpecker'. Three 6146B final tubes provide remarkable emission purity - plus big power 240W. Has IF Width and IF Shift and the best notch and audio peak filter you've ever heard. You must see this one to believe it! Cat D-2880



NOW ONLY

WAS **\$1225** **\$1049**  
INCLUDES FREE MICROPHONE!

### Antenna to Suit

If you're typical of most amateurs, you live in the suburbs where space is at a premium. You need an effective antenna, but there are usually objections to putting up a beam. You need our V5JR vertical. Virtually unnoticeable in your backyard, you'll be able to pursue your hobby without worry!

Cat D-4305  
**5 BAND VERTICAL ONLY \$99<sup>95</sup>**

### Antenna Rotator

Dick Smith brings you top value in an antenna rotator, and this one has fully approved power supply. Features include:

- Ruggedly made rotator with massive disc brake.
- Control box with beam direction indicator.

Cat D-5000 **\$169**  
Approved Supply (D-5002) \$27.50

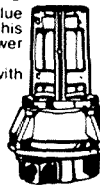

# DICK SMITH ELECTRONICS

See page 98 for full address details

A496.CT.



**7 DAY SATISFACTION GUARANTEE**

# NEW MODELS DUE FOR RELEASE MAY-JUNE '83

**KENWOOD**

## 2 FM MOBILE TRANSCEIVERS



**TM-401  
430 MHz**

**TM-201. 144 MHz**



**TW-400A  
UHF-VHF DUAL BANDER  
TRANSCEIVER**

## NEW RANGE SWR METERS

**SW-200 A/B**

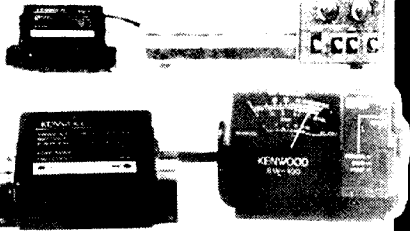

**SW-100 A/B**



**TS-830S  
SOLID STATE  
HF TRANSCEIVER**

**\$1,055**

## TS-430S

EXPORT MODEL  
INCLUDES UP/DOWN  
SCANNING MICROPHONE —  
MOBILE MOUNTING BRACKET —  
ORIGINAL "ENGLISH"  
INSTRUCTION MANUAL



**TS-130SE  
HF SSB/CW TRANSCEIVER**

**NEW R-2000 RECEIVER  
WITH MEMORY SCAN, PROGRAMME  
SCAN & MEMORY MODE RETENTION  
OPTIONAL VHF CONVERTER AVAIL. SOON.**

Ask your dealer  
for his  
Super Price.

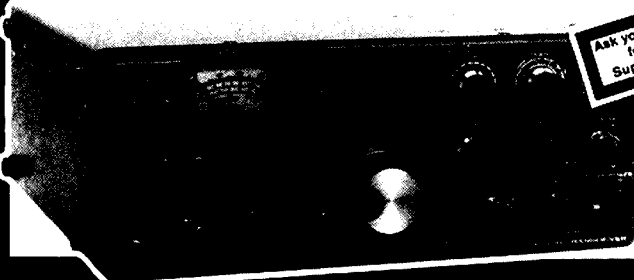

Ask your dealer  
for his  
Super Price.



Ask your dealer  
for his  
Super Price.

## TRIO-KENWOOD (AUSTRALIA) PTY. LTD.

(INCORPORATED IN N.S.W.)  
4E WOODCOCK PLACE, LANE COVE, SYDNEY, N.S.W. 2065.  
Ph. (02) 428 1455.

### NEW SOUTH WALES

- TRIO-KENWOOD (AUST) P/L — 4E WOODCOCK PLACE, LANE COVE (02) 428 1455
- SPRINGWOOD CAR RADIO — SPRINGWOOD (047) 51 4930
- UNIQUE ELECTRONICS — 418 OLD PROSPECT ROAD STH. WENTWORTHVILLE (02) 631 6689
- WASIL ELECTRICAL — 71 SUMMER STREET, ORANGE (063) 62 6249
- STOCKMAN & HIGGINS — BYRON STREET, INVERELL (067) 22 1300
- ELECTRON 2000 — 3 ELIZABETH STREET, TIGHE'S HILL, NEWCASTLE (049) 69 6399
- MADELEC PTY. LTD — 99 KENNY STREET, WOLLONGONG (042) 29 1455
- RADIO WORLD PTY. LTD — 81 NEWCASTLE STREET, Fyshwick (062) 80 6550
- DX ENGINEERING — 5 JASMINE STREET, PORT MACQUARIE (065) 83 2175
- LAND LINK — MULLALEY ROAD, GUNNEDAH (067) 42 2838
- LAND LINK — 61 BARNES STREET, TAMWORTH (067) 65 4622
- FRANK BOUNDY — LISMORE (066) 86 2145

### INTERSTATE

- VIC: EASTERN COMMUNICATIONS — 168 ELGAR ROAD, BOX HILL (03) 288 3107
- BRIAN STARES — 11 MALMSBURY STREET, BALLARAT (053) 39 2808
- SUMNER ELECTRONICS — 78 KING STREET, BENDIGO (054) 43 1977
- TAS: HOBBY ELECTRONICS — 477 NELSON ROAD, MT NELSON (002) 23 6751
- GELSTON ELECTRONICS — SUMMER HILL (003) 27 2256
- ADVANCED ELECTRONICS — 5A THE QUADRANT, LAUNCESTON (003) 31 7075
- V.K. ELECTRONICS — 57 WEST PARK GROVE, BURNIE (004) 31 1708
- QLD: MITCHELL RADIO CO — 59 ALBION ROAD, ALBION (07) 57 6830
- S.A. & N.T.: INTERNATIONAL COMMUNICATIONS SYSTEMS PTY LTD — 8 NILE ST. PORT ADELAIDE (08) 47 3688
- W.A.: ARENA COMMUNICATIONS SERVICES — 642 ALBANY HWY. EAST VICTORIA PARK (09) 361 5422
- TRI-SALES — CNR NEWCASTLE & CHARLES STREETS, PERTH (09) 328 4160
- WILLIS ELECTRONICS — 445 MURRAY STREET, PERTH (09) 321 2207
- BAY RADIO — 18 BANKSIA STREET, BUNBURY (097) 21 2236
- RON DENT — 115 PATON ROAD, SOUTH HEADLAND (091) 72 1112
- SELECT TRONIX — TOM PRICE (091) 89 1564

# QUARTZ CRYSTALS

**\* RECENTLY OPENED NEW PREMISES  
\* NOW MANUFACTURING IN AUSTRALIA \***

THE RAKON GROUP — BACKED BY 16 YEARS OF EXPERIENCE, WITH MANUFACTURING PLANTS IN NEW ZEALAND & SINGAPORE — NOW ALSO IN AUSTRALIA — FOR THE MANUFACTURE OF QUARTZ CRYSTALS.

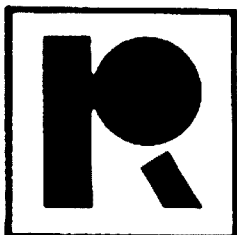

## RAKON

## AUSTRALIA PTY LTD

**39 SCORESBY ROAD, BAYSWATER, VICTORIA 3153.  
PH: (03) 720 3188 TLX: AA34590**

**RAKON EMPLOYS STATE OF THE ART FABRICATION TECHNIQUES TO PRODUCE:**

- \* **HIGH QUALITY QUARTZ CRYSTALS:** RESISTANCE WELD TYPE.  
**NB:** RESISTANCE WELDING OFFERS BETTER LONG TERM STABILITY.
- \* **PRICES — "THAT ARE REALISTIC"**
- \* **NORMAL DELIVERY:** 10 WORKING DAYS AFTER RECEIPT OF ORDER.
- \* **FAST DELIVERY:** IS AVAILABLE, IE: WITHIN 5 DAYS — AT SURCHARGE RATES.

**\* TO COMPLIMENT OUR SERVICE \***

**RAKON REPRESENTS -**



**TOYO COMMUNICATION  
EQUIPMENT CO. LTD.**

Offering an extensive range of their products including:- quartz crystal filters, monolithic crystal filters, packaged oscillators TCXO and VCXO, D.I.L. clock oscillators and S.A.W. devices.

RAKON also manufacture crystals to mil-spec and individual requirements. Inquiries re price and delivery are invited and should be forwarded to:-

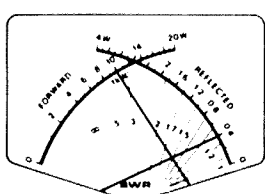

**DAIWA**

# DIRECTIONAL CERTAINTY ... WITH DAIWA

## DAIWA ROTATORS GET AUSTRALIAN AMATEURS GOING IN THE RIGHT DIRECTION WITH AUSTRALIA-BASED GREAT-CIRCLE MAPS.

With Daiwa rotators you have the advantage of control boxes with maps centred on Australia! The best way to get you going in the right direction.

Daiwa rotators offer you quality and innovation. And Daiwa rotators offer you all the choices you need.!

### A CHOICE OF CONTROL BOXES . . .

There is a round controller (Type R) which is a great-circle map centred on Australia, with area prefixes and paddle-switch control.

Or you can choose the pre-set controller (Type X) which allows you to pre-set the control area you want to work.

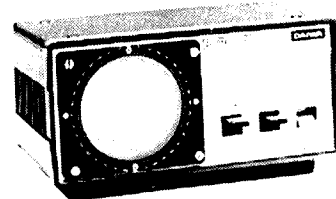

### ... AND A CHOICE OF MEDIUM OR HEAVY-DUTY ROTATORS

You can choose a Medium Duty Rotator (Model 7500) or a Heavy Duty Rotator (Model 7600). The medium duty rotator will handle the average beam with ease. The heavy duty rotator is designed to handle larger amateur and commercial beams and arrays. Compare these specifications.

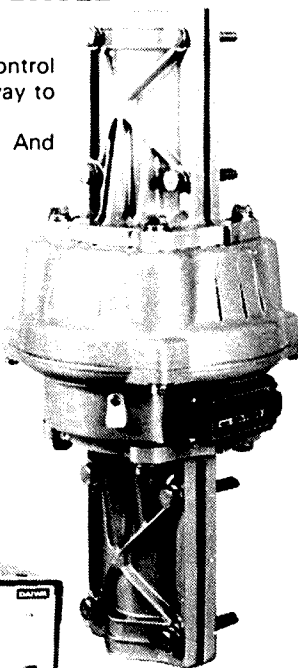

	Medium Duty (DR7500)	Heavy Duty (DR7600)
Rotation Time	60 sec	64 sec
Brake	Mechanical	Mechanical and Electrical
Stationary Brake Torque	2000kg/cm	4000kg/cm
Vertical Load Permissible	200kg	200kg
Mast Size	38-63m	38-63m
Weight	5.5kg	5.6kg
Motor	24V	24V

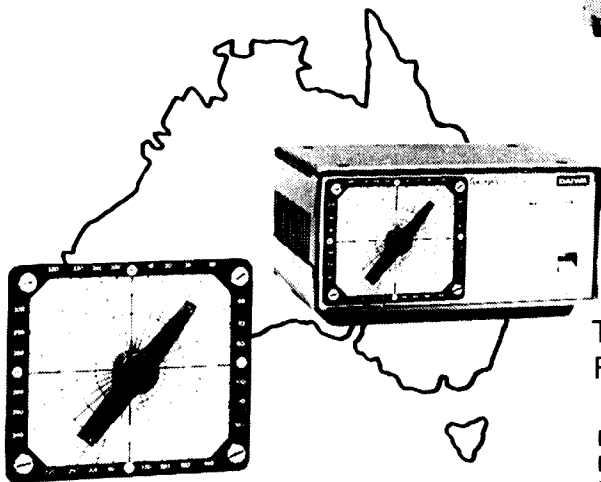

THIS GIVES YOU A CHOICE OF **FOUR** DIFFERENT COMBINATIONS . . . TO SUIT YOUR OPERATING STYLE

**DR7500R** MEDIUM DUTY; PADDLE SWITCH CONTROL BOX.

**DR7500X** MEDIUM DUTY; PRE-SET CONTROL BOX.

**DR7600R** HEAVY DUTY; PADDLE SWITCH CONTROL BOX.

**DR7600X** HEAVY DUTY; PRE-SET CONTROL BOX.

Daiwa rotators are made by the innovators who brought you cross-needle meters. They offer long life and quality Daiwa construction, and are the result of a considerable amount of research.

**SO GET YOURSELF GOING IN THE RIGHT DIRECTION. CONTACT VICOM OR ASK YOUR LOCAL VICOM DEALER.**

**VICOM**  
People to People.

#### MELBOURNE

Vicom International Pty. Ltd.,  
57 City Road,  
SOUTH MELBOURNE, VICTORIA  
PHONE: (03) 62 6931

#### SYDNEY

Vicom International Pty. Ltd.,  
6th Floor,  
118 Alfred Street,  
MILSONS POINT, NSW  
PHONE: (02) 436 276

#### WELLINGTON, NEW ZEALAND

Malvicom,  
18 Raroa Road,  
Lower Hutt,  
NEW ZEALAND  
PHONE: (4) 69 7625

**DEALER ENQUIRIES INVITED!**





# a word from your EDITOR

Amateur Radio is now half way through the year. The magazine needs many things to keep up the standard. Two very important requirements are advertising and articles.

You can help in making the magazine a success by supporting our advertisers. When you buy equipment say you saw it in Amateur Radio. If you know of any potential advertisers then let Amateur Radio's advertising manager know. Every advertisement helps the production team to put more articles in the magazine.

The other way you can help make Amateur Radio live up to your expectations is to submit articles. Articles are always required. It may be a short article on something you have built or modified right through to a major technical article. Articles on subjects of general interest to amateurs are also welcome.

Photographs are very welcome. They help to illustrate and enliven articles. Photographs of amateurs and amateur radio events are of interest to many readers. Both slides and prints are useable.

With your help the production team can make Amateur Radio even better in the second half of 1983.

*Gil Sones VK3AU*  
Editor

## INTERNATIONAL NEWS



### AMATEUR RADIO SATELLITE SESSION SCHEDULED

The XXXIVth International Astronautical Congress, organized by the International Astronautics Federation and scheduled for Budapest, Hungary, on 9-15 October 1983, will include a technical session devoted to amateur radio satellite systems. Mr Jean Gruau, F8ZS, and Dr Andras Gschwindt, HA5WH, will serve as co-chairmen of the session.

### CHILE: POSTAGE STAMP ISSUED TO COMMEMORATE 60th ANNIVERSARY OF RCC

1982 was a special year for Radio Club de Chile, which was founded on 12 July, 1922. In commemoration of the 60th anniversary of RCC, Empresa de Correos de Chile issued a special postage stamp on 29 December, 1982.

The motif is . . . in the foreground a dove in upward flight; to the left an antenna tower with the logotype of RCC at the upper end; and in the lower corner to the right a fragment of the terrestrial globe. On the lower edge of the stamp are in two lines "RADIO CLUB DE CHILE • 60 AÑOS" and "AL SERVICIO DE LA COMUNIDAD". The stamp price is 7 pesos.

### CANADA: SPECIAL WCY PREFIXES

To commemorate the World Communications Year, Canadian amateurs will be permitted to use the following special prefixes between 17 May and 17 July, 1983.

- CI1 Newfoundland (VO1)
- CI2 Labrador (VO2)
- CK1 Yukon Territory (VY1)
- CY1-8 other provinces (VE1-8)

David Sumner K1ZZ  
AR

## WIA NEWS

### NZART ANNUAL CONFERENCE

*The Annual Conference of the New Zealand Association of Radio Transmitters Incorporated will be held in Dunedin from the 3rd to 6th June, 1983.*

*Whilst the president of NZART, Arthur Godfrey ZLIHV, was in Melbourne to attend the WIA Convention last year, he extended an invitation for the WIA to send two representatives this year.*

*Bruce Bathols VK3UV, President and David Wardlaw VK3ADW will represent the WIA in New Zealand as guests of NZART.*

## WANTED



## CONTRIBUTING EDITORS

Amateur Radio requires a contributing editor for the monthly column "AMSAT Australia".

Also, contributing editors are required for two proposed columns — "SSTV" and "Computer Use in Amateur Radio".

More details are available from: The Editor, PO Box 300, Caulfield South, Vic 3162.

# A Birds Eye View of the 47th WIA Convention

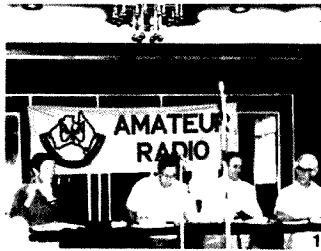

## Brief Report of the 47th WIA Annual Convention

The 47th Annual Convention of the WIA was held over the Anzac Day weekend in Melbourne. Eighteen councillors, alternate councillors and official observers attended the intensive three day, live in session, to discuss policy items and matters of concern to the Australian amateur. The executive and several visitors also attended at various times.

As well as the usual reports of the President, Treasurer and various other sections of our diverse hobby, thirty agenda and general business items were discussed in depth.

Possibly the most intensive discussion centred around the WIA submission to the proposed Radio Communication Bill. It was acknowledged that we are indeed fortunate to be given an opportunity to be able to comment on a Parliamentary Bill prior to having been debated in Parliament itself.

In fact, the very existence of the new Radio Communication Bill would be one of the most important matters to affect the Australian amateur, therefore it was essential that we utilised all available avenues to assist the WIA in its submission.

In this regard we owe a special debt of gratitude to Michael Owen, VK3KI and George Brzostowski, VK1GB for their special expertise and the tireless and much pressured CASPAR committee for their work in gathering information from each division and collating it within the short time constraints imposed upon us. (Refer May AR.)

It is worthy to note here that Dave Shaw VK3DHF/VK0HI was awarded a special certificate of achievement from the VK6 Division acknowledging his efforts and activities during the recent Heard Island Expedition.

At the Official Dinner the convention welcomed Mr John McKendry from DOC in Canberra and Mr Gavin Brain, DOC in Melbourne, as the special invited guests. We were pleased to receive further confirmation that the WIA is held in extremely high regard within the Department of Communications and ministerial areas.

In a light hearted manner the executive presented a special award to Neil Penfold VK6NE, the VK6 Federal Councillor, entitled the ARAORP (Australian Radio Amateur Order of the Raw Prawn) for services rendered to the Executive causing the most heartburn in respect of the Heard Island Expedition. The award consisted of a jam tin mounted on an irregular shaped piece of chipboard with a wooden spoon (for stirring) inserted in the jam tin.

A more detailed report of the convention proceedings will be published in Amateur Radio at a later date.

Bruce Bathols VK3UV  
Federal President

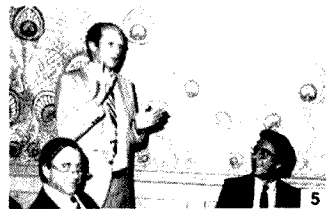
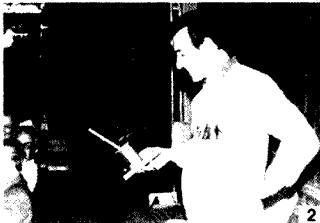

Captions: 1. Members of Executive at Convention Table. 2. Neil Penfold accepts the ARAORP award. 3. Peter Fudge and Courtney Scott. 4. VK5 Councillors. 5. John McKendry, Assistant Secretary — DOC, speaking at Official Dinner. 6. Gavin Brain, Manager Regulatory Branch — DOC and Reg Macey, Secretary/Manager — WIA. 7. Tony Tregale, Alan Foxcroft and Bill Rice at Convention.

# ANOTHER USEFUL MULTIBAND ANTENNA — THE DELTA LOOP

Guy Fletcher VK2BBF

Courtesy QUA (Hornsby & Districts ARC), January '83

*The original idea for this antenna came from RadCom a year or two ago. Having reached Mark 6 in my search for a compact versatile and effective HF antenna, I tested and developed this antenna and have used it happily for about two years now.*

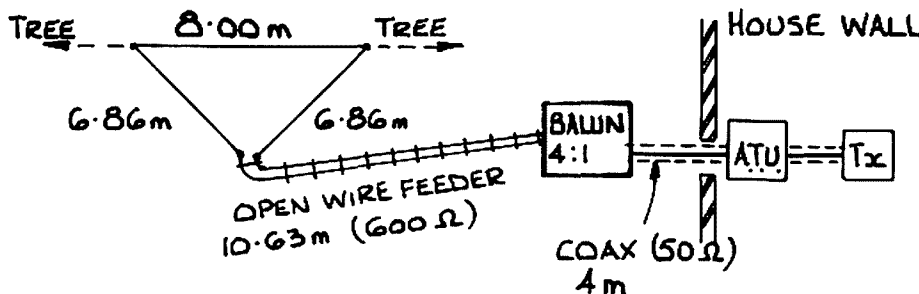

current high-voltage point in the feeder it copes quite well. However the feed impedance at the ATU is still high at maybe 500 ohms and complex (capacitive). The ATU cannot cope alone with this at any settings but with the addition of a simple inductive stub to tune out the capacitance it works fine. This stub consists of a shorted length of 10 m of 50 ohm coax connected directly across the output of the ATU only on the 3.5 MHz band using a coaxial T-connector.

Another alternative frequently suggested for this kind of situation is to tie the two feeder wires together and feed the whole system as a single wire against earth. I have tried numerous antennas fed against earth and found them all very unsatisfactory especially on transmit unless a very good earth system can be devised. I have been unable to make a sufficiently good earth in my location with the result that most of the transmitter output power went into heating the garden. Balanced antenna systems are much superior or you might try the use of counterpoises or equivalent arrangements not fed against earth.

How does it work out in practice? Of course the system will not perform as well as a beam although it does have some directional characteristics. It seems to work well on all bands and perhaps even on 10 MHz. I have no trouble working most stations even into Europe on 21 and 28 MHz and with a little more trouble 14 MHz. The whole antenna incidentally is surrounded by tall trees and high buildings though the take-off west and north is reasonable.

As to its directional characteristics, on 14 MHz it is simply the driven element of a quad antenna, radiating broadside horizontally polarised. On 28 MHz theory suggests that it should radiate best off the ends with vertical polarisation. On 21 MHz off the ends with vertical polarisation and broadside with horizontal polarisation. On 10, 7 and 3.5 MHz it should radiate mostly broadside (horizontal) but a little off the ends (vertical). These calculations were based on the simpler-to-analyse square loop. When I can find time to reprogramme the problem for a triangular loop, I expect to get essentially similar results.

REFERENCES  
1 ARRL Antenna Book.

AR

My restrictions include the need for an unbalanced coaxial feed through a hole in the wall of the house and a maximum length of the antenna top of about 8 m. The open-wire feeder is home-brew using perspex spacers about 10 cm long. The balun is a commercial type. Tests show that the balun is reasonable from 3.5 to 21 MHz, but drops off at 28 MHz in that the transformed feed impedance is rather lower than it should be. The feeder and antenna are made from 16 SWG hard-drawn copper wire.

The resonant length of a full-wave loop in metres is given by:

$$L = \frac{306.3}{f(\text{MHz})} = 21.72 \text{ m at } 14.10 \text{ MHz. (Ref 1)}$$

This is slightly longer than one wavelength which is  $\frac{299.8}{f(\text{MHz})} = 21.26 \text{ m}$ .

The exact lengths of each side of the loop are not critical. I use 8 m for the top and 6.86 m for each side. The open-wire feeder is one half-wavelength long at 14.1 MHz which is 10.63 m.

On 14.1 MHz the feed impedance at the base of the loop is expected to be about 100 ohms (Ref 1). After one half wavelength of open feeder having an SWR of 6:1 but negligible loss the balun transforms this to  $\frac{1}{4} \times 100 = 25 \text{ ohms}$ . A tolerable match with an expected SWR of 2:1 to a short length of 50 ohm coax. The ATU can well cope with this. The measured SWR on the antenna side of the ATU is 1.7:1 but on the transmitter side 1:1.

On 7.05 MHz the loop is only a half-wavelength round and the impedance is high, maybe 2000 ohms, but the open feeder of one quarter-wavelength transforms this down to a low-impedance feed

at the balun. Alternatively the entire loop plus feeder perimeter is 40 m or one wavelength giving a low-impedance feed. Because the loop is smaller in relation to the wavelength at 7 MHz than at 14 MHz the feed impedance will be lower, say 25 ohms. The balun transforms this down to  $\frac{1}{4} \times 25 = 6.25 \text{ ohms}$ . A rather poor match to the 50 ohm coax with an expected SWR of 8:1 but the losses in such a short length are still very small. The measured SWR on the antenna-side of the ATU is actually around 10:1. SWR meters are not at all accurate at such high values. But the ATU copes easily to present 50 ohms to the transmitter.

Again treating the whole 40 m perimeter of the loop plus feeder this total length is 3 wavelengths on 21 MHz and 4 wavelengths on 28 MHz giving low-impedance feeds on both bands at the balun. Probably around 200 ohms and 400 ohms respectively. The balun brings these down to 50 ohms and 100 ohms with expected SWRs of 1:1 and 2:1 respectively on the short length of coax. Measured values 1.3:1 and 2.3:1. Again the ATU fixes these to exactly 50 ohms for the transmitter.

Finally on 3.5 MHz the loop plus feeder perimeter is one half wavelength, and the balun sees a very high impedance, probably about 4000 ohms. Even when this is reduced by the balun to  $\frac{1}{4} \times 4000 = 1000 \text{ ohms}$  this impedance is not very satisfactory for the coax with an SWR of 20:1. This difficulty could be solved by opening a link in the centre of the antenna top which would restore low feed impedance but this is not physically convenient nor would it radiate well. In fact,

though the balun has too few turns for such a high impedance at 3.5 MHz and too low a voltage rating to be used at a low-

# AMATEUR TELEVISION GOES BUSH

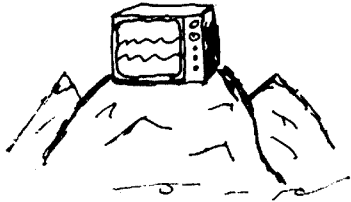

Dick Robbins VK3ARR/W8VNE  
PO Box 5, Altona North, Vic. 3025

Bill Magnusson, VK3JT, is quite a bush man and is often looking for venues for taking his students canoeing or for good VHF locations. About five years ago, when I was getting interested in 426 MHz TV, Bill suggested a spot in the Eastern Alps and I went along, taking a yogi, TV transmitter with a free running oscillator on 426, and a "cheapo" camera. Thus began the "Annual ATV Bush Expedition".



Received picture from VK3ZSD in Geelong, a distance of 200 km.

Although only a week-long expedition, we tried numerous locations and eventually realised, by some strenuous map work, that when we were in line with the Yarra Valley we had an excellent path for UHF communications back to Melbourne.

On the first expedition, the TV contacts were as primitive as imaginable. One night a QSO with Les Jenkins, VK3ZBJ, at Frankston we used a hurricane lantern for light, and Bill's black dog was no help for photogenics. A 12V fluorescent light has become part of more recent ventures and



Constructing the 2 m Quad are Damian Smith, George Bollas, VK3LA and Greg Oddo.

even a cheap B/W portapack was helpful in providing day time recording, and then the evening broadcasts didn't require any lighting.



Erecting the 23 element, 426 MHz quad.



Upscope — 426 MHz quad.

The year for bigger and better antennas became the fad which keeps motivating expeditions. The phased array 2.5 metres square, although an inconvenient size, gave us the biggest thrill — a three hour contact — and points for the Ross Hull Contest for Ray Naughton, VK3ATN, at Birchip. This 360 km contact, with a picture quality of 2 to 3, ran for three hours and began at 10.00 AM, and Ray was using only a basic converter. The confidence builder was all the regular contacts of 160 km (100 miles) with western suburbs stations — Phil VK3AWG, George VK3LA, Cole VK3 and the ATV core people, Ron VK3AHJ, Ian VK3ATY and Ian VK3ALZ. Sylvester VK3ZSD at Geelong, nearly 200 km distance, was an encouraging regular with often breathtaking results.



John McGibbon, Bill VK3JT, Huntly VK3ZE and Steve VK3YMY 40 km from nearest town.

The 1982 expedition expected visitors — a group walking the Alpine Walking Track. These dedicated walkers, mostly from the Frankston area, were provided with a chance to talk with their loved ones and friends. With everyone there, the population grew to eighteen and the track's campsite provided their last "refuelling stop". What a delightful symbol the camp fire provided that night. One of the walkers retorted that

## THUMBNAIL SKETCHES

Peter Brown VK4PJ  
16 Bede Street, Balmoral, Qld 4171

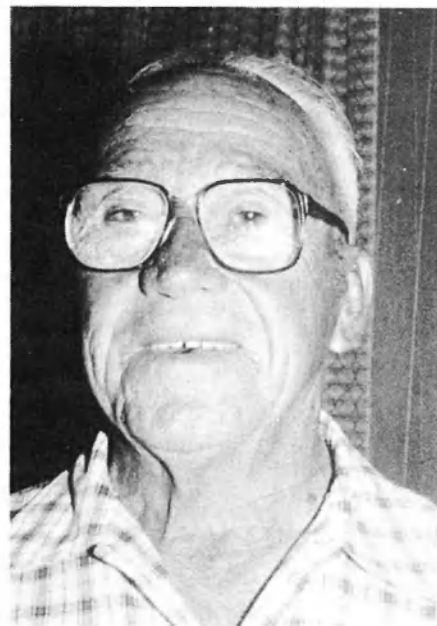

**A T Bauer. 4AT, 1927.**

Alf was operating 4QG, Brisbane, on top of the old State Government Insurance Building, from the time of the high power installation to the "take over" by the ABC.

Later joining G J Grice, he was radio servicing in Cairns for some years. At that time he had a permit and broadcasted several hours daily, using the firm's record library. The only publicity allowed was "owned and operated by A T Bauer, C/o G J Grice Ltd, Shield St, Cairns".

During the war Alf was a technical Radar Officer when such was security that all instruction books were burned after courses.

Later Alf joined DCA maintenance, then OIC Radio Workshops and Test Equipment pool, then retired OIC Materials Inspection Section all of which Alf enjoyed because of the interesting equipment involved.

In his active amateur days Alf and 4HG would go to Bribie Is with guitars and a bank of accumulators, supplied by Willard Motors, and play to the boys at Wheeler Field, Hawaii.

Alf is proud of copying Kingsford Smith, during his Pacific flight, from 4QG which was radiating 5 kW, through all the harmonics. Later Alf went to Eagle Farm with transmitting gear to broadcast the arrival.

Alf remembers when broadcasting a Dame Nellie Melba concert from the Museum Building he was asked to walk Dame Nellie to the mike. This was the only broadcast in Australia.

Alf's main retirement hobbies are bowls and gardening.

AR



**PERCY WOOD VK4RO 1930**

Yes Percy commenced experimenting with radio when he was but nine years old in 1918 and his father obtained an experimenters licence from "Mr J. Malone . . . Melbourne" not long afterwards in 1919.

In 1922 Perc would travel by train from Ipswich to buy parts from Price's Brisbane store but he avers that Homecrafts in Melbourne was the place to buy.

In his younger days he had a very free run of workshops and could actively experiment in radio and his broadcasts and aeriels brought support from interested people in the form of books, parts and gramophone records.

Early in life Perc began his own radio and electrical business and Perc can tell of operating 4PW from City Chambers, in Ipswich, and using the Central Hotel lounge for live performances, one of which brought "Smith's Weekly" reporters from Sydney for three quarters of a page including photos. Also a concert broadcast from the North Star hotel must have been one of the few occasions, in those days, when a rented PMG line was used for amateur radio.

Most of those performances were for charity especially during the depression years.

Fortunately Perc likes writing, as may be shown by articles in "Queensland Times", and he will be compiling notes on amateur radio as he knew it many years ago. These notes will be well worth reading.

Perc not only keeps his "hand in" restoring old radio sets but has a fine workshop where he constructs working models of steam engines.

Still a keen golfer he won the Eric Scott cup in 1967 and twice won the Ipswich (UK) silver cup which is another story.

A proud achievement was a two way contact with Commander Byrd's second expedition, WFA, in the 1930s.

In retirement Perc overlooks the most popular series of beaches in Australia.

AR



**Bill VK3JT, Steve VK3YMY, John McGibbon and Huntly VK3ZE resting on their laurels.**

he always had a negative reaction to aeriels, but seeing ours on this event was a most welcome sight.

The 1983 expedition is looking for more of the usual fun well into the Alps, but in line with the Yarra Valley. 426 MHz is on again. Very long quad yagis are the antenna extravaganza for the 70 cm and 2 m bands — extravagantly 6 and 4 metres in length. I am currently using both of these aeriels and I would be pleased to demonstrate them if called on 147.80 MHz most evenings.



**Method of transport for "The Flying Bedstead".**

How about a challenge in the spirit of good fun and real amateur radio? How about you taking some simple 426 MHz TV gear, even if only an aerial, TV set, and find a spot out in Western Victoria, and let's give it a go? Did you give yourself an early Christmas present? Yes, did you invest in the finest preamp there is? One of those 432 MHz GaAs FET's that Ian, VK3ATY, and Howard VK3ZJY, are selling at a bargain. This will be a respectable opportunity for you to prove to yourself that, with reasonable equipment (even without a GaAs FET) 250 km is a very respectable distance for 70 cm communications without a lot of hard work. Why not give your receive system a big ego trip this year. After all, 12V converter, 12V TV set, 12V preamp and 12V car battery are a great combination.

Let us hear from you on 147.80 MHz and give us the opportunity to send you a picture and even receive one from you.

# To Heard and Back

Dave Shaw VK3DHF/VK0HI,  
9 Milton Street, Heathmont 3135

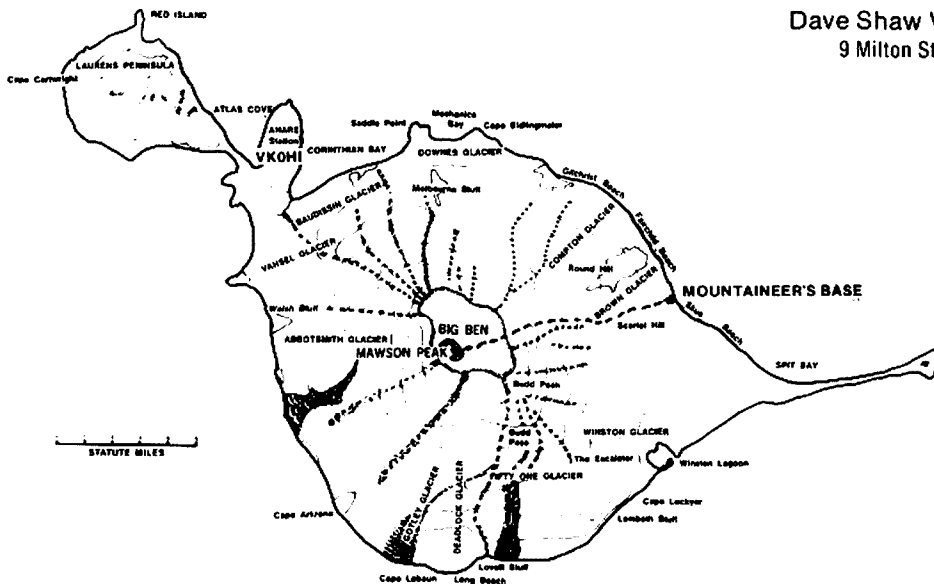

Story so far:

*On 31st December 1982 the Anaconda II set sail from Perth — destination Heard Island. All on board did shifts of sailing the yacht and many lessons were rapidly learnt.*

*Eighteen days out from Perth they anchored at Kerguelen Island for a few days break. Whist there, the radio ops had the opportunity of using Michel's, FB8XAB Station to get a little practice for the onslaught once on Heard.*

*A couple more days sailing saw our intrepid venturers arriving at Atlas Cove. HI.*

Now read on:

Even though we arrived in the early evening with the sun just setting, three of the mountaineers managed to get ashore in the failing light. The next day, which couldn't come soon enough for us all, saw a hive of activity on the boat, in fact during the night there was no shortage of people for the anchor watch.

Al and I were in the third load ashore. The conditions at Atlas Cove were perfect with very little swell or wind to worry us. First ashore came the food and bedding for us for the next month, then the transceivers and other electronic equipment. A quick break for lunch and then back to the beach for the two large drums of diesel fuel and the two 3 kVA generators.

The old ANARE base at Atlas Cove is in various stages of disrepair, only three French ARBEC huts from the joint Australian French expedition in the 1970s, are in good condition.



**The abandoned ANARE base.**

The base was originally established in 1947 and permanently inhabited until 1955 when the Australian government abandoned it to concentrate on its bases on the Antarctic continent. The records of the island indicate that up until the early sixties, the base was in good condition but the ravages of the weather in those latitudes have caused considerable deterioration since.

Half of the buildings have no roofs and the blowing volcanic sand is slowly sifting its way into the rest of the buildings. The old sealers stone buildings and equipment from last century have almost completely disappeared. Our shack was about 300 metres from the beach with the rest of the base giving us some sense of protection from the prevailing westerly winds.

We originally located the generators some distance from the operating shack, but after almost stepping on the elephant seals several times, when refuelling the tanks late at night, it was thought prudent that the generators be set up outside the shack.



**An unfriendly elephant seal.**

With the generators running sweetly, the Butternut vertical antenna and an Icom 740 transceiver were unpacked, assembled and tested. We did have a bet with some of the mountain climbers about how long from our first CQ to our first QSO, we lost by ten seconds. The contact took forty seconds to establish and was with Hugh VK6FS, the next contacts followed quickly with Ken VK3AH and then Zedan JY3ZH. It did not take long and the "pile ups" had begun.

While I continued for a while on 20 metre SSB, Al was busy unpacking and establishing the rest of our superbly packed equipment. (This job was to take the next few days, but by the 21st we were on the air in earnest). Al and I took turns at the rig for the rest of the night as after carrying loads up from the beach each day, any rest from operating was very welcome.

The next day saw one of us at the transceivers all the time when the bands were open, with the other helping to get supplies and equipment ashore. The aerials and masts arrived ashore during the morning but did not get up to the shack

until later in the afternoon. With the incessant rain, everything to be landed on the beach from the Anaconda assumed a list of priorities, transceivers being moved straight to the hut, then bedding and food.

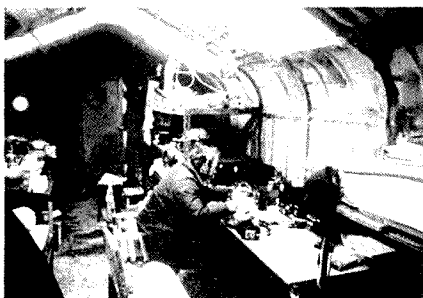

**All operating whilst Dave helps bring more equipment ashore.**

### *Operating routine is established*

Because of the amount of gear on the Anaconda, the arrival of equipment and supplies was at times not in accord with our immediate needs. Those on the vessel however had the job of sorting gear and equipment to stay at Atlas Cove or be taken down the island for the mountain assault.

With the typed waterproof check list prepared by the VK6 DXCC group and constant communications with the boat, by the end of the day everything to assure a successful expedition had been delivered ashore.

By now we had some 3000 contacts in the logs and were both keen to see the beam erected. Although without a beam we had established our operating routine to fit the conditions. North America opened between four and six o'clock in the morning (2300 and 0100 UTC) to drop out at about 1100 local (0600 UTC). Then there was a quiet period until our sched with the VK6s and the rest of those amateurs involved

across Australia at 1030 UTC. After reporting progress, the band was generally open to Japan and Australia then until about midnight (1900 UTC) we worked into Europe. Most of the operating was concentrated on 20 metres as 15 metres opened only occasionally with ten being even less useful.

During our first three days assembly of the station and our living quarters was our prime concern. The third day saw the assembly of our triband three element Wilson System 3 beam. This had been specially strengthened by Don VK6DY so that it would survive the rigors on Heard. The beam and the mast, came with extensive instructions, with everything being ready to erect in about three hours.

We grabbed every person on the island to assist. Personal opinion is that it was the excess of willing hands which saw the tower neatly bend almost in two at our first attempt at its erection.

The mast was quickly straightened and strengthened with scrap steel sections found around the island within the hour. The second attempt saw our beam standing erect with no apparent ill effects from being bent.

### *Dogpiles prove indeed to be just that*

The mast used, a Hills telemast, was steel guyed to teflon bearings at the top and halfway up. The rotator was located at the base and beam and mast rotated simultaneously. This system reduced the weight and wind loading to add to its reliability.

With our main aerials now erected, another transceiver was unpacked and all other work except eating was discontinued while propagation was open.

The "dogpiles" were indeed that and in those first hectic days it was not uncommon to have 60 to 70 kHz of twenty metres taken with people calling us and still only to have a contact a minute by deciphering two letters of a call.



**Amid the dogpile.**

The assembly of our whole station continued over the next week. When complete we were equipped with:

- 1 IC740 with inbuilt keyer for CW.
- 1 IC730 for SSB.
- 1 IC720A as backup on battery and also for checking propagation.
- 1 TS660 for listening on 10 and 6 metres.
- 1 FT680 for transmission on 6 metres.
- 2 LA1000 linear amplifiers and one 6 metre 100 W linear amplifier.
- 1 Rotatable Wilson System III Beam (strengthened).
- 1 20 to 10 metre log periodic beaming on Europe.
- 2 Vertical antennas.
- 2 Daiwa antenna tuners.
- 2 Dipoles (one each on 40 and 80 metres).
- 2 3 kVA Dunlite generating sets.

Three IC730s were kept in reserve and fortunately were never needed. This equipment was all new and had been soak tested by the DX group prior to departure. Most of our equipment was purchased with money donated from the various WIA divisions with the equipment to be returned to them after the completion of the trip, although some was bought by the VK6 DXCC to be resold on return.

After seeing our beam and equipment brought up and assembled the mountaineers departed for their objectives on the island. The first of these was a planned landing on McDonald Islands, which were adjacent to our base island. Unfortunately conditions did not allow this. The next day saw their landing on Shag Rock. This was the first ever landing on this outcrop and was appropriately done on Australia Day the 26th January.

They then moved onto Skua Beach, their permanent base camp for the future assault on Big Ben. The weather was again favourable and by that night the Anaconda was at anchor in Atlas Cove.



**Everyone helped to erect the antennas.**



**The base at Skau Beach.**



The "antenna farm" on Heard Island. The 6 m beam has an American and an Australian flag flying below it.

As the mountaineers ascended the mountain, Al and I worked steadily at achieving as many contacts as possible for our time on the island. We did not have much time for looking about or appreciating the island, but when going out to fill the generator on our first day and seeing the mountain, it was hard to get back to the transceivers.

The 3000 metre snow and ice covered volcanic mountain Big Ben, dominates the whole island, with its many glaciers flowing down to the sea. The only flat land is the narrow strip around the coast where old receded glaciers have been and around the Laurens Peninsula.

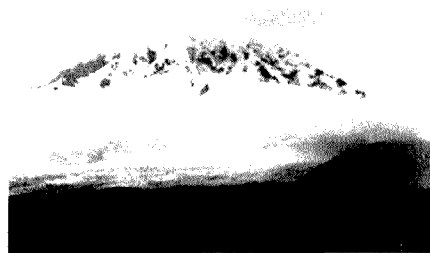

The dominant Big Ben.

At the end of fifteen days we had made approximately eighteen thousand contacts and were looking forward to a very successful DXpedition, Murphy or rather the sun's indifference took hand however with a complete blackout. Conditions were never to pick up again to the standard they were in the first few days.

This gave us a chance to see some of the

island and during the next couple of days we managed to see and photograph this isolated area. The island abounds in wildlife and a short walk from our hut were large numbers of elephant, fur and leopard seals. While around the coast there are rookeries of several penguin species. As the wildlife is unused to seeing humans they have no fear of us and walking through them is an experience that we felt privileged to experience.



Some very friendly wild life.

The Anaconda now departed to the safety of the harbour at Kerguelen Island and Al and myself were left to await the arrival of the Cheynes II. They arrived on the 6th February with objectives similar to our own. Aboard were mountaineers, scientists and their own amateur radio group.

Their amateurs set up approximately 400 metres from us in one of the ARBEC huts and soon more aeriels were sprouting on the island. The scientists set up on the other unoccupied ARBEC hut about ten metres from us and once again the base was a hive of activity.

Because of the solar activity our contact rate dropped to about a quarter or half of that when we first activated the island. At night we were greeted with the magnificent

Photograph by W. Blunt

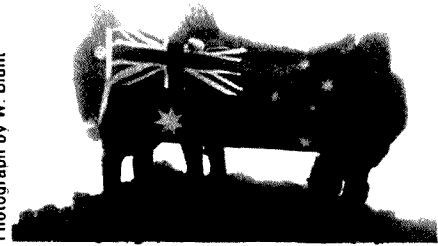

The mountaineers attain their goal.

light show of the Aurora Australis.

While we were enjoying a slight respite from our activities and dining out with the scientists and crew of the Cheynes II, our mountaineers were steadily progressing to the top of Big Ben, much scientific work being done on the way. They established their final route to the top on the 7th of February and on the day of the 9th for only the second time in history was Big Ben conquered, the first time was in 1964 when the Patenalla expedition successfully ascended, this the highest mountain in Australia and its dependencies. Heard is a volcanic island and has magnificent views from the top of the mountain. The top is mushroom shaped with swirling hot air from volcanic vents melting snow around the cap of Mawson's Peak.

### *Anaconda returns from a heat wave at Kerguelen*

Five people in all reached the top, two on the first day and three on the second then unfortunately the weather turned too warm and the climbers had to descend. The warm weather caused the snow across the mountain to wash away leaving the heavily crevassed ice slopes unsuitable and unsafe for climbing. This stopped the Austrian mountaineers from the Cheynes II reaching their goal.

The 10th February saw the return of the Anaconda from Kerguelen, where they had enjoyed a relative heat wave of 20C for their stay. Kerguelen is a sub-Antarctic island above the convergence which separates the warmer Indian Ocean from the Antarctic. Heard however is an Antarctic Island and its temperature hovers around 4C, although one day our temperature reached 10C. We were equipped with modern sleeping bags and electric blankets to brave the cold. With a couple of kerosene heaters gathered from around the base, moderate cooking, sleeping and waking conditions were achieved. We were quite comfortable.

We had all been warned of the extreme weather conditions we would be certain to encounter and these finally arrived on the 15th February. Strong winds swept across the cove and these combined with the willy-willys swirling off the glaciers caused the crews of both the Anaconda and Cheynes a few worrying moments. Our three element beam "bit the dust" in the afternoon closely followed by the vertical twenty minutes later. The beam had been steel guyed at the top and also half way up but non of these guys broke, rather it was



the twisting motion of the wind that brought them to grief.



**Bent and twisted antennas after strong winds.**

As the log periodic had already been taken down the only aerials left standing were the dipoles and the 6 metre Werner Wulf beam with the Australian and American flags flying beneath it.

As the Cheynes was leaving the next day with no sign of the weather improving, our captain radioed to enlist the aid of their small boat and we could leave also. We managed to get most of our equipment off with their help. Our two inflatable rubber boats were still at Skua Beach with the mountaineers.

Unfortunately, the Cheynes small boat broke free as they departed Atlas Cove in the evening and they asked us to help pick up their mountaineers awaiting at the beach further down the island.



Photograph by R. Vining

**Austrian mountaineers are returned to Cheynes by rubber boat.**

The next day we were greeted by our mountaineers coming around the island in the rubber boats and another couple of hours saw the Austrian mountaineers safely aboard Cheynes and their departure from the island with a jury rigged sail.

We then headed to Skua Beach to load the mountaineers equipment. As there were still some scientific studies to be completed three people were left at Skua Beach whilst the rest returned to Atlas Cove.

We spent another three days at Atlas Cove using a transceiver with batteries and the straightened driven element from the three element beam and we managed to increase our number of contacts to thirty thousand for the expedition. The operating time was interspersed with helping the scientists take penguin blood and other samples from the cove.

On the 21st February we finally departed Atlas Cove for good with the satisfying knowledge that we had alleviated the need for Heard VK0, and feeling elated to have worked two American stations using only one watt.

After picking up the rest of the party from Skua Beach all sails were set for home. Turning with the wind on the Anaconda we covered about 240 nautical miles a day for the first week and passed the Cheynes in full sail on the third night out.

### *Two helicopters greet us in the Gulf*

It was still cold on deck but with the wind behind us on our way home no-one seemed to notice the chill too much. After about two weeks we sailed into Port Adelaide after just under three months away from the Australian mainland.



Photograph by Neil Pentfold

**A warm welcome awaits Anaconda as she sails into the Port of Adelaide.**

Our arrival in Adelaide was like a Royal welcome with two helicopters to greet us in the Gulf and a crowd to greet us on the wharf. It was a great surprise to find fresh fruit, ice cream and of course plenty of beer waiting for us, as these had been in short supply on the island.

An afternoon at Ian VK5QX's QTH and later at night seeing Adelaide was a welcome relief from being on the boat, with the abundance of fresh food and drink and then being able to sleep without being woken to do a watch. The next day it was back to the boat for unpacking and cleaning, then the adventure was just about over.

Neil VK6NE, his son Vaughn and Nano VK6UN had driven over from Perth to welcome us back and they had done most of the unpacking and loading before Al and I got back to the boat.

That evening after the boat had been scrubbed clean there was a mayoral reception at the Port Adelaide Town Hall which was a fitting end to a successful

expedition and one which we were all honoured to attend.

After achieving most of the aims we set out to do I would like to thank all who contributed to the expedition as without the assistance of the associate members, the dedication of the organisers and the plain hard work of many the trip could not have been the success it was.

No article would be complete without a list of the crew of the Anaconda II, the mountaineering expeditioners and the members of the VK6 DXCC who were part of the many amateurs world wide that assisted us to achieve our goal.

The Anaconda crew comprised of Josko Grubic (Owner and Captain), Ian Grey, John Clancy, Ian Howden, Dave Fields and Kevin Fitzgerald.

The expeditioners were Bill Blunt, Ross Vining, Meg Thornton, Martin Hendy, Jonathon Chester, Alistair McGregor, Michael Golding, Rob Easter, Pauline English, Steve Tremont, Robert Hawkins, Bill Meachem, Al Fisher VK6AH1/K8CW/VK0CW and Dave Shaw VK3DHF/VK0HI.

The VK6 DX Chasers Club members include Don Reimann VK6DY, Hugh Spence VK6FS, Neil Penfold VK6NE, Nano Boegheim VK6UN, Nick Nicholls VK6XI and Gill Weaver VK6YL.



**Antarctic inhabitant.**



**ANARE base.**

Photography unless noted by Dave Shaw VK3DHF.

© This article may not be printed in part or whole without the prior written permission of the Editor of Amateur Radio.

## **HI COMPETITION WINNER**

**ALAN STEPHENSON,**  
15 Bullsgarden Road,  
Whitebridge, NSW, 2290

# MODERN MILITARY SURPLUS EQUIPMENT



Colin MacKinnon, VK2DYM

PO Box 21, Pennant Hills, NSW, 2120

## Wireless Set B47

*The B47 is a low power FM transceiver, VFO tuned in one range from 38 to 56 MHz. It was intended for short range communications with infantry who would be carrying a man-pack radio such as the AN/PRC10.*



### SPECIFICATIONS

Power requirements:  
24V DC at 2.5 amps  
Frequency Coverage:  
38 to 56 MHz  
Mode of Operation:  
Transmission and reception of FM  
Transmitter — power output  
LP (low power) — approx 20 MW  
HP (high power) — approx 600 MW  
— Deviation  
4.5 kHz for 20mV to mic input  
7 kHz for input of 20 mV to 200 mV to mic input  
Microphone: 600 ohms  
Receiver-Sensitivity:  
1.25 microvolts for 10 dB quieting  
Selectivity:  
— 70 kHz at 3 dB  
— 260 kHz at 60 dB  
Antenna:  
75 ohm via a co-axial plug  
IF Frequency: 4.3 MHz  
Dial calibration:  
100 kHz per division  
AF output:  
150mW into 50 ohms  
Weight: Approx 15 kg

### VALVE LINE UP:

Serial No.	Type	Function	Equivalent
V1	CV4010, CV850	1st RF amp	6AK5, EF95
V2	CV4010, CV850	2nd RF amp	6AK5, EF95
V3	CV4015, CV131	Local oscillator	6065, EF92
V4	CV4010, CV850	1st IF amp	6AK5, EF95
V5	CV4010, CV850	Limiter	6AK5, EF95
V6	CV469	Discriminator diode	EA76
V7	CV1833	Neon voltage stabiliser	0B2
V8	CV4010, CV850	Reactor driver	6AK5, EF95
V9	CV4040, CV416	Oscillator/power amp.	6F17
V10	CV469	Discriminator diode	EA76
V201	CV4010, CV850	2nd IF amp	6AK5, EF95
V202	CV4010, CV850	3rd IF amp	6AK5, EF95
V203	CV4010, CV850	Receiver Limiter	6AK5, EF95
V204	CV469	Receiver discriminator	EA76
V205	CV469	Receiver discriminator	EA76
V301	CV4010, CV850	AF amp/squelch driver	6AK5, EF95
V302	CV4010, CV850	AF output	6AK5, EF95
V303	CV4010, CV850	Noise amp and filter	6AK5, EF95
V304	CV469	Squelch rectifier	EA76
V305	CV4015, CV131	Mic amp	6065, EF92
V306	CV469	AMC rectifier	EA76
V401	CV2213	Dial light neon	Not known
V402	CV2213	Dial light neon	Not known
V403	CV4010, CV850	Calibrator oscillator	6AK5, EF95
MR1	CV425	Crystal mixer	0A74

The serial numbers of the valves indicate the chassis sub-unit on which they are fitted and these references are carried through for all components.

1 to 199 RF sub unit eg R113  
201 to 299 IF sub unit eg R213  
301 to 399 AF sub unit  
401 to 499 Calibrator and centre frame unit  
501 to 599 Power Supply Unit

### PRINCIPLE OF OPERATION

Receive RF signals feed through tuned circuits to two RF stages V1 and V2 and then to the crystal mixer MR1. The local oscillator V3 operating between 42.3 and 60.3 MHz also feeds to MR1. The resultant 4.3MHz frequency goes through three stages of IF amplification V4, V201, and V202 to the limiter V203. The limiter output goes to a discriminator V204, V205, then to a filter network which produces AF, noise at 10 kHz and a DC voltage. The AF is fed to AF amplifiers V301 and V302 then to the output transformer.

The noise output is fed into a noise amp V303 and the output rectified by the squelch rectifier V304. The DC signal from V304 is fed

as bias to V301, the first AF amp, which also acts as a control for the squelch relay RLA/1. A front panel control sets the squelch level.

## TRANSMIT

V9 is a master oscillator power amplifier, MOPA, tuned over 38 to 56 MHz and frequency modulated by a ferrite reactor in the plate circuit of the reactor driver V8. A neon stabiliser V7 maintains frequency stability despite variations in supply voltage.

Input to V8 consists of DC from the Automatic Frequency Control, AFC, system, plus AF from the microphone amp V305 and AF negative feedback. The AFC is derived from stray transmit signal which gets into the receiver, and thence to the narrow discriminator V204, V205 and to the sidechain wide discriminator network-V5, the AFC limiter, which receives 4.3 MHz signal from V4 into V6, V10 the discriminator.

Automatic modulation control AMC is obtained by rectifying the sidetone signal from the receiver in V306 and using this as bias to the mic amp V305.

On low power resistance is simply switched into the aerial line to dissipate some of the transmit signal.

The calibration oscillator V403 switches a 1 MHz crystal in the Cursor Adjust switch position and a 100 kHz crystal in the Channel Adjust position.

## POWER SUPPLY

The PSU is built into the rear of the case and uses a self-rectifying vibrator and a transformer and thence to a filter network.

Voltages required in the set are:

HT: +175 VDC at about 80 mA

Filaments: 6.3 VAC at about 3.5 A

Mic Amp: +6.3 VDC at about 200mA

On/Off Lamp: 12 VDC at about 100 mA

Relay Supply: 12 VDC at about 140 mA

AFC diode heaters: 12 VDC at about 140 mA

The DC voltages for the mic amp heater, lamp and relays are obtained by dropping resistors on the 24 VDC input line.

The voltage adjusting relay RLD/2 shorts out series resistance if the input voltage drops.

There is a start up circuit to prevent excessive arcing of vibrator contacts upon first switching on. A starting resistance is shorted out by RLE/2 when the voltage across a capacitor C521 is sufficient after about 1 second.

## FRONT PANEL INTERCONNECTION PLUG — SKT405

The pin connections are:

A — microphone input

B — microphone input shield

C — no connection

D — Press to talk switch

E — Rebroadcast earth

F — 24V DC switched output

G — Audio output

H — Limiter grid current (S-meter output)

J — No connection

K — Voltage control relay

L — No connection

M — Audio output

## FRONT PANEL POWER SOCKET — SKT403

A — + 24 VDC

B — Earth

## MODIFICATIONS

- To operate the B47 make the following connections:  
75 ohm co-ax to the aerial socket  
+24 VDC to pin A of the Power Socket  
Earth to pin B of the Power Socket



The authors B47 with outboard amp and SWR unit.

If you obtained a Power Lead this is simple.

600 ohm microphone to pin A of interconnection plug

600 ohm microphone shield to pin B of interconnection plug

Pin C to earth internally to a convenient earth tag

one side of a PTT switch to C the other side of the PTT switch to D headphones or a speaker to pins G and M

S — meter to pin H

S — meter return to pin C

Pin K to Pin C if input voltage is less than 30V

- As with the R210 there is room to remove the interconnection plug altogether and fit an aluminium plate across the hole. Into this plate mount a 4 pin microphone socket eg Dick Smith P-1824, and an earphone socket eg P-1231 for your speaker, and a sub-mini socket eg P-1220 for your S-meter connection.

*If you don't wish to alter any of the sets described in this series, then obtain an A or B harness and one of the control boxes, such as a J Box. Remove the 12 pin plug from the control box and fit it on to a small box into which you can mount the mike, speaker and S meter sockets and wiring etc. Connect your new control box to the set via the harness. Ensure that you retain the same wire relationship ie Pin A to socket hole A, B to B etc.*

- A 0-1 mA meter in an external box with a suitable trimmer pot in series can be connected to pins H and C earth as an S-meter. Adjust the pot so the strongest signal is at FSD and then other signals are just relative.
- Audio output level is set by RV301, a pre-set pot on the rear of the AF chassis. It has a locknut and is sealed with paint and is very fragile so be careful when adjusting it for comfortable speaker volume.
- You will probably find that as the set warms up you have to keep re-adjusting the front panel squelch and if you run out of adjustment you need to re-adjust RV302 next to RV301.
- The Aerial Tuning Unit ATU No 8 was used to match to an 8 foot rod antenna but it is useful to match the 75 ohm output to 50 ohms. Rotate the antenna tuning knob for maximum reading on the tuning meter.
- Power output of 0.5 watts into 50 ohms is adequate for local contacts but for more power you can add an external amplifier with a carrier operated Tx/Rx

relay. The B47 is very compact so the following modifications are difficult. They have all been carried out but you will have to judge whether they are worth the effort in your case.

Para 7B — Connect pin 13 to pin 6 on TS402, or alternatively pin 23 to pin 18 on SKT401. This connects the centre zero tuning meter on receive & transmit as well as during calibration and will allow you to tune in a received signal exactly. One word of caution, if when you transmit the meter needle moves off centre don't change the tuning or you and your contact will be chasing each other up and down the band trying to net. Instead, adjust trimmer capacitor C80 to bring your transmit frequency to centre zero so that it will be the same as the receive frequency.

- The tuning meter is not easy to see as it has a black face and dirty grey pointer. It is possible to remove the front panel and move it forward sufficiently to remove the meter. The meter scale can be removed and painted white and the pointer black. Be very careful with the meter glass as it cracks easily (I found out the hard way!)
- At the same time the HT power to the dial lights can be moved from pin 1 of the calibrator terminal strip TS403 to pin 2 of the terminal strip TS402, so they are on all the time.
- Strip out everything from the power supply, except the choke and smoothing capacitors and the socket that mates with the set. Fit a compact 240V transformer with suitable secondary voltages. Use silicon rectifier diodes for the HT and the mic amp filament voltages. I thought of switching the 240V from the front panel but decided it could create problems and be dangerous.
- Replace the squelch pot with a dual concentric of suitable values and use one section as an audio control. Delete RV301 and run shielded wire to the connecting points.
- Remove the front panel! Remove the ON/OFF switch and the power ON light. Make a rectangular cut-out to fit an edge-reading S-meter. Fit a sub-miniature ON/OFF switch and if you wish, an LED power indicator.
- Whilst the front panel is off, cut off the protruding aluminium surround and handles and file the panel smooth. This gives a bit more access to the controls. Paint in your favourite colour.

# HOW DANGEROUS IS RF RADIATION?

## — Part Three

*In this our third and final article of possible RF radiation hazards, the matter of Microwave RF hazards is discussed. The article was first published in Radio Communication, April 1982.*

*We trust that all WIA members have gained a little further information from this series of articles, and we invite your comments either by letter to the editor or direct to your division. —*

### **MICROWAVE RF HAZARDS**

By D. S. Evans, PhD, BSc, FIM, G3RPE\*  
RSGB microwave manager

Reproduced from Radio Communication April 1982

An earlier article<sup>1</sup> introduced the general topic of the safety or otherwise of RF sources such as transmitters. It was pointed out that a hazard could exist if parts of the body absorbed sufficiently large amounts of RF energy to cause overheating. By the very nature of the hazard, it is impossible to specify any absolutely safe or unsafe level of RF power with any precision. However, the main conclusion of the article referred to (as well as others of a similar nature) is that with typical amateur HF and VHF stations where the antennas are mounted well above ground level, the measured RF levels at points of close access generally are at least 100-fold down and up to several orders of magnitude lower than the standard "safe" level of 10 mW/cm<sup>2</sup> even when using full legal power. In these practical cases, therefore, there clearly are few problems, and even arguments about what constitutes a "safe" level become somewhat academic.

However, the RF level associated with even relatively low-power transmitters can increase to an unacceptably high level as one gets close to them, and the article emphasised the care that must be taken in testing equipment on the bench with covers removed or with unscreened dummy loads. Handy-talkies, especially those using "rubber duck" antennas, may represent a hazard if their power output exceeds a few watts.

While the same basic principles regarding RF hazards apply also in the microwave area, there are significant differences compared with lower frequencies. For example, microwave equipment is more often operated near ground level for various reasons; there is more experimental development of equipment; and, for a given transmitter power, the RF power density close to the antenna will tend to increase with frequency. For these and other considerations, the topic of RF hazards at microwaves is best dealt with separately and in perhaps more detail than at HF and VHF.

Anyone involved in safety matters, whatever the area, will be well aware how difficult it is to maintain a sense of perspective. The illogicality of many safety procedures bears testimony to this. It is all too easy to "play safe" and lay down over-restrictive rules which, at best, simply inhibit activity and, at worst, become discredited and then ignored. The objective of this article is to attempt to develop a code of practice appropriate for day-by-day use by amateurs which will reduce to a minimum the risk involved to operators and bystanders. This code is summarised below. It is followed by an outline of the nature of the hazard, and the technical background employed in developing the code.

#### **SAFE GENERATING PRACTICES WITH MICROWAVE EQUIPMENT**

It is easy to demonstrate that the maximum RF power density associated with amateur microwave equipment will almost always be significantly lower than 10 mW/cm<sup>2</sup> at even a short distance away from the antenna. Indeed, it would be rather difficult to produce a practical system in which this level was exceeded at any distance. In any case, equipment parameters can be specified to ensure that it does not. However, where the effective aperture of a system carrying RF is small, eg the open end of waveguide and in

feeds for dishes, the density can be very high and at a hazardous level. Thus for practical systems amateur microwave equipment will almost always be safe at almost any distance outside the structure of the antenna, and almost always will present a hazard within the structure, eg between the feed and a dish or inside a horn antenna. Therefore the only real risk is to operators and others who have access within a very short distance of these components.

The following is an attempt to define a code of practice for the safe handling of microwave equipment in an amateur

context.

1. It must be recognised that a potential hazard exists wherever equipment having a small effective aperture — such as the open end of waveguide and coaxial cable, horn and rod feeds — carries RF above a level ranging from 1 mW at 24 GHz to a few hundred milliwatts at 1.3 GHz. As a guide, the input power should not exceed 2.5 mW/cm<sup>2</sup> of area of the aperture if the maximum RF power density is not to exceed 10 mW/cm<sup>2</sup>.
2. For these small apertures, the maximum RF density is reached at a distance

typically  $\lambda/10$  to  $1\lambda$  from the aperture and falls rapidly by a factor of 100 at a distance of  $1-10\lambda$ : the potential hazard therefore exists over a short range only.

3. When working in close proximity to equipment, it is highly desirable to reduce power levels to below those given in 1. Where this is not possible, it is essential to dissipate the power in a screened load.
4. One golden rule should be to ensure *no* RF is present before looking down waveguide, because of the special vulnerability of the eye.
5. With high-power equipment, a hazard may exist through leakage of RF from loosely-coupled connectors and waveguide flanges, and from the coupled output of directional couplers. The power *reflected* from surfaces may exceed a safe level. Clearly, good practice demands care and discipline — and foresight.
6. It is strongly recommended that the RF power fed to a paraboloidal dish reflector should not exceed 2.5 mW of its projected area. This will ensure that the RF power density will nowhere exceed 10 mW/cm<sup>2</sup> except for the region between the feed and the dish. This limit corresponds to approximately 2 W for a dish 0.3 m in diameter, and 80 W for a dish 2 m in diameter, and therefore is unlikely to present any practical limitations to the design of equipment.
7. If the dish is fed using the Cassegrain system, then it is recommended that the power delivered to the antenna should not exceed 25 mW/cm<sup>2</sup> of the area of the *sub-reflector*, or 2.5 mW of that of the main reflector, whichever is the smaller value. In this case the leakage of RF around the sub-reflector should be less than 10 mW/cm<sup>2</sup>.
8. Care must be taken to ensure that the feed is placed in the correct position at the focus of the dish. If further from the dish than this optimum value, an image of the feed will be produced at a finite distance. The RF power density at this point may approach that at the feed and therefore be at an unsafe level. It is clearly good practice to align antennas using powers at the milliwatt levels as given in 1.
9. If the power to an antenna is limited as in 5 and 6, then the RF power density will be at a safe level everywhere other than in the region between the feed and the dish. As the power density at the feed may be very high, it is essential to limit access to this region, especially by those unfamiliar with the hazard. This can be achieved either by restricting access to the site or by raising the antenna so that its height at the centre exceeds 3 m.
10. In the case of horn antennas it is recommended that the power level should be limited to 2.5 mW/cm<sup>2</sup> of the area of the aperture. For most horns this is equivalent to  $2 \times l^2$  where  $l$  is the length of the longest side of the aperture.
11. Higher power densities can of course be tolerated provided the operator of

the equipment ensures that people cannot have access to these regions.

### NATURE OF THE HAZARD

As was pointed out in 1, the hazard associated with high RF levels is completely unconnected with radiation hazards associated with  $\gamma$ - or X-rays for example. It is simply that of heating of parts of the body following absorption of the radiation, and therefore is similar to the hazard of over-exposure to the sun or sitting too near a fire. The effectiveness of this form of heating is well demonstrated by the microwave ovens with which amateurs share the 2.3 GHz band. The main factor affecting the degree of hazard is the power density of the RF intercepted by the body. Convenient units are either watts per square metre or milliwatts per square centimetre. A second factor is the frequency of radiation, which affects the proportion of incident radiation absorbed, the site of its absorption and the power density developed by a transmitter of a given output power. These factors will be discussed below.

The effect of controlled heating can be positively beneficial, as in diathermy treatment, but large doses or even an accumulation of doses can lead to permanent damage to body tissues without a person necessarily being aware at the time that this damage is being done. One of the more vulnerable organs is the eye: the viscous fluid within the eye is affected by heat in much the same way as the white of an egg, which is transparent at room temperature but becomes opaque when warmed. In the eye, as in the egg, the process is irreversible.

Physiological characteristics also affect the degree of hazard. Thus at lower frequencies the intestines tend to be vulnerable because this is the region in which heat is generated and, being not particularly well-endowed with nerves, the effect is not immediately felt. The eye is also vulnerable because it has no bloodstream to assist in dissipating any heat that may be generated, although the same effect will also be observed at extremities such as the fingers. The effect of frequency of the radiation is quite critical. Below about 150 MHz the human body tends to become transparent to RF radiation and therefore there is no real problem. At VHF the radiation penetrates deeply into the body, and the more vulnerable parts are the internal organs. At 1-10 GHz the energy tends to be dissipated in the skin and the organs immediately below the surface: at high power densities there is a sensation of warmth. Above 10 GHz energy is absorbed in the surface layers, although it appears that a high proportion of the incident RF will be reflected.

There is a further effect which relates the absorption with the size of the organ and the wavelength of radiation. Radiation of a given density having a wavelength of 23 cm, for example, will have less effect on the eyes which have dimensions of one or two centimetres than radiation of wavelength of 3 cm, ie 10 GHz.

Another potential influence of frequency is that of affecting the RF power densities likely to be produced in practice. For a

transmitter of given power, the radiation density developed is roughly proportional to frequency. However, the amount of power that can be generated tends to fall by a corresponding amount, and thereby balancing the risk of a hazard.

Frequency is also important in the way it influences the design and use of the equipment. At lower frequencies, antennas have relatively low gain and coaxial cables have low loss: this means that antennas can readily be mounted high, usually tens of feet above ground level. At high microwave frequencies, however, there is a tendency to operate equipment near ground level. This is because antennas are so directive as to need some optical method for alignment, and cable losses so high that the antennas need to be mounted on the transmitters. These factors conspire to favour the antenna being mounted at head height, which is the least desirable from a safety point of view. Despite the complexity of the overall situation, nevertheless the majority of problems can be covered simply by specifying a maximum power level to which parts of the body should be exposed, and this is described in the following sections.

### SPECIFICATION OF "SAFE" RF POWER DENSITIES

The previous section describes several of the factors affecting the degree of hazard. It is therefore not surprising that while all authorities agree that exposure to radiation having a density of more than 100 mW/cm<sup>2</sup> is likely to be hazardous unless special clothing is worn, there is room for discussion on what constitutes a "safe" level. The Home Office and the Medical Research Council recommend a maximum density for *continuous exposure* of 10 mW/cm<sup>2</sup>. This figure implies some extra margin of safety in an amateur context, since exposure is unlikely to be classifiable as "continuous" or cover other than a small part of the body at one time. It is to be noted that some standards have allowed a maximum of 100 mW/cm<sup>2</sup> for periods up to 6 min. of exposure.

On the other hand, it is to be recognised that much amateur equipment can be of an experimental nature and not necessarily fully instrumented. Unexpectedly high radiation densities due to a power amplifier starting to oscillate, or to poor design of antennas, suggest a need for added caution. It would therefore seem wise initially to adopt a temporary arbitrary lower maximum power density during initial experimentation — possibly 1 mW/cm<sup>2</sup> — until the equipment is properly set up.

Frequency [GHz]	Waveguide No.	Internal dimensions [cm]	Maximum power [mW]
1.3	6	16.510 by 8.255	340
2.3	8	10.922 by 5.461	150
2.3	9A	8.636 by 4.318	93
3.4	10	7.216 by 3.403	61
5.7	12	4.755 by 2.215	26
5.7	14	3.485 by 1.580	14
10	16	2.286 by 1.016	5.8
24	20	1.067 by 0.432	1.2

Table 1. Maximum power for 10 mW/cm<sup>2</sup> not to be exceeded at open end of waveguide

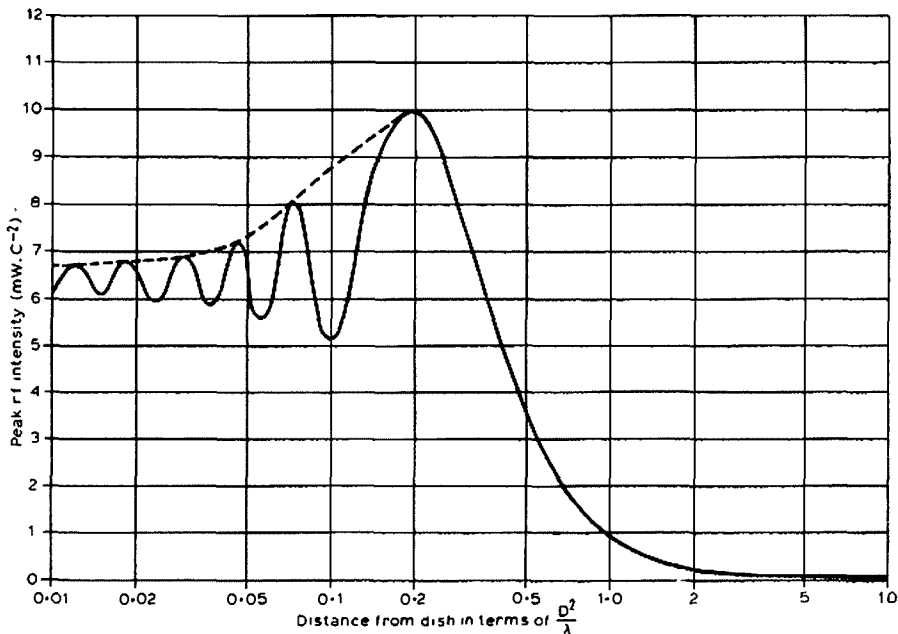

**Fig. 1. Peak RF density relative to 10 mW/cm<sup>2</sup> as a function of distance from dish expressed in terms of  $D^2/\lambda$ , where  $D$  is the diameter of the dish and  $\lambda$  the wavelength of radiation, both expressed in the same units.**

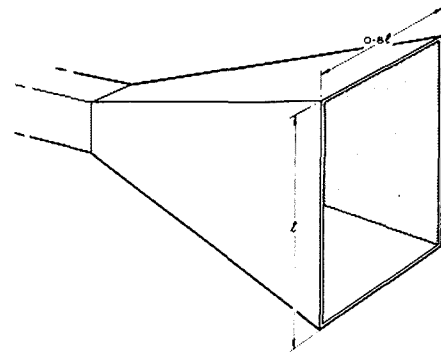

**Fig. 2. Typical horn antenna.**

### HORN ANTENNAS

In the form generally used by amateurs, Fig. 2, horn antennas consist of a length of waveguide which is flared in both directions to produce an aperture having an aspect ratio of typically 0.8:1. The radiation density within the horn falls from a relatively high value at the throat of the horn to a low value at the aperture. For the peak radiation density anywhere *outside* the antenna not to exceed 10 mW/cm<sup>2</sup>, the power in milliwatts fed to the antenna should not exceed  $2 \times l^2$  where  $l$  is the length of the longer side in centimetres. Because of their relatively large physical size relative to their gain, horn antennas tend to be used at frequencies of 10 GHz and above. At that frequency a reasonably large horn would have an aperture of 30 by 24 cm. The maximum power that could be fed to this antenna without exceeding 10 mW/cm<sup>2</sup> at the aperture would be 1.8 W, a very considerable power at that frequency.

The power density at the aperture is given by  $5P/l^2$ . For a medium size (10 GHz) transmitter of output power 100 mW, the density is only 0.6 mW/cm<sup>2</sup>, ie at a very safe level. The corresponding density at the throat increases to 170 mW/cm<sup>2</sup>, but this region is not easily accessible other than by deliberate action. For this reason, and the fact that they cannot be misaligned, horns tend to be a particularly safe form of antenna to use.

A feature of note is that the aperture of the horn is increased so the gain of the antenna increases, and therefore the effective radiated power is raised. At the same time, the larger the aperture the lower the power density at the aperture, and therefore the safer the equipment becomes. We therefore have the perhaps surprising situation that, for a given transmitter output, it is possible to have the situation that the higher the radiated power the safer the equipment can become.

### PARABOLOIDAL DISH ANTENNAS

This is the most popular form of microwave antenna. It consists of a paraboloidal reflector to which RF is fed by some form of feed placed at its focus. There are two areas of importance, which can be dealt with separately: the hazard associated with the radiation reflected by the dish and which will be at a maximum at some distance outside its focus; and the hazard associated with the region between the feed and the dish.

normalised in terms of  $D^2/\lambda$  is shown in Fig. 1 with reference to a peak density of 10 mW/cm<sup>2</sup>.

### OPEN ENDED WAVEGUIDE

As will become apparent, the radiation from the open end of waveguide represents probably the greatest risk in practice. It is compounded by the almost irresistible urge many people have to look into it.

The size of waveguide used at a particular frequency is set within fairly narrow limits: the broad width usually lies between 0.6 and  $0.95\lambda$ , and the height usually is approximately  $0.45\lambda$ . The value of  $A$  therefore is typically  $0.27\lambda^2 - 0.43\lambda^2$ . The maximum power  $P$  that can be fed to the waveguide without exceeding 10 mW/cm<sup>2</sup> peak RF power density is therefore  $0.67\lambda^2 - 1.07\lambda^2$ , where  $P$  is in milliwatts and  $\lambda$  in centimetres. The maximum density is measured at a distance of  $0.13\lambda - 0.21\lambda$  in front of the aperture, and drops by a factor of 100 at a distance of  $1.35\lambda - 2.15\lambda$ . The maximum powers that should be applied to typical waveguides at frequencies of amateur interest so as not to exceed 10 mW/cm<sup>2</sup> are given in Table 1: they are seen to be at relatively low levels. This implies that in most cases the output of most transmitters constitutes a real hazard and therefore the waveguide should always be safely terminated in a screened load where access is permitted.

As an example, the maximum radiation density from a 100 mW 10 GHz transmitter based on WG16 reaches a peak value of 170 mW/cm<sup>2</sup> at a distance of approximately 5 mm in front of the waveguide aperture. However, this falls to 1.7 mW/cm<sup>2</sup> at a distance of approximately 40 mm from the waveguide aperture.

### CHARACTERISTICS OF THE RADIATION PATTERN

It is useful to consider first radiators such as the open end of waveguides or the horn antenna, and then to move on to paraboloidal dish antennas. It can be shown that the pattern of radiation across the aperture is not uniform across a waveguide or horn in the H-plane, but follows a sine wave. Thus while the mean power across the aperture is simply  $P/A$ , where  $P$  is the power and  $A$  the area of the aperture, the peak power density is nearly four times this value, ie approximately  $4P/A$ . The use of the latter value introduces a small safety factor which is increased by the use of the physical aperture for  $A$  rather than the electrical aperture.

The maximum power density is observed along the axis of the radiator, and falls to either side. In the case of paraboloidal dish antennas, a similar pattern is observed; the feed being designed so as to reduce the power density at the edge of the dish by typically 10 dB. The maximum density is not, as perhaps would be imagined, at the aperture, but at a distance further from the dish given by  $0.2 D^2/\lambda$ , where  $D$  is the diameter of the reflector in the same units as  $\lambda$ . This relationship is equivalent to approximately  $A/4\lambda$ , which value can be used as a convenient guide with other shapes of aperture.

Between the radiator and the point of maximum power density, the density varies in a sinusoidal manner at a level of a few decibels lower than the peak value. Beyond the peak the density falls rapidly and reaches a value 20 dB down at a distance given by  $2 D^2/\lambda$  (or  $2.5 A/\lambda$ ), and thereafter falls at a rate set by the inverse square law. The overall pattern of power density

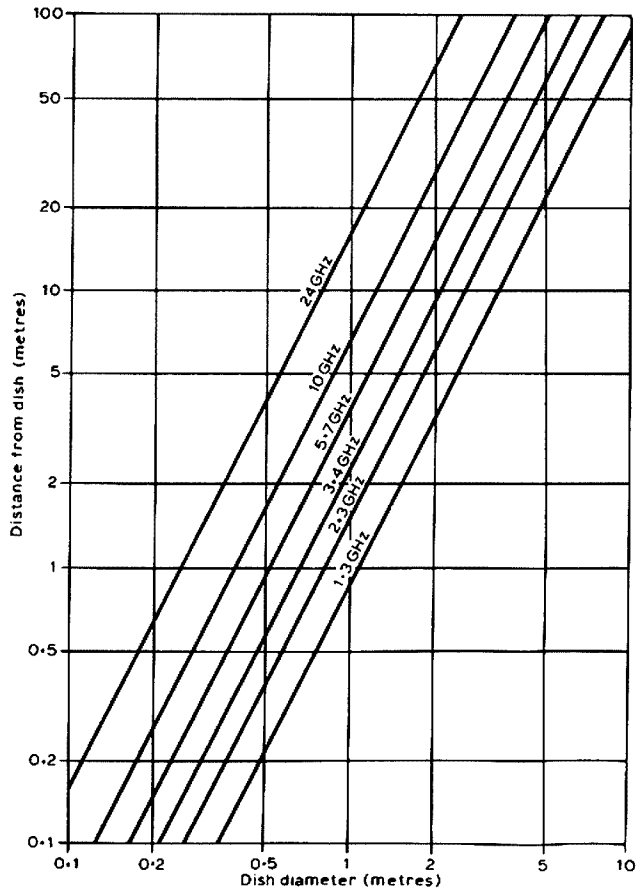

Fig. 3. Distance from dish to point of maximum RF density as a function of frequency and dish size.

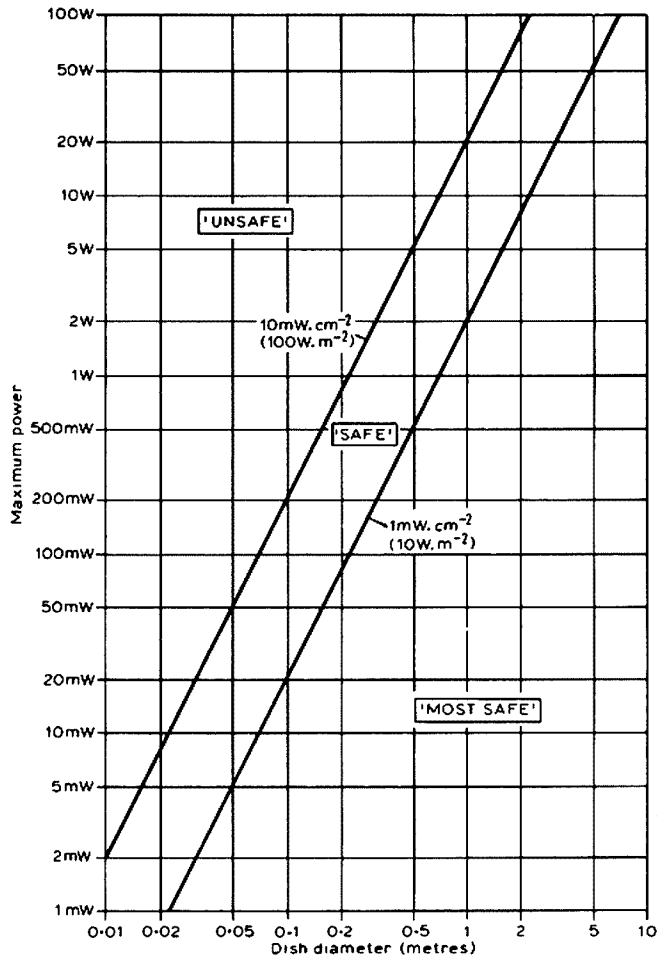

Fig. 4. Maximum power to be fed to a dish so as not to exceed an RF density of 1 or 10 mW/cm<sup>2</sup>.

### REFLECTED POWER

The pattern of radiation from a dish reflector is approximately a cone. This has an initial diameter equal to that of the dish, which increases with distance from the dish according to the beamwidth of the antenna. The radiation density across this cone is at a maximum at its centre, ie along the axis of the dish, and is designed to fall typically by about 10 dB at the edge of the cone. Along the axis the peak radiation density is found near the limit of the near field, ie at a distance  $0.2 D^2/\lambda$  from the dish, where  $D$  and  $\lambda$  respectively are the diameter of the dish and the wavelength of the RF expressed in the same units. Values for frequencies of amateur interest as a function of antenna size are shown in Fig 3.

The peak radiation density in most cases will be observed at distances of 1 to 10 m from the dish, ie well beyond the focus. The peak radiation density corresponding to this reflected power is again given by the value  $4P/A$ , where  $P$  is input power in milliwatts and  $A$  is the projected area of the dish in square centimetres. For this peak density not to exceed 10 mW/cm<sup>2</sup>, the maximum power should not exceed the values:

$$P_{\max} = 2 D^2 \text{ where } P \text{ is in milliwatts, } D \text{ (diameter) in centimetres}$$

$$P_{\max} = 20 D^2 \text{ where } P \text{ is in watts and } D \text{ in metres.}$$

This relationship, together with that for a maximum density of 1 mW/cm<sup>2</sup>, is shown as a function of dish diameter in Fig 4, with regions designated as "most safe", "safe" and "unsafe". Thus, for example, if a 1.5 m dish is available, provided that the power fed to it does not exceed 44 W, then nowhere outside the antenna structure will the power density be greater than 10 mW/cm<sup>2</sup>. It should be noted that this relationship is independent of frequency. This means in practice that a high degree of safe operation can be "built-in" a system by simply specifying its parameters. The above data of course presumes that the dish and feed are properly aligned: the effects of misalignment is discussed below. As was the case with horn antennas, for a given transmitter power, the larger the size of the dish the safer the equipment becomes, despite the fact that the effective radiated power is increased.

### THE HAZARD ASSOCIATED WITH THE FEED

It was shown in the previous section that

provided the power supplied to a parabolic reflector was related in the way described to its diameter, then the radiation density could be held to a safe level anywhere outside the antenna. This could be achieved in practice without placing too restrictive limitations on the equipment design. For example, Fig 4 shows that the minimum size of dish to be used with a 2 W transmitter should be 1 m diameter if the radiation density external to the antenna structure is not to exceed 1 mW/cm<sup>2</sup>, or 20 W if not to exceed 10 mW/cm<sup>2</sup>.

However, as the effective aperture of the feed supplying this power to the dish is usually much smaller than that of the dish, the radiation density associated with the feed will usually be at an unsafe level, and frequently at a hazardous level. The situation is somewhat similar to the horn antenna described earlier except that with a horn it is relatively difficult to physically reach the regions of high radiation density, whereas with a dish it is normally all too easy if the antenna is near ground level or not otherwise protected. The actual power density between the feed and the reflector will be set by the power of the transmitter and the dimensions of the feed. One of the simplest cases is that of the direct horn

feed, in which the horn is mounted at the focus of the dish with its aperture directed at the dish. The actual dimensions of the feed depend on the frequency of operation and the ratio of the focal length of the paraboloidal reflector to its diameter, in the manner described in 2. If it is assumed that access to the inside of the horn feed is prevented, then the maximum power that can be applied to the feed so as not to exceed a radiation density of 10 mW/cm<sup>2</sup> as a function of the focal length/diameter (f/D) ratio of the dish and of frequency. These levels should be adopted if the system is to be operated at ground level for alignment.

Practical transmitters will normally generate significantly greater powers than those shown in Table 2. For a 1 W transmitter at 10 GHz, for example, the peak radiation density in front of a feed will be in the range of a few hundred milliwatts to a few watts per square centimetre depending on the f/D ratio of the dish. These levels are clearly unsafe, and it therefore makes good sense to operate the antenna in such a way as ensures that the operator and others cannot have access to that region of the antenna.

A popular second type of feed is the Cassegrain system, in which a horn feed mounted through the centre of the dish radiates a sub-reflector which in turn illuminates the main reflector. With this system the main risk would seem to be spillage of RF around the edges of the sub-reflector. If this is to be limited to 10 mW/cm<sup>2</sup>, and the feed has a normal taper, in illumination of 10 dB, then the radiation density at the centre of the sub-reflector must not exceed 100 mW/cm<sup>2</sup>. This is achieved if the power supplied to the antenna does not exceed 25 AmW, where A is the area of the sub-reflector in square centimetres.

Calculations of radiation density around dipole-reflector combinations are difficult. There seems little doubt that stray radiation

is likely to be at a somewhat higher level than with horn feeds, and therefore correspondingly greater precautions should be taken with this type of feed.

Frequency (GHz)	Maximum power (mW)		
	f/D = 0.25	f/D = 0.6	f/D = 1.0
1.3	370	1400	4500
2.3	120	440	1400
3.4	60	200	660
5.7	25	70	230
10	6	20	70
24	1	4	13

**Table 2. Maximum power to be fed to a pyramidal horn feed as a function of f/D ratio for peak density not to exceed 10 mW/cm<sup>2</sup>**

### THE EFFECT OF DEFICIENCIES IN THE ANTENNA SYSTEM

It is appropriate to refer briefly to a number of deficiencies in antenna systems which in some cases may lead to unexpected problems.

#### (a) Under-illumination of dish

In defining the maximum radiation density by the relationship 4P/A, the area A corresponds to the physical area of the reflector *assuming ideal illumination*. The use of a feed of too high a gain will result in under-illumination of the reflector so that its effective area is smaller than the physical area. This will lead to a higher power density close to the dish than would otherwise be expected.

#### (b) Over-illumination of dish

If the gain of the feed is too low, then an excessive amount of energy will spill over the edge of the dish. This will not be hazardous unless the power fed to the dish greatly exceeds the recommended value, as the density is normally designed to fall by typically 10 dB

between the centre and edge of the dish.

#### (c) Feed positioned inside the focus

If the feed is placed between the focus and the dish, the reflected beam will be divergent. As this will reduce the power density, this condition is relatively safe.

#### (d) Feed positioned beyond the focus

This is a potentially dangerous case because the reflected beam will tend to converge to a point some distance in front of the dish, with the risk that local power densities will approach those at the feed.

### ROD ARRAY ANTENNAS

This case deserves to be considered as a separate situation. In general terms the stray radiation from this form of antenna would be expected to be greater than either horn antennas, or horn-fed dishes, and therefore greater precautions should be taken. It seems probable that the radiation pattern at a distance will be similar to that of a parabolic antenna of similar gain, and therefore the present design information will be relevant.

### OTHER PRECAUTIONS

With high-power equipment it should be recognised that there are a number of other sources of hazards. For example, the leakage of RF from loosely-coupled connectors and waveguide flanges or the coupled output from a directional coupler may be at a sufficiently high level to represent a risk. In some cases, the power reflected from some surfaces may be at an unsafe level. It is obviously wise to recognise these possibilities and to adopt the same high standards of discipline for RF as amateurs obviously already do with other hazards such as high voltages.

### REFERENCES

1. "RF hazards and the radio amateur", R. P. Blackwell, G8IZV, and I. F. White, G3SEK. *Rad Com* February 1982.
2. *VHF/UHF Manual*, D. S. Evans, G3RPE, and G. R. Jessop, G6JP, RSGB.

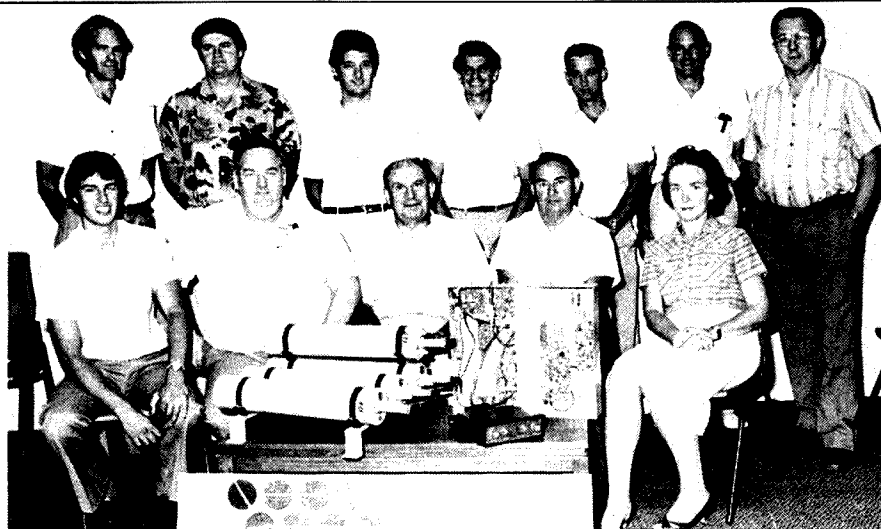

The Repeater Group L to R: seated — VK2DHR, VK2DDD, VK2APP, (chairman) VK2DBI, XYL of VK2APP. Standing — VK2ENH, VK2BQW, VK2DWT, VK2XAQ, VK2PAM, VK2DHO and VK2AMV. (Missing from group is VK2EEE). In the foreground of the photo are the cavity filters on the table at the left, the repeater right and solar cells standing against table.

Photograph by John Meagher VK2AMV.

# CLUB CORNER

John Meagher VK2AMV  
87 Rankin Street, Forbes, NSW, 2871

## REPEATER GROUP

A group of amateurs from the "Weddin Repeater Group" are working towards establishing a repeater in the Grenfell area of Central New South Wales.

The proposed repeater will serve from Dubbo to Cootamundra, Young, Temora, Wyalong and hopefully Griffith, Parkes, Condobolin and Forbes. Tests already carried out from the proposed site have been most encouraging.

The repeater is to operate on channel 10-147.100 MHz and is presently under test in a temporary location at Forbes.

AR



# INTRUDER WATCH



Bill Martin, VK2EBM,  
FEDERAL INTRUDER WATCH  
CO-ORDINATOR  
33 Somerville Rd. Hornsby Heights, NSW, 2077.

*In view of the fact of the recently-allocated new frequencies being available to the VK amateur operator, and bearing in mind the number of requests received at this QTH for information on 'where and when an intruder IS an intruder', I think it timely to include a list of the HF bands, and details regarding who can be expected legally to be present on the bands.*

## ALLOCATION OF FREQUENCY SPECTRUM FOR PURPOSES OF THE INTRUDER WATCH

### 160 Metres:

1.800-1.825 MHz — Amateur Service is Primary Service. Exclusive to amateur operators.

1.825-1.875 MHz — Amateur Service is Secondary Service. Not Exclusive to amateur operators.

### 80 Metres:

3.500-3.700 MHz and 3.794-3.800 MHz.  
In International Amateur Radio Union, Region 3, the 80 metre band is shared with fixed services — It is not exclusive to the Amateur Service. RTTY and CW non-amateur signals cannot be considered to be intruders. But broadcast stations are intruders.

### 40 Metres:

7.000-7.100 MHz — The Amateur Service is the Primary Service, and this segment is exclusive to amateur operators. Any non-

amateur signals are those of intruders.

7.100-7.300 MHz — Is shared by international broadcasting stations ONLY. Any non-amateur signal OTHER THAN broadcasters can be considered to be an intruder. Non-amateur RTTY and CW signals are intruders.

### 30 Metres:

10.100-10.150 MHz — Shared with fixed stations — The Amateur Service does not have exclusive use of these frequencies. Broadcast stations are intruders.

### 20 Metres:

14.000-14.250 MHz — Amateur Service is Primary Service. This segment is exclusive to the amateur operators. Any non-amateur signals are those of intruders.

14.250-14.350 MHz — This segment is shared with Iran, The People's Republic of China, and the USSR fixed services. It is NOT exclusive to the amateur service. RTTY and CW signals which are non-amateur cannot be considered to be intruders. But broadcast stations are intruders.

### 17 Metres:

18.068-18.168 MHz — The Amateur Service shares this segment with fixed services. Non-amateur RTTY and CW are not intruders. But broadcasters are.

### 15 Metres:

21.000-21.450 MHz — The Amateur Service is the Primary Service. This segment is exclusive to amateur operators. Any non-amateur signals are intruders.

### 12 Metres:

24.890-24.990 MHz — This band is shared, and non-amateur RTTY and CW signals are not intruders. But broadcasters are.

### 10 Metres:

28.000-29.700 MHz — The Amateur Service is the Primary Service. This segment is exclusive to amateur operators. Any non-amateur signals are intruders.

Hopefully, the above details will clear up a few queries, and establish whether or not the signal you are monitoring should legally be there. Any enquiries on the Intruder Watch to your Divisional Co-ordinator, or to VK2EBM, 73 'till next month.

John Tutton VK3ZC  
31 Denham Street, Hawthorn, Vic 3122

# RADIO AMATEUR OLD TIMER'S CLUB

Logs submitted for the March 1983 (20 metre) QSO Party between VK and ZL Old Timer's Club members were a little down on the previous one, mainly because propagation effects, skip, etc made contacts somewhat more difficult on this band. However, although no logs were received from VK6, there were several stations active over there.

CALL	MODE	QSOs	AREAS	SCORE
VK3VF	CW/SSB	24	8	960
VK2SP	SSB	19	9	855
VK40X	SSB	21	7	735
VK4AIX	CW/SSB	21	7	735
VK7RF	SSB	18	8	720
VK3XB	CW/SSB	20	7	700
VK3KS	CW/SSB	19	7	665
VK5RK	SSB	15	8	600
VK4CJ	CW	12	5	300
VK7CH	CW	11	5	275
VK7BJ	SSB	10	5	250
VK7JU	SSB	8	5	200
VK3XF	CW/SSB	10	4	200
VK3AMD	CW/SSB	9	4	180
VK3YW	CW	5	4	100
ZL2BD		19	7	665
ZL3AV		21	6	630
ZL2HS		19	6	570
ZL1BGJ		16	6	480
ZL2DM		15	5	375
ZL2US		12	5	300
ZL1GQ		8	4	160
ZL2AB		7	4	140

Members are thanked for the logs sent in and for the very kind comments made in them.

Remember that our Parties are held on the second Monday of August (40 m) and March (20 m) ie 8th August 1983 0800 UTC to 1100 UTC. Full details Amateur Radio, February 1983.

All amateurs who have been licensed for a period of 25 years or more are eligible to join the Radio Amateur Old Timer's Club. A SASE (9 x 4) to the Secretary, Harry Cliff VK3HC, PO Box 50, Point Lonsdale, Vic 3225 will bring you a membership application form.

AR



Please help INTRUDER WATCH  
by reporting all intruders.

AR



# LISTENING AROUND

Joe Baker VK2BJX  
Box 2121, Mildura, Vic. 3500

Since I was hatched in 1917, it would not be too far from the truth to say that I was brought up in that period between the wars which was known as the Golden Age of Wireless. King Bradman was on his throne knocking the opposition silly, Kingsford-Smith was doing wonderful things in aviation. De Groot helped Premier Lang to open the Sydney Harbour Bridge, the banks were closed, the Depression was upon us, relatives were on the dole, and us kids attending school in Campsie (Sydney suburb) were having bread and dripping for lunch and milk for a penny a bottle. Such was the time of my introduction to the magic of wireless.



apart, giving us one each and retired to another room to let us listen in quietness.

The station we were listening to was probably 2BL or 2GB, and the Children's Hour was on. Compering the programme was our Radio Uncle George (Saunders) ably assisted by his side-kick "Bimbo" whose real name I never did get to know. Uncle George and "Bimbo" were sending birthday greetings (2/6d I think it used to cost) and singing songs for just about every kid in Sydney, and thereupon I was smitten by a bright idea:

It so happened that a short time before this, we had learned a nursery rhyme called "Sing a Song of Sixpence" so I asked Tony (who, being my best mate, was wiser than an owl and knew everything) "how do we get this Uncle George and Bimbo to sing for us also?" Tony said that all we had to do was to take these headphone things away from our ears, put them in front of our mouths and bellow into them as loudly as we could. No sooner said than done, and remember that this was the 'Age of Wireless' when, for two small boys with vivid imaginations, just about anything could happen if you wished hard enough. An in less time than it takes to write these lines it wasn't long before Uncle George and Bimbo were "Singing a Song of Sixpence" just for us!

brought along a mysterious round glass thing that was all silvery inside and had four prongs sticking out of its bakelite base. I was entranced by the look of the thing, the like of which I had never ever seen before. "Do you know what this is?" asked "Mr Carrot Top".

I shook my head in a positively negative sort of way. "Would you like to see what is inside it?" he then asked. I nodded my assent, not knowing exactly what spectacle I was about to behold, or if a fairy or genie might pop out of it.

Thus it was, that for the first time, I was introduced to a wireless valve (they weren't called radios in those days), and he then broke it open ever so carefully exposing the innards of the battery-operated triode. I can't remember whether or not "Mr Carrot Top" tried to explain to me just how this valve worked (I probably wouldn't have understood anyway) but even though I didn't know what the glass thing did, the magic of it was that I did indeed know that this was part of a *new sort of wireless*, and a much better one than Tony's dad's crystal set.

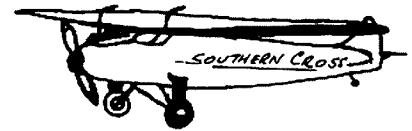

## A GREAT CRYSTAL SET

I was fortunate in having two great schoolmates — Tony Wilkinson of Robertson St, Campsie whose father was an ELECTRICIAN and therefore a veritable Edison in my eyes, and Ray Anderson who was known as the "Marconi" of our school because he could work all kinds of wizardry with wires, globes and batteries which we scrounged from out the back of the local service station. Tony Wilkinson's father had installed, in their house, a giant sized crystal set that took up most of the table in their dining room. Eventually, much to the joy of this little boy, came the day when I was invited around to Tony's place to have tea with the family and listen to their wireless.

At this distance across the half century or so, I can yet recall sitting at their tea table and drinking soup from a huge bowl big enough to fit my head into. After tea Tony and I retired to the room where the crystal set lay in all its glory on a large well-varnished table. The coils were made of green silk covered wire — "honeycomb coils" — which could be moved towards and away from each other to help the tuning, and these were mounted on a base of polished wood with shiny terminals all over it — gee, what pride they took in crystal set construction in those, now far-off, days!

The headphones were the most technical looking parts of the set — they were probably Browns or BBC, and from these issued forth mysterious voices and music when a curly wire with a fine sharp point, called a cat's whisker, was placed ever so carefully on a shiny part of the ninepenny crystal which was inside a dust cover. Tony's father, having installed us on chairs beside the table, then took the phones



## WIRELESS VALVES

Although it was the Depression, my dad had a government job as a tram conductor at five pounds a week payable fortnightly after thirteen days of shift work in all weathers, and how he managed to provide for a wife and two kids beats me even now. It was a time when anyone with two jobs was frowned upon, yet there were those who wanted to pick up an extra quid or two when they could. Dad had a "trammie" mate who was always out to earn a few extra shillings or so as an electrician when he could, and Dad got him to come and install a few extra lights for us on our front and back verandahs.

Dad's mate had a ginger nut (had red hair), so I used to think of him as "Mr Carrot Top". I watched fascinated as "Mr Carrot Top" worked, cutting up all that conduit, pulling the wires through it, installing those wonderful switches with the round white knobs that had "On" and "Off" written on them, on the round batten boards. Much to my joy, my dad's mate took note of my interest and didn't shoo me away as others might have done, but encouraged me to watch as he worked.

Came the day when "Mr Carrot Top"

## AIR WIRELESS!!

Across the bridge of time from those far off days comes another recollection as I type this article. About this time "Smithy" and Ulm were hitting the headlines from somewhere in mid-Pacific headed for Australia. On this particular day, as I walked home from school along Duke Street Campsie, and passed the home of another schoolmate named Townsend, I could hear loud static and a voice from a radio trying to make itself heard. I was told that the voice was that of "Smithy" himself — probably being rebroadcast by some commercial station. Oh, the wonder of it all for this small boy — to hear a voice from far across the mighty Pacific Ocean. (I remember that for at least one of his flights across the Tasman "Smithy" made good use of some amateur radio stations who set up their gear on Gerringong beach, south of Sydney and got the very latest pre-flight weather reports from New Zealand amateurs.)

## RADIO SHOW

Another highlight of this Age of Wireless comes to me as I write. The Sydney Radio Show held in the Town Hall was widely publicised, and the thousands of school children who had been invited, arrived in droves. We were told that Marconi himself,



"the father of Wireless" was to switch on the lights of the Sydney Town Hall by remote control from his yacht in the Mediterranean Sea. Another highlight was a Trans-Tasman radio-telephone hookup with New Zealand. The Australian Post Office was eager to display its new toy, and a silver or nickel coated telephone (it was jazzed up for us at any rate) in a sort of gilded birdsage-cum-telephone box and was installed against one wall inside the hall, while along the wall was displayed a giant painted mural, representing in graphic form the two thousand miles of ocean between Sydney and Wellington.

School children were invited to enter the gilded telephone box to talk via this two thousand miles (an awfully long distance in those days) with the operator in Wellington. I don't remember going into that box, so I assume I was either too scared or too nervous or both, so I contented myself with listening outside the box via a speaker, while other kids spoke with the man in Wellington.

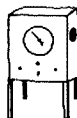

## RADIO UPDATE

When crystal sets gave way to valve wirelesses, wireless shops popped up all around Sydney. Even gramophone shops jumped on the bandwagon, and of course a few wireless shops popped up in Campsie. I pestered Mum to buy one of these new wirelesses, so arrangements were made with a shop in Beamish Street, Campsie to bring one of these sets to our home "on demo". Now be it known to all and sundry that these were still the Depression days when salesmen were falling over themselves to get these wireless sets into the homes of the people. And so, to have a set "on demo" for a week or more without deposit in those days was not at all unusual. So eventually there arrived at our house a gawky looking wireless with big long legs that looked like one of those birds in a painting that I know of who spend their eternity suspended by their long legs over a pool looking for fishes in the water they are standing in. The valves in this set always generated a cosy generous glow that on winter nights saved our light bills and kept us warm as well. And it was on this set that we could listen to "Dad and Dave", "Martins Corner", "The Cashmere Bouquet Show" or perhaps my best loved whodunit called "Scott of Scotland Yard" (a George Edwards Epic).

But as we eventually found out, all was not well with that wireless. In fact, when motor cars passed our place, that wireless made some very weird noises. Mum reckoned that there was definitely something wrong with the thing and so with me in tow, she hi-tailed it to the wireless shop. But she

didn't let on that it was one of *their* sets that she was unhappy about. Now Mum's parents came from the Emerald Isle, and when she "got her Irish up" she got hopping mad.

She told the man behind the counter that we had a wireless that was making funny noises every so often, and asked what he thought about it. "It's definitely faulty," he replied. "There's something very much wrong with that set madam. You ought to have it fixed." "Well then," said Mum reaching "Boiling Point" very quickly "you had better get your feller come and fetch back that set that you're trying to sell to us because it's no good at all" and flew out of the shop still with me in tow.



## MANTLE RADIO

Our next wireless (oh yes, we did get another) was a beautiful Mullard (Mickey Mouse mantle, I think) which worked fine and doubtless, if I had it here now, would out-perform many of the solid state sets that are around today (excuse me for showing a bias). It was for broadcast band only, got all Sydney stations without bother, and occasionally even pulled in 2KA Katoomba. And as an extra bonus, we could pick up Sydney police radio VKG which came in on a harmonic near 2BL. So, with this added bonus, we knew where the action was around Sydney Town.

At school, kids including the school's resident Marconi, Ray Anderson, were telling me about these mysterious stations called "shortwave stations" which were ever so far away, and were located so far down the dial that they were outside the range of the broadcast band mantle. How to get them was the problem, and here indeed for me was a hitherto-undiscovered world to enter into. I was advised by the school's resident Marconi and other kids that I could make the Mullard mantle pick up these mystery stations by removing some of the wire off those strange looking coils near the tuning capacitor, and this I proceeded (without parent's permission, I guess) to do. In fact I got a better idea — in order to make the coils easier to get at for further experimentation — why not move the coils to the back of the set so that they stuck out backwards? At this time such things as alignment were unknown to me, so having thus thoroughly upset the alignment of a beautiful broadcast set, I finally converted it to one that could receive broadcast and shortwave stations intermingled right across the dial. And now it could even get (on Sundays only) the experimental station VK2ME Sydney. How was I to know then that what I had done was to wreck forever one of the finest mantle sets of its day.

However, all this is with the benefit of hindsight. It was thus that I had my first introduction to the world of shortwave radio, that world that was to later bring me, among other things, to the voices of Churchill and Hitler, and much, much more, as I will tell of in later articles.

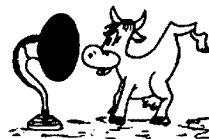

Somewhere about 1932, we moved from Campsie to Ryde, and the Empire Broadcasting Service had begun. On shortwave I could hear a voice sometimes saying "this is Daventry calling. Here is the news". Yet, I still had a soft spot for sets of the crystal variety. So, hearing that King George the Fifth was to make the first of a whole series of Christmas broadcasts (a tradition that is being followed by today's Royalty) I knocked up a crystal set in Waterview St, Ryde just so that I could say, as I do now, that I heard King George's voice for the first time on my crystal set.

George the Fifth died about 1935, Edward ascended the throne, Hitler started making loud noises like "Sieg Heil", the years rolled on and my radio was then a dual wave Gulbransen. I became an avid listener to Vatican Radio, and the bells of St Peters were often heard in our home. A novel addition to my listening pleasure and one that often startled guests at our home, was when I hooked up an old horn speaker to act as a microphone when the cow was being milked in the shed in our yard and the bellowing of "Molly the cow" could be heard in our front room, via a pickup connection on the Gulbransen.

Radio is a fine hobby. May it reign forever, and thanks to all of you who have made so many kind comments about the effort I put into this column. There's plenty more to come even if I do occasionally miss the deadlines.

73s to all  
Joe. VK2BJX  
AR

# EQUIPMENT REVIEW

Coming Soon

Equipment Reviews of —

*Mobile One Hamtennae*  
*ICOM IC-R70*  
*Nicholls Woodpecker Blanker*  
*Kenwood TR7950*  
*Kenwood R2000*



# HOW'S DX

Ken McLachlan VK3AH  
PO Box 39, Mooroolbark 3138.

*What price a DX country?* This is the question that a number of serious thinking amateurs are asking themselves and close friends after the Spratly Island misadventure that occurred in April.

The Spratly Islands consist of in excess of one hundred small islands and reefs of which thirty three only remain above high water level at all times and these are scattered over an area exceeding 150,000 square kilometres in an area of the South China Sea with China to the north, Malaysia to the south, Philippines to the east and Vietnam in the west.

These islands had little commercial value except for fishing until the mid 1970's when one of the contenders for ownership decided that the area may be a source of oil. Claimant to the area has been made by China who base their case on rights that are said to date back to 200 BC. In 1887 the French government of the time acknowledged Chinese sovereignty over all islands in the South China Sea. In 1933 France occupied nine islands but in 1940 were driven out because of World War II. The Japanese maintained a submarine base in the area during the war.

Present claimants to the area in either full or part are China, Vietnam, Malaysia, Taiwan and the Philippines and who owns what seems to be unclear even to the occupiers of the few of the islands, some of which have been occupied since 1945.

Four Cologne DX Club members decided to activate this much needed DX country for their fellow amateurs. After much seeking of transport they met up with Peter Marx and his lady Jenny Toh, who had designed and built a catamaran which was Ketch rigged and offered the luxury of four state rooms which were built into the outriggers. The saloon had two metres of head room and was finished in teak. Below deck, the finish was as impeccable. The bulkheads were carpeted to reduce engine noise and the wash basins and toilets worked. Bruce Wilson, a media correspondent from Washington, who with his XYL, had the pleasure of a cruise on this vessel described it as a miracle for such conveniences on a yacht to work.

Peter, a German master mariner and Jenny a Singapore Chinese graduate from a Swiss cordon-bleau cooking academy, had visions of taking discerning tourists, on charter trips around the South China Sea and itinerate around its myriad of islands. The four DXers chartered Peter and Jenny's vessel Sidharta named after a Hindu goddess.

Whilst enroute they were heard at this QTH to say they were within fifty miles of their goal of Camboyna Cay Island in the

Spratly group. The group were in excellent spirits and anticipated placing a signal on the air from their goal or a nearby unoccupied island within forty eight hours.

This was not to be, as soon after, a gunboat appeared and fired upon the fifteen metre Sidharta. Their last message heard on the amateur bands was —“We are being fired upon and we are on fire”—. It is understood now that one of the amateurs was killed, and the five survivors were either injured or wounded. The vessel ablaze, they took to the dingy and were still under fire from an unknown assailant.

Extensive air searches were inaugurated by fellow amateurs, with many amateurs participating, but with no sightings they were scaled down after a number of days. Meanwhile Peter somehow guided the dingy towards the shipping lanes and after nine days, four survivors were picked up by the Panama cargo ship “Linden”. Another of the amateurs had perished in the dingy.

The survivors were taken to hospital in Hong Kong by Police launch when the vessel reached harbour some forty eight hours later.

With hindsight a number of operators



**Jenny Toh and co-owner Peter Marx leave the hospital in Hong Kong after a check up.**

Photo Guy Liu courtesy Joe Hilger UPI and the Melbourne Herald.

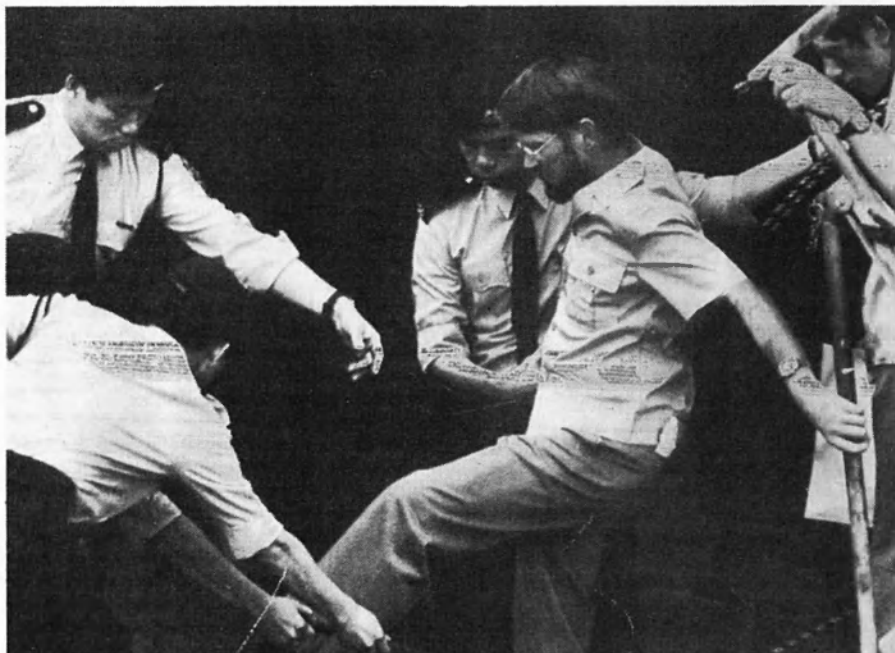

**Baldur DJ6SI one of the survivors being assisted aboard the Police launch from the cargo ship Linden at 5:00 AM in the morning.**

Photo Carl Ho courtesy Joe Hilger UPI and the Melbourne Herald.

must be commended for their diplomacy in not discussing certain aspects of the incident due to the fact that it could jeopardise any diplomatic negotiations that were taking place. Zero marks to those operators who complained of missing out on a new country and a special file in the memory bank of the call signs that were given. This practise disgusted many listening let alone crowding an emergency frequency with idle chatter.

Other incidents this decade which have caused undue hardships to the participants of other expeditions in the Pacific, include a serious aircraft accident that caused undue suffering and hospitalization to a YL operator and the slipping on some glass of a surgeon causing such damage that he was unable to further continue his profession.

No matter how meticulous the planning, it is unlikely that any of the above incidents could have been foreseen and averted but one thought is that this and other such happenings are going to be in the minds of DXpeditioners in the future.

Amateurs world wide offer their condolences to the families of those that perished in this unfortunate incident and sympathy is extended to the organisers, the Cologne DX Group who planned the operation and to Peter Marx and Jenny Toh, their ambitions and livelihood shattered.

Perhaps now is the time to take 1S off the DX Countries list before another expedition is launched with maybe more serious consequences to the participants.

#### EGYPTIAN ACTIVITY

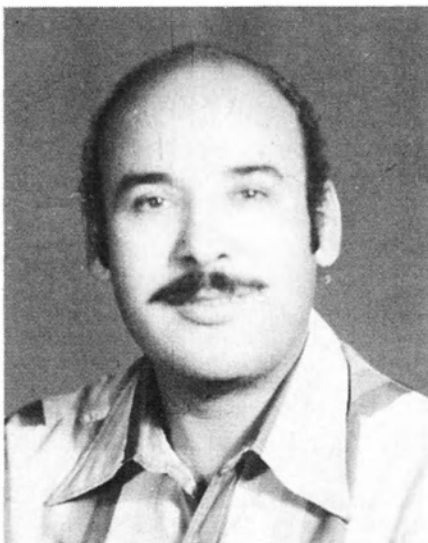

**Ezzat SU1ER**

A new amateur in SU land for 1983 is Maggi SU1MR. Maggi is the daughter of Ezzat SU1ER who has been licenced since 1976. Of the sixteen amateurs licenced in Egypt, three of them are YL's. Maggi is the youngest, only fifteen years old.

Maggi uses Ezzat's equipment, a Collins KWM2A with a TL922 Linear fed to a three element Yagi twenty metre monobander at twenty five metres. Whip antennas are used



**Maggi SU1MR**

on other bands through a coupler. Ezzat and Maggi are QRV mostly on Fridays and Saturdays between 1700 to 2100 UTC around the frequencies of 7.080, 14.280, 21.280 and 28.580 MHz. QSL's to PO Box 33, Air Port, Cairo, Egypt.

#### QRZ DX

Bob W5KNE has taken on the unenviable task of editing QRZ DX, a weekly publication in the United States of America.

A reciprocal agreement has been worked out between the writer of this column and Bob that will allow readers of both magazines greater access to DX news.

#### LEBANON ACTIVITY

Very little activity out of OD land lately but SSB enthusiasts may look for OD5FB who regularly frequents around 14.220 MHz particularly on Fridays and Saturdays. CW operators are taken care of by the regular appearance of OD5LX around 14.030 MHz.

#### DIRECT QSL'S ONLY

WA4JQS, QSL Manager for VP8s, QJ, NJ, PU, WA, ZV, ZS1DM, PY5YL and TA2TAT has made it known that he will not answer cards via the bureau and has given his bureau instructions that all cards except those from SWL's and USSR are to be sent for pulping. A self addressed envelope with adequate IRC's is required by him for a confirmation.

Well at least everybody does know where they stand and the readers can make up their own minds as to whether they subscribe.

#### HF BEACONS

It has been reported that a number of HF beacons on 18.110 and 24.900 MHz are cropping up from North America. Callsigns known to being used are KK2XJM, KM2XDU, KM2XDW and KM2XKO with voice indents.

#### AN AMATEUR FIRST

Probably not DX news as such but the

readers of this column would think it remiss of me if I did not mention a little of the history of one of the few VK and the only VK YL representative on the ARRL DXCC Honour Roll. I gleaned this information by reading a recent edition of the Radio Amateur Old Timers Club newsletter which brought to light an interesting fact about one of VK's keenest DXers and a constant contributor to this column, Austine VK3YL.

Bob VK3ML, the group's Publicity Officer mentions one of the firsts in the history of the hobby in Australia. To quote in Bob's own words — "There is one positive and unique "First" when our Austine Henry (nee Marshall) VK3YL was enrolled in the Royal Australian Air Force on 6 September 1933. She was granted the rank of AC2 with a service number of R20. She was recognised by the RAAF in a letter from the Department of Defence dated 21 May 1980 as being the first woman to enlist in the RAAF. We congratulate Austine in having this rare distinction."—.

Austine, is noted world wide for her prowess with the key since she was licenced in 1930 and over recent years Austine has combined SSB into her operating skills and is a much sought after contact from all continents when time permits her to be on air.

#### STATISTICS

Hugh VK6FS has extracted a few figures out of the logs of VK0HI and VK0CW which highlight the operating habits of VK amateurs. The breakdown of the twenty metre log of VK0HI indicates that the total calls appearing in the DX log to VK were 737 made up of VK1-22, VK2-113, VK3-205, VK4-55, VK6-166, VK7-37, VK8-8, VK9/MM-1, VK0-3, VK0/MM-1. The separate individual calls not counting multiples amounted to 581. One VK3 amateur appeared seven times, another four and twenty nine had two QSO's, two VK2's appeared four times and five three times with fourteen appearing twice and on the story goes call area by call area.

Hugh validly points out that due to duplication such as this, 156 amateurs missed out on a QSO with the rarest place in the world. A break down of the ZL participation shows that of 79 calls worked, seven were duplicated and two were triplicated in the log. No further comment is necessary!

#### MALPELO ISLAND

A note from HK3DDD remarks that he will be QRV from Malpelo in October. The call will be HK0TU. This will be one to look out for and QSL's will be taken care of by HK3DDD, Call Book QTH.

#### BHUTAN

Correspondence from Pradhan A51PN indicates that he is no longer on the bands due to equipment problems. Pradhan does not indicate what equipment he used or what the fault is but meantime A51 is climbing the rungs of the much wanted ladder in many operators logs.

## CONGO REPUBLIC

Jorg TN8AJ may be QRT from this country for good. In a letter to Ron ZL1AMM he indicated that on a trip there last November and December he only had a transceiver available that would operate up to 12.5 MHz with a power output of 100 watts and as it was the rainy season the QRN levels were very high. Jorg did succeed however in some regular QSO's with JA.

The latter part of his stay allowed use of the one kilowatt transmitter, however conditions were bad and at times difficulties were experienced in having a QSO with his QSL manager Y25LO.

To summarise the six operations from the Congo between 1979 and 1982, there have been 13,203 QSO's, 211 countries worked of which 176 have been confirmed. Broken down into bands they are 80 metres — 52 countries, 40 metres — 80, 20 metres — 147, 15 metres — 170 and 10 metres — 139 countries confirmed. Worked all States (WAS) was achieved on fifteen metres SSB.

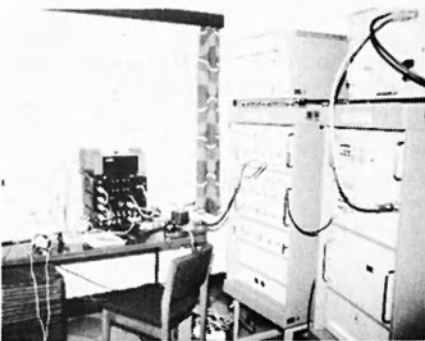

Jorg's equipment from left to right. Receiver EKV15, transceiver 100 W type SEG 100 (above RTTY receiving set F1200) — 1 KW transmitter KN1. All equipment is manufactured in the German Democratic Republic.

## HOMEBREW

Two very keen and well known DXer's from the USSR are Vlad UW6FZ and his brother Larry UA6HZ. These amateurs share the same home brew equipment and antennae. Both operators are very keen contesters. Who operates may be the toss of a coin!



Vlad UW6FZ operating the home brew station.

## WILLIS ISLAND

The new operator for Willis Island is Graeme VK9ZS. Graeme will be active from the island from this month through to the next scheduled changeover in December.

QSL arrangements will be through Jill VK6YL QTHR.

Graeme will be taking six metre equipment with him, which was donated to the Commonwealth Bureau of Meteorology for the use of amateurs stationed at the remote Bureau base, by the Heard Island expedition and the VK6 DX Chasers Club.



Three Willis Island amateurs get together on Willis with MV Cape Pillar in background. L to R: Andy VK9ZA who did the last Willis tour, Bryan who has done many tours on Willis and John VK9ZJ currently on Willis.

## MT ATHOS

Gus W6LAS/SV-A was active from this rare area and according to all reports many VK's were successful with a new country. Gus was making a habit of calling in on Stan G3MHM's ARS Net on 14.244 MHz.

## FREQUENCY SHIFT

North American stations were all set up to QSY lower in frequency around the 20th of May and were awaiting the blessing of the FCC.

The General licence holder will be permitted 14.225 MHz and above, the Advanced 14.175 MHz and above and the Extra Licence holder an extra 50 kHz, 14.150 MHz and above.

The QSYing of those regular scheds that many VK's have with Europe and VE just under 14.200 MHz are going to crowd the low phone end of twenty metres. Perhaps I might be forced into CW operation after all. The DXpeditioners frequency of 14.195 MHz may now become 14.145 MHz.

This will be the first of many changes which will effect the American privileges in all amateur bands.

## ADELIE LAND

Anyone working Dumont FB8YK can expect a quick QSL return. Dumont's XYL is handling the paperwork for him whilst he is down south. Her address is Madame D'Uraville, 24 Manresa Court, Sandy Bay 7005, Hobart, Tasmania.

Dumont, with a very powerful signal is generally heard around 14.200 MHz.

## RECOGNITION

Dave VK3DHF, probably better known as VK9ZD and later as VK0HI received quite a surprise when he called in at the 47th



Dave VK3DHF responding to the presentation Annual WIA Convention held over the ANZAC weekend.

Dave was presented with a framed certificate inscribed — "For outstanding service to amateur radio" from Bruce VK6OO President of the VK6 Division of the Institute.

Congratulations Dave, and thanks for the new countries that you have given many, on behalf of all DXers.

## AFRICA

Ten metres is not "dead" though it may be "dying". Stations from Africa have been romping through in the late afternoons in the eastern states. So if you want 5X5's and all the other rare ones don't overlook a quick CQ on ten metres.

## LATE NEWS

At the time of going to press 1S1CK was active from the Danger Reef in the Spratly Islands.

Congratulations must go to these very venturesome gentlemen that have made a new country possible for so many in the light of what has happened in this area earlier this year. QSLs to DU1CK.

## Voice of the Mediterranean

Much heard on the HF bands is Eric 9H4G. I first worked Eric in 1973 and at that time Gozo was a new country for me. The QSL was returned to me very promptly.

Eric retired from business in London in 1969 and he and his XYL Frances decided the idealistic area of Goza Island was an ideal place to settle. Now was the time to enjoy amateur radio, a hobby that has a lot to offer, which had been Eric's interest since the nineteen twenties when he joined the RSGB as a SWL member and was allocated the low number of BRS-104. Eric was first licenced in 1950 with the callsign

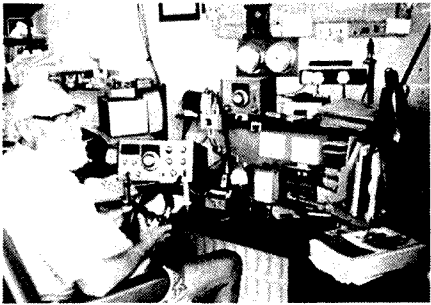

ERIC 9H4G

G3HGX but due to business pressures the bands unfortunately saw very little of Eric.

In 1972 Eric, the fifth amateur on Gozo, was allocated the callsign 9H1DG but in August that year, stations on Gozo were given callsigns running from 9H4A to 9H4Q. Now there are sixteen amateurs on the island, all members of the Gozo Amateur Radio Society of which Eric is Vice Chairman. It is of interest that only two stations, G3DOG and G4GGY, have worked all the sixteen amateurs in this area.

DXing is Eric's favourite pursuit, with a DXCC score of 316, 255 of these are on ten, 288 on fifteen and 308 on twenty metres and the new interest of forty metres over the last three months has netted some eighty three countries from all continents. The total of 303 current countries leaves Eric knocking on the bottom rung of the ARRL DXCC Honour Roll. Eric's equipment comprises a Kenwood-Trio TS515 with remote VFO into dipoles for the three HF bands and a sloper for forty metres which are located at the QTH in the village of Zebbug, 425 feet above sea level. Zebbug is the highest village on Gozo Island.

Other radio interests of this friendly gentleman includes award hunting, having some one hundred and fifty to his credit, being manager of the 9H4 QSL Bureau and promulgating the very attractive "Worked All Gozo Award" where VK stations have to work five different Gozo Island stations to qualify.

Living on this paradise island has an extremely interesting 'spin off' according to Eric and Frances and this is the number of overseas visitors that personally call to meet the couple. Over the years amateurs from countries such as DL, G, GI, GW, PA0, SM and VK have enjoyed their hospitality and readers of this column have an open invitation to join Eric and Frances over a cup of tea if they visit Gozo.

**QTH'S YOU MAY NEED**

- 3B8FL PO Box 1104, Port Louis, Mauritius.
- 3V8PS PO Box 473, Tunis, Tunisia.
- 5N8AFE PO Box 12635, Kano.
- 6C35A PO Box 35, Damascus.
- 6C35M PO Box 35, Damascus.
- 6C35N PO Box 35, Damascus.
- 6C35O PO Box 35, Damascus.
- 6W8EX PO BOX 35, Ziguinchor.
- 9J2CV PO Box 70992, Ndola, Zambia.
- 9J2TJ PO Box 28, Chisekela, Zambia.
- 9K2ADN PO Box 19593, Haitan, Kuwait.
- 9M2CH PO Box 777, Kuala Lumpur.
- A99A PO Box 22381, Muharra, Bahrein.
- AP2M PO Box 999, Rawalpindi.

- C21RK PO Box 139, Nauru.
- CT2CB PO Box 44, Santa Maria Is. Azores.
- EL2BE PO Box 1011, Monrovia, Liberia.
- F88XAB 8 Rue Messenger, Saint Michel, 91240 France.
- FH8CQ PO Box 144, Dzaoudze, Mayotte 97610 France.
- F08HL PO Box 5872, Pirae, Tahiti.
- F08IV PO Box 41, Hao Island, French Polynesia.
- FP8MX PO Box 51, 97500, St Pierre & Miquelon.
- FR0FLO PO Box 200, Tampon, 97430 France.
- HP3FL PO Box 76, David, Panama.
- J28DN PO Box 1724, Djibouti.
- J6LFL PO Box 134, Castries.
- J73AB PO Box 251, St. Georges, Grenada.
- J01BBG PO Box 2, Ogasawa Is., 10021, Tokyo, Japan.
- JW8MY PO Box 224/10, Longyearbyen, Norway.
- K4CEB 86 Hickory Grove Dr. Concord, NC 2805 USA.
- KX6PO PO Box 915, Majura, Marshall Islands 96960.
- T30DB PO Box 457, Beito, Tarawa, Kiribati. Cent. Pacific.
- TG9VT PO Box 115, Guatemala City.
- T12DL PO Box 761, Centra Colon. San Jose.
- TR8GM PO Box 3511, Libreville, Gabon.
- V55GA PO Box 1200, Brunei.
- XT2AW PO Box 2332, Ouagadougou, Upper Volta, West Africa.
- ZD8DA PO Box 4308, Patrick AFB, Fla 32925, USA.
- ZD8MF PO Box 4308, Patrick AFB, Fla 32925, USA.
- T15FP PO Box 125, Grecia, Costa Rica.
- Z21GJ PO Box 66021, Kopje.

**CW SWLing with Eric L30042**

- 28 MHz  
DU7EAL/3, JA1NAE, J01CLZ, JH4UVU, JA00IK, KH6SP, K8LEX/KH6, RA9OUF, W6FEX, W7LEI, XE3UT, YC2BDJ.
- 21 MHz  
DK1EK, OU1CK, G4RCG, HB9CGB, HL1CG, HLOBAC, JA8MZ, KC7BM/KH2, OH10U, OZ3IZ, P29BR, PA3AWW, PA0TAU, UK9MYL, UB5EC, VE7AGM, AB7P, YC3BRI, YU4WE/X, ZK1WL, ZL1AMO/C, 9Y4SL.
- 14 MHz  
A35MS, Q10F, CR1CBU, CT2QN, NOZ0/DU2, EA9KQ, F08FW, HH2VP, HL9WC, KP2G, LU9CV, ON5UM/LX, T30CH, UJ8SAO, N6YK/V2A, VP9HW, Y80AFA, YV4AU, ZL1AMO/C, 6Y5S6.
- 10 MHz  
A35MS, DJ40A, EA2AFM, F6EP0, FC9VN, G3AAE, JA6HW, KH6SP, KV4CI, LA8FK, VE3BD0, 5N7HKR (0615Z).
- 7 MHz  
WA3UHK/DU2, FG7AM, F08BI, GU5BLG, HH2VP, HL5BBM, IOUXY, KC6SZ, LZ2UG, Y03ACX, UK2BBB, UK5ICX, VU2TTC, XE1JTR, YV1AD, YU2CBM, ZL1AMO/C.
- 3.5 MHz  
JA6VU, UK5KAD, UB5UG0, VE1ZZ, 5Z4MX.

**HEARD AND WORKED IN EASTERN STATES**

- 28 MHz  
DK8VO, OZ1FTE, WH2ADG (Gamu)
- 21 MHz  
5Z4CM (Charlottesville), 9J2B0, FB8Z0, SM2EKM, T30AY, UP2BBX, UR20D, XE1MR, Z21AO, Z56CR
- 14 MHz  
3A3LF, 3B8FL, 3D2RR, 3D6BP, 3V8PS, 4K1G\* (OSL/UA0UCJ).

- 4S7EA, 4S7NB, 4S7TZG, 4S7VW, 4T3S, 4U110, 4Y9YU (OSL/YU4FRS), 5B4HF, 5H3FN, 5H3YL, 5T5AP, 5Z4DA, 6Y5HN\*, 6Y5IC (Wendy), 8J5SUN, 807AZ, 807RG, 9H1EU, 9H1GY, 9H4F, 9K2CX, 9M6VW, A35JL, A4XJV, A92P, AH9AA, C2INI, C21RK, CN8CD, CN8CX, CN8CY, CN8ES, CN8EU, C0200, C080C\*, CR9FE, CR9T\* (OSL/WA4IKZ), CR9WU, CT2CR, CX5BT, DF3MZ/ST2, DJ5RT/TT8, EA6NB, EA7DUV, EA8AHB, EA8BF\*, EK9C/O, F6FIC/T2, F88XAB, F89YK, FG7CG, FG7GT, FM7CD (OSL/F5YU), F08F0, F08HL, F08IV\*, FROFLO, F7Y7AN, G35HA, G84DX, GU5E00, H44SA, HA2KMR\*, HASAK\*, HA5KKM\*, HB0CBJ, HC2RG, HG6V, HH4WW, HH5CB (OSL/K9WJU), HK1ANP\*, HK1ESK, HL1CG\*, HR18M, HZ1AB, HZ1AB\*, IT9KZW, IT95EU\*, IZ9A, J28DM, J37AB, J37AH, J39CM, J88AJ, JY8KG (Iris), K4ICA (YL), KC6IN, KH6JKX, KH7AA, KL70D\*, KX6PD, LUSLBD, LZ2ZZ, OD5SM, OESKE\*, OH5NO, OK1AUN\*, PJ2MN, PJ9AA, PJ9VE, PP8ABV, PY0SA, PY1EFM/PY0T, PY2PE (Eva), PY7ZZ, S2BTF, SM2EKM, SP3PLV, SV10L, SV1PL, SV2RM, T2GSH, T30AC, T30AT, T30CH (Vicki), T30CJ, T30DB, T30TB, T69U1, T17CLE, T05RV, T06ZU (OSL/F60ZU), TR8JD, UF6FE, UF6FFF\*, UK0YAA\*, UK8XBD, V2AL, V2AO, VK0FY/Mobile, VK0ST, VK0VX, VK2BRQ/VK9, VK9ZJ, V02CP, VP2H, VP2MG0, VP2MKY, VP2MN (Mae), VP2MO, VP2MR, VP5KMX, VP9TAD\*, V09CI, VR6TC, V55GA, V55GH, VU2JNA, VU2NR, VU2VZ\*, W5RKP/1P1, XE1NKP, XF0M0X, Y23UJ, Y57WG, Y80AFA\*, Y83BDL (Linda), Y11BGD, Y02BEH, Y06EX\*, Y08CF\*, YU20H, ZK1CG, ZK2RS, ZL1AMO/C, ZL3PA/C, ZS20M, ZY5EG

10 MHz  
VK2AD, VK2BRG, VK4NW, ZL18TB, ZL28FL

7 MHz  
K2SHL\*, KX6PO, VE3HOS\*, W6RKY\*.

3.5 MHz  
C21RK, KX6PO.

\* Denotes CW Operation  
( ) Denotes QSL route

**QSLs RECEIVED**

3D2DX, 4Z4JS, 5H3BH, 5W1DQ, C21NI, DL2RAY\*, DL5YBU\*, EI4EN, FK0AN, FK0VU\*, FK8DK, G4HNF\*, HA5BKV, K82F5\*, K6GJDX, P29BR, P29NDX, PA0T0\*, T30CB, T3AZ, VK9XKM, VK9YFM, VP2MED, V55OX, WA2ECI\*, WH2ADG, XE1EFT, YJ8MP.

\* Denotes 10 metre contacts

**CW IN VK6**

3.5 — GU5BLG (DL4FF), 3.5 — ZL1AMO/C, 7 — 6Y5AG, 7 — F08BI, 7 — H5AFU, 7 — KC6SZ, 7 — TR8JD (F6AJA), 7 — YN180 (SK7HW), 7 — ZL1AMO/C, 14 — BV2A, 14 — K0TT/KHO, 14 — K1B1/3B9, 14 — UA0KJ, 14 — UA0QEU, 14 — UA00FU, 14 — UJ8JLB, 14 — ZL1AMO/C, 21 — 5H3TM, 21 — FB8Z0, 21 — K1B1/3B9, 21 — ZL1AMO/C.

**THANKS**

Assistance with information for these notes has been forthcoming from amateurs including VKs 1MM, 2PS, 3BY, FR, UX, YJ, YL, AXQ, 4FB, AGW, 6FS, HD, IT, NE and Eric L30042. Overseas amateurs who assisted included G3NBC, ON7WW, ZL1AMN, ZL1AMM and 9H4G. Research from magazines including HOW'S DX, DX NEWSLETTER, QRZ DX and Jan and Jay O'Brien's QSL Managers List. The closing date for information for the August issue is 23 June. Thanks to all contributors.

AR

*Time is slipping  
away*

*Join a new  
member today*

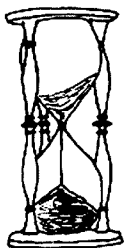

OVER 33,000  
CHANNELS

# JIL SX-200



JIL  
REGD™

More than thousands of  
frequencies including  
the AIRBAND  
and Australian Low-  
band.

■ Now available, 32 Memories  
and auto AM on CB/MARINE  
and AIRBAND.

NEW RANGE  
OF  
ACCESSORIES  
See over.

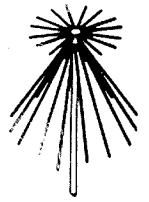
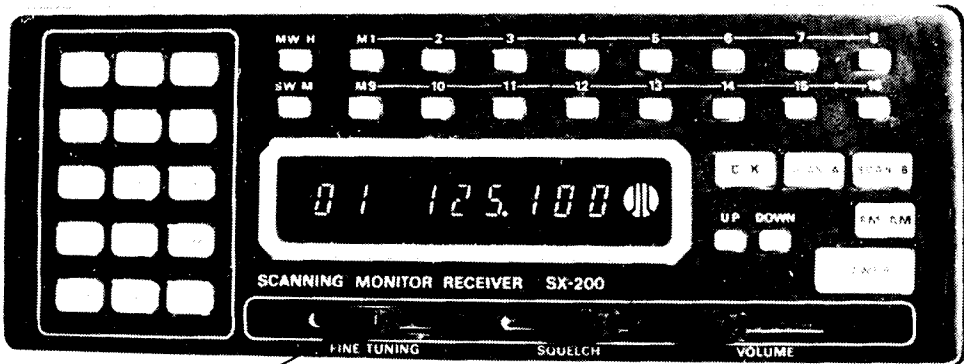

A range of accesso-  
ries is available in-  
cluding Broadband  
or High Gain BASE  
Antennas.

■ FINETUNING for coverage of all  
Australian channels on VHF Low.

## THE ONLY SCANNER THAT GOES 26-88, 108-180 & 380-514 MHz

### SPECIFICATIONS

- Type: FM & AM
- Frequency Range: a) 26-57.995 MHz Space...5 kHz  
b) 58-88 MHz Space...12.5 kHz  
c) 108-180 MHz Space...5 kHz  
d) 380-514 MHz Space...12.5 kHz
- Sensitivity: FM..a) 26-180 MHz 0.4uV S/N 12 dB  
b) 380-514 MHz 1.0uV S/N 12 dB  
AM..a) 26-180 MHz 1.0uV S/N 12 dB  
b) 380-514 MHz 2.0uV S/N 12 dB
- Selectivity: FM.....More than 60 dB at -25 kHz  
AM.....More than 60 dB at -10 kHz
- Dimensions: 210 (W) x 75 (H) x 235 (D) mm  
8-1/4 (W) x 3-1/4 (H) x 9-1/8 (D) in.
- Weight: 2.8 Kgs.
- Clock Error: Within 10 sec./month
- Memory Channel: 16 Channels
- Scan Rate: Fast .....8 Channels/sec.  
Slow .....4 Channels/sec.
- Seek Rate: Fast .....10 Channels/sec.  
Slow .....5 Channels/sec.
- Scan Delay: 0, 3 or 4 seconds
- Audio Output: 2 Watts
- Ant Impedance: 50-75 ohms  
Whip or External Antenna with  
LO/DX Control (20 dB ATT.)
- Freq. Stability: 26-180 MHz ... Within 300 Hz  
380-514 MHz ... Within 1 KHz

The JIL SX-200 represents the latest **STATE-OF-THE-ART** technology in the development of Scanning Monitor Receivers. It has many features that previous have not been available on receivers of its type.

For example the tremendous frequency coverage, which encompasses all of the following bands:— **HF & UHF CB, 27 & 155MHz MARINE, Australian LOW BAND, AIRCRAFT band, VHF SATELLITE band, 10Mx, 6Mx, 2Mx and 70CMx AMATEUR, VHF HIGH BAND and UHF TWO-WAY band** — as well as many others. Other features include detection of **AM** or **FM** on all bands. Squelch Circuitry that can be used to **LOCK OUT** carrier only signals. Fine Tuning control for off channel stations. **240 VAC** plus **12VDC** operation, Squelch Operated Output that may be used to trigger a tape recorder or channel occupancy counter and accurate Quartz Clock.

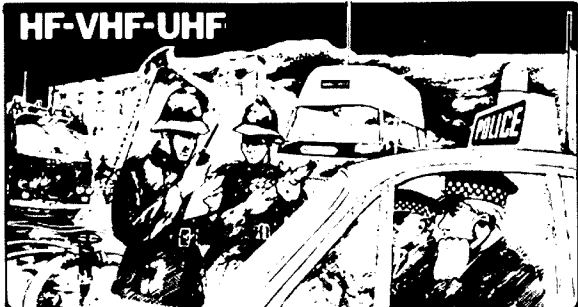

**\$599**

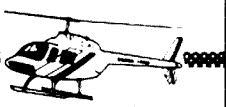

plus \$10  
P & P

### ACCESSORIES

- Service Manual \$12 + \$2 P&P
- Scan-X Base Antenna \$62 + \$10 P&P



# JIL SX-200

# A BETTER SCANNING MONITOR RECEIVER

## HIGH QUALITY AND PERFORMANCE

JIL have designed the SX-200 as a high quality, high performance programmable scanning receiver at a realistic price, design criteria which are not born in many other receivers of its type.

## MECHANICALLY RUGGED

The JIL SX-200 is ruggedly built using EPOXY-GLASS printed circuit board and double sided through hole plating techniques. Easy access and servicability is maintained throughout its design.

## 4 BIT MICROPROCESSOR WITH ONBOARD ROM AND RAM

A powerful 4 Bit PMOS Microprocessor, the uPD553, is used as a controller in the SX-200. Its features include 2000 x 8 ROM and 96 x 4 RAM onboard as well as up to 80 instructions with a 3 level subroutine stack.

## EXTREMELY LOW SPURIOUS COUNT

Even though the SX-200 covers over 33,000 Channels JIL, through careful design, have been able to reduce the number of internally generated spurious signals to an extremely low level. Not the case in most other scanning receivers.

Monitor thousands of frequencies including many Military & Civil

**HF-VHF-UHF**



## FULLY TRACKED RF AMPLIFIERS

The SX-200 makes use of 3 separate RF Amplifier Stages. They are divided into 6 bands, each band having its own electronically switched coils which are fully tracked with the receiver frequency using Varicap Diodes. Maximum performance is thus gained over the entire operating range of the set.

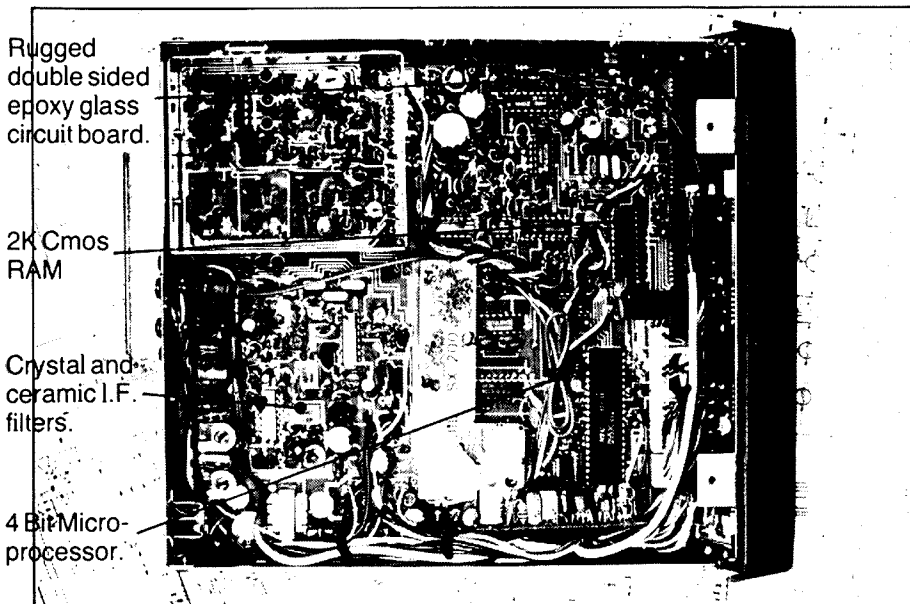

**SX-200, RUGGED CONSTRUCTION AND EASY SERVICABILITY.**

## NEW ACCESSORIES

### ■ EXP-32 KIT

Increase the memories of your SX-200 to 32 with this memory expander kit.  
\$53 + \$2 P & P

### ■ A4-AM KIT

Provides automatic AM operation on the 27 MHz CB MARINE and AIRCRAFT bands.  
\$32 + \$2 P & P

### ■ CVR-1B CONVERTER

allows your SX-200 to cover 180 to 380 MHz (Incl. SPACE SHUTTLE frequencies).  
\$199 + \$5 P & P

### ■ CVR-2 CONVERTER

allows your SX-200 to cover the SHORT WAVE bands, 0.55 to 30 MHz.  
\$189 + \$5 P & P

### ■ MFJ-332 VLF CONVERTER

allows your SX-200 to cover 5 KHz to 1600 HKz  
\$144 + \$5 P & P

## AVAILABLE FROM

W.A.: Letco Trading Co. (09) 387 4966, N.S.W.: Emtronics (02) 211 0531, QLD: CW Electronics (07) 397 0808, S.A.: Jensen Intersound (08) 269 4744. Plus many other regional outlets, contact CFS for your nearest stockist.

AUSTRALIAN AGENT & DISTRIBUTOR

**GFS ELECTRONIC IMPORTS**

Division of GD & JA WHITER PTY. LTD

15 McKean Road, Mitcham, Vic. 3132

PO Box 97, Mitcham, Vic. 3132

Telex: AA 38053 GFS

Phone: (03) 873 3939, 873 2652

# AWARDS

Mike Bazley VK6HD  
FEDERAL AWARDS MANAGER  
8 James Road, Kalamunda, WA 6076

*As can be seen, with forty nine awards issued and thirty six DXCC amendments during the past three months, yours truly has been kept quite busy. Once again, if I may remind those who are writing in, a stamped addressed envelope cuts down my work load. Cannot afford twenty seven cents? Well even a self addressed envelope helps a lot.*

Every six months this column lists all those stations who have a claimed DXCC score of over 275. A look at the March awards column should convince the majority that there seems to be a large number of calls over this magic figure. I personally believe that this total should not change, particularly if it has been the goal of a number of members over the years. The alternative is to delete from the listings any person who has not amended their totals over the past two years. If you are in this latter category and wish to remain in the listings, please drop me a line. The next DXCC top listings are due to be published in September AR. My deadline for this issue is mid July.

## AWARDS

Awards issued and amendments made during period 5 January 1983 to 22 April 1983, are listed below.

### WAVKCA AWARD

CALLSIGN	CERT NO	PA3AZF	1127
VE2DPJ	1109	JF1PHJ	1128
JA1NAQ	1110	JJ1VRO	1129
JA4VZX/3	1111	WD5HEG	1130
G4GED	1112	VK6PY	1131
W7HZL	1113	VK5GZ	1132
JA10MS	1114	JA6VNR	1133
JA8UFD	1115	JR7OEF	1134
K8IAI	1116	JH5HCP	1135
JE2GAL	1117	JH1NPX	1136
JA8CRE	1118	ZP5CF	1137
OK1AVE	1119	G3BRD	1138
VK3KHI	1120	I0SGF	1139
ZL2BHS	1121	UA2FBZ	1140
JG3NVJ	1122	UC2AFE	1141
JA1TD	1123	UA0LL	1142
JA1DNQ	1124	UB5UCH	1143
Y46XF	1125	UK9OAZ	1144
ZS2SI	1126	UA90DK	1145

### HAVKCA AWARD

UA9-145-197 67

### VHFCC AWARD

VK60X 115

### WAS (VHF)

AWARD  
VK60X 153

### DXCC NEW MEMBERS

PHONE	CALLSIGN	CERT NO	TALLY
VK5ARO		310	100
VK2DDD		311	103

VK2DVU	312	100
VK2PBK	313	125
VK3DMR	314	100
VK2AKP	315	250/252

### OPEN

VK3DAN	215	100
VK5AOK	216	100
VK3PU	217	105
VK3AHK	218	101/106

### DXCC AMENDMENTS

PHONE	CALLSIGN	TALLY		
VK2FD	211/212	VK5MS	314/361	
VK2PY	188	VK6AJW	270/272	
VK2VBL	194	VK6FS	293/297	
VK3BLN	279/283	VK6HD	306/317	
VK3DFD	275/276	VK6NE	299/309	
VK3NLS	157/159	VK7BC	282/287	
VK3OT	294/298	VK7LZ	307/327	
VK4RF	303/316	VK9NYG	153	

### CW

VK3BLN	174/176	VK6HD	273/286
VK3YD	289/324	VK6RU	261/303
VK4RF	281/305	VK7BC	151/156
VK5ARA	131	VK7LZ	271/304

### OPEN

VK2QL	308/351	VK5ARA	223/224
VK3AXQ	155/160	VK5GZ	117
VK3BLN	283/287	VK6FS	294/298
VK3NLS	171/173	VK6HD	311/329
VK3OT	297/301	VK7BC	298/305
VK4RF	309/336	VK7LZ	309/344

## THE FRANKSTON AND MORNINGTON PENINSULA AWARD

FAMPARC introduces a new world wide award which is divided into three levels. The basic award, level 3, will be named "The Coastal Towns 100 Award". Please note that it is not 100 coastal towns. The number 100 qualifies the amateurs worked, or heard around the Australian Coastline.

### GENERAL

- 1) The award is available to all licenced amateurs world wide. It is also available to SWLs on a heard basis.
- 2) Contacts after 1st January 1980 are valid.
- 3) GCR rules apply ie all log extracts must be certified by two licenced amateurs, an AR club official or a Notary Public.
- 4) Stations from net operations are not

## FRANKSTON AND MORNINGTON PENINSULA AMATEUR RADIO CLUB COASTAL TOWNS 100 AWARD

This document certifies that \_\_\_\_\_  
owner and operator of Amateur Radio Station \_\_\_\_\_  
has submitted satisfactory evidence of two-way radio communication  
to qualify for the COASTAL TOWNS AWARD, LEVEL No. 3.

Date \_\_\_\_\_

Club President \_\_\_\_\_

Awards Manager \_\_\_\_\_

acceptable.

- 5) Level 3 is the basic award and must be worked before levels 2 and 1.
- 6) A spot check for each award will be made.
- 7) All modes and all HF bands may be worked.

#### SPECIFICS FOR LEVEL 3

- a) There is no distinction between towns or capital cities — so long as the town/city/suburb is on the coast or river estuary, it qualifies for the award.
- b) A minimum of five coastal towns/cities from each of VK2, VK3, VK4, VK5 and VK7 with at least three coastal towns/cities from VK6 and three separate contacts from Darwin (VK8).
- c) A minimum of ten separate contacts from VK2 to VK7 inclusive must be made.
- d) To qualify for the basic award one only contact must be made with Frankston (VK3).

#### LEVEL 2 — SEAL — PORT PHILLIP BAY AWARD

- 1) The award is available to all licenced amateurs world wide. It is also available to SWLs.
- 2) Fifty contacts from towns around the perimeter of Port Phillip Bay must be made on two only of the HF bands with a minimum of five contacts on each band.
- 3) A station may be worked twice, once on each band.
- 4) Six of the following towns must be represented: Frankston, Mornington, Rosebud, Chelsea, Rye, Carrum, Sorrento, Mordialloc, Seaford, Altona, Port Arlington, Williamstown, Geelong, Queenscliff.

#### LEVEL 1 — SEAL — CAPE SCHANCK AWARD

- 1) The award is available to all licenced amateurs world wide. It is also available to SWLs.
- 2) All HF bands and modes.
- 3) Fifty contacts with amateur stations on the Mornington Peninsula must be made by VK, ZL, and P29.
- 4) DX countries require twenty contacts.
- 5) A station may be worked twice on different bands.
- 6) There must be at least three contacts with FAMPARC members.

Log extracts must contain: Date, UTC, Station, Signal reports, QTH, Band and Mode and must clearly show the name, callign and QTH of applicant.

Basic Award Level 3 fee is \$3 US or Australian. For successive awards \$1 US or Australian plus a SAE with three IRCs.

For overseas countries lists of coastal towns may be obtained from the Awards Manager of receipt of a SAE and three IRCs. For VK SASE only.

The Award is of average size and printed in black on a bright yellow background.

All applications with log extracts to be forwarded to — PO Box 38, Frankston 3199, Victoria, Australia.

AR



# TRY THIS with the Technical Editors

## COAXIAL CABLE BRAID PREPARATION

*Most coaxial cable terminations require the braid to be straightened out. Whilst it is possible to do this strand by strand, there is an easier way.*



The wire strands may be brushed out very neatly with a wire brush. This is analogous to brushing hair.

Use the wire brush to straighten out the strands a little at a time, rotating the cable as you do this, brushing right around the circumference. The brush strokes should be in line with the cable.

Remember to advance slowly so as not to stress the wire strands of the braid unduly. You will soon have the braid fanned out or brushed out just as you see it in all the diagrams showing how to fit coaxial connectors.

This technique is also useful for other terminations where braid and inner conductor must be separated out.

Just a little practice and care will give a professional looking result that anyone would be proud of. Just the trick for PL259s, Type N, BNC and any other coaxial cable termination.

The accompanying photos illustrate and explain the technique.

AR

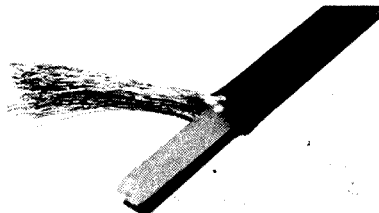



# HERE'S RTTY!

Bruce Hannaford VK5XI  
57 Haydown Road, Elizabeth Grove, SA 5112

## THE MECHANICAL RECEPTION OF RTTY

As explained in earlier articles when teleprinter machines, normally used on land lines, are used for radio reception the audio tones coming from the radio receiver must first be converted to pulses of direct current. The audio from the receiver is fed to a demodulator that converts the audio tones into on/off switching. The demodulator switching circuit is connected to the teleprinter through a DC power supply called a loop supply, the switching circuit, the Power supply and the teleprinter all being connected in series. By this arrangement the on/off switching in the demodulator will produce DC pulses through the teleprinter machine. As the incoming DC pulsed signal has very little energy in it, this fraction of a watt is only useful to trigger into action mechanical energy available from the machine's electric motor. Just as it only requires minute energy to pull the trigger of a rifle and then tremendous power is released, so the small incoming signal can trigger large amounts of mechanical power available from the machine's electric motor. As there are many makes of machines, all using somewhat different systems, the following description is of a simple hypothetical machine that serves to illustrate elementary principals.

The heart of the mechanical teleprinter receiving machine is a selector electro-magnet with its armature. This selector is rather like a large relay: when sufficient current flows through its coils the armature is closed and at other times it is opened by a spring. The armature does not work electrical contacts as in a relay instead it has projections on it that are used to trigger various mechanical actions. To function properly the armature must faithfully follow the incoming pulsed signals. The armature must be closed for mark and open for space (mark is current flow and space no current flowing).

This armature is used to control the starting and stopping of a one turn clutch connected to a receiving shaft and also controls the positioning of five code bars into either mark or space positions as the shaft turns. Firstly let us consider the one turn clutch. When the receiving machine is at rest with no signal being received a continuous mark current is flowing. When an incoming character signal is received such as a letter or figure this mark current is interrupted according to the teletype code. The first Part (or bit in computer

jargon) of any such signal is always a space so with no current flowing the armature is released and this triggers the one turn clutch into engaging and the receiving shaft starts to turn.

Once this turning commences it will continue for one turn regardless of any further signals or the absence of them as it turns. Coming to the end of its revolution normally a mark stop signal is received and the receiving shaft will then come to rest. The shaft will remain at rest until the next space signal is received. If the person at the distant transmitting station is typing very slowly the receiving shaft will be at rest for a considerable time between each letter typed. If the typing is at the machines maximum speed there will be only an extremely short rest between letters. This short rest period at the end of the reception of each character signal is necessary to achieve perfect synchronisation as it is not possible to have sending and receiving machines adjusted to one exact speed at all times.

The receiving shaft is geared slightly faster than the sending shaft in a combined send receive machine. As receiving shafts are slightly faster than sending shafts they finish their one turn a little earlier and will then stop and wait a brief moment until the sending shaft catches up with them. In other words these short waiting periods ensure that the receiving shaft always starts at the same exact time that the sending shaft sends the space starting signal and slightly inaccurate speed settings will not become a major problem. So we see that the starting and stopping of the receiving shaft is controlled by the armature of the selector and this in turn is controlled by the distant sending machine.

Now let us deal with the second function of the armature as it controls the positioning of the five code bars. The positioning of these bars determining what letters, figures etc are to be printed or what machine functions are to take place. It will be helpful to think of the one turn receiving shaft as a sort of mechanical rotary switch with seven segments. As the shaft rotates each segment in turn is exposed to the controlling action of the armature and the armature position is used to trigger various mechanical actions. The first of the seven segments is traversed as the starting pulse is received. The next segment is the first of five code segments that determine what is to be printed etc. As each code segment is reached in turn, the position of the armature at that time determines what triggering signal is given to the code bar associated with that segment.

A mark signal moves the bar into a mark

position and a space signal moves it into a space position. At the end of the revolution some bars will normally be set to mark and some to space according to the signal received and these positionings have been controlled by the incoming signal from the distant sending station. In computer language a serial code signal has been converted into a parallel code positioning of code bars. As the code bars control what is to be printed etc let's study them more closely. In their simplest form the bars are parallel to each other and close together, they run from left to right across the machine as viewed from the operator's position. As they are positioned to mark or space they slide slightly to either the left or right so for almost all character signals some will be to the left and some to the right.

These bars have slots in the top of them and above the bars and resting on them are printing control levers. These levers are at right angles to the code bars and so run towards or away from the operator's position. Each printing lever controls the printing of a particular letter etc and they are arranged in an evenly spaced row along the top of the code bars from left to right. For simplicity I have called all these "printing levers" but a few of them don't print anything but instead control some machine function such as carriage return or line feed.

The slots in the top of the code bars are so arranged that for each of the thirty-two possible coded combinations of the five bars the slots will only line up at one point under one printing lever. When this happens this particular lever will drop into the five slots and adopt a lower position than all the other printing levers. Underneath each printing lever is a projection that will be struck by a printing bail that sweeps past under the printing levers once for each revolution of the receiving shaft. The Printing bail will strike only one lever as the others have not dropped down into its path. When the printing bail strikes the printing lever this letter, figure etc is printed. This printing action commences at the end of the revolution of the receiving shaft. In the case of the levers that don't print anything, when the printing bail strikes them their movement controls some machine function such as carriage return where the machine will then start printing a new line in the left of the page.

In the foregoing for simplicity sake I have left out the fact that in typical machines only a small portion of each signal pulse or bit is used in the receiving of character

## OLD TIMERS MEET AGAIN



Photograph by Peter Brown VK4PJ

The VK4 Old Timers met again at Coorparoo in February. L to R: Jim McDermott, Ralph Pepper, Perc Wood, Arthur Walz, Fred Matthews, All Bauer, Steve Fittell, Norm Odgers and Jack Wooster.

signals. Most machines have a control called a range finder that controls what part of each pulse or bit is used and this is very handy when signals are distorted in some way. So if the first part of the signal pulse is distorted you can sample a later part or if the last part is distorted you use the earlier part. Usually the sample is taken near the middle part which normally gives best results. An additional use of the range finder is that to some extent it can be used to get better copy of signals that are slightly off speed.

Well, in this very elementary description I have left out many important details, however I trust those who previously had no idea of how things worked will now at least be able to picture with some accuracy what takes place in a typical machine.

### RE THE 1983 RD CONTEST

As I mentioned last month I am endeavouring to encourage RTTY participation in this contest and have been busy writing many letters for this purpose. How about letting your state RTTY club know that you intend to use RTTY in the contest or let me know direct. I am trying to compile a list of those who intend to participate using RTTY.

On a personal note I now have a large World War 2 transmitter that I have slightly modified for RTTY and intend to use in the 1983 RD Contest. So if you would like to work an ex WW2 Army Signaller on RTTY using a WW2 transmitter look for VK5XI.

73 to all from Bruce VK5XI .....

AR

## WCY CELEBRATIONS IN VK4

*Australia Post is celebrating World Communications Year 1983 by inviting former employees and others with Morse code experience to test their skills in a special competition to be held in the Brisbane GPO Museum during June.*

Testing will be held with finalists competing for awards which will be made to the most proficient sender, receiver and all-rounder.

A special function has been arranged for the presentation of prizes at 5 PM on Friday, 1 July, in the Telecommunications Staff Cafeteria, Telecom's Communications House, Brisbane.

Application forms are available from the GPO Museum or by writing to the Secretary of the Postal-Telecommunications Historical Society, GPO Box 6000 Brisbane, Qld 4001.

The competition judging will be restricted to Brisbane during June because of the availability of Morse keys.

Queensland's first telegraph line between Brisbane and Ipswich was opened on 13 April, 1861. Morse remained an integral part of the communications system in Queensland until 1964.

This competition is designed to salute the many thousands of telegraph operators who pioneered the establishment of the

earliest form of modern communication to the most remote parts of the state.

Although Australia Post is holding this Morse Competition in Brisbane only, it is hoped that anyone, male or female, from any part of Australia and who happens to be in the Sunshine State during June, will come along and pound a little brass. The rules don't specifically say it but bring your own key, hand or 'bug' if you wish, as I imagine there's nothing to stop you from using it.

No matter if you're rusty or out of practice — or past your best. Most OTs, professional and amateur, are now over their peak. I urge all brasspounders, or sideswipers, or 'idiot stick' fiddlers to be in it, for old times sake — also, there's no age limit, 8-80.

If, regretfully, you can't participate, come along anyway and see the Museum — it's certainly worth it and *all* will be made most welcome!

Alan Shawsmith, VK4SS

AR



1983

1983 World Communications Year

### MORSE COMPETITION

The purpose of this competition is to celebrate the 125th anniversary of the invention of the Morse code and to encourage the use of Morse code in the future.

Prizes will be awarded to the most proficient sender, receiver and all-rounder.





# VHF UHF - an expanding world

Eric Jamieson VK5LP  
10 Quinns Road, Forrester, SA 5233

All times are Universal Co-ordinated Time, indicated as UTC.

## AMATEUR BAND BEACONS

FREQ	CALLSIGN	LOCATION
50.005	H44HIR	Honiara
50.008	JA2IGY	Mie
50.020	GB3SIX	Anglesey
50.060	KH6EQ1	Pearl Harbour
50.075	VS6SIX	Hong Kong
51.020	ZL1UHF	Auckland
52.013	P29SIX	New Guinea
52.100	VK0AP	Macquarie Island
52.200	VK8VF	Darwin
52.250	ZL2VHP	Palmerston North
52.300	VK6RTV	Perth
52.320	VK6RTT	Carnarvon
52.350	VK6RTU	Kalgoorlie
52.370	VK7RST	Hobart
52.420	VK2RSY	Sydney (1)
52.425	VK2RGB	Gunnedah
52.435	VK3RMV	Hamilton
52.440	VK4RTL	Townsville
52.470	VK7RNT	Launceston (2)
52.510	ZL2MHF	Mt Climic
144.400	VK4RTT	Mt Mowbullan
144.420	VK2RSY	Sydney (1)
144.465	VK6RTW	Albany
144.475	VK1RTA	Canberra
144.480	VK8VF	Darwin
144.550	VK5RSE	Mt Gambier
144.600	VK6RTT	Carnarvon
145.000	VK6RTV	Perth
147.400	VK2RCW	Sydney
432.410	VK6RTT	Carnarvon
432.420	VK2RSY	Sydney (3)
432.440	VK4RBB	Brisbane
432.450	VK3RMB	Mt Buninyong

- 1 The VK2WI callsign for the 52 and 144 MHz beacons in Sydney has now been changed to VK2RSY.
- 2 The Launceston beacon has changed frequency to conform to the WIA band plan, and is now found as above.
- 3 This is a new beacon in Sydney carrying the same callsign as the others.  
For further information on the Sydney beacons see below.

## THE SYDNEY BEACONS

The Dural Property Officer, Jeff Pages, VK2BYY, has written some interesting information on the VK2 beacons and I pass the following on to you.  
"The new licence for the Sydney beacons has now been received. The callsign for all the beacons is now VK2RSY, and the 70 cm beacon is at last on the air on 432.420 MHz. This beacon runs about fifteen watts into a pair of horizontally polarised crossed dipoles

at a height of twenty metres above ground. Frequency shift keying is used for identification. The licence also included provision for a 1296 MHz beacon, and construction is now under way. The frequency will be 1296.420 MHz.

"The antenna of the 2 metre beacon has been replaced resulting in much improved performance. The original antenna collapsed last year and was replaced with a temporary antenna, which had also seen better days, until the new antenna could be completed.

"We are continuing to receive many reports from overseas on our 10 metre beacon, particularly from Europe. Since the beacon went to air at the beginning of 1981 we have received nearly 100 QSL cards. We have also received quite a number of cards from JA confirming reception of the 6 metre beacon.

"Looking down the latest beacon list I notice that many beacons are still not on their 'proper' frequencies. A particular problem is VK6RTT on 52.320 MHz, the secondary VK2 frequency, and there are moves to apply for a 6 metre beacon in the Newcastle area."

Thanks for the letter Jeff. The custodians of the VK6RTT beacon might note the above comment in regard to the 52.320 frequency, and assess the position with a view to making a change in due course and thus allow the proposed Newcastle beacon to start on its 'proper' frequency!

I would hope that when the VK5 beacons are finally set up again that they would be on the frequencies assigned by the band plan. However, any suggestion of this in South Australia brings about a violent reaction in certain quarters because of possible desensitising of receivers in the prime VHF areas of Adelaide, largely due to the commanding position the beacons have on Mt Lofty. So what do you do? You can't win!

## SIX METRES

The month has certainly seen some ups and downs on the band, mostly downs I would venture to say in the southern areas. Several brief openings to Japan, more on 50 rather than 52 MHz. One bright spot for VK5 was the reception of KH6IAA on 50.110 at 0355 on 16/4. Al came up on the band in response to a request from Col VK5RO as Al was pretty good on 28.885 at the time. Signals on 50.110 were rather weak so there was little likelihood of a contact emanating on 52 MHz.

15/4, 16/4 and 17/4 saw some extended periods of Es activity between VK2,3,4 and 5 depending on where you live! VK2 and VK4 were the main signals into VK5.

15/4: Ross VK4RO reported strong signals from JA1 and JA3 between 0443

and 0503, and VK2 were working ZL. I heard on the grapevine that VK2DDG and possibly others worked KH6IAA around 0330.

16/4: A good Es day, with strong signals from VK2. VK2DDG said to have worked KH6IAA. At 0410 VK8GB was S4 at KH6IAA on 52.050 CW, and subsequently a contact emanated. KH6EQ1 noted on 50.060. VK4RO (Ross) reported very strong signals from H44HIR, and Ross worked Peter H44PT with very strong signals both ways. In fact, Ross had no trouble working Peter even when he used his handheld rig! Ross also worked VK2,4 and 5, and reported the MUF only rose to 51 MHz and not 52 MHz on the JA path. Heard JA6 on and off, short openings, between 0300 and 0400. A P29 was reported active and working VK2 and VK4. Nothing heard from W, the MUF not being high enough.

17/4: H44PT worked VK4RO 5 x 9 at 0600, and other stations in the Townsville area mainly, namely VK4JH, VK4ZYA, VK4ZHO, around 0500. VK4RO to VK5LA (Woomera) at 0612 5 x 9. At 0800 VK4RO to H44PT again, Peter still hearing the Townsville beacon as late as 0850. The band was open to H44 for more than three hours. VK4RO to VK2ZQX at 0801, VK2DOA 0810, VK4KAA at 0818, finishing this contact with VK4KAA on 80 metres (what!!) cross-band because of Ch 0 problems at his end! Also worked VK4PU 0834.

## TWO METRES IN THE NORTH WEST

Dennis Hardie VK6KOZ has sent along some good information on 2 metre activity in the North West of Western Australia, describing it as fantastic, and regular contacts are being made between Exmouth, Karratha, Wickham, Port Hedland and Derby both direct and through repeaters. Exmouth to Karratha is 320 km; Karratha to Wickham 30 km; Wickham to Port Hedland 170 km; and Port Hedland to Derby 630 km. He goes on to say:

"On Saturday 2/10/82 we were having trouble with apparent pirate activity on our repeater transmit frequency 147 MHz. Later in the day you could make out words which were obviously Indonesian. Mark VK6WV was the first to make contact when he finally got a call sign and broken English coming back to his call. Harry YD9BC and Gede YD9BR in Denpasar on Bali asked us to QSY off their official Police Frequency! At this point we closed down the repeater to prevent more interference on their band. (Lots of Port Hedland people holiday in Bali.)

"Contact was continued direct on 146.500 MHz with two way signals averaging from 5 x

5 to 5 x 9 with powers ranging around 10 to 80 watts and antennae from a vertical 5/8 at 15 metres to a 4 element quad at 20 metres. On Sunday they were there again and over the two days stations from Port Hedland, Brian VK6AIH, Dennis VK6KOZ, John VK6AFA, Mark VK6WV; from Wickham, Pattie VK6SL; Karratha, Dave VK6YA, Scott VK6KES, John VK6KOJ, Nigel VK6KHD and from Exmouth Steve VK6ASF worked into Indonesia over a path of 1350 to 1400 km.

"Over the next few days we often heard interference to our repeater and someone would drive out to the Club and shut it down. I see by my log that on 13/11 they were 4 x 1 direct. Further contacts were made with Harry YD9BC and at times Brian VK6AIH could receive some of the Indonesian TV stations. Brian is on a small hill right on the coast and used eighty watts to a four element quad at 20 metres so is in the best position for 2 metres. He worked Indra YD9BAI and Jayaprana YD9BAR in Denpasar on 22/10 with 5 x 9+ signals both ways!

"The next contact I made with Indonesia was 22/1/83 at 0834 5 x 1 with Syahrir in Lombok with a call sign of J609; it is not known for sure if this is an amateur callsign.

"Around February 1983 Indonesians were again breaking through but this time on all three repeaters. They were asked to QSY off the Wickham repeater (146.100 MHz input) as the batteries were getting run down, again a number of our amateurs worked them with good two way reports. Since then, activity has been restricted to the local area, working Derby through the Wickham repeater etc.

"Now that we are aware of the two metre DX we are now better prepared, people turn antennas to different directions and scan the band more often so next year when the DX bands open up who knows what we will find."

Wickham repeater operates on Channel 2; Karratha Channel 4; Newman Channel 6; Port Hedland Channel 8.

### MOONBOUNCE REPORT

Lyle VK2ALU in "The Propogator" advises that Barry VK2ZAG had the satisfaction of seeing the newly set up dish moving in both Hour Angle and Declination under its own power on 26.3, largely as a result of some forty hours of his wiring work, and earlier motor replacement and gearbox repairs by Wojciech.

Another step forward was on 26.3 when the feed tripod, made up of 6 metre long tubes, was installed in the dish by a four man team under the leadership of Ian VK2EXN, who had made up the apex plate and tube plug arrangement for the tripod.

Construction of the transmitter 1296 MHz low level driver stage is now well under way and more useful information has been received on another type of GASfet low noise receiver preamplifier. It is intended to make up one of this type and one of the W6PO design to compare results and to provide the necessary preamplifier — postamplifier stages for the receiving system.

So it appears something is now being seen for the fruits of their labours by this loyal band of people who have had to go to so much extra work in shifting the original dish because of vandalism.

### NEWS FROM TASMANIA

Joe VK7JG has written to fill in the

blanks in the information occasionally received from VK7, and reports as follows:

"VHF activity is almost non-existent in VK7 except for the 2 metre VK3 to VK7 'inversion' contacts.

"However, quite a lot of construction has been going on. We now have a UHF repeater VK7RAB, Tx 438.625, Rx 433.625, situated on Mt Arthur at 1128 metres asl giving excellent coverage of Launceston and the North West coast. The equipment is a modified Icom IC400 and running twelve watts to a VK7JG diplexer and VK7JJ antenna array, receiver as standard 12 dB SINAD at 0.6 uV. We are at present working on a replacement unit using an AWA 15M fitted with a twenty five watt PA and GASfet pre-amp and possibly two aerials, thus eliminating the losses in the diplexer.

"The antenna is rather unusual, designed and constructed by VK7JJ. It consists of a coaxial dipole fitted with two sets of directors and a reflector. It gives a cardioid pattern with a 20° beam width, and a null of about 55 dB at the back. The aerial is orientated to put the two major lobes towards the North West coast and Hobart. Launceston is only 20 km away. We hope to stack a pair of these, one receive and one transmit, within the next six months.

"The repeater is solar powered, using 3 x 2.2A Lucas panels and 105 AH battery, being shared with a commercial system. The next repeater will incorporate an 'economiser' to reduce the standby current consumption.

"VK7REC (Tx 146.9, Rx 146.3) is a repeater situated on Snow Hill elevation 823 metres, giving excellent coverage from Hobart to Launceston and parts of the East and North West coast.

"Equipment is a 'Tait' VHF High Band mobile unit fitted with remote hi-lo power switching plus several other functions. Power out is fifteen watts hi, five watts lo. Receiving sensitivity 0.2 uV for 12 dB SINAD at the input to the cavity filter system. Tx antenna is a 'plumbers delight' as per ARRL Handbook, Rx antenna AEA Isopole. Tune up and alignment by VK7JG; callsign generator and construction by VK7JJ; remote command system by VK7ZBA; Filters construction and alignment by VK7PF; installation by VK7ZBA. This repeater is also solar powered, and once again sharing its solar panels and batteries with two other commercial systems.

"A novel feature of the callsign generator is that its tone is voltage dependent, and by listening to the pitch of the tone we have some idea of the state of charge of the batteries. And VK7RAB is to be fitted with a voltage to frequency converter, thus exact battery voltage can be determined by the tone of the callsign.

"A UHF repeater is under construction for the Hobart area and one on 438.600 for the Central Highlands." Thanks for writing Joe.

### OVERSEAS ON SIX METRES

It is interesting to look over some of the listings of contacts made from Japan during the period 24/10/82 until 28/2/83, a period including the northern hemisphere winter when one would have expected less contacts, but they still seem to keep coming.

I am indebted to the Japanese "CQ ham radio" magazine per kind thought of Graham VK6RO for the following. Through-

out the period contacts have been made with VK stations somewhere on almost every day, mostly to VK4, VK6 and VK8 but quite a sprinkling of VK2, VK3, VK5 and VK7. Apart from these, other exotic call signs have included KG6JDX, P29ZSA, P29ZFD, VS6BT, VK9ZYX, H44PT, KB7IJ/KH2, P29QA, YB30N, 4D1PJS, KG6DX, WA4TNV/KL7, VS5DX, PY5AQ, LU7DZ, LU3EX, VS6XMQ, DU1JZ, DU1WEN, LU9DER, LU2DEK, LU1FDQ, PP5WL, LU3DCA, CX4BA, LU4DGN, LU9AEA, CX9BBF, LU8AHW, LU6DLB, KC6IN, KH6IAA, K5EFW, WA6PEV, K7ICW, W5FF, N6AJ, N6CT, WA6BYA, K6QXY, WB6VGL, K6MYC, WA7JTM, WA6IJZ, WA7EPU, CE3HCE, T32AB, W6UXN, KD6PY, W6SMS, KA6ING, KB60K, WA8LLY, WA6JRA, DU1RGM, WA6THT, KH6IJ, PP5WL, LU8EEM, FK8CR, HL1XC, VS5LH, K6PXT, KH6DLW, WA7OLF, WA8LLY/6, K6JZK, WA7YWM, WB6VIM, K6UJG, WA6ELK, K6QXY, W6JKV/KHO, VS6XMT, VS6EL, VS6CT, HL2JD, HL1RB, HC2FG, VS6XLA, HL5BBB, HL1XC, HL1SB, DU1RFA, CR9CT, VS6XLP, A35GW, DU1PJS, VS6GW, VS6XNB, DU1RGM, DU1VST, YC2BSF, W6DMJ/KH6, W1XX/KH6 plus numerous contacts with ZL1, 2, 3 and 4. Many of the stations listed above were contacted time and time again, and almost without exception were on 50 MHz centred around 50.110 MHz.

In addition to the above, the following beacons were logged: VK7RNT, VK6RTT, VK8VF, H44HIR, KB7IJ/KH2, VS6SIX, P29SIX, ZB2VHF, KH6EQI, WA7TNV/KL7, ZL1UHF, VK2WI, VK2RGB, VK2BNT, VK4RTL, ZL2VHM, VK3RMV, VK6RTV, and some of these heard on many occasions. It is interesting to note that the hearing of a beacon in a certain area was then followed by quite a number of contacts to that area, indicating the beacons are serving their purpose in alerting those who are listening.

In Japan the segment 50.000 to 50.010 is exclusively CW; 50.010 to 50.100 CW and RTTY; 50.100 to 51.000 AM, SSB, RTTY, CW, SSTV; 51.000 to 52.000 FM, AM, SSB, CW; 52.000 to 52.500 RTTY, SSTV, FAX, AM, SSB, FM, CW; 52.500 to 54.000 FM, RTTY, SSTV, FAX, etc. FAX is also permitted between 50.100 and 51.000. Some of the segments are for narrow band FM, others allow up to 16 kHz.

My reading of the Japanese language is not too good, but from "CQ ham radio" per VK6RO, February 1983 edition, there is an outline of the contacts made by JE1JKL who was 5Z4CS from September 1981 until November 1982, and worked A35JT, EL2AV, EL2FY, H44PT, JH6, JA6, JA4, JH4, JR6, KG6DX, KH6HI, S22DH, P29ZFS, PY2, PY6, PP5WL, PY4, VK8GB, YB3, YB1, YC1, YC2, YB6, ZD7BW, ZD8TC, ZS5TR, ZS6, ZS3E, ZS3AK, 5B4AZ, 8P6KX, 9Y4. In addition the following were heard FY7THF, H44HIR, HC2FG, I5TDJ, JH1ECU, JH4JPO, KH6EQI, LU3EX, PY1AA, PY2AA, VS6SIX, YC2COP, DL3ZM/YV5, 5B4CY, 9Y5LL, ZS6PW, ZS6DN, ZS6LN, ZS5VHF, ZR6AW, ZS6WI, most of the last ZS6s being beacons. It looks as though it pays to go overseas at times!

### TWO METRES EME

From Bill W3XO in "QST" and "World

Above 50 MHz" comes an interesting report of W5UWB continuing to amaze himself and the EME community by having contacts via the moon using only a single yagi, a Junior Boomer. He has completed two way contacts with K1WHS, WA1JXN/7, SM7BAE, SM2GGF, K17D, VE7BQH and WA6MGZ. All these stations have fairly large arrays except WA6MGZ who has a six yagi array.

Dave, W1WHS has done much to convince others that those with single yagis and sufficient power can have EME contacts with stations using large arrays at the other end. Dave has a huge array of 24 Junior Boomers and these have been up for 2½ years. He always finds new stations to work on every moon perigee. Particularly in Europe, there seems to be a never ending source of new stations who want to work him. During the December and January perigees, Dave contacted twenty one new stations, many of them with single yagis. Some recent QSOs include UD6DFD, UK5EDT, YU1OYK, DF0VK, KG6DX and KI1KN. Also worked was VK5MC with 589/599 signals, and a single yagi station DJ5MS with 539 both ways.

In line with the above report, it seems you chaps with your 400 watts on 2 metres to a thirteen element yagi or larger could well be in the ball park for some contacts with stations such as Dave W1WHS.

Finally, I note from "Break In" that the ZLs are having a "Six Metre Only" contest on 5/11/83, commencing about 2330 and on 3/4 December 1983 will be the VHF/SHF Field Day Contest, starting on the Saturday afternoon and continuing through until the Sunday afternoon. Anyone in Australia want to sponsor a VHF Field Day to coincide with the above? The Geelong Club tried to get a field day contest going, but it collapsed for want of support, can anyone else get people moving?

#### WILLIS ISLAND GIFT

Neil VK6NE, whilst at the Federal Convention, took the opportunity to hand over



Peter VK3FR accepts six metre equipment from Neil VK6NE.

six metre equipment to the Bureau of Meteorology for use by amateur stations based at Willis Island.

The equipment is a Yaesu FT680R and the Werner Wulf beam that was used at Heard Island was accepted on the Bureau's behalf by Peter VK3FR.

The equipment which was donated by the VK6DX Chasers Club will be permanently installed on Willis Island.

The new operator from this month through to the December changeover will be Graeme VK3DSB.

#### CLOSURE

As you can read, there has not been such a lot of general VHF activity during the past month, in fact, the March-April period this year has been somewhat disappointing, but I guess generally in line with what could be expected at this time of the Cycle.

Closing with the thought for the month: "If you want your friends to be perfect, you'll never have any." 73. The Voice in the Hills.

AR



## WHO IS THIS AMATEUR???

Peter Brown VK4PJ,  
VK4 Historian

16 Bede Street, Balmoral, Qld 4171

1928 to 1931 saw him with the experimental licence OA4FN when he was a member of the Woolloowin Radio Club. He left amateur radio for a few years to return with his present call sign in 1935.

In 1946 he was a member of VK4 Council and 1947-48 saw him as a Federal Councillor.

From 1946 to 1951 he carried out simultaneous VK4WIA broadcasts on six bands.

He went to New Guinea in 1951 and founded the VK9 Division, becoming President in 1953 a position he held until 1959.

In 1959 he returned to Brisbane with his original call sign, and later moved to Rockhampton where he founded the Central Queensland Branch, where he was President from 1961 to 1968.

Back in Brisbane he carried out VK4WIA broadcasts on 80 metres from 1973 to 1981.

When in New Guinea he figured prominently in the two searches for the YASME expedition's Danny Weil which history is preserved I believe in "AR".

He has always figured prominently in Scouting radio activities particularly Jamboree on the Air. Last year he designed, built and operated the transmitter, on 1.610 MHz, for the Scout Jamboree in Queensland.

He has been top scorer in RD Contests for VK4 and VK9. A year or so ago he was presented with the Queensland Division Merit Badge and certificate for service to Amateur radio. You are right... he is Frank VK4FN.

AR





# Still More Usable Antenna For Your Money ... PLUS 30 Metres!

*That's right, Butternut's new Model HF6V offers you more active radiator on more bands than any other vertical of comparable height at any price. The HF6V's exclusive Differential Reactance Tuning™ circuitry lets the entire 26-foot antenna work for you on 80/75, 40, 30, 20 and 10 meters, and a loss-free linear decoupler provides full quarter-wave unloaded performance on 15 metres. Better still, the HF6V can be modified —without surgery — for the remaining WARC bands when the times comes. Here are just a few of the features that make the HF6V the ideal WARC antenna for your new WARC station:*

- Completely automatic bandswitching 80 through 10 metres, including 30 meters (10.1 — 10.15 MHz); 160 through 10 metres with optional TBR-160 unit.
- Retrofit capability for 18 and 24 MHz bands.
- No lossy traps to rob you of power. The HF6V's three resonator circuits use rugged HV ceramic capacitors and large-diameter self-supporting inductors for unmatched circuit Q and efficiency.
- Eye-level adjustment for precise resonance in any segment of 80/75 metres, including MARS and CAP ranges. No need to lower the antenna to QSY between phone and cw bands.
- For ground-level, rooftop, tower installations; no guys required.

### Suggested amateur net prices:

Model HF6V (automatic bandswitching 80-10 metres) .....	\$282
Model TBR-160 (160 metre base resonator) .....	\$66
Model 30MCK (30 metre conversion kit for HF5V-II/HF5V-III) .....	\$56*

\* When supplied as part of HF6V.

### Electrical and Mechanical Specifications

**Shipping Weight:** 12 lbs/5.4 kg  
**Height (adjustable):** 26 ft./7.8 m  
**Feedpoint impedance:** nominal 50 ohms with included matching section  
**VSWR at resonance:** 1.5:1 or less on all bands  
**Bandwidth for VSWR of 2:1 or less:** entire 10, 15, 20 and 30 metre bands; 250-300 kHz on 40 metres; 30-90 kHz 80/75 metres  
**Power Rating:** 2 kW PEP/1 kW cw input 80 through 10 metres.  
**Wind loading area:** 1.5 sq ft/.15 sq m

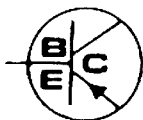

**BUTTERNUT  
ELECTRONICS  
CO.**

*For complete information concerning the HF6V and other products, amateur and commercial, contact the sole Australian distributor.*

**Traeger Distributors (NSW) Pty Ltd, PO Box 348, Cnr. Adelaide & Chester St., Moree, NSW. 2400 Phone (067) 52 1627**

### Editor's Note (CQ Review)

The Butternut HF5V-III is being phased out in favour of their new HF6V. This new antenna will eliminate the reduced power ratings of the former antenna on 80/75 metres. Ceramic capacitors are used instead of the concentric tubing capacitors, and the 10 MHz band is included. This review, although of a previous model, depicts accurately the theory of operation of the Butternut antennas both old and new. We suggest that you check their ads for any adapter kits and/or accessories.

— K2EEK



# CONTESTS



Reg Dwyer VK1BR  
FEDERAL CONTEST MANAGER  
PO Box 236, Jamison, ACT 2614

## CONTEST CALENDAR

<b>JUNE</b>	
4-5	RSGB National Field Day
11-12	World Communications Year RTTY
11-12	South American CW Test
11-13	6th VK/ZL Oceania WCY RTTY Test
11-12	ARRL VHF Test +++
18-19	All Asian Phone (Log & Rules available FCM)
18-19	Nine Lands CW Test
25-26	ARRL Field Day
<b>JULY</b>	
1	Canada Day Contest
2-3	Venezuela Phone Test
9-10	NZART Memorial Test (June AR)
9-10	IARU Radiosport Test
16-17	International QRP Test +++
16-17	SEAnet CW Test +++
30-31	Venezuela CW Test +++
<b>AUGUST</b>	
6-7	European CW Test +++
13-14	Remembrance Day Contest
13-14	DARC WAE CW Test
13-14	SEAnet Phone Test +++
20-21	SARTG RTTY Test
27-28	All Asian CW Test
<b>SEPTEMBER</b>	
3-4	DARC Corona "Corona" 10 m RTTY
10-11	G QRP Activity +++
17-18	VK Novice Test
17-18	Scandinavian CW +++
24-25	Scandinavian Phone +++

*The contests marked with +++ are not yet confirmed . . .*

## REMEMBRANCE DAY CONTEST 1983

Please note the changes

### AUGUST 13th-14th

This contest is held to commemorate those amateurs who died during the Second World War and is designed to encourage friendly participation between all amateurs and to help in the improvement of operating skills of all participants.

This contest is held annually during the weekend nearest the 15th August, the date on which hostilities ceased in the South-west Pacific area.

The contest is preceded by a short opening address on all WIA frequencies by a notable personality.

A perpetual trophy is awarded annually for competition between Divisions of the Wireless Institute of Australia. It is inscribed with the name of those who made the supreme sacrifice and so perpetuate their memory throughout amateur radio in Australia.

The name of the winning Division each year is also inscribed on the trophy and, in addition, the

winning Division will receive a suitable certificate.

## OBJECTS

Amateurs in each VK call area will endeavour to contact other amateurs:

1. In other VK call areas, P29 and ZL on all bands 1.8 through 30 MHz, except 10 MHz.
2. In any VK call area (including their own), P29 and ZL on authorised bands above 52 MHz and as indicated in Rule 5.

## CONTEST DATE

0800 UTC 13th August, 1983, to 0759 UTC 14th August, 1983.

All amateur stations are requested to observe 15 minutes silence before the commencement of the contest on Saturday afternoon. An appropriate broadcast will be relayed from all Divisional stations during this period.

## RULES

1. THERE SHALL BE 4 SECTIONS:
  - (a) Transmitting Phone.
  - (b) Transmitting CW.
  - (c) Receiving.
  - (d) Open.
2. ALL AUSTRALIAN AMATEURS (VK callsign) may enter the contest whether their stations are fixed, portable or mobile. Members and non-members of the Wireless Institute of Australia are eligible for the awards.
3. AMATEURS MAY USE THE FOLLOWING MODES:
  - Section (a) — AM, FM, SSB, TV.
  - Section (b) — CW, RTTY.
  - Section (c) — Rx A, B, C.
  - Section (d) — All modes.
4. CROSS MODE OPERATION is permitted. Cross band operation is not permitted excepting via satellite repeater.
5. SCORING CONTACTS:
  - (a) On all bands a station in another call area may be contacted once on each band using each mode. That is, you may work the same station on each of these bands on Phone, CW, SSTV and RTTY.
  - (b) All contacts score one point.
  - (c) On the bands 52 MHz and above, the same station in any call area may be worked using any of the modes listed in Rule 3 at intervals of not less than one hour since the previous same band/mode contact. However, the same station may be contacted repeatedly via satellite not more than once by each mode on each orbit.
  - (d) Acceptable logs for all sections shall show at least 10 valid contacts.
6. MULTI-OPERATOR STATIONS ARE NOT PERMITTED (except as in Rule 7), although log keepers are allowed. Only the licensed operator is allowed to make a contact under his/her own callsign. Should two or more licensed operators wish to operate any particular station each will be considered as a contestant and must submit a log under his/her own callsign.

7. CLUB STATIONS may be operated by more than one operator, but only one operator may operate at any one time, ie no multi-transmission. All operators must sign the declaration.

8. ENTRANTS must operate within the terms of their licences.

## 9. CYPHERS:

The serials number will consist of three figures that will be incremented by one for each successive contact. A contestant may start with any number between 001 and 999, but when 999 is reached he will start again at 001.

## 10. ENTRIES:

Entries must be set out as shown in the example using one side of paper only. Envelopes must be marked "Remembrance Day Contest", postmarked no later than 15th September, 1983, and posted to FCM, Box 236, Jamison 2614, and received not later than 30th September, 1983.

## 11. TERRESTRIAL REPEATERS:

Contacts via terrestrial repeaters are not permitted for scoring purposes. However, contacts may be arranged through the repeater and, if successful on another frequency, that contact counts for scoring purposes.

## 12. PORTABLE OPERATION:

Log scores of operators located outside their own call area will be credited to that call area in which the operation takes place, eg VK5XY/2. His score is added to the VK2 scores.

13. ALL LOGS shall be set out as in the example shown and, in addition, must carry a front sheet showing the following information in this order:

Section, score, callsign, mode, name and address.

Declaration: "I hereby certify that I have operated in accordance with the rules and spirit of the contest."

Signed ..... Dated .....

14. THE FEDERAL CONTEST MANAGER has the right to disqualify any entrant who, during the contest, has not observed the regulations, or has consistently departed from the accepted code of operating ethics. The Federal Contest Manager also has the right to disallow any illegible, incomplete or incorrectly set out logs.

15. THE RULING of the Federal Contest Manager of the WIA is final and no disputes will be entered into.

## AWARDS (Sections (a) and (b))

Certificates will be awarded to the top scorers in each section for each call area and will include the top limited and novice station. There will be no outright individual winner. Further certificates may be issued by the FCM at his discretion.

Certificates will be issued to top ZL and P2 scorers.

VK0 scores are added to VK7 and VK8 to VK5.

Scores by VK9 stations are added to the mainland call area geographically nearest. Scores claimed by ZL and P2 stations are not included in the scores of any VK call area. The trophy shall be forwarded to the winning Division in its container and will be held by that Division for the specified period.

**RECEIVING SECTION**

1. THIS SECTION is open to all shortwave listeners in Australia, Papua New Guinea and New Zealand, but no active transmitting station may enter.
2. CONTEST TIMES and logging of stations on each band are as for transmitting.
3. ALL LOGS shall be set out as in the example. It is not permissible to log a station calling "CQ". The detail shown in the example must be recorded.
4. NOTE the times and conditions set out in Rule 5 (transmitting).
5. CLUB STATIONS may enter this section. All operators must sign the declaration.

**AWARD'S FOR SWLs**

Certificates will be awarded to the highest scores in each call area. Further certificates may be awarded at the discretion of the Federal Contest Manager.

**RD SCORE FORMULA**

This year's weighting factor and formula is as follows.

$\frac{\text{Total Contacts per Division}}{\text{Total Licences Issued}} \times \text{Weighting factor}$

The 1983 weighting factors for each division are:

VK1	1.15
VK2	9.58
VK3	7.16
VK4	5.33
VK5/8	1.76
VK6	1.22
VK7	0.84

This is provided for advice only. The formula is applied by the FCM to the final scores.

The 1982 predicted weighting factors turned out to be very close to the actual figures gained from the results of the contest. Relationships of the predicted and actual W/F 1982.

DIV	PREDICTED	ACTUAL
VK1	1.2	1.01
VK2	10.72	7.1
VK3	7.85	5.63
VK4	4.82	4.88
VK5/8	2.08	1.13
VK6	1.47	1
VK7	0.87	1.12

Should each State perform equally as well in 1983 as in the past nine years (averaged), the results will become a seven way dead heat. Consequently, the most improved State will take the trophy and also earn a revised and lower weighting factor for the following year.

**DUPE SHEETS**

To assist in speeding the results of the contest, you can include a dupe sheet with your log.

This dupe sheet assists you in determining your previous contacts and assist me by providing me with an accurate log.

Republished here for your assistance is a method of producing a dupe sheet, which will

take very little time to complete during a contest and will save all that looking through log sheets to see if you are duplicating your contact again. It should also provide a faster turnover of contacts. I strongly advise your use of this sort of exercise.

Dupe sheet is republished from an article in AR July 1981 by John Moulder VK4YX.

**DUPE SHEET FOR THE REMEMBRANCE DAY CONTEST**

Avoiding duplications on your log sheets during a contest can be a problem, even if you have only worked 50 contacts. The method I am about to describe is not original. I came across an article in a 1960 edition of AR, which described a method of using a dupe sheet for each VK call area, plus one for ZL and P29. As you can probably surmise, it was evolved for the annual RD contest.

Juggling a few sheets during a contest didn't appeal, so I adopted the basic idea and came up with the following.

I obtained a sheet of thin white cardboard approximately 60 centimetres square from the newsagent. I measured in 4 centimetres from each side and drew a border. Along the top and bottom and likewise down each side, make a mark each 2 centimetres. Draw a grid pattern by interconnecting all the marks top and bottom and side to side. At the top and bottom of each column, starting from the left-hand side, mark each letter of the alphabet. Do the same down each side, starting at the top.

The top left-hand corner should look like Fig. 1.

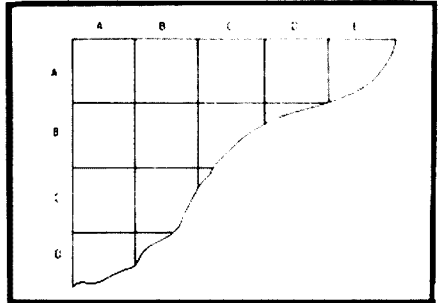

FIGURE 1

Along the top of the cardboard we label FIRST CALL LETTER. Down the sides we label SECOND and THIRD CALL LETTERS. We are now ready to go.

As an example, say we worked VK8BD on 15 metres. Looking across the top of the sheet, we locate column B; down the side we locate column D; in the intersecting square we write.

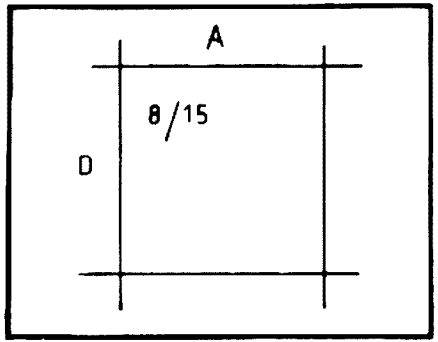

FIGURE 2

8/15. See Fig. 2. If you worked P29BD on 10 metres, you would enter P29/10 in the same square. We can take two further steps if needed. You may like to enter the mode after the callsign and the time of contact, if it can be squeezed in.

Very clever you may be thinking, but what about a callsign with a three letter suffix? As an example we'll say we worked VK7BCC on 80 metres CW, and ZL2BCA on 15 metres SSB. We locate our intersecting square of B C, and we enter 7C/80CW. Underneath this entry we write ZL2A/15SSB. See Fig. 3. All the information can be fitted in a 2 centimetre square if you use a fine tipped pen. You could use larger squares, however the size of cardboard needed may make it too unwieldy. This system is used hand in hand with your normal log sheets. What I did was work a string of stations, enter them on the dupe sheet, and then continue on in a merry way.

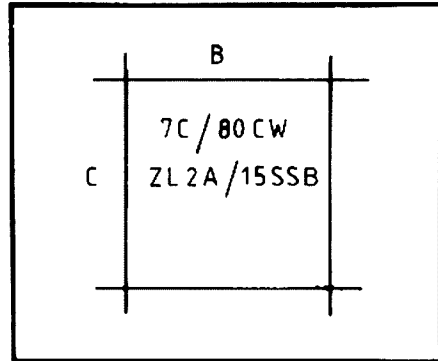

FIGURE 3

The only problem I can envisage, is the size of the sheet may make it unworkable for some operators. I got around the problem by taking over the kitchen table, which just happens to be beside our wood burning stove (very cosy). I had a great time during the 1980 RD. I made my best score, with no duplications. Unfortunately I completely forgot to send my log sheets in. Give this system a go.

*LATE NOTE: Please ensure that you keep your phone signals out of the RTTY & CW sections of the band, as the RTTY boys are intending to boost interest in this mode.*

**RESULTS OF THE 23rd ALL ASIAN CONTEST FOR VK**

PHONE: As per results published page 37, May AR.

CW:	SCORE
CALL	
AX3XB *	868
VK3RJ *	1363
AX4XA *	19376
AX2AYD *	119260
VK3AEW	48094
VK6JS	20500
VK2DID	6148
VK5GZ	748

**NZART MEMORIAL CONTEST**

When? Sat and Sun 9/10 July from 2000 to 2400 hrs each night, divided into four operating periods, 2000 to 2200 and 2200 to 2400 each night.

## CONTACTS

A station may be contacted twice during each period, once on phone and once on CW, provided the contacts are not successive.

## CYPHERS

Five serial numbers for phone and six for CW (RST and three figure SERIAL eg: 599001).

## SCORING

Phone: Each area will score fifteen points for the first contact then each subsequent contact scores one less point each time until the fifteenth contact when all further contacts will score only one point.

CW: The same as the phone scoring, except that the points will remain at live after the 11th QSO.

## LOGS

In order of Date: Time: Station Contacted: Phone or CW: Cypher Sent: Cypher Received: Points Claimed.

Logs to be sent to Jock White, NZART Contest Manager, 152 Lytton Rd, Gisbourne, New Zealand. Must arrive no later than 10th August 1983.

A photocopy of the rules may be obtained from the FCM at above address.

## RESULTS OF THE 1983 JOHN MOYLE NATIONAL FIELD DAY

### SECTION A

24 HOUR SECTION		6 HOUR SECTION	
CALL	SCORE	CALL	SCORE
VK3XQ	2715 *	VK6NSD	2317 *
VK2KFJ	464	VK3CGH	1315
		VK5QX	1097
		VK3KI	1034
		VK4NDW	870
		VK3DAW	218
		VK3VF	185

### SECTION B

Nil entries for 24 hour section	
VK2JM	139 *
VK3BKU	97

### SECTION C

Nil entries for 24 hour section	
VK3BAF	979 *

### SECTION D

VK4WIZ	9737 *	VK4WIN	3745 *
VK3APC	8185	VK3ATO	2126
VK3ANR	7459	VK3SAS	1945
VK3BGG	4660	VK3DIP	1763
VK3XK	4099	VK3DBS	1610
VK4CAU	3211	VK4WIM	1122
VK5ACE	3115	VK2BOR	659
VK2AZI	3020	VK3BMW	627
VK5ARC	2798		
VK5BPA	1172		

### SECTION E

VK3BML	10167 *	VK3ER	3577 *
VK2WG	7763	VK3WIA	1429
VK3ATM	7326		
VK2DBK	7144		
VK3AWS	6384		
VK4WIT	4348		
VK5LZ	4010		
VK4WIG	3390		
VK8DA	2639		
VK1WI	1964		

## SECTION F

Nil entries for 24 hour section	
VK2EL	1161 *
VK3SP	527
VK5YO	297

## SECTION G

VK5BW	3909 *	VK4QC	1320 *
		VK2AOA	824

## SECTION H

VK3YTT	795 *	VK3AVJ	609 *
		VK3YTO	404
		VK5DL	56

## SECTION I

VK2TR	515 *	VK3LC	825 *
VK4AOF	465	VK3XB	690
VK5DL	105	VK2BQS	680
		VK1DL	515
		VK7AL	450
		VK3DAK	335
		VK7NIM	310
		VK3KCC	175

## SECTION J

L30042	65 *	L40804	700 *
		L60036	310

Check logs were sent in by VK2EES and VK3CIF.

## COMMENTS FROM LOGS

VK3BAF . . . Sorry for the low points but the VK3 boys were involved in WICEN with the bushfires.

VK2CGH . . . Many thanks for the very enjoyable days participation.

VK2BQS . . . A very friendly and enjoyable contest again this year.

VK6NSD . . . This was my first year in this contest and really enjoyed myself.

VK4CAU . . . The change of rules leaves a little to be desired: The rule for contacting home stations once only needs reversing. No incentive to enter Section H. The change to CW makes no difference to our log as we do not use CW in contests. The thunderstorms did not affect the contest, only four hours rain.

OAKLEY ARC . . . Washed out Saturday in this area but looking forward to next year's contest.

L30042 . . . Once again a most disappointing contest, insofar as CW operating in the field was concerned — sheer contempt of the stated objective of the contest!! — vis "to encourage portable operation".

Logs from time immemorial . . . It has been world wide contest practice to list date and time headings as the first two items (Rule 16).

As you can see, the vast majority of the comments were for an enjoyable contest.

Congratulations to the winners (those marked with the \*).

## SPECIAL NOTICE

Don't forget the VK Novice Contest this year. Let's make a special effort to assist the novices and show some interest in this special contest.

# 1 KILOWATT RATED

17 Sloane St.  
Marrickville, 2204  
NSW, Australia  
Phone: (02) 516 4500  
©Copyright Mobile One

# "MOBILE ONE"

Quality Communications  
Ask for it by name:  
"HAMTENNAE" or  
"BUSH BANDIT"

# 'THE' ANTENNAE

that has taken  
the 10 mtr band  
into the 80s.  
The ONLY  
Mobile Whip to  
cover the  
WHOLE Band  
allocation.  
Under 1.5:1  
VSWR.  
Available in 60"  
and 40" sizes.

HAMTENNAE™

MODEL: M10-1

MOBILE ONE AUSTRALIA

AR



# ALARA

Australian Ladies Amateur Radio Association

Margaret Loft VK3DML  
28 Lawrence Street, Castlemaine, Vic 3450  
Photographs courtesy of Geraldine VK2NQI

Ladies don't forget the Annual General Meeting on Monday 25th July at 1030 UTC on 3.570± QRM. Please make an effort and join this important net, it is your association and we want all of you to help ensure it continues in the future.

If you cannot come up on air write to one of the executive and tell them your ideas, all suggestions will be discussed. Remember united we stand and divided we fall.

Welcome to new members:  
Peggy VK6NKU joined 15.2.83  
Dorothy VK2NVQ joined 17.3.83  
Val VK4KCJ joined 7.4.83

Sponsored members:  
Vicky T3OCH 9.3.83  
Heidi DF3LX 12.3.83  
Joan N7DGP 11.4.83

Unfortunately a number of our members have not renewed membership this year, so numbers are down on last year. So girls please if you are one who has forgotten to pay send your sub off now to ensure you are not removed from the mailing list for the newsletter. Marlene, our editor, does an excellent job with the newsletter and we all look forward to receiving the next issue.

Thank you Marlene from us all; Marlene and Brian were involved in the Ash Wednesday fires and all members were concerned for them. One of Marlene's first comments afterwards when we were speaking to her on air was don't worry the gestetner and newsletters are OK!! I would not have given them a thought.

ALARA's good wishes go to Kate Duncan one of our associate members in your Obstetrics and Gynaecological exams; we hope you pass and do well in your time overseas. Kate was one of the early members of LARA but studies in her work have kept her well occupied. I had the pleasure of meeting Ern Kinscher VK2ADL and XYL Ella in Castlemaine recently. Ern was one of the amateurs involved in the Falkland Island rescue when lone yachtsman Richard McBride ran aground on 1st March. Ern has been licensed for fifty years and was formerly in VK4 land.



Joy VK2EBX (formerly VJV and KJC).

Congratulations to Austine VK3YL who has been licensed for fifty three years now; and we wish you many more years of operating Austine.



Marilyn VK3DMS and Geraldine VK2NQI.

This month we include an article written by our editor of the ALARA newsletter about the devastating Ash Wednesday Bushfires.

Marlene Austin, VK5QO and her OM Brian VK5CA are a very well known amateur couple and during the fires in South Australia their house was situated in the path of the fires but fortunately the house was saved amid a blackened garden.



Diane VK6KYL, Bill VK6ZX, Geraldine VK2NQI and Alisa and Rivka (harmonics of Diane and Bill).

However I will leave it to Marlene to tell her story in her own inimitable way.

## A SMOKED HAM

*It was quite a day, here in the Adelaide Hills. Very hot (42° C) and winds over 100 kph. There was a duststorm, so you couldn't see the flames until they were with you. We probably had 1-1½ hours warning, being on the top of a range of hills and could distinguish smoke from the red dust in the distance.*

*We have four acres of property and had spent most of last winter burning twigs and fallen leaves. We had also permanently installed a sprinkler system in copper piping on the roof of our home, coupled to our 68,000 litre rainwater tank by a petrol driven pump. Also, we had aluminium blinds over all windows, and have our own alternator. So, we were as ready as we ever would be, and when we saw the smoke in the distance, we knew we were for it. We are at 580 metres, and the gullies in the hills act as funnels for heat and fire.*

*I can remember saying "2 pm, so far so good". Then seeing the smoke, and it was to action stations! First the bamboo blinds cut down from the front veranda, timber furniture moved indoors, aluminium blinds wired down over windows (didn't trust cords not to burn through), a check that knapsack sprays and hoses were handy (connected to our rainwater tank, not the mains water which vanished in a fire as*



From Marlene's back door.

everyone else is using it too). We even turned on the bathroom exhaust fan to pressurize the root cavity.

When all was ready we waited for the first sight of flame before turning on the sprinkler system. As it was, guessing from the smoke, we turned it on about 15 minutes too early, but knowing we had nearly a lull tank, it was a comfort to be in our own rainstorm in all that heat and wind. We didn't even think to use umbrellas — never have I been so soaked then baked then soaked again, and not even notice! I sure looked one heck of a mess, though!

Brian my OM (VK5CA) and I were putting out some spot fires near the house, when he said "look behind you" and there was a wall of flame about 15-20 metres high, just

our driveway away, going past us up the gully, with a roar like a train. The trees are about 15 metres high, and the flames were over the top of them. At that point we went inside until it passed, possibly 5-10 minutes and then came out and put out what we could after checking in the ceiling that the house was safe. What we didn't know was a spark had got in the 6 mm crack along the garage doors, under the house, and smouldered in a canvas chair before finally going out. That is a lesson we won't forget!

One of our neighbours had also gone inside to wait for the fire to go past, and she sat in her best chair — she said if she was going to die, she was going to do it in style! She shut her pet cockatoo in the toilet (after making sure he couldn't drown!).

The fire was right around our house — the garden is just black trunks and burnt leaves. What wasn't burnt, was singed — it was like a blow-torch over the land. Plastic flowerpots were burnt off plants, hoses burnt to bits, and we lost all our underground services: plastic water pipes burnt in a dozen places, the power went off, and our telephone was out for days. However, in comparison we lost nothing, when you think of the 28 dead, 312 homes lost and something like 12,000 cattle and 317,000 sheep killed in South Australia. In Victoria, on the same day, 45 people were killed and 1,719 homes lost, one of which was the

property belonging to my sister Valda VK3DVT (our Treasurer) which was the old family home where our mother grew up as a girl.

Our aerials came through surprisingly well — we lost about 3 metres of co-ax in the dipoles, that's all. The TH6 still seems to be working but the twin flex to the TV is blistered. I was on the Wireless Institute Civil Emergency Net (WICEN) until after midnight — it had been quite a day! Another of our ALARA members, Janet VK3BTU did tremendous work with WICEN in Victoria, and undoubtedly there were others too of whom I have not heard. Marilyn VK3DMS had once lived at Cockatoo, Vic. (one of the hardest hit areas) and Sandra VK4ACJ had lived in Emerald, so were particularly concerned.

Back in SA, two weeks later to the day, we had floods, with 5 metre walls of water demolishing over a dozen caravans and drowning vineyards, market gardens and cattle alike. Feet of mud through homes (ugh!), but luckily no humans killed. What a summer!

Most of our trees are regenerating, the grasses are coming up, so hopefully it won't be long before the hills are green again.

33/73/88 Margaret VK3DML

AR

## THE FISK TROPHY

(As told by VK4AW.)

In 1933 Mr E T Fisk, later Sir Ernest Fisk, of AWA, donated this trophy for annual competition between Wireless Institute Divisions.

The forerunner of this contest was the "Five Point Relay" in 1932 organised by the then Association of Radio Amateurs, NSW, which was later to become the WIA, NSW Division. This was a CW, (20 word text) message handling contest relayed through four states, plus the originating state.

The results of this contest were . . . 1st late Reg Vickary, VK4RV, 2nd C Harrison, VK7CH, 3rd Arthur Walz, VK4AW. This was a real endurance test with top scorers handling between 400 and 500 messages.

Arthur remembers working VK6SA for 3½ hours handling a total of 60 messages.

1933 was the start of the Fisk Contest organised by the WIA, a "Five Point Relay" held at the end of October and won by the Victorian Division.

1934 was a variation . . . a QRP Contest about the same time of the year won by the Queensland Division.

1935, over two weekends in August/September, was a "5 plus 5" ten letter code handling contest won by the Queensland Division. During the occasion of the 12th Federal Convention held in Brisbane, 25th/26th January 1936, at the studios of 4BC Brisbane and 2CH Sydney, Mr E T Fisk, introduced by Mr Bill Moore, VK2HZ, Federal President in Sydney studios, presented the trophy for the 1935 Contest to Arthur Walz, VK4AW, President of Queens-



Arthur Walz, VK4AW holding the Fisk Trophy

Peter Brown VK4PJ  
Amateur Historian for VK4  
16 Bede Street. Balmoral, Qld. 4171

land Division, with Harry Caldecot, VK2DA, Federal Secretary, at the Brisbane 4BC studios.

This was a "first" for Radio Broadcasting in that two interstate stations used landline "hook up" to simultaneously broadcast the same programme.

The 1936 contest, held over two weekends in September, with ten letter cypher, was again won by Queensland. Queensland was then declared the outright winner of the trophy and a pre-recorded speech by Mr E T Fisk, who at that time was en route to England, was broadcast over 4BC and relayed to the Queensland Division's 10th Annual General meeting held at the Brisbane Motor Cycle Club rooms Charlotte St on 2nd April 1937. Similar CW contests were held in 1937 and 1938 over two weekends in September and December.

Prominent contestants were the late Roy Belstead, VK4EI (Townsville), late Reg Vickary, VK4RV (Cunnamulla), Bob Beatson, VK4BB (Maryborough), late Alf Guilford VK4AP, and Arthur Walz, VK4AW (Brisbane). They operated from 10 metres through to 160 metres.

It may be accepted that the Fisk Trophy contest was really the forerunner of the present interstate annual contest . . . THE REMEMBRANCE DAY CONTEST.

The photo is an updated version of the photo appearing in the Telegraph newspaper of January 1936 reporting on the presentation of the Fisk Trophy.

AR

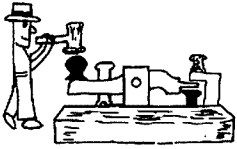

# POUNDBING BRASS

Marshall Emm VK5FN  
GPO Box 389, Adelaide, SA 5001

*Last month I suggested dropping the Tone Report from the standard R/S/T, and I wonder how it's going. These columns are written months ahead of publication, so I haven't tried anything revolutionary yet, but I do believe that if we give honest, impartial readability and strength reports, with amplification when appropriate, no-one will miss the Tone Report, and if they do they can easily write in a 9. I'm even thinking of leaving it off QSL cards in favour of "ABOLISH THE TONE REPORT" or words to that effect.*

Even when an extremely strong (S9) signal is perfectly readable (R5) it can still have technical faults which should be advised in standard format. They don't take up much space, but convey a lot of information. Typical reports might be 5/9/9X (or better yet, just 5/9X), 5/9C, or 3/7 QRN3. The amplification symbols which should be at every op's fingertips are described below.

- X Fortunately, most signals could be reported as —/—/9X, for their tone is pure and their frequency is stable. If received signals do not vary in pitch, meaning there is no variation in transmitting frequency, then X can be used to indicate that the signal is as stable as a crystal — (Xtal!) controlled one.
- C The symbol C represents "chirp" and is used to describe the sound of a signal in which each character element (dit or dah) changes in pitch in a repetitive fashion. If you hear a CQ which sounds like "cheow-chi-cheow-chi, cheow-cheow-chi-cheow", you are hearing "chirp". The problem is usually caused by an unstable VFO or oscillator which gets drawn off frequency each time it comes under load. Most commercial gear is chirp-free, but you can often hear chirpy signals coming from the USSR, where a lot of gear is home-brewed by members of the Radio Sport Clubs.
- D Sometimes a signal will drift in frequency (the pitch gradually rises or falls), in which case the symbol D is used. This is often a problem where a VFO or oscillator is subject to temperature changes such as the rig heating up as a transmission progresses. I once heard

an op in a contest who sounded like a sports-car going up a steep hill. Each time he transmitted he started zero-beat, then took off for the wild blue yonder, sometimes dropping down a bit between words before taking off again. Most drift is more gentle, and of course you should be sure it is not your receiver which is drifting before you send D. Experience is the best teacher in this regard, but as a general rule, it is probably best to ignore a small amount of drift, especially if you only notice it five minutes into the QSO.

- K Key clicks can be a real problem because they are spurious transmissions which may appear quite some distance from the QSO frequency. They are a clicking, static-y noise which occurs in time with someone's sending. They often result from over-driving the transmitter, so it is a good practice to refrain from running flat-out. Just backing off a little bit from full power can make the world of difference.
- QRM/QRN Interference, in contrast with technical faults, can be either man-made or natural (QRM or QRN, respectively). The basic principle in reporting QRM/QRN is that if it is causing no problems in copying, don't report it. Just because you can hear it doesn't mean it is causing interference, and you should think in terms of readability. A report of 5/9 QRM, for example, means "your signal is perfectly readable with no difficulty, and the difficulty is caused by man-made interference(!)".  
The main reason for reporting QRM or QRN is so the other station can adjust his sending to suit. Accordingly, the

QRM or QRN should be followed by a number from 1 to 5, representing the degree of interference. For example, if you send a report 3/7 QRN 3, the other operator knows you have noisy conditions and will (theoretically) slow down and/or repeat key words. For that matter, there is nothing to stop you from sending "RS 3 7 QRM3 ? RS 3 7 QRM3 PSE QRS10 QRS10 ES QS22 QS22" which translates as "your readability is 3, your strength is 7, with man-made interference causing significant but not overwhelming problems, please slow down to 10 WPM and send everything twice." Your chances of copying his next transmission are a lot better than if you had sent "RST 3 7 9 QRM".

If the strength report is high, but the readability is less than 5, then some amplification almost has to be given.

One last aspect of reporting deserves comment, and that is the tendency for award and certificate managers to demand "minimum reports". To my mind this is about as silly as you can get, especially when some lid keeps you from qualifying for something by giving you a 5/0/9 report. I personally do not chase paper, at least not much, but I would have to rule out anything requiring minimum reports. After all, the purpose of it all is communication, and there have been many occasions where a 3/2/9 report has meant more to me than other QSOs where I was "given" 5/9/9 PLUS 40 dB. If you have exchanged calls, reports, and names you have certainly communicated, and there is much more virtue in having done it under difficult conditions. What do you think?

Keep communicating . . . ES CUL.

AR



# EDUCATION NOTES

Brenda Edmunds VK3KT  
FEDERAL EDUCATION OFFICER  
56 Baden Powell Drive, Frankston, Vic 3199

The suggestion has been made recently that a pass in the Novice Theory exam should be made a prerequisite for an attempt at the Full Theory exam. I can see some merit in the idea, but would be very interested to hear others' opinions.

Without delving too deeply into the statistics — some of which would be very hard to obtain and analyse — it appears to me that most candidates cope with the Novice course and exam quite well, and have few complaints about the system. Of course, some do have trouble, and the pass rate does only average 40-50%, but the enthusiast who studies intelligently usually passes first or second time around.

Overall, the majority of those passing the Theory go on to attempt AOCF or AOLCP. This seems to be a much bigger hurdle. Pass rates for recent exams have been very low.

*Why do so many candidates have so much trouble?*

One factor is that there is very much more material in the Full syllabus than in the Novice.

An inspection of the syllabus in the Regs book shows the comparison.

	AOCF	NAOCF
Total Length	12½ pages	5½ pages
Basics	2 pages	½ page
Semiconductors	1½ pages	½ page
Power Supplies	1¼ pages	¼ page
Transmitters	2 pages	¾ page

In part, the difference is due to more detailed specifications at the higher level, but close comparison shows that the actual material required for the Full is much more than twice that for the Novice, and includes many topics not mentioned at the lower level.

Most Novice courses run for about 7-9 months — so an AOCF course should run for about 18 months! It is unrealistic to expect this degree of dedication from either lecturers or students, so we compromise with a shorter, more intensive course.

Many who coped with the Novice course begin to flounder when the pace increases. Those who are struggling through on their own do not always read the syllabus closely enough to see the many points where new topics are included.

As for the exam itself — one hour for Novice, 1½ hours for Full, each fifty questions — either the questions for the Full must be harder, or there should be

more of them.

*How about a two hour exam of 100 questions to adequately test the more extensive syllabus?*

Now, before you all start protesting — reconsider the previous proposal, which would allow the Full theory exam to concentrate on the 'extra' part of the syllabus, and cover it adequately in fifty questions. The only ones disadvantaged would be the few who, under the present system, go straight to AOCF theory without attempting Novice.

Another point is that the amount of knowledge required to keep up with the 'State of the Art' is increasing all the time, and very rapidly. What were new techniques when the syllabuses were put together are now commonplace and so fair game for exam questions.

*Should the syllabuses now be redrawn to include digital, logic and microprocessors as they become commonplace too?*

There doesn't seem to be much of the present syllabus that can be left out to make way for new material.

*Where does it end?*

I would welcome comment on these or any other education issues. Write to me QTHR, or call in on the Education Net Wednesdays 1100 UTC 3.685± MHz.

73 Brenda VK3KT  
AR

## COUNCIL PROBLEMS?

### THE ANSWER TO LIMITED SPACE

EFFICIENT ANTENNA FOR LIMITED SPACE

Both models C/4 & HQ1 cover 6-10-15 and 20 m.

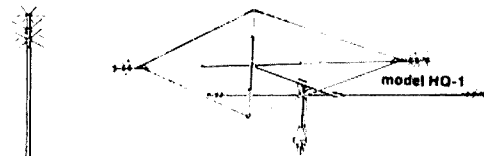

(Flats — Small Backyards —  
Caravans — Portable Ops.)

**\$222.00**  
(Freight Extra)

HQ1 — 1350 mm Boom  
3350 mm Elements  
Gain — 5.65 Bd gain (Rev Dipole)

NO GROUND RADIALS NEEDED  
Lightweight yet rugged  
3350 mm long

MIKE KILPATRICK  
VK2DJP

Miniature  
Band  
Coaxial Vertical

**\$116**  
(Freight  
Extra)

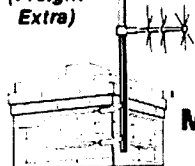

# WATCHMAN ELECTRONICS

28 Elouera Cres, Woodbine, NSW 2560  
Phone (046)26 6101



## THREE BIG NAMES

# ICOM

# ATN ANTENNAS

## AT ONE GREAT STORE



PLUS MUCH  
MUCH MORE

## ELECTRONICS

CW Electronics is the communication centre of Queensland.  
Innovators and pioneers of computer/RTTY/ASCII/CW/radio  
interface in Australia.

Come in and see our range

416 LOGAN ROAD STONES CORNER BRISBANE

PHN: (07) 397 0808 397 0888

MBG

P.O. BOX 274 SUNNYBANK QLD. 4109



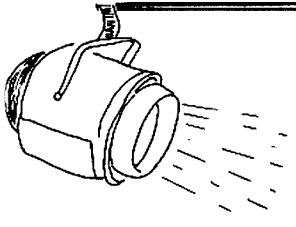

# SPOTLIGHT

## ON

# SWLING

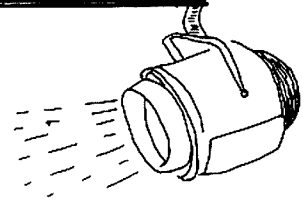

Robin Harwood VK7RH  
5 Helen Street, Launceston, Tas., 7250

All of us have some time or other been plagued by interference from Over the Horizon Radar systems. These are commonly referred to as "woodpeckers" because of its similarity to the sound of that bird's tapping. Now a committee of the Association of North American Radio Clubs (ANARC) has published a bulletin specifically dealing with interference from these OTH-B systems. Its title is very apt — "Backscatter" — and has been edited by the Chairman of that committee Bob Horvitz. I am sure that there are many who would be interested in obtaining a copy of this occasional bulletin. It costs only 4 IRCs for an airmailed copy from:

Bob Horvitz,  
54 East Manning Street,  
Providence RI 02906 USA.

A lot of the information was yielded from the files of the US Federal Communications Commission, the American regulatory body, under the Freedom of Information Act. There are over 900 pages on file and the cost of obtaining the data is \$US90.00.

### ANOTHER RARE ONE LOGGED

Recently I mentioned here that the Falkland Island Broadcasting Station is being heard here in SE Australia. Yet another difficult catch has been logged of late from the Shamrock Isle. Radio Dublin International on 6.910 MHz has been heard at about 0700 UTC. Technically this station is regarded as a pirate station. However, because a loophole in the Irish law re broadcasting was found, these unofficial stations have not been prosecuted. The State Radio — Radio Eirean — has enjoyed a monopoly ever since broadcasting commenced in Eire. But because these unofficial stations have proved more popular than the state network, the authorities haven't intervened.

Most of these unofficial stations have become even more open and commercial, mainly concentrating on MW and FM. As well, the more prosperous stations are developing networks, by buying or absorbing the smaller outfits. In the early days of Irish "unofficial" radio a few enthusiasts commenced relaying their programmes on SW, particularly around the 49 metre band, a favourite haunt of unofficial or clandestine stations in Europe. But interest waned, as the AM stations became more commercial and aggressive. Radio Dublin International only re-commenced recently on SW. It is not surprising either that their signals were weak in this area, as reportedly they are only running 40 watts. This makes positive identification extremely difficult.

### EXCEPTIONAL PROPAGATION

I find that when normally weak stations are clearly heard, that there is exceptional propagation present. For example, several low powered SW relays of the domestic Canadian networks have been heard here in Tasmania. They broadcast to the interior of Canada and are usually on the 49 metre band. They are very often not heard because of the presence of more powerful international broadcasters dominating the channels. Radio CKZN in St Johns, Newfoundland, was heard at around 1000 UTC and another station in Vancouver, CKZU, on the west coast, also part of the same network, was heard signing-off at 0900 UTC. Both stations use 6.160 MHz and broadcast in English.

Another good propagation indicator I have found, especially for Latin America, has been the Venezuelan Time station — YVTO in Caracas. It is heard from 0630 UTC and even as late as 0900 on 6.100 MHz. It runs only a kilowatt and has 100 millisecond pulses every second. Identification and local time are given every minute, naturally in Spanish.

### SPANISH BULLETIN

Recently I was surprised to receive a letter from Francisco Martinez, who is General Secretary of the Central Spain Listening Group (GECE) in Madrid. He was kind enough to forward me a copy of their monthly bulletin "MADRDX". It is in Spanish, mainly concentrating on transmissions in that language.

One section of their bulletin contained the results of a contest to find the most popular Latin American broadcaster. Radio HCJB in Quito, Ecuador was voted number one quite convincingly with thirty votes. Presumably HCJB's local programming on SW has a wider audience than just in Ecuador itself. Most surprisingly, the runner up was Radio Mexico International with eighteen votes. This station is not heard that often here, in fact I have never heard it personally. It also is reported by ANARC to be a poor verifier. Other stations such as Radio Havana were well down the list with only eight votes. Radio Sutatenza even polled well. Those interested in a sample copy should send 7 IRCs to: GECE, Apartado Postal 4031, Madrid, Spain.

I have also heard from Eric Irvine of Thoon, Vic. He has an FRG 7700 receiver and a Collins R390. The latter has an IF fault at present. He is also an amateur — VK3BXA, mainly enjoying CW, but he occasionally comes on SSB. He hopes eventually to get into RTTY and SSTV and

working through the amateur satellites. Thanks for your letter, Eric.

### NEW ANTENNA

Recently, I tried out the FRA 7700 active antenna. As you have probably deduced, it has been designed as a companion to Yaesu's FRG 7700 receiver. It connects to it by a din plug, as it requires 9-11 volts DC. However, I was able to use it satisfactorily with my FRG 7, with an external 9V supply.

Active antennas are ideal for residents in apartments or units, where there are problems erecting outside antennas, replacing the need for their installation. The FRA 7700 performed surprising well with my FRG 7 and even on an old Philips 2262 receiver. It is good between 4 and 18 MHz, and reasonable on MW. The unit also doubles as a pre-amp for longwire or especially MW loop antennas. It really improves the signals of weak broadcasts on MW and the tropical bands, but I found it very limited on SW because the powerful stations normally present a lot of splatter. All pre-amps have a big disadvantage in that they also bring up the noise, so they are best utilised where there is a low noise level. I believe that other brands of active antennas are available, also circuits and how to construct your own, using car aerial whips.

Don't forget that there is an amateur radio net devoted to SWL and DXing every Thursday evening at 1130 UTC. Net Control is shared between Don Rhodes VK3BMB, Tony Badgar VK2ECB, or myself VK7RH. We are on 3.565 MHz ± QRM and all are welcome.

Well, that is all for this month. Until July, the best of 73 and good listening — Robin VK7RH.

AR

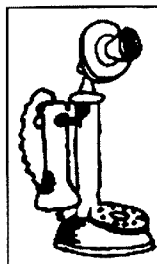

**Please remember your STD code when you advertise in HAMADS.**

# Andrews Communications Systems

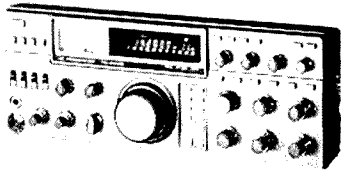

**\$1749**

- 16 memory channels
- Special TX mode
- Automatic tuner
- MC-425 scan mic

General coverage receive from 0.15-30MHz, tx 1.8-30MHz, 100W o/p, SSB-CW-AM-FSK

**WHY PAY \$1999?**

**\$999**

- Special TX mode
- MC-425
- 100W "S" model

YK-88A/C/CW/SW \$55 ex  
TS-430V ..... \$899

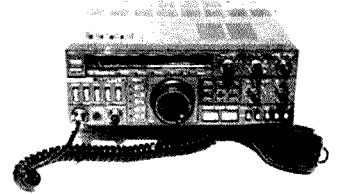

General coverage receive from 0.15-30MHz Tx 1.8-30MHz cont. SSB-CW-AM. Optional FM \$55

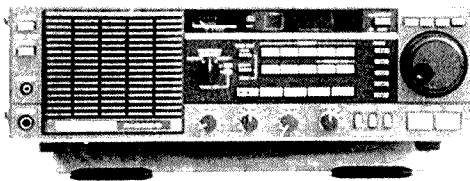

**\$619**

VHF module fitted \$769

## YAESU FT-77 SERIES

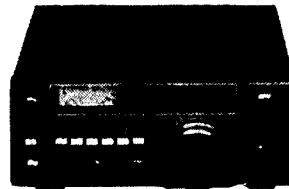

HF SSB/CW digital mobile

FT-77 100W \$678

FT-77S 10W \$575

FP-700 AC supply ..... \$195  
FC-700 Ant. tuner ..... \$158

**COMPARE FT-77 to TS-130SE and save!**

**TOKYO HY-POWER**

**FACTORY — DIRECT IMPORTER**

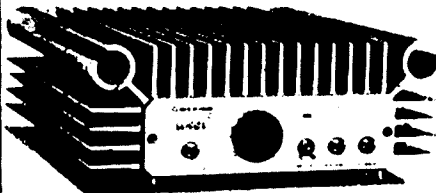

- ★ HL-90U 10W-80W, GaAsFET, UHF Linear..... \$369
- ★ HL-86V 10W-80W, FET pre amp, 6m Linear..... \$189
- ★ HL-82V 10W-80W, FET pre-amp, 2m Linear..... \$219
- ★ HL-160V 3W or 10W to 160W o/p, FET, 2m Linear..... \$339
- ★ HL-20U 2W-20W mini UHF Linear..... \$119
- ★ HL-45U 10W-45W, FET pre-amp, UHF Linear... \$219
- ★ HL-400B 80-10m Bandswitched 12V Linear 200W CW/AM, 300-350W SSB O/P, meter, protection. \$279

*Tokyo Hy-Power from someone you can trust.*

**Micro-7 UHF 200mW 3CH Handy Talkie \$179**

## KENPRO ROTATORS

Direct Importer

- KR-400 medium duty, 28 V \$129
- KR-400RC w/Round Controller \$149
- KR-600RC heavy duty w/RC \$219
- KR-2000RC super heavy duty \$429
- Top & bottom mast clamps included



**ALINCO 2m LINEARS**

- ELH-230E..... \$69
- ELH-230 ..... \$79
- ★ ELH-230D..... \$99

with receiver pre-amp fitted

**WHY PAY MORE?**

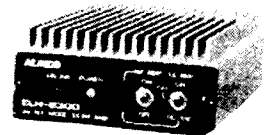

**NEW ELH-230D**

## HEAVY DUTY "RF AEROSPACE" ANTENNAE

- 3el 10 yagi 3.7m boom ... \$79, 4el 10 yagi 5.5m ... \$99
- 5el 10m 7.4m ... \$129. VHF & UHF beams available also.
- RFA-LP log-periodic, 7el 7.4m boom, only ... \$279
- RFA-34B tribander, dual driven elements, 4el total, 5m boom, only ... \$300. RFA-34X 6el total on 8.5m boom only ... \$450. True bandpass triband yagis.

## SAIKO SC-7000 INCREDIBLE 70 CH. SCANNER \$449

Scans & searches 60-90, 108-136, 140-180 and 380-520MHz in 2.5, 12.5, 2.5 and 25kHz steps respectively. Genuine lockout, priority delay AM/FM, AC/DC, up/down search, clock etc ...

**CALL (02) 349 5792 or 344 7880 NOW!**

**SHOP 7, GARDEN ST, MAROUBRA JUNCTION, SYDNEY N.S.W.**

**BUY DIRECT FROM IMPORTER AND SAVE!**

**THE MAIL ORDER SPECIALISTS Write to: P.O. BOX 33, KENSINGTON N.S.W. 2033**



# NOVICE NOTES

Ron Cook VK3AFW  
7 Dallas Avenue, Oakleigh, Vic 3166

## A STICKY END FOR YOUR COAX?

**Coaxial cable makes a very convenient feedline. If you purchase cable with a non-contaminating sheath intended for outdoor installation you can expect ten years trouble free operation, providing you can keep the rain out. If not your coax will come to a sticky end.**

Before we get on to water-proofing let me explain briefly about sheaths.

Very cheap coax has a very modest amount of braid and often seeks to redress the losses due to higher RF resistance and radiation leakage by using a reduced amount of dielectric, making up the bulk with air bubbles. Air is low-loss so this is fine. The cable is then sheathed in a very inexpensive plastic such as PVC. Over a period of time various chemicals are exuded from the sheath and some will corrode the braid. A green sticky film forms which, of course, is very lossy. Further, in sunlight, the PVC will lose its flexibility and eventually crack. In goes the rain and, yes you guessed it, more sticky green corrosion.

A good quality coax cable with a non-contaminating sheath does none of these things. Another case of "what you pay for is what you get".

Now back to weather-proofing.

Last year, I mentioned that most silicon sealants gave off acetic acid during curing and so were likely to corrode the copper wires they were supposed to protect. Ron Higgenbotham, VK3RN, and several others have pointed out that the sealant I recommended is very hard to get.

They have drawn my attention to Dow Corning Roof and Gutter Sealant 780 which is distributed by Selleys Chemical Co. It is available in 75 g tubes or 335 g cartridges. It can be kept in the tube for twelve months and is guaranteed in service for twenty years.

Dow Corning 1080 is, I am told, another possibility. Both are neutral curing silicone sealants. Local hardware stores with a Selleys Bar should carry stocks.

If you intend to get twenty years use out of your coax then the deluxe potting method used by Ken, VK3AH, will be of interest. Fig 1 shows a section of the termination. All the components and materials should be readily available. Most shops specialising in photographic supplies and film printing will give you a bag of

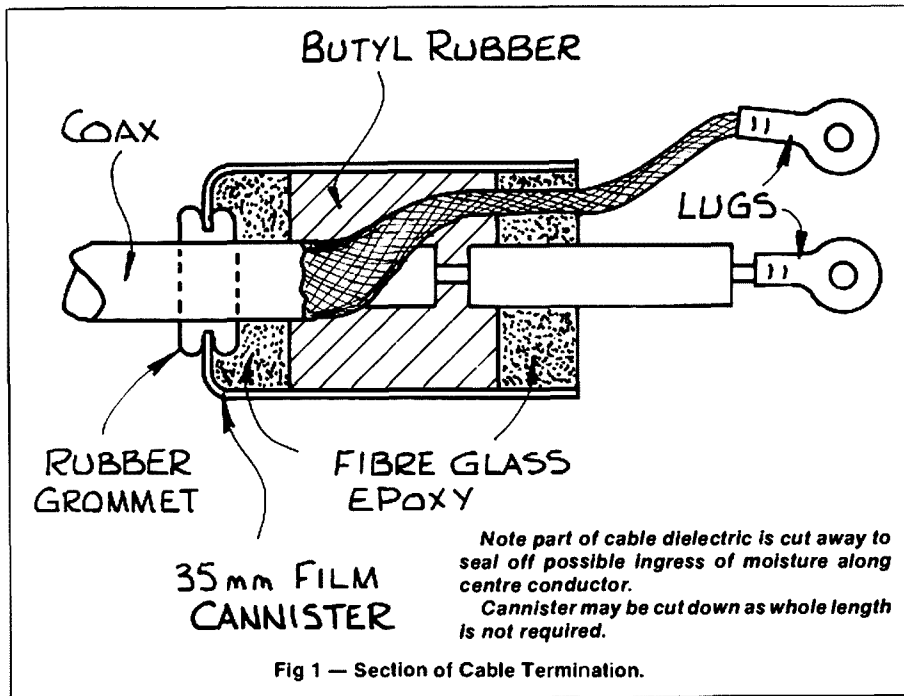
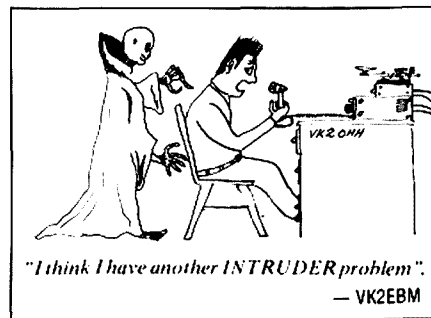
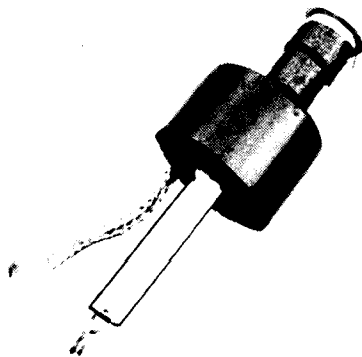

Fig 1 — Section of Cable Termination.

empty 35 mm film cannisters which are made of plastic.

The photograph shows a completed termination. Thank you Ken.

73 de VK3AFW  
AR



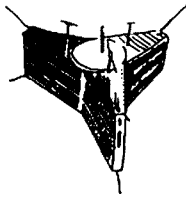

# AMSAT AUSTRALIA

Bob Arnold VK3ZBB  
41 Grammar Street, Strathmore, Vic. 3041

**NATIONAL CO-ORDINATOR**  
Chas Robinson VK3ACR

**COMMUNICATIONS NETS:**

- AMSAT Australia Control VK3ACR  
Sunday 1000 UTC  
3.680 MHz Winter  
7.064 MHz Summer  
Control W6CG  
Saturday 2200 UTC  
28.880 MHz
- AMSAT SW Pacific Control JA1ANG  
Sunday 1100 UTC  
14.305 MHz
- AMSAT Pacific

**ACKNOWLEDGEMENTS FOR INFORMATION**

Mode 'J' Newsletter  
VK5AGR  
Amateur Satellite Report  
QST October 1981

**FUTURE SATELLITES SHUTTLE STS 9**

It is becoming highly probable that Owen Garriott W5LFL will be the first amateur to operate from space. Only a final approval from European Space Agency (ESA) is required for Owen to carry a portable transceiver aboard STS 9.

**JAMSAT 'JASI'**

It is reported that the Japanese Space Agency has approved a proposal by JAMSAT to build and launch the first Japanese Amateur Satellite which will be known as 'JASI'.

Miki JR1SWB will be project manager. It is possible that a launch will be scheduled for 1986 and, although many points of detail have still to be decided the following broad outline has been proposed:

*Orbit of the Oscar 7 type, sun synchronous with a period of about 103 minutes. Inclination 50° and height 1500 km. Transponder will include a Mode 'J' type, (2 m up, 70 cm down) and a Digital PACSAT type.*

**PHASE III B**

At the time of writing the launch date of Phase III B is 3 June 1983.

For up to the minute details of the launch and direct broadcasts of the event please listen to the AMSAT Nets.

**PACSAT**

Activity is increasing in the field of development of a PACSAT-like satellite by AMSAT and possibly like interest groups. An inaugural meeting called the PACSAT Conceptional Design Meeting was held at Goddard Space Flight Centre, Greenbelt, Maryland on 25-27 February.

UOSAT SPACECRAFT CONTROL CENTRE  
UNIVERSITY OF SURREY, GUILDFORD, SURREY, ENGLAND  
\*\*\*\*\*

UOSAT SPACECRAFT OPERATIONAL STATUS:

\*\*\*\*\*  
\*\*\* UOSAT BULLETIN-19 1200 GMT 30 MARCH 1983 \*\*\*

**\*\* S/C NEWS \*\***

FURTHER COMMAND STATION FACILITIES HAVE BEEN DEVELOPED TO SUPPORT ATTITUDE MANOEUVRES DESIGNED TO ATTEMPT TO FREE THE SNAGGED TIP-MASS MAGNETOMETER CABLES BASED ON THE RELATIONSHIP BETWEEN THE SCIENTIFIC AND NAVIGATION MAGNETOMETER DATA AND THE CHANGE IN DYNAMICS OF THE SPACECRAFT COMPOSITE DUE TO CURRENT BOOM DEPLOYMENT.

IT IS NOT KNOWN WHETHER IT WILL BE POSSIBLE TO CLEAR THE CABLE PROBLEM. HOWEVER, IF AFTER ALL ATTEMPTS HAVE BEEN MADE WE ARE UNSUCCESSFUL, ALL IS NOT LOST AS THE SPACECRAFT CAN BE EITHER SPIN STABILISED OR MAGNETICALLY STABILISED OR, POSSIBLY, QUASI-GRAVITY GRADIENT STABILISED USING CONTINUOUS ON-BOARD COMPUTER ATTITUDE CONTROL. IT WILL TAKE A NUMBER OF WEEKS TO EXHAUST ALL CABLE RECOVERY POSSIBILITIES.

**\*\* S/C ATTITUDE \*\***

THE SPACECRAFT IS CURRENTLY SPIN STABILISED WITH A SPIN PERIOD OF 30 SECS.

**\*\* S/C OPERATIONS SCHEDULE \*\***

WED 30 MARCH - MON 4 APRIL.....1200/SPEECH TELEMETRY/BULLETIN

TUES 5 APRIL - THU 7 APRIL.....300 BD ASCII / RTTY TELEMETRY

CURRENT OPERATIONAL CONDITIONS SHOULD INCREASE 145MHZ AVAILABILITY DURING WEEKDAYS. NEW SOFTWARE IS UNDER TEST WHICH WILL INCREASE THE RELIABILITY OF LOADING OF THE WEEKEND BULLETIN PROGRAMS. SUGGESTIONS FOR NEW PRESENTATION FORMATS FOR THESE WOULD BE WELCOME.

**\*\* THANKS FOR FEEDBACK \*\***

K1KSY, B.LINDHOLM, WA2LQQ, W4AUZ, JA4GVA, WD4IXI, HB9RKR, HB9RJV, VE200

**\*\* POST BOX \*\***

\*\*K1KSY DE G3YJO...THANKS FOR DATA AND PLOTS RECEIVED, VERY GOOD.

\*\*WA2LQQ DE G3YJO...DOES THE US NEED ANY MORE COPIES OF THE IERE UOSAT JOURNAL, G3AAJ COULD CARRY IN MAY.

**\*SPACECRAFT ORBITAL DATA\***

**ORBITS FOR 30TH MARCH**

	UOSA.	OSCAR-8	NOAA-7	
ORBIT NO :	8183	25821	9109	
EQX TIME :	15:07:18	14:09:37	15:07:57	GMT
EQX LONG :	359.0	169.4	10.7	DEG.W
MEAN HGT :	505.1	905.0	850.0	KM
PERIOD :	94.7183514	103.1668742	101.9100825	MINS
P-DRAG :	5.394E-05	2.166E-06	7.500E-06	*N-REF
LONG INC :	23.6791479	25.7935538	25.4881782	DEGS
L-DRAG :	1.357E-05	7.030E-07	2.000E-07	*N-REF

QSL/POST CARDS CONFIRMING RECEPTION OF UOSAT DATA INCLUDING STATION DETAILS WOULD BE APPRECIATED FOR SURVEY OF NO. AND GEOGRAPHIC DISTRIBUTION OF ACTIVE STATIONS  
 SEND TO: DR.M.N.SWEETING, UOSAT CONTROL CENTRE - THANK YOU

Printout by Graham VK5AGR.

The meeting was attended by a range of interested persons and group representatives. Topics discussed ranged from highly technical PACSAT matters to launch possibilities during the coming years.

It is interesting to note that Paul Rinaldo W4RI, who will shortly move to ARRL to head up its technical departments, was in attendance. Paul is currently President of AMRAD, the Amateur Radio Research and Development Corporation, and a long standing member of AMSAT. He has been actively involved in Amateur Packet Radio and will, without doubt, bring to ARRL and the amateur fraternity in general an appreciation of digital technology. It is inevitable that this mode of radio communication will come to the fore during the next decade just as SSB developed in the 50's and 60's.

**AMSAT GENERAL MANAGER**

The Board of AMSAT has announced the appointment of William L. Lazzaro N2CF to be its General Manager and Executive Director. N2CF has been licensed since 1964, holds an Extra ticket and has a Masters Degree in Science Education.

Australian Members of AMSAT wish Bill well in his new position.

**UOSAT TRANSMISSIONS**

Many amateurs listen to the beacons of UOSAT 9 and to the fascinating digitalker but few are in a position to record and translate its bulletin board which is frequently sent in 1200 Baud ASCII.

I am indebted to Graham VK5AGR for a neat printout of the UOSAT Bulletin for 30 March which uniquely included Easter Greetings.

This printout may entice others who have computer printout facilities to enter the fascinating world of digital communications.

**PACKET RADIO**

Reference has been made recently, and in this issue, to Packet Radio and to PACSAT which is its satellite application. A

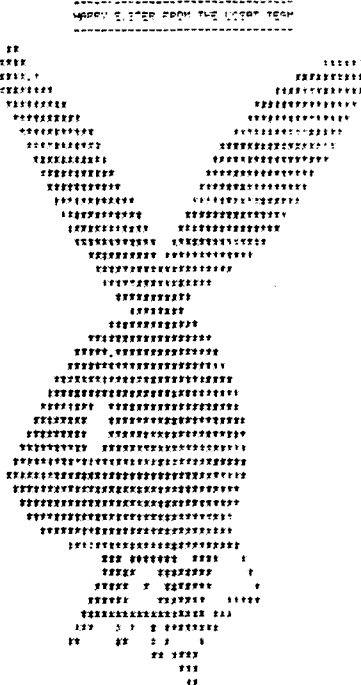

Easter greetings sent from Graham and reduced from original computer programme.

few words of explanation may be in order.

Store and forward packet switching techniques were developed in the mid 1960s and the term 'packet' was introduced by the British National Physical Laboratory.

A 'packet' is a group of ASCII characters (information) surrounded by control signals and error detection features. The control signals help recognise the presence of a packet and tell any intervening switching equipment where the packet should be sent. The error detection feature will virtually guarantee that bad information will not be observed by the destination station.

A packet is similar to a message format

and the header and tailer components are designed to be read by computers which can be either a home computer programmed to perform the function or a dedicated micro-computer board.

Amateur Radio packet experimentation has been pioneered in Canada and there are now many networks active in North America. Following success with these terrestrial networks it is now highly probable that the techniques will be applied to future amateur satellites.

**ORBITAL INFORMATION**

For those enthusiasts who are unable to listen to the AMSAT nets or who would prefer hard copy information, I am always pleased to supply lists of updated Keplerian Elements, Orbit Periods and Equator Crossing data for prescribed satellites.

All I ask is for a supply of SASE's and details of your requirement, i.e. which satellites, type of information required and the frequency of dispatch, i.e. weekly, bi-monthly, monthly etc. and I will do my best to keep you up to date.

AR

**MURPHY STRIKES**

In the April issue two photographs appearing on pages 13 and 14 were incorrectly credited to Mike Thorne VK3BKK.

Whilst Mike supplied the prints, the photographs were actually taken by Barry Wilton VK3YXX.

The error is regretted.

Gil Sones — Editor

**WIA BADGES**

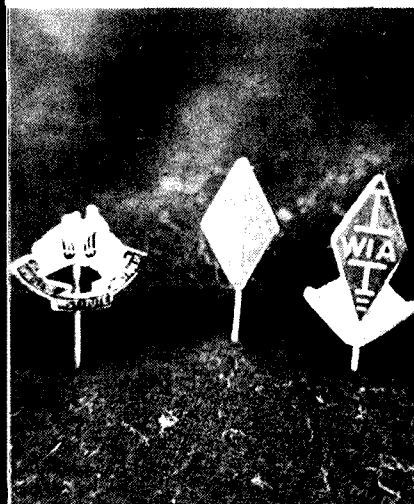

Stick Pins are now available

Contact your division

or

Federal Office

# NATIONAL EMC ADVISORY SERVICE

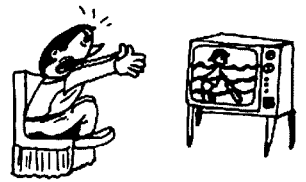

Tony Tregale VK3QQ  
FEDERAL EMC CO-ORDINATOR  
38 Wattle Drive, Watsonia, Vic. 3087

## "NO WORRIES?"

*The review of the Radiocommunications Bill made this year's Federal Convention one of the most important for the Institute. With the convention over and our submission to the Bill completed, the temptation is to relax for another year.*

If we are to provide the maximum protection for our service the "no-worries" attitude must be pushed well into the background:

*The battle has only just started!*

Even if we do get all that we have asked for, and all that we have recommended in our submission, there is still a long way to go before these recommendations can be implemented or, we are able to see a light at the end of the tunnel.

When the Bill eventually becomes an Act the associated regulations and standards will have to be drawn-up. If these regulations and standards are not favourable to the Amateur Service then we will have lost the battle.

The CASPAR Committee will be monitoring all the various aspects of the Bill/Act, the Regulations, and the Standards; and together with the Federal Executive will try to ensure that the Amateur Service gets the best possible deal. However, because of the very detailed and complex nature of legislation, regulations, and standards we must call on the assistance of all members of the Amateur Service to provide an on-going monitor of the overall situation, and provide an input to the CASPAR Committee. With this most important milestone for amateur radio it is not good enough to just leave it to the other guy.

Throughout the discussions about the Radiocommunications Bill, and other submissions recently, it became abundantly obvious that in order for the Amateur Service to secure the best possible deal in this very competitive world it is most advantageous for the Service as a whole to be able to say that our members are technically qualified responsible people.

Those amongst us who are constantly advocating for lower standards and the elimination of this or that from the examinations are doing our Service untold harm in the long term. It is simple logic that if one is seeking employment, a company is more likely to give the position to the most qualified person.

Any reduction in the technical standards necessary to obtain an Amateur Radio Licence can only serve to severely limit the power of the Amateur Service when negotiating for terms or extra privileges.

The fact that we are technically qualified (at a reasonable standard) and responsible people can open many, otherwise closed, doors. Also, these standards provide us with a good platform in relation to our position within radiocommunication legislation, and within the society of electromagnetic spectrum users.

The National EMC Advisory Service is especially concerned in regard to areas which produce major difficulties and quite often leave members of the Amateur Radio Service with very little chance of a final effective solution. These are, IMMUNITY/SUSCEPTIBILITY of domestic entertainment equipment and consumer products and, INCIDENTAL RADIATION from these and other devices.

These are the areas which need to be given top priority by all those concerned with the control of legislation, regulations, and standards. We need firm effective control based on international standards, legislation, and experience... not a wishy washy — "no worries mate, she'll be right" attitude.

Members of the Amateur Radio Service have always been very conscious of the need for high quality transmission and reception of electromagnetic energy in all forms using, modern technology, know-how, dedication and responsibility. This is reflected in many ways; one is the fact that the Amateur Service is self monitoring and very conscious of the finite and very vulnerable electromagnetic spectrum.

This is in contrast to manufacturers and importers of domestic entertainment equipment and consumer products where the object is to produce or import a product as cheaply as possible, or ensure a large turnover with as much profit as possible with little regard as to how it will operate when in close proximity to other equipment. And of course, definitely no concern for the finite electromagnetic spectrum.

The latest device to give major concern to the Amateur Radio Service is the VIDEORECORDER which is proliferating at an incredible rate. In most cases these devices require only a "sniff" of electromagnetic energy in order to send them "berserkiefied" — Today it's videorecorders:

**"What will it be tomorrow?"**

Co-operation by manufacturers and

import agents in regard to the EMC problem is, in the main, very poor. However, there are a few exceptions. The following letter from a NSW amateur is an example of co-operation by an Australian manufacturer/agent.

The case involved an Arlec AM469 intruder alarm. The writer explains:

*"The AM469 is located on the opposite side of the street, about 50 metres from my TH3MK3. The AM469 uses ultrasonic doppler technique for detection of movement in the house.*

*"As my neighbour spends most weekends away from home I am hesitant to use my radio equipment over this period for fear of setting off the alarm.*

*"Basic checks indicate that if I use only the TS820 there is no problem: However, using the FL2100 at 400 watts instantly triggers the alarm. Further checks indicate that I can use 400 watts with RTTY but not SSB."*

After consultation with our special devices advisor, and A & R Electronics of Box Hill, Victoria who were most co-operative and helpful, the amateur was advised to try a number of ideas including shielding and earthing.

After further investigations —

*"My neighbour has tried many of the ideas suggested, however, the final answer was to completely shield and earth the unit. I can now run 400 watts any mode and there is no alarm problem.*

*"I am surprised that these AM469 units are not totally shielded in the first place, complete with an earthing terminal. Surely the manufacturers cannot claim this would involve expense, because the top and bottom plates are made of wood with a decorative strip around the edge making it look like aluminium. An aluminium case would probably cost less, and be much more effective for EMC."*

The National EMC Advisory Service is most appreciative of the valuable assistance given by A & R Electronics.

The following letter from a Victorian amateur is an example of an unusual interference problem.

*"The following experience is with a Heathkit Electronic Digital clock model GC-1005, a six digit type which I built some years ago. It ran perfectly for a long time.*

"However, about two years ago it started to lose time at a random rate, sometimes up to 50 secs per week, other times 14 secs —nothing exact, always random. One could of course suspect a power failure, however these clocks go into a holding pattern when a power failure occurs.

"I checked the clock for intermittent problems, changed ICs, all to no avail. Then one day I noticed intermittent flicker of an incandescent lamp I was using to do some fine work. Thinking about this later it seemed that if there was a flicker in the lamp then there must be a period of no power. This would mean that in say 1 second there could be 30 Hz (effective) or less. The clock electronics would count this as such and the display would be in error.

"As we have two phases supplying the house I was able to ascertain that the problem was associated with only one of the phases. I suspect the problem to be a large factory nearby which uses a very large welding plant.

"I am pleased to say the problem was cured by fitting a Clipsal 423, 3 pin Static Suppressor Plug to the clock."

An effect which came to our notice recently, and could be considered ultimate EMI problem was that of EMP (electromagnetic pulse) . . . Not your regular EMP but the "big daddy" of EMP: I refer to EMP produced by an atomic explosion.

The reports refer to two major effects, one is the effect of an EMP produced by an atomic explosion in space. If the explosion is near to the satellite belt, the electronic systems of a number of satellites can be destroyed by the massive electromagnetic pulse of energy; unless of course the satellite's electronic systems are hardened against this effect.

The second effect is perhaps a little closer to home; that of a high level atomic explosion which, if correctly positioned over an Earth target, could destroy all electronic control and communications systems (not hardened), without physical damage to the target.

Most of our modern day communications and control systems employ complex solid state devices. These devices are very vulnerable to EMP (and ESD). This is one reason why some military equipment is being reverted to thermionic valves.

There are many mundane adverse, but interesting, effects of EMP (and ESD) which we will cover on another occasion.

AR



#### UPDATE ON STOLEN EQUIPMENT

The May issue of Amateur Radio carried a report of the loss of several items of equipment by GFS Electronics.

Some of the items have been recovered by the Victoria Police.

Police investigations are continuing.

AR

# LEARNING THE MORSE CODE?

## Try the All New BT-1 — Basic Trainer For Morse Code

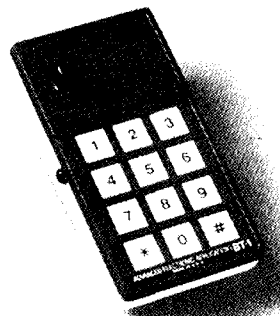

Advanced Electronic Applications in conjunction with ETS (Educational Technology and Services)\*, has developed the BT-1 Code Trainer. ETS methodology, based upon research by a prominent mid-west university, has demonstrated that a typical student using this system and the BT-1, can learn Morse Code to speeds of 20 WPM in four weeks based upon two 20 minutes daily training sessions.

The pre-programmed BT-1 computerised trainer will allow you to achieve proficiency in Morse Code faster than any other known method.

No prior knowledge of Morse Code is required to use the BT-1. There are no tapes to purchase or wear out. The BT-1 operates from a 12 VDC source, the unit can also be used in mobile settings via the 12 VDC system.

\* Education Technology & Services, see page 81 October 1981 issue of Ham Radio Magazine

**Prices and Specifications  
Subject To Change Without  
Notice Or Obligation**

**ADVANCED ELECTRONIC  
APPLICATIONS**

**Brings you the  
Breakthrough!**

**\$134.40 (Inc. of ST) Plus P&P**

### HY-TECH DISTRIBUTORS

Building 51,  
Archerfield Aerodrome, Q 4108  
Tel: (07) 277 5624  
Telex 43318

## A Call to all holders of a **NOVICE LICENCE**

Now you have joined the ranks of Amateur Radio, why not extend your activities?

**THE WIRELESS INSTITUTE  
OF AUSTRALIA  
(N.S.W. DIVISION)**

conducts a Bridging Correspondence Course for the AOCF and LAOCF Examinations.

Throughout the Course, your papers are checked and commented upon to lead you to a **SUCCESSFUL CONCLUSION.**

For further details write to:  
**THE COURSE SUPERVISOR,  
W.I.A.**

P.O. BOX 1066,  
PARRAMATTA, NSW 2150

## WANTED TO BUY

Ham gear, CB equipment, Hi Fi, video, car stereo, large or small quantities.

**WE BUY AND SELL**

**ANYTHING ELECTRONIC**

**ANY QUANTITY**

**ANY CONDITION**

# HAMRAD

104 Highbett Street,  
Richmond, Victoria.  
Phone: (03) 428 8136

# FORWARD BIAS

VK1 DIVISION



John MacPhee VK1NEN  
VK1 PUBLIC RELATIONS OFFICER  
36 Kavel Street, Torrens, ACT. 2607



FIVE-EIGHTH  
WAVE

Jennifer Warrington VK5ANW  
59 Albert Street, Clarence Gardens, SA 5039

As I write this half my mind is on the Federal Convention which takes place this coming weekend. As ever I am aware of the responsibility of the position, but having been well briefed by council as to their feelings on many subjects that will be raised, should make things easier.

Our 'Team' this year consists of myself as Federal Councillor, David Clegg VK5AMK as First Alternate Councillor and Graham Ratcliff VK5AGR as Second Alternate or Observer. This year we shall be driving over by car which will be a new experience for me. Perhaps it's just as well that we all get on well together or they might threaten to leave me in VK3! If all goes according to plan we shall be arriving back on the Tuesday, with only a few hours to spare before the Divisional AGM (forgive us if we weren't looking too bright!). Unfortunately there will not be a ballot, as only the bare minimum of nominations were received. Although this is a little premature, I would like to welcome the two new members who did nominate for council, Roland Bruce VK5OU, and John Gardiner VK5PJK and hope that you enjoy your time on council as most members find they do. Two members who have spent many years on council and despite the enjoyment they confess they have had, have decided that it is time to give someone else 'a go'. I am referring to Maurie VK5ZU, and John VK5NX both of whom have been tireless workers for the Division, and both of whom will be missed on council. However, both have assured us that although they are no longer council members, they still intend to continue in other areas when required.

By the time you read this 17th May will be long passed, and hopefully the planned AR station set up in the main hall of the GPO for that and the following three days, will have been a huge success. The credit for the idea must go to David VK5AMK, who thought that as we had the AX5ITU call sign for World Communications Day, it seemed a shame not to get some 'PR mileage' out of it. As it turned out, the man in charge of setting up a display for WC Day in the GPO (they have a 27¢ stamp and a first-day cover being released) was wondering what he could use! Hopefully as well as just being seen by the public, we may get some Media coverage as well.

## Full Convention report in July

VK1DS Peter Smith  
Head of Repeater Sub-Committee  
VK1MX Bill Maxwell  
Head of ATV Sub-Committee  
VK1KRA Rod Apathy  
WICEN Co-Ordinator  
VKs 1MX and 1RH were presented with "Certificates of Achievement" in recognition for their services to the Committee over the years. A job well done, thanks!

The VK1 Division set up a demonstration station at the Belconnen Mall Shopping Complex on ITU day as part of their PR programme. Considerable interest was shown by the public.

The display included operating stations and static displays. Operators were kept busy with enquiries about amateur radio. The display was again a huge success.

### MEETING AGENDA

27 June Studio Room  
25 July Studio Room  
22 August Room 1  
26 September Room 1  
24 October Studio Room  
28 November Studio Room

Meetings are held at the Griffen Centre, Civic and all visitors are welcome to attend.

73 John MacPhee VK1NEN  
Editor

AR

## RD WINNER

Jenny, VK5ANW accepts the RD award, on behalf of VK5, from Bruce VK3UV, Federal President, at the Federal Convention held in Melbourne during ANZAC weekend.

At the AGM a new committee was elected. The newly elected committee and their official positions are as follows:

VK1KAL Alan Hawes  
President, Broadcast Manager and Public Officer

VK1MM Fred Roberston-Mudie  
Federal Councillor, Intruder Watch Co-Ordinator and QSL and DRI Liaison

VK1IC Ian Coleman  
Alternate Federal Councillor and Education Co-Ordinator

VK1UE Richard Jenkins  
Secretary

VK1OK Kevin Olds  
Treasurer and ATV and WICEN Liaison

VK1NEB Gavan Berger  
Property Officer and Awards Manager

VK1EP Eric Piraner  
Repeater and Beacon Liaison and Book Sales

VK1ZBC Murray McInerney  
Meeting Manager

VK1NEN John MacPhee  
Public Relations Officer and Forward Bias Editor

Other non-committee members have the following positions:

VK1RH Ron Henderson  
Divisional Historian

VK1MF Mori Foster  
Inwards QSL Manager

VK1AOP Ted Pearce  
Outwards QSL Manager







# VK2 MINI BULLETIN

Jeff Pages, VK2BYY  
VK2 Mini Bulletin Editor  
PO Box 1066, Parramatta, NSW. 2150

## COUNCIL REPORT

The 1983-84 Divisional Council met for the first time on the 8th April. Tom Delandre VK2PDT was appointed to fill the casual vacancy on Council caused by the shortfall in nominations. The office bearers for the ensuing year were elected as follows:

- President: Sue Brown VK2BSB
- Vice Presidents: Jeff Pages VK2BYY and Tim Mills VK2ZTM
- Secretary: David Walters VK2AYO
- Treasurer: David Thompson VK2BDT assisted by Sue Brown VK2BSB
- Affiliated Clubs Officer: Jeff Pages VK2BYY
- Education Service Liaison: Bob Clark VK2YOD
- WICEN Liaison: Peter Jeremy VK2PJ
- Repeater Committee Chairman: Tim Mills VK2ZTM
- QSL Bureau Liaison: Tom Delandre VK2PDT
- Publications Officer: Sue Brown VK2BSB
- Dural Property Officer: Jeff Pages VK2BYY
- Parramatta Property Officer: Tom Delandre VK2PDT
- Broadcast Officer: Peter Jeremy VK2PJ
- Minibulletin Editor: Jeff Pages VK2BYY
- JOTA Officer: Tom Delandre VK2PDT
- "AR" Publicity Officer: Tom Delandre VK2PDT
- Components Officer: Bob Clark VK2YOD
- WCY '83 Publicity: Sue Brown VK2BSB
- Library Officer: Aub Topp VK2AXT
- Correspondence Course Supervisor: Cec Bardwell VK2IR
- Intruder Watch Co-ordinator: Bill Martin VK2EBM
- Co-ordinators for the Disabled: Fred Greening VK2DZL and Jim Saunders VK2BNY
- Slow Morse Supervisor: Ross Wilson VK2BRC
- Contest Publicity Officer: George Trotter VK2AVY
- Honorary Solicitor: Fred Herron VK2BHE

Ken Hargreaves VK2AKH was reappointed as Education Service State Supervisor. David MacKay VK2ZMZ, Eric Van de Weyer VK2KUR, Syd Griffith VK2AHF, Ian Nance VK2BIN, Alan Boxsell VK2YEQ, Tim Mills VK2ZTM, Fred Parker VK2ZBK/NFF and Brian Warren VK2BX were appointed to the WICEN Committee.

Jeff Pages VK2BYY, Peter Jeremy VK2PJ, Roger Henley VK2ZIG, Colin MacKinnon VK2DYM, John Marshall VK2EGI and David Walters VK2AYO were appointed to the Dural Committee.

Paul Smith VK2ZSA, Henry Lundell VK2ZHE and Max Bowey VK2ZQA were appointed to the Repeater Committee. Additional volunteers are required for this committee, which is responsible for co-ordinating repeater allocations in this state.

Twelve new membership applications

for April were accepted.

Council wishes to borrow an electric Gestetner duplicator for use in reprinting the Correspondence Course notes. If you can assist please contact the Divisional Office.

A group of clerical staff from the Department of Communications visited the Dural station to view the facilities, and also delivered the new beacon and repeater licences. Under the new licences, the beacons now identify as VK2RSY and the 2 metre and 70 centimetre repeaters now both have the call sign VK2RWI. The 70 centimetre beacon is now on air on 432.420 MHz, running 15 watts to an omnidirectional horizontally polarised antenna.

Council records its sincere thanks to Frank VK2KFB and Paul VK2ZSA for their donations of output transistors for the Dural 2 metre repeater and 70 centimetre beacon respectively.

## 8th CONFERENCE OF CLUBS

The 8th Conference of Clubs was held at the divisional headquarters in Parramatta on the 17th April, hosted by the St George Amateur Radio Society. The chairman was Jim Button VK2NPO, and Derick Sellars VK2AZS was elected as Secretary. The Central Coast, Westlakes, Liverpool, Goulburn, St George, Castle Hill RSL, Mid South Coast, Hornsby and Wagga clubs were represented. The following motions were passed by the Conference:

*"That liaison between the VK2 Repeater Committee and Repeater Committees in adjoining call areas be improved, especially with regard to frequency allocations."*

*"That the WIA NSW Division, through the Federal WIA, contact the Minister for Communications to protest at the lack of action by DOC against continued obscene broadcasts on the amateur frequencies*

*and in particular the Sydney 2 metre repeaters."*

*"That the WIA NSW Division, through the Federal WIA, write to the Minister for Communications requesting the early removal of channel 10 from the international 6 metre amateur band, as promised by the previous government."*

*"That the 8th Conference of Clubs approve a slow Morse beacon on HF or MF."*

*"That Federal Executive and the VK2 Division consider adopting a Bankcard system for payment of subscriptions, books, etc."*

*"To ask Federal Executive of WIA to continue pressure during discussions with the Minister of DOC to standardise our frequencies available, to those of other countries within our region who have greater bandwidths available."*

*"That WIA request DOC to conduct CW upgrading exams for full-licensed amateurs to sit for to have their licence endorsed to be compatible with overseas amateurs for the purpose of the issue of a reciprocal licence when visiting those countries whose Morse speed test is higher than 10 WPM."*

Councillor Peter Jeremy presented a report on the Queensland Radio Clubs Workshop, and as a result it was resolved that this 8th Conference of Clubs strongly recommend to the VK2 Council that the VK2 Conference of Clubs prior to the Federal Convention be a two day conference, and that council consider appropriate reimbursement to the delegates.

Under general business, the agenda items for the 1983 Federal Convention were discussed for the guidance of Federal Councillor Stephen Pall and Alternate Councillors Wally Watkins and Tim Mills.

It was resolved that the next Conference of Clubs be hosted by the Central Coast



Delegates and observers at the 8th Conference of Clubs.

Amateur Radio Club, with the tentative date being the 6th November.



Ian Jeffrey accepts award on behalf of Goulburn ARS for highest percentage increase in WIA membership from Divisional President Susan Brown.

**FIREWORKS DISPLAY**

The Dural Fireworks Display takes place on Saturday the 4th June at VK2WI, 63 Quarry Road, Dural. The barbecue dinner commences at 6PM, with the fireworks kicking off at 8PM. Those attending the dinner should have purchased their tickets by now, however fireworks-only tickets will be available at the gate at \$3 for adults, \$2.50 for children or \$11 for a family consisting of two adults and their children. Approximately \$500 worth of fireworks will be set off in what promises to be a most spectacular display.

NSW members and clubs are invited to submit news items for inclusion in these notes to WIA NSW Division, PO Box 1066, Parramatta, NSW, 2150 and mark items "For Mini Bulletin". Items for August AR must be received by the 22nd June.

Jeff VK2BYY

AR

**EMC**

(Electro Magnetic Compatibility)



if radio frequency interference is causing you a problem you are reminded that — "Advice on all types and aspects of interference (PLI, TVI, AFI, etc.) is available from the National EMC Advisory Service".

FORWARD DETAILS TO  
VK3QQ,  
Federal EMC Co-ordinator, QTHR.



**VK4 WIA NOTES**

The Radio Club Workshop, 1983, was held at Griffith University, Brisbane, on the weekend of 9/10th of April. No less than twenty Queensland clubs were represented. Generally there were about forty amateurs present listening to and taking part in the proceedings. As well as club delegates, several members of the Queensland Division Council and our Federal Councillors were present. The workshop is held to keep council in close touch with state members and to brief our Federal Councillors in preparation for the Federal Convention.

Guests at the workshop were Peter Jeremy, VK2PJ, VK2 councillor; Sam Voron, VK2BVS; Mr Kevin White, State Director of SES and Mr Boyd Rayment of DOC. Peter Jeremy was there as an observer for the VK2 council as VK2 had expressed an interest in our Radio Club Workshop. Sam Voron spoke on traffic nets and was very well received. Sam's talk was very informative and quelled a lot of fears held by some in the audience. Both Mr White's and Mr Rayment's contributions were received with great interest and many questions.

All who attended went back to report to their clubs that the weekend was very worthwhile and worth every cent of members' money. The Queensland Division pays for air fares for one delegate from each club so it is a costly affair. Remember that Queensland is a very big state, Cairns being as far away as Melbourne from Brisbane. It was unfortunate that inconvenient airline schedules stopped the Mt Isa Club coming.

Club motions on a wide variety of subjects were discussed, many of Queensland interest but some of interest Australia wide. These included discussion on RTTY calling frequencies, contests and upgrading the AOCPS Morse speed requirement.

The workshop proposed that RTTY calling frequencies be adopted as follows:

- 3.520 ± 5 kHz
- 7.045 ± 5 kHz
- 10.145 ± 5 kHz
- 14.090 ± 5 kHz
- 18.105 ± 5 kHz
- 21.090 ± 5 kHz
- 24.925 ± 5 kHz
- 28.090 ± 5 kHz
- 28.620 ± 5 kHz

Contests were the subject of much debate, particularly in regard to taking up whole bands for many weekends throughout the year. The workshop came out strongly to have contests confined to band segments and that the WIA negotiate with other national societies to achieve this aim. There are already kindred thoughts being expressed in many parts of the world, Region 1 being a leader.

Due to difficulties experienced by

Australian amateurs who have AOCPS Morse qualification at 10 WPM in obtaining full privilege licences when overseas, it has been proposed in several quarters that the standard requirement be raised to 12 WPM. Several points came out of the discussion. Not many of the out of the total number of Australian amateurs go overseas to operate a station. DOC will conduct Morse tests at higher speeds and furnish documentary evidence of a pass, and a most interesting question, if the speed for AOCPS qualification is raised, will all AOCPS holders with 10 WPM endorsements, be required to pass at the new higher speed?

In previous workshops, delegates have formulated policy statements, some of which have been adopted as is or in modified form by the Federal Council. RTTY is gaining many supporters. Here is the policy statement prepared at the workshop on this mode which could receive federal endorsement.

Policy statement on RTTY — FUTURE DEVELOPMENTS.

Bud, VK4QY

AR

**ELECTRONIC HOBBYIST!**

DO YOU LIVE IN . . .  
Ringwood, Lilydale,  
Boronia, Wantirna,  
Bayswater,  
Mooroolbark etc? . . .

We carry a comprehensive range of electronic components at very keen prices.

**Ian J. TRUSCOTT ELECTRONICS**

CNR EASTFIELD & BAYSWATER ROADS, SOUTH CROYDON, VIC. TELEPHONE (03) 723 3860



# VK3 WIA NOTES

## FOR SALE TO VK3 MEMBERS

An ICOM 720A HF Transceiver and matching ICOM PS15 Power Supply.

This equipment was purchased by the VK3 Division and loaned to the VK6 DX Chasers Group to use during the recent very successful DX-pedition to Heard Island.

It is in mint condition and perfect working order. As it was never our intention to make a profit on this arrangement, merely to cover costs, applications to purchase the equipment for \$1085 may be sent to

The Treasurer,  
WIA Victorian Division,  
412 Brunswick Street,  
Fitzroy, Vic 3065.

before 8th June 1983.

If necessary, a ballot will be held during the June General Meeting.

## VK0HI and VK0CW

QSLs for VK3 amateurs who QSLed direct to VK6NE including a self-addressed envelope but with **NO RETURN POSTAGE** will be bulk mailed to the VK3 office at 412 Brunswick Street, Fitzroy, Vic, 3065 and will be held for one year for collection.

Personally I think it is most unreasonable to expect ANY EXPEDITION to pay for return postage on top of the cost of the card.

## HOW ABOUT IT FELLAS — DO THE RIGHT THING!!

73 Des Clark VK3DES  
TREASURER VK3 DIVISION

A state Victorian Parliamentary Committee is inquiring into the environmental impact of larger radio masts in residential areas and has to report to Parliament by 30 June, 1983.

The National Resources and Environment Committee is particularly interested in whether the degree of environmental impact significance justifies municipal control over the appearance of such masts, and invited submissions from persons or organisations and set a deadline of 31 March.

The WIA Victorian Division submission was hand delivered to Parliament House Melbourne on 31 March — it contained about 4000 words and took roughly 100 manhours to produce.

The VK3 Taskforce on Radio Masts, Alan Noble VK3BBM and Jim Linton VK3PC, was expanded to include the VK3 Divisional Secretary Ian Palmer VK3YIP.

For more than two years the taskforce of Alan and Jim had been involved in making representations and attending conferences to put the view of the WIA concerning radio masts.

They were successful in impeding the progress of an amendment to the Mel-

bourne Metropolitan Planning Scheme in 1981 which would have resulted in a planning permit being required for radio masts together with antennae that:

(a) exceed a height of eight metres above the ground.

(b) when attached to a building exceed a height of three metres above the roof line, or

(c) have any horizontal dimensions in excess of three metres.

The then Liberal Minister for Planning was informed that such restrictive planning requirements were unjust and unworkable.

It is perhaps appropriate to mention that a planning permit for radio masts in residential areas — as used by radio amateurs — is not required.

However a building permit should be sought when the mast exceeds a height of eight metres above the ground, or when attached to a building exceeds a height of three metres above the roof line.

Under the Uniform Building Regulations the municipal council or shire has discretionary powers to refuse a permit and the applicant then has a right of appeal. At such appeal hearings the decision has traditionally been in favour of the radio amateur.

The Town Planning Appeals Tribunal has held that a resident has a right to do those things which accompany normal domestic living including the performance of a hobby. It has taken the view that a planning permit is not required for erection of radio masts used for domestic or hobby purposes. This historical fact has been highlighted in the WIA submission to the Parliamentary Inquiry.

In addition to the Taskforce on Radio Masts, a number of others provided assistance in compiling the submission. These included Michael Owen VK3KI on legal aspects, Jack O'Shannassy VK3SP with technical advice, and Mike Provis VK3KKA assisted in a journalistic capacity.

## AMATEUR OCCUPATIONS

Ken Palliser VK3GJ and John Hutchinson VK3JH provided a computer print out giving a breakdown of the various occupations held by radio amateurs and the percentage who are retired persons.

This was valuable in explaining the nature of amateur radio and dispelling any misconceptions that radio amateurs are all "boffins" or something worse — "ratbags".

The submission went through five draft stages using a professional typing service with a word-processor. It was estimated that a similar submission compiled totally by an outside firm which specialises in similar government submissions would have cost around \$10,000.

The WIA Victorian Division has indeed been fortunate in being able to draw on the resources and expertise of individual members of the amateur radio fraternity.

In addition to the main submission, the Victorian Division circulated a form letter with eight key points and these were signed by individual radio amateurs and sent to the inquiry.

The WIA Victorian Division has opposed planning controls for modern design masts used by radio amateurs which do not exceed a height of twenty metres.

It is hoped this inquiry will resolve the issue of radio masts which has been a source of concern in Victoria since the late 1960s.

## SURVEY OF BACKGROUNDS OF RADIO AMATEURS

Computer extract from membership records of 473 people, most living in the Melbourne metropolitan area, who are actively involved in amateur radio.

### PROFILE OF OCCUPATIONS

Academic 9	1.9%
Business Administration 32	6.8%
Communications and Electronics 50	10.6%
Data and Computers 11	2.3%
Engineering 34	7.2%
Finance and Accounting 10	2.1%
Technical Sales 5	1.1%
Electrical Trade 11	2.3%
Telecom 20	4.2%
Medical 13	2.8%
Transport Industry 23	4.9%
Manufacturing 15	3.2%
Building and Allied 13	2.8%
Public Service 21	4.4%
Retired 57	12.1%
Teaching 26	5.5%
Student 32	6.8%
Television Industry 6	1.3%
Miscellaneous or not stated 75	15.9%

Jim Linton VK3PC  
AR

## Remember Photo Competition

beginning July issue AR.

See page 6 May AR.

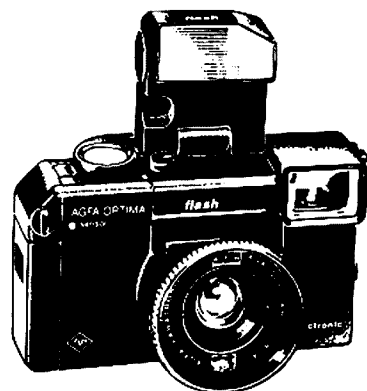

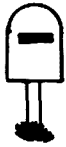

# LETTERS TO THE EDITOR

Any opinion expressed under this heading is the individual opinion of the writer and does not necessarily coincide with that of the publisher.



## HIGHER STANDARDS

58 Bainton Cres.,  
Melba. ACT 2615

As a relative newcomer to the realm of amateur radio, I am impressed by the general level of professionalism of amateurs in their approach to the hobby. However there are two aspects with which I am disappointed and with which I would encourage a re-assessment. These are in respect of the units of measurement and phonetics.

Australia has been formally, albeit not entirely, converted to metric units, a desirable adoption in a world generally using a decimal base for measurement and currency. However it seems incongruous to maintain the use of feet and inches, on the air or in correspondence, in respect to radio communication. Since wave lengths are universally measured in metres or centimetres, and as it has a direct affect on antenna design and structure, the use of imperial units can only be described as a complicating factor. For example to detail the antenna height or its elements in terms of feet and inches means little in terms of frequency unless it is first converted to metres — so why use it? Accordingly I believe we should make a concerted effort, however awkward it may be for some, to take a professional approach and get with the times.

Secondly we hear a considerable variation in phonetic spelling using local and non standard terms such as "Mexico" or "Mary" in place of "Mike" for the letter M. It may suit or please the Americans or the Mexicans, but it is not the agreed international form upon which current amateur aspirants are examined. The current choice of words may not seem optimal, but let us use appropriate forums for changing the phonetics and not drift to other terms according to whim.

Again perhaps only minor issues, but let us make the effort and maintain our otherwise high standard.

Yours faithfully,  
Ron Van Santen VK1VS

AR

## ADVERTISEMENTS

### Editor's Note:

A letter from Rex Black VK2YA was also received by the Federal Secretary on this topic.

Editor's note: A letter from Rex Black VK2YA was also received by the Federal Secretary on this topic.

Old Coonara Rd.  
Olinda Vic. 3788  
6/3/83

I read with interest, your QSP remarks, in March '83 AR, calling for us to protect our privileges by responsible "self policing" of the regulations.

I was somewhat bemused, then, to see the same magazine advertising, via its 'Emtronics Catalogue' insert, such items as speech 'scramblers', amateur and CB linear amplifiers for up to 2 kW output, a transceiver with continuous transmit coverage from 1.8 - 30 MHz etc.

Perhaps I am naive, but it seems to me to be utterly inappropriate for us, as an institute, to allow the pages of our official journal to carry implicit or explicit encouragement of readers to contravene either amateur or CB regulations.

If we do not have advertising or editorial policies covering such matters, I suggest that we should develop them as a matter of some priority.

In other respects, may I commend you on the quality of the magazine in general.

Could you consider, however, returning to the practice of using the same cover colour for a whole year. I found that this made information retrieval from large files of back issues very much easier than the present colour policy allows.

Yours faithfully,  
Norm Meiford VK3ZTN

AR

30 Brennan Pde,  
Strathpine Qld 4500

I have noted over the years the appeals by your magazine to patronise your advertisers. It also has been your policy to promote legal operations from licensed stations. So it struck me to be very unusual to read on page 12 of the Emtronics catalogue inserted in your March issue. The advertisement is for a linear amplifier for UHF hand-held CB. The output of this amplifier is 20 W yet the legal limit is only 5 W. So therefore this equipment is illegal. I realise that the advertiser is at fault here as it is his duty to stay within the law. I believe that the government should ban the imports of illegal equipment and also outlaw the sale of it. I also believe that legal equipment should only be able to be purchased by a licensed operator, and proof of this should be shown before any sale takes place. I would like to see the WIA push for this and would also like to hear your comments and the comments of your readers.

Yours sincerely,  
Bernie McIvor VK4KSB

AR

Points raised have been noted and the matter has been raised with the advertiser. — Ed

## INTRUDER WATCH

Bravo to Bill Martin for his spirited defence of Intruder Watch (AR, March 1983). However, I feel he has over-reacted somewhat, because my letter was not an attack upon Intruder Watch — a necessary and admirable service — and certainly not upon Mr Martin who is doing an excellent job and, as he says, voluntarily. My letter was concerned with encouraging people to help, rather than putting them off. Let us take a couple of examples.

The Intruder Watch segment in February AR, written half humorously I am sure, nevertheless manages to imply that, while VK1, 2, 3 and 4 are doing a fair job of reporting, VK5, 6, 7 and 8 don't give a damn and, presumably, should be ashamed.

In mid-February, the local Sunday morning WIA news bulletin gave details of the number of reports and reporters during 1982, and ended by saying that "not one" of those reports came from Western Australia. I telephoned the broadcast officer about this astonishing statement and he told me that it had come from "federal sources". This conscientious man then enquired into the facts and subsequently broadcast a retraction. If one wants to destroy enthusiasm, this is the right way to go about it.

The fact is that, frustrating as it may be to those who are doing more than their fair share (and as one who has been a club secretary, I sympathise), a man is entitled to be apathetic if he wants to be.

Let me say at this point, that I have been in direct correspondence with Mr Martin and received a courteous and helpful reply enclosing much information which I had never seen before, some of which is contained in the useful Intruder Watch

column in the March issue of AR.

I am sure he will be pleased to know that I am already sending in reports once more and join with him in urging others to do likewise — not because it is expected of them, but because it is an interesting pastime and a way of fighting back.

With best wishes,  
Jeff Jeffrey VK6AJ  
129 Coode Street  
Smith Perth, WA, 6151

For the benefit of any readers who may have been following the public correspondence between Mr Jeffrey, VK6AJ, and myself, may I say that Jeff and I have been in regular correspondence, and we are getting along famously.

We are both equally interested in the Intruder Watch, and are both trying to do our little bit to further the aims of the Intruder Watch in Australia.

Bill Martin VK2EBM  
FEDERAL IW CO-ORDINATOR

AR

## NOT IN THE CALLBOOK

A number of amateurs seem to think that just because your call sign is not in the callbook, you are a 'Pirate', or in some fashion, illegitimate. I have been questioned aggressively twice, abused and have had carriers dropped on me, and suffered various other discourtesies, such as being 'talked about' on 2 metres after being on the HF bands by parties who, for whatever reason, fail to understand that all entries in the callbook are collated some time before the date of printing. Hence, those people like myself, who passed the Novice exam in May 1982, and passed the Full exam in August 1982, and did not apply for a station license until September 1982 may not be in the callbook, especially if the editors of the callbook had not received this information on the deadline.

I would hope that this is the case, and not a case of petty jealousy. To my thinking, the amateur exam is indeed an easy matter, because of my background. Being a professional electrical engineer in the communications area, the theory is a matter which I should know. Learning the regulations is OK. I also keep a copy of the Regs and the Act with me, which one can purchase for about \$3, as well as the AO Handbook.

Learning CW is easy for those people with a musical background. I have discovered, making a di equal to a semi-quaver, and writing out the text in the Handbook for 10 WPM receive, one finds that the speed is about that of allegretto. Those CW fiends that can handle 60 WPM are the real performers, as are symphonists who can play hemi-demi-semi-quavers 'Prestissimo' (hi).

I always call 'is this frequency in use' before going full-bore into a CQ, or whatever, and also, I tune up by listening carefully to a weak station, or noise to get the ATU set up properly, if it isn't already recorded in my note-book. For coaching in operating procedure, and assistance in learning code, I extend my thanks to two friends who introduced me to amateur radio as a worthwhile hobby. Roy AA6W and Neil VE4DQ. Both of them helped me learn code before I returned to Australia. I am now engaged in helping others to learn code.

On the debate over the difficulty of the AOCPC etc I feel that it is a little too easy. The present Novice license should restrict one to CW only on the present Novice allocation. With the present AOCPC test, that should entitle one to what is presently enjoyed by Novices, plus, perhaps, 144 to 145 MHz. A more difficult exam in theory without code would entitle one access to the remaining VHF and UHF

and higher spectra, and an ability at 15 WPM plus passing the more difficult theory mentioned above, entitles one to the remainder of the HF Band. The bands are getting crowded.

I have enclosed copies of my certificates for the editor's benefit.

Peter Wolf VK7PW  
31 Dully Street,  
Ainslie, 2602.

AR

#### ART UNION LOTTERY

The Maryborough (Qld) West State School is currently running an Art Union, permit number A5312, which will be of interest to your readers.

All moneys raised will go toward completing an activities building the P and C is having built at the school.

**PRIZES** — 1st Microbee 16 K Computer, with green screen monitor, cassette recorder and an assortment of software. Value \$786.50.

2nd Sanyo Video Recorder. Value \$699.

3rd Dick Smith Wizard Computer with "BASIC" cartridge. Value \$364.50.

**BOOK BUYERS PRIZE** — (5 consecutive tickets). Choice of goods to the value of \$150.

The Art Union closes on 13th July 1983 and will be drawn on 15th July 1983.

Tickets are \$1 each, \$5 a book and are available from the promoter — E. KING, 45 Wilson Street, Maryborough, Qld 4650. (A SASE would be appreciated).

Yours faithfully,  
E. L. King VK40A  
45 Wilson Street,  
Maryborough, Qld 4650.

AR

#### CONCERNING COMMUNICATION

I live in a small country town in Western Australia, approximately five miles from the only phone box and I have passed all but the theory for my full ticket.

Having \$3000 and a good QTH, I decided to make enquiries about radio equipment to set up my station.

To my dismay the response has been poor, to say the least. All the large outfits that advertise in ARA, Amateur Radio — and I wrote to quite a large number — failed to reply. The exception was Emtronics.

I also sent money to one company that are advertisers of co-axial switches in Amateur Radio. I waited weeks and finally after something like two months I wrote again.

Finally I got the switch but no note of explanation or apology or anything to give me the confidence to deal with them again.

I understand that companies advertise to provide a service and gain revenue with their ads. I suggest at the time of printing, on heavy demand products that quantity in stock or waiting time for delivery, if any, are also printed.

As we deal on a cash basis, interest on accounts is taken into consideration by all. I feel that WIA does much to promote this fascinating hobby which, in times of emergency, has been an extremely practical and staunch service to those both connected with amateur radio and those outside its following.

The chaps I meet and Jack VK6AV, whose been around many a moon, have helped me to get started on this fascinating hobby and have offered me an open door to their shacks.

Have a nice life.

C. Chew.  
c/- Kirup Post Office,  
Kirup, WA 6251.

AR

#### PLEASE NOTE

Letters to the Editor should be short and to the point. They will be easier to read and will not require shortening or summarising.

#### NEW, MOLDABLE PLASTIC

### COAX-SEAL®

- Only material that will adhere to poly vinyl or vinyl outer coax jackets.
- Forms and seals over odd shaped and difficult fittings.
- Non-contaminating and non-conductive.
- Wide ambient temperature range (-30°F to +180°F).
- Stays flexible for years thus insuring moisture proof connections.
- Reusable — allows you to quickly disconnect fittings and reseal them with the same material.
- A must for satellite TV — microwave work — wire antenna at solder joints — in the shack.

Packaged in convenient 1" x 60" roll

\$4.32 per roll plus \$1 P&P

Seals coax fittings from moisture and corrosion

COAX-SEAL® is the new space age material that is quick and simple to apply. Remove backing from approximately 6" of plastic. Wrap outer covering toward fitting. After wrapping, knead to form a smooth surface and force out air. EFFECTIVE — FOOL PROOF — INEXPENSIVE

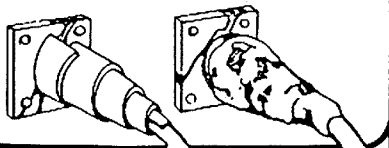

Hy-Tech Distributors,  
Building 51, Archerfield Aerodrome, Qld,  
4108  
Telephone: (07) 277 5624.

DEALER INQUIRIES WELCOME

W01105

## THE VK3BWW FORMULA FOR DX SUCCESS!!

### HIGH QUALITY AT LOW COST

#### BEAMS

3 EL 10 & 11m	\$75.00
3 EL 15m	\$83.00
3 EL 20m	\$158.00
6 EL 6m	\$108.00
5 EL 2m	\$36.00
9 EL 2m	\$59.00

#### DUOBANDER

3 EL 10m, 3 EL 15m \$148.00

Prices include Gamma match

Our beams are easy to assemble and adjust. Entirely **NEW CONCEPT** — **NO NUTS OR BOLTS.**

Spare parts, elements, booms and gamma matches available.

Plus Freight

For further information

PLEASE RING (03) 366 7042

VK3BWW

WERNER & G. WULF

92 LEONARD AVENUE  
ST. ALBANS, VICTORIA 3021

## RTTY/CW

Advanced split-screen ASCII, BAUDOT, CW software for Commodore computers . . . \$59

VIC 20 computer — 5K RAM, 8 colours, hi-res 176\*200 pixel graphics, 4 voice sound generator . . . \$299

Commodore 64 computer — 64K RAM, 16 colours, hi-res 320\*200 pixel graphics, sprites, sound synthesizer . . . \$699

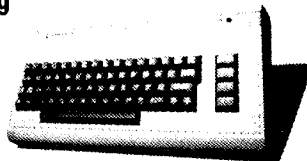

Both computers feature 20K BASIC & operating system, RS 232, parallel user port — disc drives, printers, joysticks, paddies, light pens, games, utilities etc available.

Versions also available for PET/CBM 3000, 4000 and 8000 series (includes SSTV send) — POA.

## HIGH TECHNOLOGY COMPUTER SYSTEMS PTY LTD

87 Swan Street, Richmond, Vic 3121 ph (03)  
429 1966 ask for Mike VK3BHM or Joel VK3ZKE

# IONOSPHERIC PREDICTIONS

Len Poynter VK3BYE

## NOTES ON THE PREDICTIONS

The mode of propagation used by IPS in compiling their predictions are reflected in the bar charts used to convert the Graflex symbols into a graphic picture.

When generating the Graflex charts (reproduced in a number of publications) the following symbols are used.

- 1 " " — Propagation is possible but probably less than 50% of the days of the month.
- 2 "%" — Propagation is possible between 50% and 90% of the days of the month.
- 3 "F" — Propagation is possible by the first F mode on at least 90% of the days of the month unless there is a severe ionospheric disturbance.
- 4 "M" — Propagation is possible by both first and second F modes. The strongest mode is normally the first mode, but the vertical aerial pattern may influence the mode received.
- 5 "A" — High absorption, ie above the absorption limiting frequency but probably too close to it for good communication.
- 6 "X" — Complex mixtures of modes including the second E mode.

These are the most significant types we encounter. The full lines or bars on the chart cover 2, 3, 4 taking 5 into account. The broken lines or bars are depicted by 1. 6 is extremely hard to verify and is not taken into account.

The paths from Eastern Australia are based on Canberra. The paths from West Australia are from Perth. Suitable allowance should be made on Eastern paths for geographical differences. Times, as much as 1 hour difference between Victoria and Queensland in band openings occur. Often there is no signal available in one State, whereas the opposite effect occurs in the other State, they get the lot. Marginal differences produced by layer tilt and varying degrees of ionisation can be very frustrating.

Generally the predictions show that time of day when the path should be open between the two areas. All other factors notwithstanding.

### LEGEND

-  FROM WESTERN AUSTRALIA
-  FROM EASTERN AUSTRALIA
-  BETTER THAN 50% OF THE MONTH, BUT NOT EVERYDAY
-  LESS THAN 50% OF THE MONTH.

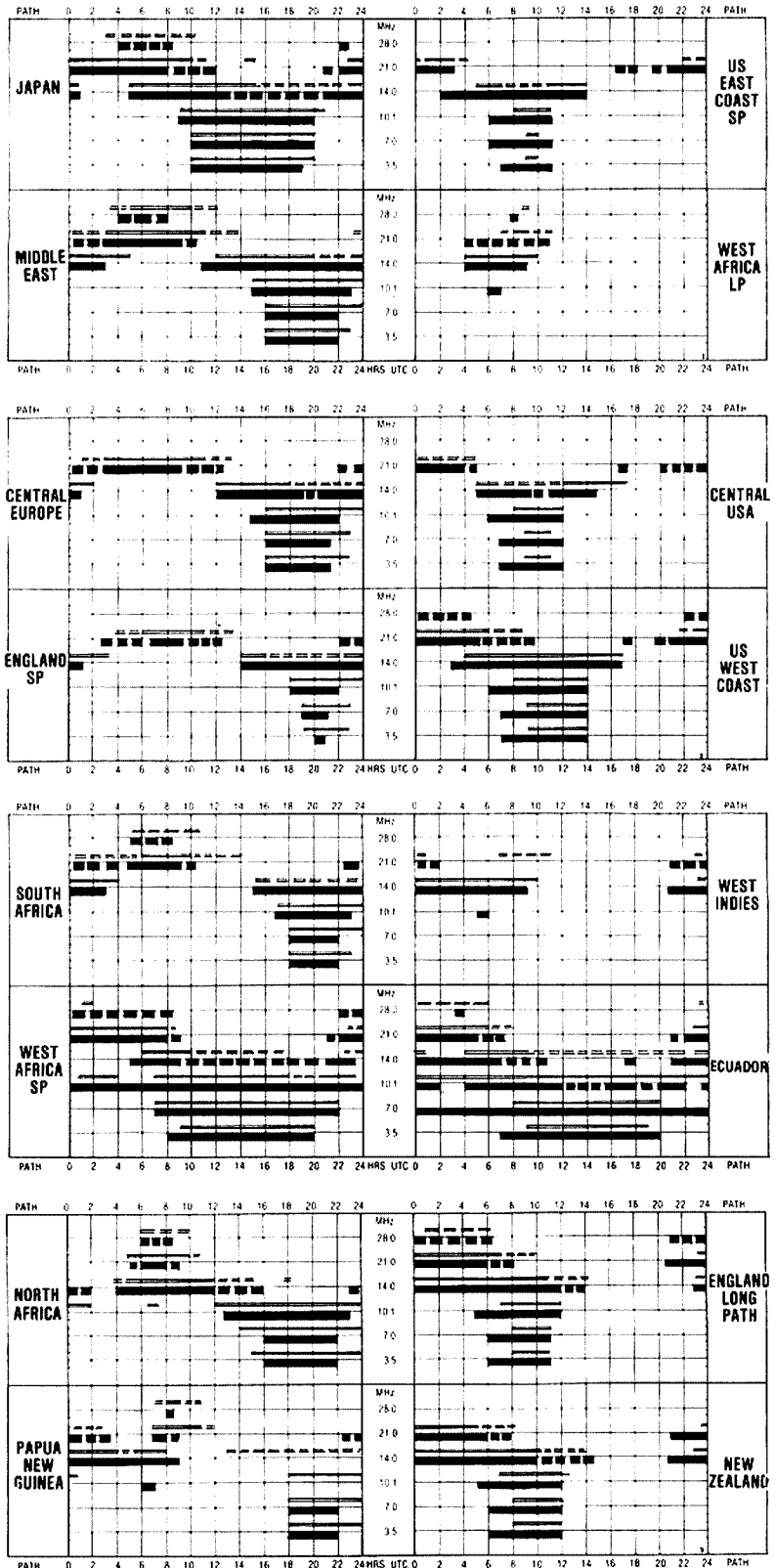

**PATHS** — Unless otherwise indicated (ie LP = Long Path) all paths are Short Path.

Predictions courtesy Department of Science and Environment IPS Sydney.  
All times universal UTC.

# Silent Keys

It is with deep regret we record the passing of —

LEN ANSELL VK2BTO  
BERT HODGE VK3HE  
G K HOFFMAN VK6NM  
J C W PARK VK6BB  
J D PRYER VK6KLA

# Obituaries

L C ANSELL VK2BTO ex VK2TO

Len Ansell was born in England. He joined the Royal Navy as a boy telegraphist. Later he joined the Royal Australian Navy.

He joined the New South Wales Police in 1932 and became a member of the Police Wireless Station, VKG. In 1937 Len was transferred as Officer in Charge of Police Wireless Waratah — VKG3 — in Newcastle, a position he held until his retirement some years ago.

Len was a keen amateur and a well respected member of the community. He passed away on 23rd March 1983.

All who knew him extend their deepest sympathy to his wife and family.

F C Meyer VK2AAX

JIM RAFTER VK4PR

On 6th February 1983, after a short illness, Jimmy Rafter, the one and only "PETER RABBIT", as most amateurs throughout Australia and the DX world new him, became a silent key. Jim started his association with radio working for Music Masters, Brisbane and it was a natural choice for him to follow this through by service in the RAAF, first as technician, then his entry into aircrew as a WAG. The end of the war saw him serving with the 36th Sqdn in the Pacific Theatre of Operations. After a short spell with the USAAF, based on Guam, he returned to Australia, and entered the Department of Civil Aviation as a radio technician, at Brisbane Airport Workshops, until his untimely retirement on medical grounds in 1977. A keen amateur, DX'er, Rag Chewer, and competitor, he served in various bodies of the amateur radio fraternity. President of the Qld Branch of the WIA and foundation member of the Brisbane DX Club.

Jim is survived by a son, daughter-in-law, and two grandchildren. Two of Jim's sisters are residents of the USA.

His passing will leave another void in the ranks of amateur radio. As with most other amateurs Australian and overseas, we will miss him.

"Old hams never die, they just drift off frequency" ... Anon

Ken Smith VK4KA

GEOFFREY HOFFMANN VK6NM

It is with deep regret that I advise the sudden passing of Geoffrey Hoffmann, VK6NM/MM, of Bowen boat harbour. The melody of CW will be sadly missed from the "Cornelius", the recent home of Geoff who passed away suddenly at Bowen on 12 March, 1983. He was a wizard with the key.

Geoff was a man of many talents. He obtained a B.Sc (Hons.) in Chemical Engineering at London University, but he gave away his office job with the CSR Company and returned to sailing. He purchased a Broome pearling lugger in 1973 and carefully transformed it into a comfortable home for his family and his shack. Geoff loved sailing. He had earned the Yachting

Federation's Yachtmaster's Certificate in 1980 and was an active member of the North Queensland Cruising Yacht Club. Many Townsville Amateur Radio Club members will remember his most entertaining and descriptive lecture of his recent circumnavigation of Australia.

Geoff had just passed an advanced Morse code examination for reciprocal overseas licensing. He will be sadly missed by his many friends.

Sincere sympathy is extended to his wife Nancy and daughter, Nicole.

Roger Cordukes VK4CO

JOAN FUDGE VK7ZYL

It is with deep regret we announce the passing of Joan Fudge, of Ulverstone, on 2nd March 1983 after a long battle with illness.

Despite poor health, Joan was involved with many different activities and was to be heard, until shortly before her death, talking cheerfully to people on the air.

Joan became active in amateur radio some years ago and took out a limited licence in 1981. Her cheery voice soon became well known on the two metre repeaters around the state, particularly on the north-west coast.

She was studying, amongst other things, computer programming whilst tirelessly supporting her husband Peter in his computer business.

From 1979 to 1983 Joan was secretary of the North-West Branch of the Tasmanian Division of the WIA and was the Branch news co-ordinator. She worked to promote amateur radio in the local schools, giving up her time to help the children with activities.

She will be sadly missed by all amateurs in Tasmania particularly those in the north-west.

Sincere sympathy is extended to her husband Peter and children, Marie, Juliet and Jonathan.

Martin Fox VK7MM

# WARNING!!

Disposing of your old rig?? Please ensure it goes ONLY to someone licensed to use it on YOUR bands.

# HAMADS

PLEASE NOTE: If you are advertising items FOR SALE and WANTED please write on separate sheets, including ALL details, eg Name, Address, on both. Please write copy for your Hamad as clearly as possible, preferably typed.

\* Please insert STD code with phone numbers when you advertise.

- Eight lines free to all WIA members. \$9 per 10 words minimum for non-members.
- Copy in typescript please or in block letters double spaced to PO Box 300, Caulfield South 3162.
- Repeats may be charged at full rates.
- Closing date: 1st day of the month preceding publication.
- QTHR means address is correct as set out in the WIA current Call Book.

Ordinary Hamads submitted from members who are deemed to be in the general electronics retail and wholesale distributive trades should be certified as referring only to private articles not being resold for merchandising purposes.

## TRADE HAMADS

Conditions for commercial advertising are as follows: The rate is \$15 for 4 lines, plus \$2 per line (or part thereof) minimum charge \$15 pre-payable. Copy is required by the first day of the month preceding publication.

AMIDON FERROMAGNETIC CORES: Large range for all receiver and transmitter applications. For data and price list send 105 x 220 SASE to: R. J. & U. S. Imports, Box 157, Mortdale, NSW 2223. (No enquiries at office: 11 Macken St, Oakley, 2223.)

CB RADIOS \$69: walkie talkies, short wave radios, military, outback, business, amateur, marine, repairs, RTTY Siemens 100A printer \$120; base mic., \$45; ultrasonic alarm, \$35; all ham bands on a single 6 ft. whip, 1.8 to 30 MHz, for base or mobile, \$300; aerials, installation, demonstrations, 40 ch. CB conversions, accessories, new rigs weekly. Bridge Disposals, 12 Old Town Plaza, opp. Bankstown Railway Station, NSW. Mail order service and all enquiries to 2 Griffith Avenue, Roseville 2069, or phone Sam VK2BVS, 7 pm to 9 pm only, on (02) 407 1066.

## WANTED — ACT

ANTENNA, YAGI TYPE, for 20 metres, antenna rotator and associated hardware. Also DC power supply for Kenwood TS 820S. Contact Ron Van Santen VK1VS. Ph: (062) 58 6871.

## WANTED — VIC

Next Page Please.

# AIR-WOUND INDUCTANCES

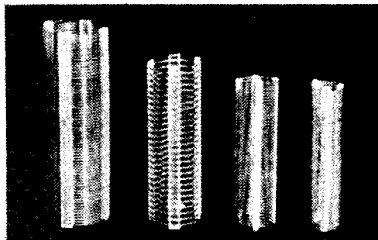

No	Turns per		B & W		Price
	Diam	Inch	Length	Equip	
1-08	1/2"	8	3"	No 3002	\$1.60
1-16	1/2"	16	3"	No 3003	\$1.60
2-08	3/8"	8	3"	No 3006	\$1.90
2-16	3/8"	16	3"	No 3007	\$1.90
3-08	3/4"	8	3"	No 3010	\$2.30
3-16	3/4"	16	3"	No 3011	\$2.30
4-08	1"	8	3"	No 3014	\$2.60
4-16	1"	16	3"	No 3015	\$2.60
5-08	1 1/4"	8	4"	No 3018	\$2.90
5-16	1 1/4"	16	4"	No 3019	\$2.90
8-10	2"	10	4"	No 3907	\$4.20
8-10/7	2"	10	7"	No 3907	\$7.20

Take the hard work out of Coil Winding — use "WILLIS" AIR-WOUND INDUCTANCES

WILLIAM WILLIS & Co. Pty. Ltd.

98 Canterbury Road, Canterbury, Vic. 3126  
PHONE: 836 0707

**CIRCUIT DIAGRAM FOR DRAKE SSR-1 receiver.** Will pay all charges for photocopy and necessary post charges. Write to: G. Himolij, 118 Wilson Rd, Newcomb, Geelong, Vic 3219.

**TRI-BAND YAGI TH3JNR** or similar as cheap as possible for local scout group with not much money to spend. Gordon VK3DBU/SAK, 15 Murdock St, Hopetoun, Vic 3396. Ph: (050) 83 3380.

**WANTED — QLD**

**WAMECO MEM-2 16K S100** memory board. Bare, assembled, or kit. Prefer no rams. Contact J. Hanran. Ph: (077) 71 2285 after 8PM.

**WANTED — WA**

**KWM2 MIC PLUG** and power lead or power plug only. Circuit diagram for B23 AWA receiver. All letters answered. C. Chew. PO Kirup 6251.

**FOR SALE — NSW**

**FRG-7 COMMUNICATIONS RX.** SSB filter installed. \$210. Nick VK2EMB, Hazelbrook. Ph: (047) 58 6581.

**ICOM IC701.** Mic. PS701. RM3 controller. all \$920; ICOM IC211. \$520; ICOM IC551. all optional boards, microwave modules linear. 2 aerials. \$700; ICOM IC245 \$260; AR240 handheld. case, charger. \$230; TRAM XL5 modified on 10 m. 1 aerial. \$100; Macrotronics RTTY interface. software, for Apple. MDK17 modem. \$350; AR22 rotator. \$45; Roger VK2DNX. Ph: (02) 546 1927.

**KENWOOD TS520 HF TRANSCEIVER 240 VAC/12 VDC — Mic — H'Book.** The complete station \$395. VK2BHO QTHR. Ph: (042) 96 2142.

**TOWERS:** Two homebrew towers using 1" angle iron (1) 24 ft long having 35" square base and 19" square top (2) 18'11" long having 20" square base and 9" square top. Each is four-legged. No fittings attached. The two for \$80. at Springwood NSW. VK2VJD. Ph: (047) 51 4257 evenings please.

**YAESU FTV-707 V/U TRANSVERTER** with 6 metre module. manual and cables. Never used. Excellent condition. \$200. Also Yaesu FV-707DM external scanning VFO. Manual included. Excellent condition. \$200. Dennis VK2KVV QTHR. Ph: (02) 645 3441 (AH).

**FOR SALE — VIC**

**AERIAL HY GAIN 14AVQ \$60:** Werner Wulf 4 element 6 m beam \$85; Yaesu RSM-2 HF mobile whips 80-10 m c/w gutter mount base \$100; Chirnside 10 m 3 element beam (incomplete \$70); battery charger \$5; 12 element microlink 432 MHz beam \$25. Lionel VK3NM QTHR. Ph: (03) 568 2733 (BH). 898 3710 (AH).

**ANTENNA 2 M ATN 8 el Yagi \$25.** Archer rotator with 30 m cable \$60. Philips FM 321. 432 MHz transceiver \$120. VK3AEP QTHR. Ph: (03) 580 2568.

**COLLINS R390A/URR RECEIVER** excellent condition, with metal cabinet, service manual, spare valves \$500. Collins R105A/ARR15 receiver, excellent condition \$60. Collins R101A/ARN-6 compass receiver \$60. G. Himolij, 118 Wilson Rd, Newcomb, Geelong, Vic 3219.

**COMPLETE SWL STATION.** FRG 7000. Auteckfilter. SX-10 preselector, battery eliminator, phones, in mint condition \$500. A. Harrison, Nilma, Vic. Ph: (056) 23 2450.

**COMTRONIX FM80** 10 metre FM transceiver, mint condition \$130. Ken VK3WM QTHR. Ph: (03) 288 2180.

**DIVCO-WAYNE HETRO-FREQ-METER AN/URM-32A** 125 kHz — 1 GHz 230 V VGC \$100. Home brew linamp grounded grid 25-40 MHz 12V DC, spare 6JG6A tube. circuit \$80. RCA rec tube manual RC-27 \$3. RSGB handbook 1963 VGC \$5. ITU call signs 20th edition 1959 \$2. Pye 4 1/2" CRO \$20. Ass valve FM units hi-band \$5 each. Jeff L-30409. Ph: (03) 546 3940 (AH) QTHR.

**FT 480R 2 METRE ALL MODE 1 W/10 W.** 30 W PEP SSB as new \$350. Tri-band beam \$150. 2 low band radios, not working \$10 each. Speakers 10 W 2 way bookshelf size \$20 pair. Cash in hand buyers only. All prices firm. Contact Phil VK3DCZ. Ph: (03) 723 1669.

**KENWOOD TS 520S VGC** new finals: CW filter \$450. AT200 Tuner VGC \$130. MC-50 Kenwood desk mike \$30, or this complete station \$600. VK3BXN QTHR. Ph: (03) 528 6527.

**SHACK CLEAROUT — C42 36-60 MHz 25 W Tx/Rx** with xtals \$30. PMG VHF FM repeater Tx (19" rack mount) with p/s \$25. 2 m 5 W AM aircraft Tx/Rx model STR-9X with manual and xtal \$15. 6 m FM 25 W STC carphone with test set \$10. 6 m AM Pye carphone \$6. Above lot for \$70. 100 kHz CRO \$15. 600 V p/s (parts) \$5. 2X Astor VHF Tx (parts) \$5. Assortment ex Telecom intercoms \$3. WIA correspondence course for LOCP — books 2 and 3 \$40 — other bits and pieces. Ph: (03) 523 5356 (AH). Not Saturday.

**WESTON ELECTRONICS DX33,** 3 el. tri-band, trap beam antenna. 14' boom, 2 kW PEP, excellent performer. very clean condition. \$150. ICOM IC22A 2 m FM 10 W transceiver, xtals for 8 repeater and 7 simplex channels. As new condition. complete with mic, mobile mount, handbook, etc \$165 VK3ARZ QTHR. Ph (03) 584 9512.

**YAESU FT107 M** all mode analogue and digital display transceiver. covers 10-160 metres including WARC and WWV/JJY. Has 12 memories. AC-DC cables, scanning microphone and instruction manual. Excellent condition, very little use. \$825. Bill. Ph: (03) 584 3521.

**YAESU FT7 VGC** no mods \$375. AWA 1955 cathode ray oscillograph. Good cond. Offer. Power supply 15 amp two meters EC\$120. VK3PCS. Ph: (03) 546 1315.

**FOR SALE — QLD**

**DECEASED ESTATE VK4PR JIM RAFTER.** KWM 1 Collins Tx type 81 Hammarlund RX. Hammarlund Tx (4022 finals) 30 ft. Lightweight tilt over tower. Tri-band quad commercial hub fibreglass spreaders. CDE MK3 rotator with control box. Coax cables. Box metal tubes. Box Tx tubes. Box old type tubes. Box 9 pin tubes. 6 kc AWA crystal. Printed circuit board holder. Miniature P/C board drill vert press (Sun Hayo). 8 mm Edipet film reviewer. Speakers. Variable voltage power supplies. Chassis with power transients. Variable condensers. Coil winding board decade box. Desk mikes, headphones. Heathkit solid state volt meter. Soldering iron. Metal cabinets. Crystal checker. Roller inductor. Oscilloscope. Box assorted crystals. Boxes resistors and condensers. Dow key coax changeover relays. Aluminium panels. Magazines... QST 1946 to 1982 bound and loose copies... 73 magazines 76/81... Ham Radio, Practical Radio... CQ... Amateur Radio and ARA mags. Handbooks... Terman radio engineering. Available for inspection by arrangement... best offers accepted. Contact Ken Smith VK4KA QTHR. Ph: (07) 38 4051.

**TONO THETA 7000-E** Communications Computer C/W power supply, cables and full documentation. Ideal keyboard for CW/RTTY/ASCII. Mint condition \$650 ONO. VK4AJR QTHR. 38 Merryl St. Rasmussen, Townsville, Qld 4815.

**430 MHZ LINEAR AMP.** Jumbo HP-45u \$150. Scalar SC-220X trap vertical \$75. Homebrew 432/28 MHz conv \$25. VK4KZA/ZRQ QTHR. Ph: (07) 343 5139.

**FOR SALE — SA**

**TOWER,** 57 ft triangular framed tower, ladder to 25 ft, stage cranks to 57 ft, \$300. Ph: (08) 356 8040.

**FOR SALE — WA**

**FT200,** with AC PSU, black panel. Fitted with G3LLL clipper, fan, and Shure 444 mike. Manual, original cartons, immaculate condition \$450. VK6JF QTHR. Ph: (090) 21 2599.

**HIDAKA VS33 TRI-BAND** beam \$150: Hills winch-up triangular lattice tower 11 m \$200: CDE Ham II rotator and controller, working but needs attention \$125: Standard SR-C146A 2 m FM HH Txcvr 5 chan \$140: Swan 350 with PS and Vox, working but needs alignment \$250. All items with manuals and all prices negotiable. EA June 71 Sept 81 incl. what offers? VK6KD QTHR. Ph: (09) 405 2841.

**FOR SALE — TAS**

**WEBSTER BANDSPANNER,** American made, single mobile whip antenna, covers 80 m-10 m. Fully adjustable. \$70. ICOM 20 amp power supply, built-in speaker, matches ICOM 701, as new. \$125. VK7MG QTHR. Ph: (002) 57 8220.

**ADVERTISERS' INDEX**

**ANDREWS COMMUNICATION SYSTEMS** ..... 50  
**BAIL ELECTRONIC SERVICES** ..... IFC  
**BRIGHT STAR CRYSTALS** ..... 2  
**CW ELECTRONICS** ..... 48  
**DICK SMITH ELECTRONICS** ..... 5  
**EASTERN COMMUNICATION CENTRE** ..... 3  
**ELECTROMARK PTY LTD** ..... 2  
**EMTRONICS** ..... IBC  
**GFS ELECTRONIC IMPORTS** ..... 32&33  
**HAMRAD** ..... 55  
**HIGH TECHNOLOGY COMPUTER SYSTEMS PTY LTD** ..... 61  
**HY-TECH DISTRIBUTORS** ..... 55&61  
**IAN J. TRUSCOTT ELECTRONICS** ..... 58  
**ICOM AUSTRALIA PTY LTD** ..... BC  
**MOBILE ONE COMMUNICATIONS SYSTEMS** ..... 4&44  
**NOVICE LICENCE — G. Scott & A. Bruce Smith** ..... 4  
**RAKON AUSTRALIA PTY LTD** ..... 7  
**TRAEGER DISTRIBUTORS (NSW) PTY LTD** ..... 41  
**TRIO-KENWOOD (AUSTRALIA) PTY LTD** ..... 4&6  
**VICOM INTERNATIONAL** ..... 8  
**VK2 WIA NOVICE LICENCE** ..... 55  
**WATCHMAN ELECTRONICS** ..... 48  
**WERNER & G. WULF** ..... 61  
**WIA BADGES** ..... 53  
**WILLIAM WILLIS & CO PTY LTD** ..... 63





# EMTRONICS

Retail Division of EMONA ELECTRONICS P/L

649 George St., Sydney, NSW. 2000. Phone: 211-0531.

CORRESPONDENCE & MAIL  
ORDERS:

Box 1121, Haymarket  
NSW, 2000, Australia

WRITE, PHONE OR CALL IN!

## FROM SYDNEY'S NEWEST ICOM CENTRE!

IC-R70 COMM RECEIVER	\$799
IC-720A HF TRANSCEIVER	\$1199
IC-730 HF TRANSCEIVER	\$819
IC-740 HF TRANSCEIVER	\$969
IC-505 6m ALL MODE TRX	\$433
IC-2A 2m FM HAND HELD	\$299
IC-25A 2m FM MOBILE TRX	\$395
IC-290 2m ALL MODE TRX	\$617
IC-4E 70cm FM HAND HELD	\$320
IC-45A 70cm FM MOBILE	\$429
IC-490A 70cm ALL MODE	\$689
IC-2KL WITH PS	\$1699
IC-AT 100 AUTO TUNER	\$357
IC-AT 500 AUTO TUNER	\$495
IC-PS 15 POWER SUPPLY	\$199
IC-PS20 POWER SUPPLY	\$279
IC-PS 740 POWER SUPPLY	\$235

## FROM SYDNEY'S OLDEST KENWOOD CENTRE

R-2000 Comm Receiver	\$655
TS-930S with tuner HF TRX	\$1935
TS-430S HF TRX	\$1055
TL-922 2KW Lin ampl.	\$1380
PS-430 power supply for TS-430	\$189
HC-10 world clock	\$129
DM-81 Grid Dip Oscillator	\$129



## FROM AUSTRALIA'S LARGEST HAM RADIO CENTRE.

### AZDEN the FM KING PCS-4000 \$459

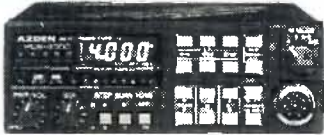

- 8 MHz COVERAGE, CAP/MARS BUILT IN: 142,000-149,995 MHz in selectable steps of 5 or 10 kHz COMPARE!
- TINY SIZE: Only 2" Hx5.5" Wx6.6" D. COMPARE!
- MICROCOMPUTER CONTROL: At the forefront of technology
- UP TO 8 NON-STANDARD SPLITS: Ultimate versatility for CAP/MARS. COMPARE!
- 16-CHANNEL MEMORY IN TWO 8-CHANNEL BANKS: Retains frequency and standard offset.
- DUAL MEMORY SCAN: Scan memory banks either separately or together. COMPARE!
- TWO RANGES OF PROGRAMMABLE BAND SCANNING: Units are quickly reset. Scan the two segments either separately or together. COMPARE!
- FREE AND VACANT SCAN MODES: Free scanning steps 5 seconds on a busy channel. Vacant scanning stops on unoccupied frequencies.
- DISCRIMINATOR SCAN CENTERING (AZDEN EXCLUSIVE PATENT!): Always stops on frequency.
- TWO PRIORITY MEMORIES: Either may be instantly recalled at any time. COMPARE!

### PCS-300 — The Standard For Comparison \$359

- 8 MHz Coverage
- Ideal size & weight distribution
- LCD Display with timed lamp
- 16 Key Autopatch
- PL Tone switch
- Programmable "odd splits"
- 9 Channel memory with scan
- Automatic inclusive or exclusive programmable band scan
- Busy and vacant scan modes
- Keyboard lock
- Transmit lock
- Digital S/Rf and memory address meter.
- High or low power
- True FM
- Automatic front end tuning
- Rugged commercial-grade modular construction
- Superior receiver
- BNC Antenna connector

### JRC:JST-100 Only After You Have Seen Everything Else — Come and See the Fantastic JST!



### \$1745

The JRS Model JST-100 HF transceiver is a new digitally synthesized, micro-computer based transmitter/receiver. It incorporates an 11-channel memory and two digital variable frequency oscillators, allowing various types of operation in all amateur bands in the emission modes of A3J, A1 and F1. The JST-100 is designed for compact and lightweight construction and ease of operation.

Write For Brochure

## RTTY EQUIPMENT

### TELEREADER:

CWR685E Comm. Terminal	\$1299
CWR670E Receive Conv.	\$499
CWR-610E Receive Conv.	\$259

### HAL:

CT-2100 2 comm.	
KB-2100 3 Terminal	\$1654

### ALINCO SSTV:

EC-720 SSTV Conv.	\$799
-------------------	-------

See us for a Complete  
Range of HF, VHF & UHF  
Linear Amplifiers

### EXCITING NEW ANTENNA TUNER EMTRON EAT-300



### \$159

MARINE — AMATEUR — COMMERCIAL  
APPLICATIONS

The Best 300W Antenna Tuner on The Market.  
The finest American Components Give You Quality Performance and Satisfaction.

- Built-in sensitive SWR meter
- Handles up to 300 watts RF output
- Matches everything from 1.8-30 MHz
- Size 190mm wide x 56mm high 180mm deep.
- Use with: coax, random wires, balanced lines.
- 4:1 Balun for balanced lines. 1000V capacitors.
- Large efficient airwound inductor gives lower losses.
- A negligible insertion loss of 0.25 dB
- Size 190mm wide x 65mm high x 150 mm deep.
- Built-in heavy duty 2mm aluminum case

## OATONG PRODUCTS

D.70, Morse Trainer	\$159
ASP, Automatic Speech Processor	\$235
FL-3 Frequency Agile Filter	\$299
AD270 Active Antenna	\$129
AD370 Active Antenna	\$199
RC, Universal Speech Clipper	\$199
RFA Broadband Pre-amp	\$79
Code Call 4096	\$79
RF Direction Indicator	\$360
VLF Converter	\$79
NFA Notch filter	\$99

Write For Full Specs On All Items

SEND 60c FOR  
OUR LATEST 1983  
PRODUCT CATALOGUE

# The Dynamic Duo

## ICOM's 2 Meter and 70cm FM



IC-25A



IC-45A

25 Watt/5 memories/2 scanning systems in a 2"H x 5½"W x 7"D package is what has made the easy-to-use IC-25A the most popular 2 meter FM mobile transceiver ever. Now ICOM presents the second half of its mobile duo... IC-45A. The IC-45A covers 430-439.995 MHz. Both transceivers are supplied with Up Down Scanning microphones as standard.

**Dual VFO's.** Dual VFO's give an extra stored frequency for scanning (memory scan scans 5 memories plus 2 VFO's) and each VFO has a different tuning rate for easy QSY.

	VFO A	VFO B
IC-25A	5 KHz	25 KHz
IC-45A	5 KHz	25 KHz

**5 Memories.** Instant access to most used frequencies. VFO A

information is transferred to the selected memory by pushing the write (IC-25A) or W/CK (IC-45A) button.

**Priority Channel.** Any memory channel may be monitored for activity on a sample basis, every 5 seconds, without disruption of a QSO conducted on a VFO frequency.

**Led Bar Meter.** Shows strength of received signal as well as relative transmitter output from the fully protected final RF amplifier. APC (automatic power control) is used to detect SWR and adjust the power output to a safe level.

**Simplex/Duplex Operation.** Standard 600 KHz offset initializes into radio at turn on. Offset may be changed by pressing the priority button while in VFO operation. Rotating the main tuning knob will now change the offset up or down and the offset will be displayed on the frequency readout.

### Adjustable Power Levels.

	Hi Pwr	Lo Pwr
IC-25A	25 W	1 W
IC-25H	45 W	2 W
IC-45A	10 W	1 W

Pulling the squelch knob out places the unit into low power. Both the high and low power may be independently set to accommodate your simplex/repeater requirements or amplifier input characteristics.

**Nor/Rev Capability.** Use of this button on the IC-25A, or the W/CK button on IC-45A, in the duplex mode, allows one touch monitoring of the repeater input frequency. If simplex operation is possible you will know instantly.

**Scanning.** Pushing the S/S button initiates the scan circuitry. With the mode switch in a memory position the unit will scan all 5 memories plus the 2VFO frequencies.

With the mode switch in VFO position, the unit will scan the entire band or the portion of the band defined by memories 1 and 2. Full band scan or program band scan is selected from the front panel in the IC-25A, internally on the IC-45A.

Both units have internally switched scanning choices of adjustable delay period after a carrier is received then resume scan, or resume on carrier drop.

**The Most Compact FM Mobiles on the Market.** Fits in the smallest of places. Stacking, matching Mobile Mounts for complete mobile communications for your car.

**Memory Backup.** When the optional IC-BU1 backup power unit is installed on the back of the IC-25A or IC-45A, memory will be maintained while transferring the unit from power source to power source. If the unit is not removed from power, it will maintain memory even when turned off with or without the IC-BU1.

Discover a new deal with  
ICOM AUSTRALIA PTY. LTD.

7 DUKE STREET WINDSOR 3181  
VICTORIA, AUSTRALIA  
TEL: (03) 529 7582 TLX: AA 35521 ICOMAS



**ICOM**

The World System

# Amateur Radio

Vol. 51, No. 7, July 1983

Registered by Australia Post — Publication No. VBH 0569



JOURNAL OF THE WIRELESS INSTITUTE OF AUSTRALIA



Convention Report



WC Doy Celebrations — 17th May

Equipment Reviews — TR-7950 & M10-1

Two Antennas to Erect

Test Equipment & Generator to build

Military Radios — Part 4

# TRIO – Still the Best Scopes for Value and Performance

## 100MHz, 4 Channels, 8 Traces. 1mV Sensitivity!

For applications requiring the highest degree of measurement sophistication, TRIO offers the new 100MHz CS-2100A. A second generation design with a new level of performance and reliability. It brings ultra-high performance standards and a vast array of features into one efficient package. This new scope represents the state-of-the-art and features a rugged industrial construction. As a result, the CS-2100A is efficient, light-weight and highly reliable.

- 100MHz response and 3.5ns rise time
- 120MHz response at -6dB
- 500µV Division cascade sensitivity
- 2ns division sweep rate with 10x magnifier
- Four-input operation provides trigger views or four separate inputs
- Selectable 1MΩ or 50Ω inputs
- Alternate timebase operation
- 20MHz bandwidth limiter for best view of low frequency signals
- Lighted function pushbuttons
- Voltage and current probe calibrators
- 8 x 10cm internal graticule CRT
- Video sync separator standard
- Dual intensity controls

CS 2100A

\$2,495\*

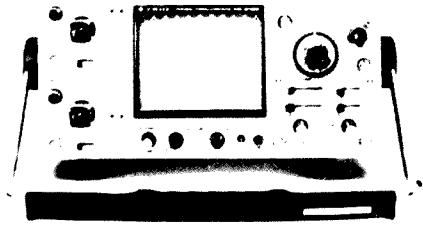

## 70MHz 4 Channel, 8 Trace, 1mV Sensitivity Scope at a 60MHz Price!

The new TRIO Model CS-2070 is a cost-effective full-feature portable lab scope. Having many of the important capabilities of the CS-2100A, the CS-2070 comes more feature-packed than most other scopes in its bandwidth class — and it offers higher performance.

- 1mV division sensitivity to 70MHz
- 500µV division cascade sensitivity
- Four-input operation provides trigger view on four separate inputs
- Alternate time base operation
- 20MHz bandwidth limiter
- Lighted function pushbuttons

CS 2070

\$1,795\*

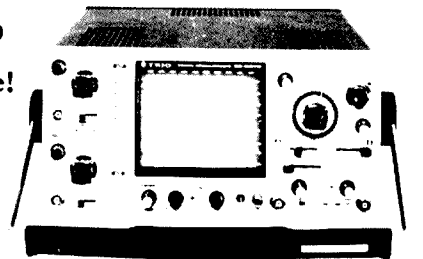

## A Favourite of Leading Computer Companies! 35MHz, 2mV Sensitivity

The CS-1577A should be your choice for microprocessor system development and troubleshooting. Broadcast studio applications. Monitoring RF waveforms. Monitoring digital data transmission. Logic and digital design work. Measuring propagation delays and phase shifts. Troubleshooting and maintaining video systems. Comparing amplifier input-output waveforms and displaying algebraic difference as a distortion curve.

- 35MHz response, usable beyond 50MHz
- Triggers on signals beyond 50MHz
- 2mV cm vertical sensitivity
- Signal delay line
- Alternate trigger capability
- Automatic or manual CHOP ALT selection
- Variable hold-off for pulse train display
- UNCAL "reminder" LEDs
- Single sweep feature for photography or observation of non-repetitive waveforms
- Video sync separators standard
- Built-in triggering filters
- Differential input capability

CS 1577A

\$995\*

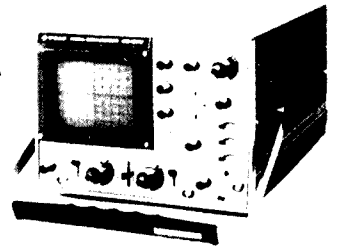

## Our Most Popular Model

### — and Still the Best Value Available!

Used extensively by educational institutions, hobbyists, and by industry, the TRIO CS 1560AII has gained an enviable record for dependability. A record unsurpassed by any other scope in its class. Truly your first choice for a workhorse oscilloscope. A reliable scope that will stand by you in even the toughest conditions.

- Sensitivity 10mV Div. (Triggers at 0.5 Div. Typ.)
- CH1 CH2 DUAL ADD and SUB
- Rise time 2.3ns
- XY Mode
- Triggered Sweep and Auto
- Sweep time 0.5µs Div. 0.5S Div. and XY

CS 1560AII

\$545\*

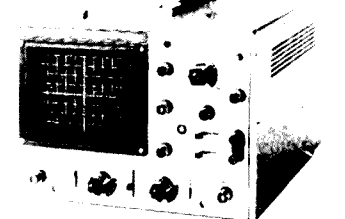

Over 2,000 Sold

## For Those Who Require the Extra Capability of a 20MHz Scope at a Reasonable Price

The CS-1022 has that extra punch needed for engineering design work. Its 20MHz bandwidth and 1mV div. sensitivity make it ideal for microprocessor, digital data, broadcast, RF and IF system design work. All performance features are geared for maximum flexibility and convenience.

- Illuminated inner-face graticule 150 mm rectangular CRT (6kV)
- Maximum sensitivity 1mV div (DC-10MHz)
- Maximum sweep speed 20ns div (X10MAG)
- Maximum accuracy ±3% (voltage and time axis 0-40°C) guaranteed
- New video sync circuit requires no troublesome trigger setup
- 8-division dynamic range
- Vertical signal output (CH1 output)

CS 1022

\$649\*

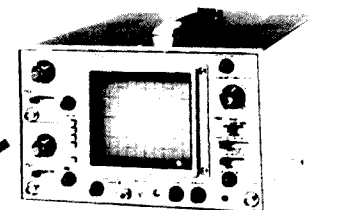

NEW

## Capture Those Unpredictable One-Time Events!

The MS-1650B captures one-time or otherwise unpredictable events, stores them in a digital memory, and instantaneously reproduces them as analog waveforms on a CRT display screen. In combination with the MU-1651 memory unit represents a powerful and versatile waveform recording and analysis tool.

- Simple storage and display of transients
- 1024 byte memory
- 1µs write time
- Conventional 10MHz oscilloscope mode
- Immediate display of stored waveform
- Can capture waveform prior to trigger signal
- Digital data output capability

\$3,195\*

"DIGITAL STORAGE"

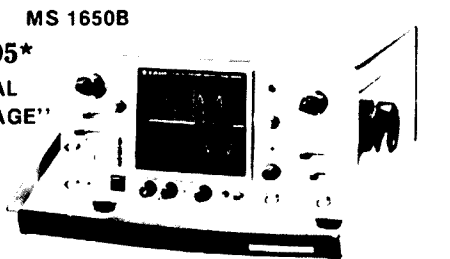

Sydney: (02) 439 3288. Melbourne: (03) 580 7444

Adelaide: PROTRONICS (08) 212 3111. TRIO ELECTRIX (08) 51 6718. K. D. FISHER (08) 277 3288. Brisbane: ST LUCIA ELECTRONICS (07) 52 3547. L. E. BOUGHEN (07) 369 1277. Cairns: THOMPSON INSTRUMENT SERVICES (070) 51 2404. Canberra: GEORGE BROWN (062) 80 4355. ORTEX (062) 80 5283. Hobart: IMBROS (002) 34 9899. GEORGE HARVEY (002) 34 2233. Launceston: GEORGE HARVEY (003) 31 6533. Melbourne: RADIO PARTS (03) 329 7888. GEORGE BROWN (03) 419 3355. ELLISTRONICS (03) 602 3282. Newcastle: D. G. E. SYSTEMS (049) 69 1625. GEORGE BROWN (049) 69 6399. Perth: W. J. MONCREIFF (09) 325 5277. PROTRONICS (09) 362 1044. Rockhampton: PURELY ELECTRONICS (079) 21 058. Sydney: GEORGE BROWN & CO (02) 519 5855. DAVID REID ELECTRONICS (02) 29 6601. Townsville: NORTEK (077) 79 8600. Wollongong: MACELEC (042) 29 1455.

\* All prices plus sales tax if applicable. Prices do not include probes.

Inc. in Victoria



PERFECTION IN MEASUREMENT



## .. in this issue ..



The opening of VK2 Division's "Amateur Radio House".

### ARTICLES

Amateur Radio House by Bruce Bathols VK3UV	7
Broadband End Fed Antenna by A M Keightley VK6YX	10
Federal Convention 1983	24
Horse Endurance Trials-Field Exercise by Ian Jackson VK3BUE	16
Modern Military Surplus Part 4-C42 & C45 by Colin Mackinnon VK2DYM	18
Murphy's Party	39
Poison Pen Letters	46
Regulations for Power Lines	39
Seven Element Yagi-Economy Version by Des Greenham VK3CO	8
Simple Marker Generator by Neville Mattick VK2QE	13
Test Equipment for Radio Experimenters by	

# amateur radio

R S Gurr VK5RG	9
WCY-Public Relations by John Hill VK3WZ	28
WCY-Students Celebrate WC Day 1983 by Ron Smith VK4AGS	14
WCY-WC Day in Adelaide by David Clegg VK5AMK	15

### DEPARTMENTS

A word from your Editor	3
Advertisers Index	64
ALARA	45
AMSAT Australia — new co-ord & scribe	47
AR showcase JRC HF Tcwr. M42G mobile ant	58
AWARDS — Rule changes for WIA awards. Work all Y2 rules	46
Club Corner — Eastern Zone Convention	9
Commercial Chatter	40
Contests — QLF, Keymen's of JA, WA's, 3.5 CW & SSB Test rules. Amend to JM results	50
Education Notes	49
Equipment Reviews — Kenwood TR-7950 & Mobile One Hamtennae M10-1	20
Five-Eigh Wave	56
Forward Bias	54
HAMADS	63

Here's RTTYI — Connecting RTTY Gear	38
How's DX	34
International News	41
Intruder Watch	37
Ionospheric Predictions	60
Letters to the Editor	59
Magazine Review	54
Main QSP — Rad Comm Bill	5
National EMC Advisory Service — Computer Car	48
Novice Notes — More about ATUs	30
Obituaries — VK4BAC & VK2ZA	63
Pounding Brass — A Retrospective	40
QSLs, QTHs, Heard & Worked	37
QSP	47
Silent Keys — VK2BIC, VK2BCM, VK3FJ & VK3MU	63
Spotlight on SWLing	44
VHF UHF — an expanding world	42
VK2 Mini Bulletin	55
VK3 WIA Notes	56
VK4 WIA News	55
WIA News	6

### DEADLINE

All copy for September AR must reach PO Box 300, Caulfield South, 3162 no later than 25th July.

**EDITOR**  
GIL SONES\* VK3AUI

**BUSINESS MANAGER & SECRETARY**  
REG MACEY

advertising agents will appreciate the absolute need for themselves to ensure that the provisions of the Act are complied with strictly.

**TECHNICAL EDITORS**  
RON COOK\* VK3AFW  
PETER GAMBLE\* VK3YRP  
EVAN JARMAN\* VK3ANI  
BILL RICE\* VK3ABP

**ADVERTISING MANAGER**  
JOHN J A HILL VK3WZ

**Victorian Consumer Affairs Act:** All advertisers are advised that advertisements containing only a PO Box number as the address cannot be accepted without the addition of the business or residential address of the box-holder or seller of the goods.

**CONTRIBUTING EDITORS**  
MIKE BAZELY VK6HD  
RON COOK\* VK3AFW  
REG DWYER VK1BR  
BRENDA EDMUNDS VK3KT  
MARSHALL EMMS VK5FN  
RON FISHER\* VK3OM  
BRUCE HANNAFORD VK5XI  
ROY HARTKOPF VK3AOH  
ROBIN HARWOOD VK7RH  
COLIN HURST VK5HI  
ERIC JAMIESON VK5LP  
MARGARET LOFT VK3DML  
KEN McLACHLAN VK3AH  
LEN POYNTER\* VK3BYE  
TONY TREGALE VK3QQ

**Enquiries and material to:**  
The Editor  
PO Box 300, Caulfield South Vic. 3162

Material should be sent direct to PO Box 300, Caulfield South Vic. 3162, by the 25th of the second month preceding publication. Phone: (03) 528 5962. Hamads should be sent direct to the same address.

Acknowledgement may not be made unless specially requested. All important items should be sent by certified mail. The editor reserves the right to edit all material, including Letters to the Editor and Hamads, and reserves the right to refuse acceptance of any material, without specifying a reason.

**Production: BETKEN PRODUCTIONS**  
5 Masefield Avenue, Mooroolbark, 3138.

**Laser Scanned Colour Separations by:**  
QUADRICOLOR INDUSTRIES PTY LTD.  
Graphic Division  
22-24 Glenvale Crescent, Mulgrave, 3170.  
Tel.: (03) 560 2222

**Typesetting by: QUADRICOLOR INDUSTRIES PTY LTD.**  
22-24 Glenvale Crescent, Mulgrave, 3170.  
Tel.: (03) 560 2222

**Photographic film and processing material courtesy**  
AGFA-GEVAERT LTD AUSTRALIA

**DRAFTING**  
GEORGE BROOKS  
LIZZ KLINE

**Trade Practices Act:** It is impossible for us to ensure that advertisements submitted for publication comply with the Trade Practices Act 1974. Therefore advertisers and

**Printers: WAVERLEY OFFSET PUBLISHING GROUP**  
Geddes Street, Mulgrave, 3170  
Tel.: (03) 560 5111

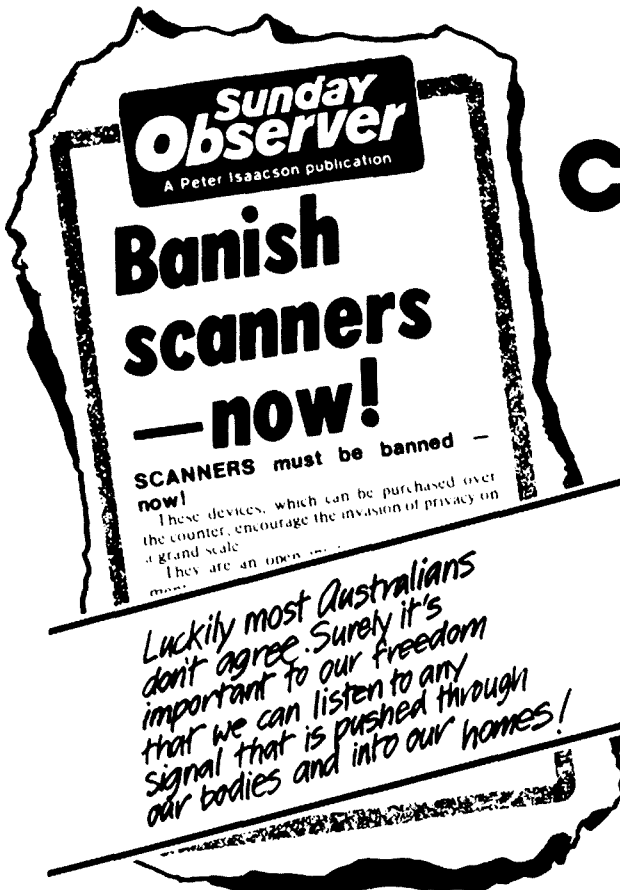

# CONTROVERSIAL NEW HOBBY SWEEPS AUSTRALIA!

## THOUSANDS ARE GLUED TO THEIR SCANNERS IN DEFIANCE OF THREATENED BANS...

Scanning is the fastest growing hobby in the world, and these units represent the 'state of the art' in scanning technology.

Just think - you can hear almost anything,

from harbour control nudging a supertanker into its berth, to exciting conversations from cars speeding along city streets! All the emergency services, authorities and forces... and of course there are thousands of amateur and C.B. radio operators. Plus the thousands of stations on the band that we don't know about yet, (we're waiting for you to tell us about them!) You can surely see why so many people all over the world are being 'turned on' by this fascinating new hobby.

### BEARCAT SCANNER 200FB

ONLY  
**\$349**

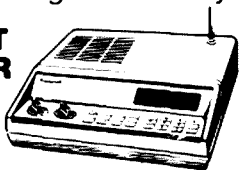

The economy scanner with deluxe features. Extended frequency range. 16 ch. memory, priority and lockout capabilities, delayed channel access... and so much more! Incredible value! Cat D-2801

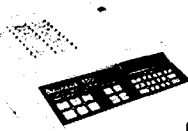

ONLY  
**\$285**

**BEARCAT  
150**

Amazing value - microprocessor control for under \$300! Features 15 ch. memory, lockout and delay facilities, touch-sensitive keypad, etc. Ideal monitor for business, emergency services, news gatherers, and others. Cat D-2800

### PRO 40 SCANNER

ONLY  
**\$399**

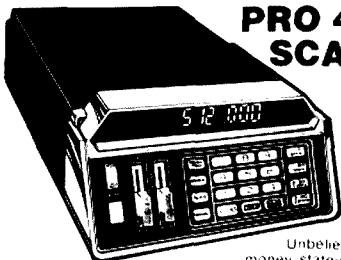

Unbelievable value for money state-of-the-art computerised scanning, 40 ch. memory, all band search facilities, priority channels & channel delay built-in plus, plus plus! Cat D-2805

### SCAN-X ANTENNA

Pick up extra stations! Ultra-wide bandwidth (65 - 520MHz) enables you to get the most from your scanner. Complete with mast clamps & 15 metres of cable. Can also stand alone on patio, roof, etc. A must for the serious scanner. Cat D-4430



ONLY **\$49<sup>95</sup>** Stocks available end of June

**"Want to know all about 'em"**



### Dick Smith's Australian Radio Frequency Handbook

Up-to-date and thorough listings of virtually all the VHF/UHF radio users we've been able to find. YES - find out who is where - and where to listen for all the excitement! PLUS: air band, marine band, and how to use a scanner, amateur radio and CB etc. Cat B-9600

**NOW AVAILABLE -  
MORE PAGES,  
MORE LISTINGS.**

**STILL  
ONLY  
\$12<sup>95</sup>**

A501 CT

# DICK SMITH ELECTRONICS

NSW • Auburn 649 0558 • Bankstown Sq 707 4888 • Blakehurst 546 7744 • Bondi Jct 387 1444 • Broadway 211 3777 • Brookvale 93 0441 • Chullora 642 8922  
 • Gore Hill 439 5311 • Gosford 25 0235 • Liverpool 600 9888 • Newcastle (Tighes Hill) 61 1896 • North Ryde 88 3855 • Parramatta 689 2188 • Penrith 323 400  
 • Sydney (Bridge St) 2 5051 • Sydney (York St) 267 9111 • Tamworth 66 1961 • Wollongong 28 3800 ACT • Fyshwick 80 4944 VIC • Coburg 383 4455  
 • Frankston 783 9144 • Geelong 78 6766 • Melbourne 67 9834 • Richmond 428 1614 • Springvale 54 7 0522 QLD • Brisbane 229 9377 • Buranda 391 6233  
 • Cherside 59 6255 • Toowoomba 38 4300 • Townsville 22 5 722 SA • Adelaide 212 1962 • Darlington 298 8977 • Enfield 260 6088 WA • Perth (William St) 328 6944  
 • Perth (Hay St) 321 4357 • Cannington 451 8666 TAS • Hobart 31 0800





# a word from your EDITOR

Each new transceiver seems to extend the features which can be provided by microprocessor control of the radio. The actual receiving and transmitting sections advance much more slowly.

There are many applications for microprocessor control both in accessories and in operating aids as well as in the basic transceiver. Many of these systems can be bought, such as RTTY and Morse computer systems and some of the logging programmes.

Many applications lie awaiting development. As the editor of Amateur Radio, I would like to run articles on such applications and developments.

Whilst the computer systems grow bigger and more versatile there have been many simple and cheap computers available. They surely mark the way ahead.

One thousand dollars and up will buy you a very powerful computer. But the price excludes all but the devoted computer hobbyist.

Those coming into amateur radio or trying to enjoy amateur radio whilst meeting other family commitments think very carefully before making such outlays. The \$200 computer is much closer to their requirements. The \$100 machines will soon be here. They are already carving their niche in the world market.

Send Amateur Radio articles on how to use these machines. What about RTTY using one of these low budget machines.

Other programme ideas are a good Oscar programme or an antenna rotator controller or maybe a transceiver controller. But most importantly send it to Amateur Radio. The field is limitless. Whilst the cheap machines may not be as impressive to the computer enthusiast they hold great promise.

*Gil Sones VK3AU  
Editor*

AR

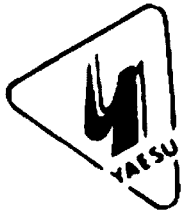

**THREE  
BIG  
NAMES**

**ICOM**

**ATN ANTENNAS**

**AT  
ONE  
GREAT  
STORE**



PLUS MUCH  
MUCH MORE

**ELECTRONICS**

CW Electronics is the communication centre of Queensland.  
Innovators and pioneers of computer/RTTY/ASCII/CW/radio  
interface in Australia.

Come in and see our range

416 LOGAN ROAD STONES CORNER BRISBANE

PHN: (07) 397 0808 397 0888

P.O. BOX 274 SUNNYBANK QLD. 4109

MBG

## VAINS ANTENNA SERVICES PTY. LTD.

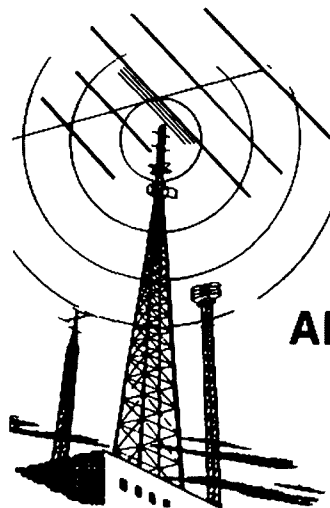

- ★ RADIO CONTROLLED VEHICLES —
- ★ INSTALLATIONS
- ★ ADDITIONAL OUTLETS FOR TV/FM
- ★ REPAIRS TO EXISTING SERVICES

**ALL SUBURBS**

- ★ PHONE FOR ADVICE
- ★ DO IT YOURSELF KITS
- ★ M.A.T.V. SYSTEMS DESIGNED & INSTALLED
- ★ TELESCOPIC MASTING & TOWERS INSTALLED

**874 3333**

13 McKEON RD., MITCHAM

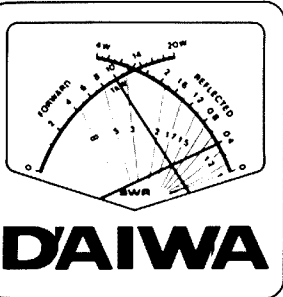

# DIRECTIONAL CERTAINTY ... WITH DAIWA

## DAIWA ROTATORS GET AUSTRALIAN AMATEURS GOING IN THE RIGHT DIRECTION WITH AUSTRALIA-BASED GREAT-CIRCLE MAPS.

With Daiwa rotators you have the advantage of control boxes with maps centred on Australia! The best way to get you going in the right direction.

Daiwa rotators offer you quality and innovation. And Daiwa rotators offer you all the choices you need.!

### A CHOICE OF CONTROL BOXES . . .

There is a round controller (Type R) which is a great-circle map centred on Australia, with area prefixes and paddle-switch control.

Or you can choose the pre-set controller (Type X) which allows you to pre-set the control area you want to work.

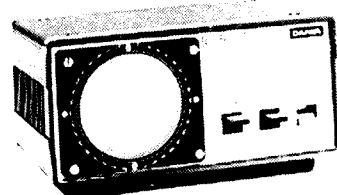

### ... AND A CHOICE OF MEDIUM OR HEAVY-DUTY ROTATORS

You can choose a Medium Duty Rotator (Model 7500) or a Heavy Duty Rotator (Model 7600). The medium duty rotator will handle the average beam with ease. The heavy duty rotator is designed to handle larger amateur and commercial beams and arrays. Compare these specifications.

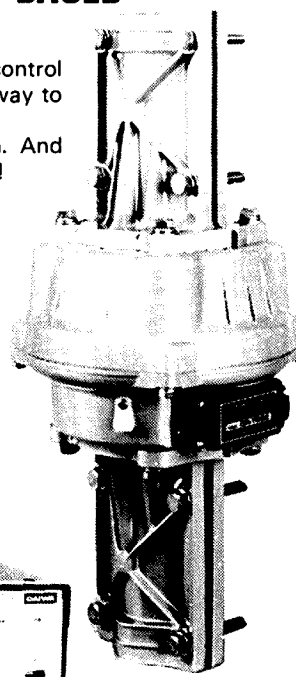

	Medium Duty (DR7500)	Heavy Duty (DR7600)
Rotation Time	60 sec	64 sec
Brake	Mechanical	Mechanical and Electrical
Stationary Brake Torque	2000kg/cm	4000kg/cm
Vertical Load Permissible	200kg	200kg
Mast Size	38-63m	38-63m
Weight	5.5kg	5.6kg
Motor	24V	24V

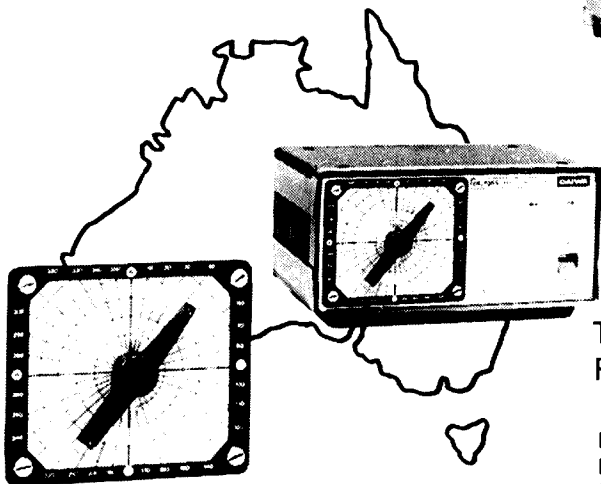

THIS GIVES YOU A CHOICE OF **FOUR** DIFFERENT COMBINATIONS . . . TO SUIT YOUR OPERATING STYLE

- DR7500R** MEDIUM DUTY; PADDLE SWITCH CONTROL BOX.
- DR7500X** MEDIUM DUTY; PRE-SET CONTROL BOX.
- DR7600R** HEAVY DUTY; PADDLE SWITCH CONTROL BOX.
- DR7600X** HEAVY DUTY; PRE-SET CONTROL BOX.

Daiwa rotators are made by the innovators who brought you cross-needle meters. They offer long life and quality Daiwa construction, and are the result of a considerable amount of research.

**SO GET YOURSELF GOING IN THE RIGHT DIRECTION. CONTACT VICOM OR ASK YOUR LOCAL VICOM DEALER.**



#### MELBOURNE

Vicom International Pty. Ltd.,  
57 City Road,  
SOUTH MELBOURNE, VICTORIA  
PHONE: (03) 62 6931

#### SYDNEY

Vicom International Pty. Ltd.,  
6th Floor,  
118 Alfred Street,  
MILSONS POINT, NSW  
PHONE: (02) 436 276

#### WELLINGTON, NEW ZEALAND

Malvicom,  
18 Raroa Road,  
Lower Hutt,  
NEW ZEALAND  
PHONE: (4) 69 7625

**DEALER ENQUIRIES INVITED!**





# QSP



## THE RADIOCOMMUNICATIONS BILL

Australian amateurs operate under regulations based on a very old Act of Parliament. The Wireless Telegraphy Act was passed by Federal Parliament in 1905, with the suggested intention of making wireless telegraphy a "Commonwealth monopoly"! The present Act, the legislative framework supporting Australia's complex mixture of public and private radio communication systems, represents seven amendments since 1905. Several newer Acts control navigation, broadcasting and television, licence fees, and other aspects of communications.

In 1980 the Department of Communications prepared for new legislation to replace completely the old Act and all its amendments. Draft principles were stated and public comment invited. The Institute's response, a twenty two page submission in January 1981, was said to be of considerable help in drafting the new Bill. After several delays the Bill was released for public comment late in February 1983.

The WIA had meanwhile set up the Communications Act Special Planning and Response Committee (CASPAR), which held its first meeting on 17 March. It has seven members VK3s AE, NE, XX, AFW and AMD with chairman VK3ABP and secretary/co-ordinator VK3QQ. Executive required from CASPAR a detailed report on all aspects of the Bill relevant to the Amateur Service, including all comments by Divisions and individual amateurs, as requested several times in AR and Divisional news broadcasts. Comment was received from the VK1, 2, 3 and 4 Divisions and from several individuals. The VK1 comments were of particular value, being a fifteen page discussion by VK1GB, a practising barrister.

After three meetings in two weeks, CASPAR presented its findings to the Institute's Federal legal consultant VK3KI at the end of March. It then met with him and members of the Executive on 14 April to discuss the draft submission which he (and 1GB on the telephone) had prepared over Easter. With little alteration the twenty three page VK3KI draft was then presented to the Federal Convention on 24 April. The final submission was presented by VK3KI personally to the IREE Workshop held in Sydney on 26 and 27 April to discuss the Bill and its implications. It was well-received by all present, including the DOC representatives, and was then formally submitted to the Department.

I have taken this long, over the history explanation to make clear that the Institute's submission is a carefully thought out legally-drafted document representing many hours' work by many people, in which there has been the greatest possible scope for participation by all members of the WIA either as individuals or through their Divisional Councillors.

*But what is in the Bill itself? What changes would we like to see in it before, tabled, debated and passed in Parliament, it finally becomes the new Act? Regrettably, in the space available here it is only possible to mention a few main points. The Bill itself has eighty three clauses and occupies forty six pages. To quote parts of the outline which follows the published text, it "makes provision for common standards for radiocommunications receivers and transmitters and for offences with respect to sub-standard equipment . . . provision for compliance statements and compliance certificates . . . provision for a spectrum plan and frequency band-plans and for transmitter and receiver licences. Part . . . is devoted to the settlement of disputes with respect to interference to radiocommunications. Enforcement and procedural matters are also dealt with."*

Many of the provisions of the Bill, as might be expected, re-state in modern terms what we already understand to be the function of the DOC. But its novel underlying theme is interference minimisation by much tighter control over transmitting equipment, to include anything capable of transmission even if **not so intended**. Unfortunately similar provisions do not apply to all receivers, nor to so-called "non-receivers" such as audio equipment. This is thought to be due to doubt about the Commonwealth's constitutional power to control such devices. It was not until 1935 that the basic power to make laws about "postal, telegraphic, telephonic and other like services" was held to encompass "Wireless telegraphy" — thirty years after the original WT Act!

Rather than continue with a description of the Bill (which is available from the Government Printing Office) the points on which the WIA has made comment will now be listed. The aspects which we find undesirable or inadequate may be inferred from the comments. The WIA:

- 1 Suggests creating specific offences regarding false distress messages, deliberate interference, and disclosure of received information by other than the intended recipient, the latter in lieu of receiver licensing.
- 2 Opposes possession of a sub-standard transmitter being made an offence.
- 3 Agrees that broad standards are necessary, particularly as regards transmitters, but considers that the Amateur Service (because, uniquely, its technically qualified operators engage in self-education by constructing or modifying their equipment) should be exempt from such standards.
- 4 Suggests that the Bill be extended to include control of interference — susceptible appliances and that the power to do this may have been established by the Trade Practices Act.
- 5 Suggest that the interference conciliation procedure be extended to cover more fully those suffering interference (from whatever source).
- 6 Opposes the power to license all receivers (other than broadcast or TV, already excluded) and suggests licensing should apply only to receivers for commercial satellite transmissions above 1 GHz, if at all.
- 7 Recommends that spectrum and band plans shall be in accordance with international agreements and subject to public comment at the draft stage.
- 8 Questions the need for any search to be authorised without issue of a warrant by at least a magistrate (as distinct from a JP).
- 9 Suggests that the Bill should not preclude licensing for periods longer than one year.

It was further decided at the Federal Convention that the Institute should recommend creating an offence of selling a radiocommunication transmitter to a person or agency not appropriately licensed.

Notification has already been received from DOC that amendments to the draft will follow WIA points 2, 4 and 7. The Institute continues to negotiate on the other points, particularly 1, 3, 6 and 8, and suggests that with such amendments the Bill should be introduced in Parliament as soon as possible in view of the urgent need for effective control of interference.

W M Rice VK3ABP  
Chairman CASPAR Committee  
AR

# WIA NEWS

## CHESS-ON-THE-AIR

Further to representations made to the Department of Communications by the WIA, and as discussed at the DOC/WIA Executive meeting of 30 March 1983, the Department has advised and confirmed, that Australian amateurs are now permitted to participate in, and conduct on-the-air chess sessions over the Amateur Network. Sessions must of course be conducted in accordance with correct amateur procedures.

AR

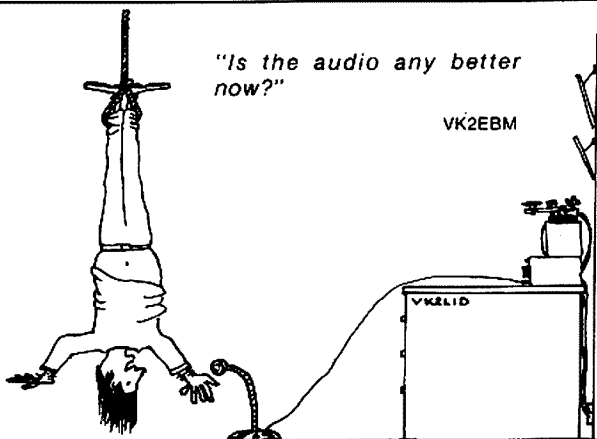

# HURRY!!

## CONTENTS

	Page
Assistance Required	Trade back cover
Books on Amateur Radio history	51
Call Signs and QSLs by Peter Ooda VK3CF	54
Chronological Historical Tabulations	15
Emergencies by Ron Henderson VK1RM	34
Federal Conventions	11
Federal Presidents	12
Foreword	5
Guide to Illustrations	64
Hagibatham Award	44
International Amateur Radio Union (IARU)	60
International Telecommunication Union (ITU)	62
Introduction	6
Let's Not Forget	39
LTE Members	14
Metric Multiples	160
Morse Keys by Alan Shawman VK4SS	41
Publications on Amateur Radio	50
Remembrance Day Comment	38
Ron Wilkinson Achievement Award	40
Satellites by Bob Arnold VK3ZBB	59
Services	47
The Ionosphere by Len Paynter VK3BYE	56
VHF Projects	65
WIA Constitution, Policies and Organisation	7
What's AR For?	46
WIA Publications by Bruce Bathols VK3UV	46

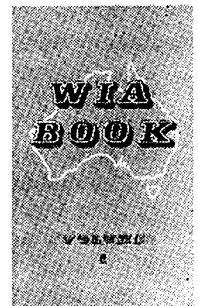

Now is the time to buy your copy of the WIA Book — Vol 1.

Limited number of first printing are still available.

## HOT OFF THE PRESS

## WIA LOG BOOKS

Available from your division,  
Magpubs — PO Box 300,  
Caulfield South, 3162 or from  
Federal Office.

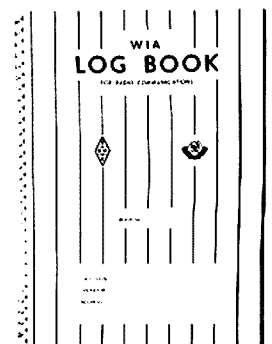

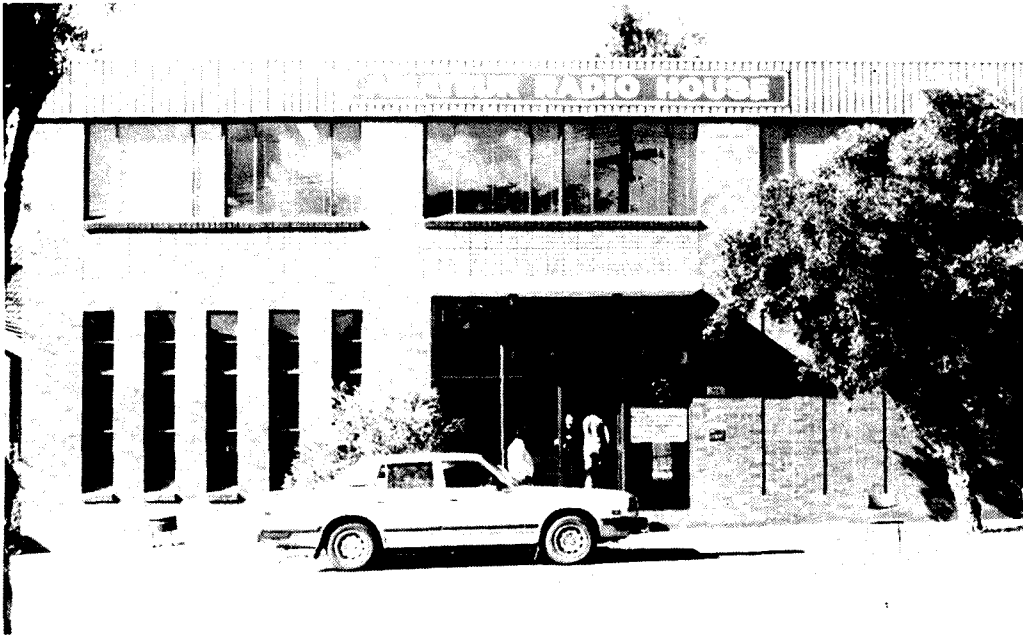

# AMATEUR RADIO HOUSE

Bruce R. Bathols VK3UV  
FEDERAL PRESIDENT

*The NSW Division's new premises at 109 Wigram Street, Parramatta, "Amateur Radio House", was officially opened on Saturday 28th May 1983 by Mr Gary Punch, MP for Barton. Mr Punch delivered a brief history on amateur radio, concluding with an acknowledgement to the WIA on its excellent submission in respect of the Radio Communications Bill.*



View of VK2 Rooms.

Special invited guests were Mr Stan Dickson, Mayor of Parramatta, Mr John Milton State Manager (NSW) Department of Communications, and the WIA Federal President Mr Bruce Bathols, VK3UV.

Approx 150 members and their wives attended the opening ceremony, which was also broadcast live on VK2BWI Amateur Television on 426 MHz. Many old timers were present, and were caught reminiscing in quiet corners.

Amateur Radio House consists of two stories, and includes a large library/reading room, activities room, offices, storage rooms etc. It is a magnificent structure, and something which the NSW Division can be very proud of.



Amateur radio "Yesterday Display" set up for the opening.



Part of the VK2 Bookshop in Amateur Radio House.

It will serve its purpose well, being centrally located amid the majority of Sydney's amateur population, no problems with parking and very convenient to public transport.

Congratulations must go to Susan Brown, VK2BSB and her tireless group of helpers in arranging such an impressive opening ceremony.

A special article is being prepared for future publication in Amateur Radio detailing some of the problems and jubilations in completing this project.

Photographs by Bruce Bathols VK3UV.

AR

**Full report from VK2 in August AR.**

# SEVEN ELEMENT YAGI ANTENNA — ECONOMY VERSION

Desmond A Greenham VK3CO  
23 Stewart Street, Seymour, Vic 3660

If you are fortunate enough to live in a high location with a good clear outlook in all directions, then a simple omnidirectional antenna is all you will need for 2 metre FM operation, particularly into repeaters. Any basic antenna such as 1/4 wave, 5/8 wave, Slim Jim, J Pole, etc will be adequate. However, if you live remote from the repeater site, or in a "difficult" location, some antenna gain and directivity will be an advantage.

The antenna to be described has a worthwhile forward gain and is simple and cheap to construct. The elements are made from aluminium wire or tubing and are 2 to 3 mm diameter. The boom is also from an old "channel 2" TV antenna and is 1" (25 mm) diameter, 2.4 m long. New material can be used and either 25 mm round or square section could be purchased depending on the method used to mount the elements. Element mounting is left to the constructor as there are numerous ways available. Suitable plastic mounting blocks are available from component retailers although these are relatively expensive. Old TV mounting brackets can be used effectively, however, the simplest method is by simply drilling holes through the boom and securing the elements with a self tapping screw. There is no best way for mounting — even the use of "Araldite" glue combined with nylon fishing line square lashing can be mechanically solid.

The antenna is quite conventional, using a folded dipole driven element, and reflector. A close spaced "launching" director is used to provide close coupling and impedance correction, and five directors for additional forward gain. The antenna is fed with fifty ohm or seventy five ohm co-axial cable with a half wave balancing section. This not only converts from unbalanced cable to a balanced feed but also raises the impedance by four times. Assuming that seventy five ohm cable is being used the impedance would be 300 ohms. The folded dipole is constructed with unequal diameter material to raise the feed impedance to 300 ohms thereby giving a good match to the feed system.

The folded dipole driven element is shown in the drawing and uses 6 mm tubing on the main element with 14 gauge (B & S) wire as the feed element. The ends are connected using solder lugs held with rivets, metal screws or "pop" rivets. The insulation block can be PVC or similar plastic — an old tooth brush handle is very suitable!

The feed cable and the 4/1 Balun should be tightly taped with PVC tape to prevent moisture entry. The cable should be taped along the boom and come away from behind the reflector. Taking the cable direct down the mast can distort the radiation pattern as the cable braid is close, and parallel to, the director elements.

For vertical polarisation, the antenna should be mounted on a length of PVC pipe or other insulating material with the

elements vertical. Mounting direct on a metal mast will affect the feed impedance and radiation pattern.

After completion, all measurements should be checked and the feed cable connected.

The PVC or Wooden stub mast should be bolted or clamped to the main metal mast and the antenna raised into the operating position as high as possible above ground.

The antenna is designed to use 75 ohm co-axial cable, however, 50 ohm cable can be used with a slight deterioration of SWR. The feed cable should be as short as possible as the loss in cable is quite high — in many cases the gain obtained by the antenna can be lost in the feed cable.

The SWR should be checked on 147.00

MHz. If everything is correct and the antenna is at least three metres above ground, in the clear, an SWR figure of 1.2 can be expected. No adjustment is provided, however, an impedance change can be made by changing the reflector to driven element spacing slightly. This will not affect the forward gain to any great extent.

This antenna is very standard and no extravagant claims are made for its performance. Provided the construction is solid and dimensions are correct, the performance will be good and equal to most commercial antennas with the same number of elements. The major difference, however, will be in the cost and this is always an important factor to the majority of amateurs.

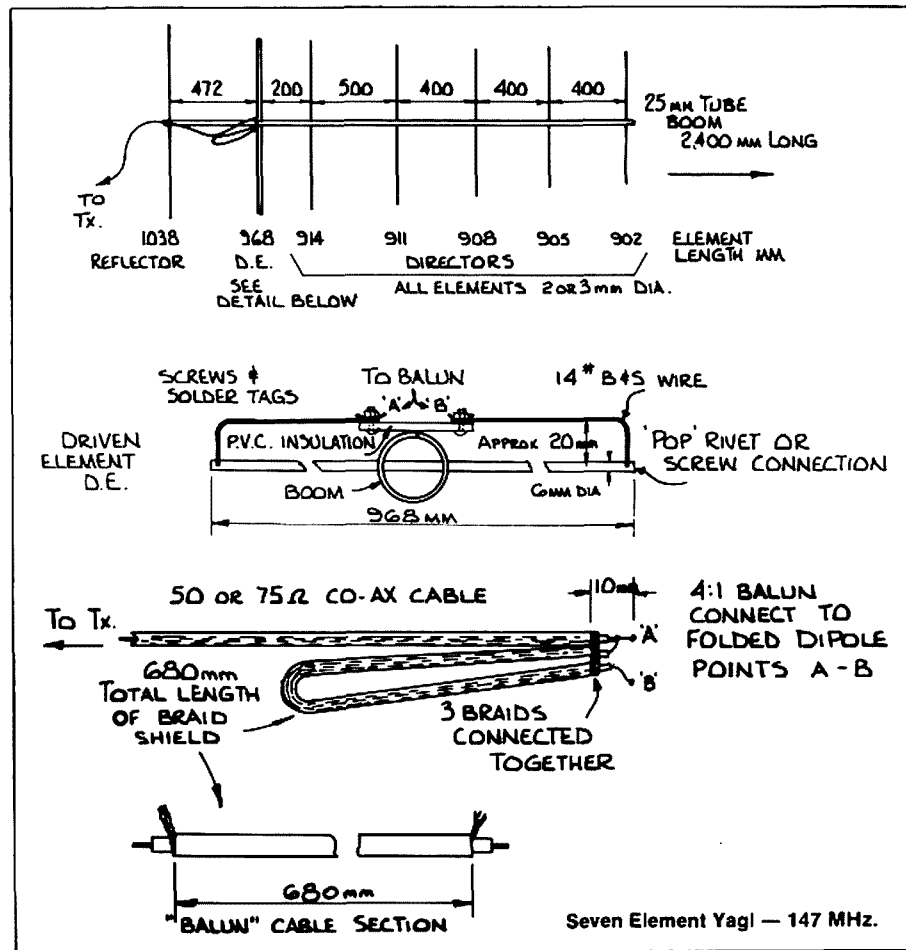

# TEST EQUIPMENT FOR THE RADIO EXPERIMENTER

## TWO TERMINAL OSCILLATOR

R S Gurr VK5RG  
PO Box 35, Daw Park, SA 5041

*One of the most useful items, installed in my workshop for some years, is a "two terminal oscillator". This simple instrument is an oscillator, either tube or transistor type, that is coupled into a standard digital frequency counter.*

There is no tuned circuit in the unit — only two terminals, across which any unknown tuned circuit may be connected. The circuit then oscillates on the resonant frequency of the L/C combination.

Direct counting on the frequency meter is of course the simplest method, however I had the unit going for twenty years prior to using the counter. The oscillator puts out harmonics, and with a general coverage receiver, it is not difficult to locate the various signals and calculate the fundamental frequency.

Application to audio frequencies as well as radio frequencies is possible, however, the most satisfactory method is to have two separate oscillators. When selecting capacitors for tuning RTTY filters built up around 88 mH toroids, the unit proved most useful.

### INDUCTANCE AND CAPACITANCE MEASUREMENT

Another advantage of the unit is the means by which L and C values may be measured approximately. At RF, I have a calibrated capacitor and inductance, across either of which an unknown L or C can be connected, and after the frequency of oscillation is known, an ARRL Lightning calculator, ABAC chart, slide rule, or electronic calculator, will give the value of the unknown very quickly.

The same method of inductance measurement for audio work is possible — a handful of surplus and valueless pot-cores can become of considerable value in a few minutes, once inductance values become known.

The basic circuits were inspired from early editions (1942 I think) of the "Radio Handbook", and the current 1982 edition still carries the same circuits. Two types, the "Transitron" and the "Cathode Coupled" oscillators are featured using 6BA6 and 12AT7 tubes respectively. The FETs I use are usually MPF102.

My own circuits have some slight modifications as shown, and in either tube or transistor format, they function satisfactorily. Other oscillator circuits will suggest themselves.

I have been able to use the unit to set tuned circuits to frequency before installation up to and beyond 30 MHz, select correct tracking and padding circuits for project receivers, check unknown Intermediate Frequency transformers, etc.

The units may be mounted on general purpose power supplies, as complete instruments, loose on leads, etc. I have them in all the above configurations. Stability for use as a VFO is determined more by the L/C combinations than by the actual circuit used, and therefore at times a complete VFO may be fabricated, and as mentioned above, tracking may be checked.

The following circuits are typical of those in use:

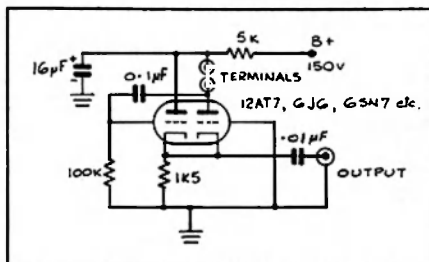

AF Oscillator

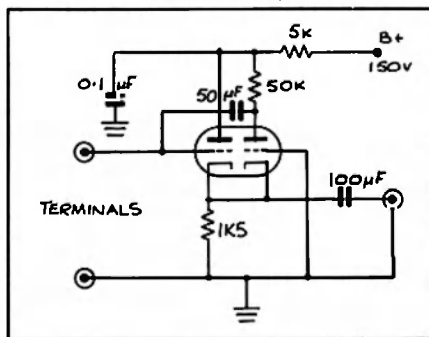

RF Oscillator

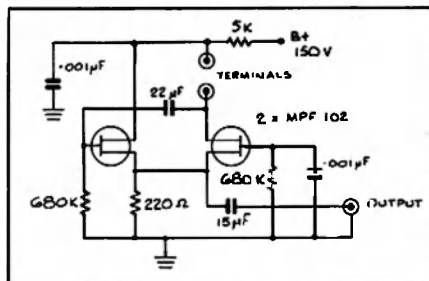

RF Oscillator (solid state)

# CLUB CORNER

## EASTERN ZONE CONVENTION

Photographs by Fred Hobson VK3QH.



Len VK3AKU, white stick operator, at the controls of the Station at the Victorian Division Eastern Zone Convention in March 1983. Len uses a speech synthesiser coupled to digital readout on transmit and audio tones to tune the transceiver and antenna.



Ken VK3KC's slow scan equipment at the Convention.



Len VK3AKU's station at the convention.



Ken VK3KC operating slow scan video camera.

# THE VK6 BROADBAND END FED ANTENNA

A M Keightley VK6YX  
242 Serpentine Rd, Albany, WA 6330

**A low noise, low SWR, 160 to 20 metre antenna only 22½ metres long.**

The basis of this antenna design is from two main sources, firstly the development of a three wire end fed antenna for amateur use by John VK6IM of Australind, with whom I have conducted on air tests for many months, (mainly on 160 metres) and secondly the recent article in 'AA' of April 1982 'The Australian Broadband Antenna'.

Prior to the testing with VK6IM I had the belief that, generally, end fed antennas suffer from the problem of powerline and man-made noise pickup much more than a balanced antenna. John kept describing the low noise pickup of his developing antenna, so I gradually became interested in thinking how the good characteristics of his design could be improved to reduce the SWR excursions being experienced. Much thought was given to the many possible methods of assembly to reduce the possibility of corrosion problems of dissimilar metals, to reduce the weight while retaining good strength.

## DESCRIPTION

Figure 1 shows the general arrangement of the final design. The antenna consists of two parts joined by a parallel connected resistor and inductor. The lower section is connected to the feed line via a balun. The upper section is about half the length of the lower section. Both sections are in a five-wire cage configuration. Further details are given later in this article.

## TESTING

An antenna was constructed, erected and considerable testing conducted to determine its characteristics. It was instal-

led between two towers with the feed end at ten feet and the far end at thirty feet. First testing was done by taking an FRG7 receiver and an RX noise bridge up the tower to the feed point and recording the antenna impedance from 1.7 to 16 MHz. Coils from 12 to 30 micro-Henry were tried before selecting 19µH. As this value gave the most satisfactory results, although it is not critical. These feed impedance figures were very interesting, showing a gradual drop below 2 MHz, a peak at 8 MHz and a gradual rise above 12 MHz, with the noise bridge indicating some 154 ohms over most of this range. See Fig 2.

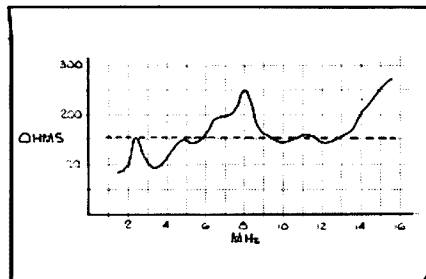

Fig 2 Noise bridge readings taken with Polomar R-X noise bridge and Yaesu FRG7 receiver at the feed point.

An Amidon T200-2 powdered iron core was obtained and a suitable matching transformer constructed to permit transmitting tests to be conducted and recorded. As indicated in the Amidon literature, the use of one of these should tend to reduce the SWR excursions. This proved to be the case and the results showed that the transformer characteristics seemed to compliment the antenna performance, with the resulting SWR not exceeding 1.2:1 from 1.8 to 14.35 MHz. See Fig 3.

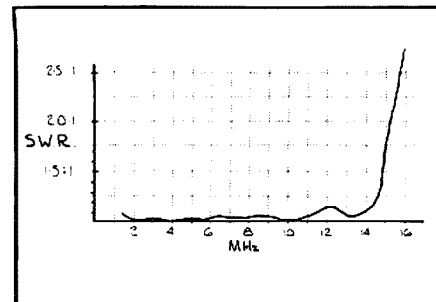

Fig 3 SWR indications recorded at transmitter end of coax using matching transformer at the feed point.

Next some listening tests were conducted, comparing audible signal to noise ratios, between the test antenna and several verticals and a dipole antenna on commercial frequencies. These certainly showed the low power line noise pickup and while signals were a little down compared to some of the antennas, the readability of signals were greatly improved on the broadband antenna. Some simple radiation tests were conducted from twelve locations reasonably equally spaced at some three kilometres radius on roads thoughtfully provided by the powers that be. Two Drake TR7 transceivers were used, mobile and at the base. Ten watts were used for the tests, taking care that the vehicle was oriented in the same direction

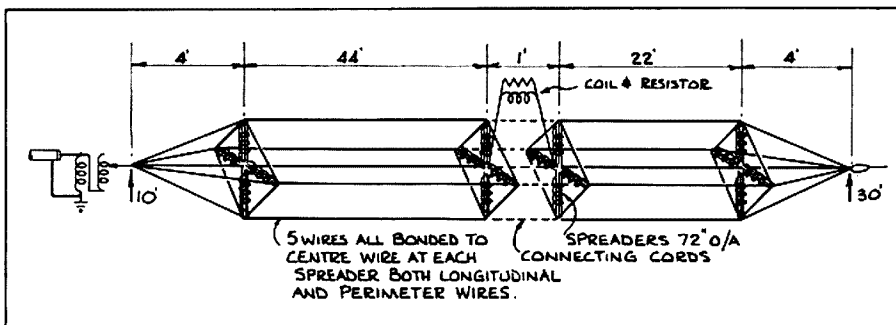

Fig 1 General arrangement of the Broadband Antenna.

compared to the test antenna. Received signal strengths were recorded in both directions on 160, 80, 40 and 20 metres. These showed a nearly circular radiation pattern on each band. Tests were then conducted over a radius of 53 kilometres on the amateur bands and some testing on a commercial frequency. These confirmed that the antenna was working up to expectations, particularly on 160 metres, which was providing excellent communication throughout the day; some 480 kilometres were travelled on this occasion, mostly 50 to 70 kilometres radius from the test antenna. The five-wire design was proving to be as effective as hoped.

## CONSTRUCTION

The wire used for the antenna is single strand .85 mm half-hard copper wire. The antenna is strong, because of the five wires in parallel and is suitably light in weight. The spreaders are 6 mm diameter fibre glass rods purchased from a city plastics supply company in three metre lengths. These are cut into 73 inch lengths and drilled in the centre and at 1½ inches in from each end, with a 1/16 inch drill, the end holes being at right angles to the centre hole. The imperial measurements came about by using an imperial rule and materials on hand. Some 1/16 inch stainless steel weld wire is cut into four, one inch pieces and sixteen pieces, ¾ of an inch long. The long pieces are hammered through the centre holes of two rods. The shorter pieces are then driven into the end holes; these are to prevent the antenna wires from moving along the rods. Take one spreader assembly and using a clove hitch, attach the end of some .85 mm copper wire to the end of one rod, above and below the pin leaving about three inches of pigtail. Pull the hitch tight. See photo 1. Measure from the centre of the rod, 51.9 inches and mark the wire with a wick pen, then place the mark on the next rod in line with the pin and form another clove hitch, pulling it tight. Continue this around the square, adjusting the length of the last one to have the wire taut. Treat the other three spreaders in the same way.

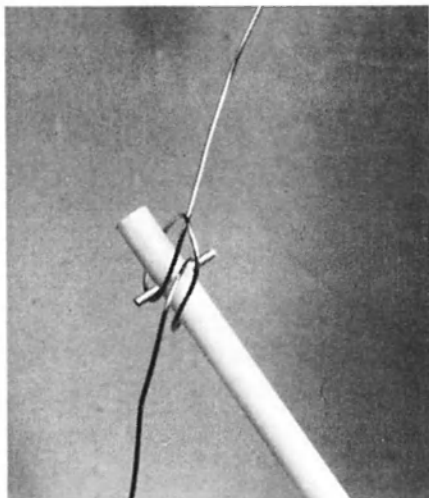

Photo 1 Wire being fitted to spreader rod, showing fibreglass rod and retaining pin.

Procure several metres of 'Vinylon' cord from your friendly butcher who uses it to tie up roasts of beef. This makes excellent supports and halyards for antennas as it does not seem to be effected by sunlight or weather conditions. Cut five pieces about two feet long, attach one end to the end of one spreader assembly using a clove hitch over the wire and pin, then measure along the cord 12 inches, place another mark and attach to another spreader assembly. Do this at each corner and at the centre.

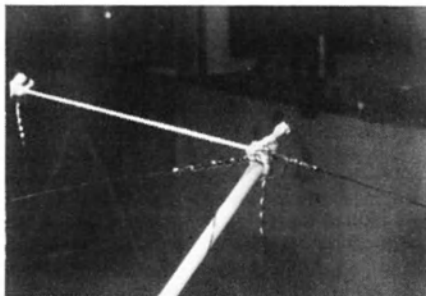

Photo 2 Centre section spreaders showing 12 inch cord tie between two spreaders and the coupling of longitudinal and circumference wires to the central wire.

The next stage requires a flat area some 80 feet long, a concrete driveway is very suitable, and some firm portable supports for each end to attach wires to for the final assembly. Cars, fences, gates can all be pressed into service; the amateur is usually most inventive here.

Several helpers will be useful for this phase of the construction. Have one person hold a spreader vertical, resting it on the ground about five feet from one end support. Tie a piece of .85 mm wire to the spreader using a clove hitch and leaving about six feet of pigtail. Tie this to the support, level with the spreader centre. Measure along the wire 44 feet from the spreader, mark the wire and cut it off about six inches longer. Now attach the wire to one of the centre pair of spreaders at its centre. Attach the end of another piece of wire to the centre of the other spreader pair, leaving a pigtail, measure along 22 feet, mark the wire before cutting it off some six feet longer and attach it to the centre of the remaining spreader. Pulling firmly, attach it to the end support some five feet away and in line with the centre. Continue this method of assembly for the next four wires placed at the ends of the rods remembering to place the wire above and below the pins to prevent it sliding along the rods in use. The next job is to bond each of the longitudinal wires to the spreader squares at each spreader, both sides of each rod. Now attach another wire to a longitudinal wire, spiral it around the rod seven or eight times to the centre and tie it to the centre wire. Do this on each rod of every spreader, effectively bonding all wires to the centre wire.

A suitable egg-type insulator is now fitted to the centre wire four feet from an end spreader and tied off. Carefully attach each of the remaining wires, keeping even tension on each wire while ensuring the

insulator remains in line with the antenna centre. Carry out the same insulator installation at the other end. Now fit two feet of multi-strand flexible insulated wire to the antenna at the insulator on the long end and secure through the insulator. Attach two similar wires one foot long to the centre wires at the centre spreaders. Now all the twisted joints are to be soldered and suitably protected from oxidation by an application of Silastic or similar material. Incidentally, do not use 'RTV732' as the chemical action during curing is corrosive to copper. 'RTV738' does not have this problem and can be used with confidence on any copper materials.

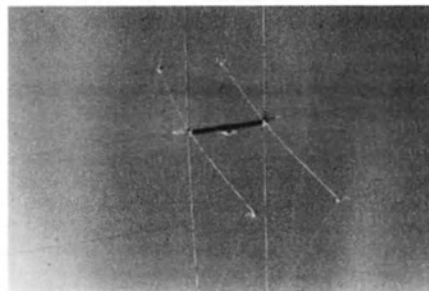

Photo 3 View of the centre section with inductance and resistors fitted.

## LOADING COIL

The loading coil is 50 turns of 1 mm enamelled wire close wound in the centre of one inch OD PVC tubing, 14 inches long. Drill two small holes through the conduit to secure the ends of the coil. Cut and tin these ends and solder six 2.2 kohm one watt resistors in parallel across the coil as shown in photo 4, the coil assembly should now be mounted in the centre of the centre spreader assembly and secured with some of the Vinylon cord, the flexible wires from the antenna centre wires shortened and soldered to the coil ends. Now protect the coil-resistor assembly from the weather by a coating of Silastic or similar.

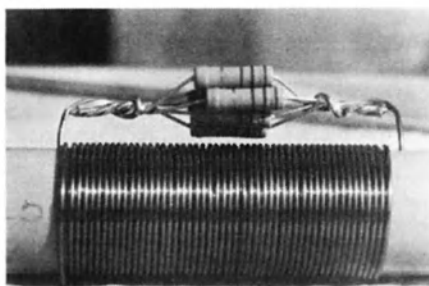

Photo 4 Inductance and resistors.

## MATCHING TRANSFORMER

Obtain about 4½ feet of two different coloured 1 mm enamelled winding wire. Twist the wires together at one end and hold in a vice. Pull the wires tight, cut them off to the same length, twist the free ends together for about a half inch and place into the chuck of a hand drill. Keeping the wires stretched firmly, wind the drill to twist the wires until there are one and a half twists per centimetre. Now wind 24 turns of



Photo 5 Matching transformer showing tapping method.

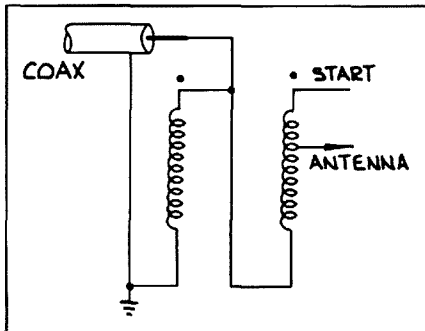

Fig 4 Matching transformer wiring.

the twisted pair on to an Amidon T 200-2 powdered iron core. Keep the turns right onto the surface of the core by forming a slight reverse bend to the wire as it is placed on the flat portions. Connect the start of one winding to the end of the other as indicated in photo 5 and Figs 3 and 4. Count around the core 18 turns, carefully cut the secondary wire, spread the ends away from the other wire and scrape the ends. Loop some 1 mm tinned copper wire around the ends, keeping it away from the second wire and form up a link. Squeeze it firmly onto the wire ends and solder in place. The transformer can now be mounted in a protective box. A square electrical junction box is very suitable as shown in photo 6. A coax fitting and two brass bolts are fitted and the core secured to the bottom of the box with Silastic. A suitable

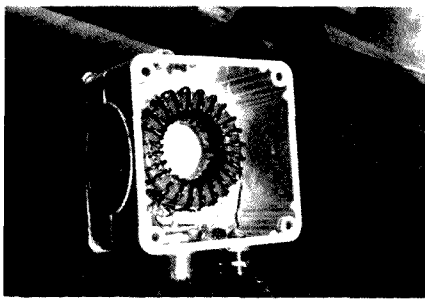

Photo 6 Method used to mount matching transformer in Clipsal 265/3 box.

bracket can be fitted to the rear of the box to hold it onto the tower or whatever support is used for the feed end of the antenna, making sure that it is close to the end of the antenna.

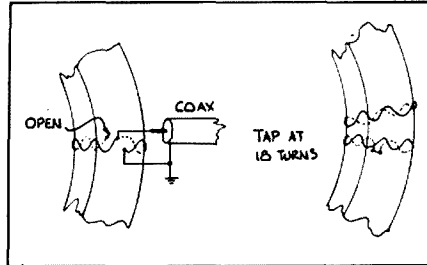

Fig 5 Matching transformer connection detail.

### INSTALLATION

Attach the feed end to a suitable support (tower, building, 2 inch water pipe in the ground etc) together with the matching transformer and run a heavy copper wire down to an earth spike, water pipes etc. The earth losses are minimal due to the moderately high feed impedance. The far end can now be hauled up to a suitable support with the antenna end being 30 feet up. Couple to the matching transformer with 50 ohm coax well weather proofed.

### USE

It is desirable to use a good low-pass filter (ARRL and RSGB handbooks) at the transmitter to prevent any possible low level spurious signals being radiated, which would normally be attenuated by the usual fairly high 'Q' antenna systems we use. This enables the antenna tuning unit to be taken out of circuit for this antenna, making band changing for those with solid state rigs, a breeze. The results with a general coverage receiver are very pleasing, compared to what we usually experience with the usual 80 metre dipole. By all means check the SWR and be amazed at the very low readings obtained, enabling the solid state rigs to give full output on all bands from 160 to 20 metres, not forgetting 30 metres.

### CONCLUSION

I believe this antenna meets the need many amateurs have for a good 160 metre antenna which can be fitted into the average suburban back yard, as it requires only 75 feet of length. The added bonus of low noise pickup and performance continuously to the top of 20 metres makes it very worthy of consideration. Those amateurs using transceivers with general coverage receiving capability, will also appreciate this antenna.

AR

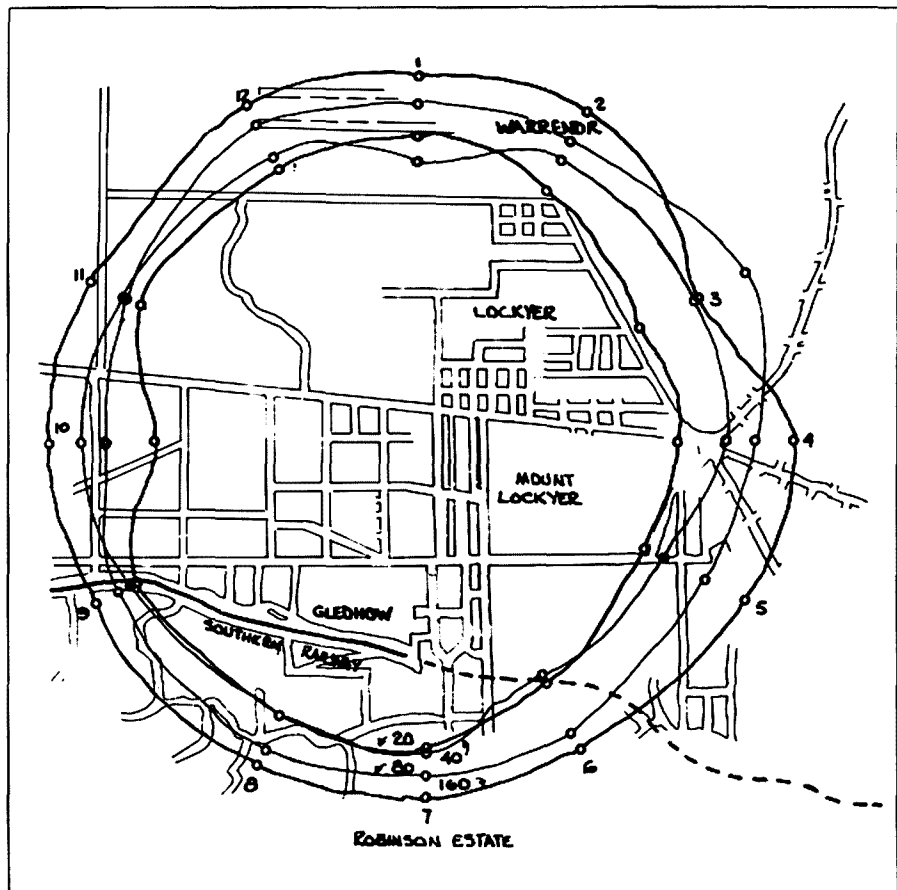

Fig 6 Amateur band radiation test results.



# SIMPLE MARKER GENERATOR

Neville Mattick VK2QF  
 "Hill Top", Hargraves, NSW 2850

Although a marker generator is probably a thing of the past this device may be as useful as a signal generator around the shack. It has obvious uses for the not so well calibrated receiver or home brew project receiver. In addition, it has uses for receiver "IF" and front end alignment with signals that are spot on frequency. With some variations it is based on a unit described in a 1977 ETI publication.

Construction is not critical. The author used a Dick Smith 'DIL' board for the four ICs and oscillator circuit. It is suggested that the oscillator components be mounted on one end, the ICs — one to four across the board. Sockets were used for all ICs. Good shielding of the generator in a metal cabinet is an advantage to lessen leakage of unwanted harmonics. The six position rotary switch used was an old eighteen position type which gave two vacant positions between output positions. Shielded cable was used to connect the switch.

Power was taken from the shack general purpose supply of 13.8 V and further regulated within the generator by a 7812 three terminal regulator.

Other combination outputs are possible. Eg: output of IC4A to input of IC4B would give 25 kHz markers which are usefull well into the 2 metre band, as are the other frequencies generated, dependent on receiver coupling, of course.

Components are common types, all ICs are CMOS devices, VC1 trimmer should be of good quality to ensure stability.

Alignment is done by selecting a known frequency standard, eg: VNG or WWV, coupling the generator to the receiver and adjusting for equal level of signal from the standard and generator on receiver "S" meter. Once this has been done adjust VC1 for zero beat condition and finally tune VC1 until there is no practical movement in receiver "S" meter.

All components are available from Rod Irving Electronics including crystal and printed circuit board.

AR

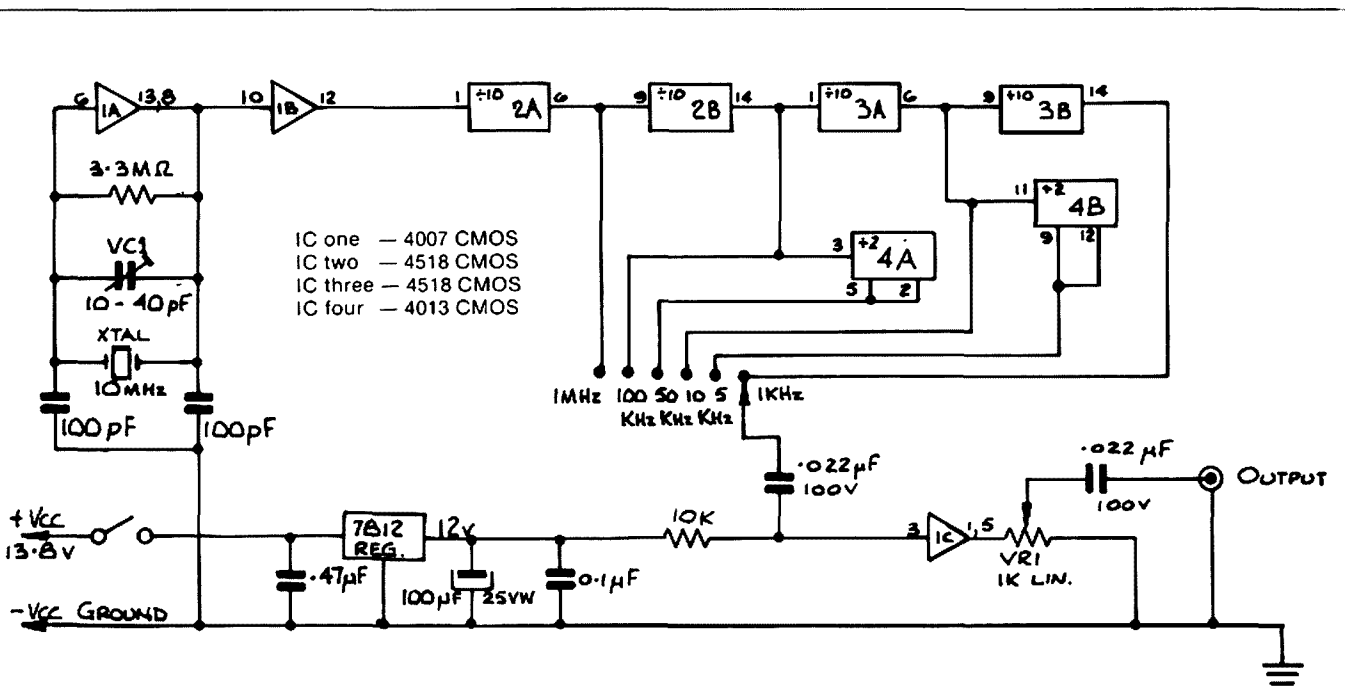

A Simple Marker Generator

IC1 (4007) Pins 7, 4 and 9 are grounded. Pins 14, 2 and 11 are plus 12 V Vcc.

IC2 and 3 (4518). Pins 7, 8 and 15 are grounded. Pins 2, 10 and 16 are plus 12 V Vcc. Pins 3, 4, 5, 11, 12, 13 — no connection.

IC4 (4013). Pins 6, 4, 8, 10 and 7 are grounded. Pin 14 is plus 12 V Vcc. Pins 1 and 13 — no connection.



# STUDENTS CELEBRATE WORLD COMMUNICATIONS DAY, 1983

Ron Smith, VK4AGS  
Oakey State High School. Old 4401

Photographs — Oakey State High School.

*Members of the Oakey High School Radio Club organised a major public display of communications at the school on 17th May, World Communications Day 1983. Members of the club read the notes about WCD in May Amateur Radio, and decided that the opportunity was too good to miss as both an educational opportunity and a promotional exercise for the hobby.*

Very early in May a letter was sent to about forty schools within 60 km, advising them of the significance of WCD and suggesting about fifty different activities in different subject areas which might be undertaken on this day.

The next move was to plan and establish the display. Early discussions indicated that although there would be an obvious bias towards our hobby, there was much more to communications than just the hobby. However, many aspects of the hobby can be used to demonstrate communications in practice, eg RTTY. Consequently approaches were made to Telecom, Department of Communications, WIA(Q) and local commercial suppliers. (An approach was made to the local military Air Traffic Control facility who, although willing, were unable to help within the short time scale.) A search was made of local amateurs' shacks and junk piles as well as other assorted "junk" around the school.



Typing at the Model 15 Keyboard are Carolyn Temple Waits watched by Ann Marie Edle.

Some of the students had little knowledge of amateur radio but were given the task of researching some aspect eg: WICEN and preparing a wall chart.

During the weekend of 14th and 15th and the Monday (16th) May, the foyer of the Science Block at the school was transformed from a collection of rocks and stuffed animals to a major display area of communications equipment and wall posters. The necessary extra antennae were mounted on the roof, and the information hand-outs printed.

The equipment displays set up were: the Club Station VK4AOH operating on SSB, CW, RTTY and 2 m FM, teleprinter wire link with a microcomputer connected to a model 15, various amateur transceivers both new and old, satellite tracking with microcomputers, aircraft transceivers old and new, communications equipment from the local SES, CRS (CB equipment), interior of broadcast receivers, various electronic components, simple beginners projects including "Fun Way" kits and prototyping boards, mobile HF antennae, and operating

magneto telephones 1920 and 1950 style. The chart/poster displays were: equipment types old and new from Telecom, role of the DOC, AMSAT and satellites, WICEN, WIA and the hobby of amateur radio.



Operating VK4AOH on HF — L to R Ron VK4AGS, Tonia Williams and Allan Williams.

At lunchtime, contacts were made with schools at Dalby VK4ZPH/P, Goombungee VK4AOR/P, and Quinalow VK4KBO/P.

Between 400 and 500 people attended the display. Many of these were students from the Oakey High School. However, one local primary school brought all its students. The younger visitors were given a QSL card as a memento of the visit. Other visitors included members of the local community, members of the local SES, members of the "Help Handicapped Enter Life" project who are about to put on air their own station, and a camera crew from the local television station.

Among the many contacts made that day, some of the most memorable were with VK4ZPH (bicycle mobile), VK8HA on RTTY, YB2BLI on RTTY, the WIA(Q) Club Net, and a demonstration with RS8.

The display was featured on the local television news. In the days following, the comments received have indicated an excellent reception from all who attended.

Participating amateurs in addition to VK4AOH were VK4AGS, VK4AOR, VK4KTW, VK4NRZ, VK4AOE, VK4ZPH, VK4NGC, VK4KBO and L40971. Also involved were another thirty students at the Oakey High School who not only set up the display but played host to the many visitors.

AR

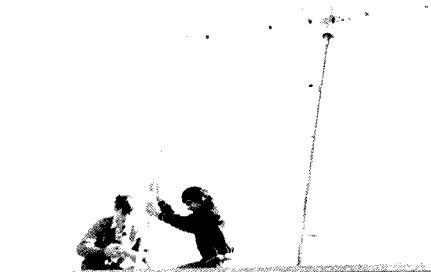

Nathan Spence (left) and Allan Williams erecting the 2 m turnstyle satellite antenna. There are seven antennae on the roof.

As word of the display spread locally, other amateurs suggested that it should be possible to arrange a "school net" for lunchtime on WCD. This was organised in consultation with the respective Principals and was conducted on both 80 m and 2 m.

The students started to assemble equipment, prepare posters and labels, and construct the necessary antennae and cables.

# WORLD COMMUNICATIONS DAY IN ADELAIDE

Photographs — VK5 Division

David Clegg, VK5AMK  
Secretary VK5 Division  
3 Coral Sea Road, Fulham, SA 5024



*When advised in early April that we would be allowed to use AX5ITU for 17th May, the problem arose of a suitable place to use it. Several phone calls and then we were greeted with enthusiasm from Australia Post. It seemed that they were releasing a stamp for WCY 83 on 18th May, as with all new releases a display was to be mounted in the large main hall of the GPO Adelaide. We were invited to be part of this display, not only for 17th May, but the 18th to the 20th also. What a windfall, four days in the centre of Adelaide. Arrangements began.*

Antennas were the first problem. A careful reconnaissance found an existing long wire up near the 4th floor. Could we use it? Apparently, disused for many years, the coax was cut off and left lying on the roof. Access was easy (if you have the right keys) with many walkways criss crossing the galvanised iron roof. I connected the coax, fed it into an office, and tried it out on a TS820. Dismal failure. It seemed that the antenna was O/C at the feed point. Almost impossible to reach and repair. Next came a welcome offer of the use of a trap vertical. The following day it was installed on the roof, beside the clock tower. It was bolted to one of the handrails and earthed to the GI roof. Coax was fed in through the clock tower and down a tightly spiralled staircase inside, about 100 feet of coax in all. Judging by the holes carved in the doors leading to the tower, I suspect that there had been coax fed through them before. A test transmission this time showed all to be working.



Trap vertical on roof of GPO. Maurie VK5ZU (right) and Dave Hogben of Australia Post.

This was a major hurdle overcome. For 2 metres we were to use a Slim Jim, which was left inside the building. Monday 16th was a holiday in SA so arrangements were made to gain access to the GPO that day to install all the gear. At this point I would like to thank Dave Hogben of Australia Post, Philatelic Section, for his genuine interest, and patience, in seeing all was set up OK.

Gear used was a TS820 on HF, YAESU FT227 on VHF. National Panasonic loaned us a VTR and TV to allow us to screen the tape 'Amateur Radio a National Resource'. A display of books was arranged by our Publications Officer. Various posters, copies of 'AR', local journal, QSL cards, were displayed.



John VK5EV and Maurie VK5ZU operating.

Three operators were arranged for each day as a minimum, but many more were to drop in from time to time.

Tuesday 17th arrived and all operators arrived early to give the display the finishing touches. At precisely 0000 UTC, AX5ITU was on the air. That day we had 140 contacts on HF and VHF. The public showed a lot of interest and helped themselves to many of our give aways. At 11.30 (Sat) a sked was arranged with two amateurs who are also postmasters, Kevin VK5APM (Ardrossan) and Ray VK5UY (Murray Bridge). The postmaster Adelaide, Murray Baehnisch, joined in from our station, and all had an interesting QSO.

Wednesday the 18th was the day of issue for the new stamp for WCY 83. The GPO hall was crowded very early with people anxious to obtain their first day covers.

This day we had Lindsay VK5GZ operating CW. This raised a lot of interest



L to R — Dave Hogben, Australia Post Philatelic Section and Murray Baehnisch, Adelaide Postmaster speaking on VK5AWI.

from the public. Our Divisional President, Bill VK5AWM, was autographing first day covers for people. AP made some presentations for an essay competition they had been running. For 18th to the 20th May we used VK5WI and VK5AWI as call signs. A steady stream of people came through the GPO for the rest of the week.

A unique QSL card is being produced for contacts with AX5ITU. We have obtained a supply of the WCY first day covers, and will be overprinting them as QSL cards. For contacts with VK5WI and VK5AWI, we will be using the WCY envelopes.



Bill VK5AWN, SA Divisional President operating.

All told we had 300 contacts. Twenty operators gave their time, and all who came along enjoyed the experience. I would like to thank all who helped in any way, by loaning gear, operating the station, or providing our station with a contact.

A lot more people in Adelaide must now be aware of what amateur radio is all about.

AR

# HORSE ENDURANCE TRIALS

## — a different type of Field Weekend

Ian Jackson VK3BUF and  
Andy Beals VK3KCS

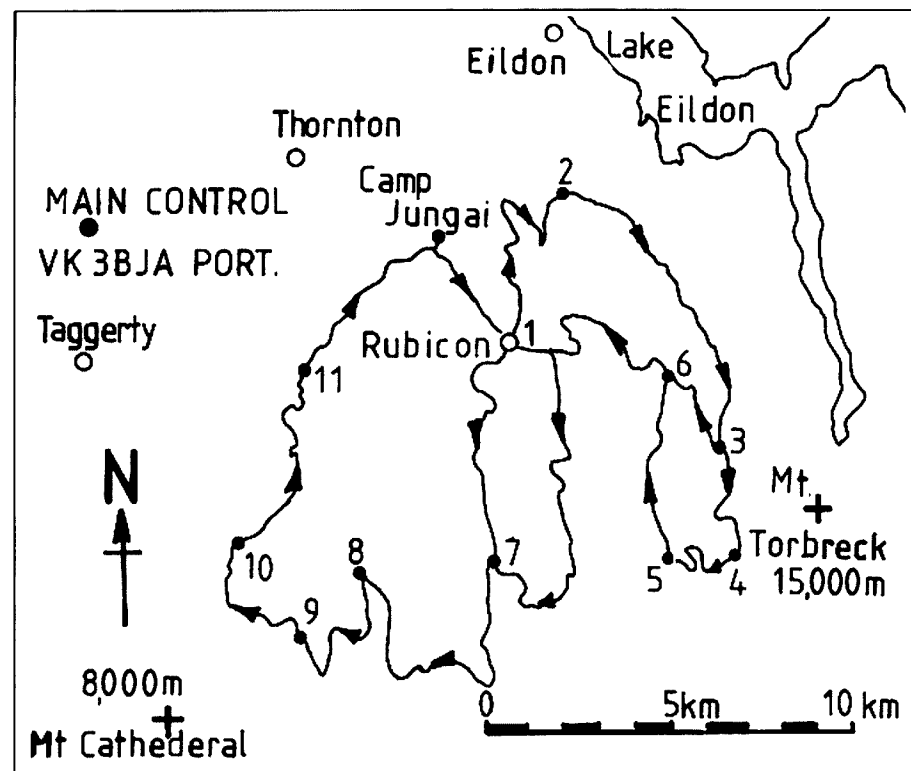

A rough map of the trial route indicating radio checkpoints.

In central Victoria lies some of the most rugged bush terrain to be found in the State. Dense forests of native gum trees clinging precariously to the side of mountains whose height exceeds 1200 metres, quite often above the snow line.

On the weekend of the 9th and 10th of April, the Alexandra branch of APEX held its annual horse endurance trials in this area. A gruelling event, the trials consist of horses and riders embarking on either the full course of some 80 km or the younger riders and novices a 56 km trial. The trials began and ended at Camp Jungai a well established bush camp at the Rubicon Power Station.

One of the main difficulties that arises in the organisation of these events is the need for reliable communications. At eleven specified points on the trial, checkpoints were stationed to monitor the passing of all contestants and assist with any difficulties which may arise. On previous trials this need had been fulfilled with varying degrees of success by CB radio using 27 MHz.

This year, due mainly to the efforts of Peter Weeks VK3YZP, who lives in Alexandra, the Gippsland Gate Radio Club

in Dandenong was invited to provide communications for the trials.

Due to the terrain over which communications need to be provided it was decided to erect a temporary VHF portable repeater and use portable or mobile 2 metre equipment at each of the checkpoints. All checkpoints reported to a radio control point operated under the club callsign of VK3BJA portable, set up at the QTH of Peter VK3YZP near Acheron. Here the information from the checkpoints was to be collated and then transmitter to the trials control point at Camp Jungai via a 2 metre radioteletype link. A 70 cm link between Acheron and Camp Jungai was provided for voice communication.

On Saturday morning two Club members Peter VK3KCW and Andy VK3KCS set off to the area of the trials to install the repeater. Using a four wheel drive vehicle to gain access to the top of Big Hill in the Royston Range the equipment was set up, but as the peak proved to be a bad RF location the next peak about 1 km away was selected. Tests from this site proved to be entirely satisfactory as the only checkpoint which could not access the repeater



Albert VK3BQO, Ben VK3KLM and Peter VK3YZP working on the 13 metre, pump-up mast at Camp Jungai.

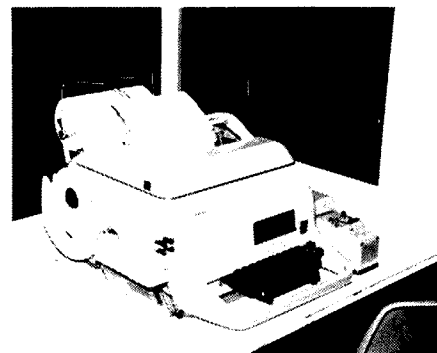

RTTY receiving terminal at Camp Jungai.

had simplex communication to Control via 2, 10 or 80 metres.

While the repeater was being installed, Peter VK3YZP, Albert VK3BQO, George VK3YZG, Ian VK3BUF, Dave VK3BJV were engaged in setting up and testing the radioteletype link. The Camp Jungai end of the link consisted of a 13 metre pneumatic telescopic mast with a 6 element 2 metre Beam and a 70 cm ground plane antenna feeding into the radio equipment in the camp manager's office. This end of the operation was manned by John VK3KCE.



Views of the main camp from the surrounding valley.

The radio control point utilised the facilities of VK3YZP's radio shack. A briefing was held at Camp Jungai to inform the checkpoint operators of checkpoint locations and issue route maps and check lists.

The radio club members were well catered for and accommodated in 6 berth cabins at the camp. Saturday night's activity consisted of descending en masse on the Pizza Parlour in Alexandra. After wrapping Saturday up at 0200 on Sunday morning we arose at 0400 for breakfast, cooked to perfection by volunteers from the APEX club. The most distant checkpoints were an hour and a half's trek away and only accessible by four wheel drive vehicles.

Everybody was in position and ready by 0600 for the 0630 start from Camp Jungai of the participants on the first stage of the 80 km trial. The horses and riders in the 56 km trial got away at 0700.

As the horses passed through each checkpoint its rider jacket colour and number were noted with the exact time. This information was radioed to the control point where it was collated and transmitted via the RTTY link to the trial organisers at Camp Jungai.



Camp Jungai.

About an hour after the start of the 56 km trial one of the riders reported his horse lame to the operator at checkpoint 3 and required assistance. A request for a horse float was made which duly arrived to collect horse and rider about twenty minutes later.

A typical checkpoint consisted of a vehicle and a radio operator. The first sign of action was the sound of horse's hooves on the stony track. A group of horses appearing through the scrub triggered a frantic burst of activity noting numbers and colours on the checklist, followed by peace and quiet until the next group arrived. As

well as people already noted, checkpoints were manned by Barry VK3NJB, Noel VK3NJJ, Doug VK3VMN, John VK3DJV and Ben VK3KLM.

By 1130 all horses had completed the first stage, roughly half the course, and were back to Camp Jungai for lunch and a vet check for the horses. Some of the horse were vetted out so the second stage of the trial was completed by 1530.

As each checkpoint completed its task the operator returned to the camp; by 1600 all had arrived for a well earned meal and then to packing up for the return trip to Melbourne.

In addition to providing highly successful communication for the horse trial, invaluable experience in message handling and co-ordination was gained by all club members who took part in this very different field weekend.

Photographs by Ian Jackson VK3BUF.

AR



Radio control point where all messages were received, collated and teletyped off to Camp Jungai. Peter Weeks VK3YZP at the micro-phone.



**URGENT!**

Please let us know of clubs and schools etc. starting theory classes.

Where, when, how much and whom to contact.

Contact Brenda VK3KT.



# MODERN MILITARY SURPLUS EQUIPMENT

Colin MacKinnon, VK2DYM

PO Box 21, Pennant Hills, NSW, 2120

## Wireless set C42 & C45.

*These sets are identical except for frequency range, and both use the Supply Unit Vibratory No 12 MK2. They were basically mobile to mobile, or mobile to forward base communications units. They include an intercom amplifier for communications within the vehicle.*

### VALVE LINE UP:

Serial No	Type	Function	Equivalent
V1	CV4010, CV850	RF amp	6AK5, EF95
V2	CV4010, CV850	1st Mixer	6AK5, EF95
V3	CV4010, CV850	100 kHz calibrator	6AK5, EF95
V4	CV4010, CV850	1 MHz calibrator	6AK5, EF95
V5	CV4010, CV850	reactor driver	6AK5, EF95
V6	CV4058, CV133	master oscillator	6C4, EC90
V7	CV2243	driver	
V8	CV220	power amp.	
V9	CV4010, CV850	1st IF amp 6MHz	6AK5, EF95
V10	CV4010, CV850	limiter	6AK5, EF95
V11	CV469	wideband discriminator	EA76
V12	CV469	wideband discriminator	EA76
V13	CV2128	2nd mixer/LO 8.4 MHz	ECH81
V14	CV4010, CV850	2nd IF amp 2.4 MHz	6AK5, EF95
V15	CV4010, CV850	3rd IF amp 2.4 MHz	6AK5, EF95
V16	CV4010, CV850	1st limiter	6AK5, EF95
V17	CV4010, CV850	2nd limiter	6AK5, EF95
V18	CV469	discriminator diode	EA76
V19	CV469	discriminator diode	EA76
V20	CV4010, CV850	1st AF amp	6AK5, EF95
V21	CV4010, CV850	2nd AF amp	6AK5, EF95
V22	CV4010, CV850	1st squelch amp	6AK5, EF95
V23	CV469	rectifier	EA76
V24	CV4010, CV850	squelch amp/switch	6AK5, EF95
V25	CV4010, CV850	intercom amp	6AK5, EF95
V26	CV4010, CV850	intercom amp	6AK5, EF95
V27	CV4015, CV131	mike amp	6065, EF92
V28	CV4010, CV850	AMC amp	6AK5, EF95
V29	CV469	AMC rectifier	EA76
V30	CV4010, CV850	mike amp	6AK5, EF95
V31	CV2209	1st local oscillator	
V32	CV449	voltage stabiliser	85A2
Power Supply Unit			
V1	CV469	time delay diode	EA76
V2	CV469	time delay diode	EA76

### PRINCIPLE OF OPERATION

**Receive:** RF signals are tuned by the RF control and amplified by V1 and fed to the 1st mixer V2. The first local oscillator V31, operates at 6MHz above the signal frequency and is tuned by the CHANNEL tuning control. There is one IF amp V9 at 6MHz — then the signal goes to the 2nd mixer V13a with a crystal oscillator V13b at 8.4 MHz. This is followed by two IF stages at 2.4 MHz V14 and V15 and then into two limiters V16 and V17 which drive the narrow discriminator containing diodes V18 and V19. AF is fed through two AF amps V20 and V21. Noise from the discriminator is amplified in V22, rectified by V23, and used to switch the squelch relay via V24.

**Transmit:** The master oscillator V6 feeds V7 a driver and thence to the power amp V8 which can be tuned over the frequency range. The Master Oscillator V6 is modulated by the reactor driver V5. V32 maintains voltage to V5 constant to prevent frequency variation. Automatic Frequency Control, AFC, is derived from the limiter V10 and wideband discriminator with diodes V11 and V12.

AF from the microphone goes through two amp stages V27 and V30. Automatic Modulation Control AMC is provided by V28 and V29 to maintain the AF output constant. This AF plus a DC voltage from the AFC circuit frequency modulates V5 but limits deviation to  $\pm 15$  kHz.

There is a fan to circulate air and prevent hot spots in the set.

**intercom:** This comprises two AF amp stages V25 and V26 switched via the harness to provide talk/listen capability within the vehicle.

**Calibrator:** Oscillator/harmonic generator V3 with a 100 kHz crystal is switched in at the CHANNEL ADJ position. In the CURSOR ADJ position V4 with a 1 MHz crystal is operative.

**Power Supply:** The PSU which is common to both the C42 and C45 is a separate unit that connects to the set via a short harness. It provides the necessary voltages and switching for the set and intercom and has overload protection.

Voltages required in the set are:  
HT1 — + 175 VDC at about 150 mA for low power output  
HT2 — + 350 VDC at about 140 mA for high power output

Filaments — 6.3 VAC at about 1.7 amps — receiver  
Filaments — 6.3 VAC at about 1.0 amps — transmitter

### SPECIFICATIONS

**Power Requirements:**  
24V DC at 8 amps Tx, 3.7 amps Rx

**Frequency coverage:**  
C42 — 1 band 36 to 60 MHz  
C45 — 1 band 23 to 38 MHz

**Mode of Operation:**  
Transmission and reception of FM

**Transmitter:**  
power output —  
low — 0.3-1.0 watts  
high — 15 watts approx.

**Deviation — Maximum  $\pm 15$  kHz**

Microphone — 600 ohms

**Receiver:**  
sensitivity — 1.25 microvolts for 10 dB quieting  
Antenna — 75 ohm via co-axial plug

**IF Frequency —**  
1st IF — 6 MHz  
2nd IF — 2.4 MHz

**Dial Calibration — 100 kHz per division**  
**AF Output — 150 MW into 50 ohms**

**Weight —**  
Approx 20 kg  
plus Approx 16 kg for PSU

**Intercom Amp:**  
Output — 250 MW into 30 ohm

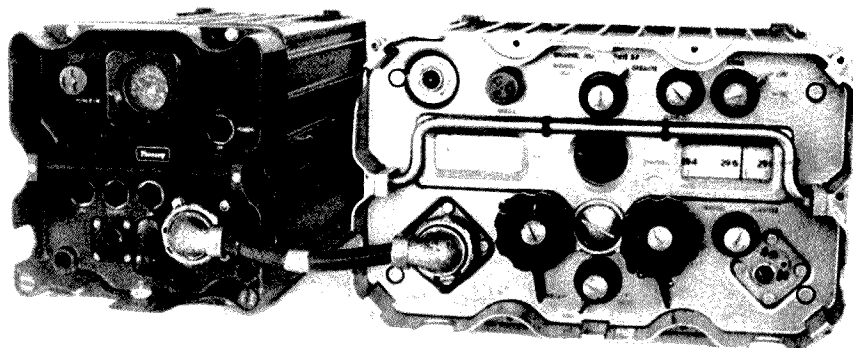

Filaments — 12 VAC at about 0.6 amps — transmit PA  
 Filaments — 6.3 VAC at about 0.5 amps — intercom  
 Filaments — 6.3 VAC balanced to earth 0.8 A — AMC unit  
 Fan & Relays — + 24 VDC at about 0.4 amps  
 Lamps — 12 VAC at about 0.2 amps  
 Diode heaters — + 12.5 VDC at about 0.1 amps

**FRONT PANEL POWER INTER-CONNECTION PLUG PL1**

The pin connections are:  
 A — + 350 VDC HT2 high power  
 B — + 175 VDC HT1 low power  
 C — Voltage control Relay — connect to earth if less than 30V  
 D — + 24 VDC — fan and relays  
 E — Push to talk PTT line  
 F — 6.3 VAC — receiver filaments  
 G — + 24 VDC switched (used with homing loop — not described)  
 H — earth  
 J — + 12.5 VDC — wide discriminator diode heaters  
 K — No connection  
 L — 6.3 VAC — receiver filaments (common to F)  
 M — 12 VAC — transmitter PA filaments

N — earth — common to H  
 O — No connection  
 P — No connection  
 Q — 6.3 VAC — receiver filaments (common to F)  
 R — 12 VAC — lamps  
 S — earth common to H  
 T — No connection  
 U — No connection  
 V — 6.3 VAC — receiver filaments (common to F)  
 W — 6.3 VAC — intercom filaments  
 X — 6.3 VAC — AMC filaments  
 Y — 6.3 VAC — AMC filaments  
 Z — 6.3 VAC — Transmitter filaments

**FRONT PANEL CONTROL INTER-CONNECTION SOCKET SK2**

A — Tx microphone input  
 B — Intercom and Tx microphone (shield)  
 C — Intercom microphone input  
 D — PTT switch line  
 E — Automatic re-broadcast (not described)  
 F — + 24 VDC output (part of homing loop circuit — not described)  
 G — intercom and receiver speaker output (shield)  
 H — limiter grid current (for an S-meter)  
 J — intercom speaker output

K — Voltage Control relay line — connected to PL1 pin C.  
 L — + 175 VDC output for rebroadcast  
 M — receiver speaker output

**MODIFICATIONS**

- To operate the set make the following connections:  
 Microphone to pins A and B (shield)  
 PTT switch to pin D  
 PTT return to earth  
 S-meter to pin H  
 S-meter return to earth  
 Speaker to pins G and M
- The PSU provides a suitable box for a 240V power supply. Although there are a number of outputs shown there can be obtained from a fairly common although large valve type transformer with a 350V secondary plus 12V and 6.3V. The 24V for the relays may have to come from a separate transformer.
- There is a little more space on and behind the front panel so sockets for mic, speaker and S-meter can be fitted to the panel. This leaves the space at SK2 socket for fitting an audio volume control. A 1 meg-ohm pot is wired with shielded wire to replace RV1 on the AF sub-unit. Para 3A To connect the centre zero tuning meter in line for Rx and Tx connect contact 4 to contacts 1 and 2 on switch bank SWA1 (the calibration switch). If your transmit frequency does not match the receive frequency adjust trimmer capacitor C49.
- The C42 is very suitable as it is for the 6 metre band and has been used recently in two cases I know of for contacts with Japan. The C45 can be used on 10m FM provided you narrow the deviation to  $\pm 3$  kHz by adjusting RV3 on the AMC unit. Ideally this should be done using a deviation meter but can be achieved by listening to a voice signal from the C45 on a SSB receiver and adjusting RV3 to a point just prior to the signal distorting. The IFs can be adjusted to narrow the response band.
- It should be possible to obtain the 100 kHz transmit shift to suit the FM repeaters by switching capacitance across L10 in the circuit of V6 the Master Oscillator. You may also have to add capacitance across the tuned circuits of L12 and L15 in the V8 circuit. Perhaps varicaps would be the best method of obtaining these capacitances. AR

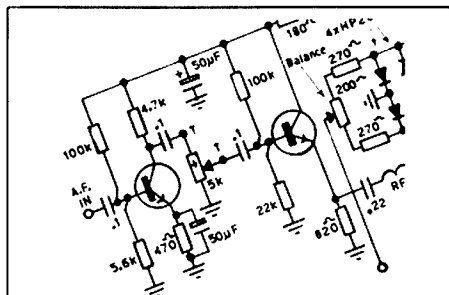

**CIRCUITS**

The Circuits of the equipment in this series of articles are held in the Federal Office.

Photocopies may be obtained by writing to the Secretary WIA at PO Box 300 South Caulfield 3162. To defray the costs of this service a suitable donation would be appreciated.

**Remember Photo Competition**

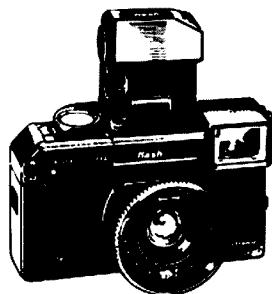

The AGFA Competition begins this month. Check May AR, page 6, for details.



**HELP PREVENT PIRATES**

Keep bands for licensed amateurs.

DO NOT sell transmitting equipment to unlicensed operators.



# EQUIPMENT REVIEW

Ron Fisher VK3OM  
3 Fairview Avenue, Glen Waverley, Vic 3150

## THE KENWOOD TR-7950 TWO METRE FM TRANSCEIVER

The first two metre FM transceiver reviewed in 'Amateur Radio' was the Kenwood TR-7200 back in September 1975. I was so impressed with that transceiver that I bought one and it is still in current use as a mobile rig. I might also mention that it has given no trouble of any kind over the years. Whether or not I replace the old 7200 with this new TR-7950 remains to be seen but I am even more impressed with the performance and general capability of the new Kenwood than I was at the time with the old one.

### THE TR-7950 DESIGN FEATURES

With a forty five watt output capability, the 7950 is somewhat larger than other current model FM mobile transceivers. It is however both lighter and more compact than the old original TR-7200 mentioned above. Overall measurements are 175 mm wide, 64 mm high and 220 mm deep. Weight is 1.8 kg. Output power is selectable for either 45 or 5 watts. But perhaps the most interesting part is the method of frequency selection and memory storage. Where in the past, most synthesised two metre transceivers used a tuning system with perhaps five or ten kHz steps and then a memory capability to back this up, the 7950 is perhaps the reverse of this. What appears to be the main tuning knob is, in fact, the memory selector with these frequencies being initially set up using the keyboard. If a frequency other than one chosen for memory operation is required then this can also be selected with the keyboard. In addition to this there are comprehensive scanning facilities for both the memories and general band scanning.

The twenty one memories can be programmed for either duplex with plus 600 kHz, duplex minus 600 kHz or for simplex operation. Once this has been initially selected and entered into the memory it is not necessary to select the repeater offset or simplex operation. Regardless of the offset chosen for repeater operation, a front panel button will give reverse repeater operation.

The frequency read out and memory channel indicator is a large and brightly illuminated liquid crystal display which is highly readable under all external lighting conditions. This same readout also shows if a + or - repeater offset is in operation or if simplex or scan modes have been chosen. While not applicable to Australia as yet, the keyboard will also act as a dialer for auto patch (telephone dialling through a suitable repeater). As each function is entered into the keyboard, a beeper indicates that the

processor has actually received the command.

When the 7950 is in operation, the front panel appearance is most impressive. The LCD readout is rear illuminated with a soft green glow. There is a LED strip indicator for receiver S meter and transmitter power output, with LED indicators for reverse operation, priority channel operation and centre tuning. The key board is illuminated from above with a green strip light and the memory selector knob has a green illuminated surround when the memory facility is in operation.

Once a memory has been entered, it is there on a permanent basis. The micro-processor is powered from a lithium battery

for which Kenwood claim a five-year life. This means that should the power supply be turned off as would normally happen with home station use, all memories are retained and the frequency last in use will reappear when switched on again.

The TR-7950 is supplied with an excellent mobile mounting bracket and a hand held microphone with up/down scan buttons incorporated.

One thing that is required if you intend to operate from home, is a good ten amp power supply. Current drain with 45 watts output is rated at 9.5 amps and, as we shall later see, is in fact a little higher than this. A matching power supply is available from Kenwood, the KPS-12 which has a rating of





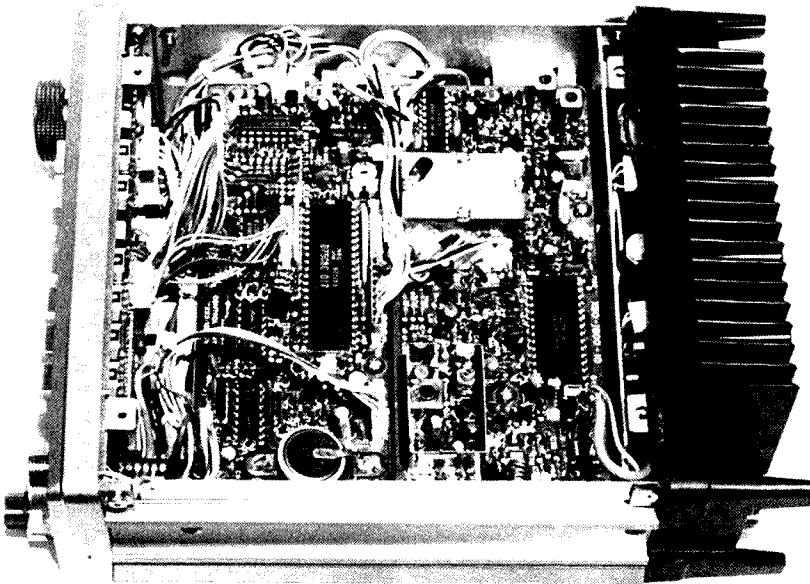

Underside View

10 amps continuous and 12 amps peak output. The Kenwood PS-30 is also very suitable.

#### THE TR-7950 TECHNICAL DESCRIPTION

Unfortunately, apart from the circuit diagram, no description of circuit operation is included in the instruction manual. However it would appear that the circuit is fairly conventional with a double conversion set up using 455 kHz and 10.695 MHz. High SWR protection is provided for the transmitter final transistors, and the output power is gradually reduced as the SWR increases. Frequency selection, memory control and all the other ingenious functions are controlled by a four bit micro-processor which in turn controls the PLL circuitry of the transceiver. Kenwood claim superior performance resulting from "The most advanced KENWOOD engineering technology". As we shall later see, they have a point.

#### THE TR-7950 ON THE AIR

As mentioned earlier a good solid power supply is needed to power the 7950. If you already have a fully solid state HF transceiver, then you possibly have a suitable power supply to share between the two. Otherwise you should have a supply capable of delivering 13.8 volts at 10 amps or more with good regulation. For receive only, current drain is about 600 to 700 mA. The receiver volume and squelch controls are concentrically mounted on the left hand side of the front panel. The power on/off switch is combined with the volume. My old 7200 had a push on/push off power switch which was most convenient. One could leave the audio output level set. The new Kenwood has reverted to the old style rotary on/off/volume setup. Not so good.

The first thing to do with the transceiver operating is to programme the memories.

They are set up on the keyboard and then entered by selecting the required memory channel and then simply pushing the 'M' button. It should be noted that while there are twenty one memory channels, four of these are paired to use for non standard repeater offsets. In practice this means that for simplex operation, the same frequency has to be entered into each of the two channels or four repeater use, the input frequency is entered into one channel and the output into the other. In other words there are only nineteen usable memory channels.

One of the nice features of many of the

new FM transceivers is the priority channel alert. With the TR-7950 any one of the memory channels can be selected as the priority channel. The priority is then automatically checked every five seconds and if a signal appears a double 'beep' is emitted from the speaker. It is then only necessary to push the priority 'OPER' button to give immediate operation on the priority channel.

With around 140 watts going into the transceiver (13.8 V at nearly 10 amps) it's not surprising that things get hot. After a two minute over (some people talk even longer) the heat sink at the rear for the final amplifier gets rather hot. I did not use the transceiver mobile but used in a hot car during some of the days we have had in Melbourne over the last few months, you would need to be careful in positioning the transceiver. Sitting it on a vinyl seat, for instance, could be dangerous. As I do not have a suitable signal generator to check actual receiver sensitivity, I always do a side by side comparison with my normal shack two metre transceiver. I have yet to find a transceiver that displays any noticeable improvement in receiving ability — until now. The TR-7950 was able to produce intelligible copy from signals that were not copyable on my transceiver. Noise limiting also appeared to be first rate and well ahead of most. Perhaps the only criticism on the receive side is that the 'S' meter (LED type) is so generous as to be quite useless in giving meaningful reports. So long as the signal was audible the indicator showed S9 or more. It looks pretty, but give me a proper meter any day.

The operation of the scanning system is quite remarkable. One could spend hours just playing with this function alone. You have several choices. A band of frequencies can be scanned, the upper and lower limits

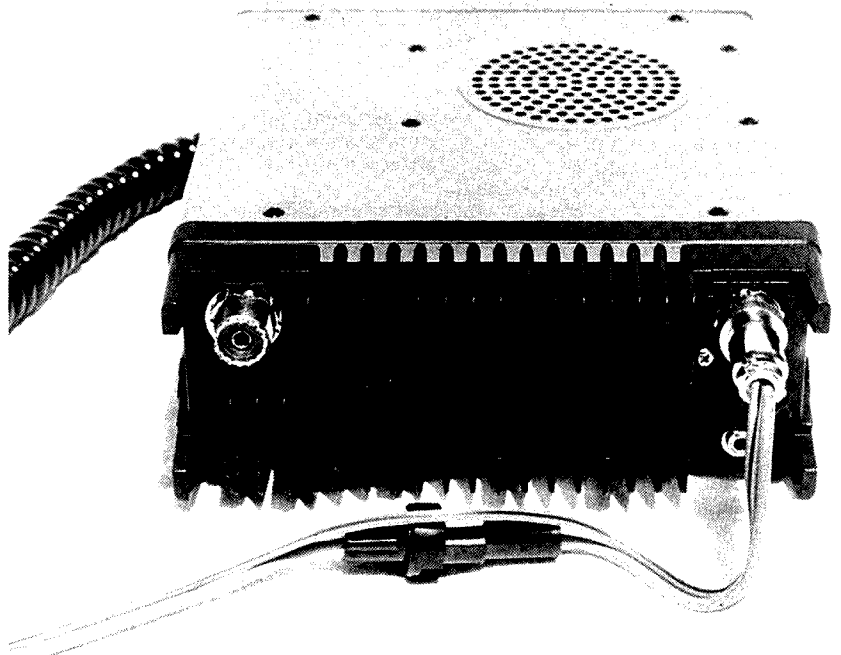

Rear View

can be chosen and entered via the keyboard. When the transceiver senses a busy channel, scanning will stop and hold on that signal for either five seconds or until such time as the channel becomes vacant. Normal pauses between overs will not allow scanning to resume. These two scan methods are selectable with a front panel control. Memories can be scanned in a similar manner but now with the addition of the priority system mentioned earlier.

On air reports of transmitted audio were all satisfactory. I listened to the rig when operated by a friend and found the quality to be clean but with a slight high frequency peak that caused known voices to sound slightly unnatural. As quality is a subjective thing, others may not agree with this.

Received audio quality was rated better than average for home station use, however the top mounted speaker is unsuitable for under dash mobile installation and an external speaker would be an essential mobile operation. Audio output power is rated at two watts and although not actually checked, sounded loud and clear during our subjective tests.

Transmitter power output was checked on our YP-150 dummy load watt meter and

with exactly 13.8 volts applied to the transceiver, 48 watts was measured in the high power setting and the rated 5 watts in the low power position. As reported earlier the current drain with full power output was 10 amps.

Finally a comment on the scanning system. One of the problems with most scanning transceivers is that the scanning tends to stop as soon as a signal opens the squelch. In the case of a strong signal this might be five or ten kilohertz off turn with resulting noise and distortion. Not so with the TR-7950. The scanner will not stop until the discriminator senses centre signal. A nice touch. At this same point the centre tune LED will light.

#### THE TR-7950 INSTRUCTION MANUAL

It seems that as the quality and performance of equipment improves, the instruction manuals that accompany them go in the opposite direction. There are a few notable exceptions to this but unfortunately the Kenwood TR-7950 is not one of them. A total of only sixteen pages plus block and schematic diagrams cover the whole thing. There is not a word of alignment, circuit description and main-

tenance of any time. Having said that, the actual operating instructions are well covered and in general easy to follow.

However, I do believe that a \$500 (approx) transceiver deserves something better than this. How about it Kenwood?

#### CONCLUSION

If you are in the market for an FM only two metre transceiver with better than normal performance on both transmit and receive then the Kenwood TR-7950 must rate top consideration. I guess it's the old story, pay a little more and get a little more. As far as I can see it out performs the opposition by a very noticeable margin. On the other side, it is also larger than most of its opponents and along with the top mounted speaker, could pose some problems mounting it in a car.

General quality of construction is very good and all the controls operate in a smooth and satisfying manner. The Kenwood TR-7950 is highly recommended.

Our review transceiver was supplied by KENWOOD (AUSTRALIA) through their Melbourne agents, Eastern Communications.

AR

## EVALUATION AND ON AIR TEST OF THE KENWOOD TR-7950

CATEGORY	RATING	COMMENTS
APPEARANCE		
Packaging	**	Carton with foam inserts.
Size	***	Relative to output capability, very good.
Weight	****	Only 1.9 kg.
External Finish	***	Good quality paint. No rough edges.
Construction quality	***	Very hard to fault.
FRONT PANEL		
Location of controls	***	Simplified controls well laid out.
Size of knobs	***	All knobs and buttons easy to use.
Labelling	**	Quite satisfactory.
Meter	**	LED type. Colourful but not accurate.
VFO knob	NA	No actual VFO.
Memory knob	****	Large with smooth click stop action.
Keyboard	***	With practice easy to use.
Dial readout		
Digital	****	Very readable under all conditions.
Status indicators	***	On air, priority, reverse and centre tuning.
REAR PANEL	**	Limited facilities easy to get at.
Receiver Operation		
VFO stability	***	
Memories	****	Number and selection best yet.
Sensitivity	****	On comparative test, the best yet found.
Noise rejection	****	High noise rejection.
Squelch action	***	Progressive action.
'S' meter	**	Of limited use. All signals S9.
Signal handling	****	No problems with adjacent channel signals.
Spurious responses	****	None heard.
QUALITY OF RECEIVED AUDIO		
Internal speaker	**	Quality of audio good. But placement poor for mobile operation.
External speaker	NA	External mobile speaker offered as option but not tested.
Headphone output	NA	No provision for headphones.
TRANSMIT OPERATION		
Power output	****	48 watts. Enough for all occasions.
Audio response	***	Clean with slightly peaky HF response.
Metering	***	LED meter gives clear output indication.
Cooling	***	Would need watching while mobile in hot weather.

Rating code: Poor \* Satisfactory \*\* Very Good \*\*\* Excellent \*\*\*\*

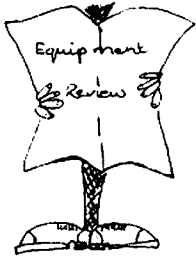

# EQUIPMENT REVIEW

Ron Cook, VK3AFW  
TECHNICAL EDITOR  
7 Dallas Avenue, Oakleigh, Vic. 3166

## THE MOBILE ONE HAMTENNAE — Model M10-1

So you are thinking about going mobile and are wondering about which band and what antenna. Why not try ten metres? You can do everything that can be done on CB, without the QRM. For the antenna the M10-1 made by Mobile One would be hard to beat.

The first impression one has of the Hamtennae M10-1 is of its very sturdy appearance. It certainly looks capable of handling a 1 kW rig, even if your battery can not.

The mobile whip supplied for review was just under 1.5 metres in length (60 inches for all OTs). It has a standard (imperial) 5/16 inch, 24 TPI female threaded base and a helical wound coil covered in a shrink-on plastic tube. The bottom of this coil has a wide pitch with a close wound coil at the top. Whereas most mobile antennae have a tapered fibreglass former this one is of uniform diameter. Fine tuning is done by means of a short length of stainless steel rod fitted at the top.

Thus we have a solid looking compact structure. Because of the forty percent reduction in height (useful for getting under tram wires, etc) some reduction in bandwidth might be expected, as well as a worse match. The helical winding is designed so as to minimise these problems. A fairly heavy gauge of wire is used to keep the efficiency high.

### ON TEST

The M10-1 was mounted on the centre of the roof of a station wagon and the length of the tuning rod reduced three millimetres (1/8 inch) at a time, by the appropriate application of a hacksaw, until resonance was obtained at 28.50 MHz. The VSWR was measured across the range 28 to 29 MHz and the results plotted on a graph (see Figure 1). A smooth curve was fitted to the results to minimise the errors due to SWR bridge inaccuracies, weak eyes, etc. The 1.5:1 VSWR bandwidth would seem to be about 1.5 MHz! Phone only operators may prefer to resonate the whip a little higher. Certainly there is little need to stop the car and readjust the whip for every frequency shift.

Unfortunately band conditions were not very good during the test period although signals from W and JA were available. The M10-1 gave noticeably better signals than a slightly longer bumper-mounted whip, even when the vehicle was aligned to give the most favourable report for the bumper-mount.

Conditions were such that the amount of improvement was difficult to gauge but it

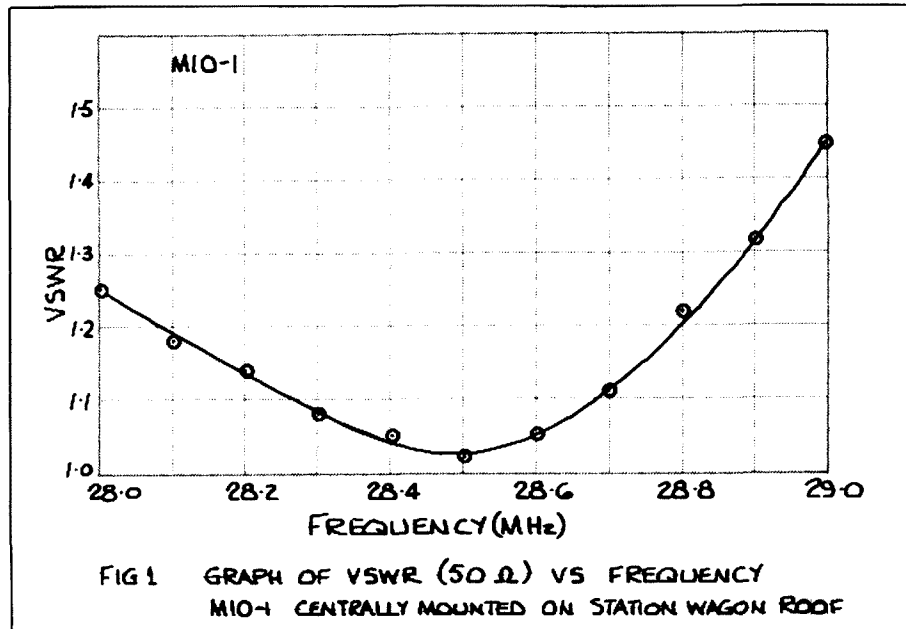

Fig 1 — Graph of VSWR (50 ohms) Vs Frequency. M10-1 centrally mounted on a station wagon roof.

seemed to be around 3 dB. On occasions there was no difference, on others, quite a considerable difference. At no time was the M10-1 inferior.

The VSWR of the other whip was similar at resonance but the VSWR bandwidth was noticeably less. The reference whip has been tested on numerous prior occasions against other verticals, dipoles and beams and has been found to give a good account of itself. Thus it can, with some confidence, be stated that the Hamtennae M10-1 would not be noticeably inferior to a full size quarter-wave whip mounted in the same position.

### OTHER REMARKS

Note that the knurled nut and coupling at the top of the M10-1 allows about ten millimetres variation of the length of the steel whip top thus enabling easy fine tuning of the resonance over perhaps  $\pm 200$  kHz. After cutting the whip top to length, any burrs should be filed off and the edge given a small chamfer.

This whip is not flexible. When the vehicle is in motion it does not bend like junior's fishing rod when it has a nine metre shark on the other end; it remains vertical. In this regard it is similar to other makes which use metal tube construction.

Unfortunately this could lead to problems if you hit a low branch. Either a "knock-down" mount or a bumper mounting could solve this problem. For such a solid antenna, particularly without a "knock-down" mount, a large diameter thread for the mounting may have been preferable. Of course these are personal opinions and it would mean that the convenience of using the standard VHF mount was lost.

### CONCLUSION

The Mobile One Hamtennae M10-1 is a high performance mobile whip. I was sorry to have to hand it back. Now if they would do the same for other frequencies . . . imagine 300 kHz bandwidth on 7 MHz.

73 de VK3AFW  
AR

# FEDERAL CONVENTION — 1983

The 47th Annual WIA Convention was held in Melbourne from the 23rd to 25th of April 1983 at the Brighton Savoy Motel.

Convention guests at a dinner function on Sunday, 24th were members of the DOC Executive, Mr John McKendry, Canberra and Mr Gavin Brain, Regulatory Branch, Melbourne.

Mr McKendry briefly described his area of responsibility within the DOC to the delegate by way of an introduction and then the President, Bruce Bathols, VK3UV, acted as chairman in an informal question and answer session, covering such items as Channel 0, the 50 MHz window, the Broadcasting Council, Cable TV, Subscriber TV and Radio Australis.

Delegates at the convention were from each division — a Federal Councillor and an Alternate Councillor, with VK2, 3 and 5 bringing observers. All members of Executive attended, in addition, Dr David Wardlaw, VK3ADW and Michael Owen, VK3KI were present at various times. Members of Executive Sub-committees and Co-ordinators attended to answer questions relating to their specialised subjects.

During the course of the Convention, a special resolution was passed to amend the Articles of Association of the Institute to enable the size of the Executive to be increased — it was felt that, due to the increasing work load and need for expertise in specialist areas, the Executive should now consist of nine members and the President.

New members of the Executive are Dr David Wardlaw, VK3ADW, who has been attending meetings in his capacities of Immediate Past President and IARU Liaison Officer, Jack O'Shannesy, VK3SP who has been a co-opted member of the Executive for the past twelve months, Alan Foxcroft, VK3AE who is the Executive representative at the Standards Association Committee — SAETE3, Gil Sones, VK3AUI editor of Amateur Radio, Bill Rice, VK3ABP currently chairman of FTAC and CASPAR and a regular attender of Executive meetings.

Members re-elected are Peter Wolfenden, VK3KAU, Courtney Scott, VK3BNG, Ken Seddon, VK3ACS and Earl Russell, VK3BER. The only retiring member of the Executive was Harold Hepburn, VK3AFQ and this is due to business relocation.

The statutory business of the Institute was carried out as required by the Companies (Victoria) Code — ie the adoption of the accounts and Executive reports. These are reported in full at the end of this article. Some twenty one agenda items proposed by the Divisional delegates were debated, plus motions arising from the co-ordinators reports and general business.

The Remembrance Day Contest Trophy was presented to the VK5 Division by the President, Bruce Bathols, commenting that VK5 appeared to have a monopoly on the trophy.

After lunch on Monday 25th, the VK6 Division Federal Councillor Neil Penfold, VK6NE presented a special certificate from the VK6 Division to Dave Shaw VK3DHF/VK0HI for his efforts on the Heard Island Expedition.

Annual Reports by the Federal Co-ordinators were dealt with at length, some Co-ordinators being present to answer queries and accept congratulations on their work over the past twelve months. As in previous years, the IARU Report was discussed with interest by the Federal Councillors and a motion arising was passed for the WIA to strongly support the Region III directors in relation to the restructuring of the IARU.

Of the twenty one agenda motions, the item of greatest interest to all amateurs was the discussion of the Radio Communications Bill '83 and the WIA's submission regarding it. During the long debate several areas of concern were highlighted, such as the use of amateur bands by unlicensed operators, the possession of substandard transmitters/receivers and the powers of radio inspectors. Space does not permit full reporting of this discussion.

A proposal to amend the wording in future Gentleman's agreements from "CW only" to "telegraphy only" was amended after debate to "Narrow Band Modes" by the Federal Council and agreed upon.

The question of World Communications Year '83 and Public Relations was discussed as a result of an agenda item and the Council decided to investigate, through the Executive, the making of a film on amateur radio by a group of experienced film makers, for use in publicising the hobby at all levels.

Overseas membership of the Institute was debated by the Council and there was general agreement on the policy to accept overseas members. The detail of how to achieve was left to the Executive to investigate and report.

Two motions to give significant recognition of the 75th anniversary of the WIA in 1985 and the Australia Day celebrations were both carried after debate.

The need for an International Amateur Licence was debated and the Executive were instructed to continue to pursue this matter further.

## REPORTS

### THE WIRELESS INSTITUTE OF AUSTRALIA A COMPANY LIMITED BY GUARANTEE INCORPORATED IN VICTORIA UNDER THE COMPANIES (VICTORIA) CODE

In accordance with the Companies (Victoria) Code, the Executive state the following:

(a) The names of the Executive in office at the date of this report are:

<i>B R Bathols</i>	<i>VK3UV</i>
<i>P A Wolfenden</i>	<i>VK3KAU</i>
<i>K C Seddon</i>	<i>VK3ACS</i>
<i>C D H Scott</i>	<i>VK3BNG</i>
<i>H L Hepburn</i>	<i>VK3AFQ</i>
<i>E R Russell</i>	<i>VK3BER</i>

(b) The principal activity of the Wireless Institute of Australia is to:

- 1 Represent generally the views of persons connected with amateur radio in the Commonwealth of Australia, its territories and dependencies.
- 2 Promote the co-operation between the Divisions in the encouragement and development of amateur radio.
- 3 Safeguard the interest of the Divisions and the members in relation to frequency allocations rights and privileges.
- 4 Promote the development progress and advancement of amateur radio in all matters in relation to amateur radio in general.

(c) The deficit of income over expenditure for the year ended 31st December 1982 was \$15,297 compared with a surplus of \$16,793 for 1981. There is no provision for income tax required as the company is exempt under Section 103A (2)(c) of the Income Tax Assessment Act.

(d) During the year provisions were decreased:

- 1 Provision for holiday and long service was decreased by \$6518 to \$6366.
- 2 Provision for Superannuation — Decreased by \$9685 to NIL.

(e) The Executive have taken reasonable steps, before the Statement of Income and Expenditure and Balance Sheet were made out, to ascertain that action had been taken in relation to the writing off of bad debts and making of provision for doubtful debts and to cause all known bad debts to be written off and adequate provision to be made for doubtful debts.

(f) At the date of this report the Executive are not aware of any circumstances which would render the amount written off for bad debts or the amount of the provision for doubtful debts, inadequate to any substantial extent.

(g) The Executive before the Statement of Income and Expenditure and Balance Sheet were made out, took reasonable steps to ascertain whether any current assets, other than debtors were unlikely to realise in the ordinary course of business their value as shown in the accounting records of the Institute.

(h) At the date of this report the Executive are not aware of any circumstances which would render the values attributed to current assets in the accounts misleading.

(i) At the date of this report no charges exist on the assets of the Institute which has arisen since the end of the financial year and does not secure the liabilities of any other person.

(j) There does not exist any contingent liability which has arisen since the end of the financial year.

(k) No contingent liability or any other liability has become enforceable within the period of twelve months after the end of the financial year which in the opinion of the Executive will or may

effect the ability of the Institute to meet its obligations when they fall due.

(l) Since the end of the previous financial year the Executive have not received or become entitled to receive a benefit by reason of a contract made by the Institute or a related corporation with the Executive or with firms of which they are members or with companies in which they have substantial financial interests.

(m) The results of the Institute's operations during the financial year were in the opinion of the executive not substantially affected by any item, transaction or event of a material and unusual nature. There has not arisen in the interval between the end of the financial year and the date of the report any item, transaction or event of a material and unusual nature likely in the opinion of the executive, to effect substantially the results of the Institute's operations for the next succeeding financial year.

Dated at Melbourne this 25th day of March, 1983.

**MEMBERS OF THE EXECUTIVE**  
(signed) B R Bathols  
(signed) C D H Scott

**STATEMENT OF INCOME AND EXPENDITURE FOR YEAR**  
**31ST DECEMBER, 1982**

	1982	1981
<b>INCOME</b>		
Members subscriptions	\$151,258	\$133,006
Interest Received	20,873	10,850
Surplus — Magpubs/Book Sales	6,479	15,065
Donation — WARC/Other	115	24
	<u>178,725</u>	<u>158,945</u>
<b>EXPENDITURE</b>		
Amateur Radio — NOTE 1	100,042	61,322
AMSAT		438
Audit Fees 1982	1,000	
1981	300	900
1979/80		300
Award Payments	7	230
Bank Fees	743	240
Bad Debts	622	496
Committee Expenses	1,172	1,092
Convention Expenses	7,515	6,256
Depreciation	975	1,147
Electricity	819	729
EDP Expenses	5,470	4,950
General Expenses	382	426
Insurance	1,053	970
IARU Dues	3,119	821
IARU Donation	500	
IARU Travelling and other expenses	5,039	
Licences and Fees	17	40
Membership Recruiting	137	6,747
Postage and Freight	7,412	5,143
Printing and Stationery	3,681	2,803
Rent and Rates	4,718	3,471
Repairs and Maintenance	809	660
Salaries and Secretarial	45,094	39,194
Superannuation	704	1,000
Telephone	2,196	1,070
Travelling and Sundry Expenses	496	1,707
	<u>194,022</u>	<u>142,152</u>
	(15,297)	16,793
<b>NET SURPLUS (DEFICIT)</b>		
Accumulated Funds Brought Forward	55,927	38,105
Add IARU Fund Brought Forward		1,029
	<u>\$ 40,630</u>	<u>\$ 55,927</u>

**NOTES TO AND FORMING PART OF THE ACCOUNTS**

	1982	1981
<b>NOTE 1:</b>		
<b>AMATEUR RADIO:</b>		
Income		
Advertising	\$ 30,673	\$ 26,454
Subscriptions and Sales	2,610	2,054
Inserts and Sundries	2,303	2,725
	<u>35,586</u>	<u>31,233</u>

<b>EXPENDITURE:</b>		
Awards		255
Debt Collection	73	43
Postage	19,494	13,175
Publishing Costs	95,526	65,391

Salaries	16,146	11,573
Travelling and Sundry Expenses	4,389	2,118
	<u>135,628</u>	<u>92,555</u>
Excess expenditure transferred to General Account representing Cost of AR to Members	\$100,042	\$ 61,322

**NOTE 2:**

<b>RON WILKINSON ACHIEVEMENT AWARD:</b>		
Balance brought forward	\$ 1,383	\$ 1,273
Add Interest	172	160
	<u>1,555</u>	<u>1,433</u>
Less Award Payment	50	50
<b>BALANCE CARRIED FORWARD</b>	<u>\$ 1,505</u>	<u>\$ 1,383</u>

**BALANCE SHEET AS AT 31ST DECEMBER, 1982**

	1982	1981
<b>MEMBERS' FUNDS:</b>		
Accumulated Funds	\$ 40,630	\$ 55,927
Add ITU/WARC	533	533
	<u>41,163</u>	<u>56,460</u>
Special Fund — Ron Wilkinson Achievement Award NOTE 2	1,505	1,383
	<u>\$ 42,668</u>	<u>\$ 57,843</u>

Represented by:

<b>CURRENT ASSETS:</b>		
Cash on Hand	112	41
Commonwealth Trading Bank	(1,150)	14,585
Short Term Deposits	162,536	40,382
Australian Savings Bonds		10,000
Australian Resources Development Bank	5,800	8,000
RESI Building Society		922
Sundry Debtors — Less Provision for Doubtful Debts (\$2,000)	11,832	11,931
Stock on Hand — At Cost	11,217	9,206
Prepayments		626
	<u>190,347</u>	<u>95,693</u>

**NON CURRENT ASSETS:**

Furniture and Fittings — At Cost less Provision for Depreciation	5,531	6,506
	<u>195,878</u>	<u>102,199</u>

**LESS CURRENT LIABILITIES:**

Sundry Creditors	1,000	900
Subscriptions in Advance	142,372	17,415
Provisions — Superannuation		9,685
— Amateur Satellites	2,972	2,972
— Holiday and Long Service Leave	6,366	12,884
Deposit VK4	500	500
	<u>153,210</u>	<u>44,356</u>
	<u>\$ 42,668</u>	<u>\$ 57,843</u>

**AUDITORS' REPORT TO THE MEMBERS OF THE WIRELESS INSTITUTE OF AUSTRALIA.**

1 In our opinion, the accompanying accounts, which have been prepared under the historical cost convention, are properly drawn up in accordance with the provisions of the Companies (Victoria) Code so as to give a true and fair view of:

(a) 1 The results of the Institute for the year ended 31st December 1982 and the state of its affairs at that date.

2 The matters required by Section 269 of that code to be dealt with in the accounts.

(b) The accounting records and other records and registers required by the Code to be kept by the Institute, have been properly kept in accordance with the provisions of that Code.

HEBERD & GUNNING  
CHARTERED ACCOUNTANTS

(signed) P W Hebard  
Partner  
Melbourne  
25th March 1983

**REPORT OF THE EXECUTIVE**

It is with pleasure that I present this Report of the Executive for the year 1982.

**1 OVERVIEW**

1.1 The Institute has made considerable progress during the past twelve months. As a measure of this, I am pleased to report that membership has increased from 8074 to 8570, while the number of DOC amateur licences issued has remained substantially unchanged. More Limited/Novice licences are taking advantage of the "K" (combined) licences and this has some effect on the statistics.

1.2 The results of the "CB boom" have passed and membership increases are now largely due to the concerted efforts of members, and through them the image presented of the WIA.

1.3 Increased membership and the consequent activities associated with improving our organisation — ('Amateur Radio', Government representation, etc) has increased the workload on the Federal office and officers, both paid and volunteers.

**2 HIGHLIGHTS FROM THE YEAR**

2.1 Increased membership during a period of economic downturn.

2.2 Release of WARC 79 amateur bands — our good results being the culmination of many years work by the Institute.

2.3 Preparation and distribution of the Federal Councillors Handbook, incorporating policy statements.

2.4 Increased production standard of 'Amateur Radio' magazine.

2.5 A start made on an organised Public Relations Campaign.

2.6 A position being obtained on a Standard Association Committee dealing with EMC matters.

2.7 Responsive and cordial relationship with the Department of Communications.

2.8 Visit to our 1982 Federal Convention by the President of the NZART, Mr A G Godfrey, ZL1HV, and NZART IARU Liaison Officer, Mr J C Pye, ZL2NN.

2.9 Retirement of Mr Peter Dodd, VK3CIF, as Secretary/Manager.

**3 MEMBERSHIP**

3.1 Membership of the Institute has increased by 6% overall and 7% for licensed amateurs, while DOC licences issued have remained substantially unchanged during the past twelve months.

3.2 In fact DOC licences issued have decreased from 14,750 in 1981 to 14,716 in 1982. According to DOC figures significant decreases of about 10% occurred in both the ACT and Victoria.

3.3 NSW has now overtaken Victoria in having the largest amateur population, although Victoria still has the largest number of WIA members.

3.4 It could be that DOC licence figures are not all up to date, as the reversal in both ACT and Victoria is in opposition to the national trend.

3.5 It remains however, that there has been no apparent net growth in licences for the year. We must be prepared to take some positive action in attracting people to amateur radio or suffer the consequences of increased costs and decreased standing in the years to come.

- 3.6 There is little point being introverted about public relations in this situation. Publicity on broadcasts and in Amateur Radio magazines will achieve little, but obviously some activity must remain if WIA membership is to continue to grow.
- 3.7 Ways and means of finding *new amateurs* are needed and perhaps a concentrated effort on schools and colleges needs consideration. Other avenues require exploration also. Positive ideas are called for.

#### 4 FREQUENCY ALLOCATIONS

- 4.1 Australia was amongst the first countries to release the 30 m band allocation to amateur service on 1st January, 1982.
- 4.2 Less than twelve months later on 16th December, 1982 the Australian Table of Frequency Allocations — the table resulting from WARC79, was released, and from that date Australian amateurs were permitted access to the new bands at 18.068 — 18.168 MHz, 24.890 — 24.990 MHz, and new allocations at 47, 75, 120, 142, 144, 241, and 248 GHz.
- 4.3 Additional spectrum was allocated on an exclusive or shared basis at 1825-1875 kHz, 3794-3800 kHz, 7100-7300 kHz, and 3500-3600 MHz.
- 4.4 1215-1240 MHz was withdrawn from the amateur service worldwide.
- 4.5 The band 50-52 MHz was also allocated to the amateur service but subject to conditions which have not yet been finalised with the DOC. At the time of preparing this Report, it would appear that a further hiatus has been introduced by the broadcasters.
- 4.6 Full details of the new allocations were published in the January and February issues of Amateur Radio magazine together with spot frequencies to be avoided.
- 4.7 Only limited use has been made of the new allocations to date, however, in time, and as other countries make the allocations available to amateurs, these bands will become more popular.
- 4.8 It is worth noting the acknowledgement paid by Mr Ross Ramsay, First Assistant Secretary, DOC, to the Institute for its efforts in the frequency table work.
- 4.9 LET EVERY AMATEUR BE AWARE OF THE SIGNIFICANT WORK DONE BY THE WIA IN THIS MATTER — IT WAS NO SMALL EFFORT!

#### 5 LICENSING

- 5.1 Licence Fees were again increased during the year. Full and limited licences from \$17 to \$18 and novices from \$10 to \$15.
- 5.2 *Sticker Licensing* — of great concern at the time of last year's Convention, now has slipped into "the bottom drawer" where hopefully it will remain!
- 5.3 *Radio Communications Licence Fees Act 1982 and Radio Communications (Miscellaneous Provisions) Act 1982.*
- 5.3.1 On June 8th, 1982 the Institute received a rather formidable letter from DOC requesting urgent consultation on these Acts.
- 5.3.2 Of major concern, was that it appeared the legislation could be used as a taxing vehicle by Government — with significant implications for the amateur service. We understood that factors of spectrum usage,

such as bandwidth, service area, power levels, etc were to play some part in the determination of licence fee levels.

- 5.3.3 Following discussions with senior DOC officers, the Institute submitted:
- (a) That there should be no immediate increase in fees and that future increases should not exceed CPI increases for the previous year;
- (b) That amateur licence fees should be set at no greater level than that which represents a reasonable and proper cost recovery and that operations of cross subsidisation are not relevant to the amateur radio service.
- 5.3.4 Examination fees and credit retentions were also discussed, with the Institute maintaining that examination fees should not inhibit potential candidates and should be fair and reasonable.
- 5.3.5 Novice licence section credits should be retained for a two year period, while candidates for higher licence sections should retain that part of the qualification represented by those sections that have been passed.
- 5.3.6 The Institute rejected the proposal that a fee should be charged for the issuance of a Certificate of Proficiency.
- 5.3.7 To date, most of these aspects have been resolved satisfactorily or are still under consideration and discussion.

#### 6 REPRESENTATION TO THE DEPARTMENT OF COMMUNICATIONS

The following were amongst the matters discussed with DOC central office:

- Australian Table of Frequency Allocations — released.*
- RTTY Identification — Dual Ident not now required.*
- Examination procedures — ongoing.*
- Morse tests at higher speeds — under discussion.*
- AX ITU for Divisional use on 15th World Telecommunications Day, 1983 — agreed.*
- AX Prefix also available for all VK amateurs on 15th World Telecommunications Day, 1983.*
- 50-50.15 MHz — still under discussion.*
- Visitors Special Callsign — under discussion.*
- Licensing Information for Overseas Visitors — now available.*
- Cable TV — possible problems.*
- Callsign retention period — 2 years deceased, 6 months others.*
- Prosecutions reporting — contact with Canberra.*
- Publication of Distress Procedures — In AR Callbook.*
- Possible use of Morse on VHF by K Licensees.*
- Non mandatory log keeping — nearing conclusion.*
- Chess on the Air — under discussion.*
- Reduction in age limits for AOCPL licence (14 years).*
- Departmental Monitoring.*
- Reciprocal Licensing — Japan, Italy, Greece and Denmark.*
- Identification of Examination Candidates — presently not an issue.*
- Emission Designations — not now to be included on licence.*
- WCY83 — National Committee to be established.*

*Sticker licensing — not currently an issue.*

#### 7 PUBLIC RELATIONS/WCY83

- 7.1 Some worthwhile PR was obtained for amateur radio during the past year — some of which filtered through to the general public.
- 7.2 Two major events which obtained national media coverage were the Commonwealth Games Station AX4QCG and the Heard Island Expedition.
- 7.3 The VK5 Division produced an excellent set of PR guidelines for WCY83 which Executive considered encompassed the requirements laid down at last year's Federal Convention. The VK5 document (with their permission) was subsequently endorsed by Executive and circulated to all Divisions for use as a guide in their activities. We wish to again thank Louise and John Badcock of the VK5 Division for their unselfish efforts in the interest of amateur radio.
- 7.4 During the year, John Hill, VK3DKK (AR Advertising), was appointed as interim PR co-ordinator. Considerable time has been devoted to the need and appointment of a Federal Public Relations Co-ordinator. Ideally, we need a retired professional public relations person who is also a knowledgeable amateur and who is prepared to provide services at little or no cost, as do other specialist Federal Officers.
- 7.5 However, such people do not seem to be available, and it is apparent that a truly professional approach would be a very costly exercise.
- 7.6 In the meantime, our "interim" co-ordinator has started at the grass roots level, by publishing a regular column in Amateur Radio magazine, thus informing and guiding individual members. An *informed* membership is perhaps our best "PR package", and a good starting point.
- 7.7 It is also pleasing to note the popularity of the video tape co-ordinator's services, and it is interesting that the ARRL has requested copies of some of our locally produced material. Good work John Ingham!
- 7.8 Most of our tape library contains material which is amateur-oriented, although a tape made for a pre WARC79 CCIR Meeting — "The National Resource of Every Nation", is ideal for general public viewing.
- 7.9 During the year, Federal MPs were forwarded copies of Amateur Radio magazine.
- 7.10 The Institute has been invited to be represented on a National Co-ordinating Committee for WCY83.
- 7.11 All of these activities are over and above "PR-type functions", which occur on a day to day basis in the form of requests for information, handouts of back copies of AR, etc.
- 8 IARU — INTERNATIONAL AFFAIRS
- 8.1 Dr David Wardlaw, VK3ADW, and Michael Owen, VK3KI, continued with their responsibilities in this area during the year.
- 8.2 On the conclusion of the Third Party Traffic Agreement with the USA (9th July, 1982), messages of greetings between the WIA Federal President and the President of the

ARRL were passed via VK3ADW and W1AW.

- 8.3 Other matters involving IARU during the year included:  
IARU Resolution 170 — restructuring.  
New President elected — Richard Baldwin, W1RU.

Region 111 Constitution.  
Gentlemen's Agreements.  
Resolution 640 — Emergency Traffic.

- 8.4 As well as their IARU responsibilities, both David and Michael continued to assist the Executive greatly in CCIR work (David), and legal advice and official submissions to Government Departments (Michael). We owe a continuing debt of gratitude to both.

#### 9 SPECIALIST COMMITTEES

- 9.1 Details of individual committee activities will be found in their Reports, however it is worth noting here a few significant achievements.

- 9.2 In the *Education* area, greater liaison has been maintained with DOC. A grant of \$500 was obtained from the Victorian Government (with the help of the VK3 Division), for use in the preparation of an Instructor's Guide. Thank you Brenda, VK3KT, and helpers.

- 9.3 Major advances have taken place with EMC work. As reported, we now have representation on the Standards Association of Australia Committee, dealing with EMC related subjects. This is a very significant development, and we wish to thank Alan Foxcroft, VK3AE for his interest and dedication. Thanks also go to Dick Huey, VK2AHU, for his interest and help in this matter.

- Cable TV appeared to be well on the way for Australia during 1982. Our EMC Co-ordinator, Tony, VK3QQ, and his team kept Executive well informed of likely developments in this and other important related subjects.

- 9.4 Federal WICEN Co-ordinator, Ron, VK1RH, has continued his high standard in overseeing this activity.

- A quote from Ron's Report written early 1983, is worth repeating here:

*"regrettably complacency has set in in some places and despite liaison by co-ordinators, the disaster control agencies are not always convinced that on the day their available communications will be taxed and inadequate. Sadly it frequently takes a tragedy to re-inforce this viewpoint."*

- Ash Wednesday, a few days later, echoed this view very loudly in both South Australia and Victoria.

- 9.5 In the *Intruder Watch* field, Bill, VK2EBM, is succeeding in reviving interest in a very difficult area. Bill took over from Bob VK4LG, whom we thank for his efforts. Intruder Watch rarely has rapid, spectacular results — but it is an essential "insurance policy" for amateur radio.

- 9.6 Neil, VK6NE, resigned as Australian Manager of the *VK/ZL Contest*. We thank Neil for his efforts over the past twelve years or so. A replacement for Neil has not yet been forthcoming. Any takers?

- 9.7 Chas, VK3ACR, has continued the good example set by Bob, VK3ZBB, in the AMSAT-AUSTRALIA co-ordinator role —

an essential activity if Australian amateurs are to be kept up-to-date with developments.

- 9.8 During the year a liaison team was established in Canberra, so that if need be, Executive could, on short notice, have suitable representation for urgent discussion with Government Departments located there. The services of Jim Lloyd, VK1JL, (previous Executive member), and Ron Henderson, VK1RH, (previous VK1 Federal Councillor and currently Federal WICEN Co-ordinator), were obtained. I am sure that such a facility will prove to be of great benefit to the Institute.

- 9.9 The activities of the Publications Committee, Federal Technical Advisory Committee, the Federal Contest Manager and Federal Awards Manager are obvious and well known to all active amateurs, and need no further elaboration here. To all concerned and other helpers — thank you.

#### 10 EXECUTIVE

- 10.1 The Executive for 1981/82 was elected as follows:

*Peter Wolfenden, VK3KAU, Federal President, Chairman*

*Bruce Bathols, VK3UV, Executive Vice-Chairman, Editor AR*

*Courtney Scott, VK3BNG, Hon Treasurer and Chairman Finance Sub-Committee*

*Harold Hepburn, VK3AFQ*

*Ken Seddon, VK3ACS*

*Earl Russell, VK3BER*

Because of business commitments, Mr Hepburn had to resign as a member of the Executive during the year.

- 10.2 Whilst not members of executive, David Wardlaw, VK3ADW, Michael Owen, VK3KI, Bill Rice, VK3ABP, Jack O'Shannassy, VK3SP, and Mike Thorn, VK3BKK, attended Executive Meetings and were of great assistance during the year.

- 10.3 A number of others also attended Executive Meetings during the year and details are shown in Appendix 2.

- 10.4 Many other people assist in the operation of the Institute; many in specialist capacities sharing the considerable workload with the Executive:

*IARU and Region 3 Liaison Officers — Mr M Owen, VK3KI; Dr D Wardlaw, VK3ADW*

*AMSAT Australia — Mr C Robinson, VK3ACR*

*Federal Intruder Watch Co-ordinator — Mr W Martin, VK2EBM*

*Federal Technical Advisory Committee — Mr W Rice, VK3ABP*

*Federal Education Co-ordinator — Mrs B Edmonds, VK3KT*

*Federal Historical Officer — Mr G M Hull, VK3ZS*

*Federal Contest Manager — Mr R Dwyer, VK1BR*

*VK/ZL Contest Manager — Mr N Pentold, VK6NE*

*Federal QSL Manager — Mr N Pentold, VK6NE*

*Federal Awards Manager — Mr M Bazley, VK6HD*

*Federal EMC Co-ordinator — Mr A Tregale, VK3QQ*

*Federal WICEN Co-ordinator — Mr R Henderson, VK1RH*

*Federal Video Tape Co-ordinator — Mr J Ingham, VK5KG*

*Chairman Federal Finance Sub-Committee — Mr C Scott, VK3BNG*

*Chairman Publications Committee — Mr B Bathols, VK3UV*

- 10.5 There are, of course, many others not listed here who serve the Institute as individuals or as members of the various specialist Committees. On behalf of WIA Members and the Executive, I thank them all.

#### 11 OFFICE AND STAFF

- 11.1 The workload on the office continues to grow with increased Membership and responsibilities.

- 11.2 It is essential that we maintain an efficient central nucleus for the operation of our dispersed Institute which relies so heavily on volunteers spread right across Australia.

- 11.3 Because of membership growth and because individuals are less prepared to volunteer their time these days more and more work is having to be done by paid staff.

- 11.4 During the year, Peter Dodd, VK3CIF, retired after more than ten years service.

Peter served the Institute well during those years, and has seen both it and amateur radio in Australia through their greatest growth periods.

A retirement dinner, attended by over fifty people, was held in Peter's honour.

Mr Reg Macey took over as Secretary/Manager from 28th August, 1982.

- 11.5 I would like to personally thank our hard-working employees and also those contractors who have contributed to the operation of the Institute during the year.

- 11.6 Present staff are:

*Mr R J Macey Secretary/Manager*

*Mr C W Perry\* Membership Records/EDP*

*Mrs A McCurdy\* Secretarial and general duties*

*Mr J Hill\* AR Advertising/interim PR Co-ordinator*

*\* part time*

- 11.7 As this is my final Report as Federal President, I would like to thank all officers of the Institute for their assistance so readily given during my years as President; but help and guidance frequently came from other sources, both amateurs and others outside the amateur ranks.

To all — thank you again.

FEDERAL PRESIDENT (1982)

(signed) P A Wolfenden

Continued page 28



**APPENDIX 1**

Membership statistics. All statistics are to 31st December, 1982 (previous years in brackets). DOC Statistics (as supplied to WIA) refer to licences issued, whereas WIA statistics refer to individual amateurs.

**TABLE 1**

	Total Licences DOC	WIA Licensees	% members to total Licensees	Other WIA members	Total WIA members
VK1	324 (352)	209 (178)	64%	25 (40)	244 (218)
VK2	4478 (4289)	2065 (1988)	46%	175 (210)	2240 (2198)
VK3	4138 (4592)	2063 (1971)	50%	283 (252)	2346 (2223)
VK4	2303 (2137)	1327 (1150)	58%	108 (102)	1435 (1252)
VK5	1789 (1732)	1052 (1002)	59%	135 (134)	1187 (1136)
VK6	1226 (1182)	729 (652)	59%	66 (76)	795 (728)
VK7	478 (466)	298 (278)	62%	25 (41)	323 (319)
TOTALS:	14716 (14750)	7743 (7219)	53% (49%)	817 (855)	8570 (8074)

**TABLE 2**  
Number of Clubs Included In above were 101 (106):

VK1 — 2; VK2 — 27; VK3 — 28; VK4 — 27; VK5 — 10; VK6 — 7; VK7

**TABLE 3**  
Number of WIA members shown as holding two Callsigns — 100 (210):

VK1 — 2; VK2 — 34; VK3 — 34; VK4 — 10; VK5 — 6; VK6 — 13; VK7 — 1

**TABLE 4**  
Percentage Increases/decreases (31-12-82 compared with 31-12-81):

	DOC Licences %	WIA Licensees %	Total WIA members %
VK1	- 9	+15	+11
VK2	+ 4	+ 4	+ 2
VK3	-11	+ 4	+ 5
VK4	+ 7	+13	+13
VK5	+ 3	+ 5	+ 4
VK6	+ 4	+11	+ 8
VK7	+ 3	+ 7	+ 1
TOTALS:	0	+ 7	+ 6

**TABLE 5**  
DOC Licences by Grade — 31-12-81 to 31-12-82:

	Full	Limited	Novice	Combined	Totals	%
VK1	172 (201)	64 (73)	68 (69)	20 (9)	324 (352)	- 9
VK2	2411 (2296)	794 (808)	1036 (1030)	237 (155)	4478 (4289)	+ 4
VK3	2098 (2079)	930 (1257)	879 (1095)	231 (161)	4138 (4592)	-11
VK4	1165 (1098)	319 (301)	618 (589)	181 (149)	2283 (2137)	+ 7
VK5	996 (927)	276 (276)	397 (435)	120 (94)	1789 (1732)	+ 3
VK6	751 (674)	178 (196)	229 (265)	68 (47)	1226 (1182)	+ 4
VK7	272 (258)	99 (99)	78 (83)	29 (26)	478 (466)	+ 3
TOTALS:	7865 (7533)	2660 (3010)	3305 (3566)	886 (641)	14716 (14750)	0

**TABLE 6**  
WIA Members by Grade:

	F/c	A/T	S	G	L	X	Clubs	Total
VK1	196	26	7	3	3	8	2	244
VK2	1774	150	31	225	9	24	27	2240
VK3	1709	224	56	226	19	84	28	2346
VK4	1140	85	3	111	7	62	27	1435
VK5	911	114	20	106	7	19	10	1187
VK6	645	55	15	45	6	22	7	795
VK7	263	21	4	25	4	6	-	323
TOTALS:	6738	675	136	741	55	225	101	8571

**APPENDIX 2**  
Attendance at Executive Meetings from 22nd April, 1982 to 14th April, 1983 inclusive.

	Attended	Maximum
Mr B Bathols	17	18
Mr P Wollenden	17	18
Mr H Hepburn	9	18
Mr C Scott	16	18
Mr K Seddon	16	18
Mr E Russell	15	18

Also attended: Mr R J Macey 11, Mr P B Dodd 7, Dr D Wardlaw 15, Mr W Rice 13, Mr J O'Shannassy 12, Mr W Roper 9, Mr J Hill 5, Mr M Thorne 3, Mr J Linton 1, Mr R Fisher 1, Mrs B Edmonds 1, Mr M Owen 1, Mr K McLachlan 1.  
Four Special Meetings were held during the year.

If members require any further details on particular points it is suggested that they contact their Federal Councillor for clarification.

AR



**PUBLIC RELATIONS**

John J A Hill VK3WZ

Well, with half the year of 1983 behind us, we'd better get some real action during the second half and I am pleased to see that divisions and clubs are getting their act together for some promotion or another during this period.

Here are some details.

The "Eastern and Mountain District Radio Club" is holding a special event on 3rd September, called "Communication EXPO '83" in the form of a Hamfest and display of communication equipment at the Nunawading Civic Centre, Whitehorse Road, Nunawading.

There will be a working station using the callsign VK3WCY specially allocated for the occasion. This callsign will be activated on all bands with EMDRC members on a roster system during the four weeks leading up to the EXPO on 3rd September.

The Victorian Division of the WIA has decided to declare the week from 28th August to 4th September — "WCY '83 Activity Week".

The VK3 President and PR Officer Jim Linton, VK3PC said that all zones and affiliated clubs had been asked to consider their own WCY activity during this period. He would assist zones and clubs with advice and hopes that individuals in the organisations would co-ordinate their activities.

I would like to make a few suggestions which could assist to make these operations a success: How about ALL divisions and clubs join the fun during that week.

Let us demonstrate at schools and shopping centres, (not with placards, songs or slogans), but with our HF equipment, and also RTTY, VHF and UHF equipment.

I would have liked to pass on some information from the Australian WCY Bulletin, but since the April issue arrived at this desk three days ago, some interesting items are too late for the AR July issue.

However here are some items:

- Aussat Pty Ltd has contracted to buy twenty one earth stations with 2.4 to 2.5 metre dish antennas to carry out technical trials for the telecommunications role of Australia's satellites. The earth stations will also be demonstrated on-site to potential users who will need modern two way voice and data links. These include mining companies, police and education authorities.
- 11-12 July — Organisational Communication Seminar, organised by Warrnambool Institute of Advanced Education. Venue: Windsor Hotel, Melbourne.
- 13-15 July — Communications and Government Seminar, Canberra College of Advanced Education.
- Register your activity for WCY.

Private or public sector organisations planning an event to mark WCY or wishing to associate an event with WCY can apply to list it as an official WCY activity by contacting Mr Allan Guster, The National Correspondent, WCY Department of Communications, PO Box 34, Belconnen ACT 2616.

73, John AR

**EMC**  
(Electro Magnetic Compatibility)

**If radio frequency interference is causing you a problem you are reminded that — "Advice on all types and aspects of interference (PLI, TVI, AFI, etc.) is available from the National EMC Advisory Service".**

**FORWARD DETAILS TO**  
**VK3QQ,**  
**Federal EMC Co-ordinator, QTHR.**



## COUNCIL PROBLEMS? THE ANSWER TO LIMITED SPACE

EFFICIENT ANTENNA FOR LIMITED SPACE

Both models C/4 & HQ1 cover 6-10-15 and 20 m.

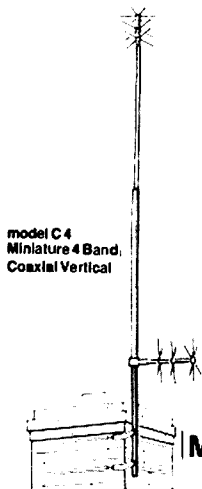

model C/4  
Miniature 4 Band  
Coaxial Vertical

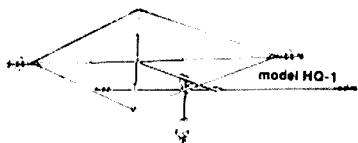

(Flats — Small Backyards —  
Caravans — Portable Ops.)

HQ1 — 1350 mm Boom  
3350 mm Elements  
Gain — 5.65 dB gain (Ref Dipole)  
NO GROUND RADIALS NEEDED  
Lightweight yet rugged  
3350 mm long

MIKE KILPATRICK  
VK2DJP

# WATCHMAN ELECTRONICS

28 Elouera Cres, Woodbine, NSW 2560  
Phone (046)26 6101

# NOVICE COURSE

## \* THEORY BOOK

- # covers entire theory for exams
  - # simple-to-follow text
  - # copious diagrams
  - # includes questions on each chapter
- \$7.50 incl. postage

## \* MORSE CODE TAPES

- # 5 word/min. Novice Tape
  - # 8/10/15 Word/min.
  - # 10 WPM exams
  - # 15 WPM practice
- all tapes \$5.00

Available from: G Scott, 11 Balmoral Cres.  
Surrey Hills 3127 Vic.

Or: A. Bruce Smith, 110 Rosemead Rd.  
Hornsby, NSW 2077.

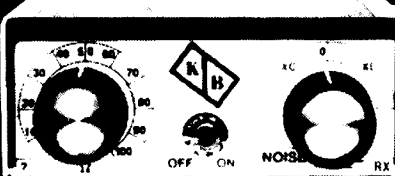

## NOISE BRIDGE

\$60 POST  
PAID

Adjust your antenna for maximum performance. Measure resonant frequency, radiation resistance and reactance. Better than an SWR meter. Operates over 100 MHz. Most useful test unit in your shack.

## ANTENNA BALUNS

3 to 30 MHz.  
Maximum Power 300 Watts.  
Centre support.  
Ideal for Dipoles, Beams, Quads.  
S0239 connector.

\$26



## POWER LINE

FILTER \$14

240 Volt @ 10 Amp



1000's of Transistors — Ferrites — Hobby  
Kits — Tag Strips — Switches etc. Send  
stamped addressed envelope for full list.

## BUTTERNUT ELECTRONICS CO.

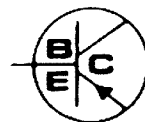

### Still More Usable Antenna For Your Money . . . Plus 30 Metres!

Butternut's new model HF6V\* offers more active radiator on more bands than any other vertical of comparable height. DIFFERENTIAL REACTANCE TUNING™ circuitry lets the 26' antenna work on 80/75, 40, 30, 20 and 10 metres and a loss-free linear decoupler gives full quarter wave unloaded performance on 15 metres. It can also be modified for remaining WARC bands.

- \* Completely automatic bandswitching 80 through 10 metres including 30 metres (10.1-10.15 MHz): 160 through 10 metres with optional TBR-160 unit
- \* Retrofit capability for 18 and 24 MHz bands
- \* No lossy traps to rob you of power. The HF6V's three resonator circuits use rugged HV ceramic capacitors and large-diameter self-supporting inductors for unmatched circuit Q and efficiency
- \* Eye-level adjustment for precise resonance in any segment of 80/75 metres, incl. MARS and CAP ranges. No need to lower antenna to QSY between phone and CW bands.
- \* For ground, rooftop, tower installations — no guys required.

Suggested amateur net prices:  
model HF6V (automatic bandswitching 80-10 meters) . . . \$282  
Model TBR-160 (160 metre base resonator) . . . \$66  
(When supplied as part of HF6V) . . . \$66

For complete information concerning the HF6V and other Butternut products, amateur and commercial, contact the sole Australian distributor:

TRAEGER DISTRIBUTORS (NSW) PTY LTD  
PO Box 348, Moree, NSW, 2400.  
Cnr Adelaide & Chester Sts.  
Phone (067) 52 1627

\* Patented device



K. BRUCE SMITH  
110 Rosemead Road  
Hornsby N.S.W. 2077

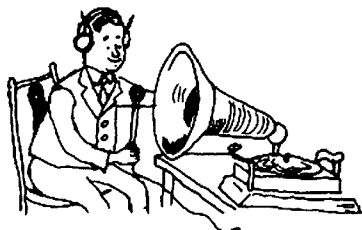

# NOVICE NOTES

Ron Cook VK3AFW  
7 Dallas Avenue, Oakleigh, Vic 3166

This month we will discuss some questions put to me by readers. They all relate to ATUs and the recent article in this column on a junk box ATU.

Firstly the errors and corrections. In Fig. 1 capacitor C4 is the unlabelled capacitor near R1. It has a value of 10 pF. Next C2 should be marked as C3 and C3 should be marked as C2. Please make these corrections to your copy.

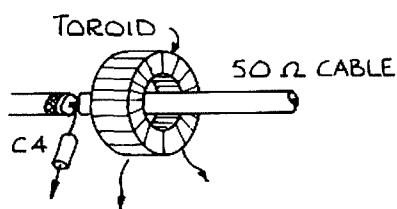

Figure 1 — Improved Arrangement for T1 in VSWR Meter of Junk Box ATU.

The left and right ends of the two separated coax braids are grounded. Another simple but effective construction method is given by Drew VK3XU in March AR page 21.

An improved method of constructing T1 is shown here in Fig 1. The braid is extended through the toroid's core so as to form a Faraday screen. This is an electrostatic screen that prevents stray capacitive coupling occurring between the cable core and the winding on the toroid. Note that this is the method used by Drew Diamond in his excellent article in AR April 1983. ('A sensitive SWR meter').

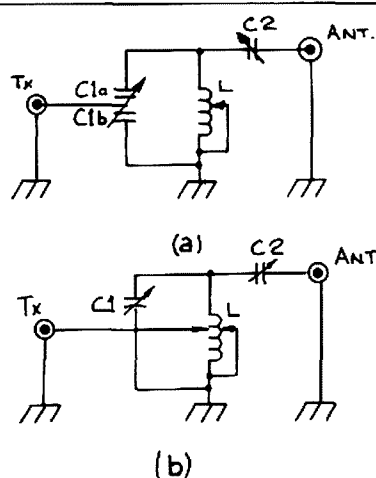

Figure 2 — Ultimate Transmatch.

a. Actual circuit.

b. Equivalent circuit without a differential capacitor.

Referring to Novice Notes for February 1983, the question has been asked as to why a differential capacitor is used in the Universal Transmatch. As stated in the text at the time the purpose of C1 (which has two halves A and B) is to provide a means of tapping the transceiver up the tuned circuit. Fig 2 shows the circuit of the ultimate transmatch and a circuit which is equivalent. Note that one extra control is required for a practical version of the equivalent circuit hence the advantage of the differential capacitor. Note that the common rotor is *not* earthed and the electrically insulated stators (the fixed plates) are connected to each end of the coil. It should also be noted that inductors with two roller contacts capable of independent adjustment would be a little difficult to make! (Think about that one.) For those of you who would like a differential capacitor but can't find one to buy then study Fig 3. I hope that gives an adequate instruction on one possible method of construction.

give good attenuation of harmonics. In some instances where TVI occurs, particularly with the old style AM/CW rigs, a low pass circuit is of benefit. See Figs 4, 5.

No matter what kind of ATU you use you will, from time to time, find an antenna that won't tune satisfactorily on one band. Back in the old days (before 1965) when AM rigs with PI couplers were common, the problem of not being able to load up on one band frequently occurred. It was solved, in most cases, by increasing the length of the transmission line. The same solution will be found to be just as successful with the ATU problem. We all know that a quarter wavelength line can be used to transform a small resistance to a large one. We also know that a half wavelength will not change the impedance if connected between a load and a transceiver. See Figs 6, 7. But what happens for other cable lengths? By using a calculator programme supplied by Evan, VK3ANI, I have been able to calculate the changes of impedance for a 50 ohm line

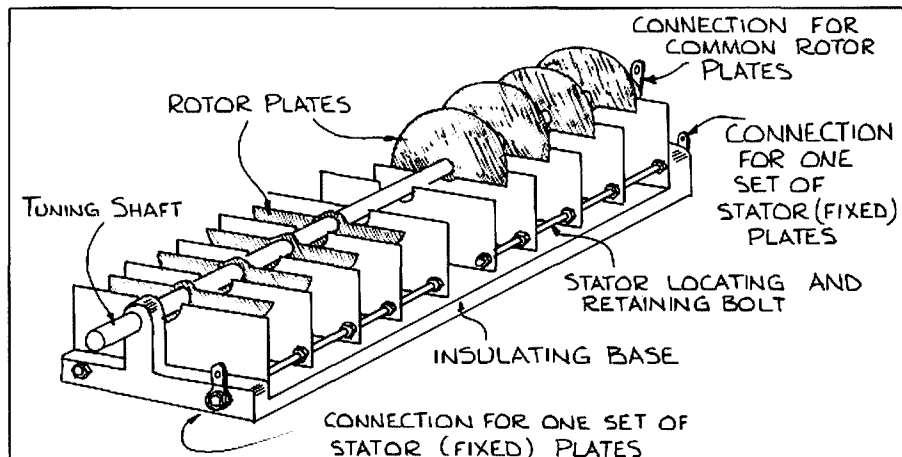

Figure 3 — Construction of a Differential Capacitor.

One form of construction is illustrated here. Two single gang capacitors may be joined to make a differential capacitor. Note that one set of rotor plates are turned 180 degrees with respect to the first set. A practical capacitor would have more plates and be more elegant in construction than the illustration.

Another question concerns the low and high pass characteristics of ATUs. "Will an ATU stop BCI?" I have been asked. The answer is probably not. Any BCI caused by a modern rig is likely to be due to overload caused by the strong signal in the vicinity of your station and not by harmonics. If an ATU has inductance in series with the hot wire and at least one capacitor to ground then that circuit will attenuate harmonics of the signal for which the unit is tuned. If it has an inductor to ground and a capacitor in series with the hot wire then there will not be much attenuation of harmonics. Both PI and L networks

with a 2:1 VSWR. The results are shown in Table 1. I have assumed a 100 ohm load. The line length is given in electrical degrees. 360 degrees equals one wavelength, 180 degrees equals half a wavelength, ninety degrees equals a quarter wavelength etc. The results are given for five degree increments up to thirty degrees and then in thirty degree increments. Negative values of reactance are capacitive reactance and positive values are inductive. The table is done this way to make it independent of frequency.

The mathematically inclined should study Fig 8 as the values in Table 1 are for series

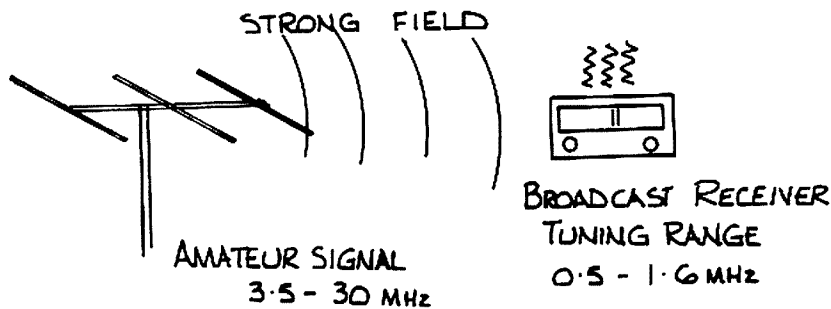

Figure 4 — BCI

BCI is most frequently caused by the strong RF field in the vicinity of a transmitters aerial. Rectification of this signal by audio stages is a common phenomenon. Low pass filters do not help here.

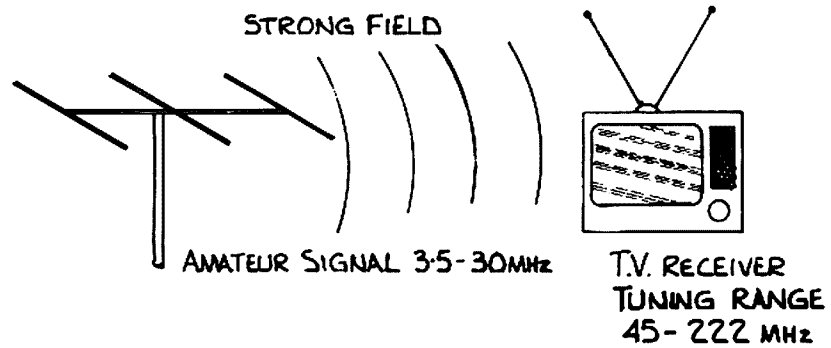

Figure 5 — TVI

Although TVI may be caused by susceptibility to strong fields, harmonics from a transmitter can often cause TVI. A low pass filter installed at the transmitter will help eliminate such TVI.

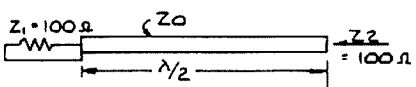

Figure 6 — Quarter Wavelength Line.

A quarter wavelength of 72 ohm cable transforms a 100 ohm resistance to a 52 ohm resistance. Resistances greater than 100 ohms are transformed to values less than 52 ohms.

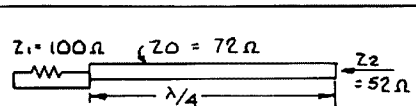

Figure 7 — Half Wavelength Line.

A half wavelength of transmission line of any impedance transfers the same value of impedance at the input to the output.

components. That is for a 100 ohm load or termination connected to a thirty degree long line the impedance seen at the other end of the line is a resistor of 57.1 ohms in series with a capacitor of 37.1 ohms reactance.

Inspection of Table 1 should reveal a periodic (repetitive) variation of impedance values as the line length is increased. In this example the resistance varies between 100

At 21 MHz  
 $X_c = 1/2 \pi f C$   
 $= 75.8 \text{ ohm}$   
 We can say C has a reactance of  $-75.8 \text{ ohms}$ .  
 $X_L = 2 \pi f L$   
 $= 131.9 \text{ ohms}$   
 We can say L has a reactance of  $131.9 \text{ ohms}$ .

Often the symbol  $j$  is used to signify reactive impedance. Thus the circuit shown below can be described at 21 MHz as  $100 - j 75.8 \text{ ohms}$ .

Figure 8 — Reactance Notation.

and twenty five ohms every ninety degrees. The reactance varies from zero through a maximum capacitive reactance of about forty ohms and back to zero for the first ninety degrees. As the line length is increased further the reactive portion again increases to

about forty ohms and back to zero but this time it is inductive. The cycle is repeated every 180 degrees.

This is a result we might have anticipated as we know that adding a half-wavelength line does not change impedances. This also allows us to remove all the exact half-wavelengths (on paper or in our imagination of course) to see what fraction remains. The transformation caused by that fraction is the transformation of the whole line.

For example a line 390 degrees long is equivalent to one only thirty degrees long as far as impedance transformation is concerned. The more knowledgeable reader will be saying that line loss has an effect too. So it does but on HF the effect is reasonably small and will not affect our general conclusions and comments.

So where have we got to? Well if our ATU has problems in tuning a particular load because the load is too high or too low we can now see a solution. That is by adding up to a quarter-wavelength of feeder a more manageable load will be presented to the ATU. In some cases up to a half-wavelength may be required.

One further point to note is that if the VSWR on the line is greater than 2:1 then the range of impedances will be greater than shown in Table 1.

At a later date I will discuss VSWR in more detail and bury a few sacred cows in the process.

73 DE VK3AFW  
AR

## For QSL Cards

Phone  
**(03) 527 7711**

### Williams Printing Service Pty Ltd

12 William Street,  
BALACLAVA 3183

**CONTACT US FOR QUOTES**

OVER 33,000  
CHANNELS

# JIL SX-200



JIL  
REGD™

Monitor thousands of frequencies including those in the AIRBAND and Australian Low Band.

Now available, 32 Memories and auto AM on CB/MARINE and AIRBAND.

NEW RANGE  
OF  
ACCESSORIES  
See over.

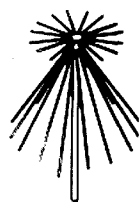
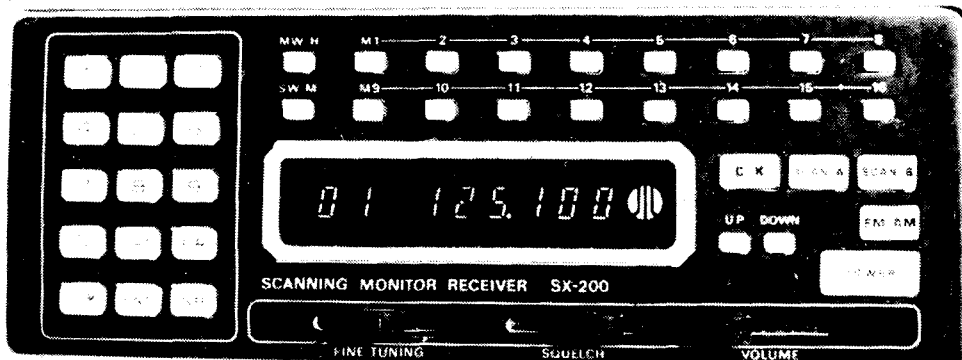

A range of accessories is available including Broadband or High Gain BASE Antennas.

FINE TUNING for coverage of all Australian channels on VHF Low.

## THE ONLY SCANNER THAT GOES 26-88, 108-180 & 380-514 MHz

### SPECIFICATIONS

- **Type:** FM & AM
- **Frequency Range:**
  - a) 26-57.995 MHz Space...5 kHz
  - b) 58-88 MHz Space...12.5 kHz
  - c) 108-180 MHz Space...5 kHz
  - d) 380-514 MHz Space...12.5 kHz
- **Sensitivity:**
  - FM...a) 26-180 MHz 0.4uV S/N 12 dB
  - b) 380-514 MHz 1.0uV S/N 12 dB
  - AM...a) 26-180 MHz 1.0uV S/N 12 dB
  - b) 380-514 MHz 2.0uV S/N 12 dB
- **Selectivity:**
  - FM.....More than 60 dB at -25 kHz
  - AM.....More than 60 dB at -10 kHz
- **Dimensions:** 210 (W) x 75 (H) x 235 (D) mm  
8-1/4 (W) x 3-1/4 (H) x 9-1/8 (D) in.
- **Weight:** 2.8 Kgs.
- **Clock Error:** Within 10 sec./month
- **Memory Channel:** 16 Channels
- **Scan Rate:**
  - Fast .....8 Channels/sec.
  - Slow .....4 Channels/sec.
- **Seek Rate:**
  - Fast .....10 Channels/sec.
  - Slow .....5 Channels/sec.
- **Scan Delay:** 0, 3 or 4 seconds
- **Audio Output:** 2 Watts
- **Ant Impedance:** 50-75 ohms  
Whip or External Antenna with LO/DX Control (20 dB ATT.)
- **Freq. Stability:**
  - 26-180 MHz ... Within 300 Hz
  - 380-514 MHz ... Within 1 kHz

The JIL SX-200 represents the latest STATE-OF-THE-ART technology in the development of Scanning Monitor Receivers. It has many features that previous have not been available on receivers of its type.

For example the tremendous frequency coverage, which encompasses all of the following bands:— HF & UHF CB, 27 & 155MHz MARINE, Australian LOW BAND, AIRCRAFT band, VHF SATELLITE band, 10Mx, 6Mx, 2Mx and 70CMx AMATEUR, VHF HIGH BAND and UHF TWO-WAY band — as well as many others. Other features include detection of AM or FM on all bands. Squelch Circuitry that can be used to LOCK OUT carrier only signals. Fine Tuning control for off channel stations, 240 VAC plus 12VDC operation, Squelch Operated Output that may be used to trigger a tape recorder or channel occupancy counter and accurate Quartz Clock.

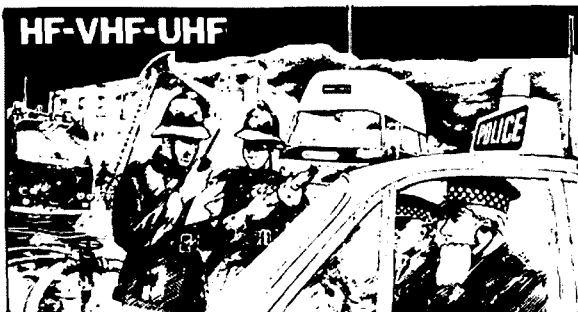

**\$599**

plus \$10  
P & P

### ACCESSORIES

- Service Manual \$12 + \$2 P&P
- Scan-X Base Antenna \$62 + \$10 P&P

# JIL SX-200

# A BETTER SCANNING MONITOR RECEIVER

## HIGH QUALITY AND PERFORMANCE

JIL have designed the SX-200 as a high quality, high performance programmable scanning receiver at a realistic price, design criteria which are not born in many other receivers of its type.

## MECHANICALLY RUGGED

The JIL SX-200 is ruggedly built using EPOXY-GLASS printed circuit board and double sided through hole plating techniques. Easy access and servicability is maintained throughout its design.

## 4 BIT MICROPROCESSOR WITH ONBOARD ROM AND RAM

A powerful 4 Bit PMOS Microprocessor, the uPD553, is used as a controller in the SX-200. Its features include 2000 x 8 ROM and 96 x 4 RAM onboard as well as up to 80 instructions with a 3 level subroutine stack.

## EXTREMELY LOW SPURIOUS COUNT

Even though the SX-200 covers over 33,000 Channels JIL, through careful design, have been able to reduce the number of internally generated spurious signals to an extremely low level. Not the case in most other scanning receivers.

Monitor thousands of frequencies including many Military & Civil  
**HF-VHF-UHF**

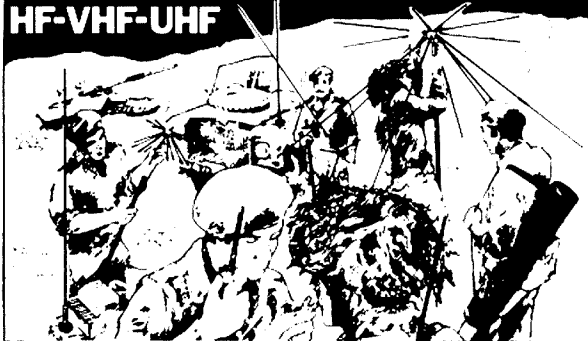

## FULLY TRACKED RF AMPLIFIERS

The SX-200 makes use of 3 separate RF Amplifier Stages. They are divided into 6 bands, each band having its own electronically switched coils which are fully tracked with the receiver frequency using Varicap Diodes. Maximum performance is thus gained over the entire operating range of the set.

Rugged double sided epoxy glass circuit board.

2K Cmos RAM

Crystal and ceramic I.F. filters.

4 Bit Microprocessor.

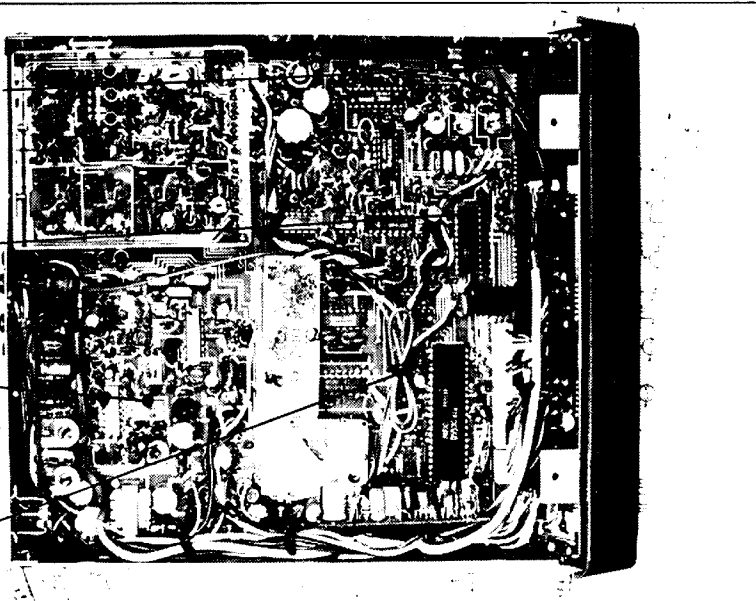

**SX-200, RUGGED CONSTRUCTION AND EASY SERVICABILITY.**

## NEW ACCESSORIES

### ■ EXP-32 KIT

Increase the memories of your SX-200 to 32 with this memory expander kit.  
\$53 + \$2 P & P

### ■ A4-AM KIT

Provides automatic AM operation on the 27 MHz CB MARINE and AIRCRAFT bands.  
\$32 + \$2 P & P

### ■ CVR-1B CONVERTER

allows your SX-200 to cover 180 to 380 MHz (Incl. SPACE SHUTTLE frequencies).  
\$199 + \$5 P & P

### ■ CVR-2 CONVERTER

allows your SX-200 to cover the SHORT WAVE bands, 0.55 to 30 MHz  
\$189 + \$5 P & P

### ■ MFJ-332 VLF CONVERTER

allows your SX-200 to cover 5 KHz to 1600 HKz  
\$144 + \$5 P & P

## AVAILABLE FROM

W.A.: Letco Trading Co. (09) 387 4966, N.S.W.: Emtronics (02) 211 0531, QLD: CW Electronics (07) 397 0808, S.A.: Jensen Intersound (08) 269 4744, Plus many other regional outlets, contact GFS for your nearest stockist.

AUSTRALIAN AGENT & DISTRIBUTOR

# GFS ELECTRONIC IMPORTS

Division of GD & JA WITTER PTY. LTD.

15 McKeon Road, Mitcham, Vic. 3132  
PO Box 97, Mitcham, Vic. 3132  
Telex: AA 38053 GFS  
Phone: (03) 873 3939, 873 2652

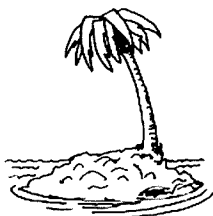

# HOW'S DX

Ken McLachlan VK3AH  
PO Box 39, Mooroolbark, Vic 3138

"DXing ain't what it used to be!" is the cry heard from many of the Old Timers as I read the mail across the 20 metre band when signals can be heard, which isn't very often.

The downward trend of the solar cycle is really beginning to show as propagation is becoming very unpredictable and the chance of reliability in regular scheds is fast diminishing. These are not enhanced with the abundance of solar flares heard of late. Ten metres, except for short path Africa, at odd times is a non event. 15 has been left to our northern neighbours and 20 is filled with barely audible harmonics from my word processor.

The 17th of May, International Telecommunications Day, was somewhat different and your scribe had the privilege of being an operator using the callsign AX3ITU for part of the twenty four hour period that its use was allowed.

A start was made at 0000 UTC by joining the long established VK3UE Net, on 14.150 MHz, for a few friendly exchanges of reports with Clarice and her long standing friends. Then a quick tune over the band, interspersed with a few CQs, brought no bites. A scan of 15 metres didn't look too encouraging so 10 metres was to be IT if there was any activity.

A half hearted CQ on a desolate band brought an abundance of replies, the dogpile had started and lasted for nearly an hour until it came to an abrupt end. Next stop, 15 metres and this proved to be very lucrative with some very strong signals but the majority suffered from very deep troughs of QSB which, at times, made the exchange of reports a little more difficult. This band collapsed or the demand for the special prefix and suffix dried up some three hours later.

This break was utilised to work some local stations that wanted the callsign on other bands then it was back to 15 for a couple of hours with the North Americans for company until 20 opened up to Europe on the long path. The QRM was unreal on this band because of the undisciplined operating techniques used in some European countries and the QSO rate per hour dropped sharply until the end of my stint at 0800 UTC when Bill VK3DXE and Des VK3DES ably carried on working 20 and 80 metres respectively.

Bill mowed through the demand from North America whilst Des kept the Novices happy on 80 metres, relieving Bill about 1400 UTC and going right through the night. Apparently the band collapsed around 2130 UTC and only a handful of contacts were made until ITU day came to an end.

Unfortunately very few JAs were heard and worked as these meticulously adept operators, who enjoy collecting special

event station's cards, did not have a chance, due to conditions that prevailed on the day, to compete in the pasteboard derby. If the band had been open to the north as well the log would have looked a lot healthier in the contacts per hour department.

It was nice to hear Socorra PY1EMF/PY0T at 5 x 9 plus calling CQ, only to be gobbled up by a thousand JAs and then disappear into a quiet band within ninety seconds also to hear A71BJ appear and be 40 dB over the North Americans on 15 metres. Other highlights of my period of operating included working two American QRP stations from the "pile up" that were running two watts into the antenna, a solar powered station running ten watts, a number of mobiles in Europe and one YL on all bands.

I am glad to have had the opportunity to use the once off special call that is worth a "kilowatt" of power and get a little more operating in on the DX bands than the normal. In all 819 stations were worked on 80 through to 10 metres by the three operators and QSLs are 100% via VK3AH either with a SASE or via the Bureau.

## DELAY

All cards for Peter VK0ST at Casey base in the Antarctic will be answered when he returns in early 1984. QSL to VK6AST either direct or via the Bureau.

## NIUE ISLAND

ZL2IK will be on Niue Island for two years. All QSLs to ZL2LF as per the 1983 Call Book or via the Bureau.

## KENYA RTTY ACTIVITY

More activity is promised from this area with the licensing of two new operators. Already there and QRV on all bands is 5Z4DJ whilst 5Z4DP is expected to arrive this month and his equipment in September. Both hope to obtain 5H licences during their stay.

The QSL information for 5Z4DJ is 39 Hamilton Rd, Bridlington, North Humberside, England and for 5Z4DP it should go to 18 Malham Ave, Anlaby Rd, Hull, North Humberside, England.

## NETS

With propagation on the downward trend the only way to increase your country tally may be to become a Net chaser or eavesdropper. Dieter, OE2DYL has made this a little easier for everybody by compiling a list of known nets, their operating frequencies and times.

His publication "DX Nets Around the World" may be obtained by sending six IRCs or equivalent currency value and a self addressed envelope to him at

Bessarabierstrasse 39, A-5020 Salzburg, Austria.

## SP

A recent QSO with a Polish friend suggested that the reissuing of licences is a very slow process and at the end of May only some 500 licences have been reissued. Apparently dipoles and 100 watts seem to be the order of the day.

## CLIPPERTON

Rumours have it that Clipperton will be activated late 1983 or early 1984. This expedition is being organised by the Club d'Océanie Radio et Astronomie who had hoped to get away earlier this year but due to various problems was postponed. The operators are supposed to consist of eight FO8s, six operators from North America and two from Japan.

## HC1JB

If you worked this station around the middle of June, and the callsign rings a "bell" of yesteryear, you were right. The callsign originally belonged to the late Clarence J Moore W9LZX, an engineer at the commercial broadcast station HCJB located in Quito, Ecuador. He was commonly known as the "Voice of the Andes". This gentleman is attributed to having invented the "Quad" in the early 1940s.

This activity was sponsored by HCJB as a contribution to WCY 1983. QSLs direct only to HC1JB, Casilla 691, Quito, Ecuador.

## CLARIFICATION

Please advise all DX friends that the QSL Manager for Chris ZL4OY/C is VK3DWJ-QTH W Johnson, Post Office, Skipton 3361 and NOT VK3DWG who has had his extra share of mail with QSL requests.

## IRCS AGAIN

With the prohibitive price of IRCS, the alternatives, if one wants the card direct, is either by "Green stamps" or American dollar bills or stamps of the country that you are requesting the card from.

At the time of writing, mid May, the exchange rate allows one "greenie" for ninety cents and these are obtainable over the counter from major banks in this country.

Another method is a service which is being run by the DX Stamp Service which allows you to send a card to the DX station with a self addressed stamped envelope with stamps of his own country, an incentive to return a card.

Further details of this service can be found by an SASE or equivalent postage to George Robertson W2AZX, 7661 Roder Parkway, Ontario NY 14519.

**MARKET REEF**

Market Reef OJ0 is expected to be QRV from July 22 to August 1 and operators will include OH0s NA, NC, RJ, G4JVG and PA0GAM.

**TRISTAN da CUNHA**

Mike ZD9BX will be QRV from this area until at least September and will be active on the bands as time from his duties as chaplain permit.

**DUPLICATES**

John Attaway's comment in March 1983 CQ of "Hey, the DX stations don't like duplicates either" was a comment on contests but it aptly applies to DXpeditions.

In this column last month mention was made of the statistics that Hugh VK6FS had extracted from the VK0HI and 0CW logs. This month Hugh has forwarded a considerable amount of impeccably laid out figures that have taken considerable hours of enthusiasm and dedication to produce. These will be summarised due to their complexity.

An overall estimated duplicate percentage on all contacts came out at 21.5% made up of VK0HI/SSB — 16.9%, VK0CW/SSB — 8.4% and VK0CW/CW — 26.26%. The areas that took the cake for duplicates on figures for VK0CW on 14 MHz was W/VE at 28.4%, Europe 26.8% and JA at 25%. VK0HI operating SSB was not as unlucky and had only a maximum 22.8% which occurred from South American operators closely followed by JA and VK operators.

Not many operators succeeded in coming near the record of duplicates set by one VK3 who contacted VK0HI seven times for a report on 14 MHz. Many Europeans, Ws and JAs appeared four, five and six times.

Hugh's comments in a covering note probably should be printed, though my remarks of last month, "No further comment is necessary" still stands.

**FCC PROPOSALS**

The North American operators have spread their wings in the 20 metre band now the FCC is considering proposals for phone band extensions in other bands such as:

BAND	PRESENT ALLOCATION MHz	PROPOSED ALLOCATION MHz
80 metres		
Extra	3.775-4.000	3.750-4.000
Advanced	3.850-4.000	3.775-4.000
General	3.890-3.850	3.850-4.000
15 metres		
Extra	21.250-21.450	21.200-21.450
Advanced	21.270-21.450	21.225-21.450
General	21.350-21.450	21.300-21.450

The proposal is to extend the present band for all HF licences from 28.500 MHz to 28.300 MHz — 29.700 MHz.

**3X YL?**

Al WB8ZJW and his XYL both have positions in the Republic of Guinea and on moving there in the near future hope to

obtain licences. Dieter DL5DAB who has been active using DL5DAB/3X has returned home but hopes to return later in the year and be issued with a 3X suffix.

**QATAR**

Dave G4BXH has been posted to Qatar. Many VKs will remember him as VP8HJ and G4BXH/VE4 however there is little likelihood of anyone hearing him on the amateur bands from this locale. He has been refused a licence in A71 land. Dave believes that no more licences will be issued.

Dave is amazed that both A71AD and A71BJ, who run at least a kilowatt input, do not seem to have a TVI problem particularly as most of the sets in that country have wide band preamplifiers and log-periodic antennas with up to 26 dB gain so that they may be able to copy transmissions from Kuwait and Oman.

**SYRIA**

It is apparent that there are only two active amateurs in this country now. Rasheed YK1AA and Michel YK1AN have an excellent QSL route through Franz DJ9ZB.

**WHAT IS THE CW NET?**

The frequency of 7.025 MHz is the meeting place, each Sunday morning, of a friendly CW operators get-together. Time unknown. Apparently the object of the "get together" is to pair operators off to different frequencies for a friendly QSO. Can any reader please supply me with more details for inclusion in this column?

**WELCOME**

Well known QSL Manager Mary Ann Crider WA3HUP has joined the WIA through the VK3 Division. Welcome Mary Ann on behalf of all VK DXers and it will be nice to see your call amongst the WIA DXCC list in the near future.

It is thought that Mary Ann is the first overseas member to join the Institute and was closely followed by Ken G3NBC. It will be interesting to see how busy Mike VK6HD, the WIA Awards Manager, is going to be if this trend continues.

**DXING YL STYLE**

In this column in May mention was made of Diana G4EZI having in excess of two hundred YL countries confirmed. A request was made to Diana if she would divulge her secrets. This she has done and if you too want to work an abundance of YLs in other countries then read on...

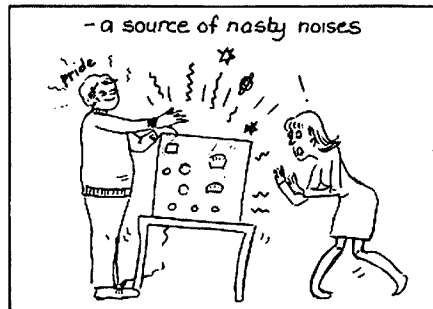

**"FIND THE LADY" or HOW YOU, TOO, CAN GET YLXXC**

Once upon a time, I was a "normal" type of radio-hating XYL. The receiver my OM Richard had, was just a source of nasty noises to me. But when he got his callsign G4DZI and actually started transmitting, I realised what fun it could be, and, like many other XYLs before and since decided I'd like to join in too.

Interest in chasing YLs could be said to have started in even those early days as I poured over my books in preparation for the RAE exam. If Richard was tuning round and I was busy elsewhere and a YL voice was heard, I'd dash in shrieking,



"There's a LADY amateur! Call her — and find out how she did it!", and my poor OM would have to stop his happy tuning and call the lady concerned, and ask how she'd managed to pass the dreaded exam.

With my own callsign finally obtained, I could do my own YL chasing. Richard and I were both collecting countries, in friendly competition with other recently licensed local amateurs. Not very seriously as we only had a vertical antenna and low power in those days. But the idea of collecting YL countries slowly crystallised after a conversation with Mike G3VUH whom I met one day on 80 m and who turned out to have worked all sorts of fascinatingly exotic YLs. He sent me a list of them, which whetted my appetite for the chase, especially as some of them were still around! Hearing that CLARA, the Canadian Ladies Amateur Radio Association offered a certificate for doing it, was all I needed. I decided I'd "specialise" in YL country collecting, and make that my own "thing" in radio. So if you decide to do this too, here's what I had to do, just to give you an idea.

First steps included listing all those I'd already worked. Not too hard a task as my log book was mainly full of G OMs on 80 m in those days, and it was quite easy to pick out the YLs. Gratifying too, to find how many I'd already got, just in the normal course of QSOing.

Getting into the swing of things I soon developed a technique, of working any DXstation I could, and blatantly asking if they knew any licensed YLs. I must have made myself a thorough nuisance at times! If I got a positive response, it was a case of cajoling the station concerned to try and arrange a sked for me. Sometimes it worked, sometimes not. I guess some stations said yes, and agreed a time and frequency to get the YL on, just to get rid of me and work their pile up in peace! But sometimes they did know a licensed YL in their country, and did succeed in getting her on for me. These times gave me the encouragement to continue.

# G4DZI

OPERATING TIME  
 G4EZI  
 G4DZI  
 G4EZI  
 G4EZI  
 G4EZI

XYL: G4EZI

RYLARA — WARO — ALARA — YLRL — CLARA — YLISSB 10088

OM: G4DZI

# G4EZI

YLDXCC YLWAS

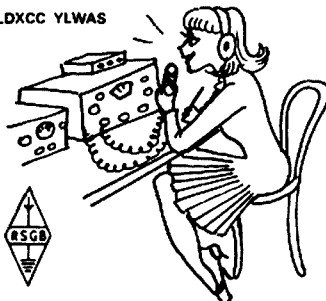

RICHARD HUGHES, 3 PRIMLEY PARK CRESCENT, LEEDS LS17 7HY, ENGLAND

DIANA HUGHES, 3 PRIMLEY PARK CRESCENT, LEEDS LS17 7HY, ENGLAND

### HIS & HERS QSL cards designed by Diane.



Richard G4DZI and Diana G4EZI. On the wall are the hard won and treasured QSLs and awards of Diana's collection.

The callbook was a big help here, because I could look up OMs who had licensed XYLS, and then scour the bands for them. When I found one I was ready to pounce with my question: "Please, please can I work your XYL?"

Alas, sometimes the lady was out shopping, or otherwise unavailable, or, most frustrating of all, just wouldn't come on. I even had to brush up my school days French, because some of the XYLS in the



French colonies couldn't or wouldn't speak English. Still, the thrill of netting another contact overcame my embarrassment over my terrible accent.

Spanish was another "must" to work Central and South American YLs. A local amateur who spoke it fluently coached me in how to make a rubber stamp QSO and how to call CO YL in Spanish. I was very timid about doing this — it didn't work anyway, and I found it much better just to search them out and call them. Again my accent was pretty terrible, but the novelty of finding even a slightly Spanish speaking English station strangely enough often seemed to prove quite an attraction to the South American YLs, who would often chat away to me quite happily, oblivious of the fact that I couldn't really understand a word they were saying!

It was very thrilling to hear a YL I'd maybe been looking for, for months or even years. I could feel my heart pounding with excitement and fright in case she got away after all! I barged in once to an American traffic net in hot pursuit of a Panamanian I'd heard there, shouting "Break! break!" excitedly. I got a real lecture from the net control, on

the correct use of the double break (emergencies only — "But I honestly didn't know that Sir", I pleaded — you see, we don't have third party traffic nets in this country). My lace was red, but at least the YL came off frequency with me and I got my contact!

Swapping information with others on the YLDXCC trail also proved very fruitful. I used to talk from time to time with an OM from 4X who had a really fantastic YLDXCC total. I despaired of ever catching up with him! But at least it was a help in knowing who to look for.

Sometimes too, I found it a distinct advantage being a YL myself. I would sometimes ask for a YL operator on a DXpedition and get her — other enquirers, who happened to be OMs were not so lucky. I felt quite guilty about this — seemed like taking an unfair advantage!

Nowadays, with 205 YL countries worked (204 confirmed — hurry up Kirsti with VK0NL!) I've slowed up a lot and really find myself waiting for DXpeditions or new licensees. Also, I cannot imagine myself ever being so "forward" on the band again,

and badgering people for contacts. I question whether some of it was worth it — hounding some poor, terrified, inactive YL onto the band, just so that I could notch up another contact. Is that really in the spirit of true amateur radio? Still, happily those instances were few. On the whole, I met some marvellous people, made some super contacts and lots of radio friends along the way. And best of all — it was fun!

Diane and Richard share the same equipment which comprises a TS 830S, FL2100 Linear that is fed into a Mosley Mustang about ten metres high. A trap dipole is used for the lower bands.

### THANKS

In compiling this column information from magazines such as RADCOM, QSL MANAGERS LIST, WORLD RADIO, HOW'S DX, DX NEWS SHEET, QRZ DX and DXPRESS were used together with reports from VKs 2SP, 3BY, UX, YJ, YL, 4FB, 6FS, NE and SWL30042. Overseas amateurs who contributed included G3NBC, G4EZI, I8SAT, ON7WW and ZL1AMN. Thanks to one and all.

AR



# QSLs, QTHs, HEARD AND WORKED

## QTHs YOU MAY NEED

151CK Chico Kintantar, 10-12 Avenue, Cubao, Quezon City 3008.  
 5H3TM PO Box 429, Mbeya, Tanzania.  
 7P8BU R Wresch, Maluti Hospital, Mapoteng, Lesotho.  
 A4XX PO Box 981, Muscat, Oman.  
 A4XCB PO Box 18530, Salalah, Oman.  
 A71AD PO Box 4747, Doha, Qatar.  
 A92Z PO Box 26855, Bahrein.  
 BY1PK and BY8AA, PO Box 6101, Beijing, Peoples Republic of China.  
 BY1MCS Sydney ARC, PO Box 1051, Sydney, NS 81P 6J7, Canada.  
 C080C PO Box 118, Holquin, Cuba.  
 CX1BBL PO Box 5063, Montevideo, Uruguay.  
 G4AVW/ST3 PO Box 2632, Khartoum.  
 GD4PTV 13 Threshold, Jurby, Isle of Man.  
 GJ4ICD PO Box 100, Island of Jersey, UK.  
 HC1JB Casilla 691, Quito, Ecuador.  
 HH2RJ PO Box 2411, Port au Prince, Haiti.  
 HZ1FM PO Box 7198, Jeddah, Saudi Arabia.  
 I1QCM/5N8 PO Box 418, Kano, Nigeria.  
 J87BS 3 Chesterfield Hill, London W1.  
 JX5DW Bjorn Dommersnes, N-8103, Jan Mayen, Norway.  
 LU4DLH PO Box 412, Gonnet Zip1897, Argentina.  
 OA4DW PO Box 35, Bristol, VA 24203 USA.  
 SV1NN PO Box 2586, Athens, Greece.  
 VP2KBU PO Box 719, Parker, CO 80134 USA.  
 VS5MK PO Box 2191, Bander Seri Bangawan, Brunei.  
 X02JCG PO Box 212, Chicoutimi, PQ G7H 5B7 Canada.  
 XT2BM PO Box 140, Ouagadougou.  
 YV6ABM PO Box 278, Puerto Ordaz, Venezuela.

## QSL MANAGERS YOU MAY NEED

1ADKM — 11MGM, 3A2EE — F9RM, 3D2CJ — GW3JI, 4K1A-UA1QAV, 4N1R — YU1DZ, 4T5N — OA9K, 5N7HKR — OE5RI, 5T5TO — F6BUM, 5X5BB — DL2BB, 6U0WCY — DF7ZH, 6U1WCY — DF7ZH, 6Y51C — G3XTJ, 7P8CL — SM5G0J,

8P6PC — N2AWM, 9J2B0 — W6ORD, A35EL — OE2DYL, A6XJC — PEOMGM, C53CJ — KB8KS, CX5RV — G5RV, DK0GDA/ZL5 — OE8NOK, DL9ZAX/TT8 — DJ5RT, ED11LT — EA1MC, FP8ZP — F6KNO, FB8ZQ — F6GZB, G4LWN — VE7BIP, GJ4LNW — VE7BIP, GU4LNW — VE7BIP, HC8GI — W3HNC, HG100KZC — HA8UB, HH2CQ — W4MGX, J87LTA — K4LTA, KC60T — JA0CUV/1, KC6SZ — JA6BSM, LA2EX/3X1 — LA2EX, LA8UX/OD5 — LA8UX, OF0BA — OH2BAZ, PA0FRI/OD — PA0FRI, T30CH — W9SLT, T32AF — WH6AIF, T77B — WA3HUP, T77Y — I0MWI, TT8AD — HB9CLA, TV6ICE — F2YT, VE2DVG/YK — E19G, VR6TC — W6HS, YB0ADJ — KA6N, YJ8KG — VK410.

## CW SWLING WITH ERIC L30042

28 MHz  
 KA6WZI/DU2, I5SMX, JA2YDC, JH9G0B, J01ACW, KH2BB, UA1DZ, VK6ZT, W6JW, Y57YG, YB5AES, ZL1BVE.

## 21 MHz

BY1PK (08Z), 0L7AA, DU6HM, F6GUO, F08EW, FK0AD, HH2VP, HL2DAK, IS0FPH, KC6DT, KH6KX, KP4CC, KX6PO, NP4P, OE3ALW, PY2SUT, UJ8JAS, VK9NC, 9H1BB.

## 14 MHz

NOZ0/DU2, EA2AFG, FB8ZQ, FK8EJ, F08FW, GU3EIG, HC2HM, HH2VP, HK1DBO, ISOAGP, JD1ABZ, KP4BN, OF0BA, ON7EX, P29VH, PY6ABZ, SP1ALK, SV5AT, T30CH, T12DL, TV6ICE, UJ8SA0, VK9NC, VU2VYN, XE1YV, Y22T0, YB0AFA, YJ8KG, YV5RE, ZL2BKM/C, 3D2CJ, 457EF.

## 10 MHz

A35MS, DF1BG, EA3ELV, EA8AFB, EI5DR, F61FG/P, FB8ZQ, FC9VN, FK8DZ, G3AAE, HL1EJ, JA1XYB, KH6CD, KP2J, KV4CI, OK1RR, PA3WBB, T32AF, VE5XU, VK8GO, VK8HA.

## 7 MHz

CT2QN, DL6WD, EA3JJ, FK8CL, HA3GK, KP2J,

LZ1KSN, NL7G, OA4CYK, SP2JS, UA1DZ, UA2FU, UB5YBS, VK9NS, N6YK/V2A, XE2MHJ, YB5AES, YC1BKQ, YU2CW, YV4AU, Y03NP, 9Y4VU.

## 3.5 MHz

F30D, HB9BCI, OK1XX, SW2GE/MM, 4K1A, UA10ED, UA3DLN, UA4PMK, UA9MRA, UB5IEP, UY500, Y03CD, YU7NUX, YU2CRU, YU2SDA.

## 1.8 MHz

VK2PS, VK5NM, VK5BC.

## NOTES

Wanted — more VK CW stations on 1.8 MHz (phone seems to be fairly well served, currently).

VK4BKM, with the rather exotic-like QTH of TIN CAN BAY is ex P29EJ, and is currently active on 14 MHz CW.

SW2GE/MM, QTH Mediterranean Sea, has been heard on 3.525 MHz with a very good CW signal at 2100 UTC (in May).

In mid May, Eric L30042 had heard 68 countries on 10 MHz CW.

## SSB WORKED ON THE EAST COAST

### 14 MHz

3D2ER, 4Z4AB, 6W8AR, 7X2FK, 9H1GY, 9H4M, 9Y4NP, AX1WCY, AX2WCY, AX3WCY, C21BD, C53DF, CR1LN, CR10F, CR1TZ, CR4CH, CR9AK, DU1EH, EA1VG, EA6MQ, EA7AH, GM2BMJ, GM3W0J, GW3AX, HA2RP, HB9ARE, HV3SJ, IT9TQH, KC6SZ, KG4DX, KH6APS, KX4R, LX1BI, OH2BH, PA0GAM, SM5IMO, SP6BZ, T32AF, T32AF, TO6HSI, TO9ER, UK5IBB, UT5DK, UV3TE, VK0RC, VK0ST, VK0VK, VK6WCY, V01CW, VP5WJR, VR6TC, XE1GPC, XE2AQ, Y08AHL, ZK1CG, ZK2RS, ZL40Y/C, ZM1BOD, ZM1WCY, ZM2WCY, ZM3WCY, ZM4WCY, ZM5WCY.

### 21 MHz

3B8FG, 4S7ZN, 5H3DM, 5N3RTF, 6Y51C, A4XHG, A71AD, A92P, C21RK, DU1CK, FB8ZQ, J37AH, K5UKL/M, KC0PP, KX6PO, NF4L, P29NSF, S83H, SV2CD, T30DB, TL8CK, UK0FAP, VE7AST, W5TGU, W60AV/M, WD9WQG, Z21A0, Z21BP, Z23JJ, ZK2JS, ZL4PO/C, ZM1AFU, ZS3GB, ZS4CV, ZS4F, ZS5DX, ZS5YG, ZS6WB.

### 28 MHz

AD50, C21RK, FB8ZP, KA6PTS, KX6PO, N6AQL, N7DZW, OZ1IQ, RB5QKS, TG9NT, VS6CT/W6, WL7E, YB3DC, YU2EU, Z210, ZL1AM0/C, ZL2ACS, ZS5DY.

Bill Martin, VK2EBM  
 FEDERAL INTRUDER WATCH  
 CO-ORDINATOR

33 Somerville Road, Hornsby Heights, NSW 2077

Is it necessary to report the activities of an intruder station on more than one occasion? The answer is a definite YES. Ideally, reporting intruder observers should keep a check on any intruders they hear, and take notice if the intruder seems to come up on a regular basis. In other words, it's a bit pointless reporting, say, a carrier heard for five or six minutes, and which may never be heard again. However, if a signal is present daily, weekly, or on any other regular basis, and it becomes apparent that the intruder station is using the amateur band(s) as a matter of course, IN DEFIANCE OF THE INTERNATIONAL TELECOMMUNICATIONS REGULATIONS, then comes the time to start sending in reports on him. Very soon, it forms a pattern as to his operating habits, and we then, by comparing reports from other areas, learn where and when he is operating. It follows then that we can

gradually build up a case for complaint but ONLY if we have sufficient quantities of reports. So send in reports of the same intruder you hear, after you have satisfied yourself that he is working on the amateur bands habitually.

The USSR Naval station, "UMS" on 21.032 MHz is a good example. The completed Observers' Log Sheet, which can be obtained from your Divisional IW Co-ordinator, or direct from the Federal IW Co-ordinator, would look something like Figure 1.

The date and time is self-explanatory, as is the frequency column. 'M' or 'E' simply

means 'measured' or 'estimated'. If you are unsure of radio modes of emission, contact the Federal IW Co-ordinator, who will advise you on this. Bearing is also 'measured' or 'estimated'. 'Details of Traffic' column contains anything you think may be helpful in tracking down the offending station. Any information to assist you in reporting intruders is available from your Divisional Co-ordinator, or from the Federal Co-ordinator. Don't forget, if you send me a C60 blank cassette tape, I will return it with all the modes described. This tape makes interesting listening. See you next month.

## INTRUDER WATCH



DATE	TIME UTC	FREQUENCY IN MHz 'M' or 'E'	CALLSIGN IF HEARD	MODE	RST	BEARING 'M' or 'E' DEGREES	DETAILS OF TRAFFIC AND ANY OTHER INFORMATION
1/4	0600	21.032 M	UMS	F1B	S9	310 M	RTTY — 500 Hz shift, 75 Bauds. Letter Groups.



RTTY Picture courtesy Les White VK5ZW.

# HERE'S RTTY!

Bruce Hannaford VK5XI  
57 Haydown Road, Elizabeth Grove, SA 5112

## CONNECTING UP RTTY GEAR

*A beautiful jig saw puzzle picture is meaningless until the pieces have been correctly put together, likewise excellent RTTY gear is useless until correctly connected up. From letters I have received I note many people who have RTTY gear don't know how to connect it up and to help such people I will show some typical RTTY set ups. The diagrams shown are chosen as the simplest arrangements that will give good results. Other methods are of course possible and some may prefer to use them but it is necessary to start somewhere and the methods shown are a good starting point.*

### AUDIO GENERATED FSK (HF bands using a mechanical system Fig 1)

The receive audio out can be taken from any convenient point, I use an external speaker and connect to this speaker's voice coil. The audio voltage needed is only a small fraction of a volt and enough will be available at quite low speaker volume. The two different audio tones of RTTY are fed into the demodulator input and the demodulator changes these into on/off switching at it's output. The transmit and receive switching is shown connecting the demod through to the loop supply. Also shown in the switching unit is a push to talk switch to control the transceiver and a local loop switch that is normally left off. This local loop switch is useful to stop the teleprinter from printing rubbish when tuning in a signal or to put in a carriage return or line feed signal from your own keyboard when the distant operator has not sent them. The switching unit has been shown as a separate unit but it is normally convenient to include it in one of the other units such as the demod.

Personally I prefer to have the mod, demod, switching and loop supply all in one metal box as this simplifies external wiring.

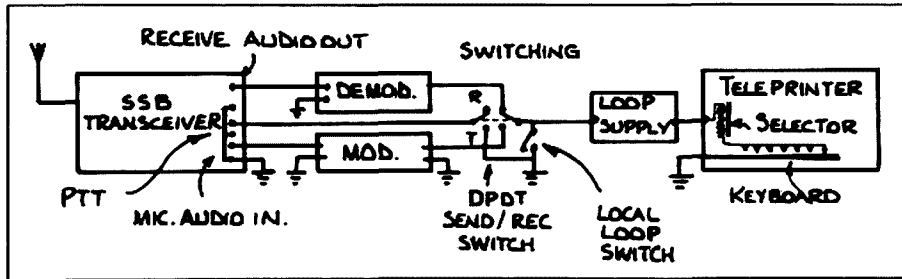

Figure 1 — Audio generated FSK (HF bands).

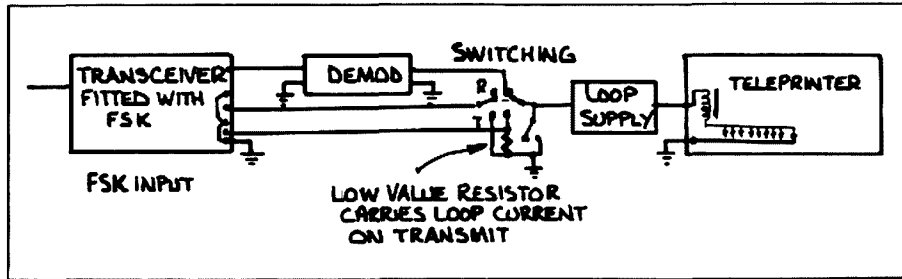

Figure 2 — DC switched FSK (HF bands).

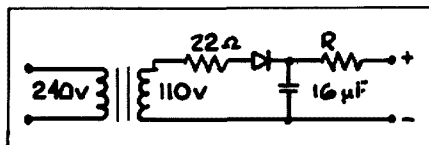

Figure 3 — Loop supply.

The loop supply is one item I have not previously dealt with so I will describe this at some length (see fig 3). The purpose of the loop supply is to provide "line" current to work a teleprinter that has been designed to work over land lines. The current needed

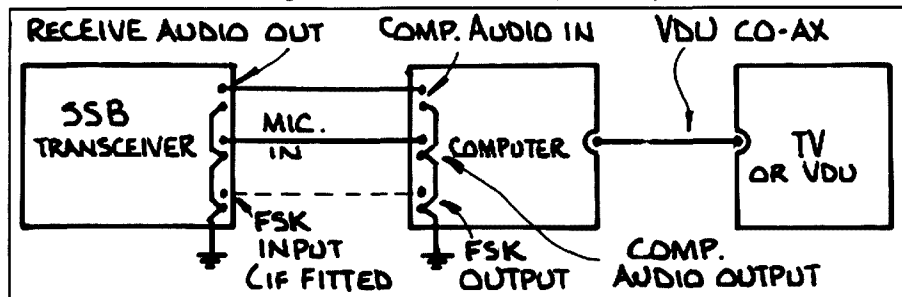

Figure 4 — Communications computer (HF bands).

depends on the machine used and in some cases how it is connected, this current is usually between 20 and 60 mA. The voltage

of the supply is not critical but is normally between about 60 to 200 volts. I would recommend about 150 volts for our type of

use. When the loop supply is providing the correct current to the teleprinter it will be found that there is only about ten or less volts drop across the machine terminals. As only say ten volts are needed to provide the correct current most people ask why is such a high voltage power supply needed? Well if only ten volts were used the circuit would be almost entirely inductive as the selector magnet coils in the machine have a great deal of inductance and in an inductive circuit the current builds up slowly so the selector armature will respond slowly to any on/off switching. The current build up is too slow for satisfactory working but by using high voltage and a high resistance current limiting resistor the circuit is no longer mainly inductive, it is now largely resistive and in such a circuit the current builds up nearly instantly. Summing this up in a few words high voltage with high resistance means a quick acting selector whereas low voltage resistance would mean a slow acting selector. Well back to the diagram and the loop current that will flow when it is switched by the output of the demod. This current is switched rapidly on and off according to the RTTY signals being received and the current flowing through the teleprinter is working the selector so as to operate the printing mechanism of the machine.

Now let's look at what happens when sending out a signal. Firstly the Tx Rx switch is put in the Tx position this switching on the transmitter and also connecting the loop supply to the modulator. Starting at the teleprinter, what is typed on the machine will cause a RTTY coded sequence of on/off switching which will mean DC pulsed loop current. This current flowing through the modulator is used to switch the modulator audio tones from one tone to the other. The modulator is an audio oscillator that only uses two fixed tones and the loop current switches these from one to the other. Normally loop current flowing means the low pitched mark tone is used and no loop current flowing means the high pitched space tone is used. The output level of the tone oscillator is too high to feed the mic circuit and will normally go via an output level control that can be set to mic level.

### DC SWITCHED FSK (Using a mechanical system Fig 2)

You will note that most of this diagram is the same as Fig 1 and such parts may not be marked. The modulator is missing from the diagram as frequency shift modulation takes place within the transceiver. The resistor R is of a low value and its voltage drop with loop current flowing provides a small DC pulsed voltage to the FSK circuit in the transceiver.

Unfortunately not many of the cheaper transceivers are fitted with FSK but it is not a major job to install it yourself.

### COMMUNICATIONS COMPUTER SYSTEM (HF bands Fig 4)

You will note less connecting wires are needed and the delightful simplicity of it all. The computer contains the mod and demod all in one unit so all that is needed

for audio generated FSK is to connect two audio leads between the transceiver and the computer and one RF lead to the TV used for a VDU, some units even have their own VDU built as part of the computer. If the transceiver has FSK fitted, the dotted line will be used instead of the computer out, mic in line shown.

When so used for FSK the computer has a switching circuit that is used to control low level DC pulses in the transceiver FSK circuit. Of course there are differences in various computers and a careful reading of the computer handbook is desirable before connecting up and attempting to use such a system.

### OPERATING IN VHF/UHF BANDS

In the HF bands FSK is used and normally on VHF/UHF Audio Frequency Shift Keying (AFSK) is used. If AFSK is kept in mind when buying or building RTTY gear the same equipment can be used for both HF and VHF. Looking at Fig 1 if the SSB transceiver is changed for a FM transceiver AFSK will result.

However it is now important that the audio tones used in the mod and demod be the right frequency for AFSK working, mark should normally be 2125 and space 2295. Operating in the VHF/UHF bands using AFSK is a delight compared to using FSK in the HF bands as the critical tuning required on the HF bands is no longer required. Of course some VHF/UHF FSK is used and in such cases the HF bands FSK diagrams will apply.

### CONNECTING UP A TELETYPE MACHINE

The first question a new RTTY machine owner asks is "How do I connect it up?". The quick answer is "Just connect all parts of it in series and put the loop supply in series with that." A send/receive machine will have keyboard and selector magnet coil connections and these can be identified by using an ohm meter. If the motor is turned slowly by hand as a key is pressed the keyboard terminals will show an intermittent connection. The selector magnet will show about 50 to 200 ohms resistance and if a few volts are applied will give a click as the armature pulls in. Connect these two parts in series and connect the correct voltage to the motor and the machine is wired ready for use. If your machine also has a paper tape player and a paper tape perforating device these are also connected in series.

Well with a few words and four diagrams I have attempted to cover a book full of information, I trust I have given sufficient clues to enable you to connect up your RTTY gear and get on the air.

My efforts to stir up RTTY activity in the coming RD Contest don't seem to be very successful to date so please put your RTTY signal on air in the contest and give me a pleasant surprise. If no one else offers a RTTY award for the best RTTY score in the 1983 RD Contest, the SA Radioteletype Group (SARG) will give one to the operator with the best scoring RTTY log. In addition to getting the best RTTY score as revealed

in the official figures when published you will need to work at least three VK5 RTTY stations and submit a signed statement to SARG that all the points in your official CW/RTTY score have been earned by RTTY contacts.

In the April Federal WIA Convention it was decided that in future gentlemen's agreements the words "CW Only" would be replaced by "Narrow Bandwidth Modes Only". This will mean RTTY is included in what some CW operators regarded as CW (Morse) only segments of the bands.

73 from Bruce VK5XJ

AR

## REGULATIONS FOR POWER LINES

*The Canadian Department of Communications has proposed new noise regulations covering power transmission and distribution lines as well as substations using phase-to-phase voltages from one to 700 kilovolts.*

*The first-ever regulations of their kind in Canada are designed to protect AM sound broadcasting, but will also benefit AMATEURS!*

*The measurement limits for the incidental electromagnetic radiation within the regulations is very complicated . . . For example . . . the limits proposed vary from several hundred microvolts per metre in the 160 metre band to tens of microvolts per metre in the 10 metre band. For lines up to 220 kV. The measuring distance is fifteen metres from a point immediately below the nearest line conductor or fifteen metres from the property line of the substation.*

AR

### MURPHY'S PARTY

*In the March Issue on page 15 Murphy went on a spree with the editorial staff. Indeed it was a great party. After several jars of Murphy's best poteen the calculations in the third column of the reprinted article "The 22S — A Common Fault" owed more to the poteen than to Ohms Law.*

*Seriously for the currents quoted resistor R141 would dissipate 111 mW for 86 mA flowing and 150 mW for 100 mA current flow. In a rig in a vehicle in summer this could well produce the effect observed. The voltages quoted are similarly in error.*

*Thanks to Ian VK3BRY who pointed out Murphy's work during a conversation. —Editor.*

## TAKE NOTE

**All copy for September AR must arrive Box 300, Caulfield South, 3162 by 25th July.**

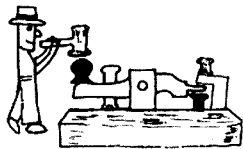

# POUNDBRING BRASS

Marshall Emm VK5FN  
GPO Box 389, Adelaide, SA 5001

## A RETROSPECTIVE

Pounding Brass is a year old now (time flies, doesn't it?), and perhaps it is appropriate to look back for a moment and consider what, if anything, we have accomplished.

We've looked at running a CW QSO, keys and keyers, signal reporting, and contest operation, and we've touched on a few other matters as well. Judging from letters received, the material has been of interest to many CW operators and may even have encouraged a few "non-operators" to locate that rusty key and try out this "new" mode.

Subjects yet to be covered include learning/teaching Morse Cde, QRPp operation, Net Operation, CW DX, and foreign alphabets/codes. If you have any other suggestions for topics please let me know.

### ZERO-BEAT OPERATION

Now here is a term which every good CW op should know, but unfortunately, there are a lot who either don't know or worse yet don't care. To "zero-beat" a signal is to precisely determine the frequency on which it is transmitted.

When a CW operator hears a signal to which he wishes to reply, he must make some effort to ensure that his transmitted signal is on the same frequency. Think about this for a moment — when you tune in a CW signal on your receiver, the pitch of the audio output goes up and down as you tune back and forth across the signal with the VFO dial. Normally you set the received frequency for maximum signal strength and/or a pitch which is comfortable for you to copy. Now, assuming you are going to transmit on exactly the same frequency you are receiving (more about that later), some problems are apparent. If you don't have a narrow filter or highly selective receiver, you have probably noticed that you can hear the received signal, at varying

pitch, over a range of two kHz or more. If the other guy has a filter, or a very selective receiver, and you transmit a kHz or so away from where he is listening, he is not going to hear you.

To be sure that he does hear you, you should a) zero-beat his signal, and b) transmit on exactly the same frequency.

Let's try zero-beating a signal. Suppose we hear a signal at about 3.548 MHz, in CW mode, which we want to zero-beat. If we tune across the signal we find that the pitch of the audio signal decreases until it disappears at about 3.550 MHz. What's happening is that the audio frequency decreases until it is no longer audible, and then finally to 0 Hz. At 0 Hz (zero-beat), if we listen carefully, we can hear a very slight rise and fall in the level of background noise. Now that we've zero-beat the signal, we know that it is exactly 3.55000 MHz, but we still have a problem.

First of all we still have to copy the incoming signal, which we can't do if we can't hear it. Next we have to arrange to transmit on exactly that frequency.

The answer is what is commonly known as "offset".

Still assuming that the rig is going to transmit on the received frequency, we can use the clarifier (or Receiver Incremental Tuning) to alter the received frequency to a comfortable pitch without altering the transmitting frequency. This is a receiver offset.

But in fact most transceivers do not transmit on exactly the same frequency — they have a transmitter offset built in. In other words, when you receive a CW signal at a comfortable pitch, the transmitter will

be offset, putting your transmitted signal somewhat closer to zero-beat. You can use this feature of modern transceivers to great advantage because most rigs have some facility for adjusting the pitch of the CW side-tone (the monitoring tone which you hear when you key the transmitter).

To use the side-tone pitch for zero-beating a received signal, first determine what the rig's transmit offset is by consulting the owner's manual. Next zero-beat a received CW signal, in the CW mode, as described above. Having located zero-beat, adjust the frequency by the amount of the transmitter offset (usually something in the range of 700-1000 Hz). Now note carefully the audio pitch of the received signal and adjust the pitch of the side-tone to match it exactly.

Having done this, all you have to do to zero-beat any CW signal is tune to the exact pitch of your side-tone, and you will transmit on a frequency that is near-as-dammit zero-beat. If you don't like copying at that audio pitch (700-1000 Hz), use the clarifier to alter the received frequency without affecting the transmit frequency.

More accuracy can be achieved by using test equipment to measure the offset and set the side-tone pitch, but this method is accurate enough for most purposes.

Having mastered this technique, you will be able to recognise expertise when you hear it — if you call CQ and a station comes back with the same pitch as your side-tone, you can say to yourself — "There's another guy who knows what he's doing!"

73 FER NW.

AR

## COMMERCIAL CHATTER

### STEWART ELECTRONICS

Stewart Electronics stock a wide range of electronic parts.

For makers and users of printed circuit boards a very extensive range of Bishop Graphics is stocked. All the tapes, pad layouts and other drafting aids for laying out really first class artwork.

Also from the Bishop Graphics range are printed circuit copper products. These are a range of copper tapes, patterns and boards. These copper products can be used to repair damaged PCBs or to lay out experimental PCBs.

Datamark dry transfers are another stock item. These are a range of the dry transfer letters which are so popular today. As well as sheets of individual letters and numbers there are sheets of commonly used words. Having the word as a whole transfer makes alignment just so much easier, which will result in a better looking panel on your next project.

Whilst the component side has been neglected so far it should be noted there is a veritable Aladdin's Cave of all common and hard-to-get parts. A most comprehensive range of parts, computer bits and other assorted goodies are kept in stock.

Quality parts are backed up by a very knowledgeable staff always ready to assist. This is a rare combination today.

Stewart Electronics are located at 44 Stafford Street, Huntingdale, Victoria. Phone (03) 543 3733.

AR



# INTERNATIONAL NEWS

## **LIBERIA**

The Liberia radio amateurs are out to draw attention to the plight of the Ganta Leprosy Colony.

Special call letters A81LC, A82LC, A85LC, A87LC, A88LC and A89LC have been authorised by the Ministry of Post and Telecommunications. This will be a special On-The-Air Activity. It will start on 6 May, 1983 at 1900 hours and continue to 31 December, 1983, 2400 hours UTC.

The members of the Liberia Radio Amateur Association will be organised to operate special designated stations in the counties identified in the special call signs. Amateurs who are contacted under these special call signs will be told about the reason for the special activities.

Bob Johansson, SM4CWY is special QSL Manager for this activity. His address is: PO Box 134, S-67101, Arvika, Sweden. All QSL cards and any other communications must be sent to Bob.

There will be a special award for any station who submits satisfactory evidence of having worked all six stations on any band. At least two of the six contacts must be made by CW.

The needs of the Ganta Leprosy Colony are great and urgent. The Liberian amateurs hope that amateurs world-wide will identify themselves with the amateurs in Liberia. The aim is to make 60 000 contacts during the period stated above.

## **MARCONI RADIO SOCIETY RE-LAUNCHES HISTORIC CALLSIGN DURING WORLD COMMUNICATIONS YEAR**

The callsign used to introduce Britain's first scheduled radio entertainment broadcast, 2MT, will be heard on the amateur bands later this year after a 60-year break in transmissions.

Home Office approval has been granted to the use of the callsign G2MT by the Marconi Radio Society, a group formed recently by amateur radio enthusiasts employed at the Stanmore headquarters of Marconi Space and Defence Systems Limited and at other company sites in the locality.

The callsign will be used at Stanmore for the first time at 1200 UTC on Saturday 2nd July 1983 using equipment owned and operated by members. The frequencies used will depend on the prevailing propagation conditions but it is hoped to organise contacts with amateur radio clubs affiliated to the BBC and with similar groups within the GEC-Marconi organisation.

Marconi's Wireless Telegraph Company Limited was first granted an experimental licence in the summer of 1920 to use the callsign to introduce news bulletins. This permission did not apparently extend to music, even in the accompanying role, and the licence was swiftly revoked following

the broadcast of 'dramma per musica' by a Danish tenor.

Following representations to the then Postmaster General by the Wireless Society of London (now the Radio Society of Great Britain), the company was later authorised to recommence transmissions. And so, the first scheduled entertainment broadcast in the UK was transmitted on 700 metres from Writtle, near Chelmsford, on 14th February 1922 under the callsign 2MT ('Two-Emma-Tock'). The 'G' (for England) has now been added to accord with current practice.

The licence restricted broadcasting to half an hour each Tuesday evening and the station was required to cease transmitting for three minutes in every ten. These frequent intervals were spent in checking to hear whether any complaints had been received.

The broadcasts provided amateurs with invaluable checking references and their content set the pattern for later public broadcasting programmes; for example, the first radio play was produced (Cyrano de Bergerac) and a rudimentary 'Children's Hour' was evolved before transmissions ceased in January 1923.

## **ST VINCENT AND THE GRENADINES**

These islands have become the 158th member of the ITU on 25th March 1983.

## **JARL**

The first amateur satellite is due to be launched in 1983.

Japanese radio law has been amended to allow ATV including novices.

Use of repeaters was permitted in Japan last year and shortly 130 stations will open on the 430 MHz and 1200 MHz bands.

JARL celebrated, on 9 October last, the 30th anniversary of the reopening of amateur radio in Japan after World War II at the Hotel Okura in Tokyo in attendance of about 500 participants.

The amateur radio activities in Japan were suspended during WW II and for several years after the war, but thanks to the united efforts of a number of people including the great pioneers in amateur radio, they came back to the air again in 1952. In the past thirty years, amateur radio in Japan has spread wider and wider with technical advances particularly in radio science and with pertinent guidances by the administration through several renovations of the amateur radio institution. No other country in the world now has so many radio amateurs as Japan.

In support of the activity of World Communications Year '83, Ministry of Posts and Telecommunications and Japan Amateur Radio League (JARL) are planning to have The World Amateur Radio International Conference (WARIC) in Tokyo this September.

In addition, for the 24th All Asian DX Contest to be held in June and August 1983, cups commemorating the World Communications Year, will be awarded to continental winners (first in each continent

on single operator multi band) by the Minister of Posts and Telecommunications in addition to the presentation of certificates from the Minister and medals from JARL as in an ordinary year.

## **RAST HOSTS SEANET**

The SEANET Convention (Southeast Asia Net), hosted by the Radio Amateur Society of Thailand, held in Bangkok 12 to 14 November, 1982, was acclaimed by the attendees as the largest and best SEANET convention to date. With more than 150 registrants from 20 different countries, all three IARU Regions were represented. The convention was formally opened with the Friday evening banquet, at which time the deputy minister of communications of Thailand welcomed the delegates and set the theme for the three-day meeting. Authorisation was granted for operation of a station at the Imperial Hotel, where HS0SEA went on the air and was given a good workout.

## **CHAIRMAN VISITED TAIWAN**

David Rankin VK3QV, Chairman Director Region III, on the way to Singapore from Tokyo stopped over at Taipei on 16 October, 1982. He, accompanied by Tim Chen, BV2A/BV2B, paid a courtesy visit to The Post & Telecommunications Department of ROC discussing amateur activities of the world and the story of IARU and Region III Association. He was told of the possibility of expanding amateur radio on this island.

## **AMATEUR RADIO IN CHINA**

The JARL observation group, consisting of eight JA amateurs headed by Mr Makoto Inami, JA6AV, Vice-President of JARL, made a tour to Beijing, Chenchou (Monastery Shao Lin) and Shanghai in China from the 6th to the 13th October last year.

They were warmly received by senior officials of the Chinese Radio Sports Association and all others concerned at all the places they visited. They exchanged views on various aspects of amateur radio in China and Japan, which promoted a better understanding and friendship of radio amateurs in both countries.

What were specially noteworthy on this tour were: that JA amateurs of the group were permitted to operate the BY1PK station, and that they participated in fox-hunting at the Chinese National Radio Direction Finding Convention as guest participants.

The Chinese National Radio Direction Finding (fox-hunting) Convention was held in the vicinity of Monastery Shao Lin about 70 km south west of Chenchou in Hanon Province. The Chinese type of fox-hunting is a combination of pedestrian exercise and orienteering which is considerably different from the conventional type of fox-hunting in other countries. The participants compete in how fast they can find as many foxes as they can in a wider area.

AR



# VHF UHF - an expanding world

Eric Jamieson VK5LP  
10 Quinns Road, Forrester, SA 5233

All times are Universal Co-ordinated Time, indicated as UTC.

## AMATEUR BAND BEACONS

FREQ	CALLSIGN	LOCATION
50.005	H4411IR	Honiara
50.008	JA2IGY	Mie
50.020	GB3SIX	Anglesey
50.060	KH6EQI	Pearl Harbour
50.075	VS6SIX	Hong Kong
51.020	ZL1UHF	Auckland
52.013	P29SIX	New Guinea
52.100	VK0AP	Macquarie Island
52.200	VK8VF	Darwin
52.250	ZL2VHP	Palmerston North
52.300	VK6RTV	Perth
52.320	VK6RTT	Carnarvon
52.350	VK6RTU	Kalgoorlie
52.370	VK7RST	Hobart
52.420	VK2RSY	Sydney
52.425	VK2RGB	Gunnedah
52.436	VK3RMV	Hamilton
52.440	VK4RTI	Townsville
52.470	VK7RNT	Launceston
52.510	ZL2MHF	Mt Climie
144.400	VK4RTT	Mt Mowbullan
144.420	VK2RSY	Sydney
144.465	VK6RTW	Albany
144.475	VK1RTA	Canberra
144.480	VK8VF	Darwin
144.550	VK5RSE	Mt Gambier
144.600	VK6RTT	Carnarvon
145.000	VK6RTV	Perth
147.400	VK2RCW	Sydney
432.410	VK6RTT	Carnarvon
432.420	VK2RSY	Sydney
432.440	VK4RBB	Brisbane
432.450	VK3RMB	Mt Bunninyong

No changes appear in the beacon list this month.

It is interesting to note that VK5RSE in Mount Gambier continues to be always available at my location, always weak but always there. Sometimes it is only audible with the mast-head pre-amp switched on, so one could say signals vary between the noise threshold to S7 when good tropo conditions exist. So, as far as I am concerned it is a very constant reliable pointer to band conditions and is serving the purpose exactly that is expected of a beacon.

## VK0AP ACTIVE

Stan VK3VD worked Peter VK0AP at 04.25UTC on the 18th June

## NEWS FROM NEW SOUTH WALES

Gordon VK2ZAB has written again with some more news of 2 metres and above in New South Wales. We are certainly very interested in what they are doing in that state, thanks for writing Gordon.

"The big news at this OTH (Berowra Heights) is an SSB tropo scatter contact on 144.020 MHz between VK2ZAB and Doug VK3UM at Chirnside Park (Melbourne) at 1128 on 2/5/83.

"Doug and I have tried several times over the past few weeks and have never failed to at

least detect the other's signal punctuated by meteor pings and occasional copy of odd words and sometimes phrases. At 0045 on 1/5 Doug was 5 x 3 here and could hear me about the same strength working Eddie VK1VP. When I heard Doug and responded the linear expired due to the excitement and reduced my power to twelve watts PEP which made things a bit difficult! Anyway, there was some form of signal enhancement operating at the time and as we were after a tropo-scatter contact to prove it could be done frequently we were not that disturbed.

"The contact on 2/5 was tropo-scatter all right and the signals were 5 x 1 both ways for about 45 seconds. We believe this is the first time a two metre contact has been made between Sydney and Melbourne. If this is not so, someone will no doubt correct us!

"Doug also made contact with Ralph VK1RK at 1100 on 1/5 and we suspect that this is the first 2 metre SSB contact between Canberra proper (Ralph is at Hughes) and Melbourne.

"To add to my comments in the previous letter, I checked my log for April and extracted those contacts made with stations beyond the local contact range (160 km or 100 miles). They are:

### On 2 metres SSB:

Doug VK2XDH Armidale 344 km 8 times  
Don VK2ADY Tamworth 276 km 9 times  
Jack VK2ZQX Gunnedah 300 km 12 times  
Barry VK2KAY Gunnedah 300 km 19 times  
Ross VK2DVU Condobolin 372 km 1 time  
Ralph VK1RK Canberra 260 km 3 times  
Brian VK2AKU Narrabri 384 km 12 times  
Glen VK1KAA Canberra 260 km 5 times  
Derrick VK2DOA Narrabri 384 km 10 times  
Eddie VK1VP Canberra 260 km 4 times  
Bob VK1RC Canberra 1 time  
Peter VK2DAU Tamworth 276 km 2 times  
Dave VK2ZDY Moree 473 km 2 times  
John VK2YEZ Griffith 476 km 1 time  
Allen VK2KAW Wagga 384 km 1 time

### On 70 cm SSB

Barry VK2KAY Gunnedah 300 km 7 times  
Eddie VK1VP Canberra 260 km 7 times

"On two metres signals were also heard from VK4LC (about 650 km), VK3UM (694 km) and VK2MQ (473 km) but no firm contacts were made at the time. On 70 cm from VK2ADY (276 km) also. As months go April was about average!"

That last statement bears a comment in that, I would be most happy myself to work so many stations on those two bands for such an average month! Most activity here in VK5 still revolves around the continuing saga of 144 and 432 MHz contacts between VK5ZRO in the first instance, joined by others from time to time, to Don VK5ZRG at Whyalla (220 km) and Neil VK5ZEE at Woomera (about 500 km). The ease with

which Bob can make these contacts from the other side of my big hill makes me green with envy, even if I can hear the Mount Gambier beacon all the time!

## BEACONS SYSTEM IN USA

Further word comes from Bill W3XO in "The World above 50 MHz" in May QST and some suggestions for implementing the system of unattended beacons in that country. Only narrow segments in each band have been permitted, 20 kHz on 50 MHz, 10 kHz on 144 and 432 MHz. When one considers there are 48 US states in the main area of their country, with Alaska some distance away being 49, further still Hawaii number 50, and all will no doubt want to share in what has been fairly commonplace in many parts of the world for quite a few years. Bill, W3XO, has worked out that it would need about 80 beacons, and this on the basis that they should not be less than 125 miles apart (the US is not metric) but there should be one at least every 250 miles, with the highest density in the high activity areas of the East and lower West Coast; beacons also would need to be located along the coasts to provide an indication of enhanced propagation.

Bill is rightly concerned at the possibility of considerable QRM from beacons close to one another in frequency, and distant separation can become short separation under improved tropo conditions. So much so, that he suggests they may need to look at time-sharing. To accomplish this, he says, each minute might be divided into four 15 second segments. In addition to selecting or being allocated a specific frequency, each beacon operator would choose or be given a segment. In this way, the number of beacon segments is multiplied by four. Until enough beacons come on the air, however, there seems no immediate need to implement time segments. Beacons should be able to operate continuously until potential conflicts develop.

We all wish the US success with their new venture, there will surely be some problems but if commonsense prevails they can be sorted out. They might well consider seeking some opinions from the European boys regarding 2 metres and 70 cm as they have many beacons in operation although over larger segments certainly but still at very close geographical distances. Here in Australia we are not faced with such decisions as we have only 7 states to consider, plus Canberra, and our distances are considerable.

Far be it for me to offer too much in the way of advice to the US but one way might be to have a lesser number of beacons initially and spread them out well, and see

how propagation affects them, where they are being heard etc. Whatever the outcome, particularly on 6 metres, it can only be good on a global basis by providing a 24 hour signal which might be heard somewhere sometime!

I also note from the May "QST" that a new 1¼ metre (220 MHz) world record has been established. "After several months of trying, following a 2 metre to 1¼ metre crossband contact last November, KP4EOR and LU7DJZ were finally able to complete a two-way contact on 220 MHz at 0033 on 9/3/83 to establish a new terrestrial world record for the band. Using atlas-listed coordinates for San Juan and Buenos Aires, the distance works out to be 3670 miles (5870 km) far exceeding the old published record of 2540 miles between W6NLZ and KH6UK established in June 1959.

"KP4EOR was running about 200 watts output to a single 17 element Boomer, and was 559 on CW and 5 x 5 on SSB at LU7DJZ's QTH. On his end, LU7DJZ runs 70 watts to two stacked 10 element yagis. His signal was 539 at David's location. Following their success, the two are trying to see how often they can work this band via the transequatorial propagation route, as well as, beginning next August, investigating the possibility of contacting on 70 cm.

"Congratulations are in order to both KP4EOR and LU7DJZ for this record breaking accomplishment. Their achievement surely marks another major event in the history of the world above 50 MHz."

We here in Australia join in congratulating the two participants. Although we are unable to operate on that band and are therefore unable to try and better the distance, we nevertheless say well done.

### NEW 3300 MHz RECORD

From "Break-In" for April 1983 comes news that "on 6th March 1983 two teams from the Wellington VHF Group succeeded in creating what is believed to be a new world record on this band at 545 km.

Peter Williams ZL2ARW and John Yaldwyn ZL2TRV travelled to Te Pahi trig station at a height of 1019 metres ASL and located just south of Cape Reinga at the tip of the North Island.

"At the southern end were John Shoreland ZL2AQE and John Wysocki ZL2TWS who operated from the Stratford plateau on Mount Egmont at 1200 metres ASL.

"The contact took place at 09.30 AM local time when signals were heard by ZL2AQE, they were so weak that initial contact was made on CW by Peter making and breaking one of the connectors in the transmitter line (Tut, tut! Fancy not taking a key on such a jaunt . . . 5LP). Shortly after this time band conditions improved and the claimed contact was on FM with 5 x 9 signals both ways. The claimed distances is 545 km and subject to confirmation is a significant improvement over the G4BYV/DB5KS distance of 464 km on 14 September last.

"Equipment line-up at both ends comprised a crystal controlled multiplier chain of 1 watt output to a 4 foot dish; on receive the ZL2ARW team used a GaAs FET preamp to an interdigital converter (VHF Comms design).

The ZL2AQE team fed the input signal straight into the converter without the preamplifier.

"Congratulations to both teams on a very fine effort, especially to Peter ZL2ARW and John ZL2TRV who drove all the way from Wellington to Te Pahi at Cape Reinga a round trip of 1130 km."

We in Australia offer our congratulations too for a fine dedicated effort, and one needs to be dedicated to drive such distances, but it seems the results have been worth while.

Incidentally, I note also that the ZL2ARW team was equipped on their journey with all bands from HF through 2 metres, 70 cm, 2300 MHz, 5 GHz and 10 GHz. However, of the microwave bands the only successful contact was that on 3300 MHz. The ZL2AQE team was similarly equipped plus ATV equipment!

### EME EXPERIMENT

The transmissions from K8HUH (see May "AR") via the 150 foot dish and the moon proved to be a non-event for me. I listened around 432.100 MHz for at least an hour on the three mornings of 14/5, 15/5 and 16/5 and although I thought I convinced I could hear something in the noise once I am not really sure I heard anything!

After the first try I telephoned Chris VK5MC to see what success he had with his dish, and to enquire if K8HUH was actually on. He confirmed he had worked the station but signals were no more than 10 dB above the noise. This being so it seemed my 16 dB of antenna gain (less coax losses) would not be adequate. To assist the next day's trials I got out the GaAs Fet pre-amplifier and coupled this into the system. This certainly made an improvement judging from the number of motor vehicles causing QRM on the band so I knew things were working fairly well. However, despite all the trying nothing happened, but it was an experience and worth a try. The fact that the total period the station was on, the sky was completely covered with cloud, didn't help as I had to rely on bearings taken with the prismatic compass. At least I know now my antenna is only three degrees off true corrected north, so it was not necessary to spend a lot of time outside in the rain with the compass!

Chris VK5MC advised he had worked K8HUH on Saturday 15th May on CW and SSB with signals up to 10 dB over noise and again on Sunday 16th May on CW. He started with 10 watts and with increasing power made contact at the 50 watts level.

As far as we can ascertain VK4ZBN, VK4AQ and VK6ACY have heard the station weakly and Hans VK6ZT is believed to have worked it.

The transmitter was running at 150 watts solid at the feed with circular polarisation, which gave 3 dB loss to most people, the frequency being 432.095 MHz

Conclusion reached was the test was not as effective as WA6LET some years ago.

### WILLIS ISLAND

Willis Island will soon be reactivated on 6 metres. The callsign VK9ZS has been

allocated to Graeme Smith who will be on Willis Island for the next six months.

The rig will be the FT680 from the VK6 DX Chasers Club which was used on the Heard Island Expedition. The antenna will be the beam used on Heard Island provided by Werner Wulf. A 100 W amplifier will be on loan from VK3AUI. The Lunar amplifier also made the trip with VK0HI.

So look out in the coming months for VK9ZS. Graeme will have a keyer which will be used to stir up activity when conditions look promising.

### CLOSURE

Just before closing, may I mention my first report (April) of the fire destruction of the VK5 beacons was not quite correct as it turned out. Fortunately Mark VK5AVQ was able to report salvaging most of the equipment, but the residence which was the source of power was destroyed, hence the beacons would have been off the air anyway. So that news is a bit brighter after all!

It must have been a quiet month around the country as very little information has come to hand. Hopefully, the mid-winter DX period might treat us well by the time you read this.

Closing with the thought for the month: "Maturity is the ability to do a job whether or not you are supervised, to carry money without spending it and to bear an injustice without wanting to get even."

73, The Voice in the Hills.

## METAL BADGES

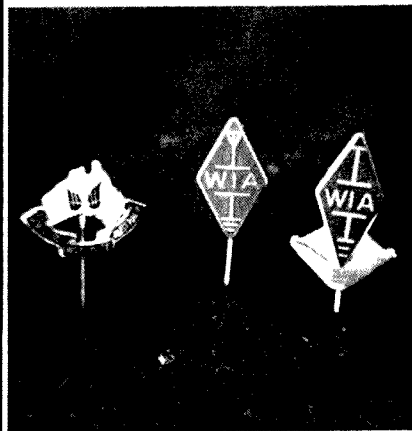

## ATTRACTIVE CAR BADGES AND STICKPINS

Stickpins are in three designs — Australia and wings, diamond logo and diamond with boomerang at base for engraving your callsign.

Car Badge is a larger replica of the Australia/wings badge.

Now obtainable from divisions, Federal Office and Magpubs.

# SPOTLIGHT

ON

SWLING

Robin L Harwood

5 Helen Street, Launceston, Tas 7250

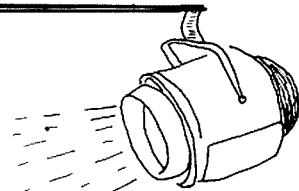
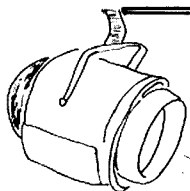

Well, the peak of the wintertime DX conditions has now passed, yet many interesting signals are continuing to be heard during the daylight hours. However, more sudden ionospheric disturbances, due to solar flares, have caused a fall in propagation particularly to the higher frequencies of 10 MHz and above. Lower frequencies are affected, but not to the same degree. Usually the east west path suffers the most. When these disturbances are present, it gives us an opportunity to hear the lower powered outlets, usually masked by the larger powerhouse signals. The majority of these lower powered outlets serve a district or provincial audience and are not designed for overseas listeners.

## MANY STATIONS DUE TO FLARES

One example of this is Radio Malaysia in Kuala Lumpur on 6025, which is normally sandwiched between Radio Moscow and either FEBC International or the AFRTS. Yet on the 17th of May, I heard it here in Launceston between 1230 and 1300 UTC. It is a domestic station and should not be confused with Suara Malaysia — the external service also in Kuala Lumpur, which is heard elsewhere on the 49 metre band in the evening hours.

Yet another station that is not normally heard here, was also observed during one of these flares. It was the AFRTS Far East Network in Tokyo on 6.155 MHz. Usually VLR6 at Lyndhurst (VIC) on 6.150 prevents any signals 5 kHz either side from being heard clearly. But as the skip distance seemingly does alter and increase, their signals were down and there was a rapid flutter on their carrier, allowing the FEN to be heard. Later on, another Asian signal closer masked their signal. The FEN in Tokyo is also heard on 3.910 MHz but its programming varies from that on 6.155 MHz.

## WE MISS THIS ONE

Many VK amateurs were disappointed that they could not work PA6PCJ — the special station mounted by Radio Nederland in Hilversum as part of WCY '83. The station was not heard very well in Australia due to the poor propagation over that weekend. Two stations that worked PA6PCJ were Arie VK2AVA and Morrison VK3BCY. I heard the station myself only once on 14.070 MHz and then it was barely audible.

## SPECIAL STATIONS

Radio HCJB, the religious broadcaster in

Quito, Ecuador, mounted a special amateur station using some of their huge antenna arrays, when they weren't required by their broadcasting transmitters, with the call of HC1JB naturally. As I am writing these notes in late May, I cannot comment on how their efforts went. However another group, the Marconi Radio Society, plan to re-activate one of the historic callsigns in Great Britain, first used over fifty years ago. It was used in the Empire broadcasts, which were aired prior to the formation of the BBC's external service in December 1932. The call will be G2MT, but I do not have any additional information relating to their operating times or frequencies, yet they may be found in International News.

## ENJOYABLE PROGRAMMES

One programme that I find interesting on the BBC World Service is called "Listening Post". This is not a DX programme nor is it connected with technical aspects of the hobby, rather it is a compilation by the BBC Monitoring Service in Caversham Park, of what the various international or local broadcasting stations are saying about news and current events in the World. Several foreign language broadcasts are translated and summarised into English. This gives an opportunity to those who don't know these other languages, an insight into what some of the foreign language newscasts contain. You can hear it at 1115 UTC Wednesdays on the usual BBC World Service frequencies.

The regular programme for listeners who want to keep up with alterations to BBC World Service frequencies, or have difficulties receiving BBC programmes, is called "Waveguide". This ten minute programme is heard at 0915 UTC on Mondays.

## MAKE UP YOUR OWN MIND!!

Have you heard a woman reading out groups of numbers in German or Spanish on unusual frequencies? If you have, you must be wondering, as I have, what the identity of these stations are. There has been speculation for some time now, that these are perhaps engaged in clandestine or espionage activities. They base this on the fact that these stations do not adhere to regular operational hours or frequencies and seldom seem to be used on consecutive days. I did hear them on 9.325 or 11.545 MHz. Listen for yourself and make up your own mind.

## HARMONICS

Recently I was trying to identify a station

on 1.654 MHz with music and announcements. As it was very weak, I was wondering if it could be 3MU at Monash University, which reportedly utilises that channel. I had also noticed that a Sydney listener claimed to have heard it. However, it only runs a watt on a cable system around the university campus to speakers. It would barely be able to get out of the campus. However, the station this listener heard presumably, is not that but is rather the second harmonic of 3GI at Sale on 828 kHz. I managed to hear the Victorian State news at 1210 UTC which positively identified it. Other ABC transmitters also seem guilty of putting out harmonics. 5AN in Adelaide on 891 kHz has been heard on its fourth harmonic of 3564 kHz by numerous amateurs now. Radio 3LO at Sydenham is heard here in the evening and early morning hours on its fifth harmonic of 3870 kHz.

## PLEASE IDENTIFY

Another trend I have noticed is that people are assuming that the station they are hearing on a particular channel, is in a certain country because it is listed in a bulletin or in the WRTH as being operational at that time etc. I urge you to wait for some form of identification announcement to verify or otherwise where the station is. This has been highlighted by a listener in northern NSW who thought he heard Madras on MW at 1030 UTC. As it is still daylight in India, it is highly unlikely it was in Madras. It seems likely that the listener may have heard Indian music from another station. So make sure that you try and identify the station, and if in doubt report it as unidentified. Others more experienced will either confirm it was that station, or inform you as to its identity.

Well, that is all for this month. If you have any news or comments for inclusion in this column, please write by the 15th of July. Until August, the best of 73s and good DXing! — Robin.

AR

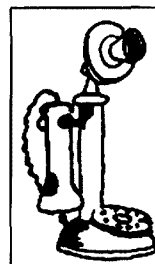

Please remember your STD code when you advertise in HAMADS.





# ALARA

Australian Ladies Amateur Radio Association

Margaret Loft VK3DML  
28 Lawrence Street, Castlemaine, Vic 3450

Hello again for this month, don't forget the Annual Meeting on Monday 25th July on 3.570 MHz at 1030 UTC. If you cannot join the net, send your votes on the form in the July Newsletter. Remember it is your association and we need your support.

## BIRTHDAY NET

ALARA will be eight years old and the birthday net will be on Monday 22nd August on the usual frequency.

Welcome to new members: Narelle VK1NG and to Heather VK4NEZ and hope you both enjoy being a part of ALARA.

Best wishes to all who are sitting for exams next month and hope you are all successful.

## BYLARA AWARD

Available to all YLs, OMs and SWLs (on a heard basis) for working YL members of BYLARA (British).

## DX OUTSIDE EUROPE

Work ten members (YL) of BYLARA to include at least six British members. Starting date: 29th April 1979. YLs must be members at time of contact. All bands; all modes; one contact per member.

No QSLs necessary; send log data.

signed by applicant with fee of £1.50, or 12 IRCs or \$US4.00 to Mrs D Wood; GM4COO, 13 Scotland Drive; DUNFERMLINE, Fife KY12 7SY, Scotland.

Look for the G girls on activity Day, the 6th day of each month, call CQ YL on the hour and gain some points for their award.

## ALARA CONTEST

ALARA's Contest No 3 will be on Saturday 12th November and this year a Trophy for the top score by a YL over five years will be added to the certificates. We hope this will foster interest in the contest, so keep this date in mind. Contest rules and a full list of ALARA members will appear in AR prior to the contest.

Membership of ALARA is down this year, unfortunately a number of YLs did not rejoin. The numbers on the nets are down also, so please try and come up on Monday night and help boost the numbers again.

Photo this month is from Marlene VK5QO on right and Jenny VK5ANW. If you enjoy seeing the photos how about sending one of yourself to me for others to see!

Until next month all the best to all.

33 73 88  
Margaret VK3DML  
AR



L to R: Jenny, VK5ANW editor for Five Eighth Wave column in AR meets with Marlene VK5QO editor of our newsletter.

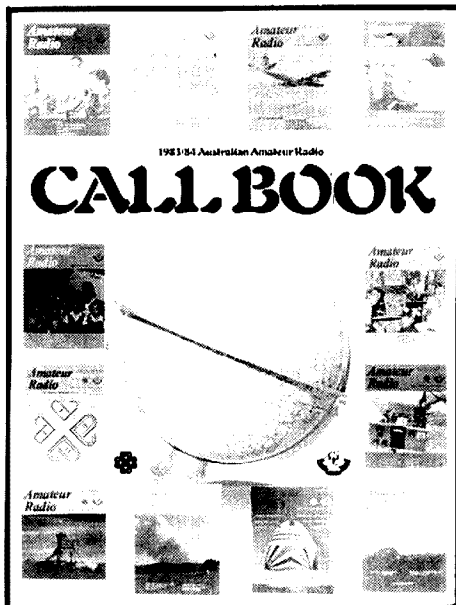

## The 1983-84 CALLBOOK

Will be available at the beginning of September.

New and updated data, repeater listings and over 3000 new and updated callsigns.

*Don't miss out this year.*

*Order your copy now from divisions, Magpubs, Box 300, Caulfield South 3162 or Federal Office.*

**\$5.75 plus postage.**

# AWARDS

At its meeting in April this year, Federal Council approved some changes to the rules governing WIA awards. Further, preliminary approval was given for a new DXCC certificate and the introduction of single and all band stickers.

Mike Bazely VK6HD  
FEDERAL AWARDS MANAGER  
8 James Road, Kalamunda, WA 6076

## RULE CHANGES FOR ALL WIA AWARDS

### AMENDMENT TO PRESENT RULE 4.1 (VERIFICATIONS)

It will be necessary for the applicant to produce verifications in the form of QSL cards or other written evidence, from the station contacted, showing that two-way contacts have taken place.

### AMENDMENT TO PRESENT RULE 4.5 (VERIFICATIONS)

In lieu of forwarding QSL cards as set out in Rules 4.1 to 4.4 above, a list giving details set out in Rule 4.3, certified by the Awards Manager, Secretary or Council Member of a division of the Wireless Institute of Australia, or two licensed amateurs known to the applicant, should accompany each application for membership.

Every person certifying an award application must sign the following declaration: *I have checked the (insert number in words) QSLs submitted by (insert call sign) and certify that the details attached correspond with the verifications inspected by me. Signed ...*

### AMENDMENT TO PRESENT RULE 5.1 (APPLICATIONS)

Applications for membership shall be addressed to the Federal Awards Manager of the WIA, accompanied by the verifications and check list with sufficient postage enclosed for their return to the applicant, registration being included if desired. WIA members should also include their address label taken from the latest edition of "Amateur Radio".

## NEW DXCC RULES

### DELETE OLD RULE 3.4 (OPERATIONS) AND INSERT THE FOLLOWING NEW RULE

The following criteria will be taken into consideration when determining the DXCC country list.

- The ARRL DXCC countries list.
- Whether the country's government or administration recognises and issues amateur radio licences.
- The Australian regulations which prohibit contacts with unlicensed stations.
- An Australian government directive prohibiting contacts with a particular country.
- The starting date for any new country to be decided by the Federal Awards Manager.

### DELETE OLD RULE 3.6 (OPERATIONS) AND INSERT THE FOLLOWING NEW RULE

All stations must be contacted from the same DXCC "country". NB: Amateurs moving from one call area to another will be given the option of transferring credits or starting on a new DXCC award. Once this option has been exercised it will not be reversed.

## NEW DXCC CERTIFICATE

*What sort of DXCC certificate would you like? A multi-coloured map of the world with spaces for endorsement stickers? I would like to get this programme off the ground as soon as possible so if you do have any views please let me know.*

It is suggested that current certificate holders will be allowed to apply for the new certificate. The actual cost of the certificate will be charged to those who wish to make the change.

## WORKED ALL Y2 AWARD

This award is available to both licensed amateurs and SWLs. The award is available for all contacts after 1 January, 1980 and the minimum requirement is for twenty points from ten districts. The districts are identified by the second letter of the suffix. The districts are as follows:

A and U	=	ROSTOCK
B	=	SCHWERIN
C	=	NEUBRANDENBURG
D and P	=	POTSDAM
E	=	FRANKFURT
F and X	=	COTTBUS
G and W	=	MAGDEBURG
H and V	=	HALLE
I and Q	=	ERFURT
J and Y	=	GERA
K	=	SUHL
L and R	=	DRESDEN
M and S	=	LEIPZIG
N and T	=	KARL-MARX-STADT
O	=	BERLIN

One point is gained for each completed QSO. A GCR list showing callsign, band, date, time and report is acceptable. Though this award is called "the Y2 award" stations using the prefix Y2 through to Y8 are included. No Y9 stations will count. Applications to RADIOKLUB der DDR, HOSEMPNSTR 14, DDR-1055, BERLIN, German Democratic Republic, together with ten IRCs to cover costs and postage.

AR



The WIA need  
**YOU**  
to enroll a new  
member today

If EVERY member joined JUST ONE new member, YOU would be spreading the joy of amateur radio.

## POISON PEN LETTERS



Readers are advised that letters of an insulting or abusive nature have been received by amateurs. These letters have been unsigned with a false name or callsign.

If you should receive such a letter you should immediately notify the authorities. Unless you do this the police and postal authorities will be unable to stamp the practice out.

**Help stamp out this practice now.**

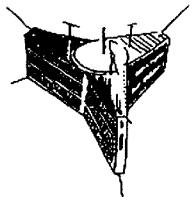

# AMSAT AUSTRALIA

Colin Hurst VK5HI  
8 Arndell Road, Salisbury Park, SA 5109

## NATIONAL CO-ORDINATOR

Graham Ratcliff VK5AGR

## INFORMATION NETS

### AMSAT AUSTRALIA

Control: VK5AGR  
Amateur  
Check in: 0945 UTC Sunday  
Bulletin  
Commences: 1000 UTC  
Winter: 3.680 MHz  
Summer: 7.064 MHz

### AMSAT PACIFIC

Control: JA1ANG  
Time: 1100 UTC Sunday  
Frequency: 14.305 MHz

### AMSAT SW PACIFIC

Control: W6CG  
Time: 2200 UTC Saturday  
Frequency: 28.880 MHz

Participating stations and listeners are able to obtain basic orbital data including Keplerian elements, from the AMSAT Australia net. This information is also included in some WIA Divisional Broadcasts.

## THANKS BOB ARNOLD

Since the August 1977 issue this column has been diligently prepared by Bob Arnold VK3ZBB. Bob has succeeded in compiling one of the most informative and constructive amateur satellite columns of any amateur magazine that you care to mention. Anyone who cares to peruse past issues of AR will find a wealth of useful operating hints, orbital parameters, future missions etc. The outstanding bonus however is a fully documented history of the happenings of the amateur satellite scene both world and Australia wide, over Bob's reporting period. Nonetheless Bob has decided that now is an opportune time to hand over the reins to another scribe, and thus allow him more time to research some ongoing projects that he has in hand. Therefore Bob, on behalf of your many readers and friends, I sincerely thank you for your contribution to the advancement of amateur satellite communication through the medium of this column.

## THANKS CHARLIE ROBINSON

Effective 30 June, Charlie VK3ACR has relinquished his position as National Co-ordinator of AMSAT Australia. Charlie stepped into the position many years back and has carried out the position with

sincere dedication. Perhaps the most outward indication of the co-ordinator's position is the dissemination of news and updates. The Sunday night skeds have, in recent years, become a significant event for amateur satellite users throughout Australia. On behalf of the regulars and the many listeners that you have kept informed through your efforts Charlie, our sincerest thanks. It is anticipated however that you will still be a regular.

## NEW NATIONAL CO-ORDINATOR

Graham Ratcliff VK5AGR has agreed to take over this position following Charlie's decision to stand down. Graham, you have a hard act to follow but we wish you well in the future as co-ordinator. Any matters relating to AMSAT Australia can be directed to Graham either during the Sunday evening skeds or by mail, QTHR.

## FIRST ASTRO-AMATEUR IN SPACE

W5LFL/Space Mobile has been approved for the space shuttle mission STS9. The mission is planned for around 30 September 83, with the primary objective of carrying aloft the joint US-European spacelab in the shuttle's cargo bay. Astronaut Owen Garriott will operate using a specially designed 2 metre transceiver on the low end of 144 MHz (approx 144.3) for one hour per day, during his off duty time. He will try to provide amateurs around the world with their first QSO via a manned orbiting spacecraft. Time, frequency and procedures will be defined later. It is stressed that the operating procedures will have to be strictly adhered to and thus avoid QRM and give everyone a chance to QSO. Abuse of the procedure could see the cessation of operations immediately. Further details as they come to hand...

TNX TO MODE J NEWSLETTER.

## STATUS REPORTS

All satellites at the time of preparation of these notes were performing normally. Some slight concern has been expressed in recent weeks once again in regard to the batteries on board Oscar 8. Changes in the operating schedule of Oscar 8 do take place at times and these are due to the efforts of the command stations to ensure that the five years of operation to date can be continued for as long as can practically be possible. Hence if it is not on the scheduled mode please realise the reason why. The current schedule for Oscar 8 is mode A: Sunday, Monday, Tuesday and mode J: Thursday, Friday and Saturday. Wednesday is the designated experimental day and as such is not available for communication. UOSAT Oscar 9 is still

undergoing status checks in an endeavour to free the snagged cables preventing deployment of the boom. At weekends UOSAT primarily transmits digital talker telemetry, 1200 baud ASCII telemetry as well as 1200 baud ASCII bulletin.

## REQUEST FOR ASSISTANCE

Despite the five to six week delay in the compilation of these notes and therefore the understandable risk of presenting out of date news in this column I would ask the assistance of satellite operators in providing news of their activities for presentation in this column. In this regard we are no worse off than overseas publications who in some cases have even longer lead times. Nonetheless this column has, in the past been compiled with the future in mind and that course will continue. Any newcomer to satellites need only research back issues of Amateur Radio and, in this particular column, the previous presenters have compiled a literal compendium of useful information. This column can only be as good as the input received, so how about it chaps...

De Colin VK5HI



# QSP

## CONGRESS APPROVES FUNDING TO SEARCH FOR EXTRATERRESTRIAL INTELLIGENCE

Following years of bitter debate, and even one "Golden Fleece" award from Sen William Proxmire, Congress has finally approved funds to be used in the search for extraterrestrial intelligence (SETI). This fiscal year, the National Aeronautics and Space Administration budget will include \$1.5 million for an instrument that attaches to a radiotelescope. The instrument, a signal analyzer, will eventually study 10 million radio frequencies simultaneously in the search for a message from intelligent beings elsewhere in the universe.

Searches conducted to date have been disappointing, but many scientists believe that a concerted effort should be undertaken as soon as possible. Carl Sagan, for example, lobbied long and hard for SETI funds, and he was finally able to convince Sen Proxmire, among others, that the search was scientifically important and relatively inexpensive.

reproduced from CQ March 1983  
AR

# NATIONAL EMC ADVISORY SERVICE

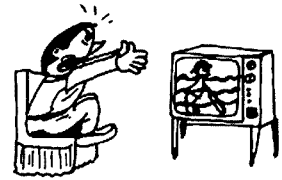

Tony Tregale VK3QQ  
NATIONAL EMC CO-ORDINATOR  
38 Wattle Drive, Watsonia, Vic 3087

## "THE COMPUTER CONTROLLED CAR"

**Knight Rider cockpit electronics is not as far away as we might think judging by the amount of computer hardware and software being squeezed into today's automobiles. In a system represented by man and machine, the machine should take over as many supporting functions as possible, so that the driver, relieved of routine chores, can relax and dedicate his whole attention to the traffic. He can achieve this if he's sure at all times that all items of the vehicle are functioning correctly.**

Recent years have seen a rapid growth in the field of vehicle electronics, especially in the area of electronic display instrumentation, and systems monitoring. The major developments in this field have occurred in a relatively short time.

The language of digital technology is one of breathtaking simplicity: 1 or 0, on or off. Despite this simple, yes/no thinking, computers can answer complicated questions quickly, reliably and accurately . . . However, accuracy in computer systems greatly depends on the system's ability to reject unwanted signals and energy. Computer systems can be, and quite often are, susceptible to electromagnetic energy. The Amateur Service, being an extensive user of the electromagnetic spectrum, views with concern the electromagnetic compatibility (EMC) of these super mobile computer systems.

The on-board computer can monitor such parameters as: average fuel consumption, how far you can go on the remaining fuel, oil level and temperature, coolant level and temperature, windscreen washer fluid level, tyre pressure, battery fluid level, collision avoidance radar, braking system operation and fluid level, transmission operation and fluid level, fuel injection, automatic self levelling system, windscreen clarity monitor, engine performance monitor, climate monitor, and others.

Perhaps the most interesting aspects of the mobile computer, and those which are of special concern to the Amateur Radio Service, are those functions which assist with the control of various vehicle parameters, and where these parameters could be inadvertently changed by on-board or close-proximity additional electronic and communications equipment. However, vehicle manufacturers are, in contrast to home entertainment and consumer product manufacturers, very conscious of the need for vehicle electronics to have good EMC. They agree there is a need to increase usage of electronics in vehicles and this does require serious consideration of electromagnetic interference effects to ensure there is no

generation of electromagnetic interference or, alternatively, effect on the vehicle from on-board and external electromagnetic radiation. Vehicles are tested to measure the effect of the electromagnetic environment experienced in proximity of radio and television broadcasting stations, fixed and mobile communications stations and radar installations.

Magnetic field tests are also performed which simulate the effect of magnetic fields encountered by the vehicle in the proximity of power transmission stations and high power transmission lines. Tests are also performed to determine the broadband for field radiated emissions from the vehicle's electrical system, which may interfere with radio and television reception. Further tests are performed to identify any narrow band radiated emissions from the vehicle's electrical system or communications equipment, outside the vehicle.

The manufacturers are quick to point out that this is a new area and there are few standards formulated. Generally, vehicle manufacturers establish their own procedures to test for EMC performance.

Their concern in regard to the problem of EMC is borne out, and illustrated, in the fact that the owner's manual contains a notice regarding installation of two-way radio systems. Nevertheless, members of the Amateur Radio Service would be well advised to investigate the vehicle's total EMC before installing additional electronic and/or communications equipment in a vehicle which has any form of electronic or computer control. Furthermore, a full series of tests should be completed after installation of communications or, other additional, electronic equipment prior to taking the vehicle on the road. On the road, proceed with caution until you are satisfied there are no ill effects from the additional on-board equipment.

Some of the controlled systems include:

- (a) *Wheel-slip-control: This helps to prevent wheel spin with driving torque and wheel locking when braking.*
- (b) *Gear-and-motor-control: This opti-*

*mises engine warm up, behaviour, fuel consumption, emission of pollutant, and noise.*

- (c) *Fuel-injection-control: This ensures that the correct amount of fuel is supplied to meet the exact needs at each particular moment.*
- (d) *Anti-lock-braking system: This prevents the wheel from locking in a skid under emergency stop conditions even on road surfaces which provide different grip left and right. The system allows full use to be made of the grip actually available on each individual wheel, thus permitting the shortest possible braking distance.*
- (e) *Automatic-self-levelling-system: This maintains the balance of the vehicle irrespective of loading, braking, or cornering.*
- (f) *Automatic-cruise-control: This provides constant cruising speed without the need for the driver's foot to be on the accelerator. The vehicle will maintain the chosen speed irrespective of external conditions. The driver can instantly disconnect this control.*

It is obvious from the information so far, the automobile industry has come a long way with electronics in recent years; this overview is only the tip of the iceberg. One of the advantages of designing in electronics is that the range of possible tasks is almost limitless. One of the disadvantages is maintaining the EMC amongst the various systems and outside influences.

In conclusion, perhaps we should consider some of the automobile EMC aspects which are covered by an Australian Standard. Although this standard is not mandatory, it does lay down some interesting parameters in regard to spark ignition systems used in motor vehicles and similar powered devices.

Australian Standard 2557/82 was prepared under the authority of the Telecommunications and Electronics Committee on Electromagnetic Interference as one of a series of standards intended to facilitate the electromagnetic compatibility of electric and electronic equipment.

The limits and methods of measurement given are based on the recommendations of the International Special Committee on Radio Interference (CISPR) in CISPR 12:1978 and acknowledgement is made of assistance obtained therefrom. The standard varies, however, in regard to the following:

- 1 Limits are extended to cover the range 30 MHz to 1000 MHz, being identical to the CISPR recommendations for the range 40 MHz to 250 MHz. Beyond this range the limits are in accordance with guidance given in CISPR 12.
- 2 Requirements for suppression devices are not included nor are methods of measurement for such components.
- 3 A clause (Clause 8) on detection of offending vehicles from the roadside has been included.

Marginal bars indicate a deviation from CISPR 12. In general the changes are editorial in nature, reflecting changed working or a re-arrangement of material which would prevent ready comparison with the international document.

The purpose of the standard is to establish uniform requirements for electromagnetic interference limits and methods of measurement for interference radiated by the ignition systems of

motor vehicles, motor boats and other devices powered by spark-ignition internal combustion engines. The term 'motor vehicles' is understood to include both road transport and off-road vehicles such as tractors, construction vehicles and snow mobiles. The term 'similarly powered devices' is understood to include chainsaws, lawnmowers, irrigation equipment, construction equipment and the like, whether mobile or stationary.

The standard does not apply to diesel-powered equipment. Other items which are sources of interference and which may contribute to the overall level of interference produced by a motor vehicle but are not within the scope of this standard are electric motors, heaters and air-conditioners, whether integral or added to the vehicle in question.

This standard establishes limits for electromagnetic interference radiated by spark ignition systems used in motor vehicles, motor boats and other similarly powered equipment, describes methods of measurement, and gives guidance on methods of interference suppression.

This standard applies to the radiation of

electromagnetic energy in the frequency range 30 MHz to 1000 MHz which may cause interference to radiocommunication services, and which is emitted from —

- (a) vehicles propelled by spark ignition internal combustion engines;
- (b) boats propelled by spark ignition internal combustion engines; and
- (c) other equipment or devices equipped with spark ignition internal combustion engines.

The standard does not apply to aircraft, electric traction systems or electrically propelled vehicles.

The limits for radiation based on quasi-peak measurements are as follows:

- (a) From 30 MHz to 75 MHz ..... 50  $\mu$ V/m.
- (b) From 75 MHz to 400 MHz ..... 50  $\mu$ V/m.  
at 75 MHz rising linearly to 180  $\mu$ V/m at 400 MHz.
- (c) From 400 MHz to 1000 MHz ... 180  $\mu$ V/m.

A fully copy of this Standard is available from the Standards Association of Australia. We trust this and other Standards of the Association will become mandatory under the auspices of the Radiocommunications Bill/Act in the near future. **AR**



## EDUCATION NOTES

I have received several letters criticising the February AOCPT Theory exam. The statistics supplied by DOC show that the pass rate was much lower than usual — as shown in the table for the last three February exams.

STATE	1983			1982		1981	
	No candidates	No passing	% pass rate	% pass rate	% pass rate	% pass rate	
VK2	232	60	26	36	32		
VK3	203	46	23	39	35		
VK4	148	20	14	45	31		
VK5/8	106	21	20	49	52		
VK6	80	15	19	50	29		
VK7	31	5	16	36	39		
Total	800	167	21	41	35		

It is tempting to conclude from these figures that this year's exam must have been harder.

However, I am sure this is not the whole answer. It is not so simple.

The papers used in February had all been used previously at major exam centres and had been accepted by candidates as fair. I have recently had another good look at all the papers used, and could find only very minor cause for complaint — one or two questions with a very wordy stem, and one word which would perhaps be unfamiliar to some candidates (not a technical term). Nor were they unbalanced — the number of questions from each section fitted the established pattern.

On each paper, at least forty of the fifty questions had been used on previous papers several times over. So this leaves only the few questions which appeared for the first time on the August papers. As I stated when commenting on the August papers, all these 'new' questions were fair and within the scope of the syllabus. However some of them did require application of knowledge rather than just recall of remembered facts.

Most of us would expect a newly licenced amateur to be able to apply the facts he has learnt to his equipment and operating procedures, and to be able to consider material from several sections of the syllabus in relation to the same problem, so I do not think a few questions of this character are unfair. Next month I will give some examples of this type of question.

The exam system is seen by some individuals as a 'contest' between DOC and the candidates, and many attempts have been made to compile lists of questions as recalled by examinees. These lists may be more of a hindrance than a help to future candidates by giving them false ideas of the actual standard required. Very few people are able to recall exam questions accurately enough to reproduce the precise wording of both stem and choices that may be necessary in a well written question, so the recalled question may end up entirely different from the original.

In other cases, the candidate remembers what he believes to have been the question, not what was actually written. This has been proven in many instances.

Brenda Edmunds VK3KT  
FEDERAL EDUCATION CO-ORDINATOR  
56 Baden Powell Drive, Frankston, Vic 3199

Even if the recalled questions are accurate, they cannot prepare the candidate for any new questions that may be added, or new styles of questions. I have said previously that it is reasonable to expect new questions to be added to the papers from time to time.

Since the Department is planning to introduce quarterly exams at both levels as soon as possible, and is ultimately aiming towards monthly exams, their question bank will need to be greatly extended in the future.

No doubt many of the questions to be added will show a change of emphasis, in keeping with the technological developments. Lecturers and candidates should all be aware of these possibilities.

With the present 'state of the art', a question on a phase-locked loop is much more relevant to most candidates than one on a vacuum tube rectifier high voltage power supply.

Both exam syllabuses are at present undergoing review with a view to reassessing content and defining depth of each section.

If you have any comments to make on these matters, I would be pleased to hear from you by letter (QTHR) or on the Education Net, Wednesday evenings 1100 UTC 3.685 MHz.

For those planning to sit the August exam, our sample paper will be available very soon from me or from the Executive office.

Best of luck to you all and remember —  
**READ THE QUESTIONS.**

73, Brenda VK3KT **AR**



# CONTESTS



Reg Dwyer VK1BR  
FEDERAL CONTEST MANAGER  
PO Box 236, Jamison, ACT 2614

## CONTEST CALENDAR

- JULY**  
 1 Canada Day Contest  
 2-3 Venezuela Phone Test  
 9-10 NZART Memorial Test (June AR)  
 9-10 IARU Radiosport Test  
 16-17 International ORP TEST \*\*\*  
 16-17 SEAnet CW Test \*\*\*  
 30-31 Venezuela CW Test \*\*\*
- AUGUST**  
 6-7 European CW Test \*\*\*  
 13-14 Remembrance Day Contest  
 13-14 DARC WAE CW Test  
 13-14 SEAnet Phone Test \*\*\*  
 17 OLF Activity  
 20-21 SARTG RTTY Test  
 27-28 All Asian CW Test
- SEPTEMBER**  
 3-4 DARC Corona "CORONA" 10 m RTTY  
 10-11 G ORP Activity \*\*\*  
 17-18 VK Novice Test  
 17-18 Scandinavian CW \*\*\*  
 24-25 Scandinavian Phone \*\*\*
- OCTOBER**  
 1-2 VK/ZL Phone Contest \*\*\*  
 15-16 VK/ZL CW \*\*\*

The contests marked with \*\*\* are not yet confirmed...

## OLF ACTIVITY

This contest should be a lot of fun and now there is a certificate for all who enter (cartoon type) and just the thing to let your hair down after the RD contest.

WHEN? — Wednesday, 17th August, 2000 through to 2200.

OBJECT? — To have a packet of fun on 80 metres.

MODE? — CW ONLY... BUT

- 1 You must use a straight key.
- 2 Operate with the hand not normally used, eg a "right-handed person" must operate the key with his LEFT hand and vice versa.
- 3 If ambidextrous, you must operate the key with your foot. (Others may do this by choice for better scoring.)

CYPHER — in three sections — RST/Mode/Branch with mode indicating method of keying as follows... Left Hand (LH); Right Hand (RH); Left Foot (LF); Right Foot (RF); so that a cypher of 579/LF/11 would indicate a report of 579 — operating key with Left Foot and in Branch 11.

SCORING — ONE point per contact EXCEPT in any contact in which either contestant is using "foot keying", both operators will count 2 points for that contact; EXCEPT where both operators use "foot keying", then both will score 3 points. TOTAL SCORE is total of points multiplied by total of different Branches worked.

LOGS — NO log to be submitted — BUT —

determine your own score as per the rules and send this to ZL2GX to be received by 31 August, 1983.

PRIZE — In keeping with such an activity this is not fully determined. It could be a free trip to Antarctica and on the other hand it might not be. Everyone gets a certificate (cartoon type). Please send an SASE.

NOTE — This is NOT an activity for any "sad sack". It is however, an opportunity to have FUN — to populate the band — to populate ALL the band — without stress or strain... so let it be...

## PLEASE NOTE — THE RD CONTEST

The practice of one operator operating two station/calls simultaneously is considered not to be within the spirit of the contest and any logs suspected of this will be disqualified without recourse.

## RTTY IN THE RD

The South Australian Radio Teletype Group (SARG) is attempting to promote the use of teletype in VK and they will be participating in the RD contest as a major exercise to gain coverage for the activity.

It is common knowledge that the band spectrum is 'slightly congested!!!!' during the test and that there are some members of the amateur fraternity that have little, if any, regard for others on the bands. This type of attitude, when carried to its limits, does nothing to promote amateur radio or good sportsmanship and in fact largely attenuates the enthusiasm and progression of the other users.

As amateur radio users we all should be keen to provide the opportunity for any and all groups to participate in the activity of their choice without corruption of their signals.

Therefore, please allow a clear band for the RTTY and CW operators during the contest.

## VK NOVICE CONTEST

Don't forget the VK Novice Contest in September. Let's generate some interest for this contest which had such a poor showing last year. This contest is a marvellous opportunity for all to participate and gain awards. The maximum speed for CW has been reduced to 10 WPM to encourage this mode.

## ALL ASIAN CW

A letter from David Pilley, the winner for Australia in the CW section of the contest was received together with copies of his winning certificates. The medal unfortunately did not reproduce well enough for printing.

He mentions that his win was achieved with the use of a TS820S and 4BTV trapped vertical. So the big equipment is not necessary to win these contests but the will

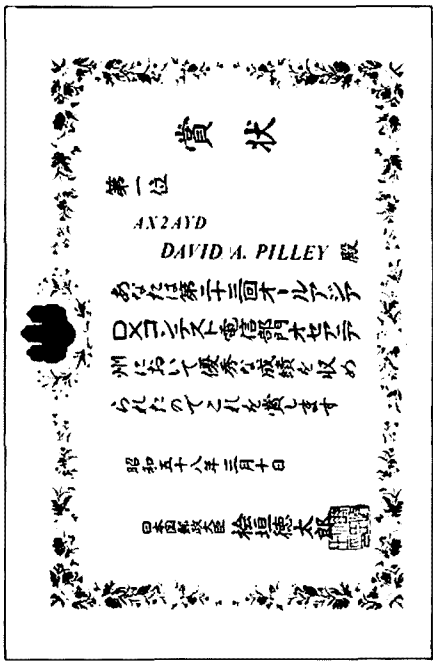

to participate is the most necessary component.

Congratulations David and thanks for representing Australia in this contest.

## AMENDMENTS TO 1983 JOHN MOYLE CONTEST PUBLISHED IN JUNE AR

In Section D, six hour section VK3BSP was omitted with a score of 1038.

Section D, twenty four hour section VK3WI, 3259 score was omitted.

Section I, twenty four hour section VK3WP, 370.

Section I, six hour section VK5NOD, 510.

Apologies to these stations for their omission, for full results see page 44, June Amateur Radio.

## KEYMEN'S CLUB OF JAPAN (KCJ) SINGLE OPERATOR CW CONTEST

OBJECT — To work as many amateur stations in as many Japanese prefectures as possible using Japanese CW bands.

ELIGIBILITY — Single operator amateur stations worldwide.

PERIOD — Starts 1200 UTC Saturday followed by the third Sunday in August; ends 1200 UTC the Sunday (August 20-21, 1983).

CATEGORIES — Single operator, CW only: a) All Bands. b) Single Band.

CONTEST EXCHANGE — JAs — RST plus Prefecture Code. Others — RST plus Continent Code.

INVALID CONTACT — a) Contact with a multi-operator station.

b) crossmode or not CW

c) crossband, via repeater or satellite.

SCORING — a) Points: One point for the complete



The Japan Amateur Radio League, Inc.

14-2, Segano 1-chome, Toshima-ku, Tokyo, Japan  
P. O. BOX 377 Tokyo Central

**JARL**

(Translation)

CITATION

*AE AX2AYD*

FIRST PRIZE

( Call & Name )

It is my honour to present you this citation as a recognition for your outstanding score achieved during the 23 All Asian DX Contest CW,  
Pa. Region

Date 10 Mar. 1983

Signed Tokutaro Higaki

The Minister of Posts and Telecommunications of Japan ( Minister's seal )

Decisions of The KCJ Contest Committee are official and final.

**DEADLINE** — All entries must be postmarked no later than the last day in November, 1983 and mailed to: Kikuo Takamitsu, JA9FT, 4-16-22 Izuminomachi, Kanazawa, Ishikawa 921 JAPAN.

**REFERENCE**

**1 JAPANESE CW BANDS**

1.907.5-1.912.5 MHz, 3.500-3.525 MHz, 7.000-7.030 MHz, 14.000-14.100 MHz, 21.000-21.150 MHz, 28.000-28.200 MHz, 50.010-50.100 MHz.

**2 JAPANESE PREFECTURE CODES**

AC Aichi, AM Aomori, AT Akita, CB Chiba, EH Ehime, FK Fukui, FO Fukuoka, FS Fukushima, GF Gifu, GM Gunma, HG Hyogo, HK Hokkaido, HS Hiroshima, IB Ibaraki, IK Ishikawa, IT Iwate, KA Kagawa, KG Kagoshima, KM Kumamoto, KN Kanagawa, KO Kochi, KT Kyoto, ME Mie, MG Miyagi, MZ Miyazaki, NG Niigata, NN Nagano, NR Nara, NS Nagasaki, ON Okinawa, OS Osaka, OT Oita, OY Okayama, SA Saga, SG Shiga, SN Shimane, SO Shizuoka, ST Saitama, TG Tochigi, TK Tokyo, TO Tokushima, TT Tottori, TY Toyama, WK Wakayama, YG Yamaguchi, YM Yamagata, YN Yamanashi.

**THE 7TH WEST AUSTRALIAN ANNUAL 3.5 MHz CW & SSB CONTESTS TRANSMITTING & RECEIVING**

**RULES**

**1 — DURATION:**

CW — Saturday 30th JULY and Sunday 31st JULY.

SSB — Saturday 3rd and Sunday 4th SEPTEMBER. On both days between the hours of 1100 UTC and 1330 UTC time ie 5 operating hours in all for each contest.

**2 — FREQUENCIES:**

All contacts to be made in the 3.5/3.7 MHz band using frequency allocation applicable to your licence conditions.

**3 — CALLING:**

Stations will call CO WAA using the three times three technique, infringement of this rule by the use of long CQ calls may entail disqualification as will pre-arranging of a QSO.

**4 — SCORING:**

Points for contacts are as follows:  
Within Western Australia 5 points per contact.  
WA to all Mainland  
    Eastern States      2 points per contact.  
WA to VK7            4 points per contact.  
WA to VK0 & Overseas 8 points per contact.  
Stations other than WA 3 points per contact with WA stations only.

**5 — MULTIPLIERS:**

A multiplier of 2 per WA Shire worked will apply to the final score.

**6 — CONTACTS:**

Stations may be worked twice on each night ie once between 1100 to 1300 UTC and again between 1300 to 1330 UTC these contacts will count for points. Each time the contact for WA stations will take the form of an exchange of 5 characters comprising RST/RS and Shire Letters.  
Eg a station in NORTHAM sends 579 NM or if in HARVEY 579HY this helps towards the worked all shires award.  
Eastern States and Overseas stations will send RST/RS plus a running number starting at 001.

**The Japan Amateur Radio League**

**ALL ASIAN DX CONTEST**

CALL: \_\_\_\_\_  
PLACE: \_\_\_\_\_  
SECTION: \_\_\_\_\_ OPERATOR: \_\_\_\_\_

貴局は、第23回オールアジアDXコンテストに際しての優秀なる成績を認められましたのでこれを表彰します。

This certifies that you have submitted a log for THE ALL ASIAN DX CONTEST.

Dated at Tokyo, Japan

Date: 2 Mar. 1983



President, JARL

**David's certificates**

- a) contact with a station in Japan on each band.
- b) Multipliers: Forty-seven Japanese prefectures on each band.
- c) Final Score: Multiply points by sum of multipliers.

**LOG INSTRUCTION** — a) Log should indicate time in UTC, callsign and exchange.

b) Multipliers should be clearly marked in the log only the first time it is worked on each band.

c) Use a separate sheet for each band.

d) The callsign of the entrant should be indicated in every sheet of the log.

e) Each entry must be accompanied by a

**Summary Sheet.**

**AWARDS** — Certificates will be awarded:

a) The top through the third scorer in each entry category.

b) Top scorers in each continent and Japanese prefecture who are ranked in the higher half of the whole entrants in each category.

All scores will be published. It is available by 1 IRC (surface mail) or 7 IRCs (air mail) enclosed with the log.

**DISQUALIFICATIONS** — An entry with more than two per cent duplicate and/or invalid contacts left on the log will be disqualified. Violation of the amateur radio regulations and/or the rules of the contest will cause disqualification.

DATE:		CALL:		OPERATOR:		
Time UTC	Call Wkd	RST Out	RST In	Shire Letters	Shire Multiplier	Points Claimed

7 - LOGS:  
Contest logs to be set out on one side of a Quarto or Foolscap sheet with columns headed as sample log.

**SAMPLE LOG:**  
Column 7 to be totalled at the foot of each page and the running totals brought forward. The last page to contain the following summary: Total number points score, Input power, Equipment and Antennas used, along with comments on the contest in general. SWL participants score as above using the outgoing Tx score.

All logs to be addressed to the WAA Contest Committee, PO Box 6250, Hay Street East, Perth 6000 and posted so as to reach us not later than 31st August for the CW Contest and 30th September for the SSB Contest. The results for both contests will be published in the December issue of AR.

**SHIRE LETTERS**

- 1 - ALBANY TOWN ..... AT
- 2 - ALBANY ..... AL
- 3 - ARMADALE ..... AK
- 4 - AUGUSTA - MARGARET RIVER ..... AM
- 5 - BASSEDEAN ..... BA
- 6 - BAYSWATER ..... BW
- 7 - BEVERLEY ..... BV
- 8 - BODDINGTON ..... BO
- 9 - BOULDER ..... BD
- 10 - BOYUP BROOK ..... BB
- 11 - BRIDGETOWN - GREENBUSHES ..... BG
- 12 - BROOKTON ..... BK
- 13 - BROOME ..... BE
- 14 - BROOMEHILL ..... BH
- 15 - BELMONT ..... BL
- 16 - BRUCE ROCK ..... BR
- 17 - BUNBURY ..... BY
- 18 - BUSSELTON ..... BN
- 19 - CANNING ..... CA
- 20 - CAPEL ..... CL
- 21 - CARNAMAH ..... CH
- 22 - CARNARVON ..... CN
- 23 - CHAPMAN VALLEY ..... CV
- 24 - CHITTERING ..... CI
- 25 - CLAREMONT ..... CT
- 26 - COCKBURN ..... CR
- 27 - COLLIE ..... CE
- 28 - COOLGARIE ..... CG
- 29 - COOROW ..... CW
- 30 - CORRIGIN ..... CS
- 31 - COTTESLOE ..... CO
- 32 - CRANBROOK ..... CK
- 33 - CUBALLING ..... CB
- 34 - CUE ..... CU
- 35 - CUNDEROIN ..... CD
- 36 - DALWALLINU ..... DU
- 37 - DANDARAGAN ..... DN
- 38 - DAROANUP ..... OP
- 39 - DENMARK ..... DK
- 40 - DONNYBROOK - BALINGUP ..... DB
- 41 - DOWERIN ..... DR
- 42 - DUMBLEYUNG ..... DG
- 43 - DUNDAS ..... DS
- 44 - EAST FREMANTLE ..... EF
- 45 - EAST PILBARA ..... EP
- 46 - ESPERANCE ..... ES
- 47 - EXMOUTH ..... EH
- 48 - FREMANTLE ..... FM
- 49 - GINGIN ..... GG
- 50 - GNOWANGERUP ..... GP
- 51 - GERALDTON ..... GN
- 52 - GOOMALLING ..... GM
- 53 - GOSNELLS ..... GS
- 54 - GREENOUGH ..... GR
- 55 - HALLS CREEK ..... HC

- 56 - HARVEY ..... HY
- 57 - IRWIN ..... IN
- 58 - KALAMUNDA ..... KA
- 59 - KALGOORLIE ..... KL
- 60 - KATANNING ..... KG
- 61 - KELLERBERRIN ..... KN
- 62 - KENT ..... KT
- 63 - KOJONUP ..... KP
- 64 - KONDININ ..... KD
- 65 - KOORDA ..... KO
- 66 - KULIN ..... KU
- 67 - KWINANA ..... KW
- 68 - LAKE GRACE ..... LG
- 69 - LAVERTON ..... LV
- 70 - LEONORA ..... LA
- 71 - MANDURAH ..... MB
- 72 - MANJIMUP ..... MP
- 73 - MEEKATHARRA ..... MK
- 74 - MELVILLE ..... MV
- 75 - MENZIES ..... MZ
- 76 - MERREDIN ..... MD
- 77 - MINGENEW ..... MW
- 78 - MOORA ..... MA
- 79 - MOROWA ..... MR
- 80 - MOSMAN ..... MS
- 81 - MUKINBUDIN ..... MU
- 82 - MULLEWA ..... ME
- 83 - MUNDARING ..... MG
- 84 - MURCHISON ..... MH
- 85 - MURRAY ..... MY
- 86 - MT MAGNET ..... MM
- 87 - MT MARSHALL ..... ML
- 88 - NANNUP ..... NP
- 89 - NAREMBEEN ..... NN
- 90 - NARROGIN ..... NG
- 91 - NARROGIN TOWN ..... NT
- 92 - NEDLANDS ..... NL
- 93 - NORTHAM ..... NM
- 94 - NORTHAM TOWN ..... NO
- 95 - NUNTHAMPTON ..... NH
- 96 - NUNGADIN ..... NG
- 97 - PEPPERMINT GROVE ..... PG
- 98 - PERENJORI ..... PJ
- 99 - PERTH ..... PH
- 100 - PINGELLY ..... PY
- 101 - PLANTAGENET ..... PT
- 102 - PORT HEDLAND ..... PD
- 103 - QUAIRADING ..... QG
- 104 - RAVENSTHORPE ..... RT
- 105 - ROCKINGHAM ..... RM
- 106 - ROEBOURNE ..... RB
- 107 - SANDSTONE ..... SS
- 108 - SERPENTINE - JARRAHDALE ..... SJ
- 109 - SHARK BAY ..... SB
- 110 - SOUTH PERTH ..... SP
- 111 - STIRLING ..... ST
- 112 - SUBIACO ..... SU
- 113 - SWAN ..... SW
- 114 - TAMBELLUP ..... TP
- 115 - TAMMIN ..... TM
- 116 - THREE SPRINGS ..... TS
- 117 - TOODYAY ..... TY
- 118 - TRAYNING ..... TG
- 119 - UPPER GASCOYNE ..... UG
- 120 - VICTORIA PLAINS ..... VP
- 121 - WAGIN ..... WN
- 122 - WANDERING ..... WD
- 123 - WANNEROO ..... WO
- 124 - WAROONA ..... WR
- 125 - WEST ARTHUR ..... WA
- 126 - WESTONIA ..... WS
- 127 - WEST PILBARA ..... WP
- 128 - WICKEPIN ..... WI
- 129 - WILUNA ..... WU
- 130 - WILLIAMS ..... WL
- 131 - WONGAN - BALLIDU ..... WB
- 132 - WOODANILLING ..... WG
- 133 - WYALKATCHEM ..... WY
- 134 - WYNDHAM EAST - KIMBERLEY ..... WE
- 135 - WEST KIMBERLEY ..... WE
- 136 - YALGOO ..... YO
- 137 - YILGARN ..... YN
- 138 - YORK ..... YK

## A Call to all holders of a **NOVICE LICENCE**

Now you have joined the ranks of Amateur Radio, why not extend your activities?

**THE WIRELESS INSTITUTE OF AUSTRALIA (N.S.W. DIVISION)**

conducts a Bridging Correspondence Course for the AOCF and LAOCF Examinations.

Throughout the Course, your papers are checked and commented upon to lead you to a **SUCCESSFUL CONCLUSION.**

For further details write to:  
**THE COURSE SUPERVISOR, W.I.A.**  
P.O. BOX 1066, PARRAMATTA, NSW 2150

## WANTED TO BUY

*Ham gear, CB equipment, Hi Fi, video, car stereo, large or small quantities.*

**WE BUY AND SELL ANYTHING ELECTRONIC ANY QUANTITY ANY CONDITION**

---

# HAMRAD

---

104 Highett Street, Richmond, Victoria.  
Phone: (03) 428 8136



**KENWOOD**

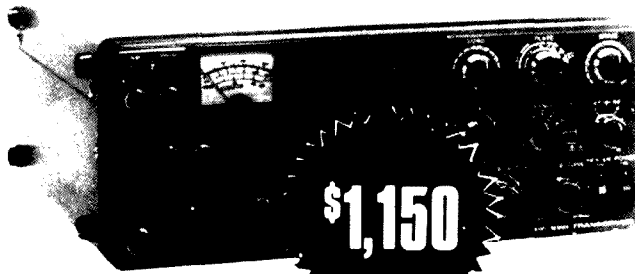

**\$1,150**

**TS-830S**  
SOLID STATE  
HF TRANSCEIVER  
COMPLETE WITH  
MC-35S MICROPHONE  
AND VFO-240.

**TR-3500**  
70CM FM  
HAND-HELD  
COMPLETE  
WITH SC-4

**\$390**



**\$460**

**SM-220**  
STATION MONITOR  
COMPLETE WITH  
BS-5 OR BS-8  
ADAPTOR



**\$760**

**TS-130SE**  
HF SSB/CW TRANSCEIVER  
COMPLETE WITH  
DFC-230 FOR ONLY \$50 EXTRA



**TR-7950**  
2M FM TRANSCEIVER

Ask your dealer  
for this  
Super Price.

**NEW LOG PERIODIC  
ANTENNA TK-50/600**

CONTINUOUS COVERAGE -  
FULLY ASSEMBLED  
50 MHZ to 600 MHZ — 19 ELEMENTS  
3 Metre Boom — 80dB Minimum gain  
12dB Maximum gain.  
Ideal for TV, Radio, Transceivers, ATV etc.,  
Maximum power 300 Watts.

**\$175**

**THE BEST ANTENNA FOR YOUR SCANNER!**

**TR-2400 OWNERS**

**ST-1  
AC/DC  
BASE STAND**



**\$30**

PLUS  
P & P

**TRIO-KENWOOD (AUSTRALIA) PTY. LTD.** ANY CUSTOMERS EXPERIENCING DIFFICULTY IN OBTAINING  
KENWOOD EQUIPMENT SHOULD CONTACT TRIO-KENWOOD  
AUSTRALIA DIRECT AT HEAD OFFICE.

(INCORPORATED IN N S W)  
4E WOODCOCK PLACE, LANE COVE, SYDNEY, N.S.W. 2065.  
Ph. (02) 428 1455

**NEW SOUTH WALES**

- TRIO-KENWOOD AUSTRALIA PTY. LTD. 4E WOODCOCK PLACE, LANE COVE, SYDNEY, N.S.W. 2065
- SPRINGWOOD CAR RADIO — SPRINGWOOD (047) 51 4930
- UNIQUE ELECTRONICS — 218 OLD PROSPERITY ROAD, ST. HELEN, WENTWORTHVILLE (02) 631 6689
- WASH ELECTRONICS — 11 SUMMER STREET, ORANGE (063) 62 6249
- WILLIAMS & HUGHES — BYRON STREET, INVERELL (067) 22 1300
- ELECTRO 2000 — 112 CABELL STREET, HIGHER HILL, NEWCASTLE (049) 69 6399
- MALCOLM PTY. LTD. — 99 KENNY STREET, WOLLONGONG (042) 29 1455
- RADIO WORLD PTY. LTD. — 81 NEWCASTLE STREET, Fyshwick (062) 80 6550
- ON ENGINEERING — 5 JASMINE STREET, PORI MACQUARIE (065) 83 2175
- LANE COVE — 45 MILLALEY ROAD, GUNNDAH (067) 42 2838
- LANE COVE — 61 BARNES STREET, LANNWORTH (067) 65 4627
- LANE COVE — 151 ISMORL (066) 86 2145

**INTERSTATE**

- VIC: EASTERN COMMUNICATIONS — 168 ELGAR ROAD, BOX HILL (03) 288 3107
- BRIAN STARES — 11 MALMSBURY STREET, BALLARAT (053) 39 2808
- SUMNER ELECTRONICS — 78 KING STREET, BENDIGO (054) 43 1977
- TAS: HOBBY ELECTRONICS — 477 NELSON ROAD, MT NELSON (002) 23 6751
- GELSTON ELECTRONICS — SUMMER HILL (003) 27 2256
- ADVANCED ELECTRONICS — 5A THE QUADRANT, LAUNCESTON (003) 31 7075
- VK ELECTRONICS — 57 WEST PARK GROVE, BURNIE (004) 31 1708
- MITCHELL RADIO CO. — 59 ALBION ROAD, ALBION (07) 57 6830
- QLD: S.A. & N.T.: INTERNATIONAL COMMUNICATIONS SYSTEMS PTY. LTD. — 8 NILE ST. PORT ADELAIDE (08) 47 3688
- ARENA COMMUNICATIONS SERVICES — 642 ALBANY HWY. EAST VICTORIA PARK (09) 361 5422
- TRI-SALES — CNR NEWCASTLE & CHARLES STREETS, PERTH (09) 328 4160
- WILLIS ELECTRONICS — 445 MURRAY STREET, PERTH (09) 321 2207
- BAY RADIO — 18 BANKSIA STREET, BUNBURY (097) 21 2236
- RON DENT — 115 PATON ROAD, SOUTH HEADLAND (091) 72 1112
- SELECT TRONIX — TOM PRICE (091) 89 1564

# MAGAZINE REVIEW



Roy Hartkopf VK3AOH  
34 Toolangi Road, Alphington, Vic 3078

(G) General. (C) Constructional. (P) Practical without detailed constructional information. (T) Theoretical. (N) Of particular information to the Novice.

## HAM RADIO January 1983

Report on propagation on the New Amateur Bands. (G) Azimuth and Elevation Calculator. (P) LF Converter. (P) The nicad 'memory' myth. (G)

## BREAK IN March 1983

HF Antenna Special.

## CQ-TV No 121 February 1983

1 GHz oscillator. (C)

## HAM RADIO March 1983

15th Anniversary Issue.

## BREAK IN April 1983

NZART Annual Conference.

## ORBIT No 12 February 1983

World wide Satellite news.

## 73 MAGAZINE May 1983

Annual Antenna Issue. Home Brew Contest.

## 73 MAGAZINE June 1983

Meter Special. New and old methods of using surplus meters. (G) International News. (G) Diary of a partially sighted amateur. (G)

## VHF COMMUNICATIONS

A European magazine published quarterly. Could be of interest to the advanced experimenter in UHF and microwaves, weather-satellite images etc. Boards and components are not easily available for the projects but basic ideas and information can be useful. Ten year index is available from WIA Federal Headquarters. Also some back copies.

## MICROWAVES AND RF

Hayden Publishing Co Inc USA. A professional magazine giving state of the art information on new products, microwave synthesisers, RF Mosfet amplifiers giving 600 watts of RF output, etc.

## WHAT'S NEW IN COMPUTING WHAT'S NEW IN ELECTRONICS

Australian Trade Magazines published by Westwick Farrow Pty Ltd NSW. Information on new products and where further literature (and possibly the actual products themselves) can be obtained. Further information available from the publishers. Recent developments include components such as a 256 K-bit EPROM and a one farad capacitor.

AR

Buying or selling Gear  
Use HAMADS first

# FORWARD BIAS

## VK1 DIVISION



John MacPhee VK1NEN  
VK1 PUBLIC RELATIONS OFFICER  
36 Kavel Street, Torrens, ACT 2607

How many times have you come up on 3.570 MHz at 1030 UTC on Sunday evenings for the VK1 Awards Net and hear the same VK1 callsigns that have been there every week? How about putting some new blood into the Awards Net? Why don't we have more full-call VK1's joining the net or better still offering to control the net for one evening? This would give our VK1 Awards Manager, Gavan VK1NEB an evening off occasionally. Think about it and any VK1 novice or full-call wishing to be VK1 Award Net Controller for an evening contact Gavan VK1NEB, Ph: 58 5390.

## QSL CARDS — NON-FINANCIAL MEMBERS

These cards will be found in the unsorted QSL card bag at each monthly meeting.

## ATV GROUP

My sources have informed me that test pictures have started and that further developments and experiments are con-

tinuing. Further information will be in August AR.

## VK1 BULK PURCHASES

The VK1 Division in the past have made bulk purchases of URM67 coax and will be purchasing more in the very near future. We have also purchased 6146B valves in quantity.

Do you have any suggestions on bulk purchases, eg PL259 connectors?

If you do contact Alan VK1KAL on 58 2568 Home.

## MEETING AGENDA

JULY: Cooper Tools — Soldering Equipment.  
AUGUST: Radio Inspector.

Well that's it for this month. If you have any information to be included in future "FORWARD BIAS" contact John VK1NEN 86 3290 Home.

73 John VK1NEN  
AR

# LEARNING THE MORSE CODE? Try the All New BT-1 — Basic Trainer For Morse Code

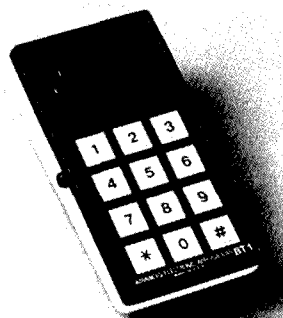

Advanced Electronic Applications in conjunction with ETS (Educational Technology and Services)\*, has developed the BT-1 Code Trainer. ETS methodology, based upon research by a prominent mid-west university, has demonstrated that a typical student using this system and the BT-1, can learn Morse Code to speeds of 20 WPM in four weeks based upon two 20 minutes daily training sessions.

The pre-programmed BT-1 computerised trainer will allow you to achieve proficiency in Morse Code faster than any other known method.

No prior knowledge of Morse Code is required to use the BT-1. There are no tapes to purchase or wear out. The BT-1 operates from a 12 VDC source, the unit can also be used in mobile settings via the 12 VDC system.

\* Education Technology & Services, see page 81 October 1981 issue of Ham Radio Magazine.

Prices and Specifications  
Subject To Change Without  
Notice Or Obligation

ADVANCED ELECTRONIC  
APPLICATIONS

Brings you the  
Breakthrough!

\$134.40 (Inc. of ST) Plus P&P

## HY-TECH DISTRIBUTORS

Building 51,  
Archerfield Aerodrome, Q 4108  
Tel: (07) 277 5624  
Telex 43318



# VK2 MINI BULLETIN

Jeff Pages VK2BYY  
PO Box 1066, Parramatta, NSW. 2150



# VK4 WIA NOTES

Bud Pounsett VK4QY  
NEWS & INFORMATION OFFICER  
33 Lasseter Street, Kedron, Qld. 4031.

## COUNCIL REPORT

Divisional Council met on the 6th May. Affiliated Clubs Officer Jeff Pages reported on the 8th Conference of Clubs, and matters arising from the Conference were discussed (see June AR Mini Bulletin). The opening of Amateur Radio House took up considerable time with the technicalities and fine detail becoming more complex as we looked closer at it. Last minute preparations included the setting up of various displays and organisation of the closed circuit TV link and video recording. Federal Councillor Stephen Pall presented a detailed report on the Federal Convention, and while many of the agenda items from VK2 were lost considerable experience was gained. Maintenance and improvements at Dural were considered, particularly with a view towards operating the Divisional station in the Australian contests. Council approved the purchase of a tri-band beam and rotator, as well as a quantity of coaxial cable. Interference during callbacks on the Dural, 2 metre repeater was discussed, and it was decided to rearrange the order of callbacks so as to take the 2 metre callbacks first.

## FIREWORKS NIGHT

The Dural fireworks night was cancelled due to a poor response to ticket sales. Considerable discussion of reasons for the downturn in interest took place during the 2 metre callbacks, giving the Dural Committee plenty of food for thought. If you have any ideas as to why this once popular event failed to attract many starters this year, or if you have any thoughts on alternative activities, please put pen to paper. Whilst on this subject, it should be pointed out that the Dural property is available to any member or club wishing to use it for barbecues, contests and so forth, provided prior arrangements are made.

## VK2 WICEN

The following exercises will be taking place over the next few months and interested amateurs may obtain further details on the Thursday night nets, VHF in Sydney on VK2RWS 7.150 at 9 pm and statewide on 3.600 MHz at 9.30 pm. Information is also given on the Sunday broadcasts.

9 July — Car rally at Batemans Bay on the south coast.

7 August — City to Surf foot race in Sydney.

17/18 September — Welfare message handling exercise, statewide.

Written communications to the WICEN Committee should be sent C/- PO Box 154, Roseville, NSW, 2069.

## AFFILIATED CLUBS

The Divisional library at Parramatta includes a section devoted to club newsletters, and librarian Aub Topp would appreciate receiving copies of such newsletters.

Here is some further information on three of our affiliated clubs.

### SUMMERLAND AMATEUR RADIO CLUB

PO Box 524, Lismore, NSW, 2480.  
Meetings: Workshop — Thursdays 1900, General — 3rd Friday monthly, at Kadina High School, Goonellabah, Lismore.

Nets: Repeater 6800 and 28.470 MHz Fridays 2000 EAST, 3.605 MHz daily 0630 EAST.

Committee: President — J G Virtue VK2GJ, Vice President — E J Virtue VK2EJV, Secretary — W K Munn VK2YHN, Treasurer — J W Alcorn VK2KCK, Committee members — L Martin VK2EA, L W Cook VK2ZAQ, E G Smith VK2ZFS.

Repeaters: VK2RiC channel 6800, VK2RSC channel 8675.

### CASTLE HILL RSL AMATEUR RADIO CLUB

C/- Mills Raod, Glenhaven, NSW, 2154.  
Meetings: 1st Wednesday of the month at 8 PM at the Castle Hill RSL Club.  
Nets: 28.450 MHz on the 2nd Wednesday of the month.

Committee: President — R Hudson VK2YVO, Vice President — P Balnaves VK2KDZ, Secretary/Treasurer — C MacKinnon VK2DYM, Publicity — I O Toole VK2ZIO.

Classes: AOCP and NAOCP courses each Monday and Tuesday night.

Club callsign: VK2DXS

### GOULBURN AMATEUR RADIO SOCIETY

C/- W J Garvey, Lot 22 MacArthur St, Taralga via Goulburn.

Meetings: 2nd Wednesday of each month at the Goulburn Police Boys Club.

Committee: President — I Jeffrey VK2XIJ, Vice President — D Thompson VK2PRA, Secretary/Treasurer — W Garvey VK2KWG.

Nets: 3.615 MHz at 2100 EAST each Sunday.

Any news and information for inclusion in the September Mini Bulletin should be sent to the WIA NSW Division, PO Box 1066, Parramatta, NSW, 2150 to reach the office by the 22nd July.

AR

## WANTED

**TAPE RECORDING.** I would like to obtain a copy of a tape which was made by W1HDQ in 1960 with the title "VHF Horizons". Approx 1 hour long. Several copies were made and distributed round Australia. Any information to Tim Mills VK2ZTM at PO Box 204, Willoughby, 2068.

## QUEENSLAND COUNCIL 1983/84

The incoming council was declared elected at the re-convened Annual General Meeting of the Division on 20 May. Eleven amateurs stood for council and were duly declared elected, there being no need for a ballot.

These are your councillors for the 1983/84 year and their portfolios.

GUY MINTER VK4ZXZ President & Alternative Federal Councillor  
HAROLD BREMMERMAN VK4HB Senior Vice-President & Minute Secretary  
THEO MARKS VK4MU Secretary  
ROSS MUTZELBURG VK4AOK Treasurer  
JOHN AARSSE VK4QA Junior Vice-President & Research Officer  
BILL DALGLEISH VK4UB Club Liaison  
KEN AYERS VK4KD State WICEN Co-ordinator  
BARRIE KER VK4BIK Publicity  
BUD POUNSETT VK4QY News & Information  
DON HOPPER VK4NN Service Liaison  
ALAN WEST VK4KWK

## BARCFEST 1983

7 May will go down in the history of amateur radio in Queensland as the birth-date of BARCFEST. This is the name given to the gathering of amateurs at the Indooroopilly High School, organised by the Brisbane Amateur Radio Club. The event was an outstanding success. There were a number of displays which attracted a lot of interest and the most talked about after the event were the RTTY and SSTV demonstrations. The South East Queensland Tele-type Group staged the former, while two individual amateurs, Rob Green, VK4NB and Col Powell, VK4ATC, demonstrated their slow-to-fast scan digital converters. There were a number of lectures and not to be left out, there was plenty of interest for the XYLs and kids, handicrafts, pottery and jumble sales. It was a one day event and was attended by some 300 amateurs. Southeast Queensland amateurs are hoping that this 1983 event will be the first of many.

## CONGRATULATIONS, MICHAEL!

Twelve year old Michael Minter, son of Guy VK4ZXZ and Anne, VK4NRA has passed his novice examination. How Guy and Anne found the time to teach Michael the mysteries of radio must in itself remain a mystery. Guy is our Divisional President and Anne is our bookshop manager. Proud Dad is hoping to talk DOC into giving Michael the callsign, VK4VXZ.

Bud VK4QY



# VK3 WIA NOTES

Jim Linton VK3PC  
PRESIDENT VK3 DIVISION



# FIVE-EIGHTH WAVE

Jennifer Warrington VK5ANW

59 Albert Street, Clarence Gardens, SA 5039

At the general meeting of the VK3 Division the following office bearers were elected.

- SECRETARY — Ian Palmer VK3YIP
- PRESIDENT — Jim Linton VK3PC
- VICE
- PRESIDENT — Bill Wilson VK3DXE
- TREASURER — Des Clarke VK3DES
- FEDERAL — Alan Noble and
- COUNCILLORS Des Clarke

"Despite what some think, intruder watching is not hard.

"If you're interferred with during a QSO just make a log note of it and at the end of the month send a report to the Intruder Watch Co-ordinator," he said.

Alf explained that an operator needed to spend only a little time and effort to be an observer. His message was clear — every radio amateur and SWL can help the

The Annual General Meeting took place on Tuesday 26th April and the following members were elected to Council. The positions were discussed and nominations made at subsequent Council Meetings.

President	Bill Wardrop	VK5AWM
Secretary	David Clegg	VK5AMK
Treasurer	Graham Ratcliff	VK5AGR
Vice		
President	Dick Boxall	VK5ARZ
Vice	Jenny	
President	Warrington	VK5ANW
Federal	Jenny	
Councillor	Warrington	VK5ANW
Membership		
Secretary	Ken Westerman	VK5AGW
Minutes		
Secretary	John Gardiner	VK5PJG
Education		
Officer	Roland Bruce	VK5OU
DOC Liaison		
Officer	David Clegg	VK5AMK
Alternate		
Federal		
Councillor	David Clegg	VK5AMK
Facilities		
Supervisor	David Clegg	VK5AMK
Facilities		
Supervisor	Graham Ratcliff	VK5AGR



Jim VK3PC presents Alf VK3LC with a silver medallion.

Photograph by Barry Wilton VK3YXX.

## VK3 HONOUR INTRUDER WATCH

The Victorian Division has honoured Alf Chandler VK3LC for his long service to the WIA and the International Amateur Radio Union.

At this year's VK3 Annual General Meeting he was awarded a silver medallion in recognition of his work in Intruder Watching. VK3 Councillor, Jim Linton VK3PC, in making the presentation, said: "Occasionally one comes across a person who leaves a lasting impression and is the type who goes about his job with a minimum of fuss and a high degree of efficiency. One such person is Alf Chandler who has served as Victorian, Federal and IARU Region 3 Intruder Watch Co-ordinator."

Alf retired as IWC last January after fourteen years, but would continue to file reports on intruders.

In accepting the medallion the old-timer who got his ticket in 1926 said he was indeed honoured. Launching into an off-the-head speech Alf said he would be failing if he didn't put a mention in for the Intruder Watch Service.

Intruder Watch Service by simply sending as little as one report on an intruder.

VK3 Intruder Watch Co-ordinator is Steve Phillips VK3JY (QTHR), who can supply free cassettes of intruder modes of transmission to help anyone identify intruders.

A list of know intruders on 80, 40, 20, 15 and 10 metres is also available and is certainly an easy method to get started on intruder watching.

Alf Chandler said the Intruder Watch had been successful in getting intruders out of the exclusive amateur bands over the years.

He recalled a couple of occasions when he had written letters to people in right places pointing out that certain stations had signals where they shouldn't be. Not all intrusions are deliberate, some are spurious emissions or harmonics.

Alf's direct approach has been necessary in the past because some radio administrations have been reluctant to act on reports of intrusions in amateur bands.

The display station which was set up in the GPO from the 17th to the 20th of May was a great success, if the enjoyment of the volunteers was any indication. Contacts were made on 2 metres and HF and the video tape entitled 'Amateur Radio — the national resource of every nation' was shown continuously (courtesy of John Ingham VK5KG who filled one side of a tape with it, and National Panasonic who lent us their 'top of the range' VCR with automatic rewind). Posters lent by Federal Office, displays of QSL cards, a map showing call-areas, and hand-outs of leaflets, old Journals, ARs, and call books, all contributed to make a most impressive and interesting display.

Another piece of PR which we are trying, is a small advertisement placed in the radio column of the Advertiser, on the Saturday prior to General Meetings, advertising the Tuesday night's programme.

It doesn't pay to make a suggestion in this Division, or you may find yourself with a job! John Mount VK5EV suggested that we should have a Disposals Officer, a position that he held for many years in VK6, so who better to know how to get it started in VK5? Congratulations John, and if my recent experience is any indication, you will find it a most rewarding occupation.

## DIARY DATE

26th July, 'Getting started in Constructional Practices' Steve Mahoney — VK5AIM.

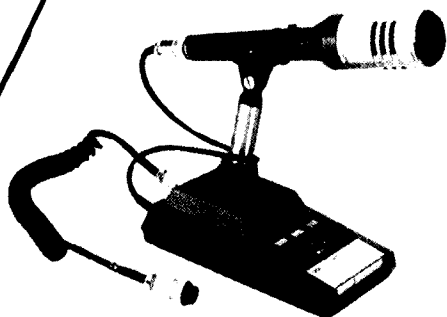

## FT726 V/UHF ALL MODE TRIBANDER

- USB, LSB, FM, CW modes
- 10 watt RF output on two metre (6 metre, 70 centimetre units optional)
- 11 memories store mode as well as band
- Programmable limited band seen between memories
- Satellite I.F. unit (optional) for full duplex cross-band
- Squelch on all modes
- GaAs FET RX pre-amp in 70 centimetre unit



**BAIL ELECTRONIC SERVICES**  
**38 FAITHFUL STREET, WANGARATTA 3677**  
Telephone: (057) 21 6260 — Telex: 56880  
**DISTRIBUTORS AND AGENTS IN ALL STATES**

Stan Roberts  
and Staff —  
VK3BSR



## FT980 HF ALL MODE COMPUTER AIDED TRANSCEIVER

Built-in computer control using 8-bit microprocessor  
(80C85)



- General coverage RX 150KHz-29.99mHz
- Power output 100 watt SSB, CW; 25 watt AM; FSK
- Two independent RX front-ends using JFets
- 12 memory channels storing mode and frequency
- Rear panel connections for transverter, linear amplifier and external microcomputer interface



**BAIL ELECTRONIC SERVICES**  
**38 FAITHFUL STREET, WANGARATTA 3677**  
Telephone: (057) 21 6260 — Telex: 56880  
**DISTRIBUTORS AND AGENTS IN ALL STATES**

Stan Roberts  
and Staff —  
VK3BSR

# AR SHOWCASE

## DIGITALLY-SYNTHESISED HF TRANSCEIVER FROM JRC

JRC presents the JST-100 smart HF amateur-band transceiver incorporating its most advanced radio technology.

The compact HF transceiver employs an 8-bit microprocessor to control all the complicated functions such as band and mode selection, and memory channel access. The 11-channel memory can easily store and recall not only VFO frequencies but also working frequency bands and modes.

The JST-100 is fully equipped with attractive and powerful capabilities such as three PLL circuits phase-locked with a highly stable 10 MHz standard crystal oscillator; two digital VFOs permitting independent selection of bands and modes; and memory finder capability to recall any stored frequency with the working VFO being held.

Standard and optional features are available and include:

Fully digital 10 Hz-Step Synthesiser, Digital



Two-VFO System, 11-channel Memory, Memory Finder Capability, Easy tuning with Main Dial and Up-Down buttons, Easy-to-operate panel design, Receiver Input circuit of Narrow BPF type, Large multi-function display, Remote control of frequencies and modes, Overmodulation indicator, Unique ALC input, Frequency data output.

Options include a power supply antenna tuner, speaker, desk microphone, hand microphone and key.

Further details about this exciting product are available from Vicom.

## M42G 500-512 MHz

The M42G is a 2 dB gain mobile antenna for the 502-512 MHz radio telephone band and has been designed for centre roof mounting on type OB base.

VSWR BW 1.5:1 — 502-512 MHz

Gain — 2 dB

Length — 390 mm

For further information contact Scalar Industries Pty Ltd, 20 Shelley Ave, Kilsyth, Vic 3137. Phone (03) 725 9677.

AR



- The Spratly Island incident — in depth.
- Yaesu's FT-980 "Computer Cat".
- Flexible mods for Yaesu FT-290R.
- An inside look at CIA propaganda stations.

IF YOU HAVEN'T LOOKED AT  
*amateur radio action*  
LATELY, THIS IS WHAT  
YOU'VE MISSED . . .

- The VK3BCN report on emergency communications.
- A plain language summary of the WIA "RADCOM" submission.
- A cheap external VFO for Yaesu's FT-707.
- The complete VHF/UHF frequency and beacon list.

OCEANIA'S AMATEUR MAGAZINE — \$1.50 AT YOUR NEWSAGENT.

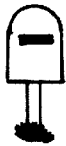

# LETTERS TO THE EDITOR

Any opinion expressed under this heading is the individual opinion of the writer and does not necessarily coincide with that of the publisher.



## MAKE MORE USE OF CW

May I say how much I agreed with and appreciated Marshall Emm's article Pounding Brass in Amateur Radio May 1983. I have had fifty eight years "on the air", much of those years in the communication branch of the FCO and can understand both the amateur and professional outlooks.

The present wording of the RST code, if adhered to when the report is from the S meter, can result in a report as follows "Reading you without any difficulty, your signals are barely audible".

We have a perfectly good code, namely the Q code. QSA and QRK (strength and readability). If it is desired to indicate the reading is by meter this could be done by QSA (Fig) SM. It has always seemed to me unnecessary to have a scale from 1 to 9 for this purpose. A strength of 2 (very weak signal) is frequently changed from 1 to 3 during a QSO and so on up the scale. 4 and 5 often occur together. This effect can be seen on the meter.

If there is a need to refer to the note (I prefer that word to tone), the signal QRI covers that need, and could be re-worded QRI? Is my note faulty. QRI your note is . . .

Quite often very little thought seems to be given to what the operator actually has said in his report. For instance, almost any day can be heard "R5" (followed by) "QRM". In other words "Your signals are perfectly readable, they are being interfered with". I am sure the op in many cases means to say he is reading alright but there are other stations near which might cause QRM. Rather like driving in heavy traffic and complaining that your driving is being interfered with.

May I now please be allowed to make a very sincere plea. Please consider making more use of CW, say one hour each month CW only for all club members with an invitation for any non-members to join in these sessions. I make this plea as I feel sure the future credibility of our service in the eyes of the world could be reduced if the general public becomes increasingly inclined to the following reaction when told about amateur radio: "Oh yes, we got one of those last Christmas, and talk to people all over the place."

The increased use of CW would have to be world-wide but surely Australia could show the way?

Sincerely  
Norman Richardson VK4BHJ  
1069 South Pine Road,  
Everton Hills,  
Brisbane, Qld 4053

AR

## TECHNICAL CORRESPONDENCE

I read with interest, Theo (VK1KV) comments on the 290R and Peter VK2XAN also, as I had one myself. I wrote to Japan and they kindly sent me the enclosed explanation.

Leo Pinkevitch VK2QB  
20 Catherine Street,  
Kotara South, 2288

Dear Mr Pinkevitch,

Thank you for your letter of 3rd February regarding the FT-290R.

We have received reports of overcharge to the Ni-Cd battery from a few customers. According to these reports, we investigated and found that the overcharge trouble is always caused by use of a different DC jack than that which we supply. We found that in some countries, a DC plug similar to ours is available, but the diameter of the outer contact sleeve is smaller than that of the one the transceiver is designed for.

When the non-standard plug is used, the switch on the EXT DC jack does not open the contacts and the DC applied to the EXT DC jack is also applied to the battery installed in the transceiver.

However, this trouble only occurs when the non-standard DC plug is used. When the supplied DC plug is used this trouble never occurs. However, to provide more protection, we have installed an additional diode between the negative terminal of EXT DC jack and ground. This modification protects against reverse DC connection to the EXT DC jack.

We hope and trust this information will prove helpful to you, while we remain.

Very truly yours,  
YAESU MUSEN CO LTD  
S. Yokoi, Export Department  
Box 1500, Tokyo, Japan

This is in reply to Peter Laughton's somewhat incomprehensible letter on page 51 of the May issue of AR regarding my modification to the Yaesu FT290R which was published in the January issue of your magazine.

My modification as stated is intended to protect the internal cells (NiCad or Alkaline) against the application of the 13.8 volt external power supply should the spring switch in J05 not open when the power supply plug is inserted into J05.

As you will no doubt agree Peter, 13.8 into 9.6 (or dry cells) does not go! At least two users of FT290 rigs in VK1 have found this out to their cost.

I hasten to explain, however, that while the circuit diagram in my article correctly shows the required modification, the written description of the modification which follows the diagram, is incorrect in that insertion of the "added diode" in the manner described would prevent the charging of the NiCads through J04.

Nor for the purposes of this modification should the Yaesu circuit diagram be regarded as a wiring diagram for this section of the FT290, as, in reality, diode D02 connects direct to the centre spring of jack J05, to which the red positive lead from the battery pack also connects.

Therefore, to carry out the mod effectively it is necessary to de-solder the red positive lead and the cathode end of diode D02 from J05, solder the cathode end of the "added diode" to this point, and then proceed as per the circuit diagram in my original article.

With the mod done new alkaline cells in my FT290 provide well in excess of 11 volts to operate my rig "walk portable". More to the point I feel much more secure in the knowledge that when operating with an external 13.8 volt power supply it is most unlikely that the dry cells will have the external supply added to them should the switch contacts in J05 not operate to isolate these cells.

Yours faithfully,  
Theo Vidler VK1KV  
18 Heysen Street,  
Weston, ACT 2611

AR

## COVER APPRECIATION

Congratulations on the cover of the May issue! Now we're really beginning to look professional. The detail, the colour and the composition are all superb and the photographer and all those involved in the preparation of this picture for printing and the final production are to be commended.

It's nice to see the white band across the top of the cover disappear and the title now blended in and the whole bled at the edges.

Thank you all for AR's finest cover ever.  
Harry (R H) Atkinson VK6WZ  
294 Middleton Road,  
Albany, WA 6330

AR

## GOOD HOME

It was with some misgiving that I asked if you could publish in your May issue a "Give Away" in the form of a RAAF AR14 Rx.

I was delighted to find on Thursday 29th April that you had done so and amazed at the response forthcoming over the next few days.

I feel that it might be of interest to the many local and interstate callers to learn that after assessment of several earlier applications I entrusted it to Dennis Sillett VK3WV, who approached me on behalf of the Historic Radio Society on the morning of 30th April.

Thank you for your help in finding a safe home for the old rig.

Yours faithfully,  
Ray Wilson VK3MU  
45 Pleasant Road,  
Hawthorn East, 3123

AR

## ELECTRONIC HOBBYIST!

DO YOU LIVE IN . . .  
Ringwood, Lilydale,  
Boronia, Wantirna,  
Bayswater, Mooroolbark etc? . . .

We carry a comprehensive range of electronic components at very keen prices.

Ian J. TRUSCOTT  
ELECTRONICS

CNR EASTFIELD  
& BAYSWATER ROADS,  
SOUTH CROYDON,  
VIC.  
TELEPHONE  
(03) 723 3860

# IONOSPHERIC PREDICTIONS

Len Poynter VK3BYE

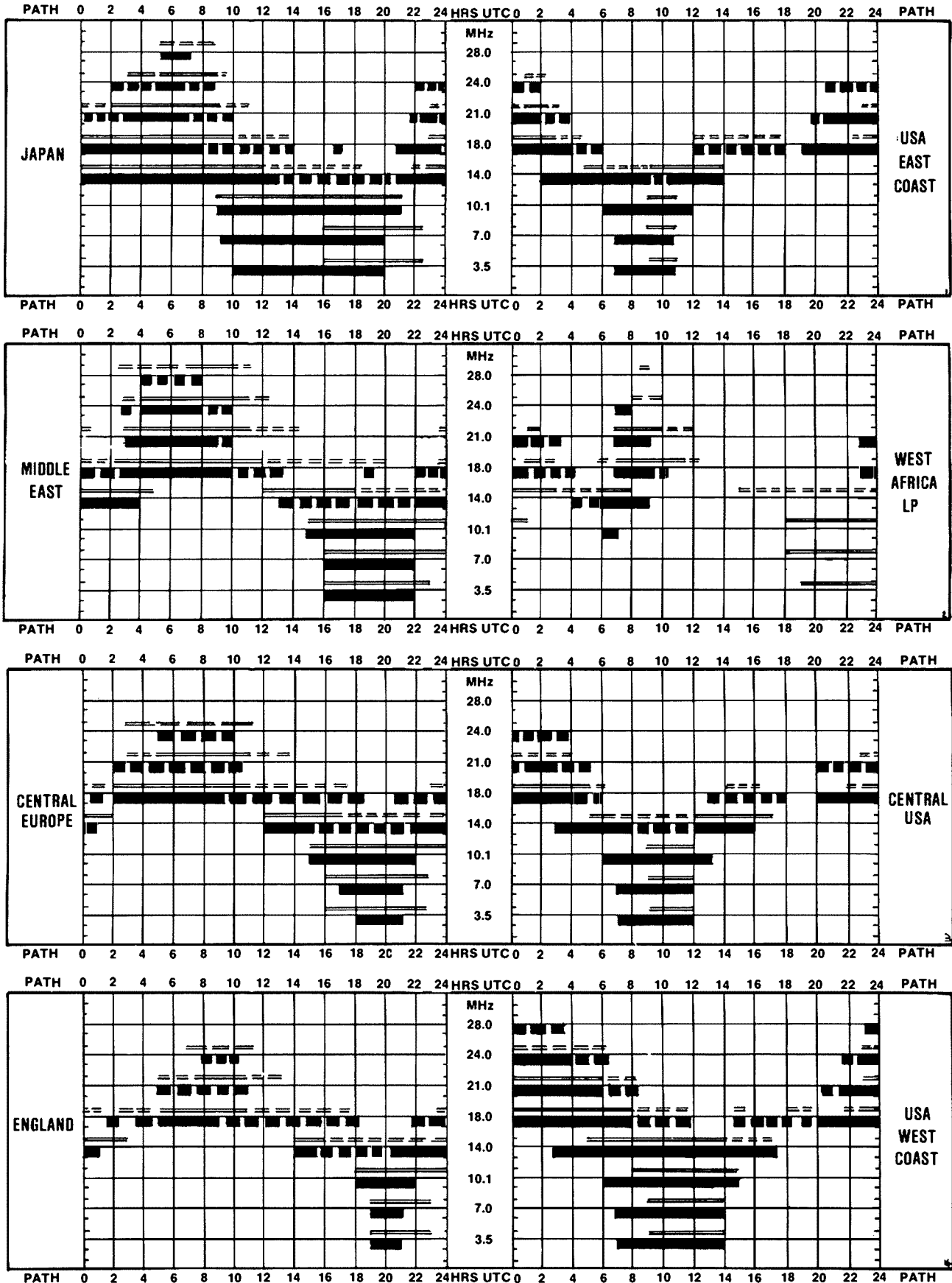



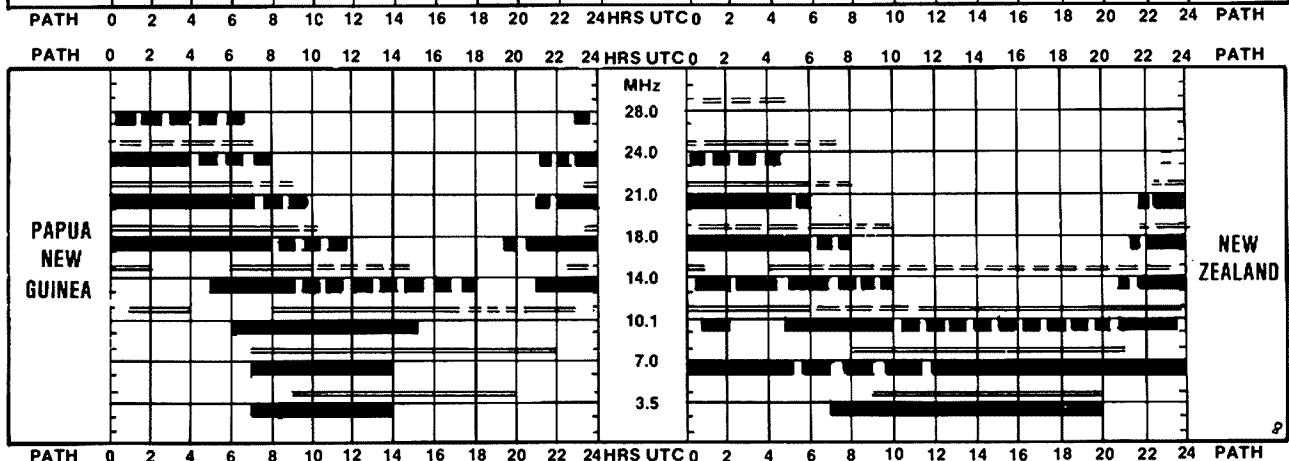
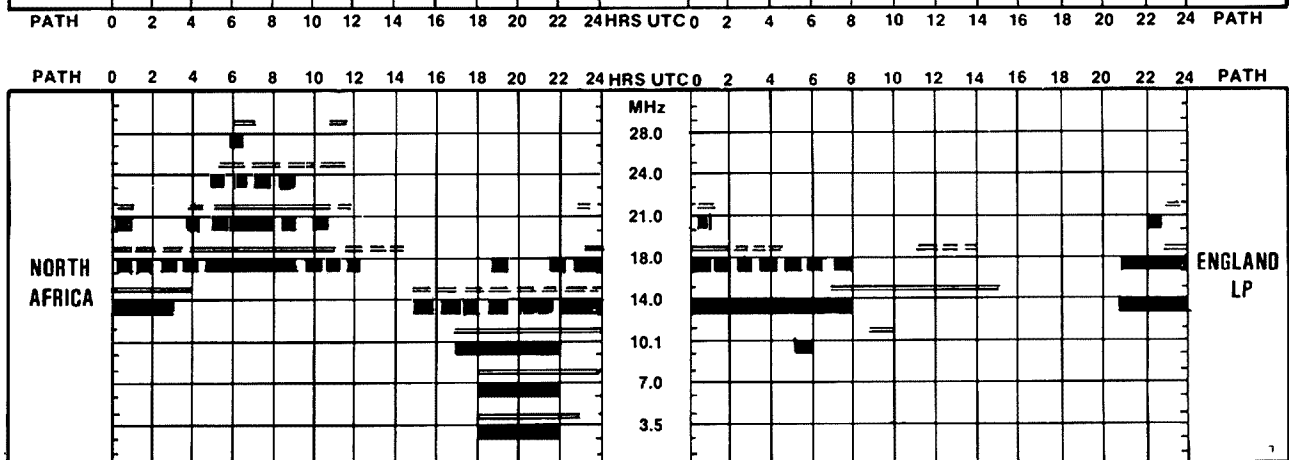
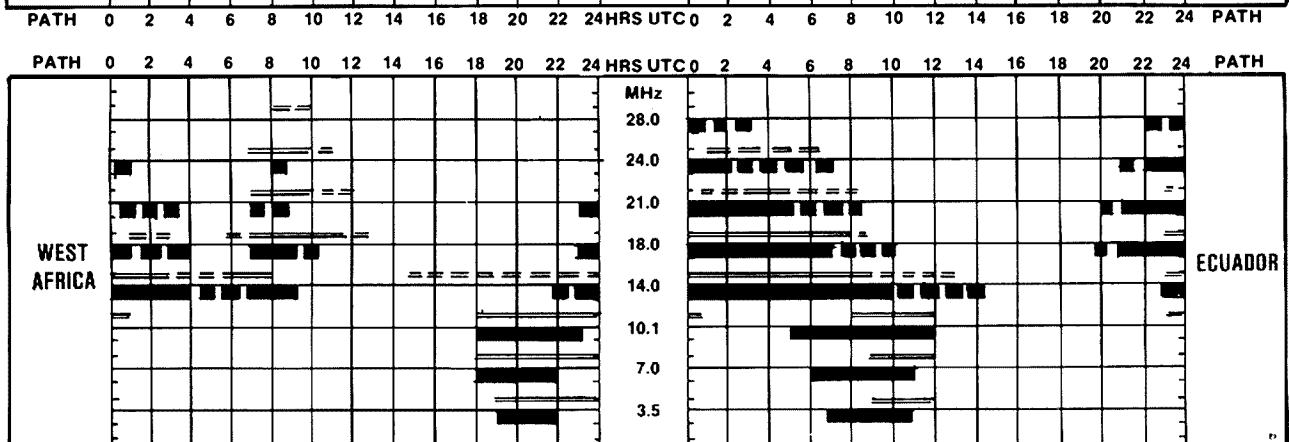
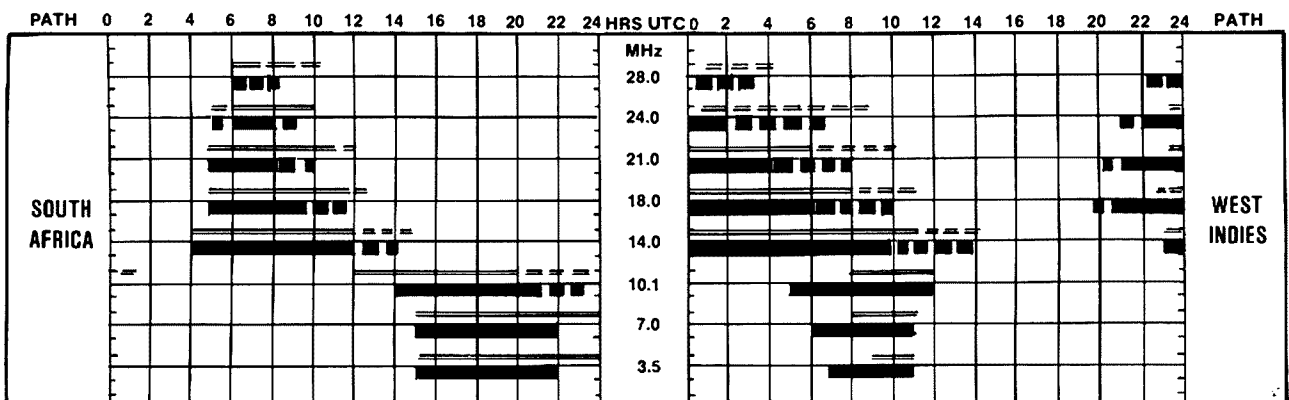

Predictions courtesy Department of Science and Environment IPS Sydney. All times in UTC.



# ILP TOROIDALS — UNBEATABLE VALUE

ILP toroidal transformers meet modern day requirements for a smaller size, low magnetic interference field transformer. Featuring a nearly ideal physical construction, one can expect excellent performance. Small size and weight (approximately 50% of conventional transformers), extremely low noise and low magnetic interference field make the toroidal transformer ideal for compact power supplies.



110 V Primary 0 instead of x  
220 V Primary 1 instead of x  
240 V Primary 2 instead of x

TYPE	SERIES	SECONDARY RMS																			
	No.	Volts	Current																		
30 VA 70x30mm 0.45Kg	1X010	6-6	2.50	80 VA	3X010	6-6	6.64	160 VA	5X011	9-9	8.89	300 VA	7X014	18-18	8.33	625 VA	9X017	30-30	10.41		
	1X011	9-9	1.66		3X011	9-9	4.44		5X012	12-12	6.66		7X015	22-22	6.82		9X018	35-35	8.92		
	1X012	12-12	1.25	3X012	12-12	3.33	5X013	15-15	5.33	7X016	25-25	6.00	9X026	40-40	7.81	140x75mm 5.0 Kg	9X025	45-45	6.94		
	1X013	15-15	1.00	90x30mm	3X013	15-15	2.66	5X014	18-18	4.44	7X017	30-30	5.00	9X033	50-50		6.25	9X042	55-55	5.68	
	1X014	18-18	0.83	1 kg	3X014	18-18	2.22	5X015	22-22	3.63	7X018	35-35	4.28	9X028	110	5.68	9X029	220	2.84		
	1X015	22-22	0.68	Regulation	3X015	22-22	1.81	5X016	25-25	3.20	7X026	40-40	3.75	4%	9X030	240	2.60				
	1X016	25-25	0.60	12%	3X016	25-25	1.60	5X017	30-30	2.66	7X025	45-45	3.33								
	1X017	30-30	0.50	Regulation	3X017	30-30	1.33	5X018	35-35	2.28	7X033	50-50	3.00								
				12%	3X028	110	0.72	5X026	40-40	2.00	7X028	110	2.72								
					3X029	220	0.36	5X028	110	1.45	7X029	220	1.36								
				3X030	240	0.33	5X029	220	0.72	7X030	240	1.25									
							5X030	240	0.66												
50VA 80x35mm 0.9 Kg	2X010	6-6	4.16	120 VA	4X010	6-6	10.00	225 VA	6X012	12-12	9.38	500 VA	8X017	30-30	8.33	Rating	List	Rating	List		
	2X011	9-9	2.77		4X011	9-9	6.66		6X013	15-15	7.50		8X018	35-35	7.14		30 VA	\$24.38	225 VA	\$55.43	
	2X012	12-12	2.08	4X012	12-12	5.00	6X014	18-18	6.25	6X015	22-22	5.11	50 VA	30.59	300 VA	64.28					
	2X013	15-15	1.66	90x40mm	4X013	15-15	4.00	6X016	25-25	4.50	6X017	30-30	3.75	80 VA	33.58	500 VA	88.89				
	2X014	18-18	1.38	1.2 Kg	4X014	18-18	3.33	6X018	35-35	3.21	6X026	40-40	2.81	120 VA	37.96	625 VA	108.09				
	2X015	22-22	1.13	Regulation	4X015	22-22	2.72	6X025	45-45	2.50	6X028	110	2.04	160 VA	45.99						
	2X016	25-25	1.00	11%	4X016	25-25	2.40	6X028	110	2.04	6X029	220	1.02								
	2X017	30-30	0.83		4X017	30-30	2.00	6X029	220	1.02	6X030	240	0.93								
	2X028	110	0.45		4X018	35-35	1.71														
	2X029	220	0.22		4X028	110	1.09														
2X030	240	0.20		4X029	220	0.54															
				4X030	240	0.50															

**IMPORTANT.** Regulator references All voltages quoted are FULL LOAD. Please add regulation figure to secondary voltage to obtain off load voltage.

Rating	List	Rating	List
30 VA	\$24.38	225 VA	\$55.43
50 VA	30.59	300 VA	64.28
80 VA	33.58	500 VA	88.89
120 VA	37.96	625 VA	108.09
160 VA	45.99		

All prices. Sales Tax incl.

To order or for further information please contact:

## ELECTROMARK Pty Ltd

40 Barry Avenue,  
Mortdale N.S.W. 2223  
Telephone (02) 533 4896

**BANKCARD  
ACCEPTED**

## THE VK3BWW FORMULA FOR DX SUCCESS!!

W01105

### HIGH QUALITY AT LOW COST

#### BEAMS

3 EL 10 & 11m .....	\$75.00
3 EL 15m .....	\$83.00
3 EL 20m .....	\$158.00
6 EL 6m .....	\$108.00
5 EL 2m .....	\$36.00
9 EL 2m .....	\$59.00

#### DUOBANDER

3 EL 10m, 3 EL 15m \$148.00  
Prices include Gamma match

Our beams are easy to assemble and adjust. Entirely **NEW CONCEPT — NO NUTS OR BOLTS.**

Spare parts, elements, booms and gamma matches available.  
**Plus Freight**

For further information  
PLEASE RING (03) 366 7042  
**VK3BWW**  
**WERNER & G. WULF**  
92 LEONARD AVENUE  
ST. ALBANS, VICTORIA 3021

## RTTY / CW

Advanced split-screen ASCII, BAUDOT, CW software for Commodore computers ... \$59

VIC 20 computer — 5K RAM, 8 colours, hi-res 176\*200 pixel graphics, 4 voice sound generator ... \$299

Commodore 64 computer — 64K RAM, 16 colours, hi-res 320\*200 pixel graphics, sprites, sound synthesizer ... \$699

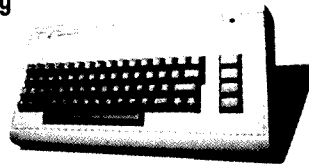

Both computers feature 20K BASIC & operating system, RS 232, parallel user port — disc drives, printers, joysticks, paddles, light pens, games, utilities etc available.

Versions also available for PET/CBM 3000, 4000 and 8000 series (includes SSTV send) — POA.

## HIGH TECHNOLOGY COMPUTER SYSTEMS PTY LTD

87 Swan Street, Richmond, Vic 3121 ph (03)  
429 1966 ask for Mike VK3BHM or Joel VK3ZKE

# Obituaries

**ANTHONY (Tony) BURGE VK4BAC**

The amateurs on the Darling Downs and in many places were saddened by the passing of Tony on 15th January, 1983.

Tony was the tender age of 19 years. His amateur activities started in January 1981 as VK4VKJ. He upgraded in December 1981 to VK4BAC. Tony was active on SSB, CW and shortly before his death was setting up for RTTY. He was an honorary member of the Darling Downs Radio Club and conducted the local 2 metre net.

What was not known by amateurs who contacted Tony was that he was confined to a wheelchair and had no use of his legs and very limited use of his arms and hands. Tony was never heard complaining about his disability on air. Nevertheless Tony insisted on sitting for the CW exam to upgrade where he had extreme difficulty in moving his arm across the page.

In recent times Tony was looking at ways to enable him to use a soldering iron to work on constructing projects and equipment. Tony's example of a handicapped person successfully and very actively participating in the hobby has been a guide to other handicapped people. As a result of a generous donation by his family, Tony's efforts will be remembered by all amateurs with the establishment of a club station for handicapped people on the Downs.

To Tony's family, father Bill, mother Coral, and brother Greg we extend our sympathies and thanks for the wonderful hospitality extended to all amateurs both on and off the air by Tony and his family.

RON VK4AGS and ROLEY VK4AOR  
AR

**ARTHUR ALEXANDER  
BURROWS SLIGHT (Alec) VK2ZA**

Alec was born in London, England on 1 October 1902 and he died peacefully in hospital on 1 November 1982, aged 81. He came to Australia in 1914 and later joined the RAAF in the permanent Air Force in 1927. He acquired his amateur licence no. 1199 on 11-12-1930 (AOCP).

I first met Alec in 1941 when we were mutually engaged in the type testing, at AWA Ashfield, of the RAAF AT5/AR8. He was RAAF Liaison Officer and I was the resident AID inspector stationed at AWA. During those wartime years our paths crossed several times on other RAAF work.

Alec subsequently became Wing Commander and Officer in Charge of Ballarat RAAF Communications Training College. Upon retirement he came to live in Sydney again where he later took up full time teaching with the Department of Technical Education (1959). It was here at North Sydney Technical College that we met again, both of us teaching television. It was a pleasure and privilege to work with such a competent and helpful colleague. He was a master of the 'home brew' and imparted this skill to many of his students.

Upon his second retirement in 1965 he 'home brewed' his SSB transmitter and receiver making a line job of them both. He, with others, inaugurated the 'Electorates Award' and personally went out of his way to assist those wishing to get this award.

He was one of the 'old timers' whose occupation was also his loved hobby.

Long will he be remembered by his family, his RAAF and technical mates and those whom he befriended over years of amateur radio QSOs.

Arthur VK2IK  
AR

# Silent Keys

*It is with deep regret we record the passing of —*

Mr H E HANCOCK VK2BIC  
MR ALBERT C McGRADY VK2BGM  
MR A MOFFAT VK3FJ  
MR R G O WILSON VK3MU

# AIR-WOUND INDUCTANCES

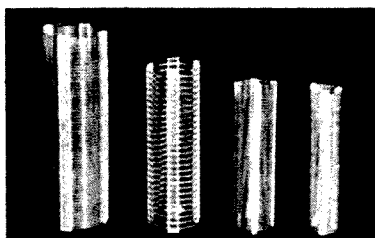

No	Oiam	Turns per Inch	Length	B & W Equiv	Price
1-08	1/8"	8	3"	No 3002	\$1.60
1-16	1/2"	16	3"	No 3003	\$1.60
2-08	3/8"	8	3"	No 3006	\$1.90
2-16	3/8"	16	3"	No 3007	\$1.90
3-08	3/4"	8	3"	No 3010	\$2.30
3-16	3/4"	16	3"	No 3011	\$2.30
4-08	1"	8	3"	No 3014	\$2.60
4-16	1"	16	3"	No 3015	\$2.60
5-08	1 1/4"	8	4"	No 3018	\$2.90
5-16	1 1/4"	16	4"	No 3019	\$2.90
8-10	2"	10	4"	No 3907	\$4.20
8-10/7	2"	10	7"	No 3907	\$7.20

Take the hard work out of Coil Winding — use "WILLIS" AIR-WOUND INDUCTANCES

**WILLIAM WILLIS & Co. Pty. Ltd.**  
98 Canterbury Road, Canterbury, Vic. 3126  
PHONE: 836 0707

# WARNING!!

Disposing of your old rig?? Please ensure it goes ONLY to someone licensed to use it on YOUR bands.

# HAMADS

PLEASE NOTE: If you are advertising items FOR SALE and WANTED please write on separate sheets, including ALL details, eg Name, Address, on both. Please write copy for your Hamad as clearly as possible, preferably typed.

\* Please Insert STD code with phone numbers when you advertise.

- Eight lines free to all WIA members. \$9 per 10 words minimum for non-members.
- Copy in typescript please or in block letters double spaced to PO Box 300, Caulfield South 3162.
- Repeats may be charged at full rates.
- Closing date: 1st day of the month preceding publication.
- OTHR means address is correct as set out in the WIA current Call Book.

Ordinary Hamads submitted from members who are deemed to be in the general electronics retail and wholesale distributive trades should be certified as referring only to private articles not being resold for merchandising purposes.

## TRADE HAMADS

Conditions for commercial advertising are as follows: The rate is \$15 for 4 lines, plus \$2 per line (or part thereof) minimum charge \$15 pre-payable. Copy is required by the first day of the month preceding publication.

**AMIDON FERROMAGNETIC CORES:** Large range for all receiver and transmitter applications. For data and price list send 105 x 220 SASE to: R. J. & U. S. Imports, Box 157, Mortdale, NSW 2223. (No enquiries at office: 11 Macken St, Oakley, 2223.)

**CB RADIOS \$69:** walkie talkies, short wave radios, military, outback, business, amateur, marine, repairs, RTTY Siemens 100A printer \$120; base mic., \$45; ultrasonic alarm, \$35; all ham bands on a single 6 ft. whip, 1.8 to 30 MHz, for base or mobile, \$300; aerials, installation, demonstrations, 40 ch. CB conversions, accessories, new rigs weekly. Bridge Disposals, 12 Old Town Plaza, opp. Bankstown Railway Station, NSW. Mail order service and all enquiries to 2 Griffith Avenue, Roseville 2069, or phone Sam VK2BVS, 7 pm to 9 pm only, on (02) 407 1066.

## TAKE AWAY

TYPE 15 MACHINE, 240-110 V transformer, 750 VA. Free to first caller. VK2KH OTHR. Ph: (02) 525 2981.

## WANTED — NSW

840-12 TRANSISTOR. 1 only. Barry, VK2ZXB. Ph: (02) 476 3911.

CIRCUIT OR GENERAL DATA on Admiralty B41 VLF Rx. ECH81 and EF92 valves also needed. All replies answered. Nev. VK2QF OTHR.

MORSE KEY. Ex PMG, auto mechanical type. "Simplex Auto" or similar type. Reasonable price paid. Ken, VK2EKT. Ph: (062) 97 2315.

PSU FOR FT200 (complete) or power transformer Yaesu 34002. Details to Sumnerland ARC, Box 524, Lismore, 2480.

VACUUM TUBE(S) type 8122. Price and history to VK2ZAB OTHR. Ph: (02) 456 3972.

## WANTED — VIC

EDDYSTONE 770R COMMUNICATIONS RECEIVER (19-165 MHz) Handbook. Buy or borrow on deposit for copy. URGENT. Also 6299, 7554, 6442, 6884, 7077, 6205

vacuum tubes. D Bruce. VK3BFB QTHR. Ph: (03) 583 1638.

WHIPS for 20, 40, 80 metres and base. Also 18 AVT or similar. All GC. Ph: (059) 41 2070.

YC221 DIGI DISPLAY for FT221 2 m transceiver. Craig. VK3CRA. Ph: (03) 418 5430 (BH) or (03) 754 6437 (AH) or 3.567 MHz 1000 UTC. Wednesdays.

### WANTED — QLD

MANUAL OR PHOTOCOPY of manual for TR1986 VHF Transmitter/Receiver. Will pay costs. VK4JZ QTHR. Ph: (07) 44 7980.

YAESU FTV901R. FV9010M. FC901. Y0901. Bencher or similar paddle or keyer. Write to Doug. VK4RP. M/S 346. Nanango. Old. 4315.

### WANTED — WA

ARRL RADIO AMATEURS HANDBOOKS pre 1940. VK6FS. QTHR.

MILITARY RF AMP. AM-4306/GRC. See advt p2 AR Jan-May 76. Also AN-PRC/25/77/64/47/46/68 Radios. VK6KO QTHR. Ph: (09) 381 1180.

### WANTED — TAS

YAESU FTD 401 TRANSCEIVER. FV401 Ext VFO. SP401 spkr or FTDX100 or FL200B Tx. FR100B Rx and spkr to match above. Must be clean or near new condition. Not tampered with. VK7AN QTHR. Ph: (003) 31 7914.

### FOR SALE — ACT

ANTENNAS: TH60XX with BN86 balun and instructions \$200. Wilson 3 el monoband Yagi for 10 or 11 m (new) \$100. ATN 51-53-5 6 m 5 el Yagi \$64. Ringo type 2 m base antenna with decoupling radials \$50. Station Master 3/4 wave 27-29 MHz base antenna. All prices plus freight. Would consider exchange for other amateur gear. VHF/UHF. Morse/RTTY etc. VK1CJ. Ph: (062) 51 1816 (AH) or (062) 64 4680 (BH).

ICOM IC22U 2 m FM mobile Tcvt. 12 mths old. As new. Only used 4 times. In orig carton and packing. Manual, cradle etc \$180. VK1ZAT QTHR. Ph: (062) 47 6998.

KENWOOD R1000 COMM RX 0-30 MHz \$300. Belcom Liner 430 70 cm SSB/CW Tcvt 10 W final 432.0-432.5 and 435.0-435.5 MHz \$150. Kenwood TS700A 2 m FM/AM/SSB/CW Tcvt 144-148 MHz 10 W final \$300. Toyomura (KEN) RF speech processor. Model KP12A \$75. Creed Model 7B teleprinter \$50. Yaesu 9 MHz Xtal filter with match SSB carrier Xtals. as used in FT200 etc \$30. John VK1FT QTHR. Ph: (062) 80 6481 (BH) or (062) 86 2364 (AH).

### FOR SALE — NSW

CLEARANCE for any reasonable offer or swap. Kenwood TS520 as new. Only used a few hours. Amplifier (Pye) 15/15 W plus 2/40 W speakers. good HiFi at low price. Pioneer Amp. SM-B200A. all there. needs service. Avometer Mod 7. Valves 83, 807, 9001, 6146, 6D06A, 6AC7, 6BE6, 6BJ6, 5763, 12AV6, 12AU7, 6AU6, EF86 and many similar, most boxed. Power transformers, large, 449 volt sec. Panel meters. VK2KR QTHR. Ph: (02) 449 4524.

ICOM IC720A Tcvt. Ex condition with manual and carton \$990. Yaesu FT290R as new with carry case and nicad batts. All made portable. Very little use \$335. Ph: (02) 569 5639.

ICOM 720A with PS-15 pwr supply, narrow CW filter. HM9 hand mic. Excel condition \$950. VK2OHF QTHR. Ph: (02) 634 5065.

KENWOOD TR2200A 2 m Tcvt. 9 repeater and 3 simplex chants. Complete with batts and charger \$150. Microwave modules 10 W transverter 144-146 to 28 MHz. Never used \$150. Berry VK2ABB QTHR. Ph: (02) 520 0866.

KENWOOD TR7400 2 m FM. 25 W output. Fully synthesised Tcvt. VG condition. Never used mobile. S220. Henry 2 m amplifier. SSB/FM. 80 W output. heavy duty const. \$130. VK2BHF. Ph: (02) 981 4762.

KENWOOD TR7400A 2 m Tcvt. 25 W. 800 Ch. Perfect operate conditions. Covers never been off. Used only as base station \$260. Max VK2GE. Ph: (043) 92 4900.

RTTY EQUIP include Model 15 in good work condition. 300 VA transformer, manuals, spare brushes and tuning fork. As well as EA mod/demod cased with full switching, 20 mA loop and UART. All perfect work order with metering, filtering and circuits. All inc cost \$170. Peter VK2BTI QTHR. Ph: (02) 871 8394.

TELETYPES M00 15. All working 45.45 BAUD govern motor. One no case \$55, one complete \$15, one with off line punch \$25 plus parts. VK2BZE. Ph: (042) 96 4595.

XITEX GLASS RTTY in box with P/S \$160. KDK FM2016A 2 m Tcvt \$200. Kenwood transverters (1) 2 m TV502S and (1) 6 m TV506 \$150 ea. MMC Rx converters (1) UHF/VHF 432/144/S and (1) UHF/HF 432/28/S \$50. Bruce. VK2RT QTHR. Ph: (02) 520 7838.

YAESU FT101E. FT7 and FR67. Plus antenna switches, meters, coax, ext speakers, car cassette player, etc. All housed in custom made pineboard cabinet. All offers considered. Ross VK2KDH. Ph: (069) 21 4415 weekends.

YAESU FT101E HF Tcvt. Very good cond. Complete with all leads, book and orig packing \$475. VK2DYV QTHR. Ph: (060) 26 3282.

YAESU FT200 Tcvt. FP200 power supply, cartons, manuals. Ex cond \$300. Teletypes, all in ex cond. 240 V. 45 BAUD. Seimens M100 with tape reader \$100 Seimens typing reper \$50. Both \$120. Model 15 \$60. VK2ELS. Ph: (02) 871 2515.

YAESU FTOX100 TRX recently o'hauled and litted new finals. Tx side needs minor work. Complete with desk mic, book and circuit \$225 or offer. Ph: Shoal Bay (049) 81 3413.

YAESU YC-7B DIGI READOUT. VG condition, orig box and all factory information/manual \$100 ONO. Phil. VK2VII QTHR. Ph: (044) 21 0039.

### FOR SALE — VIC

ATLAS 215X with 220 CS AC desk console plus mobile brackets, cables, mic and manuals. Very good cond \$350 ONO. Oscilloscope Heathkit OS2 with manual. Very good cond \$120 ONO. Both items ex VK3PW deceased estate. Allan VK3AMD QTHR. Ph: (03) 570 4610.

KENWOOD TV502 2 m transverter suit TS520 or 820. Complete with cables and H'book. Ex condition \$165. VK3KLF. Ph: (03) 417 2702 (BH) or (03) 337 3249 (AH).

NALLY SELF SUPPORT TOWER. 2 section, windup, tilt-over \$350. Drake 2B comm Rx \$150. VK3EG QTHR. Ph: (03) 729 1315.

NEC UHF PORTABLE Tcvt (2 only). Model ATR400P1-9A on approx 460 MHz. Complete with nicads, chargers, manuals etc. \$300 the pair. One NEC UHF 15 W SS mobile Tcvt on 433.160 MHz \$130. David Norris VK3DWN. Box 231, Mildura. 3500. Ph: (050) 23 7188.

POWER SUPPLIES. Rack mounting 240 V input. Regulated, metered output 0-450 V. 0-200 mA. 3 off \$25 ea. VK3BPN QTHR. Ph: (03) 546 1233.

TANDY TRS80 COMPUTER. Level 2 with extension to 48K. As new. Number of programmes on cassette included. \$749 ONO. Dot matrix printer. ITOH, as used with TONO comm computer. Bidirectional, full ASCII set, upper and lower case. Complete with box of paper \$695 ONO. TS180S HF SSB Tcvt Superb DX Tcvt. Noise blanker speech processor, all WARC bands litted. Extras include sharp filters for ultra narrow CW and RTTY reception. Power supply incl \$650 ONO. Scotty VK3ZR QTHR. Ph: (03) 890 4645.

TOWER: 30 ft galv triangular section. Tower consists of lengths of heavy duty 5 ft sections each 9 ins across the flat \$120. Ken VK3BKD. (QTHR AS VK3KHA). Ph: (03) 878 2229.

YAESU FT7 C/W most bits for 140 W. SS amp \$375 BC348 Rx in work condition \$50. Collins 51J4 0.5 MHz to 30 MHz Rx in excell order. C/W mechanical and crystal filter. Offers or consider swap for HF Tcvt. VK3DPM QTHR. Ph: (03) 596 3968.

### FOR SALE — QLD

KENWOOD TS130S in mint cond with WARC bands. MC10 mic. Orig pack and H'book. Only used as standby rig \$575. VK4AIF QTHR. Ph: (07) 284 9230.

YAESU FT101B with ext speaker \$400. Yaesu FT200 S200. Pair 6SJ6C S10. Mike VK4ACM QTHR. Ph: (074) 65 3261.

### FOR SALE — WA

HARRIS RF301 continuous tuning Rx and Tx 2-15 MHz. ex USN in work order, with service manual. Will arrange transport \$550. VK6APS QTHR. Ph: (099) 41 2092 (AH).

## ADVERTISERS' INDEX

AMATEUR RADIO ACTION	58
BAIL ELECTRONIC SERVICES	57
CW ELECTRONICS	3
DICK SMITH ELECTRONICS	2
ELECTROMARK PTY LTD	62
EMTRONICS	IBC
GFS ELECTRONIC IMPORTS	32 & 33
HAMRAD	52
HIGH TECHNOLOGY COMPUTER SYSTEMS PTY LTD	62
HY-TECH DISTRIBUTORS	54
IAN J TRUSCOTT ELECTRONICS	59
ICOM AUSTRALIA PTY LTD	BC
K BRUCE SMITH	29
MAGPUBS	6, 43 & 45
NOVICE LICENCE VK2	52
NOVICE LICENCE — G Scott & A Bruce Smith	29
PARAMETERS PTY LTD	IFC
TRAEGER DISTRIBUTORS (NSW) PTY LTD	29
TRIO-KENWOOD (AUSTRALIA) PTY LTD	53
VAINS ANTENNA SERVICES PTY LTD	3
VICOM INTERNATIONAL PTY LTD	4
WATCHMAN ELECTRONICS	29
WERNER & G WULF	62
WILLIAM WILLIS & CO PTY LTD	63
WILLIAMS PRINTERS	31



# emtronics

EMTRONICS  
Retail Division of EMONA ELECTRONICS P/L  
649 George Street, Sydney, NSW 2000  
Phone 211 0531

CORRESPONDENCE & MAIL ORDERS:  
Box K21, Haymarket, NSW. 2000. Australia.  
WRITE, PHONE OR CALL IN!

## AZDEN THE LEADER:

The two most popular 2m Transceivers on the Market

### PCS-300 HANDHELD



**\$359**

WRITE FOR COLOUR BROCHURE  
FULL WARRANTY  
BANKCARD WELCOME

### PCS-4000

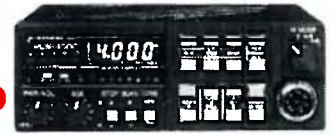

**\$459**

### ICOM

Overstocked!! Now going at special prices!

REMEMBER:

When you buy ICOM from us you buy from factory appointed dealer with English manuals and full 12 month warranty.

### NEW JST-100

After you have seen everything else — Come and see the fantastic JST.



**\$1745**

NEW DIGITALLY SYNTHESISED MICRO-COMPUTER BASED TRANSMITTER/RECEIVER, WITH 11 CHANNEL MEMORY ETC. (Write for Colour Brochure)

### KENWOOD

New stock — Just arrived!  
Contact us for Best Prices:

R-2000 \$?  
TS-430S \$?  
TL-922 \$?  
DM-81 \$?  
HC-12 \$?

**FULL 12 MONTHS WARRANTY**

### NEW STOCK HERE!! ENB-1 NOISE BRIDGE



only \$89 incl Battery (+ \$4 post)

First delivery sold out before release — if you'd like to know more write for Specs.

### THE EAT-300 TUNER IS RACK



**\$159  
+ \$9  
post**

All mail orders ready now — Enormous success, covers all freq. between 1.6 - 30 MHz continuously.  
**ENORMOUS DEMAND!**

### NEW! ATC-720SP



Full coverage 720 channels 118-136 MHz/AM PLL SYNTHESISED AIR BAND TRANSCEIVER NOW IN STOCK!

Write or ring for Specs.

### SWR & POWER METERS BELOW COST!

\*PM-4HV — \$40 now \$29  
\*PM-5V — \$56 now \$39  
\*PM-3HV — \$63 now \$45  
\*MCLA-1 — \$95 now \$68  
\*AAF-1 — \$95 now \$68  
\*MM-1 — \$55 now \$28  
\*APM-2H — \$79 now \$56  
\*PM 3HV — \$63 now \$45

and many more — write for details

### UDK MULTI-750X 2m — ALL MODES only \$350 + \$10 post LIMITED STOCK ONLY



<b>AZDEN</b>		
PCS-300 Transceiver .....	\$359	+ \$9.00 post
LC-11 Leather Case .....	\$33	+ \$2.50 post
SDX-316 Microphone .....	\$32	+ \$4.00 post
BP500F Battery Pack .....	\$33	+ \$4.00 post
PCS-4000 Transceiver .....	\$459	+ \$10 post
PCS-4300 Transceiver .....	POA	
PCS-2800 10m Transceiver .....	\$199	+ \$9.00 post
<b>TELEREADER</b>		
CWR-685E RTTY, CW, etc .....	\$1299	+ \$25 Frt.
CWR-670E RTTY, CW, etc .....	\$499	+ \$10 Frt.
CWR-610E RTTY, CW, etc .....	\$259	+ \$10 Frt.
CWR-675EP RTTY, CW, etc .....	\$999	
<b>HAL</b>		
DS3100ASR RTTY, CW, etc .....	\$3290	+ \$30 Frt.
DS3100 MS03100 RTTY, CW, etc .....	\$4350	+ \$35 Frt.
CT2100 RTTY, CW, etc .....	\$1376	+ \$30 Frt.
KB2100 RTTY, CW, etc .....	\$284	+ \$25 Frt.
<b>THP</b>		
HL-82V VHF Amplifier .....	\$245	+ \$9.00 post
HL-86V VHF Amplifier .....	\$210	+ \$9.00 post

HL-90U UHF Amplifier .....	\$369	+ \$10 post
HL-45U UHF Amplifier .....	\$239	+ \$9.00 post
HL-20U UHF Amplifier .....	\$120	+ \$6.50 post
HL-32V VHF Amplifier .....	\$125	+ \$6.50 post
HC 2000 Tuner .....	\$450	+ \$10 post
HC-200 Tuner .....	\$149	+ \$9.00 post
HP-315 Power Supply .....	\$209	+ \$10 post
HRA-7 .....	\$189	+ \$9.00 post
MIRCO-7 70cm Transceiver .....	\$189	+ \$9.00 post

<b>LUNAR</b>		
2M25-150P Amplifier .....	\$359	+ \$9.00 post
2M10-150P Amplifier .....	\$299	+ \$9.00 post
2M2-100P Amplifier .....	\$339	+ \$9.00 post
2M10-80P Amplifier .....	\$249	+ \$9.00 post
2M4-40P Amplifier .....	\$159	+ \$9.00 post
6M10-120P Amplifier .....	\$329	+ \$9.00 post
6M3-50P Amplifier .....	\$239	+ \$9.00 post
PA 28, 50, 144 Preamp .....	\$65	+ \$2.00 post
PA-432 Preamp .....	\$98	+ \$2.00 post
PAD 28, 50, 144 Preamp .....	\$75	+ \$2.00 post
PAG 144, 432 Preamp .....	\$180	+ \$4.00 post

### FDK EXPANDER — 430 DUAL BAND ALL MODE

only \$299 + \$10 post

Designed to use with MULTI-750X to convert it into dual band all mode BASE/MOBILE station. A truly versatile package at very economical price, providing 1 MHz steps 144, 145, (144-148) and then 430-440 MHz looping back again to 144 etc.

WRITE FOR SPECS.

FOR FULL DETAILS SEND 60 cents FOR OUR NEW 40 PAGE CATALOGUE!

**NEW**  
Competition  
Grade  
Transceiver!

# ICOM IC-751

## The New Standard of Comparison



**Arriving Soon — call ICOM for details!**

ICOM is proud to announce the most advanced amateur transceiver in communications history. Based on ICOM's proven high technology and wide dynamic range HF receiver designs, the IC-751 is a competition grade ham receiver, a 100kHz to 30 MHz continuous tuning general coverage receiver, and a full featured all mode solid state ham band transmitter, that covers all the new WARC bands. And with the optional internal AC power supply, it becomes one compact, portable/field day package.

**Receiver.** Utilizing an ICOM developed J-FET DBM, the IC-751 has a 105dB dynamic range. The 70.4515MHz first IF virtually eliminates spurious responses, and a high gain 9.0115MHz second IF, with ICOM's PBT

selectivity. A deep IF notch filter, adjustable AGC and noise blanker (can be adjusted to eliminate the woodpecker), audio tone control, plus RIT with separate readout provides easy-to-adjust, clear reception even in the presence of strong QRM or high noise levels. A low noise receiver preamp provides exceptional reception sensitivity as required.

**Transmitter.** The transmitter features high reliability 2SC2097 transistors in a low IMD (-32dB : 100W), full 100% duty cycle (internal cooling fan standard), 12 volt DC design. Quiet relay selection of transmitter LPF's, transmit audio tone control, monitor circuit (to monitor your own CW or SSB signal), XIT, and a high performance speech processor enhance the IC-751 transmitter's operation. For the CW operator, semi break-in or full QSK is provided for smooth, fast break-in keying.

**Dual VFO.** Dual VFO's controlled by a large tuning knob provide easy access to split frequencies used in DX operation. Normal tuning rate is in 10Hz increments and increasing the speed of rotation of the main tuning knob shifts the tuning to 100Hz increments automatically. Pushing the tuning speed button gives 1KHz tuning. Digital outputs are available for computer control of the transceiver frequency and functions, and for a synthesized voice frequency readout.

**32 memories.** Thirty two tunable memories are provided to store mode, VFO, and frequency, and the CPU is backed by an internal lithium memory backup battery to maintain the memories for up to seven years. Scanning of frequencies, memories and bands are possible from the unit, or from the HM 12 scanning microphone. In the Mode-S mode, only those memories with

a particular mode are scanned; others are bypassed. Data may be transferred between VFO's, from VFO to memories, or from memories to VFO.

**Features.** All of the above features plus full function metering, SSB and FM squelch, convenient large controls, FM option, a large selection of plug-in filters, and a new high visibility multi-color fluorescent display that shows frequency in white, and other functions in white or red, make the IC-751 your best choice for a superior grade HF base transceiver.

**Options.** FM unit, external frequency controller, external PS-15 power supply, internal power supply, high stability reference crystal (less than 100Hz, -10 C to +60 C), HM12 hand mic, desk mic, filter options:  
SSB: FL30, FL44A  
CWN: FL52A, FL53A  
AM: FL33

**Discover a new deal with  
ICOM AUSTRALIA PTY. LTD.**

7 DUKE STREET WINDSOR 3181  
VICTORIA, AUSTRALIA  
TEL: (03) 529 7582 TLX: AA 35521 ICOMAS

 **ICOM**  
**The World System**

# AMATEUR RADIO

VOL. 51, NO. 8 AUGUST 1983

Registered by Australia Post — Publication No. VBH 0569

JOURNAL OF THE WIRELESS INSTITUTE OF AUSTRALIA



Computer Programme for Logs & QSLs  
WIA Reps visit NZART Conference  
Presidential Comment: 30% Tariff Duty  
Concluding: Military Radios — The C11  
Erect a Simple Ground Plane  
Exciting New Communications — Packet Radio  
First Amateur Radio in Space

# BBC World Service

NEWS AND PROGRAMMES DAILY FROM

# LONDON

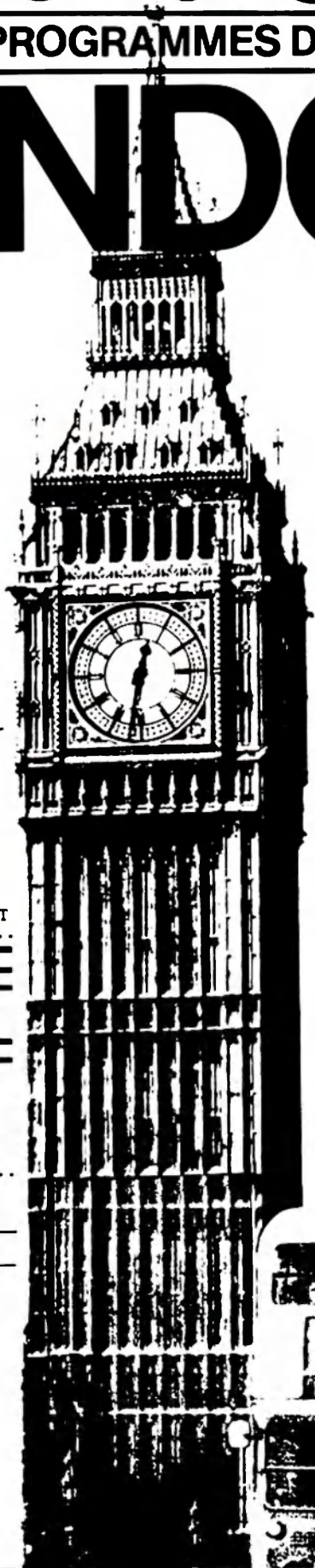

All times GMT.

## WORLD NEWS

0600, 0700, 0800,  
0900, 1100, 1300, 2000,  
2200

## NEWS ABOUT BRITAIN

0709 (Sats, Suns only),  
1109

## BRITISH PRESS REVIEW

0909

## NEWS DESK

0600

As well as Drama, Music,  
Comedy, Sport, Science,  
Commerce, Industry, Literature,  
Religion and Finance.

## RADIO NEWSREEL

1200, 1500

BBC World Service is on  
Short Wave. Your set probably  
has Short Wave. Try it today!

Short Wave frequencies for Australia.

MHz	05	06	07	08	09	10	11	GMT
25.65	+	+	+					
21.55	+	+	+					
15.31								
15.07								
11.955								
11.75								
9.74								
9.64								
9.57								
9.51								
9.41								
7.15								
	05	06	07	08	09	10	11	12

For your local time: Victoria, NSW,  
Canberra, Queensland, Tasmania, add  
10 hrs. South Australia, N. Territory, add  
9½ hrs. Western Australia, add 8 hrs.

13	14	15	20	21	22	23	Metres
							11.70
							13.92
							19.60
							19.91
							25.09
							25.53
							30.80
							31.12
							31.35
							31.55
							31.88
							41.96
13	14	15	20	21	22	23	

Full programme and frequency infor-  
mation in LONDON CALLING. For a free  
copy post this coupon to: BBC Office,  
Westfield Towers, 100 William Street,  
Sydney, New South Wales 2011.

Name \_\_\_\_\_

Address \_\_\_\_\_







# AMATEUR RADIO

Registered Office:  
3/105 Hawthorn Road,  
Caulfield North 3161.  
Tel. (03) 528 5962

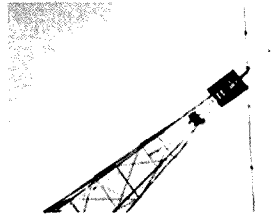

"REACH FOR THE WORLD"

14 MHz 6 element quad on a 15 metre boom at 27.5 metres high situated at Mandurang near Bendigo. by N Stillwell, VK3ACN.

## ARTICLES

Amateur Radio House by Susan Brown, VK2BSB .....	20
Bill Blitheringwit by Ted Holmes, VK3DEH .....	14
Can you help? .....	63
Computer Programme for Log & QSL Card Printing by M Mohan, VE6AZM .....	29
Ground Plane Antenna by J Gazard, VK5JG .....	16
July's Best Photograph .....	52
Modern Military Surplus — Concluding — The C11 by Colin MacKinnon, VK2DYM .....	12
Murphy Strikes with Vengeance .....	52
Packet Radio .....	23
Personalities Attending Mt Gambler Convention .....	34
Presidential Comment — 30% Tariff Duty Imposed on HF Transceivers .....	8

Radio Amateur Old Timers Club .....	41
Shack Crawling 1930s Style by Alan Shaw-smith, VK4SS .....	15
Stolen Equipment .....	63
VK/ZL/Oceania Contest 1983 .....	48
WOY 83 — ARRL President Visits White House .....	53
WIA Representatives Visit NZART Annual Conference by Bruce Bathols, VK3UV .....	11
Win a VHF Converter .....	35
World Communications Year — Amateur Radio in Space .....	23

## DEPARTMENTS

A word from your Editor .....	8
Advertisers Index .....	64
ALARA .....	47
AMSAT Australia .....	44
AR Showcase — Scanning Receiver, Video Enhancer & new Antenna for Scanners .....	39
Awards — Ballarat & Western Zone awards .....	42
Club Corner — Moorabbin & District Field Day, EMDRC Expo '83 .....	38
Commercial Chatter .....	31
Contests — Winner of 82/83 Contest Champion .....	50
Equipment Review — Nicholls Woodpecker Blanker .....	18

Hamads .....	63
Here's RTTY — Operating Procedures .....	40
How's DX .....	24
International News .....	28
Intruder Watch .....	50
Ionospheric Predictions .....	60
Letters to the Editor .....	58
Main QSP — Joint WIA & NZART Statement .....	9
National EMC Advisory Service — A warning from Canada .....	30
Obituaries — VK4GJ & VK3VKO .....	63
Pounding Brass .....	47
QSP .....	28 & 48
Silent Keys — VK4GJ & VK3PEN .....	63
Spotlight on SWLING .....	51
Technical Correspondence — 13.8V Power Supply, EMF for ICOM IC-22S .....	53
Try This — Simple Signal Sources by A G Loveday, VK4KAL .....	17
VHF UHF — An expanding world .....	36
VK2 Mini Bulletin .....	54
VK3 WIA Notes .....	55
WA Bulletin .....	54
WICEN News .....	28

## DEADLINE

All copy for October RB must reach PO Box 300, Caulfield South, 3162 no later than 25th August.

**EDITOR**  
GIL SONES' VK3AUI

**BUSINESS MANAGER & SECRETARY**  
REG MACEY

advertising agents will appreciate the absolute need for themselves to ensure that the provisions of the Act are complied with strictly.

**TECHNICAL EDITORS**  
RON COOK' VK3AFW  
PETER GAMBLE' VK3YRP  
EVAN JARMAN' VK3ANI  
BILL RICE' VK3ABP

**ADVERTISING MANAGER**  
JOHN J A HILL VK3WZ

**Victorian Consumer Affairs Act:** All advertisers are advised that advertisements containing only a PO Box number as the address cannot be accepted without the addition of the business or residential address of the box-holder or seller of the goods.

**CONTRIBUTING EDITORS**  
MIKE BAZELY VK6HD  
RON COOK' VK3AFW  
REG DWYER VK1BR  
BRENDA EDMUNDS VK3KT  
MARSHALL EMMS VK5FN  
RON FISHER' VK3OM  
BRUCE HANNAFORD VK5XI  
ROY HARTKOPF' VK3AOH  
ROBIN HARWOOD VK7RH  
COLIN HURST VK5HI  
ERIC JAMIESON VK5LP  
MARGARET LOFT VK3DML  
KEN MCLACHLAN VK3AH  
LEN POYNTER' VK3BYE  
TONY TREGALE VK3QQ

\*Member of Publications Committee

Enquiries and material to:  
The Editor  
PO Box 300, Caulfield South Vic. 3162

**Production: BETKEN PRODUCTIONS**  
5 Masfield Avenue, Mooroolbark, 3138.

Material should be sent direct to PO Box 300, Caulfield South Vic., 3162, by the 25th of the second month preceding publication. Phone: (03) 528 5962. Hamads should be sent direct to the same address.

**Laser Scanned Colour Separations by: QUADRICOLOR INDUSTRIES PTY LTD, Graphic Division**  
22-24 Glenvale Crescent, Mulgrave, 3170.  
Tel.: (03) 560 2222

Acknowledgement may not be made unless specially requested. All important items should be sent by certified mail. The editor reserves the right to edit all material, including Letters to the Editor and Hamads, and reserves the right to refuse acceptance of any material, without specifying a reason.

**Typesetting by: QUADRICOLOR INDUSTRIES PTY LTD,**  
22-24 Glenvale Crescent, Mulgrave, 3170.  
Tel.: (03) 560 2222

**DRAFTING**  
GEORGE BROOKS  
LIZZ KLINE

**Trade Practices Act:** It is impossible for us to ensure that advertisements submitted for publication comply with the Trade Practices Act 1974. Therefore advertisers and

**Photographic film and processing material courtesy AGFA-GEVAERT LTD AUSTRALIA**

**Printers: WAVERLEY OFFSET PUBLISHING GROUP**  
Geddes Street, Mulgrave, 3170  
Tel.: (03) 560 5111

# WHY TAKE THE RISK?

# IDEAL NOVICE SET FOR THOSE WHO WANT TO GROW UP!

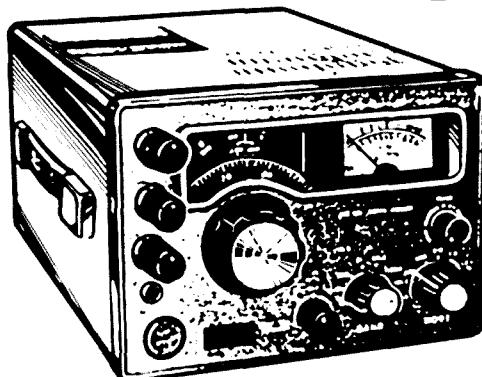

## Economy All mode SS105 TRANSCEIVER

Here's THE transceiver that's not only fantastic value for the novice... but it grows with you!

With everything the novice needs - including a low, low price tag - the superb SS105 transceiver gives you something pretty rare these days: a chance to get 'on the air' without breaking the bank!

And you can even add FM (for transverting) later on - just by adding the low-cost FM boards! Just imagine: FM in a transceiver so low in price!

Here's what it's got:

- 3.5 to 28MHz band coverage
- LSB, USB & CW emission (FM optional)
- 13.5V DC operation: take it anywhere (great mobile/emergency set!)
- Plug-in pcb construction for easy servicing if required.
- Complete with manual with full circuit diagram & alignment data, parts lists, etc.

Hurry ... limited stock of this outstanding transceiver. Options see facing page. Cat D-2900

**GREAT VALUE**

**\$549**

### of buying without the DICK SMITH BENEFITS

- We are Australia's largest supplier and Yaesu factory approved distributor and service centre.
- Dick Smith Electronics has more amateur radio licence holders to advise you of your requirements than any other company selling amateur radio.
- We are proud of our Amateur Radio Department and back every piece of equipment we sell with our exclusive 7 day satisfaction guarantee.

That's the DICK SMITH GUARANTEE



**YOU REAP THE BENEFIT!**

## 2 metre transceivers below cost!

Unbelievable! If you want a top quality Yaesu transceiver here's your chance to grab a real bargain! Last few left in stock are actually BELOW COST! Hurry - they won't last long at these crazy prices.

**FT-720 RVH** **ORIGINALLY \$450**

25 watts output with full PLL 144-148MHz band coverage. Slinky design can 'split apart' for room problems. Sold for \$450 back in 1982 ... look at the price now! Cat D-2890

**ONLY \$275**

**FT-101 ZFM**

The last of the fabulous '101's - the transceivers that made Yaesu famous with amateurs! Full 160 to 10 metre band coverage (nowward) and this one has an FM board - great for 10m or transverting. Was \$325 two years ago... Cat D-2872

**ONLY \$765**

**FT-227 RB**

One of the most popular two metre transceivers ever made. Ten watts output, ideal for working around the city (great with repeaters!) and has four memory channels to choose from (in addition to the PLL scanner). Originally \$379... Here's your chance to get into two metres really cheaply. Cat D-2891

**ORIGINALLY \$379**

**ONLY \$260**

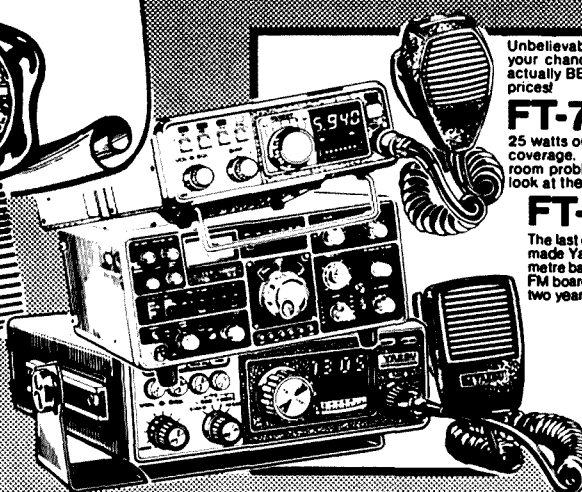

## Want to update your SS105 Transceiver?

### Noise Blanker

That really works! Minimise most types of pulse noise. Highly recommended for maximum transceiver capability.  
Cat D-2901

**\$29<sup>95</sup>**

### FM receive IF unit

FM receive circuit to convert 9MHz to 455kHz and amplify and detect signals; equipped with a built-in squelch circuit.  
Cat D-2902

**\$59<sup>95</sup>**

### FM transmit IF unit

IF circuit for FM transmit consisting of a modulation circuit & IF amplifier  
Cat D-2903

**\$34<sup>95</sup>**

### 25 kHz Monitor

Plug-in pcb to give 25kHz for accurate calibration.  
Cat D-2904

**\$34<sup>95</sup>**

### 100W Linear Amp

100w Linear Amplifier. For when you've got that big ticket! Work the world - and more (more?)  
Cat D-2905

**\$249**

**AMAZING QUALITY**

LIMITED STOCKS OF ALL THESE ACCESSORIES - DON'T MISS OUT!

## LANDLINE INTERFACE

**PHONY PATCH**



Legal Phone Patching could be just around the corner now third party is ok! Be ready for phone patching when it arrives with this superb kit - easy to build, really good results from your HF or VHF transceiver. As described in the June 83 Electronics Today Int.

Cat K-3054

**ONLY \$59<sup>50</sup>**

## FT-707 SERIES Powerful performance in a small package

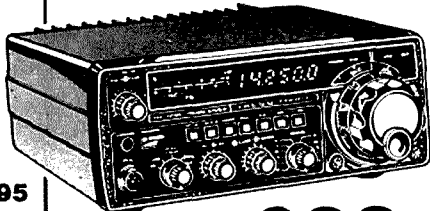

### FT-707 HF TRANSCEIVER

**WAS \$795**

**NOW \$699**

Quick! This could be your last chance to grab one of the all-time amateur bargains! The mighty Yaesu FT-707 transceiver at pre-devaluation, pre sales tax, pre everything price! A real powerhouse ready to go to work on all HF bands, with 100 watts output on most bands - in a package not much bigger than some two metre units! But be warned! This ridiculous price cannot last (with recent increases they should be selling for well over \$900!!!) If you want a superb FT-707, don't put it off any longer. You'll miss out!  
Cat D-2869



### FC-707 ANTENNA TUNER

**NOW \$139** **WAS \$157<sup>50</sup>**

Match your FT-707 into just about anything - even a piece of wet string! Complete with superb power & SWR meter, push-button operation and just plugs in to your 707 for power. Fantastic value (use with other rigs, too!) but once again - be warned. Extremely limited stock. Your local store may even have to order one for you. But it's worth it!  
Cat D-2875

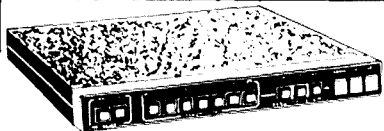

### YAESU FV-707 VFO ONLY

**WAS \$299<sup>50</sup>**

Full digitally synthesised VFO giving you unbelievable control over your 707. Slim-line construction, ideal for slotting underneath the rig. And if you thought the others were in short supply, these are scarcer'n hens' teeth. At our low, low price it's strictly first come, first served - while stocks last!  
Cat D-2896

*Very limited stock.*

### FTV-707 TRANSVERTER

Low-cost transverter for getting upstairs with your 707 - the economical way! Just plug in the module you want - and you're away.

Cat D-2876

**ONLY \$145**

### MODULES for above transverter

2 Metre Module Cat D-2877 **\$149**

6 Metre Module Cat D-2878 **\$109**

70cm Module Cat D-2879 **\$249**



The above products may all be ordered through your nearest Dick Smith Store (while stocks last!). However, most of the 'Ham Shack' stores listed below may have the items actually in stock; ring them on the number shown to check!

Dick Smith Ham Shacks are located in the Dick Smith Stores listed below. You'll find a licensed amateur at each Shack.

● Sydney 125 York St 267 9111 ● Sydney 6 Bridge St 27 5051 ● Gore Hill 162 Pacific Hwy 439 5311 ● North Ryde Lane Cove & Waterloo Rds 88 3855 ● Gosford 315 Mann St 25 0235 ● Melbourne 399 Lonsdale St 67 9834 ● Richmond Bridge Rd 428 1614 ● Springvale Springvale & Dandenong Rds 547 0522 ● Brisbane: Buranda 166 Logan Rd 391 6233 ● Townsville Ingham Rd & Cowley St West End 72 5722 ● Toowoomba Bowen & Ruthven Sts 38 4300 ● Adelaide: Wright & Market Sts 212 1962 ● Perth William St & Robinson Ave 328 6944 ● Cannington Wharf St & Albany Hwy 451 8666 ● Hobart 25 Barrack St 31 0800

Terms available to approved applicants through...



# DICK SMITH Electronics



**STOP PRESS: BUY NOW AT DUTY-FREE PRICES**  
(NEW 30% DUTY MUST BE ADDED TO NEW SHIPMENTS.)

### EMTRON EAT-300 EXCITING NEW ANTENNA TUNER



**\$159**

#### MARINE-AMATEUR-COMMERCIAL APPLICATIONS

The best 500W antenna tuner on the market. The finest American components give you quality performance and satisfaction

- Built-in sensitive SWR meter
- Handles up to 500 watts RF output
- Matches everything from 1.8-30MHz
- Size 180mm wide by 65mm high and 150mm deep
- Use with coax, random wires or balanced lines
- 4:1 Balun for balanced lines, 1000V capacitors
- Large efficient airwound inductor gives lower losses
- Negligible insertion loss of 0.25dB
- Built-in a heavy duty 2mm aluminium case

### EAT-301 THE NEW ANTENNA TUNER

**\$89**

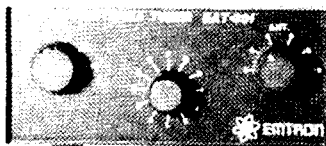

This tuner has same specifications as EAT-300, but no SWR bridge, 160m band coverage and 4:1 balun.

#### COAXIAL SWITCHES

- TOYO 8A-4B0, 2pos, 2kW, 800MHz.....\$26
- WELZ CH-20A, 2pos, 2kW, 900MHz.....\$39
- WELZ CH-20N, 2pos, 2kW, 1.300MHz.....\$69
- DAIWA CS-201, 2pos, 2kW, 800MHz.....\$29
- DAIWA CS-401, 4pos, 2kW, 800MHz.....\$99

### RF NOISE BRIDGE New FROM EMTRON **\$89**

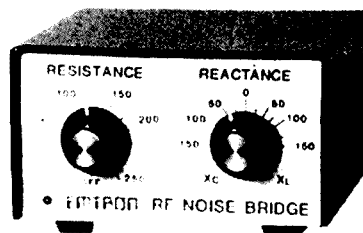

ENB-1, the professionally made noise bridge for all kinds of RF measurement

ENB-1, the best investment in your shack!  
Adjustments of single and multi-band dipole, inverted vee, beam, vertical, mobile whip or random system for maximum performance.

Range extender, expanded capacitance range (150pf)  
Other uses: tune antenna tuners, adjust tuned circuits, measure inductance, capacitance, RF impedance, baluns, transformers, electrical circuits, velocity factor, impedance of coax etc.

#### TRANSCEIVERS

ICOM: At before "DUTY" prices

- IC-720A.....\$1199
- IC-730A.....\$619
- IC-740A.....\$989
- IC-2A.....\$299
- IC-4E.....\$320
- IC-25A.....\$395
- IC-290H.....\$617

#### KENWOOD:

- TS-430S.....POA

#### JRC:

- JBT-100.....\$2246

AZDEN: At before "DUTY" prices

- PCS-300.....\$379
- DCS-4000.....\$479

#### RECEIVERS

- JRC-NRD 818.....\$1795
- Drake-R7A.....\$2300
- ICOM-ICR 70.....\$799
- Kenwood-R2000.....\$650
- MARC-NR 62F1 12band SW.....\$340

#### RF AMPLIFIERS

##### LUNAR:

- 6M3-80P, 6m, 80W.....\$239
- 2M4-40P, 2m, 40W.....\$149
- 2M10-80P, 2m, 80W.....\$249
- 2M25-180, 2m, 180W.....\$359

##### THP:

- HL-90U, 70cm, 90W.....\$369
- HL-48U, 70cm, 48W.....\$239
- HL-180V, 2m, 180W.....\$399
- HL-82V, 2m, 80W.....\$246
- HL-66V, 6m, 80W.....\$210

#### THP ANTENNAS

- HB-335P 3el, 3 band beam.....\$325
- HB-34D 4el, 3 band beam.....\$359
- HB-38C 6el, 3 band beam.....\$439
- MV-BBH 6 band vertical.....\$179
- MV-3BH 3 band vertical.....\$146
- TE11F3J 3el, 11m broad band beam.....\$97
- TE11F6J 6el, 11m broad band beam.....\$189

#### ANTENNA ROTATORS

- KR-260 light duty rotator.....\$115
- KR-400 medium duty rotator.....\$149
- KR-600RC med duty rotator.....\$259
- KR-2000RC heavy duty rotator.....\$489
- KR-800 elevation rotators.....\$196
- K8-080 stay bearing.....\$39
- 8 core rotator cable.....\$0.96/metre

#### NEW EMTRON ALL BAND ANTENNA - only \$59

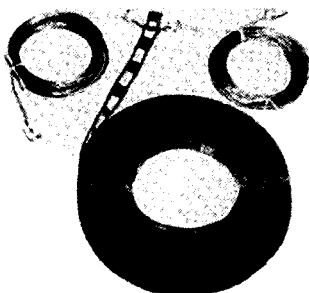

The perfect match for your Emtron EAT-300 antenna tuner. Covers 160-10m, handles 2kW PEP and comes completely assembled without any efficiency robbing traps.

#### FILTERS

- DRAKE: TV 3300 LP filter.....\$46
- MONITOR TV: HF30 HP filter.....\$29

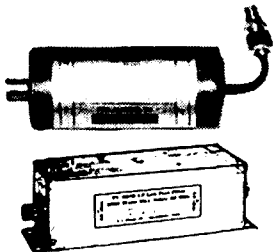

#### VALVES

- 872B.....\$69
- 3-800Z.....\$199
- 4:1000A.....POA
- 6146B RCA.....\$24
- 6146W RCA.....\$29
- 6J56C.....\$14
- 6KD6.....\$15
- 8980.....\$23
- 6MJ6/8LQ6/6JZ6C.....\$18
- 12BY7.....\$6.80
- 60K6.....\$6.80

#### BEYONDA BALUNS

- KAUFMAN, 1:1, 2kW for dipoles.....\$29
- HOKUSHIN HS-60B, 1:1, 2kW for dipoles.....\$32
- WELZ DP-BU6/BU7, 1:1, 2kW for beams.....\$32
- SCALAR 4:1, 2kW for beams & dipoles.....\$49
- SCALAR 1:1, 2kW for beams & dipoles.....\$49
- EMTRON EBL 300 4:1 300W for ant tuners.....\$19
- EMTRON EBL 1000 4:1, 1000W for ant tuners.....\$33
- EMTRON EBL 2000 4:1, 2000W for ant tuners.....\$44

#### DUMMY LOADS

- TOYO T28, 25W, 200MHz.....\$19
- TOYO T100, 100W, 200MHz.....\$69
- TOYO T200, 200W, 200MHz.....\$69
- WELZ CT18A, 18W, 480MHz.....\$22
- WELZ CT18N, 18W, 480MHz.....\$29
- WELZ CT180, 180W, 480MHz.....\$65
- WELZ CT300, 300W, 250MHz.....\$110

#### SWR & POWER METRES

- AKIGAWA FM-2H.....\$69
- AKIGAWA FM-6H.....\$49
- AKIGAWA APM-IV, VHP peak power, SWR.....\$69
- TOYO T-430 UHF SWR meter.....\$65
- WELZ SP-350, 1.6-800MHz, 2 sensors.....\$119
- WELZ SP-280, 1.6-60MHz, 20,200,2000W.....\$99

### GREAT SPECIAL 200W ALL BRAND ANTENNA TUNER from TOKYO HIGH POWER — HC-200

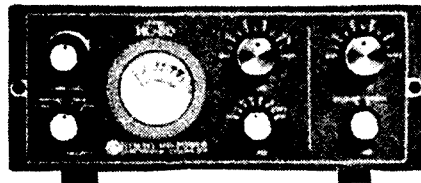

**\$139**

### NEW 4K PROGRAMABLE MEMORY ELECTRONIC KEYER FOR DEDICATED CW OPERATORS



Eight long memory channels.  
**\$350**

### ELECTRONIC KEYER: KP-100



**\$149**

Small in size. BIG in features. Adjustable weight and tone, front panel volume and speed controls. Dot-dash memories, speaker, sidetone, selection or semi-auto/tune etc. Best value on the market

### BENCHER THE ULTIMATE IAMBIC PADDLE KEYS

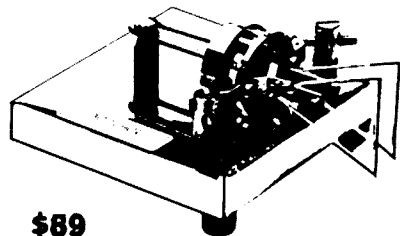

**\$89**

- Full range of adjustment in tension and contact spacing
- Self-adjusting nylon and steel needle bearings
- Solid silver contact points
- Polished lucite paddles
- Precision-machined, chrome plated brass frames
- Standard model has black textured finish base. deluxe model is chrome plated
- Heavy steel base, non-skid feet

### Protect your expensive equipment with COAXIAL LIGHTNING SURGE PROTECTOR CA-35A

**\$29**

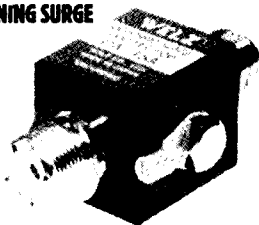

### TRANSMITTING TYPE VARIABLE CAPACITORS

for high power RF amplifiers and antenna tuners

ECC 32-208, 210pF, 1000V for tuners	\$23
ECC 48-800, 800pF, 2800V for tuners	\$88
ECC 88-120, 210pF, 4800V for tuners	\$89
ECC 32-800, 800pF loading capacitor	\$89
ECC 78-280, 280pF plate capacitor.....	\$87

### UNIQUE DESK TYPE MICROPHONE WITH DIGITAL CLOCK DX480

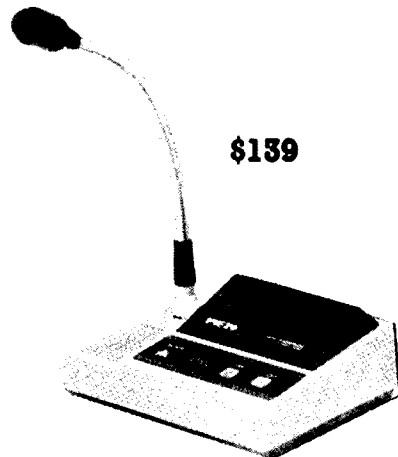

**\$139**

Hi-Class Base Station Microphone  
You have DX-480 simultaneously in three ways — the highest class base station microphone, a digital chronometer and an external speaker of clear tonal quality. The pleasant sensation with this 3-in-1 super machine will tell you the AMATEUR life is entering a new age.

### DATONG MORSE TUTOR

The only way to learn Morse code

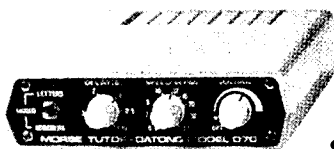

**\$159**

### MODEL D-70 MORSETUTOR

Produces random 5 character groups: all letters, all figures or mixed.  
Calibrated variable speed (61/2 to 37 WPM) and variable delay (up to 5 secs) between letters for optimum learning efficiency.  
Internal loudspeaker, plus personal earpiece for private listening.  
Battery operated therefore always ready for use. Current drain is very low for long battery life.

### AM-303 DESK TOP MICROPHONE

AM-303 can be used with any HF, VHF or UHF transmitter and features a high performance, low noise microphone with amplifier built in. Highly sensitive condenser microphone and flexible tube employed. Provided with tactile feel up/down switch and voice quality selector switch for FM/SSB.

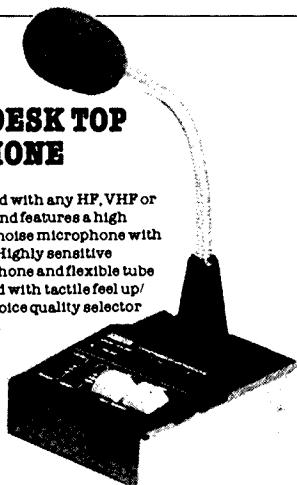

### TOROID CORES

All the popular sizes & mixes

#### IRON POWDER TOROIDS:

CORE SIZE	MIX B .5-30 MILS $\mu = 10$	MIX C 10-90 MILS $\mu = 8.5$	MIX 18 90-300 MILS $\mu = 4$	SIZE OD [in.]	PRICE \$
T-200	120			2.00	\$8.90
T-108	138			1.06	\$2.90
T-80	58	48		.80	\$1.80
T-88	87	47	21	.68	\$1.70
T-80	81	40	18	.80	\$1.50
T-37	42	30	18	.28	\$1.40
T-28	34	27	12	.37	\$1.20

### HF FERRITE TOROIDS:

CORE SIZE	MIX Q1 $\mu = 188$ .1-70 MILS	MIX Q8 $\mu = 40$ 10-180 MILS	SIZE OD (in.)	PRICE \$
F-240	1300	400	2.40	N.A.
F-128	900	300	1.28	\$3.80
F-87	600	190	.87	\$3.80
F-80	800	190	.80	\$2.10
F-37	400	140	.37	\$1.80
F-23	190	80	.23	\$1.30

Chart shows  $\mu$ H per 100 turns

### ACTIVE RECEIVING

#### ANTENNAS

#### Model 270 & 370

Ultra compact receiving antenna systems giving wideband coverage from 800kHz to 30 MHz at high sensitivity Models AD270 & AD370 give similar receive performance to large conventional antenna systems yet are only 3 metres in overall length. The balanced dipole configuration also gives good rejection of local interference

**AD-270.....\$129**

**AD-370.....\$199**

# HEARD ISLAND EXPEDITION 1983 ADVENTURE SOUTH

## THE EXPEDITION JOURNAL

A photographic essay and collection of stories recounting the experiences of the Expeditioners on the Island — their successes and disappointments and the beauty and dangers they faced whilst living on this remote wind torn island.

56 pages, over 120 photographs and 25 stories by 10 authors. Limited Edition. Price \$6.00 plus \$1.00 for postage.

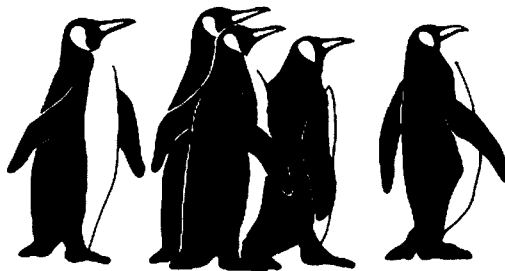

## THE EXPEDITION 'T' SHIRT

A graphic design based on the majestic King Penguin. Hand printed by the Expeditioners. Available in all sizes — when ordering, include Australian metric size or chest measurement — for children, specify age. Bonds Gotcha sweat shirt available with the same design. 'T' Shirts \$8.50 plus \$1.00 postage. Sweat Shirt \$18.50 plus \$1.50 postage.

Please send me .....	Tickets to "ADVENTURE SOUTH"	\$5.00 Each	\$ .....	My method of payment is <input type="checkbox"/> Cheque <input type="checkbox"/> Moneyorder <input type="checkbox"/> Bankdraft (\$Aust) or debit my credit card (include full card number) <input type="checkbox"/> Bankcard .....	
.....	Tickets to "WIND ICE & FIRE"	\$2.00 Each	\$ .....		<input type="checkbox"/> American Express .....
.....	Copies of the Expedition Journal — \$6.00 Each plus \$1.00 postage		\$ .....		<input type="checkbox"/> Diners Club .....
Please send me <input type="checkbox"/>	(number) Expedition 'T' SHIRTS Sizes (chest meas)		\$ .....		<input type="checkbox"/> Mastercard .....
.....		\$8.50 (Aust) EACH (Add \$1.00 for postage)		Expiry date .....	
Please send me <input type="checkbox"/>	(number) Expedition SWEAT SHIRT Sizes (chest meas)		\$ .....	Signature .....	
.....		\$18.50 (Aust) EACH (Add \$1.50 for postage)		NAME .....	
			TOTAL \$ .....	ADDRESS .....	
				COUNTRY .....	

**Post to: HEARD ISLAND EXPEDITION, G.P.O. BOX 4773, SYDNEY, 2001, AUSTRALIA.**



IF YOU HAVEN'T LOOKED AT  
**amateur radio action**  
LATELY, THIS IS WHAT  
YOU'VE MISSED ...

- The Spratly Island incident — in depth.
- Yaesu's FT-980 "Computer Cat".
- Flexible mods for Yaesu FT-290R.
- An inside look at CIA propaganda stations.
- The VK3BCN report on emergency communications.
- A plain language summary of the WIA "RADCOM" submission.
- A cheap external VFO for Yaesu's FT-707.
- The complete VHF/UHF frequency and beacon list.

**OCEANIA'S AMATEUR MAGAZINE — \$1.50 AT YOUR NEWSAGENT.**

# THE CONVENIENCE REVOLUTION.



**A BRILLIANT LINEUP OF HIGH QUALITY AMATEUR RADIO ACCESSORIES.**

## ANTENNA ROTATORS

Round controller with world map indicator.  
DR7500R, DR7600R.

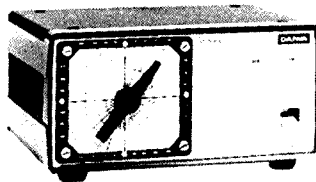
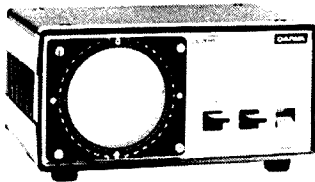

Pre-set controller.  
DR7500X, DR7600X.

Set your antenna with a choice of Daiwa Heavy Duty and Medium Duty Rotators. They'll get you going in the right direction. Type X allows you to pre-set the call area you want and Type R comes with Paddle Switch Control and world map display.

**DR7500R** Daiwa Ant. Rotator, Medium Duty. **DR7500X** Daiwa Ant. Rotator, Medium Duty, Pre-set. **DR7600R** Daiwa Ant. Rotator, Heavy Duty. **DR7600X** Daiwa Ant. Rotator, Heavy Duty, Pre-set.

## SWR/POWER METERS

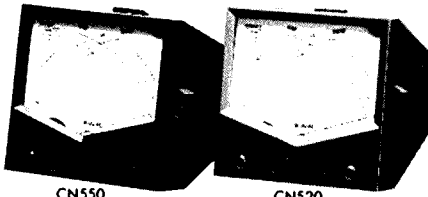

Hands-off operation.

The famous cross-needle meter provides three measurements at the push of one PTT button. And their compact size means they fit into even the most crowded shack. There's a compact cross-needle meter to suit almost any need—choose the one that suits you.

**CN510** 1.8-60MHz. 200W/2kW. **CN520** 1.8-60MHz. 20W/200W. **CN540** 50-150MHz. 20W/200W. **CN550** 144-250MHz. 20W/200W. **CN620A** 1.8-150MHz. 20W/200W/1000W. **CN630/CN630N** 140-450MHz. 20W/200W. **CN650** 1.2-2.5GHz. 2W/20W. **CN720** 1.8-150MHz. 20W/200W/1kW.

## ANTENNA TUNERS

**AUTOMATIC** The **CNA1001** and the **CNA2002** are two of the most advanced antenna tuners on the market.

Both provide the convenience and accuracy of automatic tuning at the push of a button! The **CNA2002** is rated at 2.5kW PEP while the **CNA1001** is rated at 500 watts PEP. Both units auto tune within all HF bands 3.5-30MHz, including the new WARC bands. Both units incorporate the unique Daiwa cross-needle meter to indicate SWR and Power. A built-in dummy load is also included for preliminary tuning. **CNA1001** Daiwa Automatic Tuner 200W. **CNA2002** Daiwa Automatic Antenna Tuner 2.5kW.



Daiwa **CNA2002**

**MANUAL** Daiwa has a superb range of Manual Antenna Tuners to ensure your station operates efficiently by getting maximum power to your antenna system. Rugged design and ease of operation make these tuners a must for any amateur station! **CNWS18** Daiwa Manual Antenna Tuner 3.5-50MHz (including WARC). **CN418** Daiwa Manual Antenna Tuner 3.5-30MHz. **CNW218** Daiwa Manual Antenna Tuner 3.5-30MHz.

## COAXIAL SWITCHES

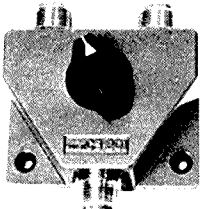

You get low-loss and good isolation with Daiwa's professional quality coaxial switches. They all complement Vicom's own unbeatable relays and operate from HF to 70cm. **CS201** Daiwa Coaxial Switch, 2 Pos. **CS201N** Daiwa Coaxial Switch, 2 Pos "N" type. **CS401** Daiwa Coaxial Switch, 4 Pos.



### MELBOURNE

Vicom International Pty. Ltd.,  
57 City Road,  
SOUTH MELBOURNE, VICTORIA  
PHONE: (03) 62 6931

### SYDNEY

Vicom International Pty. Ltd.,  
6th Floor,  
118 Alfred Street,  
MILSONS POINT, NSW  
PHONE: (02) 436 276

### WELLINGTON, NEW ZEALAND

Malvicom,  
18 Raroa Road,  
Lower Hutt,  
NEW ZEALAND  
PHONE: (4) 69 7625

**DEALER ENQUIRIES INVITED!**



# a word from your EDITOR

The subject of specifications of amateur equipment crops up from time to time. Unfortunately specifications are open to interpretation.

Manufacturers write their specifications around what the transceiver or other equipment is capable of doing. They refer to the prime role of the equipment. If the equipment is used in some other role then some care should be exercised.

We as amateurs should carefully inspect the specification of the equipment and see that it does indeed apply for the usage we have in mind.

For instance, mobile transceivers are usually characterised for operation in a vehicle with the engine running. That is for a battery voltage of a nominal 13.8 volts. If we wish to work for a long time from a stationary vehicle a battery voltage between eleven and twelve volts is likely.

For use under such conditions the maker may well give a negative percentage of the battery voltage. However, if the same positive percentage is applied in the battery voltage tolerance the rig may suffer damage when working off another power supply. This is often covered by a warning in the handbook.

Similarly an SSB transceiver may not perform as well as the SSB power input and output figures would indicate if used for FM or FSK RTTY. Considerably reduced output or inefficient operation may well be encountered in these modes.

To avoid such embarrassments the specifications and handbook should be perused carefully prior to purchase. Also the help and advice of a reputable dealer is of value. A small monetary saving at a discount house may soon be lost if you are wrongly advised or if warranty service is needed.

AR

## PRESIDENTIAL COMMENT

# Thirty Per Cent Tariff Duty Imposed on HF Transceivers

*On 28th June 1983, a new 30 per cent Customs Tariff Duty was imposed on ALL imported transceivers for use in the HF bands, including amateur band only HF transceivers.*

The WIA initially negotiated the import by-law approximately 10 years ago, which allowed HF transmitters and transceivers designed for use on the amateur bands to be brought into Australia duty free.

The lifting of the by-law now means the end-user retail price will escalate to approximately 40-45 per cent above current retail prices on all amateur HF transceivers.

The WIA and the amateur importing industry were shocked at this news. It would appear from our initial investigations that a number of the current 'general coverage' type amateur transceivers have been illegally modified by unscrupulous retailers and individuals. These modified sets have been sold to the yachting fraternity and others.

The purpose of this type of undesirable activity, was to sell modified amateur equipment for use on the marine bands, at greatly reduced prices than that applicable to 'type approved'

and licenceable marine radio equipment, which is manufactured locally.

Equipment designed for amateur use is not able to be type approved, nor licensed for use on any other bands, whether modified or not.

*(Please refer elsewhere in this issue regarding a joint WIA/INZART statement on illegal maritime mobile operations. That statement was written several weeks prior to notification of the new tariff duties being received.)*

It also appears that top level Government negotiations have been going on for some time in secrecy, so much so, that neither the WIA nor the amateur importing industry itself had any prior knowledge of the new tariff duty.

On 6th July 1983, a joint meeting was held at the WIA Federal Office between WIA representatives, senior personnel from Icom, Kenwood, Yaesu, importers and distributors, a customs agent, and the editor of Amateur Radio Action.

The meeting was held to determine a recommendation for the W.I.A.'s attitude, and to seek facts and advice on how best to handle this new tariff duty.

At the time of writing this report, we have certain information available to us which may assist us, also details of the 'How and Why' the tariff was initially imposed.

We need to act very quickly and further expert advice is being sought. Members will be kept informed of further developments by Federal Broadcast Tapes, circulars to Divisional Councilors, and articles published in Amateur Radio, Amateur Radio Action and other electronic magazines.

*If ever we need a united front, it is now. Please enrol as many new members as possible to preserve our negotiating powers.*

Bruce R. Bathols, VK3UV  
WIA Federal President





# QSP



## PIRATE OPERATORS AND IMPROPERLY LICENSED STATIONS

*This is a joint statement issued by the Wireless Institute of Australia, and the New Zealand Association of Radio Transmitters. The statement was issued on 1st July 1983. All radio amateurs should read it carefully.*

### YOUR RESPONSIBILITY AS A RADIO AMATEUR

As licensed radio amateurs, we organise ourselves through the Wireless Institute of Australia and the New Zealand Association of Radio Transmitters Inc. to uphold the standards of the Amateur Service, including the present high standard of entry.

We accept responsibility for helping people who want to become radio amateurs, and for protecting their interests once they have become properly qualified.

We must seek to remove improper and illegal practices that bring the amateur service into disrepute in licensing matters, make regulatory improvement difficult, make it extremely difficult to get support for the amateur service at International conferences, and cheapen the worth of our qualifications and licences.

### IMPROPER AND ILLEGAL PRACTICES

We are not directly concerned with stations operating outside amateur bands.

In bands allocated to the amateur service, pirate operators and improperly licensed stations are operating. They are posing as amateur stations, but they fall short of our standards in these ways:

- 1 *The operator is unqualified.*
- 2 *Their callsign has not been issued by an administration recognised by the ITU or*
- 3 *An administration may have issued the callsign without ensuring that a minimum standard of competence to operate in the amateur service has been demonstrated, and*
- 4 *Operation is contrary to the ITU regulations, the Australian Radio Regulations or the New Zealand Radio regulations.*

### MARITIME MOBILE STATIONS

The WIA and the NZART help properly qualified radio amateurs who go to sea, and the sea-going enthusiast who wants to become a genuine radio amateur.

Genuine /MM stations are encouraged to make their activities known through IARU societies and amateur radio publications.

Unfortunately, many /MM stations using the amateur bands are illegal.

The prefixes used in the Pacific by yachtsmen suggest many improper licences. The International Callbook does not list many callsigns or callsign-sequences used, and enquiries by IARU societies in many countries (for example Liberia) have shown that their licensing administrations are concerned about these pirated callsigns. The Department of Communications in Australia, and the New Zealand Post Office are also most disturbed at these pirate /MM activities.

Amateur equipment is cheaper than type-approved equipment, and this may be a reason for what seems to be a concerted effort in yachting circles to encourage the trend away from the maritime service to the amateur service.

### ACTION

Except in a GENUINE EMERGENCY involving safety of life when any frequency may be used, as a radio amateur you should:

- 1 *Cease contact with pirate or improperly licensed stations operating in amateur bands.*
- 2 *NOT accept third party and other traffic requests.*
- 3 *If in doubt about the legality of the station you work, seek these details:*
  - (a) *Name of vessel*
  - (b) *Name of operator, and*
  - (c) *Origin of the licence.*

Tell the Australian Department of Communications or the New Zealand Post Office about the station, and tell the station that you are doing so. Get in touch with:

- 1 *Your local Radio Inspector — he is listed in the telephone book. (Australian amateurs look under 'Department of Communications'.)*

2 *The NZART Post Office liaison officer — his address is PO Box 40 525, Upper Hutt NZ. (New Zealand amateurs only.)*

3 *The WIA Executive, PO Box 300, Caulfield South, Vic 3162. (Write brief details of matter discussed — Australian amateurs only.)*

Help the WIA and NZART to stamp out illegal practices, and to protect your interests.

### SALES OF TRANSMITTING EQUIPMENT.

The WIA and NZART considers that the present control of sales of transmitting equipment is unsatisfactory, and will continue to press for stringent control.

When selling transmitting equipment, you should sell only to licensed operators.

### THE NEW ZEALAND POST OFFICE AND THE AUSTRALIAN DEPARTMENT OF COMMUNICATIONS

Both fully support the NZART and the WIA in their desire to stamp out improper practices.

The NZPO and DOC have inspected vessels and impounded amateur-type equipment.

The NZPO and DOC will continue to take action against shore-based stations that take part in improper practices.

### SPREAD THE WORD

Draw this statement on pirate operators and improperly licensed stations to the attention of any radio amateur who has traffic with pirate /MM stations.

For this purpose you may photocopy this statement.

*This statement is published jointly and in conjunction with the Wireless Institute of Australia and the New Zealand Association of Radio Transmitters.*

Authorised by  
Bruce R. Bathols  
WIA FEDERAL PRESIDENT  
AR

# WINTER IS HERE — BAND CONDITIONS ARE POOR

*Curl up beside the fire and read a book*

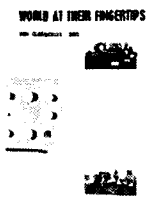

**WORLD AT THEIR FINGER TIPS** by John Clarricoats, G6CL  
A hardcover book of 300 pages telling the story of amateur radio in words and glossy photographs.



**VHF UHF MANUAL** by G R Jessop, G6JP  
This 4th edition hardcover book tells of the technical advances in 6 years, since the last edition was published.

**RADIO AMATEURS EXAMINATION MANUAL** by G L Benbow, G3HB  
130 pages of information to assist one to pass the amateur examinations.



**TV FOR AMATEURS** by John L Wood, G3YQC  
A handy little book explaining the principles and getting started in TV to color TV and the 1.3 GHz TV band.



**NZART CALL BOOK '83**  
Full callsign listing for ZL plus much helpful information.

**TEST EQUIPMENT FOR THE RADIO AMATEUR** by H L Gibson, G2BUP  
Hardcover book describing the range of test equipment and measurement methods.

This new shipment of books is now available.

Contact your division of Magpubs, Box 300, South Caulfield, Vic 3162.

# WIA REPRESENTATIVES VISIT NZART ANNUAL CONFERENCE

Bruce Bathols, VK3UV  
WIA FEDERAL PRESIDENT

As part of the continuing two-way exchange of information between the WIA and the NZART, Bruce Bathols, VK3UV WIA Federal President and David Wardlaw, VK3ADW WIA Executive Member and IARU Liaison Officer, were invited guests at the annual conference of the New Zealand Association of Radio Transmitters (NZART) which was held in Dunedin, NZ over the weekend of 3rd to 6th June 1983.

Both organisations exchange reciprocal visits, thereby keeping in close touch with items which can be mutually beneficial, and of interest to each others members. The aims of both amateur bodies are identical, and needless to say, so are the problems.

The NZART is structured slightly differently to the WIA, in that there are no divisions as we know them here in Australia. The NZART consists of approx eighty 'branches', each branch being formed by a local radio club and consists of either transmitting or non-transmitting members. A branch may be formed if more than eight members in a particular area are desirous of forming such a branch.

At the annual conference, a delegate from each branch is represented, however, some of the smaller branches may not send a delegate, therefore a branch desirous of having its views known but not being able to have a delegate present, will give a proxy to a delegate from a larger branch who will present votes on behalf of the absent branch. It was not uncommon for one branch delegate to be holding proxies for three or four other smaller branches.

Each member of the NZART is able to register a vote through his/her branch, therefore a delegate representing the branch (either direct or by proxy) may vote proportionally for or against a particular REMIT (motion discussion point) as it is presented.

Remits are published in Break In one month prior to the annual conference, therefore each branch is able to discuss their voting preferences prior to the conference, and the aggregate of individual branch members voting preferences are then presented to the conference through the attending delegate.

In amateur operating matters etc, votes of Remits are restricted to transmitting members only, matters of an administrative nature are open to all branch members to vote upon.

Daily administrative and operational policy matters are handled by the NZART Council (similar to the WIA Executive). The Council consists of twenty two NZART members who are elected to office by the branches in an election which is conducted several weeks prior to the conference.

Councillors reside in all parts of the country, therefore the council meets in person only once each year. That meeting is on the day prior to the annual conference. It will discuss policy matters and general administrative affairs.

To keep in regular contact with each other,

council conducts a monthly net on 80 metres, and discusses 'on air' items of importance to the NZART in general.

A full time paid secretary (based in Upper Hutt) co-ordinates council activities and circulates matters to councillors on a regular basis. Matters which are of a sensitive nature and unable to be discussed on the monthly net are handled by mail.

Much use is made of volunteer labour in a similar manner as in the WIA, and it is agreed by both organisations, that due to increasing demands of members, a certain amount of paid professional help is now required. Neither organisation can function without the backbone of volunteers at the grass roots level, but the day is coming in the not too distant future where daily administrative matters can only be handled by paid full time staff. This will certainly be the case as membership numbers increase. It will put both the WIA and the NZART on the same administrative basis as the RSGB (UK) and the ARRL (USA).

Some of the problems common to both amateur societies are:

*Tower difficulties — a greater public awareness of amateur radio towers and their effect on the environment is evident. NZART have several legal cases pending at the moment.*

*TVI and RFI (a world-wide problem).*

*Lack of volunteers (suitably qualified or otherwise) to service important posts.*

*Difficulty in obtaining major press publicity in amateur radio affairs. The AREC (Amateur Radio Emergency Corps — similar to our*

*WICEN) appears to have a much greater acceptance with the authorities, and is officially recognised for its capabilities. A certain amount of press coverage is given to AREC matters, as it is the primary service associated with major Search and Rescue and Civil Defence organisations.*

*Increasing inflation, and a possible loss of members as fees are increased to cover normal running costs. It was recognised by both groups that fees must be increased annually to maintain existing services, otherwise reserves would be eroded as inflation took its effect.*

*Increasing costs of production of the respective amateur journals (Amateur Radio and Break In). Both groups suffered heavy losses in 1982 due to increased costs in the printing industry.*

*Both groups share excellent liaison with the relevant licensing authorities — Department of Communications and the New Zealand Post Office.*

*Two NZART representatives will be attending the WIA convention in 1984, and WIA representatives will attend the NZART conference in 1985.*

*Mail exchanges during the year also help to keep each group up to date. It was accepted that these continuing exchanges are important, so that both groups are aware of changing trends as they occur.*

*For the mutual benefit of both societies, and the amateur service in general, these lines of communication must always be kept open.*

**Below — Bruce VK3UV and David VK3ADW at the NZART Conference.** AR



# MODERN MILITARY SURPLUS EQUIPMENT

Colin MacKinnon VK2DYM  
PO Box 21, Pennant Hills NSW 2120

## WIRELESS SENDER — THE C11

*The C11 is a transmitter for CW, AM and FSK covering 2-16 MHz. It was used mobile in some AFV's and in command wireless vehicles. The associated receiver is the R210. The power supply was the Supply Unit Transformer Rotary 24V and it had a very nice aerial tuner ATU No 7.*

### SPECIFICATIONS

Power Requirements:  
24V at 20 amps Tx, 3 amps standby.  
Frequency coverage:  
Band 1 2 to 4 MHz  
Band 2 4 to 8 MHz  
Band 3 8 to 16 MHz

Mode of Operation:  
Transmission of CW, AM and FSK with an adaptor  
Power output:  
Low — 3 to 10 watts  
High — 12 to 50 watts dependent on frequency in use.  
Microphone: 600 ohms  
Antenna: 75 ohms

Dial Calibration:  
Band 1 and 2-2.5 kHz/division  
Band 3-5 kHz/division  
Weight: C11 31 Kg.  
PSU 20 kg.  
ATU 9 kg.  
Total: 60 kg

Intercom amp:  
output — 250 MW into 30 ohms.

### PRINCIPLE OF OPERATION

The master oscillator V1 covers a frequency from 2 MHz to 4 MHz. The oscillator unit is housed in a sealed, substantial diecast case. The output is buffered in V2 and fed to the band switch. On band 1 V3 is bypassed but on band 2 V3 a doubler is brought into circuit and V4 is an amplifier. On band 3, V4 becomes a doubler also. V5 & V6 are final amplifiers in parallel.

V11 is a microphone amplifier feeding an AF amp V10 thence to the push pull modulator V8 and V9. Modulation is applied to the screens of V4, V5 and V6 and also to the anodes of V5 and V6. V7 is a detector for Automatic Modulation Control AMC which is fed back to V11 to maintain modulation level constant.

V13 is a sidetone oscillator for CW and amplified by V10.

V14 is a voltage stabiliser for V1 and is housed in the same enclosure.

For calibration a 100 kHz signal from oscillator V12B is mixed in V12A with the master oscillator output from buffer V2. The resultant beat signal is amplified in the AF amp stages.

The intercom AF amp V15 and V16 is powered by voltage from the R210 receiver.

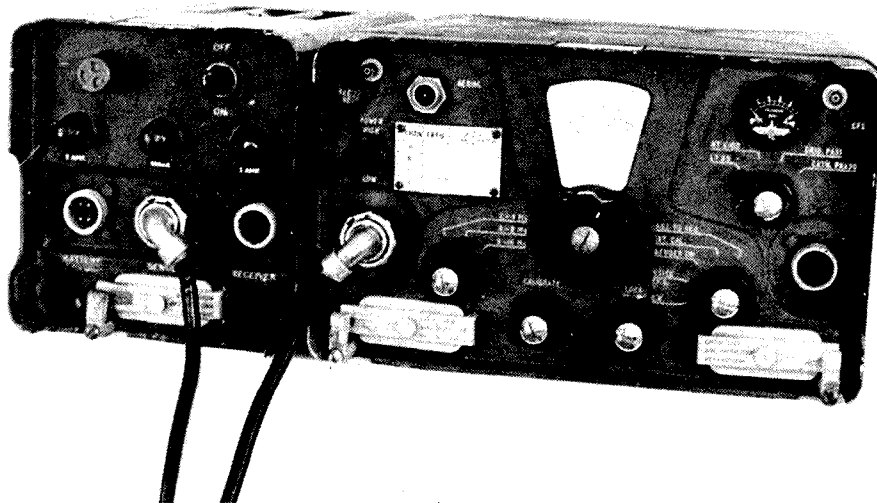

### VALVE LINE UP:

Serial No.	Type	Function	Equivalent
V1	CV4010, CV850	Master oscillator	6AK5, EF95
V2	CV4039, CV2129	Buffer	5763, QV03-12
V3	CV4039, CV2129	Amp/doubler	5763, QV03-12
V4	CV4039, CV2129	Amp/doubler	5763, QV03-12
V5	CV2347	Power amp	
V6	CV2347	Power amp	
V7	CV4007, CV283	AMC Detector	6AL5
V8	CV2347	Modulator	
V9	CV2347	Modulator	
V10	CV4003, CV491	AF amp	12AU7, ECC82
V11	CV4015, CV131	Mic amp	6065, EF92
V12	CV4003, CV491	Mixer/osc.	12AU7, ECC82
V13	CV4010, CV850	CW sidetone Oscillator	6AK5, EF95
V14	CV287	Voltage stabiliser	150B3
V15	CV4010, CV850	Intercom amp.	6AK5, EF95
V16	CV4010, CV850	Intercom amp.	6AK5, EF95
Power Supply Unit			
V101	CV395	Voltage Stabiliser	QS150/45
V102	CV395	Voltage Stabiliser	QS150/45

## ANTENNA TUNING UNIT NO 7

This unit matches the 75 ohm transmitter output to various short antennae over the frequency range. It has a variable capacitor controlled by a Match knob and a roller inductor tuned via a Tune control with a digital counter to indicate position. An aerial current metre assists the tuning process. The output connection is a large insulated single wire terminal.

The aerial base used with a rod aerial is specified as a Base No 31. The base for the VHF units is a No 28.

## POWER SUPPLY UNIT

The PSU connects to the C11 via a harness and a 12 pin socket. It also has a 12 pin socket for a harness to the R210. The power plug is 4 pin and the power lead has two wires in parallel for +ve and -ve to carry the current. A rotary transformer converts 24V to  $\pm 530V$  and a stabilised +300V via dropping resistors and stabilisers V101 and V102.

Voltages required by the C11 are:

HT1 — +300 VDC  
 HT2 — +530 VDC at about 500 mA.  
 HT2 — -530 VDC — ie isolated from chassis earth.

Filaments- +19 VDC  
 Fan & Relays +24 VDC

## FRONT PANEL CONTROL INTERCONNECTION SOCKET SK1B

- A — Tx mike input
- B — intercom and Tx microphone shield
- C — intercom microphone input
- D — PTT line
- E — no connection
- F — +24 VDC output via PLA-K
- G — intercom and speaker output
- H — no connection
- J — intercom speaker output
- K — no connection
- L — no connection
- M — speaker output.

## MODIFICATIONS

- 1) To operate the set make the following connections:-

Microphone to pins A and B Shield to B.  
 PTT switch to pin D  
 PTT return to earth  
 Speaker to pins G and M  
 Receiver to REC AE receiver aerial BNC socket

Note that during operation the vents on the front and rear of both the C11 and PSU must be opened to allow air circulation.

When the C11 control switch is set to CW the PTT line can be keyed and operates semi-break-in.

- 2) The C11 can be operated directly into a dipole using 75 ohm co-ax. For other impedances the ATU No 7 can be used. The large insulator on the rear can be replaced with an SO239 on a metal plate fitted in place of the insulator.

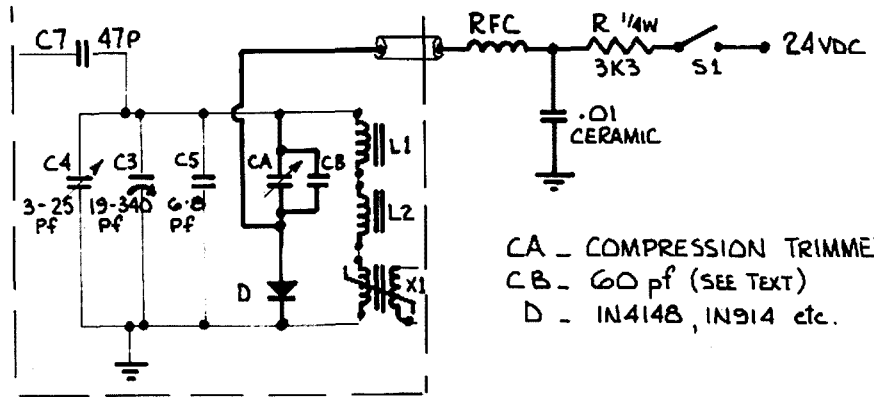

CA — COMPRESSION TRIMMER  
 CB — 60 pF (SEE TEXT)  
 D — IN4148, IN914 etc.

Oscillator Sub-Unit

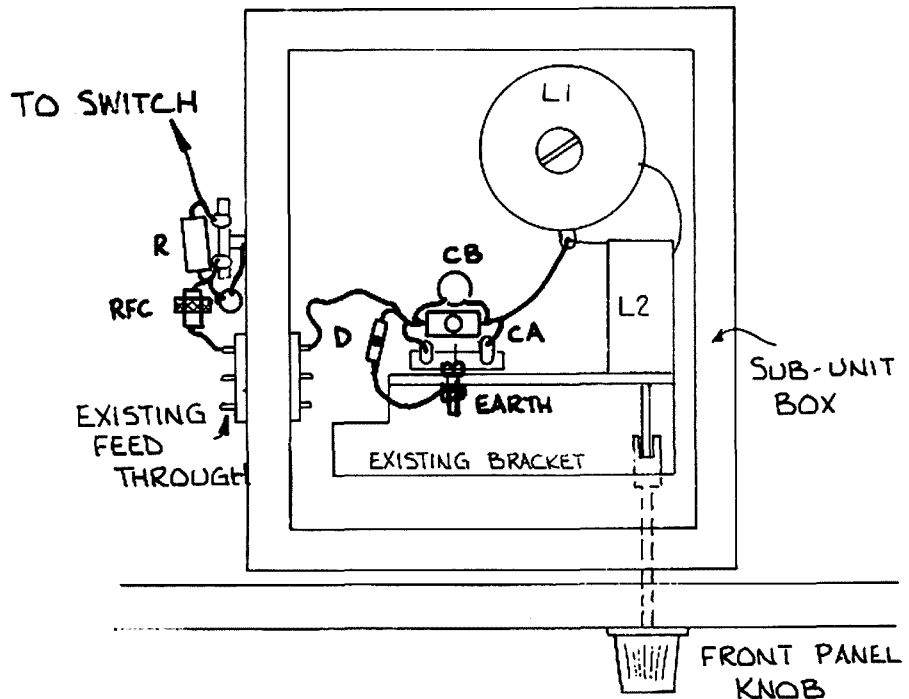

Layout

## 160 METRE MODIFICATION

The C11 can be modified to operate on the 1.80-1.86 band by switching in added capacitance across C3, the tuning capacitor in the oscillator sub-unit.

The bottom cover was removed from the oscillator sub-unit to reveal coil L1, and L2 which is adjustable from the front panel for calibration.

The bracket supporting L2 was drilled to mount a small 2 lug tag strip onto which was mounted the compression trimmer and 60 pF capacitor with the diode going from one end to an earth lug. A wire was soldered from the other side of C(A) to the top of L1 (actually the farthest end of L1 looking from the top). Another wire was connected from the junction of the diode and C(A) to an existing unused terminal feed-through on the sub-unit.

Use heavy, rigid connecting wire and ensure the added parts are supported rigidly to prevent vibration and frequency variations.

A second 2 lug tag strip was fitted on an existing bolt on the feed through block on the outside of the sub-unit and the RFC, R, and bypass capacitor mounted there-on.

I found a space on the front panel just to the left of the metre and big enough for a miniature SPST switch. There is a convenient 24V terminal available near the right hand side of the meter.

I used a frequency counter as an aid to calibration but other means of determining the frequency should be satisfactory.

The calibration procedure followed was to set the tuning dial on 2.000 MHz, the front calibration central (L2) at mid travel and the new switch off.

Run the transmitter for at least half an hour to allow temperatures to stabilise.

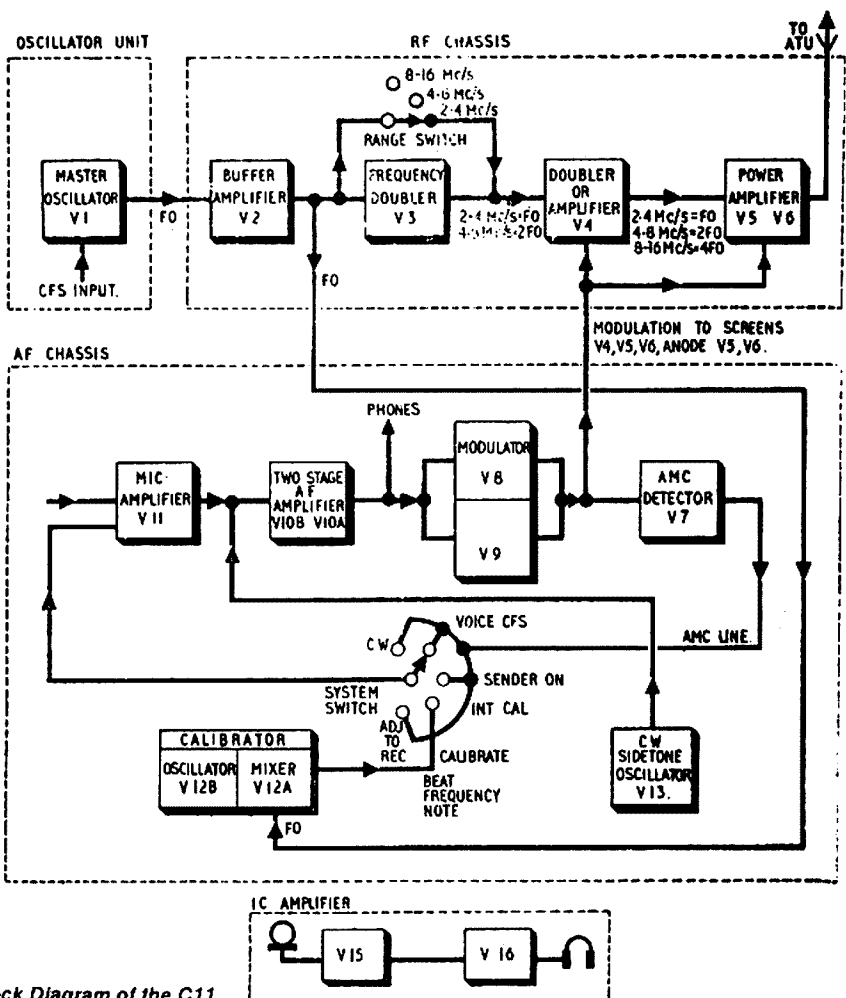

Block Diagram of the C11

With the transmitter keyed at low power into a dummy load the frequency was adjusted to exactly 2.000 MHz by adjusting the position of the ferrite slug in L1.

The new switch was then operated and the trimmer C(A) adjusted till the transmit frequency was now exactly 1.800 MHz.

I found some interaction between the adjustments so you may have to go through the procedure a couple of times to get a close calibration. During normal operation the calibration control and internal crystal calibrator can be used for exact frequency setting.

I also found that a 60 pF N750 capacitor for C(B) was best for my set after trying various others. One problem is to get the frequency / temperature variations reasonably correct. At one stage I had the normal 2.00 MHz increasing in frequency with temperature and the 1.8 MHz decreasing.

As I was not concerned about operating on the 3.5-3.70 MHz band I didn't try to adjust for correct frequency tracking or power output but did adjust L8 and L12 for maximum output at 1.80 MHz and C28 and C49 for maximum at 1.86 MHz. These adjustments interact so need to be done a couple of times.

Although I had no problem bringing the oscillator sub-unit down to 1.800 MHz it did tend to drop out of oscillation just below 1.8 MHz.

Depending on the gain and feedback of individual sets, some modification may be needed to ensure reliable oscillation at the 1.80 MHz frequency.

**ACKNOWLEDGEMENT.** These articles could not have been written without the help of Ian VK2ZIO, Ross VK2ZUY, and Tony VK2DKY, who know this equipment far better than I. I just put pen to paper! I must also thank Abe, our friendly disposals proprietor, who let us climb on his mountains of electronic gear, looking for parts.

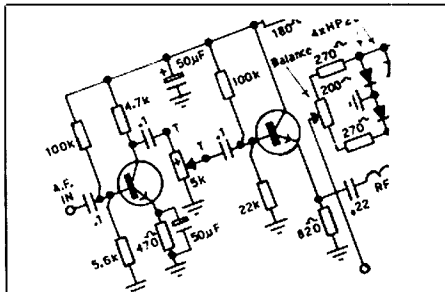

**CIRCUITS**

The Circuits of the equipment in this series of articles are held in the Federal Office.

Photocopies may be obtained by writing to the Secretary WIA at PO Box 300 South Caulfield 3162. To defray the costs of this service a suitable donation would be appreciated.



**Bill Blitheringwit**

Ted Holmes, VK3DEH  
20 Edmond Street, Parkdale, Vic 3195

**BILL PREPARES TO GO MOBILE**

After the fiasco involving the wrecking of his TV antenna, Bill Blitheringwit was banned from any further radio activities in the house. Bill was not unduly concerned. It had happened before. His wife usually relented in the end, being unable to stand the sight of Bill's woebegone expression as he moped around the place. Bill's face was already adopting the pitiful spaniel look, in preparation for his campaign to resume his normal trail of destruction. It generally worked, but, meantime, he had decided to go mobile.

Bill's somewhat battered Holden station wagon was standing in the driveway, all doors open, and Bill was about to drill a hole in the centre of the roof. He stood on a small cane bottomed chair, purloined from the lounge room, and, as soon as his full weight was deployed upon the fragile cane seat, the cane broke and Bill fell through it. He stood there, wearing the chair likt a skirt around his hips, staring with dismay at the power drill he was holding. For in his sudden descent, the drill bit had struck the gutter of the Holden and snapped off. All he had left was a jagged stump.

This was awkward! It would take him hours to find another bit. Never mind. He wrenched himself out of the ruins of the lounge room chair and plunged into the morass of the garage. An hour or so later he discovered another bit — albeit somewhat rusty — but it would do. This one was larger than the first, but it seemed OK. At any rate, it was when he had last used it in 1938.

He stood on the car bonnet and aimed the drill in roughly the centre of the roof. Owing to the size of the bit and the fact that Bill had not made a starter hole, the thing skidded a few times before finally biting. This resulted in numerous scratches appearing in the already saddened paintwork, but, in the end, Bill had made a decent sized hole.

His satisfaction was rather diminished when he looked inside the car and discovered that the drill had effectively destroyed the inside roof light. His spirits sank lower still when he looked at the car bonnet, whereon two large dents, size 9, were clearly evident.

True to type, Bill pressed on regardless and finally got his long suffering 22S installed beneath the dashboard. He hooked up the RG58U coax and slammed the car door, thereby neatly severing the coax, which had not been properly guided into the driving compartment.

He sighed and sat down to think about it. What with one thing and another, it just wasn't his day!

# SHACK CRAWLING 1930s STYLE

Alan Shawsmith, VK4SS  
35 Whynot Street, West End, Qld 4101

## or *THREE MEN IN A RUBBIDY-DUB-DUB*

*Since pre-war days man's mobility has increased dramatically but even the lack of high-speed reliable transport did not dampen the enthusiasm for 'Shack Crawling', half a century ago.*

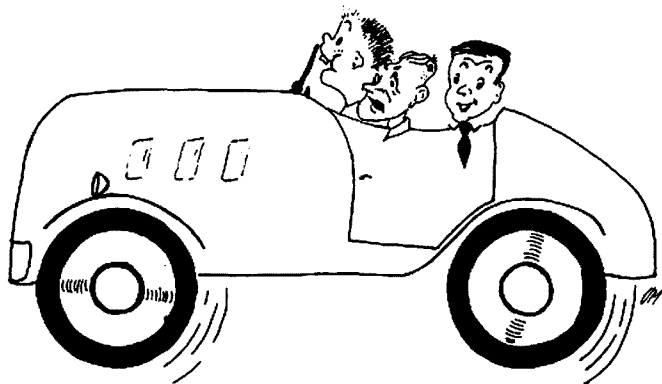

One promising morning three Southside Brisbane amateurs, viz Harry 4HR, Bill 4YO and Fred 4RF set out in a gregarious frame of mind to visit a few cross-town Northsiders, one in particular being Arthur (Chilla) 4SD — a round trip of about thirty miles. Lacking wheels of any sort, they harrowed a Baby Austin Seven HP Tourer which, although mobile, probably would not have passed a machinery test. In high spirits, the three scrambled aboard.

As such vehicles can now be seen only in glossy magazines or at Vintage Displays, a short description is in order. The Baby Austin Seven was a small, lightweight, low priced, economy 'jalopy' of narrow proportions and held together with a minimum of parts; in the modern vernacular it might have been described as 'a cheap heap', especially if secondhand. Alongside its more cumbersome, heavyweight counterparts of the day it looked almost like a toy. This writer had the misfortune to own a Baby Austin Seven Tourer in the late 30s and more time was spent repairing it than driving it. In fact it was finally nicknamed JIGSAW — at every bump it fell to bits. As long as the motor compression was 100 per cent its full seven HP could, by planting the foot, maintain a reasonable speed. However, once wear and tear set in the vehicle was usually re-named 'Baby Austin Seven Kanardly' — can hardly go downhill with the wind, let alone up any.

Those 'do-it-yourself backyard homebrewers' who removed the motor head to rebore the Baby out mostly received a shock. The pistons looked like some half size toy of the real thing. Any strong youth could lift the back or front wheels off the ground — in fact, there was a standing joke which said, "Never park it broadside to a westerly wind

or you'll come back and find it blown over." Another derisive comment about the Baby Austin Seven was that it lacked the very thing it needed most — a pair of bicycle pedals.

Anyway, so much for its mechanics. Our above-mentioned enthusiastic trio were in too high a mood to worry about a bit of slap and play in their newly-acquired means of locomotion, they were out to enjoy themselves — but Fate had other plans! Their spirits were soon to be dashed; catastrophe awaited at the bottom of the first hill. Three men in a Baby Austin is like three men in a tub; there's more human flesh than tin and iron. As they approached the first intersection, it was found the brakes (mechanical of course) just weren't up to coping with the load, so it was a case of swerving sharply or shooting out into a busy main road. This sudden deviation was too much, the Baby skidded in gravel, listed onto two wheels, hung for a moment defying gravity then crashed on its side to the accompaniment of smashing glass

and snapping metal. After a long moment of stunned silence the three disentangled themselves and bailed out with great alacrity through a halo of raised dust. A quick appraisal of the battered Baby clearly showed the JIGSAW syndrome; the windscreen had fallen out, one headlamp was missing and superficial dents and scratches marred the bodywork. A few nuts and bolts lay near by, while petrol, water, oil and battery fluid (but thankfully no blood) seeped across the road. Apart from a few small patches of missing skin, the occupants had proved more durable than the Baby.

However, where there's a will there's a way. Having pooled their pocket money and filled the tank, they naturally didn't want to see the liquid vaporize itself in the dirt at their feet — besides cash was a scarce commodity in those immediate post depression days, even though a gallon of gas could be got for a mere eighteen cents. It was a simple matter to put the Baby back on its feet and, as all four wheels appeared to point in the same general direction, it was decided to carry on undaunted — that is, if what was left of the velocipede would work. So, gathering up the broken bits and pieces, the trio gingerly climbed back into the Austin Seven and, wonder of wonders, the motor motored and the steering steered. They had already found out about the 'anchors'...

Apart from a periodic, spasmodic splutter from the motor, the round trip was safely accomplished. Needless to say, returning the jalopy to the lender presented an anxious moment. However, the owner, though obviously not pleased at the spectacle, philosophically accepted the situation that better a battered Baby than three battered amateurs.

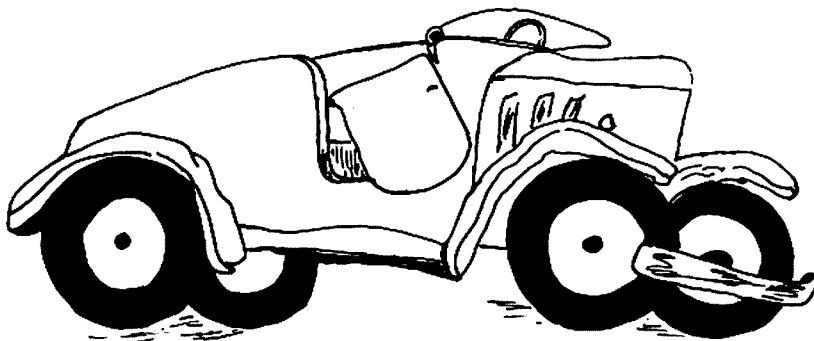

# THE GROUND PLANE ANTENNA

J A Gazard VK5JG  
2 Corbin Road, Medindie Gardens, SA 5081

*The ground plane antenna is very popular on VHF both with amateur and commercial stations. It consists of a quarter wave vertical element and four quarter wave horizontal radials with angles of 90 degrees between them. It is usually fed by a coaxial cable, the centre conductor of which goes to the vertical and the outer is joined to the radials at their centre point. An even simpler version could be useful on the HF bands.*

When a signal is fed to the antenna currents will flow into the radials and they will be equal and opposite in each pair of opposed radials. Therefore any radiation due to these currents will be cancelled, the radials will not radiate and will have no radiation resistance. The resistance or impedance of the radials will be just the "copper" resistance and will be close to zero.

The currents flowing in the radials will therefore consume near zero power and all the power will be concentrated in the vertical which has a low angle of radiation. This is the property which makes the GP antenna successful. The GP can be considered as a vertical dipole in which the lower half consumes no power and has zero resistance so that the impedance of the GP should be half that of a dipole, that is 35 ohms. This is approximately so.

Now if this reasoning is correct then one pair of opposed radials will be sufficient to cancel the field of the radials so that a GP should function just as well with only two radials set at 180 degrees. To test this idea the

following simple on-air tests were carried out:

1 The strength of a 144 MHz signal radiated by GP antenna was measured by an S-meter at a point about 9 km away. Two opposite radials were then removed from the antenna and the signal strength measured again. There was no change in the signal strength or the SWR when the radials were removed.

2 Only one radial was removed. Again there was no change and rotating the antenna showed no directional effect. This result surprised at first because it was thought that the unopposed radial would radiate, change the low angle pattern and have a directional effect; also that there would be a change in the SWR. However it was later realised that the opposed pair of radials would have zero impedance and would thus "short out" the unopposed radial so that it would have no effect.

3 Two radials were removed leaving two radials at 90 degrees. There was a pronounced directional effect — the signal varying from a maximum of slightly above that when the four radials were in use to appreciably less as the

antenna was rotated. The SWR changed from 1.5 noted in the previous tests to 1.2 indicating that the impedance was now closer to 50 ohms.

These tests although not very precise support the reasoning that a GP with two opposed radials will perform just the same as one with four. There is little to be gained in cost and convenience by using only two radials at VHF but on the lower frequency bands the use of only two radials would greatly simplify the erection of a GP antenna.

Figure 1 shows how a two radial GP antenna for the new 18 MHz band could be set up in a back garden. It would use only a light wooden pole, plastic cord, and wire and would be easy to erect and adjust. With adjusted wire lengths the antenna could be used on the 28, 24, 21 and 14 MHz bands but would require a taller pole for 7 MHz.

Next to a beam the GP with its low angle of radiation is generally considered to be the best DX antenna so that this set-up should be worth trying.

Figure 1: Two Radial Ground Plane Antennas.

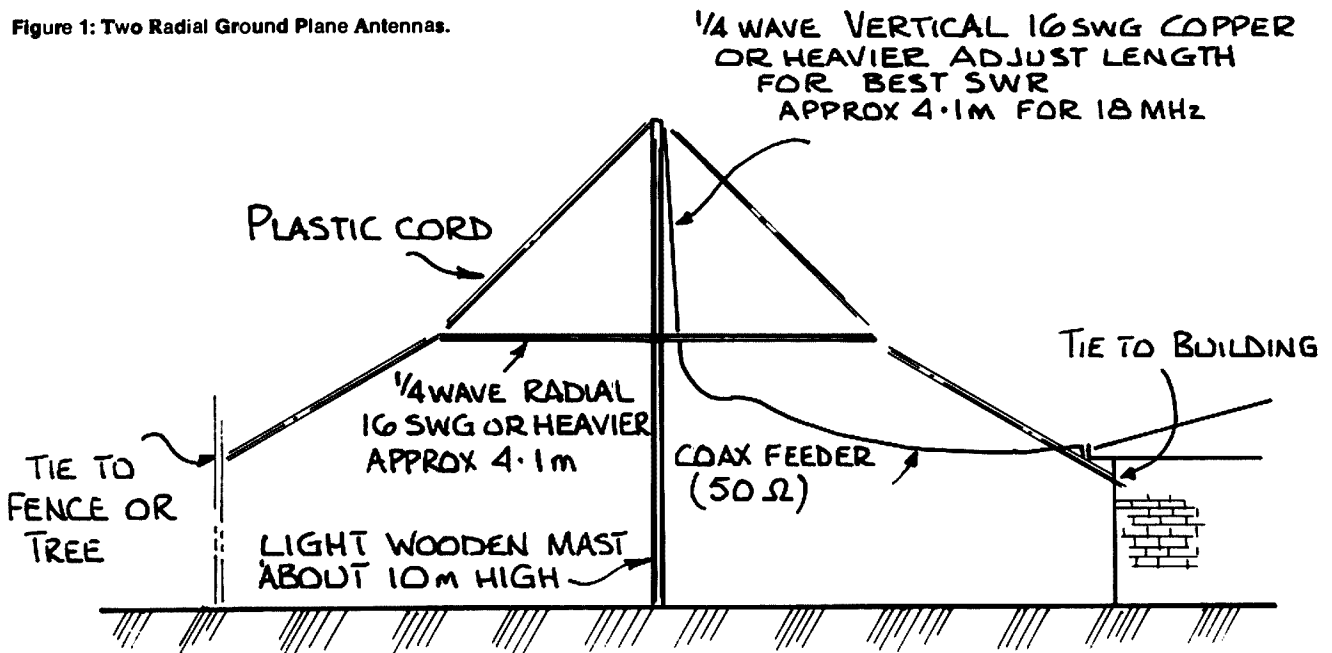

AR





# TRY THIS

# SIMPLE SIGNAL SOURCES

A G Loveday VK4KAL  
 "Aviemoire", Rubyvale, Qld 4702

Although it is the age of SSB, transistors, ICs and sundry exotic means of generating radio signals, some newcomers to radio, as a hobby, probably don't realise it was not always as now — especially on the VHF front.

The days of AM (amplitude modulation) may be long since gone, which is a shame as it still has its uses. Some "new" explorers to two metres may like to try their skill at getting simple gear to work; here is something to whet your appetite. The author got a great deal of pleasure building and working with it; the cost: next to nothing. Fig 1 shows a single valve two metre source.

I daresay it could be transistorised quite easily, for those who may not be familiar with valves. Fig 2 is a suggested circuit.

I wonder how many stations there are, still using AM on two metres. I am aware of a few around Brisbane. I think a comeback to AM would be a good thing on VHF where there is plenty of band, just waiting to be used. However, try your luck with these. Put your theory into practise and add your own PA.

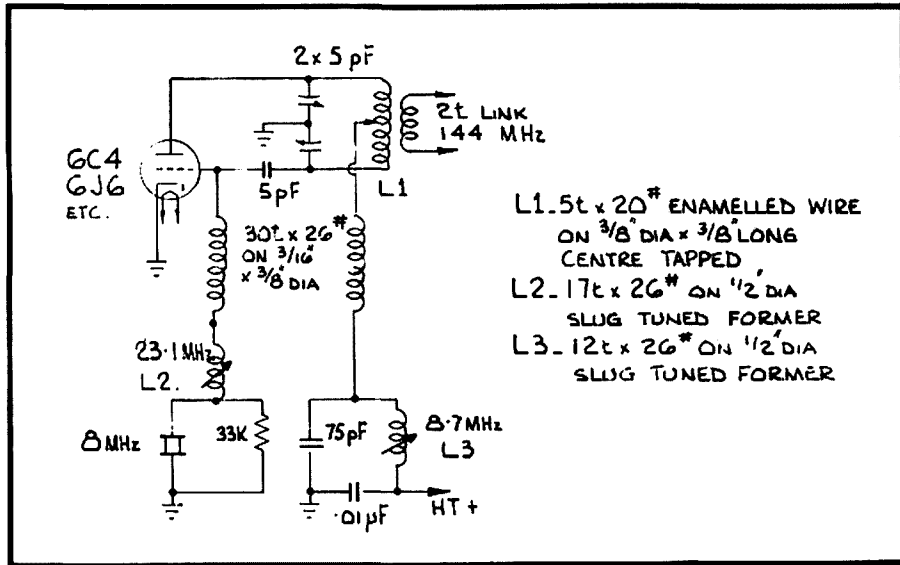

Fig 1 Single valve two metre source.

## TECHNICAL EDITOR'S NOTE

The circuits described here produce many harmonics in addition to the desired one at 144 MHz. In some applications these could cause problems.

Note also that the power available at 144 MHz is very limited. You won't drive a following PA stage beyond the mW region.

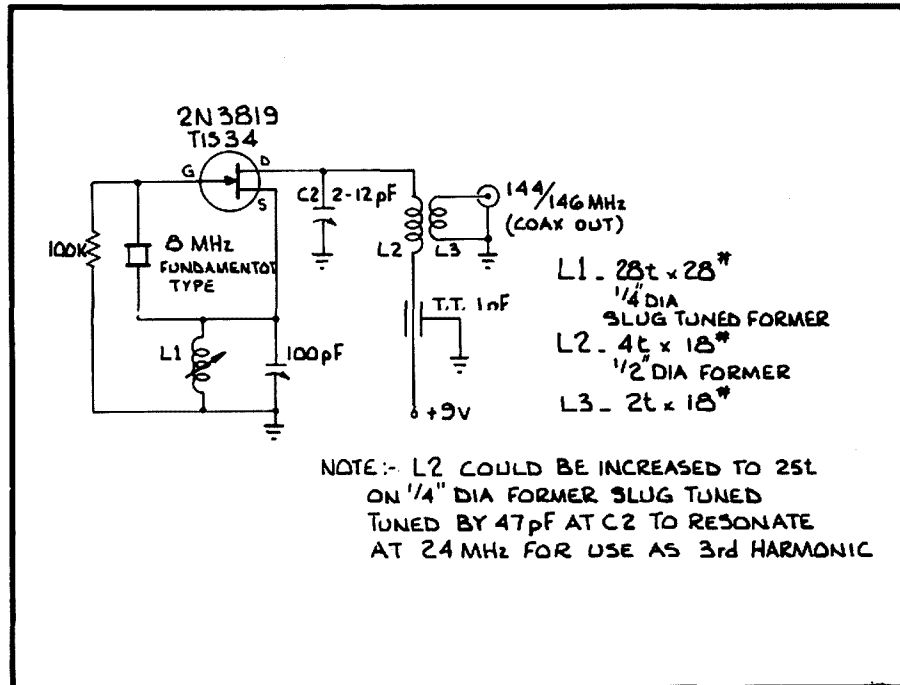

Fig 2 Single transistor two metre source.

## EMC

(Electro Magnetic Compatibility)



If radio frequency interference is causing you a problem you are reminded that — "Advice on all types and aspects of interference (PLI, TVI, AFI, etc.) is available from the National EMC Advisory Service".

FORWARD DETAILS TO  
 VK3QQ,  
 Federal EMC Co-ordinator, QTHR.



# EQUIPMENT REVIEW

Ron Fisher VK3OM  
TECHNICAL EDITOR  
3 Fairview Avenue, Glen Waverley, Vic 3150

## THE NICHOLLS "WOODPECKER" BLANKER

I am sure that all HF operators (unless you only work on 80 metres) are familiar with the "Woodpecker" over the Horizon Radar and the problems that it can cause to reception. At times it can run well over 59 and wipe out very strong amateur signals.

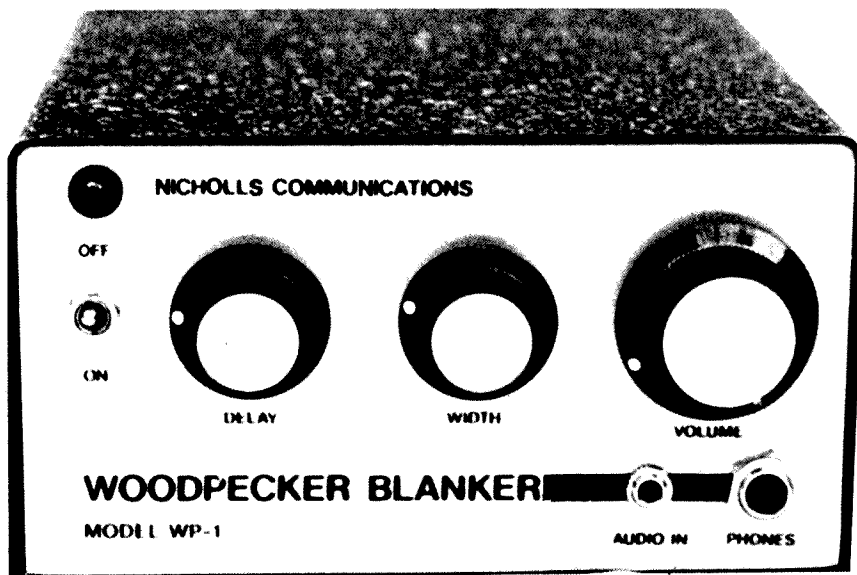

Many of the current model transceivers now have noise blankers that are intended to cope with the Woodpecker problem but readers of Amateur Radio reviews will have noted that few of these blankers are as effective as they could be. Older transceivers with normal noise blankers have no hope at all. However all is not lost. For some time now, NICHOLLS COMMUNICATIONS have been producing their WOODPECKER BLANKER which they claim is the best answer available to the problem.

Let me quote from their description of the unit.

*"The Woodpecker can be wired directly into most noise blanker circuits provided in HF communications receivers. Used in this fashion, it can reduce the strength of the interference by up to 70 dB. Alternatively, for receivers without a built in noise blanker, the device functions as an audio stage blanker and offers relief from the audible effects of the Woodpecker. To*

*facilitate this, the Woodpecker Blanker incorporates its own audio amplifier and plugs directly into the headphone or tape outputs from any receiver. The circuit employs the principle of "synchronous blanking", in which a local crystal-locked oscillator generates a reference signal to control the blanking circuit. This is possible because the Woodpecker radar transmissions use a constant, precisely defined pulse repetition frequency. The blanker is synchronised manually with the incoming interference pulses, and subsequently remains in sync for lengthy periods."*

The Nicholls blanker is available in either kit form or completely built up and ready to go. It is, however, necessary to wire in a connection to your transceiver noise blanker and provide a 12 to 15 volt DC power supply. In general the connection to the transceiver is quite simple and instructions are included that cover most popular models. A suitable miniature coax con-

ductor must also be fitted to the transceiver. Luckily many transceivers provide spare RCA type sockets on the rear panel.

For our test, I used a Kenwood R-820 receiver which was also modified to provide the required 12 volt DC operating voltage.

### THE WOODPECKER BLANKER ON TEST

First find your Woodpecker. When I hooked the blanker up, I thought someone must have passed the information to the intruders alerting them to switch the thing off. A bit like the local two metre repeater which is always on the air — until you want to line up your receiver!

However like the bad penny it turned up at last. First thing of course, it is not necessary to turn on the noise blanker in the transceiver for Woodpecker blanking. All control is done from the Woodpecker blanker itself. For IF blanking, which we are now set up for, the delay and width controls

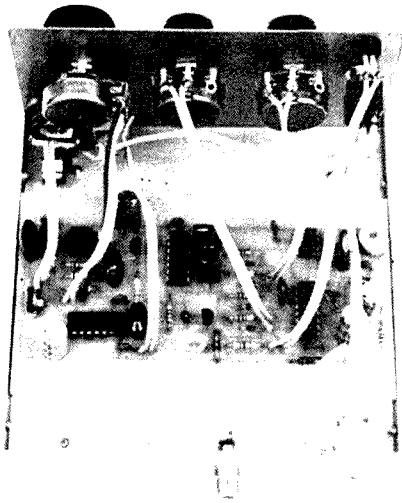

Internal View of the Woodpecker Blunker

set the blanking action. The volume control is used for audio blanking as we shall see later. The blanking pulses are generated by an IC divider controlled by an internal crystal oscillator. The 'Delay' control is adjusted to synchronise these pulses with the woodpecker. The 'width' control sets the gap width which of course must be as wide as possible to give the best intelligibility. Does it work? Yes!! Indeed it does.

but don't try to use it for CW reception. The blanking pulses will remove about 50% of the signal. With voice reception of course, it is possible to lose a considerable amount of the transmitted signal and yet still retain a fair degree of intelligibility.

The action of the NICHOLLS BLANKER is really quite remarkable. Even with the Woodpecker running S9+20 dB it is possible to copy signals around the S5 mark. However when I say copy, I don't mean perfect 'armchair' copy — you will be working hard, but the signal will be there.

One of the problems is to know when the Woodpecker has stopped. The blunker is like a Woodpecker in reverse. There are holes in place of strong signal pulses.

Now for a few slight problems. Adjustment of the width and delay controls is fairly critical to get the best effect. If you are tempted to turn the blunker off to see if the Woodpecker has disappeared, the controls will need to be peaked again.

Now to the action of the audio section of the blunker. This is designed to be used with a transceiver or receiver that does not have a noise blunker. A couple of common ones that come to mind are the FT-200 and the FRG-7. Audio output from the headphone jack is fed to the audio input socket on the front panel of the blunker. Headphones are plugged in, volume adjusted and the width and delay controls set in the

same manner as before. I found that the best effect was obtained with a fast AGC action or possibly no AGC at all. With slow AGC; the receiver is shut off during the Woodpecker pulses and no amount of external blanking will restore the wanted signal. The overall action of the audio section of the blunker is certainly not as good as the IF blanking, but with careful adjustment of receiver and blunker excellent results can be obtained.

Next slight problem. The headphone jack on the blunker is not a stereo type, so your Supermarket type phones will only work on one side.

The general construction of the NICHOLLS BLANKER is quite reasonable. The front panel looks attractive and good quality components are used throughout. One other slight problem however is the DC power connector. A miniature audio type plug is used for this which if inserted incorrectly could short out the input supply. A concentric type DC connector should be used here.

The instructions supplied are complete and well written. A full parts list, circuit diagram, board layout and waveform diagrams are included.

Our review Blunker was supplied by NICHOLLS COMMUNICATIONS PO Box 246, Jamison, ACT 2614 to whom all enquiries should be addressed.

AR

## COUNCIL PROBLEMS? THE ANSWER TO LIMITED SPACE

EFFICIENT ANTENNA FOR LIMITED SPACE  
Both models C/4 & HQ1 cover 6-10-15 and 20 m.

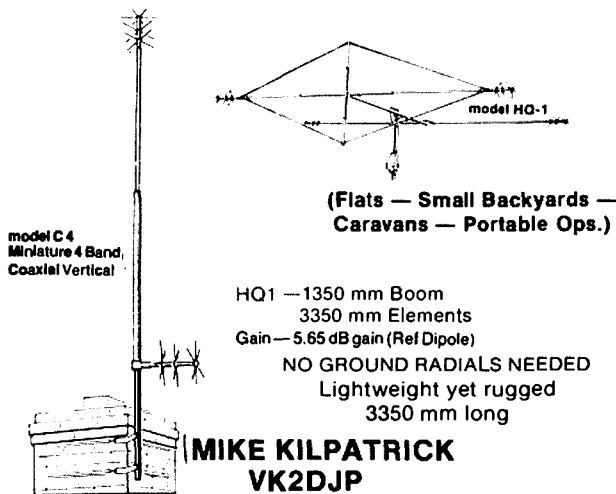

(Flats — Small Backyards —  
Caravans — Portable Ops.)

HQ1 — 1350 mm Boom  
3350 mm Elements  
Gain — 5.65 dB gain (Ref Dipole)  
NO GROUND RADIALS NEEDED  
Lightweight yet rugged  
3350 mm long

MIKE KILPATRICK  
VK2DJP

# WATCHMAN ELECTRONICS

28 Elouera Cres, Woodbine, NSW 2560  
Phone (046) 26 6101

## BUTTERNUT ELECTRONICS CO.

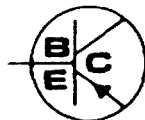

### Still More Usable Antenna For Your Money . . . Plus 30 Metres!

Butternut's new model HF6V<sup>1</sup> offers more active radiator on more bands than any other vertical of comparable height. DIFFERENTIAL REACTANCE TUNING™ circuitry lets the 26' antenna work on 80/75, 40, 30, 20 and 10 metres and a loss-free linear decoupler gives full quarter wave unloaded performance on 15 metres. It can also be modified for remaining WARC bands.

- Completely automatic bandswitching 80 through 10 metres including 30 metres (10.1-10.15 MHz); 160 through 10 metres with optional TBR-160 unit.
- Retrofit capability for 18 and 24 MHz bands.
- No lossy traps to rob you of power. The HF6V's three resonator circuits use rugged HV ceramic capacitors and large-diameter self-supporting inductors for unmatched circuit Q and efficiency.
- Eye-level adjustment for precise resonance in any segment of 80/75 metres, incl. MARS and CAP ranges. No need to lower antenna to QSY between phone and CW bands.
- For ground, rooftop, tower installations — no guys required.

Suggested amateur net prices:  
model HF6V (automatic bandswitching 80-10 metres) . . . \$282  
Model TBR-160 (160 metre base resonator)  
(When supplied as part of HF6V) . . . \$66  
For complete information concerning the HF6V and other Butternut products, amateur and commercial, contact the sole Australian distributor:

TRAEGER DISTRIBUTORS (NSW) PTY LTD  
PO Box 348, Moree, NSW. 2400.  
Cnr Adelaide & Chester Sts.  
Phone (067) 52 1627

\* Patented device

# "AMATEUR RADIO HOUSE"

Susan Brown, VK2BSB  
DIVISIONAL PRESIDENT  
Box 1066, Parramatta, NSW 2150

**On the 28th May the new divisional premises of VK2 were officially opened. This is a story of the lead up to this exciting and important day.**

The NSW Division's new premises at 109 Wigram Street, Parramatta, "Amateur Radio House", was officially opened on Saturday 28th May, 1983 by Mr Gary Punch, Federal MP for Barton. Distinguished guests at the opening included Mr Stan Dickson, Mayor of Parramatta, Mr John Milton, NSW State Manager of the Department of Communications, Federal President of the WIA Mr Bruce Bathols VK3UV and three Life Members of the NSW Division, Mr Bill Moore VK2HZ, Mr Cec Bardwell VK2IR and Mr Keith Howard VK2AKX.

The opening was the culmination of three years of preparations and negotiations by NSW amateurs, particularly members of Divisional Council both past and present. The idea to sell the Crows Nest property had been around for over ten years but was first discussed seriously at the Fourth Conference of Clubs in May 1981 when a motion recommending that "Council investigate selling the Atchison Street property and purchasing property in the Granville/Parramatta area" was carried. At the July 1981 meeting of the Divisional Council, Stephen Pall VK2PS (then VK2VHP) was authorised to research the

feasibility and costs involved with a move to the Parramatta area. After negotiations with four leading estate agents, Steve presented a four page report to council and the Fifth Conference of Clubs. This report was then presented to all members for decision at the March 1982 AGM of the Division. The motion to sell and move to Parramatta was carried with a majority of 2:1.

Thanks largely to Steve's excellent preparation and research, the move to Parramatta was effected within four months. The Crows Nest property sold for \$410 000 and after purchase of our new two storey brick building at Parramatta for \$345 000, a net gain of about \$40 000 was realised after payment of transfer fees, advertising and legal expenses.

Those of you who have moved house will appreciate the amount of work involved, and the Division is greatly indebted to not only Steve, but our Honorary Solicitor Fred Herron VK2BHE who handled all the legal aspects and transfers of monies, and the then Divisional Secretary Athol Tilley VK2BAD who supervised transfer of property and conducted the great volume of correspondence involved throughout the move. A

new Administrative Secretary Mrs Joan Condon was employed after interviewing fifteen applicants and the new office opened for business in September 1982.

Nearly \$25 000 has been spent partitioning and furnishing the office and library area on the first floor which is carpeted and air-conditioned. The Divisional library now has over 10 000 magazines and books on display in thirteen bookshelves arranged around the lounge area. Special thanks must go to two members of the Division; Bill Hayes VK2AJL, who spent four years collating and sorting in the basement stack room at Crows Nest, and Aub Topp VK2AXT who is the present Honorary Librarian and is responsible for the fine display at Parramatta. (PS Donations are always welcome). The building is open five days a week from 11 am to 2 pm and Wednesday evenings from 7 to 9 pm.

When the room downstairs is let, the resultant rent will more than cover the running costs of the new building. It is thanks to the support of all members over the years who have contributed to the NSW Division that this fine facility for amateurs has been made possible. **AR**



Four hundred years of ragchewing and amateur radio. Some oldtimers who attended the opening of "Amateur Radio House" on 28th May at Parramatta. Back row l to r: Bruce Thomas VK2FD (licenced 40 years), Bill Hayes VK2AJL (45), Cecil Bardwell VK2IR (45), Tom O'Donnell VK2OD (52), Harry Caldecott VK2DA (57). Front row l to r: Eric Smith VK2NWV (83 years old and licenced since 1978!) Ivan Agar VK2AIM (46), Bill Moore VK2HZ (52) and Bert Dimmock VK2OW (48).



Gary Punch, Federal MP for Barton soldering after making a UHF contact.



1



2



3



4



5



1. David VK2BDT and Ivan VK2AIM. 2. Gary Punch delivering his opening address. 3. Keith VK2AKX and Ivan VK2AIM. 4. Barry VK2AAB and Bill VK2EBM next to the VHF/UHF display. 5. Ray VK2DB with the display of old radio gear. 6. Bob VK2VKD, Dave VK2KDW and Col VK2DYM. 7. Outside view of Amateur Radio House.



7



6





1



2



3



4



5



*1. Auh VK2AXT and his wife next to a park gap transmitter. 2. Athol VK2BAD. 3. Bill VK2HZ. 4. Virginia and Ken Mathews VK2WE. 5. General view of audience. 6. Gareth VK2ANF and Bruce VK2FD. 7. Steven VK2ZSK, Wendy Wilson and Jan Henley.*



7



6



**ANNEE MONDIALE DES  
COMMUNICATIONS**  
**WORLD COMMUNICATIONS  
YEAR**  
**AÑO MUNDIAL DE LAS  
COMUNICACIONES**



**AMATEUR RADIO IN SPACE**

Astronaut Owen Garriott plans a historic astronaut-to-private-citizen link-up during the STS-9 mission, currently scheduled for launch on 30 September, 1983.

There will be an amateur radio transceiver aboard STS-9. Dr Owen Garriott, an amateur radio operator, will use a hand-held radio during part of his off-duty time to communicate with some of the thousands of amateur radio operators around the world. Garriott's callsign is W5LFL. Use of the transceiver will be limited to one hour a day. All amateur radio operations for STS-9 will be in the two metre band. Transmissions will be in the range 145.51 MHz to 145.770 MHz FM. Reception will be in the range 144.910 to 145.470 MHz FM. Twenty kilohertz steps will be used to both transmit and receive.

Garriott will wear the standard in-flight headset when operating the radio. Plans call for Astronaut Garriott to use the equipment during his off-duty periods in such a way as not to interfere with other mission activities. Random contacts will be made with individual radio amateurs in various parts of the world, thus providing the first occasion in the history of the space programme for individual citizens around the world to speak directly with an astronaut in space using their own equipment from their own homes and automobiles.

While there will be practical limits to the number of two-way contacts possible during the course of a single shuttle mission, both radio amateurs and non-amateurs possessing receivers and scanners will be able to listen to transmissions by W5LFL as the spacecraft passes overhead.

This operation will directly support the objectives of the US Council for World Communications Year 83 by directing public attention to another important dimension of space communications in which astronauts and private citizens in countries all around the world are brought into direct contact for the first time in history.

Confirmation cards will be issued by the American Radio Relay League to all of those making contact with the spacecraft during the mission, as well as to those submitting evidence of reception of Astronaut Garriott's transmissions via W5LFL.

It may also interest you to know that STS-9 will be the first flight of the Spacelab, a joint effort of NASA and the European Space Agency. The crew will be John Young, mission commander; Air Force Major Brewster H Shaw, pilot; Dr Owen K Garriott and Dr Robert A Parker, mission specialists. The prime or onboard payload specialists selected by ESA and NASA for this flight are: Ulf Merbold, a German Physicist, and Byron K Lichtenberg, a biomedical engineer. The second European, Wubbo J Ockels, a Dutch physicist, and the second American, Michael Lampton, a physicist, will act as flight backups and will be deeply involved with the payload operations from the ground throughout the duration of the mission.

Information supplied by:

Mrs I L Scott,  
Public Services Branch,  
Office of Public Affairs,  
NASA,  
Houston, Texas, 77058 USA.

**PACKET  
RADIO**



**VK PACKET RADIO GROUP**

The Sydney Amateur Digital Communications Group has been established to foster interest in Packet Radio.

The group has established a local area network (LAN) consisting of VK2BVD, VK2KFJ, VK2ZJO and VK2ZXQ. The frequencies used are 147.6 MHz for a digital repeater and 145.575 MHz for liaison and direct communications.

Experiments so far include a bulletin board and digital repeater. Operation has been at a data rate of 1200 Baud.

Further experiments include HF operation and HF Gateways and the establishment of further packet radio networks and interstate links.

Packet Radio is a new and exciting means of communication using Data and Computer techniques to provide communications both directly and by means of relay techniques. It is one of the ways in which we must expand.

Interested readers are urged to contact the group who have made the first steps in this exciting field.

Further information may be obtained from — Jim Swetlikoe, VK2BVD, 8 Prahran Avenue, French's Forrest, NSW 2086. Phone (02) 452 2668 in the evenings. Or phone John Tanner, VK2ZXQ at (02) 663 0161 in the daytime.

**INTERCONTINENTAL PACKET RADIO TESTS SUCCESSFUL**

At approximately 2300 UTC on 27 May, a successful digital packet radio QSO was held between Tom Clark, W3IWI in Maryland and Ian Ashley, ZL1AOX near Auckland, New Zealand on 28 MHz. This 13850 km path represents the longest distance yet bridged using packet radio. Both stations were using the Terminal Node Controller (TNC) developed by the Tucson Amateur Packet Radio group in conjunction with home built S-100 computers. The QSO used Frequency Shift Keying (FSK) techniques at a data rate of 1200 Baud.

Although propagation conditions were marginal, data exchanges consisted of "beacon" transmissions and two-way connection acknowledgements using the amateur AX.25 HDLC protocol. With this protocol messages are sent repeatedly until they are successfully acknowledged by the other station.

Also participating in the test was Bob Diersing, N5AHD in Corpus Christi, Texas, W3IWI and N5AHD have held several successful packet radio QSOs. N5AHD monitored the beacon and text transmissions from both W3IWI and ZL1AOX.

All three stations involved are affiliated with AMSAT and have been experimenting with high speed digital transmissions in anticipation of conducting similar activities with AMSAT's Phase-3B satellite due to be launched in the near future, and with AMSAT's PACSAT packet radio satellite now being designed.

Terry Carrol, ZL3QL  
33 Ryeland Avenue, Christchurch 4 NZ

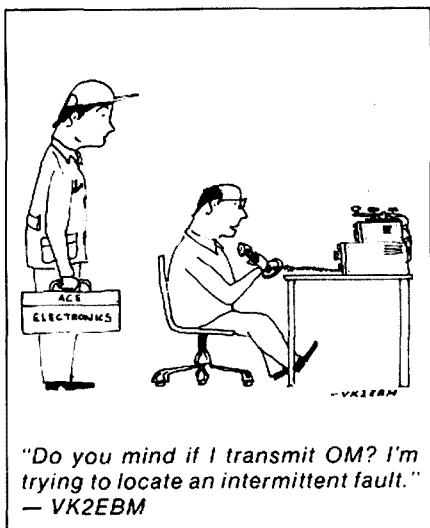

"Do you mind if I transmit OM? I'm trying to locate an intermittent fault."  
— VK2EBM



Mmmm — I must oil this key!! —  
VK2EBM

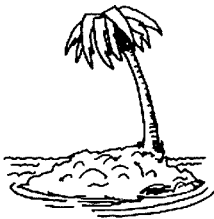

# HOW'S DX

Ken McLachlan, VK3AH  
Box 39, Mooroolbark, Vic 3138

It is two years since I commenced writing these notes and although the bands are on the downward trend, a lot of new countries have been activated and worked by VK's for a new one towards their DXCC score. The rarer countries are still there but it requires more patience to develop the art of finding the elusive country that will be a new one for your score and when it is found it will be a lot harder to dig it out of the noise to make a successful contact.

I commenced with one helper, Eric L30042, who has not missed one monthly report. Now it has grown to many more subscribers from most states, and new ones are still appearing from time to time. To those that have supplied information or written notes of thanks and given me the incentive to continue, sincere thanks. To those operators and listeners that have thought about sending in a report and have not done so, please do, as any information helps, even if it is duplicated with another report. It helps to verify what may have been discarded as a dubious rumour. At all times the endeavour is to bring to you, the reader, accurate and up to date information about past and forthcoming DX, QSL managers and routes to assist all readers to achieve more confirmed DX countries, and general interesting DX news.

During the period of writing the column, I have been able to build up reciprocal agreements with DX editors of other magazines world wide, so that we can exchange documentation of what is happening around the world. It has and will continue to be my policy that no information used in the column will be taken through verbal contacts with any sources and all information is verified and researched as much as possible before being printed.

## CHINA

New stations that should be QRV this year to assist BY1PK and BY1AA in the demand made by the multitudes are BY1QH and BY7RA according to Tom VE7BC. Still no news on when SSB will be officially introduced though.

## LIBERIA

The Liberian Radio Amateurs Association has announced that their administration has issued the special calls A81LC, A82LC, A85LC, A87LC, A88LC and A89LC which will be current until the end of the year.

These special call signs are to highlight the Ganta Leper Colonies plight (Ganta is located about 350 km NE of Monrovia) and all amounts sent for postage of QSL's will be donated to the colony. There is a special award for working all of the six call signs.

QSL's to B Johannson, PO Box 134, S-67101, Arvika, Sweden.

## LARGE CLASS

Bill P29BR and another staff member of the Papua New Guinea Technical University set up a demonstration amateur station as a public relations exercise. The results were overwhelming and now this busy duo have a class of some 110 that will be sitting for the amateur exam in November. With some luck a number of new P29 calls will be heard on the DX bands early next year.

## MAIL INTERCEPTION

Herick FH0FLO still claims that his mail is being interfered with. Please do not put call signs on the envelopes, but simply Herick Maudit-Larive, PO Box 200, Tampon 97430 France. This should reach him intact.

Without saying, it is not necessary to have your own call or any other give away that the letter concerns your hobby.

## FURTHER DOCUMENTATION

Don Search, who administers the ARRL DXCC programme, is not satisfied with the credentials that have been presented by Peter S2BTF, and at this time he is rejecting claims on this station. The last station from this area, that had the green light, was S21GW and that was in late 1981.

## XU1SS

According to a report in "QRZ DX" JH3DPB anticipates a JA group will be QRV for three weeks from the 10th August.

Recently a group of JA's have had lengthy discussions with the Prime Minister of XU in an effort to establish amateur stations there. Apparently the man they were talking with was Son San. Son San is the head of the Khymer People's National Liberation Front (the "Khymer Serei") which is one of the two guerrilla governments, the other being the "Khymer Rouge" which overthrew the US backed Lon Nol government in 1975.

What countries are going to recognise what licences if they are issued? Don Search, the gentleman looking down the microscope on QSL cards at ARRL Headquarters is in for a few not so restful weeks ahead if this comes off, even if it only turns out to be a well organised propaganda stunt.

## DONATIONS OR CONTRIBUTIONS?

The above paragraph has jogged my memory that no cards have been forthcoming from the updated calls of the 1Z9 group that were active in early March. Could this be a genuine "bottom of the harbour" scheme which includes my investment of two "greenies" for cards and photographs?

Another long awaited answer, this time to the tune of ten "greenies" is that 7JY7 Diploma which was promulgated late last year. It is known that another VK amateur fulfilled the

requirements and applied. Neither that person or myself have gained a glimpse of any mail from the palace in Jordan.

## TURKEY

It is believed that a new law was passed in Turkey in April which will legalise amateur operations in that country this year. This indeed is excellent news for the amateur fraternity as a whole though it would be prudent still not to advertise the hobby on any correspondence to friends in that country.

## OMISSION

In relating the statistics of VK0HI in this column (June p29) VK5 was unintentionally omitted from the listing. In fact 126 VK5 operators contacted VK0HI on SSB and five of these appeared more than three times and fifteen more than twice in the log.

## STRANGE PREFIX

Remember the "DXpedition" using the unusual call 4T3S that was emanating from the ruins of Sechin in early April and the excellent signal that was being received by all and sundry in the eastern states.

The operator was Carlos OA4CIT and he kindly forwarded Austine VK3YL, a photograph of himself at the operating position along with his QSL card.



Carlos OA4CIT.

## SMOM

The next planned operation of the rare station 1A0KM is October and November. The driving force behind the whole operation since its inception has been Mario IOMGM and due to his business commitments, as an attorney, the station has not been manned as originally was envisaged.

## T31 AND KH1

For those that missed out on Erik SM0AGD when he was in the area there may be another chance for these elusive calls.

From all reports received it appears that Doug T30DB will be operating from Central Kiribati and American Phoenix towards the latter part of this month if the carefully laid plans come to fruition.



### THIRTY METRE NET

Stewart VK2LS is running a daily net on 10.146 MHz USB (just outside the prohibited area of 10.141.5 ± 4 kHz) at 0700 UTC and presently covers stations from the VK2, 3, 4 and 5 call areas. The object of the net is to increase usage of the 10, 18 and 24 MHz allocations. Don't be shy, place a dipole in the air and join in. You will be made welcome.

### ANGOLA

There is a strong possibility that OK3TAB and his helpers will sign OK3TAB/D2A again in the near future. Their last operation was in 1979 and with the new DXers since that period, business for them should be brisk.

### FATHER MAKSYMILIAN KOLBE SP3RN

Father Maksymilian Kolbe, a Polish Franciscan friar, was canonised on 10 October 1982 by Pope John Paul following a joint proposal to the Holy See by both the Polish and German churches.

Fr Kolbe was incarcerated in Auschwitz concentration camp during World War II. On the morning of 2 August '41, a man escaped while being taken to work. The authorities immediately retaliated by killing ten people from each block of the camp.

In Block 14, Fr Kolbe asked that he be taken in place of one of the ten who had a wife and children. This was agreed to and Fr Kolbe was killed by a lethal injection on the 14th August. The man whose place he took is now an elderly crippled Polish farmer, according to the satellite TV pictures and commentary that was received in this country. This gentleman was presented to Pope John Paul II during his recent trip to Poland.



Father Kolbe from RadCom May '83

### ZS SPECIAL SUFFIX

The special suffix RSA was activated by many ZS operators including Diane ZS5DC, at the end of May. This special suffix was allocated by the administration to celebrate the 22nd anniversary of the formation of the Republic of South Africa. All QSL's to ZS5L either direct or via the bureau.

### NOT VALID

DXpress reports that Don Search W3AZD, the ARRL DXCC administrator, has stated that no C9 operation in the last two years will count as a credit for DXCC. This will come as a let down for many who thought they had this country off their wanted list.

### A FIRST?

A QSO between VK6RO and DL7UX. So what, many will say! This contact was made in December last year and was on 24 MHz. Probably the first that was made on that band between VK and DL.

Graham VK6RO, had a CW QSO with G6ZO on 18 MHz at 1300 UTC on the 27th December 1982 and he was told by the other operator that it was the first QSO on that band between VK and G, also a CW QSO on 24 MHz between G3KMA and Graham at 1036 UTC on 26 December 1982 was another first for both countries.

Graham is also claiming a first for the following countries:

24 MHz			
DATE	UTC	CALL	MODE
18:12:82	1146	OESHEW	CW
26:12:82	1110	OZ2RH	CW
27:12:82	1023	F8FE	CW
27:12:82	1035	4X6CA	CW
27:12:82	1052	HB9FT	CW
08:01:83	1112	PA0PN	CW
15:01:83	1119	GW3AHN	CW
13:03:83	1046	A4XYF	CW
13:03:83	1047	A4XYF	SSB
18:03:83	1116	G4GPC	CW
19:03:83	1124	VK9YC	CW
20:03:83	0856	ZS6JW	CW
23:03:83	0011	ZS6BCI	SSB
23:03:83	1017	K1BJ/388	CW
23:03:83	1018	K1BJ/388	SSB
31:03:83	1050	K1BJ/389	CW
31:03:83	1050	K1BJ/389	SSB

18 MHz			
27:12:82	1315	GM3WOJ	CW
27:12:82	1331	DL1TO	CW
08:01:83	1259	OZ2RH	CW
23:12:82	0930	ZS6BT	CW
23:12:82	0931	ZS6BCT	SSB
15:01:83	1119	GW3AHN	CW
06:03:83	1121	VK9YC	CW
23:03:83	1023	K1BJ/388CW	CW

To settle who was the first VK to work various countries on the new WARC bands should not be a momentous task and I am willing to sort it out. If contenders for the honour care to send copies of documented evidence such as QSL cards to me, I will select the first stations to work each new band and publish the results in this column. If there are no contenders by the first of November it will be taken that Graham's claim is valid for all the "firsts" as noted above.

Graham in his letter mentions that there are very few amateurs on these new bands but signals are there as his proves with the extract from his log. How about it DXers, let us populate all our bands this year in commemoration of WCY83.

### MORE ON THE WARC BANDS

An interesting letter from Lindsay VK5GZ, commenting on the activity on these bands and some of the good DX he has heard and worked. Lindsay notes that he has more CW contacts on 30 metres than any other band now and the recent acquisition of Dan C31XO in the log book has spurred his interest.

Lindsay's equipment is an Icom 730 into dipoles and inverted Vee's for coverage across the spectrum.

Lindsay, it is felt that the readers of this

column will look forward to further reports from you on the activity of the 10, 18 and 24 MHz bands in future issues.

### CELEBRATIONS

It was a pleasure to have a SSB QSO with Soupy W5NW on twenty metres at 0723 UTC on the 20 June. Not unusual to hear this big signal in VK at anytime on either CW or SSB, however this was a celebration, as it was Soupy's sixtieth anniversary of obtaining his amateur licence.

Many of Soupy's friends congregated from the Oceania area to wish him well and many more years of happy operating with his XYL Beth W5DUR.

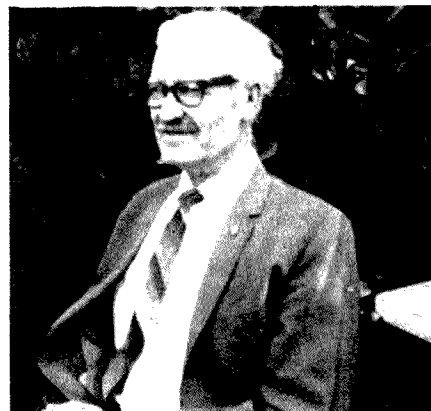

Soupy, W5NW

Soupy has dedicated all his spare time to the hobby since he gained his licence at the age of sixteen and over the years that he has been licenced and it could be said that he has never made an enemy. This is the type of person Soupy is. Soupy has 354 DXCC countries confirmed according to the ARRL DXCC list. Quite an effort! Think of the QSO's over this period, a total would look similar to an ISD telephone number.

### AX3ITU

All cards that have been received by mail have been replied to and the balance of contacts that were made have had cards placed in the bureau on their behalf.

### RADIOTELEGRAPHY CHAMPIONSHIP

The first European Radiotelegraphy Championship supported by the IARU Region 1 Division will be held in Moscow in December. The contest has been organised by the USSR amateurs for World Communications Year 1983. Many events are on the programme, including tests for speed and accuracy in both reception and transmission for both lady and gentleman operators, also special events are envisaged for men and women under 18. This is one country that is fostering the continued use of telegraphy on our bands.

### VISITOR FROM ACROSS THE TASMAN

Arthur VK3UX and his daughter Betty, played host to Bill ZL4AW on his recent whistle stop tour of the VK eastern states. Both amateurs have been long standing members of the ANZA Net on 21.203 MHz at 0500 UTC daily and the International Pacific



Photograph: VK3AH.

**Percy VK3PA, Bill ZL4AW and Art VK3UX.**

DX Net that is held on Tuesdays and Fridays at 0600 UTC on 14.265 MHz.

No photo of such a meeting would be complete without the presence of Percy VK3PA, who has been the anchor man of these nets over a period of many years. Arrangements were made and Percy made the trip to Arthur's QTH.

These three operators have an aggregate of 14 years of operating experience between them since they were licenced and on appearances many more hours will be spent at the hobby in the decades to come.

### CONGRATULATIONS

On a quick scan through a recent edition of CqDX, produced by the DARL it was noticed that John VK6AJW took out the Oceania continent top score in the 1982 European DX Contest. John had a score of 50900 points.

Another excellent performance was by VK6NCW who gained himself a certificate for his high score and weekend of effort. Thanks to these and other operators who ably represented the VK prefix on this weekend.

### DEMOCRATIC REPUBLIC OF YEMEN

Pierre, J28AZ, over many years of travelling to this country on business now says he has permission to operate.

Another starting date, 24th August for eight days.

He will be using the callsign 7O1AB. Limitations have been placed on his countries list.

### SAN FELIX

Still not to be overlooked this year. A CE group hope to activate San Ambrosio or another nearby small island. These alternatives are due to the military situation on San Felix.

### IA ORANA

Did you work French Polynesia (FO8/TO8 or FO0/TO0) during 10th to 17 July? The Radio Club of French Polynesia was participating in this year's "Tiurai Special" which coincides with French Bastille Day.

Stations that contacted at least three stations on at least two different bands qualify for an attractive multi-coloured certificate.

QSL information for FO/TOs — 8 HL, HO, DF, HI and OFB is via WB6GFJ.

Certificate is obtainable for 12 IRCs from RCFP, BP5006, Pirae, Island of Tahiti, French Polynesia.

### WCY83 IN SYRIA

Syrian Radio Amateurs shall be using a new prefix to celebrate World Communications Year.

Four stations will be operating in all bands with the callsign of 6C1AA, 6C1AM, 6C1AN and 6C1AO. Operation will be during the

period of: 0000 UTC Saturday, 15 October, 1983 until 2400 UTC Friday 21 October, 1983. During this period no station in Syria shall be using the YK prefix.

AR

### PROFILE DK2WH

Many VK operators will possess the fine QSL card that shows the ivory carving of famous "Erbacher Rose". One such operator that uses this picture is Gunter DK2WH.



**DK 2 WH**

Gunter obtained his licence in mid 1968 at the age of sixteen and his equipment comprised a HW32 into a five band ground plane. Gunter was "hooked" on DX from the very start of his amateur activities and took the opportunity in the late 70s to purchase land nearly on top of a mountain in the area that he lives so that he could build a house and have plenty of estate for an antenna farm with farmland on the other side of the road.

Early 1981 saw the new house completed and the beginnings of an antenna farm with dipoles for 80 to 40 metres and a Mosley MP 33 for the higher bands. Gunter has updated his equipment to the Drake "C" line running into a L4B amplifier and now also runs a Siemens T100 teleprinter.

Gunter is supported in his hobby by his XYL (though unlicensed) and their seven year old daughter and all of his spare time, from his demanding occupation of teaching mentally handicapped children, is taken up with his hobbies of amateur radio and playing the trombone in a band.

VH0HI was the 297th country for his DXCC and of these he has 293 confirmed.

### HAPPY ZL OPERATORS

A gang of keen DXers is one way to describe the Johnston family from Papakura NZ. Dave ZL1AMN, XYL Aola ZL1ALE and daughter Carol ZL1AJL are all in the bracket of having confirmed in excess of 300 countries. Dave mentions in a letter that when he has Heard Island confirmed he will be able to obtain the ARRL 315 countries sticker.

This family is not new to the hobby by any means as Dave is a retired NZART Councillor, Vice President of the local NZART Branch, part time lecturer at licence classes and Editor of the Club Magazine. Dave and Carol will be remembered for their part in the last Kermadec Island expedition which took place in late 1977.

The "antenna farm", which allows action from 432 MHz to 80 metres, at the families QTH which is five hundred feet above sea level and has a clear look across the Tasman.

Dave is looking forward to his retirement in October 1984. Plans and "bookings" for such events as Thanksgiving Dinner for Aola and himself with Tom ex KH6HDA (a well known callsign that shows up in VK logs many times), a fishing trip with Tony KL7AF from Kodiak Island, visits to many of Aola's YL operator friends in Vancouver and that is only for starters. Thoughts of a visit to the UK are



**Gunter in his spacious shack**



Dave ZL1AMN



Aola ZL1ALE



Carol ZL1AJL

still in the embryo stage but a guess is that GM areas will not be overlooked.

On return to "Kiwi" land, the agenda has such notes, that conjure up thoughts of putting devices into service that have been bought on the holiday, improving that already big signal and the search for more countries as they become available.

Aola, your unlimited time with the use of the equipment during the daytime is coming to an end. Now is the time to accrue as many countries as you can before you go overseas.

#### QTH's YOU MAY NEED

- 5H3TM PO Box 1426, Mbeya, Tanzania.  
 5Z4DD PO Box 30270, Nairobi, Kenya.  
 6Y5AM PO Box 90, Kingston, Jamaica.  
 9J2CV PO Box 70992, Ndola, Zambia.  
 9K2CX PO Box 19593, Haitan, Kuwait.  
 E0ZAD PO Box 3016, Valparaiso, Chile.  
 C21BD PO Box 225, Nauru, Central Pacific.  
 C21RK PO Box 139, Nauru, Central Pacific.  
 CE7AQK PO Box 206, Ancud, Chile.  
 CP8IHS PO Box 105, Trinidad City.  
 EA9CF PO Box 410, Ceuta, Spain.  
 H5AK PO Box 147, Mafeking 8670, Bophuthatswana.  
 HZ1AJ PO Box 6177, Jeddah, Saudi Arabia.  
 JT1KAA PO Box 844, Ulan Bator.  
 KDBCE/J6L PO Box 101, Castries, St Lucia.  
 OX5RM PO Box 1569, APO NY 09023 USA.

- T77J PO Box 1, 1-47031, Republic of San Marino, Italy.  
 TZ6BMA PO Box 198, Bamako, Republic of Mali.  
 W2KW/WK4 PO Box 7055, St Thomas, Virgin Islands.  
 YK1AO PO Box 245, Damascus, Syria.  
 ZK1CG PO Box 618, Rarotonga, South Pacific.  
 ZK2RS PO Box Niue Island, South Pacific.

#### QSL VIA

3D6AK-G3WPF, 4K1QAV-UA1QAV, 5R8AL-WA4VDE, 5Z4MX-SM3CXS, 6U0WCY-DF7ZH, 6UIWCY-DF7ZH, 6W8HL-WA4VDE, 6Y5IC-G3XTJ, 6W8FZ-DJ7BG, 9G2XX-AK3F, 9Y4NP-W3HMK, AH9AA-KW6HF, AX2ITU-VK2WI, AX3ITU-VK3AH, C31XO-F6GOW, C31ZQ-I1FHQ, CEOAE-WA3HUP, D68AM-WB2OHD, EA9KF-EA9IE, ED1ILT-EA1MC, EK9C/0-UK9CAE, EK9D/1-UK9CAR, F2JD/TR8JD-F6AJA, F6ERH/TR8YL-F6AJA, FG0HUL/FS-N3COM, FPOHSH-KC8A, FPOHSH-KC6A, FY0HVL-F6AJA, FY0HVM-F6AJA, FY7BC-F9LM, HC1BP-N4BPO, HH2MC-KB4IT, HH2SD-VE3CVZ, HH2VP-W1FJ, J28DT-DF6AD, J3AVT-W8UVZ, J37AH-WB2LCH, J37DF-N4CRU, J73JW-N3AWS, JD1YAA-JA1WU, JD1YAB-JARL, JX6RE-LA9RE, JX6BAA-LA7JO, JY9RC-W1VBI, KH6LW/KH7-KH6JEB, OF0BA-OH2BAZ, S79ARB-WA2PPN, T30AT-G3XZF, T30CH-W9SLT, TJ1AF-N4IAM, T05RV/FC-F5RV, TR8DX-WA4VDE, TR8MYA-JA8ATG, VK3WCY-VK3ER, VK9ZS-VK6YL, VR6KY-LA7JO, VR6TC-W6HS, XT2BG-F2BS, YP3A-YO3KAA, ZD9BV-W4FRU, ZD9BX-KA1DE, ZD9YL-W4FRU, ZL1-9WCY-ZL2HE, ZL2BJE/C-ZL2HE, ZL4DE/C-ZL2HE, ZP0PX-W3HMK, ZP5XDW-N4DW.

#### WORKED ON THE EAST COAST

14 MHz  
 1S1CK, 1Z9B, 388DB, 389DA, 3V8PS, 4S7EA, 4U1UN, 584JE, 5H3DM, 5N3RTF, 6W8AR, 6W8DS, 707LW, 8Q7AV, 9H1EU, 9N1MM, AH2AN, AH9AA, AX2WCY, AX3ITU, BV2B, BY1PK\*, C21BO, C21RK, CEOERY/Z CE2EVG/CEOZ, C020M, CR1LN, CR4NH, CT2FH, CT4TK\*, CY6CNJ, C21BK, D44BC, DF7WCY, EA6NB, EA8AFB, EA8AFS, EA8BF\*, EA8BS, EA9IE, EA9JE, E14ARL, EL2A0, EL2BE, FB8ZG, FG0HUL/FS, F67BT, FM7CD, F08DL, FR7ZN, GW3AX, HA1XR\*, HB9AYX, HH2JD, HH4SA, H18GB, HK5500, HP1XN, HZ1AB, J20WYC, J39CM, JW4GN, JX6BAA, JY7CL, KG4DX, KH6LW/KH7, KX6PO, PJ7ARI, PY1EFM/PY0T, S83H, T70AE, TL8CK, TL8ER, T05RV/FC, TR8CR, TR8GM, TR8IG TT8AD\*, TU2JL, UG6GAF, V2AR, VE6CCO\*, VK0VK, VP2MDG, VR6TC, W6LAS/SV1A, WH2A0G, Y11BG0, ZB2HO, ZB2J, Z07BW, ZL3PO/C, ZS3GB.

\* Denotes CW operation.

3.5 MHz  
 K6EID, T15EWL, YJ8RG, ZL40Y/C.

28 MHz  
 AX3ITU, C21BD, KC6IN, KH6HR, SV3RF, T30AL, UB51QA, WH2ADG, YU7KMN.

21 MHz  
 1S1CK, 5W1DZ, 6Y5IC, AX3ITU, C21BD, C06KW, CY5AFA, H44SA, VU2AUS, ZK2JS, ZL4PO/C, ZS3PG.

#### WORKED ON THE WESTCOAST

(1.8) ZL40Y/C\*, (14) HV3SJ, (28) ZD7CW, (7) 4K1B\*, (7) 4U8ITU\*, (7) 9Y4VU\*, (7) PJ7ARY, (7) V66GAI\*, (7) VP90R\*.

( ) Denotes frequency in MHz.  
 \* Denotes CW operation.

#### CW SWLING with Eric L30042

28MHz  
 BY7PO (0700 UTC), HL5GZ, JH8FQF, UK5MAF.

21 MHz  
 BY1PK, BY8AA, DLOVN/P, EA7CMP, F6HAD, FK0AD, G3YDX, HA5KDD, HLDC, KC6YA, KH6OZ, KP4CC, OH1XT, SM6LJU, TT8AD, UK0JAA, CY7EIE, KT7H/M, XE2MX, YC2BDJ, YJ8KG, ZS1H, ZS4U, ZS6ARK, 5W1EJ.

14 MHz  
 FK8EH, F08DP, FY7BO, HL1CX, KP2J, KX6Q0, SP2JS, T30AT, U180K, N6YK/V2A, CY7WJ, T07GAS, Y80AFA, YV5DEK, 9M2M0.

10 MHz  
 A35MS, DL1SV, F3NB, FB8ZQ, G40YC, GM3GJB, JA6HW, AL7B, KP2J, OK2BFX, OZ4CB/A, VE3QU, VE5XU, VE6UM, OL2GG/YV5.

7 MHz  
 C07RM, CT3DJ, OJ0GP, EA20P, FB8ZQ, HA5KKK, HB9AUQ, H13CP, KL7Y, LZ1KOP, ON7HE, SP2JKC, UK2PCR, UB5ADN, UA9YAE, UK10AV, UK7LAA, CY3KUC, VK9NC, VP2MM, Y03NP, YU4FDE, ZS6CK, Y51ZE.

3.5 MHz  
 G3LZT, KL7AF, SM6CPY, UK2BBB, UK0ICO, UK4WAB, VK9NS, W5RK, KY0S.

1.8 MHz  
 VK5(4), VK9NS, ZL1HY, ZL2AVK.

#### QSLs received by Eric L30042

3D2ER, 3D2MK, 5Z4CV, 9J2LL, 9U5WR, A4XJP, W6KG/A7, BY8AA, ZL3TZ/C, ZL4GF/C, DL1KS\*, OL6RX\*, DJ6TK\*, OL9MK\*, F6ARC\*, FM7AV, G3NWG\*, G3TWG\*, G150QR\*, HB9AM0\*, HB9DX\*, HL1HV, J2DDU, JA8AQN/JD1, JR1EBE/JD1, KH60A, LU1UG (28 MHz beacon), OE3GW\*, W2BBK/PJ7, UD6DLK, UQ2GLR, VP9BA (28 MHz beacon), VK9NC, ZF2FR, ZB2G, ZK1XX, K60D0\*.

\* Denotes 10 MHz confirmations.

#### QSLs received by Steve VK2PS

DU7RLC, F08IV, C21RK, ZK2RS, KX6PO, 9M2EE, UH8EAD, UA0ZCQ, UA9ULC, UA4CGP, UK30BS, UK2ABC, UK2FAH, UK1ADK, Y09HP, OH100, OH9TJ, OH6BR, OH3FM, Y80AFA, VK9ZA, I2PAH, ZK2WM, FK8EU, HLOY, HLOSF.

#### THANKS

Assistance with information for these notes has been forthcoming from amateurs including VKs 2PS, 3BY, FR, PA, UX, YJ, YL, 5GZ, 6FS, HD, NE and Eric L30042. Overseas amateurs who assisted included G3NBC, ON7WW, ZL1AMN. Research from magazines, including BREAK IN, cq DX, CQ, HOW'S DX, DX NEWSLETTER, DX POST, DX PRESS, JAN and JAY O'BRIENS QSL MANAGER LIST, QST, REGION 1, 2 & 3 NEWS and WORLD RADIO.

The closing date for information for the October notes is 23 August.

Thanks to all sources of information.

AR

## BUYING, SELLING or WANTING?

Check HAMADS first.  
Eight lines free to all WIA Members.

# WICEN NEWS



Ron Henderson VK1RH  
FEDERAL WICEN CO-ORDINATOR  
171 Kingsford Smith Drive, Melba, ACT 2615



# QSP

## BREATHALYZERS AND RF

Four models of breathalyzers produced in America were recently found to be susceptible to radio frequency interference (RFI). When the devices are operated in strong RF fields, test results could contain major inaccuracies.

Questions of the accuracy of these particular machines has resulted in at least one drunk driving case being dismissed in America and the recommendation that state police "temporarily stop using their breathalyzer machines".

Adapted from CQ magazine April 83

AR

## POLICY STATEMENT — WICEN AND EMERGENCY COMMUNICATIONS

Recognising that:

- The obligation on amateur radio operators to respond to emergency transmissions they receive;
- The desire of amateurs to offer their services in emergencies;
- ITU Resolution 640, which states that certain amateur bands may be used by administrations to meet the needs of international disaster communications;
- The frequently unpredictable onset of disaster situations;
- The value of training and preparation prior to any emergency or disaster;
- The existence of amateur Third Party Traffic Networks (TPTN);
- The complimentary nature of WICEN and TPTN and the likelihood of amateurs interchanging between these activities;
- The need to accredit amateur emergency communications with disaster control agencies;
- The fact that not all amateurs will wish to be actively involved in disaster communications training;

This Council:

- Identifies four levels of amateur involvement in emergency and disaster communications, namely:
  - as an active member of a State Emergency Service (SES),
  - as an active member of the Wireless Institute Civil Emergency Network (WICEN),
  - as an active member of TPTNs,
  - as a responsible operator.
- Confirms the role of WICEN as "A pool of trained licenced operators with equipment, available for deployment by a disaster control agency to aid communications in an emergency";
- Identifies the emergency or disaster role of TPTNs as "Provision of communications for the general public within the terms of prevailing regulations and licences";
- Seeks co-ordination between WICEN and TPTN. The Federal WICEN Co-ordinator is directed to initiate such actions in the first instance;

- Sees a requirement for WICEN training and exercises together with exposure of other amateurs to WICEN message handling and voice procedure;
- Observes that WICEN message handling and voice procedure should be aligned with that used by the SES for improved inter-operability;
- Seeks standardisation of message forms based upon the general format and layout of the SES message form;
- Confirms the requirement for declared and publicised WICEN calling frequencies in all the amateur HF bands.

AR

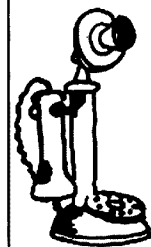

**Please remember your STD code when you advertise in HAMADS.**

# INTERNATIONAL NEWS



## HIGH HONOUR FOR AUSTRALIAN HEAD OF THE INTERNATIONAL TELECOMMUNICATION UNION (ITU)

A recommendation by the Spanish Council of Ministers has granted the Highest Telecommunication Honour of Spain to Richard E Butler, the Australian Secretary-General of the International Communication Union and Co-ordinator of World Communications Year (1983): Development of Communications infrastructures, as proclaimed by the United Nations.

The award is in recognition of Mr Butler's substantive contribution to the realisation of development through international telecommunications co-operation.

The award was presented to Mr Butler on behalf of His Majesty the King of Spain, Don Juan Carlos, by the Deputy Minister for Transport, Tourism and Communications of Spain, Mr Gerardo Entrena, during celebrations of the 15th World Telecommunication Day at ITU Headquarters on 17 May 1983 — the 118th anniversary of ITU's foundation.

Mr Butler was elected Secretary-General of the ITU by its Plenipotentiary Conference, held at Nairobi in October 1982, and took office on 1 January 1983. He has served as Deputy Secretary-General of the Union since 1968 on being elected, after nomination by Australia. He is seconded from TELECOM (Australia).

AR

## CHESS AND AMATEUR RADIO INTERNATIONAL — CARI

CARI is a newly formed international club for people wishing to play chess via amateur radio.

The club is organised by Vince K2VJ, PO Box 682, Cologne, New Jersey, USA 08213, who publishes a quarterly newsletter with details on how to set up local or international games.

You can contact Kevin VK3ASM or Craig VK3CRA both QTHR or check into our local CARI net on Wednesday night 1000 UTC 3.567 MHz and you will be very welcome whether a beginner or an expert.

AR

# COMPUTER PROGRAMME FOR STATION LOG AND QSL CARD PRINTING

*This programme was provided by M. Mohan, VE6AZM. It is written in BASIC and, with minor modifications can be used on any computer with a BASIC compiler.*

A menu is displayed when the programme is run to allow the following choices to be made:

1. Display log by callsign (displays all QSOs with given callsign)
2. Display log by date (displays all QSOs on a given date)
3. Enter a new contact (just that)
4. Print QSL by a call (prints a QSL for each QSO with that callsign)
5. Print QSL by a date (prints a QSL for each QSO on that date).

To change the programme to suit your situation change VE6AZM to your call in all places where it occurs, except in line 100. Don't forget lines 918 & 926. Do not enter line 1000 on. Change lines 931, 932, 996 to incorporate your details.

The details of changes to be made for different machines are not given here because, to be reliable, access to all of the major machine types would be required.

At least 4 K of RAM would be required for a useful log. If you are very active you will need more. For example 1000 QSOs may require 64 K of RAM.

```

* * ***** ** * ***** * *
* * * * * ** * * * * *
* * ***** ** * ***** * *
* * * * * ** * * * * *
* * ***** ** * ***** * *

```

AMATEUR RADIO STATION CONFIRMING WITH AX3AH  
A THO HAV Q3 QSO OF 821010 DATE AT 1538 UT ON 14.17  
MHZ AND REPORTING 59 RST WITH A 2 ELEMENT HOME-BREH  
CUBICAL QUAD. STATION'S ACTIVE ON FH RTTY SSB SSTU  
DATA HAS PRINTED BY MICROCOMPUTER DIRECTLY FROM THE  
LOG ENTRIES IN THE MEMORY WITH A HOME-BREH SOFTWARE

KEN PLEASE QSL->80X 46 HINTERBURN ALBERTA T0E 2NO  
OR VIA UES BUREAU, TNX FER THE QSO

```

100 REM *** REPORT HEADER ***
101 PRINT "DATE TIME CALL MHZ EH RST QSL"
102 FOR I=1 TO 39: PRINT " _": NEXT I: PRINT "-"
103 RETURN
104 REM *PRINT ALL QSL CARDS*
105 GOSUB 700
106 IF A=99999 THEN 910
107 IF S$="N" THEN 910
108 IF S$="Y" THEN 612
109 PRINT "-"
110 PRINT " "
111 PRINT " * * ***** ** * ***** * *"
112 PRINT " * * * * * ** * * * * * "
113 PRINT " * * ***** ** * ***** * *"
114 PRINT " * * * * * ** * * * * * "
115 PRINT " * * ***** ** * ***** * *"
116 PRINT " * * * * * ** * * * * * "
117 PRINT " * * ***** ** * ***** * *"
118 PRINT " * * * * * ** * * * * * "
119 RETURN
120 REM *STATION CONFIRMING WITH *S$*
121 PRINT "A THO HAV *S$* QSO OF *Z* DATE AT *VS* UT ON *SH*"
122 PRINT "CUBICAL QUAD. STATION'S ACTIVE ON FH RTTY SSB SSTU"
123 PRINT "DATA HAS PRINTED BY MICROCOMPUTER DIRECTLY FROM THE"
124 PRINT "LOG ENTRIES IN THE MEMORY WITH A HOME-BREH SOFTWARE"
125 PRINT
126 IF A$="N" THEN PRINT " *S$* PLEASE QSL->80X 46 HINTERBURN ALBERTA"
127 PRINT " T0E 2NO": PRINT "OR VIA UES BUREAU, TNX FER THE QSO"
128 IF A$="Y" THEN PRINT "TNX FER UR QSL CARD *S$*"
129 PRINT "-"
130 RETURN
131 PRINT "TO RESTORE ENTER 0 -> "I#
132 IF I# = 0 THEN RESTORE: GOTO 103
133 PRINT "INVALID,RE-ENTER": GOTO 950
134 END
1000 DATA 800105,0145,R230HA,14.20,A3,57,53,N,N,0152,ULAO
1001 DATA 800105,0155,RK20AG,14.20,A3,57,57,N,N,0157,ALEX
1002 DATA 800113,2325,CE3BPC,21.34,A3,57,57,N,N,2328,JIM
1003 DATA 800120,0401,HB2PTH,14.23,A3,59,59,N,N,0404,STU

```

```

618 GOTO 612
620 GOSUB 906
622 GOTO 612
700 REM *REPORT HEADER*
702 READ A:Z = A: IF Z = 99999 THEN 950
704 READ A:V$ = A$
706 READ B:V$ = B$
708 READ C:V$ = C$
710 READ D:V$ = D$
712 READ E:V$ = E$
714 READ F:V$ = F$
716 READ G:V$ = G$
718 READ H:V$ = H$
720 READ I:V$ = I$
722 READ J:V$ = J$
724 RETURN
726 REM *DISPLAY DATA*
728 PRINT " *S$* *Z* *VS* *SH*"
730 PRINT TAB(23) " *S$* *Z* *VS* *SH*"
732 PRINT " *S$* *Z* *VS* *SH*"
734 RETURN
736 REM *REPORT HEADER*
738 HOME
740 PRINT "DATE TIME CALL MHZ EH RST QSL"
742 FOR I=1 TO 39: PRINT " _": NEXT I: PRINT "-"
744 RETURN
746 REM *PRINT ALL QSL CARDS*
748 GOSUB 700
750 IF A=99999 THEN 910
752 IF S$="N" THEN 910
754 IF S$="Y" THEN 612
756 PRINT "-"
758 PRINT " "
760 PRINT " * * ***** ** * ***** * *"
762 PRINT " * * * * * ** * * * * * "
764 PRINT " * * ***** ** * ***** * *"
766 PRINT " * * * * * ** * * * * * "
768 PRINT " * * ***** ** * ***** * *"
770 PRINT " * * * * * ** * * * * * "
772 PRINT " * * ***** ** * ***** * *"
774 PRINT " * * * * * ** * * * * * "
776 RETURN
778 REM *STATION CONFIRMING WITH *S$*
780 PRINT "A THO HAV *S$* QSO OF *Z* DATE AT *VS* UT ON *SH*"
782 PRINT "CUBICAL QUAD. STATION'S ACTIVE ON FH RTTY SSB SSTU"
784 PRINT "DATA HAS PRINTED BY MICROCOMPUTER DIRECTLY FROM THE"
786 PRINT "LOG ENTRIES IN THE MEMORY WITH A HOME-BREH SOFTWARE"
788 PRINT
790 IF A$="N" THEN PRINT " *S$* PLEASE QSL->80X 46 HINTERBURN ALBERTA"
792 PRINT " T0E 2NO": PRINT "OR VIA UES BUREAU, TNX FER THE QSO"
794 IF A$="Y" THEN PRINT "TNX FER UR QSL CARD *S$*"
796 PRINT "-"
798 RETURN
799 PRINT "TO RESTORE ENTER 0 -> "I#
800 IF I# = 0 THEN RESTORE: GOTO 103
801 PRINT "INVALID,RE-ENTER": GOTO 950
802 END
1000 DATA 800105,0145,R230HA,14.20,A3,57,53,N,N,0152,ULAO
1001 DATA 800105,0155,RK20AG,14.20,A3,57,57,N,N,0157,ALEX
1002 DATA 800113,2325,CE3BPC,21.34,A3,57,57,N,N,2328,JIM
1003 DATA 800120,0401,HB2PTH,14.23,A3,59,59,N,N,0404,STU

```

# NATIONAL EMC ADVISORY SERVICE

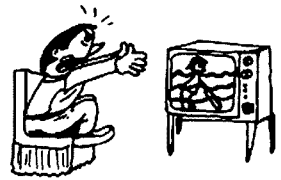

Tony Tregale VK3QQ  
NATIONAL EMC CO-ORDINATOR  
38 Wattle Drive, Watsonia, Vic 3087

## "A WARNING FROM CANADA"

*Australian amateurs beware — this could happen here! The psychology behind this Canadian situation could have far reaching consequences in other areas of electronics and electronic communications. It is very easy for us all to be sold down the river by profit orientated entertainment entrepreneurs and big business.*

The ubiquitous presence of electrical and electronic equipment in today's living has benefited mankind immeasurably, but we are paying an ever increasing price for this service, not only in monetary terms but in terms of Electromagnetic Interference. The very use of this equipment is causing ever increasing interference, and in consequence, social and legal problems.

Cable TV interference is not a new kind of interference. We have had it since the first day cable TV systems were built in Canada almost thirty years ago. But it is new for amateur and other radio services beginning the day cable TV system began to use mid-band and super-band frequencies. It is due to leaks in cable TV systems which allow signals in the cable to leak out and interfere with radio systems on the outside. Of course, those same leaks make the cable system susceptible to interference leaking into the cable.

In years gone by, whenever amateurs had interference problems, only the complainant (most often a private individual), the amateur and DOC were involved. With a little co-operation these problems were quickly resolved. However, amateurs and amateur clubs involved with cable TV interference problems will have to play an entirely different ball game.

The opponent is a company rather than an individual; two umpires with different objectives in mind will do the judging, and the corrective measures will be very costly and time-consuming to implement. Amateurs can win if they are prepared to understand the game and take advantage of all the opportunities that it creates.

Cable TV systems are regulated under the Radio Act by the Department of Communications which grants Technical Construction and Operating Certificates, and under the Broadcasting Act by the Canadian Radio-television and Telecommunications Commission which grants licenses. According to the two Acts, the license has no authority unless both the Technical Construction and the Operating certificates are valid. Therefore, the Department of Communications has the power to close down a cable system if a case of interference were not resolved. **HOWEVER, DOC WOULD BE VERY RELUCTANT TO DEPRIVE A CITY OF UMPTEN CHANNELS OF TV.**

This is where we arrive at the psychological situation — "How much chance would the Amateur Service have against a whole city?" The catch 22 is, that once a system, or equipment, of this nature is allowed to get a foot in the door it becomes a creeping disease which is protected by its consumers, while its controllers sit back and relax all the way to the bank . . . We should remember CB which caused the DOC an awful problem, while providing the entrepreneurs with a pot of gold.

There is no easy answer to this "catch penny" situation, however, the Amateur Service can help to ensure that the promoters of such systems and schemes do not sneak through our back door by, each and every member of the Amateur Radio Service, doing his or her best to continually monitor all trends and events in the world of commercial communications and electronics.

To see what opportunities are available for amateurs to get a case of Cable TVI resolved, we should start by familiarising ourselves with both of the authorisation processes.

Proofs of performance are important. They show the DOC that "the system performance is essentially meeting standards of the Department". Broadcast procedure 23 sets out the standards (including the radiation standard) and how they are to be measured. A proof has to be submitted one year after a system commences operation and one year prior to the expiry date of the Certificates. Again, we have a loophole! Once the system has started serving consumers, it's virtually impossible to shut it down . . . "Remember Channel O and 5A?"

It is essential that you know the radiation limits that the Cable Company has to meet and how they are measured. Because leakage in the 2 metre band from a cable system which meets the DOC standard (10 microvolts per metre at three metres from the cable) will result in a receivable signal in modern amateur equipment sixty feet from the cable, one cannot assume that, since a signal is received, the standard is exceeded . . . Another warning for Australia! . . . Therefore, the leakage from the cable lines must be measured at a number of locations throughout the interference area to confirm that the leakage exceeds the DOC requirements.

It is a time-consuming task but, because DOC inspectors may not have time to do the investigations . . . "Another warning for Australia!" . . . there may be no alternative. Be sure the carrier measured comes from the cable and not directly from some distant transmitter. Test equipment (receiver, transmission line and antenna) should be calibrated. You may be pitted against a Cable Company and/or DOC engineer on the matter of measurements and you will want to have a good case technically.

Now, equipped with measurements that prove interference, you can go and talk to the cable company to get them to repair the leaks . . . some hope, based on USA experience. If they are reluctant, bear in mind that locating and repairing the leak can cost many thousands of dollars, especially if the system is not well maintained.

The Canadian Cable Television Association recognizes that leaks result not only in interference to, but also make a cable system susceptible to interference from, other radio services. Leakage is therefore of concern to the Association and its members. The Association has produced a "Radiation Monitoring Handbook" to assist member companies. Included in the handbook is advice on how to monitor a system for radiation leaks, measure radiation and locate leaks. Technical help is also available to the companies from many other sources. Accordingly, amateurs should not become involved in any more than helping cable technicians locate leaks.

Amateurs should not overlook another complication. House and apartment building "wiring" when improperly done, can cause terrible interference problems and, depending on who owns and maintains the distribution system in the building, may be beyond the control of the cable company.

At the present time, the Australian Department of Communications is attempting to administer the finite electromagnetic spectrum with grossly inadequate mandatory legislation, and an inadequate number of staff to properly supervise the use of one of our most important natural, and extremely vulnerable resources.

This warning from Canada is an illustration of the vulnerability of government control bodies when they are involved with com-

mercial interests and high, often international, finance. It is most important that our legislators understand and cater for, in the Bill, this absolutely disastrous form of "catch 22".

Members of the Amateur Service should, in the interest of the continued well being of our Service, keep a very close watch on this psychological/financial manoeuvring by those in society who are concerned only with profit... Remember, cable TV was used here only to illustrate this potentially disastrous situation. The psychological implications can equally apply in many similar areas — "Let us heed the warning from Canada".

Acknowledgements to:  
TCA MAGAZINE and VE3NR

AR

## ELECTRONIC HOBBYIST!

DO YOU LIVE IN . . .  
Ringwood, Lilydale,  
Boronia, Wantirna,  
Bayswater, Mooroolbark etc? . . .

We carry a comprehensive range of electronic components at very keen prices.

## Ian J. TRUSCOTT ELECTRONICS

CNR EASTFIELD  
& BAYSWATER ROADS,  
SOUTH CROYDON,  
VIC.  
TELEPHONE  
(03) 723 3860

## NOTICE

DEADLINES FOR NEXT  
ISSUE

All copy for OCTOBER Magazine must  
ARRIVE at Federal Office by the 25th  
AUGUST.



# COMMERCIAL CHATTER

## STEWART ELECTRONICS OPENS NEW STORE

Due to an ever increasing demand and requests for an outlet closer to the city and western suburbs Stewart Electronics has opened a new sales outlet at 437 City Road, South Melbourne. The new store will carry the same range as the Huntingdale head-office and will be well supported with daily distribution of stock. Callers are most welcome and full counter/cash sale facilities are available.

AR

## GFS MOVES QTH

GFS Electronic Imports have moved to new premises at 17 McKeon Road, Mitcham, Victoria. (Next door to their old shop).

Due to Greg's ever increasing overseas franchises the previous location was becoming too small. The new store has a larger display area with an ever increasing range of goods.

Call in and inspect the new premises. Greg and Alf will make you most welcome.

Note: Postal address and telephone number remain the same.

AR

Below — GFS Electronics' new show room.



AR

## DICK SMITH OPENS IN TOOWOOMBA

As a convenience to our many customers who live in the Darling Downs area, the important retailing centre of Toowoomba, Queensland has become the host for the latest Dick Smith Electronics store.

Now Toowoomba's electronic enthusiasts (and enthusiastic beginners as well) will have, at their doorstep, everything from components to kits, home computers, telephone products, HI FI equipment, electronic games, etc.

Located at the corner of Ruthven and Bowen Sts, the phone number is (076) 38 4300. Toowoomba store manager, Brian Marney (pictured here), and his specially trained staff are looking forward to serving you.



So, why not drop into Dick's new Toowoomba store, have a look around and take advantage of the fantastic specials and direct import prices.



# GFS Electronic Imports

15 McKeon Road, Mitcham, Victoria, 3132  
PO Box 97, Mitcham, Victoria, 3132 Phone: (03) 873 3939, 873 2652  
Telex: GFS AA 38053 Cable: "Comimports" Melbourne

**NEW**

## 2.3 GHz Microwave Downconverter Kit. Price \$89

The RX-2300 includes all components, teflon PCB, case and BNC connectors. May be tuned to any 30 MHz segment between 1.69 and 2.7 GHz. Included in this range are Weather Satellites, NASA Space Shuttle TV and Audio, NASA beacon on the moon.

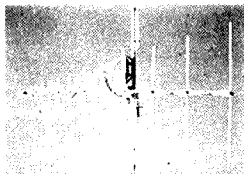
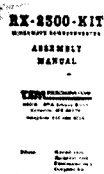

## NEW BROAD BAND VHF/UHF BEAMS

LOG-S, 100 to 520 MHz Log Periodic Beam, 9 element 1.02 metre boom, 9.5 dBi gain, 200 Watts \$89 + 10 P&P

LOG-SP, 65 to 520 MHz Log Periodic, 13 elements, 3.07 metre boom, 11.5 dBi gain, 200 watts. \$125 + \$10 P&P

## ANTENNA ROTATORS

We stock EMOTATOR rotators, the rotator that has been serving the Australian amateur for over 20 years.

- 103 SAX MEDIUM DUTY \$235 + \$10 P&P
- 502 SAX HEAVY DUTY \$366 + \$10 P&P
- 1102 MSAX EXTRA HEAVY DUTY \$484 + \$10 P&P

SHORTENED TRAPPED DIPOLE FOR 80, 40 & 20 METRES

A-248D Approx 60 ft long, includes wire, insulators and traps. **\$93 + \$7 P&P**

## 1983 callbooks

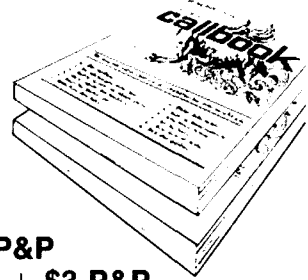

**NOW READY!**

US CALLBOOK \$26 + \$3 P&P  
FOREIGN CALLBOOK \$25 + \$3 P&P

## ATN ANTENNA'S

GFS keep the ATN range of HF, VHF and UHF beams. Write for a brochure on the full range.

**COME AND CELEBRATE WITH US  
IN OUR NEW LARGER SHOWROOM**

SQ-61 6 metre SWISS QUAD'S 12dBd gain.

were **\$171**  
now **\$89 + \$10 P&P**  
ONLY DURING AUGUST.

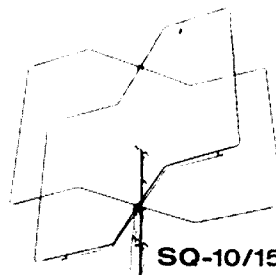

SQ-10/15/61

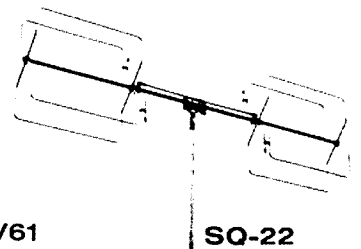

SQ-22

We also stock HF, 2 metre on 70 cm high performance SWISS QUADS. Write for details.





# GFS Electronic Imports

15 McKeon Road, Mitcham, Victoria, 3132  
PO Box 97, Mitcham, Victoria, 3132 Phone: (03) 873 3939, 873 2652  
Telex: GFS AA 38053 Cable: "Comimports" Melbourne



RINGO

HF-5DX Self supporting trapped vertical complete with self supporting radials. Needs no guys. Covers 80, 40, 20, 15 & 10/11 metre. **\$187 + \$10 P&P**

2 metre RINGO, 9 dBI gain omnidirectional vertical antenna. **\$60 + \$10 P&P**

## KEEP YOUR QSL CARDS NEAT & TIDY

with our Plastic QSL Card Holder. Each pack includes two 20 pocket plastic card holders.

**Price \$3 + \$1 P&P**



## RTTY THE EASY WAY

AFSK MOD-DEMOM FOR RTTY, ASCII, 45 to 1200 BAUD  
**MODEL MDK-17 KIT**

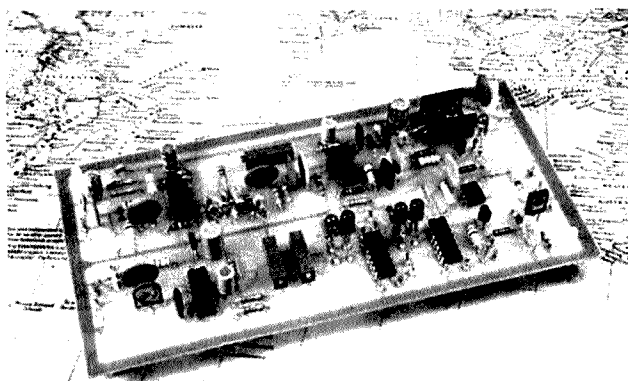

\* Interfaces directly to baudot Type Machines. \* Provides for all Combinations of TTL or high voltage send-receive systems. \* Only single + 12V Supply required. A high Gain Amp/Limiter and active band pass filter precede an XR2211 Demod I.C. \* Good Data recovery is assured, even under difficult conditions \* Excellent temperature stability is provided by an XR2206 I.C. in the tone generator. \* Sense invert capability \* LED indication of transmit tones, receiver tuning and valid signal. \* Auto start output available (TTL). \* Supplied with comprehensive documentation.

**MDK-17 Kit \$106 + \$10 Airmail,  
Assembled and Tested \$161**

## NEW EXTRA LARGE 12 INCH 24 HOUR QUARTZ CLOCK

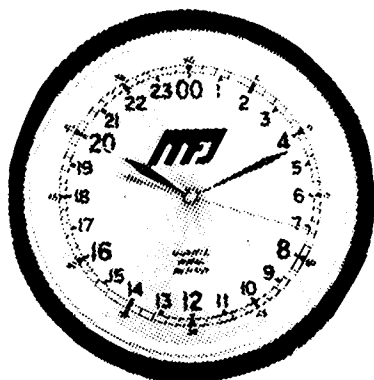

**MFJ-105 \$125 + \$6 P&P**

True 24 hour quartz wall clock has huge 12 inch diameter face. Gives excellent visibility across computer/radio room. Fifteen seconds per month accuracy.

Single "AA" battery provides over one year operation, immunity from power line failure and eliminates power cord.

Sweep second hand. Brown hi-impact case. Glass front. 24 hour military time format.

# PERSONALITIES ATTENDING THE MT GAMBIER CONVENTION

Photographs —  
Gil Sones VK3AUJ



Beven VK5TV.



David VK5KK.



Harry VK3XI.



Eric VK5LP.



Woody VK3AGD.

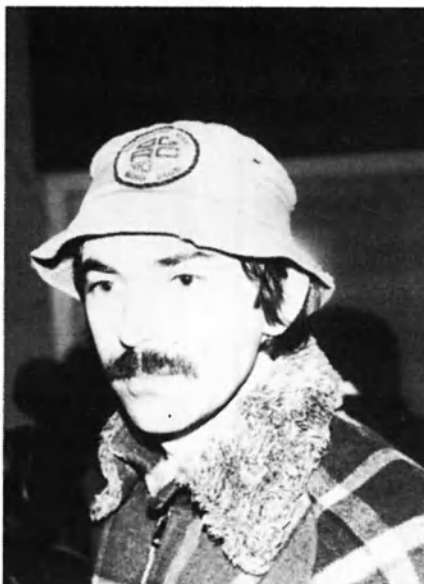

Ian VK3BUF.



David VK5ZOO

# WIN A VHF CONVERTER COMPETITION

*GFS Electronic Imports of 17 McKeon Road, Mitcham, Victoria have kindly donated a MFJ VHF Converter for the lucky WIA member whose name is drawn from the correct entries submitted.*

The converter allows you to listen to Rural Fire Brigades, VHF Marine & Coastguard and allows you to enjoy all the benefits of your handie-talkie such as scanning, programmability, frequency readout, excellent sensitivity, selectivity, stability, limiting and AM rejection. A great prize.

Post your entry today.

## ANSWER THIS QUESTION

*What has twice as many edges as it has sides and two thirds as many corners as it has edges. It also has twenty one markings.*

## RULES

The contest is open to all members of the WIA, with the exception of all people and their immediate families associated with the production of Amateur Radio. One entry per member, each entry to be hand-written on the back of a standard Australia Post approved small envelope.

Entries must be received no later than the last mail, Friday, 30 September, 1983 and the winning entry will be the first correct answer drawn by the Editor of AR, on the 4th October.

The Editor's decision will be final and no correspondence will be entered into regarding the decision. Results will be published in November AR.

All entries to: AR Competition Box 300, Caulfield South, 3162. On the back of the envelope, your name, address, callsign and the answer to the problem.

Only entries in the above format will be accepted. All others will be disqualified.



Duncan VK3LZ demonstrating ICOM gear at the Convention.



Ron VK3BEE.



Don VK5ZOD/NOD presenting the Club Trophy to Greg VK3BGW.



Lionel VK3NM enroute to Mt Gambier with a drowned engine.



# VHF UHF - an expanding world

Eric Jamieson VK5LP  
10 Quinns Road, Forrester, SA 5233

All times are Universal Co-ordinated Time, indicated as UTC.

## AMATEUR BAND BEACONS

FREQ	CALLSIGN	LOCATION
50.005	H44HIR	Honiara
50.008	JA2IGY	Mie
50.020	GB3SIX	Anglesey
50.060	KH6EQI	Pearl Harbour
50.075	VS6SIX	Hong Kong
51.020	ZL1UHF	Auckland
52.013	P29SIX	New Guinea
52.100	VK0AP	Macquarie Island
52.200	VK8VF	Darwin
52.250	Z1.2VHP	Palmerston North
52.300	VK6RTV	Perth
52.320	VK6RTT	Carnarvon
52.350	VK6RTU	Kalgoorlie
52.370	VK7RST	Hobart
52.420	VK2RSY	Sydney
52.425	VK2RGB	Gunnedah
52.436	VK3RMV	Hamilton
52.440	VK4RTI	Townsville
52.470	VK7RNT	Launceston
52.510	Z1.2MHF	Mt Climie
144.400	VK4RTT	Mt Mowbullian
144.420	VK2RSY	Sydney
144.465	VK6RTW	Albany
144.475	VK1RTA	Canberra
144.480	VK8VF	Darwin
144.550	VK5RSE	Mt Gambier
144.600	VK6RTT	Carnarvon
145.000	VK6RTV	Perth
147.400	VK2RCW	Sydney
432.410	VK6RTT	Carnarvon
432.420	VK2RSY	Sydney
432.440	VK4RBB	Brisbane
432.450	VK3RMB	Mt Bunninyong

No changes appear in the beacon list this month.

Last month I mentioned the unusual consistency of VK5RSE on 144.550 and operating from Mount Gambier, in that it is always available at this QTH. On the Monday following the SERG Convention at Mount Gambier, Peter Becker VK5KBF invited me to inspect the beacon site, so I was duly directed to a building on a small rise at Glencoe, about 23 km north west of Mount Gambier, and there it was! To say I was surprised would be an understatement! The antenna is a horizontal dipole joined to the chimney of the house with an ordinary TV mast about 2 m long and the co-ax goes down the chimney to the equipment cunningly hidden inside. The beacon is beautifully made with all the usual protection circuitry and a few other things besides. The site barely clears the surrounding pine forests but despite all this, it is reliable, and serves its purpose as a beacon very well. Any directivity which might exist from the antenna would favour both Adelaide and Melbourne!

## SIX METRES

Gil VK3AUI phoned to report that on Saturday 18th June Peter VK0AP at Macquarie

Island worked Stan VK3VD who was at his Allambee establishment in the Gippsland area at 0425. The beacon at VK0AP was received from 0400 to 0500. At the same time ZL TV was noted, also a signal from Chatham Island, so it is apparent some form of enhanced propagation from that south-easterly direction enabled the contact to be made with Peter. Stan was unable to raise any other 6 metre stations either locally or elsewhere.

Graham VK6RO has sent a copy of the May 1983 Japan "Ham Radio" magazine which contains some interesting information. Again my Japanese is not good but I decipher the following: *The Hong Kong boys are really getting into the 6 metre act and Steve VS6XMQ reports the following will be on this year: VS6CT, VS6BT, VS6AL, VS6FX, VS6EL, VS6GW, VS6XLE, VS6XLX, VS6XMP, VS6XLA, VS6XMQ, VS6XLA, VS6XMT and VS6XMU. They will be using 50.110 for CW and this will be the main calling frequency, 50.200 for SSB and 50.300 for FM.*

From the same "Ham Radio" comes advice that 5Z4CS is now QRT. Also some QSL information: A35GW: PO Box 46, Nukualofa, Kingdom of Tonga; FK8EM: PO Box 1976, Noumea, New Caledonia; CR9CT: Via KB2XS, Rudolf F Lehnert: PO Box 1150, Princeton, New Jersey, 08540.

The Japanese 6 metre operators continue to work exotic places, and one wonders with the obvious increased level of activity generated by Cycle 21 whether the type of contacts they are having may not continue despite the decline of the cycle, perhaps not as consistent as at the peak, but it is certainly looking good for them, even if not for VK. The report covers the period from March to 24/4/83, and callsigns being worked include all areas of VK, with prominence to VK4 and VK8, ZL1, ZL2 and ZL3, many contacts to New Guinea and other places such as KG6JDX, DU1BN and many others in DU, YC1CHG, H44PT, HS1SD, FK8EM, A35GW, FK1SB, YB0ACB, VS6XMQ, FK0TAA, FK8EB, KC6IN, YB1CS, YB1BZ, YB2BSF, HL4XK, YC2DPY, VS6EL, VS6GW, HL1UH, FK8AX, HL5BAS, YC0VM, HL2AIB, ZK2RS, and many of these were worked on more than one occasion. Whether we are working them from VK or not it still indicates there is plenty of interest in 6 metres around the Pacific yet, hopefully it will continue.

## THE MOUNT GAMBIER CONVENTION

On the local scene I have been on leave and the gear hasn't been on other than FM in the car so there is little to report. However, the car took me to Mount Gambier and the South East Radio Group Annual Convention which was very well supported by both VK5 and VK3. The Committee had obviously done a lot of ground work in preparing for the Convention as a very elaborate programme of events

had been arranged and taxed the ingenuity of the participants. Some new ideas added much interest to the proceedings, plenty of trade support with many of the latest goodies to look at, or buy. A stall with second-hand material for sale was of interest, and of course the famous SERG tea provided by the ladies on the Sunday night was a winner as usual. Much improved arrangements for the meals was a credit to the organisers and they were able to handle the very large gathering in record time.

VK5 won the SERG trophy again thanks to the efforts of VK5KK, VK5CK, VK5AVQ, VK5ACE, VK5TV and some others. However, the VK3 crews did not disgrace themselves and managed to carry home quite a few trophies. The winner of the home-brew competition was David VK5KK with a 28 MHz transceiver, all solid state. When questioned as to why a dedicated VHF type like he obviously is, should be fiddling around with 28 MHz equipment, David replied, with tongue in cheek, that it was useful to supply 28 MHz energy for VHF equipment!

After the Convention I stayed in the area for a few days and met up with Chris VK5MC at Hatherleigh and had another look at his EME equipment, and was able to observe him operating his 144 MHz equipment via the rhombics on two mornings, unfortunately this time without a great deal of success, although signals were heard from KG6DX well above the noise.

After leaving there, a few days were spent with mother-in-law (to satisfy the petticoat government), and then on to Ray VK3ATN, who, I am pleased to report seems to be getting along pretty well after his accident when his tower collapsed in a gale and he tried to ride it to the ground! He is very busy making antennas for a living, but is still very interested in EME and hopes to get there again in the not too distant future. He is already doing some work on his 15.5 m dish which has been lying around for a number of years. Best wishes for a complete recovery Ray.

I noted also that Steve VK5AIM gave himself a birthday present recently and took his new FT290R on holidays to Victoria, and was able to drag himself away from the repeaters long enough to have a few contacts on the machine using SSB! Steve even worked back to home town Elizabeth on 7.070 MHz (well!!!) using the FT-7! 114 and 432 from NSW.

Gordon McDonald VK2ZAB has written with some further news of his many VHF exploits during May. He says "Looking at my log I find there is too much in the beyond 200 km category to write about! I have made 108 contacts over 200 km and I know of many others made between other parties. So where do we start?"



Photograph by Gil Sones VK3AJU

**North East Radio Group, Greg Williams VK3BGW holds the Club Trophy for group performance by a club, surrounded by members, YLs and YFs.**

"I therefore report on contacts which are significant because they are either beyond 400 km or else have some other point of interest:

"1. Contacts, Sydney to Melbourne on 2 metres: Doug VK3UM and I have managed to pass callsigns and signal reports on 6 occasions during May. This path is just short of 700 km. Signals are generally S1 but occasionally and briefly go to S2-3, except for meteor pings.

"2. Contacts, Canberra to Melbourne on 2 metres, 460 km. Ralph VK1RK has made contact with Doug VK3UM on numerous occasions. Glen VK1KAA has also worked VK3UM several times. VK1RK also worked VK3ZHP on 27/5.

"3. Sydney to Bendigo, 2 metres, 614 km. I worked VK3XDP on 6/5, Peter was 5/3 here and gave me 5/4.

"4. Other significant contacts on 2 metres: VK2ZAB to VK2YEZ 474 km, 2/5, 11/5, 18/5, 23/5. John is at Griffith. VK2ZAB to VK2XDH 356 km, 6/5, 7/5, 21/5, 27/5. Doug is in Armidale and the Channel 5A translator limits his operating time to early mornings and this limits my operating times to weekends. VK2ZAB to VK2DSM, 10/5, 11/5. Bob was portable at Mt Caputa, 368 km. VK2ZAB to VK2ECC 520 km, 13/5, 18/5, Doug is at Yetman. VK2ZAB to VK2ZDY, 474 km, 6/5, 20/5, operator is Dave. VK2ZAB to VK2MQ,

474 km, 13/5, 16/5, 17/5, 20/5, 23/5. Graham. VK2KAY to VK1VP 11/5, 17/5, to VK1RK on 17/5 and VK1KAA also on 17/5, all Gunnedah to Canberra at 486 km.

"5. On 432 MHz: VK2ZAB to VK2KAY 300 km, 1/5, 17/5 and 27/5. VK2ZAB to VK1VP 260 km 5/5 and 21/5. These contacts indicate VK2KAY and VK1VP have good receivers as VK2ZAB is running 10 watts! VK2KAY to VK1VP 486 km, 11/5 and 17/5.

"General and conclusions: Country NSW stations equipped with 70 cm SSB include VK2KAY, VK2XDH (Armidale), VK2ADY (Tamworth) and VK2DOA (Narrabri). The Griffith gang have 70 cm but are repeater bound. Moves are afoot in VK1 to try the path to Melbourne on 70 cm.

"On 2 metres VK3UM has run a CW call several times and has been heard in Sydney by VK2AAS, VK2BKQ, VK2ZRU, VK2ZHT and VK2ZAB. He has been heard in Gunnedah by VK2KAY and in Narrabri by VK2AKU and VK2DOA.

"Brian VK2AKU in Narrabri and Darcy VK2KAY in Gunnedah are running 2 metre skeds to Brisbane and northern VK4. Others in Melbourne are turning their beams north, with VK3ZBJ and VK3XQ coming to mind. Where are the VK7 SSB stations?"

Thanks for a very newsy letter Gordon and you make us quite envious down here. It seems Channel 5A has effectively eliminated

all 2 metre operation from Western Victoria which often started contacts which eventually ended up in Melbourne for those in VK5. We now seem to be almost as isolated as VK6!

As if all the above wasn't enough, another letter has come from Gordon VK2ZAB with some more hot news. "Working near the shack on 5/6 a CO call came up on 2 metres, turning out to be Garry VK3ZHP, who was 5/3 in Sydney, later rising to 5/5, at 2345 (4/5 UTC time). After establishing contact we both paused to allow other stations listening to call in, but no takers. Tried 70 cm but no joy. Using other means we called in some other stations in both cities and this resulted in several Sydney to Melbourne contacts, viz: VK2ZAB to VK3ZHP, VK3BKF, VK3UM; VK2ZRU to VK3ZHP, VK3UM; VK2ZHT to VK3ZHP, VK3BKF.

"Canberra stations VK1RK, VK1KAA and VK1ZQR also worked the Melbourne boys. I also had a scratchy contact with Peter VK3ZDP in Bendigo. Another station with a callsign which appeared to end in JJ was also heard in Sydney. All so strange, a few weeks ago it had never been done before, now it is becoming commonplace!"

Well, it's always been said you have to be in it to win it, and it would appear the general overall vigilance of some stations is paying off, and others are reaping the side benefits! Maybe it will be a time soon for Sydney and VK5 to make it again, it certainly is quite a few

years since I last worked into Sydney on 2 metres but would certainly like to do so again. Have 160 watts to a pair of 13 element yagis at 24 m and a 3SK97 masthead pre-amp for starters, but the QTH is rather poor, but always willing to try!

### THE LEAST SUCCESSFUL VET

Although not strictly amateur radio I was quite tickled by the following in the June 1983 "Propogator" of the Illawarra Amateur Radio Society.

*"In the course of his duties in August 1977, a Dutch veterinary surgeon was required to treat an ailing cow. To investigate its internal gases he inserted a tube into that end of the animal not capable of facial expression and struck a match.*

*"The jet of flame set fire first to some bales of hay and then to the whole farm causing damage estimated at \$90,000. The vet was later fined \$280 for starting a fire in a manner surprising to the magistrate! The cow escaped with shock." — from the Book of Heroic Failures.*

### VK2AMW MOONBOUNCE REPORT

*"Lyle VK2ALU continues to keep us informed on the progress of the re-installation of the Dapto EME equipment, shifted some years ago from its former location where it was subject to damage from vandals. Currently Lyle reports work is proceeding with the painting of shelving, and Jim VK2DLJ being given the material and working drawings for making up the main part of the dual mode feed horn for 1296 MHz. The low level driver stage for the transmitter is now complete and is giving 2 watts output from 400 milliwatts input. When installed in the drive chain, this will provide more than adequate drive for the power amplifier to give 120 watts output. Most of the mechanical work is now completed on 2 receiving pre-amplifiers of the DL7YC design." From "The Propogator".*

### OTHER NEWS

Steve VK5AIM provides me with info from "The Short Wave Magazine" published in the UK. Included this time is a note on 6 metres that Paul G4IJE has set out to work the other thirty nine stations in the UK who have been allotted licences, and so far has found thirteen of them. It didn't take them long to learn the art of crossband contacts to 2 metres, but Paul does things a little differently from most in that on 27/2 he worked DJ5MS 6 m to 2 m crossband meteor scatter! That's playing it hard! Another station OK10A has built a 6 metre converter and using a dipole taped to a window completed a crossband MS QSO!

This other news section is light on this time as I have been away, hopefully there will be something to report on openings which often occur during June/July most years, next month.

In the meantime, closing with the thought for the month: "Speaking without thinking is like shooting without aiming". 73 The Voice in the Hills. AR

## Help!! Intruder Watch



# CLUB CORNER

## MOORABBIN AND DISTRICT RADIO CLUB

### RULES FOR THE MIDWINTER FIELD DAY

Operation 0100 to 0600 UTC on 7th August 1983.

Any authorised amateur band above 52 MHz and for section B the 10 metre band.

Any authorised mode of transmission may be used.

All stations must operate in the terms of their licence.

Portable stations must not use public or private mains supply.

Portable stations must at least be 2 km from their home QTH.

Any station may be worked twice during the contest providing that two hours elapsed from the first contact.

Net frequencies or repeaters are not to be used for scoring purposes.

No cross band operation is permitted for scoring purposes.

Scoring portable to portable.

Section "A" VHF

4 points per km for contacts up to 500 km on 52 MHz

1 point per km for contacts above 500 km on 52 MHz

4 points per km for contacts on 144 MHz

12 points per km for contacts on 432 MHz

16 points per km for contacts on 576 MHz

24 points per km for contacts on 1296 MHz

Section "B" on 10 Metres

2 points per contact for stations in your call area on 10 metres

4 points per contact for stations outside your call area on 10 metres

Points for portable to home stations are half the above points.

Any contact with the official station of the Club VK3APC will count as double points for that contact.

Entries will be accepted from any portable station providing that only one operator operates that station at any one time.

Entries are to be in the form of a log extract with all points calculated and totalled and be posted to the Contest Officer, Moorabbin and District Radio Club, PO Box 88, East Bentleigh, 3165 to arrive no later than four weeks after the contest.

The winner of each section will receive an Honorary Membership Certificate of the club and twelve months subscription of the Club Magazine APC. AR

### EMDRC

A combination hamfest and communications exhibition under the title of "Communications Expo '83" will be held in Melbourne's eastern suburbs on 3 September.

It will be the largest event of its kind ever in Melbourne and is being organised by the Eastern and Mountain District Radio Club as part of World Communications Year.

The Nunawading Civic Centre, Whitehorse Road, Nunawading, is the venue and the Expo will feature a working Amateur Radio Station,

a wide variety of communications technology displayed by emergency services, electronics companies and the army.

VK3WCY will be on HF and VHF from 0930 to 1630 UTC on 3 September from the Expo, —but this special callsign will also be on most bands around the clock from 3 August.

The Expo includes foxhunts, RTTY and ATV demonstrations, a homebrew competition, kit-building and JOTA display by the Scout Association, and a host of trade displays.

Box Hill Electric Supply Authority will test any household appliance for safety.

For the keen person a pentathlon of competitions has been arranged with the best aggregate score being the winner.

The events are: Callsign recognition from a taperecorder dogpile, Morse code at a nominal speed but with an increasing level of QRM, time trial — tune and match an antenna, guessing the bands of a row of helical whips, and the final competition is to be decided.

The Expo is for both the communications enthusiast and the general public — make sure you don't miss it.

**FOR FURTHER INFORMATION CONTACT:**  
Jim Linton. Ph: (03) 232 3534.

AR

# INSIGNIAS



## Car Stickers

—50¢

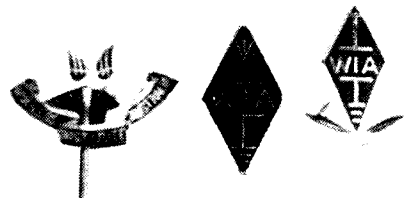

## Lapel Stick Pins

## Metal Car Badges



Prices are available from your division or write to Magpubs, Box 300, Caulfield South, Vic 3162.

# AR SHOWCASE

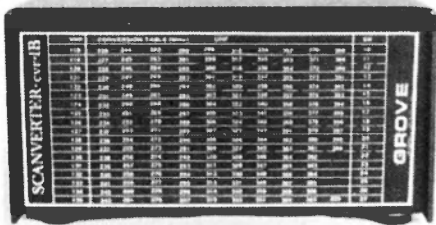

## NEW ACCESSORIES FOR JIL SX-200 SCANNING RECEIVER

GFS Electronics recently announced the release of a number of new accessories to suit their JIL SX-200 Scanning receiver. All four are designed to further enhance the already high performance of the scanner which is the only one of its type designed to cover 26 to 88 MHz, 108 to 180 MHz and 380 to 514 MHz AM and FM.

The first, known as the Model CVR-1B Scanverter, allows the SX-200 to cover 216 to 380 MHz. It simply plugs in series with the SX-200's external antenna lead. After adding 12 volts DC the SX-200 has full frequency coverage from 26 MHz to 514 MHz with no gaps except for the 88 to 108 MHz FM Broadcast band. The range 216 to 380 MHz encompasses a number of military frequencies as well as frequencies used by the Space Shuttle crew for direct communication to tracking stations.

The Model CVR-2 Globscan shortwave converter turns the SX-200 into a broadcast and shortwave receiver. It provides coverage from 550 kHz to 26 MHz enabling the user to receive all normal broadcast stations as well as thousands of overseas signals from shortwave stations. Like the CVR-1B it simply plugs in series with the external antenna lead of the SX-200. Priced at \$199 and \$189 respectively the CVR-1B and CVR-2 turn the SX-200 into a full coverage programmable receiver from 550 kHz through to 514 MHz with the exception of 88 to 108 MHz.

Also available and designed to increase the JIL SX-200's facilities, are two user assembled and installed kits.

The A4-AM kit allows the SX-200 to automatically select the AM mode whenever it receives and Airband or 27 MHz Marine/CB frequency. The facility is also manually overrideable so that the FM mode can be used in either of these bands, if required. The EXP-32 memory expander kit provides the SX-200 with an additional 16 memory channels. With this kit installed a total of 32 memories are available and may be selected in two separate banks of 16 or the entire 32.

Prices are \$32 and \$53 for the A4-AM and

EXP-32 respectively. For full details of all four products contact the suppliers: GFS Electronic Imports, 15 McKeon Road, Mitcham, Victoria 3132. Phone (03) 873 3939, Telex 38053 GFS.

Electronic Imports, 17 McKeon Road, Mitcham, Victoria, 3132 (PO Box 97 Mitcham). Phone: (03) 873 3939.



## NEW VIDEO ENHANCER/STABILISER

The MFJ-1421 (PAL) is a combination Image Enhancer, Stabiliser and Distribution Amplifier especially designed for the PAL TV System.

It is unique in a number of areas including its built-in Noise Cancel Control. This control overcomes the problem of increased picture noise as enhancement is increased, a problem which plagues most other image enhancers available here.

It also features a built-in Sync Stabiliser for improving video with poor sync, a video gain control which is particularly useful when using the MFJ-1421 (PAL) Distribution Amplifier Section. Also provided is switching for direct bypass of the unit.

Price of the MFJ-1421 (PAL) is \$224 plus freight. For further information contact GFS

## NEW HIGH GAIN DIRECTIONAL ANTENNAS FOR SCANNING RECEIVERS

GFS Electronic Imports recently announced the release of two VHF/UHF antennas. They are high gain broad band directional types designed for use in a wide variety of VHF/UHF applications, particularly suited for scanning receiver use, and provide excellent performance in fringe areas when compared with a standard discone.

Known as the LOG-S and LOG-SP the new antennas are of the log periodic type. The Model LOG-S has 9 elements with an average gain of 9 dBi and a bandwidth of 100 to 520 MHz. Boom length is 102 metres. The LOG-SP has a bandwidth of 65 to 520 MHz, 13 elements and an average gain of 11.5 dBi with a boom length of 3.07 metres.

Both antennas are also quite suited to transmission applications over their designed bandwidth. Maximum input power handling is 200 watts.

Price of the LOG-S is \$89 plus \$10 freight and the LOG-SP is \$125 plus \$10 freight.

For further information contact: GFS Electronic Imports, 15 McKeon Road, Mitcham, Victoria 3132. Phone (03) 873 3939.

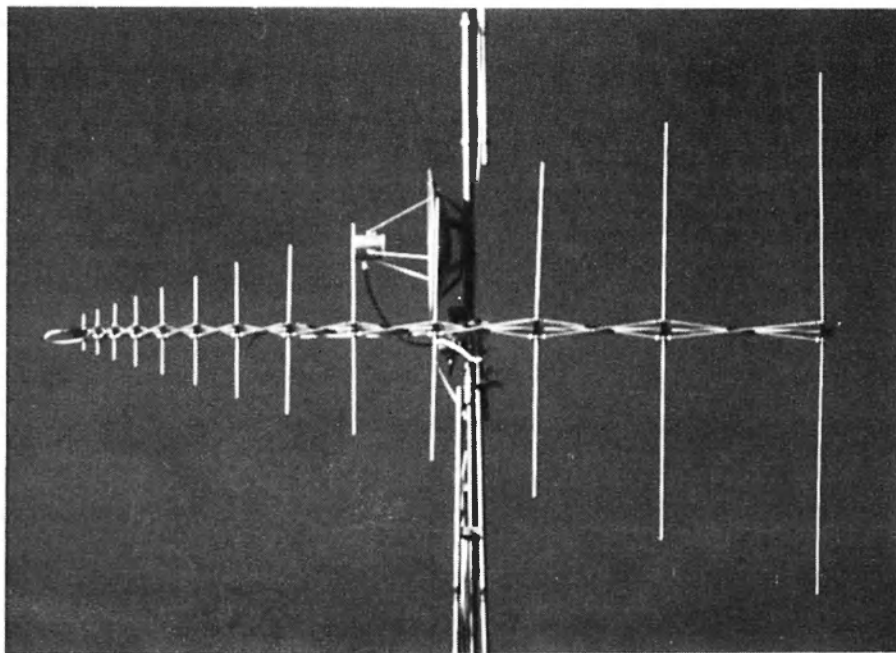

# HERE'S RTTY!

Bruce Hannaford, VK5XI  
57 Haydown Road, Elizabeth Grove, SA 5112

## RTTY OPERATING PROCEDURES

*Those who have just obtained RTTY gear are well advised to do a lot of RTTY printing (listening) before going on air. Also it is a good idea to keep off the DX bands until you have got some idea of good operating procedure. One of the first considerations in good RTTY operating is to remember the other fellows equipment may not be the same as yours and consequently you should as far as possible operate in a way that will suit any normal equipment.*

the printing is on paper (often called "hard copy") and with the computer it is shown on a screen (often called "glass copy"). In reception the mechanical system must have proper carriage return (CR) and line feed (LF) signals sent to it in order to prevent overprinting. Overprinting meaning the same paper is printed on more than once and in so doing all the information thus combined is made unreadable. However signals received on a computer system will not overprint as when a display line is completed the computer automatically goes to the next line not needing any CR or LF signals to do so. Two computer operators could happily work each other all day without sending a single CR or LF signal but any mechanical system operator trying to copy them would curse them for doing so. Mechanical systems will be around for many years to come and computer operators should be considerate of those using such systems.

Most computer systems automatically send a CR and LF signal at intervals to suit mechanical copying systems and this interval called "line length" is normally adjustable by the computer operator. Most mechanical systems have a line length of about seventy columns that is the total of printed characters and the word spaces between them total seventy across the width of the page. As line lengths differ with different makes of machines it is best to stick to a short line length and sixty three has been found a good number of columns to use. With mechanical systems the operators should likewise remember that the line length of their machine may be greater than some other machines and not extend their lines right to the right hand side of the paper, once again sixty three is a good number of columns and this does not waste much paper. With computer systems there is often a switch where the operator in reception can switch off CR LF as this often wastes space on the screen and is unnecessary with the computer starting new lines automatically.

The following is a guide for normal practice in RTTY operating.

*Baudot speed should be set at 45.45.*

*Shift should be set at 170 Hz.*

*Using FSK on HF bands, shift polarity should be such that the highest RF frequency is Mark and the lowest is Space. When using a SSB transceiver with audio generated FSK this would mean using LSB on all HF bands.*

*Using AFSK on VHF/UHF bands the tone frequencies should be Mark 2125 and Space 2295 Hz.*

*Your licence allows you to use either Baudot or ASCII codes but as normal mechanical systems can't print ASCII, computer operators are advised to normally stick to Baudot.*

*Normal operating procedures such as Ior phone or CW are also used on RTTY. You call CQ etc and use callsigns in exactly the same way except for a few additional points I now mention. As RTTY requires more exact tuning than CW or SSB it is normal practice to give a few seconds of tuning up signal at the beginning of each transmission. This is usually a string of RY letters repeated for as long as necessary. RY contains all the possible combinations of Mark and Space for each of the five Baudot code positions thus being a good test signal to tune up on.*

Another thing needed for mechanical RTTY is to start each transmission with a CR LF and letters (LTRS) signal. This makes sure the receiving machine starts at the left of the page printing on a new line and printing letters. The receiving machine may for example have been printing figures and have stopped in the middle of a line. If you now send a full line without CR LF and LTRS this machine would print a string of figures and miscellaneous signs for the remaining half line and then overprint on the last printing position until you send a CR LF and even then if you don't send LTRS it will remain printing FIGS until you do send a LTRS signal. In other words all your efforts are wasted because you failed to send CR LF and LTRS at the beginning. It is also good practice to use CR LF and LTRS at the end of any long transmission thus leaving the receiving machine ready for the next call or message. Additionally many operators

RTTY picture courtesy Les White, VK5ZW

If you use a communications computer don't forget many others are using mechanical systems and although your operating procedure may be acceptable to other computer operators it may well be most annoying to those using mechanical systems. Those using mechanical systems should remember computer line lengths are often not the same as theirs, usually only about half their length, so anything set out in columns or any mechanical system RTTY pictures will usually be meaningless on a computer screen.

Both computer and mechanical system operators should realise that although the letters of the alphabet and figures are standardised many of the other miscellaneous signs seen on their keyboards are not standardised and may not print out at the other end in the way you sent them. In addition to letters and figures the following miscellaneous signs are also normally standardised — full stop, comma, question mark, hyphen-brackets on and off, oblique stroke, and colon. These will usually be received as you sent them. There are many other signs on your keyboard but be cautious about using them when you don't know what equipment is being used at the other end. Computer operators should also remember some of the signs on their keyboard are only useful for ASCII and do not operate on Baudot RTTY.

An example of the miscellaneous signs problem is as follows. I often work a friend who uses a Telereader computer and if I am using my Siemens mechanical system in order for him to receive a dollar sign on his screen I must send a % sign from my keyboard and in order to print a dollar sign on my paper he needs to send a @ sign from his keyboard. Of course while we are understanding each other perfectly others printing us may well be getting something different again and wondering what is going on. When you don't know what the other fellow is using, better to spell out dollars etc to avoid confusion.

In order to understand the reasons for some RTTY operating procedures I will outline some contrasting details of mechanical and computer systems. In a mechanical system







# AWARDS

Mike Bazely, VK6HD  
FEDERAL AWARDS MANAGER  
8 James Road, Kalamunda, WA 6076

Reading through amateur journals, DX newsheets and listening to on air chatter, many operators are expressing the opinion that Spratly Island should be deleted from the DXCC countries list. My initial comment is, why Spratly Island? Don't get me wrong, I am with the rest of the amateur population who mourn the loss of life during the recent DXpedition to Spratly, but to me the question still remains. It seems ludicrous that we can talk about the deletion of Spratly Island and at the same time talk about the inclusion of Peter the First Island. (If you are not sure of the location it is approximately 68° S and 90° W). I would suggest the dangers in reaching this location would be great and if it becomes a new DXCC country it will not be long before someone tries to put it on the air.

There are two possible viewpoints. Firstly, do we recognise that in man there is a natural desire to attempt the seemingly impossible? (No-one said we should stop trying to climb Everest or conquer Space). Alternatively we can take the second course and only recognise, as DXCC countries, those areas that are regularly inhabited. If we are going to change the rules, let's try and anticipate trouble and be wise before the event instead of after. For myself I do not wish someone to put his life at risk so I may advance my DXCC total by one.

## DXCC Countries

Another XZ5A type operation is in the offing. It has been reported that a group of JAs are trying to get permission to operate in a part of Kampuchea that is held by the Khmer People's National Liberation Front. It is not known what callsign would be issued and if this operation would count as XU. The problem is that most countries, ours included, do not recognise the present Vietnam controlled government of Kampuchea.

Further, it is not certain whether they recognise the KPNLF, so once again we have a DXCC problem. Will it count or not? In line with the amended rules (see July AR) it looks as if this one could also suffer the same fate as XZ5A.

Whilst on the subject of DXCC, there is some doubt, whether DJ5RT/TT8 had a legitimate licence particularly as an HB9 operator was issued with the call TT8AD. At the present time I have been accepting this operation *with the proviso*, if it subsequently turns out to be an unlicensed operation, credits already given will be deleted. My advice is to work TT8AD while you can. (He is very QRV at weekends on 21 MHz CW).

## BARG AND WZVD AWARDS

Maurie, VK3XEX, has supplied an update on awards that are available from the Ballarat Amateur Radio Group and the Western Zone Victorian Division.

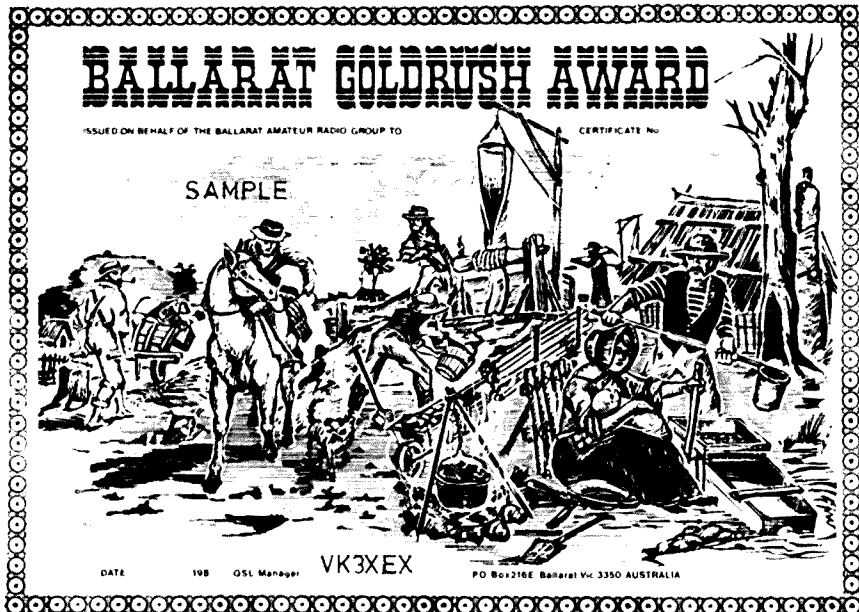

Contact ten Ballarat stations for this award: Cost \$2.00

WIRELESS INSTITUTE of AUSTRALIA  
VICTORIAN DIVISION — WESTERN ZONE

# WESTERN DISTRICT AWARD



Contact ten Western District stations (Ballarat, Horsham, Warrnambool, Port Fairy, Stawell, Ararat and Districts) \$2.00.

We hereby award to you, dear **SAMPLE** **XYL** of

- \* In grateful recognition of outstanding patience shown by you during the many endless QSO nights, alone in bed while the bands were open ...
- \* For the exemplary tolerance displayed towards the nasty TVI and RFI being created and for calming irate neighbours on account of it ...
- \* For ignoring the weird noises and kooky language coming from the shack (which was supposed to be your room anyway) ...
- \* For turning a blind eye to truck loads of assorted scores, rigs and things that may come in handy one day about the house ...
- \* For going cheerfully without that new dress, colour T.V. or perm, when the cash was more urgently needed for replacement parts of a new antenna, after the last one blew down in the storm ...
- \* For not grumbling (too much) when we came home from the contest or field day rather the worse for wear and in no mood for romance



THE  
**DX WIDOWS AWARD FIRST CLASS**  
From the world-wide brotherhood of Radio Amateurs with mny trnx!!

Send YL or XYL's name and your callsign with \$2.00.

1983/84 Australian Amateur Radio

# CALLBOOK

## DON'T MISS OUT!!

ORDER  
YOUR  
1983/84  
CALLBOOK  
NOW

The 1983/84 edition will be on sale in September with new look call listings and over 3000 new and updated coll-signs.

Place your order now to avoid disappointment.

\$5.75 plus postage

AR

## WIA WESTERN ZONE, Vic.Div.

Lake Goldsmith  
STEAM-RADIO

STEAM-RADIO  
AWARD 1983

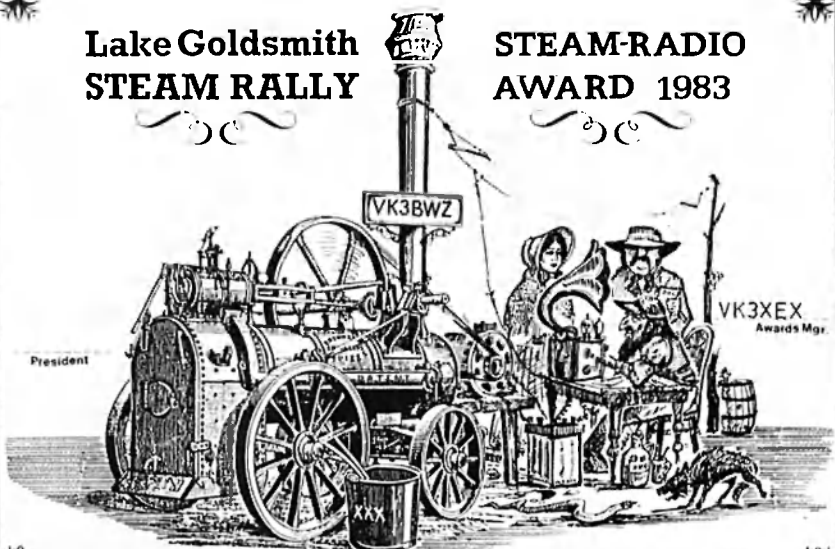

CERTIFICATE No. \_\_\_\_\_ Awarded to **SAMPLE** for Contacts on \_\_\_\_\_ Meters

Refer April AR, p 54 for details of this award.

The current awards are:

- Gold Rush Award
- DX Widows Award
- Western Districts Award
- Lake Goldsmith Rally Award

The Begonia Award is now no longer available. All the above awards may be obtained from VK3XEX, Maurie Batt, RSD, Rokewood Junction, Victoria 3351.

### INFORMATION REQUIRED

If your award has not been listed during the past two years and you would like to have some publicity, drop a line to me with all the details.

Many Thanks.  
73 es DX, Mike VK6HD.

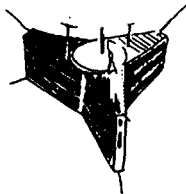

# AMSAT AUSTRALIA

Colin Hurst VK5HI  
8 Arndell Road, Salisbury Park, SA 5109

## NATIONAL CO-ORDINATOR

Graham Ratcliff VK5AGR

## INFORMATION NETS

### AMSAT AUSTRALIA

Control: VK5AGR  
Amateur Check-in: 0945 UTC Sunday  
Bulletin Commences: 1000 UTC  
Winter: 3.680 MHz Summer: 7.064 MHz

### AMSAT PACIFIC

Control: JA1ANG  
1100 UTC Sunday  
14.035 MHz

### AMSAT SW PACIFIC

Control: W6CG  
2200 UTC Saturday  
28.880 MHz

Participating stations and listeners are able to obtain basic orbital data including Keplerian elements from the AMSAT Australia net. This information is also included in some WIA Divisional Broadcasts.

## ACKNOWLEDGEMENTS

Contributions this month have been received from Bob VK3ZBB (ups and downs) and Gary VK5ZK (JAS-1). In recent weeks the University of Surrey team, responsible for the ongoing operations of OSCAR 9, have perfected a new bootstrap loader to ensure error free loading of data sourced from the ground station into the onboard spacecraft computers. Consequently the UOSAT control centre is now able to load a much larger weekly bulletin (14.5 kilobyte maximum) for the dissemination of amateur satellite news. These bulletins in recent months have become the major source of news for satellite users in Australia as the traditional HF links, that have in the past provided the information, have become very unreliable due to diminishing sun spot activity. The bulletin is generally available along with the telemetry and digi-talker experiment on Friday, Saturday and Sunday. Transmission is on 145.825 using 1200 baud ASCII (1 start + 7 data + even parity + 3 stop bits) with 1200 Hz and 2400 Hz tones (Kansas City Standard). In view of their accuracy and conciseness I have included, direct from the latest bulletins, the most topical and pertinent items. Our thanks to the UOS-UOSAT team.

## AMSAT OSCAR 10 LAUNCHED

The latest Amateur Radio Communications Spacecraft, OSCAR-10, was launched successfully on board an ESA Ariane Rocket at 11:59:03 UTC from Kourou, French Guiana

on Thursday 16 June. The spacecraft has been placed in a geosynchronous transfer orbit prior to motor firing to take it to a highly elliptic 63 degree inclination orbit due to take place shortly. The spacecraft carries two transponders (435 MHz to 145 MHz and 1268 to 436 MHz) and four general and engineering beacons (GB:145.810; EB:145.987; GB:436.04; EB:436.02 MHz). The 145 MHz beacons will be operated intermittently whilst initial power budget tests are performed. The transponders will not be available for general use until the spacecraft has been fully commissioned in some four to six weeks time.

Congratulations to AMSAT and ESA on a perfect launch.

## OPERATIONAL STATUS OF OSCAR 10

The 145.810 MHz general beacon on board OSCAR 10 was activated some 2.5 hours after launch and telemetry data has been received by many stations. Preliminary analysis has indicated the spacecraft spin axis to be aligned towards the sun and the corresponding low battery charge rate will mean that the beacons will only be activated for short periods until the spin axis has been re-aligned. The 145.810 MHz GB has been transmitting CW and PSK telemetry.

Information now to hand states that the firing of the kick motor originally scheduled for orbit #3 has now been postponed to orbit #50. This delay is to allow realignment of the spacecraft's attitude to ensure that the required orbital parameters are achieved.

## OSCAR 10 GENERAL BEACON CW FORMAT

The following format is utilised for the CW telemetry of the general beacon.

HI HI AMSAT OSCAR 10 AT \*:\*:\* UTC  
orbit \*:\* MA \*:\*/\*256 TLM: UBAT \*:\* V  
TBAT \*:\* C IARRAY \*:\* A SA \*:\* DG SPIN  
\*:\* RPM satellite status: (Herein is contained the bulletin concluding with) AMSAT OSCAR 10 HI HI.

The figures shown as \*:\* are inserted by the onboard computer and are real time values at the time the bulletin is transmitted. UBAT is the primary battery. TBAT is its temperature. IARRAY is the solar panel current. SA is the sun angle referenced to the spin axis. SPIN is the spin rate about the Z axis. The MA value following the orbit number is the mean anomaly and is referenced to 256, eg a value of 128 indicates it is at apogee and a zero value is the perigee.

## OSCAR 10 PRELIMINARY ORBITAL ELEMENTS

EPOCH TIME: 83.168.05000000  
Fri June 17 01:12:00 1983 UTC  
ELEMENT SET: 1  
INCLINATION: 8.6080 deg

RA OF NODE: 249.1370 deg  
ECCENTRICITY: 0.7290751  
ARG OF PERIGEE: 178.3420 deg  
MEAN ANOMALY: 86.8220 deg  
MEAN MOTION: 2.29579060 rev/day  
DECAY RATE: 0.0023431 rev/day ^ 2  
EPOCH REV: 1  
SEMI MAJOR AXIS: 24277.706 km  
ANOM PERIOD: 627.234905 min  
APOGEE: 35599.832 km  
PERIGEE: 199.290 km  
BEACON: 145.8100 MHz

## UOSAT OSCAR 9 OPERATIONAL STATUS: JUNE 17

The spacecraft remains stable in a flat (end over end) spin with a decreased +Y/-Y facet temperature gradient of around 55C. Further experiments with the boom and scientific magnetometer have confirmed that the boom has been straightened and the tip mass re-oriented successfully to within 15 degrees of the spacecraft Z-axis. The tip mass has been retracted to the top face of the spacecraft. The magnetometer data has remained stable and will facilitate navigation and future attitude manoeuvres. Assuming that no significant changes occur to the tip mass, no further boom experiments are scheduled.

## OSCAR 8 STATUS (7 JUNE 83)

Following the OSCAR 8 battery charge problems that have occurred in recent weeks the following message has been received from W9KDR: . . . "Do not attempt communication through the OSCAR 8 transponders during this low voltage emergency. Presently OSCAR 8 is in Mode A and command stations have been instructed to return to Mode D. (recharge) when telemetry tests are complete. Telemetry received in Mode A indicates the battery voltage has dropped to a point that has caused the telemetry to "hangup". The present frame of 180, 252, 324, 496, 568, 696, even after several days of recharge, indicates that the battery is not charging. Observations so far indicate that OSCAR 8 is following a similar battery problem that OSCAR 7 suffered. It is quite possible that any future operation of OSCAR 8 will be during times that the spacecraft is in sunlight. Presently we are in a minimum sunlight period which complicates matters even more. REMEMBER — No operation until further notice. 73 Bernie W9KDR . . ."

## JAPANESE AMATEUR SATELLITE (JAS-1)

On a recent trip to Japan, Gary VK5ZK visited JARL Headquarters. Through his interpreter Gary expressed an interest in satellites, and was subsequently introduced to the presumed co-ordinator for the JAS-1

project. Unfortunately, Gary misplaced the persons name and callsign, however he did come away with two excellent publications in Japanese and a specification broadsheet in English.

The proposed specifications are:

#### 1.1 Launch

Date: Early 1986  
 Vehicle: H-1 Test Rocket  
 Agency: National Space Development Agency of Japan  
 Site: Tanegashima, Japan

#### 1.2 Orbital Parameters

General designation: Medium altitude, circular orbit  
 Periods: 120 minutes  
 Altitude: 1500 km  
 Inclination: 50 degrees  
 Access distance: Average 6000 km

#### 1.3 Tracking, Telemetry and Command

Tracking: JARL and world-wide amateur stations  
 Command: JARL and specific world-wide amateur stations

#### 1.4 Satellite

Weight: 50 kg  
 Dimensions: 400 mm x 400 mm x 300 mm (Heights), hexahedron  
 Communication: J-mode

#### (1) Analog system:

Frequencies allocation  
 Up-link: 145.9-146 MHz  
 Down-link: 435.9-435.8 MHz  
 Output power: 2 W (PEP)

#### (2) Digital system:

Frequency: 435.7 MHz  
 Modulation: FSK, 1200 Baud  
 Memory: 1 M Byte  
 Output power: 1 W (carrier power)

### VHF ENTHUSIASTS

Back issues of VHF Communications are now available.

Also the Complete Index of all Volumes from 1970-82 (inclusive) except 1971 - 1 & 4.

Write to Mogpubs, Box 300, South Caulfield, Vic 3162.

## OSCAR 9 FORMULAE UPDATE

TELEMETRY SENSOR ALLOCATION:

UPDATE: 26 Apr 1983

CHANNEL	PARAMETER	CAL EQUATION
00	Secondary S/C Computer (F100L)	1.2N MA (0.125A <I< 1A)
01	Solar Array Current +X	200 + 1.12N MA
02	Battery Half Voltage	N/100*(1.01)
03	Radiation Detector A O/P	40N*(1.04) Counts/S
04	Radiation Detector B O/P	40N*(1.04) Counts/S
05	Magnetometer Expt HY-Coarse	Int(NYC/63.5+0.689)*8054-FY
06	Magnetometer Expt HX-Coarse	Int(NXC/63.5+0.689)*8103-FX
07	Magnetometer Expt HZ-Coarse	-Int(NZC/63.5+0.689)*8009+FZ
08	Battery Pack-A Temperature	(474-N)/5*(1.01) degrees C
09	Spacecraft Facet Temperature +X	(474-N)/5*(1.01)degrees C
10	Visual Display Expt CCD Current	1.2*(N-30) MA (0.15A <I< 1A)
11	Solar Array Current -Y	200 + 1.12N MA
12	2.4 GHz Beacon Expt Power O/P	(N-145)*0.45 MW
13	Radiation Expt EHT volts	N volts
14	Radiation Detectors Expt Current	(N+20)/8*(0.983) MA
15	Magnetometer Expt HY-Fine	FY=18.55*(NFY-495.7) see 05
16	Magnetometer Expt HX-Fine	FX=18.53*(NFX-496.45) see 06
17	Magnetometer Expt HZ-Fine	FZ=18.34*(NFZ-493.55) see 07
18	Battery Pack-B Temperature	(474-N)/5*(1.01) degrees C
19	Spacecraft Facet Temperature -X	(474-N)/5*(1.01) degrees C
20	Spacecraft Computer Current	1.2*(N-25) MA (0.125A <I< 1A)
21	Solar Array Current -X	200 + 1.12N MA
22	Battery/BCR +14V BUS	N/50*(1.056)
23	Sun Sensor +Z Axis	N/200*(1.01)
24	10.4 GHz Beacon Expt Current	(N-40)/4*0.97
25	Magnetometer Expt Temperature	(467-N)/6.85 degrees C
26	Magnetometer Expt Current	(N/8)*0.9945
27	Telecommand Receiver Current	(N-16)/8*(0.952) MA
28	Radiation Expt Temperature +X1	(474-N)/5*(1.01) degrees C
29	Spacecraft Facet Temperature -Y	(474-N)/5*(1.01) degrees C
30	Battery Charge Current	2.9N MA
31	Solar Array Current +Y	200 + 1.12N MA
32	Power Conditioning Module +10V	N/60*(0.93)
33	Telemetry System Current	(N-16)/30*(1.084) MA
34	2.4 GHz Beacon Expt Current	0.4*(N-11)*(1.072) MA
35	145 MHz Data Beacon Power O/P	(N-82)*1.67
36	145 MHz Data Beacon Current	(N-7)/4*1.014
37	145 MHz Data Beacon Temperature	(474-N)/5*(1.01) degrees C
38	PRI S/C Computer Temperature -X1	(474-N)/5*(1.01) degrees C
39	Spacecraft Facet Temperature +Y	(474-N)/5*(1.01) degrees C
40	+14V Line Current	2.86N MA
41	+5V Line Current	1.28(N-50) MA (0.075A <I< 1A)
42	Power Conditioning Module + 5V	2N/300*(1.12)
43	Sun Sensor -Z Axis	N/200*(1.01)
44	HF Beacons Expt Current	(N-36)/3*1.038 MA
45	435 MHz Data Beacon Power O/P	(N-102)*1.792
46	435 MHz Data Beacon Current	(N-34)/3*1.053 MA
47	435 MHz Beacon Temperature	(474-N)/5*(1.01) degrees C
48	Sec S/C Computer Temperature -Y1	(474-N)/5*(1.01) degrees C
49	Spacecraft Facet Temperature +Z	(474-N)/5*(1.01) degrees C
50	+10V Line Current	3N MA
51	-10V Line Current	1.3*(N-60) MA
52	Power Conditioning Module -10V	0.0158N-0.0224N*(N=CH 32)
53	Navigation Magnetometer Y-Axis	(N-663.44)*183.486 (NT)
54	Navigation Magnetometer Z-Axis	-(N-336.55)*189.54 (NT)
55	Navigation Magnetometer X-Axis	-(N-496.5)*194.55 (NT)
56	Speech Synthesiser Current	(N-16)/10*1.009 MA
57	CCD Imager Temperature	(474-N)/5*(1.01) degrees C
58	Telemetry System Temperature +Y1	(474-N)/5*(1.01) degrees C
59	Spacecraft Facet Temperature -Z	(474-N)/5*(1.01) degrees C

The navigation magnetometer is subject to temperature drift which can cause clipping of the output.

NOTE: The axis labelling now employed is right-handed for all sub-systems.

## UPS AND DOWNS

A regular listing in overseas magazines is the compilation of all satellite launches and re-entries. Bob VK3ZBB has now offered to prepare similar information for inclusion in this column on a regular basis. Thanks Bob for your offer and I look forward to the next listing.

The listing of "Ups and Downs" for March/April 1983 is as follows:

## LAUNCHES

NUMBER	NAME	NATION	DATE OF LAUNCH	PERIOD MIN	APOGEE KM	PERIGEE KM	INCLN DEG	FACILITIES
1983-020A	ASTRON	USSR	23 Mar	98 hr	200 000	2000	5.5	SI
1983-021A	COSMOS 1447	USSR	24 Mar					
1983-022A	NOAA8	USA	28 Mar	101.2	829	806	98.8	W SAR
1983-023A	COSMOS 1448	USSR	30 Mar	104.9	1017	977	83	SI TM
1983-024A	COSMOS 1449	USSR	31 Mar	90.3	402	207	72.9	SI TM
1983-025A	MOLNIYA 1	USSR	2 Apr	700	39 023	483	62.9	TV CS
1983-026A	STS 6	USA	4 Apr	90.3	291	284	28.5	M
1983-026B	TDRS-A	USA	5 Apr	1086.1	35 388	21 857	2.4	To be GS at 54.4°W SL
1983-027A	COSMOS 1450	USSR	6 Apr	94.7	515	474	65.9	SI TM
1983-028A	RAOUGA	USSR	8 Apr	1440	25 870		1.3	TV CS
1983-029A	COSMOS 1451	USSR	8 Apr					
1983-030A	SATCOM 6	USA	11 Apr	634.2	35 974	172	24.1	To be GS at 128°W CS
1983-031A	COSMOS 1452	USSR	12 Apr	100.3	826	786	74	SI TM
1983-032A	XXX		15 Apr					
1983-033A	ROHINI 3?	India?	17 Apr					
1983-034A	COSMOS 1453	USSR	20 Apr	94.5	520	473	74	SI TM
1983-035A	SOYUZ T8	USSR	19 Apr	89.5	278	226	51.6	M

KEY: GS — Geosynchronous  
M — Manned  
TM — Telemetry  
TV — Television  
SI — Scientific Instruments

CS — Communication Systems  
SAR — Search and Rescue Facility  
SL — Satellite Communication Link  
W — Weather Observations

## THE FOLLOWING SATELLITES HAVE DECAYED

1983-012A	COSMOS 1442	11 Apr
1983-018A	COSMOS 1446	30 Mar
1983-024A	COSMOS 1449	15 Apr
1983-26A	STS 6	9 Apr
1983-029A	COSMOS 1451	22 Apr
1983-035A	SOYUZ T8	22 Apr

Together with 44 other objects.

AR



## HELP PREVENT PIRATES

Keep bands for licensed amateurs.

DO NOT sell transmitting equipment to unlicensed operators.

# A Call to all holders of a NOVICE LICENCE

Now you have joined the ranks of Amateur Radio, why not extend your activities?

## THE WIRELESS INSTITUTE OF AUSTRALIA (N.S.W. DIVISION)

conducts a Bridging Correspondence Course for the AOCF and LAOCF Examinations.

Throughout the Course, your papers are checked and commented upon to lead you to a SUCCESSFUL CONCLUSION.

For further details write to:  
**THE COURSE SUPERVISOR, W.I.A.**

P.O. BOX 1066,  
PARRAMATTA, NSW 2150

## RTTY/CW

Advanced split-screen ASCII, BAUDOT, CW software for Commodore computers . . . \$59

VIC 20 computer — 5K RAM, 8 colours, hi-res 176\*200 pixel graphics, 4 voice sound generator . . . \$299

Commodore 64 computer — 64K RAM, 16 colours, hi-res 320\*200 pixel graphics, sprites, sound synthesizer . . . \$699

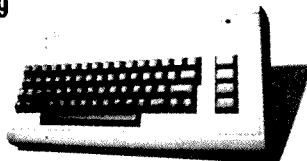

Both computers feature 20K BASIC & operating system, RS 232, parallel user port — disc drives, printers, joysticks, paddles, light pens, games, utilities etc available.

Versions also available for PET/CBM 3000, 4000 and 8000 series (includes SSTV send) — POA.

## HIGH TECHNOLOGY COMPUTER SYSTEMS PTY LTD

87 Swan Street, Richmond, Vic 3121 ph (03)  
429 1966 ask for Mike VK3BHM or Joel VK3ZKE

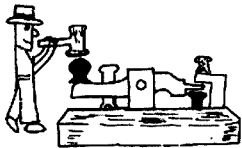

# POUNDRING BRASS

Marshall Emm-VK5FN  
GPO Box 389, Adelaide, SA 5001

Last month's column on zero-beating has generated some interest, so we'll go a step further now by describing a couple of situations where the technique comes in handy.

Let's say, for example, that ZZ1FB has just reappeared on the HF bands for the first time since 1897. ZZ1 is a tiny island in the Pacific which is never heard from because it's under water at high tide, but the amateur who just bought it won't know that for a few hours yet. Anyway, he's up, you just have to work him, and you are in a dogpile with 10 000 Js and twice as many Ws.

Now you might think at first that it would be a good idea to zero-beat ZZ1FBs signal — but that's what a lot of people are trying to do and it's pretty darned crowded. After a while you will realise that you can't hear the guys the ZZ1 is working at all and it suddenly dawns on you that he's done what any phone operator would do — he's tuning across the edges of the dogpile perhaps 10 kHz away where he has a chance of copying somebody.

What you need to do is determine whom he is working and where. There is no easy way to do that but it can be done with patience and a bit of concentration. Say it's JA1ABC about 8kHz up. Having found out who and where, all you have to do is zero-beat the JA1 and 'tail-end' him. You wait until they've just finished and hit the key, zero-beat on the same frequency, and if you have done it properly, the ZZ1 will think the JA has decided to send something else, and all of a sudden he's listening to you.

Of course it is a lot easier if you have two (or

more) VFOs, and even then it might take two or three attempts before you are rewarded with a ZZ1 in the logbook.

The other area where the zero-beat technique is handy is during a contest. Usually there is so much QRM around that a station calling CO has everything on his receiver wound down as tight as possible, and if you go back to him a few hundred hertz off his frequency he simply won't hear you. Zero-beat him and you've got a good chance of making that point or multiplier, or maybe just the satisfaction of having used some expertise!

Another technique which is overdue to be mentioned is break-in operation. Strictly speaking, break-in means the ability to receive between the dots and dashes as you are sending. More often this is referred to as 'full-break-in', while receiving momentarily between words or phrases is known as 'semi break-in'.

There is a tendency for state-of-the-art bells and whistles rigs (your FT-Ones and TS-930s, etc) to offer full break-in, but it is very tricky to get used to it. The first time you use it you are bound to end up in a muddle, because the background noise on receive is turned on and off in time with your sending, so the effect is 'negative Morse' — very distracting. I suppose the answer would have to be to turn down the AF gain till you can just hear the station you are working if he should try to 'break you'. If you have too much trouble, and turn the AF gain all the way down, you might as well not have break-in, because you aren't receiving anything in between.

Semi break-in is available on most modern

transceivers by way of the VOX circuitry. To use it you set the rig for VOX operation and each time you key the rig the VOX relay trips and holds the rig in transmit mode until a set period (VOX Delay) after you release the key. You should be able to set the delay period so that the relay drops out between words or sentences, but you will have to adjust it when you change speeds. At very slow speeds you could probably set the delay to zero and thereby simulate full break-in, with the relay tripping between the dots and dashes, but this is not recommended — it's not too good for the relay.

The Q-Code QSK is used in conjunction with break-in operation, but modern usage is a bit different from the original, which came about in the good old days of separate receiving and transmitting equipment and antennas, and/or split-frequency working. Nowadays, if a station asks you "QSK?" he wants to know if you can break back and forth with him rather than using call signs at the beginning and end of every transmission. Usually he will send something like "QSK OK? BK" and you just respond with an R if you want to operate that way. Each station ends a transmission with BK (break, sometimes sent as BK but usually as separate letters) and call signs are only used every once in a while (at least once every ten minutes to comply with regulations). It considerably speeds things up and you should certainly try it.

That's pretty well filled the column for this month. Next month we'll talk about tuning out the garbage. Till then 73.

AR



## ALARA

Australian Ladies Amateur Radio Association

Margaret Loft, VK3DML  
28 Lawrence Street, Castlemaine, Vic 3450

Well by the time you read this our Annual meeting will be over; thank you to all who accepted nomination for the next year. A full list will appear next month.

Sincere thanks to the executive committee over the past year for their time and efforts from all members of ALARA. In particular Geraldine, Jessie, Valda and Marlene.

### NEW MEMBER

Welcome to new member Christine VK7CC who joined on 10th June 1983. We hope you enjoy being a member of ALARA. Former calls Christine has held are G1BIBH and G18CXI.

ALARA membership now stands at ninety VK-YLs, sixty seven DX-YLs and two subscribers. Valda would be pleased to hear from any prospective members. Details may be obtained from Valda at PO Box 4, Brighton, 3186. Membership is \$5.00 per year.

### PHOTOS WANTED

We are trying to compile a two page album for inclusion in AR later in the year. We have some but do need more. Put your name on the back so we can return them to you.

### TWELFTH JLRS PARTY CONTEST

Phone section Saturday 24th September at 0300 UTC to end Sunday 25th at 0300 UTC.

CW section Saturday 1st October at 0300 UTC to end Sunday 2nd at 0300 UTC.

All licensed men and women are invited to participate. OMs exchange RS or RST and QSO number starting at 001, YLs exchange RS or RST and QSO number starting at 2001 and JLRS members RS or RST and QSO number starting at 5001. Separate consecutive QSO numbers must be used in PHONE and CW contest.

Entry in each contest is limited to ONE of the following classes — A: more than four bands. B: less than three bands.

### Scoring:

- Phone and CW will be scored as separate contests. Separate log for each contest.
- Each contact with the same station on different bands will be counted.
- OMs score one point for each contact with YL, five points for JLRS member. YLs score one point for OMs and five points for each YL contacted.
- Multiply the number of contact points by the total number of prefixes worked in each band.

Copies of all Phone and CW logs must show claimed score, band, mode, RST, call sign worked and power transmitted and be SIGNED by the operator and postmarked not later than 20.10.83. Typed or printed logs please to JA1YL; Kuni Kan 4-5-38-406 Hyakunincho, Shinjuku-ku, Tokyo 160 Japan.

Certificates will be sent to all participants who submit a log.

Until next month 33/73/88 from Margaret VK3DML.

AR

THE AMATEUR SOCIETY OF AUSTRALIA  
VK-ZL OCEANIA DX CONTEST

This is to certify that \_\_\_\_\_ has been  
awarded this certificate for \_\_\_\_\_ place in the  
section of the \_\_\_\_\_ contest and scoring  
points.

# VK/ZL/OCEANIA Contest 1983

Greg Williams, VK3BGW  
VK/ZL/O CONTEST MANAGER  
1 Noorabil Court, Greensborough, Vic 3088

*The WIA and NZART, the National Amateur Radio Associations in Australia and New Zealand, invite world-wide participation in this year's VK/ZL DX Contest.*

Phone section to be held for twenty four hours from 1000 UTC, Saturday, 1st October to 1000 UTC, Sunday, 2nd October.

CW section will be held for twenty four hours from 1000 UTC, Saturday, 8th October to 1000 UTC, Sunday, 9th October.

## RULES

There shall be five main sections in this contest:

- Transmitting Phone.
- Transmitting CW.
- Receiving — Phone and CW combined.

### For VK/ZL only

- Transmitting Phone — eight hour section.
- Transmitting CW — eight hour section.

All amateur bands may be used but no crossband operation is permitted.

VK/ZL stations, irrespective of the location, DO NOT contact each other for contest purpose EXCEPT on 80 and 160 metres.

Only one contact on CW and one contact on Phone per band is permitted with any one station for scoring purposes.

Only one amateur is to operate any one station under the owner's callsign. Should two or more operate any particular station, each will be considered a competitor and must submit a separate log under his own callsign. This is not applicable to overseas competitors operating club stations.

Cyphers. Before points can be claimed for a contact, serial numbers must be exchanged and *acknowledged*. The serial number of five or six figures will be made up of the RS (Phone) or RST (CW) report, plus three figures which begin with 001 and increase in value by one for each successive contact.

### Scoring:

- For the world: 2 points for each contact on each band with VK/ZL stations. *Single band* score will be QSO points for that band multiplied by total VK/ZL call areas worked on that band. *All Band* score will be total QSO points for all bands multiplied by total VK/ZL call areas worked on all bands.
- For VK/ZL stations: points for each QSO on different bands as follows: 160 m, 20 points; 80 m, 10 points; 40 m, 5 points, 20 m, 1 point; 15 m, 2 points; 10 m, 3 points.

Score for EACH BAND will be the total points score for that band multiplied by the TOTAL PREFIXES worked on that band. Final "All Band" score is the sum of the contact points from each band, multiplied by the sum of the multipliers on each band.

Note W1, K1, WA1, WN1, A1, N1, are all separate prefixes and count as multipliers. W6AA/1 would count as "W1" not as "W6".

80 metre section: for contacts on this band between VK and ZL, each VK and ZL call area is considered a "scoring area", with each contact counting 10 points. Each different call area will count as a multiplier.

160 metres section: as for 80 metres except each contact counts as 20 points.

### Logs: Overseas Stations

- Logs to show date, time in UTC, callsign of station contacted, band, serial number sent, serial number received. Underline each new VK/ZL call area contacted. Separate logs must be submitted for each band.
- Summary sheet to show callsign, name and address, equipment used, and for each band, QSO points for that band. VK/ZL call areas worked on that band.

### VK/ZL Stations

- Logs to show date, time in UTC, callsign of station worked, band, serial number sent, serial number received.
- Summary sheet to show callsign, name and address for each band, QSO points for that band, prefixes worked on that band, claimed score for that band. All band score computed from sum of points from each band, multiplied by the sum of the multipliers on each band.

A separate log for each band is required starting with 001 for each band.

Failure to remove duplicate contacts will incur heavy penalties and greater than two per cent duplicates will disqualify the entry.

Awards: Separate awards for Phone and CW.

### A — World:

- Certificates to the top scorers in each country (call areas in W, J, U).
- Depending on reasonable degree of activity, separate awards may be made for top scorers on different bands.

### B — VK/ZL:

- Top scorers in each call area of VK/ZL.
- Top scorers on individual bands.

### Eight hour section:

- and (b) as above.

### Entries to:

WIA VK/ZL Contest Manager VK3BGW  
1 Noorabil Court  
Greensborough  
Victoria 3088  
Australia.

For VK/ZL, entries to arrive before 31 December, 1983, and from overseas by 31 January 1984.

## SWL SECTION

The rules are similar to the transmitting section but it is open to all members of any SWL Society in the world. No transmitting station is permitted to enter this section.

The contest times and logging of stations on each band per weekend are as for the transmitting section except that the same station may be logged twice on any band — once on phone and once on CW.

To count for points, the station heard must be in QSO exchanging cyphers in the VK/ZL DX contest and the following details noted — date, time in UTC, call of the station heard, call of the station he is working, RS(T) of the station heard, serial number sent by the station heard, band, points claimed.

Scoring is on the same basis as for the transmitting section and a summary sheet should be similarly set out.

Overseas stations may log only VK/ZL stations, but VK receiving stations may log overseas stations and ZL stations, while ZL receiving stations may log overseas stations and VK stations.

Certificates will be awarded as listed in the section under awards.

AR



# QSP

## RF RADIATION

The FCC is looking into the matter of exposure standards for human beings.

Focus on this problem stems from the fact that energy in electromagnetic waves can present a hazard to life. Eg: X-rays and gamma rays can produce ionisation and subsequent genetic damage while RF radiation of sufficiently high intensity can heat biological tissue. (Refer AR April, May and June.)

According to the Office of Science and Technology, FCC, studies have shown that the human body absorbs RF energy at a maximum rate in the 30 to 300 MHz region. Accordingly, the FCC has undertaken the task of developing RF safety standards which take account of frequency dependence.

Adapted from CQ magazine April 83

AR



## Crystal Clear?

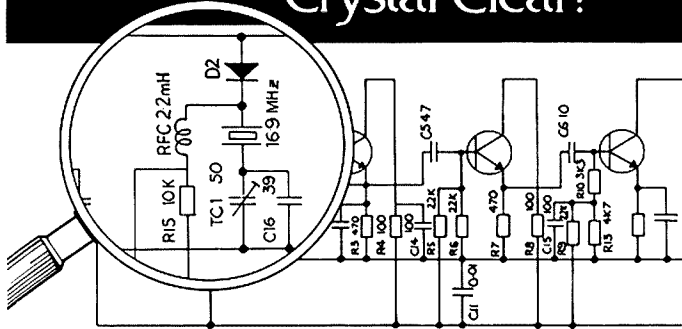

**RAKON EMPLOYS STATE OF THE ART FABRICATION TECHNIQUES TO PRODUCE:**

- **HIGH QUALITY QUARTZ CRYSTALS:** RESISTANCE WELD TYPE. NB: RESISTANCE WELDING OFFERS BETTER LONG TERM STABILITY.
- **PRICES — "THAT ARE REALISTIC"**
- **NORMAL DELIVERY: 10 WORKING DAYS AFTER RECEIPT OF ORDER.**
- **FAST DELIVERY:** IS AVAILABLE, IE: WITHIN 5 DAYS — AT SURCHARGE RATES.

\*Where the crystal parameters are unknown, our experienced engineering staff is available to advise on selection of the correct specification.



# RAKON AUSTRALIA PTY. LTD.

★ **MANUFACTURERS OF QUARTZ CRYSTALS** ★

39 SCORESBY ROAD, BAYSWATER, VICTORIA 3153.

PH: (03) 720 3188 TLX: AA34590

**RAKON REPRESENTS —**



**TOYO COMMUNICATION EQUIPMENT CO. LTD.**

Offering an extensive range of their products including:- quartz crystal filters, monolithic crystal filters, packaged oscillators TCXO and VCXO, DIL clock oscillators and SAW devices. NOTE: Inquiries re price & delivery should be forwarded to above address

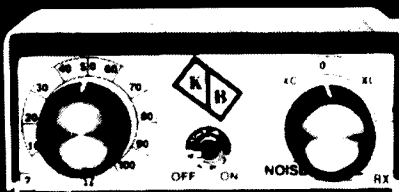

**NOISE BRIDGE**  
\$60 POST PAID

Adjust your antenna for maximum performance. Measure resonant frequency, radiation resistance and reactance. Better than an SWR meter. Operates over 100 MHz. Most useful test unit in your shack.

### ANTENNA BALUNS

3 to 30 MHz.  
Maximum Power 300 Watts.  
Centre support.  
Ideal for Dipoles, Beams, Quads.  
S0239 connector.

\$26

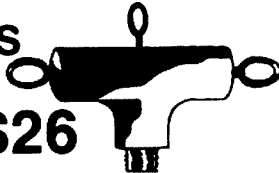

### POWER LINE FILTER

240 Volt @ 10 Amp

\$14



1000's of Transistors — Ferrites — Hobby Kits — Tag Strips — Switches etc. Send stamped addressed envelope for full list.



**K. BRUCESMITH**  
110 Rosemead Road  
Hornsby N.S.W. 2077

## VAINS ANTENNA SERVICES PTY. LTD.

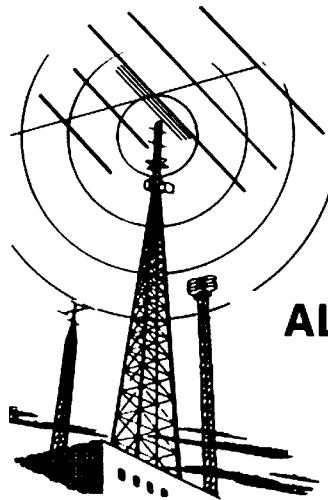

- ★ RADIO CONTROLLED VEHICLES — INSTALLATIONS
- ★ ADDITIONAL OUTLETS FOR TV/FM
- ★ REPAIRS TO EXISTING SERVICES

**ALL SUBURBS**

- ★ PHONE FOR ADVICE
- ★ DO IT YOURSELF KITS
- ★ M.A.T.V. SYSTEMS DESIGNED & INSTALLED
- ★ TELESCOPIC MASTING & TOWERS INSTALLED

**874 3333**

13 McKEON RD., MITCHAM



# CONTESTS



Reg Dwyer, VK1BR  
FEDERAL CONTEST MANAGER  
Box 236, Jamison, ACT 2614



## INTRUDER WATCH

Bill Martin, VK2EBM  
FEDERAL INTRUDER WATCH  
CO-ORDINATOR  
33 Somerville Road, Hornsby Heights,  
NSW, 2077

### CONTEST CALENDAR

- AUGUST**  
 6-7 European CW Test +++  
 13-14 Remembrance Day Contest. Rules in June AR  
 13-14 OARC WAE CW Test +++  
 13-14 SEAnet Phone Test +++  
 17 QLF Activity  
 20-21 SARTG RTTY Test  
 20-21 Keymans Club of Japan  
 27-28 All Asian CW Test

- SEPTEMBER**  
 3-4 DARC Corona "CORONA" 10 m RTTY  
 10-11 G QRP Activity  
 10-11 DARC WAE Phone Test  
 17-18 VK Novice Test  
 17-18 Scandinavian CW +++  
 24-25 Scandinavian Phone +++

- OCTOBER**  
 1-2 VK/ZL Phone Contest  
 8-9 GARTG SSTV Test  
 15-16 VK/ZL CW Contest  
 29-30 CQ WW DX CW Test

- NOVEMBER**  
 12-13 DARC WAE RTTY Contest  
 26-27 CQ WW DX CW Test

All tests marked with +++ are not yet confirmed.

### PLEASE NOTE

#### THE RD CONTEST

The practice of one operator operating two station/calls simultaneously is considered not to be within the spirit of the contest and any logs suspected of this will be disqualified without recourse.

#### VK NOVICE CONTEST

Don't forget the VK Novice Contest in September. Let's generate some interest for this contest which had such a poor showing last year. This contest is a marvellous opportunity for all to participate and gain awards. The maximum speed for CW has been reduced to 10 WPM to encourage this mode.

### CONTEST CHAMPION 1982/83 CONTEST

#### Winner is... VK5QX

The contests chosen for the VK Contest Champion were: John Moyle, VK/ZL, RD and the VK Novice Contests. The points awarded are as follows: 1st = 10 points, 2nd = 9 points, 3rd = 8 points, etc thru to 10th position for 1 point.

An entrant must be included in three of the four contests. He/she may not score but must have entered.

To win the entrant must be a member of the WIA. On the completion of all contests the highest points scorer wins the contest champion trophy for one year.

The contests for the 1982 year have been completed and the available results are listed below. The results of the VK/ZL contest are not usually available until the June edition of AR. Therefore the trophy is awarded in the latter part of the year and held for the following year.

The contest for the 1983 year began with the John Moyle National Field Day and will continue with the Remembrance Day Contest. To become eligible you must enter and to stand a chance of winning you should try for a high score (positions one to ten) in each of the contests.

Good luck.

The winner of the contest champion trophy for 1982 is VK5QX, for being the most consistent high scorer and participator in the VK contest scene.

CALLSIGN	JM	VK/ZL	RD	VK NOV	TOTAL
5QX	10	16	10	14	50
4XA	—	36	10	—	46
3WP	10	—	10	18	38
3AEW	—	8	—	10	10
3ADW	7	—	7	—	14
7RY	—	9	7	—	7
3BRM	—	9	9	—	9
1LF	—	—	3	4	7
6RZ	—	9	3	—	3

### RESULTS FOR THE 1983 CONTEST SO FAR

CALLSIGN	JM	VK/ZL	RD	VK NOV	TOTAL
3XQ	10	—	—	—	10
2KFJ	9	—	—	—	9
6NSD	10	—	—	—	10
3CGH	9	—	—	—	9
5QX	8	—	—	—	8
3KI	7	—	—	—	7
4NDW	6	—	—	—	6
3DAW	5	—	—	—	5
3VF	4	—	—	—	4
2JM	10	—	—	—	10
3BKU	9	—	—	—	9
3BAF	10	—	—	—	10
2EL	10	—	—	—	10
3SP	9	—	—	—	9
5Y0	8	—	—	—	8
2TR	10	—	—	—	10
4A0F	9	—	—	—	9
5DL	8	—	—	—	8
3LC	10	—	—	—	10
3XB	9	—	—	—	9
2B0S	8	—	—	—	8
1DL	7	—	—	—	7
7AL	6	—	—	—	6
3DAK	5	—	—	—	5
7NIM	4	—	—	—	4
3KCC	3	—	—	—	3

Readers of this column will have seen, over the last several issues, listed examples of intruder stations using AM, RTTY, and CW modes of emission. There are, of course, other modes being employed by intruders, which are forbidden to the amateur operator, and are therefore very difficult, if not impossible to resolve and identify. The best thing we can do is to keep an eye on them, and see if they appear to be coming up on a regular basis, and start reporting them if this seems to be the case.

Probably one of the most important aspects regarding the presence of an intruder station on the amateur bands is the need to *NOT OSY* when he appears.

Obviously this is going to present the amateur operator with some problems, as some of the intruder signals, as we know, are quite strong. However, I find it a measure of satisfaction *NOT* to OSY if an intruder comes on top of my QSO. This is precisely what the intruder station wants — you to move aside for him. If you don't mind being bullied, then by all means shift frequency, or abandon the OSO altogether. But this certainly won't encourage the intruder to use this own frequencies, and move away from *YOUR* bands.

If you are QRM'd by an intruder, stay with it, and let him suffer the QRM from your *LEGITIMATE SIGNAL*. I rather suspect that, even although the amateur's power output is usually rather lower than that of the intruder, the intruder will become aware that someone else is on the frequency, and, with any luck, it will cause the intruder some hardship.

No doubt we are all aware of the problems caused by a CW signal coming up on top of us when we are conducting a CW QSO. Hopefully, the same problems will be encountered by the intruder, when we stay on our legal frequency. But the difference of course, is that the amateur operator *IS THE ONE ENTITLED TO BE THERE*.

Past experiences have shown that intruders will QSY if there is enough interference from an amateur station, particularly when both modes employed are that of RTTY. However, don't waste your time trying to out-talk Radio Beijing or Radio Tirana on 40 metres. Most importantly, don't cause any QRM to an unidentified station, unless you are one hundred per cent sure that the offending station is in fact an intruder. We have enough problems with intruders without the need for amateurs to QRM each other! The intruder problem is a continuing one, and needs continuing efforts by us all to try and resolve it. Please support the Intruder Watch, if only occasionally.

AR

AR

# SPOTLIGHT

## ON

## SWLING

Robin Harwood, VK7RH  
5 Helen Street, Launceston, Tas 7250

Well, the annual Remembrance Day Contest has rolled around once more. This contest is held in memory of those Australian amateurs who made the Supreme Sacrifice with their lives for our Nation during the Second World War. It usually is staged as closely to VJ Day — the date on which hostilities ceased, and this year will be over the weekend of the 13th and 14th of August from 0800 UTC until 0759.

For further details regarding the rules of the RD, refer to the June issue of this magazine on page 42. Don't forget that there is a receiving section of this contest, open to all SWLs. However, I expect that some of you will be tied up assisting with local amateurs in their logkeeping chores. Anyhow, all the best to you in the "RD — the friendly contest".

### RADIO NETHERLANDS

It now seems unlikely that Radio Netherlands will conduct any further experiments over shortwave in the exchange of computer data transfer. Recent evaluation of their Phase Three broadcast on 4th November, based upon 550 recorded reports from listeners, has proved to be disappointing. Only 178 were of sufficient quality to provide a perfect or near perfect readout at the rate of 300 baud. The faster 1200 baud rate failed to come out on shortwave, and is therefore too unreliable.

As well, all of the successful printouts came from within Europe. Evidently multi-hop propagation does not give a sufficiently constant signal level or strength to remain within the tolerance levels of the home computer. Yet another problem was that the transfer from the Hilversum studios to the two relay bases in Bonaire and Madagascar via Intelsat communications satellite was also unsatisfactory and unreliable. This prevented any coherent data being provided by listeners to these relayed transmissions. Because of phase distortion on the satellite circuit, as well as the digital to analogue converters, employed on voice and music programmes, failed to re-convert the computer audio to its proper shape. Because of these difficulties and the unreliability of satellite circuits at the present time, it is clear that there is no future to using the relay bases without the use of special modems.

Therefore, these results have indicated to Radio Netherlands that there is no point persisting with these experimental transmissions on shortwave of data transfer, until technology improves.

### SUCCESSFUL COMPUTER DATA TRANSFER

However, as computer data transfers seems

to be successful on MW and FM, particularly in Holland, Radio Netherlands will be including data transfer on taped transcriptions of their Media Network programmes. These are made available to local radio stations on MW and FM throughout the World. There has been a successful weekly programme over one of the Dutch domestic networks devoted to computers, which includes data transfers without any reception problems, even at 1200 baud. However, because of the problems experienced with different brand computers with programming language, a sort of computer esperanto had to be developed to facilitate the exchange of data between brands such as Commodore and TRS 80. Known as BASICODE, this system has been in use successfully in data transfer between different computer models for over a year now. Recent improvements to the system have been developed and a handbook in English or Dutch has been written explaining it, together with an accompanying cassette. These should be available shortly from Radio Netherlands. For further details regarding price and postage information, please write to the following address:

*Media Network Computer Experiments,  
English Section,  
Radio Netherlands,  
PO Box 222 1200 JG,  
Hilversum, The Netherlands.*

### SATELLITE SWLING

Satellites have been in the news lately, with the successful launch of AMSAT-OSCAR 10 in mid-June, as well as the projected amateur activity from the next space shuttle flight in November. It is interesting to note that Radio Netherlands has released a twelve page booklet explaining satellites for the shortwave listener. This follows up on a recent segment on Media Network devoted to this subject. Written by John Branegan, this booklet tells how to monitor some of the satellites with just an ordinary shortwave receiver and a simple antenna, explaining how experiments can be done in propagation and importantly how to keep track of the satellite. This booklet is free and is available from the above address.

### WATCH FOR THESE

There are two very interesting programmes coming up this month on shortwave radio. On the 14th at 1430 UTC, you can hear an account of an event that happened over 100 years ago. Krakatoa was a mountainous outcrop between Java and Sumatra, which suddenly exploded, killing thousands of people. The noise of its eruption was clearly heard many thousands of kilometres away in

Adelaide, while the cloud of debris in the sky provided spectacular sunsets for many months afterwards. Tune to the BBC World Service on Sunday the 14th August at 1430 UTC, or on Friday the 19th at 2330 UTC for an account "Krakatoa — the Island that Exploded".

On Wednesday the 17th August, Radio Netherlands is broadcasting a special report entitled "A Bridge Too Far". This is an account of the mighty air-borne army assault for a narrow corridor of land near the Dutch town of Arnhem launched in 1944. Reporter Bob Chaundy will be with a reunion tour by some participants in this battle, which was code-named Operation Market Garden. Was this operation a daring success or a failure? Judge for yourselves at either 0748 or 0848 UTC on 9.770 or 9.715 MHz. Note that 9.715 will only carry the 0848 release.

Well, that is all for this month. Until September, the best of listening and 73 — Robin VK7RH.

AR

## For QSL Cards

Phone

(03) 527 7711

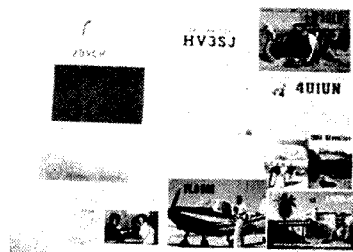

**Williams Printing  
Service Pty Ltd**

12 William Street,  
BALACLAVA 3183

CONTACT US FOR QUOTES

# MURPHY STRIKES WITH VENGEANCE

Our old friend, Mr Murphy really let his hair down in *Novice Notes*, page 30, last month. The reactance table referred to was omitted and the drawings of Figures 6 and 7 were transposed although the text was correct.

Line Length (degrees)	0	5	10	15	30	60	90	120	150	180	210
Resistance (ohm)	100	97.8	91.7	83.3	57.1	30.8	25.0	30.8	57.1	100	57.1
Reactance jx (ohm)	0.0	-12.7	-23.5	-31.2	-37.1	-20.0	0.0	20.0	37.1	0.0	-37.1

**TABLE 1 — REACTANCE VS LINE LENGTH**

The values in the table are the values that would be measured by an RF bridge connected to a 50 ohm transmission line connected to a 100 ohm load. If the load were an antenna then these are the resistances and reactances that an ATU would need to cope with.

No matter what kind of ATU you use you will, from time to time, find an antenna that won't tune satisfactorily on one band. Back in the old days (before 1965) when AM rigs with PI couplers were common, the problem of not being able to load up on one band frequently occurred. It was solved, in most cases, by increasing the length of the transmission line. The same solution will be found to be just as successful with the ATU problem. We all know that a quarter wavelength line can be used to transform a small resistance to a large one. We also know that a half wavelength will not change the impedance if connected between a load and a transceiver. See Figs 6, 7. But what happens for other cable lengths? By using a calculator programme supplied by Evan, VK3ANI, I have been able to calculate the changes of impedance for a 50 ohm line

equals a quarter wavelength etc. The results are given for five degree increments up to thirty degrees and then in thirty degree increments. Negative values of reactance are capacitive reactance and positive values are inductive. The table is done this way to make it independent of frequency.

The mathematically inclined should study Fig 8 as the values in Table 1 are for series

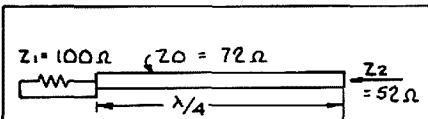

**Figure 6 — Quarter Wavelength Line.**

A quarter wavelength of 72 ohm cable transforms a 100 ohm resistance to a 52 ohm resistance. Resistances greater than 100 ohms are transformed to values less than 52 ohms.

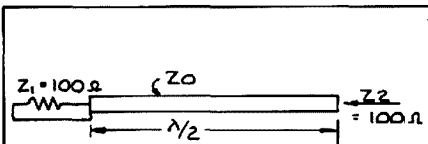

**Figure 7 — Half Wavelength Line.**

A half wavelength of transmission line of any impedance transfers the same value of impedance at the input to the output.

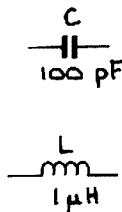

At 21 MHz  
 $X_c = 1/2 \pi f C$   
 = 75.8 ohm

We can say C has a reactance of -75.8 ohms.

$X_l = 2 \pi f L$   
 = 131.9 ohms

We can say L has a reactance of 131.9 ohms.

Often the symbol j is used to signify reactive impedance. Thus the circuit shown can be described at 21 MHz as  $100 - j 75.8$  ohms.

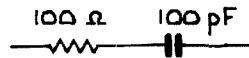

**Figure 8 — Reactance Notation.**

components. That is for a 100 ohm load or termination connected to a thirty degree long line the impedance seen at the other end of the line is a resistor of 57.1 ohms in series with a capacitor of 37.1 ohms reactance.

Inspection of Table 1 should reveal a periodic (repetitive) variation of impedance values as the line length is increased. In this example the resistance varies between 100 and twenty five ohms every ninety degrees. The reactance varies from zero through a maximum capacitive reactance of about forty ohms and back to zero for the first ninety degrees. As the line length is increased

further the reactive portion again increases to about forty ohms and back to zero but this time it is inductive. The cycle is repeated every 180 degrees.

This is a result we might have anticipated as we know that adding a half-wavelength line does not change impedances. This also allows us to remove all the exact half-wavelengths (on paper or in our imagination of course) to see what fraction remains. The transformation caused by that fraction is the transformation of the whole line.

For example a line 390 degrees long is equivalent to one only thirty degrees long as far as impedance transformation is concerned. The more knowledgeable reader will be saying that line loss has an effect too. So it does but on HF the effect is reasonably small and will not affect our general conclusions and comments.

So where have we got to? Well if our ATU has problems in tuning a particular load because the load is too high or too low we can now see a solution. That is by adding up to a quarter-wavelength of feeder a more manageable load will be presented to the ATU. In some cases up to a half-wavelength may be required.

One further point to note is that if the VSWR on the line is greater than 2:1 then the range of impedances will be greater than shown in Table 1.

At a later date I will discuss VSWR in more detail and bury a few sacred cows in the process.

73 DE VK3AFW  
 AR

## JULY'S BEST PHOTOGRAPHS

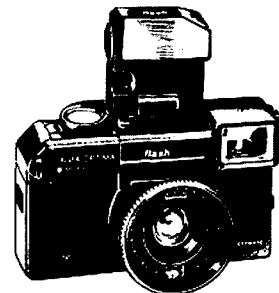

The judges selected the underside view of the TR7950, page 21, *Trap Vertical on the roof of the GPO*, page 15 and *Ken VK3KC operating SSTV*, page 9. These photographs will now be considered for the AGFA CAMERA prize at the end of the competition in June 1984.



# TECHNICAL CORRESPONDENCE

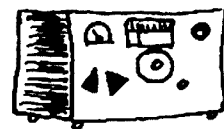

## REGULATED 13.8 V POWER SUPPLY

In the May issue of AR you published an article of mine concerning the construction of a Regulated 13.8 V Power Supply (page 14).

The article has created quite a deal of interest and I have received many requests for information. One of the requests has been for the supplier of the voltage regulator used — it appears to be difficult to obtain in states other than Victoria.

Would you please place an entry in the next issue (if possible) advising that Voltage Regulator UA78HG is obtainable from Stewart Electronic Components, 44 Stafford Street, Huntingdale, Vic 3166 at \$7.92 each, plus tax.

Yours faithfully  
Desmond Greenham, VK3CO  
23 Stewart Street,  
Seymour, Vic 3660

AR

## EMF FOR ICOM IC-22S

I refer to the article "Simple External Frequency Selection for the ICOM IC-22S" in AR, April 1983 (page 22).

The usefulness of this accessory is very greatly increased if used in conjunction with a table relating frequency to switch positions. In the DRAGNET article such a table was referred to. It was compiled by Trevor Mayhew, VK2YEP and published in an earlier edition of DRAGNET. This part was edited out of the AR article.

Anyone familiar with binary numbers can easily produce such a table. A modified version of Trevor's table is shown in Fig 1.

Inspection of the table shows that it should be possible to operate the IC-22S beyond 147.975 MHz and I have verified that this is so, using a dummy load, of course. Therefore care is needed when using the device and also when setting up the internal diode matrix.

A minor typographical error has been carried across from the DRAGNET article — the last word in the third last paragraph should be "correct" rather than "covered".

I was interested to find an allusion to the prior existence of the technique in the article by Ian Jackson, VK3BUF in AR, March 1983 (page 15). I will be following up Ian's suggestion regarding replacement of R141 in the near future. (See note\*.)

Yours faithfully  
Reg Fookes, VK2AKY  
19 Delagoa Place,  
Carlingbah, NSW 2229

\* Readers attention is drawn to the correction printed in AR July, (page 39), re R141.

AR

	144.								145.								146.								147.							
	D				D				D				D				D				D				D							
	7	6	5	4	3	2	1	0	7	6	5	4	3	2	1	0	7	6	5	4	3	2	1	0	7	6	5	4	3	2	1	0
	128	64	32	16	8	4	2	1	128	64	32	16	8	4	2	1	128	64	32	16	8	4	2	1	128	64	32	16	8	4	2	1
.000																																
.025																																
.050																																
.075																																
.100																																
.125																																
.150																																
.175																																
.200																																
.225																																
.250																																
.275																																
.300																																
.325																																
.350																																
.375																																
.400																																
.425																																
.450																																
.475																																
.500																																
.525																																
.550																																
.575																																
.600																																
.625																																
.650																																
.675																																
.700																																
.725																																
.750																																
.775																																
.800																																
.825																																
.850																																
.875																																
.900																																
.925																																
.950																																
.975																																

Fig 1 — IC-22S Frequency Code

A dot signifies that the Switch is closed.

## WCY 83 ARRL PRESIDENT VISITS THE WHITE HOUSE



ARRL President Clark W4KFC, who serves on the Council for World Communications Year 83, attended ceremonies at the White House when President Reagan officially announced US participation in WCY83.

Also in attendance were other members of the WCY Council including the Under Secretary of State, William Schneider, K2TT.

A reception to celebrate WCY83 was also hosted by William K2TT at the Department of State.

America is really taking WCY to the top. Let us in VK be positive with our hobby and let the outside world know that amateur radio does exist.

Adapted from CQ magazine April 83.

AR



# VK2 MINI BULLETIN

Jeff Pages, VK2BYY  
VK2 MINI BULLETIN EDITOR  
Box 1066, Parramatta, NSW 2150

# WA BULLETIN

Jim Rumble VK6RU  
VK6 QSL MANAGER  
Box F319, GPO, Perth, WA 6001

*The QSL Bureau is for members of the WIA. The address for all correspondence to the VK6 Bureau is Box F319, GPO, Perth, WA 6001.*

## COUNCIL REPORT

Divisional Council met on the 17th June at Amateur Radio House. The Glen Innes and District Amateur Radio Club and the Far South Coast Amateur Radio Club were affiliated with the NSW Division, bringing the total number of affiliated clubs to thirty three. Matters arising from the recent Conference of Clubs were further discussed. Council decided to invest \$5000 in Premier State Bonds, taking advantage of the high rate of interest offered. Fourteen new members were accepted to the division.

## REMEMBRANCE DAY CONTEST

All members are reminded that the Remembrance Day Contest is coming up on the 13th and 14th August (see *June AR* for the rules). This year VK2 has a weighting factor of 9.58, the highest of all divisions, so with a bit of effort we stand a good chance of taking out the trophy. As usual, the contest will be opened by a special broadcast from VK2WI on all the normal frequencies at 0730 UTC on the 13th, and there will be no morning broadcast on the 14th. As the contest result depends heavily on percentage participation, don't forget to send in your log!

## NOVICE COURSE

The Coff's Harbour and District Amateur Radio Club is conducting another Novice Radio Class at the Orana High School. The theory instructor is Rick Fletcher VK2BKV, with Harry Alderson VK2EP in charge of CW. The course began on the 13th July, but if you are interested then contact Brian Lackie VK2DLM at 60 Yellow Rock Road, Urunga.

## HERE AND THERE

In the June Mini Bulletin Jim Button's callsign was incorrectly given as VK2NPO, and should be VK2NPA. Apologies Jim. The next Conference of Clubs will be hosted by the Central Coast Amateur Radio Club on the 6th November, and agenda items for discussion must be received at the Divisional Office by the 16th September. Broadcast Officer Peter Jeremy VK2PJ is looking for additional volunteers to join the broadcast roster as announcers and engineers for either morning or evening broadcasts. If you would like to join the broadcast team either advise on the callbacks or contact the Divisional Office. Please feel free to call in at Dural any Sunday to see what goes on in putting the broadcast to air.

NSW members and clubs are invited to submit news items for inclusion in these notes to the WIA NSW Division, PO Box 1066, Parramatta, NSW, 2150. Items for October AR must reach the office by the 22nd August.

## AFFILIATED CLUBS

**GLEN INNES AND DISTRICT AMATEUR RADIO CLUB**  
PO Box 26, Glen Innes, NSW, 2370.

Meetings: Last Tuesday of month at 7.30 pm at the Glen Innes High School. AGM in July.

Nets: Each Sunday at 8 pm on 3.580 MHz.  
Committee: Ivan Botha VK2BIO President, Russell Scott VK2ERS Secretary, Lyn Cameron VK2BSF Treasurer, Richard Cambridge VK2BYV, Graeme Willey VK2EBU, Anthony Berger VK2BGQ.

Classes: Each Wednesday from 11.30 to 12.45 at the High School, as part of the "interest elective" programme.

Club Station: VK2DQO.

**FAR SOUTH COAST AMATEUR RADIO CLUB**

PO Box 339, Merimbula, NSW, 2548.

Committee: Jim O'Brien VK2BHU President, Owen Roberts VK2PCJ Vice President, Ron Ride VK2BOF Secretary, Terry Howard VK2XBK Treasurer.

Repeater: VK2RFS channel 6750.

Contact: Ron Ride VK2BOF on (0649) 51698.

**BLUE MOUNTAINS AMATEUR RADIO CLUB**

PO Box 54, Springwood, NSW, 2777.

Meetings: First Friday each Month at Springwood High School, Grose Rd, Springwood.

Nets: Tuesday 8.30 pm on 3.540 MHz and 9 pm on rep 7050.

Committee: Brad VK2KTT President, Terry VK2BRQ Vice President, Les VK2WU Secretary, Len VK2BLZ Treasurer, Eric VK2BXB, Dennis VK2EMF, Noel VK2ZNS, Jim VK2PBU/XAG, Eion VK2ZRI, Dave VK2XDS and Brian VK2BX.

Repeaters: VK2RBM channel 7050, VK2RUT channel 8375.

Club callsigns: VK2AUX, VK2NCM.

73 from Jeff VK2BYY

AR

**EMC**  
(Electro Magnetic Compatibility)



If radio frequency interference is causing you a problem you are reminded that — "Advice on all types and aspects of interference (PLI, TVI, AFI, etc.) is available from the National EMC Advisory Service".

**FORWARD DETAILS TO**  
VK3QQ,  
Federal EMC Co-ordinator, QTHR.

## QSL BUREAU

### INWARDS

Cards from overseas and other states of Australia arrive at regular intervals and are sorted into files which are available at each WIA meeting. Those members who cannot attend meetings are invited to forward some stamped self-addressed envelopes to the above address when incoming cards will be despatched. Please number the back of your envelopes to indicate when the last has been used.

### OUTWARDS

Each outgoing card must have a QSL Sticker affixed to its back and it is desirable to place the callsign of the recipient also on the back of the card to facilitate sorting. QSL Stickers are available from the above address for \$2.00 per sheet of 100. Cards are posted regularly in bulk by surface mail to the QSL Bureau of the addressee's country or to his QSL Manager whichever is indicated.

**QSL BUREAU**  
**VK6RU P.O. Box F319**  
**Perth, West Australia**

Please pre-sort your cards into their respective countries by prefix — it speeds up transit of your cards outwards.

As cards for VK6 stations go immediately into the local files there is no need to affix a sticker to them.

If you change your address then please advise the Bureau so that the amendment may be made to your remaining envelopes.

### CHARGES SINCE JAN 1946

1 January 1946	5/- per 100
1 March 1966	50c per 100
1 December 1974	80c per 100
1 September 1975	\$1 per 100
1 September 1976	\$2 per 100

AR

### DEADLINE

**All copy for October AR must REACH  
PO Box 300, Coufield South, 3162 no  
later than 25th AUGUST.**



# VK3 WIA NOTES

Greater community awareness of amateur radio was essential, the President of the Victorian Division, Jim Linton VK3PC said recently.

Recent issues such as the question of radio masts, phone-patching and the Radio Communications Bill, which was to come before Parliament, all showed a lack of awareness by members of the general public as to the extent, value and nature of amateur radio, he added.

"It is absolutely vital that our hobby of amateur radio is recognised," he said.

"The recent bush fire emergency showed how little public awareness exists.

"The WIA, being the oldest radio society must get the recognition it deserves.

"CB received a lot of publicity during its boom period and unfortunately amateur radio became confused with it in the general public's mind."

Jim said that he had three primary aims to achieve during his term in office.

They were:

- To improve the awareness of amateur radio in the community.
- To improve communications between the Divisional Council and zones, clubs and members.
- To improve the image of the Divisional Council amongst members.

While Victoria had the largest number of amateur members of any division, it was essential that the number of members be increased, Jim added.

"Many amateurs just do not realise the services that the Institute provides in representing their individual interests at an official level, such as the recent Victorian inquiry into high radio masts," Jim said.

"If you listen to any amateur repeater you'll hear people using them regularly who are not members of the WIA. They seem to be using them completely unaware of who provides the facility — sometimes I don't think they are.

"Yet these same people are the first to criticise, if for some reason a repeater is out of action. They just don't appreciate that \$32 a year would go some of the way to helping to provide the facilities they are using."

Communications between the Victorian Division Council and zones, clubs and members was a two-way contact, Jim said.

"We have to let the members know what is happening and they have to let us know their views," he added.

"How often do you hear people moaning on air, but if you suggest that they come to a meeting and say the same thing they are often too busy.

"Sure, we on the council have to reflect the members views but it is difficult to do that unless amateurs join the Institute and take an active interest in its affairs."

"Quite frankly, in the past, the Victorian Divisional Council probably was not attracting the right number and calibre of people, but

the new Council is a group of highly enthusiastic people dedicated to amateur radio.

"It is my aim to ensure that the image of the Victorian Divisional Council is held more highly."

Jim, a 36-year-old journalist, joined the WIA in 1962 as a Junior Associate (SWL).

In 1971 he was a member of the broadcast committee as an announcer on the weekly Sunday broadcasts, and at the same time was a committee member of the Eastern and Mountain District Radio Club.

In April 1981, Jim started the "Stop the Russian Woodpecker Campaign" and later the same year was made an ex-officio member of the Victorian Divisional Council to help with the issue of radio masts — an on-going task.

In the same year he began campaigning for Telecom to lift its prohibition on phone-patch and following a meeting with Telecom, Jim conducted Australia's first authorised phone-patch experiment with DOC and Telecom approval.

Jim is continuing the campaign saying: "Phone-patch will eventually be approved for radio amateurs in Australia — its only a matter of time".

In 1982 he began assisting the WIA in Victoria with public relations and earlier this year joined the VK3 Divisional Council and was official observer at the WIA Federal Convention in April, assisting Federal Councillor, Alan Noble VK3BBM and Alternative Councillor Des Clarke VK3DES.

## VICE-PRESIDENT



**Bill Wilson, VK3DXE.**  
Age 49. Occupation — Electronic Service Engineer.  
Joined Council in 1983.  
Portfolio — Vice President.

## SECRETARY



**Ian Palmer, VK3YIP.**  
Age 37. Occupation — Communications Engineer.  
Joined Council in 1982.  
Portfolio — Secretary.

## PRESIDENT



**Jim Linton, VK3PC.**  
Age 36. Occupation — Journalist.  
Portfolio — President.

**TREASURER**



**Des Clarke, VK3DES.**  
Age 53. Occupation — Retired.  
Joined Council in 1981.  
Portfolio — Treasurer, Alternate Federal Council and Outwards QSL Manager.

**MINUTE SECRETARY**



**Margaret Wilson.**  
Occupation — Typist/Clerk.  
Portfolio — Minute Secretary.

**CHAIRMAN**



**Alan Heath, VK3KZ.**  
Joined Council in 1978.  
Portfolio — Chairman.

AR

**DISPOSALS OFFICER**



**Fred McConnell, VK3BOU.**  
Age 47. Occupation — Installation Inspector, SECV.  
Joined Council in 1980.  
Portfolio — Disposals Officer.

**VICE CHAIRMAN & COUNCIL NEWS CO-ORDINATOR**



**David Johnson, VK3YWZ.**  
Occupation — Civil Servant.  
Joined Council in 1982.  
Portfolio — Vice Chairman & Council News Co-ordinator.

**WANTED TO BUY**

Ham gear, CB equipment, Hi Fi, video, car stereo, large or small quantities.

**WE BUY AND SELL ANYTHING ELECTRONIC ANY QUANTITY ANY CONDITION**

**HAMRAD**

104 Highbett Street,  
Richmond, Victoria.  
Phone: (03) 428 8136



**JOIN A NEW MEMBER NOW!**





KENWOOD



\$495

\$450

## MOBILE MEMORIES!

The KENWOOD TM-201A 2-meter FM mobile transceiver and TM-401A 70-centimeter FM mobile transceiver are designed to be the ultimate in compact size and light weight, allowing maximum flexibility in automotive installations. New microprocessor controlled operating features, improved receive and transmit circuitry, a powerful 25 watts (TM-201A) and 12 watts (TM-401A) of RF output, and an easy-to-operate front panel control layout are packed into these new, ultra-compact radios, providing extended flexibility and ease of operation.

### ULTRA COMPACT AND LIGHTWEIGHT

Measures only 5.6 (141) W x 1.6 (39.5) H x 7.3 (183) D, inch (mm) and weight only 2.8 lbs (1.25 kg), ideally sized for installation in today's compact automobiles.

\* The depth of 7.3 inches (183mm) is the maximum effective length using flexible antenna cable and connector.

### 25 WATT OUTPUT, WITH HI/LO POWER SWITCH

The TM-201A produces a powerful 25W of RF output from a surprisingly compact design. (The TM-401 produces 12W of RF output at HI power position.)

### DUAL DIGITAL VFO'S BUILT-IN

Features dual digital VFO's, with front panel VFO-A/B switch.

### 5 MEMORIES PLUS "COM" CHANNEL

Memory 1 is for the priority alert function. Memories 2 and 3 store a single frequency, and permit repeater operation using the OFFSET switch. Memories 4, 5 and the COM (common) channel store transmit and receive frequencies independently, allowing operation on repeaters having both standard and odd offset.

### PRIORITY ALERT SCAN

With ALERT switch "ON", once every 6 seconds the unit scans back to memory channel 1 for approximately 0.3 seconds to monitor the activity on the priority channel (CH-1).

### MEMORY SCAN AND PROGRAMMABLE BAND SCAN

MS switch initiates memory scan. Skip memories in which no data is stored. In both memory and band scans, scanning stops on busy channel and automatically resumes after 6 seconds.

### HIGHLY VISIBLE YELLOW LED FREQUENCY DISPLAY

Four digit yellow LED display featuring improved visibility indicates receive and transmit frequencies. An S/R/F LED bar meter with "BUSY" indicator, plus "MR" (Memory recall), "ALERT", and "ON AIR" LED indicators are provided.

### OPTIONAL FC-10 FREQUENCY CONTROLLER

An extremely compact optional frequency controller, model FC-10, may be easily connected to the TM-201A/TM-401A and can be mounted in any convenient location.

### EXTERNAL HIGH QUALITY SPEAKER SUPPLIED

The TM-201A and the TM-401A are supplied with a compact, high quality, external speaker, (no internal speaker) providing flexibility in installation for maximum convenience.

### OTHER FEATURES

- AUDIBLE "BEEPER" CONFIRMS OPERATION
- UP/DOWN microphone is supplied
- HIGH PERFORMANCE RECEIVE/TRANSMIT SPECIFICATIONS
- REPEATER OFFSET SWITCH AND REVERSE SWITCH
- OPTIONAL TU-3 TWO FREQUENCY TONE ENCODER
- EASY-TO-INSTALL MOBILE MOUNT
- LITHIUM BATTERY BACK-UP (estimated 5 years life)

ANY CUSTOMERS EXPERIENCING DIFFICULTY IN OBTAINING KENWOOD EQUIPMENT SHOULD CONTACT TRIO-KENWOOD AUSTRALIA DIRECT AT HEAD OFFICE.

## TRIO-KENWOOD (AUSTRALIA) PTY. LTD.

(INCORPORATED IN N.S.W.)

4E WOODCOCK PLACE, LANE COVE, SYDNEY, N.S.W. 2065.

Ph. (02) 428 1455.

### NEW SOUTH WALES

TRIO KENWOOD (AUST) P/L — 4E WOODCOCK PLACE LANE COVE (02) 428 1455  
SPRINGWOOD CAR RADIO — SPRINGWOOD (047) 51 4930  
UNIQUE ELECTRONICS — 418 OLD PROSPECT ROAD 5TH WENTWORTHVILLE (02) 631 6689  
WASH ELECTRICAL — 71 SUMMER STREET ORANGE (063) 62 6249  
STOCKMAN & HIGGINS — BYRON STREET INVERELL (067) 22 1300  
ELECTRON 2000 — 3 ELIZABETH STREET TIGHES HILL NEWCASTLE (049) 69 6399  
MACELEC PTY LTD — 99 KENNY STREET WOLLONGONG (042) 29 1455  
RADIO WORLD PTY LTD — 81 NEWCASTLE STREET Fyshwick (062) 80 6550  
DX ENGINEERING — 5 JASMINE STREET PORT MACQUARIE (065) 83 2175  
LAND LINK — MULLALEY ROAD GUNNEDAH (067) 42 2838  
LAND LINK — 61 BARNES STREET TAMWORTH (067) 65 4622  
FRANK BOUNDY — LISMORE (066) 86 2145

### INTERSTATE

VIC: EASTERN COMMUNICATIONS — 168 ELGAR ROAD, Bux Hill (03) 288 3107  
BRIAN STARES — 11 MALMSBURY STREET, BALLARAT (053) 39 2808  
SUMNER ELECTRONICS — 78 KING STREET, BENDIGO (054) 43 1977  
TAS: HOBBY ELECTRONICS — 477 NELSON ROAD, MT NELSON (002) 23 6: 51  
GELSTON ELECTRONICS — SUMMER HILL (003) 27 2256  
ADVANCED ELECTRONICS — 5A THE QUADRANT, LAUNCESTON (003) 31 7075  
VK ELECTRONICS — 214 MOUNT STREET, BURNIE (004) 31 7733  
QLD: MITCHELL RADIO CO — 59 ALBION ROAD, ALBION (07) 57 6830  
S.A. &  
N.T.: INTERNATIONAL COMMUNICATIONS SYSTEMS PTY. LTD. — 8 NILE ST, PORT ADELAIDE (08) 47 3688  
W.A.: ARENA COMMUNICATIONS SERVICES — 642 ALBANY HWY., EAST VICTORIA PARK (09) 361 5422  
TRI-SALES — CNR NEWCASTLE & CHARLES STREETS, PERTH (09) 328 4160  
WILLIS ELECTRONICS — 445 MURRAY STREET, PERTH (09) 321 2207  
BAY RADIO — 18 BANKSIA STREET, BUNBURY (097) 21 2236  
RON DENT — 115 PATON ROAD, SOUTH HEADLAND (091) 72 1112  
SELECT TRONIX — TOM PRICE (091) 89 1564  
FORD ELECTRONICS — 209 HANCOCK STREET, DOUBLE VIEW (09) 446 4705



# LETTERS TO THE EDITOR

Any opinion expressed under this heading is the individual opinion of the writer and does not necessarily coincide with that of the publisher.



## CONGRATULATIONS

Bill Orr, W6SAI, and I enjoy reading AMATEUR RADIO each month and would like to congratulate you and your associates on the high-class job you do on this fine amateur radio journal. It sets a standard which is, I am sure, admired worldwide and achieves a fine balance between the technical and human interest stories.

And it is improving with every issue!  
Best wishes to all our VK friends.

Sincerely,  
Suart O Cowan, W2LX, KM2XDU  
Radio Publications, Inc.  
Box 149,  
Wilton, Conn. 06897, USA

AR

## SPRATLY ISLAND

*This letter was written to the DX Editor*

The Spratly Island tragedy serves very well to illustrate how our hobby has failed to move with the times. What was originally a good idea has become a nightmare as old ideas are overtaken by current realities. In the process DXpeditions are becoming unacceptably dangerous and costly, legally questionable and the real purpose of the DXCC award is being lost.

In times past, when radio was a pup, the concept of DXCC was to work the world and the use of national prefixes was a convenient and valid basis for the award. The complexity and validity of this approach has now reached a point where the whole purpose of the major amateur awards needs to be reassessed in more rational terms.

To begin with, what the DXCC really measures is an ability to place a workable signal anywhere on the face of the globe. Secondly, it requires evidence of LEGAL Operation. Where the present system falls down is that it requires the controlling bodies, eg ARRL, to make political decisions. Something it is not supposed to do.

A more equitable system should surely be to divide the globe into areas based on the navigational grid, for example 20 x 20 degrees giving 324 areas. DXCC and WAZ are largely politically based whereas a grid system is not and hence would not involve a non-political body in making political judgements.

A grid system would have a number of advantages.

- The worked all areas, WAA, could be made more prestigious by its very nature of working the globe.
- It would encourage portable/mobile operation and thus more technically difficult operations.
- DXpeditions would be safer as dangerous places, both in a military sense and a physical sense, could be avoided.
- WAC and WAZ could be redefined in terms of assemblies of base grids and could thereby make Siberia and Antarctica "continents" as well as the traditional areas.
- WAC and WAZ could become steps towards the prime WAA award.

There would still be, under this scheme, a place for the concept of countries by limiting these to those whose administrations are recognised de-facto or de-jure by the UN and who allow amateur operations. Two letters, one to the Secretary General and another to the administration concerned would be enough to establish this fact. Such an award could be "Worked All Nations".

WAPX would remain as at present and could become the award that people, who like to cover their walls with paper, make their objective. However, the amateur controlling bodies would have to be ruthless in allowing credit only for those prefixes which are not in political dispute. Such a policy would, for example, eliminate Burma at the present time.

I believe that a scheme along these lines is used in some places for VHF purposes, and as such is not a new concept. Considering the danger and dispute that characterises the DXCC at present perhaps the time has come to extend the principles to the HF spectrum as well. Whatever system is adopted it must satisfy the requirements.

- of being capable of administration without entering into political judgement
- of minimising the danger to amateur operators who choose to visit remote regions
- of presenting a real technical challenge in working all areas on the face of the earth with the subsidiary benefit of encouraging portable, mobile and possibly QRP operation

I would be very interested in seeing what ideas others may come up with to deal with this very important problem.

With best regards  
John Andersen, VK5ZFO  
230 Young Street,  
North Unley, SA 5061

AR

## DELETE THE SPRATLYS

In response to the devastating news regarding DJ3NG and DJ4EI, the Blue Mountains Amateur Radio Club urges Australia to take the lead in deleting the Spratly Islands from the DXCC lists.

Why wait for the DX Advisory Committee in Newington (Connecticut) to do it? Is their word gospel? By taking the lead in opposing Spratly's inclusion, we set an example to the world, and maybe encourage other nations to delete this "country" from their DXCC lists.

We join many amateurs around the world in condemning the perpetrators of this tragedy, but hasten to point out that it wouldn't have occurred if Spratly had not have been elevated to the status it now enjoys by a couple of people in Connecticut.

Whilst Spratly remains on the countries list, someone will try to activate it — witness Chito, DU1CK's expedition not one month after the DL group's tragedy. While the temptation is there, adventurous amateurs will place their lives in danger. This is unacceptable and thus, such temptation must be removed for our own sakes.

Yours faithfully  
Blue Mountains Amateur Radio Club  
Les Cullen VK2ZU  
Secretary  
PO Box 54, Springwood, NSW 2777

AR

## PROFIT MAKING ADVERTISING

I have read the letter by Norm Melford, VK3ZTN in AR June 1983 and I wish to add the following to what has already been said.

I too have seen advertisements for a wide variety of equipment such as high power 2 kW amps for 26-27 MHz, up to 240 W transceivers covering 26-27 MHz, cordless telephones, door openers, radio alarm systems, etc.

It would seem that no matter what the advice is and no matter how illegal it is, that all one has to do is import and sell a large number of such items and they will eventually be legalised by the DOC. The key wording here being "profitable marketing by

the creation of a demand for such items and not giving a damn what you sell and who you sell it to.

Today anyone who has the cash can purchase any type of transmitting equipment that is available on the market with no questions asked not like, just after WWII, when a variety of AM/CW transceivers (even kruddy ones) appeared on the disposals market, one had to sign a declaration that the transmitting section would be dismantled within a certain time before one could purchase such items.

Yours sincerely  
Graham Muirhead, VK5ZCM  
PO Box 38  
Magill, SA 5072

AR

## APPRECIATION

I would like to express my appreciation to Des Greenham VK3CO for his article on the 13.8 regulated power pack published in the May issue of the AR.

Whilst the concept was not new it did make me go looking for an old TV set so that I could wind a transformer and knock up a unit.

I found two old TV sets at Salvo's jumble sale for five dollars and apart from the transformers I now have a lot of bits.

The unit works very well but I expect that Des knows this without being told and it is in constant use with the 2 metre equipment.

Thank you VK3CO  
Yours faithfully  
Den Smith VK3DI5  
4 Sunlight Crescent, East Brighton, 3187

AR

## HELP NEEDED

I live too far away from the major centres so I'll have to ask for assistance from other amateurs who also have a problem when it comes to deciding among the ever-increasing variety of makes and models of second-hand radios and equipment that is offered for sale!

I would treasure a reference directory of amateur radio equipment, describing all the gear on sale since, say 1960, together with the year it first hit the market and the price it sold for. A brief description listing the salient points and the manufacturer would be all that would be necessary.

Such a directory would culminate with current manufacturers offerings and possibly could be incorporated with our call book and would undoubtedly make that reference book even more useful.

How do others feel about this? Surely I can't be the only one considerably confused when trying to sort out, say 2 metre rigs from the model numbers in the "Hamads"!

This would be of great benefit to our novices with the purchase of a first HF rig. (Some of the old valve sets are still excellent performers!)

73 John Brennan VK4SZ  
PO Box 26, Innisfail 4860  
Any volunteers? — Editor

AR

## LICENCES

With reference to the letter in June 'AR' from VK7PW, Peter Wolf; on the matter of the examination for the Novice Licence being too easy, I feel as he has a background making the examination easy for him to pass he has not considered the situation of a lot of novice licence holders who have had to work very hard to achieve their licence, and for various reasons are not capable of doing better, and would

thereby be deprived of a very beneficial hobby that keeps them in touch with people. I hope to eventually pass the AOCIP.

Yours faithfully  
Bron Brown VK3NTD  
99 Foam Street, Rosabud 3939  
AR

### SINCERE THANKS

A letter of sincere thanks to those amateurs (many unknown) who enabled an urgent message to reach me, at a time of communication disruption during recent VK4 floods.

Briefly the facts: Late April, YXL and I departed for VK4 land (with VHF mobile), objectives — Carnarvon Gorge and to meet VK4NIH Tim. By Injune the terrain was saturated, 50 km south of the Gorge car bogged, three hour extrication, return to Injune. Phoned Gorge for road info, they had message from Tim to phone my home QTH friend VK3DTH Rex — learned of death of my only brother, in Victoria, and made several necessary phone calls. Deteriorating roads and time obviated attending funeral.

Communication links for message to reach me — my son in Victoria received news of death — he only knew I hoped to meet a Q'land amateur called Tim, and he phoned Rex, who recalled a QSO with myself and a VK4 named Tim — combed log book and found VK4NIH. Rex went on 20-40-80 metre bands for 8 hours to trace any of my 2 metre contacts, or Tim. I had been heard at Parkes, Moree, St George, Roma, but no Tim! Rex then phoned VICEN, VK4KD Ken, gave his phone number, and VK4NIH Tim as possible link to me. Tim is a Govt drilling rig operator, port/mob Emerald area, no fixed QTH or phone, and flood bound! Ken alerted VK4 operators, including, among others, VK4KAL, VK4LE and VK4APJ Andy at Emerald, who luckily knew Tim personally, and that he occasionally spent weekends with friend Ray (no phone) at Springsure. Andy and YXL Chris (VK4VIT) made 160 km trip in 4WD vehicle to Springsure — and found Tim! — who contacted Ken VICEN, received message and phoned that to Carnarvon Gorge. Thus was the circuit closed, taking only 20 hours!!

Days later, YXL and I were 'flood bound' at Moura (phone and mail unpredictable) — met VK4NHX Mick — used his rig to contact Rex at home, who then phoned my family in Victoria advising both safe at Moura.

Heartfelt thanks to all concerned, especially Tim, and Chris, Ray and Carol, Mick and Barbara, Keith and Beryl, who made homes and rigs unreservedly available under those trying circumstances — such is the amateur radio fraternity.

73 Reg VK2ELB and YXL Eif  
63 Buffalo Crescent, Thurgoona via Albury 2640  
AR

### IONOSPHERIC PREDICTIONS

Once again I write to enquire about your "Ionospheric Predictions" (courtesy Dept of Science and Environment IPS Sydney) on the matter of "Legend" for this particular system. Are we the readers to understand that the three lines as shown for Western Australia in the legend appear as two lines in the actual prediction.

Also on the "Notes on Predictions" mention is made of symbols numbering one to six yet these likewise do not appear on the prediction chart.

I would appreciate the courtesy of a reply to this second letter of mine if thought worthy of one this time. I look forward to your magazine with much enthusiasm each month.

Yours faithfully  
R A Davey, VK6NND  
12 Lillian Street  
Cottesloe, WA

### EDITORS NOTE

The discrepancy of three lines in the legend and two lines in the charts is a drafting error which will be corrected.

The symbols referred to are Gallex symbols as noted in the text of "Notes on the Predictions". The Gallex Charts are reproduced in other publications. The charts in

Amateur Radio Magazine are produced by Len VK3BYE using information supplied by the Department of Science and Environment IPS, Sydney.

Normally publication of a letter to the editor is regarded as acknowledgement. The policy regarding acknowledgement is stated on Page 1.

Editor  
AR

### COPYRIGHT! WHY?

It was with quite some astonishment, dismay and alarm, followed by concern that I noted that the article 'To Heard and Back' by Dave Shaw, VK3DHF/VK0HI published in the May and June issues of 'Amateur Radio' were marked '1983 Copyright Amateur Radio'. The article clearly carried an amplification of this fact in the following words appended thereto: "This article may not be printed in part or whole without the prior written permission of the Editor of Amateur Radio".

My first thoughts were, surely someone has made a bad mistake. Further contemplation of the subject produced the conclusion that our hobby was now definitely being prostituted to commercialism. If this was not the case why should an article of general interest to DXing amateur radio operators all over the world carry such a marking?

I am well aware that the mountaineering component of the Heard Island expedition 1983 may have aims with regard to recouping costs and even possibly making a profit and of this I have no criticism, however let the experience gained by us as 'AMATEUR' radio operators provide a lesson.

It is an almost certain fact that without the support of amateur radio world wide the expedition would not have taken place. Similarly, the amateur radio component would never have made it on its own as a viable operation. It can be noted that other expeditions have had to include a variety of interests to help cover costs.

The lesson referred to is that we must stand up for our rights when engaging in any joint ventures with people who may not properly understand the true meaning and spirit of amateur radio as a hobby.

However, back to the copyright matter.

By this action you have made it, whilst not impossible, at least difficult and inconvenient for our fellow amateurs all around the world to print for the interest of other amateurs extracts from this story of one of the most important DXpeditions in amateur radio history and one which could have certainly put Australia well and truly to the forefront of the international amateur DX scene. Those inconvenienced in this manner range from editors of minor club newsletters, sundry DX information sheets right through to the mighty ARRL 'QST' magazine.

Let's face it, many amateurs world wide contributed financially to the expedition and many would be most interested in written reports on same.

Thus, why did our magazine do something which to my mind runs completely contrary to the spirit of amateur radio and which in my memory has never before happened?

Please don't tell me the magazine was legally bound in this way because I believe that the contract signed by expedition members specifically allows for articles for amateur radio purposes without copyright, viz. Paragraph 13 of same:

"The Expeditioner shall not withstanding the provisions of Clauses 11 and 12 hereof be entitled to publish directly or indirectly accounts photographs and other information of the expedition in magazines and publications and to meetings for the benefit of radio amateurs and to this end no copyright shall be assigned to the Company but such members shall not otherwise publish any material for a period of five (5) years from the date hereof without the prior written consent of the Company."

So, could you please put my mind at rest and confirm for me that in this instance a mistake has been made in taking out any copyright on the article referred to. Further, should this really be the case could you please publish in the interests of amateur

radio in general a complete waiver to the copyright claimed?

Yours sincerely  
Ian J Hunt VK5QX  
8 Dexter Drive, Salisbury East 5109

Amateur Radio Magazine normally extends reprinting rights to kindred societies and many other publishers subject only to Amateur Radio Magazine receiving credit as the source. Such rights are generally on a reciprocal basis.

From time to time Amateur Radio Magazine publishes material where some additional conditions apply. In such cases a note regarding copyright is published. One other article has already been printed with such a note this year.

Both requests to reprint 'To Heard and Back' have been acceded to.

The Editor  
AR

### STOLEN EQUIPMENT REGISTER

The VK2 Divisional Office currently maintains a register of stolen radio equipment. With a comprehensive listing of such equipment, members about to purchase gear can contact the office during normal hours of business and check with the Register before completing the transaction.

Through this service, it is hoped to be able to track the interstate or intrastate movement of stolen radio equipment and hopefully find the people responsible for its theft and distribution.

If you know of equipment which has been stolen or lost or require further information contact the VK2 Divisional Office.

AR

## ATN ANTENNAS

A Victorian Approved Decentralised Secondary Industry

Registered Office:

56 CAMPBELL STREET,  
BIRCHIP, Vic 3483

Address all correspondence to:

PO BOX 80,  
BIRCHIP, Vic 3483

Phone: (054) 92 2224  
Telex: AA55480 OCOBIR

Contact ATN Antennas, a company with a proven track record for over 35 years, for the most comprehensive range in Radio Astronomy Education and Research Facilities and VHF, HF & UHF Antennas.

Write to us or your local dealer for a free catalogue on our complete range.

# IONOSPHERIC PREDICTIONS

Len Poynter VK3BYE

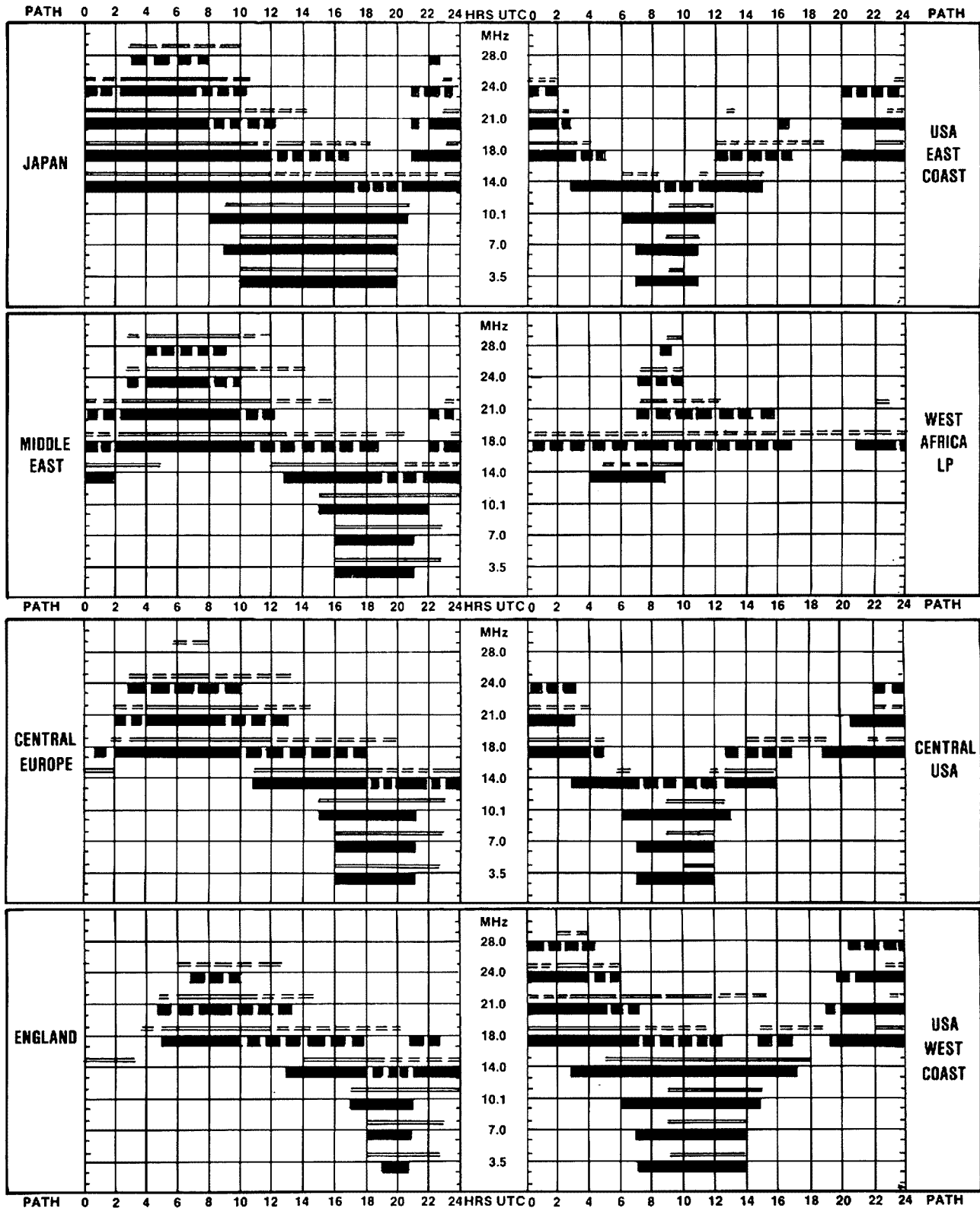

## LEGEND

— From West Australia

— From East Australia



Better than 50% of the month, but not every day

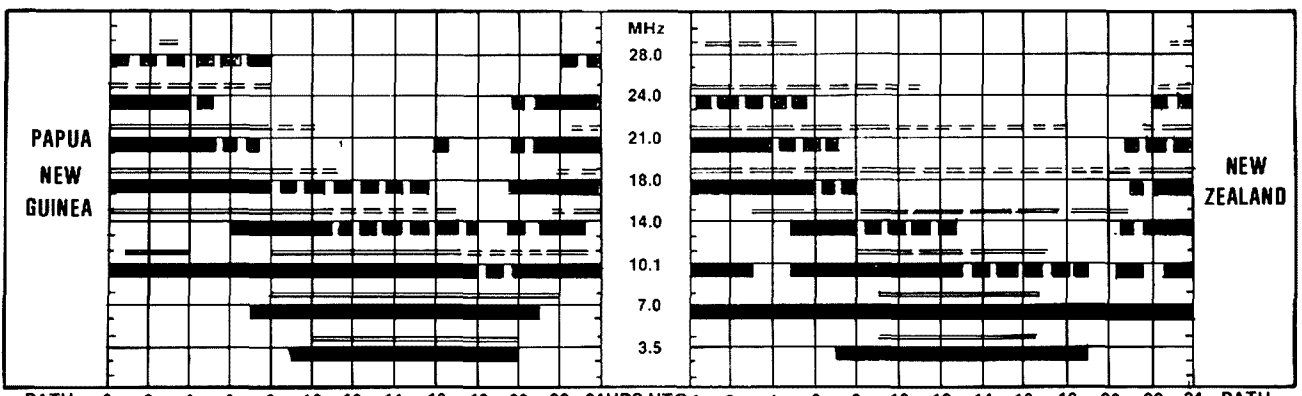
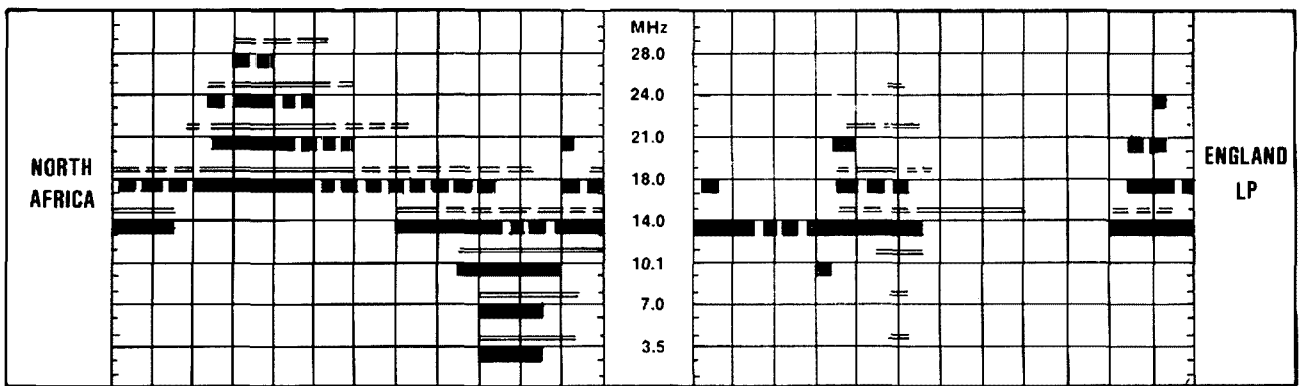
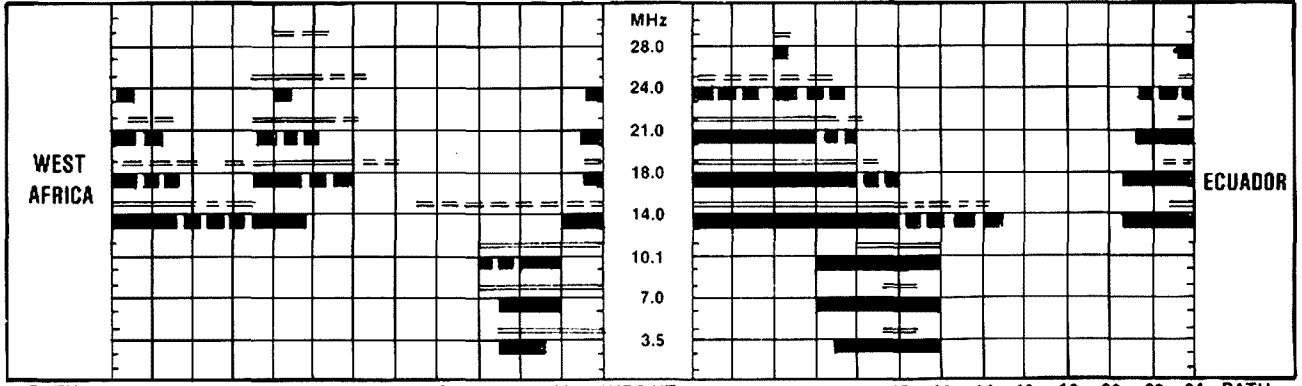
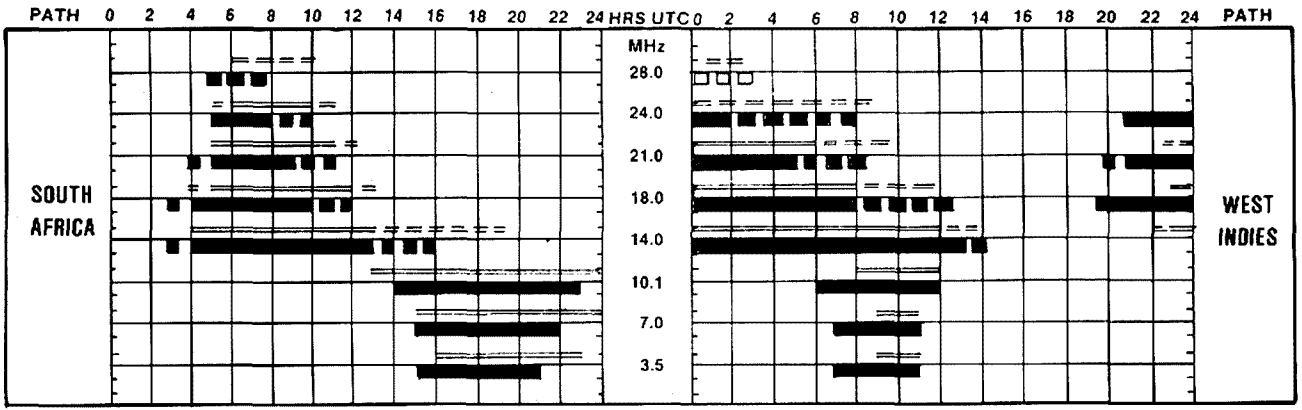

Predictions courtesy Department of Science and Environment IPS Sydney. All times in UTC.

 Less than 50% of the month

*PATHS* — Unless otherwise indicated (ie LP = Long Path) all paths are Short Path.

A DMM you can be proud of  
 . . . At a price you can afford!

Optional  
 carrying case  
 available \$10.00\*

Basic DCV accuracy 0.1% (7040)  
 Battery life to 2000 hrs  
 Brilliant quality LCD display  
 Current ranges to 10A (7040)  
 3 1/2 digits

A breakthrough in price, performance and quality! Our new Models 601 and 7040 Digital Multimeters are superb quality instruments that will serve you faithfully for many years. They feature all the accuracy, facilities and rugged serviceability that you're ever likely to need. — At a remarkably low price.

Ask at your local stockist about the 601 and 7040 for unbeatable value.

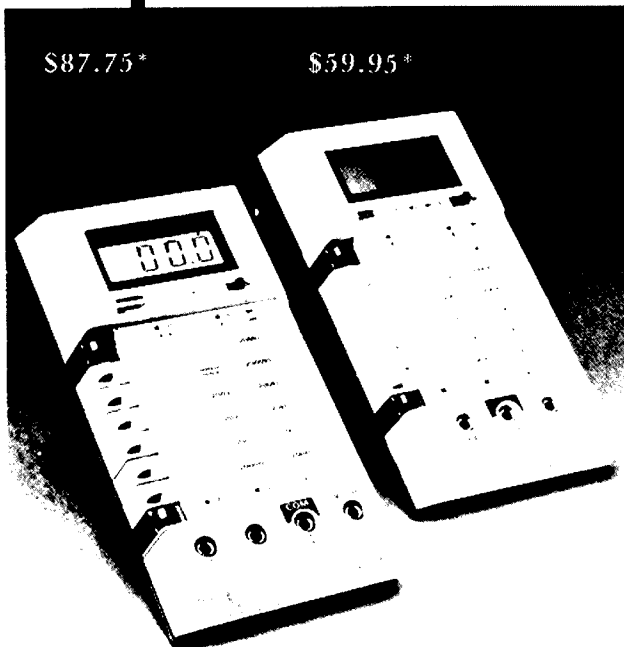

\$87.75\*

\$59.95\*

\*Prices do not include sales tax

**PARAMETERS** PTY LTD

PERFECTION IN MEASUREMENT  
 Sydney 439 3288 Melbourne 580 7444

Incorporated in Victoria

Xypar246

## COMPUTER BOOKS

This range covers subjects to whet the appetite of anyone interested in computers from the very beginner going out to buy their first computer to the more experienced dabbler.

### A SMALL SAMPLE OF THE COMPUTER BOOKS

#### HOW TO BUY AND USE MINICOMPUTERS AND MICROCOMPUTERS

by William Barden, Jnr. 240 pages  
 for \$14.95.

This book explains the basics of computers, their software and hardware, peripheral devices and various language and techniques available.

#### COMPUTER DICTIONARY

(Third Edition) by Charles J  
 Sipl. 624 pages for \$20.95.

A small (approx 140 x 215 mm) reference to translate computer jargon and terminology into easily understood language. More than 12,000 definitions which will be invaluable to computer veterans and novices alike.

#### CIRCUIT DESIGN PROGRAMS FOR THE TRS-80®

by Howard M Berlin. 144 pages  
 for \$18.50.

Containing a number of programmes written to aid the use of a TRS-80 and Level II BASIC for the design and analysis of many electronic circuits. This book can also be translated to run on other microcomputers.

#### ENHANCING YOUR APPLE® II

(Volume 1) by Don Lancaster. 244  
 pages for \$19.95.

This book will help to learn to mix text, LORES and HIRES together anywhere on the screen in any combination, to make a one wire mod to open up whole new worlds of 3D graphics and other special effects and a fast and easy way to tear apart and understand somebody else's machine language programme.

BANKCARD AND MAIL ORDERS WELCOME — POST FREE

## STCWRRT ELECTRONIC COMPONENTS PTY LTD

44 Stafford Street, HUNTINGDALE, Vic 3166. Phone: (03) 543 3733  
 437 City Road, SOUTH MELBOURNE, Vic 3205. Phone: (03) 690 8333

# THE KEY TO GOOD CW

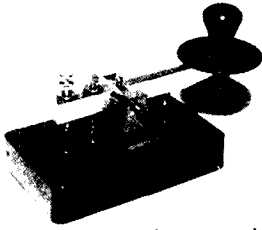

There has never been a better designed Morse Code Key — SOLID, ROBUST and BEAUTIFULLY BALANCED.

## MODEL 610 POST OFFICE PATTERN MORSE CODE KEY

Spring tension is adjustable to minimise wrist fatigue when transmitting for long periods and these quality Clipsal keys are beautifully balanced for fast, reliable operation.

**PRICE \$39** POST PAID  
AUSTRALIA

WILLIAM WILLIS & Co. Pty. Ltd.

MANUFACTURERS AND IMPORTERS  
98 CANTERBURY ROAD, CANTERBURY, VIC., 3126  
PHONE: (03) 836 0707 w01107



# The WIA need YOU

## to enroll a new member today

If EVERY member joined JUST ONE new member, YOU would be spreading the joy of amateur radio.

# Obituaries

**GLEN ARTHUR VK4GJ**

Glen Arthur became a silent key on 17th May 1983, having held the callsign VK4GJ since July 1936, licence number 4348 and after the war, since 1946. He was the holder of a First Class Commercial Operators Certificate of Proficiency and was for many years employed as an engineer in Broadcast Stations.

Glen also had letters in music and for sometime had his own dance band which played at Brisbane's Clubland which was only recently demolished.

CW was Glen's main amateur interest although he was an ardent "home brewer", adapting disposals gear and throw-away items such as toothbrush handles etc, to his needs.

With sadness we record the passing of another "OLD TIMER".

Clive VK4CC  
AR

**JOHN DICKENSON VK3VKO**

It is with deep regret that we announce the passing of John Dickenson, VK3VKO on 17th of June.

John became interested in the radio hobby in 1976 and acquired his callsign in January 1980.

He was well known on the PNG-net and made many friends all over the world also as an active international 10/10 member.

He will be sadly missed by all who knew him. Our sincere sympathy is extended to his wife and teenage daughters.

John Hill VK3WZ  
AR

**FRANK BAKER**

It is with deep regret we announce the passing of Frank Baker, brother of Joe, VK2BJX columnist of "Listening Around".

Condolences are extended to Joe and the family from the Cocktail Net.

## CAN YOU HELP?

Alan Shawsmith, VK4SS is compiling a history of amateur radio in VK4 during the years 1930-39 inclusive, for the Queensland Division of the WIA. If any reader obtained a VK4 licence during this period, or knows someone who did, Alan would very much like to hear from you.

It is sad but true that most of the OOTs who obtained a ticket in the 1920s are now SKs — and in a few years the same will be said of those licensed in the 1930s. The Queensland Division's records are not yet complete but it would appear that already over one-half of these latter are also SKs. These are the statistics no-one can avoid.

So, help the WIA record for posterity the names, calls and details of all those who pre-war took out an amateur licence. Write to VK4SS, 35 Whynot Street, West End, Qld 4101.

AR

## Stolen Equipment

ICOM 22S 2 m Transceiver and Yaesu Gutter Mount and Base stolen on 25th May, 1983.

Anyone with information about this equipment should contact the owner, John Latham, VK2KFK or North Sydney Police Station. The transceiver has a 12 pin socket on rear.

# Silent Keys

It is with deep regret we record the passing of —

**GLEN ARTHUR  
JOHN REGAN**

**VK4GJ  
VK3PEN**

# WARNING!!



Disposing of your old rig?? Please ensure it goes ONLY to someone licensed to use it on YOUR bands.

# HAMADS

**PLEASE NOTE:** If you are advertising items FOR SALE and WANTED please write on separate sheets, including ALL details, eg Name, Address, on both. Please write copy for your Hamad as clearly as possible, preferably typed.

\* Please insert STD code with phone numbers when you advertise.

• Eight lines free to all WIA members. \$9 per 10 words minimum for non-members.

• Copy in typescript please or in block letters double spaced to PO Box 300, Caulfield South 3162.

• Repeats may be charged at full rates.

• QTHR means address is correct as set out in the WIA current Call Book.

Ordinary Hamads submitted from members who are deemed to be in the general electronics retail and wholesale distributive trades should be certified as referring only to private articles not being resold for merchandising purposes.

## TRADE HAMADS

**23 CM LOOP YAGIS AND POWER METERS:** semi rigid coax PTFE PC board, Waveguide, Flanges, Gunn and Mixer diodes and our 3 cm transceiver module are a few items from our lists. SAE to MICROWAVE DEVELOPMENTS, 6 Nelly Road, Mount Barker, SA 5251.

**AMIDON FERROMAGNETIC CORES:** Large range for all receiver and transmitter applications. For data and price list send 105 x 220 SASE TO: RJ & US IMPORTS, Box 157, Morddale, NSW 2223 (No enquiries at office, 11 Macken Street, Oakley, 2223). PLEASE NOTE: Business closed during October.

**CB RADIOS S69:** Walkie talkies, short wave radios, military, outback, business, amateur, marine, repairs. RTTY Siemens 100 A printer S120; base mic S45; ultrasonic alarm S35; all ham bands on a single 6 ft

whip. 1.8 to 30 MHz. for base or mobile S300. aeriels. installation. demonstrations. 40 Ch CB conversions. accessories. new rigs weekly. BRIDGE DISPOSALS. 12 Old Town Plaza. opp Bankstown Railway Station. NSW. Mail order service and all enquiries to 2 Griffith Avenue. Roseville. 2069. or phone Sam VK2BVS. 7 pm to 9 pm only on (02) 407 1066

**NOVELTY WALL PLAQUE/ASH TRAY.** Special design for Australian radio amateurs individually personalised with your call sign (refer AR Showcase. May 1982). Fully glazed with high quality deep golden brown finish. also available with gold etching. An ideal gift to an amateur friend or just something different for the shack or lounge room. Enquiries to PAM SAXON. VK3NSB. 77 Edithvale Road. Edithvale. Vic 3196. Phone: (03) 772 1975. (Wholly made in Australia).

**PANELS/LABELS:** Custom made project front panels. labels for electronic and home use. Metal or plastic base. For further information send SASE to R N SINCLAIR. PO Box 323. Coogee. 2034. Ph: (02) 664 1306

**FREE — VIC**

**AVAILABLE FREE TO ANY RADIO CLUB** or any amateur prepared to collect from QTH. Issues of AR 1972 to 1980. Approx 75 issues of "New Scientist" magazine 1979/80. George Cranby. VK3GI. Box 22. Woodend. 3442. Ph: (054) 27 2576.

**WANTED — NSW**

**AUSTRALIAN RADIO SERVICE MANUALS.** Also Wireless Weekly and Australasian Radio World magazines. Also pre 1940 radios and components. Brian VK2EFD. Box 131. Cooranbong. 2265. Ph: (049) 77 2178.

**CIRCUIT DIAGRAM AND OWNERS MANUAL.** Also any mods (or reference to mods) for Kenwood TR-3200 UHF port tcvr. Gladly pay copying costs. David Flynn. VK2YYN. QTHR or ph: (02) 622 4694.

**WANTED — VIC**

**RECORDS** — I collect 78s of Jazz and popular music of 1920s and 30s. Can anybody help? I will buy your old 78s and make you a good quality tape copy if desired. VK3NJ. QTHR or ph: (03) 546 4924.

**TYPE 3 MARK 2 TX-RX.** Complete. Also Kenwood spkr. SP230. SP820 or similar with audio filters. Ken VK3ZFI. QTHR or ph: (03) 580 5347.

**URGENTLY NEEDED.** Geloso 3 gang tuning cond as used for 807 plate tuning in Geloso Tx. OTs please check your junk box. Leo. VK3YX. QTHR or ph: (03) 232 9422.

**WANTED — QLD**

**EIMAC 8874.** VK4WR. QTHR or ph: (071) 41 1315

**HANDBOOK AND/OR MAINT MANUAL** for ICOM IC 22S. Buy or borrow for copying. VK4AAC. QTHR or ph: (07) 390 6423.

**HUSTLER 5BTV.** 803 or 4-400A bases and oil filled high voltage caps for linear PSU. Details to VK4SZ. QTHR or ph: (070) 61 3286.

**KENWOOD TS506V6** m transvert to suit TS520S. Must be first class order complete with manual and leads. Write VK4KG0. QTHR or ph: (079) 27 1442 after 6pm.

**FOR SALE — NSW**

**COMPLETE SSB Tx 52.** 144. 432 MHz. 350 W out. EIMAC triodes. R Graham. Ph: (02) 642 0122.

**DECEASED ESTATE** of Mac. VK2BCM. late of Dubbo. FT101E VGC S550. FL1000 linear VGC S300. R1000 VGC S400. All in orig cartons with h'books and serv manuals. Heathkit Model 0-12 5" CRO \$100. Inquiries Jim. VK2AJ0. QTHR or ph: (068) 82 2685.

**ICOM IC-720A HF SSB/CW tcvr.** 0-30 MHz coverage. Tx and Rx. Factory installed. Also improved variable noise blank. AM and CW filter. mic — late model as new. S850 ONO. Orig box. owners man supplied. Be early. Manfred Mayer. VK2RV. Box 120. Vaucluse. 2030. Ph: (02) 371 8854.

**MONOBAND YAGI** for 15 m. 3 elements. S40. Price firm. VK2DET. QTHR or ph: (047) 87 7003.

**SWAN 350** with power supply and PTT mic. 400 W PEP. Works well. S300. VK2BPO. QTHR or ph: (02) 713 1831 AH.

**TEN TEC ARGONAUT 515.** 210 power supply. 208A notch and CW filter. 645 keyer. All match with manuals. S450 ONO. Sony ICF 2001 as new. box and manuals. S160 ONO. Glen Torr. VK2EGT. Leave message at ph: (02) 498 2164.

**YAESU FT101E tcvr.** FV101B VFO. spare finals. manuals. ext digi display project 80% complete. VGC. Little use S700 ONO. RTTY. Mod 15 print. Mod 14 T/D. Mod 14 reperfector and 1200 VA stepdown tranny. spare keyboard less base for the T/D and patch box for local loop operation S150 ONO. Peter. VK2DRK. QTHR or ph: (067) 42 0966 AH.

**YAESU FT107 DMS** 10-160 m incl WARC bands. 12 mems. AC/DC. scan hand mic. AM filter fitted. instruct man. As new. S800. VK2NAU. QTHR or ph: (02) 774 2464.

**FOR SALE — VIC**

**COLLINS 75S** — 3A Rx. 14 + 14 bands. EC. Speak. manual. spare valves S400. TCA T5223 Rx. 30-1 MHz bands. 1 kHz readout. manual. spare valves. EC S300. G Himolij. 118 Wilson Road. Newcomb. Geelong. 3219. Ph: (052) 48 1410.

**FT 107 m YAESU Txcvr** 160-10 m with DM mem — no WARC bands. YM-38 dynamic mic — scan type. all S720. Werner Wulf 2 el 10-15 m beam S90. Chirnside vert CE-5-SS80/10 m S70. Frank. VK3ZJ. QTHR or ph: (03) 598 4711.

**IC2022 m SSB tcvr.** Fitted with 4 xtals. covers 144-144.8 MHz. No mods. With h'book. S140. VK3RT. QTHR or ph: (03) 288 5611.

**ICOM IC-21A 2 m FM.** 10 W. xtals for 5 repeat and 5 simplex Chnls. With mic. h'book. AC/DC cable. S150 ONO. VK3BY0. QTHR or ph: (03) 337 0425 AH.

**SIGNAL GENERATOR VHF AWA 25-50 MHz.** Type 6RF490 very good construction. Would make 1st class VFO S25. Ron. VK3ZRR. QTHR or ph: (059) 86 1580.

**STEPPING MOTORS** American SLO-SYN. M092-FC08. 1.8 degrees step angle. 3 V-4 A. (3) new in pack S100 ea ONO. Ph: (052) 61 3144.

**TRANSCEIVERS.** 6 m SSB. HM brew SS. 6 digi dial. 9 MHz KVG filter. 20 W PEP output. Built in reg DC supply. Professionally built. Comm appearance. Ex Tx/Rx performance. Inc circuits etc S185 ONO. 2 m SSB tcvr similar to 6 m rig. No pwr supp. 12 V DC 15 W PEP output. Incl circuits etc S115 ONO. Eddystone mod S870 Rx 150 kHz — 18 MHz. AM only. Slide rule dial. 230 V AC. Circuit incl S45 ONO. VK3AOM. QTHR or ph: (03) 592 2168 alter 6 pm.

**YAESU FL-2000B** linear amp. PC S450. VK3AUT. QTHR or ph: 890 5206

**YAESU FT 78.** As new with mic & inst book. Little use S475 ONO. John. VK3NPB. ph: 754 3966.

**YAESU FT707** comp with mic. inst and service mans. CB Xtals fitted. VGC S600. VK3KCB. ph: (03) 579 3503.

**FOR SALE — QLD**

**EIMAC 3-1000Z S495 ONO.** SK500 air system socket to suit S475 ONO. Both S950 ONO. Save S200. Orig packing never used 1 kW ground grid lin RF O/P with applic notes. Ring for info. Ph: (07) 57 5496.

**FR 101/0 DIGI Rx.** All old bands 160-2 with some broadcast bands. Extra 2.1 kHz filter and CW 500 Hz. FL101 Tx. Old bands but room for 2 more. Incl RF

processor. spare finals. Both in orig cartons S900 the two or offers. VK4VU. QTHR or ph: (071) 41 1466.

**HEATHKIT HW101 SSB tcvr.** 80-10 m with HP23B power supply and h'book. GC S285. Freight extra. VK4AAC. QTHR or ph: (07) 390 6423.

**IC 502** — 6 m portable. mic and inst book. VGC. used only as base station S180. VK4KAL. QTHR or ph: (071) 85 4168 nights only.

**TS 130 V LOW POWER HF tcvr.** 80-10 m incl WARC bands. Rarely used in GC. Orig packing with manual. Ross. VK4AQK (QTHR as VK4KRM 1982/83 Call Book) or ph: (075) 65 1445 weekends only.

**FOR SALE — SA**

**KENWOOD TS520S SSB/CW tcvr** with SP 520 spkr and MC50 base mic. Used as Rx S490. VA-23 Rank Arena colour video camera adaptor. (new) S50. Peter. L50582. QTHR or ph: (085) 22 3967.

**FOR SALE — WA**

**MIRAGE B10B VHF** all mode amp with 10 dB preamp. 10 W input/80 W output. S180. Phil. VK6SF. QTHR or ph: (098) 51 1670.

**YAESU FT7 HF MOBILE tcvr.** mobile bracket. mic etc S350. ICOM IC502 6 m SSB port S150. Will pay freight. Nigel VK6KHD. QTHR or ph: (091) 85 1779.

**ADVERTISERS' INDEX**

AMATEUR RADIO ACTION ..... 6  
 ATN ANTENNAS ..... 59  
 BAIL ELECTRONIC SERVICES ..... IBC  
 BBC WORLD SERVICE ..... IFC  
 DICK SMITH ELECTRONICS ..... 2 & 3  
 EMTRONICS ..... 4 & 5  
 GFS ELECTRONIC IMPORTS ..... 32 & 33  
 HAMRAD ..... 56  
 HIGH TECHNOLOGY COMPUTER SYSTEMS PTY LTD ..... 46  
 IAN J TRUSCOTT ELECTRONICS ..... 31  
 ICOM AUSTRALIA PTY LTD ..... BC  
 K BRUCE SMITH ..... 49  
 MAGPUBS ..... 10, 38, 43 & 45  
 NOVICE LICENCE — VK2 ..... 46  
 PARAMETERS PTY LTD ..... 62  
 RAKON AUSTRALIA PTY LTD ..... 49  
 STEWART ELECTRONIC COMPONENTS PTY LTD ..... 62  
 TRAEGER DISTRIBUTORS (NSW) PTY LTD ..... 19  
 TRIO-KENWOOD (AUSTRALIA) PTY LTD ..... 57  
 VAINS ANTENNA SERVICES PTY LTD ... 49  
 VICOM INTERNATIONAL PTY LTD ..... 7  
 VK6 DX CHASERS CLUB ..... 6  
 WATCHMAN ELECTRONICS ..... 19  
 WERNER & G WULF ..... 63  
 WILLIAM WILLIS & CO PTY LTD ..... 63  
 WILLIAMS PRINTING SERVICES PTY LTD ..... 51





# FT726 V/UHF ALL MODE TRIBANDER

- USB, LSB, FM, CW modes
- 10 watt RF output on two metre (6 metre, 70 centimetre units optional)
- 11 memories store mode as well as band
- Programmable limited band seen between memories
- Satellite I.F. unit (optional) for full duplex cross-band
- Squelch on all modes
- GaAs FET RX pre-amp in 70 centimetre unit



**BAIL ELECTRONIC SERVICES**  
**38 FAITHFUL STREET, WANGARATTA 3677**  
Telephone: (057) 21 6260 — Telex: 56880  
**DISTRIBUTORS AND AGENTS IN ALL STATES**

Stan Roberts  
and Staff —  
VK3BSR



# FT980 HF ALL MODE COMPUTER AIDED TRANSCEIVER

Built-in computer control using 8-bit microprocessor  
(80C85)



- General coverage RX 150KHz-29.99MHz
- Power output 100 watt SSB, CW; 25 watt AM; FSK
- Two independent RX front-ends using JFets
- 12 memory channels storing mode and frequency
- Rear panel connections for transverter, linear amplifier and external microcomputer interface



**BAIL ELECTRONIC SERVICES**  
**38 FAITHFUL STREET, WANGARATTA 3677**  
Telephone: (057) 21 6260 — Telex: 56880  
**DISTRIBUTORS AND AGENTS IN ALL STATES**

Stan Roberts  
and Staff —  
VK3BSR

# IC-271A

25 Watts of FM, SSB, CW for 2 Meters

**NEW!**



Arriving soon — Contact ICOM for details

ICOM presents the most advanced all mode, two meter base station available today... the IC-271A.

25 watts of power from 12 VDC or from 240 VAC with the optional internal power supply/32 full function memories/multimodes/subaudible tones/PLL locked to 10Hz/high visibility, multi-color fluorescent display/RIT readout/scanning/dual VFO's/new size.

25 watts. Now a 2 meter base station with 25 watts of power and an optional internal power supply. The IC-271A is a complete station.

**32 full function memories.** Each memory holds frequency, offset, offset direction, mode, and subaudible tone. Frequency, tones and offset are selected by rotating the main tuning knob.

**Subaudible tones.** Subaudible tones are selected by rotating the main tuning knob and may be stored into memory.

**PLL locked to 10Hz.** Extremely low noise and a good signal-to-noise ratio PLL allow synthesizer lock to 10Hz.

**High visibility display.** ICOM's new high visibility, multi-color display gives easy to read

at-a-glance display of frequency, mode, offset, VFO in use, memory channel, and RIT offset direction and amount.

**Scanning.** The IC-271A can scan memories, programmable sections of the band, or modes. Mode-S scan is a mode scan and can be used to scan memories with a particular mode or to lock out frequencies continuously busy so that the receiver will not stop at that memory channel each time.

**Dual VFOs.** ICOM's dual VFO system is now even more versatile with the ability to transfer from memory to VFO. This allows frequencies from the tunable

memories to transfer directly into another memory without moving a VFO to the new frequency first.

**New size.** Only 11¼"W x 4¾"H x 10¾"D the IC-271A is styled to look good and engineered for ease of operation.

**Other features.** To make the IC-271A functional and easy to use, ICOM has incorporated many asked for features: UP/DN buttons, dial lock, switchable preamplifier, duplex check, all mode squelch, receive audio tone control, S meter, center meter, computer interface, and 7 year lithium battery memory backup.

Discover a new deal with  
ICOM AUSTRALIA PTY. LTD.

7 DUKE STREET WINDSOR 3181  
VICTORIA, AUSTRALIA  
TEL: (03) 529 7582 TLX: AA 35521 ICOMAS



The World System

WARNING: When purchasing an ICOM unit, please confirm that you are dealing with an Authorized ICOM Dealer, as the ICOM Warranty applies only to units supplied by ICOM Australia Pty. Ltd., to Authorized ICOM Dealers.

# AMATEUR RADIO

VOL. 51, NO. 9, SEPTEMBER 1983

Registered by Australia Post — Publication No. MBH 0569

JOURNAL OF THE WIRELESS INSTITUTE OF AUSTRALIA



New Repeater Earns Its Keep

Digi-Control for IC-720A

Five-Eighths Vertical for 6m

John Moyle from an Island

Spratly Island by a Survivor

WIA Video Tape Catalogue



**emtronics**

EMTRON C3  
Retail Division of EMONA ELECTRONICS P/L  
649 George Street, Sydney, NSW 2000  
Phone 211 0531

CORRESPONDENCE & MAIL ORDERS:  
Box K21, Haymarket, NSW, 2000, Australia.  
WRITE, PHONE OR CALL IN!

# NEW TELEREADER **CWR-675EP** BRINGS NEW DIMENSIONS TO SHORT WAVE MONITORING

This new wonder machine is especially designed for the inquisitive shortwave listeners, amateurs, professional monitoring institutions, Government, Press, etc.

An entire new world is opened to those who are willing to explore it. Monitoring weather, press, ship traffic, embassies, interpol and many unusual services can prove to be fun! And for permanent record, just press the button and the inbuilt 40-column printer will do the rest for you. The CWR-675E and CWR-675EP are similar except that the CWR-675EP has the built-in printer.



## **CWR-675EP**

The CWR-675EP is a compact electronic communications terminal designed for reception of Baudot and ASCII Radio Teleprinter (RTTY) signals as well as Morse code (CW) signals. The CWR-675EP includes built-in RTTY and Morse demodulators, video generation circuits, and 5" diagonal measure video screen. The built-in video screen of the CWR-675EP eliminates the need for a separate video monitor in receive-only applications. Moreover, 40 columns thermal printer kit PK-675 can be added optionally to the unit. The CWR-675EP no longer needs any external unit. And, like the other TELEREADER terminals, the CWR-675EP runs on 12 VDC.

This makes the CWR-675EP easily usable in mobile or portable locations where AC power is not available. The internal RTTY demodulator allows selection of all three standard shifts (170, 425, 850) for reception of "High Tones" (U.S. Standard) or "Low Tones" (IARU Standard). A parallel ASCII printer output is provided for connection to an external receive printer in addition to the optional built-in printer. TTL level (low voltage) input and output connections are provided in addition to the normal audio input from the receiver.



CWR-675EP (with printer) \$1095.



# AMATEUR RADIO

Registered Office:  
3/105 Hawthorn Road,  
Caulfield North 3161.  
Tel. (03) 528 5962

Photograph by Jeanette Wiley VK2EJW

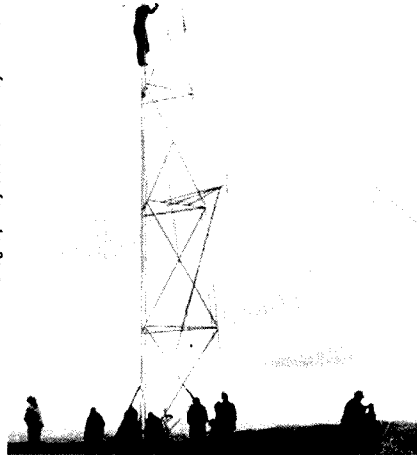

**Glen Innes Repeater Site. Refer story page 12.**

## DEPARTMENTS

Advertisers Index .....	64
AMSAT Australia .....	48
Awards-Amendments to Australian Awards .....	31
Club Corner — Gold Coast Amateur Radio Society .....	53
Contest — Rules of Novice, JLRS, ALARA, RSGB CW & Phone, Results RSGB RTTY .....	50
Education Notes .....	53

Equipment Review — ICOM IC-R70 .....	22
Five-Eighth Wave .....	56
Forward Bias .....	56
Hamads .....	63
Here's RTTY! — RTTY Demodulator .....	38
How's DX .....	34
International News — Special Station & USA Callsign System .....	37
Intruder Watch .....	40
Ionospheric Predictions .....	60
Letters to the Editor .....	58
Magazine Review .....	30
Main QSP — Six Metres, Part Returned .....	9
National EMC Advisory Service — ESD .....	46
Obituaries — VK2QV, VK5AWJ, VK5HN & VK5BB .....	62
Pounding Brass — Getting Rid of the Garbage .....	41
QSP .....	31, 41 & 49
Silent Keys — VK2AIS .....	63
Spotlight on SWLing .....	30
Thumbnail Sketches — Jim McDermott .....	11
VHF UHF — an expanding world .....	42
VK2 Mini Bulletin .....	57
VK3 WIA Notes .....	54
VK4 WIA Notes .....	57
Who is this Amateur? .....	16
WICEN News .....	45

## ARTICLES

August's Best Photographs .....	46
Exercise "SES Mitchell" by Ted Gabriel VK4YG .....	20
Family Radio by XYL of Arthur Russell VK6NAR .....	19
JM Field Day on an Island by Dennis Hardie VK6KOZ .....	26
JOTA — Jamboree on the Air by Tom Delandre VK2PDT .....	25
Murphy .....	47
New Repeater Earns its Keep by Jeanette Wiley VK2EJW .....	12
Open Letter from WIA Videotape Co-ordinator .....	47
Practical Digi Control Unit for the ICOM 720A by Bob Young VK4BRY ...	14
Radio Astronaut in Space by Roy Neal K6DUE .....	11
Spratly Island by Baldur Drobnica DJ6SI .....	28
Two by Five Eighth Vertical for 6m by Colin MacKinnon VK2DYM .....	17
Videotape Catalogue .....	45

## DEADLINE

All copy for November RA must reach PO Box 300, Caulfield South, 3162 no later than 23rd September.

**EDITOR**  
GIL SONES\* VK3AJU

**TECHNICAL EDITORS**  
RON COOK\* VK3AFW  
PETER GAMBLE\* VK3YRP  
EVAN JARMAN\* VK3ANI  
BILL RICE\* VK3ABP

**CONTRIBUTING EDITORS**  
MIKE BAZELY VK6HD  
RON COOK\* VK3AFW  
REG DWYER VK1BR  
BRENDA EDMUNDS VK3KT  
MARSHALL EMM VK5FN  
RON FISHER\* VK3OM  
BRUCE HANNAFORD VK5XI  
ROY HARTKOPF\* VK3AOH  
ROBIN HARWOOD VK7RH  
COLIN HURST VK5HI  
ERIC JAMIESON VK5LP  
MARGARET LOFT VK3DML  
KEN McLACHLAN VK3AH  
LEN POYNTER\* VK3BYE  
TONY TREGALE VK3QQ

**DRAFTING**  
GEORGE BROOKS  
LIZZ KLINE

**BUSINESS MANAGER & SECRETARY**  
REG MACEY

**ADVERTISING MANAGER**  
JOHN J A HILL VK3WZ

\*Member of Publications Committee

Enquiries and material to:  
The Editor  
PO Box 300, Caulfield South Vic. 3162

Material should be sent direct to PO Box 300, Caulfield South Vic., 3162, by the 25th of the second month preceding publication. Phone: (03) 528 5962. Hamads should be sent direct to the same address.

Acknowledgement may not be made unless specially requested. All important items should be sent by certified mail. The editor reserves the right to edit all material, including Letters to the Editor and Hamads, and reserves the right to refuse acceptance of any material, without specifying a reason.

Trade Practices Act: It is impossible for us to ensure that advertisements submitted for publication comply with the Trade Practices Act 1974. Therefore advertisers and

advertising agents will appreciate the absolute need for themselves to ensure that the provisions of the Act are complied with strictly.

Victorian Consumer Affairs Act: All advertisers are advised that advertisements containing only a PO Box number as the address cannot be accepted without the addition of the business or residential address of the box-holder or seller of the goods.

Production: BETKEN PRODUCTIONS  
5 Masefield Avenue, Mooroolbark, 3138.

Laser Scanned Colour Separations by:  
QUADRICOLOR INDUSTRIES PTY LTD.  
Graphic Division  
22-24 Glenvale Crescent, Mulgrave, 3170.  
Tel.: (03) 560 2222

Typesetting by: QUAORICOLOR INDUSTRIES PTY LTD.  
22-24 Glenvale Crescent, Mulgrave, 3170.  
Tel.: (03) 560 2222

Photographic film and processing material courtesy  
AGFA-GEVAERT LTD AUSTRALIA

Printers: WAVERLEY OFFSET PUBLISHING GROUP  
Geddes Street, Mulgrave, 3170  
Tel.: (03) 560 5111

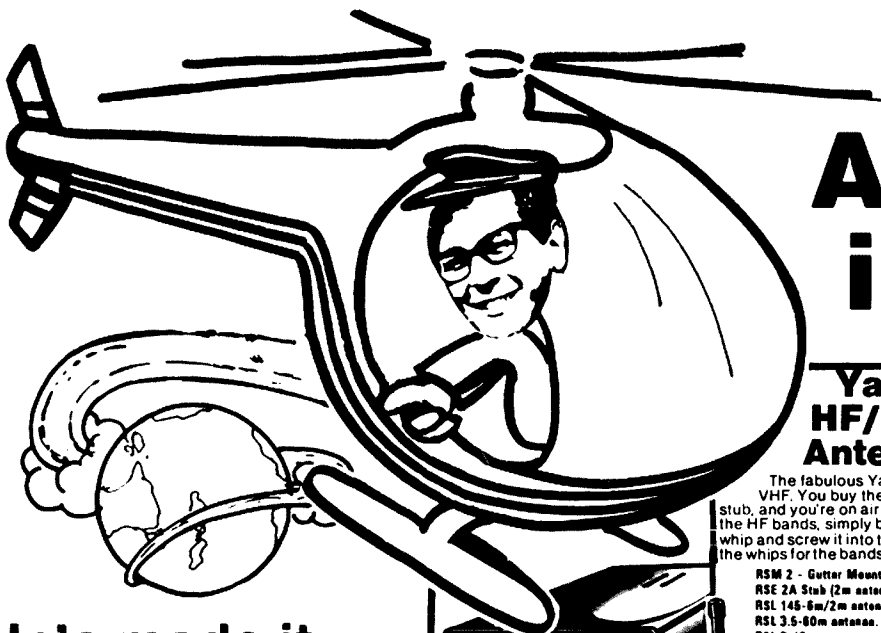

# Amateur in Dick's

## He's made it

Just as we went to press, Dick Smith, VK2DIK, completed the final leg of his solo round-the-world helicopter flight by landing at the Bell Helicopter factory at Fort Worth, Texas USA.

During this long and gruelling flight, Dick captured several world records and 'firsts' including:

- First solo helicopter flight around the world.
- First single engined helicopter crossing of the Atlantic.
- First helicopter flight around the world not escorted by a fixed wing aircraft.

When asked 'Why?' Dick said that he wanted to find out how the early aviators felt. And despite the modern Bell Jetranger helicopter having all modern safety & navigational aids possible, Dick at times was absolutely exhausted from the sheer effort required in flying through strange areas.

Part of the problem was the fact that flying any aircraft into a foreign country requires the same amount of work - whether it is a tiny helicopter or a massive Jumbo. But on a Jumbo the tasks are shared. Dick did it all alone. Then, of course, there was the fatigue of flying over vast tracks of ocean.

This is where amateur radio really came into its own.

“Every step of the way I was in contact with amateur operators all over the world, I'd like to say a huge 'thank you' to all the amateurs who contacted me. And to those who didn't - but I knew were monitoring just in case, if ever it needed proving its worth to me, this flight was it. And yes, I will be QSLing all those contacted who send me cards. Just as soon as I get my feet back on the ground and have a chance to start answering the huge pile of mail that has built up since I left.”

“Thank you amateurs.”

*Dick Smith*



### SUPER COMPACT ALINCO ELH-230E

Don't pay more! This amp does a better job and will cost you less. This is an all mode, high efficiency linear amplifier for 2 meters. 30 watts output with only 3 watts in 13.8V DC supply makes it perfect for mobile use. Dual time constant for SSB or FM operation. Reverse polarity protection too. Works great with our FT-290R and FT-208B or any 2M transceiver with up to 3 watts out. The best value in Australia! Cat D-2546

30 WATTS

ONLY \$89.50

**MICRO ELECTRONICS BREAKTHROUGH!**



### 2 METRE FM-FT230R

The FT-230R uses the latest breakthrough in microelectronics, providing you with unbelievable flexibility with simple operation and a full 25 watts output. Advanced micro-processor control gives you 5 or 10 KHz steps, full 144-148 coverage, 10 memories, 2 VFO's and built-in memory backup. The most incredible 2 metre FM around and you won't believe its small size! Cat D-2893

WHY PAY MORE?

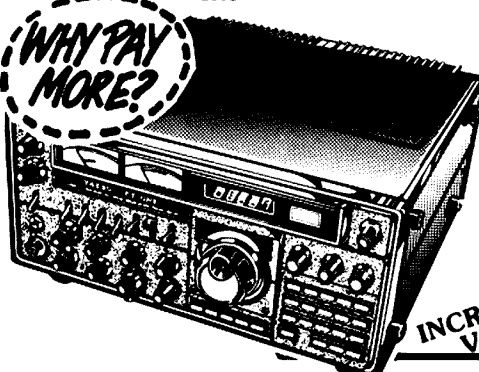

## Yaesu Quality HF/VHF Mobile Antenna System

The fabulous Yaesu antenna system for HF and VHF. You buy the gutter mount base and 2 metre stub, and you're on air on 2m immediately. As you want the HF bands, simply buy that band resonator/antenna whip and screw it into the 2m stub. You only have to buy the whips for the bands you want. Go mobile with Yaesu.

RSM 2 - Gutter Mount	Cat D-4100	\$29.95
RSE 2A Stub (2m antenna)	Cat D-4102	\$12.95
RSL 145-6m/2m antenna	Cat D-4104	\$32.50
RSL 3.5-60m antenna	Cat D-4110	\$28.00
RSL 7-40m antenna	Cat D-4112	\$28.50
RSL 14-20m antenna	Cat D-4114	\$28.50
RSL 21-15m antenna	Cat D-4116	\$28.50
RSL 28-10m antenna	Cat D-4118	\$28.50

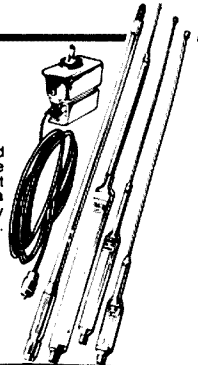

## TEN MEMORIES & SCAN FACILITIES YAESU FT208R

COMPLETE WITH NICAD BATTERY & CHARGER

The FT-208 R transceiver brings a new flexibility to today's active 2m operator. An easy to read LCD display is coupled with a 4-bit microprocessor, bringing 10 memories and a scanning function. Because of LCD you get extra long battery life. Only with Yaesu can you get all the features at such an economical price. Cat D-2889



### NOW PA3 Charger Unit

\$359  
WAS \$388

A DC-DC converter that simply plugs into your cigarette lighter. Gives 10.8V main power plus a separate charging current for the Ni-Cads. Use with FT208 & FT290. Cat D-2899



\$32.50

## Genuine Yaesu Amateur Radio Mics

**YD148 Dual Z Desk Mic**  
Smart styling-great performance and dual impedance versatility! East action P-T-T bar, with self-locking position for those long QSO's. Heavy base so it won't slip around on the desk. Impedance is set by a switch on the rear of the mic base. Cat C-1118

\$49.95

**YE7A Standard Model**  
The favourite, suits not only Yaesu but dozens of others as well. Cat C-1117

\$16.95

**YM38 Dual Z desk type with Scanning**  
Similar to above Yaesu desk mic, rphone also with switch for dual impedance. This one also has extra push buttons for use on scanning transceivers. May be used on other transceivers by using different pins. Cat C-1113

\$55.00

## FT ONE \*

You've dreamed of owning a transceiver like this. Now your dreams can come true! Compare the Yaesu FT-ONE with other multi-band transceivers, you'll find it offers much, much more - and at a lower price! If you want a transceiver that commands the bands, you won't do better than buying your Yaesu from Dick Smith Electronics, Australia's leading factory - approved Yaesu agent with full back-up and service facilities. Cat D-2852

INCREDIBLE VALUE \$1995

# DICK SMITH Electronics



# radio proves it's value round-the-world flight!



## HI POWER YAESU HF TRANSCEIVER SP102 FT102 \* FC102

Features a large 120mm hi fi speakers with selectable low and high-cut audio filters, allowing 12 possible response curves. Headphones can be connected to the SP-102. Filter allows audio tailoring for each bandwidth and mode of operation. Two input jacks provided. Cat D-2883

A fantastic new, super high performance HF transceiver has arrived. The FT102 has all the amateur bands PLUS the new WARC bands. Special high voltage JFET RF amplifier provides exceptional dynamic range - well beyond 100dB. Adjustable Noise Blanker even works on the 'Woodpecker'. Three 6146B final tubes provide remarkable emission purity - plus big power 240W. Has IF Width and IF Shift and the best notch and audio peak filter you've ever heard! You must see this one to believe it!  
Cat D-2880

This newly designed antenna tuner is ideally suited for use with the FT-102 station. Power handling capability of 1.2kW. Bandswitch L-C pi-network will match a wide variety of antennas (including a single wire) to your transceiver.  
Cat D-2881

ONLY  
**\$7250**

WAS  
**\$1225**

NOW  
**\$1049**  
\*Optional FM Board.  
Cat D-2882 **\$72.50**

ONLY  
**\$369**

## INCREDIBLE VALUE ON ANTENNAS

### V5JR 5 Band Vertical

If you're typical of most amateurs, you live in the suburbs where space is at a premium. You need an effective antenna but there are usually objections to putting up a beam. You need our V5JR vertical. Virtually unnoticeable in your backyard, you'll be able to pursue your hobby without worry! Cat D-4305

VALUE  
ONLY

**\$99<sup>95</sup>**

### Tri-band Beam

Mini-Multi's MSC33 offers top performance 10, 15 & 20 metres and its compact design makes it ideal where space is a limiting factor. Durable and lightweight, it is ideal for rooftop or lightweight tower installations. Featuring separate and matched HI-O traps for each band. It feeds with 50ohm coax and delivers maximum front to back ratio. The MSC33 has a SWR of less than 1.5:1 at resonance.  
Cat D-4303

- Maximum element length ..... 6.3 metres
- Boom Length ..... 3.8 metres
- Weight ..... 8 kilograms
- Rated at 600 watts PEP
- Average gain ..... 8dB

AMAZING  
VALUE **\$349**

The most up-to-date Communication radio in the world

## FRG 7700/ SW



For the professional monitor or serious SWL! If you want the best, you want the Yaesu FRG 7700 SW. Complete shortwave coverage with ease of operation the others only dream about. Just look at these features:

- 2MHz - 30MHz continuous
- ALL Mode - including FM (great for working with converters!)
- Digital frequency readout, with digital clock
- Timer for turning receiver on/off plus control of external equipment (such as tape recorder)

Ask for a copy of our brochure showing you what the FRG 7700 SW can do for you. Cat D-2841

FRG 7700 HF 150kHz - 30MHz version also available. Cat D-2840

Optional Memory Unit **\$149<sup>50</sup>**  
Gives you single button re-call of any of 12 chosen frequencies. Simple connection. Instructions included. Cat D-2842

### VHF CONVERTER

There's a lot more to listening pleasure than just the HF bands! Listen in to the exciting world of VHF radio, all the services, amateurs etc, etc. 50-59, 118-130, 140-150kHz. Cat D-2844

**\$149<sup>50</sup>**

### ANTENNA COUPLER

The FRG 7700 works with many types of antennas, but best with a low impedance one. This coupler ensures optimum performance always. Cat D-2843

**\$95<sup>00</sup>**

### ACTIVE ANTENNA

Don't want to string up an antenna outside? Use the active antenna - powerful preamplifier plus a whip antenna will pull in stations you didn't think possible. Cat D-2845

**\$89<sup>50</sup>**



## A thrifty HF Transceiver FT-77 \* Cat D-2915

With all solid state 'no tune' circuitry, the FT-77 is ideal for today's amateur on the move. With Yaesu's new 'CAD/CAM' circuitry it represents the 'state of the art' in reliability, simplicity and economy.

- All amateur bands including WARC
- 12 volt operation (240V with optional supply)
- Nominal 100 watts output
- SSB & CW operation (FM optional)
- 0.3uV sensitivity (SSB & CW)

\* Computer aided design, computer aided manufacture.

### FM Unit

Plug in PCB to give your FT-77 transmit and receive. Great with converters or for working W & K on 10m!  
Cat D-2918

ONLY  
**\$44<sup>95</sup>**

### Marker Unit

Accurate marker to help you make sure you're not trespassing outside your band. An absolute must!  
Cat D-2919

ONLY **\$15<sup>95</sup>** GREAT VALUE ONLY **\$799**

SAVE \$120  
AROUND

ON THIS

## EXPERIMENTERS MOBILE RADIO

WAS  
**\$160**  
NOW  
ONLY  
**\$49<sup>95</sup>**



Here's one for all the amateurs, servicemen, technicians etc. Famous National brand 9 channel 27MHz CB. Ideal for conversion to 10 meters, use as spare parts, experiment with etc. We over-bought on this model and we MUST reduce stocks - our loss is your gain. Take advantage of our mistake and save a fortune! Cat D-2500

WARRANTY NOT AVAILABLE THIS MODEL

A566EADPS/RW

**STOP PRESS:**  
BUY NOW AT DUTY-FREE PRICES  
\* New Government regulations mean 30% duty must be added to new shipments of Amateur radio transceivers.

Dick Smith Ham Shacks are located in the Dick Smith Stores listed below.

You'll find a licensed amateur at each Shack.

- Sydney 125 York St 267 9111
- Sydney 6 Bridge St 27 5051
- Gera Hill 162 Pacific Hwy 439 5311
- North Ryde 1 Lane Cove & Waterloo Rds 88 3855
- Gasford 315 Mann St 25 0235
- Melbourne 399 Lonsdale St 67 9834
- Richmond Bridge Rd 428 1614
- Springfield Springsvale & Dandenong Rds 547 0522
- Brisbane: Baranda 166 Logan Rd 391 6233
- Townsville Ingham Rd & Cowley St West End 72 5722
- Toowoomba Bowen & Ruthven Sts 38 4300
- Adelaide: Wright & Market Sts 212 1962
- Perth Wilam St & Robson Ave 328 6944
- Cannington Wharf St & Albany Hwy 451 8666
- Hobart 25 Barrack St 31 0800

# Introducing the **hy-gain**® **EXPLORER 14**

## Remarkably Compact, High Performance Broadband Tribander with Quad-Band Option

### New Para-Sleeve Design

The Explorer 14 is a new antenna design we call PARA-SLEEVE which uses an "open-sleeve" dipole optimized for maximum bandwidth and directivity. Here is the concept. A central dipole, driven directly by the transmission line, has a 1/2 wave resonance on the lowest operating frequency. Two shorter sleeve elements, tightly coupled to the central dipole, modify its impedance to create a 1/2 wave resonance to the highest operating frequency. This para-sleeve system is expanded by the addition of 15 meter traps and 20 meter element tips. A revolutionary new concept for HF tribanders. So unique, we've applied for a patent.

### Broadband Performance

The Explorer 14 will load solid state transceivers to maximum output with VSWR below 2:1, eliminating the need for an antenna tuner. You'll have edge to edge broadband

performance on 20, 15 and 10 meters with gain and front-to-back ratio competitive to giant tribanders that cost twice as much or more. You'll be able to work stations you cannot even hear with a dipole antenna. And, the Explorer 14 handles maximum continuous legal power with a respectable safety margin.

### Short Boom Save Space and Money

If your space or budget was too limited for a long boom tribander, chances are the Explorer 14 will fit both. The boom is only 14' (4.3 m) long and the turning radius requires only 17'3" (5.3 m). The compactness of the Explorer 14 reduces its overall weight and windload surface so you can mount it on a roof tripod, a mast or a tower. For Example, the Hy-Gain CD-45II rotator and HG52 tower are a perfect match for the Explorer 14. This saves you the cost of an extra heavy duty rotator and tower.

### Superior Construction

The Explorer 14 includes passivated stainless steel hardware and heavy gauge, pre-formed element and mast brackets. High grade 6063-T832 thick wall swaged aluminum tubing is used throughout. A BN86 balun is included and a new Beta Multi-Match provides DC ground to reduce lightning hazard and precipitation static. It's a rugged, easily assembled antenna that survives winds to 100 mph (160 km/h).

### Quad Band Option

You can add a fourth band, either 30 meters or 40 meters to the Explorer 14 with the QK-710 kit. A kit that attaches to the central dipole and is easily adjusted for either 30 meters (WARC) or 40 meters at minimal extra cost.



Lew McCoy, W1ICP, is among the most authoritative writers in amateur radio. For over 30 years he served on the ARRL technical staff with his last position as assistant senior technical editor. Presently he is the technical writer for CQ magazine. Here is what he had to say about the Explorer 14:

"In my opinion, with Explorer 14, Hy-Gain produced a truly high gain, high performance antenna in a small package. The "para-sleeve" design provides the amateur a whole new ball game, particularly in the area of broadbanding. I was really surprised when I actually verified the gain, front-to-back and bandwidth during my recent visit to the Hy-Gain labs and antenna range in Lincoln, Nebraska. The Explorer 14 is a winner."

### Specifications:

	Electrical		
	20M	15M	10M
Frequencies of operation:			
Under 2:1 VSWR (MHz)	14.0-14.35	21.0-21.45	28.0-29.7
Maximum F/B Ratio (dB)	27	27	21
Maximum Gain (dB)	7.5	8.0	8.0
Maximum Power		Maximum Legal DC Ground	
Mechanical			
Boom Length	14'1 1/2" (4.3 m)		
Turning Radius	17'3" (5.3 m)		
Net Weight	43 lbs. (19.5 kg)		
Wind Surface Area	7.5 sq. ft. (.69m <sup>2</sup> )		

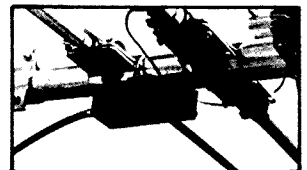

Feed point and balun

## **TELEX** *hy-gain*

### AUDIO TELEX COMMUNICATIONS PTY LTD

Incorporated in NSW  
 Head Office: 1 Little St, Parramatta. PO Box 421, 2150.  
 NSW. Tel: 633 4344. Telex AA 22251.  
 Regional Offices: 7 Essex Rd, Mt Waverley,  
 PO Box 468, 3149. Vic.  
 Tel: 277 5311. 42 Commercial Rd, Fortitude Valley,  
 PO Box 871, 4006. Qld. Tel: 52 1312



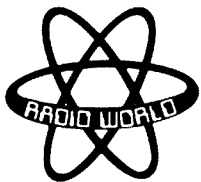

# RADIO WORLD PTY LTD

81 NEWCASTLE STREET, FYSHWICK A.C.T. 2609  
PHONE 062-806550. TELEX AA62097

**KENWOOD  
TS430S  
HF  
TRANSCEIVER**

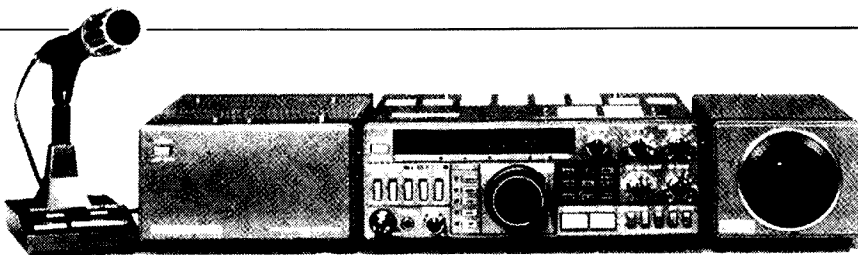

MC-60A

PS-430

TS-430S

SP-430

**ICOM  
IC-R70**

**COMMUNICATIONS  
RECEIVER**

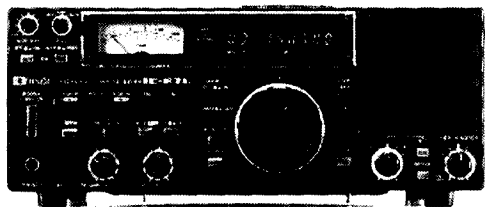

**NEW IC-R70  
Commercial Grade Communications Receiver**

**YAESU  
FT-980  
COMPUTER  
CONTROL  
TRANSCEIVER**



HF MICROPROCESSOR CONTROL  
TRANSCEIVER FT-980

## CB RADIOS — MARINE RADIOS



**PRESIDENT 718  
55 CHANNEL  
VHF  
SEA PHONE**

**uniden  
AX144  
27 MHz  
CB Radio**



40 CHANNELS AM-LSB-USB

We also carry a very comprehensive range of all types of all types of plugs, VHF/UHF, 'N' type, BNC, etc. We have a good range of Japanese transistors, ICs, spare parts for CB radios and car stereos. We do all types of electronic repairs and all modifications on CB radios and amateur equipment. If you can't get your unit repaired send it to us for expert repairs.

### MAIL ORDER COUPON/ENQUIRY

PLEASE SEND ME THE FOLLOWING INFORMATION  
SEND \$1.00 FOR POSTAGE ON PAMPHLETS

- TRIO-KENWOOD     ICOM     YAESU
- CB RADIOS AND CAR SOUND

NAME ..... PHONE NO. ....

ADDRESS .....

..... P/CODE .....

PLEASE SEND ME THE FOLLOWING ITEM/S

PRICE ..... FREIGHT .....

BANKCARD/C.O.D./TELEGRAPHIC TRANSFER

BANKCARD NO. ....

EXPIRY DATE ..... SIGNATURE .....

**CAR RADIOS AND STEREO  
THE ULTIMATE IN CAR HI-FI STEREOS**

**CONCORD  
HPL-532**



**CRAIG  
CAR STEREOS**



**T780 ROAD RATED XL RECEIVER/CASSETTE PLAYER**



**YAESU**  
**DAIWA**  
**ICOM**

**ATN ANTENNAS**

**BIG NAMES**

**AT ONE GREAT STORE**



**CW ELECTRONICS**

PLUS MUCH MUCH MORE

CW Electronics is the communication centre of Queensland  
Innovators and pioneers of computer RTTY ASCII CW radio  
interface in Australia

Come in and see our range

**416 LOGAN ROAD STONES CORNER BRISBANE**  
**PHN: (07) 397 0888**  
PO BOX 274 SUNNYBANK QLD 4109

**DO YOUR EYES NEED ATTENTION?**



**Why Don't You Direct Yourself To One Of Your Big Family?**

**OPTILUX**  
**Optical Dispensers & Photo Dealers**

**363 Parramatta Road, LEICHHARDT, NSW 2040**  
**Phone (02) 560 9415**

**ASK FOR BRUNO VK2BPO**

He can arrange an immediate appointment for a complete eye examination without any need of referral

**BIG RANGE OF IMPORTED FRAMES — VERY QUICK SERVICE — DISCOUNT FOR ANY AMATEUR OR SWL AND A CAMERA STORE TOO AT COMPETITIVE PRICES AT YOUR DISPOSITION**

*SEE YOU SOON*

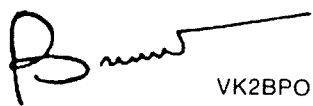

**VK2BPO**



**NOISE BRIDGE**  
**\$60 POST PAID**

Adjust your antenna for maximum performance. Measure resonant frequency, radiation resistance and reactance. Better than an SWR meter. Operates over 100 MHz. Most useful test unit in your shack.

**ANTENNA BALUNS**  
3 to 30 MHz.  
Maximum Power 300 Watts.  
Centre support.  
Ideal for Dipoles, Beams, Quads.  
S0239 connector.



**\$26**

**POWER LINE FILTER**  
240 Volt @ 10 Amp



**\$14**

1000's of Transistors — Ferrites — Hobby Kits — Tag Strips — Switches etc. Send stamped addressed envelope for full list.



**K. BRUCESMITH**  
**110 Rosemead Road**  
**Hornsby N.S.W. 2077**

**VAINS ANTENNA SERVICES**  
**PTY. LTD.**



- ★ RADIO CONTROLLED VEHICLES —
- ★ INSTALLATIONS
- ★ ADDITIONAL OUTLETS FOR TV/FM
- ★ REPAIRS TO EXISTING SERVICES

**ALL SUBURBS**

- ★ PHONE FOR ADVICE
- ★ DO IT YOURSELF KITS
- ★ M.A.T.V. SYSTEMS DESIGNED & INSTALLED
- ★ TELESCOPIC MASTING & TOWERS INSTALLED

**874 3333**  
13 McKEON RD., MITCHAM



# YAESU'S NEW HF TRANSCEIVER



## FT-77

- ALL AMATEUR BANDS  
3.5 to 29.9 MHz (including WARC)
- CW, SSB MODES (FM optional)
- 100W OUTPUT
- WEIGHT: 6 kg
- SIZE: 240(W)x95(H)x300(D) mm,  
including heat sink

### FT-77 HF TRANSCEIVER

Featuring efficient, all solid state, no tune circuitry, the FT-77 offers a nominal 100 watts of RF output on all amateur bands between 3.5 and 29.9 MHz, including the three new WARC bands. The new CAD/CAM\* techniques plus the simple design of the FT-77 add up to one of the smallest, lightest HF transceivers ever, both in your hands, and on your wallet.

The front panel control layout and operation are actually simpler than some VHF FM transceivers, with only the essential operating controls. Nevertheless, all of the essential modern operating features for HF SSB and CW are included, along with extras such as dual selectable noise blanker

Computer-aided design of the circuit boards in the FT-77 ensures the most efficient component layout possible in the smallest space, while automatic parts insertion and soldering greatly diminish the chance of human error. Reliability and quality

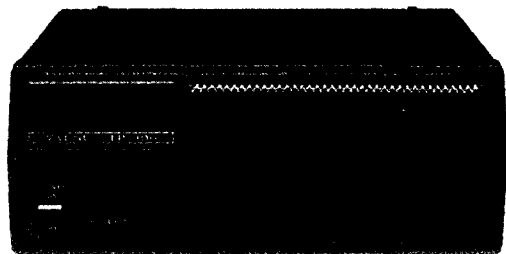

### FP-700 AC POWER SUPPLY

control are thus improved and simplified beyond the degree previously attainable in amateur equipment.

The extremely compact size and simple control layout make the FT-77 ideal for mobile operation, or as a complete base station with the optional FP-700 AC Power Supply, FV-700DM Digital Scanning VFO and Memory System, FTV-700 V/UHF Transverter and the FC-700 Antenna Tuner.

\* Computer-Aided Design/Computer-Aided Manufacture

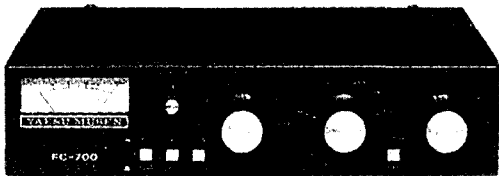

### FC-700 ANTENNA TUNER

pulse widths (designed to blank the woodpecker or common impulse noise), full SWR metering, and capabilities for an optional internal fixed-frequency channel crystal, narrow CW filter and FM Unit.



## Bail Electronic Services

38 Faithful Street,  
Wangaratta 3677  
Telephone: (057) 21 6260 — Telex: 56880



Bankcard Welcome

Stan Roberts  
VK3BSR

## COUNCIL PROBLEMS? THE ANSWER TO LIMITED SPACE

EFFICIENT ANTENNA FOR LIMITED SPACE

Both models C/4 & HQ1 cover 6-10-15 and 20 m.

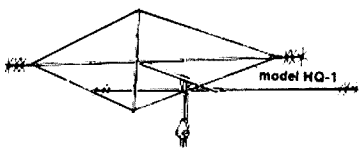
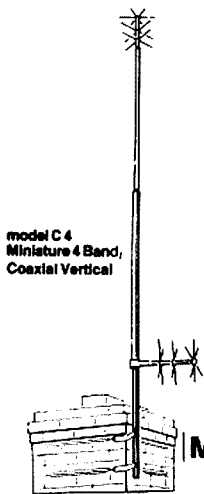

(Flats — Small Backyards —  
Caravans — Portable Ops.)

HQ1 — 1350 mm Boom  
3350 mm Elements  
Gain — 5.65 dB gain (Ref Dipole)  
NO GROUND RADIALS NEEDED  
Lightweight yet rugged  
3350 mm long

MIKE KILPATRICK  
VK2DJP

# WATCHMAN ELECTRONICS

28 Elouera Cres, Woodbine, NSW 2560  
Phone (046)26 6101

## BUTTERNUT ELECTRONICS CO.

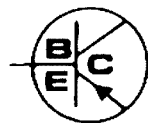

### Still More Usable Antenna For Your Money . . . Plus 30 Metres!

Butternut's new model HF6V\* offers more active radiator on more bands than any other vertical of comparable height. DIFFERENTIAL REACTANCE TUNING™ circuitry lets the 26' antenna work on 80/75, 40, 30, 20 and 10 metres and a loss-free linear decoupler gives full quarter wave unloaded performance on 15 metres. It can also be modified for remaining WARC bands.

- \* Completely automatic bandswitching 80 through 10 metres including 30 metres (10.1-10.15 MHz): 160 through 10 metres with optional TBR-160 unit.
- \* Retrofit capability for 18 and 24 MHz bands.
- \* No lossy traps to rob you of power. The HF6V's three resonator circuits use rugged HV ceramic capacitors and large-diameter self-supporting inductors for unmatched circuit Q and efficiency.
- \* Eye-level adjustment for precise resonance in any segment of 80/75 metres, incl. MARS and CAP ranges. No need to lower antenna to QSY between phone and CW bands.
- \* For ground, rooftop, tower installations — no guys required.

Suggested amateur net prices:  
model HF6V (automatic bandswitching 80-10 meters) . . . \$282  
Model TBR-160 (160 metre base resonator)

(When supplied as part of HF6V) . . . \$68

For complete information concerning the HF6V and other Butternut products, amateur and commercial, contact the sole Australian distributor:

**TAEGER DISTRIBUTORS (NSW) PTY LTD**  
PO Box 348, Moree, NSW. 2400.  
Cnr Adelaide & Chester Sts.  
Phone (067) 52 1627

\* Patented device

# COMPUTER BOOKS

TV TYPEWRITER COOKBOOK	\$16.95
HOW TO BUY AND USE MINICOMPUTERS & MICROCOMPUTERS	\$14.95
THE Z-80 MICRO COMPUTER HANDBOOK	\$17.95
USING THE 6800 MICRO PROCESSOR	\$12.95
THE CHEAP VIDEO COOKBOOK	\$11.95
FUNDAMENTALS OF DIGITAL COMPUTERS — (2ND ED)	\$15.95
MICRO-COMPUTER ANALOG CONVERTER SOFTWARE & HARDWARE INTERFACING	\$15.95
8080-8085 SOFTWARE DESIGN — BOOK 1	\$17.95
INTERFACING AND SCIENTIFIC DATA COMMUNICATION EXPERIMENTS	\$11.95
Z-80 MICROPROCESSOR PROGRAMMING & INTERFACING — BOOK 1	\$16.95
AS ABOVE — BOOK 2	\$20.95
MICROCOMPUTER INTERFACING WITH THE 8255 PPI CHIP	\$13.95
8080-8085 SOFTWARE DESIGN — BOOK 2	\$16.95
TRS-80 INTERFACING — BOOK 1	\$14.95
HOWARD W SAMS CRASH COURSE IN MICRO COMPUTERS PROGRAMMING & INTERFACING THE 6502. WITH EXPERIMENTS	\$21.95
COMPUTER DICTIONARY — (3RD ED)	\$20.95
6502 SOFTWARE DESIGN	\$17.50
INTRODUCTION TO MICRO-COMPUTERS FOR THE HAMSHACK	\$9.95
Z-80 MICROPROCESSOR DESIGN PROJECTS	\$18.95
COMPUTERS & PROGRAMMING GUIDE FOR SCIENTISTS & ENGINEERS — (2ND ED)	\$19.95
8085A COOKBOOK	\$19.95
SON OF CHEAP VIDEO	\$14.95
6801, 68701 AND 6803 MICROCOMPUTER PROGRAMMING & INTERFACING	\$18.95
TRS-80 INTERFACING — BOOK 2	\$15.95
CIRCUIT DESIGN PROGRAMS FOR THE TRS-80	\$18.50
TRS-80 INTERFACING. 2 VOLUME SET	\$24.95
TRS-80 — BOOK 1	\$16.95
MOSTLY BASIC: APPLICATIONS FOR YOUR PET	\$17.95
CP/M PRIMER	\$18.95
PASCAL PRIMER	\$21.95
PET INTERFACING	\$20.95
6809 MICROCOMPUTER PROGRAMMING & INTERFACING. WITH EXPERIMENTS	\$18.95
HEXADECIMAL CHRONICLES	\$21.95
16-BIT MICROPROCESSORS	\$19.95
INTERMEDIATE PROGRAMMING FOR THE TRS-80 MODEL I	\$13.95
THE S-100 AND OTHER MICROBUSES — (2ND ED)	\$13.95
TRS-80 — MORE THAN BASIC	\$14.95
MICROCOMPUTER DESIGN AND TROUBLESHOOTING	\$21.95
DON LANCASTER'S MICRO COOKBOOK — VOL 1	\$21.95
REAL TIME CONTROL W/THE TRS-80	\$18.95
ADVANCED 6502 INTERFACING	\$16.95
USING THE Z-80 IN THE TRS-80	\$17.95
ENHANCING YOUR APPLE II — (VOL-1)	\$19.95
TRS-80 ASSEMBLY LANGUAGE MADE SIMPLE	\$16.95

BANKCARD AND MAIL ORDERS WELCOME — POST FREE

# STEWART ELECTRONIC COMPONENTS PTY LTD

44 Stafford Street, HUNTINGDALE, Vic 3166.

Phone: (03) 543 3733

437 City Road, SOUTH MELBOURNE, Vic 3205.

Phone: (03) 690 8333



# QSP



## SIX METRES, PART RETURNED

Last month, we published a special insert detailing the Department of Communication's advice on approval to operate in the six metre segment, 50-50.150 MHz.

This was as a result of negotiations which have been conducted for over five years, for a return of the band, 50-52 MHz. In the very early stages, we were advised that as the band 50-52 MHz was now allocated to the Broadcasting Service, when television Channel O commenced operation, we would have little, if any chance of regaining any portion of that band whatsoever.

We were able to demonstrate to the Department, that successful overseas experiments were being conducted in the lower portions of six metres, whereas on many occasions, propagation was not possible at 52 MHz. Such being the peculiarities of this band.

Over many years, as technology improves, the community at large demands more radio spectrum facilities. Demands on the limited resource of practical radio spectrum are increasing daily.

Mobile radio telephone communications ability is a specific requirement. It seems many small businesses with two or three vehicles on the road, want to be able to communicate instantly with their representatives. Gone are the days when a commercial business can expect to receive a private channel for its exclusive use. Many such businesses must share a specific channel, and there can be no guarantee of privacy of communications.

At each WARC conference, frequencies are shuffled around to suit the requirements of most services. Every service seems to want more, but the resources are limited.

Commercialisation of the radio spectrum is big business. There is much income to be made by a government in the licencing of various frequencies. Television and Broadcasting stations pay dearly for the privilege of spectrum usage, and it is no wonder that objections are raised when the Amateur Service requests an extension to its allocations.

We have been granted, albeit a limited access, portion of a band initially removed from the Amateur Service for commercial purposes. We have overcome what may have been thought the impossible. In this respect, we must now justify our actions, and prove to the authorities and outside commercial interests, that we indeed are a respectable service. Specific restrictions have been placed on amateur usage of the new allocation, and this is basically that *no* interference is to be caused to any Channel O transmission.

Further, except for Western Australia, the External Territories and Antarctica, operation is restricted to, outside of Channel O transmission hours.

We are the secondary service in this band allocation, the primary service, Broadcasting, will be given the protection it demands from interference of secondary station transmissions.

We expect a review of this allocation to be made in approx twelve months. Therefore, it is important that users of this new segment should ensure that accurate logs are kept, and the restrictions of operating times are strictly adhered to.

We should also strive to ensure we don't try to 'bend the rules', and accept the restrictions placed on us.

Failure to do so will result in permanent loss of this band allocation.

I trust we can live up to what is expected of us.

*B R Bathols, VK3UV.  
WIA FEDERAL PRESIDENT*  
AR

# EASTERN

## COMMUNICATION CENTRE

COMMUNICATIONS, ELECTRONICS AND COMPUTERS

168 ELGAR ROAD, BOX HILL SOUTH, 3128

Phone enquiries: 288 3107

CONTACT Keith VK3ACE or David VK3UD

HOURS: Mon.-Fri. 9-5.30, Sat. 9-12

BANKCARD WELCOME OR WE CAN ARRANGE FINANCE

### ALTRONICS DISTRIBUTOR • FULLY EQUIPPED SERVICE CENTRE



#### HF GENERAL COVERAGE RECEIVER

Listen to the world of HF with the R70, a 100kHz to 30MHz commercial grade receiver designed by ICOM Incorporated, the leader in advanced receiver design. Built from knowledge gained by designing receivers for commercial, marine and amateur use, the R70 surpasses other receivers on the market... even receivers costing more than twice as much.

Utilizing ICOM's DFM (Direct Feed Mixer), the R70 is a receiver which in normal usage is virtually immune to intermodulation distortion or cross modulation, yet still maintains superior sensitivity. Whether you are a Short Wave Listener, Amateur Radio Operator, Maritime Operator or Commercial User, the R70 provides the features you need.

The R70 is an ideal general coverage receiver to complement any amateur shack. Use it with your existing transmitter or transceiver to provide dual receiver capability.

The R70's built-in monitor system lets you listen to your own transmitted audio and a mute input automatically protects the R70's receiver from your signal.

An option for FM allows listening to the 10 metre FM activity.

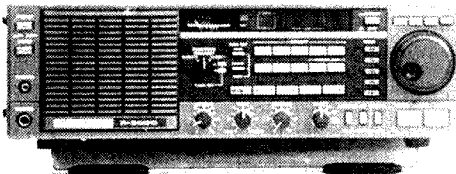

The TS-430S combines the ultimate in compact styling with its counterparts in advanced circuit design and performance. An all solid-state SSB, CW and AM transceiver, with FM optional, covering the 160-10 metre Amateur bands including the new WARC bands, this remarkable radio also incorporates a 150 kHz-30 MHz general coverage receiver, having an extra wide dynamic range. Key features include dual digital VFO's, eight memory channels, memory scan.



The TR-2500 is a compact, designed for tomorrow, 2 meter FM handheld transceiver, incorporating the latest in electronic technology, including LCD readout, 10 channel memory with improved memory backup, memory scan, programmable automatic baud scan, keyboard channel selection, and improved flexibility with a variety of new accessories. Big in features, big in performance, the TR-2500 will surprise you with its small size.

#### TW 4000A - 70cm/2m

#### DUO-BANDER

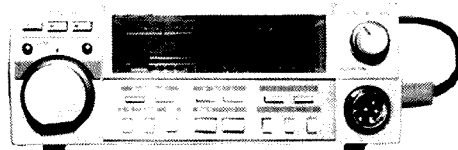

**\$699**

#### VS1-VOICE SYNTHESIZER-\$40

#### HAMPACK II MODEM!

Plugs into APPLE® or compatible computers. Software and documentation for instant CW, BAUDOT, ASCII transmissions.

ORDER NOW - LIMITED STOCKS

**\$210**

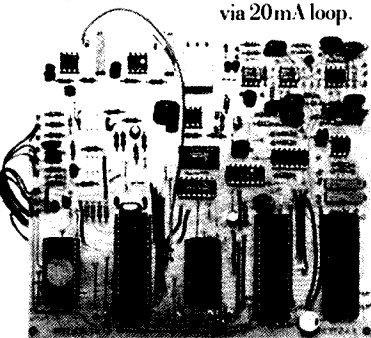
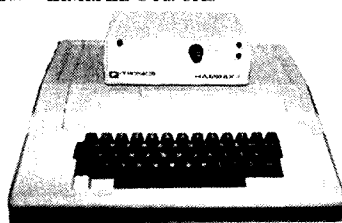

#### RTTY BAUD V70 RTTY COMPUTER

Connect to terminal and modem.

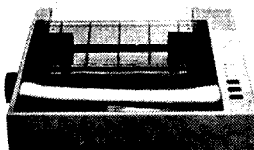

#### FAX-80

80 column printer. Bi-directional, graphics printer.

**\$495** plus Tax

### EPROMS - COPIED AND PROGRAMMED PCB's - MANUFACTURED TO ORDER.

# WORLD COMMUNICATIONS YEAR

## RADIO ASTRONAUT IN SPACE

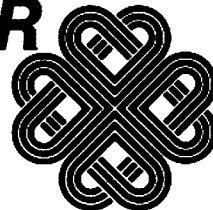

1983

Roy Neal K6DUE

3000 West Alameda Ave, Burbank, CA 91523, U.S.A.

*So you want to work an astronaut in space?*

Well, the timetable to launch is growing short for Dr Owen Garriott, W5LFL. He's scheduled to go into orbit on 30 September, in the Columbia, and the Flight Directors and engineers are polishing the fine details on a flight plan that calls for up to an hour a day of amateur operating by Owen on 2 metres.

During the mission, he will sign "W5LFL from Columbia", using a transceiver specially built for the flight. Five manufacturers volunteered to provide the equipment. At this writing, NASA engineers at the Johnson Space Centre in Houston are running evaluation tests to choose the entry best suited to the flight... "STS-9", to give it the official NASA designation.

The radio will be powered with alkaline batteries and will run 5 watts, FM modulated. Transmissions will be in the range 145.51-145.77 MHz and Garriott will listen between 144.910 and 145.470 MHz in 20 kHz increments.

Exact times and frequencies are still being worked out.

The mission is scheduled to last nine days but don't look for Owen until day three. It will take that long to get the Columbia bedded down and the European built Space Lab 1 working properly. The Space Lab is the prime payload on this flight, no matter how important we amateurs like to consider *our* payload.

The radio will be operated from the aft flight deck. Dr Garriott will place his split ring antenna in a window that overlooks the Space Lab. This works because the payload bay is operated with the lab facing toward the earth and that puts the

amateur antenna into line of sight perspective during most of the flight.

W5LFL has been authorised by NASA to operate up to an hour a day. The astronauts work 12-hours-on and 12-hours-off, so Owen plans to use the time on either end of his 8-hour sleep periods for 2 metres. (Co-sponsors of the project are AMSAT and ARRL).

The flight directorate has mapped out the times when his orbital track will put the ship over the places where amateurs are concentrated. The flight path, at an inclination of 57 degrees, goes over most of the heavily populated areas on earth.

Flying at an altitude of about 200 statute miles, Garriott will have line of sight to a distance of about a thousand miles. His speed will be around 17 thousand miles an hour. This means he will be on-station up to a maximum of 8 minutes at any given point, less than that most of the time.

Based on results from OSCAR, however, AMSAT tells us we can expect to receive full quieting signals, even on a hand-held radio with a rubber duckie for an antenna, while the ship is passing overhead. On transmit it will take at least ten watts and a gain antenna, however, to stand a fighting chance of getting through and *being heard by W5LFL*.

On the air, Owen plans to transmit on even minutes and listen on odd minutes during the times selected for operation. He will identify his location and call areas for which he will stand by. For the most part, his transmissions will be spent acknowledging the calls that he has been able to log.

For us earth-bound mortals, it is recom-

*mended that you transmit only your call during the odd minutes.*

If you call and are not acknowledged during the flight, don't give up hope. Garriott will tape record all amateur activity and the tapes will be used as a log, after the fact, for QSLs. But you may have to settle for an SWL QSL!

The station will only be able to go on the air at selected times, primarily dictated by the astronaut schedule and the physical location of the ship as its orbit criss-crosses the globe, 15 to 20 orbits at most are expected to be effective. Even on a good pass, only a few dozen stations can be worked... but even ten watt transmitters have a chance of getting through, according to the AMSAT and NASA engineers.

If, as a group, we do a good job of operating on this flight, hopefully there will be many more similar operations in the future. Tony England, WOORE, for example, another astronaut, hopes to take equipment with him when he flies in 1985. So it well behoves the amateur fraternity to put its best operating foot forward with an eye toward the future. Help police the action in your area.

You'll need separate transmit and receive capability because W5LFL does not plan to operate the normal 600 kHz split. A hand-held will do well on receive. At least ten watts and a simple gain antenna should be used on transmit. Unless you have the experience of tracking satellites, it is recommended to stay with a simple antenna... one that is mounted high enough to see the horizon. Check your antenna handbooks for designs.

*Contributed by: Jim McLeod, VK2VLO*



## THUMBNAIL SKETCHES

Peter Brown VK4PJ  
VK4 Amateur Historian  
16 Bede Street, Balmoral, Qld 4171

**JW McDERMOTT. EX VK4JM. 1930.**

Jim, of 1913 vintage, started his radio career at Glen Eagles, near Beaudesert, with crystals and batteries. He later moved to Rosemount near Nambour where he built a 240 VAC power supply using a motor cycle engine, single cylinder, to drive the alternator until reticulated AC became available and he moved to Nambour.

A licensed electrician, Jim became prominent in the district as a radio serviceman in which calling he is still active.

In his younger days he operated the cinema in Maroochydore, using incandescent lamps, assisted by Arthur VK4AW.

Jim's father and brother also obtained amateur radio licences and they were all also keen sailors, building their own boats. Wartime service as a WO, AEME, included security work and lecturing on advanced electronics.

Jim is a member of the Institute of Radio and Electronic Engineers London and a registered Technical Engineer with the Council of Engineers London.



AR

# NEW REPEATER EARNS ITS KEEP

Jeanette Wiley, VK2EJW  
24 Blessing Street, Glen Innes, NSW 2370

## GLEN INNES CHANNEL 7 REPEATER

*The Glen Innes repeater, VK2RNE, operating on channel 7, repeater input 146.350 MHz and repeater output 146.950 MHz, came into operation on Saturday 9th July 1983. It had been in the planning stages since 1977 when the North West Amateur Radio Group was formed to provide repeater coverage in Region 2, NSW.*

VK2RAB, channel 5 Gunnedah and VK2RMI, channel 7 Moree were both established by this group at sites where other installations were already present. (County Council and Telecom). Applications to establish the repeater at a similar site near Glen Innes were refused so the search began for a suitable site in the area. In 1981 a site was found and the club voted to go ahead with the project.

The present location, some 30 km south-west of Glen Innes and 1503 metres above sea level was tested by a party using an IC22S and a "Slim Jim" at six metres. Stations from the coast and from Narrabri, Tamworth, Armidale, Inverell, Moree and Glen Innes could all access the site without much difficulty.

The NWARG holds the licence for the repeater and supplied the transmitter and receiver sections, the cavity filters and the aerials. The Glen Innes and District Amateur Radio Club was made responsible for the site, repeater accommodation, tower, power supply, control box, solar panel and labour — a huge task considering club membership is currently only twenty one.

The repeater itself is a converted STC MTR 10-151B with ten watts output. The transmit and receive sections were separated by Reg. VK2ATS. Richard, VK2BYV built the control box (the ident board, timing circuitry etc).

A Glen Innes resident at the time, who has since gone home to England, Nick Butt, is a solar power genius. He worked on the solar power supply system to make it as efficient as possible. It is his personal design and he built it himself. The club could not afford to purchase it from him with money, but some club members provided labour on his farm instead.

The repeater is exclusively solar powered by a Solarex 2.1 amp panel charging two 6 volt batteries in series, supplying 12 volts 110 amp hours. When no signal is detected by the repeater for a few minutes everything but the receiver shuts down, so the total standby current consumption is only 110 mA. When a signal is detected the transmitter and control sections come back on and the repeater idents. The time out period is approximately 4 mins 30 secs.

After six months of tests the WIA repeater committee suggested swapping crystals with VK2RMI Moree. With Coffs Harbour being channel 1 it was felt that there could be

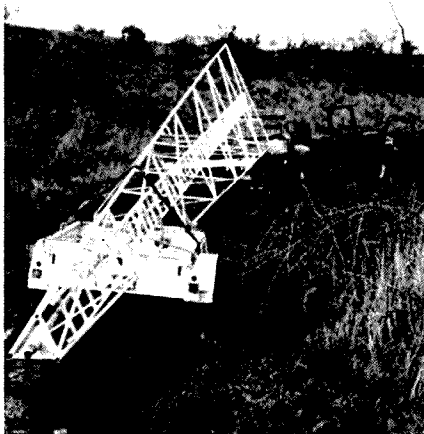

The Tower enroute up the Mountain.

interference between the two repeaters. So Moree became channel 1 and Glen Innes was licenced for channel 7 operation.

Some idea of the difficulties encountered can be imagined. This was just a bare mountain top; no electricity, no running water and access by four wheel-drive vehicles only. It is a very bleak site — cold and windy. Most working bees took place in temperatures barely above 0°C and the day the repeater was installed the ground had snow on it all day.

For support the 21.5 m tower, donated by Ivan VK2BIO, has three concrete footings with 1.8 m rock bolts. Because the site experiences extreme winds three guy wires were added later for extra peace of mind.

The Glen Innes Rescue Squad provided equipment and know-how to move the tower from Glen Innes, where it had been sanded and painted by members, to the site. This was not an easy exercise. Glen Innes, drought stricken for four years, had had millimetres of rain and the track up the mountain was very slippery. Many times members had to lift the back end of the tower back onto the track after it had slipped off. All were very relieved and satisfied to see the tower vertical, complete with lightning arrestor and aerials mounted. The aerials, half wave collinears with approximately 6 dBi gain are mounted



Rigging the Antennas.



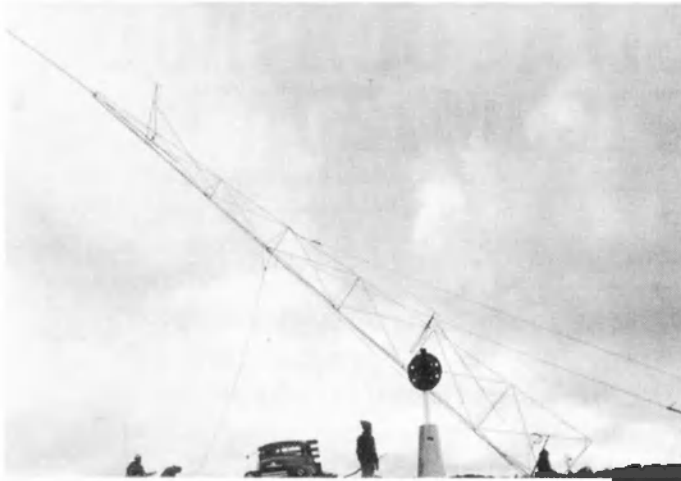

**Up she goes.**



**The Crew that raised the Tower.**

with the transmit aerial at 6 m and the receive aerial at 15 m. Hopefully this is enough separation to prevent desensing problems. Graeme, VK2EBU had the honour of being first man up the tower to release the ropes.

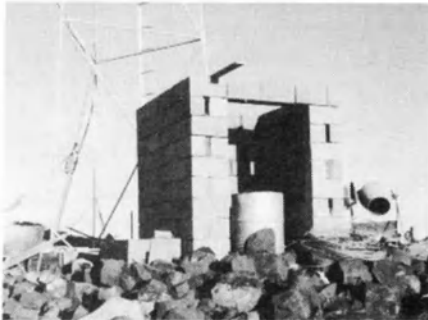

**The makings of a Repeater Shack.**

The group were held up several times by wet weather, but over several weekends a concrete slab was put down and a shack built to house the repeater equipment.

Finally came the big day. On Saturday 9th July, the repeater was installed and there was plenty of excitement as all heard the first ident. For the rest of Saturday and Sunday the repeater had plenty of use! Most distant signals into the repeater so far have been Dalby in Queensland and Newcastle.

The local amateurs hope that the repeater will be useful, not only for socialising on air, but also for emergency situations. It should give good coverage of the nearby Gibraltar Range National Park in case WICEN should be called out to assist in a search, as well as assisting liaison throughout Region 2.

A feature of this whole project is the excellent co-operation and assistance received from the Lands Department, Severn Shire Council, Glen Innes SES and Glen Innes Rescue Squad. There has also been support in the form of materials and assistance from local businessmen. It is amazing how little this project has cost the club but finances are now at rock bottom and the project couldn't have managed without their help.

It is difficult to name everyone who has helped, but here is a list and apologies if



**Solar panel mounted on the roof.**

anyone has been omitted: *Richard VK2BYV, Reg VK2ATS, Mike VK2NBT, Peter VK2KDA, Russ VK2ERS, Graeme VK2EBU, Ivan VK2BIO, Tony VK2BGQ, Ian VK2EIJ, Lyn VK2BSF, Dave VK2ZDY, Phil VK2XPB, Dallas VK2ECC, Angus VK2PNV, Bill VK2NXT, Rob and Mark Dunk, Bryan Burgess, Brian Donnelly, Mike Digby, Geoff Kiehne, Malcolm Lane, Bob McLeod, Peter and Graham*

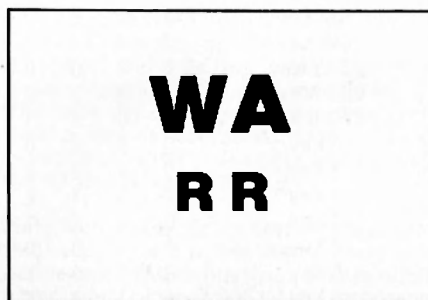

*Fletcher, Bill and Brendan Byrne, Nick Butt, Russ Davies, Wayne McCarthy, Richard Tucker and Jeff Benes.*

If anyone is interested in more information about the repeater please write to the club via PO Box 26 Glen Innes.

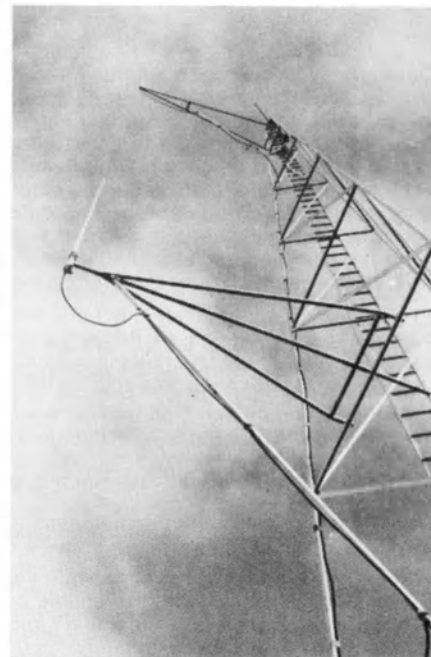

**The 21.5 metre Tower.**

*Postscript: A few hours after completing this article it was learnt that the repeater has indeed earned its keep already. Phil VK2XPB was travelling near Inverell and came across a car accident. Three chaps were very badly injured. Phil called "Mayday" on channel 7 and Reg VK2ATS dropped everything to answer. Ambulances were despatched immediately and the three were taken to hospital without delay.*

**AR**

Photographs supplied by Jeanette Wiley VK2EJW

# A PRACTICAL DIGITAL CONTROL UNIT FOR THE ICOM720A

Bob Young VK4BRY  
9 Boblynn St, Chapel Hill 4069

The unit to be described is built around the keyboard of a discarded desk calculator and uses only seven digital integrated circuits. When connected to the IC720A via the accessory socket it interfaces with the transceiver's internal central processing unit (CPU) and permits immediate selection of operating mode, VFO A or B and frequency or alternatively, the variation of any one of these operating parameters on its own. The controller also incorporates the facility to override the housekeeping circuitry of the CPU which includes the inbuilt inhibit of the transmit mode for frequencies outside the amateur bands, thus making the IC720A a true general coverage transceiver.\*

The process of encoding the internal CPU by means of the controller is as simple as entering a ten digit number on a calculator. Having the control unit connected to the IC720A does not in any way interfere with normal manual control of the set if desired. Description of the keyboard controller is somewhat simplified if it is considered in two parts, ie the keyboard binary code generator and the logic board.

## THE KEYPAD LOGIC GENERATOR

This part of the control unit is built quite simply by wiring the appropriate keys of a discarded calculator keyboard to facilitate the generation of the binary codes corresponding to the numerals 0 to 9, the address code specific to the CPU of the ICOM transceiver, the two VFOs and the five available operating modes, ie upper side band, lower side band, AM, CW, and RTTY. In addition a key is required to activate the RT control line and a switch to enable or disable the RC line as required (the RT and RC controls will be dealt with later).

Data is encoded in 8421 BCD. This data is generated by using the various keys of the calculator keyboard to ground the cathodes of discrete diodes in an array connected to four data lines denoted D8, D4, D2 and D1. The two examples shown in the circuit below will, I am sure, preclude the need for further explanation. The type of diode used is not critical. I used 1N914s because they were the cheapest available.

The IC720A handbook does not provide any coding information. It does, however, identify the access points of the accessory socket although the method of identification gives very little indication of the function of the various lines. Those of relevance are as follows:

4 Data Bus Lines identified as DB8PIN 24  
DB4PIN 23  
DB2PIN 22  
DB1PIN 21

4 Data control lines  
Data Bus Control InputPIN 16  
RC Control InputPIN 18  
RT Signal LinePIN 20  
DV Data Valid LinePIN 19  
+13.8V (Switched)PIN 2  
GroundPIN 8

7 Key	0	1	1	1
8 Key	1	0	0	0
9 Key	1	0	0	1

To the astute observer it will be evident that in a number of instances the same binary code is used for two different entities, for example 0000 denotes numeral 0 and also Upper Side Band. The encoding sequence takes care of this anomaly.

## THE LOGIC BOARD

A full circuit diagram is provided and clearly identifies all relevant data and control lines. I do not propose to discuss the circuit function in detail; however, a list of the functions it carries out may be of interest.

- 1 Suppression of key bounce.
- 2 Generation of control levels necessary for programming or reading the CPU.
- 3 Sequencing of control levels where necessary and
- 4 The provision of a visual indication of the data on the Data Bus Lines and the logic level of the DV line.

Layout is not critical, all components are cheap and readily available. Construction should not present any problems providing one observes the rules relating to the use of CMOS and TTL integrated circuits. My unit was assembled on a piece of veroboard. There is no reason why CMOS ICs cannot be used throughout if desired. I would, however, make the point that if this is done, the power supply level must not exceed five volts: the CPU in the IC720A tends to malfunction when presented with Logic Levels in excess of those normally available from TTL.

## ACCESSING THE CPU AND MESSAGE FORMAT.

It is assumed at this stage that the diode array and logic board have been assembled

As was pointed out above the handbook does not furnish any encoding data and at this stage I would like to express my gratitude to Garner Annett VK3NZZ for his article in ARA Vol 5 No 3 in which he describes in detail, not only the relevant data codes but also the message format and control level data for the CPU. The encoding table below furnishes the data necessary to wire up the diode array for the keyboard.

## DATA UNIT ON KEYPAD

	DB8	DB4	DB2	DB1
Address Key	1	1	1	0
USB Key	0	0	0	0
LSB Key	1	0	1	1
AM Key	1	0	0	0
CW Key	0	1	1	0
RTTY Key	1	1	0	0
VFO A Key	1	0	1	0
VFO B Key	1	0	1	1
0 Key	0	0	0	0
1 Key	0	0	0	1
2 Key	0	0	1	0
3 Key	0	0	1	1
4 Key	0	1	0	0
5 Key	0	1	0	1
6 Key	0	1	1	0

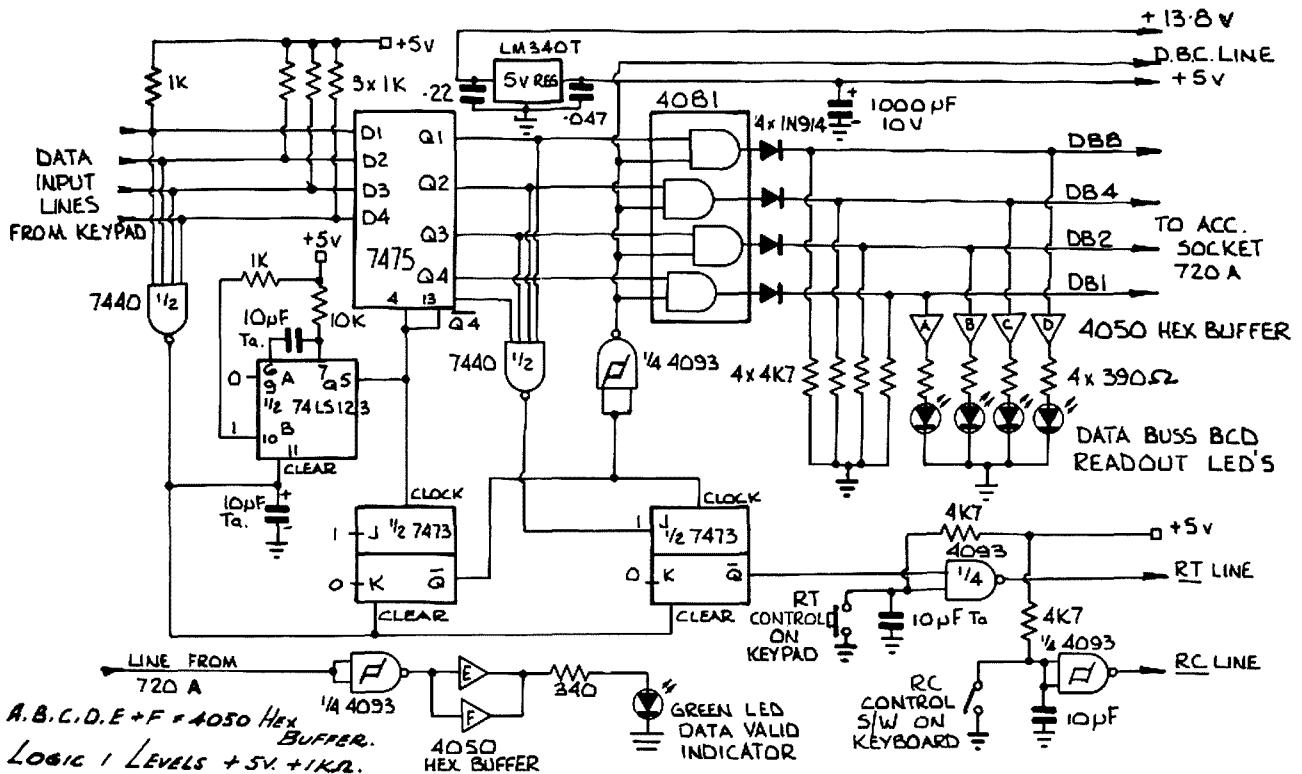

Logic Board \* indicates connection to ACC SKT of 720A.

and interconnected and that routine circuit checks have been made. I would suggest that it is most important to ensure that every key to be used on the keyboard generates the correct binary code when depressed.

**STEP 1** Depress and release the address key, then depress and release the RT key. If all is well, the DV indicator (green LED) will be lit and so also will be the red LEDs associated with the DB8, DB4 and DB2 lines.

This procedure places the address data bit on the Data Bus and raises the Data Bus control line to a logic 1. Releasing the address key allows the Data Bus control line to return to logic 0 and depression of the RT key places a logic 1 on the RT line allowing the indicator LEDs on the Data Bus Line to read the last bit of data (the address) sent to the CPU. NB. Some form of readout at this point is necessary. The process of addressing the CPU takes a finite time dependent on the state of the internal housekeeping circuit and at times it may be found necessary to repeat the actual address procedure. I mention this point specifically because it will be of relevance to those interested in further developing the controller to the stage of having multiple memory and scan facilities.

**Step 2** The remaining data is entered into the CPU simply by pressing the appropriate

keys in the correct sequence which is as follows:

- 1 Desired mode ie USB, LSB, AM, CW, RTTY.
- 2 Desired VFO (A or B) and
- 3 Six digits in descending order of significance in order to define the desired frequency of operation. At this stage a glance at the digital readout on the IC720A will show that the transceiver is now ready for operation on the frequency that has just been keyed in.

The desired VFO and mode of operation may not be as required. The explanation for this will be given later. The entry of a data bit into the CPU requires the following:

- a The appropriate data bit must be placed on the Data Bus lines
- b The Data Bus line is then raised to logic level 1
- c Step (b) having been achieved, the RT line is raised to logic level 1 and
- d The RT and Data Bus Control Lines are simultaneously returned to logic 0.

The logic circuitry does exactly this each time a key is depressed and released except that in the case of the address key the RT line is held at logic 0.

**Note** With respect to the entry of the actual frequency data, the first digit entered will define tens of MHz thus if you wish to enter a frequency of say 7.065.0 MHz be sure to

enter the digits 070650. If you fail to do this the CPU will be confused, you may be confused and the readout on the transceiver will suggest that it has suddenly become a VHF rig! You will also find that the receiver has gone very quiet. In the event of such an error, one merely has to readdress the CPU and encode the correct data.

#### THE RT CONTROL KEY

Once the CPU has been accessed (step 1) repeated actuation of the RT key steps through, in normal sequence, the data stored in the CPU. With each operation of the RT key a specific data bit in the CPU will be displayed in BCD form by the red LEDs wired to the Data Bus Lines. By way of example, let us assume that the set is tuned to lower side band, VFO A and a frequency of 7.050 MHz. You wish to operate on upper side band VFO A and 14.050 MHz. Access the CPU by depressing the address keys and RT keys in turn, then depress and release the upper side band key, VFO A is OK therefore press and release the RT key. The digits 1 and 4 have to be entered at this stage, therefore depress the appropriate keys in sequence. The remaining four digits do not need to be changed therefore press the RT key four times. Clearly it is just as easy to encode the CPU in full each time but for those interested in further development in understanding of the true function of the RT line will be important.

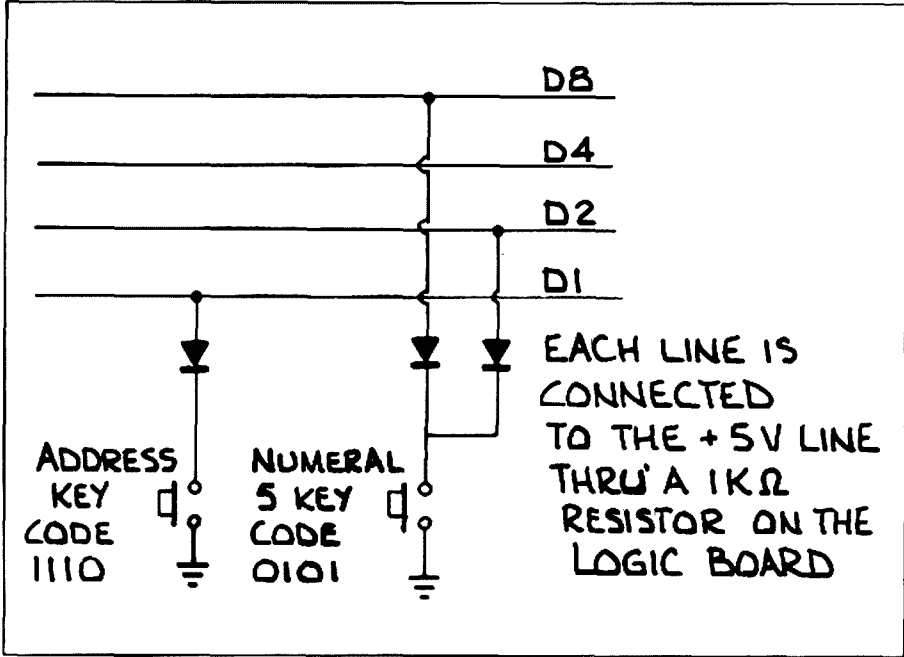

**THE RC LINE SWITCH**

The CPU incorporates an internal housekeeping circuit which in normal operation takes into account the setting of various buttons on the front panel of the set, for example VFO A, VFO B and the various buttons to define operating mode. When the RC line is held at logic 0, priority is given to the internal housekeeping circuitry, ie if the buttons on the panel are set for lower side band and VFO B and an attempt is made using the key board to change operating mode VFO and frequency it will be found that although the frequency will change to the one desired, the set remains with the mode and VFO functions unaltered and in complete correspondence with the setting of the buttons on the front of the set. Setting the RC line to logic level 1 overcomes this difficulty. With the RC line at logic 1 the keyboard has priority and the CPU will process data exactly as it is encoded from the keyboard. As a matter of interest setting the RC line to logic level 1 also serves to disable the inhibit on transmit mode for frequencies outside the amateur bands.

**THE DV LINE**

Essentially this line is used to furnish a visual indication that data is valid at each step of the encoding process. In short, if the green LED goes out you have made a mistake, or a malfunction has developed.

**A FEW POINTS WORTHY OF NOTE**

- 1 With the circuit provided the time constant for the debounce function is perhaps a bit long. Providing the encoding process is carried out slowly and deliberately, there will be no problem. If however one tries to rush the encoding procedure the results, to say the least, will be quite confusing.
- 2 When the controller was first put into service it seemed a good idea to encode the required data and then access the CPU on

the assumption that when necessary, the next data entry could be fed to the CPU starting with the mode key. To put it simply, the CPU did not go along with my "good idea". It was noted that after about one minute the DV indicator LED would go out and that the CPU could no longer be accessed in the normal way. Further, manual tuning of the transceiver appeared to be lost also. Experience has shown that no harm is done to the equipment but when such an impasse results it becomes necessary to switch off for about thirty seconds and start all over again.

3 A hint for those interested in adding memory and/or scan functions to the control unit. As it stands at present, the encoding problem has been reduced to one of sequentially activating and deactivating ten simple switches. There is one snag; it is necessary to check that the first two operations have in fact accessed the CPU before encoding can begin.

To make full use of the memory function of the IC720A a permanently active back-up power supply for the CPU is required. Apart from the obvious risk of fire and equipment damage resulting from a supply failure occurring in the absence of the operator, even the briefest loss of line voltage results in loss of data in the memory. The controller described facilitates rapid selection of any desired mode of operation, VFO and frequency and virtually obviates the need for the one memory function dependent upon a back-up supply. It should be possible to construct a controller such as the one described for somewhere near the cost of the back-up power supply providing, of course, a suitable keyboard can be salvaged from some other equipment. The controller makes operation of the transceiver substantially easier, and with minor modifications could be an invaluable aid to a blind operator.

**WHO IS THIS AMATEUR?**

Alan Shaws Smith VK4SS  
35 Whynot Street, West End, Qld 4101



Anyone who has listened regularly on the bands during these last forty-five years must have heard his pleasant, well-spoken voice, either working DX or ragchewing. He first became interested in wireless in the early thirties when he built a two tube regenerative receiver and heard amateurs in QSO. The "bug bit" and, to use his own words he said, "That's for me!". Consequently, he took out his licence on 21st June 1937, operating firstly in Brisbane, then for many years in Gympie before returning to Brisbane and finally settling at the seaside resort of Brighton, Queensland.

His first transmitter was a MOPA, using a 201A final; this meant QRP operation of a few watts maximum. Like so many old devotees of his era, his station was completely homebrew for a long time until he eventually changed to SSB and commercial gear.

Professionally he was a Broadcast Technician with several Queensland commercial radio stations, viz 4SB, 4BU, 4LG and 4GY. A man of many talents, he did his stint as a DJ (called announcing in those days) and as the station's sales representative. He retired from broadcasting in 1970 and operated a mixed business at Paddington, Brisbane for eleven years; now he divides his time between fishing, gardening, music appreciation and amateur radio — in other words, lives the life of Riley.

A long time member of the WIA he was active with the Wide Bay Burnett Branch for many years. As a final clue, he appeared on the front page of AR in October 1964 together with a group of scouts at the Jamboree on the Air. You've guessed rightly — his call is VK4XR (Xray Romeo) and his name is Eric Chippindall.

AR



# A TWO BY FIVE EIGHTHS WAVELENGTH VERTICAL FOR SIX METRES

Colin MacKinnon VK2DYM  
16 Mills Road, Glenhaven NSW 2154

*The antenna to be described is a vertical consisting of two five eighths wavelength sections in phase. With the design sizes given it has an SWR of 1.05:1 at 52.6 MHz and less than 1.5:1 over the 52-54 MHz band. It has withstood some fierce winds at its installed height of twenty seven metres and gives good omnidirectional coverage.*

DESIGN FREQUENCY 52.525 m Hz

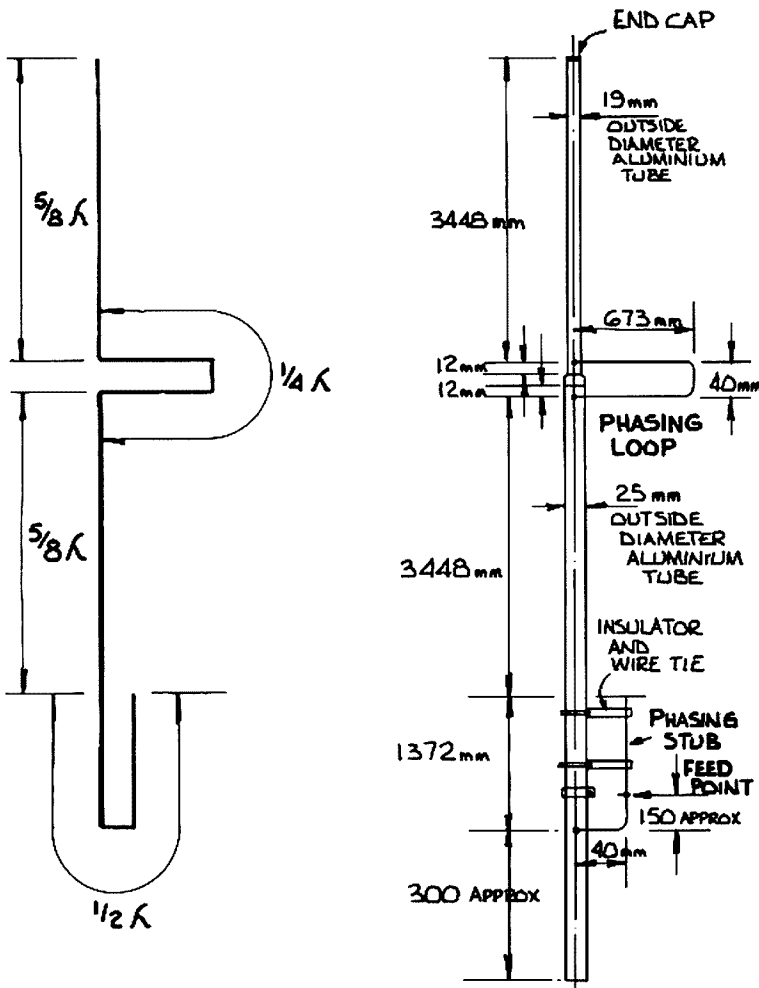

Design Details.

My first design used small diameter tubing but was too flexible and had the disconcerting habit of bending like a banana in strong winds so the top half become horizontal! Signal reports had to be given as "S5 to windward", or "S3 to leeward with gusts to S6". With the tube sizes now specified the antenna is light but strong, and I have minimised holes and other stress points as they hasten fatigue failure. Although my design is for 6 metres the principles can be applied to other VHF antennas.

## COMPONENT MANUFACTURE — FOR 52.525 MHz DESIGN FREQUENCY

Cut a length of 19 mm outside diameter by 1.42 mm wall thickness aluminium tubing to 3460 mm ( $\frac{5}{8}$  wavelength by 12 mm).

Cut a length of 25 mm outside diameter by 1.6 mm wall thickness aluminium tubing to at least 5130 mm which allows about 300 mm for clamping to a support. I used a full 5.5 metre length.

Deburr and file a radius on the inside ends of the tubes.

Machine a 270 mm length of 25 mm diameter hardwood dowel so that 150 mm is a close sliding fit inside the 19 mm outside diameter tube. Turn down the other end of the dowel so about 100 mm is a slide fit in the 25 mm outside diameter tube. When turning down the dowel avoid sharp edges at the diameter changes. Heavily radius the ends of the dowel to reduce stresses where the tubing flexes under wind loads. Waterproof the dowel by dipping it in marine varnish, epoxy resin etc. If you don't seal the timber it can absorb moisture, expand and will easily split the tubing.

Bend up the phasing loop from aluminium or brass wire of about 3 mm diameter starting with a length of about 1425 mm which allows enough for 2 loops for screws to be inserted. Avoid sharp bends or nicks in the wire as these promote stresses. After making the U-shape I rolled it round a 150 mm paint tin to make it more compact and durable.

Bend up the lower phasing stub. Although you can use aluminium wire I used brass welding rod (3 mm diameter) so that I could solder the co-ax wire directly to it. To prevent galvanic corrosion I fitted stainless steel washers between the brass and the aluminium. The starting length for the stub is about 1425 mm to allow for bending a loop for a screw.

Make up 4 or 5 insulating spacers about 40 mm long. I used black polypropylene strip

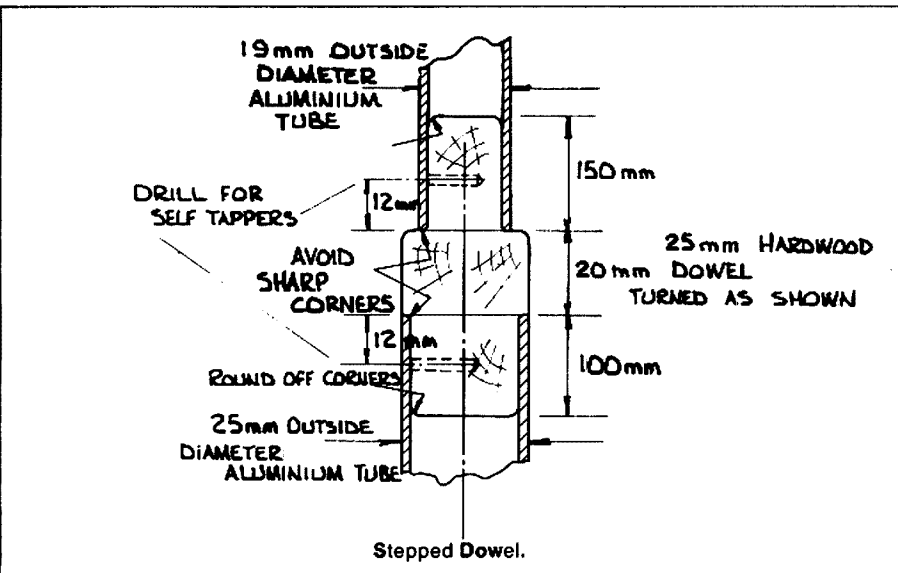

Tap the 300 mm dowel into the 25 mm outside diameter tube behind the first dowel so that it is under the clamping location for the antenna support.

Fit the stepped dowel into the opposite end of the 25 mm outside diameter tube and drill a hole for a self tapper exactly 12 mm in from the tube end.

Remove the stepped dowel and fit it now into the 19 mm outside diameter tube. Drill a hole for a self-tapper 12 mm in from the end of the tube, making sure the two holes in the dowel are in line.

Assemble the lower phasing stub to the 25 mm outside diameter tube using a stainless steel self tapper (and stainless steel washers if you used brass or copper wire). Space the stub from the tube using the insulators and nylon cable ties round the tube.

Assemble the two tubes together with the stepped dowel and attach the phasing loop with two stainless steel self tappers. Use an insulator strip and cable tie to support the centre of the phasing loop if you have rolled it into a circle. Fit a cap or plug into the top of the 19 mm outside diameter tube to keep water out.

I sanded the aluminium tubes at each screw hole and applied a dab of "Aloxin" or similar conductive paste to improve electrical contact.

You now have a monstrosity over seven metres long — but it should not prove too difficult to carry and lift up to the vertical. Some care is needed to prevent accidental damage to the phasing loop and stub during erection.

### TUNING

I hammered a one metre length of suitable sized water pipe into the ground to act as a clamping support for the antenna during tuning.

The co-ax shield is attached to the circular clamp and positioned approx 150 mm up from the stub attachment point. The co-ax centre wire is attached to the stub via a crocodile clip about level with the shield position.

Connect an SWR meter into the co-ax about one metre from the feed point. Feed a low power carrier at 52.525 MHz (or your design frequency) into the antenna and slide the co-ax connections up or down to achieve minimum SWR.

Subsequently, when my antenna was raised to five metres the point of lowest SWR moved up to 52.6 MHz and didn't alter further at the installed height of twenty metres, so I didn't bother trying to retune it to the design frequency.

If you used brass or copper wire for the phasing stub you can solder the co-ax wire to it. If you used aluminium you need to fit some sort of clamp and use "Aloxin" etc to make a permanent connection.

I use a quarter wavelength co-ax balun to balance the feed but couldn't detect any difference without it. The balun is coiled into a 150 mm circle and it and the co-ax feed line are clamped to the antenna using more nylon wire ties (they sure come in handy.) Make sure you waterproof the end of the co-ax.

The antenna can be clamped to its support using U-clamps or similar making sure you position them over that internal reinforcing dowel. Use insulating tape to separate dissimilar metals. The antenna is at earth potential at this point.

Following are readings of SWR taken after raising the antenna firstly to five metres, then to twenty metres.

FREQUENCY (MHZ)	52	52.5	52.6	53	53.5	54
SWR at ground level	—	1.02	—	—	—	—
SWR at 5 m above ground level	1.5	1.1	1.05	1.15	1.25	1.3
SWR at 20 m above ground level	1.4	1.1	1.05	1.15	1.4	1.5

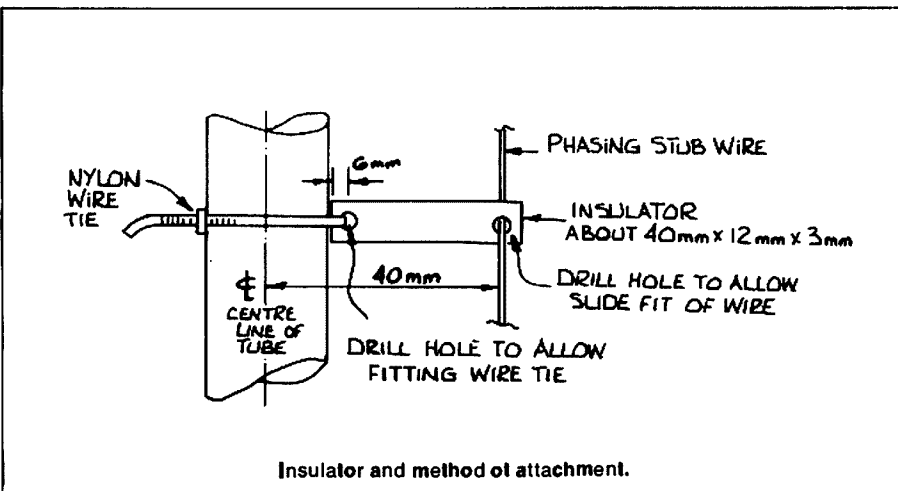
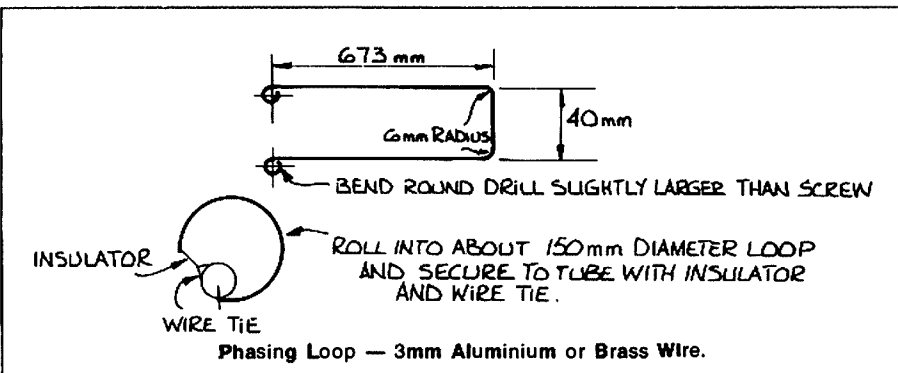

about 12 mm wide by 3 mm thick but other alternatives will be suitable. Drill small holes about 12 mm in from each end, to take the phasing stub wire and a wire tie.

Turn down two lengths of dowel so they will just slide inside the 25 mm outside diameter tube. Make one length about 150 mm and the other 300 mm. Again, heavily radius the ends and waterproof the dowels.

Make up a circular clamp to fit the 25 mm outside diameter tube so the co-ax cable shield can be attached. Stainless steel hardware is

used to separate the co-ax shield from the aluminium. Alternatively use a stainless steel hose clamp.

### ASSEMBLY

Tap the 150 mm long dowel into the 25 mm outside diameter tube until it is centred under the point where the phasing stub will be attached. This is 4832 mm from the end of the tube ( $\frac{1}{4}$  wavelength  $\times$  12 mm). Drill a hole at this point for a self-tapping screw.

## Family Radio

The Russell family of Coolbellup, WA believe amateur radio is a family affair.

Arthur is a newcomer to the bands, obtaining his licence (VK6NAR) in November 1982, but in this short time he has not let the grass grow under his feet.



Arthur tunes up his "Telephone Exchange".

Recently he bought an old telephone exchange and built his transceiver, multi metre, aerial rotator etc into it. His XYL is his QSL manager and the children climb the trees to connect the antenna wires.

AR

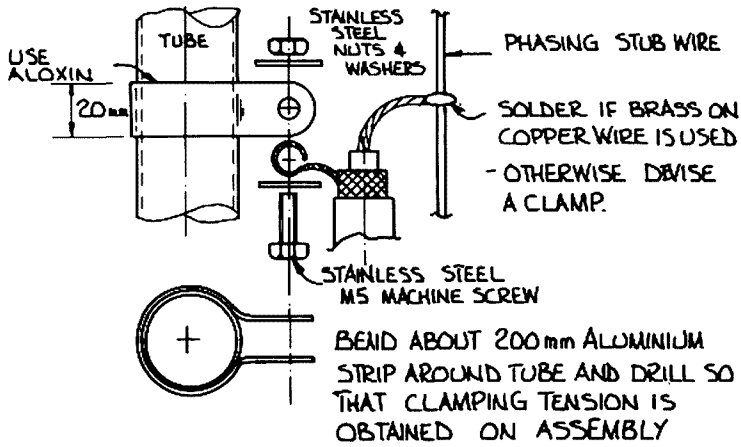

Circular Clamp and method of attaching Coaxial Cable.

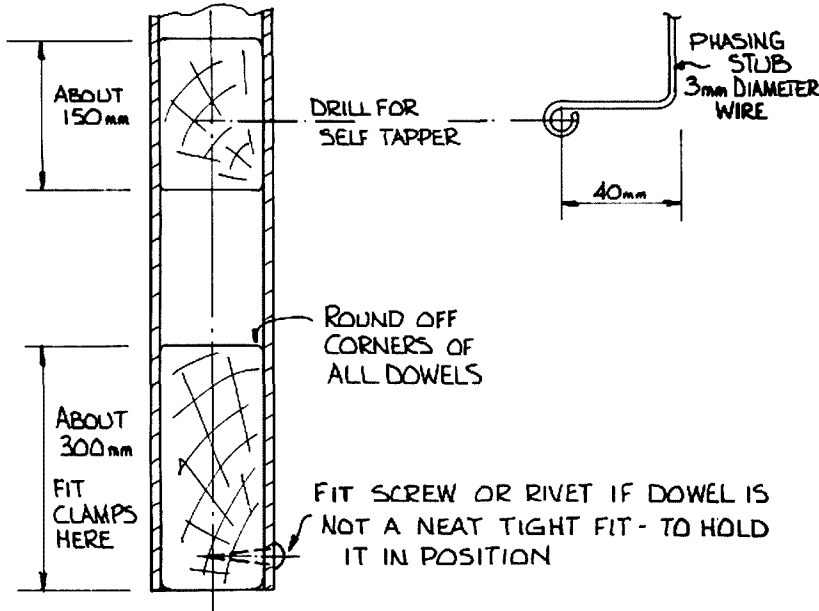

Re-inforcing Dowels and attachment of Phasing Stub.

I also discovered that the SWR dips to a minimum of 1.6:1 at 38, 42.5 and 47 MHz, and rises to a maximum of 3.2:1 at 39.9, 44.5 and 49 MHz. Fascinating, but don't ask me what it all means!

Undoubtedly you can vary the construction and materials to suit what you have available. The critical dimensions are the lengths of the tubing and the phasing wires and these are given by standard wavelength calculations.

Mechanically it is important to reduce stress points (or reinforce them) and to minimise galvanic corrosion between dissimilar materials. The extra effort of fitting radiused, reinforcing dowels and using stainless steel hardware will ensure maximum life and reliability.

See you on 6FM.

### LIST OF MATERIALS

One 3460 mm length aluminium tube 19 mm

outside diameter by 1.42 mm wall thickness (6061 grade preferred), one 5130 mm length (or longer) aluminium tube 25 mm outside diameter by 1.6 mm wall thickness. Two 1425 mm lengths 3 mm diameter aluminium wire (or brass, copper). Welding rod or fencing wire could be used. One 750 mm length 25 mm diameter hardwood dowel (broom-handle etc).

One 200 mm aluminium strip about 20 mm wide x 1.2 mm thick (for circular clamp round 25 mm outside diameter tube). Alternative — stainless steel hose clamp. Five or six insulating spacers approx 40 mm x 12 mm x 3 mm. One plug or cap to fit 19 mm outside diameter tube.

Three 20 mm x 10 g stainless steel self-tapping screws. Approx 8 stainless steel washers to fit screws. One 25 mm x 6 mm stainless steel machine screw with nut. Approx 9 x 150 mm nylon cable ties. A tube of "Aloxin" or similar conductive paste suitable for aluminium. AR

## THREE NEW BOOKS HAVE JUST ARRIVED FROM RSGB

Teleprinter Handbook. (Hard Cover)

Radio Communications Handbook. Vol 1 & 2 combined.

World at their Fingertips. (Hard Cover)

These and many more books are now available from your division or from Magpubs, PO Box 300, Caulfield South, Vic. 3162.

# EXERCISE "SES MITCHCLL"

Ted Gabriel VK4YG  
WICEN CO-ORDINATOR REGION ONE, QUEENSLAND  
3 Corkill Street, Freshwater, Qld, 4872

**Queensland's highest mountain, Mt Bartle Frere, 1622 m (5230 ft) is located 55 Km (34 miles) south of Cairns and rears up behind the small sugar mill town of Babinda. This mountain and its near neighbour to the north, Mt Bellenden Ker, 1541 m (5120 ft) lie close to the aircraft approaches to Cairns and have, over the years, claimed many aircraft unfortunate enough to fly too close to them in cloud. It was on this basis that the Babinda group of the State Emergency Service planned an ambitious search and rescue exercise to cover a period of forty eight hours, and invited all local emergency service groups to participate.**

Another purpose of this exercise was to test portable HF and VHF radio equipment under tropical rainforest conditions in order to find suitable units for the SES since present portable communications equipment such as 27 MHz handhelds were virtually useless in the North Queensland environment and most back pack type HF rigs too heavy to lug up tropical mountains.

The Cairns group of Region One WICEN was asked to provide back up communications for the SAR teams and a forward base communications centre in the field.

Accordingly, Oxley VK4BKO and Ted VK4YG attended planning meetings with the SES where it was determined that at least four unrestricted or 'K' licencees would be required to accompany the SES teams so we formulated our operational plan on the use of the Cairns repeater, VK4RCA and several VHF Simplex channels.

The Cairns repeater is located at the television station on Mt Bellenden Ker, the antenna, halfway up the 92 metres mast is at an altitude of 1628 metres making it the second highest in the country. Its range is quite remarkable and it has the ability to reach into some of the seemingly inaccessible corners of this rugged mountainous region.

A twin engined aircraft lost in the area was only discovered when Telecom technicians on their way up to the station on the 4.8 km long cableway smelled the petrol fumes from the ruptured tanks.

Our operational plan was submitted to the local DRI on the basis that a WICEN net controller would assume control of the repeater as required for primary traffic to ensure the safety of personnel on the mountain and that free periods for general use would be allowed for non exercise traffic where possible. This plan was approved by the DOC.

Since Cairns WICEN had earlier surveyed many emergency forward base sites with VHF operations in view the choice for this exercise was not difficult.

A ridge rising up from Wopen Creek on the Russell River south of the mountain gave a direct line of sight on this side while the repeater on Mt Bellenden Ker covered the northern and eastern faces.

Thus two primary channels were allocated to the WICEN operators with the climbers — Repeater 6950 and 51 Simplex plus a separate medical emergency channel on 53 Simplex. A command link from forward base to Babinda SES HQ was set up on Ch 52 Simplex and three VHF mobiles were available.

WICEN operators with the SES teams were Colin VK4EX, Andrew VK4KGA, Albert VK4AEQ and his son Michael VK4NDD.

Forward base net controllers and operators were Oxley VK4BKO: 2 I/C and RTTY operator, Ted VK4MH, Gordon VK4AGZ, Allen VK4BAJ, John VK4VKL, Bill VK4VGA, Anne VK4NXX and Phyl VK4NDG.

Saturday morning 26th March was overcast and raining as group leaders gathered

in the pre dawn gloom at Babinda SES for briefing. While waiting Ted VK4YG spoke with canefarmer Silvio Grasso who, in April 1942, was a member of the team which climbed the mountain to search for an American B25 Mitchell bomber which had crashed in bad weather while returning from a bombing raid in New Guinea. Silvio said that after locating the aircraft and burying the crew members they later had to climb back up again with an American party to recover the bodies.

As we watched the young SES members quietly and carefully checking their packs and equipment, we realised that for some of them this was not the first time that they had been up that mountain in their 'backyard'. Indeed some had recently been out searching for a light aircraft which was lost on a flight between Mount Isa and Cairns and has not yet been found. Also, some SES team members were carrying light weight altimeters and since it is almost impossible to determine map grid refer-



WICEN forward base station.

Photograph by VK4NXX



ences in rainforest the altitude on a known track is given as a position report.

Following briefing the SAR teams were transported to the start of their respective climbing tracks and the exercise commenced.

Colin VK4EX and Albert VK4AEQ were carrying ICOM IC2As with extra battery packs and Andrew VK4KGA had a Yaesu 290R with extra energiser batteries. The WICEN forward base at Wopen Creek had a Kenwood TR9000 into a 6 element yagi on Channel 51. IC2A handhelds were sufficient for use into the repeater which was line of sight. An IC22S mobile provided a command link on Ch 52 to Gordon VK4AGZ in his mobile at Babinda SES HQ while another IC22S was available for the medical emergency channel (53) or as a spare.

A field telephone connected us to an SES forward base further along the same ridge where operators were monitoring HF and VHF channels.

After preliminary radio checks with the climbers the forward base operators settled down to routine watch keeping, hourly position reports and message traffic.

The weather was anything but pleasant with frequent showers and periods of gusty wind, while the mountain was completely concealed behind a mantle of cloud. Some people were even doubting if the exercise should proceed, however, it was pointed out that aircraft don't usually fly into mountains in clear sunny weather!

While our forward base was reasonably dry, odd wind gusts would blow water over equipment and one gust did just that to Oxley's Tono keyboard — undaunted, he proceeded to pull it all apart and with the help of John VK4VKL, managed to dry it out and get it operating again. Although subjected to frequent showers duty operators did not grumble as they realised what their mates on the mountain had to contend with.

The SES Welfare group were delivering hot meals in special canteens and off duty operators could 'boil the billy' in Ted's caravan. Had the weather been fine it was planned to provide the climbers with hot meals but with low cloud and poor visibility helicopter operations were impossible.

WICEN COMMS proceeded smoothly until mid morning when Albert VK4AEQ failed to report at several sked times; we then learnt through an SES channel that his rig was U/S, apparently through water penetration. Albert and his 14 year old son Michael, VK4NDD returned to base escorting an SES member who was suffering from extreme exhaustion.

At 1530 hours, Andrew VK4KGA, happily announced that team 'Bravo' had reached the crash site (1413 metres) and were setting up camp, everyone was well but rather damp and having trouble with leeches. Colin VK4EX, with team 'Charlie' reported that they were still about two hours from the site with a lot of 'up and down' country in between and so had decided to camp for the night. 'Delta' team with radio problems had reached the South peak and also made camp after a hard struggle up the most difficult approach.



Radio watchkeeping. L to R: Ted VK4YG, Anne VK4NXX, John VK4VKL.

After the evening meal and stand down time WICEN operators were able to relax but a listening watch had to be kept in case of emergencies. Light and power were supplied from a small covered 'power house' consisting of two 350 watt gen sets which were run alternatively. Even colour TV was available in Ted's caravan.

Sunday 27th March: Dawn and it was still raining and 'that' mountain was again covered with cloud — the first calls from 'on high' informed us that everyone was well even if somewhat damp and cold. Teams 'Delta' and 'Charlie' were instructed to return to base while team 'Bravo' were to collect suitable items of aircraft wreckage that they could carry for donation to the Australian War Museum and to local museums. An early weather forecast indicated clearing showers with freshening E-SE winds.

At 1130K a notable 'first' for Region One Cairns WICEN took place with the transmission and receipt of a RTTY message from the WICEN forward base to the State WICEN Co-ordinator, Ken VK4KD, on the Gold Coast. Anne VK4NXX, typed the message into the memory of the Tono and Oxley VK4BKO, sent it on its way on 20 metres thus demonstrating that in the Queensland WICEN RTTY network we now have a superior high speed method of handling bulk emergency traffic even under portable conditions in the field.

Teams 'Charlie' and 'Delta' arrived back at Babinda around mid-day and were given a warm welcome and an equally warm meal by the ladies of the SES Welfare group, most of the team members had bleeding leech punctures which were quickly attended to by the medical orderlies. 'Bravo' team, as Andrew advised us, halted at 1245K on the way down for a rest and a light meal and finally arrived back at base around 1500 hours.

At debriefing the Cairns WICEN team were praised for the efficiency of their VHF communications, the SES described their



'Bravo' team leader Alec Davies examining wreckage of the Mitchell.

HF backpack sets as 'useless junk' and opted for a lightweight VHF set as they were very impressed with the rigs used by Colin and Andrew.

As in any combined exercise of this nature valuable lessons are learnt by all groups involved which leads to a higher degree of efficiency in an actual operation.

In congratulating all those who participated the retiring Regional Operations Officer, Sergeant Joe Porter, said that a high level of dedication was evident in those who were prepared to climb tropical mountains in wet season conditions on search and rescue missions and they must be truly regarded as professionals.

The Cairns WICEN team is proud to be included in that category.

Photograph by VK4NXX

Photograph by Stephen Fowler

AM



# EQUIPMENT REVIEW

Ron Fisher VK3OM  
TECHNICAL EDITOR

3 Fairview Avenue, Glen Waverley, Vic 3150

## THE ICOM IC-R70 RECEIVER

It is perhaps strange that as the ICOM Company were one of the first to produce a general coverage transceiver, it is only over the last few months that their first receiver has been released. They have no doubt had the technology required to do this for several years. One wonders what their market research on the production of a receiver only turned up. Whatever, several other Japanese firms have undoubtedly been doing very nicely selling their receivers now for some years. One thing however is certain, that when ICOM do something, they do not follow fashion but follow a method of design and presentation that sets their equipment apart from the others.



As might be expected, the R-70 has that ICOM look. In fact at a quick glance it could easily be mistaken for the IC-740 transceiver. It also incorporates many of the features that we have become used to in the ICOM amateur transceivers. As we shall later see, the R-70 has a performance that is in every way comparable with the IC-720A transceiver and performance has not been compromised by the introduction of gimmicks.

Let's have a look at the features of the IC R-70 receiver. Front panel size is the same as the IC-740 but depth is about 100 mm less. The height matches the IC-720 and ICOM intend to produce an adaptor to allow the 720A and the R-70 to operate as a fully integrated system with VFO control from either set. At the time of our review this adaptor was not available so I am unable to comment on its effectiveness.

The R-70 is an all mode receiver with provision for AM, CW, SSB, RTTY and FM reception. It has three speed tuning system

and two separate VFO's. Coverage is from 100 kHz to 30 MHz in 1 MHz steps but it is possible to change the stepping rate from 1 MHz to amateur band selection only. The noise blanker is designed for either normal electrical interference such as power line noise and car ignition noise or for the Woodpecker. Pass band tuning and a notch filter are provided to pull through the hard ones and an RIT control allows an offset from the selected VFO frequency. A monitor control allows you to listen to a companion transmitter and would no doubt be useful when the R-70 is teamed with the 720A.

The only facility that the R-70 does not have is a memory. Strange that ICOM did not use the 730/740 system or even enlarge on this. There is also no scanning offered. There is of course no analogue dial readout. Frequency indication is via a very bright six digit readout that also shows the mode and VFO selection. To finish off the line up of facilities, there is a tone and squelch

control.

The R-70 is a triple conversion receiver with IF frequencies at 70.4515 MHz, 9.0115 MHz, 455 kHz and then back to 9.0115 MHz. The last IF is used in conjunction with the second IF frequency to produce the band-pass tuning. The pre-amp in/out facility on the 730/740 has been taken one step further on the R-70. There is now a Pre-amp in plus an attenuator position. The R-70 is normally AC operated but our review model was fitted with the optional 12 volt DC operation kit. The FM reception facility is also an optional extra which was fitted.

Other options are a 500 Hz CW filter and an extra 455 kHz SSB filter. This latter item was fitted to our review receiver but no mention is made in the instruction manual as to its effect or specification. The rear panel has quite comprehensive facilities. Again there is no information in the instruction manual as how many of them could be used. There is a 24 pin accessory

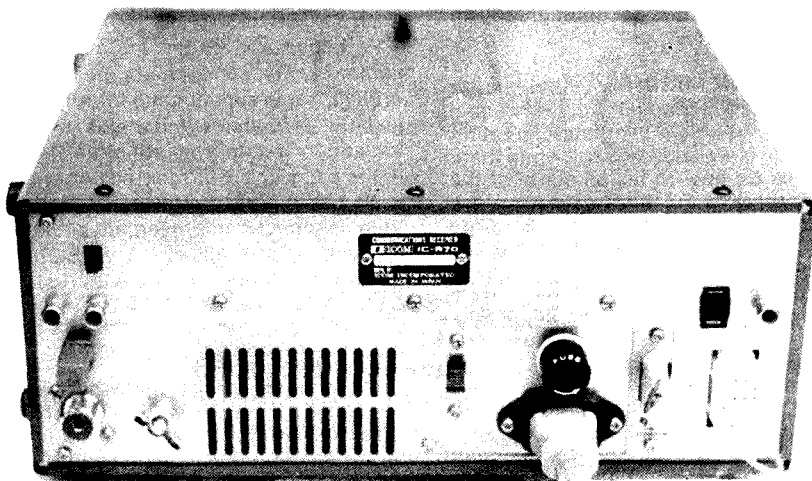

Rear View of the IC-R70.

socket which obviously allows access to the micro processor that controls the operation of the R-70 but apart from naming these functions, no mention is made of either their use or future intended use.

#### THE ICOM R-70 IN USE

On initial switch on the receiver comes up on 15 MHz if the general coverage mode is selected or on 7.1 MHz if the amateur band mode is selected. Side band selection is automatically chosen to give LSB on 7, 3.5, and 1.8 MHz and USB from 10 MHz up. The same change over point occurs in the general coverage mode also. Selecting the other sideband is a two button job. It is first necessary to push the function button and then the SSB button. The digital indicator at the left of the frequency readout will also show that 'U' or 'L' side band is in operation.

As is common with all ICOM gear, it is necessary to retune when the sideband is changed, the frequency difference being 3 kHz. It's a pity that ICOM haven't seen fit to overcome this and it is perhaps the least professional feature of an otherwise very professional receiver.

The R-70 differs from other current general coverage receivers in that the tuning is not continuous. Once a particular MHz range has been selected it is not possible to tune out of this range. To go up a MHz it is necessary to push the 'Band Up' button. Not only that but it is necessary to give the button a push for each and every MHz one wants to go up or down.

However in general the operation of the R-70 proved to be very satisfactory. The three tuning rates have been well chosen and are the same as the 730/740 transceivers. The 10 HZ steps give a tuning rate of 1 kHz per knob rotation, the 100 HZ steps 10 kHz and the 1 kHz steps an ideal band scanning rate of 100 kHz per knob rotation.

In my past reviews I have had some harsh things to say about noise blankers. The blanker in the R-70 is, without doubt, the best of the current bunch. Its action on eliminating the Woodpecker is excellent and can certainly make the difference of copy or no copy. The blanker action is equally good on ignition and other elec-

trical type noises.

By using the two VFO's it is possible to up the receiver on two frequencies on two entirely different bands, that is two amateur bands or two short wave bands. Unfortunately the selected mode will not follow. If, for instance, you chose USB on 14.2 MHz with VFO one, your only choice would be LSB on 3.6 MHz with VFO two. If AM is required on 80 then it will be necessary to reselect USB on 20. With the R-70 operating from a constant AC supply then the last frequency tuned to will reappear when the set is turned on again. However if you are listening to a contact and decide to go up a MHz and then come back, your original frequency will have been lost unless you swap VFO's before the change of tuning.

All this sounds rather complicated but does not cause the confusion you might think and actual operating is, in most cases, easy.

The notch filter and the bandpass tuning are both similar to the set up in the IC-740. They are, however, now concentric rotary controls in place of the slider controls. As such they are easier and smoother to operate. Performance of both is similar to the 740.

The new pre-amp/off/attenuator switch gives one a chance to try everything. Using the R-70 on the higher bands, the overall gain sounded low with the pre-amp off. Sensitivity appeared to be OK but 'S'6 signals just would not lift the 'S' meter. I could find no instance where the attenuator was needed, and immunity to front and overload seemed very high. It's also nice to see an all band receiver fitted with an RF gain control which is missing from many contemporary receivers. The action of the RF gain is excellent, being smooth and progressive.

The built-in loud speaker works quite well. Although of small diameter, about 6 cm, it has a large and effective magnet that obviously gives it a much higher efficiency than normal. While many might prefer a large speaker in an external cabinet, the built-in unit has a well balanced response and an excellent transient response.

Now for a few 'funnies' discovered when operating the R-70. It seems that the CPU is

rather slow in its operation. A quick stab at the Band Up or Down button will often have no effect. It often took quite a lengthy push to produce a frequency. At the same time, it took quite a while for the selected mode to catch up when changing bands. Maybe this is peculiar to this receiver, I don't know.

#### THE IC R-70 ON TEST

The following test equipment was used to produce our figures. Daven audio power output meter. AWA F242A noise and distortion meter. A 100 kHz crystal calibrator with multivibrator output. With no access to a calibrated signal generator, all sensitivity tests are subjective and are checked in side by side tests with other receiving equipment. Audio output was taken from the external speaker socket and the power meter terminated in 8 ohms. Noise level with the audio gain set at zero was -50 dBm unweighted and -42 dBm weighted. If you have sensitive hearing you might notice some hiss when listening on headphones.

Maximum audio output was measured at 4 watts at 40% distortion. The 4 watts could only be produced from a very strong signal from the calibrator and with the AGC switched off. At 2 watts output the distortion had dropped to 3.2% and at 1.8 watts it was a very creditable 1%. With the audio output set to 2 watts it was noted that the output rose to 2.2 watts when the AGC was switched from slow to fast.

It is interesting to note that these figures correlate very closely to our figures on the IC-740.

The tone control performed much better than the 740. At full effect it produced a drop of 12 dB at 2.5 kHz, -7 dB at 1.5 kHz, -5 dB at 1 kHz and -2.5 dB at 700 Hz.

AGC action of the R-70 is very good. Listening across the various bands in all modes, there was no sign of pumping or popping with a very constant output level. To check this, the crystal calibrator was fed in to produce signals varying from an indicated 'S'1 to 'S'9+30 dB with the preamp switched in. Audio output only changed by .5 dB over this range, an excellent figure.

The response of the SSB filter was checked by feeding in a weak signal, the output measured with the AGC switched off. The -6 dB points were at 200 Hz and 2.7 kHz. The output was down to -40 dB at 2.9 kHz. The response of the optional CW filter was checked in the same way, the -6 dB points being 400 Hz and 1.1 kHz with a very sharp cut off beyond these points. The notch filter was checked across the audio range. The actual drop in audio output was a constant 20 dB except below 500 Hz where it increased to 25 dB. When listening to a signal at normal level, 20 dB will reduce a heterodyne to almost inaudible point.

It was noted that when the 100 kHz calibrator was fed into the receiver to produce an 'S'9+30 dB signal many spurious signals appeared throughout the tuning range, with a large amount of white noise on either side of both the wanted and spurious signals. . . . In contrast to this, the

R-70 proved to be one of the best performers I have checked on the broadcast and long wave bands. Used with a long wire antenna about 20 metres long, broadcast and aircraft NDB stations were received with a notable lack of cross modulation. Frequency drift was checked by running the receiver in zero beat with VNG on 7.5 MHz. Any slight drift could be checked by comparing the tone beep against the same tone as heard on an AM receiver running alongside. It was noted that even with the tuning of the R-70 set to the 10 Hz rate it was not possible to set the tone to the exact frequency. The initial error was estimated at about 5 Hz. After about one hour's operation the R-70 had drifted around 25 Hz. Quite a superb effort! Due to the method of frequency generation in the R-

70 the total drift should not differ greatly on any other frequency.

#### INSTRUCTION MANUAL

The instruction manual is good in some respects and very poor in others. Operating information is well covered but while there are details on how to install some of the options, there is no information on the available options themselves. Strange indeed. You will have to chase up the information on the available options yourself. A circuit diagram is included but no other service information at all. For a receiver bordering on the professional class this is poor. Maybe ICOM have a service manual in the pipeline but as I have previously stated with ICOM reviews I have yet to see one for any model.

#### CONCLUSIONS

Perhaps some readers might have taken some of my remarks as being rather critical, but in summing up I would have to give the R-70 almost top marks. If you are looking for multiple memories and flashing lights then you will look elsewhere. The R-70 has a solid professional feel. Sure there is room for improvement but after all it doesn't cost \$3000 either. If you need a general coverage receiver with first class performance that will still be going well in years hence, then this might well be the one you are looking for.

Our review receiver was supplied by ICOM AUSTRALIA of Duke Street, Windsor, Vic. 3181.

## EVALUATION AND ON AIR TEST OF THE ICOM IC R-70 RECEIVER

CATEGORY	RATING	COMMENTS
Packaging	****	Excellent quality carton with carry handle.
Size	***	Reasonable size.
Weight	***	Quite reasonable.
External Finish	***	Very well finished and clean appearance.
Construction quality	****	Well up to the usual ICOM quality.
<b>FRONT PANEL</b>		
Location of controls	****	An excellent layout, plenty of room for everything.
Size of Knobs	***	Some knobs rather small but control action very smooth.
Labelling	**	SSB reverse and narrow CW confusing, otherwise satisfactory.
'S' Meter	***	Brightly illuminated. 'S' and Sinpo calibration.
Status Indicators	**	Could use a few more.
VFO knob action	****	The best in the business. Three tuning rates.
Dial readout		
Analogue	NA	
Digital	***	Bright and accurate. Does not show RIT frequency shift.
<b>REAR PANEL</b>	**	Plenty of facilities but no information on how to use them.
<b>RECEIVER OPERATION</b>		
VFO stability	****	Hard to fault. See test section.
Digital dial accuracy	****	Spot on calibration.
Memories	*	Only second VFO useable as limited memory.
Bandpass tuning	**	Reasonable reduction in high end QRM.
Notch filter	****	Excellent reduction of heterodyne interference.
Spurious responses	***	Very clean.
'S' meter	***	Realistic response with pre-amp in.
Signal handling	***	No trace of overload under normal operating conditions. But see test section.
Sensitivity	***	With pre-amp is on a par with contemporary equipment.
Pre-amp/attenuator	**	As above. Pre-amp needed most of the time.
RF gain	***	Smooth progressive action.
Squelch	***	Works on all modes. Quite handy.
Tone control	***	Well chosen response. See test section.
Noise Blanker	****	One of the best yet heard. Even works on the Woodpecker.
<b>QUALITY OF RECEIVED SIGNAL</b>		
Internal speaker	***	Well balanced response.
External speaker	NA	No mention made of any option.
Headphone output	**	Stereo Headphone compatible. Some hiss audible.
Power output	***	Plenty of audio with low distortion. See test section.
Manual (owner's handbook)	**	Lots more information needed.

Rating Code: Poor \*      Satisfactory \*\*      Very Good \*\*\*      Excellent \*\*\*\*

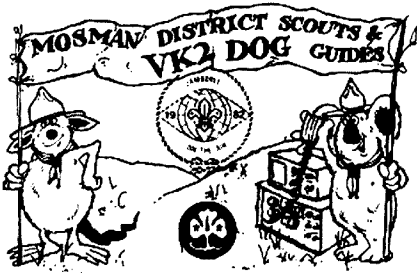

# JOTA (Jamboree On The Air)

Tom Delandre, VK2PDT  
 JOTA LIAISON FOR VK2  
 102 Buffalo Road, Ryde, NSW 2112

**The 26th JAMBOREE ON THE AIR is scheduled to commence at midnight on Friday 14th October, 1983 and to terminate at midnight on Sunday 16th October, 1983. JOTA is an exercise conducted annually by the Scout Association with the co-operation of amateur radio operators throughout the world.**

In a large number of areas it has been an outstanding success whilst in other areas it has been either non-existent or a dismal failure. The results are dependent entirely on the enthusiasm and preparation on the behalf of scouters and amateur radio operators.

Last year I took the position of JOTA liaison officer at the last moment having held off hoping another amateur with more experience would volunteer. I should have known better. They say OLD SOLDIERS NEVER VOLUNTEER.

On contacting the Scout Association I was told to contact Eric Van De Weyer for scouts and Mrs Valda Lambert for guides which I did and I must commend in particular the help and co-operation which I received from Mrs Lambert.

An example of what can be done even at short notice was the result of an enquiry from Mr Colin Taken of the Mosman district scouts. The request for assistance was passed on to the Manly Warringah ARC who immediately got to work on the project.

Today — NOT next week — next month is the time to prepare to participate. I know that at times you meet up with a lack of enthusiasm, should this be the case let me know so that in conjunction with the Scout Association we can endeavour to inspire the necessary enthusiasm in areas not giving these boys and girls the opportunity to participate. May I add that this is not a condemnation of leaders in these areas for they may have their hands more than full with existing exercises and know only to well their limitations.

To participate contact the local Scout or Guide leader and offer your assistance but do insist that suitable supervision be provided by the group concerned for you are the licensed radio operator not a scouting leader, kindergarten teacher or youth counsellor.

Confirm the location at which you will be operating and the number it is anticipated will be participating. Do not take on more than you can capably handle. Liaison with your local scouter as to a firm schedule on the size and times of groups is essential.

The erection prior to JOTA or the careful planning of portable antennas, can be a rewarding exercise undertaken in co-operation with the scouts. Do not overlook the advantage of high gain wire antennas. Quads, yagis, log periodics and the like can all be made up with wire and even if fixed can, with reference to the IPS reports, give quite

amazing results if you do your homework now.

Try to arrange some prior instruction for the boys and girls participating on operating procedures. Remember your first QSO how fluent were you at the time, have them prepare some topics on points of local interest to pass on to their contacts — interesting exercises they had taken part in at school, scouting, holidays, travel. Help them over the HM — AR — AR — AND etc. You may not be a public speaker but you have learned something in the art of communication, pass it on, that is what youth and this world needs. *Don't Waffle.*

Amongst the scouters you may find some capable CW exponents, try to foster this art. Have you RTTY facilities? Some of the nimble fingers amongst the guides could upgrade your station.

Another thought on antennas, don't overlook the simple vertical or dipole which has an advantage over beams for local contacts. Did it really matter if your first QSO was over 10 km or 10,000 km. Try to arrange skeds with other participating groups to keep the action going when DX is not on.

Remember in most instances you will need

the assistance of fellow licensed operators, make firm arrangements in plenty of time. Never allow your station to be operated without the supervision of a licensed radio operator. Your equipment and your good name are both of real value.

Ensure beforehand that all your equipment is in A1 condition. How long can you operate portable? Have you arranged extra fully charged, back up batteries. Play it safe not only with AC and DC but remember that whilst a nine year old wolf cub may be the perfect radiator of AF he would be a sizzler when it comes to RF.

There are a number of Scout Radio Stations operating in Australia and they run a net on the first and third Sundays of each month. Net station for these nets is VK4SAA with a back up by VK4BNK the frequencies and times are 7.090 MHz 2330 UTC, 21.190 MHz at 0001 UTC, 14.109 MHz at 0030 UTC with 21.190 MHz. Information on scout amateur radio activities will be publicised on these nets.

For information on JOTA liaison contact your division for additional information. Best wishes to all for a pleasant and productive JOTA 1983.

AR



Simon Sebato and friend from 1st Clifton Gardens Cub Pack enjoying JOTA '82 with the help of Manly Warringah District Radio Club.

# JOHN MOYLE FIELD DAY ON AN ISLAND

Dennis Hardie VK6KOZ  
35 Lawson Street, South Hedland, WA, 6722.

There is a radio club in the remote Northwest of Western Australia, the North West Amateur Radio Society based in Port Hedland with chapters in Wickham, Karratha and Newman. It is one of the largest "clubs" in Australia, not in numbers but in the area covered by our membership from Wyndham in the North to Boyup Brook, South of Perth. The club call sign, as used portable on the weekend, is VK6ANW.

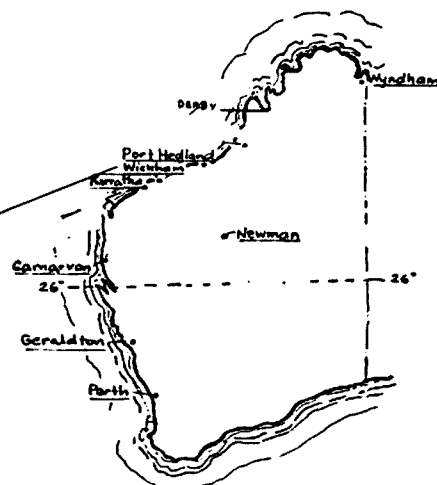
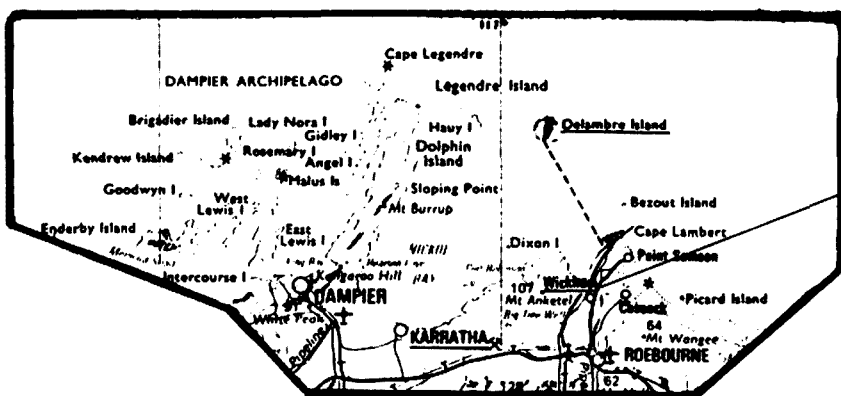

Each chapter runs its own VHF Repeater and a new chapter in Exmouth, with the assistance of the other chapters are in the process of building a repeater to cover that area.

This year the club decided to enter the John Moyle Field Day Contest operating from Delambre Island which is 16 kms off the coast of Wickham at the top end of the Dampier Archipelago.

Most of the organisation was done via the repeaters. There is excellent ducting and contacts, over 200 kms are normal, it is not unusual to talk to Bali in Indonesia.

**Repeater Frequencies (MHz)** Wickham 146.100/146.70, Hedland 146.400/147.000, Karratha 146.200/146.800, Newman 146.300/146.900.

## VILLIANS IN THE STORY

Dave VK6ADR, Dave VK6YA, Clement VK6AFA's son, Brian VK6AIH, Dennis VK6KOZ, Mathew VK6NU's son, Mark VK6WV, Peter, Trusty Assistant, Rossco VK6SL's OM, Maria VK6AFA's XYL and Shawn and Craig, the sons of VK6KOZ.

Others who assisted but didn't make the island as the story will reveal were Pattie VK6SL and family, John VK6AFA and family, Ron VK6KRD and family, Norm VK6NU and other son.

## THE CAMP

It was planned that the boat "PHOENIX" a 6 m aluminium craft with twin 80 hp outboards and Rossco (VK6SL's OM) in his 6.4 m fibreglass boat with a 200 hp motor would take some people and most of the equipment over on Friday morning. This equipment included three generators up to 3 kw, two tower sections one with winch and pipe extension, five transceivers, two ATU's, extension leads, coax, tools etc, as well as enough camping gear for the expected twenty five people.

Dave VK6ADR and Brian VK6AIH were late into Wickham as their water pump failed near Whim Creek, a famous country pub, Dave VK6YA went out to tow them in. Peter, myself and my two boys went over to the island to start setting up camp. Rossco, the two Daves and Brian arrived two hours later.

The first major task was to assemble the antennas.

## THE ANTENNA SYSTEMS

The finished article was made up of the tower with the TH3 at 8 metres and the four element 6 m beam at 10 metres above the sand. The beams were fitted to the rotator after much arguing as to who had put two of the TH3 traps in the wrong place. The

whole lot was then lifted using a small but very long block and tackle and guyed back to three star pickets driven into the sand. The wind didn't stop blowing from then on and the system didn't show any sign of giving way. I can't say the same however, about the tents, which needed constant work to keep them on the ground.

On the beach there are two rotary clothes hoists which local fishermen put in to give some shelter for day trippers. One of these was used for the three element 10 m beam which finished up about 4 metres off the sand. Due to the wind we had to tie a rubbish bin to the clothes hoist to stop it turning in the wrong direction.

The five element, 2 m beam was stuck on a pipe and stood near the door of the tent at 2.5 metres above sand.

For working 160 m, 80 m and 40 m we had a random length of wire from the top of the tower to a pipe on a sand dune 100 metres away.

We also had, and used until the wind became too strong, a balloon filled with hydrogen. The wire antenna was to be at about 40 metres above ground which was achieved from time to time. We got reports at 5 x 9 + 20dB on this system where we were only 5 x 9 on the long wire, so the idea was good but not the conditions. The wire



Ten metre beam and weather balloon. antennas were fed through ATU's.

### THE SHACK

At the back of the tent, sorry SHACK we set up a large sheet of plywood on stands for the radio gear.

We have it from a reliable source, Maria, that the shack was very well kept and the sleeping, cooking quarters was like a pig sty. We still believe our priorities are right, we didn't sleep much anyway.

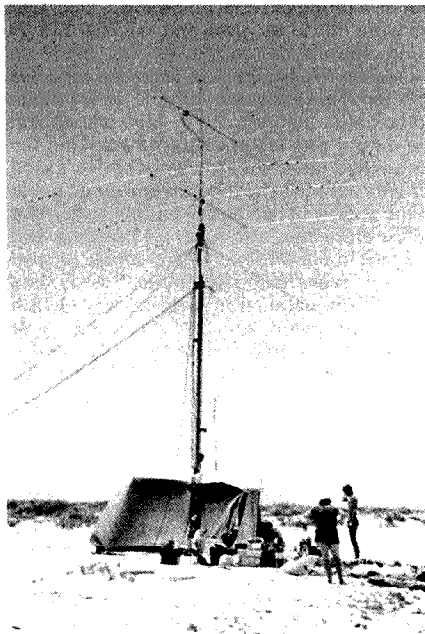

The Tower and Shack.

### THE BOAT

On Friday evening, Roscco returned to Wickham for the night. Both boats went so we could pick up Maria, Mathew, Clement and Mark VK6WV at the yacht club.

We were in contact with Mark via the Wickham repeater so we all arrived at the yacht club at the same time. The sea had been getting rougher throughout the day and was running about 1 metre high into the boat ramp which made it very difficult getting Roscco's boat onto the trailer. We left the other boat at anchor and could sometimes hear it hit the bottom. When Roscco's boat was out of the water we loaded gear onto the boat for the trip back to Delambre.

It was dark when we left the yacht club but we had a flood light on the tower to guide us to the island. On the way over we

were beating into the waves so the trip was very slow and wet, and we were over half way across before we could see the light at the camp.

It didn't take long to unload the boat, anchor her off the beach and get some hot coffee and food into us.

### DISASTER STRUCK

At about 10 PM Dave (6YA) came over and said something looked odd about the boat. When we got the light onto the boat we could only see the silver triangle of the bottom of the bow.

We swam out to investigate and found the bow floating with the motors on the bottom, the boat of course was upside-down.

It didn't take long to get organised. We eased the boat in toward shore on the main anchor which fortunately, was well dug in. We then brought out another anchor from the beach and managed to turn the boat up the right way and run the boat bow first onto the beach. For the next hour we kept the boat pointing up the beach while the tide came in and went out leaving the boat high and dry we found that the bung was missing, it had unscrewed itself hitting rocks on the bottom when at the yacht club.



Equipment washed ashore from the upturned boat.

This whole episode took about four hours and the maximum effort of all concerned, as the waves were breaking onto the beach. The sea didn't calm down until morning.

After a short sleep it was up looking for gear while the tide was out. Surprisingly, we recovered most of the equipment mainly scuba diving equipment. The lighter gear had washed ashore so was easily recovered by the children.

This episode put a damper on the enthusiasm of most of the people but we worked on the principal that as all the radio gear was there and set up we might as well carry on with the contest.

Via 2 metres we advised all the other participants of the problem and asked them not to turn up.

On Saturday Roscco brought out a spare battery and some DWF to flush out the two outboards. We managed to get one of the motors running so we were able to get back to shore under our own power at the end of the weekend.

When Roscco returned to Wickham on Saturday afternoon, he took Dave (YA) Maria, Mathew, Clement, Shawn, Craig and any equipment which was not needed on the island.

### THE CONTEST

Throughout the twenty four hours we managed to work about 290 contacts on all bands except 160 m, so our preparation had paid off. The noise levels on the island were very low, which made it easier to hear the more difficult stations. (Heard Island 5 x 9+ on Friday evening.) Our main problem at night was turtles. The baby turtles travelling from their nests to the water were attracted to the lights of the camp. More time was spent taking them down to the water than working the contest but it was an interesting diversion.



Dave VK6ADR operating during the contest.

Within two hours of the contest ending we had broken camp, lowered and dismantled the antennas and loaded the boats. The "Phoenix" on one motor could not reach planing speed so we ran a tow-line out to Roscco's boat and the extra horse-power allowed us to travel at 25 kph. The rest of the return trip was uneventful except we lost Dave's (VK6ADR) car, the water pump had not been repaired as promised and the car was locked in the local service station and of course the proprietor couldn't be found. Dave got his car back the next weekend.

### THANKS

Thanks must go to all members of the North West Amateur Radio Society and families for their assistance with organising the weekend.

My personal thanks to those on the island for their help with the boat.

Special thanks to Roscco and Pattie for all the running around on the weekend and the hot shower and meal on Sunday afternoon.

The weekend was an education in more ways than one, for all of us, and it proved again that an amateur in need has many friends. Thank you.

AR

Photographs by Mark Dunning VK6WV

# AMATEURS UNITE

## Join the Wireless Institute of Australia.

The following article was forwarded to the DX Editor by Ken Hail, VK5AKH. Ken received the article from Baldur Drobnic, DJ6SI, a member of the ill fated expedition to Spratly Island in April. Here in Baldur's words is a full account of the expedition.

# SPRATLY ISLAND

© 1983

Baldur Drobnic, DJ6SI

In February 1983 several OM's of the Cologne-DX-Club met to discuss the realisation of a DXpedition to Peter and Paul (PY0P).

DJ3NG and myself doubted if PY0P was sufficiently activated in November 1982. Therefore Gero and I decided to spend our time and money in a different DXpedition. As Spratly was number one in the list of the most requested countries, we chose 1S. Another advantage in going to the Spratly Islands was that there were no tedious procedures obtaining an Amateur Radio Licence. Considering the geographical point it was decided it would be best to realise the DXpedition from Brunei. Many contacts were made with OM's in Brunei. During weekly skeds all chances and possibilities were discussed. At the time it was learned that in VS5 a DXpedition to 1S was discussed for Christmas 1982. We were told that there were no suitable boats in VS5 which could go to Barque Canada.

In the German magazine "YACHT" we found an advertisement of a German captain, who chartered his catamaran from Singapore, and duly got in touch with him, Captain Peter Marx. Additionally we had constant skeds with 9V1WC. We introduced Peter Marx to Henner 9V1WC. The preparations in Singapore were very satisfactory. All heavy equipment was cared for there, such as batteries, generators, canvas, gas etc.

Our journey was originally planned for 21st March, but Captain Marx advised us against this date as the monsoon season lasted very long this year and the wind would blow against us all the time. He preferred 3rd April. On 31st March DJ3NG, DJ4EI, DF6FK and DJ6SI took the plane to Amsterdam and from there to Singapore, to be met by 9V1WC. Together we made last minute purchases, such as masts etc. Henner and his XYL Brigitte took us to a typical Chinese restaurant in the evening. On Easter Sunday we took our equipment on board and left the mooring by 15:00 hours local time. During the next few days we sailed through the Singapore Strait passing the Anambas and North Natunas.

With our equipment and a 15 m and 20 m Dipole (inverted V) we kept in touch with SEA Net, 9V1WC and Cologne as DJ3NG/MM and C53DZ/MM with net control by DK9KN. Weather and excellent cooking were responsible for a good atmosphere on board, but to our dismay the monsoon was still blowing very strongly from the NE, so that the timetable got a little mixed up. After passing the Natunas, ship-traffic grew less and we were soon completely alone. On 10th April we had a very strong wind and were able to go under sail for the first time of the trip.

Unfortunately we could not keep exactly to our chartered course. Destination was Barque Canada at 8° 04' N, 113° 12' E. On the way lies Amboyna Cay 7° 53' N 112° 55' E. For better

control of our course we took Amboyna Cay as a fixing point. A landing was not intended. We were not sure if there was a garrison or similar establishments although the captain had heard in Singapore that there might be Phillipine enforcement there.

From the Singapore newspaper clippings we had collected, we knew that Amboyna Cay was claimed by Malaysia and that they had erected an obelisk on the island to show their claim.

We reefed the sail and made a very slow and careful approach to Amboyna Cay under engine. As we could not see any buildings from this far distance, we had the impression that this sandbar was not occupied. Then came the idea — why go all the way to Barque Canada, we could save 30 SM, as we were already two days behind schedule.

As we approached Amboyna Cay a hut-like building came into sight, and later three antenna masts but without recognisable antennas, but no humans in sight.

At a distance of about 2 km we saw a watchtower and changed course immediately. We had hoisted the German flag but could not see any flag on the island. As we changed course we saw the first man. He stood on a tower and gave signs with two handsignals (similar to the equipment used at airports for guiding planes on the runway).

As shelling started, we knew, he had focused a gun on us. The first volley fell short. The second round of three shots hit the captain in the right side of the chest, he was bleeding from nose and mouth. He threw himself on to the floor and tried to keep the ship going on course. The third round hit the complete gas-supply of 120 litres (approx 32 gal) which was stored on quarter-deck. Also in this part of the ship were the dinghi and life-belt with flashlight. As we were being fired upon Gero was in contact with Pat, NOZO/DU2 on 20 m and gave the following message, which should go round the world afterwards: "We are being shelled — lire on board!"

Everyone rushed from the quarter-deck to the saloon, then we climbed through the garret outside. We pulled Gero from the equipment and pushed him through the garret also. On fore-deck we found that Diethelm DJ4EI was missing. Who had seen him last and when? It was quite certain that he had not been in the saloon. Had he been standing beside the gas-tanks before the explosion. Had he been shot, was he burnt or had he fallen into the sea? Perhaps all of it. His last words to me were: "My god, I can't swim." The ship was ablaze, and poisonous smoke took our breath.

The shelling went on without interruption. While lashing empty gas-barrels together with ropes I was hit on the elbow and blood gushed from the wound. Norbert DF6FK tore

a sleeve from his shirt and applied a tourniquet to my arm. He was hit later by shell-fragments. A 70 litre watertank was tied to five empty barrels and were then pushed into the sea, but the wind drove them directly near the dangerous plasticedge. We could not reach them anymore. The heat was now unbearable, and our hair was already singed. We slipped into the water, fetched the ropes with which we had tied the tanks together and thought we could swim like that to Amboyna Cay, and hand ourselves over to the gunmen and be safe.

A new round of shots made it very clear that we were not to be given this chance. Everything should be destroyed. No boat, no witnesses. We would have vanished for ever.

Peter Marx saw our dinghi. A fortunate coincidence had burnt the rope with which the dinghi was fastened to the ship and the dinghi had fallen into the water. Peter asked his wife Jenny if she thought she could get it. In the shelter of two empty barrels, which she held before her, she reached the boat and rowed it in our direction. All climbed aboard. As we were searching for Diethelm we saw the hulls of the catamaran were peppered with shots. We called for Diethelm a few more times, but no sign or sound from him.

Still under shelling we drifted off the coast. At the time of the malicious attack we were south-west of Amboyna Cay. As the wind below from the north-east we drifted away from the sandbar.

After about an hour the firing ceased because of its non-effect. Now the time of summary had arrived. Gero had to explain and repeat his last radio message. Had the contact been confirmed. Yes — Pat had everything OK. Peter believed that the US Airforce should arrive within two hours with a search party. That meant hope. Then we saw to our clothing. Gero, Norbert and I were in swimming shorts. Jenny wore a wrap-around-skirt, Peter was in shorts. Gero was top-less, I wore a yellow snow-shirt and a tiny hat and the others had T-shirts on. Norbert also had a hat but no-one had shoes.

In the boat we found a screw-driver, a preserving-jar, a little basket, a cloth and a plastic-bottle with a cut-off top, for scooping. That was all. The boat had no water! Nothing to eat. No signal-apparatus. Midship underneath the waterline we had a leak, caused by a gunbullet. We stopped the leakage as well as we could with rags. Every half hour we had to scoop out the water. The sun went down. At that moment it was clear to us that help would not arrive before the next day. It was a long night.

So close to the equator night lasts for twelve hours. A lot of time to ask many questions. How had Diethelm died. Strangely enough there was no debate.



The next day we lived with the hope that a nice big plane would start from Manila, which would drop us life-saving-equipment until they were able to pick us up. The day went by and nothing happened. The next day dawned with calm weather. Flying tuna — no plane. We could not count on ships in this part of the world. Because of its reefs, sandbars and shallow waters it was marked as "Dangerous Grounds" in the sea-charts. Ships pass this area in the far distance as too many have been stranded on the sandbars before.

On the fourth and fifth days it was sure that no-one was searching for us! The thirst tortured us. Gero tried to distill water — without success. Small fish, really tiny ones, swam into our basket. Still wriggling they were swallowed greedily. To our despair we lost the basket. At the bottom of the boat we felt tiny colonies of mussels and scraped them off with our fingernails and sucked them. Gero weakened considerably. His skin was too sensitive and sunburn and shivers tormented him. Clothes were exchanged. Norbert gave his T-shirt to Jenny, she gave her wrap-around-skirt to Norbert and Gero so both had sunshelter during the day and a cover at night.

I unscrewed the machined steel plate which was meant to hold the outboard-engine. Later on we used it as a signal-plate which reflected the sun to draw ships attention to us. The back was used as a diary, engraving the most important events, such as the date DJ4EI died — why does no-one search for us — where was the US Airforce? On the ninth day, by about 13:00 hours local time I had to engrave Gero's death as well. I intended to put the plate back in its place later on, so that when the boat was found it would give hints as to what had happened to us.

During the sixth or seventh night a ship passed, fully illuminated, only about 400 m from us. No chance to give signals. Nevertheless, great joy and rising hope. Now we knew, that the constant north-easterly wind had carried us into the shipping route. But it was too early to rejoice. During the following day, no ship in sight. Another long cold and wet night. We had filled the two diesel-barrels with seawater and used them as a drag-anchor, so the boat went quite steadily. Nevertheless, some waves hit us by surprise in our sleep and for some time we could not find sleep again.

Shortly after sunrise a big ship came along, but it passed and did not see us. As it should happen more than once later on as one or two ships passed that day and another night, and our hopes for rescue fell. Gero's condition grew worse. Again ships during the night and the following day. Then I told all on board that I had heard a voice during the second night — loud and clear — that we would be rescued on our tenth day. We prayed often.

On the ninth day Gero died. It was terrible not to be able to help. Norbert told us, Gero had drunk sea-water during the night. At 14:00 hours we said a prayer and buried Gero in the sea at about 7° 52' N, 109° 44' E. Shortly afterwards we saw a big plane without country-index. It flew in circles and we hoped it was looking for us. But its interest was in a Russian trawler which passed by on the horizon. And then night again. The following day ships came only in the afternoon, some of

them quite near. The letters "DATSUN" were very clear. A little later a tanker "LPG" only 300 m from us, passed by. No reaction. Norbert was in a very bad state. He had hallucinations. He would not survive the following night. The captain got considerably worse too.

Suddenly a ship very near, only 200 m from us. We waved frantically, even tried to shout. Perhaps someone on deck might hear us. It passed very quickly. Very tired, already resigning, we waved behind her. We had given up, it was already too far away. We prepared for another night. Then Jenny saw it first.

The ship that had passed us had changed its course, had turned 90° and stayed in place. Later we were told that the First Officer YAMADA had seen us and had reported it to Captain INOSE. After he had stopped the engine he had lost us. The ship drew a circle around us, found us again and went into the lee. We went on board via the gangway they had lowered for us.

During all those dreadful days we were not hungry, only the thirst had tortured us. During the first fourteen hours on board the "LINDEN" we drank about twenty litres of water. The Japanese crew of the "LINDEN" cared for us marvellously. The wounds were looked after, cabins were cleared for us, clean beds and clothes were provided immediately. Slowly we picked up condition again. I had lost 15 kg and weighed only 60 kg. Our bodies had scratches and ulcers.

On arrival in Hong Kong we were examined by a physician on board the "LINDEN" then a police patrolboat took us to the harbour and from there in an ambulance to the Queen Mary Hospital. After minor treatment we left the hospital and went to the Hilton Hotel where we received treatment for our wounds by a doctor of our choice. On arrival in Singapore we were welcomed heartily by Henner 9V1WC and his XYL Brigitte.

Besides the grievous loss of our friends we counted up the balance of our material losses.

One OMNIB, one IC 720, one IC 730, one matchbox, one ELBUG, Microphones, Ear-phones, one two-element Fritzel-beam, one P 50 beam from DJ2UT, two aluminium-masts, Dipole, two 220 V/12 V generators (Honda and Bosch) and many tools etc.

We also lost approx 20 000 DM (\$US10 000). Additionally we lost all our clothes and money, in my case \$US2000 cash. Also there was flight and charter totalling 5500 DM each. This can all be replaced, but not our dead friends.

I have written to our government on behalf of the whole crew and proposed the Captain and First Officer of the "LINDEN" for decoration for the way in which they reacted and cared for us so marvellously. We will never forget them, and will always be thankful.



**Baldur in happier days operating DJ6SI/6W8.**

*Written by Baldur Drobnica, DJ6SI*

*Translated by XYL of DJ6AP*

© by DJ6SI

AR



**Baldur is assisted aboard a police boat from the Linden.**

Photo Carl Ho courtesy Joe Hilger UPI and the Melbourne Herald.

# SPOTLIGHT

ON

SWLING

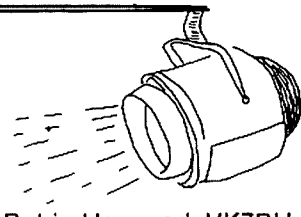
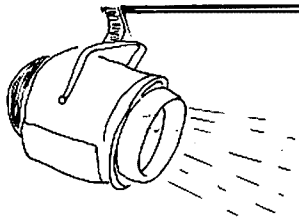

Robin Harwood, VK7RH  
5 Helen Street, Launceston, Tas 7250

Well, Spring has arrived once again. It is also the start of the S-83 period, which commenced on the 4th of this month from 0100 hours UTC. On this date, the various international broadcasters alter their operational frequencies to take account of seasonal effects of propagation. The months of November, March, May and September and the first Sundays within those months, have been chosen for international stations to make their alterations. Normally, you will not find that too many stations will change their frequency usage that month. Nevertheless, it still is a good exercise to check frequency occupancy. This could indicate that there have been changes, and some of the lowered powered stations, not normally audible, can be often heard underneath the stronger senders.

HF propagation has certainly been disappointing, particularly during the hours of darkness. Signals have markedly deteriorated even further on signals above 11 MHz. When this occurs, it is recommended that you try the lower frequencies, as propagational characteristics on these frequencies are improved even more than during the maxima of the Sunspot cycle. From experience, I find that 3.5 MHz performs very well during the Sunspot minima. The amount of strong ZL stations heard at exceptionally strong levels attest to this. Also many Latin American and Asian stations are heard on the 60 and 90 metre tropical bands, but the African stations are noticeable by their absence. I understand that others have heard them on the long path during our local daylight hours.

On the 6th and 7th of July, I came across a station broadcasting in Spanish on 6.900 MHz. I observed it between 1100 and 1200 UTC and it was not all that loud, which made positive identification almost impossible. I had noticed in overseas DX publications, that many clandestine stations in Central America were heard in the US on various odd channels. Most of these stations heard were broadcasting on behalf of the El Salvadorean guerrillas engaged in the civil war which has been going on for several years there.

Yet the station I was hearing, seemed to be transmitting anti-Sandinista slogans, indicative of supporting one or more groups engaged in trying to topple the Nicaraguan government. The programme had plenty of slogans, mentioning El Salvador, communism etc with many German marches for example "Alte Karameden", which seemed strangely out of place coming from a Latin American station.

I managed to identify this station after Matthew Francis in Hobart reported in the July issue of the "ADZN", the official publication of the Australian Radio DX Club, that he was hearing the station early in June.

The station does identify itself as Radio 15 dell Septiembre. Naturally, no addresses are given where reception reports can be sent. Personally, I estimate that the power of the sender must be two or three kilowatts. Their professional style of presentation is also indicative of a permanent transmitting site within Central America.

Recently, I was very fortunate in being able to test out the Realistic PRO-2002 scanner. This model is programmable, via keyboard access, over 50 channels. The frequency range is between 68-88 MHz, 108-136 MHz (AM), 138-174 MHz and 410-512 MHz UHF. It has five memory banks in which you can store the required channels. Power requirements are 240 volts AC or 12 V DC negative ground. Personally, I think the unit is a trifle too large and conspicuous to have in a mobile installation.

Performance from this scanner was very surprising, in comparison with a Regency M400E that I had alongside. In some respects, superior to that scanner. Although I had the scanner hooked up to my two metre ground plane antenna, the set seemed to pick up signals fairly easily. I am sure that if I had a proper VHF/UHF ground plane or discone antenna, I would have obtained better results. The Realistic PRO-2002 is comparable to the JX-200 as the Regency M400E does not have the 108-136 Air band included, and only scans twenty channels.

As I had the unit over a weekend here in Launceston, naturally activity on the various channels was light, except for certain predictable channels. The model I had under test, did not seem to be plagued with those annoying lockouts, that I have encountered with other brands. Naturally, there are some, but not as many as indicated in the manual. The manual itself was written for the American version of this scanner, the main difference being that the Lo-band of 30-50 MHz is included to the 68-88 MHz band on the Australian model.

There are many individuals interested in listening and scanning across the VHF/UHF bands, following on what is happening in their local area. Personally, I am not that interested in snooping around the VHF bands, preferring instead to monitor the range of frequencies between 3 and 30 MHz.

At present, I am evaluating the Tono 9000E communications terminal. Once mastered, it opens up a new world to the SWL and amateur. I realise that some have found the unit too complex, but with patience, I have found it has revealed many and different forms of communications, that were alien before.

In the course of listening between the various international broadcasting alloca-

tions, I am sure that you have come across many strange stations and signals. A recent publication has been a help to me in identifying and locating the source of these utility stations. Called the Confidential Frequency List, it has been compiled by Oliver Ferral, Chief Executive Officer of Gilfer Associates, that well-known outlet in the US catering for the needs of the SWL. It lists all the known SSB and CW outlets of the utility stations between 4 and 30 MHz. A companion volume is available with the stations using RTTY, entitled "A Guide to RTTY Frequencies".

I have found this volume an inestimable aid to my utility monitoring. My copy came through the DX club I am connected with, but I believe that they are available either through Dick Smith in Sydney or the Technical Book and Magazine store in Melbourne.

At present, I have been watching the news come in from one of the many international newsagencies on 20.079 MHz. Unfortunately, it is in French, yet I can follow what is being sent, from the lessons I learnt while in school many years ago. I have found VK1MM's article on RTTY frequencies in the April issue of AR very helpful, also.

Well, that is all for this month. Until next time, the best of 73 and good DXing!

Robin VK7RH  
AR

## MAGAZINE REVIEW

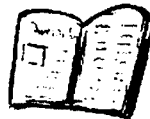

Roy Hartkopf, VK3AOH  
34 Toolangi Road, Alphington, Vic 3078

(G) General. (C) Constructional. (P) Practical without detailed constructional information. (T) Theoretical. (N) Of particular interest to the Novice.

**QST. MARCH 1983.** Converter and test equipment for 70 cm. (C) Antenna impedance. (NG) Impedance measuring. (P) Baluns (G).

**CQ. APRIL 1983.** Special Antenna Issue. (G) LCD displays. (G).

**CQ. MAY 1983.** DX Contest results. (G).

**HAM RADIO. APRIL 1983.** Cheap Video monitor. (G) Loaded dipoles. (T).

**73 MAGAZINE JULY 1983.** Morse Code Trainer chip. (C) Heard Island. (G) Special code lover's issue.

AR



# AWARDS

Mike Bazely, VK6HD  
FEDERAL AWARDS MANAGER  
8 James Road, Kalamunda, WA 6076

Awards issued to the 10th July 1983 and DXCC amendments made up to the 21st July are listed below. *Is your call missing?* Maybe it is because you have not updated during the last two years. *Want to get your call back into the lists?* Drop a line to yours truly.

A welcome to Mary Ann, WA3HUP, to our DXCC lists. Mary Anne should need no introduction particularly to those who, like myself, have received QSLs from her. The following DXCC confirmations are in the melting pot. F6FIC/TZ — it is not certain whether a licence was issued to this station prior to the granting of a TZ6FIC licence. The same applies to the first operations by 3X4EX when he was signing LA2EX/3XI. S2BTF had a licence in 1979 and there is some doubt whether this licence was renewed, and therefore his present operation is in doubt. Finally DJ5RT/TT8 — at present there has been no confirmation whether this station received authorisation from the Chad authorities.

## DXCC TOP LISTINGS

PHONE	Tally	Callsign	Tally
Callsign		Callsign	
VK6RU	314/362	VK3AKK	299/304
VK5MS	314/361	VK30T	295/299
VK4KS	314/345	VK6FS	295/299
VK5AB	313/347	VK3AWY	291/295
VK6MK	312/352	VK6YL	291/294
VK7DK	308/327	VK5WO	290/314
VK6LK	308/325	VK3RF	285/290
VK7LZ	307/327	VK7BC	282/287
VK6HD	306/317	VK2AHH	280/307
VK3JF	305/320	VK3YJ	280/281
VK4VC	305/319	VK3DU	279/284
VK4RF	305/318	VK3BLN	279/283
VK4AK	304/314	VK4BG	275/286
VK5WV	301/316	VK3DFD	275/282
VK6NE	300/310	VK4DO	261/282

CW	Tally	Callsign	Tally
Callsign		Callsign	
VK2QL	300/351	VK7LZ	271/324
VK3YD	289/324	VK6RU	261/303
VK4RF	283/307	VK3RJ	259/288
VK6HD	275/290		

OPEN	Tally	Callsign	Tally
Callsign		Callsign	
VK6RU	314/363	VK5WO	300/329
VK4KS	314/353	VK3AKK	299/304
VK4SD	313/349	VK7BC	298/305
VK6MK	312/352	VK30T	298/302
VK4RF	311/338	VK6FS	296/300
VK6HD	311/329	VK2SG	292/314
VK7DK	310/329	VK2AHH	286/316
WA3HUP	310/328	VK3BLN	283/287
VK7LZ	309/344	VK4BG	282/296
VK3JF	308/332	VK4DO	270/299
VK4AK	307/318	VK3JI	266/293
VK5WV	302/317	VK5BO	252/286

## DXCC NEW MEMBERS

PHONE	Cert No	Tally
Callsign		
VK2AXN	316	109/110
VK3BTU	317	101
VK4NML	318	123/124
VK2DTH	319	233

OPEN	Cert No	Tally
Callsign		
VK6RO	219	234/235
WA3HUP	220	311/332

## DXCC AMENDMENTS

PHONE	Cert No	Tally	
Callsign			
VK2FD	214/215	VK3NSR	238/241
VK2PY	202	VK4AK	304/314
VK2AHH	280/307	VK4BG	275/286
VK2AXN	114/115	VK4DO	261/282
VK2BQS	140	VK4RF	305/318
VK2DPN/M	241	VK5AB	313/345
VK3DS	220/226	VK5WO	290/314
VK3GB	242/260	VK5WV	301/306
VK30T	295/299	VK6FS	295/299
VK3RF	285/290	VK6NE	300/310
VK3YJ	280/281	VK6RO	233/234
VK3AKK	299/304	VK6YF	155
VK3AWN	209	VK6YL	291/294
VK3AWY	209/295	VK7DK	308/327
VK3NLS	159/161	VK8KRD	156

CW	Cert No	Tally	
Callsign			
VK3AKK	181/182	VK5WO	147/152
VK4DO	209/235	VK6HD	275/290
VK4RF	283/307		

OPEN	Cert No	Tally	
Callsign			
VK2AHH	286/316	VK4BG	282/296
VK30T	298/302	VK4DO	270/299
VK3AKK	299/304	VK4RF	311/338
VK3AXQ	163/168	VK5WO	300/329
VK3BLN	176/178	VK5WV	302/317
VK3NLS	173/175	VK6FS	296/300
VK4AK	307/318	VK7DK	310/329

## WAVKCA AWARD

Callsign	Cert No	Tally	
JH3CGR	1146	WA2VUY	1161
SV1JG	1147	JA7AS	1162
JR2MWZ	1148	WA0JYJ	1163
VK3KPJ	1149	E18EK	1164
JA4KWU	1150	JA7ADU	1165
JH7NRE	1151	J11QPU	1166
Y22HC	1152	Z21GJ	1167
KQ7Y	1153	JE2SPW	1168
JA2EGM	1154	JL1GZH	1169
HB9WZ	1155	GI4DQO	1170
JH5AVY	1156	JA2LMY	1171
J11VVB	1157	HL4XM	1172
JA1CZI	1158	JF1JLW	1173
JA6CXY	1159	JR1TNE	1174
DU9RG	1160	JR3WXA	1175

## HEARD WAVKCA AWARD

Callsign	Cert No	Name
QNL-4003	68	E. Herston

## WAS (VHF) AWARD

Callsign	Cert No
JF2BKV	154

Well that's about the lot for this month. The compilation of these lists takes up a considerable amount of time. On the positive side, it is pleasing to note the increasing interest in our award programme. Finally I have a few IRCs which I would prefer to keep in circulation rather than cash them at the Post Office. The price is twelve for \$5.00 plus SAE.

73 es DX Mike, VK6HD

AR



# QSP

## "Persecution of the Amateur Radio Service" — A World-Wide Problem

A recent report from the United Kingdom suggests that the social and legal problems associated with the areas of EMC, and aerial mast planning permission are increasing at an alarming rate.

Conflicts with neighbours and local authorities are causing many radio amateurs to resort to a technique of using such innocent looking items as, clothes lines, flags poles, or television aerial feeders, as transmitting aeriels.

It is suggested that, the situation is so bad in places, it has almost returned to the 1950's and 1960's. Within the past decade the number of local statutes seeking to restrict the right of members of the Amateur Radio Service to erect antennas — and in many cases to operate at all — has increased dramatically.

With the large amount of domestic entertainment equipment and consumer products being poured into the electronics market by profit orientated manufacturers and import entrepreneurs, who have little regard for EMC factors, or how their equipment will react when in the proximity of other electronic equipment; there is little doubt that the problem will continue, and get worse, as long as governments and authorities are unwilling to provide regulations and legislation to ensure that all electronic equipment complies with reasonable EMC factors.

Lack of effective EMC control over the whole range of electronic products, can only lead to spectrum and social anarchy. . . . The world of electronics is growing at a fantastic rate.

from National EMC Advisory Service

AR



# GFS Electronic Imports

17 McKeon Road, Mitcham, Victoria, 3132  
PO Box 97, Mitcham, Victoria, 3132 Phone: (03) 873 3939, 873 2652  
Telex: GFS AA 38053 Cable: "Comimports" Melbourne

## MFJ-410 "Professor Morse" lets you . . . COPY CW FASTER AND UPGRADE QUICKER

New MFJ Random Code Generator/Keyer sends unlimited random code in random groups for practice. Never repeats same sequence. Tailor level to your ability. Vary speed 5 to 50 WPM. Vary spacing between characters. Speed Meter. Full Feature Keyer.



**\$233 + \$7 P & P**

*Sends unlimited random code. Never repeats same sequence.  
Tailor level to your ability. Vary speed 5-50 WPM.*

## MFJ ACCESSORIES FOR THE SWL

ACTIVE OUTDOOR RECEIVING ANTENNA covering 50 kHz to 30 MHz using telescopic whip.

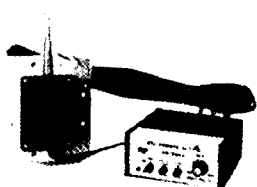

**\$233 +  
\$7 P&P**

At lower frequencies performance is equivalent to that of a long wire. At higher frequencies it provides gain. Supplied with 50 feet of coax.

**\$192**

**+ \$7 P&P**



MFJ-959 RECEIVER ANTENNA TUNER has low noise 20 dB preamp for weak stations. Match antenna to receiver for maximum signal. 1.6 to 30 MHz. Can use 2 ant., and 2 rcvrs. Select tuner, tuner with preamp, tuner with 20 dB attenuator, bypass. Gain control. Coax, phono jacks. 9-18 VDC 9x2x6 in.

## HEAR COMMERCIAL VHF HIGH BAND AND VHF MARINE SIGNALS

on 2 Metre Handhelds with this MFJ VHF Converter.

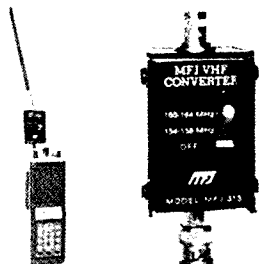

Scanning  
MFJ-313

**\$88.00 +  
\$5 P&P**

New MFJ VHF converter turns your synthesized scanning 2 metre handheld into a hot VHF HIGH band scanner.

144-148 MHz handhelds receive marine on 154-158 MHz with direct frequency readout. Hear VHF commercial stations plus more on 160-164 MHz.

Mounts between handheld and rubber ducky.

Feedthru allows simultaneous scanning of both 2 metres and commercial bands. No missed calls.

Highpass input filter and 2.5 GHz transistor gives excellent uniform sensitivity over both bands. Crystal controlled.

Bypass/OFF switch allows transmitting. Won't burn out if you transmit (up to 5 watts) with converter on. Low insertion SWR. Uses AAA battery. 2 1/4 x 1 1/2 x 1 1/2 in. BNC connectors.

Enjoy scanning, memory, digital readout, etc. as provided by your handheld on 154-158 and 160-164 MHz bands.

## STANDARD C-58E 2 METRE MULTIMODE PORTABLE NOW IN STOCK AGAIN.

Write for a brochure and full specifications.  
**\$377 + \$10 P&P**  
**CPB58E MATCHING 25 WATT LINEAR \$188 + \$10 P&P**

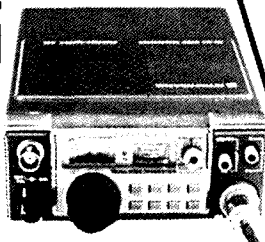

**NEW C-8900E 2m MOBILE IN STOCK.**

\* ULTRA SLIM LINE 31H X 178D X 138W cms  
\* Ga As FET front end, 0.15 uV @ 12 dB SINAD  
Write for a brochure and full specifications.

**Price \$413 + \$10 P&P**



# GFS Electronic Imports

17 McKeon Road, Mitcham, Victoria, 3132  
PO Box 97, Mitcham, Victoria, 3132 Phone: (03) 873 3939, 873 2652  
Telex: GFS AA 38053 Cable: "Comimports" Melbourne

## MFJ

ENTERPRISES,  
INCORPORATED

## ANTENNA TUNERS TO SUIT ALL REQUIREMENTS UP TO 3 kW

### MFJ-941C 300 Watt Versa Tuner II

Has SWR/Wattmeter, Antenna Switch, Balun. Matches everything 1.8-30 MHz: dipoles, vees, random wires, verticals, mobile whips, beams, balanced lines, coax lines.



\$201

+ \$7 P&P

Matches everything from 1.8-30MHz: dipoles, inverted vees, random wires, verticals, mobile whips, beams, balanced and coax lines.

Run up to 300 watts RF power output. SWR and dual range wattmeter (300 & 30 watts full scale, forward/reflected power). Sensitive meter measures SWR to 5 watts.

Flexible antenna switch selects 2 coax lines, direct or through tuner, random wire/balanced line, or tuner bypass for dummy load.

12 position efficient airwound inductor for lower losses, more watts out. Built-in 4:1 balun for balanced lines.

Measures 8x2x6".

### MFJ-949B VERSA TUNER II

MFJ-949B

\$265

+ \$7 P&P



MFJ's best 300 watt Versa Tuner II. Matches everything from 1.8-30 MHz, coax, randoms, balanced lines, up to 300W output, solid-state or tubes.

Tunes out SWR on dipoles, vees, long wires, verticals, whips, beams, quads.

Built in 4:1 balun. 300 W, 50-ohm dummy load. SWR meter and 2-range wattmeter (300W and 30W).

6 position antenna switch on front panel, 12 position air-wound inductor, coax connectors, binding posts, black and beige case 10x3x7".

### MFJ-989 VERSA TUNER V

MFJ-989

\$562

+ \$15 P&P



New smaller size matches new smaller rigs — only 10-3/4 W x 4-1/2Hx 14-7/8D".

3 kW PEP. 250 pf-6kV caps. Matches coax, balanced lines, random wires 1.8-30 MHz.

Roller Inductor, 3-digit turns counter plus spinner knob for precise inductance control to get that SWR down.

Built-in 300 watt, 50 ohm dummy load.

Built-in 4:1 ferrite balun.

Built-in lighted 2% meter reads SWR plus forward/reflected power. 2 ranges (200 & 2000W).

6 position ant. switch. Al. cabinet. Tilt bail.

### MFJ DUMMY LOADS

Tune up fast into 50 ohm resistive load. Extend life of finals.

Includes high quality transformer oil.

\$58.00

+ \$8 P&P



New MFJ-250 VERSALOAD Kilowatt Dummy Load lets you tune up fast. Extends life of transmitter finals. Reduces on-the-air QRM.

Run 1 kW CW or 2 kW PEP for 10 minutes. 1/2 kW CW or 1 kW PEP for 20 minutes. Continuous duty with 200 watts CW or 400 watts PEP. Complete with derating curve.

Quality 50 ohm non-inductive resistor.

Oil cooled. Includes high quality, industrial grade transformer oil (contains no PCB).

Low VSWR to 400 MHz: Under 1.2:1, 0-30 MHz. 1.5:1, 30-300 MHz. 2:1, 300-400 MHz.

Ideal for testing HF and VHF transmitters.

S0-239 coax connector. Vented for safety. Removable vent cap. Has carrying handle. 7-1/2 in. high, 6-5/8 in. diameter.

### MFJ-900 VERSA TUNER

MFJ-900

\$125

+ \$7 P&P

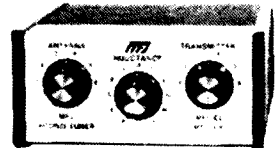

Matches coax, random wires 1.8-30 MHz.

Handles up to 200 watts output; efficient air-wound inductor gives more watts out. 5x2x6".

Use any transceiver, solid state or tube.

Operate all bands with one antenna.

2 OTHER 200W MODELS:

MFJ-901, \$138 (+ \$7), like 900 but includes 4:1 balun for use with balanced lines.

### MFJ-962 VERSA TUNER III

MFJ-962

\$326

+ \$15 P&P



Run up to 1.5 kW PEP, match any feed line from 1.8-30 MHz.

Built-in SWR/Wattmeter has 2000 and 200 watt ranges, forward and reflected.

6 position antenna switch handles 2 coax lines (direct or through tuner), wire and balanced lines.

4:1 balun. 250 pf 6kV cap. 12 pos. inductor. Ceramic switches. Black cabinet, panel.

\$100.00

+ \$8 P&P

MFJ-262

MFJ-262 (1 kW)



### BY-1 PADDLE \$78 + \$7 P&P

OPTIONAL BENCHER IAMBIC PADDLE FOR ALL MEMORY KEYS. Dot and dash paddles have fully adjustable tension and spacing for the exact "feel" you like. Heavy base with non-slip rubber feet eliminates "walking."

Air cooled, non-inductive 50 ohm resistor in perforated metal housing with S0-239 connectors. Full load for 30 seconds, derating curves to 5 minutes. SWR 1.5:1 for 30 MHz. 3x3x13 inches.





# HOW'S DX

Ken McLachlan, VK3AH  
Box 39, Mooroolbark, Vic 3138

Many amateurs, on achieving the Certificate of Proficiency to operate on the amateur bands, commence DXing with the enthusiasm of a firecracker. Generally, in most cases, particularly the way the bands have been of late, this burst of enthusiasm wanes very quickly and their interest moves to other facets of the hobby.

A few are tenacious enough to stay with it and patiently listen and meticulously scan the DX bands trying to add to their DXCC countries list and reach 100 countries confirmed. You never think that you will make it. How did all those "old timers" ever make 200 and 300 is the question that you ask yourself. Every new country you work, you total up the cards to see if you have missed one that may be claimable.

The dedicated send off cards direct to the QSL route that is nominated as soon as the OSO is finished and the wait begins. Will he QSL? is the question in your mind, you patiently await the mail deliveries and your cards from the bureau. You wonder about each card and when will it be returned so that you may add it to your total. On receipt of any new card the household reverberates with your enthusiasm to continue.

Is it all worth it? I personally think that it is even though my thoughts are that the art of DXing and QSLing are on the wane in this country. Whether this is due to economics, the failure of achieving confirmation for that special QSO and cancerous commercialism that has crept into DXpeditionings, one is not sure.

In this country it is apparent that only a small percentage of amateurs are genuine DXers and in my opinion it is on the decline. This is true if the percentage of VK's that contacted the VK0HI DXpedition is any indication. Is it too hard and time consuming in our modern society where one can relax in front of the TV and watch an entertaining programme interspersed with pet food ads or if they indulged their household in a video recorder, for a nominal rental they can hire any entertainment that their whim desires.

What do the readers of this column think? Do you concur or disagree with my thoughts? Your comments would be appreciated but be warned there is no prize of a free DX credit for any letter received.

## ANGUILLA

Still need Anguilla confirmed? Many do and your big chance could be during November and December this year.

The Anguilla Contest Team are going into action again. They will be participating in the CQWW CW DX Contest on the weekend of 26-27 November and in the ARRL 10 Metre Contest on 10-11 December. In between times they will be operational on all bands.

In a note from the co-ordinator Jeff K8ND, he reminiscently recalls the happy QSO's that the group had with VK's on previous visits and



The "shack", antennae and ocean view.

hopes that they can rekindle old friendships as well as creating many new ones.

The callsigns will be VP2E and VP2EV. QSL's can be had through K8ND, 4410 Norwell Drive, Columbus, Ohio 43220 USA.

## SMOM

Mario and his group did make an unexpected appearance on the first weekend of July and the deserving who monitor the band were rewarded with a new country. For those that missed out, and there are quite a few, September and October should be rewarding particularly on twenty metres. All QSL's to Mario I0MGM.

## POLAND

The authorities allowed the use of the special callsign SN0JP to commemorate the visit of Pope John Paul. Those lucky enough to QSO this station may obtain a special card direct from PO Box 150, Poznan 9, Poland.

## MAYBE

The Andaman Islands are again in the news with an application by two VU's to launch an expedition to that area. Many VK's want this rarely occupied country and it is to be hoped VU officialdom can be convinced to give the green light to this venture.

## CRITICISM

Many disgruntled operators complain bitterly about the length of time required to get a confirmation from a DX expedition. Probably you cannot make everybody happy all the time but one recent expedition went to a lot of pains to present a first class card for the lucky operators that worked a new country. Perhaps the bemoaning operators talking across town with their linear tubes glowing red didn't realise that the photograph that graced the card had to come back with the logs, be processed, a quality printer had to be engaged and it had to be slotted into his already heavy commitments. The most time consuming operation of the whole exercise was trying to find many entries that were in local time or at times that appeared to be in celestial time and date.

The bumper sticker that is seen on many vehicles this day and age of "Engage brain before opening mouth" is very apt in my humble opinion.

## QUERY ANSWERED

Ask and you receive help. This has been the case of a request for details on the CW Net (p35 July AR). Allan VK3AE, has reminded your scribe that full details appeared on p12 July 1974 AR. Rex VK2YA also went to the trouble of explaining how it works and his letter is printed in part to whet the appetite of intending participants.

"I noted your comments on the CW NET in July issue of 'AR' and it may be of interest to know that this net assembles between 0000 UTC and 0200 UTC each Sunday. Each net contains a Net Control Station and he (or she) starts the operation by calling 'CQ CQ CQ CW NET de VK... QNI K'.

"As the participating stations break into the net, the NCS allots them a frequency starting with 7.003 and then 7.006, 7.009, 7.012, 7.015 and so on at 3 kHz intervals. Each of the paired stations stays and engages in friendly dialogue. After each pair finishes, they report back to the NCS. If they wish to stay in the net, the NCS re-pairs them and so on until 0200.

"There is no MEMBERSHIP as such. Any AOCOP qualified operator can take part. There are no fees and there IS a wide range of operating speeds. However, the 'speed boys' invariably slow down to meet the needs and skills of the others in their pairs.

"A series of 'Q' Signals specially designed for net operation is used. For example, 'QNI?' can mean 'May I join the net?', 'ONX' means 'I want to leave the net now' and so on.

"I might mention that this net has been running for over 520 weeks — which looks to me like 'over ten years'. The leading hand in the net organisation is Eric VK2BI. He arranges for various operators to act as NCS on a roster basis, but, in case there are hitches, Eric is almost always on hand to ensure that the net starts on scheduled time.

"In short, this net is a very worthwhile activity and I can certainly recommend it to all CW enthusiasts. Incidentally, some participants use hand-keys, others use 'bug keys', others use electronic keyers and the more affluent use KEYBOARDS!"

Thankyou Allan and Rex for your interest and what about joining Eric VK2BI in the near future. You will be made very welcome.

## KERMADEC AT LAST

Warwick ZL3AFH, a DXer and island hopper for many a year has been assigned to the Kermadec Islands weather station.

Kermadec has a high priority on the wanted countries list of many amateurs in VK an overseas countries so he is going to be kept very busy.

Remour has it that he will arrive this month but will not be QRV on a regular basis until around Christmas time. If he is active before the New Year it will be a nice Christmas present for the lucky ones.

## PRIBILOV ISLANDS

This island group is located about 500 kilometres north of the Aleutians and about the same distance from the mainland of Alaska. Presently this group is classified as the Aleutians and previous applications for separate DXCC status have been denied due to the 800 kilometre rule.

There is a new move a foot for another application and proof will be tendered to Newington that the Pribilof Islands are geologically distinct from the Aleutians, in the hope that the 400 kilometre rule applies.

Well here's hoping for a new one and the Alaskan DX Association are planning a visit there this month. If you hear them, work them, and then cross your fingers. I personally will not hold my breath awaiting a positive answer as there would be no DX column next month.

## CHRISTMAS IS COMING!!

With it getting to that time of the year again, it was thought that a mention regarding the posting of mail to overseas friends was in order. This being beyond my capabilities it was time to call in the experts and no expert could be better than the amiable and obliging Public Relations Manager of Australia Post, Jim Foley.

In Jim's words, here are a few words of wisdom —

*Christmas might still seem light years away but now is the time to be thinking of overseas parcels and cards. Some forward planning can mean that advantage can be taken of surface postage rates.*

*Australia Post, on Wednesday 14 September, will bring out its overseas surface rate stamp for Christmas cards. This stamp will have an unusual aspect this year as will the domestic and overseas air mail stamps to be issued on 2 November. The three stamps were produced from designs produced by winners of a national contest.*

*The competition asked primary school children to illustrate "what Christmas means to me" and many thousands of entries were received.*

*The overseas surface mail stamp is intended for cards carried by surface mail to overseas countries. Around the time of the stamp issue, Post Offices will have supplies of a pamphlet that lists, in detail, the closing times for overseas surface mails.*

*Please ensure that your cards are properly addressed bearing name, street number, street name, town, state, country and post-code, where applicable. Each year thousands of Christmas cards are destroyed because of insufficient or no address.*

*Write your name and address on the back of the envelope so it can be returned to you if it cannot be delivered.*

*When buying cards, ensure that they are in standard size envelopes because articles larger than this cost more to post. Post Offices can supply letter gauges to help customers ensure their mail conforms to standard size requirements.*

*So, by posting in time to catch overseas surface mail deadlines and using standard size envelopes, you can keep your postage costs down.*

*Parcels should be carefully packed because they need special protection from the pressure of travel. Sturdy containers well packed with*

*cushioning materials such as shredded paper, wood, wool and cellulose should be used. Parcels containing heavy items should be wrapped with heavy paper, and all parcels should be well sealed with tape and tied with cord. Again, Post Offices can provide brochures and advice to assist with packing and can also advise on articles that cannot be sent through the Post such as matches and flammable substances.*

*One overseas parcel facility worth special mention is the Surface Air Lifted service.*

*SAL is particularly suitable for heavier packets and parcels and, by using road and air services, costs more than surface mail but less than air mail.*

*It provides a mail medium speed delivery of around two to three weeks. Your Post Office can give details of countries serviced by SAL.*

*Should you miss the surface mail closing dates, Australia Post later produces a brochure giving details of the closing times for air mail.*

## TRISTAN DA CUNHA

That hard to come by country is quite active with four amateurs proliferating the airwaves. Calls ZD9CB, ZD9BW, ZD9BX and a YL ZD9CS have been quite active on the bands.

## CALLSIGN CHANGE

From November until the end of December this year, the prefix 6V will be used in lieu of 6W8. Also for the prefix hunters, this country, from this date, will use figures to distinguish the eight counties from 1-8. Figure 9 will be reserved for club stations and figure 0 for visitors.

## FALSE START

Apparently the USSR has not yet released any of the WARC bands. QSL cards have turned up in the United Kingdom remarking that it was a mistake!!

## NEW SOVIET OBLAST

It is understood that the Soviet Oblast system has had a change or two with the forming of a new oblast by dividing an existing area into two. Any reader have any details on this one?

## NEW PREFIX BLOCK

The FCC have allocated the new prefix back of KP5 for Desecheo Island.

## TRIPPING AGAIN

Jan and Jay O'Brien, publishers of the W6GO/K6HHD QSL Manager List are planning to return to French Polynesia in November. This time they plan to be armed with two stations and Jay hopes to concentrate more on the CW mode and particularly on 40 and 80 metres. Whether it is the DX or the tropical fruit that appeals to this happy twosome is unknown but they should continue on to VK to meet some of their friends. If not this time Jan and Jay what about next time?

## PETER 1ST ISLAND

Well it has been bandied around for a while as to whether it will or not be accepted. W1AW made an announcement that it will now be accepted. This, because of its co-ordinates, could prove to be a difficult and hazardous island to get to. Who will be the first to mount an expedition there is the big question?

## AMSTERDAM IS TO DJIBOUTI

Alain FB8ZQ, enroute to his homeland will call at Djibouti and will be operational in November as J28CB.

## TREKKING AROUND NEPAL

A chance remark by Ms Julie Lane, the Laser Scanner operator that produces the colour separations for the front cover of Amateur Radio, regarding a proposed trip to the foothills of the Himalayas, brought the remark from me that no trip could be complete to that area without a visit to Fr Moran 9N1MM, the pioneer of amateur radio in the country.

Arrangements were made with Moran via catching up with him on the South East Asia Net and Julie's invitation was confirmed.

I will leave Julie to tell her own story of this interesting personality located in the fascinating country of Nepal.

*To the SE of Kathmandu is the village of Godavari. It was here that I met Father Marshall Moran. Fr Moran was born in Chicago in 1906 and went to school at St Ignatius High and later Loyola University. During 1924 he entered the Jesuit order and in 1929 headed to India where he began his career in Asia as a teacher. After a brief visit to Nepal in 1949 Fr Moran returned in 1951 and has lived there since May of that year. He has established several schools in Nepal, including St Xaviers at Godavari and St Marys at Patan.*

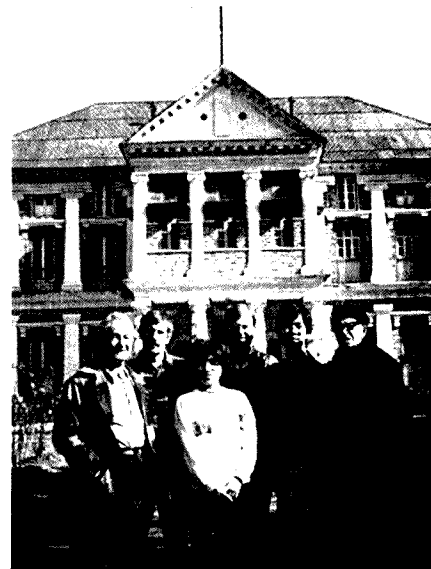

Special gang at 9N38MM celebrating the King's 38th Birthday. L to R: K7AW, W6OAT, VU2YOU, 9N1MM, J12VLY and JM1RFT.

*When I arrived Fr Moran was having a typical day — flat out! Apart from being administrator of St Xaviers he is involved in several community affairs and of course his interest in amateur radio, which goes back to his student days when he made radio receivers for the neighbours. All this contributes to a hectic life style, not a bad effort for a seventy seven year old.*

*Having spent six weeks in Nepal I can appreciate why Fr Moran chose to live there. Kathmandu, the capital city, is an adventure*



**A view of the countryside from 9N1MM's QTH.**

in itself. In the old section of the city you can wander through the street stalls that sell everything from handmade Tibetan carpets to false teeth. If you require public transport, the bicycle rickshaws race through the narrow dirt streets, dodging cars, beggars, tourists and cows, adding to the already chaotic scene.



**Julie waiting outside the dentist's for the bus to Godavari. (Note the ready to wear prosthetic teeth on display in the window.)**

Eating your way around Kathmandu is a pleasant way to spend a few days at minimal cost. There are a variety of restaurants that have international cuisine and the traditional Nepali food. Of course the pie shops are hard to avoid with their mouth watering selection. One way to loose a bit of weight after eating so well is to go trekking.

The variety of area to trek in makes it



**The famous Monkey Temple in Kathmandu.**

suitable to most age groups and levels of fitness. If you can manage one of the longer treks it is worthwhile to experience the immensity of the mountains at close range. The views are utterly staggering and when the rhododendron forests are in bloom it's a breathtaking combination.



**Nepali Natives.**

The Nepali people are most hospitable and welcome trekkers to their villages, I don't think you could meet a happier and more genuine people than the Nepalis and Tibetans. The only thing wrong with Nepal is that it instills the urge to return, hopefully that won't be far off.

Thankyou Julie and perhaps we could have an update on your next visit which it is believed will take place when leave and funds can be accumulated.

## CW SWLING WITH ERIC L30042

28 MHz  
VK3AZW, VK6JQ, WA6HXM.

24 MHz  
VK3LC, VK3RJ, VK5GZ

21 MHz  
A35RZ, DL20Y, EC3BPS, FK8CE, FK8EH, HL1NK, HR1RC (0135 z), HZ1AB, JR8AKR, JA5XDX/MM, KX6QC, OH3BM, KD1M, W5MBY, W6QHS, KW7L, KA8SIG, YC2BDJ, ZL4PA.

18 MHz  
VK3LV, VK3LC, VK3MR, VK3RJ, VK3ML, VK3XB, VK3ZJ, VK4AIX, VK4BG, VU2REC (0700 z), VK5GZ.

14 MHz  
DJ2BE, NO2O/DU2, G6ZY/EA6, FK8CC, F08JM, GJ4/PA0BFM, GJ4/PA0ERA, HL2GW, OH0AM, OK3AL, PY1FB/MM, T05RS, UC20Q, UK2FBR, UK7FAP, XE1FA0, YB5ASO, 4J4F, 4K1QAV, 4N90LY.

10 MHz  
ZL2BKM/C, DJ2CK, F3NB, FK8CE, F08FO, FG0DOV/F5, G2BY, GM3GJB, JA6HW, JA7EYL, KP2J, WP4CBB, OK1DAV, PA3CRV, VP2KBM, W (all dists), XE1RM, Y25KH, DL2GG/YV5, 8P6AU.

7 MHz  
CT10Q, DK0TU, EA7JA, EA8RL, FK8CE, HA1XW, HP3FL, I2UIY, LZ2KAF, OH3ES, SM7ALC, SP3AAK, PY6BK, TI2PZ, UA1JN, UB5ZEQ, UK4CCC, UK5IBB, UP2BKZ, UU2M, VP2MM, YU7Q0T, YV5ANT, XE3ARV, 4N4WF.

3.5 MHz  
FK8KAA/P, G3CCZ, OH3YI, SM6CPY, UA1AUW, UA4ANT, UA9ACZ, UA9CBM, UK5ICX, UD6DHM, UQ2GCN, UQ2GFA, UU2M, VK9NS, K0FX, YUIER, ZS2WV.

1.8 MHz  
VK1BB, VK2BHO, VK2DPS, VK5KL, VK7BC, VK9NS, W7TJ, VK3BVS, VK3DGJ, VK3DRX, VK3RW.

### RECENT QSL CARDS RECEIVED

C6ABA, C02JM, EA6BD, FY7BO, GB2RN, DJ2CS/HB, HB0BHA, LU9EIE, RA9UM0, T30CH, UF6CR, VC3FRA, VK0HI, YC2BDJ, 4Z40M, 5N7HKR, 9J2B0.

### WORKED ON THE EAST COAST

21 MHz  
FK8KAA/P, G3CCZ, OH3YI, SM6CPY, UA1AUW, UA4ANT, UA9ACZ, UA9CBM, UK5ICX, UD6DHM, UQ2GCN, UQ2GFA, UU2M, VK9NS, K0FX, YUIER, ZS2WV.

14 MHz  
1A0KM, 3X4EX, 5N3RTF, 8R1Y, 9N1NL, A71AD, AP2MQ, C21BD, C21RK, C30LAB, C53DF, C6ANI, CN8EL, C07AM, CS2AK, CT3BM, EA8XS, EL2AD, EL2BE, FB8XI, FG0HYJ/FS7, FK8EB, FM7CD\*, F08BI, GU4UN, H44DX, I8UDB/I08, J6LB, KX6OR, O44IZ, OH0BT, OK1ALQ\*, SP9AID, T77B, TL8ER, TR8CR, TR8JLD, TZ8DC, UF6FE, UK2GAH, UQ2BQ, VE3NDO\*, VK0VK, VK2AGT, VK9ZS, VP2VD, VP9CP, XT2AU, ZB2J, ZL40Y/C

### LOWER BANDS WORKED ON THE WEST COAST

4U1UN+, UA0KBC\*\*, UA0LFU\*\*, VK5BI +++, VK9NS+,, VU2MDM+, XE1J+, XE2ADI+.

\* Denotes CW

\*\* Denotes 3.5 MHz

+ Denotes 7 MHz

+++ Denotes 1.8 MHz

### THANKS

In compiling this column information from such magazines as KH6BZF REPORTS, RADCOM, QSL MANAGERS LIST, WORLD RADIO, QRZ DX, VERON, DXEXPRESS, QRZ DX, DX NEWS SHEET were used together with reports from VK's 2PS, YA, 3AE, BY, FR, PA, YJ, YL, UX, 6FS, NE, YF, SWL 30042 and Ms Julie Lane. Amateurs from overseas countries who have contributed include G3NBC, I8SAT, ZL1AMM and ZL1AMN. Sincere thanks to one and all.

AR





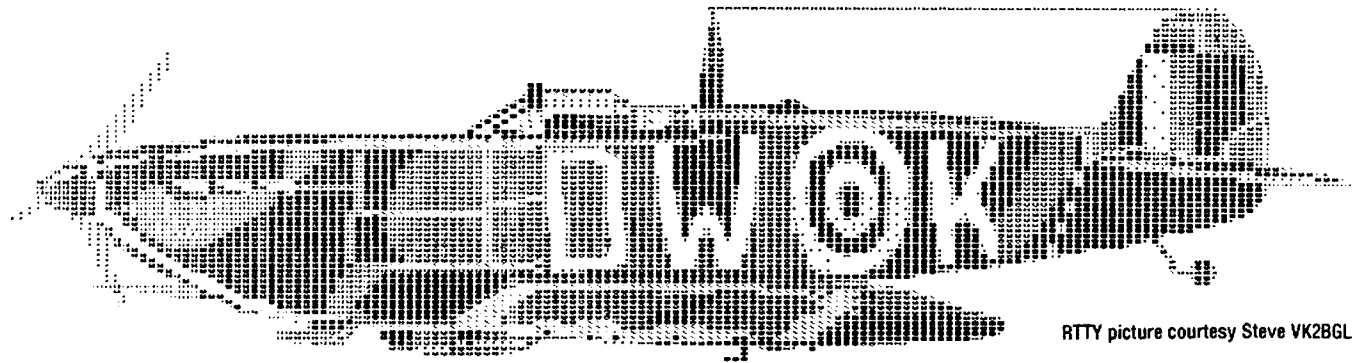

RTTY picture courtesy Steve VK2BGL

# HERE'S RTTY!

Bruce Hannaford, VK5XI  
57 Haydown Road, Elizabeth Grove, SA 5112

## THE RTTY DEMODULATOR

In the "AM" days I remember the oft repeated statement "If you can't hear them you can't work them". Updating this to the RTTY era "If you can't print them you can't work them". In both cases these statements underline the importance of first correctly receiving the signal. With RTTY, part of correct reception is dependant on a suitable demodulator. There are plenty of good receivers available but some demodulators leave much to be desired. The demodulator converts the audio tones from the receiver into DC pulses either to work a mechanical printer or a computer type unit. The requirements of a good demodulator are much more stringent for HF bands than for VHF/UHF bands. The main difference being due to selective fading on the HF bands. With selective fading of a FSK signal the mark and space transmissions fade independently, some of the time mark will be strongest and at other times space will be strongest. If the demodulator design is such that it must have both mark and space signals present at a reasonable level to operate successfully, then very little will be printed from such a signal. If the demodulator can work from either mark or space or from both, then all will be received so long as at least one signal is coming through at a reasonable level.

Of course all the information necessary for correct printing is contained in either the mark or space signals so by transmitting both this gives the receiving station two chances instead of one to get a good printout. This dual transmission and reception system is similar to a diversity system and of course is superior to a single system when receiving conditions are bad.

Most of the remarks to follow will refer to HF band FSK working but the same demodulator can also be used with AFSK on the VHF/UHF bands. In this short description I will only cover rather basic points sufficient to give a ground work understanding of demodulators.

The term demodulator is now in common use but in some cases the name converter or terminal unit is used. Adding to the name confusion there is, on the market, a unit containing both a modulator and a demodulator and this is referred to as a demodulator. In computer jargon such a unit would be

called a modem coming from MOdulator DEModulator.

Before we get into the workings of demodulators let's give some thought to the HF receiver that will be providing the audio tones to work the demodulator. Firstly, it must have very good frequency stability and band-spread tuning, as the tuning of FSK signals is more critical than that of SSB or CW. Secondly, selectivity a little sharper than the usual SSB bandwidth is helpful. The fitting of a 500 Hz CW type filter will give better copy where noise and QRM are a problem. However, first check that with such a filter fitted to your transceiver you can still receive audio tones suitable for working your demodulator. In some cases you may only be able to receive audio of around 800 Hz intended for CW work. Normally the filter would be plugged into a SSB filter position rather than a CW position to give suitable audio out frequencies. In some cases it may be necessary to detune the carrier oscillator to centre the mark space tones into the filter pass band.

In the early days of RTTY, when a shift of 850 Hz, valves and mechanical printers were the normal thing, a very simple FSK demodulator was sometimes used. To introduce practical demodulators we will first consider this primitive system.

Looking at figure one, the audio transformer steps up the audio from the receiver loud-

speaker voice coil to the grid impedance giving a large voltage step up at the same time. The diode rectifies the audio and presents a negative voltage to the grid. A reasonable level of audio will produce enough negative volts to completely cut off the switching valve plate current. Thus with audio present the current through the printer electro magnet coils will cease and with no audio input the valve will have no bias and will conduct, allowing current to flow through the printer coils. The value of this printer current is controlled to the correct value by a suitable setting of the screen voltage.

To operate the system the receiver was tuned to zero beat on the mark signal and then only the space signal was present to produce RTTY audio output switching the valve on and off. This would work out quite well if signals were good with very little noise present. However, if there was noise present it would act as a space signal and cause many misprints.

An improvement could be made by tuning the secondary of the input transformer to 850 Hz to favour the space tone being used with mark on zero beat. The current through the printer coils was unaffected by the level of signal input as large signals just produced more valve cut off bias voltage than was necessary. With no signal input the valve current would prevent the printer from

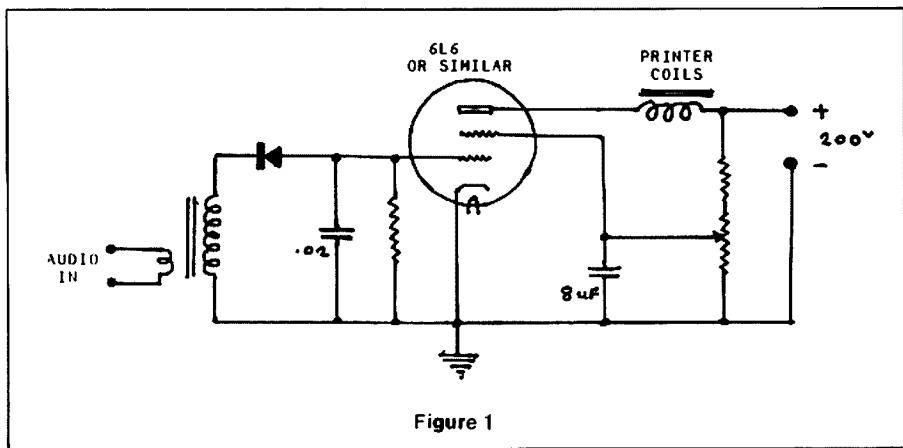
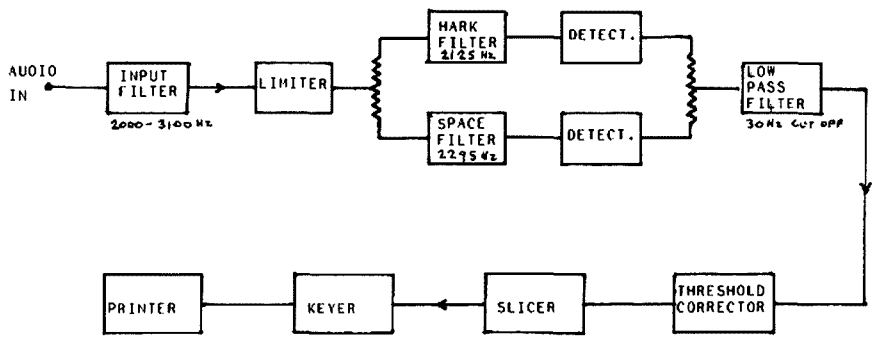

Figure 1

FIGURE 2 MODERN SOLID STATE DEMODULATOR



"running open" holding it at rest ready for the next incoming signal. Even with the tuned input circuit the results were poor as only the space tone was used and to get best results both tones should be used.

We will now look at a modern solid state system and note the improvements obtained. In figure 2, for simplicity sake, we have made this a fixed system using high tones with 170 Hz shift. The 2125 and 2295 Hz tones from the receiver will pass through the input filter and most of the other audio frequencies from the receiver will be rejected by this band pass filter. The limiter prevents overloading of the mark and space detector systems and any signal of a reasonable level will saturate it and thus give a constant output level. A mark signal will pass through the mark filter and be rectified by the detector, likewise with the space signal, the space filter and the detector.

One detector is connected to give positive output voltage and the other to give negative output voltage, as both outputs are combined, if some audio passes through both filters at the same time the strongest signal will determine the output voltage polarity. In normal operation mark may for example produce positive and space negative and thus the output will be rapidly switched from positive to negative as a RTTY signal is received. These DC pulsed signals will pass through the low pass filter, which will reject any high frequency audio and prevent any problems it may cause further on. As the mark and space signals may not always be the same amplitude or one may even be completely absent at times, this could cause problems and should be corrected. The pulses from the low pass filter are fed into the threshold corrector, which restores the balance of the mark and space signals when necessary. For example, if mark were twice the level of space at a given instant the threshold corrector would make both equal in amplitude at its output. This is obviously a very useful function and the device is indeed remarkable in its operation. It would take thousands of words to give a detailed explanation so I will simply show what it does with the aid of figure 3.

Let us assume the signal wave forms shown are being fed into the threshold corrector. At the top diagram an ideal letter R waveform is depicted, mark and space are exactly equal, mark being shown as positive and space as negative. With such a signal the threshold corrector has nothing to do, but this is not the case with the waveform shown at the bottom

of the diagram. In this case some selective fading or perhaps some mistuning of the receiver has caused the space signals to be much reduced in strength. A indicates the peak value of mark, C indicates the peak value of space and B is the normal no signal reference point or threshold from which the signals increase in either a positive or negative direction. When this sort of signal is fed into the threshold corrector, the output of the corrector gives a balanced value of mark and space.

Looking at the right of the diagram you will note X indicating the peak value of mark Z indicating the peak value of space and halfway between them is Y which is the new threshold or reference point established by the threshold corrector. The overall amplitude is reduced but the waveform is good, a great improvement on what was at the input of the threshold corrector. Looking at this lower diagram you can see how even a signal with one tone missing will still give an equal positive and negative drive to the slicer unit that follows. The slicer is a device which will accept small positive and negative input voltages and produce, at its output, larger constant level positive and negative voltages suitable to drive the switching transistor that follows. The switching transistor does just

that, it switches on and off the current that operates either a mechanical printer or drives a computer type unit.

Many modern demodulator units are capable of working with many different tone frequencies, shift values and Baud rates, this of course complicates the design and makes it difficult to equal the performance of a unit designed for only one set of tones at a given Baud rate. In spite of these difficulties many such commercial units are able to give quite good results with a vast number of tones, shifts and Baud rates.

One thing I have not mentioned in this simple explanation is something you may come across at times and that is the terms "AM" and "FM" demodulators. Briefly an "AM" demodulator does not use a limiter and a "FM" one does use a limiter. There is somewhat of a controversy as to which is best under difficult signal reception conditions. Perhaps to be ideal you should have a switch to convert from one to the other according to the conditions existing at the time.

As limiters are often used in demodulators the following points are worth considering. A limiter receiving sufficient input puts out a signal of constant amplitude. It does this by preventing higher levels from passing through it. Levels below its fixed output level will however pass through it without difficulty. If a very large signal level is fed into a limiter it may do more harm than good as the desired signal output is now limited to a similar level as many formerly smaller noise and QRM signals present. The strongest signal into a limiter "captures" it so if this is the desired signal all will be well but if the desired signal fades below the noise level the noise takes over and the signal is lost. From the above you will note sometimes limiters help and sometimes hinder good reception. Of course limiters introduce audio distortion but this matters little in demodulators. Of more importance is the fact that limiters introduce some "mixing" noise into the system. In demodulators, a limiter may often be as simple as two silicon diodes connected in parallel conductively facing in opposite directions. The

FIGURE 3 THRESHOLD CORRECTOR OPERATION

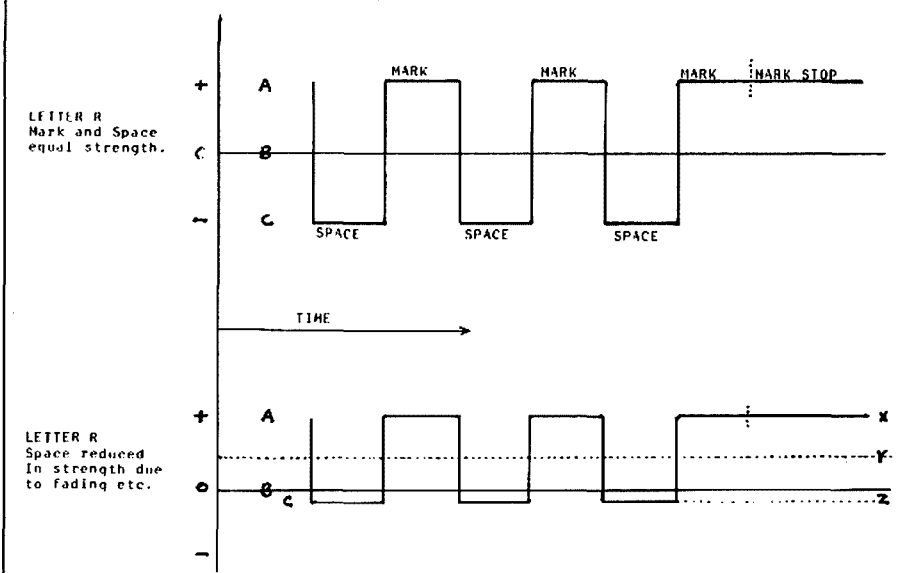

output voltage of such a limiter will be about .6 of a volt.

As stated earlier most of the foregoing concerns HF band FSK however most demodulators designed for such use will have performance to spare for VHF/UHF AFSK use provided the right tone frequencies and shift are used. By the way, the simple valve demodulator would be useless unless a sharp tuning circuit tuned to 2295 Hz were used at its input, with AFSK there is no way of zero beating the mark tone to eliminate it as with FSK.

### HANDY BOOK

I have to hand a book from America entitled "GUIDE TO RTTY FREQUENCIES" by Oliver P Ferrell, published by Gilfer Associates Inc, PO Box 239, 52 Park Avenue, Park Ridge, NJ 07656, USA. This book would be very valuable to any who search the HF bands for RTTY signals. About 4500 stations or frequencies are itemised with ancillary information about the location, speed and shift format, purpose and power and where applicable, even news cast schedules. At the present time I am not aware of any Australian book shops stocking this goldmine of RTTY information but from the details above, you should be able to order a copy, or gain more information.

### RTTY FREQUENCIES

I note in an ANARTS RTTY news broadcast on Sunday 10/7/83 some recommended Gentlemen's Agreement RTTY frequencies. I now quote these frequencies in MHz as copied from the broadcast. 160 metres: 1.825 to 1.835 — 80 m: 3.535 to 3.545 — 40 m: 7.035 to 7.045 — 30 m: 10.140 to 10.150 — 20 m: 14.080 to 14.100 — 17 m: 18.100 to 18.110 — 15 m: 21.080 to 21.120 — 12 m: 24.920 to 24.930 — 10 m: 28.050 to 28.150 — 6 m: 52.080 to 52.100 — 2 m: 146.600 spot frequency. Thanks to ANARTS for this information. You should note the above are recommended frequencies and also note that the WIA have indicated provisional RTTY calling frequencies and these are as listed in the VK4 notes on page 57 of the June issue of AR.

73 to all from Bruce VK5XI

AR



Collin 9M2CR spans the World on AMTOR using a TS120 V running 10 watts. Photograph by 9M2CR.

## INTRUDER WATCH



Bill Martin, VK2EBM  
FEDERAL INTRUDER WATCH  
CO-ODINATOR

33 Somerville Rd, Hornsby Heights, NSW 2077

*If your hobby was fishing, and you devoted quite a lot of time to its pursuit with possibly a sizeable amount of money tied up in gear, boat rental, possibly your own boat etc, and you found that nearly every time you went to spend some of your leisure time indulging yourself in the sport, someone came along and tried to spoil it for you, would you be upset? Would you remonstrate with the offenders? Supposing you had just settled down in your favourite spot for a couple of hours' quiet relaxation, the sun shining, the boat gently rocking, and even perhaps the promise of the odd bite or two, when suddenly up come one or more 'big gun' boats and proceed to harass you and make things generally uncomfortable, even to the stage where you had to up-anchor and move elsewhere (or go home) — would you do anything about it, or just quietly give in to the bullies and let them tell you where and when you could enjoy your day off?*

I rather think that most of us, given the same set of circumstances, would certainly have something to say.

OK — so you don't fish — let's assume that golf is your pastime. The story could well be the same — you spend your precious day off at the course, the weather's great, and you're just in the mood for a nice eighteen holes. But there's a foursome behind you that keeps hitting through, breathing down your neck when you're on the green, and making a lot of noise just as the wood comes down for the tee shot. At this stage, you're not having much fun — right? Would you be moved to mention one or two things to the irksome foursome? (Politely, of course). Well, then — we've established, I think, everyone's right to enjoy his hobby without interference from others, who may do so intentionally, out of ignorance or just with plain callous disregard for your rights.

### WHAT ABOUT THE HOBBY OF AMATEUR RADIO?

Consider the scene — You've found yourself with a couple of spare hours (having successfully caught up with your domestic chores, or made mental plans to catch up

tomorrow) and have decided to look for a ragchew on 80 metres, perhaps chase the elusive DX or possibly to look for the ONE contact you need for a particular award. You're settled in the shack — all tuned-up, antennae still reasonably elevated, Murphy's having the day off, and the microphone and key are at the ready.

"Let's have a look at 20-metres" . . . Hmm; sounds like Europe is coming in rather well — "THERE'S A SP3 COMING IN". "I'll go for him." Grab the mike — BANG — up comes a commercial RTTY station right on top of you, 10 over 9. You wait for a while, but the RTTY wipes out the SP3 completely . . . finally, the RTTY station goes QRT, but, naturally, the Polish station is nowhere to be found. "OK, let's have a look at 15 metres." This time it's a CW intruder, going hammer and tongs, RST 599 and no callsign. "What now? — QSY, or go to the other room and operate the receive-only VHF TV unit?" Whatever you decide to do, the evening has been spoilt.

Where the first two examples of hobby-time being interrupted by inconsiderate people would perhaps not happen in reality too often, the third example, that of a QSO being ruined completely, or at best, made difficult, is a DAILY happening on the amateur bands. The next time it happens to you, send a report of the details to the Intruder Watch, via your Divisional Co-ordinator. Sure — that won't make up for your lost contact, but it could, with the assistance of others who have found themselves in similar situations, help the Intruder Watch to make representations ON YOUR BEHALF to the offending administrations. Of course, it takes time . . . let us have those reports and we'll do all we can to make things uncomfortable for those who show us no consideration. Find your Divisional Intruder Watch Co-ordinator through your Divisional Office, or check in the current callbook. Help to make UN-AUTHORISED stations QSY.

PS: That RTTY station may have been one of the 'BXT' stations (BXT17, 44, 47, etc) which originate in Beijing (formerly called Peking).

AR

## NOTICE

Copy for November magazine (columns HAMADS, etc) must arrive at Box 300, Caulfield South, 3162 no later than 23rd September 1983.

# WA



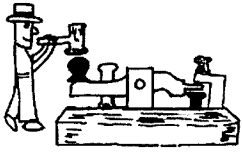

# POUNDRING BRASS

M Emm VK5FN

GPO Box 389, Adelaide, SA 5001

## GETTING RID OF THE GARBAGE

*Wouldn't it be wonderful if the moment we began a QSO, everything else on the band just vanished? Think of it . . . no QRM, no QRN, absolutely nothing! Unfortunately it doesn't work that way, and it's just as well for the sake of anyone else who might want to use the band. There is no way we can get rid of all the other signals and noise, so we will always have to live with a certain amount of interference.*

Although I don't think it's been expressed quite this way before, the goal of any receiver designer is to make it appear that there is only one signal on the band — the one you want to copy. There are really only two ways to go about this, by increasing the signal-to-noise ratio, or increasing the selectivity. *Receiver design should therefore be quite simple, shouldn't it?*

It should be fair to assume that you have done everything you can to get desirable signals into your receiver's front-end, and made its job easier by controlling such things as beam direction and proximity to power-lines. *What else can you do to get rid of the garbage?*

Most modern receivers incorporate a number of features designed to increase selectivity, and improve the signal to noise ratio. Some features are optional extras, and still others can be added on between the receiver and the speaker or headphones. Let's start at the Intermediate Frequency or IF and see what can be done. In view of the number of receivers on the market now with multiple conversion (two or more IFs) it should be stated that for practical purposes, it doesn't matter which IF you apply these techniques to, although optimum combinations exist in some circumstances.

Think of the IF as a tunnel, into which go a potentially large number of signals, on a wide range of frequencies. The range of frequencies which is present at the IF is called the passband or IF bandwidth. If you are working CW you are only interested in a single spot frequency (with some slight tolerance for drift and possibly chirp), so you could conceivably

set up an IF system which allows a bandwidth of only a few hertz to pass, and that would theoretically be ideal for CW operation. In fact, you can't reduce the pass-band that far until you have located a signal you want to copy, otherwise it is very difficult to find the signal in the first place. So ideally, you should have a facility to vary the IF pass-band from fairly wide to very narrow.

This facility is afforded by selectable filtering and variable bandwidth tuning. Most modern transceivers offer a selection of IF filters with different bandwidths, and it is important not to get too narrow a filter if you cannot switch it out of the circuit (either by means of a filter switch or by going from CW mode to SSB, with its wider bandwidth). If you listen in SSB mode and then switch over to a 250 Hz filter, you will lose the received signal unless your VFO was tuned within 125 Hz of zero-beat. With some rigs it is possible to alter the width of the band-pass, or its shape, with the same effect more or less as adding in a filter.

In either case, the problems associated with a very narrow band-pass are quite well illustrated in the CQ situation. If you call CQ, and are using a 500 Hz filter (or achieving the same effect with audio peak filtering or some other gadget), you will not hear a returning signal that is more than 250 Hz away from your transmitting frequency. Few and far between are the operators who routinely zero-beat and can come up spot on every time. For that matter, there are still a lot of less fortunate operators who have to make their own transmitters, and can't build in that much control or stability. When you call you should expect an answering signal to appear anywhere within a range of 2 kHz or more. So the trick is to listen with as little filtering as possible. Switchable filters are ideal, and listening in the SSB position is equally useful. Variable IF adjustments are fine for tuning any given signal you might be interested in, but it can be very tricky to get back to normal if you need to. Many experienced contest operators use audio peak filtering only for that reason — they can switch it on and off at the touch of a button, without any need to retune.

Another gadget which is of interest at the IF is the notch filter. This is a circuit which acts as a band-stop filter over a very small portion of the IF bandwidth, so that an interfering signal such as another CW station or an AM heterodyne can be blocked. They can be very effective, and a usual degree of effectiveness is quoted as -40 dB, which means that signals within the notch are suppressed by 40 dB in comparison with the rest of the IF bandwidth. It does not get rid of them completely, but can often reduce the level of interference to a mere annoyance.

If your rig is equipped with an IF shift control, the frequency of the IF itself is shifted a bit to either side, which can often eliminate interference from other stations including SSB (who of course would not be in the CW part of the band in the first place).

Beyond the IF capabilities, the audio stages can be made more selective too. The Audio Peak Filter (APF) was mentioned earlier, and it is probably about the most effective treatment. As with radio frequency CW signals, the audio consists of a single tone which is identifiable with a single audio frequency. The APF provides a means of suppressing all but the wanted pitch, and usually has some means of adjusting the frequency of that pitch.

Among the other things that can be done at the audio end of the chain, a tone control for the output can work wonders with QRN. After all, one of the great things about CW is its simplicity, so not much is required in the way of fidelity when it comes to speakers.

Many audio filtering techniques can be applied outside the rig, between it and the speaker. Circuits can be found in most handbooks, and factory made devices are readily available from most suppliers of amateur gear.

You don't have to have many of the features discussed above to get rid of the vast majority of interference problems. If you take the trouble to find out how they work, and use them properly, you can indeed get rid of most of the garbage. CU next month.

AR



# QSP

## MICROCOMPUTERS IN AMATEUR RADIO

*For amateurs interested in combining computers and amateur radio there are now two groups in the UK for users of micro-computers in amateur radio.*

*Membership of either group is open to licence-holders and SWLs and provides members with ideas, circuits, programmes etc to help them make better use of their micro in the radio-shack. Both groups are non-commercial in nature.*

*The Sinclair Amateur Radio User Group (SARUG) is open to users of the Sinclair range of micros (zx81/TS1000 and Spectrum/TS2000). Full information may be obtained from Paul Newman G4INP, 3 Red House Lane, Leiston, Suffolk IP16 4JZ UK.*

*Radio Amateurs Microprocessor Techniques & Operations (RAMTOP) is open to all users of micros other than Sinclairs. Full details can be had from Revd R P Butcher G4NWH, The School, Wellingborough, Northamptonshire NN8 2BX.*

*Please note that in both cases two International Reply Coupons must be enclosed to ensure an airmail reply.*

*Both groups co-operate and this is proving very beneficial to members.*

AR



# VHF UHF - an expanding world

Eric Jamieson, VK5LP  
1 Quinns Road, Forrester, SA 5233

All times are Universal Co-ordinated  
Time, indicated as UTC

## AMATEUR BAND BEACONS

FREQ	CALLSIGN	LOCATION
50.005	H44HIR	Honiara
50.008	JA2IGY	Mie
50.020	GB3SIX	Anglesey
50.060	KH6EQI	Pearl Harbour
50.075	VS6SIX	Hong Kong
50.945	ZS1SIX	South Africa*
51.020	ZL1UHF	Auckland
52.013	P29SIX	New Guinea
52.100	VK0AP	Macquarie Island
52.200	VK8VF	Darwin
52.250	ZL2VHP	Palmerston North
52.300	VK6RTV	Perth
52.320	VK6RTT	Carnarvon
52.350	VK6RTU	Kalgoorlie
52.370	VK7RST	Hobart
52.420	VK2RSY	Sydney
52.425	VK2RGB	Gunnedah
52.435	VK3RMV	Hamilton
52.440	VK4RTL	Townsville
52.470	VK7RNT	Launceston
52.510	ZL2MHF	Mount Climie
144.400	VK4RTT	Mount Mowbulla
144.420	VK2RSY	Sydney
144.465	VK6RTW	Albany
144.475	VK1RTA	Canberra
144.480	VK8VF	Darwin
144.550	VK5RSE	Mount Gambier
144.600	VK6RTT	Carnarvon
145.000	VK6RTV	Perth
147.400	VK2RCW	Sydney
432.410	VK6RTT	Carnarvon
432.420	VK2RSY	Sydney
432.440	VK4RBB	Brisbane
432.450	VK3RMB	Mount Bunninyong

28/2/83 from 0115 to 0235 GI4FFL/A at the station of GI6EYO contacted K1WHS with signals peaking to 3 dB over noise. GI6EYO used a Drake TR-7 HF transceiver driving a 2 metre transverter with BF900 RF and mixer stages, plus BF981 masthead amplifier — an 8874 PA drives four Cushcraft 214-B yagis, with elevation control, at a height of 60 feet, and fed with heliax cable. We say "well done" for the effort involved with a modest station set-up.

Interested to note that the now famous Mu Tek organisation in the UK have produced an Interesting 2 metre pre-amplifier for 144 MHz using an MGF1200 GasFET in a 'noiseless' negative feedback circuit. The claimed performance includes a noise figure of 0.9 dB or better, a gain of 13 dB, input and output third order intercepts of +14 and +27 dB m respectively, and a power handling capability of one kilowatt in the SSB mode. It comes complete with a control sequencer. Looks like an interesting device.

The allocation of the forty 6 metre licences in the UK has come in for a lot of criticism, as was to be expected, mainly from those who were unsuccessful, and the fiak is still flying. They are allowed to operate between 50 and 52 MHz outside BBC1 transmission hours, which commence at 0830 with the firing up of the old 405 line transmitters, which are due to close down in 1984. It seems about 500 amateurs expressed an interest in transmitting on the band, and 126 returned an RSGB questionnaire on the subject, and forty were selected!

## VHF & UHF IN THE USSR

David Rankin 9V1RH/VK3QV has written from Singapore submitting a current list of records which have been attained by amateurs in Russia. David writes: "A short explanation is in order. Dex Anderson W4KM regularly receives copies of various Russian radio magazines. He goes through them and anything he finds of general interest he roughly (summary) translates into English. He makes a full translation of anything of special interest.

"The list of records attached is in the latter category. It is interesting to note that the literal translation for VHF/UHF in Russian is 'ultrashortwave'. Radio #3 was the March issue of 'RADIO' the RSF version of 'Amateur Radio'. Thus, full credit for the translation is due to the work of W4KM.

"CHRONICLE: The Collectives at UK5EFL and UK5ECZ from Krivoy Rog are continuing their experiments on SHF. On 6th August they conducted a special outing to the shores of the Sea of Azov, taking equipment for 5.6 and 10 GHz. Contacts were established over a distance of 101 km. Thus a new category is established for the USSR RECORD FOR THE 5.6 GHZ BAND AND THE RECORD FOR THE 10 GHZ IS BETTERED . . . For 5.6 GHz a

parabolic antenna with a 30 dB gain was used and transmitter power was 45 mW. For 10 GHz a 36 dB gain was used and transmitter power was also 45 mW.

"In the following table, a new item is introduced: '144 MHz — iono' which reflects achievements in DX communications established with the help of a previously little-known propagation mode — ULTRASHORT-WAVE SCATTERING CAUSED BY UNEVEN IONISATION IN LAYER E OF THE IONOSPHERE (in foreign radio amateur literature this is called (begin English text) Ionospheric Scatter By Field Aligned Irregularities (FAI) (end English text) and also aurora E . . . The calculation of the QRB's for QSO's reported by U's (except Moon ones), as previously, was carried out on a YeS-1040 A computer by A Tarakanov, UA3AGX.

Table of Achievements by Ultrashortwave in Distant Ultrashortwave Communication.

144 MHz — 'tropo' — 15.09.82 — RC2WBR/G4GFX — 1943 km (3025 km)
144 MHz — 'aurora' — 26.09.82 — UC2ACA/G5BM — 2029 km (2138 km)
144 MHz — 'meteors' — 12.08.77 — UW6MA/GW4CQT — 3099 km
144 MHz — 'Es' — 28.06.79 — UB5JIN/F6EZP — 2826 km (3864 km)
144 MHz — 'EME' — 15.08.82 — UA1ZCL/VK5MC — 14 000 km (17 525 km)
144 MHz — 'iono' — 27.06.82 — UA1ZCL/DK3UZ — 2150 km
430 MHz — 'tropo' — 15.09.82 — UP2BJB/G4GFX — 1712 km (1824 km)
430 MHz — 'aurora' — 13.07.81 — UA3LBO/SM6EAN — 1276 km
430 MHz — 'EME' — 6.11.82 — UA3LBO/K2UYH — 8750 km (18437 km)
1215 MHz — 'tropo' — 22.02.82 — UP2BJB/DF3XU — 878 km (1360 km)
5640 MHz — 'tropo' — 6.08.82 — UK5ECZ/UK5EFL — 101 km (217 km)
10000 MHz — 'tropo' — 6.08.82 — UK5ECZ/UK5EFL — 101 km (869 km)

The figures shown in brackets are probably the world standing record but I cannot vouch for the accuracy of these (VK5LP).

It is interesting to note that there seems to be some degree of VHF/UHF activity in Russia and they are prepared to go out to selected good locations for attempts at extending the distances previously achieved, so it seems there is little difference in this aspect of amateur radio there when compared with what is done from time to time in other parts of the world. Thankyou David for sending the information, something of interest from quite a different source.

## 6 METRE NET

Peter VK3XHH, Publicity Officer for the Victorian Railways Institute Wireless Club, VK3RI, has written advising the Club is currently operating a 6 metre SSB net every

\* ZS1SIX is a new beacon at Picketberg in Cape Province of South Africa and is 807 m ASL, and runs 16 watts to a ground plane antenna. It is alternatively operating in FSK and FM modes, and sends "CQ DE ZS1SIX QTH PIKETBERG SA FSK MODE PSE QSL TO ZS1CT 73".

It is noted with interest that the RSGB is seeking permission to operate a 50 MHz beacon from their Headquarters with the call sign GB3NHQ. Initially it would only operate outside TV hours, but next year continuous operation is envisaged.

Dave Lewis GW4HBK has now worked nine of the now thirty eight 6 metre operators permitted in the UK but he complains of QRM as everyone seems to operate within a few kilohertz of 50.100! Now, where have we heard that before!

The above three items are contained in "The Short Wave Magazine" May 1983, and sent through the kindness of Steve VK5AIM. The next three short items come from the same source.

There has been a claimed "first" 2 metre EME QSO between Ireland and the USA. On

Sunday morning from 2315. The Club also holds nets, when members are available, every day at 2315 and 0915. The weekday nets are on a less reliable basis than the Sunday net as they depend on shifts, leave availability or retired members etc. The net frequency is 52.080 MHz after an initial call is given on 52.050 MHz, the 6 metre calling frequency. Any licenced amateur is very welcome to join in any of the Club's nets.

### MACQUARIE ISLAND

Just a preliminary note to say it looks as though David VK5CK will be going to Macquarie Island later this year for a period of service there and is hopeful of maintaining the 6 metre beacon there and to increase the level of 6 metre activity from the island if the work load and conditions permit. It is hoped to bring you some more information on this matter at a later date when more is known. Suffice to say at the moment that we all wish David well for his tour to a very cold area, and know he will use his well known VHF abilities to the full.

### SIX METRES IN NEW ZEALAND

It is encouraging to read in "Break In" that the latest news is that conditions are improving on this band after a long period of very low solar flux. On 4/5/83 the 6Y5RC beacon was copied by ZL2AQR, the beacon is in Jamaica.

On 2/5 ZL4OY/C from the Chatham Islands appeared on 50 MHz and was worked by ZL2AQR, and again on 3/5 by ZL1MQ, ZL2KT, ZL1BHV and ZL2AQR. The islands are really a new country and it was said to be the first recorded QSO on 6 metres with the Chatham Islands. (I am not quite certain but I seem to believe reading or hearing about a 6 metre station operating from those islands quite a few years ago so this may not be the first QSO. Someone is bound to put the record straight soon! . . . 5LP.)

On 8/4 ZL1BHV, ZL2AQR, ZL2KT and ZL2TJX worked KH6IAA on 51 MHz, and on 16/4, 27/4 and 30/4 FK8A and FK8EM worked all ZL districts.

There have been no similar reports of this being done from the eastern seaboard of VK so perhaps we are a bit too far away at present.

### THE MAY EME WEEKEND

You will recall I recently gave some details of the EME tests which were carried out by K8HUH last May, during which I reported the signals did not find my QTH! Since then, I have received a lengthy tape recording from Gerry VK2BMZ, detailing the proceedings, plus a lot of written information and copies of the log etc (the latter items being more of interest to the EME operators than the average amateur, and they will receive copies in due course. I have spent some time transcribing the hour of spoken information on the tape and what follows is a condensed version containing the information likely to interest most people. I am indeed grateful to Gerry for going to so much trouble in preparing the facts for me, so I hope I can transcribe it with justice!

First of all, the technical description of the 140 foot radio telescope of the National Radio Astronomy Observatory (NRAO) at Green Bank, West Virginia, must indeed be of interest to everyone.

**REFLECTOR** — Paraboloid diameter: 140 feet. Surface:  $\frac{1}{8}$  inch aluminium plate. Surface area:  $\frac{3}{8}$  acre. Surface tolerance: 0.030 inches at zenith. Contains: 350 tons of aluminium; 35 tons of concrete ballast; 5 tons of balancing blocks.

**FOCUS** — 60 feet above the surface. Carries  $\frac{1}{2}$  ton of receiving equipment. Position relative to paraboloid stable to  $\frac{1}{4}$  inch.

**DECLINATION AXIS SHAFT** — Length: 67  $\frac{1}{2}$  feet overall; 57 feet between bearings. Diameter: 2 feet. Material: Composite aluminium and steel shaft running in two spherical roller bearings. Rotates 145°-53° north of zenith and 92° south.

**YOKE** — Serves to support the declination shaft and to rotate the antenna east and west about the polar axis by means of the polar gear.

**POLAR AXIS SHAFT** — Length: 67 feet. Diameter: 12 feet. Weight: 555 tons of steel; 170 tons of high density concrete ballast. Rotates 220°-110° east of meridian and 110° west.

**GEAR SECTORS** — Diameter of polar sector: 84 feet. Diameter of declination sector 71 feet.

**SPHERICAL BEARING** — Diameter 17  $\frac{1}{2}$  feet. Surface tolerance: 0.003 inches. Floats on oil film 0.005 inches thick.

**BASE** — Height: 60 feet; 41 feet 6 inches to observation deck. Contains: 5700 tons of concrete; 140 tons of steel. Wall thickness: 3 feet. Houses control room, hydraulic and electric equipment, transformer vault, and electronic workshop.

**TOTAL MOVING WEIGHT** — About 2500 tons.

**MOUNT** — Equatorial — two mutually perpendicular axes.

**POINTING PRECISION** — 10 seconds of arc — about the diameter of a dime at 400 yards.

**RESEARCH PROGRAMME** — Studies of known element and molecular spectral lines. Continuum research at other than line frequencies. Generally at wavelengths between 2 and 40 cm. Very-long base interferometry (VLB) using the 140 foot and non-NRAO telescopes.

**DATE OF COMPLETION** — Spring, 1965.

Gerry, VK2BMZ, spent four months in the US returning home late May 1983. His working period was spent at Greenbank West Virginia at the National Radio Astronomy Observatory (NRAO) so he was there at the time of the actual tests.

Two Australian stations worked were Chris VK5MC and Hans VK6ZT, the latter believed to be about the limit as far as the window goes between West Virginia and the rest of the world going west as the moon would be setting. The people at Greenbank were very happy with the results achieved and with it the success of the weekend lies strongly with Tom Clarke, W3AWA, who came down originally for an observing run and spent his time building up equipment for use on the EME weekend.

On the history side, the Observatory, or NRAO as it is usually called, is run on a thing called Associated Universities and financed from the National Science Foundation and essentially their charter is to provide radio astronomy facilities of the best possible quality for the Radio Astronomy Committee, both in the USA and for visitors around the world. They have very few astronomers on the

staff, staff there mainly runs the observatories, they have one 40 foot and one 300 foot antenna and an interferometer in Greenbank. The head office and main computer facilities are in Charlottesville in Virginia about 300 miles east of Greenbank, they have a 36 foot antenna at Pecan, Arizona for millimetre work which is basically 43 GHz up to 300 GHz, and they have a thing called a Viewray south of Albuquerque, New Mexico, they are the main facilities. Greenbank Viewray sight which first started in 1956-57 which is now fairly old and some of its glamour has been lost but not to take anything away from the observatory, it's just that new facilities have sprung up. 1983 was the 50th anniversary of radio astronomy which commenced about 5th May 1932 with Carl Janske giving the lead, and deciding there were three kinds of interference on the phone circuits he was receiving, one from a nearby electrical storm, one from much more distant electrical storms. Propagated from the atmosphere was a third source now called Star Noise which he finally decided came from well overhead in a position slowly changing. He first thought it was the sun, but after the equinox the source of noise still kept on rotating in the same direction each day so he came to the conclusion that it was star noise.

So in 1983, a three day workshop was held in Greenbank to bring together a lot of people involved in the beginnings of radio astronomy. There were about twenty members of the Janske clan present, and this event put the NRAO Greenbank back on the market to commemorate the fifty years of such work. Two amateur projects were decided upon, in the front yard of Greenbank was a reproduction of the 1932 antenna which Carl Janske used on 20.5 MHz, and so for the weekend before the EME test a couple of people put this antenna on 15 metres with a crude antenna coupler and about 2 kW. The following weekend were the EME tests and this was probably the first time an actual transmitter had been put on the NRAO antenna and it was a case of doing the best possible without interfering with its original activities. The 300 foot antenna which is probably half a mile away from the 140 foot antenna was scheduled for observations that weekend as well as the interferometer working on 1600 MHz and it was one of the conditions of the EME operation that no interference be caused to the other operations. This was helped of course by having a few amateurs on the staff in the right places who were able to assist in keeping out the interference and for ensuring the right attitude was developed towards the experiments.

The equipment was built in two parts, NRAO have a standard receiver box about 4 feet long by 3 feet square and fits in any of the Greenbank telescopes. We got hold of an old receiver which had the electronics stripped out of it so all we had was a waterproof package with a floor and ceiling in it with a few power connectors, fans, ducting, temperature sensor; everything else we needed had to be built and it wasn't until Tom Clarke arrived with a station wagon load of equipment about ten days before the EME weekend that we were able to start to get things ready. Tom was able to buy several Bird watt meters, directional couplers and filters to put in the

line as we were worried about harmonics of 70 cm, particularly the second harmonic was potentially disastrous because of the 700 MHz work being done on the pulsars on the 300 foot dish and part of the time that was looking past the 140 foot dish. Apart from one scare which we decided was not our fault we did not cause any interference to the 300 foot antenna.

On the outside of the package was mounted the feed consisting of two fairly thick reasonably broadband crossed dipoles which became the focus of the antenna. These were connected by no more than 4 inches of semi rigid coax to a hybrid connected to one coax switch and then to a transmitter switch. Things were a bit hazy as Bill Brundage and I were running around trying to buy things and many changes were made from the original ideas. But there were three coaxial switches up the front end to change the polarisation, isolate the transmitter etc and a third switch to connect a noise source to enable the receiver system to be swept. After the switches there were some band pass cavity filters which Tom Clarke had collected and tuned up, the transmitter was a nominal 100 watts which actually gave out 150 watts! It was owned by AMSAT and operated at 12 volts 20 amps. We had problems getting such a supply but eventually got a large 30 amp unit using an SCR in the primary, on loan from people who wanted it back if needed as it was their spare! Our worries that there might be hash from the SCR switching were unfounded.

The receiver consisted of two GasFET pre-amplifiers, home made. Initially we were going to come down at 28 MHz with 28 MHz in one cable and 70 cm in the other but we found the local oscillator in the converter was radiating harmonics which were getting into the front end so we amplified the signal and brought it downstairs where it was split several ways. There were two spectrum analysers one at 70 cm and one at 30 MHz, the signal was then split two more ways to provide 28 MHz into an Icom 720A and a Drake TR4 receiver so there were two independent positions for tuning around the nominated frequency.

The 150 watt solid state transmitter was driven by a Mirage 25 watt amplifier which in turn was driven by an Icom IC451 70 cm rig. Much padding down of signal powers was needed all along the transmit chain and high power pads had to be scrounged as all pads around a radio astronomy set up are low power, eg 2 watts. Facilities were included to allow signals to be transmitted from the driver stage and the 10 watt IC451 if need be. Tom went to a lot of trouble to ensure that when you wound up the power on the IC451 that all drive levels were correct along the chain to 150 watts output stage. Hence the need for a number of Bird watt meters.

Additional equipment hung on to the system consisted of a video tape recorder, Morse teletype auto ASCII decoder, bug keys, pocket radio rig, plus the very latest HP noise figure indicators (in the \$2500 price range!) and they had the capability of displaying a swept frequency response, noise figure, gain and return loss. It was used extensively to optimise the receiver front end; it was possible to go on swept noise from 10 MHz to 1500 MHz. All cables used were swept from 2 to 4 GHz to

make sure they were in good condition, the match was good, connectors tight etc. A multitude of connectors were in use, SMA, BNC, UHF and there were problems matching one type to another. Those involved were working up to eighteen hours a day. My (VK2BMZ) contribution was to build up the electronics which allowed the polarisation switches to be independently set for transmit or receive, with indicator lights to show the operating positions of the various switches or relays.

All equipment was tested in a special building which amongst other things gives a vibration test to check firmness of cables, mountings etc. Two days was spent in there debugging the equipment before it was finally mounted in the telescope.

Some final figures for the receiver were that the easiest place to measure the noise figure was at the input to the output of the hybrid, where it was agreed it was 65-70 degrees Kelvins which included a couple of switch losses in front of the pre-amps. It was estimated by the time you put on the hybrid and cross dipoles and you do a NF measurement of feed plus the rest of the system it was probably up to 110 k; by the time it was on the 140 foot dish looking at the moon with its radiation as well as receiver noise the figure would be up to 150 k.

The whole system was computer controlled; it appeared the beam width was about twice the diameter of the moon at 70 cm so we were sort of over limiting the moon, but we were able to tap the moon from horizon to horizon without trouble. Once the programme was written and equipment set up we got echoes from the moon. By watching the total power on the chart recorder we started to drive off the centre position of the moon in each co-ordinate and we went in one direction enabling us to obtain stronger signals. The sun and moon were close together on the Friday with a consequent rise in received noise, two days later they were much further apart so we didn't have that trouble then. The weather was cloudy most of the time and rained on the Sunday.

This was my first experience with EME and suitably impressed with our echoes coming back. SSB on 150 watts was no trouble with return echoes up to 15 dB above noise on the spectrum analyser. We could turn off the amplifier and get our signals back on SSB using only 10 watts from the IC451, and by turning the rig down to 100 mW we could still hear our echoes on CW!

As far as we know we are able to work everyone who called us, some signals were very weak. The transmitter was left on 432.095 MHz and tuning about 100 kHz from there with both receivers. The TR4 was used primarily as a spotting receiver and the IC720A the main working receiver. There was always one person tuning the band, sometimes two, with an automatic keyer for call signs etc. We were conscious there were a lot of people out there wanting to work us so we made every effort to work anyone we heard. One hundred and thirty one contacts on CW and seventy two on SSB were made, to some stations more than once. Signal reports were up to 589 on CW and 5 x 8 on SSB, with most reports being in the excellent class. About 132 different stations were worked. All

continents were worked even though it required a phone call to rustle up someone from South America (YV5ZZ). Z25JJ provided the African contact, there were many European and Japanese contacts apart from the USA and Canadian contacts.

Operators involved included WA4MVI, K8OCL, KB2M, VK2BMZ, N4QQ, W3IWI, K2AOE, WB3AXN, WA2LOQ, AD8T, KA8NQR and K8HUH.

Those participating concluded the amount of work had been very worthwhile and if nothing else had re-established the position of the Greenbank Observatory, and alerted operators around the world as to the possibilities of EME on a global scale. One area of exception was no contact with New Zealand.

The above is an extract from the large amount of material sent to me by Gerry VK2BMZ to whom I am indebted for his interest in informing me of the events. It has taken a fair amount of space in the notes but should be of general interest to most VHF/UHF operators and I guess others as well. Anyone want to start building an EME antenna?

## LATE NEWS

Just to hand is a note advising the Department of Communications has agreed to allow VK stations to use the band 50.000 to 50.150 MHz on the basis of non-interference to Channel O. Stations in VK6, Antarctica and external territories will be allowed to operate on an unrestricted basis, all other VK areas will be permitted to operate outside of Channel O broadcasting hours.

After such a long time its a welcome break to be allowed this section of the band again. Other comments will be left until another issue but suffice to say if amateurs play the game according to the rules we may find a relaxing of the rules in the future to permit operation on a wider basis.

That's all for this month. Concluding with the thought for the month: "The reason most of us don't live within our income is because we don't consider that living." 73. The Voice in the Hills. **AR**

## Have You Obtained Your New Call Book Yet?

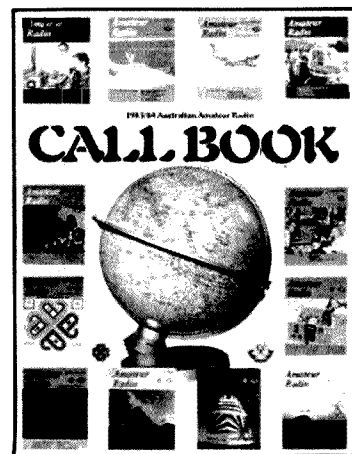

The new 1983-84 Call Book is now available from your Division or Magpubs for \$5.75.





# WICEN NEWS

Ron Henderson, VK1RH  
 FEDERAL WICEN CO-ORDINATOR  
 171 Kingsford Smith Drive, Melba, ACT 2615

## SIMULATED EMERGENCY TEST

This year the annual ARRL Simulated Emergency Test (SET) involvement will be combined with a NSW WICEN State Wide Welfare Message Handling Exercise over weekend 17/18 September 1983. The NSW exercise is aimed at establishing contact with welfare agencies throughout the state. To provide a greater scope for international messages NSW WICEN will be canvassing interest from other states but essentially the ARRL SET aspects will be played low key.

## THIRD PARTY TRAFFIC NETWORKS

A little while ago I received from Sam Voron, VK2BVS, the Australian Traffic Network Co-ordinator, a copy of the "Manual for Operators on the Australian Traffic Network (ATN)". The manual is a complete guide or handbook for TPTN operators and copies may be obtained by sending a 70¢ stamped addressed envelope 355 mm by 230 mm to Sam Voron, 2 Griffith Ave, East Roseville, NSW 2069. Sam carefully and in considerable detail sets out the background and considerations of TPTNs and offers several wall charts on ATN frequencies, numbered radiograms and operating techniques.

Also of interest is the WIA Policy Statement on Third Party Traffic as drafted at the 1982 Federal Convention. It reads:

### RECOGNISING:

- The ability of the Amateur Radio Service to provide public service through the use of their frequency bands, specialised equipment and knowledge;
- The ongoing need to promote the Amateur Radio Service to the general public;
- A desire to develop operating skills within the Amateur Radio Service;
- The potential for the development of national and international goodwill;
- A separate need for emergency networks operating in support of official counter disaster agencies;
- The right of amateur radio operators to choose whether or not to be involved in such activity.

### THIS COUNCIL RESOLVES TO:

- Support the use of third party traffic handling privileges on all amateur bands and by all interested amateur radio operators;
- Support the existence of networks of facilitating third party traffic handling;
- Support the existence of emergency

# WIA VIDEOTAPE CATALOGUE

Copyright	TITLE (Each section in accession order)	Approx Dur	Col/ B&W	Ordering Info
Yes	7J1RL DXpedition (JARL)	60 mins	Colour	Loan Only
Yes	G6CJ's Aerial Circus (G6CJ)	90 mins	B&W	Loan Only
Yes	Wireless Telegraphy - circa 1910 (VK3ADW)	10 mins	B&W	Loan Only
No	Op of Burley Griffen Bldg — SA WIA HQ	50 mins	Colour	Copy Avail
No	This is Amateur Radio (teens) (ARRL)		Colour	Copy Avail
No	Moving Up to Amateur Radio (CB) (ARRL)	15 mins	Colour	Copy Avail
No	The Ham's Wide World (Obsolete) (ARRL)	30 mins	Colour	Copy Avail
No	The World of Amateur Radio (ARRL)	30 mins	Colour	Copy Avail
No	TWH7DAYS — Amateur Radio (teens) (HSV7)	25 mins	Colour	Copy Avail
No	Amat Radio — The Nat Resource (VK5KG)	6 mins	Colour	Copy Avail
No	SSTV Pictures from Space (Voyager) (VK5KG)	15 mins	Colour	Copy Avail
No	Low Definition Television (VK5KG)	25 mins	Colour	Copy Avail
No	History of ATV in South Aust (VK5KG)	30 mins	Colour	Copy Avail
No	VK5RTV's uComputer Controller (VK5KG)	10 mins	Colour	Copy Avail
No	ATV in Australia 1978 — for BATC (VK5KG)	30 mins	Colour	Copy Avail
No	ATV in Australia 1980/81 — for BATC (VK5KG)	30 mins	Colour	Copy Avail
No	ATV in United Kingdom 1980 (G8CJS)	30 mins	Colour	Copy Avail
No	ATV in United Kingdom 1980 Revisited (G8CJS)	30 mins	Colour	Copy Avail
No	An ATV Hamshack Micro-computer (VK3AHJ)	10 mins	Colour	Copy Avail
No	The Signal to Noise Story (VK3ATY)	45 mins	Colour	Copy Avail
No	UHF Preamplifiers (VK3ATY)	45 mins	Colour	Copy Avail
No	CQ ATV DX International (WB2LLB)	60 mins	Colour	Copy Avail
No	Overseas TV Clips about ATV etc (WB2LLB)	60 mins	Colour	Copy Avail
No	Model Aero-Nautical Mobile ATV (VK5KG)	15 mins	Colour	Copy Avail
Lectures recorded at VK5 WIA HQ . . .				
No	— RTTY (VK5QX)	40 mins	B&W	Copy Avail
No	— Tracking Oscar (VK5CI)	40 mins	B&W	Copy Avail
No	— Wire Antennas (VK5RG)	40 mins	B&W	Copy Avail
No	— Loaded Wire Antennas (VK5NN)	50 mins	Colour	Copy Avail
No	— Apollo 13 Disaster (VK5JM)	90 mins	Colour	Copy Avail
No	— History of uProcessors (VK5ZFQ)	60 mins	Colour	Copy Avail
No	— Understanding uProcessors (VK5PE)	60 mins	Colour	Copy Avail
No	— Winning Foxhunts (VK5TV)	45 mins	Colour	Copy Avail
No	— An Aux Batt Charger (VK5NX)	25 mins	Colour	Copy Avail
No	— Testing ATV TX (VK5KG)	50 mins	Colour	Copy Avail
Getting Starting in . . . As above but made to mark WCY				
No	— Amateur Television (VK5KTV)	55 mins	Colour	Copy Avail
No	— Amateur Satellites (VK5AGR)	50 mins	Colour	Copy Avail
No	— Amateur RTTY (VK5JM)	85 mins	Colour	Copy Avail
No	— Amateur uComputers (VK5IF)	40 mins	Colour	Copy Avail

These Video Tapes are available from the Federal Video Tape Co-Ordinator, John Ingham, VK5KG, 37 Second Avenue, Selton Park, SA 5083. (refer page 47).

- networks operating in support of official counter disaster agencies;
- Educate interested members in third party traffic handling techniques, procedures and responsibilities;
- Promote co-ordination between third party traffic networks and authorised amateur emergency networks;
- Continue to pursue the establishment of third party traffic agreements with other countries.

### COMMON AIM

Naturally WICEN and TPTNs have differences but they are based upon a common aim — to pass message traffic for others — and it is this which gives them a common cause in differing operating circumstances.

AR

**WA**  
**RR**  
**???**

# NATIONAL EMC ADVISORY SERVICE

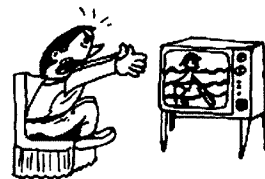

Tony Tregale, VK3QQ  
FEDERAL EMC CO-ORDINATOR  
38 Wattle Drive, Watsonia, Vic 3087

## ESD — "The Electronics Killer"

**Electromagnetic interference is, in most cases, just an annoyance to electronic equipment: ElectroStatic Discharge (ESD) is quite often a "killer" of modern solid-state electronic devices.**

Mother nature provides the best large scale illustration of ESD. Charge concentration in thunderclouds can produce potential differences of millions of volts between clouds and clouds, and clouds and ground. The breakdown between charge centres results in a lightning discharge. The electromagnetic energy thus released can cause severe interference to radio communications services.

Electrostatic discharge is a phenomenon in which an electrostatic charge accumulates on the surface of a body or particular type of material, usually resulting from mechanical movement of one insulated body or material in relation to another. The actual discharge occurs when the insulating material between the charged object can no longer withstand the stress of the charge potential.

A persons body can, similar to a capacitor, become charged to several thousand volts with respect to earth or similar zero potential. Most of us would be familiar with the surprising shock received after waking across certain types of carpet and then catching hold of some innocent metal object. The current pulse that flows as a result of ESD may be several hundred milliamperes with a delay constant of a few tenths of a micro second. This short duration current flow produced by a 15-20 kV ESD, although basically harmless can be quite painful.

Electrostatic voltage can be generated at any time by dissimilar materials, where the triboelectric (frictional) charge currents are flowing in opposition to each other. Charge generation occurs whenever two materials contact each other and then separate, or where there is relative movement between the materials.

The voltage thus generated is a function of the degree of separation or relative movement in the triboelectric series, modified by the relative humidity. The Triboelectric Series is a galvanic order of non-conducting materials. In the order — cotton comes at the centre, teflon at the negative end, and air at the positive end of the scale. Therefore, by choosing materials which have minimum triboelectric spread, the incidence of ESD can be minimised.

Once the charge has been generated, the distribution of the charge depends on the material's resistivity. Conductive materials allow charges to be removed by grounding. Non-conductive materials have to be dealt with by supplying them with a constant

stream of positive and negative air-ions. The charged non-conductor then attracts oppositely charged ions to its surface, thereby neutralising the non-conductor.

An object such as an antenna which is exposed to moving air containing, sand or dust particles, water, or snow, can become static charged. The potential which can result may be in the order of several thousand volts. This potential is limited only by the point at which the corona discharge occurs.

However, perhaps the most important area of electronics which has so much to lose from the effects of ESD, is solid-state. With the dramatic increase in the use of sensitive solid-state devices, in all aspects of communications and electronics, the incidence of damage due to ESD has increased significantly. To the extent, that most major manufacturers of communications and electronic equipment have embarked on a fully integrated programme of ESD protection on their production and assembly lines.

If we consider the components we are using today, the susceptibility range of most is below 500 volts. The range of typical electrostatic voltages developed by the various effects of everyday living and working range from 100 volts to 35 000 volts. Because our body susceptibility (minimum sensitivity) is from about 3000 volts (short duration — low current), we would often be unaware of the damaging effect of ESD, when handling modern sensitive components.

We are all familiar with component damage and component malfunction, these are usually connected with definite failures. Quite often damage from ESD is not so pronounced. It can be of an intermittent nature, or it can reduce the life of the components. In addition, the effects of ESD on electronic components is quite often not recognised as such, because failures due to electrostatic discharge are quite often masked by other failures.

In conclusion, there are a number of rules which, if followed, can help to minimise the effects of ESD on today's sensitive components:

- Assume all electronic components are sensitive to ESD damage.
- Do not touch a sensitive component unless you are grounded, or have been discharged.
- Do not transport, store or handle sensitive components except in a static free environment.

- Disconnect power before removing or replacing sensitive components.
- Use only anti-static coolant spray.
- Touch the grounded chassis, with a hand, prior to removing or inserting an ESD sensitive device.
- Discharge test equipment before use.
- Ground the ESD protective package before removing the replacement devices.
- When removing a device from an ESD protective package, avoid touching connections or circuitry.

This short article is intended as an overview, or brief outline, of the very complex and wide ranging issues of ESD. Nevertheless, we trust this outline will provide a basic insight into this growing problem. For those who wish to pursue the subject further, the National EMC Advisory Service does have a wide range of additional material.

AR

## AUGUST'S BEST PHOTOGRAPHS

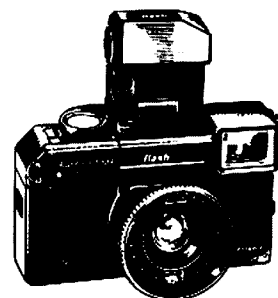

*The Judges at Quadricolor Industries and Waverley Offset Printing Group selected the front cover photograph and the judges at AGFA-GEVAERT selected the group photo on page 37.*

*These photos will now be considered for the AGFA CAMERA prize at the end of the competition in June 1984.*

# OPEN LETTER TO RADIO CLUB PROGRAMME ORGANISERS FROM THE WIA FEDERAL VIDEOTAPE CO-ORDINATOR

c/o 37 Second Avenue, Sefton Park,  
South Australia 5083

Here is a way for your club to benefit, in yet another way, from its affiliation with the WIA. You can provide your members with quality technical lectures on subjects covering the whole range of amateur radio activities by taking advantage of the WIA Federal Videotape Library. You'll find this a boon, particularly if yours is a country club which often has difficulty obtaining a variety of expert lecturers for its regular meetings.

It's inexpensive and it's easy. Here's how it works . . .

Except for those titles for which the WIA does NOT hold a copyright licence, all you have to do is . . .

Supply me with a video-cassette of an "acceptable format"

Plus a stamped, return-addressed padded mailbag

and the programme is free for you to use in support of amateur radio in your area . . . including copying and transmission over the air if you wish.

Those programmes which are copyright are available only ON LOAN. To obtain any of them send with your request . . .

Information about your preferred VCR format.

A statement signed by a Responsible Officer of your club that, "I undertake that while (Programme Title) is assigned to me, I will not allow it to be transmitted over the air, nor copied by any means whatsoever, and that I will return the same promptly after showing."

A stamped addressed padded mailbag suitable for cassettes of your preferred format.

The present "acceptable formats" are as follows . . .

VHS (Size 200 x 110 x 30 mm, Mass 350 gr, 3 Hr max)

Umatic (Size 260 x 180 x 40 mm, Mass 835 gr, 1 Hr max)

Philips N1500 (Size 100 x 140 x 50 mm, Mass 625 gr, 1 Hr max)

Of these the VHS is preferable as being smaller and lighter it is much less expensive to post.

I hope that this information provides you with sufficient information on how to successfully make use of this free service without further delay.

73

John F Ingham, VK5KG  
FEDERAL VIDEOTAPE CO-ORDINATOR

## LEARNING THE MORSE CODE? Try the All New BT-1 - Basic Trainer For Morse Code



Advanced Electronic Applications in conjunction with ETS (Educational Technology and Services)\*, has developed the BT-1 Code Trainer. ETS methodology, based upon research by a prominent mid-west university, has demonstrated that a typical student using this system and the BT-1, can learn Morse Code to speeds of 20 WPM in four weeks based upon two 20 minutes daily training sessions.

The pre-programmed BT-1 computerised trainer will allow you to achieve proficiency in Morse Code faster than any other known method.

No prior knowledge of Morse Code is required to use the BT-1. There are no tapes to purchase or wear out. The BT-1 operates from a 12 VDC source, the unit can also be used in mobile settings via the 12 VDC system.

\* Educational Technology & Services, see page 81 October 1981 issue of Ham Radio Magazine.

Prices and Specifications  
Subject To Change Without  
Notice Or Obligation

**ADVANCED ELECTRONIC  
APPLICATIONS**

Brings you the  
Breakthrough!

\$134.40 (Inc. of ST) Plus P&P

### HY-TECH DISTRIBUTORS

Building 51,  
Archerfield Aerodrome, Q 4108  
Tel: (07) 277 5624  
Telex 43318

## MURPHY!!

The correct height of Mt Torbreck,  
Page 16, July AR is 1500m.



WHO SAID MT TORBRECK ISNT  
1500 M HIGH?

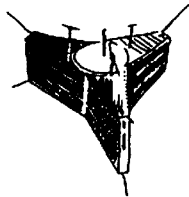

# AMSAT AUSTRALIA

Colin Hurst, VK5HI  
8 Arndell Road, Salisbury Park, SA 5109

## NATIONAL CO-ORDINATOR

Graham Ratcliff VK5AGR

## INFORMATION NETS

### AMSAT AUSTRALIA

Control: VK5AGR

Amateur Checkin: 0945 UTC Sunday

Bulletin Commences: 1000 UTC

Winter: 3.680 MHz

Summer: 7.064 MHz

### AMSAT PACIFIC

Control: JA1ANG

1100 UTC Sunday, 14.305 MHz

### AMSAT SW PACIFIC

Control: W6CG

2200 UTC Saturday, 28.880 MHz

Participating stations and listeners are able to obtain basic orbital data including Keplerian elements from the AMSAT Australia Net. This information is also included in some WIA Divisional Broadcasts.

## ACKNOWLEDGEMENTS

Contributions this month were received from Bob VK3ZBB, Graham VK5AGR, Peter VK7PF and thanks are extended to AMSAT Telemail, UOSAT Bulletin Board and Mode J Newsletter for excerpts.

## AMSAT TELEMAIL ACCESS

Following an approach from Graham VK5AGR to Rich Zwirko, K1HTV (Vice-President, Operations — AMSAT) access to the AMSAT Telemail Bulletin Board has been granted to AMSAT Australia. Consequently, amateurs throughout Australia are now able to obtain the latest satellite news direct from AMSAT Headquarters. Although it would appear, in the first instance, to be a rather expensive medium for the dissemination of news, it must be borne in mind that, at this juncture, it is the only reliable source of accurate and reliable news input at our disposal. In the months to come its worth to the satellite community throughout Australia will be accurately assessed.

## OSCAR 10 NEWS AND HAPPENINGS

Following the successful launch of Oscar 10 as reported in this column last month, the chain of events that have transpired since then would fill a complete issue of Amateur Radio and I doubt whether our erstwhile editor would allow that. Suffice to say it was obvious that the apparently smooth launch had not been so smooth after all. Notwithstanding the AMSAT-Oscar 10 team got on with their demanding schedule and on the 11th July at 22:30:48 UTC performed an heroic act by successfully firing the kick motor.

## VIA TELEMAIL FROM THE AMSAT PRESIDENT, TOM CLARK W3IWI

"CONGRATULATIONS!!! I know I speak for all when I say to Jan, Karl, Dick, Gordon and all the

rest of the builders of Phase-3B, congratulations on a superb show today. Despite the fact that ESA didn't give us the best ride and "bumped" us in the posterior, it looks like we did it! Today was truly the birth of a new era in amateur satellites and amateur radio. We may now add to our unblemished string of 'firsts' the first non-governmental, non-commercial motor firing in space. I predict that the months of June and July 1983 will go down in the record books as the equal of the first amateur DX bridge over the Atlantic. WELL DONE."

Following Tom's congratulations to the AMSAT-Oscar 10 team questions were asked in reference to the "bump in the posterior", as it had been rumoured that an incident had occurred at separation from the launch vehicle. Subsequently the following official document, dated the 13th July, was released on 15th July by the European Space Agency, ArianeSpace, Centre National d'Etudes Spatiales (CNES) and AMSAT.

## ARIANE LAUNCH LB ORBIT INJECTION OF OSCAR 10 SATELLITE

The apogee motor firing of (AMSAT) Oscar 10, the radio amateur satellite launched on the 16th of July, took place during the night of 11 to 12 July and injected the satellite successfully into an intermediate orbit of approximately 3900 km perigee, 35 800 km apogee height and 26 degree inclination. A second and final apogee motor firing is scheduled within the next fortnight. All equipment on board the satellite checked out so far including the main transponder with its antennas working perfectly. The firing had been delayed by about three weeks since the satellite's attitude and spin rate, after separation, were not as expected. Indeed, whilst separation and orbital injection of the ECS 1 satellite were perfect the first acquisition of telemetry from the Oscar 10 satellite five hours after launch indicated that there were gross errors in attitude and spin rate. The satellite authority took rapid and effective action to guarantee the immediate survival of the satellite so that the situation could be analysed and further corrective action taken. During the past weeks the AMSAT project authority has established full control of the satellite and brought it into the correct attitude for a first firing of the restartable liquid propellant apogee motor. In doing so the AMSAT project authority has demonstrated the extraordinary operational flexibility of the design of its satellite and of the people who operate it. Examination of the launcher telemetry has shown that the dual launch system SYLDA had functioned nominally and that the original separation parameters (including satellite attitude and spin) had been correct. This fact has later been confirmed by stored satellite telemetry data. Detailed investigation of both launcher and satellite data indicates with a high degree of probability, that 53 seconds after separation the third stage caught up with the satellite, this would explain the attitude and spin rate anomalies observed subsequent to separation.

This supposition of a physical contact is reinforced by observation of small shocks registered at that time by launcher vibration sensors and by indications that at least one of the satellite's antennas is slightly damaged. The most likely reason that the third stage caught up with the satellite is that the thrust due to programmed venting of the oxygen tank was significantly higher than predicted and annulled the margins taken for setting up the sequence of orientation manoeuvres. Following separation of each satellite, the Ariane 3rd stage performs an attitude and spin change programme which is then followed by a lateral distancing manoeuvre of this stage. This sequence includes opening and closing of the 3rd stage oxygen vent valves to control residual tank pressure and to provide thrust for the distancing manoeuvre. For future launches the higher residual thrust level and additional margins will be taken into account and the sequence of operations will be adjusted accordingly so that this kind of problem will not be encountered again.

From the above statement it would appear that disaster was very close at hand for Phase-3B. However, that is now of historical interest, and the future now appears very promising. We now await the second burn of the kick motor to place it at its final orbit position with the anticipated transponder turn on scheduled for mid-August.

## OSCAR 10 TRANSPONDER FREQUENCIES

MODE B: Uplink 435.025 to 435.175, Downlink 145.975 to 145.825 inverted passband.

MODE: Uplink 1269.05 to 1269.85, Downlink: 436.95 to 436.15 inverted passband.

BEACONS: General 145.810 and 436.020. Engineering 145.987 and 436.040.

## UOSAT — OSCAR 9

The following three items are from UOSAT Bulletin-33 posted at 0000 UTC, 16 July 1983 — Tnx to the UOSAT team.

## UOSAT SPACECRAFT NEWS

Power budget tests have been carried out on the UOSAT batteries during the last week to assess their capacity state and to assist power management. All non-vital spacecraft systems were switched off to allow the batteries to reach full charge and then a heavy load applied and the battery performance monitored throughout the entire orbit by the on-board computer. The heavy discharge during eclipse was of particular interest. The data has been collected and is being analysed at UOS. It was encouraging to see that the spacecraft continued to operate nominally even at low battery volts. Preliminary analysis indicates that the spacecraft runs with a marginally negative power budget over the weekends when the 2.4 GHz beacon is on in addition to other normal loads with the current sun angle and spacecraft attitude.

The 2.4 GHz beacon will be switched OFF this weekend whilst we complete our analysis. The whole orbit data collection programme was run at a number of times during this week to collect the battery charge information. The 144 MHz beacon was only used for short periods over Europe for most of these runs. The telemetry channels recorded were: 2, 22, 23, 30, 32, 43, 54. The run times were 12:16:20 and 15:19:08 on 13/07/83, 13:27:29 and 16:38:45 on 14/07/83, 13:10:02 and 14:44:50 on 15/07/83. The 16:38:45 one failed due to operational error.

### SPACECRAFT ATTITUDE

The spacecraft remains stable in a flat (end over end) spin with a fluctuating +Y/-Y facet temperature gradient of around 55 C to 65 C, this possibly being caused by the HF antennas deployment. Analysis and preparations continue for magnetorquer attitude manoeuvres during next week to reorient the spacecraft spin axis and introduce a slow Z-spin to improve the temperature gradients.

### PACSAT TESTS

Preliminary tests have been carried out on UOSAT-Oscar 9 to evaluate the use of the spacecraft in 'PACSAT' demonstrations. This exercise will allow the PACSAT development team to evaluate a number of techniques under consideration for a future PACSAT — an amateur digital communications spacecraft using packet radio. These preliminary experiments have been most encouraging. On orbit 9658, 1196 packets of 8 bytes each (6 data, 2 checksum) were transmitted to UOSAT from Surrey using the 438 MHz command uplink. This link has previously proved difficult for command transmission due to a priority mechanism frequently giving preference to the 144 MHz command uplink. However, in data mode, the problem has been overcome and 762 packets were correctly received by the spacecraft giving a reliability of 63.7 equivalent to over 8000 packets per overhead pass, more than sufficient to fill the UOSAT 16 kilobyte memory. An extra checksum byte will be added to further improve integrity, and an improved acknowledgement system is being designed.

### OSCAR 8 REMAINS SILENT

No positive news has been received in recent weeks on the status of the batteries on board Oscar 8. In this instance it is most unfortunate that no news is bad news. Nonetheless all good things come to those who wait and amateur satellite users are renowned for their patience.

### CONFERENCE ON PRIVATE SECTOR SPACE RESEARCH

The first annual conference on private sector space research and exploration will be held in Florida 4th to 7th August, 1983 coinciding with the STS8 night launch. Included among the participants are AMSAT, UOSAT, JAMSAT and AMSAT-France. The conference will be devoted to non-governmental space exploration and scientific research designed to further the understanding of the space environment.

### SATELLITE PREDICTIONS

I have been approached by a number of

## UPS AND DOWNS... TNX TO VK3ZBB

### LAUNCHES

NUMBER	NAME	NATION	DATE OF LAUNCH	PERIOD MIN	APOGEE KM	PERIGEE KM	INCLN DEG	FACILITIES
1983-036A	COSMOS 1454	USSR	22 Apr	89.7	374	181	89.7	SI TM
1983-037A	COSMOS 1455	USSR	23 Apr	97.8	676	648	82.5	SI TM
1983-038A	COSMOS 1456	USSR	25 Apr	709	39 343	613	62.8	SI TM
1983-039A	COSMOS 1457	USSR	26 Apr	89.8	376	180	—	SI TM
1983-040A	COSMOS 1458	USSR	28 Apr	89.1	275	220	82.3	SI TM
1983-041A	GOES 6	USA	28 Apr	1707.4	48 400	33 483	0.5	MW SE EI
1983-042A	COSMOS 1459	USSR	6 May	104.7	1014	942	83.0	SI TM
1983-043A	COSMOS 1460	USSR	6 May	90.1	369	218	70.3	SI TM
1983-044A	COSMOS 1461	USSR	7 May	93.3	457	438	65	SI TM
1983-045A	COSMOS 1462	USSR	17 May	89.5	318	224	82.3	SI TM
1983-046A	COSMOS 1463	USSR	19 May	103.5	1570	307	82.9	SI TM
1983-047A	INTELSAT V	USA	19 May	634.2	35 980	166	23.4	CS MCS*

KEY: \* Initial Orbit Elements  
 SI — Scientific Instruments  
 TM — Telemetry  
 MW — Meteorological Data  
 EI — Earth Imaging

CS — Communication Systems  
 MCS — Maritime Communication Systems  
 SE — Space Environment

ATS1. As at 13 April the location of ATS1 was 164.42°E, 5.009°S. Frequencies 136.549628 and 136.349385 MHz.

people for an inclusion into this column of satellite parameters on a monthly basis. At this juncture I am in two minds as to whether this is in fact a wise use of this column, especially as the predictions are dated by the time they are received. Notwithstanding I am open to further suggestions on this matter and will further research the matter personally. In the meantime current predictions are available each week on the Sunday evening sessions and Bob VK3ZBB can also assist as per the instructions, (Reference Amateur Radio June 1983, page 53).

de Colin VK5HI  
 AB

### THE FOLLOWING SATELLITES RE-ENTERED OR WERE RECOVERED

1980-15A	TRANSEI 4	12 May
1980-83A	COSMOS 1215	12 May
1982-76A	COSMOS 1397	18 May
1983-012A	COSMOS 1442	11 Apr
1983-024A	COSMOS 1449	15 Apr
1983-026A	STS 6	9 Apr
1983-029A	COSMOS 1451	22 Apr
1983-036A	COSMOS 1454	22 May
1983-040A	COSMOS 1458	11 May
1983-043A	COSMOS 1460	20 May

Also forty seven other objects.



# QSP

## ARRL QN Signals For CW Net Use

### CW ENTHUSIASTS

Refer "How's DX" August for information about the CW Net. The following QN code may prove useful.

- QNA\* Answer in prearranged order.
- QNB\* Act as relay Between \_\_\_ and \_\_\_.
- QNC All net stations Copy. I have a message for all net stations.
- QND\* Net is Directed (controlled by net control station).
- QNE\* Entire set stand by.
- QNF Net is Free (not controlled).
- QNG Take over as net control station.
- QNH Your net frequency is High.
- QNI Net station report in. I am reporting into net. (Follow with a list of traffic or QRU.)
- QNJ Can you copy me? Can you copy \_\_\_?
- QNK\* Transmit messages for \_\_\_ to \_\_\_.
- QNL Your net frequency is Low.

- QNM\* You are QRMing the net. Stand by.
  - QNN Net control station is \_\_\_ What station has net control?
  - QNO Station is leaving the net.
  - QNP Unable to copy you. Unable to copy \_\_\_.
  - QNQ\* Move frequency to \_\_\_ and wait for \_\_\_ to finish handling traffic. Then send him traffic for \_\_\_.
  - QNR\* Answer \_\_\_ and Receive traffic.
  - QNS Following Stations are in the net.\* (Follow with the list.) Request list of stations in the net.
  - QNT I request permission to leave the net for \_\_\_ minutes.
  - QNU\* The net has traffic for you. Stand by.
  - QNV\* Establish contact with \_\_\_ on this frequency. If successful, move to and send him traffic for \_\_\_.
  - QNW How do I route messages for \_\_\_?
  - QNX You are excused from the net.\* Request to be excused from the net.
  - QNY\* Shift to another frequency (or to \_\_\_ kHz) to clear traffic with \_\_\_.
  - QNZ Zero beat your signal with mine.
- \* For use only by the Net Control Station.

### Notes on Use of QN Signals

The QN signals above are special ARRL signals for use in amateur CW nets only. They are not for use in casual amateur conversation. Other meanings that may be used in other services do not apply. Do not use QN signals on phone nets. Say it with words. QN signals need not be followed by a question mark, even though the meaning may be interrogatory. AB



# CONTESTS



Reg Dwyer, VK1BR  
FEDERAL CONTEST MANAGER  
PO Box 236, Jamison, ACT 2614

## CONTEST CALENDAR

### SEPTEMBER

- 3-4 DARC Corona "CORONA" 10 m RTTY
- 4 Bulgarian CW Test
- 10-11 G QRP Activity
- 10-11 DARC WAE Phone Test
- 17-18 VK Novice Test
- 17-18 Scandinavian CW \*\*\*
- 24-25 Scandinavian Phone \*\*\*
- 24-25 12th JLRS Test

### OCTOBER

- 1-2 VK/ZL Phone Contest
- 8-9 GARTG SSTV Test
- 15-16 VK/ZL CW
- 22-23 YLRL Anniversary CW Party
- 22-23 CLARA AC/DC Test
- 29-30 CQ WW DX CW Test

### NOVEMBER

- 5-6 YLRL Anniversary Phone Party
- 12-13 DARC WAE RTTY Contest
- 12 ALARA Contest
- 26-27 CQ WW DX CW Test

All contests marked with \*\*\* are not yet confirmed. . .

## VK NOVICE CONTEST

Don't forget the VK Novice Contest in September. Let's generate some interest for this contest which had such a poor showing last year. This contest is a marvellous opportunity for all to participate and gain awards. The maximum speed for CW has been reduced to 10 WPM to encourage this mode.

This contest was originally the Westlakes Radio Club Contest, usually held in September, and is designed to encourage Novices to gain skills in contest operation and to improve their abilities with possible thought to assisting in their upgrading to full call licences. The contest provides excellent opportunities for all Novices to compete on an even footing with all comers. The majority of points scored are contacts with novice and club stations and the minor points are scored with contacts with full call licences.

The contest will take place from 0800 UTC 17th September to 0759 UTC 18th September, 1983 for all novice and full call amateurs.

**OBJECTS OF THE CONTEST** — To encourage contest working between amateur stations in Australia, New Zealand and Papua-New Guinea during a 24-hour period with special emphasis on contacts with novice and radio club stations.

**STATIONS ELIGIBLE** — Only stations in VK, ZL and P2 call areas may enter. No stations outside these areas are permitted to be worked or entered in a log. Except for radio clubs, no multi-operation working is allowed. Stations in your own call area as well as other call areas may be worked.

**CONTEST BANDS** — Only the novice allocations on 80, 15 and 10 metres may be used. This applies to full call stations as well. No crossband operation is allowed. Contacts

should be phone or CW. CW operation: Maximum speed ten words per minute. To encourage the use of CW for the betterment of both novice and those operators who are not as proficient as maybe they should be, the maximum transmitting speed of CW will be limited to ten words per minute.

**SCORING** — Transmitting: For contacts with a Novice station — five points. For contacts with a radio club station — ten points. For contacts with a full station — two points. Listening: Novice/Novice contact — five points. Full Call/Novice — two points. Novice/Full Call — two points. Full Call/Full Call — two points. Any contact with a radio club — 10 points.

**CALL PROCEDURE** — Phone call "Call Novice Contest" and on CW "CQN". Stations may be worked only once per mode per band.

**EXCHANGE** — Phone RS report plus three figures. These three figures may start anywhere between 001 and 999 but when 999 is reached you must start again at 001. CW, RST report plus three figures on the previous basis. Radio club stations will add the letter "C" after the number above.

**CONTEST SECTIONS** — (a) Novice/Full Call Phone. (b) Novice/Full Call CW. (c) Listeners.

**LOGS** — Logs must show UTC time, station worked, band, mode, number sent, number received, score claimed and score tally for each page. A front sheet must be attached showing the following: Name of operator, callsign, address, section entered and points claimed. Logs are to be sent to the Federal Contest Manager, Box 236, Jamison, ACT 2614, and must be post-marked no later than 12th October, 1983, and received no later than 29th October, 1983.

**CERTIFICATES** — Certificates will be awarded to the highest score from Novice Phone, Novice CW, Radio Club Phone, Radio Club CW, Full Call Phone, Full Call CW, Listener Phone and Listener CW in each division. A trophy to be known as "The Keith Howard VK2AKX Trophy" will be awarded to the entrant with the highest aggregate scores in the (a) and (b) overall sections and will be held by the winner for a period of twelve months. The decision of the Federal Contest Manager is final and no correspondence will be entered into.

## THE 12TH JLRS PARTY CONTEST

**PHONE** — Start Sat 24 Sept 1983 to 0300 UTC; ends Sun 25 Sept 1983 at 0300.

**CW** — Start Sat 1 Oct 1983 at 0300 UTC; ends Sun 2 Oct 1983 at 0300.

**PURPOSE** — JLRS shall sponsor the Annual JLRS Party Contest to promote the activity of women amateur radio operators and to further co-operation among them.

**ELIGIBILITY** — All licensed men and women operators throughout the world are invited to participate.

**OPERATION** — All bands and all modes may be used in accordance with operator and

station licences. Crossband operation is not permitted. All contacts must be made from the same location. Net contacts and contacts with mobile stations or club stations will not count.

**PROCEDURE** — OMs: "CQ YL". YLs: "CQ CONTESTS". CW: "CQ TEST".

**EXCHANGE** — OMs: RS or RST and QSO number starting at 001. YLs: RS or RST and QSO number starting at 2001. JLRS members: RS or RST and QSO number starting at 5001. Separate consecutive QSO numbers must be used in PHONE and CW contest.

**ENTRY** — Entry in each contest is limited to one of the following two classes: A. more than four bands; B. less than three bands.

**SCORING** — 1. PHONE AND CW will be scored as separate contests. Submit separate logs for each contest. 2. Each contact with the same station on different bands will be counted. 3. OMs: Score one point for each contact with YL and five points for each contact with a member of JLRS. YLs: Score one point for each contact with OM and five points for each contact with YL. 4. Multiply the number of contact points by the total number of different prefixes worked in each band.

**LOGS** — Copies of all PHONE and CW logs must show claimed scores, band, mode, RST, callsigns worked and power transmitted, be signed by the operator, and be postmarked not later than 20th October 1983. Be sure your log is legible. Please PRINT or TYPE. Send logs to the Contest Custodian, Kuni Kan JA1YL, 4-5-38-406 Hyakunincho, Shinjuku-ku, Tokyo 160, JAPAN.

**CERTIFICATES** — All participants will receive a Certificate of the Contest Participation and a list of the result of the contest in December 1983. Then stickers shall be added to the Certificate at every participation for ten years from the issue of the Certificate.

**SUGGESTED CONTEST FREQUENCIES** — PHONE: 14.160, 14.280, 21.280 and 28.600 MHz. CW: 14.080, 21.080 and 28.080 MHz.

(A copy of the list of callsigns of the 500 members of JLRS can be obtained (with SASE) from Marlene VK500.)

## ALARA CONTEST

**ELIGIBILITY** — All licensed operators throughout the world are invited to participate. Also SWLs.

**OBJECT** — PARTICIPATION! YL works everyone, OM works YLs only. One contest (combined phone and CW) run over 24 hours.

**STARTS** — Saturday 12th November 1983 at 0001 hours UTC.

**ENDS** — Saturday 12th November 1983 at 2359 hours UTC.

**FREQUENCIES** — All bands may be used. The following are suggested frequencies for easier location of contacts:

CW 28.100 to 28.110	PHONE 28.480 to 28.520
21.125 to 21.135	21.180 to 21.200
14.050 to 14.060	21.350 to 21.370

7.010 to 7.020      14.180 to 14.200  
 3.525 to 3.535      14.280 to 14.300  
                              7.100 to 7.120  
                              3.570 to 3.590

**OPERATION** — Phone and CW operation: Each station may be counted twice on each band for credit; once on phone and once on CW. All contacts must be made in accordance with operator and station licence regulations. No net or list operations, no crossmode. No repeater contacts may be claimed.

**PROCEDURE** — Phone: call "CQ ALARA CONTEST"; CW: call "CQ TEST ALARA".

**EXCHANGES** — ALARA member: RS or RST, serial number starting at 001, ALARA member, name. YL non-member or OM: RS or RST, serial number starting at 001, name.

**SCORING** — Phone: Ten points for ALARA Club Stations Contacted, VK2DYL, VK3DYF. Five points for ALARA member contacted. Three points for YL non-member contacted. One point for OM contacted. CW: Double all points for CW contacts. SWL: Five points for ALARA member logged. Three points for YL non-member logged.

**LOGS** — Single log entry. Logs must show: date/time UTC, band, mode, callsign worked, report and serial number sent, report and serial number received, name of operator of station worked, and points claimed.

**SAMPLE LOG —**

Date/Time UTC	Band MHz	Mode	Callsign	RS (T) and serial No sent	RS (T) and serial No recd	Name	Points
12/11 0135	28	SSB	VK3DML	59001	58028	Margaret	5
0141	21	SSB	VK2DYL	59002	59037	Geraldine	10

**LOGS MUST BE SIGNED** Logs also to show full name, callsign and address of operator, and show final score (points claimed).

Logs must be legible, either typed or printed. No carbon copies. No logs will be returned. Decision of the Contest Manager will be final. Logs must be received by the Contest Manager by 31st December 1983.

**CONTEST MANAGER** — Mrs Margaret Loft VK3DML, 28 Lawrence Street, Castlemaine, Victoria, Australia 3450.

**A TROPHY** — Will be awarded for the highest aggregate score over five years, commencing 1983, of a licensed YL operator (not necessarily Australian).

**CERTIFICATES** — Will be awarded to the following:

- Top scorer overall
  - Top score ALARA member in each country and VK call area.
  - Top score YL non-member in each Continent
  - Top score OM in each Continent
  - Top score SWL in each Continent
  - Top score VK novice.
- The ALARA club stations will not be eligible for a certificate or trophy.

**21/28 MHZ RSGB TELEPHONY CONTEST 1983**

**TRANSMITTING SECTION**

**ELIGIBLE ENTRANTS** — (a) British Isles: RSGB members only. (b) Overseas (including EI). All licensed amateurs.

**PERIOD** — 0700 to 1900 UTC Sunday 9 October 1983.

**SECTIONS** — (i) Single-operator. (ii) Multi-

operator, multi-band only.

**FREQUENCIES/MODE** — 21 and 28 MHz, phone only. Entrants are requested not to operate in the bands 21.400 to 21.450 MHz; 28.200 to 28.400 MHz and 29.100 to 29.700 MHz.

**EXCHANGE** — RS report and serial number starting at 001.

**SCORING** — Three points for each completed contact with a station in the British Isles. Multipliers will be British Isles prefixes which are: G2, G3, G4, G5, G6, G8, GD2, GD3, GD4, GD5, GD6, GD8, G12, G13, G14, G15, G16, G18, GJ2, GJ3, GJ4, GJ5, GJ6, GJ8, GM2, GM3, GM4, GM5, GM6, GM8, GU2, GU3, GU4, GU5, GU6, GUB, GW2, GW3, GW4, GW5, GW6, GW8.

Contacts with GB stations will not count for points or multipliers.

For all entrants the total score will be the number of points on each band added together, times the number of multipliers on each band added together. Unmarked duplicate contacts will be penalised at ten times the points claimed. Entries containing five or more such duplicate will be automatically disqualified.

**LOGS** — Log sheets to be headed: date/time UTC; station worked; RS and serial number sent; RS and serial number received; multiplier; points claimed. Separate logs must be submitted for each band a summary sheet

showing the multipliers worked on each band must be included.

**DECLARATION** — Each entry must be accompanied by the following declaration, signed and dated: "I declare that this station was operated strictly in accordance with the rules and spirit of the contest and agree that the decisions of the Council of the RSGB shall be final in all cases of dispute".

**ADDRESS FOR LOGS** — RSGB HF Contest Committee, c/o Mr P Miles, PO Box 73, Lichfield, Staffs, England.

**CLOSING DATE FOR LOGS** — Entries must be received by 1 December 1983.

**AWARDS** — Certificates of merit will be awarded to the leading station in each country and to the leading station in the multi-operator section.

**RECEIVING SECTION** — Rules as for the transmitting section except as varied below.

**ELIGIBLE ENTRANTS** — (a) British Isles: RSGB members only. (b) Overseas (including EI): all SWLs.

Note that holders of transmitting licences for frequencies above 30 MHz may enter the receiving section.

**SCORING/MULTIPLIERS** — SWLs should only log British Isles stations in contact with overseas stations taking part in the contest. Scoring and multipliers as the transmitting section.

**LOGS** — Logs to be headed: date/time UTC; callsign of station heard; callsign being worked, multiplier; points claimed. A summary sheet showing multipliers heard on each band must be included.

Note: In the column headed station being worked, the same callsign may only appear once in every three contacts logged except when the logged station is a new multiplier for the receiving station.

**DECLARATION** — Each log must be accompanied by the following declaration: "I declare that this station was operated within the rules of the contest and I do not hold a transmitting licence for frequencies below 30 MHz".

**AWARDS** — Certificates of merit will be awarded to the leading entrants in each overseas country.

**21 MHZ RSGB CW CONTEST 1983 RULES**

Special note for both sections: entrants are particularly requested to use standard size (A4) log sheets.

**TRANSMITTING SECTION**

**ELIGIBLE ENTRANTS** — Single operator stations only. British Isles entrants must be members of RSGB. Overseas entrants, all licensed amateurs.

**PERIOD** — 0700 to 1900 UTC Sunday 16 October 1983.

**SECTIONS** — (a) British Isles section. (b) QRP British Isles section. British Isles stations using less than 10 W input. (c) Overseas section (including EI). (d) QRP Overseas section. Overseas stations using less than 10 W input

**FREQUENCY/MODE** — 21 MHz. CW only. Entrants are requested not to operate in the band 21.075 to 21.125 MHz.

**EXCHANGE** — RST report plus a progressive QSO number starting with 001.

**SCORING** — Overseas stations. Each completed contact with a British Isles station will score three points. The final score is the number of British Isles prefixes multiplied by the total number of points. British Isles prefixes are: G2, G3, G4, G5, G6, G8, GD2, GD3, GD4, GD5, GD6, GD8, G12, G13, G14, G15, G16, G18, GJ2, GJ3, GJ4, GJ5, GJ6, GJ8, GM2, GM3, GM4, GM5, GM6, GM8, GU2, GU3, GU4, GU5, GU6, GUB, GW2, GW3, GW4, GW5, GW6 and GW8.

Contacts with GB stations will not count for points or multipliers.

**DUPLICATE CONTACTS** — Unmarked duplicate contacts for which points have been claimed will be penalised at ten times the claimed points. Entries containing more than five such duplicates will be automatically disqualified.

**LOGS** — Log sheets to be headed: date/time UTC; station worked; RST and serial number sent; RST and serial number received; multiplier; points claimed. They should be submitted with a cover sheet indicating antenna, equipment power used and must include a separate list of countries worked as specified in scoring.

**DECLARATION** — Each entry must be accompanied by the following declaration, signed and dated: "I declare that this station was operated strictly in accordance with the rules and spirit of the contest and agree that the decision of the Council of the RSGB will be final in all cases of dispute".

**ADDRESS FOR LOGS** — RSGB HF Contests Committee, c/o D S Booty, 139 Petersfield Avenue, Staines, Middx TW18 1DH, England.

**CLOSING DATE FOR LOGS** — 31 December 1983.

**AWARDS** — Certificates of merit will be awarded to the leading station in each overseas

country.  
**RECEIVING STATION** — Rules as transmitting section except where specified below.

**ELIGIBLE ENTRANTS** — (a) British Isles: RSGB members only. (b) Overseas (including EI): all SWLs.

Holder of transmitting licences for frequencies above 30 MHz may also enter the receiving section.

**SCORING** — Overseas SWLs should only log British Isles stations in contact with overseas stations participating in the contest. Scoring and multipliers as in transmitting section.

**LOGS** — Log sheets to be headed; date/time UTC; callsign of station heard; callsign of station being worked; multiplier; points claimed.

Note: In the column headed station being worked, the same callsign may only appear once in every three contacts except when the logged station is a new multiplier for the receiving station.

**DECLARATION** — Each entry should be accompanied by a completed declaration: "I declare that this station was operated within the rules of the contest and that I do not hold a transmitting licence for frequencies below 30 MHz".

**AWARDS** — Certificates of merit will be awarded to the leading entrant from each overseas country.

## BRITISH AMATEUR RADIO TELEPRINTER GROUP

### 1983 SPRING CONTEST RESULTS

#### SINGLE OPERATOR SECTION

NO	CALLSIGN	POINTS	TOTAL QSO's
1.	ON4UN	716690	365
2.	YU7AM	341736	276
3.	I1HUH	339600	226
4.	DJ6JC	289100	187
5.	Y250L	288696	197
6.	YB2BLJ	280578	164
7.	HB9AAA	280200	161
8.	SM6ASD	270940	197
9.	W3FV	243212	179
10.	W2IUC	225792	201
11.	G14AHP	223380	206
12.	YQ2IS	211684	201
13.	KB2VO	195506	158
14.	I4JXE	182188	151
15.	VK2SG	167570	158
16.	I0UIQ	164604	167
17.	I8JRA	159510	132
18.	K4AGC	158796	147
19.	GM3ZXL	158148	130
20.	W3FIZ	154100	118
21.	I0ZSG	142400	166
22.	WB3HAZ	141858	108
23.	UT5RP	137350	215
24.	ON7EP	133080	105
25.	DL9MBZ	131216	113
26.	KQJH	126852	121
27.	9M2CR	121968	121
28.	K6WZ	119048	142
29.	WD5ELJ	118320	156
30.	JA2VFW	109300	101
31.	GW3EHN	103000	106
32.	W6JOX	101332	118
33.	G4NYO	96000	84
34.	JR2CFD	94188	79
35.	JR2TZL	92610	93
36.	SM5BKA	91800	74
37.	I0WOP	88920	127
38.	OK2SPS	88896	106
39.	VE2AXO	87710	99
40.	LA7AJ	86940	74
41.	OH8TA	82560	148
42.	VK1GM	74400	86
43.	JA1BYL	73800	72

44.	VK2BQS	72068	80
45.	DK1BX	71516	69
46.	SM5FUG	70684	74
47.	OH2BDN	69156	125
48.	DK9CK	66144	52
49.	KB9DM	62968	66
50.	PY2ERA	61440	100
51.	DL8QP	60420	63
52.	WB4UBD	60104	63
53.	SM7LSU	59544	67
54.	PY6ACP	56440	70
55.	DF9XI	56364	87
56.	WB3IGR	56160	44
57.	VE8CM	55020	78
58.	OK1MP	53690	36
59.	N7AKQ	50928	113
60.	OK1AWC	48112	58
61.	VE7VP	47740	54
62.	W2KHQ	45954	65
63.	ON6ZM	45760	56
64.	SM7ABL	42630	47
65.	YU2CB	41664	51
66.	DF5BX	39234	67
67.	JR6AG	38976	45
68.	WA6WGL	38760	50
69.	WA3ZKZ	37590	49
70.	Y37UF	36120	42
71.	G4MKO	32660	42
72.	SM6AEN	32344	46
73.	G4NJW	30144	28
74.	XT2AU	28130	37
75.	W3AOH	27360	34
76.	OZ1GRF	26180	39
77.	IK1AAW	25200	26
78.	JH2PDS	24886	29
79.	DJ8WCY/P	22288	47
80.	SM7BGE	22088	42
81.	OH5YW	21630	23
82.	OL3YBU	20480	24
83.	F3J	19418	23
84.	Y08FR	16942	71
85.	JF2PZH	16768	32
86.	W7C8Y	16586	33
87.	Y55ZF	14490	33
88.	SM0BYD/7	14436	21
89.	PY6SL	13468	17
90.	G3RDG	12996	30
91.	TI2DO	12900	26
92.	ON7EU	12492	31
93.	Y53VA	12236	34
94.	Y71SH	10008	39
95.	K2TY	8736	24
96.	Y02AC	7548	26
97.	PY2FWX	5808	14
98.	F3PI	4928	16
99.	SM5AAY	4860	14
100.	HA6VX	2512	13
101.	OK3TZL	1596	9
102.	W8TCO	720	4
103.	Y59ZF	672	4

#### MULTIPLE OPERATOR SECTION

1.	LZ1KDP	441604	274
2.	OH2AA	413996	310
3.	G3ZRS	378566	249
4.	LZ2KRR	310460	246
5.	GW4RDO	182700	141
6.	OK1RJB	159256	119
7.	G4ALE	156996	118
8.	HA5KBM	133052	131
9.	HA6KVD	102700	107
10.	OK3KJF	92312	114
11.	KD4RT	73950	73
12.	OK3KGI	69888	112
13.	G4LLR/A	63900	86
14.	KL7RS	25116	50
15.	Y83KMF	20256	33
16.	SM6LTO	5408	24

The Contest Manager gratefully acknowledges the receipt of check logs from the following stations: DF7FB, EI3CN, G4KZE, G8CDW, K4VDM, PA0ANK, JM1OFJ, Y24NL, Y24UD/A, Y47YM, Y750L and Y2ZN. These logs are most useful and in a number of cases, essential to claims for certain awards so many thanks for your help.

#### SHORT WAVE LISTENER SECTION

NO	CALLSIGN	COUNTRY	POINTS	TOTAL QSO's	LOGGED
1.	ONL-5566	Belgium	354348	233	
2.	OZ-DR 2135	Denmark	312984	221	
3.	I1-053GE	Italy	261096	175	
4.	NL-4483	The Netherlands	194668	119	
5.	John Matthews	United States	111936	92	
6.	OK2-21478	Czechoslovakia	95900	170	
7.	FE-3700	France	66290	71	
8.	Y2-19600/A	German Dem Rep	51768	67	
9.	BRS-31976	England	32214	35	
10.	FE-1107	France	27432	44	
11.	W Ludwig	German Fed Rep	13160	14	
12.	NL-5288	The Netherlands	9880	16	
13.	HE9DFN	Switzerland	2310	13	

A total of 144 Logs were received as a result of the 1983 Contest and a total of eighteen new Quarter Century Awards will be issued as a direct result of the Contest.

During the Contest, RTTY activity took place from the following Countries: Alaska, Argentina, Austria, Australia, Barbados, Belgium, Brazil, Bulgaria, Canary Islands, Canada, Chile, Costa Rica, Colombia, Czechoslovakia, Denmark, Dominican Republic, Eire, England, Finland, France, French Guyana, German Democratic Republic, German Federal Republic, Greece, Greenland, Guernsey, Hawaii, Hungary, Indonesia, Israel, Italy, Japan, Kenya, Kuwait, Lebanon, Liechtenstein, Luxembourg, Macau, Malaysia, Martinique, Mauritania, Mexico, Monaco, Morocco, Namibia, Northern Ireland, The Netherlands, New Caledonia, New Zealand, Norway, Philippines, Puerto Rico, Romania, Sardinia, Saudi Arabia, Scotland, South Africa, Spain, Sri Lanka, Sweden, Switzerland, Togo Rep, United States of America, USSR, Ukraine, United Nations (Geneva), Upper Volta Rep, Vanuatu, Venezuela, Wales, Yugoslavia and Zimbabwe.

### VP2E 1983 — FOURTH ANNUAL CONTEST EXPEDITION TO ANGUILLA

The Anguilla Contest Team will be active from the West Indies island of Anguilla (VP2E) from 21 November to 14 December, 1983. This will include contest operations in the CQWW CW DX Contest, the ARRL 160 Metre Contest, and the ARRL 10 Metre Contest. During non-contest periods they will be active on all bands 160-6 metres on CW and SSB.

#### CQWW CW DX CONTEST: 26-27 NOVEMBER, 1983

During the CQWW CW DX Contest, several single-operator, single-band contest efforts will be active simultaneously using the call 'VP2E'. These efforts will be using kilowatt stations with monoband yagi antennas on 40 through 10 metres, and vertical antennas on 80 and 160 metres. It's hoped to have operators on all bands (160 through 10 metres) during the contest: look around 20 kHz and 30 kHz above the bottom of each band.

Note that sunset will occur at approximately 2110 UTC and sunrise will occur at approximately 0950 UTC on Anguilla during the CQWW CW DX Contest.



This will be the first time that Anguilla has been available on CW to DX stations in an international DX contest.

#### ARRL 10 METRE CONTEST: 10-11 DECEMBER, 1983

During the ARRL 10 Metre Contest the group will be active on CW and SSB as a multi-operator, single transmitter station using the call 'VP2E'. They plan to operate above and below the US phone band as dictated by propagation.

#### LORD HOWE

The Down Under DXers Contest Club intend to activate Lord Howe Island for CQ World Wide phone test in October, 1983. The group will be on the island from 23 October to 2 November, and at this stage will be using the callsign VK2WU portable LHI. QSLs go to Les Cullen, VK2WU, PO Box 31, Winmalee, NSW, Australia, 2777; or the bureau.

They intend to be using yagis on 10, 15 and 20; and wire antennae for 40, 80 and 160. Listen for them on the usual phone frequencies on the high bands; on 80 they will Tx 3.695 and Rx 3.805+ MHz; on 160 metres they will be in the DX windows.

AR



## EDUCATION NOTES

Brenda Edmonds, VK3KT  
FEDERAL EDUCATION OFFICER  
56 Baden Powell Drive, Frankston, Vic 3199

The statistics for the May Novice examinations were released recently. There are no surprises in these figures. As usual, pass rates are highest for CW sending (79.9%) and higher for regulations (64.3%) than for theory (49.9%). The theory figure is down a bit on the rate for last November (54.4%), but the May figures are usually lower than November. The range is from 46.7% for VK3 to 54.8% for VK7. These figures are significantly higher than the corresponding figures for AOC, as previously discussed.

The big difference this year is the drop in the number of candidates sitting. There are always fewer at the May exam than in November — presumably because many classes aim towards the November exam. But the 489 entrants this time is the lowest number for some time. It will be interesting to see if this is just a temporary drop or a continuing trend.

As a result of recent comments about the place of CW in amateur licensing, I have had a fresh look at CW pass rates. As we know the pass rate for sending is always higher than for receiving at any exam — but why should the pass rate of 5 WPM be consistently much higher than for 10 WPM. Here are the figures for the last 10 exams.

Level	Total entrants	Passes	Percentage	Range
AOC	3488	1337	38.3%	25.1% May '82
10 WPM				46.4% Aug '82
NAOC	2881	1592	55.3%	50% Feb '82
5 WPM				64.6% Aug '82

The difference at each exam is highly significant. Lowest difference — February 1982 with 40.1% and 50% respectively, and highest difference — May 1982 with 25.1% and 59.5% respectively, but there does not appear to be any overall rise or fall. There are several possible explanations. Perhaps there is more incentive for a potential novice to pass, since without the CW, he/she cannot gain a licence. Perhaps more people sit for 10 WPM 'for practice' without really being ready for it, knowing that even if they fail, they can still continue as a limited operator.

Unfortunately we do not know how many entrants make more than one attempt or the distribution of licences among those entering for either level. One would think that those who have previously passed 5 WPM would have little trouble passing 10 WPM, and that this would raise the pass rate.

Perhaps there is room here for some of the clubs to put an effort into helping members with the CW. I know a number of individuals are giving considerable help to a few friends, and that the broadcast practice sessions are very useful, but in what I have heard of classes the CW does seem to be a bit of an afterthought. The only group which has told me they are running specific Morse code classes is in Elizabeth, VK5. Are there any

others? I would be interested to hear pass rate figures from groups which do run classes.

If anyone wishes to look at the exam statistics more closely, copies can be obtained from the Executive Officer or from me (QTHR). I can also be reached on the Education Net which is now running on Thursday evenings at 11.30 UTC, about 3.685 MHz. The aim of the net is to bring together amateurs who are involved in the running or organising of classes, and to offer support especially to those who are new in the field. However, any comments are welcome. I realise that the frequency is out of the Novice Band — but I do not see it as a forum for discussion of early questions or as a 'school of the air'. If someone else would like to start up this kind of net, I am sure it would be popular. Perhaps it already exists. Tell me about it.

73 Brenda VK3KT  
AR

Buying or selling Gear  
Use HAMADS first

# WANTED TO BUY

Ham gear, CB equipment, Hi Fi,  
video, car stereo, large or small  
quantities.

WE BUY AND SELL  
ANYTHING ELECTRONIC  
ANY QUANTITY  
ANY CONDITION

# HAMRAD

104 Highett Street,  
Richmond, Victoria.  
Phone: (03) 428 8136



## CLUB CORNER

#### GOLD COAST AMATEUR RADIO SOCIETY

The Sixth Annual Gold Coast Hamfest will be held on Saturday 12th November, 1983. The venue, once again, will be the Albert Waterways Community Centre, at Broadbeach, in the heart of the Gold Coast.

This is now one of the major events on Australia's amateur calendar, and we attract visitors from all over Queensland and interstate.

There will be the usual trade displays, and demonstrations of all facets of amateur radio, plus, stalls and displays for the ladies, and games and prizes for the children. A Dinner/Dance will be held in the evening, with a full nights dancing and entertainment arranged.

John Webber, VK4NNE  
HONORARY SECRETARY, HAMFEST ORGANIZER

# WA RR IS COMING!!



# VK3 WIA NOTES

Peter Drury, VK3JN  
412 Brunswick Street, Fitzroy, Vic 3065

## WORLD COMMUNICATION YEAR ACTIVITIES

At least three clubs in Victoria have organised activities in VK3 as part of WCY:

The Eastern and Mountain District Radio Club will hold its Communications Expo '83 — a combined exhibition and hamfest — at the Nunawading Civic Centre on Saturday 3rd September. One of its main aims is to educate the general public about amateur radio, so come along and bring a friend to share your day with you.

The Northwest Zone will open its new clubrooms at the Mildura Airport on 3rd September. This represents the culmination of a lot of hard work by a very small band of people. Visitors to the opening will be most welcome.

The Shepparton and District Amateur Radio Club, in conjunction with the Northeast Zone, has chosen 11th September for a combined field day to be held at Mooroopna, 3.2 km west of Shepparton. The events commence at 10.00 am local at the Mooroopna Scout and Guide Complex in Echuca Road, Mooroopna. Talk-in frequencies are: 3.596 MHz, 28.470 MHz and 146.650 MHz (repeater 1). Make it a family day: wives and children are especially welcome.

## WIA BROADCASTS

It is very gratifying to see the number of news items which have been sent directly to the broadcast news post office box following some minor problems earlier. We advise that the address is now: Boradcast News, PO Box 308, Cheltenham, Vic 3192.

Plans are also well advanced, we are told, for the re-broadcasting of the Sunday morning broadcast somewhat later in the week. We'll keep you advised on that as news comes to hand.

A few gaps still remain in the divisional record of past presidents, and help is sought from anyone who can supply authoritative information. We're trying to determine who were the Victorian Presidents for the years 1921, 1922, 1926, 1927, 1928 and 1932. If you

can possibly help, please contact the Divisional Historical Officer, John Adcock, VK3ACA.

The VK-ZL Contest now has a new manager. The Wireless Institute Federal Executive has accepted the offer of Greg Williams VK3BGW to fill this vacancy. Greg is also the Victorian Division Awards Manager, and has a number of ideas to ensure that VK3 wins the Remembrance Day Contest, this year.

The division notes with pleasure the upsurge of interest in the RTTY transmission mode. One reason for this is unquestionably the current availability of Siemens Model 100 Teleprinters. These are most readily obtained by contacting the divisional headquarters at 412, Brunswick Street, Fitzroy.

Amateurs operating RTTY on 2 metres in the Melbourne area have the benefit of operating via VK3RTY repeater, owned by the EMDRC. This unit is located on Mount Dandenong with an output frequency of 147.350 MHz, Duplex B. The repeater is accessed by sending a space character in Baudot code at the amateur standard of 45.45 Baud, with 170 Hz shift. The repeater also has the ability to transmit standard messages, on command, and has on file information such as test tones, test messages, and recorded information on the Victorian Division and the Eastern and Mountain Districts Radio Club. This information is updated at regular intervals, and provides an additional news outlet between Sunday morning broadcasts.

Finally for this month, a couple of notes for zone and club officials in VK3. First: This column is available to you — if you have items or pictures which you would like to be published in the column then please send them to me, QTHR.

Lastly a reminder that the Club and Zone Net is held every Sunday at 1000 UTC on 3.605 MHz plus or minus QRM. Surely it's in the best interests of your club or zone members that you participate.

See you all next month. 73  
Peter VK3JN

AR

## A Call to all holders of a **'NOVICE LICENCE**

Now you have joined the ranks of Amateur Radio, why not extend your activities?

### THE WIRELESS INSTITUTE OF AUSTRALIA (N.S.W. DIVISION)

conducts a Bridging Correspondence Course for the AOCF and LAOCF Examinations.

Throughout the Course, your papers are checked and commented upon to lead you to a **SUCCESSFUL CONCLUSION.**

For further details write to:  
**THE COURSE SUPERVISOR,  
W.I.A.**

P.O. BOX 1066,  
PARRAMATTA, NSW 2150

## ELECTRONIC HOBBYIST!

DO YOU LIVE IN . . .  
Ringwood, Lilydale,  
Boronia, Wantirna,  
Bayswater, Mooroolbark etc? . . .

We carry a comprehensive range of electronic components at very keen prices.

**Ian J. TRUSCOTT  
ELECTRONICS**

CNR EASTFIELD  
& BAYSWATER ROADS,  
SOUTH CROYDON,  
VIC.

TELEPHONE  
(03) 723 3860



Please  
remember  
your STD code  
when you  
advertise in  
**HAMADS.**

# WA WHAT IS R R?

# KENWOOD

## TS-130SE

### HF SSB/CW TRANSCEIVER

The TS-130 Series is an incredibly compact, full-featured reasonably priced, all solid-state HF SSB/CW transceiver for both mobile and fixed operation. It covers 3.5 ~ 29.7 MHz (including the three amateur bands) and is loaded with optimum operating features.



**NO PRICE  
INCREASE YET**

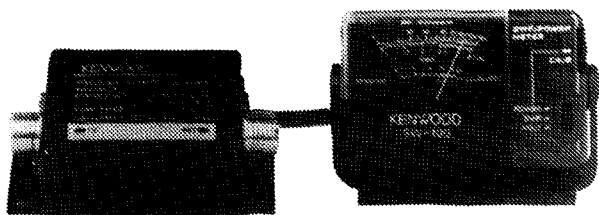

SW-100 A/B

## NEW RANGE SWR METERS

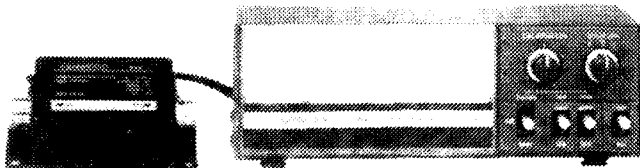

SW-200 A/B

## TS-830S

### SOLID STATE HF TRANSCEIVER

The TS-830S is a high-performance, very affordable, HF SSB/CW transceiver with every conceivable operating feature built-in for 160 through 10 meters (including the three new bands).

## TW-4000A UHF-VHF DUAL BANDER TRANSCEIVER

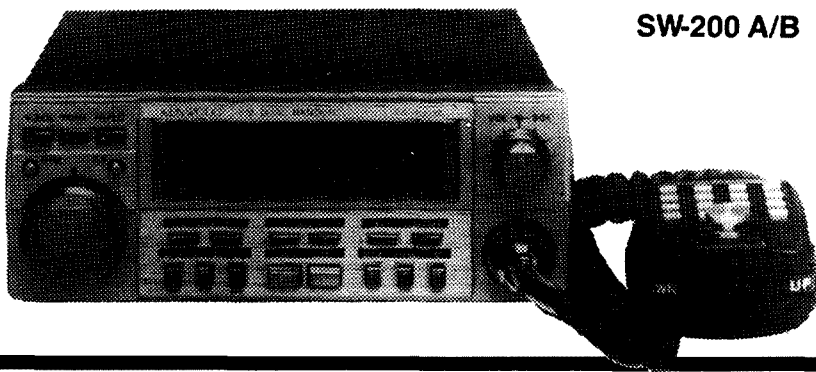

## TRIO-KENWOOD (AUSTRALIA) PTY. LTD.

(INCORPORATED IN N.S.W.)

4E WOODCOCK PLACE, LANE COVE, SYDNEY, N.S.W. 2065.

Ph. (02) 428 1455.

### NEW SOUTH WALES

TRIO-KENWOOD (AUST) P/L — 4E WOODCOCK PLACE, LANE COVE (02) 428 1455  
 SPRINGWOOD CAR RADIO — SPRINGWOOD (047) 51 4930  
 UNIQUE ELECTRONICS — 41B OLD PROSPECT ROAD, STH. WENTWORTHVILLE (02) 631 6689  
 WASIL ELECTRICAL — 71 SUMMER STREET, ORANGE (063) 62 6249  
 STOCKMAN & HIGGINS — BYRON STREET, INVERELL (067) 22 1300  
 ELECTRON 2000 — 3 ELIZABETH STREET, TIGHE'S HILL, NEWCASTLE (049) 69 6399  
 MACELEC PTY. LTD. — 99 KENNY STREET, WOLLONGONG (042) 29 1455  
 RADIO WORLD PTY. LTD. — 81 NEWCASTLE STREET, Fyshwick (062) 80 6550  
 DX ENGINEERING — 5 JASMINE STREET, PORT MACQUARIE (065) 83 2175  
 LAND LINK — MULLALEY ROAD, GUNNDAH (067) 42 2838  
 LAND LINK — 61 BARNES STREET, TAMWORTH (067) 65 4622  
 FRANK BOUNDY — LISMORE (066) 86 2145

### INTERSTATE

VIC: EASTERN COMMUNICATIONS — 168 ELGAR ROAD, BOX HILL (03) 288 3107  
 BRIAN STARES — 11 MALMSBURY STREET, BALLARAT (053) 39 2808  
 SUMNER ELECTRONICS — 78 KING STREET, BENDIGO (054) 43 1977  
 TAS: HOBBY ELECTRONICS — 477 NELSON ROAD, MT. NELSON (002) 23 6751  
 GELSTON ELECTRONICS — SUMMER HILL (003) 27 2256  
 ADVANCED ELECTRONICS — 5A THE QUADRANT, LAUNCESTON (003) 31 7075  
 VK: ELECTRONICS — 214 MOUNT STREET, BURNIE (004) 31 7733  
 QLD: MITCHELL RADIO CO — 59 ALBION ROAD, ALBION (07) 57 6830

### S.A. &

N.T.: INTERNATIONAL COMMUNICATIONS SYSTEMS PTY. LTD. — 8 NILE ST., PORT ADELAIDE (08) 47 3688  
 W.A.: ARENA COMMUNICATIONS SERVICES — 642 ALBANY HWY., EAST VICTORIA PARK (09) 361 5422  
 TRI-SALES — CNR NEWCASTLE & CHARLES STREETS, PERTH (09) 328 4160  
 WILLIS ELECTRONICS — 445 MURRAY STREET, PERTH (09) 321 2207  
 BAY RADIO — 18 BANKSIA STREET, BUNBURY (097) 21 2236  
 RON DENT — 115 PATON ROAD, SOUTH HEADLAND (091) 72 1112  
 SELECT TRONIX — TOM PRICE (081) 89 1564  
 FORD ELECTROMICS — 208 HANCOCK STREET, DOUBLE VIEW (09) 446 4705

# FORWARD BIAS

VK1 DIVISION



John MacPhee, VK1NEN  
PUBLICITY OFFICER AND  
FORWARD BIAS EDITOR  
36 Kavel Street, Torrens, ACT 2607

As I mentioned in my last FB column, in July AR a lot of activity has been happening in the nations capital, (not all political). Our ATV is well on the way, and I am pleased that Bill VK1MX has giving me a report on the groups activities. So without further ado here is Bill's report.

## ATV UPDATE

Earlier notes in this column advised of the creation of an ATV group in VK1, following a visit by the VK3 ATV "Roadshow" gang. The group now consists of eight members and enjoys sub-committee status within the Division. After an initial flurry of activity, progress has been slower than we would have wished, largely through supply problems with minor, but key, components. The resulting delay meant that the commencement of the 1983 academic year caught up with some members, enforcing postponement of their transmitter construction. Sufficient components for fourteen VK3ATY transmitters have been obtained and at least five are now operational.

Simplex trials have been conducted over recent weeks, with results becoming increasingly promising as our understanding of the mode, the equipment and UHF propagation grows. These trails have unfortunately confirmed fears that the hilly Canberra terrain will restrict simplex operation. We have therefore been obliged to accelerate planning for the 50 cm repeater. Luckily, simplex trials from the proposed repeater site promise useful signals at most VK1 locations, provided that adequate attention is paid to antenna location and design, probably with some degree of pre-amplification.

Prior to commencing repeater design, contact was established with the ATV fraternity in VK3, 4 and 5.

Their assistance is gratefully acknowledged. Our proposed site sports a 30 metre tower and already houses one of the 2 metre FM repeaters. The plan calls for the erection of a modified corner reflector, which last saw commercial service on 80 MHz, at the 15 metre level. This will give the repeater a good

sight of Canberra and an antenna beam-width to suit. The receiver design is expected to make use of a commercial video-chain, after requisite mast-head amplification and down-conversion. The transmitter design is expected to be relatively conventional, with output power being determined by the possible availability of a linear. 240 VAC power is available on site. However, the owner of the site uses it for very esoteric work indeed and our residency is conditional upon meeting very stringent degrees of harmonic suppression; -180 dB at 2300 MHz! Liberal use of inter-digital filtering and a chinese box-puzzle approach to packaging will hopefully provide the answer.

Housekeeping tasks will be assigned to a micro-processor (what else). This approach will enable us to provide most of the facilities available elsewhere, notably on the Adelaide machine, including user-selectable functions such as colour-bar generation, received signal strength reports, walking-board displays etc. A 2 metre transceiver will also be incorporated, both to facilitate control and to provide full duplex audio. Given that most of the hardware will be already available, we also intend to install a message-storage and retrieval facility, handling both Baudot and ASCII transmissions. Output will be by walking-board display, upon reception of the addressee's security code. This facility should widen the use of the repeater beyond the ATV enthusiast to any station equipped with RTTY or a computer. More details as they become available.

Anyone wanting further information about the VK1 ATV activity, should contact the group's co-ordinator, Bill VK1MX, QTHR.

Thanks Bill for your most informative and interesting report. I look forward to receiving your next one. Any other group with information that I could use in this column please forward it to me.

## MEETING AGENDA

26th September, IPS

Until next time, good DXing and good health.

73's John VK1NEN



# FIVE-EIGHTH WAVE

Jennifer Warrington VK5ANW  
59 Albert Street, Clarence Gardens, SA 5039

For sometime now the Divisional Council have been concerned at the apparent gulf in communications between ourselves and our country members, including of course VK8. We have heard 'rumblings' from afar, mostly because they feel that we are not interested in what happens to them. I can assure you all that this is not the case, and we have been 'stirring the grey cells' in an attempt to come up with a solution.

For the past few years VK4 representatives at the Federal Convention have been telling us that their 'Clubs Convention', which is held just prior to the FC, has been a marvellous way of getting their clubs' opinions on all manner of topics, and making the clubs feel that they really are part of the whole division. The only problem, as far as our division was concerned, seemed to be money, however we now feel that we have even found a solution to this problem. Therefore, I am pleased to announce that, all being well, the VK5 Divisional Council will be hosting a Convention of Clubs affiliated to the VK5 Division on 13th, 14th and 15th April, 1984.

Half the travelling expenses, and accommodation for one member from each club will be met by the division, however if the club wishes to send more than one member at its own expense or the members wish to pay their own expenses we shall of course be delighted to see them. The venue will probably be the 'Parnanga Campsite' at O'Sullivan's Beach, great for that early morning run, or dip; and very handy for the South Coast Radio Club, whose clubrooms are right next door! You will be hearing more about this shortly, but in the meantime start thinking about the sorts of things you would like to discuss, and keep the weekend of the 13th/15th April, 1984 free.

The South East Radio Group held another of its very successful conventions on the Queen's Birthday long weekend. Unfortunately I was unable to attend, but those who did are, I believe, already planning to go back next year. Congratulations to David VK5KK who brought the Trophy back for VK5, and to all those others who had a good time trying.

Merv Millar VK5MX, has for sometime seen the need for an encouragement award for homebrewers. Our September meeting is always the 'Display of Members Equipment' and although we receive one of the quarterly vouchers which John Moffat of ICS very generously donates (formerly known as the Kenwood Trophy) and prizes are also donated by the division, Merv still felt that something in the way of a Merit Certificate to encourage those who might feel less than competent, would be worthwhile. Needless to say, the council felt that Merv's offer was most generous, and was only too happy to accept — so come on all you homebrewers, 27th September isn't far away!

## SPECIAL EDUCATION QSP

Brenda VK3KT has available Trail Examination Papers:  
Theory, Novice, AOC, Regulations.  
Also past CW exams from DOC. There are:  
10 exams at 5WPM  
10 exams at 10WPM  
Ten exams fill a C60 cassette tape.  
INTERESTED? Send a tape and state your requirements and Brenda will transcribe it

onto your tape.

Have you any complaints or other comments about the amateur examinations?

Please make your grievances known to Brenda VK3KT, your Federal Education Officer. Brenda may be found each Thursday evening on the Education Net at 1130 UTC, 3.685 MHz  $\pm$  or write QTHR.



# VK2 MINI BULLETIN

Jeff Pages, VK2BYY  
VK2 MINI BULLETIN EDITOR  
PO Box 1066, Parramatta, NSW 2150

## COUNCIL REPORT

Divisional Council met on the 15th July. Federal Councillor Stephen Pall VK2PS presented a report on a meeting between WIA representatives, DOC and the Federation of Australian Commercial Television Stations, which resulted in the limited release of the 50 to 50.15 MHz segment as outlined in the insert in last month's AR.

Council requires information on Divisional Presidents and Secretaries prior to the war. Anyone who can assist should contact the Divisional Office. Peter Jeremy VK2PJ presented a report on the Queensland Radio Club Workshop, and this will be raised at the next Conference of Clubs. Council decided to install a logging recorder at Dural to record broadcasts for reference should any queries arise. Stephen Pall reported that a tenant had been found for the downstairs room at Amateur Radio House.

Council reminds all repeater groups to ensure that their repeaters comply with all the requirements under regulation 5.11 of the Handbook, particularly with regard to identification. Repeaters must only be operated from the site at which they are licensed. The practice of putting repeaters and beacons to air before the licence is processed does not enhance the image of the amateur service as a self-regulating group, and must cease.

## DURAL

A four element triband beam and rotator has been installed at the Dural station for use during contest and WICEN activities. It is intended to operate the Divisional Station VK2WI during all of the Australian contests. During July the control unit of the Dural 2

metre repeater was replaced. The new controller, based on a Z80 microprocessor, now controls both the 2 metre and 70 centimetre repeaters, and an information sheet detailing the operation of these repeaters is available from the Divisional Office. Provision has been made in the hardware and software to allow additional repeaters to be added at a future time.

## FISHER'S GHOST AMATEUR RADIO CLUB

The fisher's Ghost Amateur Radio Club has only recently been formed, and as the name implies, embraces the Campbelltown-Camden area. Nets are held on 80 metres each Friday at 1000 UTC on 3.580 MHz, and on 10 metres each Sunday at 1000 UTC on 28.520 MHz, both frequencies plus or minus QRM.

The monthly meetings are held at Bradbury Primary School, Campbelltown, on the fourth Wednesday of each month, commencing at 7.30 pm. An invitation is extended to anyone to attend the meetings as a visitor or intending member. Licensed Amateur Radio Operators may become Full Members, and all others may become Associates. For further information ring the President, Charlie VK2PMG on (046) 59 6388 or the Secretary, A J Harris VK2PFW on (046) 46 1476.

The Fisher's Ghost Amateur Radio Club is affiliated with the WIA NSW Division.

## SOUTH WEST AMATEUR RADIO SOCIETY CONVENTION

The 31st SWARS convention will be held this year in Tumarumba over the long weekend 1st and 2nd October. The venue will

be the Tumarumba Show Ground, a very nice setting for a convention of this type. A programme of events has been arranged and also bus and car trips to the many scenic spots in the Tumarumba District.

On Saturday a conducted car trip will visit many of the closer scenic places including Paddy River Falls. On Sunday a bus tour to Khancoban has been organised.

Motel accommodation is very limited in Tumarumba. Some hotel and on-site caravan accommodation is available, as are caravan and camping sites. For those who care to bring sleeping bags and blankets a Sports Pavilion is available with showers, etc. A deposit of \$20 is required per room for accommodation bookings, which should be in by the 16th September. For information and bookings contact Mr J Clode, Ournie via Jingellic, NSW, 2642, or phone (060) 37 3134.

The programme of events is as follows:

**Saturday:**

- 10 AM — Registration and morning tea
- 10.30 AM — 10 m transmitter hunt
- 12-2 PM — Barbecue lunch
- 2 PM — Conducted car tour
- 4.30 PM — 80 m and 2 m transmitter hunts
- 5.30 PM — 2 m pedestrian hunt
- 7.30 PM — Dinner — \$10 per head, under 12 years free
- 9 PM — Films, rag chew, etc.

**Sunday:**

- 9 AM — Registration and morning tea
- 10 AM — Bus tour
- 11.30 AM — 2 m talk-in
- 1 PM — Barbecue lunch
- 2 PM — 2 m scramble — all modes
- 3 PM — 2 m multi-transmitter hunt
- 3 PM — Return of bus trip
- 5 PM — Prize presentations. Jeff VK2BYY



# VK4 WIA NOTES

Bud Pounsett VK4QY  
Box 638, GPO, Brisbane, Qld, 4001

## NORTH QUEENSLAND RADIO CONVENTION

Are you planning to visit North Queensland toward the end of September? If you are, you will be very welcome to join in the fun at the James Cook University over the weekend of the 23, 24 and 25th of September. Townsville have been staging these highly enjoyable and well attended conventions for some years and this one will be no exception.

An informal get-together at the James Cook University Club starts the convention on Friday evening. Out-of-towners can meet the locals. On Saturday, the activities really get underway. There are fox hunts, scrambles, lectures, ladies activities, demonstrations, discussions, trade displays, an auction, homebrew competition, trophies to be won. So it sounds like any other amateur convention, but up in Townsville there is a big difference. It is all conducted in an atmos-

phere of the famous North Queensland friendliness.

For further particulars phone: Evelyn Bahr, VK4EQ, 79 1357, AH 79 4301; Roger Cordukes, VK4CD, 72 1944, AH 7 3334 or write to: The Convention Committee, TARC, PO Box 964 Townsville, Qld, 4810.

## AMATEUR RADIO GOES TO SCHOOL

You may get to follow the example of Brisbane amateur Rob Green, VK4NBJ. Rob's young son, Bradley, was telling his teacher at St Peters Primary School, Rochedale about dad's amateur radio station. The teacher spoke to Bradley's mum, Margaret about it and the upshot was that during a free period recently, the class were able to watch a video-tape introducing amateur radio to these ten and eleven-year-old boys and girls. The video-tape was obtained from the Institute by Rob who saw this as a unique opportunity to inform these children that there is such a thing as amateur radio.

Most schools these days have video recorders and teachers are always on the lookout for interesting and informative activities for free periods. Maybe you can follow up on this idea, particularly

in the year of World Communication. There is a big audience out there just waiting to be told that amateur radio exists.

## AMATEUR ADVISORY COMMITTEE

A recent issue of QTC, our Queensland newsletter, inserted into all 4000 series postcoded ARs, told our members that they were the best operators in Australia. They had better be, because Queensland, it seems, has the only really active amateur advisory committee in Australia.

Do not think that here in the Sunshine State, we go on the air in fear and trepidation that Big Brother is listening. The members of the AAC are just a few ordinary amateurs who monitor our bands and firmly but politely, correct those of us who do not observe the regulations as laid down in the handbook. These amateurs are appointed to the committee by DOC and a DOC officer chairs the meetings which are held every two months. The AAC is not a WIA committee although several of the members are WIA members.

The Amateur Advisory Committee is a buffer between careless or thoughtless operators and officialdom. Here in Queensland, the AAC works, should not there be one in every State?



# LETTERS TO THE EDITOR

Any opinion expressed under this heading is the individual opinion of the writer and does not necessarily coincide with that of the publisher.



## PLEASE NOTE

Letters to the Editor should be short and to the point. They will be easier to read and will not require shortening or summarising.

Amateur Radio is produced under a very tight budget. Space for each item printed in the magazine is at a premium.

## HEARTFELT THANKS

I have been requested by the members of the WICEN Region 3A and 4 groups, who participated in the communications exercise in conjunction with the James Hardie National Car Rally on 16 and 17 July 1983, to convey their heartfelt THANKS to all radio amateurs, who, in the true "Amateur Spirit", immediately cleared the 3.605 MHz spot when requested to do so.

Due to peculiar propagation problems the 80 m spot became the busiest frequency to cover the event and thus the co-operation of all concerned was, and is, greatly appreciated.

Thanks again gals and guys.

John Aarsse, VK4QA  
WICEN REG 4 CO-ORDINATOR  
Box 597, Toowoong, Qld 4066

## THE "ULTIMATE" VHF QTH

I trust that you will find this letter regarding my 2 m experiences of sufficient interest to publish.

My location is one of those highly sought after elevated QTH's with all antennas looking out across the water and no obstructions in any direction to interfere with VHF operation. Perfect I thought — and so it was to begin with. Using my IC290A and my dual 3/4th in phase, vertical antenna, the latter mounted own 20 ft mast fixed to the ridge of the roof of the house, I found that most of Melbourne and Geelong were within simplex range. In addition I could access ten VK3 repeaters and quite often VK5 and VK7 repeaters.

All went well until approx August 1982 when a paging system with a 60 dB over S9 signal appeared in the 146.500 area. It was proved to be a 3rd order intermodulation product problem with my receiver and I learned to live with it. The situation today is different — on the 15th June 1983, between 0930-1030 EST I logged 76 different frequencies on which I had intermodulation problems — (four of these being on repeater output frequencies) — ranging in bandwidth from 5 kHz to 25 kHz. No doubt some of them were 4th and 5th order intermodulation products. However, it all but rendered 2 m useless and the thought of living in a valley became quite attractive, particularly as other makes of transceivers showed no improvement over my own.

The problem has partly been overcome by downgrading my antenna system and 2 m is again of some use to me. To those of you who are thinking of a new QTH atop a hill and who "try out" its 2 m capabilities from the "mobile" or with a "hand held" beware of what may be there when you ultimately put that antenna up at a higher level.

To those who are contemplating such a move I refer you to AR of October 1982, where a very good article appears dealing with the problem and also to QST of May 1983, where another informative article is published. Have you perhaps blamed a "button pusher" for interference at some time when in fact the cause is entirely different?

This is not a letter of complaint just a statement of my experiences in that "perfect VHF location" that so many of us look for. Perhaps the manufacturers

could apply themselves to the problems of "overload" and "intermodulation" so that a "good QTH" can be used effectively.

Believe me intermodulation is alive and well and living in VK3.

Stan Williams, VK3DSW  
2 Gannel Street, Mt Eliza 3930

## AN OPEN LETTER TO ALL RADIO AMATEURS

1983 is World Communications Year. It is also the year that the BOYS BRIGADE celebrates its 100th Birthday.

Founded on the 4th of October 1883 by William Alexander Smith the Boys Brigade was formed out of a group of youngsters who attended Sunday School. They were encouraged by their leader to participate in drill, gymnastics and team games, as well as to continue with their Christian studies.

From the small beginnings in Glasgow, Scotland the Boys Brigade quickly expanded, and spread throughout the British Isles and Commonwealth. The Boys Brigade inspired many other groups. The Girls Brigade was started in Ireland in 1893 with the scouts following some sixteen years later.

Her Majesty Queen Elizabeth the Second is Patron. Her patronage extends to all Boys Brigades in the following countries: *Great Britain, Ireland, Australia, New Zealand, Cook Islands, Niue, Solomon Islands, Tuvalu, Vanuatu, Papua-New Guinea, Canada, Bermuda, Falkland Is, Bahamas, Honduras, Jamaica, Haiti, Antigua, Barbados, Guiana, British Virgin Is, Dominica, Grenada, St Kitts, Monserrat, Netherlands, Antilles, Trinidad, Hong Kong, Malaysia, Singapore, Sierra Leone, Ghana, Nigeria, Cameroon, Uganda, Malawi, Zambia, Zimbabwe and South Africa.*

I would like to propose that all amateurs, amateur groups or societies approach your local Boys Brigade and open up your station to the Boys Brigade for the first four days of October 1983.

During this period it would be hoped that stations try and operate at least three hours every day or a minimum of six hours on the 4th October.

Dates and Times of the event are suggested as: 1200 hrs Saturday 1st of October (midday local time) to 2400 hrs Tuesday 4th of October (midnight local time).

Stations will use the following frequencies  $\pm$  5 kHz for calling "CQ Boys Brigade" or "CQ BB 100".  
On 10 metres 28.480 MHz  
On 15 metres 21.180 MHz  
On 20 metres 14.240 MHz  
On 80 metres 3.620 MHz

During quiet periods of operating, stations should listen on the hour and the half hour for new contacts.

After initial contact all stations should QSY to other parts of the band to establish a full exchange of communication and avoid interference to other stations calling.

It is hoped this method of operation will enable a useful and economic use of the frequencies available and promote more contacts.

Normal modes of transmission to be used.

To all amateur radio groups I ask you to please get involved. Arrange a special club station and establish contact with your local Boys Brigade. They are making approaches to Amateur Radio Societies and groups, you could assist much to promote Boys Brigade by making a station available to them on the 1st, 2nd, 3rd and 4th of October, this year 1983.

It is hoped that this will be the first of many an informal gathering of members of the Boys Brigade

each year. Not only will it benefit the Boys Brigade and amateur radio it will assist to strengthen the ties of the Commonwealth and encourage a greater understanding amongst all people that there is Peace and Goodwill available to all in this world.

I invite you to share with me any information about your proposed activities, as well as the actual events that happen before and after this period of celebration for the first 100 years of the BOYS BRIGADE.

I wish you much success.

Yours faithfully,  
Frank May (VK2PIO)  
Box 33,  
Rosebery, NSW, 2018  
AR

## COPYRIGHT

I refer to my previous letter of 5th June, 1983 wherein I expressed my feelings regarding the unfortunate copyrighting of the article 'To Heard and Back' by Dave Shaw, VK3DHF/VK0HI.

Could you please inform both your other readers as well as myself as to just how many applications you have received from other papers/magazines for use of this article? Also whether or not such applications have included such eminent publications as QST, CQ, 73, Radio Communications, Ham Radio or perhaps even Break In, or World Radio. Have any of the major DX newsheets such as The DX Bulletin also been included in such applications as may have been received?

It would also be of great interest to learn whether either Dave VK3DHF or Al Fischer K8CW/VK0CW have provided articles to any of the amateur radio magazines other than your publications.

Ian J Hunt, VK5QX  
8 Dexter Drive, Salisbury East, SA

## EDITORS NOTE

Two requests were received from the Japan DX Family Foundation and from Veron QXpress. Both requests were acceded to. No other requests have been received. The Editor of Amateur Radio Magazine has knowledge only of material submitted to Amateur Radio Magazine.

Editor  
AR

## KINKY HINTS??

I have just been reading some amateur radio magazines from overseas and, in comparison, I feel our own Wireless Institute publication is as good, if not better, than most of them.

However, I was interested in the 'Hint's and Kink's' section published in 'QST', and I feel a page could be set aside in our own magazine, for the experimenters or innovators within the Australian Amateur Fraternity. We do, as a nation, have a reputation of being very inventive and innovative, due to the distance we are from the major markets of the world. However, we have to our credit the invention of the 'Stump Jump Plough', also the first utility car and, believe it or not, the Hula Hoop!!

It irks me to think that we could have been the first in many aspects of amateur radio if the inventors among us had had a public forum, to air their views. Let's face it, not everybody can sit down and write a long technical article, but most of us would be able to draw a rough diagram, with a short covering note, to explain the principle of the devices, or more importantly perhaps, the application of viable, cheap, easy to get at material for all aspects of our hobby. If only one per cent contributed an article per year, there would be enough material to keep a column going to benefit all, with perhaps the incentive of a yearly prize.

donated by one of the commercial advertisers, for the best idea published.

Being flippant, the column could be called 'Kinky Hints'.

Yours sincerely  
Jim E Joyce, VK3YJ  
44 Wren St, Altona, 3018

What do others think? — Ed.

AR

### EIGHTY METRE NETS

I would suggest that a list of all Australian 80 metre nets should be published in this magazine. This would provide two benefits. 1. Those wishing to join a particular net would know when and where to find it. 2. Those wishing to make a sked with a friend would know when and where to avoid a net. It is obvious that nets are growing more popular and are increasing. Such a list would also help those wishing to establish a new net. We all realise that no one has a right to monopolise any one frequency (except for WICEN), but a properly run net enables a group of operators to use a single frequency thus helping to reduce congestion on the band.

As a starter, I would like to nominate the Tasmanian Devil Net which operates every Tuesday night from 1000 UTC on or about 3.590 MHz. You might also list WIA weekly broadcasts.

Your sincerely  
Bob Jackson, VK7NBF  
Falmouth House, Falmouth, 7215

Any Volunteers? — Ed.

AR

### WHAT PRICE DX?

I would like to add my comments to those made by previous contributors regarding the cost of QSL confirmations.

For many years now I have sent the more usual QSLs by the Bureau, and the rarer ones direct, in the ratio of approximately 50/50. Since by now every new country I work is relatively rare most of my cards go direct. I always inclose two IRCs (or a green stamp) and, most importantly, a self addressed airmail envelope. SAEs appear to be the single most important factor in obtaining a reasonable rate of return. Only a few cards had to be sent more than once. Among the ten confirmations outstanding there are only four to whom I sent my card direct, and they are all still fairly recent.

As a result I have at present 206 countries confirmed out of a total of 216 worked, a success rate of ninety five per cent.

In today's money two IRC's plus air mail comes to two dollars. Assuming that fifty per cent of my total were sent direct the average cost of a confirmation, at today's postage rates, runs therefore to \$1.00.

\$200.00, over more than ten years, does not seem such an enormous sum to spend on one's hobby, considering the money spent by most amateurs for equipment, whether home brew or commercial.

Best regards and 73s  
George Cranby, VK3GI  
PO Box 22, Woodend, 3442

AR

**\*\*HELP\*\***  
**INTRUDER**  
**WATCH**



Please help INTRUDER WATCH  
by reporting all intruders.

## For QSL Cards

Phone  
(03) 527 7711

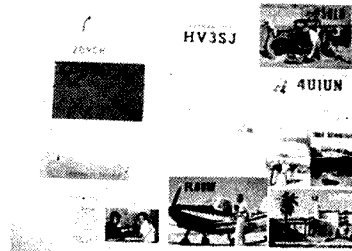

**Williams Printing**  
**Service Pty Ltd**

12 William Street,  
BALACLAVA 3183

CONTACT US FOR QUOTES

## AIR-WOUND INDUCTANCES

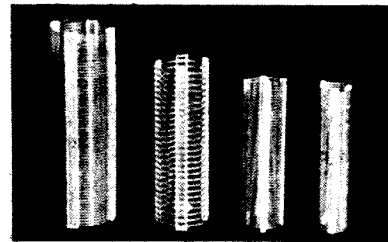

No	Diam	Turns per		B & W	Price
		Inch	Length		
1-08	1/2"	8	3"	No 3002	\$1.60
1-16	1/2"	16	3"	No 3003	\$1.60
2-08	3/8"	8	3"	No 3006	\$1.90
2-16	3/8"	16	3"	No 3007	\$1.90
3-08	3/4"	8	3"	No 3010	\$2.30
3-16	3/4"	16	3"	No 3011	\$2.30
4-08	1"	8	3"	No 3014	\$2.60
4-16	1"	16	3"	No 3015	\$2.60
5-08	1 1/4"	8	4"	No 3018	\$2.90
5-16	1 1/4"	16	4"	No 3019	\$2.90
8-10	2"	10	4"	No 3907	\$4.20
8-10/7	2"	10	7"	No 3907	\$7.20

Take the hard work out of Coil Winding  
— use "WILLIS" AIR-WOUND  
INDUCTANCES

**WILLIAM WILLIS & Co. Pty. Ltd.**

98 Canterbury Road, Canterbury, Vic. 3126  
PHONE: 836 0707

## RTTY/CW

Advanced split-screen ASCII, BAUDOT, CW software for  
Commodore computers ... \$59

VIC 20 computer — 5K RAM, 8  
colours, hi-res 176\*200 pixel  
graphics, 4 voice sound  
generator ... \$299

Commodore 64 computer —  
64K RAM, 16 colours, hi-res  
320\*200 pixel graphics,  
sprites, sound synthesizer ...  
\$699

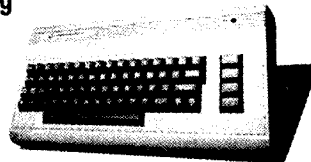

Both computers feature 20K BASIC & operating system, RS  
232, parallel user port — disc drives, printers, joysticks,  
paddles, light pens, games, utilities etc available.

Versions also available for PET/CBM 3000, 4000 and 8000  
series (includes SSTV send) — POA.

**HIGH TECHNOLOGY COMPUTER**  
**SYSTEMS PTY LTD**

87 Swan Street, Richmond, Vic 3121 ph (03)  
429 1966 ask for Mike VK3BHM or Joel VK3ZKE

# IONOSPHERIC PREDICTIONS

Len Poynter VK3BYE

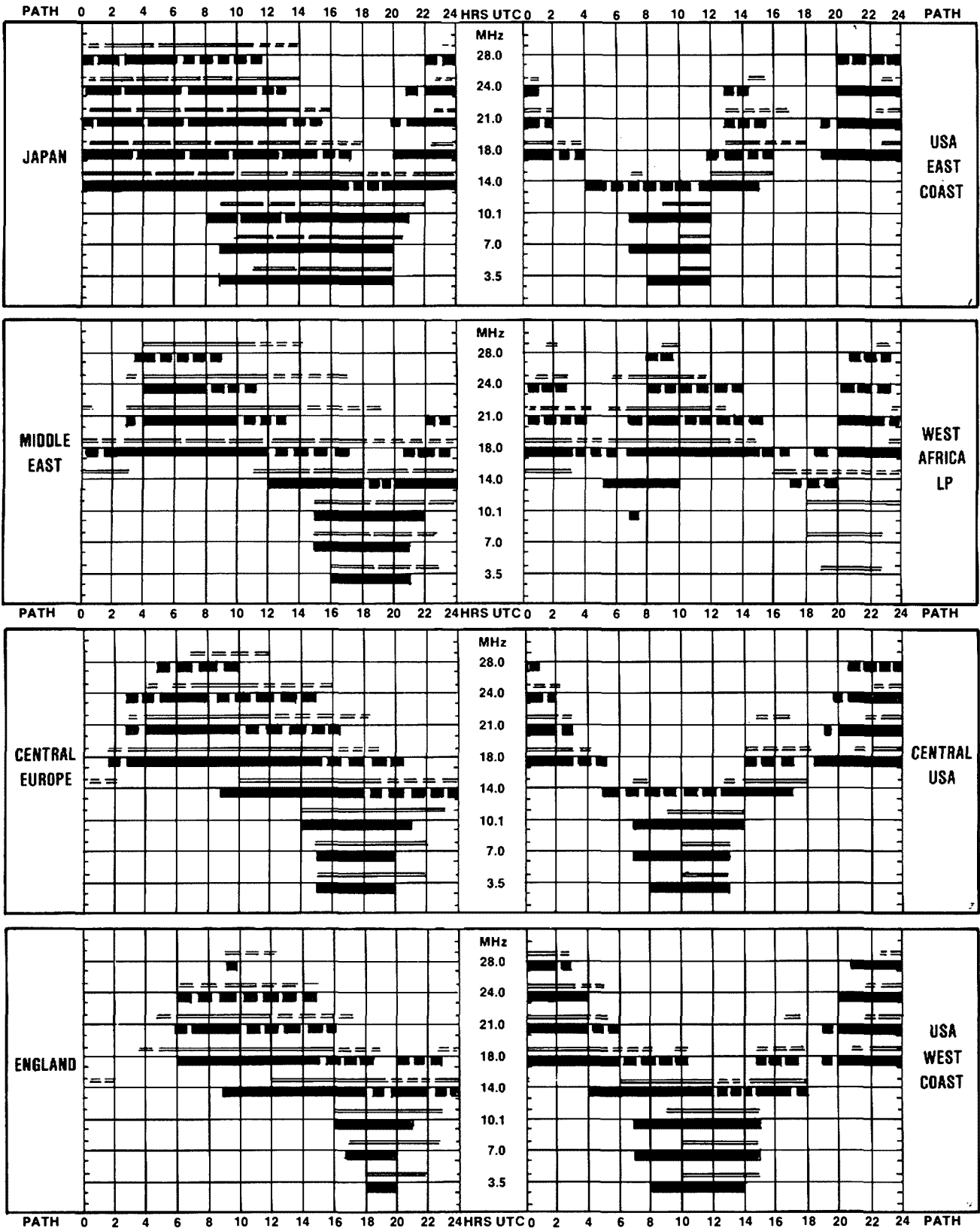

## LEGEND

==== From West Australia

———— From East Australia



Better than 50% of the month, but not every day



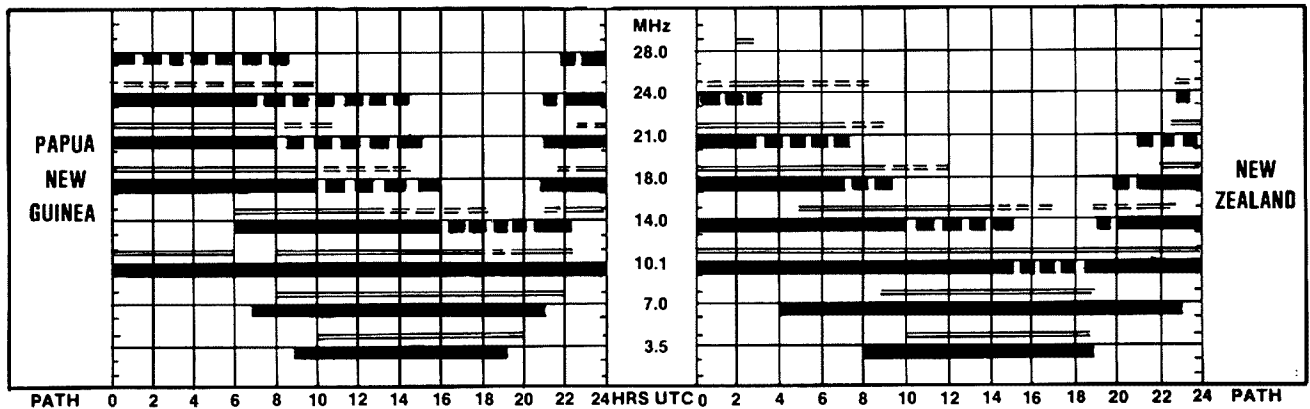
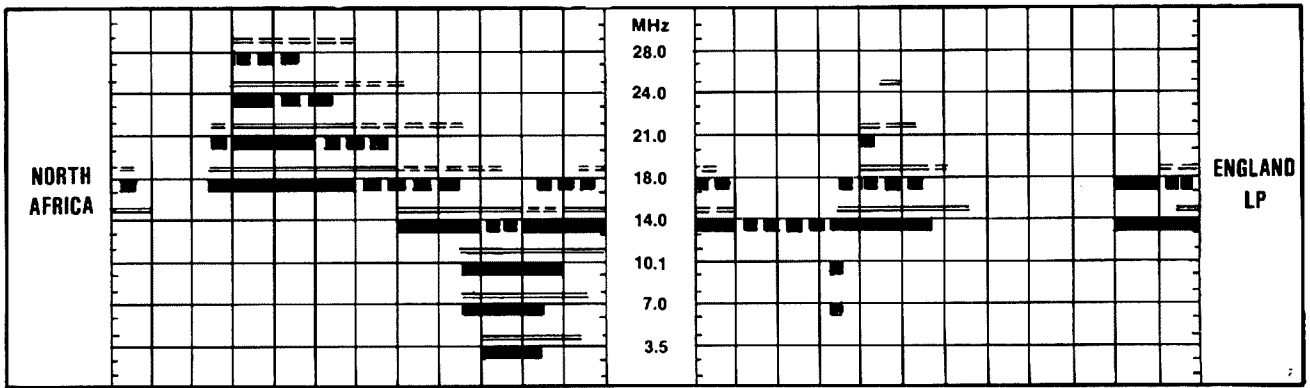
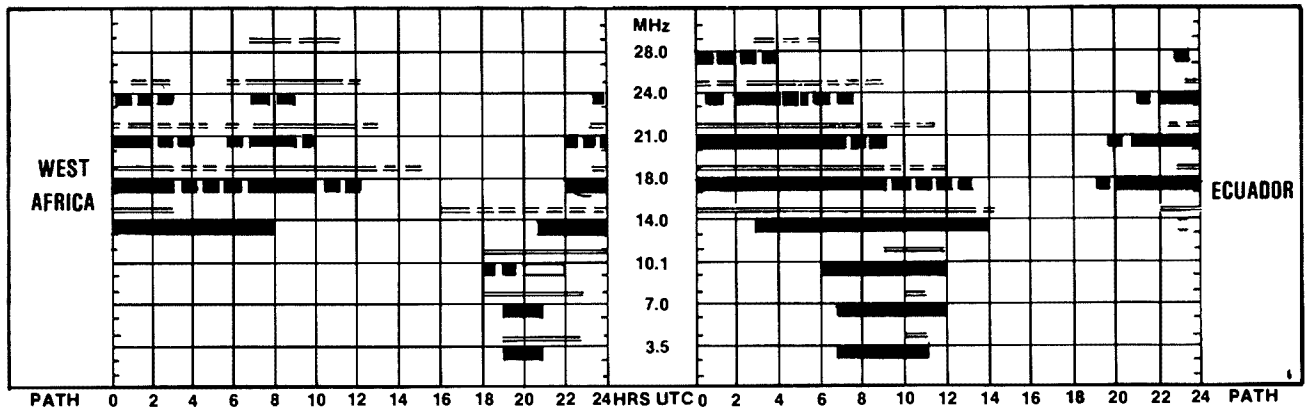
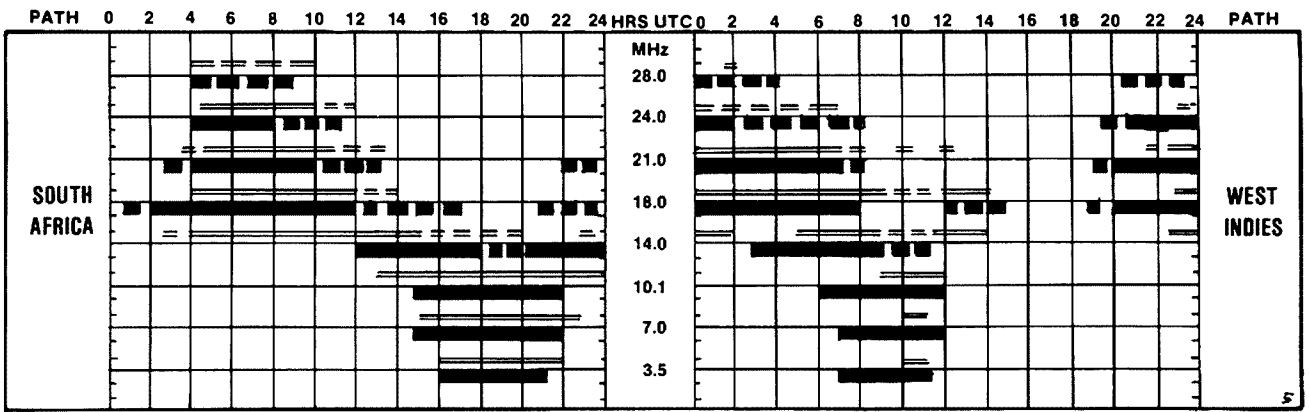

Predictions courtesy Department of Science and Environment IPS Sydney. All times in UTC.



Less than 50% of the month

PATHS — Unless otherwise indicated (ie LP = Long Path) all paths are Short Path.

# Obituaries



## PERCY SARA VK2QV

On Tuesday, 21st June, 1983 "VK2 QUEEN VICTOR" left his earthly life and became a silent key.

Percy Sara was born in Sydney in 1920 and was educated at Sydney Grammar School. During the war he volunteered for service and was sent to England where he later joined 460 Squadron, (Lancaster Bombers). Whilst training at Church Broughton he met Betty, a WAF who was destined to become his wife.

Unfortunately, on a mission over Germany as tail-gunner in a Lancaster, Percy's aircraft was shot down and he, and the rest of the crew parachuted to "safety" (thus also qualifying for membership in the exclusive "caterpillar" club). A few days of freedom followed. However he was finally captured and handed over to the Gestapo for interrogation and ultimate processing to Stalag Luft 3. Two years as a POW did little for the health of any of the prisoners and eventually was responsible for Percy becoming TPI.

Percy and Betty were married after his release in 1945. They returned to Australia and had their first child Geollrey in 1946. As an ambulance Superintendent, Percy transferred from Coolah to Bellingen as it was here in 1950 that the famous Sara Quads were born. Subsequently Percy, who by now had the callsign VK2QV, was one of the few amateurs able to decorate his QSL card with quads of a different kind.

The family left Bellingen in 1954 and returned to Sydney but it was Percy's wish to retire to the North Coast and they settled in Urunga in October 1980.

Percy immediately involved himself in community activities and took an active part in the running of the Coifs Harbour and District Amateur Radio Club where he was Treasurer until his passing.

Retirement did not see him vegetate — indeed his interests in amateur radio expanded to include RTTY and computers. It is an example to us all that he had returned to "school" to study computer programming to "find out what it was all about". He attended "class" on the Monday night where he used the knowledge he had already acquired to help others who were having difficulty. Percy passed away quietly in his sleep on Tuesday morning.

Our sympathy is extended to Betty and their family at the passing of "nature's gentleman" — he will be sadly missed by all his amateur mates.

Rick Fletcher, VK2BKV  
AR

## W B (BILL) JOHNSON VK5AWJ

Bill became a silent key on 25th June, 1983. He came from New Zealand thirty years ago, where he had held the callsigns ZL4HT and ZL2VO, and became VK5FZ for a time and then his licence lapsed until 1978 when he became VK5AWJ.

This callsign became familiar on HF and VHF — you could hear it most mornings "hand held, walking the dog in Vale Park" or else booming out on twenty metres, amplifier, monobander and all.

More recently Bill was seen and heard on Amateur Television, but only in the daytime, although his operating from home was restricted for the past year due to him being hospitalised in June 1982, but he managed to get home for a few precious hours, several days each week.

These were the times he loved best — talking on air with his friends!

Most knew that it was only a matter of time, but his cheery voice and manner belied his terminal illness. In fact the medical and nursing staff at the hospital admired his courage in his day to day living and agreed that his fascination with amateur radio was a major factor in his ability to cope with his ever increasing medical problems.

Bill continued to operate on two metres from hospital, and, just the day before he died, was talking on the repeater arranging to send a cheerful message to friends in New Zealand.

For Bill the end was peaceful and dignified and although he will be missed by his many friends it is comforting to realise that, at last, his troubles are over.

Chris, VK5PN  
AR

## HARRY ROBINSON VK5HN

Harry VK5HN passed away suddenly on 12th May, 1983.

He was employed by the South Australian Fire Brigade in 1923 and was attached to the St John Ambulance Brigade as a driver and attendant. (In those days the ambulance was operated by the fire brigade.)

Harry joined the Brigade a few years before a fire aboard the ship "City of Singapore". This fire caused an explosion which resulted in three of Harry's firemen friends being killed.

It is said that if it were not for Harry's expert medical attention to others at the fire scene, the death toll would have been much higher.

Harry joined the ranks of amateur radio in the late '30s and was working at the art less than seven hours before his death.

He took great pride in his "radio career" and was always ready and willing to assist the "youngsters" of the amateur fraternity.

He will be sadly missed.

R Gill, VK5NVM  
AR

## BERT BEHENNA VK5BB

Bert VK5BB passed away on 8th July after a long illness. He was 65.

Bert was licensed about 1947 and was active on the bands until two years ago.

He had been an RAAF pilot and also worked at the Port Pirie Radio Station, 5PI, for many years.

Sympathies are extended to his wife and six surviving children.

Jenny Warrington, VK5ANW  
AR



## URGENT!

Please let us know of clubs and schools etc. starting theory classes.

Where, when, how much and whom to contact.

Contact Brenda VK3KT.

# Chirnside Antennas

For a BIG Signal

CE-5SS  
80-40-20-15-10 m  
Trapped Vertical

Base or Portable  
Self Supporting  
Only \$99.00

Why Poy approx  
\$160 for  
imported types?

## MULTIBAND BEAMS

CE-33 3 el 20-15-10 m	.....	\$269
CE-52 el 15-10 m	.....	\$205
CE-42 4 el 15-10 m	.....	\$149
CE3-11/10 3 el 10 or 11 m	..	\$79
CE2-5 el 2 m yogi	.....	\$29
CE2-8 el 2 m yogi	.....	\$49

## Mobile Helicals

80 m 6'6" long	.....	\$29.00
40 m 6'6" long	.....	\$27.50
20 m 6'6" long	.....	\$27.50
15 m 6'6" long	.....	\$27.50
10/11 m 6'6" long	.....	\$27.00

For our mobile antennas we use only high quality components. .71 mm wire, rop loading, solid brass fittings with adjustable stainless steel tip and heavy wall heat-shrink tubing.

Special Vertical for Novice Bonds (10, 15, 80 m) \$79.

Soon available: Trapped vertical self supporting for 3.5, 30-18 and 24 MHz under \$100.

All available by mail order from:-

**Chirnside Electronics  
Pty Ltd**

26 Edwards Rd, Chirnside Park,  
Vic 3116. Phone (03) 726 7353

Please allow sufficient for freight and insurance.

# ATN ANTENNAS

A Victorian Approved Decentralised Secondary Industry providing apprenticeships and training to many young people in the only Secondary Industry in the Shire of Birchip. Situated in NW Victoria, the Shire has an area of 1470 square kilometres and a population of 1470.

We have manufacturing and testing facilities for Satellite, TV, Radio Astronomy, EME and all type of CB, Amateur and Commercial Communications Antennas and supply to many Overseas Countries.

If our High Gain TV Antennas are unable to solve a particular TV reception problem WITHOUT THE USE OF BOOSTERS on either VHF or UHF, then the problem cannot be solved. (TV Dealer enquiries welcomed.)

With thirty-five years' experience and the first Amateur Radio Station in the Southern hemisphere to conduct successful Two-way Radio Contacts via Lunar Reflection on VHF in 1966 and subsequently on UHF (resulting in the only non-American ever to be awarded the ARRL TECHNICAL MERIT AWARD) our record is hard to beat.

FOR A FREE CATALOGUE ON OUR COMPREHENSIVE RANGE OF PRODUCTS WRITE TO:

# ATN ANTENNAS

PO Box 80,  
Lot 11, Morrison Street,  
Birchip, 3483  
Phone: (059) 92 2224 (24 hours)  
Telex: AA 55480 OCOBIR

Or one of our many approved distributors throughout Australia, New Zealand and the Islands.

## Silent Keys

It is with deep regret we record the passing of —

A F GRAYDON

VK2AIS

## Crystals for Amateur and General Communication Frequencies

Prompt Delivery  
Guaranteed  
Prices On Application

## Quartz Crystal Laboratories

79 Deakin Street,  
East Bengleigh,  
Vic 3165

Phone (03) 570 2354



DEADLINE

All copy for November AR must REACH PO Box 300, Caulfield South, 3162 no later than 23rd September.

## HAMADS

PLEASE NOTE: If you are advertising items FOR SALE and WANTED please write on separate sheets, including ALL details, eg Name, Address, on both. Please write copy for your Hamad as clearly as possible, preferably typed.

\* Please insert STD code with phone numbers when you advertise.

• Eight lines free to all WIA members. \$9 per 10 words minimum for non-members.

• Copy in typescript please or in block letters double spaced to PO Box 300, Caulfield South 3162.

• Repeats may be charged at full rates.

• QTHR means address is correct as set out in the WIA current Call Book.

Ordinary Hamads submitted from members who are deemed to be in the general electronics retail and wholesale distributive trades should be certified as referring only to private articles not being resold for merchandising purposes.

### TRADE HAMADS

AMIDON FERROMAGNETIC CORES: Large range for all receiver and transmitter applications. For data and price list send 105 x 220 SASE TO: RJ & US IMPORTS, Box 157, Mortdale, NSW 2223. (No enquiries at office: 11 Macken Street, Oakley, 2223). PLEASE NOTE: Business closed during October.

CB RADIOS \$69: Walkie talkies, short wave radios, military, outback, business, amateur, marine, repairs. RTTY Siemens 100 A printer \$120; base mic \$45; ultrasonic alarm \$35; all ham bands on a single 6 ft whip, 1.8 to 30 MHz, for base or mobile \$300; aerials, installation, demonstrations, 40 Ch CB conversions, accessories, new rigs weekly. BRIDGE DISPOSALS, 12 Old Town Plaza, opp Bankstown Railway Station, NSW. Mail order service and all enquiries to 2 Griffith Avenue, Roseville, 2069, or phone Sam VK2BVS, 7 pm to 9 pm only on (02) 407 1066.

NOVELTY WALL PLAQUE/ASH TRAY. Special design for Australian radio amateurs individually personalised with your call sign (refer AR Showcase, May 1982). Fully glazed with high quality deep golden brown finish, also available with gold etching. An ideal gift to an amateur friend or just something different for the shack or lounge room. Enquiries to PAM SAXON, VK3NSB, 77 Edithvale Road, Edithvale, Vic 3196. Phone: (03) 772 1975. (Wholly made in Australia).

SELL: ICOM IC-750, yen 203,900 . . . Kenwood TS-430S, yen 158,800 de Makoto Takano, D13-4, Nagahori, Tokai, Ibaraki, 319-11 JAPAN.

### FREE — VIC

FREE PETS: Shack cats, ten months up. Several. VK3BVR, QTHR.

MAGAZINES: QST, 1943-1979, AR, 1946-1979. Preference to WIA affiliated club. Alan, VK3AL, QTHR. Ph: (03) 690 1691.

### WANTED — NSW

DIGITAL READOUT for FT-101 series. Ade. Ph: (049) 73 2621.

DRAKE TR7A/TR7 tcvr. MN 2700 ant tuner, TV 3300 low pass filter, CDE HAM 4 rotor, KLM KT 34XA beam, TET HB35C beam. Ph: (042) 29 1408.

### WANTED — VIC

CIRCUIT DIAGRAM for R216 Rx. Ex army, 19-156 MHz. Will pay for photocopying and postal. B Munro, 6 Shirley St, Fawkner, Vic 3060. Ph: (03) 359 1992.

**KEN KP-202** circuit diagram or photocopy. Will pay necessary charges. VK3ZHG/NCR, QTHR. Ph: (03) 749 5215 (AH).

**TRIBAND BEAM** 3 el, TH3, AS33 or similar. Laurie VK3CLB. Ph: (03) 857 9750.

**RCF MD1612** Microphone dynamic insert. VK3BAX, QTHR.

**COE — HAMIII** or **HAM "M"** rotator complete control and indicator for 230 VAC. 50 Hz operation. Unit preferred to be new or in good cond. Wanted urgently. Will pay top price for good unit. Ric VK3RC. Ph: (057) 84 1742.

### WANTED — QLD

**COLLINS 30S-1 LINEAR AMPLIFIER.** Circuit diagram for Naigai linear amp, model Nag-144-XL. Also large Tx valves ex broadcast use for display purposes. All costs reimbursed. David VK4ZJL. Ph: (07) 44 1749.

**SSTV CONVERTER** in good working order. Box 5209. Bundall. Qld 4217.

### WANTED — TAS

**UHF EQUIPMENT** must be GWO. Need not be state of art. Cheap low pwr 2 m Tx. Varactor diodes. Super pro or similar comm Rx. Wayne VK7WD, QTHR. Ph: (002) 38 8775 (BH), 67 2356 (AH).

### FOR SALE — ACT

**KENWOOD 530S** as new. 27 MHz fitted. \$700 ONO or will swap for Kenwood 130S in same condition. Ph: (062) 51 2788.

**MODEL 15 TELETYPE.** transformer filled for 240 V operation, 20 mA. Current loop, ex cond, compete with spares and manual \$60. Dumont CRO. 2 MHz fitted with triggered sweep \$40. VK1GW, QTHR. Ph: (062) 88 2596.

**REALISTIC AX-190** amateur bands Rx. AM/SSB/CW Q mult. Xtal Cal. 100/25 kHz, ext sprk etc \$140. QM 70 144/432 transverter. Trips on Tx, convert on Rx \$50. Johnson Viking 352D SSB/AM CB, PLL problem, no mic, as is \$40. VK1DA. Ph: (062) 48 3253 (BH), (062) 81 4209 (AH).

### FOR SALE — NSW

**AMATEUR QTH** in elevated position overlooking sea. Excellent for DX, 40 ft mast with G5RV. Neighbours docile, comfortable shack with access to kitchen, Irig, etc in a neat 2 bedroom home on a 50 x 100 ft block. Quiet street close to shops and all amenities. Don VK2ADR, QTHR. Ph: (044) 55 2848.

**ANTENNA — 18 AVT** vertical antenna plus 80 m dipole complete balun, coax and masts. \$50. Ph: (02) 570 8705.

**COMMODORE PET COMPUTER.** 2001 series 8 K model with inbuilt cassette and B/W monitor. Ideal for amateur as virtually no interference to tcvr. Sound unit fitted. With a heap of amateur programmes incl amateur log, contest duplicate checker, range and bearing, contest to tape, Morse trainer. Plus many programmes and games, etc. Cost \$1400. Sell for \$499. Neil VK2KCN, QTHR. Ph: (02) 633 2238 (BH) or 634 1882.

**DENTRON** Clipperton-L 2 kW amplifier \$650. Dentron 3 kW ant tuner \$150. Model 15 page printer \$25. Tape perforator \$25. 3 head reader \$30. TRS-80 Model 1, Level II \$300. VK2BYF, QTHR. Ph: (02) 727 5629.

**DIGI READOUT** Yaesu YC-7B for FT-7B \$100. Ade VK2ACY, QTHR. Ph: (049) 73 2621.

**ELEVEN C90 CASSETTES** of Morse Code 10-12 WPM. Just send equivalent blank tapes and return mail expenses. I will send you the lot. Bruno VK2BPO, 2 Marmion Rd, Abbotsford, NSW 2046. Ph: (02) 560 9415 (BH).

**ICOM IC701, PS701, mic, RM3** Controller, all \$850. ICOM IC211 \$470. ICOM IC511 with all opt boards, micro modules, linear, yagi and vert ants \$650. ICOM IC245 \$230. AR240 handheld, case, charger \$210. TRAM XL5 modified on 10 m \$90. Macrotronics RTTY interface, software for Apple MDK 17 MODEM. All cost over \$500. Sell \$330. Roger VK2DNX, QTHR. Ph: (02) 546 1927.

**KENWOOD DFC230** digi freq controller to suit TS120/TS130 series. Built in digi VFO, 4 mems, freq shift with mic, split freq operation, extra extens cord included. \$130. Tony VK2BBJ. Ph: (02) 84 7170.

**KENWOOD TS1BOS** DFC with mems, scan and final protect \$790. MC 50 mic \$40. AT180 tuner \$150. Ext VFO 180 \$120. SP180 sprk \$60. All ex cond or \$990 the lot. Commodore ICs for 3000 and 4000 series CBMs. Arrow loads cassette 7 times faster, Basic Aid a must for programming, toolkit, Commando Pro \$25 each. Wordpro \$35. Viscialc \$95. CBM 4032 32 k with many ICs \$950. 3040 dual disc drive \$800. Ph: (02) 588 4414.

**KENWOOD TS-520S** tcvr \$475. DG-5 digi readout \$180. VFO-520S remote VFO \$130. TV-502 2 m transverter \$150. Gil VK2RI, QTHR. Ph: (02) 84 6510.

**MODEL 15 PRINTER.** 45 Baud \$10. ASCII 100 Baud TTY with paper, tape punch and reader. RS 232 interface. \$80. VK2BZE. Ph: (042) 96 4595.

**MORSE** sending for unexpanded VIC-20. Programme has fully variable speed to above 20 WPM and prints message on screen. \$10 gels you a tape and audio interface (works off TV) and postage. Andrew VK2PJP, 91 Parker St, Bega 2550.

**RACAL COMMERCIAL BASE STATION** type TA-83. (Unused) Rated 500 watts SSB. Continuous coverage from 3-15 MHz. Final stage could be used as an amplifier with 500 ohm input and output. Remote switching for 4 bands. \$500. VK2CD, QTHR. Ph: (02) 419 7283.

**TELETYPE MODEL 32 ASR** 2 units 50/75 Baud. Similar to ASR 33 but Baudot. \$100 ea. Colour TV camera, 3 tube Hitachi type HV 1100 A complete with CCU, cables, h/book etc. Requires "C" MT lens. \$600 ONO. VK2ZPM. Ph: (02) 629 1904.

**YAESU FT101Z,** fan and hand mic plus desk mic YD148. As new. Little use \$525. VK2DCG, QTHR. Ph: (02) 498 1103.

**YAESU FTOX 401** with manuals and sep VFO, FV401 plus some spare valves. In perfect cond. One owner. Can be heard on air or any test. \$350. Jack VK2CX. Ph: (049) 81 1582.

### FOR SALE — VIC

**ALPHA LINEAR 374 AE.** Tcvt IC740 w/inbuilt AC supply, FM board and SSB 455 kHz filter. Tcvt IC 25H, 45 W, 2 m FM mobile. Kenwood TR8400, 432 MHz FM tcvt, 10 and 15 m Swiss quads. Shure 414 mobile mic. Kenwood SP820 sprk w/filters, w/13.8 V 10 A supply inbuilt. Ph: (03) 240 1231. (AH) 209 7937.

**IC2A FM TCVR** in new cond with ant, vinyl case, charger and all acc. 6 mths careful use. Reasonable offer. FRG7 Rx with Yaesu SSB IF filt and slow motion fine tuning drive fitted. \$200 ONO. VK3SY or VK3ABK, QTHR. Ph: (052) 21 1340.

**KENWOOD BS5 PAN ADAPTOR** for SM220. New \$50. Foxtango crystal filter cascading kit for FT101 series shape factor 1.19. New \$70. John. Ph: (055) 23 1025.

**KENWOOD TS520S** with remote VFO plus spare finals. VGC. Sell VFO sep. \$600. Geoff VK3ED, QTHR. Ph: (03) 338 2105.

**TH80XX** tri-band beam. Excellent cond. \$350. Bob VK3SK, QTHR. Ph: (03) 527 1861.

**TRANSCEIVER — 2 m** Arowden AS1000. 2/25 W, 11 ch, C/W ni-cad charger \$85. VK3BUS, QTHR. Ph: (054) 26 1233.

**YAESU FT501/FP501** HF tcvt. 560 W PEP input with h/book and mic fitted with all filters and NB, digi readout, \$425. Tellurometer distance measuring unit optical model MA100 complete \$750 ONO. Racal 1SB adaptor for RA17 \$100. 12 misc test instruments \$20-\$50 each. VK3AAR, QTHR. Ph: (03) 836 4279.

### FOR SALE — QLD

**HOME CONSTRUCTOR SPECIAL.** Mizhuo SG-9 9 MHz SSB generator unit plus Mizhuo VFD-5. Unused in orig packing with all instructions. \$100 the lot, post free in Australia. VK4BF, QTHR. Ph: (070) 71 5028.

**VALVES — 175 valves** for \$200, incl EA50, VR78, VR92, 6AK5, 6AL5, 6AM5, 6AQ5, 6AU6, 6AV6, 6BA6, 6BH6, 6BL8, 6BM8, 6BZ6, 6C4, 6CB6, 6CG7, 6CM5, 6CW7, 6CQ8, 6DQ6A, 6EA8, 6ET6, 6FH5, 6GK5, 6GW8, 6HG5, 6HG8, 6J6A, 6M5, 6N3, 6N8, 6U8, 6U9, 6V6G, 12AD6, 12AQ5, 12AT7, 12AU7A, 12AX7, etc. Also 3Z26 for \$10. 803 for \$5. Hal Hobler, VK4D0. Ph: (079) 28 1550.

**YAESU FT2FB 2 m tcvt.** Rptrs 6700, 6800, 7000, simp 6000, 6450, 6500, 6550. \$135. Willis 2 m amp. 25W \$35. Both for \$150. John VK4LJ, QTHR. Ph: (07) 341 6135.

**YAESU FT620B** 6 m, all mode tcvt. Complete carton, cables, manual. VG condition. 240/12 V \$300. Mary VK4PZ.

### FOR SALE — SA

**FT-707, FV-707,** mobile mount bracket, scan mic \$700. ONO. TR9000 2 m multimode 10 W tcvt \$350. PRC10 — what offers? Trevor Bartlett, VK5ATB.

### FOR SALE — WA

**TRANSMITTING VALVES.** TB2.5/300. TY2-125 European 58LL/1924, US (12) QB3.5/750 European 6156 US (15). New in cartons. Single lot offer for (27) VK6FK, QTHR.

### FOR SALE — TAS

**TRANSFORMER.** FT101Z power tranny, unused. What offers? Wayne VK7WD, QTHR. Ph: (002) 38 8775 (BH), 67 2356 (AH).

## ADVERTISERS' INDEX

Amateur Radio Action .....	IBC
ATN Antennas .....	63
Audio Telex Communications Pty Ltd ..	4
Bail Electronic Services .....	7
Chirnside Electronics Pty Ltd .....	62
CW Electronics .....	6
Dick Smith Electronics .....	2 & 3
Eastern Communication Centre .....	10
Emtronics .....	IFC
GFS Electronic Imports .....	32 & 33
Harad .....	53
High Technology Computer Systems Pty Ltd .....	59
Hy-Tech Distributors .....	47
Ian J Truscott Electronics .....	54
ICOM Australia Pty Ltd .....	BC
K Brucesmith .....	6
Magpups .....	19 & 44
Novice Licence — VK2 .....	54
Optilux .....	6
Parameters Pty Ltd .....	IBC
Quartz Crystal Laboratories .....	63
Radio World Pty Ltd .....	5
Stewart Electronic Components Pty Ltd .....	8
Traeger Distributors (NSW) Pty Ltd ..	8
Trio Kenwood (Australia) Pty Ltd ..	55
Vains Antenna Services Pty Ltd .....	6
Watchman Electronics .....	8
William Willis & Co Pty Ltd .....	59
Williams Printing Service Pty Ltd ..	59

A DMM you can be proud of  
 . . . At a price you can afford!

Optional  
 carrying case  
 available \$10.00\*

Basic DCV accuracy 0.1% (7040)  
 Battery life to 2000 hrs  
 Brilliant quality LCD display  
 Current ranges to 10A (7040)  
 3 1/2 digits

A breakthrough in price, performance and quality!  
 Our new Models 601 and 7040 Digital Multimeters  
 are superb quality instruments that will serve you  
 faithfully for many years. They feature all the  
 accuracy, facilities and rugged serviceability that  
 you're ever likely to need. — At a remarkably low  
 price.

Ask at your local stockist about the 601 and 7040  
 for unbeatable value.

\*Prices do not include sales tax.

**PARAMETERS** PTY LTD

PERFECTION IN MEASUREMENT  
 Sydney 439 3288 Melbourne 580 7444

(Incorporated in Victoria)

Xypar246



\$87.75\*

\$59.95\*



IF YOU HAVEN'T LOOKED AT  
*amateur radio action*  
 LATELY, THIS IS WHAT  
 YOU'VE MISSED . . .

- The Spratly Island incident — in depth.
- Yaesu's FT-980 "Computer Cat".
- Flexible mods for Yaesu FT-290R.
- An inside look at CIA propaganda stations.
- The VK3BCN report on emergency communi-  
 cations.
- A plain language summary of the WIA  
 "RADCOM" submission.
- A cheap external VFO for Yaesu's FT-707.
- The complete VHF/UHF frequency and beacon  
 list.

OCEANIA'S AMATEUR MAGAZINE — \$1.50 AT YOUR NEWSAGENT.

# ICOM IC-751

## The New Standard of Comparison

**NEW**  
Competition  
Grade  
Transceiver!



## Arriving Soon — call ICOM for details!

ICOM is proud to announce the most advanced amateur transceiver in communications history. Based on ICOM's proven high technology and wide dynamic range HF receiver designs, the IC-751 is a competition grade ham receiver, a 100kHz to 30 MHz continuous tuning general coverage receiver, and a full featured all mode solid state ham band transmitter, that covers all the new WARC bands. And with the optional internal AC power supply, it becomes one compact, portable/field day package.

**Receiver.** Utilizing an ICOM developed J-FET DBM, the IC-751 has a 105dB dynamic range. The 70.4515MHz first IF virtually eliminates spurious responses, and a high gain 9.0115MHz second IF, with ICOM's PBT

selectivity. A deep IF notch filter, adjustable AGC and noise blanker (can be adjusted to eliminate the woodpecker), audio tone control, plus RIT with separate readout provides easy-to-adjust, clear reception even in the presence of strong QRM or high noise levels. A low noise receiver preamp provides exceptional reception sensitivity as required.

**Transmitter.** The transmitter features high reliability 2SC2097 transistors in a low IMD (-32dB : 100W), full 100% duty cycle (internal cooling fan standard), 12 volt DC design. Quiet relay selection of transmitter LPFs, transmit audio tone control, monitor circuit (to monitor your own CW or SSB signal), XIT, and a high performance speech processor enhance the IC-751 transmitter's operation. For the CW operator, semi break-in or full QSK is provided for smooth, fast break-in keying.

**Dual VFO.** Dual VFO's controlled by a large tuning knob provide easy access to split frequencies used in DX operation. Normal tuning rate is in 10Hz increments and increasing the speed of rotation of the main tuning knob shifts the tuning to 100Hz increments automatically. Pushing the tuning speed button gives 1KHz tuning. Digital outputs are available for computer control of the transceiver frequency and functions, and for a synthesized voice frequency readout.

**32 memories.** Thirty two tunable memories are provided to store mode, VFO, and frequency, and the CPU is backed by an internal lithium memory backup battery to maintain the memories for up to seven years. Scanning of frequencies, memories and bands are possible from the unit, or from the HM 12 scanning microphone. In the Mode-S mode, only those memories with

a particular mode are scanned; others are bypassed. Data may be transferred between VFO's, from VFO to memories, or from memories to VFO's.

**Features.** All of the above features plus full function metering, SSB and FM squelch, convenient large controls, FM option, a large selection of plug-in filters, and a new high visibility multi-color fluorescent display that shows frequency in white, and other functions in white or red, make the IC-751 your best choice for a superior grade HF base transceiver.

**Options.** FM unit, external frequency controller, external PS-15 power supply, internal power supply, high stability reference crystal (less than 100Hz, -10 C to +60 C), HM12 hand mic, desk mic, filter options:  
SSB: FL30, FL44A  
CW/N: FL52A, FL53A  
AM: FL33

**Discover a new deal with  
ICOM AUSTRALIA PTY. LTD.**

7 DUKE STREET WINDSOR 3181  
VICTORIA, AUSTRALIA  
TEL: (03) 529 7582 TLX: AA 35521 ICOMAS

**ICOM**

**The World System**

# AMATEUR RADIO

VOL. 51, No. 10, OCTOBER 1983

Registered by Australia Post — Publication No. VBH 0569

JOURNAL OF THE WIRELESS INSTITUTE OF AUSTRALIA



*Golden Jubilee  
Issue 1933-1983*





# RADIO WORLD PTY LTD

81 NEWCASTLE STREET, FYSHWICK A.C.T. 2609  
PHONE 062-806550. TELEX AA62097

**KENWOOD**  
TS430S  
HF  
TRANSCEIVER

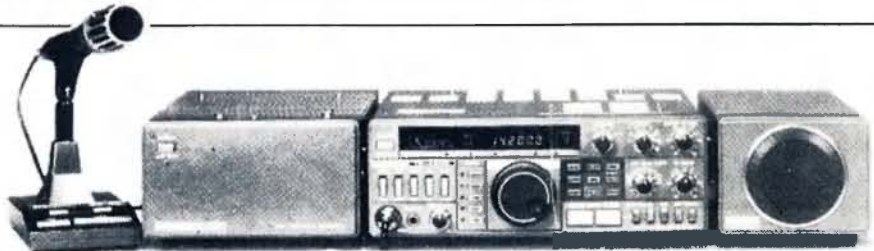

MC-60A

PS-430

TS-430S

SP-430

**ICOM**  
IC-R70

**COMMUNICATIONS  
RECEIVER**



NEW IC-R70  
Commercial Grade Communications Receiver

**YAESU**

**FT-980**  
**COMPUTER  
CONTROL  
TRANSCEIVER**



HF MICROPROCESSOR CONTROL  
TRANSCEIVER FT-980

## CB RADIOS — MARINE RADIOS



**uniden**  
AX144  
27 MHz  
CB Radio

**PRESIDENT 718**  
55 CHANNEL  
VHF  
SEA PHONE



40 CHANNELS AM-LSB-USB

We also carry a very comprehensive range of all types of plugs, VHF/UHF, 'N' type, BNC, etc. We have a good range of Japanese transistors, ICs, spare parts for CB radios and car stereos. We do all types of electronic repairs and all modifications on CB radios and amateur equipment. If you can't get your unit repaired send it to us for expert repairs.

### MAIL ORDER COUPON/ENQUIRY

PLEASE SEND ME THE FOLLOWING INFORMATION  
SEND \$1.00 FOR POSTAGE ON PAMPHLETS

- TRIO-KENWOOD     ICOM     YAESU  
 CB RADIOS AND CAR SOUND

NAME ..... PHONE NO. ....  
ADDRESS .....  
..... P/CODE .....

PLEASE SEND ME THE FOLLOWING ITEM/S

PRICE ..... FREIGHT .....

BANKCARD/C.O.D./TELEGRAPHIC TRANSFER  
BANKCARD NO. ....  
EXPIRY DATE ..... SIGNATURE .....

**CAR RADIOS AND STEREO**  
**THE ULTIMATE IN CAR HI-FI STEREO**

**CONCORD**  
HPL-532



**CRAIG**  
CAR STEREO



7780 ROAD RATED XL RECEIVER/CASSETTE PLAYER





Registered Office:  
3/105 Hawthorn Road,  
Caulfield North 3161.  
Tel. (03) 528 5962

# AMATEUR RADIO



Gavin VK3YK, WIA Secretary in 1933, peruses the first copy of AR as he ponders the advances of AR and the hobby over the past 50 years.

## ARTICLES

- A 70 cm Base Station Antenna by late Nev Fenton VK2ZBQ ..... 21
- Golden Jubilee by Jim Linton VK3PC ..... 12
- Hey-Day of Home Brewing ..... 53
- Jamboree on the Air ..... 56
- Memorial to VK4LK & the Flying Doctor by Peter Renton VK4PV ..... 27
- Message from the Minister for Communications ..... 9
- Mod for IC22S by Keith Heitsch VK4AHK ... 18
- New Game — What's my Callsign? ..... 75
- Old Timer, Old Rig ..... 25
- Pioneers of Amateur Radio in Australia by Maxwell Hull VK3ZS ..... 28

- Presidential Comment ..... 10
- Programmable Keyer by Gil Sones VK3AUI .. 19
- Reminiscing 62 years of Wireless by Frank Bridgewater VK2ZI ..... 34
- September's Best Photographs ..... 75
- Special Invitation ..... 59
- STS — 9 Update ..... 48
- The BC 348 Classic Communications Receiver by Allan Shawsmith VK4SS ..... 32
- Tower Safety ..... 35
- Weekend Project No 1 — Panoramic Adaptor by Ivan Huser VK5QV ..... 16
- Weekend Project No 2 — Digi Inside/Outside Thermometer by Ivan Huser VK5QV ..... 22
- What is the Historical Society of Australia .. 33

- International News ..... 36
- Intruder Watch ..... 50
- Ionospheric Predictions ..... 76
- Letters to the Editor ..... 74
- Listening Around ..... 49
- Magazine Review ..... 48
- National EMC Advisory Service ..... 64
- Obituaries — VK4BJ, VK2APV, VK2ZL, VK4FP ..... 78
- Pounding Brass ..... 62
- QSP ..... 50 & 59
- Silent Keys — VK5BB, VK7GW ..... 78
- Spotlight on SWLING ..... 63
- Thumbnail Sketches — VK2BWQ, VK4YF, VK4ADJ ..... 24
- VHF UHF — an expanding world ..... 54
- VK2 Mini Bulletin ..... 68
- VK3 WIA Notes ..... 69
- VK4 WIA Notes ..... 71
- WA Bulletin & the answer to RR ..... 72
- WIA News — Log Book Keeping & 50 year Callsigns ..... 11
- WICEN News ..... 59

## DEPARTMENTS

- A word from your Editor ..... 10
- Advertisers Index ..... 80
- ALARA ..... 56
- AMSAT AUSTRALIA ..... 60
- Awards — Paraguay, Cagou, SWL, Malta & Premier Town Awards ..... 52
- Book Review — New Call Book, 70 Years of Valves ..... 51
- Club Corner ..... 26
- Contests — Contest Champion ..... 65
- Education Notes ..... 46
- Five-Eighth Wave ..... 70
- Forward Bias ..... 68
- Hamads ..... 79
- Here's RTTY! ..... 57
- How's OX ..... 42

## DEADLINE

All copy for December AR must REACH PO Box 300, Caulfield South, 3162 no later than 25th October. Also please note the early deadline for January 1984 is the 18th November.

**EDITOR**  
GIL SONES\* VK3AUI

**TECHNICAL EDITORS**  
RON COOK\* VK3AFW  
PETER GAMBLE\* VK3YRP  
EVAN JARMAN\* VK3ANI  
BILL RICE\* VK3ABP

**CONTRIBUTING EDITORS**  
MIKE BAZELY VK6HD  
RON COOK\* VK3AFW  
REG DWYER VK1BR  
BRENDA EDMUNDS VK3KT  
MARSHALL EMM VK5FN  
RON FISHER\* VK3OM  
BRUCE HANNAFORD VK5XI  
ROY HARTKOPF\* VK3AOH  
ROBIN HARWOOD VK7RH  
COLIN HURST VK5HI  
ERIC JAMIESON VK5LP  
MARGARET LOFT VK3DML  
KEN MCLACHLAN VK3AH  
LEN POYNTER\* VK3BYE  
TONY TREGALE VK3QQ

**DRAFTING**  
GEORGE BROOKS  
LIZZ KLINE

**BUSINESS MANAGER & SECRETARY**  
REG MACEY

**ADVERTISING MANAGER**  
JOHN J A HILL VK3WZ  
\*Member of Publications Committee

Enquiries and material to:  
The Editor  
PO Box 300, Caulfield South Vic. 3162  
Material should be sent direct to PO Box 300, Caulfield South Vic., 3162, by the 25th of the second month preceding publication. Phone: (03) 528 5962. Hamads should be sent direct to the same address.  
Acknowledgement may not be made unless specially requested. All important items should be sent by certified mail. The editor reserves the right to edit all material, including Letters to the Editor and Hamads, and reserves the right to refuse acceptance of any material, without specifying a reason.

**Trade Practices Act:** It is impossible for us to ensure that advertisements submitted for publication comply with

the Trade Practices Act 1974. Therefore advertisers and advertising agents will appreciate the absolute need for themselves to ensure that the provisions of the Act are complied with strictly.

**Victorian Consumer Affairs Act:** All advertisers are advised that advertisements containing only a PO Box number as the address cannot be accepted without the addition of the business or residential address of the box-holder or seller of the goods.

**Production: BETKEN PRODUCTIONS**  
5 Masefield Avenue, Mooroolbark, 3138.

**Laser Scanned Colour Separations by: QUADRICOLOR INDUSTRIES PTY LTD, Graphic Division**  
22-24 Glenvale Crescent, Mulgrave, 3170.  
Tel.: (03) 560 2222

**Typesetting by: QUADRICOLOR INDUSTRIES PTY LTD,**  
22-24 Glenvale Crescent, Mulgrave, 3170.  
Tel.: (03) 560 2222

**Photographic film and processing material courtesy AGFA-GEVAERT LTD AUSTRALIA**

**Printers: WAVERLEY OFFSET PUBLISHING GROUP**  
Geddes Street, Mulgrave, 3170  
Tel.: (03) 560 5111



## AZDEN THE LEADER!

The two most popular 2m Transceivers on the Market

### PCS-300 HANDHELD



WRITE FOR COLOUR BROCHURE  
FULL WARRANTY  
BANKCARD WELCOME

**\$379**

### PCS-4000

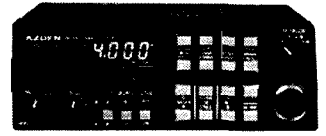

**\$475**

### ICOM

Overstocked!! Now going at special prices!

REMEMBER:

When you buy ICOM from us you buy from factory appointed dealer with English manuals and full 12 month warranty.

### NEW JST — 100

After you have seen everything else — Come and see the fantastic JST.

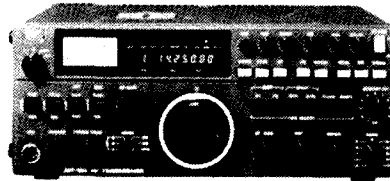

**\$2420**

NEW DIGITALLY SYNTHESISED MICRO-COMPUTER BASED TRANSMITTER/RECEIVER, WITH 11 CHANNEL MEMORY ETC. (Write for Colour Brochure)

### KENWOOD

New stock — Just arrived!  
Contact us for Best Prices:

R-2000	\$?
TS-430S	\$?
TL-922	\$?
DM-81	\$?
HC-12	\$?
<b>FULL 12 MONTHS WARRANTY</b>	

### NEW STOCK HERE!! ENB-1 NOISE BRIDGE



only \$89 incl Battery  
(+ \$4 post)

First delivery sold out before release — if you'd like to know more write for Specs. (Thanks for your many orders!)

### THE EAT — 300 TUNER IS BACK



**\$159**  
+ \$9  
post

All mail orders ready now — Enormous success, covers all freq. between 1.6 - 30 MHz continuously. Orders keep pouring in!

### NEW! ATC — 720SP



Full coverage 720 channels 118-136 MHz/AM PLL SYNTHESISED AIR BAND TRANSCEIVER NOW IN STOCK!

Write or ring for Specs.

### SWR & POWER METERS BELOW COST!

*PM-4HV —	\$40 now \$29
*PM-5V —	\$56 now \$39
*PM-3HV —	\$63 now \$45
*MCLA-1 —	\$95 now \$68
*AAF-1 —	\$95 now \$68
*MM-1 —	\$55 now \$28
*APM-2H —	\$79 now \$56
*PM 3HV —	\$63 now \$45

and many more — write for details

**HURRY — LAST STOCK**  
Almost sold out.

### NEW RX — 40 RECEIVER

- PLL Synthesised VHF/FM
- All main amateur commercial and marine bands.
- 800 channels

HERE AT LAST IN RESPONSE TO MANY REQUESTS — write for specs



### EMTRON ALL BAND ANTENNA

only \$69  
+ \$6 post  
GREAT  
VALUE!



The perfect match for your Emtron EAT-300 antenna tuner. Covers 160-10m, handles 2kW PEP and comes completely assembled without any efficiency robbing traps.



**FILTERS**  
DRAKE: TV 3300 LP filter..... \$45 + \$2 post  
MONITOR TV: HP30 HP filter \$29 + \$2 post

### EAT-301 THE NEW ANTENNA TUNER

**\$99 + \$6 post**



This tuner has same specifications as EAT-300, but no SWR bridge. 160m band coverage and 4:1 balun

### SPECIAL REDUCED

200W ALL BRAND ANTENNA TUNER  
from  
**TOKYO HIGH POWER —  
HC-200**

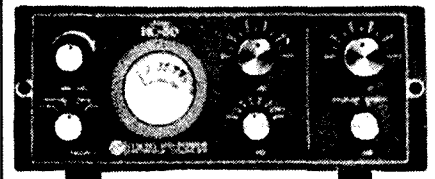

**\$139**



The HF Allmode Transceiver you have been waiting for — from **YAESU**

## FT757GX

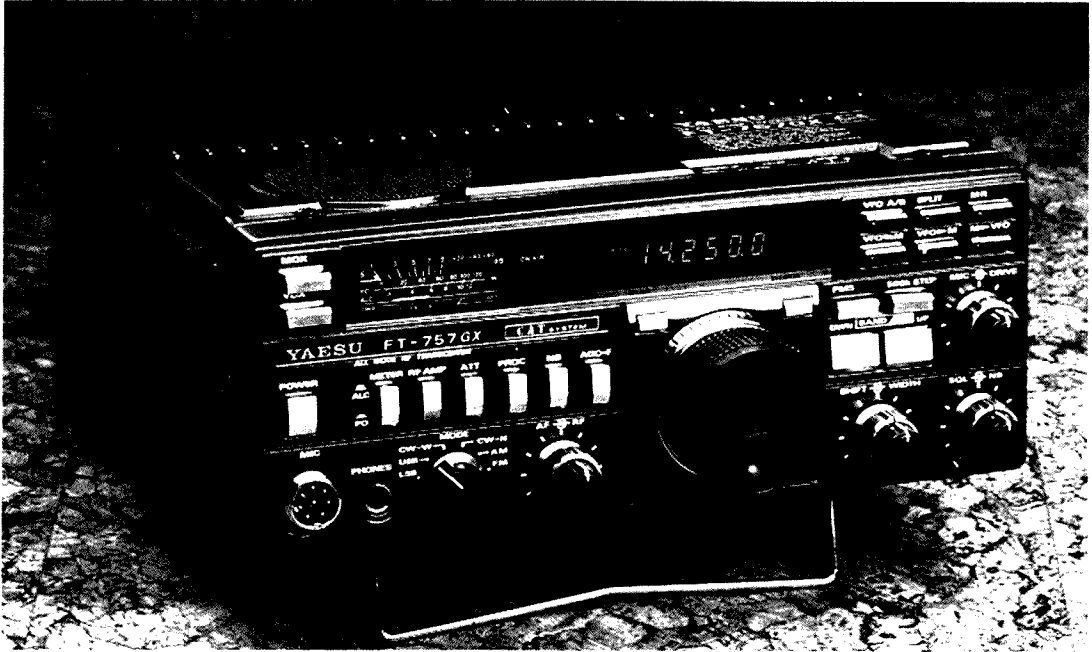

100W Output PEP/DC — 25W AM Carrier — 13.4 V DC, (19 A for 100W output) — Weight 4.5 kg

### FEATURES:

- Dual VFO's and eight memories.
- Programmable Memory Scanning.
- SSB, AM, FM Modes Standard.
- Squelch on all Modes.
- Full Break-in CW.
- Accessories installed include:  
600Hz CW Filter, iambic keyer with dot-dash memory, marker, IF shift and width, N.B. (only option is CAT Interface to external computer control).
- High performance General Coverage Receiver.

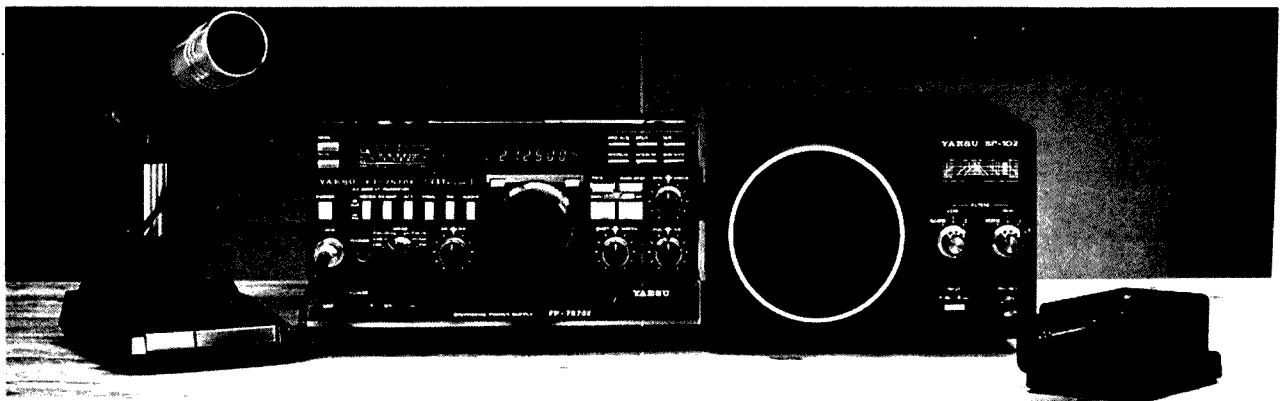

**bail**

**BAIL ELECTRONIC SERVICES**  
**38 FAITHFUL STREET, WANGARATTA 3677**  
Telephone: (057) 21 6260 — Telex: 56880  
**DISTRIBUTORS AND AGENTS IN ALL STATES**

Stan Roberts  
and Staff —  
VK3BSR

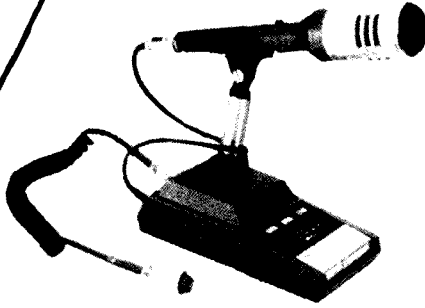

## FT726 V/UHF ALL MODE TRIBANDER

- USB, LSB, FM, CW modes
- 10 watt RF output on two metre (6 metre, 70 centimetre units optional)
- 11 memories store mode as well as band
- Programmable limited band seen between memories
- Satellite I.F. unit (optional) for full duplex cross-band
- Squelch on all modes
- GaAs FET RX pre-amp in 70 centimetre unit



Congratulations AR on your Golden Jubilee.



## FT980 HF ALL MODE COMPUTER AIDED TRANSCEIVER

Built-in computer control using 8-bit microprocessor  
(80C85)



- General coverage RX 150KHz-29.99MHz
- Power output 100 watt SSB, CW; 25 watt AM; FSK
- Two independent RX front-ends using JFets
- 12 memory channels storing mode and frequency
- Rear panel connections for transverter, linear amplifier and external microcomputer interface

**bail**

**BAIL ELECTRONIC SERVICES**  
**38 FAITHFUL STREET, WANGARATTA 3677**  
Telephone: (057) 21 6260 — Telex: 56880  
**DISTRIBUTORS AND AGENTS IN ALL STATES**

Stan Roberts  
and Staff —  
VK3BSR

# Is the World of ELECTRONICS Your Scene?

- MICROPROCESSORS
- RADAR
- TRANSMITTERS
- RECEIVERS

Switch on to courses leading to challenging, well paid careers as a Radio Officer or Electronics Technical Officer at the



## Australian Maritime College

Two year, Associate Diploma courses, HSC or equivalent entry, available in Marine Radiocommunication and/or Maritime Electronics.

The Australian Maritime College is Australia's only national, tertiary educational institution providing multi-level, maritime courses exclusively for the fishing, shipping, port and offshore industries. The AMC is the only place in Australia where training for Radio Officers is conducted.

Cut out and send to:  
Admissions Office,  
Australian Maritime College,  
P.O. Box 986,  
Launceston, 7250,  
Tasmania.  
Telephone: (003) 26 0731

Please send me more information on  
Marine Radiocommunication and/or  
Maritime Electronics Courses.

Please print

Name: \_\_\_\_\_  
Address: \_\_\_\_\_  
Postcode: \_\_\_\_\_  
AR

18905

## COUNCIL PROBLEMS? THE ANSWER TO LIMITED SPACE

EFFICIENT ANTENNA FOR LIMITED SPACE

Both models C/4 & HQ1 cover 6-10-15 and 20 m.

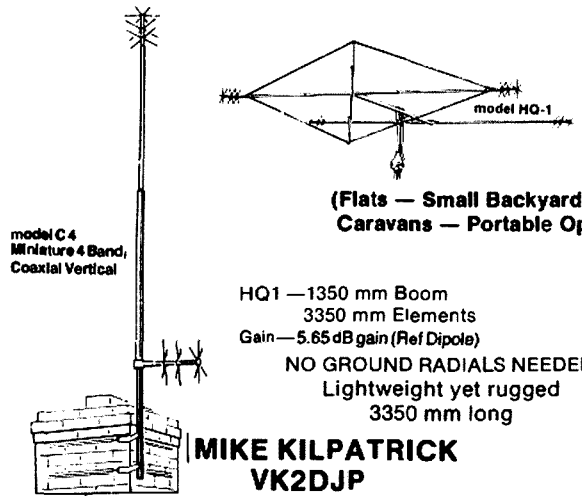

(Flats — Small Backyards —  
Caravans — Portable Ops.)

HQ1 — 1350 mm Boom  
3350 mm Elements  
Gain — 5.65 dB gain (Ref Dipole)

NO GROUND RADIALS NEEDED  
Lightweight yet rugged  
3350 mm long

MIKE KILPATRICK  
VK2DJP

# WATCHMAN ELECTRONICS

28 Elouera Cres, Woodbine, NSW 2560  
Phone (046)26 6101

## VAINS ANTENNA SERVICES PTY. LTD.

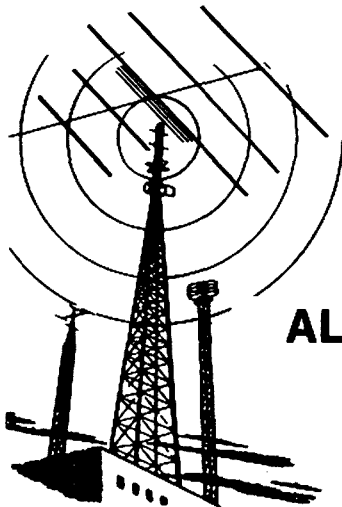

- ★ RADIO CONTROLLED VEHICLES — INSTALLATIONS
- ★ ADDITIONAL OUTLETS FOR TV/FM
- ★ REPAIRS TO EXISTING SERVICES

### ALL SUBURBS

- ★ PHONE FOR ADVICE
- ★ DO IT YOURSELF KITS
- ★ M.A.T.V. SYSTEMS DESIGNED & INSTALLED
- ★ TELESCOPIC MASTING & TOWERS INSTALLED

# 874 3333

13 McKEON RD., MITCHAM

## DO YOUR EYES NEED ATTENTION?



Why Don't You Direct Yourself To  
One Of Your Big Family?

## OPTILUX Optical Dispensers & Photo Dealers

363 Parramatta Road,  
LEICHHARDT, NSW 2040  
Phone (02) 560 9415

ASK FOR BRUNO VK2BPO

He can arrange an immediate appointment for a complete eye examination without any need of referral

BIG RANGE OF IMPORTED FRAMES — VERY QUICK SERVICE — DISCOUNT FOR ANY AMATEUR OR SWL AND A CAMERA STORE TOO AT COMPETITIVE PRICES AT YOUR DISPOSITION

SEE YOU SOON

VK2BPO

Congratulations to Amateur Radio for fifty years of support and service to the Australian Amateur.

# CAMERAS & FILMS



TO COLOUR  
YOUR LIFE...  
BEAUTIFULLY

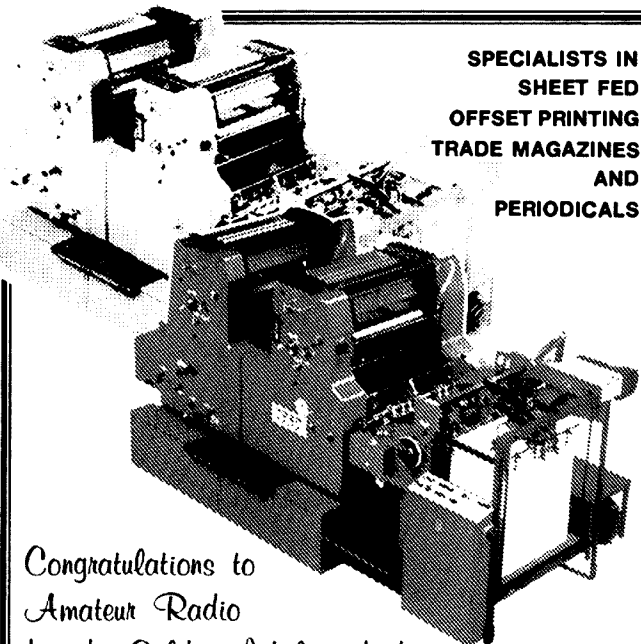

SPECIALISTS IN  
SHEET FED  
OFFSET PRINTING  
TRADE MAGAZINES  
AND  
PERIODICALS

Congratulations to  
Amateur Radio  
for the Golden Jubilee of their magazine.

**WAVERLEY  
OFFSET  
PUBLISHING  
GROUP**

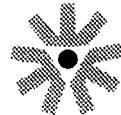

GEDDES STREET,  
MULGRAVE, 3170.  
PHONE 560 5111  
(10 LINES)

*Quadricolor Industries  
Pty Ltd,  
wish to congratulate the  
Wireless Institute of  
Australia on their 50th  
Anniversary. Quadricolor are  
proud to be associated with  
the publication of Amateur  
Radio through our typesetting  
and reproduction facilities at  
our modern printing plant in  
Mulgrave, Vic.*

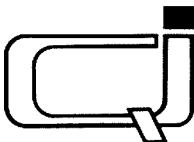

**QUADRICOLOR  
INDUSTRIES PTY LTD**  
"The magazine printing specialists"

33-35 Glenvale Crescent, Mulgrave, Vic. 3170.  
Telephone: (03) 560 2222 Telex: AA36000

## Congratulations on 50 YEARS

*anniversary  
special*

**\$199**

Previous price  
**\$229**

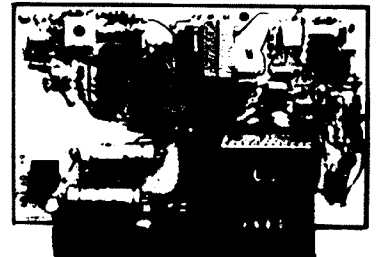

**TDK-20 RTTY Interface for the VIC-20. Send and receive RTTY code, listen to Radio Amateurs and International News Radio Teletype (RTTY) with your VIC, TDK-20 and receiver.**  
Requires 1/12 volt centre taped transformer (\$6.50) 1 user port plus (\$6.50) and if required AFSK board (\$52.00)

For pure sophistication in RTTY/ASCII  
**AMT-1 AMTOR TERMINAL UNIT \$599**  
**AMTOR MARK 2 (Assembled and tested) \$299**

**CW ELECTRONICS**

416 LOGAN ROAD, STONES CORNER, BRISBANE.  
PHN: (07) 397 0888  
P.O. BOX 274, SUNNYBANK, QLD, 4109.

**IF YOU CAN'T FIND IT ANYWHERE ELSE —  
BECAUSE IT'S TOO SMALL (LIKE IS, SPRATLY IS.) —  
DON'T WASTE MORE TIME, USE:**

**THE COMMUNICATIONS ACCESSORY  
EVERY OPERATOR SHOULD HAVE**

Some of the features are:

- AMATEUR RADIO PREFIXES  
WITH STATE PREFIXES.
- GREAT CIRCLES.
- WAZ ZONES
- ITU REGIONS
- 10m BEACON LOCATIONS AND CALLSIGNS.
- THE MOST IMPORTANT STANDARD FREQUENCY  
AND TIME SIGNAL STATIONS.
- SHORTWAVE BROADCAST TRANSMITTERS.
- CONTINENTAL BORDERLINES.
- INTERNATIONAL DATELINE.
- DAYLIGHT/DARKNESS ZONES.
- TWILIGHT ZONES.
- SUNRISE/SUNSET TIMES.
- POSITION OF SUN DEPENDING ON DAY TIME  
AND SEASON.
- SUBSOLAR POINT PROJECTION.
- DISTANCE MARKINGS ON GREAT CIRCLES.

Price: \$174.00 ex warehouse Perth  
Airfreight: \$8.00 within Australia

**“THE GRAY-LINE RADIO GLOBE”  
by Columbus  
(A WEST-GERMAN QUALITY PRODUCT)**



Distributors for Columbus  
Terrestrial, Celestial  
and Lunar Globes

**RIALTO INTERNATIONAL**

26 Karoonda Rd, Booragoon, W.A. 6154  
Tel (09) 364 4768

**William Willis & Co. Pty. Ltd.**

**“TRIO” DM801  
DIP II METER**



**\$147.60  
inc post &  
packaging**

98 Canterbury Rd, Canterbury  
Vic 3126  
Phone: 836 0707

CO-AX CABLES H D COPPER WIRE  
HIGH QUALITY PORCELAINE  
INSULATORS

Congratulations to  
“AMATEUR RADIO”  
magazine  
on its 50th year of publication

THE TYPE 610 BRITISH POST  
OFFICE designed MORSE CODE KEY

**\$41 inc post & packaging**

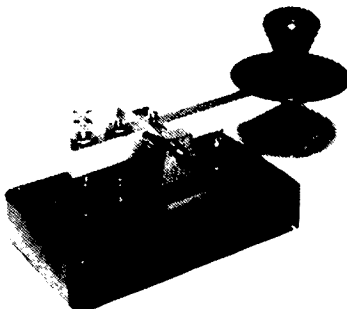

There has never been a better designed Morse  
Code Key — SOLID, ROBUST and BEAUTIFULLY  
BALANCED.



**MODEL 444-D  
DUAL IMPEDANCE  
CONTROLLED MAGNETIC®  
COMMUNICATIONS  
MICROPHONE**

**GENERAL:** The Model 444-D is a pressure-operated  
CONTROLLED MAGNETIC microphone. It is specifically  
designed for radio communication applications and provides  
optimum performance from single sideband transmitters as  
well as AM and FM units. The response cuts off sharply below  
300 Hz and above 3000 Hz, with a rising characteristic to  
3000 Hz. This special response characteristic results in  
optimum speech intelligibility and audio punch to cut  
through noise and interference.

**MICROPHONE FEATURES:** • A response tailored for single  
sideband transmissions • A switch for instantaneous  
selection of Press-To-Talk or VOX (voice-operated relay  
control) operation • Finger-tip control bar (locking or non-  
locking action) to actuate microphone and an external relay  
or control circuit • Long-life switch to satisfy severe  
requirement of communication systems • Adjustable  
microphone height • A sturdy, high impact ARMO-DUR®  
base and microphone case • Dependability — under all  
operating conditions.  
The “SHURE” MODEL 444 has one of the best “sounds” on  
the amateur bands.

**IT'S THE BASE STATION  
MICROPHONE FOR YOUR STATION**

**Price: \$145 (inc post)**





MINISTER FOR COMMUNICATIONS  
PARLIAMENT HOUSE  
CANBERRA ACT 2600

22 AUG 1983

Mr B. Bathols  
Federal President  
Wireless Institute of  
Australia  
PO Box 300  
CAULFIELD SOUTH VIC 3162

Dear Mr Bathols

It is with great pleasure that I congratulate the Wireless Institute of Australia on the Golden Anniversary of the Institute's magazine - Amateur Radio.

Since its inception, the magazine has contributed significantly to the technical and social needs of WIA members, and indeed, to the Amateur Service as a whole. I believe that it must be a matter of considerable pride to the WIA that the high standards initially set by this publication have been so consistently maintained over such a long period of time.

The magazine has always most generously provided a forum for dissemination of Government policies and I would like to take this opportunity of expressing my appreciation of the willingness with which the WIA has provided this service to the advantage of both my Department and the Amateur community. Since becoming Minister for Communications I have been particularly impressed to observe the cordial relationship which exists between the Institute and my Department's Radio Frequency Management Division.

It is indeed no mean feat for a publication of this nature to have provided the service it does so well to its members for half a century. I wish the magazine well in its role as a continuing source of information for the Australian Amateur and trust that its next half century will be as successful as that of the past fifty years.

Yours sincerely

Michael Duffy





# a word from your EDITOR

This is the Golden Jubilee issue of Amateur Radio magazine. Amateur Radio magazine has now been published for fifty years.

Many changes have taken place over the years, changes in both the magazine and also in our hobby of amateur radio.

Whilst the technological changes have been great, the basic aims of the amateur service have remained the same. The technological changes have opened up many new areas of interest to the enthusiast.

Amateur Radio magazine production has evolved and this magazine is now the result of these changes. The technology of magazine production has moved forward at a similar rate as our technology advances and in many instances uses the same technology advances that have given us the amateur radio equipment of today.

Both the hobby of amateur radio and Amateur Radio magazine depend on the work of the enthusiasts who carry on with the basic aims of the Amateur Radio Service.

Happy Jubilee AR — and long may you continue to serve the members.

Gil Sones, VK3AUI

AR

## PRESIDENTIAL COMMENT

### WITH THE PRESIDENT

It is good to receive some correspondence from members in respect of some of our editorials, it just goes to prove that there are some readers out there taking an interest in what is going on.

A letter from Syd VK3ASC suggests my calculations of escalated costs of amateur equipment may have been incorrect in respect of the thirty percent tariff duty. I initially stated prices will escalate to forty to forty five percent above current retail prices (see August AR, P8). This figure was arrived at during informal discussions with some of the importers, however, on paper anyway, Syd is certainly correct.

Assuming all stages from importers, landed costs through to wholesale and retail distribution carry a mark up profit margin of twenty five percent, then the end user price should only be a twenty seven to thirty percent increase on current retail prices. This is still far too much, yet if my information is correct, certain 'hidden' costs could be added to the final selling price.

Perhaps the trade should take a warning, amateurs are prepared to be hit over the head, and pay their fair dues, but stamping us into the ground at the same time, could be just the straw to break the camel's back.

### RD CONTEST

The VK5 division has raised a query from a member in respect of anomalies with the 1983 RD Contest rules. The major point in question was the rule change to exclude an operator running two separate stations simultaneously, that is, using his/her own callsign for one station, and a club callsign for the other.

I believe Reg Dwyer, our contest manager, has acted quite correctly with this one, by not allowing credit to be given in such cases.

Fair crack of the whip fellows, that is a case of wanting your cake and eating it too!

If operators are desirous of such activity, there is no objection to splitting your time between the two callsigns. Say, four hours with the club callsign, then four hours with your own, but not both together. What do others think?

### GENERAL

Members might like to know that there is quite a lot of activity going on behind the scenes at the moment (as is always!).

After going through panic stations with the twenty eight percent tariff duty increase, which by the way is not settled yet, but we are working on it with some light at the end of the tunnel, we still have the new Radio Communications Bill to contend with. We are hopeful the Bill will have been tabled in Parliament by the time this item appears in print.

Much has been said about the Bill in this and other publications. Providing it gets through the politicians without too much alteration from its final draft form, we can expect far greater activity in respect of the policing of some illegal operations. Sales of equipment to unlicensed persons are being tightened up, and a general cleaning up of some of the anomalies associated with the old W and T Act. In many cases, the Bill will benefit the Amateur Service as a whole, but the odd individual who doesn't toe the line now, is going to discover that the Department actually does have some teeth, and is prepared to use them.

## SCANNERS

A hot issue at the moment revolves around scanning receivers. Various points have been published in the daily media. We are all a bit in the dark on this, as on one hand there is extreme pressure from law enforcement agencies and Telecom on the Department to 'do something', yet on the other hand, there are countless thousands of scanning receivers in use by the general public.

It puts the Department into quite a dilemma, doesn't it?

It seems a pity that the horse is now eight furlongs down the straight, yet now we discover the starting gates are to be closed.

This tiger will attack if its tail is pulled hard enough, so how does one regulate a system which is virtually unregulatable? The short answer is — you can't!

Our ancient laws and customs regulations are not keeping pace with today's technology. We would like to suggest that some measure of protection could be given to those requiring privacy of radio communications, by installing scrambler systems immediately. Do the job properly too, and outlaw today import of scrambler detection devices, and put them under strict Government control, before some enterprising company starts to bring them into this country by the truck load.

The place to stop it is at the import stage, not after it has been landed and sold.

Ban publication of circuits of these devices in the name of National Security.

These types of measures must be taken immediately. There are too many examples of imported electronic equipment coming into Australia first, before the consequences of some have been realised.

Think first, then act, so that we amateurs can get down to running our hobby, as it should be, without political intervention.

## HAPPY BIRTHDAY AR

This month starts the beginning of the second Golden Jubilee in the production of Amateur Radio magazine.

The first issue of Amateur Radio was published in October 1933. Please see Jim Linton's special article printed elsewhere in this issue.

Perhaps most of our younger amateurs will still be around in October 2033, to see the Centenary issue.

How rapidly we have expanded in the past fifty years, and each day brings a new development in technology.

Wouldn't it make an interesting prophecy to look into the future, to see what develops?

I guess myself and many others like me will be able to look down from the Ethereal Shack, perhaps we might say — "I still reckon tubes do a better job!"

Happy 50th, AR.

Bruce R Bathols, VK3UV  
WIA FEDERAL PRESIDENT

AR



# WIA NEWS

## LOG BOOK KEEPING

As a result of negotiations between the Institute and the Department of Communications concerning log keeping requirements for amateurs.

The Department has advised the Institute that in accordance with the provisions of Wireless Telegraphy Regulation 31 (1), the following changes to the conditions governing log keeping by Australian amateur stations have been authorised:

Log keeping shall be optional, provided (a) every amateur station shall have a log book

available in which to record distress and emergency traffic. In the case of a network carrying emergency traffic, a log shall be kept by the control station. (b) a log shall be kept by an amateur if requested to do so by an officer of the Department of Communications.

It is important to note that club stations are still required to maintain a log of all transmissions in accordance with the format detailed in Para 6.11 and Appendix 15 of the Amateur Operators Handbook.

Suitable log books are obtainable from your division or Magpubs.

## PHONE PATCHING

Mr Peter Thomas of Telecom Australia has released guidelines on phone patching in this country, which includes the amateur service.

Mr Thomas stated that Australian radio amateurs would be able to use approved phone patch equipment that was wired in place by Telecom.

Further details of this arrangement may be obtained from Telecom Headquarters and November AR.

# GOLDEN JUBILEE

Jim Linton, VK3PC  
4 Ansett Court, Forest Hill, Vic 3131

The official journal of the Wireless Institute of Australia — Amateur Radio — was born fifty years ago this month. It was fathered by forward-thinking WIA members who nursed it through its pre-World War 2 childhood.

On the outbreak of hostilities AR was saved from death by another group of radio amateurs which nurtured the magazine through most difficult times.

It survived and soon after the war reached adolescence, blossomed into adulthood, weathered the times of change and in 1983 has attained a maturity that should see it around for as long as the hobby of amateur radio exists.

In researching this article it became clear that one man can be rightly described as "The Father of AR" — Harry Kinnear (ex VK3KN now VK4AVJ).

Later in this biography of AR Harry's own recollections of the early days are reproduced in his words — but now let us have a look at what others have to say about the magazine.

## HOW DID IT ALL BEGIN?

Bob Anderson VK3WY, Assistant VK3 Divisional Secretary 1930-33 and Secretary 1933-47, remembers that there used to be a roneoed publication of a few pages put out by Cedric Searl, late VK3ARX. Bob said this publication was done in a humorous style and in his opinion it could not really be called a forerunner of AR. "When it stopped being produced it gave a glimmer of the idea that a magazine was desirable. A magazine was talked about at meetings a number of times."

He said those on the VK3 Divisional Council gave it much thought and a lot of hard work was carried out by Harry Kinnear, Vaughan Marshall, Bill Gronow and himself.

Bob said: "The financial aspect gave us a worry. Various ideas and thoughts were pooled and we worked out that it could be done."

"The main theme in the back of our minds was that the ARRL was centred around QST, the ARRL journal. It was felt we should do the same thing in Australia."

He said a magazine was seen as desirable for its Public Relations value. "We thought it would help keep the Institute together and get publicity for the Institute."

"Over the years, prior to 1933, it was felt that amateur radio in Australia could do with Public Relations."

"There were some stories in the daily papers, but the hobby was not generally taken seriously."

"There was a weekly column in Listener In<sup>1</sup> about amateur radio. But it was thought a magazine would do more for the hobby and bring other amateurs into the Institute."

## COMMITTEE MEETS TO DESIGN THE COVER

The first cover design was decided at a meeting in the home of Bill Sones who was involved in WIA activities and was a Vice-President on the Victorian Divisional Council.

Those who attended this historic meeting in 1933 were Bill Gronow VK3WG and Vaughan Marshall VK3UK.

Bill Gronow, VK3 Divisional President 1935-41, Federal President 1939, 1947-50 and 1954, recently recalled: "Bill Sones was not an amateur, he used to write a page on shortwave listening matters for Listener In.

"He was interested in the setting up of the magazine and had quite a bit to do with the Council discussions on it, but I don't think he took any actual part in its preparation because of his connections with Listener In."

The magazine committee for the first edition was editor Harry Kinnear, sub-editors Bill Gronow, and Vaughan Marshall. When Bill Sones stepped out of AR affairs Jim Marsland, late VK3NY, joined as committee secretary.

Bill Gronow said: "Harry and I did most of the advertising selling — but it got too big for us and we couldn't cope."

"When printing of the magazine was transferred from Wilke & Co to Elsum Printing Company, in 1934, Elsum took over the advertising selling."

Bill Gronow became editor in 1936, a position he held until January 1941. Enlistment in the RAAF of most of the magazine committee and with the Victorian Division unable to continue publication the February 1941 issue did not appear.

A new committee was formed and AR was resuscitated with a war-time hand duplicated issue until September 1945.

The war-time committee included Tom Hogan as editor, Jim Marsland and Herb Stevens VK3JO, VK3 Divisional President 1941-45.

It was the job of Herb to have the names and addresses written on the AR wrappers and bundle them up for the divisions to distribute.

Reaching back into his memory he recollects: "The first issue during the war-time was the worst, none of us had been completely familiar with a duplicator."

"We had to sort out the good copies from the spoilt ones — believe me there were plenty of spoils."

"It was quite a time-consuming problem. Some of the committee had a conference with

the representative of the duplicator firm to see if things were being done right."

Anyone who has used the type of duplicator used by the committee knows all too well that spoils are a fact of life.

Herb said everyone involved with the war-time AR felt it was important to keep the magazine going.

He said: "The magazine was particularly important during war-time when membership dwindled, people were away at war, and we saw it as a way of keeping in touch."

"We couldn't communicate by radio. A nucleus kept it going with the feeling that at the end of the war there would be renewed interest and with a magazine helping to get things going after the war."

"It let those overseas know that the WIA continued during the war. Those in the services who received it appreciated notes about fellow amateurs in the services and what they were doing."

"One had to be careful because of censorship, and not say exactly whereabouts overseas they were."

DECEMBER 1st, 1939 AMATEUR RADIO Page 25

### Royal Australian Air Force

---

#### VACANCIES FOR WIRELESS OPERATORS

Applications will be received from amateurs in all States.  
Details of enlistment from the Secretary, Air Board, or W.I.A. Divisional Headquarters.  
Apply at once by mailing the form below.

---

The Secretary,  
Air Board,  
Victoria Barracks,  
MELBOURNE, S.C. 1

I wish to enlist in the Royal Australian Air Force as a Wireless Operator. My age is \_\_\_\_\_ years<sup>1</sup>, I hold the A.O.P.C. and can send and receive at \_\_\_\_\_ w.p.m.<sup>2</sup> I am available for immediate war service.

Signed \_\_\_\_\_  
Address \_\_\_\_\_

Date \_\_\_\_\_

<sup>1</sup>Age limits are 18 to 35 years and minimum speaking speed is 14 w.p.m.  
NOTE 1.—Enlistees appear upon giving full details of qualifications, etc.  
NOTE 2.—Persons who do not possess the above qualifications, but who are desirous of enlisting for military or wireless operations may do so by applying to the above address stating their particulars.

The magazine kept the spirit of the hobby alive, despite the officially imposed radio silence, and united amateurs in a determination to get back on air at the end of the war.

Just try and imagine printing about 600 copies of AR, wrapping, addressing and posting them, all by hand.

The war-time issues had up to sixteen pages and to fill the pages must have been no easy task — remember that there were no active radio amateurs because their equipment was compulsorily put into sealed boxes.

The widow of Jim Marsland, Mrs Elva Marsland remembers vividly the production of the war-time AR on a hand-operated duplicator at her home in Camberwell.

She said her late husband and the others took two consecutive Saturdays a month turning out the magazine pages.

During that four and a half year period Mrs Marsland was the tea-lady for the "printing office" and assisted in the collation of pages.

Mrs Marsland said the magazine was sent free to servicemen who were radio amateurs before the war and appreciation for this was received from the men stationed overseas.



**Wartime Production Crew. L to R: Herb Stevens, Bert Vertigan, Elva Marsland, Jim Marsland, Charlie Quinn and Tom Hogan.**

*"The hobby was a bit of a dream for many servicemen. I think most of us had built about fifty transmitters in our own minds as a sort of a sideline if we had time to think about it."*

Bill Gronow has some firm views on the worth and role of AR. He said: *"The magazine is essential to hold the WIA together. Without it you would have a very disjointed Wireless Institute because of the different states and areas."*

*"It's not all that easy to hold a big show together unless you've got communication — the magazine provides it."*

*"Today's amateurs owe a lot to AR — it bound them together, co-ordinated the activities, and was the only way to inform both the active and inactive amateur."*

*"I would say that the Institute could cut out a lot of things — but not AR — it's vital."*

It was October 1945 when AR resumed normal issues and the advertisers who previously supported the magazine gave their support again.

The basic format and content changed little over the following years, but every issue had something for everyone.

Up until February 1972 the Victorian Division of the WIA produced the magazine and for reasons including the financial burden it imposed, AR was handed over to the Federal Office.

The person who would have had the longest direct association with AR is Ron Higginbotham VK3RN.

He helped with the war-time issues before joining the army. After the war he renewed his association by doing the linotyping for the magazine from 1947-49, being a lino operator at the printing firm — The Richmond Chronicle.

In mid-1949 The Richmond Chronicle took over the printing of the magazine with Ron doing the work.

He was a member of the WIA publications committee 1947-64 and The Richmond Chronicle continued printing AR up until March 1973.

Ron said the war-time AR ensured that the magazine returned to normal printing after the war and that was what those involved with the war issues were hoping.

He is in a unique position due to his long association with AR to be able to comment with authority on its troubles and development

over the years.

Ron said it is an essential item to have a house journal, particularly these days because there are so many facets of the hobby.

He said: *"Finance was one difficulty and the Federal Convention wouldn't give more money to help with AR production."*

*"There were many requests over the years from members to improve the paper quality from the newsprint it was printed on."*

*"Advertising revenue increased allowing the quality of paper to progressively be improved to an art quality."*

First came the war surplus disposals gear which was extremely useful to radio amateurs and of a quality and price that could only have been dreamed of before the war.

There were transmitters, receivers, transceivers, ATU's, and a wide range of bits and pieces easily adapted for amateur purposes.

Then later there were commercially made items aimed at radio amateurs such as the Gelo VFO's, then Gelo receivers and transmitters.

The real "black-box" age started with the Swan and Galaxy transceivers that appeared in various models. Eddystone receivers, Johnson Matchbox ATU's, Johnson transceivers and then came the now familiar Yaesu transceivers.

Not only AR revenue from advertising was helped by the "black-boxes" according to Ron, but those amateurs off the air had their interest in the hobby "re-kindled" after reading about the commercial gear.

However the "black-boxes" had an adverse effect on AR with a downturn in technical articles because amateurs were just not building things.

Ron is a WIA Life Member, and on his retirement from the Publications Committee in 1964 the committee decided, in recognition of his long service, to re-name the Editor's Award for the best technical article — The Ron Higginbotham Award.

The scope of this award has changed since to reflect a downturn in the number of technical articles being supplied to the magazine.

#### **THE MAGAZINE IN THE 1980s**

Since 1972 the magazine has been under the full control of the WIA Federal Body.

Those who have kept a close watch on our



**L to R: Jim Marsland, Bert Vertigan and Tom Hogan prepare another edition of AR during the war years.**

Jim Marsland's involvement with AR covered a life-time of positions including editor and he also served as the secretary of the WIA's Federal Executive.

In tribute to him Bill Gronow said: *"Jim was undoubtedly one of the most loyal and hardworking members of the war-time committee."*

*"The fellars did a fine job in keeping the magazine going. Tom Hogan, editor, was a marvellous person, confined to a wheelchair — always a cheerful bloke."*

*"I imagine getting the magazine out at that time would not have been easy — to get enough copy for one thing."*

Bill said he believed having AR going was a great help after the war, a concept of what was wanted, and all the fellars coming back "full of vim and vigour" to get back to normal.

**AUSTRALASIAN ENGINEERING EQUIPMENT CO.**  
PTY. LTD.  
"Ervana House," 415 Bourke Street, Melbourne, C.I.

**TRANSMITTING CONDENSERS**  
HIGH VOLTAGE

Paper Dielectric—Wax Filled  
**T.C.C. CONDENSERS**

T.C.C. High Voltage Transmitting Condensers have been used practically exclusively by the "A" and "B" Class Broadcasting Stations throughout Australia, and also by all the leading Amateurs.

Type No.	Capacity	Height	Width	Thickness	Working Voltage D.C.	Price
181	0.0015	1 1/2	1 1/2	1/8	1500	12/1
121	0.01	1 1/2	1 1/2	1/8	1500	12/1
101	1 mfd.	1 1/2	1 1/2	1/8	810	18/6
121	1 mfd.	1 1/2	1 1/2	1/8	810	18/6
121	1 mfd.	6	6	1/8	1500	24/6
121	2 mfd.	6	6	1/8	1500	24/6
121	2 mfd.	6	6	1/8	2500	31/6
121	2 mfd.	6	6	1/8	2500	31/6

High Tension Condensers for smoothing purposes, with working voltages up to 25,000 volts D.C., may also be obtained. Prices on application.

— THE —  
**Harlie**  
MICROPHONE

Single Carbon Button Type.  
List Price, £5/5/- Complete.

The Harlie Mike has approximately 25 volt output. It is self-contained, having matching Transformer and Bias Battery incorporated in base. Complete with On-Off Switch.  
Height adjustable from 18 in. to 18 1/2 in.

**Microphones**  
VEALLS as usually Made in Types  
for Amateur Stations



**Piezo Astatic Microphones**  
MODEL D104 £7/15/0

BRUSH CRYSTAL MICROPHONES  
G253P £27 10/0. H252P £17 10/0.  
G450P £39 10/0. L353P £16 10/0.

B.G.F. HOME BROADCASTERS  
Small Table Microphone complete Transformer notes for use with small P.A. Amplifier 39/-

Write for Illustrated Price Lists and full Particulars

**VEALLS**  
215-219 Swanston St., Melbourne  
168 Swanston St., Melbourne  
299-301 Ch. Hill St., Fitzroy  
3-5 Riverdale Rd., Camberwell  
Cent. 3058 16 10e-81, 10-21.  
Wind. 1605, W 5160

**Victorian QSL Bureau.**  
H. H. JONES, VE6LH



**QSL NOTES FOR MAY.**  
Cards sent on hand at the Bureau, 23 Lombard Street, from Bill for the following Victorian stations, and likewise, and will be furnished on receipt of postage:

312, 313, 314, 315, 316, 317, 318, 319, 320, 321, 322, 323, 324, 325, 326, 327, 328, 329, 330, 331, 332, 333, 334, 335, 336, 337, 338, 339, 340, 341, 342, 343, 344, 345, 346, 347, 348, 349, 350, 351, 352, 353, 354, 355, 356, 357, 358, 359, 360, 361, 362, 363, 364, 365, 366, 367, 368, 369, 370, 371, 372, 373, 374, 375, 376, 377, 378, 379, 380, 381, 382, 383, 384, 385, 386, 387, 388, 389, 390, 391, 392, 393, 394, 395, 396, 397, 398, 399, 400, 401, 402, 403, 404, 405, 406, 407, 408, 409, 410, 411, 412, 413, 414, 415, 416, 417, 418, 419, 420, 421, 422, 423, 424, 425, 426, 427, 428, 429, 430, 431, 432, 433, 434, 435, 436, 437, 438, 439, 440, 441, 442, 443, 444, 445, 446, 447, 448, 449, 450, 451, 452, 453, 454, 455, 456, 457, 458, 459, 460, 461, 462, 463, 464, 465, 466, 467, 468, 469, 470, 471, 472, 473, 474, 475, 476, 477, 478, 479, 480, 481, 482, 483, 484, 485, 486, 487, 488, 489, 490, 491, 492, 493, 494, 495, 496, 497, 498, 499, 500, 501, 502, 503, 504, 505, 506, 507, 508, 509, 510, 511, 512, 513, 514, 515, 516, 517, 518, 519, 520, 521, 522, 523, 524, 525, 526, 527, 528, 529, 530, 531, 532, 533, 534, 535, 536, 537, 538, 539, 540, 541, 542, 543, 544, 545, 546, 547, 548, 549, 550, 551, 552, 553, 554, 555, 556, 557, 558, 559, 560, 561, 562, 563, 564, 565, 566, 567, 568, 569, 570, 571, 572, 573, 574, 575, 576, 577, 578, 579, 580, 581, 582, 583, 584, 585, 586, 587, 588, 589, 590, 591, 592, 593, 594, 595, 596, 597, 598, 599, 600, 601, 602, 603, 604, 605, 606, 607, 608, 609, 610, 611, 612, 613, 614, 615, 616, 617, 618, 619, 620, 621, 622, 623, 624, 625, 626, 627, 628, 629, 630, 631, 632, 633, 634, 635, 636, 637, 638, 639, 640, 641, 642, 643, 644, 645, 646, 647, 648, 649, 650, 651, 652, 653, 654, 655, 656, 657, 658, 659, 660, 661, 662, 663, 664, 665, 666, 667, 668, 669, 670, 671, 672, 673, 674, 675, 676, 677, 678, 679, 680, 681, 682, 683, 684, 685, 686, 687, 688, 689, 690, 691, 692, 693, 694, 695, 696, 697, 698, 699, 700, 701, 702, 703, 704, 705, 706, 707, 708, 709, 710, 711, 712, 713, 714, 715, 716, 717, 718, 719, 720, 721, 722, 723, 724, 725, 726, 727, 728, 729, 730, 731, 732, 733, 734, 735, 736, 737, 738, 739, 740, 741, 742, 743, 744, 745, 746, 747, 748, 749, 750, 751, 752, 753, 754, 755, 756, 757, 758, 759, 760, 761, 762, 763, 764, 765, 766, 767, 768, 769, 770, 771, 772, 773, 774, 775, 776, 777, 778, 779, 780, 781, 782, 783, 784, 785, 786, 787, 788, 789, 790, 791, 792, 793, 794, 795, 796, 797, 798, 799, 800, 801, 802, 803, 804, 805, 806, 807, 808, 809, 810, 811, 812, 813, 814, 815, 816, 817, 818, 819, 820, 821, 822, 823, 824, 825, 826, 827, 828, 829, 830, 831, 832, 833, 834, 835, 836, 837, 838, 839, 840, 841, 842, 843, 844, 845, 846, 847, 848, 849, 850, 851, 852, 853, 854, 855, 856, 857, 858, 859, 860, 861, 862, 863, 864, 865, 866, 867, 868, 869, 870, 871, 872, 873, 874, 875, 876, 877, 878, 879, 880, 881, 882, 883, 884, 885, 886, 887, 888, 889, 890, 891, 892, 893, 894, 895, 896, 897, 898, 899, 900, 901, 902, 903, 904, 905, 906, 907, 908, 909, 910, 911, 912, 913, 914, 915, 916, 917, 918, 919, 920, 921, 922, 923, 924, 925, 926, 927, 928, 929, 930, 931, 932, 933, 934, 935, 936, 937, 938, 939, 940, 941, 942, 943, 944, 945, 946, 947, 948, 949, 950, 951, 952, 953, 954, 955, 956, 957, 958, 959, 960, 961, 962, 963, 964, 965, 966, 967, 968, 969, 970, 971, 972, 973, 974, 975, 976, 977, 978, 979, 980, 981, 982, 983, 984, 985, 986, 987, 988, 989, 990, 991, 992, 993, 994, 995, 996, 997, 998, 999, 1000.

Still keeps Working when others have Stopped...

**THE DIAMOND**

**DIAMOND RADIO BATTERIES**

DIAMOND TORCH BATTERIES have the same PS quality of Dependability, Consistency and Increased Service.

THE PS LABEL IS ON THE ENDS OF ALL GENUINE DIAMOND RADIO BATTERIES

WHAT IS IT?

1. The PS has the great ability to deliver efficient current down to the lowest voltage loads.
2. There is no overnight collapse with PS—will continue to "carry" after others have gone.
3. The very gradual decay of PS will give ample warning before new PS's are required.
4. The PS guarantees increased service, stable dependability and maximum economy.

WIDDIS DIAMOND DRY CELLS PTY. LTD.  
119 HAWKE STREET, WEST MELBOURNE  
PHONE F 1175

**OBTAINABLE NOW EVERYWHERE**

**Typical AR Advertising of the 1930 era.**

magazine would have noticed that in 1982 it received a facelift and generally widened its news content.

This "maturing" process was under the editorship of Bruce Bathols VK3UV, Editor 1977-82.

An eight member publications committee meets once a month to review the last edition of the magazine and plan future articles including those on technical topics and equipment reviews. There is a paid contractor for production and a paid advertising representative.

Bruce said he saw the editor's job as "sole control and responsibility" for the magazine. "The editor ensures what goes into the magazine relates to Institute policy."

Bruce said responsibility for individual columns is with the contributing editors on an "honour system".

However it was the editor's role to make sure those regular contributors were aware of policy and any borderline cases which appear in their copy is drawn to their attention.

He said the purpose of the magazine was: "Basically a forum for members, an avenue to publish members thoughts and their experiments — and Institute policy".

He explained the part advertising plays. Without any advertising the section of the WIA membership subscription which pays for AR production covers forty eight pages.

Advertising revenue increases the pages by ten to twelve, and pays for the extra production costs and remuneration for the advertising salesman.

The editor keeps an eye on the advertising — bearing in mind consumer or Trade Practice Regulations, which may be in force. Bruce said: "We would never knowingly advertise anything illegal."

WIA members have also been quick to react

when advertisers have placed advertisements for CB radio and have written to the editor with their complaints.

Obviously those who put their complaints in writing feel that AR magazine is only for the hobby of amateur radio.

The letters to the editor help the editor keep in touch with readers' views and their worthy ideas are reflected in the magazine.

Bruce said the magazine's most popular section is the Hamads with many WIA members reading them before looking at other pages.

The VHF Notes, How's DX column, and other regular pages also have their following, but as is usual with publications the editorial comment would be the last or least read.

The magazine has an important role that most WIA members are not aware of — getting the message into the hands of non-members.

AR is sent on a reciprocal basis to the radio societies and bodies in about forty countries, including NZART, RGSB and ARRL.

It also, within Australia, reaches into government departments and private enterprises in the communications field. Libraries and technical schools also subscribe to the Institute's journal.

**THE FATHER OF AMATEUR RADIO MAGAZINE**

On researching this article it was the consensus among those involved in the past history of the magazine that one person could rightly be described as the father of the Institute's journal.

Harry Kinnear, VK4AVJ, VK3 President 1934-35, 1945-47, Federal Vice-President 1953, was AR editor for 1933-36.

This month he is given the highest recognition available from the WIA — HONOURARY LIFE MEMBERSHIP.

The Victorian Division of the Institute made Mr Kinnear a Life Member in recognition of his outstanding service to amateur radio, being a past Divisional President and the far-sighted attitude he had in pushing for an Institute journal.

His contemporaries have described him as the "driving force" behind getting the magazine going.

The name "Amateur Radio" for the magazine was Harry's own idea and he said recently that although it sounded corny — it was most appropriate.

He recalls in his own words those early days of the magazine:

Dear Jim,  
Many thanks for your letter regarding your project of writing about the history of "AR".

My Amateur Licence No 944 was gained in 1932. I had been a member of the WIA Victorian Division for a year or so prior to that. In the schooling days at Kelvin Hall, I think, I met some very good mates and after getting on the air became interested in the administrative side of the Institute.

Somehow I found myself a member of the VK3 Council and early in 1933 promoted the idea of having a house magazine. Of course I found myself with the job of getting it going.

We had a bunch of magazine fellows who were very enthusiastic. The writing of editorials was easy at first and shared by the team.

The gleaning of technical information was a lot harder. It was essential to have a good stock-pile of such things.

Max Howden, Geo Glover, Bill Gronow,, Vaughan Marshall and many others helped me to keep well supplied. Sometimes it was necessary at the regular monthly meetings to thump the table in an exhortational technique.



# WARBURTON FRANKI'S REMOVAL SALE

To facilitate our forthcoming move to new premises stock must be drastically reduced. This means big price reductions and a unique opportunity for you.

## AMPLIFIERS, Pioneer SM-B160

**Features**  
Twin A.M. Tuners with Short Wave Band 3.8 to 12 Mc.  
9 watts per Channel.  
12 Valves.  
Freq. response: 20 to 20K c.p.s.  $\pm 1$  db.  
S/N. Ratio exceeds 80 db.  
Hum and Noise less than 3 mV.  
Channel separation 50 db.  
Input for Crystal or Ceramic Cartridge.  
Output: 4, 8 or 16 ohms, Centre Amplifier. Tape.  
Few Only.  
**£57-10-0** including Sales Tax.  
+ Freight to cover weight 25 lb.

## TEST EQUIPMENT

**Shop Soiled, Three Only**  
**HANSEN T.S.M. MULTIMETERS**  
Sensitivity: 10,000 o.p.v.  
A.C./D.C. Volta: Up to 700.  
D.C. Current: 0-100, 0-1.4, 0-140 mA.  
A.C. Current: 0-200 mA.  
Resistance: 0-50K ohms, 0-5 megohms.  
Capacity: 0-1  $\mu$ F, 0-100  $\mu$ F.  
Inductance: 0-1,000 H.  
Decibels: -15 to +59.  
**Features:** Tube emission G.M., Mirror Scale.  
**Accessories supplied:** V.I.G. Probe, E.H.T. Probe 0-17.5 k.v., Cap. Ind. Adaptor.  
Size: 6 1/2" x 4" x 2 1/2".  
**10 GNS.** including Sales Tax.  
+ Pack and Post 2/-.

## TRANSISTOR RADIOS

**POCKET SIZE.** Six Transistor Radios attractively boxed, carrying case and earpiece. Complete with battery.  
**£9-19-6** including Sales Tax.  
+ Pack and Post 1/6.

## UNION 2-Station Intercoms.

With Radio built into Master Unit. Cheaper than a Radio alone, yet you get the benefit of the intercomm. feature. Fully transistorised and supplied complete with connecting wire, batteries and instructions.

**£10-19-6** including Sales Tax.  
+ Pack and Post 3/6.

## RECORD CHANGER in Case

Famous DUAL Mono. Model 1005 De Luxe Record Changer in solid carrying case. One only.

**£11-19-6** including Sales Tax.  
+ Freight 5/-.

## RECORDING TAPE

**American Irish Brand**

5" 900'	25/-
5" 1,200'	30/-
5 1/2" 850'	25/-

Also famous German GRUNDIG Tape in plastic cassette—

5 1/2" 1,200'	35/-
---------------	------

Prices include Sales Tax.  
+ Pack and Post 6d. reel.

## CHOKES

1 Henry 300 mA. National.  
**12/6** each, including Sales Tax.  
+ Pack and Post 1/-.

## POTENTIOMETERS

25K, 100K and 250K Ohms	1/-
250K Ohms with Switch	1/6

including Sales Tax, and  
+ Pack and Post 6d.

## PILLOW PHONES

Will connect to Transistor Radio.  
**19/11** each, + Pack and Post 6d.

## CIRCULAR

### EXTENSION SPEAKERS

9" diameter, 15 Ohms Impedance, Ideal Patios, Boats, etc.  
**69/6** + Pack and Post 2/6.

## TELEVISION AERIALS

Rabbit-Ears, Golden "V", English made.  
**29/11** each, + Pack & Post 1/6.

## CRYSTAL

### PICK-UP CARTRIDGES

Complete with L.P. and Sapphire Stylus.  
**19/11** + Pack and Post 6d.

## GOLDRING PICK-UP ARMS

Complete with base and wiring.  
**9/11** + Pack and Post 6d.

## LINE FILTERS

For effective use two are required, and they will carry 10 amps.  
**55/-** pair + Pack and Post 2/6.

- TRADE ALSO SUPPLIED
- OPEN SAT. MORNING

Please include postage or freight with all orders.

# LOW DRIFT CRYSTALS

FOR

## AMATEUR BANDS

ACCURACY 0.02% OF  
STATED FREQUENCY

**3.5 and 7 Mc.**  
Unmounted, **£2/10/0**  
Mounted, **£3/0/0**

**12.5 and 14 Mc.**  
Fundamental Crystals,  
"Low Drift,"  
Mounted only, **£5.**

THESE PRICES DO NOT  
INCLUDE SALES TAX.

Spot Frequency Crystals  
Prices on Application.

Regrinds ..... **£1/10/0**

## MAXWELL HOWDEN

15 CLAREMONT CRES.,  
CANTERBURY, E.7,  
VICTORIA

technical discussions, as we used to, would be a real hassle.

I wish you every success with the AR fifty years story.

73  
Harry Kinnear

\* Listener In was a weekly paper that was devoted to wireless in Victoria.

ACKNOWLEDGEMENTS: The following people have helped the author with this article — Bob Anderson, Bruce Bathols, Peter Dodd, Gavin Douglas, Bill Gronow, Ron Higginbotham, Max Hull, Harry Kinnear, Vaughan Marshall, Mrs Elva Marsland, Ken McLachlan, Herb Stevens, Barry Wilton.

AR

**MOVING SHORTLY TO 220 PARK ST., STH. MELBOURNE**

Amateur Radio, May, 1964

**FOSTER DYNAMIC MICROPHONES**  
SPECIFICATIONS  
Output Impedance 50 ohms or 50K ohms  
Edison output level -50 db. (10 db. — level 1V. Standard)  
Frequency response 50 to 15,000 cps

**OMNI-DIRECTIONAL DYNAMIC**  
Plastic Diaphragm. Sensitive 80-500 Hz type. Standard  
30" long 1 1/2" diameter. Colour: TRANSPARENT GREEN.  
Cable 12 ft. of PVC.  
Retail Price 30 ohms **£4/7/9** + Sales Tax 10/11  
Retail Price 50K ohms **£4/10/0** + Sales Tax 11/3  
A QUALITY PRODUCT FOR TAPE RECORDERS & P.A. USERS

Made by **ZEPHYR PRODUCTS PTY. LTD.**  
54 HIGH STREET, GLEN HURST, 51.6, VICTORIA Phone: 25-1300 25-4554  
Manufacturers of Radio and Electrical Equipment and Components

Agents: D. R. Sturges & Co., New Market Ltd., Northcote, Tel: 2-1-1, Jany, Moorabool & Co. P.O., 7 St. Martin P.O.

Advertising 1960 style.

AWA were regulars — and very generous with their donations of equipment, particularly hi-voltage triodes. These were of course prizes in the various competitions we ran.

One hardware firm, Thos Warburton, at our request stocked and advertised hard-drawn "stretchless" copper antenna wire, and next door to them was Warburton Franki, Bill Gronow was in charge of their Weston Meter sales. His company Zephyr Products was later to be a very good advertiser.

I had the honour of ultimately being President of VK3 Division. We had our meetings in the large lecture room at Melbourne Tech, with full houses quite frequently and plenty of heckling from the back benches.

How I would like to be back on the air again for a natter on old times. But to go on the air in these modern times and get involved in

Early on the RAAF Wireless Reserve came in and occupied a number of pages. The original format measured about 8" x 5" — we could not afford photo's in those days and even the cost of line-blocks was tough but essential.

Advertising was mainly my job as I had opportunities during my travelling around the city to make contacts. Max Howden ran a regular advertisement for crystals which stated, inter alia, "All Xtals tested to a Pentode load".



# PANORAMIC ADAPTOR — A Weekend Project No. 1

Ivan Huser, VK5QV  
7 Bond Street, Mount Gambier, SA 5290

For some years I have used a panoramic adaptor and a 'home-brew' cathode-ray-oscilloscope originally with a FT200 and currently with a FT101Z.

A panoramic adaptor converts a standard cathode-ray-oscilloscope to a basic spectrum analyser to sweep a given frequency range above and below that to which the receiver is tuned. Each signal within the sweep range will produce a pip on the screen and if correctly adjusted, will enable the operator to determine quite accurately (within a few kHz) the areas of high activity or perhaps a clear frequency to which it may be desirable to QSY. The height of the pip will also give an indication of the strength of the signal.

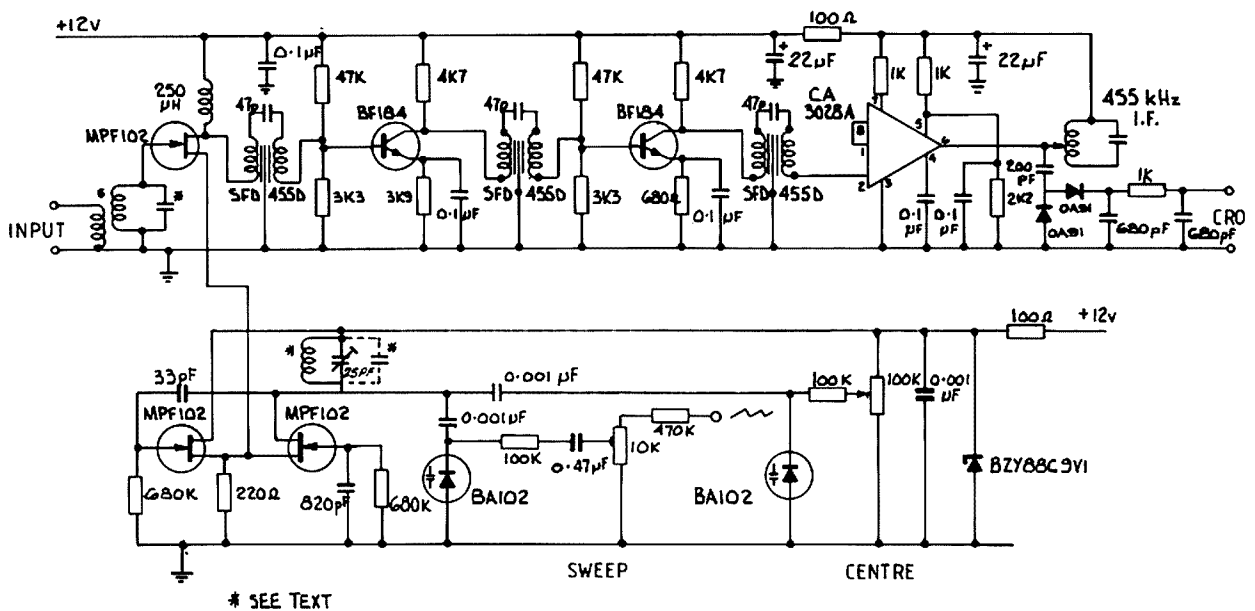

Figure 1 — Panadaptor Circuit Diagram

The basic requirements for the oscilloscope is a low frequency response (DC coupled) and a slow time-base. Oscilloscopes currently selling for under \$200 are quite acceptable for use with the panoramic adaptor.

The circuit is not original and was first published by ZL3SW some years ago in 'Break-in.' No claim was made by ZL3SW for originality and due credit was given to ZL3AA, ZL2AMJ and Electronics Australia for help and circuitry.

## Circuit

Two MPF102 field effect transistors are connected as a source coupled oscillator. A BA102 diode capacitor and a 100 k potentiometer

forms a horizontal shift facility to allow centring of the display. A second BA102 receives a sweep voltage from the time-base output of the oscilloscope thus varying the oscillator frequency at the sweep rate. Variation of sweep width (frequency width scanned) can be obtained by adjustment of the 10 k cermet trim-pot.

Output from the oscillator is fed to the source of another MPF102 and is mixed with the IF output from the receiver to obtain a 455 kHz IF signal. This 455 kHz signal is passed through a filter using Murata SFD455D dual ceramic resonators which are top coupled with 47 pF capacitors.

The output from the IF filter is amplified by

the CA3028A, detected and the resultant DC output fed into the vertical amplifier of the cathode-ray-oscilloscope. Since the oscillator frequency is a function of the sweep voltage, the horizontal axis of the oscilloscope may be calibrated in frequency as shown in Figure 2.

## Components

All components are readily available with perhaps the exception of the IF transformer. A suitable transformer may be obtained from an old transistorised radio. The printed circuit board allows for a transformer in the TCF series which were very popular some years ago and a hunt through the junk box may be worthwhile. These transformers were num-



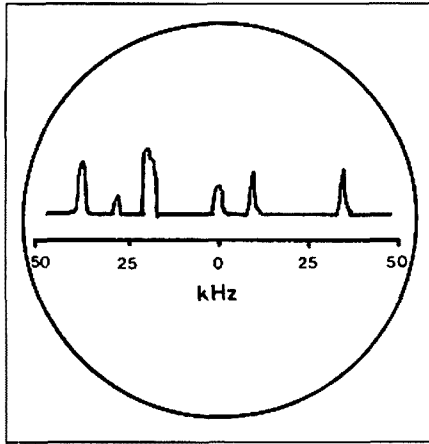

Figure 2 — Display

bered 307A (yellow slug) 307B (white slug) and 307C (black slug) all of which are quite satisfactory. Note that the TCF 308 (red slug) is an oscillator coil.

The input and oscillator coils of the panoramic adaptor are wound on small ferrite toroids. The original used 9.5 mm Philips (magenta coloured) toroids and some manipulation of turns and shunt capacity may be required depending on the toroids used and the IF frequency of the receiver.

For an IF frequency of 9 MHz, the oscillator coil requires about eleven turns of 0.455 mm (25 B & S) with no extra padding. The input coil requires about twenty turns of 0.36 mm (27 B & S) and a 22 pF capacitor across it. The primary winding consists of two turns of hook-up wire. The wire size is not critical, but the windings should be spread out evenly around the toroid.

#### Printed Circuit

The reproduction of the printed circuit board should be well within the capability of

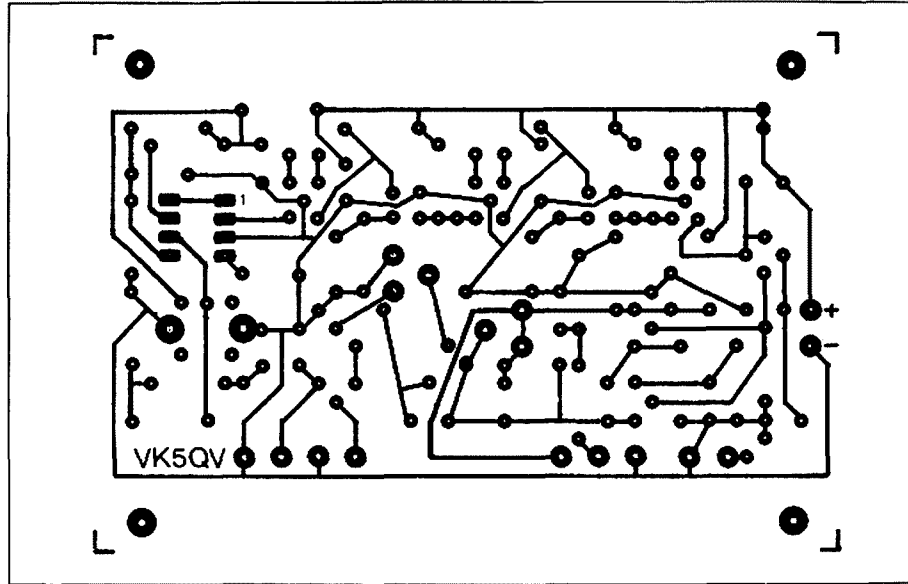

Figure 3 — PCB Layout (Copper Side)

most constructors and an excellent finish can be obtained by using rub-on dots<sup>2</sup> and a resist pen. Figure 3 shows the full size layout.

For those readers attempting the manufacture of a printed circuit board for the first time, the following hints may be found useful.

- 1 Cut the copper laminate to size.
- 2 Smooth the edges with emery tape and polish the copper with steel wool.
- 3 Attach a photo-copy of the PCB pattern to the copper side of the board.
- 4 Carefully centre punch the board (an automatic centre punch is ideal) and drill the holes using a number 72 drill. Before removing the paper from the board, check that all the holes have been drilled by holding the board up to the light.
- 5 De-burr the holes using a slightly larger

drill. Be careful not to take off too much copper.

- 6 Thoroughly clean the copper to remove greasy finger marks and tape copper side up to a solid surface such as a drawing board or table top. Make sure that the tape does not interfere with the pattern.
- 7 Rub on and burnish the dots. Rub-on lettering may also be used to add a touch of individuality such as your callsign.
- 8 Using a small steel rule and with only one corner touching the board, carefully complete the pattern with a resist pen. Make sure that the pen is held vertically if fine lines are to be obtained.
- 9 Check for errors. Unwanted lines may be removed with the aid of a sharp knife and a ball-point pen eraser.

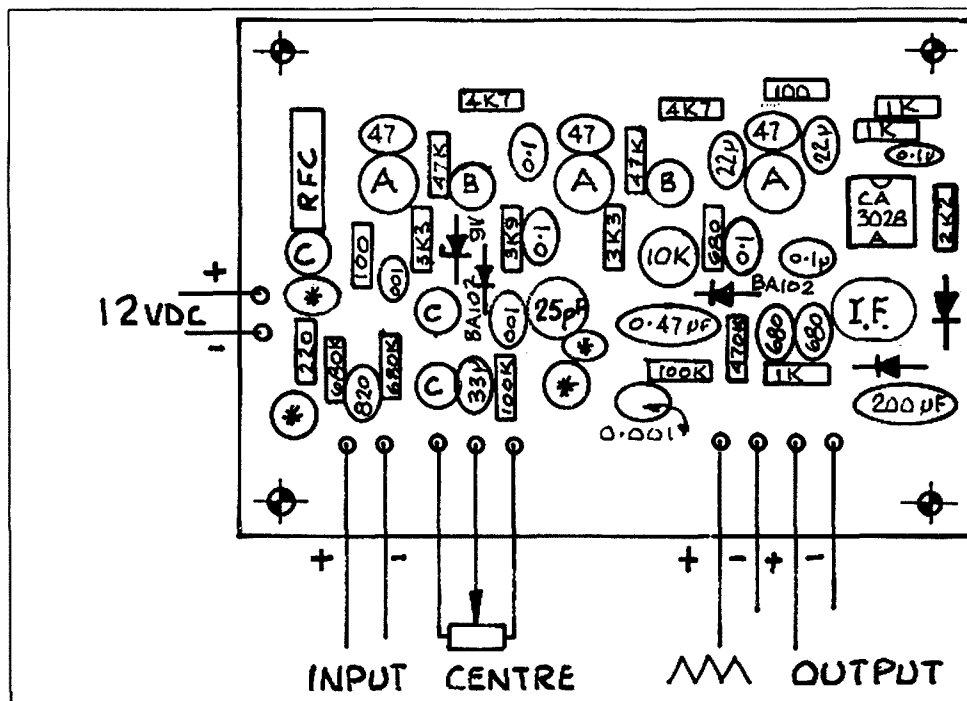

Figure 4 — Overlay (Component Side)

- A = SFD 455 D
- B = BF 184
- C = MPF 102
- \* SEE TEXT

- 10 Allow a few minutes to dry the resist before etching in Ferric Chloride.
- 11 Finally remove the resist with white spirit, give the board a final polish with steel wool and then spray with one of the available PCB lacquers.

### Initial Adjustment

Some patience is needed to initially set up the panoramic adaptor, but the following procedure should be followed.

Connect the unit to the receiver, oscilloscope and a 12 volt supply. Set the gain of the oscilloscope vertical amplifier to about half, the sweep rate until the trace just starts to flicker like a 1920 movie and the AC/DC switch to the DC position.

Tune the receiver to a strong signal on a band where there is not too much activity. This makes identification of the signals on the panoramic display much easier. With the 10 k sweep potentiometer and the centring control set to mid range, adjust the oscillator frequency until the signal being received is at mid scale on the oscilloscope. Adjust the slug of the IF transformer to give maximum pip height.

Once the pips have been obtained, each control may be carefully adjusted to obtain the required frequency coverage and pip height. Some adjustment to the resistor values in the sweep control circuit may be necessary depending on the sweep voltage

obtained from the oscilloscope and the scan width required.

### Component List

- ¼ WATT RESISTORS
- 2 100R
  - 1 220R
  - 1 680R
  - 3 1k
  - 1 2k2
  - 2 3k3
  - 1 3k9
  - 2 4k7
  - 2 47k
  - 2 100k
  - 1 470k
  - 2 680k

- 3 0.001u ceramic
- 5 0.1u ceramic
- 1 0.47u green cap
- 1 200p styro
- 2 22u tantalum
- 1 25p trimmer

### SEMI-CONDUCTORS

- 1 BZY88 C9V1
- 2 OA91
- 2 BA102
- 3 MPF102
- 2 BF184
- 1 CA3028A

### VARIABLE RESISTORS

- 1 10k cermet trim-pot
- 1 100 k linear pot

### INDUCTORS

- 1 250uH RFC
- 1 455kHz IF\*
- 2 small toroids\*

### CAPACITORS

- 1 22p\* ceramic
- 1 33p ceramic
- 3 47p ceramic
- 2 680p ceramic
- 1 820p ceramic

### FILTERS

- 3 SFD455D

\* See text

### Finale

Since the oscillator in the panoramic adaptor is self excited, some drift will be

noticeable. My unit requires about ten minutes to settle down after switch on with a total drift of about 50 kHz. Most of this drift occurs within the first minute or so of switching on.

If the unit is connected to a receiver not having provision for a monitor, two things will have to be considered. Firstly the output from the receiver must be obtained before the IF filter. Secondly, some anti — AGC circuitry must be used so that the signals don't disappear as they are tuned in. It would appear that at least the FT101Z has such a circuit and no doubt other transceivers also.

After using the panoramic adaptor for a time, one is able to identify signals within the sweep range as unmodulated carriers, CW, SSB, RTTY or even that friend who may frequent the band regularly — and all without tuning.

Once one becomes accustomed to using a panoramic display, one feels somewhat at a loss without it — a little like losing the digital readout. So give yourself a treat and build a panoramic adaptor this weekend.

### Notes

- 1 Notes on a Panoramic Monitor — W. Whitehead ZL3SW — Break-in (date unknown).
- 2 A range of resist dots are available from Ellstronics — Melbourne.

AR

## MODIFICATION OF "SIMPLE FREQUENCY SELECTION FOR THE ICOM IC22S"\* to allow for LED Display of Channel Switches Operated

Keith Heitsch, VK4AHK  
67 Oleander Avenue, Scarness, Qld

This LED readout is in use by the author and has proved to work very well.

The LEDs have no detrimental effect on normal of the 22S as they are in opposition to the channel diodes.

Also, as suggested in AR\*, March 1983, page 15 R141, 15 ohms in the 22S be replaced with a half watt, or even a one watt type resistor if it can be fitted in the space, to give

more current reserve to carry the LED's extra load on the regulator.

The LEDs are mounted above the switches on the original panel of VK2AKY's.

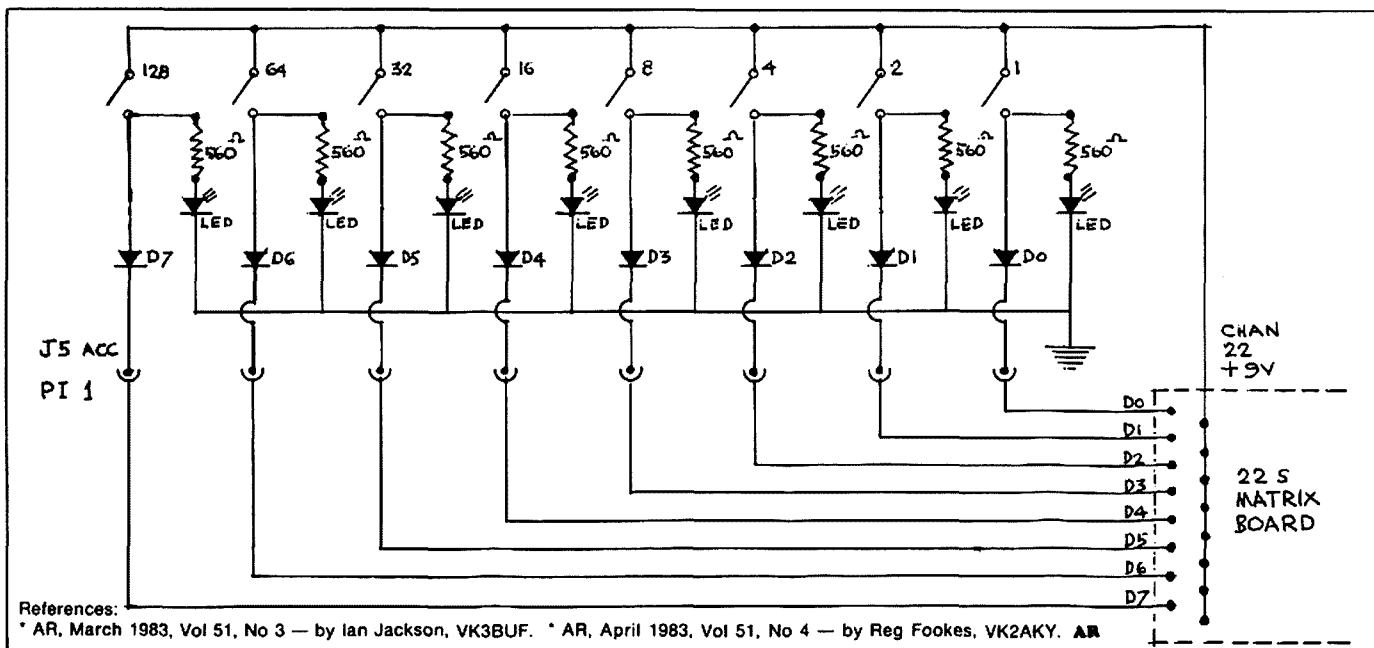

# PROGRAMMABLE KEYER

Gil Sones, VK3AU1  
30 Moore Street, Box Hill, Vic

A preprogrammed keyer was required for two six metre DX operations. These were the stations on Macquarie Island, VK0AP, and Heard Island, VK0HI, which were set up to activate these rare countries on six metres. The VK0HI keyer has been sent to VK9ZS Willis Island along with the FT680 courtesy of the VK6 DX Chasers Club.

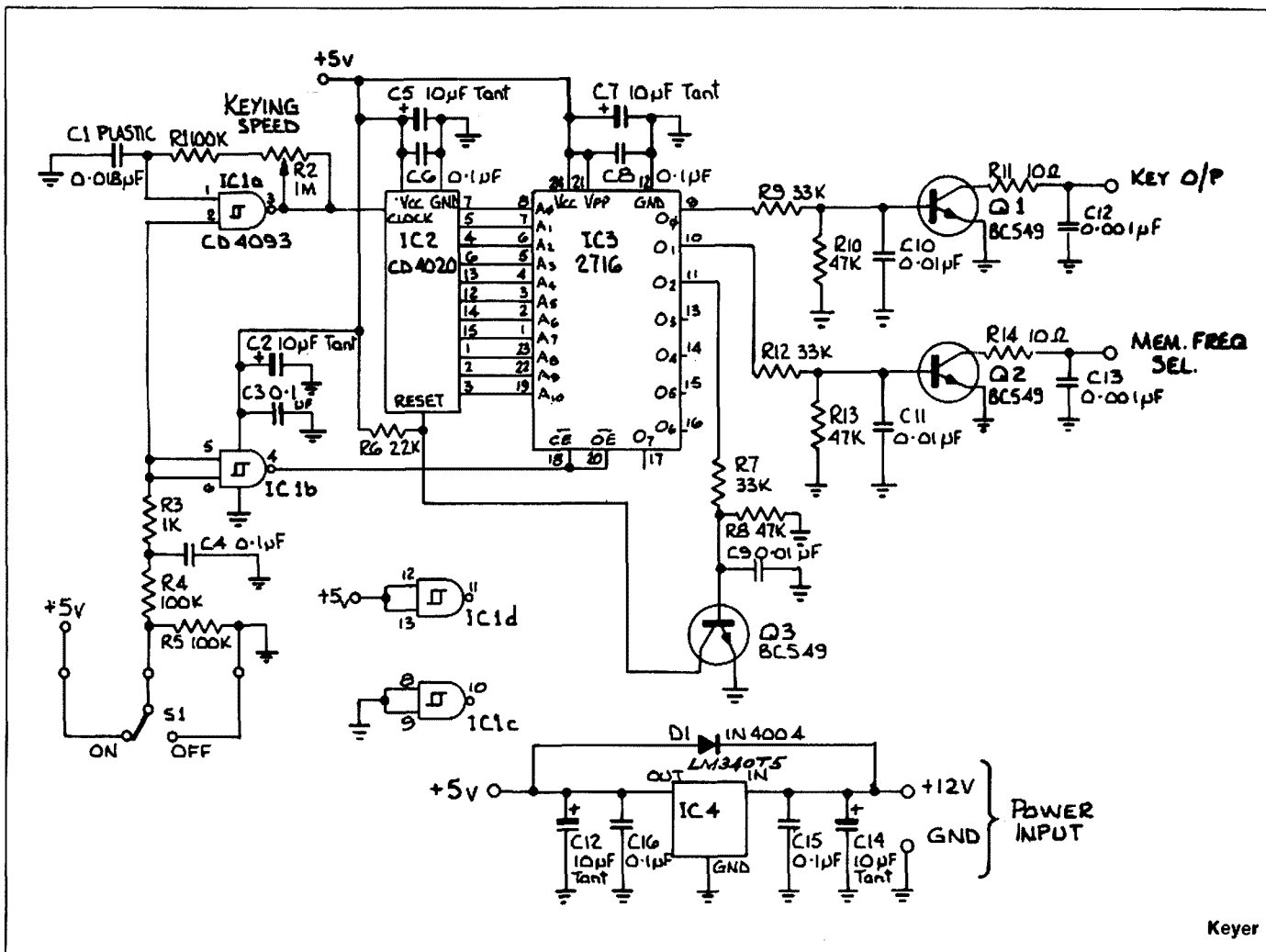

Keyer

The circuit given is a simple use of a memory device known as an EPROM. EPROM stands for Electrically Programmable Read Only Memory. These devices may be programmed electrically. Later on the type used may be erased by exposure to intense ultraviolet light.

The EPROM used is relatively cheap and is available from many sources. Some of the devices used in the development of this project were obtained from MacGraths in Melbourne.

During the development of the circuit a CMOS equivalent of the EPROM became available. This equivalent was obtained from National Semiconductor and had the type number NMC27C16Q. These CMOS equivalents have a much reduced current drain.

A standard 2716 memory can easily sop up 100 milliamps at 5 volts. For those readers unfamiliar with the labelling used by integrated circuit manufacturers the figures 2716 are not the whole type number. For example the same device was labelled by one

manufacturer as MK2716 and by another as MB2716.

The CMOS memory used in the same circuit dropped consumption to around 10 milliamps from the previous 50 to 100 milliamps.

Another possible benefit of a CMOS memory is the ability to have either TTL output or CMOS output. This would have enabled the transistor Q3 used as a buffer to be dispensed with.

Memory in the EPROM is arranged as 2048 words of 8 bits each. The address of each word is a binary number applied to the address lines A0 through A10.

Each word is used as a basic unit in the message stored. It may represent key up or key down for the time of one dit or one space. A dah or a longer space is obtained by using a number of these basic units. Due to the size of the memory quite a long message can be stored.

If switching were employed a number of messages or a much longer message could be accommodated.

An auxiliary output was provided which was used to activate a 10 metre receiver on Heard Island. This could be used to operate the PTT line.

The rigs used in both operations were FT680s which are keyed into transmit and hold between characters. Additionally on Heard Island a TS660 was available and this was memory switched to monitor 28.885 MHz during the keying cycle.

The circuit works as follows. The switch turns the keyer on by placing +5 volts on one gate of IC1A, which sets the clock oscillator in operation, and also on both inputs of IC1B which inverts this to zero or ground which is applied to the enabling pins of the EPROM.

The EPROM program is the heart of the keyer. The information contained in the EPROM consists of a series of words of 8 bits. Five of these bits are not used. Three bits are used and these contain Keying Information, PTT or Auxiliary Information, and the Reset

bit. These may be programmed manually, as binary information, but if you use any sort of programmer then Hexadecimal will be needed particularly for address information. Most of the manual programmers use Hex for the addressing.

Output Function	Memory Words — Binary								Memory Word
	O <sub>0</sub>	O <sub>1</sub>	O <sub>2</sub>	O <sub>3</sub>	O <sub>4</sub>	O <sub>5</sub>	O <sub>6</sub>	O <sub>7</sub>	
Receive	0	0	1	0	0	0	0	0	4
Tx Key Up	0	1	1	0	0	0	0	0	6
Tx Key Down	1	1	1	0	0	0	0	0	7
Reset	0	0	0	0	0	0	0	0	0

Output O<sub>0</sub> is the Key.  
Output O<sub>1</sub> is the PTT or Auxiliary Output.  
Output O<sub>2</sub> is the Reset.

The clock oscillator starts IC2 counting. IC2 is a divider. IC2 has been held reset during the off period by the +5 volts applied to its Reset. When the EPROM is enabled the output turns Q3 on and holds Q3 on for the duration of the message. A reset at the end of the message is achieved by programming an O or low output into the appropriate bit of the end of message word.

IC2 is a rather large divider as it has the capacity to divide by 2 to the power of 14. The divide output is brought out in binary form and is used to address the EPROM sequentially. Unfortunately not all the outputs are

brought out in the sequence but by choosing outputs a suitable address sequence can be obtained. Outputs corresponding to divisions of 2 to the power of 4 to 2 to the power of 14 were used. The clock oscillator runs at sixteen times the dit speed.

The clock oscillator uses a Schmitt NAND gate. One gate is used for control and the second is used for the oscillator.

The keyer was constructed on double sided printed circuit board. One side was used as an earth plane. Each IC was bypassed and ferrite beads were used on each transistor base lead. These measures were taken to avoid EMC problems when operating close to a transmitter.

The EPROM needs to be programmed and this can be a real problem. You can build a variety of programmers and you could buy a programmer. However for just one IC this is not very practical.

If you have access to a programmer then you will have no trouble. However for those who must have the EPROM programmed arrangements have been made to have this done. GFS have agreed to arrange EPROM programming. This must of necessity be on a quotation basis. GFS may be contacted at PO Box 97, Mitcham, Vic 3132 or by phone on (03) 873 3939.

The author wishes to thank VK3GJ, VK3NM and VK3AUQ for their assistance in developing and producing these keyers for VK0AP, VK0HI and VK9ZS.

AR



## NOVICE LICENCE

THE WHOLE FAMILY CAN GET ONE!

- \* THEORY BOOK \$7.50 incl. postage
- \* MORSE CODE TAPES \$5.00 incl. postage

Theory book: + covers whole syllabus  
+ simple text  
+ clear diagrams  
+ questions incl.

Morse tapes: + 5 WPM Novice  
+ 8/10/15 WPM  
+ 10 WPM exams  
+ 15 WPM

Available from: G.Scott 11 Balmoral Cres.  
Surrey Hills 3127 Vic.  
or : A.Brucsmith, 110 Rosemead  
Rd. Hornsby 2077 NSW.

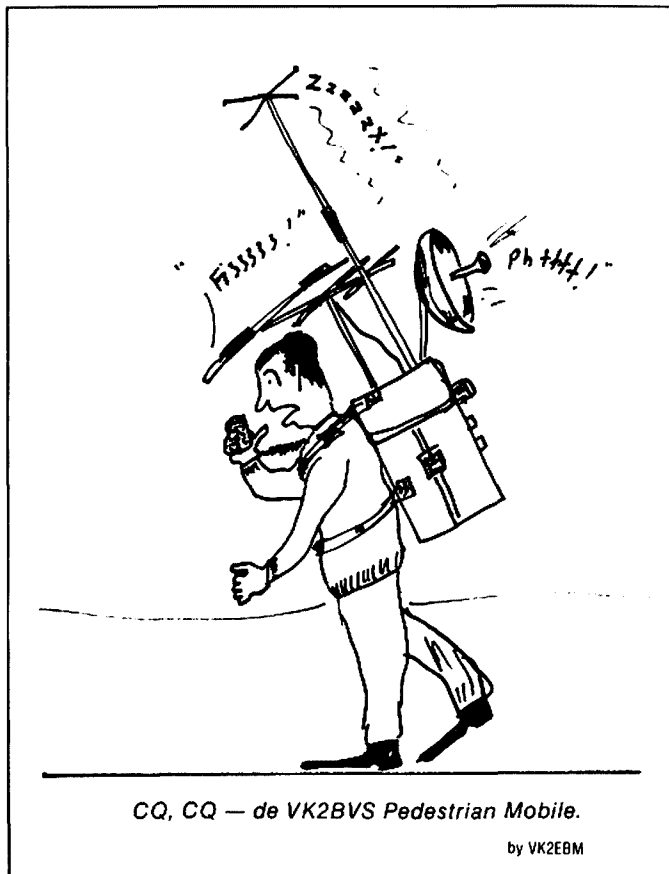

# A 70 CM BASE STATION ANTENNA

The late Nev Fenton VK2ZBQ

*With 70 cm now well established as a reliable and TVI proof band, mobile and net operations are becoming increasingly popular. The growing number of base stations separated by kilometres calls for the antenna system to have some gain, gain usually means dollars.*

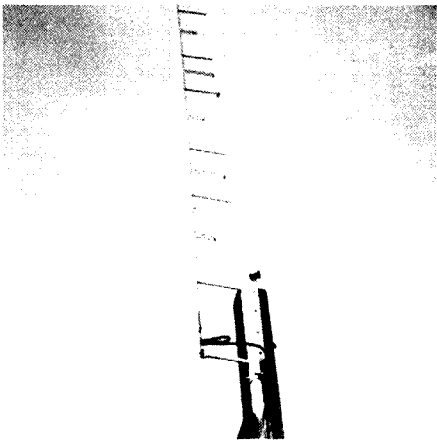

The 70 cm base station antenna has the following features: low cost (\$20) less the Co-Ax; bolts securely to an existing mast, tower or the fence; good wind resistance (has withstood 60 km gusts at this QTH); construction and tuning, a piece of cake, (if the dimensions given are carefully followed, should perform with maximum efficiency); light weight (less than 3 kg); easy to handle (has been roped to the car roof-rack for portable operation at razor back and hilltop and then bolted to a fence).

Sid VK2NQ did all the construction and tuning. Field testing was carried out from this QTH and other locations.

## MATERIAL REQUIRED

Brass Rod. 4370 mm x 3 mm diameter or six brazing rods.

Copper or Brass Tube 229 mm x 6 mm diameter.

Pine Stand Off. 1.5 m x 13 mm diameter.

Support Mast. 4.2 m x 38 mm x 38 mm. Pine or any light straight grained timber.

## TECHNICAL DESCRIPTION

Type, omni-directional, co-linear, gain, around the 6 dB mark.

Radiators. 6 x 5/8 wavelength.

Phasing Sections. 3 x 1/4 wavelength.

Phasing Sections. 2 x 1/2 wavelength.

Matching Section. 1/4 wavelength.

Feed Point "Z" = 200 ohm, 4:1 Balun, 50 ohm line.

URM 67 or better, preferred.

SWR at 433.025 MHz = 1:2; at 438.025

MHz = 1.1; at 439.00 MHz = 1.25.

AR

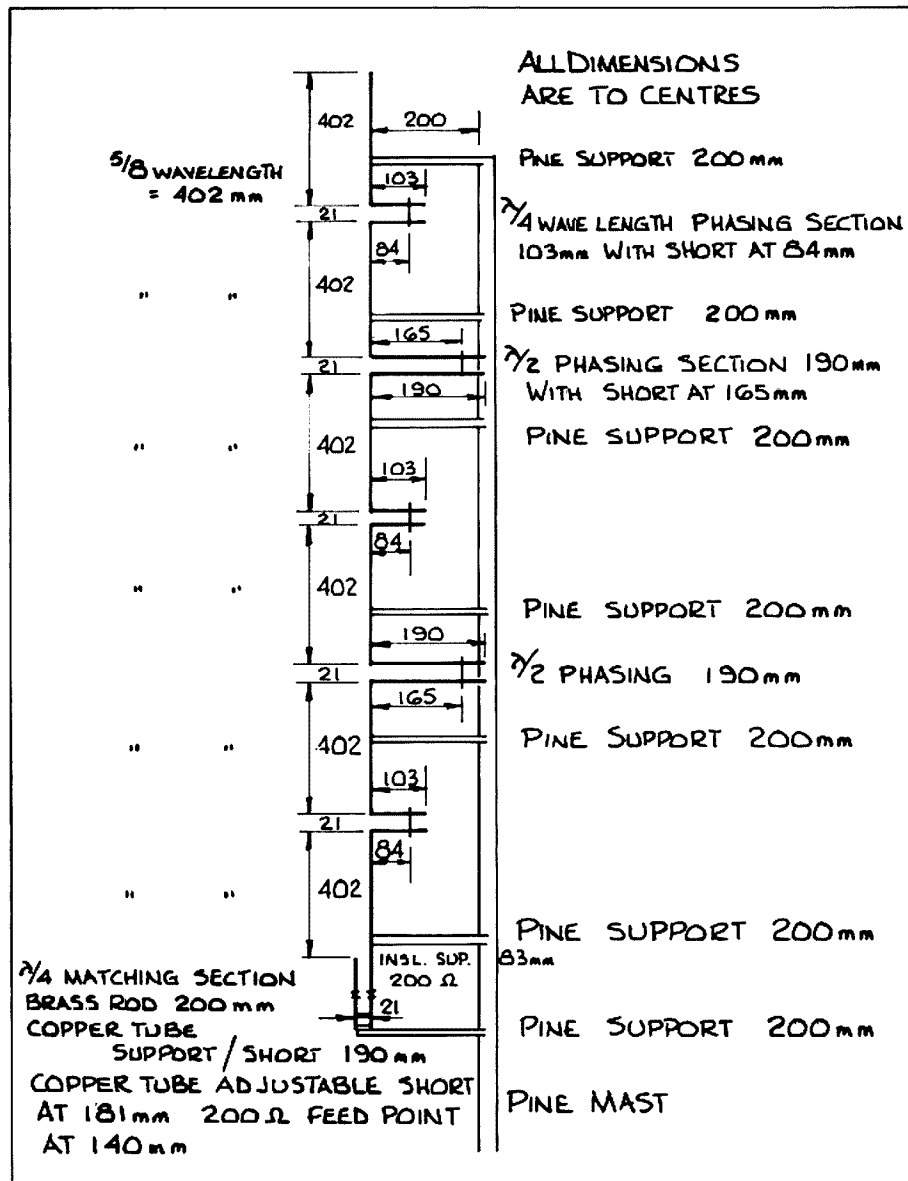



# DIGITAL INSIDE/OUTSIDE THERMOMETER — A Weekend Project No. 2

Ivan Huser, VK5QV  
7 Bond Street, Mount Gambier, SA 5290

This project is based on the versatile RS3-1270 Digital Thermometer/Controller<sup>1</sup> integrated circuit. When used in conjunction with a thermistor and either a LED or LCD display, the RS3-1270 forms a complete unit suitable for temperature measurement and control applications.

As well as the digital display, two control outputs are provided. One output operates when the temperature reading is higher than the set-point and the other when the reading is lower than the set-point. The set-point and the hysteresis above and below the set-point can be programmed by a diode matrix and it is suggested that the data sheet<sup>2</sup> be consulted if it is intended to use this function.

A power failure detector is incorporated on the integrated circuit. If power to the chip is removed for longer than a specified time, the initial reading at restoration of the power will be retained and the display will flash at about 1 Hz. To use this function, link 'A' on the printed circuit board should be replaced with a re-set button. Greater delay times may be obtained by increasing the value of the capacitor on pin 10.

The measurement and control range provided, is from -399 to +399 with the option of the decimal point in any position. In this application, the maximum temperature limit is +39.9 degrees Celsius above which, over-range occurs. This condition also causes the display to flash at about 1 Hz. The numeral which flashes on over-range must be added to the 39.9° (40°) to obtain the actual temperature. Used as an inside/outside thermometer, the flashing over-range indication simply says "Oh brother — ain't it hot".

## Circuit

Depending on stability requirements, the clock oscillator may be operated with a RC network, a LC network, or by injecting an appropriate signal into the IC. A RC network was chosen to obtain a clock frequency of about 560 kHz.

The chip provides output for a three digit LED or LCD display. In this application, I have opted to use a two digit LED display with the 'tenths' digit mounted on the main PCB — this digit only being required for initial setting up.

Temperatures below 0° C will be indicated by the decimal point being illuminated via pin 40. The diode connected between pins 2 and 9 inhibits the LCD backplate waveform when the LED display is used.

Separate 'set zero' and 'set full scale' trim-pots are used and switched together with the respective thermistor by a 3 pole 2 position

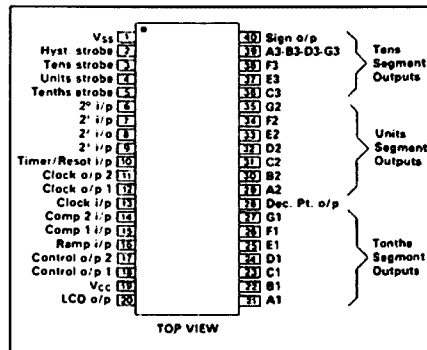

Figure 1 — Pin Connections

switch to obtain inside/outside measurements. 'On card' voltage stabilisation is also used to improve the accuracy of the temperature reading.

## Components

All components are readily available. Resistors are 1/4 watt and the trim-pots horizontal mounting cermet types.

It is recommended that a 40 pin dual-in-line socket be used for the integrated circuit. A socket may also be used for the 'tenths' digit if so desired.

The two printed circuit boards may be constructed using the rub-on dot and resist pen method. Full size PCB patterns are given in Figure 3. The inter-connection between the two boards may be done using a short length of rainbow cable.

## Component List

### 1/4 WATT RESISTORS

- 1 330
- 1 680
- 19 2k2
- 1 3k3
- 3 10k
- 1 22k
- 2 68k

### THERMISTORS

- 2 RS 151-158\*
- Trim-pots
- 1 1k cermet
- 2 10k cermet
- 2 100k cermet

### CAPACITORS

- 1 15 p ceramic
- 1 0.001u greencap
- 3 1u tantalum
- 2 10u 16V single-ended electrolytic
- 1 47u 16V single-ended electrolytic

### SEMI-CONDUCTORS

- 1 RS 3-1270 Thermometer IC\*
- 1 7805 positive voltage regulator
- 1 1N4148 diode
- 3 Z-4117 common anode LED displays

### SUNDRIES

- 1 3 pole 2 position switch
- 1 20 pin DIL socket

\* See note 1

## Construction

Construction should present few problems. The thermistors are very small and care should be used when handling and in particular when soldering to the leads. Twin shielded leads should be used for connecting the thermistors and a neat enclosure can be made by setting them in epoxy resin inside

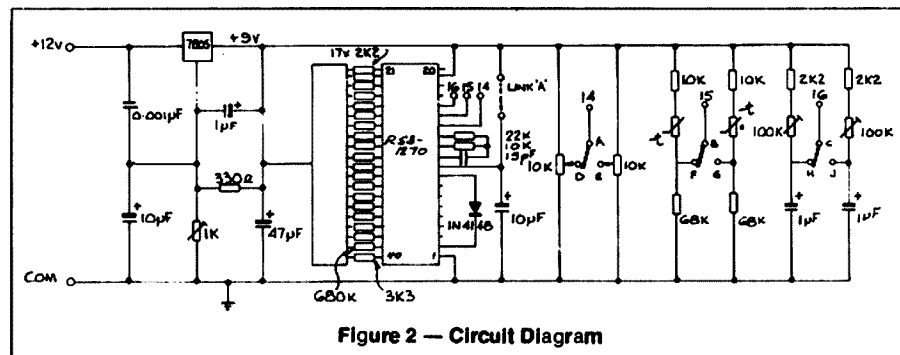

Figure 2 — Circuit Diagram

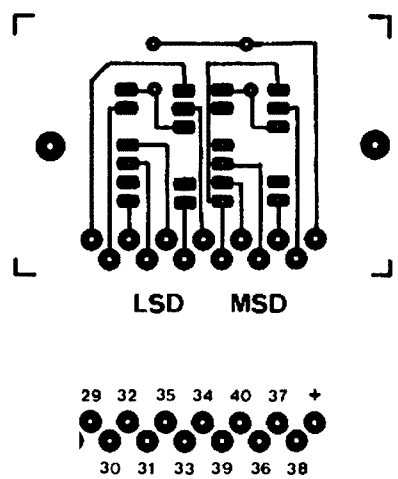
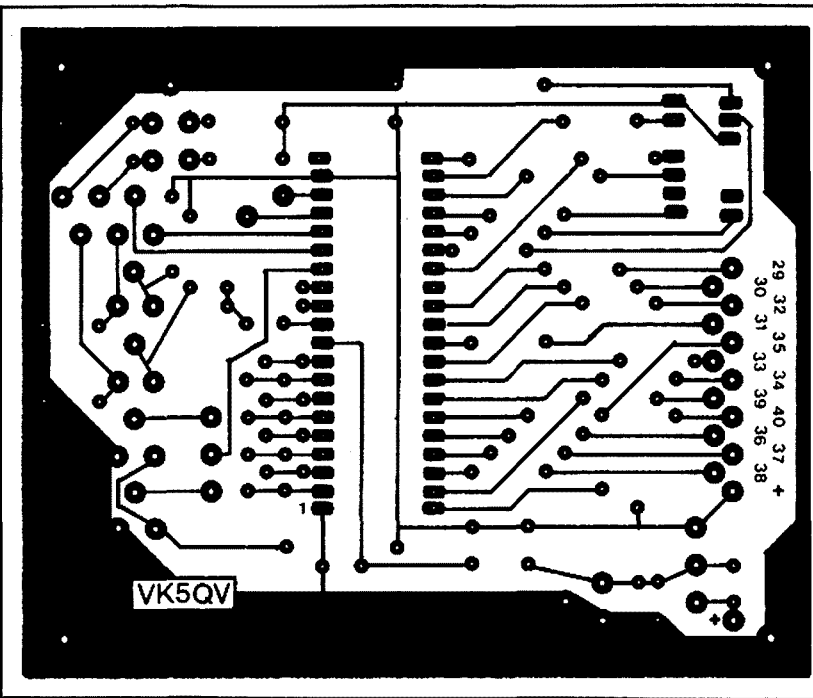

Figure 3 a & b — PCB Patterns

short lengths of thin walled copper or brass tubing and then covering with heat-shrink tubing. See Figure 4.

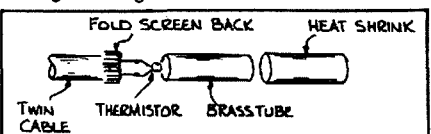

Figure 4 — Thermistor Assembly

Allow enough lead length on the thermistors to enable them to be installed in their final position. The 'inside' thermistor should be kept away from sources of direct heat such as radiators and the rig. Similarly, the 'outside' thermistor should be installed in a shady position — perhaps under a verandah.

**Initial Adjustment**

Set the voltage adjust trim-pot to minimum resistance and the temperature calibration trim-pots to mid position. Connect to a nominal 12 volt supply and adjust the voltage out from the regulator to 9 volts. With the thermistors connected, some random display should be obtained.

A 'set zero' trim-pots (10 k) should be adjusted as close as possible to 0°C. A container of iced water (mostly ice) may be used and will give a temperature of around +2° to +3° Celsius. Make sure that the temperature has stabilised before making the adjustment.

The 'set full scale' trim-pots (100 k) should be adjusted at a temperature close to 30°C. This can be obtained by using a container of warm water, topping up with hot water as necessary to maintain the temperature. Once again make sure that the temperature has stabilised before making the adjustment.

The adjustment at the low and high ends of the temperature range should be repeated until no further adjustment is possible. The trim-pots may now be fixed in position with coloured nail varnish.

Calibration is best done against a good industrial type thermometer, but quite satisfactory results will be achieved with a cheap household type.

**Finale**

My thermometer has been in use for some time and has provided me with quite accurate inside/outside readings. The lowest temperature I have so far recorded was +3°C and the highest +44°C. These of course being outside temperatures.

Order the components now and build yourself an inside/outside thermometer one weekend.

**Notes**

- 1 The RS3-1270 Integrated circuit is obtainable from Radiospares Components — Rosebery, NSW and West Leaderville, WA. Stock number is 309-485.
- 2 Data sheet 4074 July 82 is available from RS Components.

AR

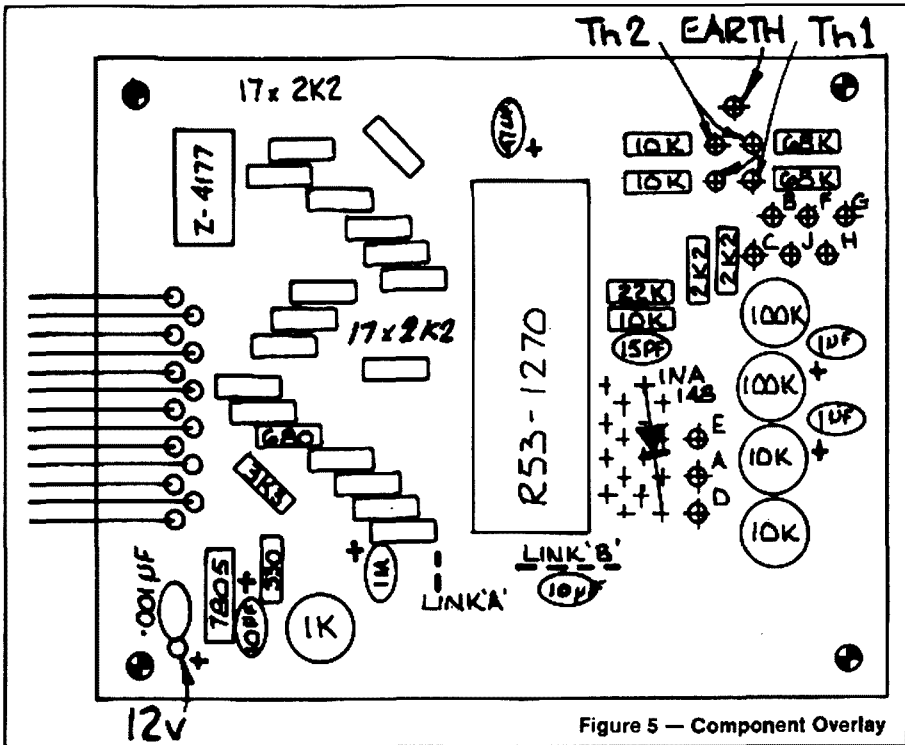

Figure 5 — Component Overlay



# THUMBNAIL SKETCHES

Peter Brown VK4PJ  
16 Bede Street, Balmoral, Qld 4171



**HAROLD AND CHAS STEPHENSON.  
OA4RG 1926.**

**CHAS STEPHENSON. VK2BWQ 1974.**

In 1926 the Woolloowin Radio Club requested Chas to obtain an experimental licence for the Club, to which request Harold, now 80, and Chas, now 78, complied, in that year.

About this time Chas was active with the Queensland Division of the WIA and operated the WIA station 4AE, also 4WN the Woolloowin Radio Club station in contests etc.

Chas was appointed as Junior Operator, Queensland Radio Service in 1925, of the first broadcasting station in Queensland, 4QG, and as a radio amateur doubtless was more advanced technically than other members of the staff.

Shortly after the Commonwealth took over the station, Chas moved to Sydney where he became involved in building and installing cinema sound equipment throughout NSW and Fiji in 1932.

In 1930 Chas won first prize for a transmitter/receiver in a "Wireless Weekly" show in the Sydney Town Hall, which was his last amateur activity until he obtained his VK2BWQ callsign in 1979.

Automobiles were another involvement, throughout NSW, from which Chas retired some twelve years ago. He featured in a Channel 2 "Your Career" programme, on autos, some years ago.

While in Bourke for some years Chas built a boat propelled by an electric motor, 18 V 12 amp, and capable of 7 mph.

One of Chas's adventures was, at very short notice, giving progress reports by CW on the Forster Cup, run on Moreton Bay in 1928, with 2HC in Quirindi monitoring, while Chas held on to the open top of the "Doomba's" bridge by "the skin of his teeth". Harold, now living in Sydney, is out of amateur radio but Chas is still active on HF. Listen for him.

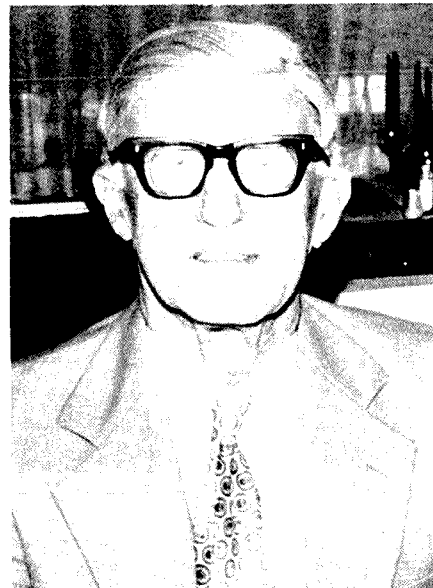

**STEVE FITTELL. VK4JO. 1929.  
VK4YF.**

Steve first saw light in 1910. He claims this was well timed to enter the workforce during the big "Depression", when his job finished with his apprenticeship as a mechanic. As a schoolboy Steve got the radio "bug" and read all that he could lay his hands upon relating to radio. Enthused by a visit from an ex-local amateur, OA4AT, Alf Bauer, he settled to intense study and obtained his licence VK4JO in 1929. For many years he was the only amateur in the Gympie area and needing income published a small advertisement, "Radio Repair and Set Building Service", which service developed into a sizeable business recently disposed of by Steve.

Amateur licences in the 1920/30s approved operations down to 1200 Kilocycles and Steve became a Sunday morning broadcaster of records, using low battery power only. However this was the first loud and clear reception the locals had heard, the nearest station until then being 100 miles away, and the hundreds of appreciative letters and reports from five other states and New Zealand encouraged Steve to apply for a commercial licence.

A local company was formed but World War 2 intervened, causing serious delays in equipment supply and installation, and 4GY did not commence operating until 1941.

Steve did not expect to renew his amateur licence after the war but overseas friends "twisted his arm" and he obtained VK4YF in 1970, to maintain those overseas contacts.

A onetime foundation member of Rotary, Steve's main interest, apart from amateur

THE  
**WIRELESS INSTITUTE OF AUSTRALIA**  
(QUEENSLAND DIVISION)

Office-Bearers, 1926-27

Patron:  
A. G. JACKSON, A.E.E., A.M.I.E. (Aust.)

Vice-Patrons:  
Prof. T. PARNELL, M.A.      Dr. BOYD  
J. CHRISTIE

Past President:  
A. K. LAWTON

President:  
W. MONKHOUSE, A.E.E., A.M.I.E. (Aust.)

Vice-Presidents:  
C. H. CASPERSON      J. C. PRICE  
CHAS DUNN            S. H. SMITH  
E. M. GIBSON         A. N. STEPHENS  
A. A. JACKSON

Hon. Members:  
S. V. COLVILLE      THE COMMONWEALTH  
C. W. ISLES            RADIO INSPECTOR for QLD.  
J. SUTTON             THE MANAGER OF STATE  
F. WALKER             RADIO STATION.

Council:  
R. J. BROWNE         H. J. STEPHENSON  
R. W. BURT            C. W. STEPHENSON  
F. E. FOULK            J. WILLIAMS  
F. V. SHARPE

Hon. Secretary  
O. R. CHAS RUNGE

Hon. Treasurer:  
T. H. DUTTON

Hon. Auditor:  
A. HOPE-JONES

CIRCULAR

**Wireless Institute of Australia**  
(Queensland Division)

Headquarters:  
"COURIER" BUILDING,  
Queen Street,  
BRISBANE

Dear Sir,

*The Adjourned ANNUAL GENERAL MEETING of the above Institute will be held in the rooms, "Courier" Buildings, Queen Street, Brisbane, on Friday, 4th day of June, at 7.45 p.m.*

*As the General Business is very important, you are particularly requested to attend.*

**AGENDA:**

Correspondence  
Report and Balance Sheet for year 1925-6.  
General Business.

C. W. STEPHENSON,  
*Acting Hon. Secretary*

MEMBERSHIP—  
Members are reminded that Annual Subscriptions for year 1926-7 are now due and should be paid at once.

**VK4 Annual General Meeting Invitation 1926**



radio, is the Far East Broadcasting Company, which operates 29 powerful missionary broadcasting stations throughout the world. Steve is a foundation member of the Company.



**DENNIS HARKIN. A-3YN 1924. VK4ADJ**

By the time that you read this Dennis will be eighty years old. He completed the Marconi School first class PMG certificate in 1923 and from 1924 to 1926 was active on the 30 metre band using a Marconi V24, 6 V<sup>3</sup>/<sub>4</sub> amp, and "lugging" the accumulator to the nearest electrician for charging, to keep his receiver going.

The transmitter was a self excited oscillator using a Marconi UV-202, 10 W input, and a lot of DX on CW was worked, mainly due to the antenna which was a four wire tapered cage, twelve inches to three inches, suspended from a sixty four foot wooden mast above a counterpoise covering the backyard.

Dennis joined the RAAF in 1926 and was posted to Bowen on the Barrier Reef Survey while holding the callsign A-4YN. Back to Victoria as A-3YN and then to Pearce WA, as A-6YN until the outbreak of WW2, whence to Darwin for a couple of years and finally New Guinea, mostly at Madang.

Dennis retired from the RAAF as a commissioned officer after twenty one years service and later retired from the PMG in 1963. His VK3ADJ callsign became VK4ADJ in 1975.

Dennis tells that his longest QSO was 4 1/4 hours on 30 metres with A-3LP using a self excited rig and ordinary telephone mike, coupled to the antenna. This QSO ended because the mike, passed from one hand to the other, became too hot to handle.

About that time Trevor, A-2NS, founded the Rag Chewers Club, with A-3LP and A-3YN as foundation members of the twelve members.

After a recent setback Dennis enjoys good health and will be pleased to have a QSO with you principally on 20 metres or perhaps via a satellite.

AR

# OLD TIMER, OLD RIG



Mac using his equipment on the "Coffee Break Session".

Well known old timer Jock "Mac" McConnell VK3RV has reconstructed his original station which he first used in 1936. Most components are original — the three gang capacitor being part of a Pi output stage as a TVI precaution.



The equipment can often be heard on the "Coffee Break Session" 0100 UTC weekdays on 1.820 MHz.



The transmitter is a crystal oscillator 2A5 to 210 class C plate modulated final running 15 watts.

The modulator uses three 57 valves to a pair of 250s running class A and using the original 1936 home brew transformers for coupling and modulator. The microphone is a popular D 104 crystal type.

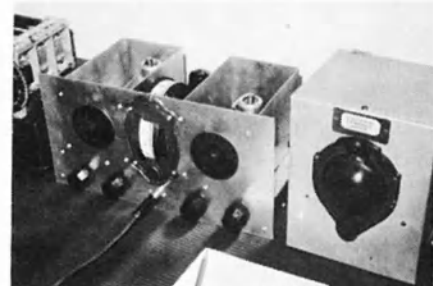

The receiver uses a 58 pentode RF stage into 57 regenerative detector and a 2A5 output which is amazingly good on SSB, but it does take some practice.

Is this the "oldest" serviceable rig in operation in Australia?

AR

Photographs by Peter Wolfendon VK3KAU



## FRANKSTON AND MORNINGTON PENINSULA ARC

The club will be operating portable from the Information Centre, Elizabeth Street, Mornington during the weekend 29th October through to Tuesday 1st November.

The call sign VK3BHU/P will be used.

The event the club will be celebrating is the Mornington Annual Ti-Tree Festival in conjunction with promoting amateur radio and WCY '83.

The club is hoping to get a sponsor to provide a special certificate or card to mark the occasion. In this event contacts on air will be advised of where and how to apply.

The club would like fellow amateurs to support them on this weekend by listening for the call sign, VK3BHU/P, and giving them a chance to make contacts throughout Australia and beyond.

During the period it is hoped to be working on 15 through to 80 metres depending on propagation. **AR**

## LAKE GOLDSMITH STEAM RALLY

On April 30th and May 1st 1983, VK3BWZ the Western Zone WIA Victorian Division station was operated from the Lake Goldsmith Steam Rally. The operation was very successful, 366 contacts being made on all bands and modes. The weather was not very kind for us but in spite of this a good time was had by all.

The steam engine used was a Marshall portable, 6 HP and was built in the UK in 1914, the generator was a Crompton 230 V, this was built in 1920 and was used at the Sydney Gasworks.



Generator and Steam Engine

Ballarat Amateur Radio Group provided antennas for 10, 15, 20, 40 and 80 metres, two stations, tent and log sheets.



Antenna Farm

There were SSTV and video displays, a VHF and UHF station, RTTY, antique radio and QSL card display.

Operators involved were: VK3s, AEU, VEJ, DLO, ASS, XEX, KGL, KJH, AGD, AUK, GN, PAL, VU, DFI, NQQ, BRZ, AEX, VVX, NIH, NIA, KLZ, PAF, PEC, BGY, PFF, DLO, DQQ, NBV and BWW, also VK50A.



Maurie VK3XEX operating the VHF/UHF station

A special award was designed and produced by Henry VK3DXC for the Rally.

Of the 366 contacts, 200 applications for the award have been issued to date. These came from all VK States, ZL, DL, W, VU, JA, DL and UAO.

It is expected that we will be at Lake Goldsmith again in May 1984, the date and other information will be notified in "AR" and the Sunday morning broadcasts from each VK Division at a later date.

Maurie Batt, VK3XEX  
PUBLICITY OFFICER WESTERN ZONE **AR**

## SPACE AGE TECHNOLOGY

An insight into the space age technology employed at the Loy Yang electricity generating station.

Seventeen members of the Victorian WIA Eastern Zone had the honour of being amongst the first people to look over the fascinating computer controlled and instrumented coal winning section of the Victorian State Electricity Commission's newest power station in Gippsland.



L to R: Geoff Roberts, operator, Roger Noble, Technical Officer, Michael VK3ZQV, Sue and Geoffrey, family of VK3KDK, Stewart VK3BSM and Charlie VK3CMA

Mr Geoff Roberts at the instrument console, keeps a watchful eye on the video screens and other trouble indication devices as some of the guests look over his shoulder.

Photograph by Fred Hobson, VK3QH **AR**

## EXPO '83

On Saturday 3rd September the Eastern and Mountain District Radio Club staged a combination hamfest and communications exhibition as part of WCY.

Despite inclement weather the day was a huge success.



Tony VK3QQ, Federal EMC Co-ordinator inspects SWL antennas at the Expo.



VK3WCY on air from the Nunawading Civic Centre.



Peter VK3BFG demonstrated Amateur Television.



Trade Displays.

# MEMORIAL TO VERN KERR (VK4LK) AND THE ROYAL FLYING DOCTOR SERVICE

Peter Renton, VK4PV  
PUBLICITY OFFICER  
Townsville Amateur Radio Club



Vern Kerr in his shack in the 1930s.

In the presence of the Mayor and other distinguished guests, the display was officially handed over to the Charters Towers branch of the National Trust by Bill Sebbens VK4XZ.

As a young man, Vern Kerr was the first radio operator to be associated with the Royal Flying Doctor Service when it opened in Cloncurry in 1934, having already gained his amateur radio licence two years earlier. During the forty-three years of his professional career he saw the radio equipment change from the original crude typewriter morse machines, through the famous "pedal" radios to modern solid state transceivers.

On his passing away in 1979, he left a few unfinished projects among which was the construction of a replica of the first receiver used at Cloncurry. This labour of love was taken over by Ron Tulloch VK4BF.

Problems were many, not the least of which were the absence of the exact circuit and not knowing the physical size of the receiver. However as the result of research into old photos and records the project was completed. Others who assisted Ron were Ted Gabriel VK4YG, Alan Stephenson VK4PS, Jenny Colby (XYL of Ron VK4ZOH) and Merle Howie of Charters Towers.

Professor Ward of James Cook University donated the original control console from the Charters Towers base, and this now forms the centre section of the display.

Ian Sutton (VK4ZT) and John Stevens (VK4AFS) assisted Ron Tulloch to put the display together.

It was pleasing to see many members of the Townsville Amateur Radio Club journey to Charters Towers for the occasion, particularly as Mrs Kerr was present to see this recognition of her late husband's work.

On behalf of the National Trust, the President of the Charters Towers branch, Miss Anne Rollinson said she was delighted to accept the display. Having known Vern during his twenty-one years in Charters Towers, she was confident that the display was a fitting memorial to "the Man and his Work".

Members of the public were then asked to inspect the display, and the assemblage was then invited to join members at afternoon tea which was held in the old historic Stock Exchange building.

*The historic golf mining town of Charters Towers in North Queensland was the setting recently for the dedication of a display honouring the memory of the late Vern Kerr VK4LK.*

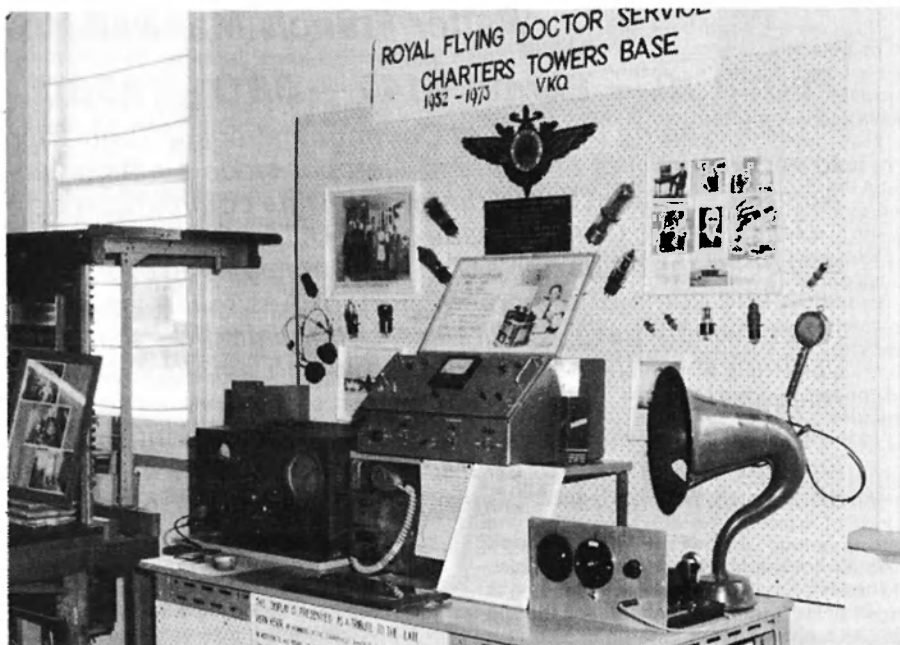

The memorial to Vern VK4LK. The plaque reads "This display is presented as a tribute to the late Vern Kerr by members of the Townsville Amateur Radio Club. In addition to his years of service as a professional radio operator with the Royal Flying Doctor Service, Vern was also an active, widely known and respected amateur radio operator, gaining his licence in 1932. His callsign was VK4LK."



Amateurs, XYLs and children that attended the dedication of a memorial for the late Vern Kerr, VK4LK. Standing L to R: Noel VK4KNW, Charlie VK4BQ, Ray VK4LU, Bob VK4WJ, Vince VK4NBS, Max VK4VDF, John VK4AFS, Ron VK4BF, John VK4NIE, Ian VK4ZT and Bill VK4XZ. Seated second from left Evelyn VK4EQ and Mrs Kerr surrounded by XYLs and harmonics.

AR



# PIONEERS OF AMATEUR RADIO IN AUSTRALIA

Maxwell Hull, VK3ZS  
FEDERAL HISTORICAL SECTION

## Sixtieth Anniversary of World-Wide Communication

*Walter Francis Maxwell Howden*

### **Permit 19 — Permit V140 — 3BQ — A3BQ — OA3BQ — VK3BQ**

*1983 — being the Year of Communications — is an appropriate occasion to recall that it is 60 years in October since amateur radio, particularly in Australia, demonstrated that world-wide communication was possible.*

*This historic October issue of "AMATEUR RADIO" magazine, celebrating as it does, the magazine's 50th Anniversary, is an even more timely reason for recalling some of the epic history of Australian amateur radio experimentation which gave to wireless communication that first 'glimpse' of the usefulness of the frequencies to which amateur experimenters had been relegated.*

*This short article deals specifically with the contribution of one of the most learned and colourful characters in the history of amateur communicators and experimenters — Walter Francis Maxwell Howden — VK3BQ.*

Walter Francis Maxwell Howden was born on the 18th April, 1899, and was educated at the Brighton Grammar School, founded in 1882 as a private school by the late Dr G H Crowther. The school badge, with the wings of ambition following the guidance of the finger of education pointing to the star of achievement, was intended to be a symbolic representation of the motto — "Meliora Sequamur" — which means — "Let Us Follow Better Things". Max was equal 'dux' of the school in 1916 at the age of seventeen.

There is no doubt that Max Howden lived up to his school motto for he certainly reached the star of achievement in the field of wireless, being one of those dedicated experimenters who literally became a public idol as he gained so many firsts in the mysterious form of communication first made practical by Senator Guglielmo Marconi.

From Brighton Grammar School he attended the Working Men's College, later to become the Melbourne Technical College and more latterly the Royal Melbourne Institute of Technology, where he studied electrical engineering, the basis from which stemmed wireless studies in the early days.

Following the cessation of hostilities of World War I in 1918 wireless communications was in control of the Royal Australian Navy under Commander F G Cresswell, AMIEE. Experimental stations had been closed down in 1914 and all equipment impounded. The war saw great strides in the development of communication, introducing wireless telephony and the triode and tetrode valves. However, the Navy was loth to issue licences to transmit but it did issue permits for

receiving purposes only and Max Howden was issued with Permit No 19 in 1918, this being replaced by Permit V104 in 1919.

In November of that year the Victorian Section of the Wireless Institute of Australia conferred with Commander Cresswell seeking approval for experimental stations to transmit using a power of 250 watts but the Navy was obstinate. By November, 1919, the American and Canadian Governments had 'lifted' the war-time bans on transmitting. Australian experimenters had banded together and the Wireless Institute in Victoria, Queensland, South Australia and New South Wales had again commenced activity and were taking steps to approach the Federal Government for permission to transmit as well as receive. In July of 1920 controls under the Wireless Telegraphy Act were transferred back to the Postmaster-General's Department under the jurisdiction of Mr Jim Malone who was to become a good friend of the Wireless Institute of Australia and amateur radio in general. The introduction of experimental transmitting licences following this change was the commencement of the most exciting era in the history of communications. The wonders of 'wireless' was on the lips of the populace at large and the amateur experimenter held the centre of the stage.

To hear another station from interstate was indeed an achievement, the area of experimentation being from 3500 metres down to 200 metres. The Navy had done some experimenting with 'telephony' during the war and climaxed this with the first telephony transmission in October, 1920, between its office in Lonsdale Street, Melbourne, and the

local Exhibition Building. Fantastic! In the same month the Wireless Institute in Victoria conducted wireless telephony communication for — HENLEY ON THE YARRA. Mr L A Hooke — manager of Amalgamated Wireless (Australasia) Limited — broadcast a programme from his home to a meeting of both Houses of Federal Parliament in Queen's Hall, Melbourne. Broadcasting had really taken off and the amateur experimenters were right in the middle of it. The shorter wave bands had yet to be 'discovered'.

1921 saw the Victorian Division of the WIA transmitting news bulletins nightly on 200 metres. The Institute had adopted a publication — "SEA, LAND & AIR" — (first published in 1918) as its official organ. The Western Australian Division of the WIA was incorporated. Valves were released on the market making Types UV202, UV203 and UV204 available to experimenters and these were rushed despite the high price. News from overseas magazines and periodicals advised of 'long distance' communication using shorter wave lengths (two-way communication hadn't been established) between the USA and the United Kingdom across the Atlantic Ocean. This exciting information triggered off a fervor of activity in Australia. By March of 1922 the first two-way third party 'DX' contact had been made between 2CM on 1350 metres from the roof of the Wentworth Hotel, Sydney, and 2JR on 2200 metres from the PMG Radio Service Station from the top of Collins House, Melbourne.

Because Australian experimenters had been limited to permits for 'Receiving Purposes Only' a great deal of time had been spent

developing sensitive receivers. Max Howden was one of the most dedicated experimenters in this field being appointed as technical designer to — CORBETT, DERAHM & CO PTY LTD — receiver manufacturers of the then famous TUNAFONE range, and agents for other wireless components with offices in Melbourne, Sydney and Adelaide.

In December, 1922, Mr H Kingsley Love, 3BM, President of the Victorian Division of the WIA after having heard transmission from high powered American commercial stations, conceived the idea of organising TRANS-PACIFIC TESTS because he was convinced that amateur stations on the Pacific coast of the USA might be audible. The Victorian Division supported his idea and appointed him to head a special Committee to organise the tests. The arrangements had of course to be made with the USA by correspondence. Letters to several Pacific coast amateur associations brought only one reply — from Long Beach Radio Association in California, who welcomed the proposal "with typical American fervor" and replied "that the matter would be taken up all over America". But nothing further was heard until a communication was received from a commercial publisher — "RADIO JOURNAL" — advising that the organisation of the proposed tests was beyond an amateur experimental association and stating that the publication had taken over control in the USA and had already enlisted 500 participants. The enthusiasm of the Americans was high. The tests would be conducted on a wavelength of 200 metres. To authenticate the reception of the American transmissions in Australia the USA amateurs were each to be given a 'code word'. The schedule of these codes was finally received and lodged with the Controller of Wireless, Melbourne, who willingly involved the Postmaster-General's Department in confirming the contacts from submitted logs at the conclusion of the tests.

Drought conditions proved disastrous at the time selected for the tests — 1st May to 17th May, 1923 — but a few Sydney and Melbourne experimenters logged the code signal "MOTT" on the 5th day. The drought broke on the 10th May and atmospheric conditions worsened to the point where "RADIO JOURNAL" were cabled to abandon the tests until a period from the 20th to the 31st May. The choice was a good one, conditions improved, the tests proceeded and made history. After the conclusion of the tests and logs had been checked the winner was — "decisively Mr Max Howden, 3BQ, of Box Hill, Victoria". His log was reported in the press and radio periodicals as being — "a masterpiece of consistency". He had logged twenty two stations out of the twenty three who transmitted code words. The records don't show what happened to the other 477 stations who were supposed to have applied to take part in the tests!

Max Howden was the recipient of congratulations from the whole radio fraternity. He was tendered a social evening by the local Radio Club, the Box Hill Section of the Wireless Institute of Australia, to commemorate the event, at which he was presented with a handsome piece of crystal ware. Descriptions of his 'apparatus' appeared in radio magazines all over the world, some of the articles being written by himself.

In those days receiving was considered the difficult part of experimenting and receivers were home constructed in such a manner that stages of radio frequency and audio frequency amplification could be bypassed or 'shorted out'. Many receivers were of the 'regenerative' design requiring precise tuning to avoid oscillation which could re-radiate from the antenna system and cause untold interference to other experimenters. The 'heterodyne' and 'super-heterodyne' receivers had not yet arrived on the scene but were just around the corner.

The overall scene of wireless was in something of a mess and regulations were on the way, causing amateur experimenters considerable anxiety. The Commonwealth Controller of Wireless, speaking at Max Howden's social evening stated — "the experimenters should not, and would not, be hampered. Their endeavours should be encouraged in every possible way. Such performances as that of Mr Howden substantiated this contention. The endeavours put forward in this test had yielded a result of considerable commercial interest (!), and one felt like labelling Mr Howden's receiving set as the most efficient in the world." Mr E W Greenwood, MLA, for Box Hill and Councillor W Young, President of Nunawading Shire, endorsed these remarks.

Further TRANS-PACIFIC TESTS were planned for October 1923 but this time the Australian experimenter was seeking to establish two-way communication. The transmitting Americans in the May Tests had used powers of 1000 watts. Some two months before the October tests special permission to use a power of 1000 watts was granted. Early tests by Max Howden using high power and a high antenna system resulted in 'poor efficiency' so he experimented with shortening the antenna system and reducing the wavelength to which his receiver would tune resulting in much better signals to New Zealand on 140 metres; but two-way communication with America was still not achieved. It was known that the Americans were experimenting on lower wavelengths. By June of 1924, Max Howden had designed a 'low-loss' receiver using a detector and one stage of audio. With only one 'tuning control' to contend with, the Americans could be tuned in on almost any night. Encouraged with the results Max Howden decided to attempt two-way communication with America again and with 250 watts was successful in working X3AA on the Port Curtis at a distance of 5800 miles on 140 metres. But still no contact with the Americans although they were pouring in on his newly developed 'low-loss' receiver. Finally he installed a Philips 250 watt valve (in place of 5 x 30 watters in parallel), reduced his antenna system and receiver tuning range to 85 metres and on 3rd November, 1924, made the first ever two-way contact between Australia and the United States of America by exchanging CW messages with U6AHP. Max Howden had done it again! Others were close behind. The world went crazy with amazement! Amateur experimentalists had 'bridged the globe'. The useless wavelengths below 200 metres were indeed proving to be far from useless.

Max Howden — now A3BQ — was full of ambition when it came to experimenting. His success in working America inspired him.

Within ten days, 14th November, 1924, he was tuning his receiver at 5.04 am and heard this relatively weak but good Morse signal. In Max's own words — "I forgot the earliness of the hour, and my sleepiness, and just waited and waited for him to sign his call. His tuning was sharp so I knew he was a distant station, and I thought he was English by his very 'pure' note. After keeping me in suspense for nearly five minutes he eventually signed off. It was G2OD in England! I called and sent him congratulations and greetings from Australia. With signals fading he confirmed the contact and I replied and made a schedule for 1800 GMT the following morning and signed — GN.

"I sat back, lit a cigarette, and studied my DX cards, wondering where his card, the best DX I could ever get, would look best. It would depend on the size of the frame! After a while I came down to earth, or rather back to Australia, and remembered that I was very sleepy, and that there was at least 2½ hours before I could report, so I went back to bed. About midday I received a cable from Mr Simmonds, G2OD, confirming the establishment of the first two-way communication between England and Australia that morning, so I had not dreamt it!" Here was another 'first' for Maxwell Howden. Again his story was written up in the press and radio journals. Establishing two-way communication between the two most far distant continents within ten days of each other heralded an era of intense activity.

With the clamour of his success still ringing in his ears, Max Howden reasoned he should be able to establish two-way communication using 'telephony'. He had done some earlier experiments in 1923. In January, 1925, with typical engineering ingenuity, he — "put a primary and core inside the wire coil used as a grid leak to turn it into a modulation transformer, then connected a battery and carbon microphone in series with the primary, closed the key, and talked". He had immediate success working interstate with his modest system so he decided to attempt to try an overseas telephony transmission. When next he contacted G2OD on the 9th February, 1925, he asked Mr Simmonds if he would like to try receiving 'speech'. Being himself an expert experimenter Mr Simmonds agreed to participate in the test.

Max Howden switched over to phone and transmitted — "Hello, Hello, G2OD. Hello Mr Simmonds, hope you are getting this OK" (then he counted from 1 to 10 several times) and finished by saying "Right Oh G2OD, I will change back to CW now". The reply from G2OD confirming that the text of the short message had been reliably received across the world by wireless telephony for the first time. Max Howden had done it yet again! Station A3BQ was becoming notorious for its 'firsts' in amateur experimenting. In the interim Max had joined and was President of the Canterbury Wireless Club. In commemoration of his Australia-England two-way telephony achievement the Club presented him with an elaborate old English hand lettered certificate incorporating in the top left corner the motto — TRANS AE THERE VOCAT — Talking Across The Ether: the certificate read as follows —

To Mr Max Howden — President of the Canterbury Wireless Club — affiliated section of the Victorian Division of the Wireless Institute of Australia — This token of congratulations and esteem is presented in commemoration of his wonderful achievement on 9 February 1925 when he transmitted his voice on a wavelength of 83 metres from Box Hill, Victoria, to Gerrard's Cross, Bucks, England, being there heard by Mr G F Simmonds, and thereby attaining the unique position of being the first of Australian amateurs to speak across the world . . . Thus also he opened up a new era in Wireless Transmission for all amateurs, as well as deepening the great regard and admiration felt for him, not only by his club, but also by the World-Wide Brotherhood of True Experimenters. A J Stokes — Vice-President. C J Falconer — Secretary.

Max Howden had certainly opened up a new era. Audio became a new area for experimentation and the next five years was not only to see great developments in 'wireless telephony' on short waves but also transmission of musical programmes by selected amateurs operating on the 200 metre bands — transmissions which were often stated in the press as being superior in quality to many of the commercial transmissions of the day. The WIA later formed a "PHONE SECTION" as part of its activities.

Following the introduction of new regulations covering all forms of 'broadcasting' which came into force in December, 1922, under which favourable conditions were made available to amateur experimenters, the Wireless Institute in Australia grew rapidly and became the catalyst for introducing radio to the people. In 1924 the Victorian Division convened and organised the first — WIRELESS & ELECTRICAL EXHIBITION & CONVENTION — which was held from the 14th to the 19th May in the Melbourne Town Hall. Max Howden was a Vice-President of the Institute and was involved in the organisation of the Exhibition which attracted thousands of people and was supported by a large number of Trade Houses dealing in wireless receivers and components for the experimenter. The convention part of the event brought the Divisions of the Wireless Institute of Australia together for the first time, resulting in its Federal organisation developing. The second Federal Convention was held in Perth in August, 1925. So gratifying was the success of the Exhibition that the Victorian Division of the WIA organised another, much larger Exhibition in May of the following year, 1925, the response being so great that intending exhibitors had to be turned away. It was held at a site known as WIRTHS' PARK — the location of part of Melbourne's new Concert Hall and Arts Centre today. Max Howden was still serving on the Council of the Wireless Institute and not only exhibited some of his latest equipment but was rostered, amongst others, to deliver technical lectures. Max's being on the subject of — LONG DISTANCE WORK. Much was written in the press of the day reporting the great advance in radio receiver design over the previous twelve months. Max Howden's TUNAFONE receivers were incorporating some of these

advances. 1926 saw yet another Exhibition on the same site, this time bringing to the notice of the public how amateur experimenters had — "dived deeply into short-wave bands and had uncovered some of the secrets of science and the ether". Thousands of miles had been spanned by amateurs using less power than was required to operate an electric iron! Great possibilities were being forecast for the wavelengths from 1 to 100 metres and the years from 1926 to the outbreak of World War II was to substantiate this. Amateur wireless experimenting experienced great growth over this period with the introduction of 'crystal control' bringing about highly stable transmission.

Max Howden — now OA3BQ — was an early experimenter with crystals and went on to form his own crystal grinding business supplying crystals to industry and the amateur fraternity. As in every other field of experimentation with wireless he became an expert with crystal control of transmitters, delivering lectures and writing articles on their use including articles in the American amateur publication — "QST".

For some years he was the writer of a weekly page on amateur radio in the Melbourne — "LISTENER IN" — at the same time being the 'Technical Director' of the Victorian Division of the WIA. Despite all the time devoted to reading, writing and lecturing he found time to continue experimenting with the shorter wavelengths and in September, 1928, was the first to establish two-way 10 metre communication across Australia between his home (then in Ringwood, Victoria) and the home of Mr H Austin in Victoria Park, Perth, Western Australia. As far as was known at the time, it was also a world record.

Every activity of the Wireless Institute of Australia involved Max Howden and others of course whose history might well be written. In 1929 Mr H Kingsley Love, President of the WIA, himself an ex-war pilot and then a Flight Lieutenant in the Citizen Airforce, formulated a scheme which interested the Defence Department of the day; this was an organisation of skilled operators to form a Wireless Reserve within the WIA to be of service where and when required. It arose from the desire of the WIA to prove to the Government that the Australian wireless amateur was more than an enthusiast who delighted in experimenting. It was an immediate success attracting hundreds of members who also became members of the Royal Australian Airforce.

Its first 'trial' was to provide communication for the Sydney to Perth Air Race held by the RAAF in 1929. The scheme called for transmitting and receiving equipment at the site of all aerodromes along the route and this was set up by the Wireless Reserve personnel together with auxiliary 'guard stations' in each State. Max Howden was the operator of the 'guard station' for Victoria.

He also designed and installed a portable transmitter and receiver in the plane which preceded the aircraft competing in the race. The story is an article in itself and occupied over two pages of the 16th October edition of the Melbourne "LISTENER IN". Suffice to say that the event was highly successful and ensured the continuation of the WIA Wireless Reserve Scheme, many of its operators taking up commissioned rank in the communication

sections of the armed forces at the outbreak of World War II.

Space and time does not permit of expounding further on Max Howden's contributions to the science of "RADIO" as we know it today for in detail it would fill a book. Perhaps the nostalgia of this short article, whilst being still within the memory of some Old Timers, may assist the modern day amateur to understand a little more of how difficult a task was faced by the pioneers of radio who were dedicated to exploring the unknown and largely constructed all their own equipment and learned more and more about the science as they did so. Max Howden was one of many.

Perhaps Mr C R Brandish who wrote the article for the Melbourne Herald weekly publication "TABLE TALK" in the "Prominent Personalities" column in 1925, and for which illustrator L F Reynolds drew the accompanying living likeness cartoon of Max Howden in his prime, got close to describing the temperament of the man . . .



*"A curious man, with a face paled by long vigils and with eyes lighted by the fanaticism of one who has dedicated a life to a passion. The technics of wireless slip off his tongue as glibly as the prayers of a Buddhist monk, and I doubt if he has, in recent years, ever mentioned any other subject with animation. He has the strange gift of concentration on one thing which marks men of high talent."*

Vale Max Howden, VK3BQ, 18th May, 1980

AR

**JOIN A NEW  
MEMBER**

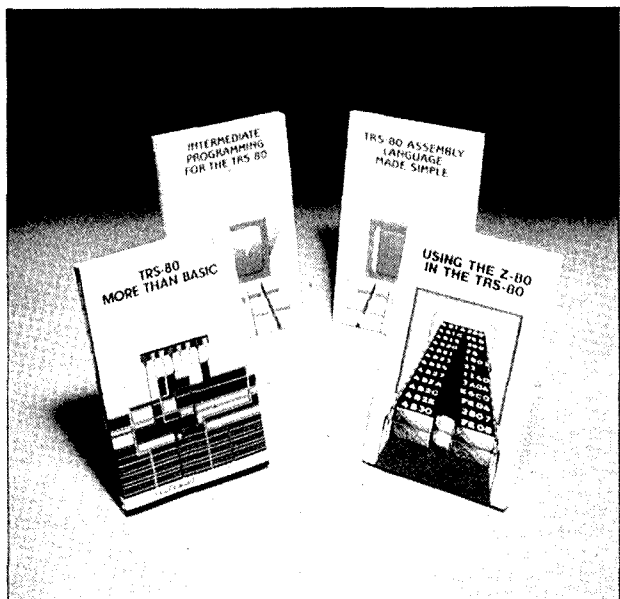

TTL Cookbook	\$16.95
How to Read Schematic Diagrams (3rd Ed)	\$11.50
Active-Filter Cookbook	\$18.95
Reference Data for Radio-Engineers (6th Ed) Hord	\$38.95
CMOS Cookbook	\$17.95
Understanding IC Operational Amplifiers (2nd Ed)	\$11.50
IC Converter Cookbook	\$18.95
Handbook for Electronic Tables & Formulas (5th Ed) Hard	\$16.95
Design of Op-Amp Circuit. With Experiments	\$15.95
The 555 Timer Applications Source Book. With Experiments	\$11.50
Design of Active Filters. With Experiments	\$14.94
The Design of Phase Locked Loop Circuits. With Experiments	\$14.95
Audio IC Op-Amps Applications (2nd Ed)	\$13.95
Transistor-Transistor Logic (2nd Ed)	\$12.95
Understanding CMOS Integrated Circuits (2nd Ed)	\$10.95
Guide to CMOS Basics. Circuits & Experiments	\$13.95
Design of VMOS Circuits. With Experiments	\$15.95
IC Op-Amp Cookbook (2nd Ed)	\$20.95
SCR's and Related Thyristor Devices	\$16.95
Introduction to Automotive Solid State Electronics	\$13.95
Wind/Solar Energy for Radio-Communications and Low Power Electrical Systems (2nd Ed)	\$16.95
Understanding Digital Logic Circuits	\$22.95
RF Circuit Design	\$26.95
Radio Handbook (22nd Ed)	\$43.95
STD Bus Interfacing	\$17.95
IC Timer Cookbook (2nd Ed)	\$21.95

BANKCARD AND MAIL ORDERS WELCOME — POST FREE

## STEWART ELECTRONIC COMPONENTS PTY LTD

44 Stafford Street, HUNTINGDALE, Vic 3166.

Phone: (03) 543 3733

437 City Road, SOUTH MELBOURNE, Vic 3205.

Phone: (03) 690 8333

# Hy-Tech DISTRIBUTORS

Building 51, Archerfield Aerodrome, Qld. 4108 Australia.  
P.O. Box 136, Archerfield, Qld. 4108 Australia.

Telephone: (07) 275 3030 Telex: AA43318 RADCCN  
(07) 277 5624

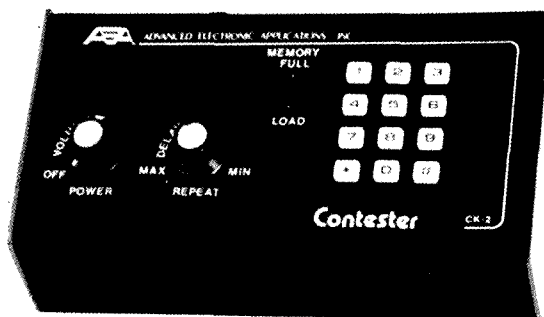

### CK-2

Speed 1 to 99 WPM  
500 character memory  
Auto contest serial number  
Selectable dot and dash memory  
Repeat message mode  
Message editing  
Calibrated speed to 1 WPM  
Semi-auto mode  
Calibrated beacon mode **\$186.72 + P&P**

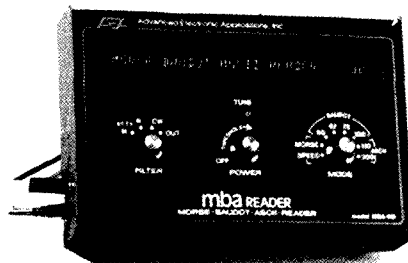

### MBA-RO

32 character readout  
Ascii, Baudot, RTTY and CW  
Speed range in CW to 99 WPM  
Dual filters 170 Hz and 425 Hz  
13 VDC  $\pm$  2 VDC at 500 mA.  
Ideal for intruder watch  
No receiver modification  
Check your own CW sending

**\$300.37 + P&P**

### WORLD PRESS SERVICES FREQUENCIES

Worldwide radio teletype news stations  
3 complete station lists viz  
\*by transmitting time  
\*by frequency order  
\*by country and press service

**\$8.74 + P&P**

# The BC 348 Classic Communication Receiver

Allan Shawsmith, VK4SS

35 Whynot Street, West End Brisbane 4101

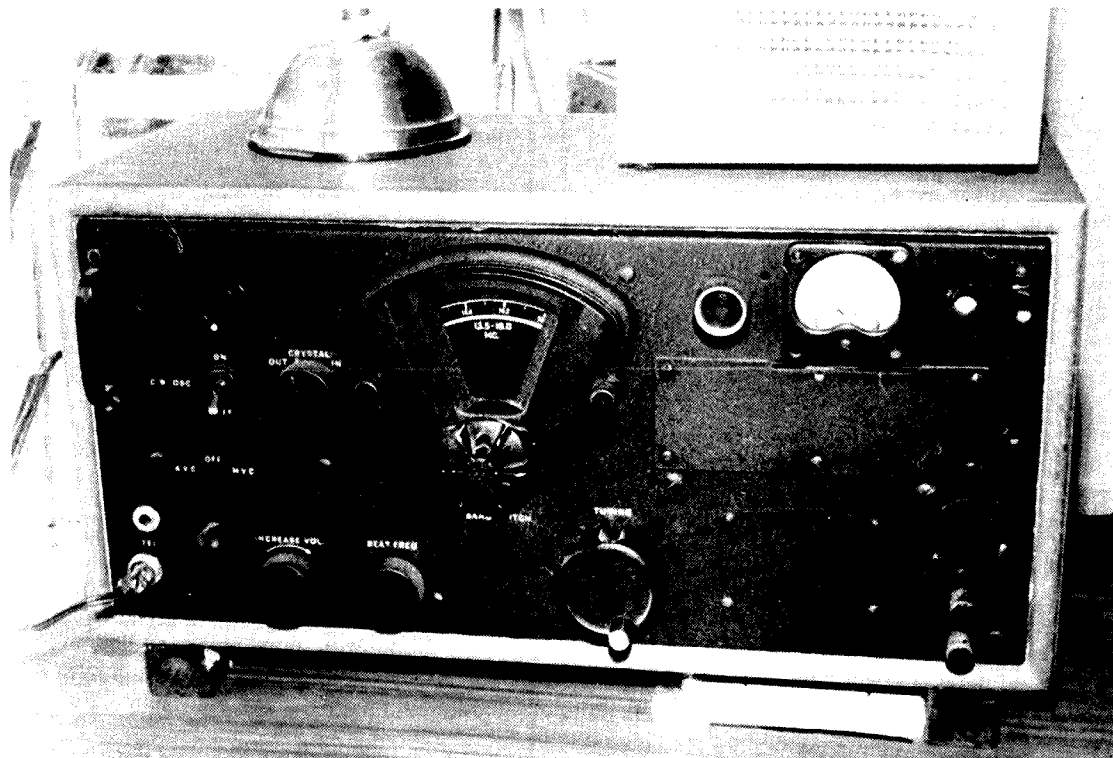

*Many people, engaged in a variety of pursuits, benefited in a number of ways from the huge quantity of high quality disposals equipment available as a result of WWII. None did better than the amateur radio operator; the list of surplus electronic gear to be obtained for a minimum outlay in dollars ran to pages upon pages. Most of it required modifications for optimum performance on the amateur bands but these were usually so minor they presented no real problems. The BC 348 was one of the more popular makes on the market, mainly because it could be put to use almost as was — however, most amateurs preferred to carry out their own particular alterations, depending upon need or fancy.*

## ORIGIN

This receiver, widely used in most American and many British aircraft from 1942 onwards, was mass produced in the United States by numerous sub-contractors. Their identity may be ascertained from the suffix to the type-number on the front panel; eg BC348J comes from Wells-Gardner. Several detail differences occur in models from the various 'stables', viz. Some versions incorporate an aerial alignment trimmer, while others do not. Basically, however, almost all versions conform with the details given below:

## BASIC CIRCUIT

Two RF amplifiers, both 6K7  
First detector 6L7  
Separate local oscillator 6C5  
First IF amplifier 6K7  
Second IF amplifier and beat

frequency oscillator 6L7

Third IF amplifier and second detector 6B8

Output valve 6K6

Voltage regulator to oscillator valve RCA991

COMMENT: This valve line-up is a representative one, although numerous permutations occur among different models. In one version, the CW oscillator is combined with the second detector and there are two IF stages. In another, the luxury of three IF stages is achieved by putting the CW oscillator on to the second IF, while the second detector and third IF are combined in one valve. The importance of securing the correct circuit diagram for the particular model purchased is self-evident. The claimed sensitivity for the three IF version is as good as 3 to 7 microvolts overall on all bands, this for 10 milliwatts output into a 4000 ohm

load.

Having 200-500 kHz available makes the set ideal for use with an RF band switched converter. The band spread is such (1 dial turn = 2 kHz) that it is ideal for SSB reception (provided a suitable product detector is included). Also, the stability on this band is rock-like. If used for this form of reception, with an external converter, this latter unit must have an independently tuned RF + 1st converter so as to peak and track with the tuning in the 200-500 kHz band.

## WAVERANGES COVERED

Band No 1 200-500 kHz  
Band No 2 1.5-3.5 MHz  
Band No 3 3.5-6.0 MHz  
Band No 4 6.0-9.5 MHz  
Band No 5 9.5-13.5 MHz  
Band No 6 13.5-18.0 MHz



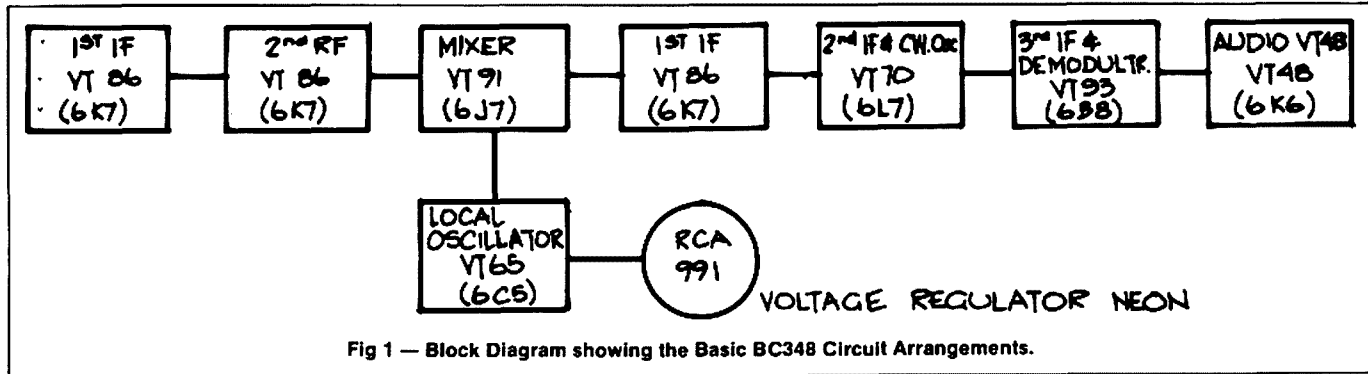

Fig 1 — Block Diagram showing the Basic BC348 Circuit Arrangements.

**POWER REQUIREMENTS**

In its original condition the BC348 comes with a 28 volt dynamotor that is likely to be of little or no value to the average enthusiast.

**COMMENT:** The space made available when the dynamotor is removed will comfortably accommodate a mains power unit of sufficient size to deliver the 200 volts at 50mA and 6.3 volts at 2.5A required by this receiver. A slightly larger mains power supply unit can be installed if a reserve is required for external converters or a crystal calibrator.

**CONTROLS**

In the centre is the bandchange knob. The range in use is registered in the dial window above it. Below is the reduction-drive tuning knob actuating a four-gang capacitor: to the left, gain control and CW oscillator pitch control. Above them: the crystal gate switch and the CW oscillator on/off switch. Extreme left: manual or automatic gain control lever switch. Top right: dimmer for dial lights. Far right: aerial alignment control (when fitted).

**COMMENT:** The BC348 earns high marks for the intelligent placement of controls. While the right hand rotates the tuning knob, either directly or with the little handle fitted to it, the left hand has all other needful user-controls within short reach. No cross-hands performance is called for.

Being a general coverage receiver the BC348 does not offer electrical bandspreading of the type required for use on the crowded amateur bands. Those bands occupy on the tuning scale 1 inch (1.8 MHz), 2 inches (3.5 MHz), ½ inch (7 MHz), and 1½ inches (14MHz). However, the order of tuning knob rotation called for, to cover each of these bands is:

BAND	REVOLUTIONS
1.8 MHz	10
3.5 MHz	16½
7.0 MHz	4½
14.0 MHz	8

It might be added, that when the receiver is used as a 4-6 MHz IF strip for a 144-146MHz converter, this span of 2MHz is covered in no less than 66 revolutions.

**RECOMMENDED BASIC MODIFICATIONS**

**HEATERS:** In the original model with 28 volt dynamotor, the valve heaters are wired in a complex series-parallel arrangement to allow 6.3 volt valves to operate from 28 volt aircraft batteries. It is recommended that the existing heater wiring (generally pins 2 and 7 on IO valve holders) be removed and a complete re-run made to parallel all heaters for 6.3 volt operation from a mains power unit.

**AERIAL INPUT:** Because most receivers will be fed from an aerial tuning unit via low impedance cable, it is recommended that the existing aerial terminal be removed and replaced by a Belling-Lee co-axial socket.

**USE WITH EXTERNAL CONVERTER:** The provision of a coaxial input circuit is especially essential when the BC348 is fed from a converter, to minimize IF breakthrough.

**SEPARATING THE GAIN CONTROLS:** To facilitate reception of SSB signals it is desirable to fit separate AF and RF gain controls. In the original, there are two ganged potentiometers of 20,000 ohms (front) and 350,000 ohms (rear) operated simultaneously by the front panel gain control knob. It is no difficult matter to disconnect the 20,000 ohm potentiometer — it controls the second RF stage — and reposition it in place of the dial light dimmer, not generally required.

**GAIN EQUALIZER:** In some models a variable resistor rotates with the gang-capacitor shaft. Its purpose is to equalize the gain over the entire tuning range. It may be removed with profit.

**CAPACITORS — A WARNING:** Most BC348 receivers purchased today will be at least 40 years old and some deterioration in the condition of the fixed capacitors may have occurred. This will sometimes be self-evident, either through failure of a stage or stages to function, instability or more dramatically by short-circuits on the HT line. To disconnect and test every one of the dozens of capacitors in this model is a tedious business but probably worthwhile in the long run.

**SELECTIVITY:** The IF strip is aligned at 915 kHz. While this particular frequency is OK for SSB reception and helps eliminate or reduce unwanted images, some may deem this as unsuitable for CW reception, even though the

crystal filter, when in circuit, produces a single signal only. For these CW 'bufs', the addition of an external audio filter will provide all the selectivity the most critical ear would need.

**"S" METER:** Another modification that can be carried out to advantage is the inclusion of an "S" meter. This can be separately housed in a small metal box set on top of the BC348 and fed from a cable via the front or rear panels — or mounted on the front panel. If the latter, it will be necessary to cut or drill out a hole to suit the meter. This is not a difficult job, as aluminium is a soft metal. When drilling, place a clean rag inside the set behind the panel to catch any small metal fragments. Space does not permit a detailed explanation of the circuit modification but it is commonplace and shown in many journals and handbooks.

**AUDIO OUTPUT:** The 6K6 output tube delivers enough audio to drive a small speaker, as well as the phones; however, most replace this valve with a power pentode, or add it to the 6K6 for full 3 watts output. The audio quality is exceptionally good. The slightly wider than average 915 kHz IF no doubt contributes to this.

The BC348 and its close cousins BC312 etc were, for the period (1942), outstanding communications receivers in all departments of design, construction and performance and fully deserve the title CLASSIC. AR

## WHAT IS THE HISTORICAL SOCIETY OF AUSTRALIA?

Historical Radio Society of Australia  
49 Sharon Rd, Springvale 3172. Phone (03) 546 5558

The Historical Radio Society of Australia was formed on 17th April, 1982, to cater for the needs of those interested in preserving the equipment and records of past times in radio, especially in this country. It is a non-profit society with members in every state of Australia.

A quarterly newsletter is distributed to members, and members are encouraged to contribute such items as tips on restoration of equipment, information on early equipment and memories of the days when radio was the wonder of the world. The activities of the Society and its members also form subject matter for the newsletter, while a free advertising service is available for purposes within the scope of the Society's objectives (such as the sale or exchange of surplus vintage equipment).

Meetings are held in Melbourne about four times a year, and members in other areas are encouraged to hold their own meetings. The Society has also participated in the Bendigo National Swap Meet, and intends to make this a regular activity, for as long as members are anxious to participate.

The annual membership fee, at present is \$7.50 a yr, covers the twelve month period from July to June, and members who join during the year will receive copies of all newsletters issued during that year.

Membership of HRSA now stands at over one hundred and is steadily increasing. This is an excellent beginning and means that the Society is here to stay — as Australia's first formed such group.

There is no need to own a collection of one sort or another to be eligible for membership — just as long as your interest in early wireless is bona fide, you are invited to join. Write in the first instance for a membership form to the Secretary whose address is given above.

Alan Shawsmith, VK4SS

*This article was compiled by Frank Bridgewater, VK2ZI, relating some of his experiences during his interest in radio which spans sixty two years.*

# Reminiscing Sixty Two Years of Wireless

Frank Bridgewater, VK2ZI  
31 Williams Street, Broken Hill, NSW 2880

My interest in wireless dates back to 1921, when at the age of fourteen and a half I made my first crystal set. Later of course I had a ball with valve sets, to use a modern expression.

Late in 1922, I came to Australia and went to work on Eyre Peninsula in the farming business. Before I left England the officials in Australia House had assured me that there would be plenty of tractors for me to be interested in and work on when I arrived in Australia, but sad to say, where I worked on the Eyre Peninsula, at Woodna, I don't think there was a tractor within 300 miles. Furthermore, my employers hadn't even heard of wireless and when I tried to tell them about the wonderful happenings in England, and 2LO, they frankly didn't believe me.

After three years on Eyre Peninsula, I travelled to Adelaide and gained employment with a firm which is now extinct. It was located in Rundle Street, precisely where Myer's are today, and that firm had a wireless department. The Manager was Jack Chesterfield, a well-known operator for AWA in those days, and he had been at Willis Island, I believe, for some time. I stayed in that department for several months, and also used to frequent the studios and the transmitting room of the original 5CL — Central Broadcasters Ltd, which was located in the Grosvenor Hotel, in North Terrace, Adelaide. The Chief Engineer was Ern Gunner, and the Manager/Announcer was Mr Bill Smallwickham.

In October, 1927, I left Adelaide and went to Sydney for greener fields, and in March, 1928 I went back to England on an extended holiday through Europe, United States, New Zealand, and back to Australia, where once again I entered into the world of wireless, or, as it was gradually beginning to be called — radio.

On the 26th September, 1932, I met with an unfortunate accident. An explosion at my home of an ammonia-type refrigeration unit, sent me totally blind. This happened three days before my twenty sixth birthday. I was in hospital for eight weeks or so and felt that I would never be able to work with wireless again, and was wondering what I was going to be able to do with my life. However, fortunately, a customer, whom I'd made a set for, lived only a couple of blocks away from where I was living, and they had a break-down in their set, only a few days after I'd come home from the hospital. After being persuaded by the lady to come and take a look at their set, (which I was quite sure I wasn't going to be able to do anything about) — I was lucky. The problem was only a broken lead off the end of a battery, which of course, I was able to clean up, poke in the right place, and away it went, and so did I! They took me back home and I

went straight up the yard to the wireless shack, that I thought I'd never be able to operate in again, and got busy.

In 1933, the PMG's Department granted me a special experimental radio licence to operate, with some special conditions.

The Zero Beat Radio Club, of which I was the foundation Vice-President, undertook to put glass doors over the front of the cabinet, where my breadboard rig was to be located, with a safety switch to cut the power off if the doors were open — to make sure that I didn't get any nasty bites! The callsign allotted to me was VK2ZO.



Photo by Bill, VK2HZ

**Frank's station in 1933 when he was VK2ZO.**

There are several members of the old Zero Beat Radio Club still alive, one that I recall having worked this year, is Geoff VK2UA. Some six or eight months after getting the station established and operating on 80, 40 and 20 m we received a permit to operate on the broadcast band after the commercial stations had closed down.

Alan VK2WR, Morris VK2FV of Tuross Heads, Geoff VK2CAS and Bill VK2HZ, VK2 Division Secretary at the time, were some amateurs involved in operating on the Broadcast Band.

During this time I operated a public address business, however, by 1948 Sydney was becoming too much of a rat race, everything closed down, the public address business was sold, and I migrated to Broken Hill, where I had no opportunity of using amateur radio because of being involved in an entirely different type of business which demanded very long working hours. Furthermore, there wasn't enough room for the radio.

Twenty three years later, I decided to get back into amateur radio ... on applying for the ticket and callsign, it was refused. Eventually I was successful again, having passed a special examination satisfactorily, and accordingly I asked for a callsign as close to the old one as possible. VK2ZI was available and here we are. I'm well and truly retired now and on the way towards seventy seven, but still having a ball with amateur radio and especially on the satellites.

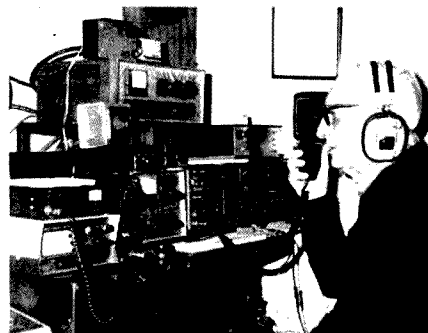

**The present day station.**

Well, there you have a brief resume of sixty two years involvement in wireless/radio and this year is the celebration of my fiftieth anniversary of my first callsign and I believe I was the first totally blind operator in VK2.

AR



Announcing —

# SKYTRIM

Today's premier  
free standing  
crank up tower line

A range of telescopic towers for amateur and commercial applications, from 6.5m to 20m, with tilt-over facility enabling antennae installation and adjustment to be done at ground level.

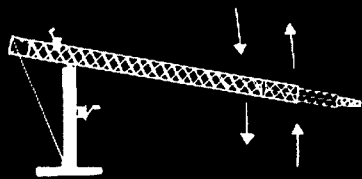

What other tower can offer you these features?

- \* Rugged, all welded, diamond web construction.
- \* Hot Dip Galvanized inside and out, after fabrication.
- \* Easily erected on a limited area site.
- \* Only heavy-duty marine fittings used.
- \* Rotator mounts inside tower.
- \* Thrust bearing fitted.
- \* Engineering drawings supplied (including foundation detail).

**SKYTRIM — A Tower of Strength**  
Further details available from —

Bruce P. Pinkerton,  
P.O. Box 428, Parramatta, N.S.W. 2150  
Australia. Tel. 635 3555, 635 8777

## TOWER SAFETY



With good weather approaching many will be working on their antenna towers. Here is a timely tale from the Sterling-Rock Falls Newsletter by an unknown author and contributed by Soupy WSNW.

The scene opens upon an amateur sitting at his desk contemplating how he should answer a letter from his insurance company. Eventually this is his reply . . .

*I am writing in response to your request for additional information in block number three of the accident reporting form. I put "poor planning" as the cause of my accident. You said in your letter that I should explain more fully, and I trust that the following details will be sufficient.*

*I am an amateur radio operator. On the day of the accident I was working alone on the top section of my new 80 foot tower. When I had completed my work, I discovered that I had, over the course of several trips up the tower, brought up about 300 pounds of tools and spare hardware. Rather than carry the now unneeded tools and material down by hand, I decided to lower the items down in a small barrel by using a pulley, which fortunately was attached to the gin pole at the top of the tower.*

*Securing the rope at ground level, I went to the top of the tower and loaded the tools and material into the barrel. Then I went back to the ground level and untied the rope, holding tightly to insure a slow descent of the 300 pounds of tools. You will note in block number eleven of the accident reporting form that I weigh only 155 lbs.*

*Due to my surprise at being jerked off the ground so suddenly, I lost my presence of mind and forgot to let go of the rope. Needless to say I proceeded at a rather rapid rate of speed up the side of the tower. In the vicinity of the 40 foot level I met the barrel coming down. This explains my fractured skull and broken collarbone. Slowed only slightly, I continued my rapid ascent, not stopping until the fingers of my right hand were two knuckles deep into the pulley.*

*Fortunately by this time, I had regained my presence of mind and was able to hold onto the rope in spite of my pain. At approximately the same time, however, the barrel of tools hit the ground and the bottom fell out of the barrel. Devoid of the weight of the tools, the barrel now weighed approximately 20 pounds. I refer you again to my weight in block number eleven. As you might imagine I began a rapid descent down the side of the tower. In the vicinity of the 40 foot level I met the barrel coming up. This accounts for the two fractured ankles and lacerations of my legs and lower body.*

*The encounter with the barrel slowed me enough to lessen my injuries when I fell onto the pile of tools and, fortunately, only three vertebra were cracked. I am sorry to report, however, that as I lay there on the tools in pain, unable to stand, and watching the empty barrel 80 feet above me . . . I again lost my presence of mind. I let go of the rope.*

AR

# INTERNATIONAL NEWS



## ITU CONFERENCE

*World Administrative Radio Conference for the planning of the HF Bands allocated to the Broadcasting Service.*

The first session of this conference will be held in Geneva for five weeks, beginning in January 1984.

The Administrative Council of the ITU has resolved that the planning be based on DSB emissions and that consideration shall also be given in the manner in which an SSB system could be introduced progressively without impairing the DSB emissions, taking into account the economic and other aspects associated with the introduction of an SSB system.

The agenda of the first session covers the establishment of the technical parameters to be used for planning and the principles governing the use of the HF bands allocated to the Broadcasting Service.

And also the establishment for use by the second session, which is set down for October/November 1986 of planning principles, method of planning and approaches to implementation. Also a programme for progressive introduction of SSB transmissions; and the action necessary to eliminate harmful interference, and the theoretical capacity of any given high frequency broadcasting band.

The Administrative Council of the ITU considers that the revision of the table of frequency allocations is not within the mandate of the Conference except those footnotes relating to the high frequency bands allocated exclusively to the Broadcasting Service.

## CONGRATULATION TO TOM CLARKSON, ZL2AZ

Tom was awarded the MBE in the New Zealand section of the Queen's Birthday Honours List published on 11 June, 1983. He is well-known as a former Director of IARU Region 3 and was a member of the WARC 1979 IARU team. The award is for "services to amateur radio".

## ACTIVITY IN SYRIA

The Syrian Radio Amateurs shall be using a new prefix to celebrate the World Telecommunication Year.

Four stations will be operating in all bands with the call signs of 6C1AA, 6C1AM, 6C1AN and 6C1AO. Operation will be during the period of 00.00 UTC Saturday, October 15, 1983 until 24.00 UTC Friday, October 21, 1983. During this period no stations in Syria will be using the YK prefix.

## NEWS FROM BOTSWANA

The first Botswana novice amateur transmitting licences were issued at the end of January, 1983.

As a result of correspondence with the IARU, Botswana are expecting to receive a Heath SB-104A SSB HF transceiver, for use in the BARS hut. It is understood that the transceiver was donated to the IARU for use "in a country where there is not much amateur activity".

Also on the way from the IARU are 10 "Project Goodwill" 20 m transceiver kits, which will be constructed as part of the Novice classes at the BARS hut, and additional teaching materials.

## COMMEMORATION TIME FOR BELGIUM

KNOKKE, Canada-City 1" in Belgium, will spend a week in the sign of the Maple Leaf, national emblem of Canada: the Canada that thirty nine years ago sent out its sons to this region.

Organisation of the Canadian Liberation March is in the hands of the local lore "CNOC IS IER" with the co-operation of the Canadian Embassies of Den Haag and Brussels, the Red Cross, the National Patriotic Organisations, the Town Councils of Terneuzen, Oostburg, Sluis and Knokke-Heist, the brass band "De Zeegalm, Feestkring Oud-Knokke-Heist", the brass band "De Zeegalm, Feestkring Oud-Knokke", Willemsfonds Knokke and the radio amateurs from the East Coast.

Every year an attempt is made to have veterans flown in from Canada, and a platoon of Canadian Engineers become the guests of Liberation Week.

Gerard Adrianssens, Gaspar Warnier and Danny Lannoy, representatives of the organising team, stand in the breach to give the Canadian soldiers and veterans a pleasant stay. As 1983 is the YEAR OF COMMUNICATION the local radio amateur Club Station ON6HC will be stationed in the Townhall of Knokke during the period of the 28th October until the 2nd of November, 1983. The Minister of PTT has been asked to grant a special call sign during this week.

A splendid multi-coloured award will be issued to confirm each QSO or SWL report. Applicants must send their own QSL cards. **AR**

## NORTHERN CALIFORNIA DX FOUNDATION TWENTY METRE BEACONS

Monitor 14.100 MHz any time, day or night, for 10 minutes and see how many of the eight worldwide power-attenuating beacon net stations you can hear as they transmit automatically one after the other. In that short time, you can get a quick, general appraisal of the various 14-MHz paths that may (or may not) be open around the world, and the direction and the quality of the opening.

## NCDXF BEACONS TRANSMITTING SEQUENCE

Time	Station	Location
0000	4U1UN/B	United Nations, New York
0001	W6WX/B	Stanford University, California

0002	KH6O/B	Honolulu Community College, Hawaii
0003	JA2IGY/B	JARL, Mt Asama, Japan
0004	4X6TU/B	Tel Aviv University, Israel
0005	OH2B	Helsinki Technical University, Finland
0006	CT3B	ARRM, Madeira Island
0007	ZS6DN/B	Transvaal, South Africa

Same sequence repeats every 10 minutes. Beacons are crystal-controlled and are on 14.100 MHz. First "Q" of each beacon's "QST" begins within a fraction of a second of the assigned time, plus or minus human starting error. The sequence may vary as more beacons are added to the net.

## TEXT TRANSMITTED BY EACH BEACON

Power Level	CW Message
100 W	QST de (W6WX/B) beacon
100 W	..... 9-second dash
10 W	..... 9-second dash
1 W	..... 9-second dash
0.1 W	..... 9-second dash
100 W	SK (W6WX/B)

Transmission time: ± 58 seconds  
Speed: 20+ WPM  
Power attenuated in 10 dB steps.

The beacon net was organised and financed by the Northern California DX Foundation (NCDXF). The overall beacon transmitter concept and RF power-level switching was designed by Dave Leeson, W6QHS. Jack Curtis, K6KU, of Curtis Electro Devices, designed the clock, the microprocessor and the programming components. The engineering, production and packaging was done by Cam Pierce, K6RU.

adapted from QST June 1983

**AR**

## TIARA FOREIGN AMATEUR REPEATER IN TOKYO

In April 83, the Tokyo International Amateur Radio Association (TIARA) held a party to celebrate the approval, thanks to support from the JARL, of its application for a foreign amateur repeater in Tokyo. Shown in the photo from left to right are: Makoto Miyazaki, JN1WLE (Okura Hotel Amateur Radio Club); Keiichi Ogo, JG1SIY (President Okura Hotel Amateur Radio Club); Yasuo Hashimoto, JI1TUY (Okura Hotel Amateur Radio Club); Yutaka Kasahara, JA1CLN (JARL Manager External Affairs); Joe Speroni, AH0A (President TIARA); Richard L Baldwin, W1RU (President IARU); Shozo Hara, JA1AN (President JARL); Edward Johnson, W2ZWA (Vice-President TIARA); John Donald G4JFM (TIARA); Andrew Clark, WA4PRF (TIARA); Rossella Strom, I1RYS (TIARA); Kjell Strom, SM6CPI (Secretary TIARA).

The repeater operates on 434.78 (in)/439.78 (out) and is located on the new wing of the Okura Hotel in Akasaka Tokyo, about 75 metres above ground. An 88.5 Hz sub-audible tone is required for access. The location is central to the business area and convenient for the foreign community living in or just visiting Tokyo. The Okura Hotel is also the meeting place for TIARA.



TIARA is a group of eighty foreign amateurs from fourteen countries living in Japan. First organised in 1970 it has grown steadily and over the years assisted many foreign amateurs in getting on the air in Japan. Visitors are welcomed at meetings which are usually held on the last Friday of the month. TIARA's mailing address is — TIARA, PO Box 119, Akasaka, Minato-ku, Tokyo 107/Japan.

Tokyo International Amateur Radio Association

AR

## THE SOUTH EAST RADIO AMATEUR NETWORK

SEAnet is an informal group of radio amateurs which meets every day at 1200 hours UTC on a frequency of 14.320 MHz. The purpose of the net is to provide for the comradeship obtained in talking to one another 'on the air'. More than a hundred amateurs from South East Asia, Japan and the Pacific area, the Middle East, Australia and Africa check in.

In 1971, about twenty five of these amateurs met in Penang, Malaysia for the first time. They decided that an annual SEAnet convention should be arranged by the South East Asia region every year for the amateurs to meet one another. Since then, conventions have been held in Bangkok three times, Singapore twice, Manila twice, Kuala Lumpur, Jogjakarta, Jakarta and Penang once each.

The convention normally has an informal programme covering matters of interest to the science of amateur radio, discussions on the operation of SEAnet, commercial exhibits, visits to places of interest and a grand banquet.

GET TOGETHER WITH US  
**SINGAPORE**



This years convention is being hosted by the Singapore Amateur Radio Transmitting Society on 18th-20th November, 1983.

## PROVISIONAL PROGRAMME

Friday 18 November

Afternoon: Registration

Evening: Opening Ceremony  
Exhibition & Display  
Buffet Dinner

Saturday 19 November

Morning: Tours & Visits

Afternoon: Symposium

Evening: Grand Banquet

Sunday 20 November

Morning: Open Forum & Brunch

Closing Ceremony

## CONVENTION HIGHLIGHTS

SEAnet Contest Awards

SEAnet Station

Exhibition and Display

"SEAnet SONG" Contest

## LIST OF FOUNDING DATES OF MEMBERS TO IARU

as at May 12, 1983

### SOCIETY COUNTRY

SOCIETY COUNTRY	YEAR OF JOINING	
WIA	Australia	1910
RSGB	United Kingdom	1913
ARRL	USA	May 18, 1914
CRRL	Canada	1920
SRAL	Finland	Apr 14, 1921
RCA	Argentina	Oct 21, 1921
RCC	Chile	July 12, 1922
GRC	Ecuador	May 9, 1923
UBA	Belgium	1923
REF	France	Apr 1925
SARL	South Africa	May 25, 1925
SSA	Sweden	Sept 10, 1925
OVSV	Austria	Apr 1926
RCD	Dominican Republic	June 12, 1926
JARL	Japan	June 12, 1926
NZART	New Zealand	Aug 16, 1926
ARI	Italy	Jan 1, 1927
EDR	Denmark	June 1927
DARC	Fed Rep of Germany	1927
NRRL	Norway	Aug 8, 1928
USKA	Switzerland	Aug 4, 1929
HARTS	Hong Kong	Oct 1929
PZK	Poland	Feb 23, 1930
RCP	Peru	Dec 6, 1930
LMRE	Mexico	Jan 10, 1932
PARA	Philippines	Nov 1932
IRTS	Ireland	1932
LCRA	Colombia	Aug 13, 1933
MARL	Malta	1933
RCU	Uruguay	1933
LABRE	Brazil	Feb 2, 1934
CORA	French Polynesia	1934
FRR	Romania	1936
RL	Luxembourg	Mar 7, 1937
JARA	Jamaica	Feb 17, 1939
RCB	Bolivia	Mar 1, 1940

RCP	Paraguay	Jan 23, 1941
CREN	Nicaragua	Sept 15, 1945
VERON	Netherlands	Oct 21, 1945
TIR	Syria	1947
VERONA	Netherlands Antilles	Jan 6, 1948
RSB	Bermuda	Oct 15, 1950
RAL	Lebanon	1950
TTARS	Trinidad and Tobago	1951
RKDDR	German Democratic Rep	Feb 6, 1953
MARTS	Malaysia	Mar 10, 1953
RCCR	Costa Rica	Sept 30, 1953
ARM	Monaco	1953
ARSI	India	May 14, 1954
RSF	USSR	Dec 1959
NARS	Nigeria	1961
LRAA	Liberia	1962
RAST	Thailand	Nov 27, 1963
ARA	Algeria	1963
ABARS	Antigua and Barbuda	1965
ARRAM	Morocco	June 19, 1966
WSARC	Western Samoa	1968
ARAB	Bahrain	Sept 21, 1970
CARS	Cyprus	1972
ROARS	Oman	1972
SLARS	Sierra Leone	1975
ARAD	Djibouti	Apr 30, 1979
BARL	Bangladesh	May 20, 1979
ARRSM	San Marino	Apr 15, 1980
LARS	Lesotho	Nov 4, 1982

AR

## VE3CJ ELECTED AS PRESIDENT EMERITUS

The International Amateur Radio Union now has a President Emeritus: Noel B Eaton, VK3CJ. Seventy three member societies cast affirmative votes on the Proposal No 173, which the Headquarters made in the light of a recommendation adopted by the Manila Conference of the IARU Region 3 Association.

AR

## THREE NEW BANDS AT 10, 18 AND 24 MHz

The IARU Member societies of the following countries have notified the Headquarters of the availability of new bands for their use.

10.100-10.150 MHz: Algeria, Australia (less 10.1375-10.1455), Austria, Bermuda, Botswana, Canada, Cayman Islands, Colombia, Costa Rica, Denmark, Djibouti, Commonwealth of Dominica, Faroe Islands, France, Fed Rep of Germany, Honduras, Indonesia, Israel, Japan, Luxembourg, Malaysia, Malta, Monaco, Netherlands, Netherlands Antilles, New Zealand (10.100-10.125 and 10.135-10.150), Nicaragua, Nigeria, Norway, Panama, Papua New Guinea, San Marino, Solomon Islands, South Africa, Spain (10.1075-10.1135), Suriname, Switzerland, Syria, Tonga, Trinidad & Tobago, United Kingdom, USA (10.100-10.109 and 10.115-10.150), Western Samoa, and Yugoslavia

18.066-18.168 MHz: Algeria, Australia (less 18.071-18.079, 18.101-18.109, 18.121-18.134, 18.141-18.149 and 18.156-18.164), Austria, Botswana, Cayman Islands, Colombia, Costa Rica, Denmark, Djibouti, Faroe Islands, France, Fed Rep of Germany, Honduras, Monaco (less 18.103-18.116, 18.129, 18.135 and 18.165), Netherlands, Nicaragua, Nigeria, Norway, Oman, Panama, San Marino, South Africa, Switzerland, Syria, Tonga, Trinidad & Tobago, United Kingdom, and Yugoslavia.

24.890-24.990 MHz: Algeria, Argentina, Australia (less 24.896-24.904), Austria, Botswana, Cayman Islands, Colombia, Costa Rica, Denmark, Djibouti, Faroe Islands, France, Fed Rep of Germany, Honduras, Monaco, Netherlands, Nicaragua, Nigeria, Norway, Oman, Panama, San Marino, South Africa, Switzerland, Syria, Tonga, Trinidad & Tobago, United Kingdom, and Yugoslavia.

AR

# BUTTERNUT ELECTRONICS CO.

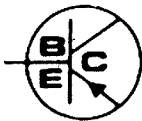

## Still More Usable Antenna For Your Money . . . Plus 30 Metres!

Butternut's new model HF6V\* offers more active radiator on more bands than any other vertical of comparable height. DIFFERENTIAL REACTANCE TUNING™ circuitry lets the 26' antenna work on 80/75, 40, 30, 20 and 10 metres and a loss-free linear decoupler gives full quarter wave unloaded performance on 15 metres. It can also be modified for remaining WARC bands.

- \* Completely automatic bandswitching 60 through 10 metres including 30 metres (10.1-10.15 MHz); 160 through 10 metres with optional TBR-160 unit.
- \* Retrofit capability for 18 and 24 MHz bands.
- \* No lossy traps to rob you of power. The HF6V's three resonator circuits use rugged HV ceramic capacitors and large-diameter self-supporting inductors for unmatched circuit Q and efficiency.
- \* Eye-level adjustment for precise resonance in any segment of 80/75 metres, incl. MARS and CAP ranges. No need to lower antenna to QSY between phone and CW bands.
- \* For ground, rooftop, tower installations — no guys required.

Suggested amateur net prices:  
 model HF6V (automatic bandswitching 80-10 meters) . . . \$282  
 Model TBR-160 (160 metre base resonator)  
 (When supplied as part of HF6V) . . . \$66

For complete information concerning the HF6V and other Butternut products, amateur and commercial, contact the sole Australian distributor -

**TRAEGER DISTRIBUTORS (NSW) PTY LTD**  
 PO Box 348, Moree, NSW, 2400.  
 Cnr Adelaide & Chester Sts.  
 Phone (067) 52 1627

\* Patented device

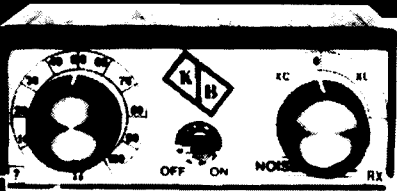

# NOISE BRIDGE \$60

Powerline and voltage transient filter  
 Ideal for computers. \$22.

Adjust your antenna for maximum performance. Measure resonant frequency, radiation resistance and reactance. Better than an SWR meter. Operates over 100 MHz. Most useful test unit in your shack.

## ANTENNA BALUNS

3 to 30 MHz.  
 Maximum Power 300 Watts.  
 Centre support.  
 Ideal for Dipoles, Beams, Quads.  
 S0239 connector.



\$26

## POWER LINE FILTER

240 Volt @ 10 Amp



\$16

1000's of Transistors — Ferrites — Hobby Kits — Tag Strips — Switches etc. Send stamped addressed envelope for full list.



**K. BRUCE SMITH**  
 110 Rosemead Road  
 Hornsby N.S.W. 2077

## Crystal Clear?

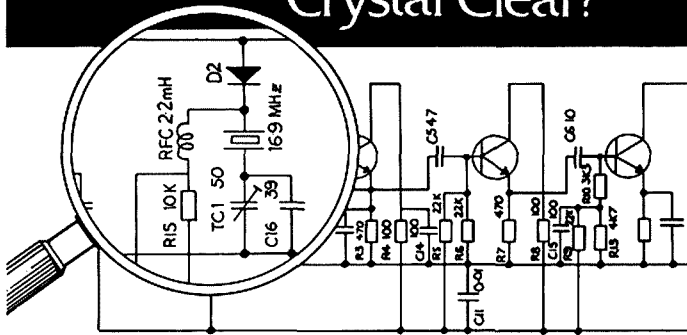

### RAKON EMPLOYS STATE OF THE ART FABRICATION TECHNIQUES TO PRODUCE:

- \* HIGH QUALITY QUARTZ CRYSTALS: RESISTANCE WELD TYPE.
- NB: RESISTANCE WELDING OFFERS BETTER LONG TERM STABILITY.
- \* PRICES — "THAT ARE REALISTIC".
- \* NORMAL DELIVERY: 10 WORKING DAYS ARO.
- \* FAST DELIVERY: IS AVAILABLE, IE: WITHIN 5 DAYS — AT SURCHARGE RATES.

\* Where the crystal parameters are unknown, our experienced engineering staff is available to advise on selection of the correct specification.



# RAKON AUSTRALIA PTY. LTD.

## ★ MANUFACTURERS OF QUARTZ CRYSTALS ★

39 SCORESBY ROAD, BAYSWATER, VICTORIA 3153.  
 PH: (03) 720 3188 TLX: AA34590

RAKON ALSO REPRESENTS —



### TOYO COMMUNICATION EQUIPMENT CO LTD

Offering an extensive range of their products including:— quartz crystal filters, monolithic crystal filters, packaged oscillators TCXO and VCXO, DIL clock oscillators and SAW devices.

NOTE: Inquiries re price and delivery should be forwarded to above address.

# KENWOOD

TS-930S

## 93-X MARK II HF TRANSCEIVER



**\$2099**

**\$1150**

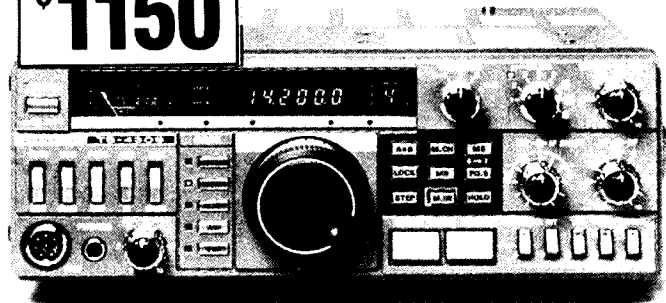

## TS-430S 43-X HF TRANSCEIVER



**\$689**

**TR-9500**  
**NOW AVAILABLE!**  
**START WORKING THE**  
**AMATEUR SATELLITE NOW.**

## NOTICE TO ALL HAMS

To comply with the new Government regulations the TS-430S will be known as the 43-X and the TS-930S Mark II will be known as the 93-X Mark II.

These are not new world models and are for Australian sales only.

The performance and features are identical to the present model numbers and the only difference is that the out-of-Amateur band transmissions are no longer possible. However the Receiving section is totally unchanged.

All equipment capable of transmitting outside of the Amateur Bands rate a 30% duty and this equipment is not in the spirit of Amateur Radio.

**\$640**



## PROFESSIONAL ROTATOR

Microprocessor controlled.  
10 Memories.  
Scanning.  
Stepping.  
Search.  
Azimuth centered on  
East Coast of Australia.

## TRIO-KENWOOD (AUSTRALIA) PTY. LTD.

(INCORPORATED IN N.S.W.)  
4E WOODCOCK PLACE, LANE COVE, SYDNEY, N.S.W. 2065.  
Ph. (02) 428 1455.

**ALL PRICES & SPECIAL OFFERS  
WILL ONLY BE MAINTAINED  
FOR A PERIOD OF ONE MONTH**

### NEW SOUTH WALES

- TRIO-KENWOOD (AUST) P/L — 4E WOODCOCK PLACE, LANE COVE (02) 428 1455
- SPRINGWOOD CAR RADIO — SPRINGWOOD (047) 51 4930
- UNIQUE ELECTRONICS — 418 OLD PROSPECT ROAD, ST. WENTWORTHVILLE (02) 631 6689
- WASIL ELECTRICAL — 71 SUMMER STREET, ORANGE (063) 62 6249
- STOCKMAN & HIGGINS — BYRON STREET, INVERELL (067) 22 1300
- ELECTRON 2000 — 3 ELIZABETH STREET, TIGHE HILL, NEWCASTLE (049) 69 6399
- MACLEIC PTY. LTD. — 99 KENNY STREET, WOLLONGONG (042) 29 1455
- RADIO WORLD PTY. LTD. — 81 NEWCASTLE STREET, FISHWICK (062) 80 6550
- DX ENGINEERING — 5 JASMINE STREET, PORT MACQUARIE (065) 83 2175
- LAND LINK — MULLALEY ROAD, GUNNEDAH (067) 42 2838
- LAND LINK — 61 BARNES STREET, TAMWORTH (067) 65 4622
- FRANK BOUNOY — LISMORE (066) 86 2145

### INTERSTATE

- VIC: EASTERN COMMUNICATIONS — 168 ELGAR ROAD, BOX HILL (03) 288 3107
- BRIAN STARES — 11 MALMSBURY STREET, BALLARAT (053) 39 2808
- SUMNER ELECTRONICS — 78 KING STREET, BENDIGO (054) 43 1977
- TAS: HOBBY ELECTRONICS — 477 NELSON ROAD, MT. NELSON (002) 23 6751
- GELSTON ELECTRONICS — SUMMER HILL (003) 27 2256
- ADVANCED ELECTRONICS — 5A THE QUADRANT, LAUNCESTON (003) 31 7075
- V.K. ELECTRONICS — 214 MOUNT STREET, BURNIE (004) 31 7733
- MITCHELL RADIO CO — 59 ALBION ROAD, ALBION (07) 57 6830
- S.A. & N.T.: INTERNATIONAL COMMUNICATIONS SYSTEMS PTY. LTD. — 8 NILE ST., PORT ADELAIDE (08) 47 3688
- W.A.: ARENA COMMUNICATIONS SERVICES — 642 ALBANY HWY., EAST VICTORIA PARK (09) 361 5422
- TRI-SALES — CNR NEWCASTLE & CHARLES STREETS, PERTH (09) 328 4160
- WILLIS ELECTRONICS — 445 MURRAY STREET, PERTH (09) 321 2207
- BAY RADIO — 18 BANKSIA STREET, BUNBURY (097) 21 2236
- RON DENT — 115 RATON ROAD, SOUTH HEADLAND (091) 72 1112
- SELECT TRONIX — TOM PRICE (091) 89 1564
- FORD ELECTRONICS — 209 HANCOCK STREET, DOUBLE VIEW (09) 446 4705



# GFS Electronic Imports

17 McKeon Road, Mitcham, Victoria, 3132  
PO Box 97, Mitcham, Victoria, 3132 Phone: (03) 873 3939, 873 2652  
Telex: GFS AA 38053 Cable: "Comimports" Melbourne

## MFJ-410 "Professor Morse" lets you . . . COPY CW FASTER AND UPGRADE QUICKER

New MFJ Random Code Generator/Keyer sends unlimited random code in random groups for practice. Never repeats same sequence. Tailor level to your ability. Vary speed 5 to 50 WPM. Vary spacing between characters. Speed Meter. Full Feature Keyer.

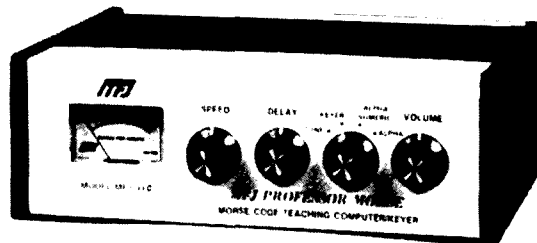

**\$233 + \$7 P & P**

*Sends unlimited random code. Never repeats same sequence.*

*Tailor level to your ability. Vary speed 5-50 WPM.*

## MFJ ACCESSORIES FOR THE SWL

ACTIVE OUTDOOR RECEIVING ANTENNA covering 50 kHz to 30 MHz using telescopic whip.

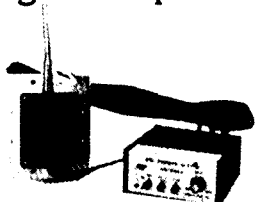

**\$233 +  
\$7 P&P**

At lower frequencies performance is equivalent to that of a long wire. At higher frequencies it provides gain. Supplied with 50 feet of coax.

**\$192  
+ \$7 P&P**



MFJ-959 RECEIVER ANTENNA TUNER has low noise 20 dB preamp for weak stations. Match antenna to receiver for maximum signal. 1.6 to 30 MHz. Can use 2 ant., and 2 rcvrs. Select tuner, tuner with preamp, tuner with 20 dB attenuator, bypass. Gain control. Coax, phono jacks. 9-18 VDC 9x2x6 in.

## HEAR COMMERCIAL VHF HIGH BAND AND VHF MARINE SIGNALS

on 2 Metre Handhelds with this MFJ VHF Converter.

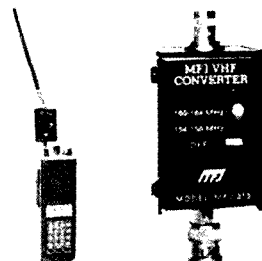

Scanning

MFJ-313

**\$88.00 +  
\$5 P&P**

New MFJ VHF converter turns your synthesized scanning 2 metre handheld into a hot VHF HIGH band scanner.

144-148 MHz handhelds receive marine on 154-158 MHz with direct frequency readout. Hear VHF commercial stations plus more on 160-164 MHz.

Mounts between handheld and rubber ducky.

Feedthru allows simultaneous scanning of both 2 metres and commercial bands. No missed calls.

Highpass Input filter and 2.5 GHz transistor gives excellent uniform sensitivity over both bands. Crystal controlled.

Bypass/OFF switch allows transmitting. Won't burn out if you transmit (up to 5 watts) with converter on. Low insertion SWR. Uses AAA battery. 2 1/4 x 1 1/2 x 1 1/2 in. BNC connectors.

Enjoy scanning, memory, digital readout, etc. as provided by your handheld on 154-158 and 160-164 MHz bands.

## STANDARD C-58E 2 METRE MULTIMODE PORTABLE NOW IN STOCK AGAIN.

Write for a brochure and full specifications.  
**\$377 + \$10 P&P**  
**CPB58E MATCHING 25 WATT LINEAR \$188 + \$10 P&P**



**NEW C-8900E 2m MOBILE IN STOCK.**

\* ULTRA SLIM LINE 31H X 178D X 138W cms  
\* Ga As FET front end, 0.15 uV @ 12 dB SINAD  
Write for a brochure and full specifications.

**Price \$413 + \$10 P&P**





# GFS Electronic Imports

17 McKeon Road, Mitcham, Victoria, 3132  
PO Box 97, Mitcham, Victoria, 3132 Phone: (03) 873 3939, 873 2652  
Telex: GFS AA 38053 Cable: "Comimports" Melbourne

## MFJ

ENTERPRISES,  
INCORPORATED

## ANTENNA TUNERS TO SUIT ALL REQUIREMENTS UP TO 3 kW

### MFJ-941C 300 Watt Versa Tuner II

Has SWR/Wattmeter, Antenna Switch, Balun. Matches everything 1.8-30 MHz: dipoles, vees, random wires, verticals, mobile whips, beams, balanced lines, coax lines.



**\$201**  
+ \$7 P&P

Matches everything from 1.8-30MHz: dipoles, inverted vees, random wires, verticals, mobile whips, beams, balanced and coax lines.

Run up to 300 watts RF power output. SWR and dual range wattmeter (300 & 30 watts full scale, forward/reflected power). Sensitive meter measures SWR to 5 watts.

Flexible antenna switch selects 2 coax lines, direct or through tuner, random wire/balanced line, or tuner bypass for dummy load.

12 position efficient airwound Inductor for lower losses, more watts out. Built-in 4:1 balun for balanced lines.

Measures 8x2x6".

### MFJ-949B VERSA TUNER II

MFJ-949B

**\$265**  
+ \$7 P&P



MFJ's best 300 watt Versa Tuner II. Matches everything from 1.8-30 MHz, coax, randoms, balanced lines, up to 300W output, solid-state or tubes.

Tunes out SWR on dipoles, vees, long wires, verticals, whips, beams, quads.

Built in 4:1 balun. 300 W, 50-ohm dummy load. SWR meter and 2-range wattmeter (300W and 30W).

6 position antenna switch on front panel, 12 position air-wound inductor, coax connectors, binding posts, black and beige case 10x3x7".

### MFJ-989 VERSA TUNER V

MFJ-989

**\$562**  
+ \$15 P&P



New smaller size matches new smaller rigs — only 10-3/4 W x 4-1/2Hx 14-7/8D".

3 kW PEP, 250 pf-6kV caps. Matches coax, balanced lines, random wires 1.8-30 MHz.

Roller inductor, 3-digit turns counter plus spinner knob for precise inductance control to get that SWR down.

Built-in 300 watt, 50 ohm dummy load.

Built-in 4:1 ferrite balun.

Built-in lighted 2% meter reads SWR plus forward/reflected power. 2 ranges (200 & 2000W).

6 position ant. switch. Al. cabinet. Tilt bail.

### MFJ DUMMY LOADS

Tune up fast into 50 ohm resistive load. Extend life of finals.

Includes high quality transformer oil.

**\$58.00**  
+ \$8 P&P



New MFJ-250 VERSALOAD Kilowatt Dummy Load lets you tune up fast. Extends life of transmitter finals. Reduces on-the-air QRM.

Run 1 kW CW or 2 kW PEP for 10 minutes. 1/2 kW CW or 1 kW PEP for 20 minutes. Continuous duty with 200 watts CW or 400 watts PEP. Complete with derating curve. Quality 50 ohm non-inductive resistor.

Oil cooled. Includes high quality, industrial grade transformer oil (contains no PCB). Low VSWR to 400 MHz: Under 1.2:1, 0-30 MHz. 1.5:1, 30-300 MHz. 2:1, 300-400 MHz.

Ideal for testing HF and VHF transmitters.

SO-239 coax connector. Vented for safety. Removable vent cap. Has carrying handle. 7-1/2 in. high, 6-5/8 in. diameter.

### MFJ-900 VERSA TUNER

MFJ-900

**\$125**  
+ \$7 P&P

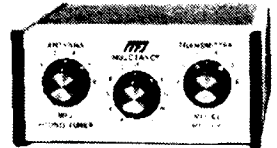

Matches coax, random wires 1.8-30 MHz.

Handles up to 200 watts output; efficient air-wound inductor gives more watts out. 5x2x6".

Use any transceiver, solid state or tube.

Operate all bands with one antenna.

2 OTHER 200W MODELS:

MFJ-901, \$138 (+ \$7), like 900 but includes 4:1 balun for use with balanced lines.

### MFJ-962 VERSA TUNER III

MFJ-962

**\$326**  
+ \$15 P&P



Run up to 1.5 kW PEP, match any feed line from 1.8-30 MHz.

Built-in SWR/Wattmeter has 2000 and 200 watt ranges, forward and reflected.

6 position antenna switch handles 2 coax lines (direct or through tuner), wire and balanced lines.

4:1 balun. 250 pf 6kV cap. 12 pos. inductor. Ceramic switches. Black cabinet, panel.

**\$100.00**  
+ \$8 P&P

MFJ-262

MFJ-262 (1 kW)



### BY-1 PADDLE \$78 + \$7 P&P

OPTIONAL BENCHER IAMBIC PADDLE FOR ALL MEMORY KEYERS. Dot and dash paddles have fully adjustable tension and spacing for the exact "feel" you like. Heavy base with non-slip rubber feet eliminates "walking."

Air cooled, non-inductive 50 ohm resistor in perforated metal housing with SO-239 connectors. Full load for 30 seconds, derating curves to 5 minutes. SWR 1.5:1 for 30 MHz. 3x3x13 inches.



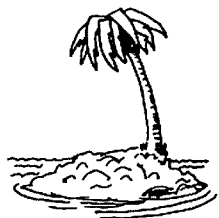

# HOW'S DX

Ken McLachlan, VK3AH  
Box 39, Mooroolbark, Vic 3138

Postage increases of 11% plus effective this month, surely is sad news for the DXer and this will create a greater strain on the never tiring WIA QSL Bureau managers and their assistants. It is, more than ever, beneficial to have access to your divisional bureau so that you may despatch those cards expediently with a minimum of cost.

When one tots up the cost of despatching a card by post to an exotic overseas country, it becomes astronomical. A self addressed envelope, 2 IRC's at a minimum, an envelope to place it all in, time in addressing the envelope and that STAMP. It all adds up to a very tidy sum. With the bureau at ones disposal, the charges are minimal.

When one is placing a card through the bureau, it would be considerate to take a little care so that you may participate in the assistance of the sorting of thousands of cards in a year by adhering to the basics that are common to all bureaus.

The basics include accurate alphanumeric sorting of all cards that you intend to send and the call sign in 10mm high legible lettering of the designated station on the top right hand reverse side of the card.

Each VK QSL bureau has certain limitations and they have rules that vary from division to division. It is up to you, as a member, to inquire of the rules that are pertinent to your division and abide by them, so that the volunteer labour will not be overtaxed beyond the limits. A number of QSL Bureaus in overseas countries employ paid staff. One such country is JA, where some 25 people are employed in the inwards and outwards departments.

Whilst on the subject of QSLing, it was mentioned last year that, in conjunction with Jan and Jay's publication of the QSL Managers List, all bad QSLers would be printed. Unfortunately, very few VK's sent in any reports. Of those that did, no concrete evidence as to a non QSLing station was obtained and apparently the same happened to Jan and Jay, as they have not printed anymore. Perhaps the amateur fraternity on the whole is too lethargic.

One amateur from VK5 kindly submitted his list of successes and not so successful returns, and a quick glance shows that he has had about a 97 percent rate of return. Not the ultimate, and for this day and age, not a bad effort.

This amateur notes in his letter that he always sends a self addressed envelope and two IRC's. The list shows that some operators are very prompt, others tardy and very inconsiderate of their fellow amateur. It is known that one VK operator who jumped in to become a QSL manager, still owes cards to at least one VK3.

## TURKEY

Still need TA on CW? Unal TA1UA, has been active on both fifteen and twenty metres.

Generally to be found 25 to 30 kHz inside the band edge. If you are successful QSL direct to Unal Akbal, PO Box 787, Istanbul, Turkey and please no reference to the hobby on either envelope.

## RARE ONES

Ed W4MGN, was at it again and operated from C5, 6W and 9U during one of his whirlwind trips to Africa. Ed has intimated that DX operations have come to a standstill in Gambia, due to all of the DXers having left the country. The remaining operators have only one interest and that is working back into the UK.

Burundi is changing too, in so much that Jean 9U5JM is expected to return home to France in the near future. His place may be taken by Jim N4HX. Jim has been appointed the American ambassador and hopes to obtain operating privileges in the near future.

## PRINCE WILLIAM

The unusual call sign GB1BOY was used on 21 June to celebrate Prince William's first birthday. This is another indication that the licensing authorities have taken a special view on their attitude towards special event stations. Let's hope that it will not become like VE, and we will have to learn to cope with learning new prefixes every couple of weeks.

## UNUSUAL PREFIXES

The USSR authorities have really let their hair down and issued some very unusual prefixes in commemoration of World Communications Year.

Such prefixes as EM6, UU, 4J4 and 4K1 have been heard with poor band conditions, but at extremely good strength at this QTH on twenty metres. Some signals from these regions were subject to very strong flutter at times.

Not to be outdone, the Canadian stations, who operate under many prefixes with the least excuse have been using such exotics as CK4 and XJ3 around the bands.

## MALPELO ISLAND

Latest information is that the DX group will make it and they will commence around the 12th of this month. Like others I will be queueing up to work this one as it has escaped me over the years. Good luck to all those that need it for a new one. To those that have it confirmed and claimed on their DXCC score, please stand aside and let the stations that need it for a new country work it first.

## NO LICENCE

A recent application by an amateur for permission to operate in A51 was turned down by the authorities with the explanation that there is no legislation to permit amateur radio operations by non nationals.

Pradhan A51PN looks like the only hope to those wanting this country, and the chances of him appearing in the near future are very slim.

## KNIGHTS OF MALTA

Don't overlook the operation from this rarely activated area scheduled for this month. Mario 10MGM, the station's QSL Manager, should have 1A0KM on the air from all accounts.

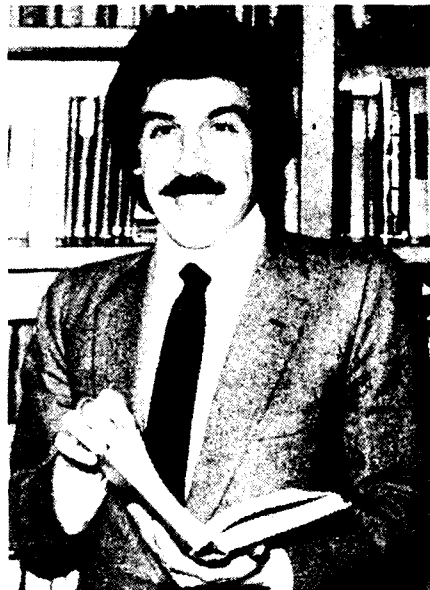

Mario 10MGM Photo courtesy W6VGO and World Radio.

## ASSIGNMENT OF US CALLSIGNS

Ever wondered what that strange call sign was that was emanating from the United States. I have, and Bob W5KNE, Editor of QRZ DX has kindly put me right, and sent me a full list which has been reprinted for your benefit.

## PUBLIC NOTICE ISSUED ON AMATEUR RADIO CALLSIGN ASSIGNMENT SYSTEM

The FCC has issued a bulletin pointing out that even though they mentioned in April 1978 that they would not be reissuing unassigned call signs for five years, *no plans are being considered "to establish a schedule in the foreseeable future for reassignment of any call sign."* The FCC did say, however, that they were "extending the period in which secondary call signs may be assigned to primary stations." Also, any call sign can now be renewed within two years after expiration. The new prefix block "KP5" has been set aside for Desecheo Island.

## CALLSIGN ASSIGNMENT ORDER. . .

- Extra Class (Group A)
- Advanced Class (Group B)
- Technician/General (Group C)
- Novice Class (Group D)

## CONTINENTAL UNITED STATES

KA#A-KZ#Z; NA#A-NZ#Z; WA#A-WZ#Z;  
AA#AA-AK#ZZ (Except:  
KH, KL, KP, NH, NL, NP, WH, WL, WP.)

KB#AA-KZ#ZZ; NA#AA-NZ#ZZ; WA#AA-  
WZ#ZZ (In 1-lands: 1st block=KA1AA-KZ1ZZ -  
Same Exceptions)

N#AAA-N#ZZZ; W#AAA-W#ZZZ (No  
Exclusions)

KA#AAA-KZ#ZZZ; WA#AAA-WZ#ZZZ (Except:  
KH, KL, KP, WC, WH, WK, WL, WM, WP, WR,  
WT).

## NON-CONTIGUOUS U.S.A.

(Extra) Pacific Area = AH#A-Z, NH#A-Z,  
WH#A-Z; Alaska = NL7A-Z, WL7A-Z, AL7A-Z;  
Atlantic Area = KP#A-Z; NP#A-Z; WP#A-Z;  
(Advanced) Pacific Area = AH#AA-ZZ; Alaska =  
AL7AA-ZZ; Atlantic Area = KP#AA-ZZ  
(Tech/Gen) Pacific Area = KH#AA-ZZ, NH#AA-  
ZZ, WH#AA-ZZ; Alaska = KL7AA-ZZ, NL7AA-  
ZZ, WL7AA-ZZ; Atlantic Area = NP#AA-ZZ;  
WP#AA-ZZ (Novice) Pacific Area = WH#AAA-  
ZZZ; Alaska = WL7AAA-ZZZ; Atlantic Area =  
WP#AAA-ZZZ

## NUMERICAL DESIGNATORS FOR NON- CONTIGUOUS U.S.A. DIGIT LOCATION

- 1 Baker, Howland Island
- 2 Guam
- 3 Johnston Island
- 4 Midway Island
- 5 Palmyra Island
- 5K Kingman Reef (K Suffix)
- 6 State of Hawaii
- 7 Kure Island
- 8 American Samoa
- 9 Wake, Wilkes, Peale Islands
- 0 Commonwealth of Northern Mariana Islands
- 7 State of Alaska
- 1 Navassa Island
- 2 Virgin Islands
- 4 Commonwealth of Puerto Rico
- 5 Desecheo Island

*Note: Designator: "3" has been discontinued.  
Previously assigned to Roncador Cay, Quita  
Sueno Bank and Serrana Bank.*

So we hope that it is now a little clearer than  
it was before and thanks Bob.

## IDENTIFICATION

On browsing through the Royal Omani  
Amateur Radio Societies newsletter (ROARS)  
mention is made of a new membership  
requirement. This requirement is an identifi-  
cation card for each member. To be an  
amateur or SWL in Oman you must be a  
member of the society.

This move has been brought about by the  
number of pirate operations emanating or  
purported to emanate from Oman. Another  
measure is the identification of equipment to  
the society, with such details as the exact  
location of the equipment, the make, model  
and serial number of all equipment held by  
the member.

It is an offence to sell transmitting equip-  
ment within Oman without the prior know-  
ledge and consent of the society.

## PETER 1st ISLAND

A new DXCC listing and it did cause quite a  
stir on the bands. Many questions were asked  
by many DX operators. Questions embracing  
where is it, who has operated there and the  
most searching of them all, when will it be  
operated and by whom?

All good questions, most answerable. This  
island is located some 400 kilometres off the  
Antarctic mainland and spans an area 22  
kilometres by 11 kilometres, co-ordinates  
being 69° 0 S and 91° 0 W. It has a peak of  
1220 metres at its highest point.

It was founded in 1822 by a Russian  
explorer and not claimed until 1931, when the  
Norwegians occupied it to assist in the  
policing of their whaling rights in the sur-  
rounding waters. This island has been  
described by one journalist as "... bleak,  
dangerous and uninviting. . ."

One other amateur, who has sailed near it,  
has described it similarly but remarks that  
there might be only a few days of the year  
when a landing would be possible as the  
surface is covered with ice rather than snow.

It is apparent that any expedition who were  
venturesome would have to convince the  
Norwegian government of their intentions  
and be able to take out a 3Y call. This exercise  
could prove to make Heard Island look like a  
piece of "cake" in comparison.

The Norwegian claim is not recognised by  
many countries, only those who are signa-  
tories to the Antarctic Treaty. Australia is a  
signatory to this agreement whereas the USA  
and USSR are not.

Problems aside, who will be the first to  
activate this desolate area, will it become a  
non starter because of the difficulties and if  
eventually some amateurs are willing to risk  
life and limb will it be universally recognised. I  
feel that it will see that the ARRL have  
listed it as current country number three  
hundred and sixteen when it is operated by a  
valid and legitimate expedition.

Any takers to activate this one? The  
authorities will not be killed in the rush for  
licence issues that is for sure.

## CLIPPERTON

The propagation is still falling and the  
enthusiasts are still making plans for an  
expedition in early 1984. Stay tuned for any  
updates between now and February 1984.

## ANGOLA

The near future may allow OK3TAB/D2A to  
be heard on the bands. This station was last  
heard in 1979, so if it comes to pass it could  
prove to be on the much wanted list of newer  
licences.

## RODRIGUEZ ISLAND

This island will be activated by 3B9FK until  
approximately mid December. QSL's to PO  
Box 1080, Port Louis, Mauritius.

## ST PAUL ISLAND

This rarely activated area should be active  
the first week of this month. Stations partici-  
pating in the venture of putting VE1SPI to air  
include VE's 1ASJ, CEG, CER, TT, JH1VRQ,  
W1GNC and WBOSN.

They promised to be active on all bands  
with CW, SSB and RTTY.

## BLANK QSL CARDS

This column has not been quite compli-  
mentary to "open" QSL cards in the past and  
again they are appearing, this time to an  
expedition QSL Manager.

Neil, VK6NE has received cards to fill in for  
"yourself or your friends" in the hope of

receiving a confirmation for the much wanted  
QSL from Heard Island. Some readers will  
 scoff at the thought of this practice but it is  
100 percent truthful. I have seen the evidence  
at this QTH, before the cards were returned to  
their South American owner.

One wonders how many other legitimate  
QSL Managers come across such violations  
of the ethics of the hobby and the temptations  
placed upon them. No matter who, all cards  
should be checked against the log, a practice  
that is not always adhered to unfortunately, I  
am afraid.

These cards have been cancelled and  
suitably endorsed, leaving no doubt to the  
station licensee, no matter if there is a  
language barrier, as to the integrity of the  
VK0HI and CW cards authenticity, and the  
practice is not appreciated in this country by  
at least one QSL Manager.

Congratulations Neil on the stand that you  
and your helpers took with such "freeloaders".

## DEMOCRATIC KAMPUCHEA

A note from Mike JH1KRC, the Executive  
for Overseas Relations with the DX Family  
Foundation, to one of the main contributors  
to this column, explains that XU1SS was  
licensed by Mr Son Sann, the Prime Minister  
of the Coalition Government of Democratic  
Kampuchea for operation of amateur radio by  
his own people.

Mike, along with the other JA operators  
(nine in all) will act as instructors and hoped  
to be allowed to operate. This was the case as  
I had the pleasure of working XU1SS and  
personally speaking to Mike, who gave the  
VK's an excellent chance of working them.

Whether the DXCC committees and awards  
managers will accept this as a legitimate  
country will have to be seen over the coming  
months. The first step is to receive the QSL  
card, if you worked them of course, and the  
only route is a direct QSL to JA1HQG, with of  
course adequate return postage and SAE. It is  
unfortunate and quite apparent that no  
bureau cards will be solicited for obvious  
reasons.

This group has established and is construct-  
ing "Tokyo Village" which will incorporate a  
refugee camp. Equipment such as two FT77's,  
one FL2100, one FT101, electronic keys and the  
antennae department includes a triband  
beam, rotator and a vertical. Power supplies  
have not been forgotten as two engine  
generators have been also donated by the  
amateur fraternity and amateur dealers in JA.

## GOLDEN ANNIVERSARY

A number of special calls are active from  
Columbia at the present. These calls include  
5J1LM to 5J0LM and 5K1LM to 5K0LM.

These calls are being used to celebrate the  
fiftieth anniversary of the Columbian society  
and will be current until the end of the year.

## PROFILE OF ZS20M

Andrew XS20M, a "white cane operator"  
for some twenty years, is known far and wide,  
but particularly in VK and ZL for his amiable  
QSO's that he enjoys before departing for his  
work QTH. Andrew enjoys frequenting the  
ten, fifteen and twenty metre bands when  
conditions permit.

Born around 1925 in South Africa of  
Scottish parents, Andrew became interested

in amateur radio just after the second World War, when he and his brother ZS2OW (also a white "cane operator") purchased some disposal receiving equipment and listened into contacts from all over the world.

Andrew and Willy's interest was further kindled when a school teacher, who was also an amateur, came to their town. This gentleman's assistance helped them gain the licence.

Apart from radio, and his countless friends overseas, Andrew has few hobbies. He has had in excess of two thousand QSO's with one of his regular friends, Bill ZL4AW since 1969. Another interest is Lions International, where Andrew was a director for eight years and still attends all meetings.

It could be said that Andrew is a man of habit, being very particular about leaving for his work QTH at a particular time each day. He holds a responsible position in a company that deals in agricultural requirements for the farming community around the town of Konga where he resides, a position he has held for in excess of twenty five years, even though he has been with the company for a considerably longer period.



Andrew ZS2OM at work.

When asked in a recent QSO as to how many DX countries he has on his tally, the answer was "I had about 250 about ten years ago, but since then I have lost count."

Anyone wishing to have a QSO with Andrew may join the ANZA Net around 0500 UTC at 21.204 MHz and QSY to an adjoining frequency for a chat before he rushes off to the "saltmine" six days per week.

### NEW DX CLUB

A note from Chris VK3FY informs of a group of DX orientated amateurs that have formed themselves into a group with the name of the Down Under DXers Contest Club.

Their first venture will be a trip to Lord Howe Island between the 23rd October and the 3rd November, taking in the CQWW Phone Contest and they will be operating on all current contest bands during their stay.

Members of the group at present comprise Marv WA2BFW, Les VK2WU, Peter VK2DAV, Chris VK2NYA, Sue VK2PSC, Stu VK2ADE, Martin VK4VU and Chris VK3FY.

Good luck to the group in their efforts and it is refreshing to see the novice and full calls getting together in a joint venture.

### UNITED ARAB EMIRATES

Fred VK1MM, received a note from Jan A6XJA with some interesting information concerning operations from that country.

Jan notes that there are three stations active from the UAE and they are all acceptable for DXCC credits. The three stations are A6XJA, A6XJC and A6XTH.

The note also gives the only QSL info, which is "Callsign", PO Box 5708, Dubai, United Arab Emirates. Please enclose a self addressed envelope with a US "green stamp" as IRC's are sometimes a non event, four IRC's are required for an airmail stamp at some Post Offices.

These stations are QRV on 21.180 MHz daily at 1600 UTC and on other bands. Modes for these gentlemen are SSB with A6XTH running RTTY and soon SSTV. Jan is also building RTTY equipment.

### SILENT KEY

It is sad to record that Nara 9M2LN, became a "silent key" on the 21st July this year due to a heart attack. Nara will be remembered by many VK's for the assistance he gave them in CW tutorials and he has helped many to upgrade.

His work is being carried on by his friend Hock 9M2FR. (Refer article in AR, page 17, November 82.)

### TASMANIAN DEVIL AWARD

To maintain interest in this well presented award, the VK7s hold a net on 3.590 MHz at 1000 UTC each Tuesday.

It would be appreciated if some VK7s could join the Pacific DX Net on Tuesdays and Fridays at 0600 UTC on 14.265 MHz, as they are in demand by many overseas operators for this award.

### THE DXING TUCKERS

The Tuckers are a family of six licensed amateurs spread over 350 km of Northern California. The family consists of mother, father, two sons and their XYL's and it is hoped in the not too distant future that the grandchildren will stretch the family into the third generation of Tucker amateurs.

Vic, K6SEA and Fran, K6SBL live in a small community, Franklin, situated about 25 km

south of Sacramento. Their main interest is working their local 2 m repeater and among their equipment is a Heathkit 2 m transceiver which Fran built. They have both been licensed since 1958 and some of their achievements include providing radio communications for the 1960 World Olympics held in Squaw Valley, providing emergency communications during an Alaskan earthquake and tidal wave and communications during floods in 1964. They have been heavily involved in search and rescue work and handling traffic to overseas servicemen.

Son Ken, WB6AGM attained his licence in 1965 whilst in high school after he became involved in an electronics programme. His XYL, Centella, WB6WEM was licensed in 1977. They live in the small community of Greenville and run a grocery store. Their main activity is also 2 m and are not as active as they would like to be on the DX bands.

Other son Dave, KA6BIM and his XYL Dottie, KA6BIL have been licensed since 1978. They live in Manteca about 100 km east of San Francisco and 100 km south of Sacramento, where Dave is a fireman and Dottie is fully employed in raising their small son Daniel. Dave is the real DX Hound of the family and has worked over 140 countries. He is very active on 15 and 20 m with a little operating on 10 m. Dave and Dottie are very eager for young Daniel to take up the amateur bug as soon as he is old enough and make a third generation of Tuckers on air.

★ K6SEA VIC	K6SBL ★ FRAN
★ WB6AGM KEN	WB6WEM ★ TELLA
★ KA6BIM DAVE	KA6BIL ★ DOT
The Tucker Family MUCH THANKS	



Dave, KA6BIM, Dottie, KA6BIL, Ken, WB6AGM, Centella, WB6WEM, Fran, K6SBL and Vic, K6SEA.

## SAN MARINO

Since the change of prefix, a number of the operators have been quite busy on twenty metres.



Relaxing after working the multitudes. (L to R), Giovanni T77D, Franz DJ9ZB, Pergio T77V and Antonio T77C.

Picture courtesy QRZ DX and DJ9ZB.

## QSL MANAGERS YOU MAY NEED

1AOKM — 10MGM, 1D6AK — G3WPF, 3B8DB — K5BDX, 3D6AK — G3WPF, 4K1B — UK6LAZ, 4K1D — UF6FFF, 4K1GDW — UQ2GDW, 4N5KU — YU5CXY, 4N6ARG — YU6SCG, 4U1UN — W2MZV, 4X4WCY — 4X4AT, 4X6DF — KC2MS, 4X6WCY — 4X6DW, 5N3RTF — DK1IF, 5R8AL — WA4VDE, 5Z4CQ — KA7KSY, 6U1WCY — DF7ZH, 6W8JI — WA4VDE, 7P8CG — KC0FH, 9H1EL — LA2TO, 9K2BE — G4GIR, 9K2EZ — PA0NCV, 9M2MO — K9DX, 9V0TL — 9V1TL, A4XYA — G4ADJ, A71BJ — G4HNP, AH9AA — KW6HF, B7YPO — BY1PK, C30LAC — EA5AQX, C30LAE — EA3CRX, C31FO — F3BW, EH3ITU — EA3AOC, EK1O — UK1OAZ, EM6F — UK6FFF, EN6FCR — UF6CR, FB8WI — F6GXB, FOHSK/FC — DL5FN, FB8WI — F6GXB, FE32CCC — TI2CCC, FG0HYJ/FS7 — VE2EWS, FP0HOQ — NS4M, FY0GS — DK4VW, HV2VO — IOGPI, J88AN — W3BL, J88AQ — W2MIG, KC6YA — W9GW, KD4LI/TI2 — W2GBX, KP4CC — KP4EHB, KX6PO — W4FRU, N2EDQ/KH7 — KH6JEB, OH0AM — OH2BH, OY1R — W2KF, OZ9LM/OY — OZ9LM, PY0FE — PY1BYV, T30AT — G3XZF, T30DB — G8LGB, TE32CCC — TI2CCC, TG9NX — N4FKZ, TL8CK — F6EWM, TL8ER — F6GQK, TO00FB — WB6GFJ, TO7GAS — FG7AS, TR8DR — W2PD, TR8NYA — JA1LFP, TR8SDP — F8BC, TU2JL — F6CXV, UA0ZDA — UA3AEL, VK9ZS — VK6YL, VP2MM — AB1U, VS6IM — K1MM, W1BWS/CS2 — W1BWS, Y83TSF — Y41YM, YB5ASO — W4BBP, ZD9CA — KA1DE, ZD9CJ — K0VCR, ZD9CS — KA1DE, ZK1CH — ZL1SD, ZL4DE — ZL2HE.

## QSL ROUTES

5H3LM PO Box 511, Mbeya.  
5N8HEM PO Box 7355, Kano.  
5V7WI PO Box 1499, Lome.  
5Z4DD PO Box 30270, Nairobi, Kenya.  
7P8CI PO Box 949, Maseru 100, Lesotho.  
7P8CT PO Box 959, Maseru 100, Lesotho.  
A4XJV PO Box 5530, Ruwi, Oman.  
CE8ABF Estancia Lago Gaviota, Punta Arenas, Chile.  
CO6KB PO Box 955, Santa Clara, Cuba.  
CP8GB PO Box 35, Riberalto, Bolivia.  
CP8HD PO Box 101, Beni, Bolivia.  
EL2AM PO Box 1011, Monrovia, Liberia.  
FG7BM PO Box 1249, Point-a-Pitre.

FM7WD PO Box 879, Fort de France.  
H44AP PO Box 581, Honiara.  
J20WYC BP 1076, Djibouti.  
KX6QO PO Box 444, APO SF 96555, USA.  
J87BS 3 Chesterfield Hill, London W1.  
JY5DT PO Box 2353, Amman.  
PZ1DV PO Box 9006, Paramaribo.  
S79ARB PO Box 178, Winslow, NJ 08095.  
S79WHW PO Box 491, Seychelles.  
TR8CR PO Box 4356, Libreville.  
TR8DC PO Box 484, Libreville.  
TR8IG PO Box 740, Libreville.  
VP8ANT PO Box 146, Cambridge.  
VU2USE C/- American Embassy, New Delhi.  
WA4VDE Route 5, Box 107, Canton GA 30144.  
YK5AK PO Box 132, Padang.  
ZK1CG PO Box 618, Raratonga, Cook Islands, South Pacific.

## CW SWLING WITH ERIC L30042

28 MHz  
HL9TX, JA(3), VK3(5), VK6(1).  
21 MHz  
AH2G, BY1PK (0800z), BY8AA (0200z), DJ5WCY, OU1TV, EA30B, FK8AX, F08JM, HL0C, I6LVT, N6CUQ/KH2 JP1FEE, KH6BGE, P29NPL, PA0LOU, PY8AFT, SM7AZ, UK8AAI, VE2HQ, VE3BDO, KB6AWO, KOKES, YB1DRE, YU1KL, ZK2BW, ZS5KI.  
18 MHz  
VK3BW, VK3ABR, VK5GZ.  
14 MHz  
DF2QS, WA3UHK/DU2, G6ZY/EA6, F2NQ, FK0AQ, F08JM, FR7BP, G4DAA, HG5A, HL1CX, HL9SN, HP1AW, ISOPEC, KH6AK, KL7RS, OE6WF, OK1AAW, PY2BW, SM7ABO, SP2AYC, UA100R, UK5UCU/U1N, UA9YAN, UC2CFA, UL7PBD, VU2RQ, XE10E, YB4FN, Y03RF, 4K1QAV, 9M2MW.  
10 MHz  
OF3TB, F6IGQ, FC8TT, FG7BP, FK8KAA, G3UOF, GM3DPK, HB9NL, JA6HW, KP2J, OZ2RH, PA3BTH, VE3QH, W (all call areas), Y39UO, ZM2AGY, 4X4WF.

7 MHz  
CO2TM, DJ4PI, EA11V, F6KSY, FK8DK, F08BI, HG5A, HC4WA, HL4XM, IV3DVN, KD7P/KH2, KC4AAA, KG6RT, KP2J, KP4L, ISOLKX, LZ2PP, OH1AA/OHO, OH0AM, PA0LOU, OK3EY, UV3WS, UK2GAB, UC2SKZ, UP2BAO, KP4DEX/V2A, VK3WCY, XE3ARV, Y03CD, YU2RA, YV5DRN, Y51XE, 4K1B, 8P6AU.

3.5 MHz  
HH2VP, LA2JE, LZ1KDP, SM6CPY, SM7WI, UA3DJN, UA4CCC, UA4PWW, UK2GAB, UB5GFI, UB5LLE, U18BI, UK6LAZ, UQ2GCN, Y02BV, Y08BPK, YU2CFM, 3D6AK.

1.8 MHz  
VE3INQ, VK2(3), VK3(2), VK4NN, VK5(6), VK7(2), VK9NS, N7EIJ, WA7HSN, ZL1HY.

## QSLs RECEIVED BY ERIC L30042

DL18L\*, DJ2FR\*, DF3TB\*, DL7NS\*, DJ9GD\*, FA30G\*, EA6KZ, F5Z1\* FK8ET, HH2VP, KC6DT, KC6YA, OZ4CB/A\*, PA0LOU\*, T30CH, K1VV/M1\*, K2AGJ\*, W9UZL\*, K0WKT\*, Y8NLT, ZS2WV, 5Y4CS.

\* Denotes 10 MHz confirmations.

## HEARD AND WORKED ON THE WEST COAST

1.8 MHz  
GJ30QR.  
14 MHz  
OH0/K8MFO.  
21 MHz  
EL2AE, FB8ZQ, GJ4/PA3BFM, HH2VP, PY0FE, TR8DR, TR8JLD, TZ8DC.

28 MHz  
GJ4/PA0ERA, GJ4/PA3BFM, HZ1AB, TR8DR.

3.5 MHz  
FB8WI, TZ8DC.

7 MHz  
A4XJP, FB8WI, GJ4/PA0ERA, HH2VP, TZ8DC, TZ8DC\*, UK2FAA

\* Denotes SSB operation.

## HEARD AND WORKED ON THE EAST COAST

14 MHz  
CY3WCY, D44BC, OH1RX, OK2BFN\*, PCT3/G4JMB, 3X4EX, 6W8EX, 7X2AC, 7X2LS, 8J0XPH, 8Q7AV, 9Y4LL, A22GM, C21FS, C21RK, CE0EVG, CE0FCM, CE0ZAD, CN8EL, C02HS, CT2QN, EA8AKN, EA8NL, EA9JE, EL2AD, FB8WI, FB8ZQ, FC7FOCH, FC9UC, FG7BT, FH8CB, F08JP, FR7CV, FS7/FG0HYJ, GJ3MWR, HP1XLS, HS0HS, J88AG, JY9TS, KC4AAA, KH8/WA6DJ0, KX60R, KX6PO, PZ1AP, T30AT, TF5TP, TL8ER, TR8CR, UK6LAZ, UQ2GDQ, VK0GC, VK0VK, VK2AGT, VP2MK, VP8AEL, XT2AU, XU1KC, XU1SS, ZB2J, ZK1AR, ZK8RS, ZS3GB.

21 MHz  
A71BJ, V3TV, VK9ZS, FB8ZP, TR8DX, YV5CMI, YV5WKM.

28 MHz  
YN1AGI.

3.5 MHz  
NL7K, VK9NS.

7 MHz  
4K1B, CE0ZAD, EA8QL, GJ3WFA.

\* Denotes CW operation.

## INTERESTING QSLs RECEIVED

1S1CK (for 14 & 21 MHz), AP2P, BY1PK, CX4BW, F08JE, HK6FAO, JY3ZH (from manager DJ9ZB), KA6KL, KG6JDX, LX1KE, OD5AS, OH1BO, TG6VT, TR8BJ, UA1CY, UQ2GCW, VK0CV, VK0DX, VP5WJR, WL7AZC, Y26SO, Y41ZM Y118GD.



Gero YU4TU, confined to a wheel chair due to being a sufferer of muscular dystrophy, enjoys DXing.

## THANKS

This column is never complete without a word of thanks to the many readers that make it possible with their news and reports. Some items are long, some short, but all are equally appreciated and acknowledged in this segment of the column.

Information gained from such magazines as KH6BZF REPORTS, RADCOM, QSL MANAGERS LIST, WORLD RADIO, QRZ DX, VERON, DXPRESS, QRZ DX, DX NEWS SHEET were used together with reports from VKs 1MM, WB, 2PS, EBX, 3BY, FR, FY, UX, YJ, YL, 6FS, HD, NE and SWL 30042. Amateurs from overseas countries who have contributed include G3NBC, JH1KRC, ISAT, W5KNE and ZL1AMN. Thanks to one and all.



# EDUCATION NOTES

Brenda Edmonds, VK3KT  
FEDERAL EDUCATION OFFICER  
56 Baden Powell Drive, Frankston, Vic 3199

Especially for those sitting for the November Novice Examination and those anticipating to sit in the near future Brenda has supplied a trial examination paper. This paper is typical of the type of questions asked so read the questions well and go to it. Don't sneak a look until all the questions are answered, but the answers appear in this issue after the Hamads.

Good Luck — Ed

## NAOCP TRIAL EXAM

### Instructions to Candidates:

Select the correct or most appropriate alternative and indicate it on the answer sheet as instructed.

### Hints to Candidates:

- 1 Read the questions carefully and thoroughly;
- 2 Take care when transferring selections to the Answer Sheet;
- 3 Do not waste time on a question that has completely baffled you. Come back to it when you have finished the rest;
- 4 When you have your results, go back to the paper and check up on all the questions where you were not sure of the answer. See that you know why the particular answer was correct;
- 5 Use this test as a guide to the areas where your knowledge is weakest.

Best wishes and 73 to all  
B M and J W Edmonds

### NOTE:

These papers have been prepared to conform as closely as possible to the DOC plan for question allocation to the various sections of the syllabus.

All questions were written without reference to pre-existing questions — ie they are *not* reprints. Therefore they will *not* appear word for word in the November Novice Exam.

However, DOC has approved it, and has a copy.

- 1 A primary cell is one that —
  - a cannot be recharged
  - b has a steady EMF of one volt
  - c contains a liquid electrolyte
  - d can be recharged with a steady current of one amp
- 2 A sine wave has a frequency of 1 Megahertz. This means that each cycle occupies —
  - a one second
  - b one millisecond
  - c one hundred microseconds
  - d one microsecond
- 3 Bipolar transistors are frequently associated with 'heat sinks'. This is because —
  - a any heat generated can then be used to heat other components
  - b they function best if kept warm
  - c some internal connections are made of silver which has a low melting point
  - d temperature rises may cause increased current flow which causes further temperature rise

- 4 A capacitor is labelled 0.0047 microfarad. This is the same as —
  - a 47 millifarads
  - b 47 picofarads
  - c 4.7 millifarads
  - d 4700 picofarads
- 5 Two 600 ohm resistors are connected in parallel. If an EMF of 12 volts is applied across them, the current through one of the resistors would be —
  - a 20 amperes
  - b 200 milliamperes
  - c 50 milliamperes
  - d 20 milliamperes
- 6 The reactance of an inductor —
  - a falls as the frequency increases
  - b depends on the dimension of the coil
  - c is a measure of its ability to dissipate power
  - d is measured in henries
- 7 The output from this bridge rectifier —

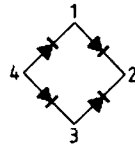

- a would be taken from terminals 2 and 4
  - b would be steady direct current
  - c would be an amplified version of the input
  - d would be present on positive input half cycles only
- 8 An amateur operator in Melbourne can hear a New Zealand station and a Brisbane station both in contact with a Sydney station, but the Melbourne operator cannot hear the Sydney station. This suggests that —
    - a the signals from Sydney are not being refracted by the ionosphere
    - b Melbourne is in the skip zone for the Sydney station
    - c the Melbourne operator's antenna is not functioning properly
    - d the New Zealand and Brisbane operators are using illegal power
  - 9 In this block diagram of an amplitude modulation transmitter transmitting on 7 MHz —

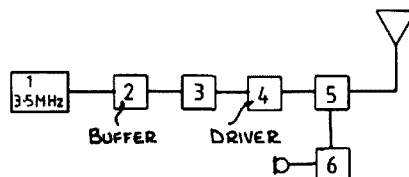

- a Block 3 would be a tripler and Block 6 a modulator
- b Block 3 would be a doubler and Block 5 a power amplifier

- c Block 5 would be a doubler and Block 6 a modulator
  - d Block 6 would be a Radio Frequency Oscillator and Block 5 a linear amplifier
- 10 A mains powered soldering iron transformer has a 3 volt output. If the input current is 300 milliamps, the maximum current that can be drawn from the secondary is slightly less than —
    - a 240 amps
    - b 24 amps
    - c 2.4 amps
    - d 240 milliamps
  - 11 A linear amplifier stage
    - a is used only where high output power is desired —
    - b increases both amplitude and frequency of the input
    - c is always operated in Class C
    - d increases the amplitude of the input without altering the frequency
  - 12 To find the voltage drop across  $R_3$ , you could use a meter at —

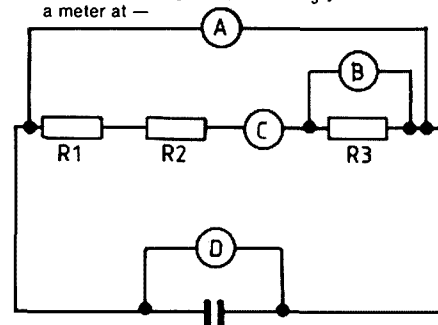

- 13 The crystal microphone
  - a is a cheap sturdy instrument suitable for mobile use —
  - b relies for its operation on the piezo electric effect
  - c has its diaphragm connected to a coil in a magnetic field
  - d is the most appropriate microphone to use in noisy conditions because of its good high frequency response
- 14 A superheterodyne receiver has a single IF stage tuned to 455 kHz. To receive a signal on 3.575 MHz, the Local Oscillator should be set to —
  - a 458.525 kHz
  - b 3779.55 kHz
  - c 2665 kHz
  - d 4030 kHz
- 15 A radio frequency carrier wave displayed on a cathode ray oscilloscope screen appears as —



If an audio frequency is applied to the carrier to the point where there is more than 100% modulation, the pattern will appear as —

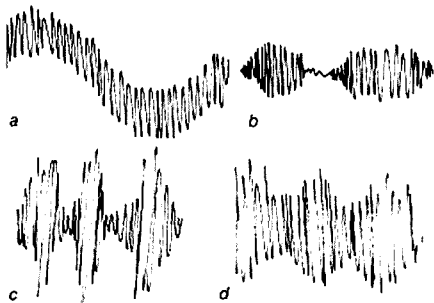

16 A resistor having the value of 4700 ohms  $\pm$  10% would be colour coded —

- a yellow blue orange silver
- b yellow violet orange gold
- c yellow violet red silver
- d orange blue brown gold

17 This section of a circuit contains, among other components —

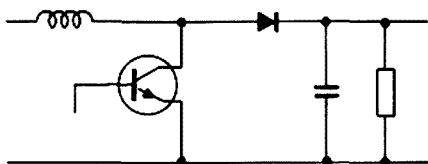

- a a PNP transistor, a cell, and a diode
- b an NPN transistor, an inductor and a diode
- c a field effect transistor, a resistor and a capacitor
- d a PNP transistor, a zener diode and a choke

18 The detector most commonly used for SSB reception is —

- a a diode
- b a product detector
- c a regenerative detector
- d a balanced modulator

19 Television reception is interfered with by a novice transmitter operating on low power and on various bands. The TVI is probably due to —

- a harmonic radiation
- b overmodulation
- c key clicks
- d TV front end overload

20 In a series resonant circuit at resonance —

- a impedance is maximum
- b  $X_L = X_C$
- c resistance to direct current flow is minimum
- d  $X_L = \frac{1}{X_C}$

21 The function of a fuse in a circuit is to —

- a supply a minimum current drain when no load is applied
- b provide a safe earth path in the event of an overload
- c regulate the current flow to a steady level
- d break the circuit if excess current is drawn

22 The power supply for a novice transmitter capable of 30 watts PEP output should —

- a be well regulated and capable of 30 watts output from the filtering system
- b have poor regulation to allow for the fluctuating power requirements of SSB
- c be capable of supplying the peak power requirements of the transmitter although this rates the power supply at more than 30 watts
- d be solid state and not vacuum tube rectified

23 Care must be taken in keying many modern transmitters because —

- a the microphone is left in circuit
- b a dangerous bias voltage appears across the key
- c dirty contacts can cause chirping
- d dirty contacts can cause key clicks

24 TV or radio receiver overload caused by novice operation may be reduced by —

- a increasing transmitter power
- b the appropriate low pass filter at the transmitter
- c reduced transmitter power
- d increasing the height of the receiver antenna

25 80 metre signals may be useful up to several hundred kilometres during daylight hours if —

- a they are refracted from the G layer
- b the ground is flat
- c they are not absorbed in the D layer
- d thunderstorms are providing highly ionized paths

26 When testing a transmitter, use is made of an artificial antenna or 'dummy load'. This is done to —

- a ensure maximum radiated power for test purposes
- b allow accurate measurement of the SWR of the antenna
- c reduce output of harmonics with the signal
- d dissipate the transmitter output instead of radiating it

27 The output from one stage of a sideband transmitter is double sideband suppressed carrier. This stage is —

- a the carrier oscillator
- b the balanced modulator
- c the sideband filter
- d the linear amplifier

28 An amateur SSB signal is reported by one distant station as of excellent quality but neighbouring amateurs complain of excessive bandwidth and 'splatter'. The amateur is probably —

- a radiating unwanted subharmonics
- b radiating the third harmonic only
- c using a speech processor
- d overmodulating

29 A disadvantage of vertical antennas is that —

- a they usually produce a higher background noise in the receiver
- b they are more readily detuned by rain or dew
- c they radiate at a higher angle, especially if they are resonant
- d they are not able to be protected from lightning

30 A transmitter stage is self-oscillating when power is applied. It needs to —

- a have some parasitic suppressed
- b have an antenna tuning unit to prevent harmonic radiation
- c have the voltage to the final amplifier reduced
- d be neutralised

31 Selectivity of a receiver is —

- a the ability to receive weak signals
- b the ability to remain on the frequency selected
- c determined by the speaker transformer characteristics
- d the ability to reject signals on adjacent frequencies

32 The best way to obtain a clean CW signal is to —

- a use a high pass filter and seek reports
- b reduce power to prevent over modulation
- c use an oscilloscope to improve the wave shape
- d use an unregulated power supply to the oscillator

33 For efficient energy transfer the transmission line must be matched —

- a to the transmitter output impedance or to the antenna impedance
- b to the antenna tuning unit which will tune the antenna
- c by cutting it to  $\frac{\lambda}{4}$  or multiples of  $\frac{\lambda}{4}$  in length
- d to both transmitter output and antenna input impedances

34 Single band antennae may be preferable to a multi-band antenna when —

- a the transmitter is prone to parasitic oscillations

b the amateur operator does not use an antenna tuning unit

c the amateur station is in a remote country area away from TV reception

d portable operation in emergencies is required

35 A disadvantage of double conversion super-heterodyne receivers may be —

- a poor image response
- b spurious signals due to unwanted mixing products
- c poor sensitivity
- d poor selectivity

36 A receiver has two IF stages, a BFO and a simple diode detector. It may be —

- a an AM receiver only
- b an SSB receiver
- c an AM and CW receiver with some SSB reception capability
- d a CW receiver only

37 The basic difference between coaxial line and twin feeder line is that —

- a coaxial line has a lower reactance than twin feeder
- b twin feeders must be air-spaced
- c coaxial line is unbalanced, twin feed line is balanced
- d coaxial line is unsuitable for use on 3.5 MHz

38 An RFI complaint is that a 3.5 MHz signal is being heard on a nearby 2.6 MHz emergency service base station. The most likely cause is —

- a overmodulation
- b cross modulation
- c a 455 kHz IF in the emergency service base station
- d a parasitic transmission at 2.6 MHz

39 The edge of an amateur band may be easily checked by using —

- a a grid dip meter
- b a broadcast receiver
- c a wavemeter
- d a marker crystal

40 The capacitance of a variable capacitor diode can be varied by —

- a varying the spacing of the plates
- b varying the voltage applied
- c increasing the DC flowing
- d putting a capacitor in series

41 A diode is rated at 10 amps maximum forward current and 50 volts peak inverse voltage. It would best be used as —

- a an RF amplifier in a receiver
- b an AM detector
- c a linear amplifier in a low power transmitter
- d a rectifier in a 12 volt power supply

42 For good amateur communication quality on SSB the bandwidth of the signal should not be —

- a more than 3 kHz
- b less than 3 kHz
- c more than 6 kHz
- d more than 4.5 kHz

43 A Yagi antenna for use on 28 MHz will have —

- a a driven element approximately 5 metres long
- b a reflector element slightly over 10 metres long
- c one or more directors between the reflector and the driven element
- d at least one director slightly longer than the reflector

44 The power ratio of two signals is 3 dB. This means that one must be —

- a 3 times the power of the other
- b one third the power of the other
- c twice the power of the other
- d at least 3 watts output

45 The grid in a triode vacuum tube —

- a controls the flow of electrons to the cathode
- b prevents secondary emission
- c is usually earthed in RF amplifiers
- d is between the cathode and the anode

46 A novice AM transmitter uses 250 volts on the

anode of the final amplifier. The DC Input power to this stage is 10 watts when the anode current is —

- a 60 mA
- b 40 mA
- c 240 mA
- d 120 mA

47 This is —

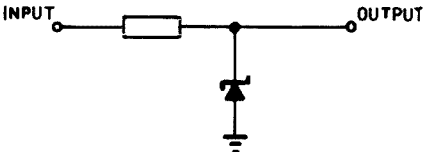

- a part of a voltage regulator circuit
- b a voltage multiplier circuit
- c a spike voltage protection circuit
- d a frequency response control

Input Output

48 A solid state device has a drain and a gate. It is probably —

- a an NPN transistor with an emitter
- b a FET with a collector
- c a PNP transistor with a base
- d a FET with a source

49 Fading of radio signals from a distant station might be due to —

- a sudden variations in sunspot numbers
- b signals which have travelled along different paths cancelling each other out
- c changes in the path of the ground wave
- d changes in the efficiency of the receiving antenna as the received frequency changes

50 The input power to a transformer is 50 watts. The output on load is 12 volts at 2 amps. The efficiency of the power supply under the load is —

- a 25%
- b 24%
- c 48%
- d 96%

AR

# MAGAZINE REVIEW

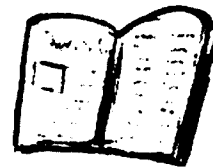

Roy Hartkopf, VK3AOH  
34 Toolangi Road, Alphington, Vic 3078

(G) General. (C) Constructional. (P) Practical without detailed constructional information. (T) Theoretical. (N) Of particular interest to the Novice.

## 73 MAGAZINE. AUGUST 1983

Simple customised power supply. (P) Spratly Island DXpedition. (G) DXpedition to Sealand. (G) 18 kV Voltage multiplier. (P).

## QST JUNE 1983

Antennas for the beginner. (N) 50th Anniversary field day. (G) SSTV. (G) Home made transmitting capacitors. (P).

## ORBIT. April 1983

General satellite information.

## CQ-TV. NO 122 MAY 1983

General ATV information, Colour TV Phasing. 1.3 GHz helix.

## HAM RADIO. MAY 1983

Antenna Issue. Yagis, Verticals, Dipoles, etc.

## HAM RADIO. JUNE 1983

PEP Measurement. (P) Harmonic Product Detector. (P) Squelch. (P).

## CO. JUNE 1983

QRP Special. Low Power Operation.

## RADIO COMMUNICATION. JULY 1983

13.8 volt Power Units (TP).

AR

ANNEE MONDIALE DES COMMUNICATIONS  
WORLD COMMUNICATIONS YEAR  
AÑO MUNDIAL DE LAS COMUNICACIONES



## STS — 9 UPDATE

Further to our report last month of "Radio Astronaut in Space", page 11.

The STS-9 launch has been rescheduled from the announced date of 30th September to 28th October.

# ILP TOROIDALS — UNBEATABLE VALUE

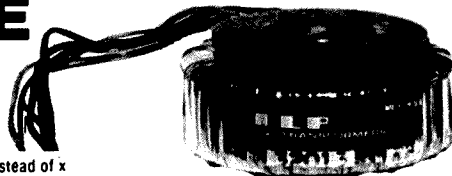

ILP toroidal transformers meet modern day requirements for a smaller size, low magnetic interference field transformer. Featuring a nearly ideal physical construction, one can expect excellent performance. Small size and weight (approximately 50% of conventional transformers), extremely low noise and low magnetic interference field make the toroidal transformer ideal for compact power supplies.

110 V Primary 0 instead of x  
220 V Primary 1 instead of x  
240 V Primary 2 instead of x

TYPE	SERIES	SECONDARY RMS																
	No.	Volts	Current															
30 VA 70x30mm 0.45Kg	1X010	6+6	2.50	80 VA	3X010	6+6	6.64	160 VA	5X011	9+9	8.89	300 VA	7X014	18+18	8.33			
	1X011	9+9	1.66		3X011	9+9	4.44		5X012	12+12	6.66		7X015	22+22	6.82			
	1X012	12+12	1.25		3X012	12+12	3.33		5X013	15+15	5.33		7X016	25+25	6.00			
	Regulation 18%	1X013	15+15	1.00	90x30mm 1 kg	3X013	15+15	2.66	110x40mm 1.8 Kg	5X014	18+18	4.44	110x50mm 2.6 Kg	7X017	30+30	5.00		
		1X014	18+18	0.83		3X014	18+18	2.22		5X015	22+22	3.63		7X018	35+35	4.28		
		1X015	22+22	0.68		3X015	22+22	1.81		5X016	25+25	3.20		7X026	40+40	3.75		
		18% 1X016	25+25	0.60	Regulation 12%	3X016	25+25	1.60	4X017	30+30	2.66	5X017	30+30	2.66	Regulation 6%	7X025	45+45	3.33
			1X017	30+30		0.50	3X017	30+30		1.33	5X018		35+35	2.28		7X033	50+50	3.00
							3X018	35+35		1.71	5X026		40+40	2.00		7X028	110	2.72
						3X019	110	0.72	5X028	110	1.45	7X029	220	2.84				
					3X029	220	0.36	5X029	220	0.72	7X030	240	1.36					
					3X030	240	0.33	5X030	240	0.66				7X030	240	1.25		

TYPE	SERIES	SEC	RMS															
	NO	VOLTS	CURRENT															
50VA 80x35mm 0.9 Kg	2X010	6+6	4.16	120 VA	4X010	6+6	10.00	225 VA	6X012	12+12	9.38	500 VA	8X017	30+30	8.33			
	2X011	9+9	2.77		4X011	9+9	6.66		6X013	15+15	7.50		8X018	35+35	7.14			
	2X012	12+12	2.08		4X012	12+12	5.00		6X014	18+18	6.25		8X026	40+40	6.25			
	Regulation 13%	2X013	15+15	1.66	90x40mm 1.2 Kg	4X013	15+15	4.00	110x45mm 2.2 Kg	6X015	22+22	5.11	140x60mm 4.0 Kg	8X025	45+45	5.55		
		2X014	18+18	1.38		4X014	18+18	3.33		6X016	25+25	4.50		8X033	50+50	5.00		
		2X015	22+22	1.13		4X015	22+22	2.40		6X017	30+30	3.75		8X042	55+55	4.54		
		2X016	25+25	1.00	Regulation 11%	4X016	25+25	2.40	4X017	30+30	2.70	5X028	110	4.54	Regulation 4%	8X028	110	4.54
			2X017	30+30		0.83	4X017	30+30		2.00	5X028		110	2.04		8X029	220	2.27
			2X028	110		0.45	4X018	35+35		1.71	6X028		110	1.02		8X030	240	2.08
			2X029	220	0.22	4X028	110	1.09	6X029	220	0.54							
2X030			240	0.20	4X030	240	0.50	6X030	240	0.93								

IMPORTANT. Regulator references  
All voltages quoted are FULL LOAD.  
Please add regulation figure to  
secondary voltage to obtain  
off load voltage

To order or for further information please contact: Phone or write for price details

ELECTROMARK Pty Ltd

40 Barry Avenue,  
Mortdale N.S.W. 2223  
Telephone (02) 533 4896

BANKCARD  
ACCEPTED





# LISTENING AROUND

Joe Baker, VK2BJX  
PO Box 2121, Mildura, Vic 3500

The prewar years in Sydney were times when every suburb seemed to have its own wireless wizard who could be heard on the high frequency end of the broadcast band every Sunday morning between 6 and 7.30 am, grinding out old 78s and sending birthday wishes to anyone who said they would be listening to him. Viewed in retrospect, what an excellent piece of PR work this was for the radio amateur, because in this way anybody with an ordinary domestic receiver could hear him. Living at Campsie as I was then one of our nearest radio amateurs, was a chap at Lakemba, who even used to invite a local pastor to his "studio" to deliver a Sunday morning sermon to the unseen audience.

Another, whose callsign or name I cannot remember was located at "14 Watkin Street, Canterbury" an address that I remember clearly because he gave it out so often.

I would like to have been able to record here for posterity the callsigns of these two amateurs who thus unknowingly helped introduce me to our fine hobby, but the years have erased their callsigns from my memory.

About the time I was ready to enter the work force from college, hostilities were beginning in Europe, and I was a bit uncertain whether to keep on at college or not. I had been earning a bit of pocket money by keeping my ears and eyes open while cycling around Sydney and ringing up the newspapers when I observed something that I thought might be newsworthy. To assist in this worthy cause, although I knew that the newspapers monitored the police radio, I knew the times that they were not monitoring and filled them in on whatever stories they missed out on later. I didn't know anything about Wireless Telegraphy Regulations then of course.

Anyway, a lot of the news tips that I phoned them about concerned actual observations that I had made. For example, on Black Friday 13th January, 1939, I spotted smoke in the general direction of Parramatta and on cycling there saw scores of people bundling their worldly belongings into all sorts of vehicles as the terrible bushfires converged in around that area. Another news tip off came my way as I watched two teams of "girls" playing hockey in a sports oval. Closer observation revealed that some of the "girls" were he-men, who had been rigged out in female attire to make up the numbers.

A phone call to the Sydney Daily Telegraph brought reporter Des Foster and a photographer to take a look, and the result was a humorous story in the next day's paper about the "girls with hairy legs". After this Des Foster became my regular contact at the Telegraph, which later entered into a "contract" with me to pay me 16/- PER MONTH for newstips. Later, I plucked up courage to ask Consolidated Press if I could get a "regular" job and landed the job of

copyboy, with a recommendation I am sure from my friend Des Foster.

Now the job of copyboy, I will have you all know, is mainly that of being a general dogsbody or rouseabout who is supposed to do anything he is told or get kicked out of the job — and no back lip, if you please.

As the Telegraph was a morning paper, the copyboy's job took him from just before tea time until long after the paper was "put to bed" — as the "journos say" — approximately 4 am. The copyboys were in the tender care of Mr Davis and Mr Colless, whose duty it was to see to it that when some sub-editor pressed the buzzer and bellowed out "B-O-Y" with a voice like a bull, some hapless lad would have come at the double, to the sub's office. He'd then be asked perhaps to take some copy down to the Chief Censor's Office in Pitt St (remember, it was wartime and newspapers couldn't print just anything they liked). And if the Chief Censor's decision was that the copy was "NOT TO BE PUBLISHED" an official stamp bearing those words was spread across the copy.

Other duties of the copyboys included collecting and signing for incoming Press cables from PMG Telegramboys and Beam Wireless messengers.

Copyboys had also to attend to the teleprinter, when the printer had to have its paper roll changed. There was no end of the sorts of jobs which copyboys might be obliged to do, and if one survived being a copyboy for long enough, with luck he might eventually be selected to become a cadet journalist, and looking back on those now far off days, came many a well known journalist of today.

Now you might ask what has all of this got to do with radio? Hold your horses and I'll tell you for it is what I have been leading up to. It so happens that the Daily Telegraph had two radio rooms — there was the main one — a receiving station in the front room of a private house at 3 Alan Street, Cammeray a Sydney suburb, and this was connected by PMG cables to the other one in the newspaper office. It being wartime, overseas news was of major importance, and news gathered by radio was used to supplement information arriving by cable. In many cases when cables were held up because of wartime activity, there was always the BBC, San Francisco Radio and others. My job as copyboy took me many times into the room where reporters wearing headphones were transcribing incoming transmissions into shorthand so I knew that room very well. Cammeray covered about 45 or 50 newsbroadcasts per night, some in languages other than English, and for these there was interpreter, Dr Emery Barcs. At times when Churchill was due to deliver a major speech (which usually came through about midnight), the presses would be held

and copyboys would be racing from the city radio room to the subs desk with page after page of copy as fast as their legs would take them. Remember, that there were *no tape recorders at this time*.

In due course, I was assigned to work at the Cammeray receiving station, which had only one other employee, Roy Philips. We had five receivers there and a multiplicity of antennae in the backyard. The only receiver I can remember at this distance of time is a Skyraider. The outputs of all receivers could be fed via a switching panel to any one of the three special PMG lines which took the traffic to the Castlereagh Street office. Sometimes all three lines would be in use at once, with broadcasts from different parts of the world. I learned how to operate the switching panel, and although I don't speak German, I learned how to identify Berlin Radio, when we were due to take that one at 11 pm, by its identifying gong and the announcement "Deutchercus-lander Berlin" (excuse my spelling, if it's wrong) — "This is Berlin Calling" I think it means.

On finishing the night shift at Cammeray, which was usually around 4 am, I would switch everything off, let myself out the front door and catch an early morning tram over the Bridge, to Wynyard, and from there walk all the way up George Street to the Ultimo tram depot from where I would get the newspaper tram to Ryde where we lived. During wartime the trams, like the rest of the city, were in semi-darkness, or the "brownout" as it was called and there was a general air of gloom and foreboding over all. Also all sorts of undesirable characters were wandering the city at that time.

On this particular morning I was somewhere near the Haymarket when I heard footsteps approaching from across the road. "Maybe it's undesirables wanting a smoke" I thought. It was not long before I found out. "Hey you", yelled one of the pair, "What's your name?". I looked back at the two figures approaching me from out of the gloom. "Who wants to know?" I replied (shaking in my boots). They said they were detectives who had had me under surveillance for some time, and "what's a young fellow like you doing out at this time of morning" and always walking by myself up George Street. I tried to explain to them that I was an employee of Consolidated Press and invited them to contact my boss if they wanted to know if I was telling the truth. But they declined and told me to get lost, or something like that.

Another morning, I was challenged by military police who saw me wearing an overcoat and thought I was an AWOL soldier, but after shining a searchlight in my face, decided that I wasn't the catch they were after. Yet another time I was detained by four tall specimens driving an old sedan car, just

after I left the Cammeray address. The four looked like real cloak and dagger types, and they called me over to their car. One who seemed like their leader said "What's that place you've just come away from? — The place with all those aerials in the backyard." I tried to explain that this was the Daily Telegraph's receiving station, but it was clear that he did not believe me. Neither did he believe me when I told him my name, although I was unable to produce the identity card which people were supposed to carry at that time. "I think we had better have a look over this joint" he said as they marched me back up the steps and in the front door of the station.

Back inside the door of the room where the receivers were, their leader — who had very successfully scared the living daylight out of youthful me — sat me on a chair and started

asking questions while the other three rummaged all over the room, at the back of the sets and under the benches. I produced the receiving station log as evidence that what I was saying was true, but even that didn't convince them for they were looking for a non-existent transmitter as I later found out. When they couldn't find the transmitter they took off.

Bear in mind that the time I write of was wartime, when anyone who even dared to put up a clothesline in his yard might find a suspicious neighbour on the phone to the authorities, and no doubt it was the unusual antenna array in the backyard that had set this witch hunt off.

Later, I reported the incident to D L Thompson, then Chief of Staff of the Daily Telegraph, who instructed me to prepare a written report on the happenings and hand it

to him personally. "Why did you let them inside the premises?" he asked, and I replied that it was because they said they were detectives and they had really frightened me. "Did you ask them to show any identification?" was his next query, "and why not", "because they LOOKED LIKE detectives" I said in all innocence. "But I'll bet they asked you for your identity card" he said, and they, being professionals of course had done just that.

More later, but in the meanwhile, thanks to the many who have expressed condolences to me on the death of my brother Frank on 13th of June (age 61) and a special thanks to members of the Cocktail Net for their floral tribute. It was much appreciated fellers. 73s for now but more of my wartime reminiscences later.

Joe, VK2BJX

AR

## INTRUDER WATCH

Bill Martin, VK2EBM  
FEDERAL INTRUDER WATCH  
CO-ORDINATOR

33 Somerville Road, Hornsby Heights,  
NSW, 2077.



# QSP

## COMPUTER FOR THE HANDICAPPED

A revolutionary, low-cost computer has been developed that will allow the physically handicapped to work from their own homes and make contact with other people.

"This system will allow the handicapped to keep their income and self-respect," says a spokesman for Maincomp, the London-based firm that manufactures the computers. Maincomp believes that, until now, computers designed for the blind, deaf, dumb or severely disabled have been too basic and too expensive for most people to afford.

The blind system will be based on a unique voice synthesis machine, that types documents and checks copy. A totally new concept will permit the deaf and dumb to make telephone calls.

The operator types the message into the computer before dialling the telephone number to which the message is being sent. When the telephone is answered, the encoded message is sent down the line by a synthesized voice. If the recipient has a similar system he can then send back a reply which will appear on the original caller's computer screen.

Maincomp are particularly optimistic about the computer's usefulness to those disabled by multiple sclerosis, as the machine can be adapted as the disease progresses. The company will launch the computers on the British market shortly and hope to find foreign outlets as well.

(Maincomp Ltd, 1-2 Cambridge Gate, Regents Park, London NW1).

AR

## BUYING, SELLING or WANTING?

Check HAMADS first.  
Eight lines free to all WIA Members.

With the forthcoming WARC '84 (Broadcasting) nearly upon us, it seems timely to mention a few aspects of intruders in the 40 metre band, and what the future holds for the amateur operator who uses this band. Recent correspondence from the DOC gives us the following information:

"Broadcast transmissions emanating from the People's Republic of China, within bands allocated to the Amateur Service, have been evident for a number of years. The Department (DOC) is well aware of the situation and recognises that the presence of these stations, in some respects, restricts the ability of amateurs as a whole to pursue their hobby. It is pointed out that the People's Republic of China is a relatively new member of the International Telecommunications Union (ITU). Consequently, the international regulations relating to the registration of frequency assignments, which have been in force for many years and tend to favour the status quo, are seen to place China at some disadvantage. These regulations combined with the present congestion within the HF broadcasting bands have in fact prevented China from obtaining the registrations necessary to transfer many of its existing services to the appropriate bands. At the signing of the Final Acts to WARC '79, the Chinese delegation had a statement incorporated into the Final Protocol relating to the use of frequencies for broadcasting." This statement, along with eighty two others, was 'taken note of' by Australian and all other Administrations. The statement, No 20, is as follows:

### For the People's Republic of China:

At the time of signing the final acts of the World Administrative Radio Conference, Geneva, 1979, the delegation of the People's Republic of China, on behalf of the Chinese Government, states the following: "The Chinese delegation takes note of the decision taken by the present Conference on the convening of a World Administrative Radio Conference for the planning of the HF bands

allocated to the broadcasting service and believes that it is an effective measure to solve the problem of congestion in the HF broadcasting bands and out-of-band transmissions. However, owing to historical reasons, the Chinese Administration reserves the right to continue to use those frequencies which it uses for broadcasting at present in the band 5,060-27,500 MHz until the establishment and implementation of the proposed HF broadcasting plan."

Even allowing for this, the DOC has continued to approach the Chinese Administration expressing its concern at the operation of broadcasting stations within the internationally recognised amateur bands.

In January, 1984, there will be a WARC held at Geneva for the broadcasting services. The NZART is to ask the New Zealand Administration to instruct their delegation to the conference to ensure that Resolution 641 of WARC '79 is drawn to the attention of the conference, and given firm support for its implementation. Resolution 641 of WARC '79 states: "the band 7,000-7,100 MHz is prohibited for use by broadcast stations, and those already in it were to get out of it."

Intruder Watch Observers world-wide have been asked to pay special attention to broadcast intruders in this segment of the 40 metre band, and, hopefully, a comprehensive record will be able to be put together to support the claims for the implementation of Resolution 641 at WARC '84. If this occurs, amateurs world-wide will see the disappearance of many broadcast stations from the amateur segment of the 40 metre band, with more satisfying conditions being made available to amateur operators. If WARC '84 is not successful in this, who knows? Let us wish the conference every success in their endeavours, and keep our fingers crossed. Perhaps the problems of the 40 metre band may soon be a thing of the past. Finally, don't forget all are welcome on the Intruder Watch net on 3,540 MHz on Thursday evenings, at 1030 UTC.

AR

# BOOK REVIEW

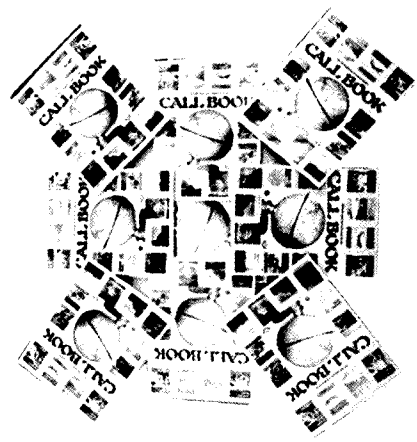

## 1983/84 CALL BOOK

Jim Linton, VK3PC  
4 Ansett Court, Forest Hill, Vic 3131

The 1983/84 callbook is exactly the same size and has an identical number of pages (176) as last year's edition — but has new reference material inside, and of course an updated callsign listing.

The first thing that strikes you about the callbook is its full-colour cover.

Credit for the cover design featuring the Gray-Line Radio Globe surrounded by twelve covers of AR magazine goes to Ken McLachlan VK3AH — it's a very eye-catching layout.

The main purpose of the callbook is to list the callsigns of radio amateurs in Australia and Papua New Guinea, and Australian Short Wave Listeners WIA member numbers.

In all there's about 15,000 entries drawn from the WIA computer records and supplied by the Department of Communications.

The callsign entries are in a different typesetting format than the previous callbook in order to accommodate more callsigns without increasing the number of pages — but the typeface is clear and easy to read.

The WIA Publications Committee has done a fine job in updating the listings, remembering that new callsigns are being issued each day, and people are upgrading from Novice, Limited or Combined, to Full Call.

In response to the great number of changed listings the callbook has sufficient room at the end of each callsign prefix area for operators to jot down for their personal record new callsigns.

But this publication is more than just a list of calls, it contains valuable and interesting reference material of use to the active radio amateur and SWL.

New segments include WIA band plans for MF, HF, VHF and UHF, and there's a section on Amateur Fast Scan TV.

The Australian DXCC Countries' List is fully updated, and details of Australian Radio Amateur Awards have been revised.

Callbook editor Gil Sones VK3AUI in his editorial says "... the material has been selected by the Publications Committee to allow the reader to gain more knowledge and enjoyment from their chosen hobby."

There's little one can add to that statement, except perhaps state the obvious that the callbook is a vital piece of reference material for every shack.

The recommended price is \$5.75 — good value.

AR

but produced and printed in the United States by the Vestal Press Ltd, of Vestal New York. The production is excellent with hundreds of black and white photos, the only colour used is on the cover sleeve with the same photo reproduced opposite the title page.

The 247 pages and 27 chapters trace the entire history of vacuum tubes from the original Edison lamp right through to the miniature tube of the fifties and sixties. One can only wonder where the solid state device will be after it has had as many years development as the tube.

Chapters include, The Grid, Some Early American Independents, Another Grid, Developments in Tetrodes, Metal Envelopes, Octal Based and All Glass Tubes, Transmitting Tubes, Canadian and Australian Tube Manufacture, The British Electrical Companies and many others.

The contents are not in chronological order apart from the first couple of chapters. Indeed each chapter is a complete story in itself. Unfortunately transmitting tubes only rate six pages and the most famous of them all, the 807 does not get a mention.

The book was written more as an historical rather than a technical treatise with the only technical data being the reproduction of a few old specification sheets and some advertising pages.

However, there is plenty of information for the collector trying to date his latest find. I was delighted to find a description of the AWA Expanse 'B' valve which was used by many of the original amateur operators including Max Howden 3BQ in the receiver used to pick up signals from the USA in the early twenties.

All in all, a most readable book that you will find hard to put down. With the valve fast disappearing from general use in a few years time the only trace left will be in museums and books like this.

AR

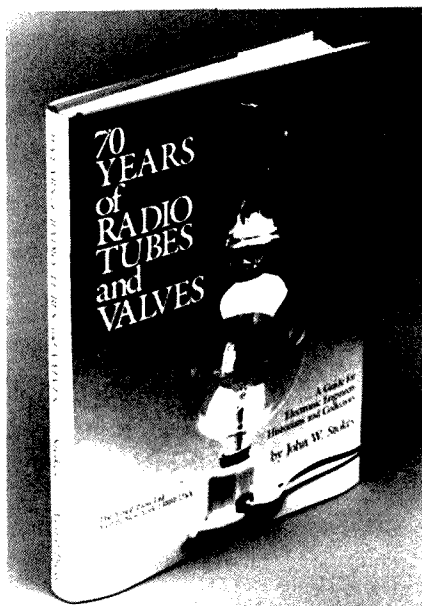

## SEVENTY YEARS OF RADIO TUBES AND VALVES

Ron Fisher, VK3OM  
TECHNICAL EDITOR

Being something of a collector of old radio sets and bits and pieces, I guess it was only natural that I got to review this fascinating book.

70 Years of Radio Tubes and Valves, the last word being used to describe the products of Europe, Australia and New Zealand, was written by a New Zealander, John W Stokes,

**\*\*HELP\*\***

**INTRUDER WATCH**

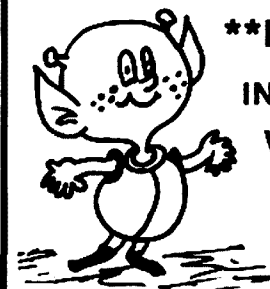

**Please help INTRUDER WATCH by reporting all intruders.**



# AWARDS

Mike Bazely, VK6HD  
FEDERAL AWARDS MANAGER  
8 James Road, Kalamunda, WA 6076

Have you ever thought of applying for single, 5 band or 6 band, worked all continents? These certificates are issued by the IARU and can be endorsed for any recognised mode. To apply, send the QSLs to me, with return postage, and I will do the rest. Do not forget to send in your address label from an issue of AR as these awards are only available to members of the Institute. These awards are not available for operations on any of the new WARC bands.

Further to a note on the "Ballarat Gold Rush" Award in August AR, the cost of this award is \$3.00 and not \$2.00 as printed. All other information is correct, that is, one needs to contact ten Ballarat stations and applications should be sent to VK3EX. Incidentally this award is unusual in that it comes with suggestions on how to mount the award as the award has been printed on self adhesive material. Yes, it is printed on a gold background!

## PARAGUAY AWARDS

The following are some of the awards issued by the "Radio Club of Paraguay". Each award costs 5 IRCs and contacts need to have been made after 15 May 1952. A certified list should be sent for each award to Radio Club Paraguayo, Alberto Tauber, ZP5PX, PO Box 512, Asuncion, Paraguay.

(Note. The list has to be certified by myself and this can be done by sending the list with the QSLs and return postage to me.)

The All Mediterranean Countries Award is given for confirmed contacts with Mediterranean countries (inland) as follows:

- Class A: 41 countries
- Class B: 30 countries
- Class C: 20 countries

A ZP contact is obligatory in any class.

Countries: A2, A5, AC3, C31, CP, HA, HB, HB0, HV, JT, LX, OE, TL, TT, TZ, OK, UC2, UD6, UG6, UH8, UI8, UJ8, UL7, UM8, UO5, XT, XW8, YA, ZE, ZP, 3D6, 4U1, 5U7, 5X5, 7P8, 7Q7, M1, 9J2, 9N1, 9U5, 9X5.

The Tropics of Cancer and Capricorn Award is given for confirmed contacts with countries touched by the Tropics of Cancer and Capricorn as follows:

- Class A: 28 countries
- Class B: 20 countries
- Class C: 12 countries

A ZP contact is obligatory in any class.

Countries valid for this award:

- Tropic of Cancer: S2/3, BV, BY, EA9, (Sahara) KH6, A4, A6, SU, TZ, C6, VU, XE, XZ2, 5A, 5T5, 5U7, 7X, 7Z.
- Tropic of Capricorn: A2, CE, C9, LU, PY, VK, ZP, ZS, ZS3, 5R8.

The All Zone 11 Prefixes is given for confirmed contacts with prefixes in CQ: WAZ Zone 11 as follows:

- Class A: 30 prefixes
- Class B: 19 prefixes
- Class C: 12 prefixes

Prefixes List: ZP1 to ZP9, PY1 to PY0 and

the special prefixes issued for WPX contests.

The Diploma Sud-America is given for confirmed contacts with countries located in ITU zones 12, 13, 14, 15, 16 and 73 as follows:

A ZP contact is obligatory in all classes

— Class A: 33 countries and 6 ITU zones

— Class B: 25 countries and 6 ITU zones

— Class C: 18 countries and 5 ITU zones

Countries:

Zone 12 — FY, HC, HC8, HK, HK0 (Malpelo I) OA, PZ, 8R, YV, GP1/8/9.

Zone 13 — PY6/7/8, PY0 (Fernando do Noronha), PY0 (St Peter and St Paul)

Zone 14 — CE1/2/3/4/5, CE0X, CE0Z, CP2/3/4/5/6/7, ZP, CX, LU, A/U/Y.

Zone 15 — PY1/2/3/4/5/9, PY0 (Trindade Is).

Zone 16 — CE6/7/8, VP8 (Falkland), LU-V-W/X.

Zone 73 — KC4USP (Palmer Station), LU-Z CE9AA/AM, VP8 (Graham Land), VP8 (South Georgia), VP8 (South Orkney), VP8 (South Sandwich), VP8 (South Shetland).

## CAGOU AWARD

The Amateur Radio Association of New Caledonia offers the "CAGOU" Award. The rules, which are quite simple, are as follows:

- 1) Six different contacts with FK8 stations are required.
- 2) All contacts after 1 Jan 1980 count.
- 3) Any band or mode may be used.
- 4) Log information only required.

Send your application, with 12 IRCs to ARANC, Awards Manager, PO Box 3956, Noumea, New Caledonia.

## SWL AWARDS

VK6NHD has kindly forwarded to me details of awards issued by the ISWL. These details are reproduced below.

Each award is a separate coloured certificate, available to all amateurs and SWLs. GCR list of QSLs together with fee of \$3 Australian or 10 IRCs for each award to: ISWL Awards Manager, Mr Clifford A Tookey, 6 Chelmer Avenue, Rayleigh, Essex, England SS6 7TB.

### Century Club

For verified contact/reception of 100 different countries as defined in the ISWL Country list, with stickers for each additional twenty five countries to 350.

### Continental Award

For verified contact/reception of ten stations in each of the six continents: a total of sixty QSLs are required which need not be from separate countries.

### States Award

For verified contact/reception of the forty eight states of continental USA, plus Hawaii (KH6) and Alaska (KL7), a total of fifty QSLs are required.

### Commonwealth Award

For verified contact/reception of fifty different countries within the British Com-

monwealth of Nations. (SW BC Listeners need reception of thirty countries only.)

### European Award

For verified contact/reception of fifty different countries within the continent of Europe. (SW BC Listeners need reception of thirty five countries only.)

### Pacific Ocean Award

For verified contact/reception of forty five different countries which have at least a part of their coastline on or in the Pacific Ocean, as in VE, W, VK, ZL, KH6, etc. (SW BC Listeners need reception of thirty countries only.)

### Zone Award

For verified contact/reception of twenty five ITU Zones, as defined in ISWL Country List and Zone map, (available from ISWL HQ or ISWL Awards Manager price 35p or 3 IRCs). Stickers available for 50 and 75 Zones hrd/wkd, price 20p or 1 IRC.

### Five Band DXCC Award

For verified contact/reception of 100 different countries on each of the five separate bands. Total 500 QSLs in all, and need not be the same countries on each band.

Well that's about the lot for this month. Happy hunting, 73 es DX de Mike, VK6HD.

## MALTA AWARD

To commemorate the 50th Anniversary from the foundation of the MARL Amateur Radio League, this league has decided to issue a special award to be known as:

### THE MARL GOLDEN JUBILEE

Period: From 1st September 1983 until 31st September 1984. This award is available to licenced amateurs and SWL's (on heard basis).

To apply for this award one must work 9H50DC the special station. This can only be worked once, and any other four 9H stations on any band and in any mode.

Each station can be worked more than once on the same band but this must not be on the same day.

No QSL cards are required, only a copy of the log certified by the awards manager of the National Society or by two licenced radio amateurs.

The fee for this award is US\$3 or 15 IRCs.

All applications should be addressed to: The President MARL, PO Box 575, Valetta, Malta.

## PREMIER TOWN AWARD

The Midland Zone of the WIA Victorian Division has launched the first ever award for the central Victorian city of Bendigo.

The award certificate is a full color photograph of the Central Deborah Mine and popular tourist attraction the "Talking Tram".

Bendigo's Tourist Trust is sponsoring the award which marks Bendigo being given the prestigious state government "Premier Town Award" title for the next three years.

To qualify for the award contacts are

# BENDIGO PREMIER TOWN AWARD



AWARDED TO  
 FOR CONTACTING AMATEUR RADIO STATION IN BENDIGO,  
 CENTRAL VICTORIA.  
 AWARD NO.  
 AWARD MANAGER  
 PRESIDENT

needed with five amateur stations whose addresses are in the Bendigo area postcodes of 3550, 3551, 3555 and 3556.

The Midland Zone station VK3ATO will count as three contacts. To apply for the award send a log extract together with a QSL card and \$1.00 to the Award Manager, Joan Sutherland VK3NLO, 25 Casey Street, Bendigo, Vic 3550.

The award will be forwarded by the Bendigo Tourist Trust. The Midland Zone hopes the award will help publicise the tourist aspects of Bendigo to both Australian and overseas radio amateurs.

Award chasers are welcome to join in the Midland Zone's two weekly nets — Tuesdays at 1000 UTC on 14.200 MHz, and Thursdays 1000 UTC on 3.600 MHz. **AR**

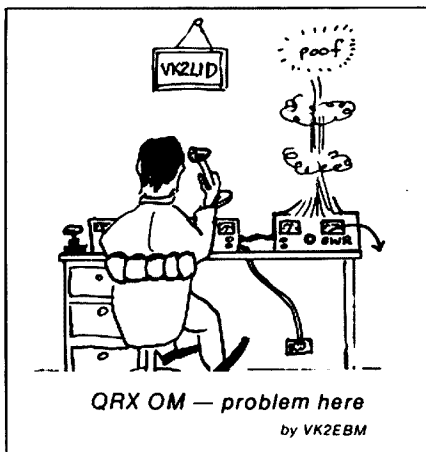

## THE HEY-DAY OF HOME BREWING

"There has never been anything comparable in any other period of history to the impact of radio on the ordinary individual in the 1920's. It was the product of some of the most imaginative developments that have ever occurred in physics and it was as near magic as anyone could conceive, in that with a few mainly home made components simply connected together one could conjure speech and music out of the air. The construction of radio receivers was just within the competence of the average man, who could always make modifications that might improve his aerial or his receiver and give him something to boast about to his friends. I acquired much of my manipulative skill through building and handling receivers; when at last I could afford a thermionic valve in 1928, I built a receiver that picked up transmissions from Melbourne, which that station acknowledged by sending me a postcard carrying the signatures of the English Test Team."

From chapter 1, Part 1 of "Most Secret War" by RV Jones, who devised and directed counter-measures against German radio and radar target-finding transmissions during World War II, and in 1946, at the age of 34 was appointed to the Chair of Natural Philosophy at the University of Aberdeen thus becoming a Professor of Physics.

Published in 1978 by Hamish Hamilton Ltd and later in paperback it is probably available from or through your municipal library. The author includes some entertaining accounts of his brushes with high level Air Force personnel who considered that no "outsider" (especially a civilian) could possibly know as much as they did. In many cases, Jones knew a good deal more.

Submitted by Dick Goslin VK3SV.

**AR**

**URGENT!**  
 Please let us know of clubs and schools etc. starting theory classes.  
 Where, when, how much and whom to contact.  
 Contact Brenda VK3KT.



# VHF UHF - an expanding world

Eric Jamieson, VK5LP  
1 Quinns Road, Forreston, SA 5233

All times are Universal Co-ordinated  
Time, indicated as UTC

## AMATEUR BAND BEACONS

FREQ	CALLSIGN	LOCATION
50.005	H44HIR	Honiara
50.008	JA2IGY	Mie
50.020	GB3SIX	Anglesey
50.060	KH6EQI	Pearl Harbour
50.075	VS6SIX	Hong Kong
50.945	ZS1SIX	South Africa
51.020	ZL1UHF	Auckland
52.013	P29SIX	New Guinea
52.100	VK0AP	Macquarie Island
52.200	VK8VF	Darwin
52.250	ZL2VHP	Palmerston North
52.300	VK6RTV	Perth
52.320	VK6RTT	Carnarvon
52.350	VK6RTU	Kalgoorlie
52.370	VK7RST	Hobart
52.420	VK2RSY	Sydney
52.425	VK2RGB	Gunnedah
52.435	VK3RMV	Hamilton
52.440	VK4RTL	Townsville
52.470	VK7RNT	Launceston
52.510	ZL2MHF	Mount Climie
144.400	VK4RTT	Mount Mowbullan
144.420	VK2RSY	Sydney
144.465	VK6RTW	Albany
144.475	VK1RTA	Canberra
144.480	VK8VF	Darwin
144.550	VK5RSE	Mount Gambier
144.600	VK6RTT	Carnarvon
145.000	VK6RTV	Perth
147.400	VK2RCW	Sydney
432.410	VK6RTT	Carnarvon
432.420	VK2RSY	Sydney
432.425	VK3RMB	Mount Bunninyong*
432.440	VK4RBB	Brisbane

\* This indicates a correction to the frequency of VK3RMB, with thanks to Murray, VK3AAI, President of the Ballarat Amateur Radio Group for the advice of same.

## SIX METRES

My late news announcement last month of the granting of operating privileges in the segment 50.000 to 50.150 MHz outside Channel O hours was received with a sigh of relief in most quarters, as being a start at least to allow VK stations some compatibility with overseas countries for DX working. I suppose we should not look a gift horse in the mouth, so the expression goes, but it seems a pity such a move could not be considered for the peak of Cycle 21 now long since past!

Anyway, we have something to start with so let's make the most of what is available. If we do the right thing during the interim period and not cause too much trouble to Channel O then there may be some relaxing of the hours of non-operation, which seem to be unduly restrictive in some areas.

It seems sensible to use 50.110 as the calling frequency which should be largely in line with overseas ideas and it would seem equally sensible for the time being at any rate to use the new segment for what we originally wanted it for, DX particularly overseas stations. It would seem a great pity if we suddenly left 52 MHz during the Es season and did our interstate working on 50 MHz. Sufficient to consider this type of operation if we ever are fortunate enough to have unrestricted use of the 50 MHz end, but for the time being let's keep 50 MHz for specialised working, and 52 MHz for general working. One way for this arrangement to be kept so would be for the Ross Hull Memorial Contest to be conducted on 52 MHz and above — perhaps the Federal Contest Manager should seriously consider this matter.

So far, there have been some contacts amongst VK stations on 50 MHz, mainly to try out the band and equipment. Most will have found some shortcomings, particularly in the antenna department, if same has been cut for 52 MHz, but the change is on the favourable side, as going lower in frequency does not seem to worry an antenna as much as going up in frequency. Anyway, an SWR of 1.5 or so won't be much of a problem; with the transmitters most transceivers already tune 4 MHz so they are not a problem, perhaps the homebrew linears might be a bit touchy, but if you have progressed to the stage of building your own 6 metre linear then I am sure you will be quite capable of making it work on both sections of the band!

## SIX METRE COUNTRIES LISTINGS

A letter has come from David VK2BA enclosing a list of the 6 metre countries he has worked, in fact, an updating from his former list. He also asks for a VK list to be published. I did promise this a couple of years ago but for various reasons it wasn't done. However, I will definitely take the matter up with the Editor of "AR" and see when space can be made available and start the ball rolling. With the publication of the first list there should be some incentive for those, not already advising, to do so.

As a reminder, if you are sending a list, and I urge you to do so, I require the following information for each contact: Date, Time in UTC, Callsign, Country, Mode, Report sent and received and advice of whether a QSL card or other confirmation has been received. If you are still awaiting confirmation, add that country but indicate no QSL so far, this will be acknowledged in the listing separately. What about it chaps?

## LOCATOR AWARD

Steve VK5AIM has indicated he would like to see a move start in VK to make use of the latitude/longitude locator squares system for hopefully, an increase in VHF activity. The

filling of squares as a result of VHF contacts is a great sport in the UK and Europe. Steve has offered to pay for some certificates so we will look into the matter and see what can be done. If readers have any thoughts on the matter we would be interested to hear from you.

## OSCAR 10

It seems Oscar 10 has been causing quite a deal of interest around the world. Certainly being from far the least active has been Bob VK5ZRO who has been having a ball!!

Starting with Orbit 113 at 1450 UTC on 7/8/83 Bob had his first contact with DK2ZF in Germany, who is VHF Editor of the German "CQ DL" magazine. From that time onwards Bob has been having daily contacts around the globe and at 21/8/83 had contacted more than 150 different stations in 26 countries. Over the weekend of 21/8 he contacted more than 70 stations in the US, plus VE3, VE5 and VE7. So far Bob has worked about half the States in the US.

Countries worked so far include Germany, Northern Ireland, Ireland, England, Holland, Sweden, Switzerland, Belgium, Austria, France, Italy, Greece, Denmark, Finland, Luxembourg, Hungary, Israel, Hong Kong, Japan, Solomon Islands, Hawaii, New Zealand, USA, Canada, Alaska, Ecuador and Australia. (VK1, 2, 3, 4, 5, 7 and 8, but no VK6).

The contact with DK2ZF on 7/8/83 is claimed by the German to be the first ever Germany to Australia contact via a satellite — Bob is not sure so is making no claims!

Bob uses about 40 watts PEP to transmit on 70 cm to either a bay of four 70 cm yagis horizontally polarised, or a 15 element yagi vertically polarised. On 2 metres for reception he uses 11 elements horizontal or 11 elements vertical as dictated by conditions. The vertical antennas can be tilted to follow Oscar 10 and are about 6m high. The system provides from 8 to 10 hours of daily access to Oscar 10, and some contacts have been maintained for over an hour. Two RTTY contacts have been made to Japan to JA1ANP and JA1MIN, signal reports 569 for an hour or more.

Bob says the actual polarisation is quite important, and you need to experiment between horizontal and vertical for best results, hence circular could be even better. He said some contacts might have been made earlier than 1450 UTC on 7/8 but for the fact that the low gain aerials on Oscar were in use for the early orbits, and signals improve significantly after the higher gain antennas were brought into use. Many VK stations went to bed too early that night!

Stations in VK5 so far reported either working through Oscar 10 or trying include VK5ZRO, ZK, AGR, ZDR, JM, ZTS, ZRG, QM, DK and ME.

Oscar 10 transmits on 145.975 to 145.825, and you transmit on 435.025 to 435.175,

remembering that as you go up in frequency then the received signal on 2 metres goes down.

Congratulations to you Bob for a fine effort, and as time progresses we will no doubt hear more of your exploits and those of others participating in this very interesting phase of amateur radio.

## ANOTHER TWO METRE DX-PEDITION!

Steve, VK4ZSH has been at it again! His latest DX-pedition chasing 2 metre TEP DX to Japan took place in April/May this year, and as usual, his letter makes interesting reading, so I have taken the following from it:

"The 1983 April/May 2 metre TEP DX-pedition did not go as planned, in fact, it became more of an endurance test with unseasonal widespread heavy rain that inundated most of Queensland for many weeks making it a very wet, cold, windy, muddy, boring and eventful trip! I started in Boulia but after twelve days sitting in the front seat of my car swatting flies there was still no sign of the improvement in geomagnetic conditions hoped for, so moved north 3 degrees.

"22nd April: Raining 30 km west of Camooweal in VK8. While telling Hide JA2DDN on 6 metres that 2 metres was closed, it opened and in 30 seconds the 146.760 MHz beacon had reached S5. My JA followers were caught by surprise and during the short opening I found no English speakers! Beacons 1000 to 1035 UTC. The distribution of JA paging transmitter beacons received indicated further south would be better for JAB.

"23rd April: After checking road conditions headed off for Urandangie and only just made it because of more rain. As I arrived, stretching from one side of town to the other were four double decker beef cattle road trains being coupled to a D7 bulldozer for an attempt at crossing the Georgina River. I wisely resisted the temptation to hitch a ride to VK8 by chaining my car to the back of the 120 m long 180 wheeled monster road train! It took eight hours for the D7 to pull and push the road trains to drier roads on the other side of the river, in the process re-arranging the countryside and destroying what road there was.

"2 metres opened and at 1035 worked JA1RJU and at 1051 JA1VOK. Beacons 1023 to 1145.

"24th April: Urandangie and more rain. On 2 metres 1020 JA1RJU, 1023 JK1DUP, 1025 JA7OXL. This latter is the third record contact with Toshinobu and breaks our VK record by 106 km. JA7OXL uses a TS770 to a 4CX350F running 240 watts input and eight 10 element yagis at 18 m. 1026 JA1VOK, beacons 1012 to 1155.

"25th April: Half year of rain and at one stage even though the car was on some of the highest ground for miles water reached the wheel rims! Also assisted in the thrilling rescue of the four road train drivers who had been stuck for some time in a metre of water and mud 16 km out of town.

"28th April: Still stuck in Urandangie but rain has stopped. Beacons 1050 to 1120 and weak JA's.

"29th April: Finally got back to the bitumen and Boulia. 1010 to 1125 beacons and

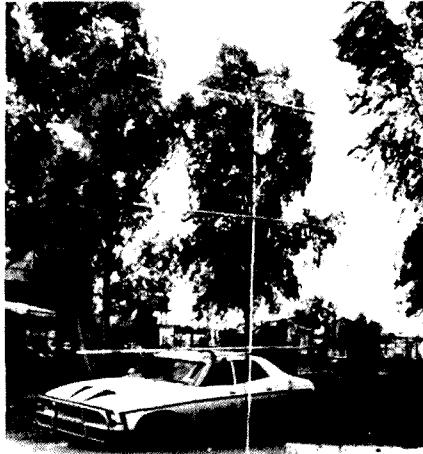

Water laps the tyres during Queensland floods and the VK4ZSH DX-pedition.

swapped signal reports with JA1VOK. At about 23°S this is the greatest distance south a 2 metre TEP signal has been heard in VK.

"1st May: Boulia. Beacons 1034 to 1050 plus 1120 to 1145. As a sideline had arranged 2 metre tropo skeds with John VK6GU in Wyndham, WA. Because of the rotten tropo weather the skeds soon became meteor scatter skeds. Following a couple of failures due to our inexperience with the mode we went to 6 metres for some practice!

"3rd May: Now 12 km west of Camooweal and at 1130 completed the first VK4 to VK6 MS OSO with John VK6GU at Wyndham on 6 metres; later that UTC day at 2150 worked VK6GU on 2 metres MS exchanging 5 x 5 reports. John was using an IC251 with 150 Watt PA with pre-amp to 10 element yagi at 10 m. My gear was an IC251 with 70 W PA NE64535 preamp to 2 x 10 element yagis at 5 m. The QSO just happened to coincide with the peak of the Eta Aqarid shower with the longest burst being eight seconds. The distance is certainly no record but this must surely be the first VK4 to VK6 2 metre QSO.

"4th May: Cloncurry; against all indications and predications 2 metres opened, surprising the JA's again, but this time their warning system worked. At 1050 JA1RJU, 1053 JM1JFC, 1057 JM1SOZ, 1058 JL1CWS, 1059 JO1CFO, 1102 JA01XX, 1103 JA1VC, 1105 JO1GZR, 1106 JA1ACT, 1111 JM11ON. Beacons 1045 to 1255.

"5th May: Cloncurry, beacons 1026 to 1115. Even the trip home to Brisbane was difficult involving a detour via Townsville, with little sleep and bailing a lot of water out of the car!

"As this is my last trip at least for this sunspot cycle a review of the three trips is in order: total distance 36,000 km (that's like Brisbane to Perth via South America) using 5,300 litres of fuel which is not cheap in the outback.

Trip	Days in area	Days 2 m opened	Days JA's OSO'd	#JA QSO's	Total hours beacons heard	Average opening hours
April/May 1982	27	10	8	128	19.6	2
October 1982	17	6	4	22	10.8	1.8
April/May 1983	26	8	3	16	9.0	1.1

"The table is interesting in that it appears to show that despite the downhill slide at the end of this sunspot cycle the only major effect is a drop in signal strength. The sun still seems to be able to produce the TEP ducts at about the same average rate of one opening per three days but lower energy levels mean the ducts leak and the resultant lower signal strengths make openings shorter and thus contacts fewer.

"I would be surprised if contacts did not continue right through the sunspot minima though with much reduced frequency unless there is a marked improvement in the generally poor grade of VK stations currently operating 2 metres TEP.

"I would like to thank Hide JA2DDN and Kazu JA1RJU for their considerable help once again, and Beth and Frank Austin at Urandangie for their kind hospitality."

Thanks for writing Steve, we all hope your dedicated efforts will prove of value in trying to unlock the mysteries of VHF propagation, and we look forward to hearing of your exploits when they start again.

## NEWS FROM NEW SOUTH WALES

Gordon VK2ZAB has written again from Berowra Heights in Sydney and says he has recently completed a new 2 metre linear using a pair of 4CX250B's and replacing the 8122's which expired a while ago. The new unit also runs 400 W PEP and is coupled to four, 9 element yagis. On 70 cm Gordon uses four, 11 elements and 10 W.

Gordon reports John VK2YEZ in Griffith can be worked most times. He also works into Melbourne but Griffiths is closer to Melbourne than Sydney. John has a 4CX250B on 2 metres and the last contact was on 4/8 with signals 5x4 both ways. Trying 70 cm John was audible in Sydney, but Gordon's 10 W wasn't enough!

Doug VK3UM at Chirnside Park was 5x1 at 2033 on 30/7 and 5x3 at 2045 on 12/8 and gave VK2ZAB 5x4 on 2 metres. Doug is also getting fired up on 70 cm. He also worked VK1RK, VK1KAA and VK1VP on 12/8.

Doug VK2XDH has moved from Armidale where his 2 metre operations were restricted by a Channel 5A translator, to Uralla where things are better, and runs 25 W on 2 metres and worked VK2ZAB on 3/8, 4/8 and 12/8 and 14/8 signals from 5x1 to 5x3 and in return gives 5x5 to 5x9.

Barry VK2KAY at Gunnedah is changing his antennas but Jock VK2ZQX still puts in an almost nightly appearance on 144.2 MHz, with signals to 5x6. Don VK2ADY at Tamworth worked on 4/8 but is a shift worker and contacts vary accordingly.

In Sydney, VK2ZHT is active on 144 and 432 MHz, and so is Ross VK2ZRU. Jack VK2AAS has just put up a new 2 metre beam. Adrian VK2EDB is also on 2 metres SSB and contacts are being increased in range as time progresses.

All in all, it's good to know something is being done in and around Sydney as well as the country areas. I wonder what is being worked in Melbourne?

### VK2AMW EME PROJECT

Lyle VK2ALU reported to the July 1983 meeting of the Illawarra Amateur Radio Society that so far this year more than 500 man hours had been spent on getting the 32 foot dish ready for use, and some 50 to 100 more such hours would be needed to get the project on the air on a "lash-up basis".

Lyle said the power amplifier is to be mounted in the dish with remote tuning facilities, and it is hoped to achieve 120 W output with a beam width of 2 degrees between half power points. Frequency will be 1296 MHz with circular polarisation. Because the path loss to the moon and back is -272 dB, sensitivity of the returned signal will be only 1/2000 millivolt!

Thanks to "The Propogator" for the above piece of information.

### WILLIS ISLAND ACTIVE

Graham VK9ZS is anxiously awaiting contacts on six metres. He has the keyer running on 52.075 MHz.

### CLOSURE

There hasn't been a lot else to report this time. I note Bob VK5ZRO and Don VK5ZRG at Whyalla are still maintaining their almost nightly skeds on 70 cm despite all the activity on Oscar 10.

VK5RSE the Mount Gambier 2 metre beacon is still a consistent signal into the VK5LP establishment, continuing to be there day or night, rain or shine. Sometimes the masthead pre-amp is needed to lift it up out of the noise, but it's always there, serving its purpose as a constant indicator. Can anyone report how consistent it is in Melbourne please?

The thought for the month this time comes from Steve VK4ZSH, who probably had a lot of time to think about such things whilst sitting for twelve days in his car at the back of nowhere, swatting flies! "Let me not seem to have lived in vain" (Tycho Brame), or to put it more modernly: "It's not what you know, it's not who you know, and it's not what you know about who you know, it's what you do that counts". Signed: The voice in the wilderness ... Steve VK4ZSH. Thanks for your thought Steve. 73 from The Voice in the Hills.

AR



# ALARA

Australian Ladies Amateur Radio Association

Margaret Loft, VK3DML  
28 Lawrence Street, Castlemaine, Vic 3450

Well we are back in sunny Victoria again after a most enjoyable touring trip through the coastal area of NSW and Qld as far as Bundaberg. Along the way we met up with Grahame VK2ZZV at Newcastle and Roy VK4NE formerly from Castlemaine. Also spent a day with Peg and Bert VK4BKU ex VK3KU from Kilmore.

ALARA members we met were Wendy VK4BSQ, Freda VK2SU and OM Stan VK2DZP and also stayed overnight with Narelle VK1NG and family in Canberra.

Thank you all for your hospitality to us and a very special thank you to Narelle, Marlene VK5QO and Valda VK3DVT for the daily skeds they kept with us while we were travelling.

The AGM on 25th July was very successful with twenty six on air including two ZLs and VK states 1 to 7 represented. Six proxy votes as well were recorded. Very pleasing result for the executive committee to know they have the support of so many.

Slight changes were made to the constitution, otherwise all reports etc were accepted as per the newsletter prior to the meeting.

Executive Committee for 1983-4 is:

President: Helene VK7HD

Vice-Presidents: Joyce VK2DIX and Margaret VK3DML

Immediate Past President: Geraldine VK2NQL

Secretary: Jenny VK5ANW

Treasurer: Valda VK3DVT

Minute Secretary: Marilyn VK3DMS

Editor: Marlene VK5QO

Publicity: Margaret VK3DML

Awards Custodian: Mavis VK3KS

Contest Manager: Margaret VK3DML

Librarian: Bev VK6NYL

Souvenir Custodian: Joyce VK3VBK

Sponsorship Secretary: Jessie VK3VAN

Historian: Mavis VK3KS

State Representatives: VK1 & 2 Narelle VK1NG, VK3 Marilyn VK3DMS, VK4 Margaret VK4AOE, VK5 Joy VK5YJ, VK6 Poppy VK6YF, VK7 Helene VK7HD.

Sincere thanks to all the above for accepting or offering your services to ALARA and I hope it is an enjoyable task for you.

All ALARA members will join with me in a

special thank you to Geraldine for the excellent job as President at the time we were going national rather than a VK3 based organisation. Also to Jessie VK3VAN who was Secretary for us through the same period. We do appreciate all you have done for ALARA. We hope you enjoy your new positions on the committee.

ALARA's eighth birthday was celebrated on air on 22nd August and was very successful with eighteen members present to wish ALARA many more birthdays. Greetings also were passed on from DX members ZL2QY, G4EZI, WA3HUP, WB3CQN and from Geraldine VK2NQL and Margaret VK4AOE.

Mavis VK3BIR, one of the early members of ALARA, suggested we start looking at a special function in 1985 for our tenth birthday.

Welcome to new members Carol VK5PWA, nice to meet you on the birthday net, Joan VK5KVJ and to sponsored member Ann K9RXX.

### GI YL ACTIVITY DAY

First day of each month on the hour UTC. Frequencies: 14.233, 21.333 and 28.433 MHz.

This is in addition to the usual activity day on the sixth day of each month.

ALARA's Third Contest is on Saturday 12th November starting at 0001 UTC, full contest rules were in September issue of AR page 50. A full list of ALARA members will appear in November issue.

Starting from this year a trophy will be awarded to the highest score over five years to a YL, not necessarily a member. So please mark this date on your calendar and see who will have a chance at the trophy.

Ruthanna WB3CQN one of our DX members is planning a visit to Australia in November and she is looking forward to meeting some of the members she has talked to. Ruthanna is one of our regulars on the contest.

That's all for this month, and hope to talk to you on the 12th of next month in the Contest. 33/73 and 88 to all.

Margaret VK3DML

AR

## JAMBOREE ON THE AIR



### Participation Report & Log Sheet

Some amateur operator participants in JOTA may be unaware that a Report and Log Sheet should be completed by them as well as the Scout/Guide personnel to enable accurate participation records to be sent to the Scout World Bureau.

A photocopy of these sheets may be obtained from the Federal Office of the WIA by those unable to obtain same from their Scouting Group.

## SPECIAL EDUCATION QSP

Brenda VK3KT has available Trail Examination Papers:

Theory, Novice, AOC, Regulations.

Also past CW exams from DOC. There are:

10 exams at 5WPM

10 exams at 10WPM

Ten exams fill a C60 cassette tape.

INTERESTED? Send a tape and state your requirements and Brenda will transcribe it

onto your tape.

Have you any complaints or other comments about the amateur examinations?

Please make your grievances known to Brenda VK3KT, your Federal Education Officer. Brenda may be found each Thursday evening on the Education Net at 1130 UTC, 3.685 MHz ± or write QTHR.



# HERE'S RTTY!

Bruce Hannaford, VK5XI  
57 Haydown Road, Elizabeth Grove, SA 5112

## SETTING THE SPEED OF MECHANICAL RTTY GEAR

machine. I noted its speed is reduced by going through two sets of gears. I only needed to determine the ratio from the motor to the final cog attached to the counter, count the final cog RPM and multiply by the ratio to get the motor speed. Obviously accurate results could easily be obtained without a tachometer or other such gear.

I determined the ratio by first counting teeth on the cogs and then checked it by turning the motor by hand and counting the turns required to give one turn of the counter cog. I found the ratio is 223/1. The motor speed for 50 bauds is stated in the handbook as 3750 so at our speed of 45.45 this is reduced in proportion to 3409 RPM or 56.817 per second.

The speed of the counter cog would be 3409 divided by 223 = 15.29 RPM. For comparison the 50 baud speed is 16.8 RPM. For accurate counting I marked the cog with a dab of white liquid paper and fixed a wire pointer to give a definite indicating spot. Holding a watch close to the cog and quickly glancing from the cog to the second hand from time to time I found an accurate count could be made. When I had the speed nearly right I counted for three minutes to get greater accuracy. Having done this I checked

with some sophisticated gear and found the speed was quite accurate. With this method the machine need not be printing anything so keep loop current flowing while testing and avoid the machine running open.

If you have a different make of machine without an hour counter all is not lost as you can count how many operations per minute it is working at and check the speed in this way. This method has an advantage in that it is not necessary to know motor speeds and you may not have this information anyhow. Adding up the milliseconds in one operation signal such as a letter, using the normal 1.5 times stop pulse it comes to 165 milliseconds per operation this means 364 operations per minute (364 OPM). Operations including such machine function signals as carriage return or space etc. So if your machine is at the correct 45.45 bauds speed it could for example print a string of 364 letter "A" in one minute. In practice as the line length is much shorter than this five lines would be required, this needing five carriage returns and five line feed signals so only 354 letters could be actually printed out of a total of 364 operations.

If your machine has paper tape playing facilities get a few feet of perforated tape with

RTTY picture courtesy Steve VK2BGL.



In these days of sophisticated testing gear we have learned to expect so much of such equipment that at times we can't see the wood for the trees.

Many who use sophisticated gear to set their machines speed have overlooked many simple methods of achieving the same results. There are some quite simple but accurate methods of setting the speed (baud rate) of the Siemens 100 Teletype M15 etc. The following is mainly based on the Siemens 100 but the methods can be adapted to other machines as well.

Looking at my Siemens in operation I noted that there are some slow moving parts where the revs could easily be counted visually using the second hand of a watch or better still a stop watch. One such part in the Siemens is the slow moving hours of use counter at the front right hand side of the

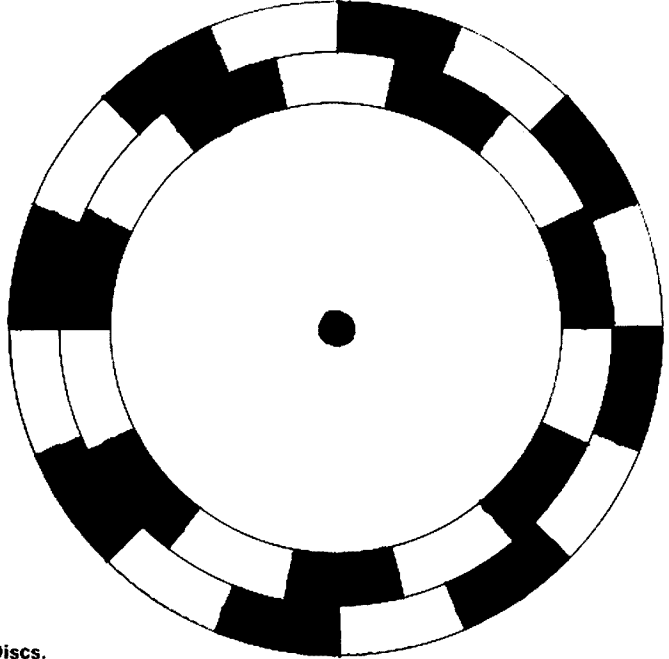
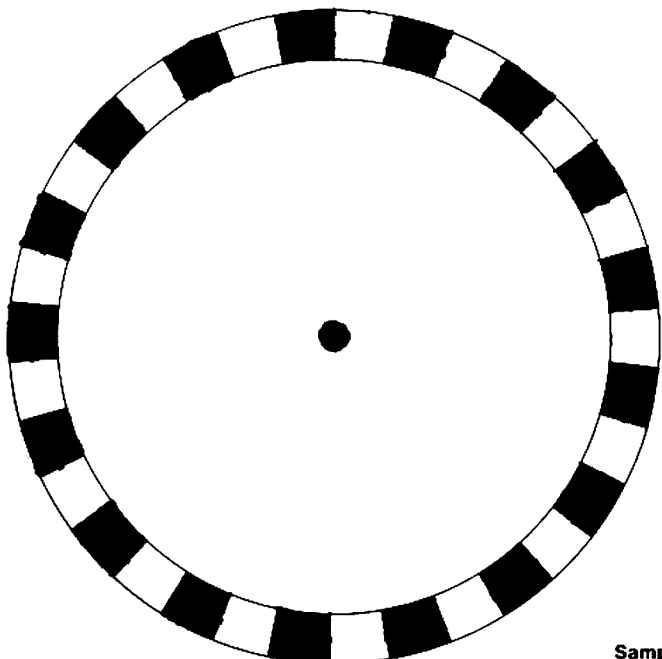

Sample Discs.

anything at all on it and starting about one inch from the start make a mark across the tape over a line of holes. Starting from this point play the tape for exactly one minute, stop the machine and mark the finishing spot of the tape (above the pins) then count the number of feed holes between the two marks. The count should be 364 if the machine is running at correct speed. The count is made easier if you use a pair of dividers set to say 50 holes to speed up the count.

If you have no tape playing facilities you can still use the OPM method by counting the revs of the ribbon spool as the machine is repeating a given character or function signal. As the ribbon travels from one spool to the other note which spool is winding the ribbon on and remove this spool from its winding shaft and fix a pointer to this shaft for the easy counting of its RPM. On the Siemens there is, above the centre of the keyboard, a tab switch marked with a string of five dots, if this is held pressed whatever the machine last printed or did will be repeated until you release the switch. With this key you can for example print a string of dots for a dotted line etc. Press the repeat key and note that the ribbon spool shaft slowly turns. Now with the pointer set to a marked spot tap the space bar counting as you do so, continuing until the pointer has done one turn and noting how many taps it took to make the pointer do one revolution. Try this several times and make sure you always get the same results as, if you don't, this method is useless on your machine. I found on my machine counting with the ribbon in place gave unreliable counts so that is why I recommend removing the spool. In my case I found that it needed 87 key operations for two turns of the spool this being 43.5 operations per turn. Well we know the machine should do 364 OPM at 45.45 bauds, we know 43.5 operations are needed for a rev of the spool shaft so it follows 8.37 revs per minute will be the correct spool shaft speed. Or for greater accuracy a three minute run will give just over 25 turns. As nothing needs to be printed for this test I used the space bar and then pressed the repeat key. If your machine does not have a repeat key locate the lever or device that, when moved, allows the sending shaft to start turning and holding this in the operating position you can do the same test.

Another method is to time how long it takes to print a line using the above repeat method. However I found it easier to time until the end of the line bell rang as I could then keep my eyes on the watch second hand counting the seconds until the bell rang. As you need to start at the beginning of a line you must have just sent a CR and LF signal and you don't want to repeat the last of these so you need to print one letter before you press the repeat key, in other words the line length to the bell or end of line will be one less than normal. In my case I found 59 repeats rang the bell and at correct speed that worked out at 9.73 seconds. Work out your own time figures, remembering that 364 OPM = 6.0666 per second or one operation = .1648351 seconds.

A good method of counting OPM is to use an ex PMG type counter, these can often be obtained at disposals stores, they are about an inch square and four inches long, on the front there is a four digit wheel type display. I believe there are two varieties, one for 12 and

one for 24 volts, the 12 volt one is preferable for our purpose. The 12 V counter can be connected directly in series with the loop circuit if the current is between 20 and 40 mA, it will be slightly overloaded at such currents but will take it OK. If you have 60 mA loop current, shunt some resistance across the counter to keep the volts down to about 12 volts. The counter should be operated right side up and in a horizontal position.

With everything connected up, most likely each letter you type will advance the count by one, however it will be found some letters are unreliable and may give two counts. The counter operates and advances by one each time the current through it is interrupted. It follows that some letters or signals that go rapidly from mark to space will have more than one interruption and if the counter is able to follow such rapid pulses it will count them. I find the letters O or M are best to use as they both start with a long space and finish with a long mark so the counter will follow them OK. As the counter can not be reset to zero note the reading first and then repeat say M for one minute and the increase in count should be 364. Of course there will be a black blob at the end of the line as you do this but it will really do no harm for a short test. If you wish to avoid this the typing pressure can be reduced until no printing takes place while the test is being made. The Siemens has a lever to do this near the centre right of the machine as you look down into the works. This method is very accurate and it is well worth while getting one of these counters, mine cost me \$1.50, a very cheap speed tester indeed.

Finally it is possible to use stroboscope methods to set the machine speed. Of course the accuracy of the result is only as good as the accuracy of the frequency of the testing source. A function generator with its digital counter feeding into an amplifier driving a flashing light can be very useful for this purpose. However this article is about simple methods without elaborate gear so we will stick to something simple. The AC mains are to most Australians a very reliable and accurate 50 Hz so we will use this frequency for our flashing light. As there is a negative and a positive pulse for each cycle there are two flashes per mains cycle or 100 flashes per second. Incandescent lamps don't cool off completely at the zero current parts of the cycle so don't give a perfect pattern on a strobe disc, fluro lights give a much more distinct pattern and are to be preferred.

As there are 100 flashes per second from our light to make a strobe disc pattern appear stationary there must be 100 white spokes or segments past a given point per second. However a somewhat blurred pattern will also be seen if the number of segments are half or double this number and even greater fractions or multiples may sometimes be seen. Of course there are the same number of black segments as white but for simplicity sake I am sticking to only mentioning the white segments.

Stroboscope relationships can be summed up as follows.

*White segments = flashes per sec divided by the speed in revs per sec.*

*Speed (revs per sec) = flashes per sec divided by the number of white segments.*

*Flashes needed to stop the pattern = number of white segments times the speed in revs per sec.*

By the above means knowing any two of the factors you can calculate the third.

For the Siemens machine, if you have no paper tape playing facilities fitted to the right hand front of the machine, there is a shaft running parallel to and near the front of the machine. The right hand end has a washer held on to the end of the shaft with a metal screw. A small strobe disc can be fitted under this screw if some spacing washers are used to bring the disc out clear of surrounding stationary metal. This shaft turns at 363.6 RPM or 6.06 RPS so we divide the flashes by the speed to get the number of segments needed. 100 divided by 6.06 = 16.5 segments.

Now as we need a whole number of segments we will use 17 instead of 16.5. With the 17 segment strobe the pattern will turn slowly clockwise in the direction of the shaft rotation at the correct speed. We could put two tracks on the strobe disc, one of 16 and one of 17 segments. In this case one pattern would turn slowly clockwise and one slowly anti clockwise, however the 17 pattern alone will be sufficiently accurate if it is slowly turning clockwise.

Now those who do have tape facilities fitted can't use the shaft we have been describing so at the back of the machine near the terminal connecting block is the short end of a shaft driven from the motor pinion cog. This shaft turns at 779.2 RPM or 12.986 RPS but let's put it into round figures and say 13 RPS.

Unfortunately the speed of this shaft is such that the number of segments needed is between 7 and 8 actually 7.7 segments making 8 the closest number. All these figures are of course for 45.45 bauds. Well we got around this problem in the following way. We use a strobe disc with both 7 and 8 segment tracks knowing one pattern will appear to rotate clockwise and the other anti clockwise and that the 8 segment pattern will rotate the slowest. With the machine operating at 50 bauds the 7 segment pattern will appear stationary. If the 8 segment pattern appears stationary the machine is set at 43.75 bauds. Now if the machine is correctly set at 45.45 bauds the 8 segment track is rotating anti clockwise at a fair speed and the seven track is rotating rather fast in a clockwise direction. The seven segment track will be moving so fast it will be just possible to see a blurred set of segments. Now as the shaft speed for a stationary pattern on the 8 segment track is 12.5 RPS and not the speed we require of 13 RPS, there is a difference of .5 rev per second or 30 per minute. Now it is possible to count this 30 per minute in the following way. Watching the 8 segment track pattern revolving follow it with a pen held close to it. Turn the pen at the same speed as the pattern rotation. After a bit of practice you can do this reasonably accurately, count the number of pen rotations per minute and they should be 30. Once you have obtained the correct speed in this way take a good look at the overall picture of the two revolving patterns and in future you will not need to do any counting just set the speed so the patterns look the same as they now do. Strobe discs can be made using white cardboard. Make the centre hole small so it will be tight on the shaft it is to be attached to, as this will be sufficient

attachment. Two sample discs are shown to assist you. Much more could be said about this and the other methods mentioned but we will leave it at this point and conclude with a few final statements.

How accurate does the speed need to be? I note with my Siemens set exactly to 45.45 bauds I can still copy more than half of a 50 baud transmission. If a machine were to be set between 45.45 and 50 bauds no doubt it could print both quite well however it would not be desirable to use this non standard speed for transmission. The Siemens has a control lever inside at the right front of the machine, there is a 0 to 120 scale for this range finder control. The control determines what part of the received signal pulses are sampled (usually the middle part is sampled) normally the control is set at about 50. Now if the incoming signals are not quite the same speed as your machine, different settings of the range finder can often be used to assist in getting a good print. In other words the range finder can be used like a speed control when receiving, it will however only cope with slight speed inaccuracies.

Well I trust all this will help those with mechanical machines and especially those who have acquired one of the many ex Telecom Siemens machines recently released. 73 from Bruce VK5XI

AR

## SPECIAL INVITATION



Some years ago a group of ex RAAF personnel conceived the idea of a memorial lawn at Adelaide Airport. The Air Force Memorials Adelaide Airport Committee was formed to establish and administer this memorial and in the subsequent years many squadron and unit plaques have been dedicated.

Recently, ex Signals and Radar personnel, who formed an association in the immediate post-war period, decided that they should also have a memorial plaque.

### DEDICATION OF MEMORIAL PLAQUE

#### RAAF SIGNALS AND RADAR

An invitation is extended to all ex members of Signals and Radar Units of the RAAF to attend the dedication ceremony of a memorial plaque at the Adelaide Airport on Sunday 30th October 1983\* at 11.00 AM. Family and friends welcome.

The Chief of Air Staff, Air Marshall S D Evans, AO, DSO, AFC, has been invited to represent the RAAF at the Dedication Ceremony.

Any member who may wish to contribute to the expense of this venture may do so by sending a donation to the Honorary Secretary, Reg Hart, 67 Port Wakefield Road, Two Wells, 5501.

John Allan, VK5UL.  
Ray Deane, VK5RK.  
Committee Members.

\* Note: Sunday 30th Oct is the first day of daylight saving in SA.

AR



# WICEN NEWS

Peter Jeremy, VK2PJ  
VK2 BROADCAST & WICEN  
LIAISON OFFICER  
PO Box 1066, Parramatta, NSW 2150

### VK2 WICEN REGIONAL MEETING

On Saturday 30th July, a group of amateurs and friends from the NSW Central West attended a meeting at Canobolas High School, Orange, to discuss WICEN and amateur emergency communications.

The meeting was opened with addresses from Robert VK2ZRJ, Central West WICEN Co-ordinator, Sue VK2BSB, Divisional President, and David VK2ZMZ, State WICEN Co-ordinator.

- Amongst the items discussed were:
- Third Party amateur emergency communications and exercises
  - WICEN emergency communications and exercises
  - Use of "W"-series WICEN callsigns for exercises and emergencies

- Qualification requirements for WICEN operators
  - Training of amateurs for third party emergency communications and WICEN procedures
  - Publicity stemming from WICEN operations
- Motions passed included: that the WIA and WICEN outline the distinctions between third party and WICEN traffic handling procedures, that references to other certificates be deleted from the WICEN membership card, and that consideration be given to a name change for WICEN incorporating the words 'amateur radio'.

Overall, the meeting was very successful in resolving several matters that had caused local WICEN members some concern.

AR



Photo courtesy of John VK2AMV.

Left to right (standing): John VK2AMV, Alan VK2BVL, John VK2BHM, Graham VK2BVU (behind), Chris VK2APP/XYL, Frank VK2ZFE, Kim VK2ASY (behind), Bob VK2DSM, Ian VK2KMA (behind), Sue VK2BSB, Peter VK2TK (behind), Barry VK2AAB, Peter VK2PJ, David VK2ZMZ, Bruce VK2DEQ, Jack VK2DDN.  
Seated: Wally VK2DEW, Neville VK2DR, Peter VK2APP, Ross VK2BRC.

## NOTICE

Copy for December magazine (columns, Hamads, etc) must arrive at Box 300, Caulfield South, 3162 no later than 25th October. Also please note the early deadline for January 1984 — 18th November.



# QSP

### RF ENERGY IN LIGHTING

RF energy will be used in two lighting devices now being developed in the USA. One is an RF light bulb designed for conventional household use. The other is an RF ballast that replaces the conventional ballast in fluorescent fixtures.

The units will use RF energy between 20 and 100 kHz and have a potential for interfering with AM broadcast reception if not adequately controlled.

Adapted from "The ARRL Letter" Vol 2, No 16.

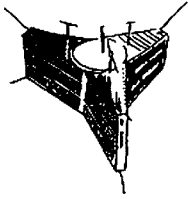

# AMSAT AUSTRALIA

Colin Hurst, VK5HI

8 Arndell Road, Salisbury Park, SA 5109

## NATIONAL CO-ORDINATOR

Graham Ratcliff VK5AGR

## INFORMATION NETS

AMSAT AUSTRALIA

Control: VK5AGR

Amateur Checkin: 0945 UTC Sunday

Bulletin Commences: 1000 UTC

Winter: 3.680 MHz

Summer: 7.064 MHz

AMSAT PACIFIC

Control: JA1ANG

1100 UTC Sunday, 14.035 MHz

AMSAT SW PACIFIC

Control: W6CG

2200 UTC Saturday, 21.280 MHz

Participating stations and listeners are able to obtain basic orbital data including Keplerian elements from the AMSAT Australia net. This information is also included in some WIA Divisional Broadcasts.

## ACKNOWLEDGEMENTS

Contributions this month were received from Bob VK3ZBB, Graham VK5AGR, Peter VK7PF and thanks are extended to AMSAT Telemail and UOSAT Bulletin Board for excerpts.

## OSCAR 10 (as at 18 August)

Following the successful initial burn of the kick motor as reported last month the second burn of the motor was awaited with considerable anxiety by the AMSAT crew on the 26th July, as the telemetry had been indicating that the Helium Pressure on board the spacecraft was slowly decreasing. This was believed to be as a result of the collision that occurred at separation of the spacecraft from the launch vehicle. Their worst fears were realised when it became apparent that the motor failed to fire as there was insufficient Helium to open the valves in the motor. Consequently the spacecraft will now remain in its initial transfer orbit and as such will favour southern hemisphere operators more so than the intended orbit. Following a period of re-orientation the Mode B Transponder was switched on at 1430 UTC on the 6th August. Results on the first evening were most disappointing as only the "moon-bouncers" with their kilowatt ERP signals could access it. On the following day the gain antennae were initiated on both receive and transmit and the passband literally came alive with signals. Since then world-wide VHF communication has become a reality and numerous record breaking distance QSO's have taken place via the satellite. Under ideal conditions ERP's of 100 watts can be utilised to reliably communicate however the general rule is that ERP's of the order of 500-1000 watts are being used much to the detriment of

the lower powered stations. It is hoped that once the initial enthusiasm of DX operation through Oscar 10 has passed that a more responsible attitude will prevail and that ERP levels will be restrained to the minimum levels required for communicating.

Perhaps the following message from DJ4ZC Posted on Telemail tells all... "Telemetry of transponder — AGC shows values between -15 and -22 dB during most of the time — in other words: if most stations would reduce their power at least tenfold, nothing would change other than that weaker stations would get louder. Please spread the word... 73 Karl..."

## OSCAR 10 BANDPLAN

The following bandplan has been published by AMSAT and all users of Oscar 10 are requested to adhere rigidly to the plan to ensure that the maximum benefit is gained by all users of the transponder.

### Uplink Downlink

	145.987 Engineering beacon
435.025	145.975 SSC H1
435.035	145.965 SSC H2
435.038	145.962 SSB only — Upper limit
435.080	145.920 SSB only
435.080	145.920 mixed SSB/CW
435.120	145.880 mixed SSB/CW
435.120	145.880 CW only
435.162	145.838 CW only — Lower limit
435.165	145.835 SSC L2
435.15	145.825 SSC L1
	145.810 General Beacon

The Special Service Channels (SSC) are for special purposes (eg bulletins, scheduled experiments, etc) and must not be used for normal transponder communication.

## WHERE IS OSCAR 10?

This question appears to be the most asked of any pertaining to the new spacecraft. To date the most successful method is to have a home computer able to run one of the many excellent programmes available to compute the relevant azimuth and elevation bearings that you require. However this is impractical for those who do not own a computer, nonetheless I am sure of at least one amateur in each capital city of Australia who does and as such does help out others with the info. I am aware that an article is soon to appear in ORBIT Magazine entitled the SATELLIPSE by K2ZRO the inventor of SATELLABE, an excellent circular orbit calculator. It is expected that his SATELLIPSE will at least be the equal of SATELLABE. In the meantime I suggest that you make friends with a fellow amateur who does own a computer, alternatively listen to the AMSAT Australia Net on Sunday evenings for the latest data. Nonetheless it has been reported, albeit unsubstantiated, that the current orbit of Oscar 10 has a repeatability of every nineteen days.

Should this be the case the tracking will be simplified significantly. I have no doubt that there will now be a profusion of tracking kits come onto the market and I will endeavour to seek them out and evaluate them for this column.

## UOSAT OSCAR 9

The following four items are from Bulletin 37, 12 August and once again our thanks to the UOSAT Team.

## PACSAT NEWS

G3YJO, G8NOB and G8NEF from UoS attended the PACSAT design meeting near Boston, USA last weekend. The meeting ran from Friday to Sunday afternoon and was attended by members of the PACSAT design team from USA, UK and Canada. The basic spacecraft systems philosophy, interface, schedules and budget were detailed in addition to the definition of communications formats and systems design. The PACSAT mission will give radio amateurs access to store and forward digital communications using packet radio techniques, providing a communications service similar to, but more extended, than the low earth orbit analogue transponders of AO-6, 7 and 8. It is anticipated that the PACSAT spacecraft will be launched into a low (850 km) polar earth orbit in the 1985-6 timeframe. Further details of this new project will be posted on the bulletin shortly.

Miki Nakayama, JR1SWB, visited the University of Surrey on Thursday 4/8/83 to discuss various aspects of the JAS-1 spacecraft and to exchange information on the British and Japanese AMSAT operations. JAS-1 will carry a PACSAT-type digital transponder due for launch in 1986.

## HF EXPERIMENT

Although the on-board telemetry indicates that all of the HF beacons are functioning correctly (including synthesiser lock), signals have only been received from the 21 MHz beacon. Preliminary tests have not been able to receive signals from the 7, 14 and 29 MHz beacons. As the boom was to contribute to the 7 MHz antenna system and in view of the QRM and propagation mode on that frequency, it is perhaps not surprising that signals have yet to be received from that beacon. The lack of signals heard on the ground from the 14 and 29 MHz beacons indicate that there may be a problem with the deployment of one of the HF antennas — as those beacons share one and the 7 and 21 MHz the other. Further analysis will continue.

## SPACECRAFT ATTITUDE

Analysis and preparations have been completed for magnetorquer attitude manoeuvres to reorient the spacecraft spin axis and introduce a slow Z-spin to improve the temperature gradients and improve the

power budget. Preliminary manoeuvres were carried out on Tuesday this week, and will be continued next week.

### CCD TRANSMISSIONS

In view of the number of requests that have been received for CCD transmissions, CCD data will be scheduled for transmission on Wednesdays and may comprise either image data or test patterns. The data transfer, memory and transmission mechanisms are functioning well, however the CCD sensor itself has not yielded images up to the anticipated quality standard. Notwithstanding the poor quality of the image data, the transmissions are still of value to those stations who possess image processing facilities or who wish to study/check ground-station decoding/display equipment.

### RUSSION RS SATELLITES

Although I have received no specific reports as to how active these satellites are in the VK-ZL region I did overhear UA3CR via Oscar 10 extolling the virtues of these satellites to fellow European stations. They are indeed excellent Mode A Transponders and afford beginners to Satellite Communication the opportunity to come to grips with the techniques and procedures necessary to conduct a contact. More importantly because of the sensitivity of the onboard receivers high power uplinks are totally unnecessary.

### OSCARS 7 AND 8

No reports of either satellite has come to hand in the past month on a world-wide basis. Any person who hears either satellite is asked to communicate the time and date of the reception of signals to VK5AGR-QTHR.

### ORBIT PREDICTIONS

Following numerous requests for orbital predictions I have compiled the following table from the latest elements available at the time of preparing this column. In some instances the elements will be markedly incorrect by the time you receive this issue and this should be taken into account should you use them. Remember up to date elements are available each Sunday evening on the AMSAT Australia net.

**KEY:** AC — Amateur Communications  
M — Manned  
TV — Television  
TM — Telemetry  
IP — Interplanetary Station  
ESA — European Space Agency  
GS — Geosynchronous  
CS — Communications  
SI — Scientific Instrumentation  
SR — Space Research  
† — Downlink Frequency  
2250, 2287.5 MHz  
M\* — Cosmonauts Liakov and Aleksandrov

## SATELLITE UPS AND DOWNS

### LAUNCHES TO 23 JUNE

NUMBER	NAME	NATION	DATE	INITIAL DATA				FACILITIES REMARKS
				PERIOD MIN	APOGEE KM	PERIGEE KM	INCLN DEG	
1983-048A	COSMOS 1464	USSR	24 May	104.9	1022	985	82.9	TM SI
1983-049A	COSMOS 1465	USSR	26 May	93.4	551	349	50.7	TM SI
1983-050A	COSMOS 1466	USSR	26 May	89.7	367	180	64.9	TM SI
1983-051A	EXOSAT	ESA	26 May	5435.4	191 709	347	72.5	SR
1983-052A	COSMOS 1467	USSR	31 May	90.0	389	209	72.9	TM SI
1983-053A	VENERA 15	USSR	2 Jun	—	—	—	—	IP SI
1983-054A	VENERA 16	USSR	7 Jun	—	—	—	—	IP SI
1983-055A	COSMOS 1468	USSR	7 Jun	89.3	283	277	82.3	
1983-056A	NA	—	9 Jun	—	—	—	—	
1983-056C	NA	—	9 Jun	—	—	—	—	
1983-056D	NA	—	9 Jun	—	—	—	—	
1983-057A	COSMOS 1469	USSR	14 Jun	—	—	—	—	
1983-058A	ECS 1	ESA	16 Jun	627.0	35 600	200	8.6	CS
1983-058B	OSCAR 10	AMSAT	16 Jun	627.2	35 595	199	8.6	AC
1983-059A	STS 7	USA	18 Jun	90.4	296	291	28.5	M†
1983-059B	TELESAT 6	CANADA	18 Jun	640.9	36 190	303	23.0	To be GS CS TV
1983-059C	PALAPA B1	INOO	19 Jun	662.9	37 288	324	24.6	To be GS CS TV
1983-060A	SPAS 01	GER	22 Jun	90.5	300	295	28.5	
1983-060A	NA	—	20 Jun	—	—	—	—	
1983-060C	NA	—	20 Jun	—	—	—	—	
1983-061A	COSMOS 1470	USSR	23 Jun	—	—	—	—	

During the period the following satellites decayed or were recovered:

1975-100A	GOES 1	103.390°W	3.660°
1977-048A	GOES 2	106.970°W	1.762°
1978-062A	GOES 3	90.591°W	1.276°
1983-039A	COSMOS 1457	Jun 8	
1983-045A	COSMOS 1462	May 31	
1983-052A	COSMOS 1467	Jun 12	
1983-055A	COSMOS 1468	Jun 21	

Transmitting frequencies: (MHz)

ATS 1	136.459	137.349
ATS 3	136.470	137.350
GOES 1	136.379	
GOES 2	136.380	
GOES 3	136.380	137.190

A further 33 objects decayed during the period.

The following updated positions are reported:

1966-100A	ATS 1	163.48°E 5.37°N	10.976°
1967-111A	ATS 3	105.7°W	9.868°
NOAA 6			
NOAA 7			
NOAA 8		136.770	137.770

### LAUNCHES FROM 27 JUNE-20 JULY 1983

1983-062A	SOYUZ T9	USSR	27 Jun	90	303	258	51.6	M*
1983-063A	—	—	27 Jun	—	—	—	—	
1983-064A	COSMOS 1471	USSR	28 Jun	89.7	369	182	67.2	TM SI
1983-065A	GALAXY 1	USA	28 Jun	642.4	36 365	203	22.9	SL
1983-066A	HORIZONT	USSR	1 Jul	1479	26 600	—	1.3	TV CS
1983-067A	PROGNOZ 9	USSR	1 Jul	26.7 day	720 000	380	65.5	SI
1983-068A	COSMOS 1472	USSR	5 Jul	88.8	264	197	82.4	TM SI
1983-069A	COSMOS 1473	USSR	6 Jul	—	—	069A to 069H	—	
1983-069B	COSMOS 1474	USSR	6 Jul	—	—	are all	—	
1983-069C	COSMOS 1475	USSR	6 Jul	115.1	1511	1448	74	TM SI
1983-069D	COSMOS 1476	USSR	6 Jul	—	—	—	—	
1983-069E	COSMOS 1477	USSR	6 Jul	—	—	—	—	
1983-069F	COSMOS 1478	USSR	6 Jul	—	—	—	—	
1983-069G	COSMOS 1479	USSR	6 Jul	—	—	—	—	
1983-069H	COSMOS 1480	USSR	6 Jul	—	—	—	—	
1983-070A	COSMOS 1481	USSR	8 Jul	718	40 165	615	62.8	
1983-071A	COSMOS 1482	USSR	13 Jul	90.2	376	217	70	
1983-072A	—	—	14 Jul	—	—	—	—	
1983-073A	MOLNIYA 1	USSR	17 Jul	700	39 025	480	62.9	TV CS
1983-074A	COSMOS 1483	USSR	20 Jul	—	—	—	—	

The following satellites were recovered or decayed during the period:

1983-050A	Cosmos 1466	6 July
1983-068A	Cosmos 1472	19 July

together with 11 other objects.

## ORBITAL PREDICTIONS

Satellite Name	Oscar 7	Oscar 8	Oscar 9	Oscar 10	RS3	RS4	RS5	RS6	RS7	RS8
Catalogue Number	7530	10703	12888	14129	12997	13000	12999	13002	13001	12998
Bulletin Reference	NASA#492	NASA#783	NASA#496	KA90	NASA#72	NASA#131	NASA#103	NASA#60	NASA#116	NASA#236
Epoch Year 83 Day	212.85422125	218.49568460	217.89605163	222.0000	191.32021167	211.69734955	214.31659598	213.21141136	207.40479652	212.27882435
Inclination	101.4063	98.7540	97.5489	26.1660	82.9597	82.9635	82.9597	82.9615	82.9605	82.9600
Right Ascension	210.2418	228.7723	184.2381	247.1180	323.1865	317.5611	317.0707	312.3350	318.5280	319.4171
Eccentricity	.0011974	.0006300	.0004136	.0636909	.0058523	.0017937	.0011375	.0049350	.0021233	.0020364
Argument of Perigee	151.4280	181.2384	118.3726	193.1950	346.4632	18.9526	48.5754	316.6699	347.9504	91.6040
Mean Anomaly	208.7474	178.8697	241.7941	119.1280	13.4858	341.2199	311.6287	43.0494	12.1058	268.7395
Mean Motion	12.53385175	13.96570992	15.22662067	2.05851732	12.15577793	12.06661212	12.05038381	12.13553810	12.08675075	12.02936482
First Derivative	-.00000006	.00000078	.00004163	0	.00000003	.00000004	.00000004	.00000004	.00000003	.00000004
Epoch Revolution	39842	27626	10136	118	6925	7119	7141	7178	7079	7104
Ascending Node Reference Orbits	40007	27731	10229	—	7323	7208	7258	7309	7280	7245
Time UTC	0034.98	0026.27	0010.90	—	0151.46	0157.52	0043.80	0016.24	0101.12	0008.16
Long Deg W	107.73	92.51	132.24	—	42.80	29.35	19.07	17.58	25.78	8.86
Node Date	14 Aug	14 Aug	12 Aug	—	12 Aug	7 Aug	12 Aug	12 Aug	12 Aug	12 Aug

de VK5HI AR

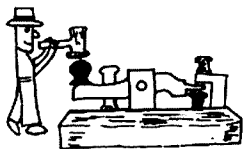

# POUNDRING BRASS

Marshall Emm, VK5FN  
Box 389, Adelaide, SA 5001

## LEARNING THE MORSE CODE

If all goes according to plan, this should appear in Amateur Radio in early October, giving you a month to six weeks to try some of the recommended techniques before the November examination. Surely by this time you have learned the code and it is just a matter of getting your speed up, but even if you haven't you should still have adequate time to prepare for the exam — if you are able and willing to practice. There are no magic recipes which will qualify you as a brass-pounder overnight. There are a number of tips and techniques which can make the job easier, but ultimately it's up to you.

When Mr Samuel Morse invented his code, he had no idea anyone would ever be trying to copy dits and dahs from wireless transmission. In the first place, the code was devised for use on the land-line telegraph. In the second place, the intention was for the signals to be transcribed onto a paper tape by a swinging pen, and then read by sight. Once operators learned the code they quickly found that they could recognize incoming characters by the clicks the pen made, and it wasn't long before they realised that it was actually easier, so the pen gave way to the sounder.

The Morse code consists of patterns of short sounds and long sounds, interspersed with spaces. Forget you ever heard of dots and dashes (at least till you've learned the code) and think of the short sounds as "dits" and the long sound as "dahs". This gives you a useful way to represent the sound of the code any time you want — your own voice.

And here, already, is your first secret technique to help make the job easier — now that you know how to say a Morse code letter by using dits and dahs, forget you ever heard of dits and dahs! What you are really interested in is the sound of a letter.

For example, when you hear the sound "di-di-dit" you should recognise the sound as representing the letter S. You should not count the dits. Take a more difficult one now,

"di-di-dah-dit". Say it over and over to yourself until you recognize the sound of an F without having to think of it in terms of a bunch of dits with a dah toward the end.

The sound of the dits is written without the T (except for the last one) for a very good reason — they have to be said quickly, and you can't manage that if you say "dit-dit-dah-dit". Try it — "dit-dit-dah-dit... di-di-dah-dit."

You should now be ready to learn another secret technique, which is speed. You should learn the characters at a speed high enough that they sound like Morse characters, not individual dits and dahs. While you are learning the code, the character speed should be eight to ten words per minute (*I'm not kidding!*) with extra space in between the characters to slow the message speed down to something you can handle. This is called proportional spacing.

An exercise which I use when introducing someone to the code for the first time is to send the letter S at a speed of fifty words per minute. Just once, all by itself. Most people can recognize it without difficulty. This proves that there is no problem in hearing code characters and remembering them — the problem is in converting them into letters!

You should by now be ready to start learning the code — you've had all the tools you need since the day you were born; it is simply a matter of applying them (or applying yourself) to the task at hand.

Ideally you should listen to pure audio tones, such as those sent over the air or by a good practice oscillator driven by a competent operator. You certainly can learn the code characters by saying them to yourself all day long, without benefit of an instructor or tapes, but there are easier ways.

If you can get someone to send to you, have them send at a character speed of 8-10 WPM, spaced out so they send a character every three or four seconds. This gives you plenty of time to recognise the character, but not enough time to mentally go through the

whole alphabet until you locate it.

You need a programme for learning the characters, so I would suggest the following groups, which give you easy letters mixed with hard ones so you aren't tripped up by Qs, Js, Xs and Zs which you would probably have put off till last.

**AXSET HBDIJ OPQRM ZCGNV UYLKWF  
12345 67890**

Learn each group thoroughly on its own, then add it to the letters already learned, then make up words using the letters learned. Leave the numbers until you have mastered the letters, and you will find them a lot easier.

**DO NOT GO ON TO THE NEXT GROUP UNTIL YOU HAVE MASTERED ALL OF THE LETTERS LEARNED SO FAR.**

You can get a lot of practice in by writing the group you are studying on a bit of paper (writing dits and dahs, of course, not dots and dashes!) and glancing at it while on the bus, or at work, or whenever you have two minutes to yourself.

Once you have learned the first group you can start listening to practice tapes and the Slow Morse Broadcasts (VK2BWI, 0930 UTC, 3.550 MHz and VK5AWI, 1030 UTC, same frequency). Just worry about picking out the letters you recognise, and form a good habit now — if you miss a letter forget it and concentrate on the next one. If you strain too hard to remember a letter, you will miss the next several letters and that's a circumstance which could cost you a pass on the exam.

Once you've learned the code, it's just a matter of getting your speed up to the required level (or the level you desire, which should be higher than the required level). The only way to get your speed up is to practice, whether its listening to tapes or live code on air, having a friend send to you, or calling out license plates from passing cars. But next month we'll give you some more ideas for practice and getting you up as fast as you want to go.

Till then, 73.

AR

# SPOTLIGHT

ON

SWLING

Robin Harwood, VK7RH  
5 Helen Street, Launceston, Tas 7250

Well, October has arrived as 1983 rapidly draws to its conclusion. Hopefully, by now, propagation conditions will have improved a little as the daylight lengthens. I have already noticed a marginal improvement, however, judging from observation made in the Northern Hemisphere by SWL's, signals on frequencies above 17 MHz and higher, have not been as reliable as past years over the Northern summer. The sunspot count is steadily decreasing and the presence of sudden ionospheric disturbances (SIDs) are frequently contributing to a somewhat unsettled HF spectrum.

During our local winter months, propagation of the lower frequency bands has been quite reasonable. However, you will find that the amount of atmospheric static from thunderstorms will render signals in these allocations virtually unintelligible, especially during the hours of darkness. It does not seem quite as noisy, particularly here in Launceston, on observations made just after sunrise, compared to those made in the evenings.

## MERRY-GO-ROUND

While we are on sunspot counts, I noticed that "Shortwave Merry-Go-Round" from Swiss Radio International has re-introduced the monthly sunspot count, after an absence of eighteen months. Observations come from the Royal Belgian Observatory, which happens to be based in Switzerland. The programme is hosted by Bob Thomann and Bob Zanotti and mainly consists of replying to listener's queries about radio and shortwave listening. I do believe that one of the comperes is an active amateur. The best time to hear this in the eastern states is at 0705 hours UTC on either 9.535 or 9.560 MHz on Saturdays. Western Australians will hear it much better at 0905 on either 15.305 or 9.560 MHz. Incidentally, "Shortwave Merry-Go-Round" is only aired on the second and fourth Saturdays of the month.

## IONOSPHERICS

If you want to know how the ionosphere is behaving on a daily basis, I suggest that you use the daily bulletins over the American Standard Frequency Station, WWV at 18 minutes past the hour to keep in touch with the latest state of propagation. The station is located at Fort Collins, Colorado and can be heard on either 2.5, 5, 10, 15 or 20 MHz.

## UPGRADING

At present, the Voice of America — the US government external service — is currently trying to get Congressional approval for funding to upgrade their technical facilities worldwide. Many senders were manufactured

during the Second World War, and maintenance of these is increasingly becoming a big headache, for spare tubes or parts are in short supply, as manufacture of these ceased many years ago.

Although the Reagan Administration is in favour of the funds for the upgrading, the US Congress is trying to trim the size of the American budget deficit. Hence the delay of these funds. In his briefing to a Congressional committee, the Director of the United States Information Agency — the parent organisation of the VOA — pointed out that those nations who jammed VOA and other western broadcasts, expended about three times the total allocation of funds that the "Voice" budgeted for to present programmes, to try and suppress or jam signals from reaching their target audience. This information I heard over "Media Network" — Radio Nederlands weekly communications magazine. I expect that eventually the USA will get their funding.

## INTERNATIONAL SATELLITE TV???

Yet technology may overtake them, for I heard an interview on the BBC World Service, with Peter Frankel, controller of the BBC European Services. In it, he predicted that by the year 2001, Direct Broadcasting Satellites will be in use to send television from one nation to another. This would make international broadcasting obsolete via shortwave radio. Already the Soviet Union is utilising domestic broadcasting of TV via satellite to Siberia, Eastern Europe as well as to Cuba.

The ABC utilises two transponders on the Intelsat at present to send programmes into the outback. As well, in 1985, the Aussat Communications Satellite will carry both ABC and commercial programmes into the interior. I am also informed that recently there was an international conference to allocate what channels would be available for Domestic Satellite Broadcasting in the Americas. So perhaps in the future, we will be watching International Satellite TV in our homes, instead of listening to sound broadcasting on shortwave.

Regular listeners to the BBC Far Eastern Relay in Kranji (Singapore) will have by now noticed an improvement in audio quality on the signal. The secret behind this is that from the 1st August, the studios in Bush House are directly linked by satellite to the Kranji transmitters. This means that they no longer have to re-broadcast audio off shortwave feeders, so the mushiness that was indicative of a shortwave relay is a thing of the past. Other BBC relay bases in Lesotho (near South Africa) and at Ascension Island will also come on stream with the satellites in the

near future instead of relying on a shortwave feeder.

## RTTY

I mentioned in last month's column, I had been trying out a Tono 9000E communications terminal. Well, it has become a permanent fixture in my shack and I am slowly gaining confidence in transmitting RTTY. When not transmitting, I usually use it to monitor many different stations that use this mode. However, I do find that not all stations on RTTY will print out. For example, Soviet stations employ a third shift to accommodate their cyrillic alphabet. They also use non-standard shifts of either 500 or 1000 Hz frequency shifts. The many Japanese marine coast stations employ a six bit code and maritime stations worldwide have a seven bit code instead of the five bit standard employed by commercial stations. This is, presumably, to overcome phase distortion or dropouts on the circuit.

Talking of dropouts, I particularly note that CW signals often will not print up on the VDU. The signal has to be at a consistently high level to provide an accurate readout. Machine sent copy, I find, is more reliable than hand-generated copy. For example "ARE" may either be "AL" or "AAE" or vice versa. This means that the only truly reliable copy is that obtained from aural means to that of a mechanical readout.

My unit has facilities for ASCII, but I have yet to hear any fixed or amateur station employing this mode on RTTY. I mentioned in previous columns of the decision of Radio Nederlands to halt their experiments with computer data transfer via shortwave radio. Because of the high Baud rate required, quite a lot of the copy would be lost. I have noticed this from observing the number of dropouts on RTTY at 74.2 Baud myself. So I do not expect that there will be many transfers over distances with ASCII. I have noticed that more amateurs are using the AMTOR mode. You can hear them on approximately 14.075 ± especially at weekends. From my rudimentary knowledge of it, it is an error correction code. It does not print up as RTTY either. Many marine coast stations employ a variation of this mode called SITOR. What about somebody writing an article on how amateurs can be involved using this for "Amateur Radio"? I am sure that there are many of us who would appreciate keeping up with the State of the Art.

Well, that is all for this month. Until November, the best of 73's and good listening.

Robin, VK7RH

# NATIONAL EMC ADVISORY SERVICE

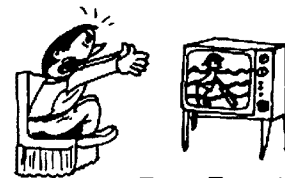

Tony Tregale, VK3QQ  
FEDERAL EMC CO-ORDINATOR  
38 Wattle Drive, Watsonia, Vic 3087

## POWER LINE INTERFERENCE — Incidental radiation, levels and limits

*Electrical Power distribution systems are intended and required to transport electrical energy — Nothing else! . . . Incidental Radiation is Spectrum Pollution.*

In the western world's most industrialised and technically advanced country, the United States, a power distribution system is classified as an Incidental Radiation Device . . . "A device that radiates electromagnetic energy during the course of its operation although the device is not intentionally designed to generate electromagnetic energy. An incidental radiation device shall be operated so that any electromagnetic energy that is emitted does not cause harmful interference. In the event that harmful interference is caused, the operator of the device shall promptly take steps to eliminate the harmful interference. Harmful interference is the emission, radiation and induction which endangers the functioning of a radio-navigation service or of other safety services or seriously degrades, obstructs or repeatedly interrupts a RADIOCOMMUNICATION SERVICE" . . . (FCC R & R part 15).

There is a very large amount of technical material available which covers in great detail, the causes, the effects, the location of, and the proposed cures for Power Line Interference. However, when we get right down to the "nuts and bolts" of the situation, it boils down to, economic excuses and apathy . . . INTERFERENCE FROM POWER DISTRIBUTION SYSTEMS CAN BE ELIMINATED AT THE SOURCE!

Most of the PLI which affects members of the community, members of the Amateur Radio Service, and various professional and business communications services is produced by lines and equipment operating at or below 66 kV. So for the moment we can exclude corona discharge which is, mainly, associated with lines and equipment above 66 kV.

When considering overhead power lines and associated distribution equipment we can, for the ease of understanding, make an analogy with radio transmitting antenna construction and operating procedures. Both overhead power distribution systems and antenna systems use, insulators, wire, and hardware; and both cases involve high voltages. In both systems insulators are intended to insulate, or separate, one potential from another. Wire is there to transport/ interface the energy. Hardware is required for physical support.

In designing and constructing radio communications antenna systems, communications engineers ensure that the

insulators and other antenna equipment will withstand potentials well in excess of those which the transmitter power will produce. Great care is taken to ensure that all connections, joints, and hardware bonding is first class. This is not only necessary to ensure a good "clean" transmission but also to ensure that unwanted noise, which could play havoc with other nearby electronic equipment, is kept to an absolute minimum . . . CAN WE SAY THE SAME ABOUT POWER LINES?

Like insulators in antenna systems, insulators associated with overhead power lines and equipment are intended to separate differing potentials. The potential on either side of insulators should, in the main, remain constant and unaffected by the necessary support hardware. Failure to achieve this encourages any insulator leakage current, or any induced current, to flow in an uneven or intermittent manner. Intermittent current flow generates noise spikes which results in "illegal spark transmission" from "super elevated antenna systems".

In order to ensure a constant potential on either side of an insulator, and a constant and even leakage path, it is simply necessary to ensure that all mechanical couplings used in the support hardware have first class electrical bonding. And, rather like digital circuits, the "cold" end of an insulator should not be allowed to float or find its own potential — the "cold" ends of ALL equipment should have first class bonding to a first class ground.

The electromagnetic spectrum is not getting any bigger! Man's demand for more and more instant communications is placing ever increasing pressure on this limited resource. We cannot afford to waste this special, and most valuable, natural occurrence by using devices which take up more space than necessary; or which generate unnecessary signals or noise within the finite electromagnetic spectrum. Radiocommunications authorities banned spark transmission many years ago . . . why then are power distribution authorities allowed to continue to transmit this outdated mode in an area reserved for radiocommunications.

The Australian Department of Communications states that interference from overhead power distribution systems is common throughout Australia. The Department goes on to outline that most PLI could be eliminated by better engineering design prior to the line

being installed.

Having established where good communications engineering practice would eliminate most PLI — perhaps we should examine, in a little more detail, the problems associated with the poor power line engineering practices for lines and equipment operating at 66 kV and below. Lines and equipment above 66 kV can be a source of interference but because of the better design and heavier construction they are not a major problem.

Interference is most apparent during hot, dry and windy weather conditions. Insulator leakage current which is increased by fine airborne contaminants tries to flow to ground or other phases via the often dirty, loose and unbonded hardware. The spark/s which result, not only produces wide band interference noise signals (unlicensed) within the electromagnetic spectrum but also increases the contaminants around the sparking area, thereby producing an even bigger spark. Many of the old style insulators are hopelessly inadequate. Under certain weather conditions you could light a cigar off the continuous base flash-over.

Slack spans at dead-ends and Tee-offs are one of the most common problems — again, with a full and efficient communications style bonding system these situations would no longer be a major problem.

Wooden poles should not be used as part of the insulator system. Leakage current can cause burning or charring of the wood under the hardware. Good bonding of all "cold" hardware to ground would ensure that the pole does not try to carry leakage currents. Old wooden poles and heavy leakage currents can cause pole fires.

The International Electrotechnical Commission through its Special Committee on Radio Interference lays down general procedures for establishing the limits of the radio noise field from power lines and equipment together with typical values and methods of measurements in the frequency range 0.15 to 300 MHz. Site measurements and service experience have shown that levels of noise from power lines at frequencies above 300 MHz are so low that interference is unlikely to be caused to television reception. The value limits are calculated to provide a reasonable degree of protection to the reception of broadcasting at the edges of the recognised service areas of the appropriate



transmitters in the AM radio frequency bands, in the least favourable conditions likely to be generally encountered. The limits are intended to provide guidance at the planning stage of the line and standards against which the performance of the line may be checked after construction and during its useful life. Recommendations are made on the design, routing, construction and maintenance of lines and equipment to minimise interference. (CISPR 18-1-1982).

In Canada, the Department of Communications has proposed various amendments to the Radio Interference Regulations. Amendments outlined in DGTR-021-82 indicates the seriousness with which Canada regards the whole problem of interference from power distribution systems.

The proposed amendments state that a person who owns, is in possession of or controls a power system shall promptly locate and suppress any machinery, apparatus or equipment which, after investigations by a person appointed by the Minister, is shown to be the cause of radio noise within the power system. The maximum field intensity of radio noise that may be produced by a power

system in fair weather varies from several hundred microvolts per metre in the 160 metre band to tens of microvolts in the 10 metre band for lines up to 220 kV. The measuring distance is 15 metres from the point immediately below the nearest line conductor or 15 metres from the property line of a substation. In the practical aspect Canada is conducting interference measurements in the vertical direction over power lines using EMI measurement instruments in helicopters.

Strong USA representation on the subcommittee preparing the CISPR manual on "Interference from overhead power lines and high voltage equipment" should result in the manual, particularly part 2, being accepted by the United States electric supply utilities AND by the FCC.

In conclusion, perhaps we should consider the early days of radio when the only limitations on its utilisation were imposed by the natural electromagnetic environment and the development of science and technology in the design and construction of radio equipment. A few working devices could be far apart in space and frequency and the

problem of interference and spectrum protection in the contemporary meaning of the word did not exist. With technical progress the situation began to change, but nobody anticipated then, that a state would so quickly develop in which problems of sharing of the limited resources of the electromagnetic spectrum by many users (with the resulting electromagnetic environment pollution and interference problems) would become the key to further development of radiocommunications, and more broadly speaking to the development of any kind of information transmission using electromagnetic phenomena.

The electromagnetic spectrum is an indispensable resource in modern civilisation. Its intensive utilisation is a prerequisite for our existence and development, and a solution for EMC must be vigorously sought after.

The Australian Department of Communications is fighting a battle against incidental radiation from many sources with a shortage of staff, a lack of mandatory standards and regulations, and a lack of government legislation.

AR



# CONTESTS

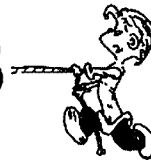

Reg Dwyer, VK1BR  
FEDERAL CONTEST MANAGER  
Box 236, Jamison, ACT 2614

## CONTEST CALENDAR OCTOBER

- 1-2 VK/ZL Phone Contest
- 8-9 GARTG SSTV Test
- 8-9 VK/ZL CW
- 8-9 ARRL CW QSO Party
- 9-10 ARRL Phone QSO Party
- 9 RSGB 21/28 MHz Phone
- 16 RSGB 21/28 MHz CW
- 15-16 Jamboree on the Air
- 22-23 ARC QRP QSO Party
- 22-23 YLRL Anniversary CW Party
- 22-23 CLARA AC/DC Test
- 29-30 CQ WW DX Phone Test

## NOVEMBER

- 5-6 YLRL Anniversary Phone Party
- 12-13 DARC WAE RTTY Contest
- 12 ALARA Contest
- 26-27 CQ WW DX CW Test

A letter received from Anne Hood of the MID LANARK ARS, Scotland brings to our notice, the Special Events Station of GB2MOD to be included in the annual festival of poetry, national songs and the Gaelic language. This festival will be held during the week 8-14 October 1983. Details appear in September AR, page 37.

## COMMENTS ON THE CHAMPION OF CONTESTS

I would appreciate some general comment on the Champion of Contests awards.

The results below are included as some sort of encouragement for those who generally enter contests but not really on a regular basis and to show these entrants that a score can be

attained that is in the winning circle so that future interest can be derived for this award.

The results for the contest have previously been taken section by section.

VK4XA's result would, in that case, be something like forty six points and not the thirty six published.

I must admit that the results taken as the high scorers of each section may better be compiled as the total points scored for the particular contest worked.

The results for VK3BQS were omitted from the list and should have read as follows:  
VK2BQS RD=9, JM=8, VKNOV=7, VK/ZL=14  
TOTAL=38

This score is a reputable one and should not have been omitted from the results. My sincere apologies to Jim.

Please comment on the method of scoring the winners.

1 Does the method of taking each section individually seriously detract from the other contestants?

or

2 Does the current method of scoring correctly ascertain the true winners and consistent high scorers of our contests?

Your opinion please.

## CONTEST CHAMPION 1982/83 CONTEST

Contests chosen for the VK Contest Champion were:

John Moyle, VK/ZL, RD, VK Novice.

The points awarded are as follows:

1st = 10 points

2nd = 9 points

3rd = 8 points

etc thru to 10th position for 1 point.

An entrant must be included in three of the four contests. He/she may not score but must have entered.

To win the entrant must be a member of the WIA.

On the completion of all contests the highest points scorer will the Contest Champion Trophy for one year.

The contests for the 1982 year have been completed and the available results are listed below. The results of the VK/ZL contest are not usually available until the June edition of AR. Therefore the trophy is awarded in the latter part of the year and held for the following year.

## THE RESULTS FOR 1982

CALLSIGN	JM	VK/ZL	RD	VK NOV	TOTAL
5QX	10	16	10	14	50
3WP	10	—	10	18	38
4XA	—	36	10	—	46
3AEW	—	8	—	10	18
7RY	—	9	7	—	16
3ADW	7	—	7	—	14
6RZ	—	9	3	—	12
1LF	—	—	3	4	7
3BRM	—	9	9	—	18

AR

**REMEMBER  
JAMBOREE ON THE  
AIR**

15th and 16th October.  
BE PREPARED!!



# Andrews Communications Systems

## THE NEW ICOM IC-741 ... \$1245

Economical all-band SSB-CW-RTTY-AM. Optional FM \$60. HF 100 W transceiver with general coverage receiver section, 16 Ch memory, scanning, PBT etc.



12 month warranty

Not in stock!

## ICOM IC-750 ... \$1595 INCL FM

Competition grade HF solid-state transceiver w/general coverage Rx and 32 Ch memory. Mode-scan. SSB-CW-AM-FM-RTTY.



12 month warranty

## KENWOOD TS-430S ... \$1249

Solid-state HF transceiver w/general coverage receive and 8 Ch memory. SSB-CW-AM modes. FM \$69. (AM and CW filters \$69 each limited stock)



12 month warranty

## KENWOOD R-2000 ... \$619 or w/VHF fitted ... \$749

HF Communications receiver, covers 2-30 MHz, optional VHF converter 118-174 MHz, 10 Ch memory, digital readout, AC/DC.



12 month warranty

CAD/CAM design

## THE NEW YAESU FT-757 GX ... \$Call

Compare features and performance to any other radio.  
 \* General coverage receive 500 kHz-30 MHz.  
 \* Receiver dynamic range in excess of 100 dB (CW-N, 20 m).  
 \* Dual VFO's, 8 Ch memory with programmable memory scan.  
 \* 100% duty cycle on Tx, at 100 W RF output. Speech processor.  
 \* SSB-CW-AM-FM-modes, AM and CW filters all included.  
 \* IF shift plus IF width filters included. Opt. FC-757AT auto-tuner.

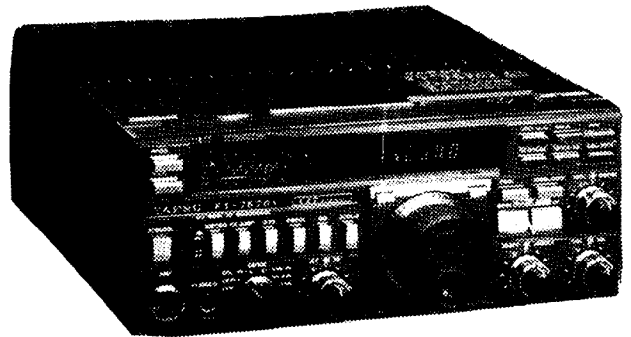

Coming soon. Best price in Australia, of course! Full 12 months warranty. Why should you pay more elsewhere?

## SAIKO SC-7000 INCREDIBLE 70 CH SCANNER COMPARE TO ALL OTHER SCANNERS ... \$449

Scans and searches Australian low band, high band, UHF and aircraft with up and down searching. Fast/slow scanning. Automatic AM/FM sel. Genuine lock out, AM/FM, AC/DC. Direct channel access, priority delay. Message counter, dig clock. Auxiliary output for tape recorder, etc.

**AMAZING 2.5 kHz STEPS ON AUSTRALIAN LOW AND HIGH BAND, NOT 12.5 kHz!  
NEW MODEL WITH EXCELLENT SENSITIVITY ON UHF!**

ICOM IC-R70 comms receiver ..... \$679  
 YAESU FRG-7700 SW comms receiver ..... \$489  
 TOKYO HY-POWER HL-160V .. \$349, HL-82V .. \$219  
 HL-90U ... \$369, HL-45U ... \$219  
 ALINCO ELH-230D ... \$99, ELH-265D 50 W .. \$149  
 KEN ROTATORS, KR-400RC .. \$159, KR-600RC .. \$229  
 KR-2000RC ..... \$439, KR-250 ..... \$79  
 KR-500 ..... \$169, KS-050 ..... \$25

## TELEREADER CWR-685 ... \$1195

Export version Tx and Rx CW-ASCII-Baudot, RTTY speeds selectable, low or hi tones, 5 inch CRT, 6 prog messages, 15 line transmitting buffer memory.

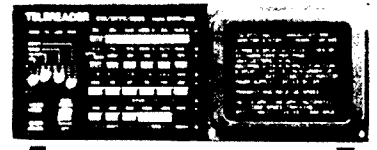

Price inc keyboard

## TELEREADER CWR-670E ... \$465

EXPORT VERSION  
 Receive Morse, Baudot, ASCII, RTTY speed are selectable, CW 3-50 WPM, Printer/RF/Video outputs.

## CD CORONA POWER!

ALL NEW GASFET 70 cm/2 m LINEAR AMPLIFIERS.

\* HP-150V DX 10-150 W 2 m linear w/protection ..... \$379  
 \* HP-80V DX 10-80 W 2 m linear w/metering ..... \$249  
 \* HP-50U DX 10-50 W 70 cm w/coax relays ..... \$279  
 (HP-120U DX due soon \$429) UHF linears use coaxial relays.

AMATEURS EXPERIENCING DIFFICULTY IN OBTAINING KENWOOD, ICOM OR YAESU

**CALL (02) 349 5792 or 344 7880 NOW!**

**SHOP 7, GARDEN ST, MAROUBRA JUNCTION, SYDNEY NSW**

**THE MAIL ORDER SPECIALISTS Write to: PO BOX 33, KENSINGTON, NSW 2033**



**IF YOU HAVEN'T LOOKED AT**

**amateur  
radio  
action**

**LATELY, THIS IS WHAT  
YOU'VE MISSED**

- Up to date News and Views
- Advance News on the Latest Rig
- Complete Awards Information
- The Latest DX News & QSL Routes
- Complete Contest Information
- Lab Tests of the Latest Transceivers
- Spratly Island — In Depth.
- Heard Island — The VKOJS Report.
- Computer RTTY the Easy Way.
- Worldwide HF Beacon & Net Listing.
- A Cheap VFO for the FT-707.
- Amateur Operation in the Pacific.
- Radial & Ground Systems for Vertical Antennas.
- The Facts about Lightning & its Effects.

**PLEASE PUT ME DOWN FOR 13 ISSUES  
OF AMATEUR RADIO ACTION  
STARTING NOW!**

I enclose a cheque for \$18.00

Name.....

Address.....

Postcode.....

Send to: **AMATEUR RADIO ACTION  
SUBSCRIPTIONS, P.O. BOX 628E,  
GPO MELBOURNE, 3001, AUSTRALIA**

# Coaxial Cables and Connectors

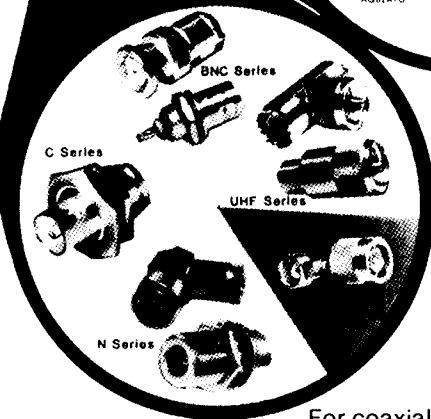
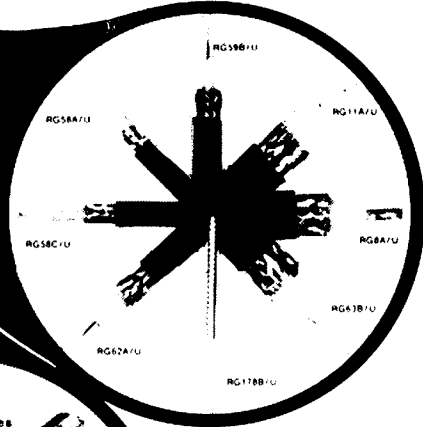

PROUDLY  
AUSTRALIAN 

For coaxial cables and connectors the **only** name to remember is ACME! Whether you need imported Mil-Spec coaxial connectors or cable, ACME will supply. In fact, ACME manufacture, right here in Australia, a wide range of popular connectors. Ask for literature by contacting the ACME office near you.



**ACME ELECTRONICS**

A Division of James Hardie Electrical (Hardie Trading Ltd. Inc. in Vic.)

**VIC.** 2-18 Canterbury Rd, Kilsyth 3137. Tel: 729 6211  
**N.S.W.** 120 Beaconsfield St, Auburn 2144. Tel: 648 2255

**QLD.** 358 2011 (Brisbane) **A.C.T.** 80 4654  
71 4131 (Townsville) **S.A.** 272 8011  
51 4422 (Cairns) **W.A.** 272 7122  
38 5933 (Surfers Par) **TAS.** 34 2811 (Hobart)  
31 5545 (Launceston)

# FORWARD BIAS



John MacPhee, VK1NEN  
36 Kavel Street, Torrens, ACT 2607

## VK1 DIVISION

August was a very busy time in Australia's National Capital. VK1IT, the official callsign for International Technology House, was instigated and numerous amateurs took part in operating the fixed station. The equipment used was supplied by Kenwood and there were plenty of people wanting to get their hands on the latest equipment and experience some of the technological advances made in amateur gear.

IT House was viewed by the general public and it appears as though the venture was a great success. All the amateurs that helped in either manning the station or answering questions from the public, should give themselves a pat on the back for a job well done.

A full story on IT House will appear in November AR.

### AACP CLASSES

By now all those candidates who sat for the August Full Call exam should have their

results and are probably using all the bands previously taboo to them. Congratulations to all the successful candidates. To those who didn't succeed this time, "Better luck next time".

There are a couple of people who deserve a mention for their efforts in helping others pass the exam. Firstly, the instructor, Gilbert Hughes. Gil with his faultless knowledge on the theory of radio and components was right on frequency whenever any problems arose. He soon solved the tricky ones and made the students job a lot easier. Thanks Gil.

Secondly, we had one of the best Morse code tutors, Finn Stevens. Finn gave two sessions of Morse every lecture night without fail for the entire course and was instrumental in giving everyone the confidence needed to sit the exam.

Thanks Finn for a job well done.

Due to postal problems this next article was

too late for the September issue, so we will put it in this one.

### THE DISTRICT RADIO INSPECTOR AND HIS DUTIES

We have in Canberra, very good relations with the DRI. Therefore we invited Mr Alan Jordan, DRI, to attend our August meeting to tell us exactly what the DRI and his office do. Alan was very thorough in his discription of his duties and answered many questions from the curious group. I am sure we all understand what the office does and that if you have any problems you can contact them for advice. Thanks Alan for an interesting talk.

### MEETING AGENDA

24th October — Proposed Topic ATV.

Well that's it for now. Next month IT House.

See you soon!

73 John VK1NEN

PUBLICITY OFFICER AND EDITOR

AR



# VK2 MINI BULLETIN

Jeff Pages, VK2BYY  
VK2 MINI BULLETIN EDITOR  
PO Box 1066, Parramatta, NSW 2150

### COUNCIL REPORT

The August Council meeting was attended by Divisional Historian Jo Harris VK2KAA, who gave a report on her progress so far in assembling a history of the VK2 Division. Information is still required on early Divisional Presidents and Secretaries, and also on original and subsequent holders of two letter callsigns in this state.

Council resolved that Bankcard will be accepted by the NSW Division for books, equipment, new membership, social functions, etc, as well as by the VK2 QSL Bureau, Correspondence course, WICEN and the Education Service. It should be stressed that Bankcard cannot be accepted for membership renewals or other Federal items, and at this stage the VK2 Division is the only one to accept Bankcard.

Beacon Officer John Marshall VK2EGI is investigating the feasibility of establishing a 20 metre beacon as part of the international beacon project. Beacons operate on a time-share basis on 14.100 MHz.

The lease for the downstairs room at Amateur Radio House is currently being prepared for our Honorary Solicitor, and Council resolved that Stephen Pall VK2PS be authorised to make all the necessary arrangements for the leasing.

Council resolved that the 10th Conference of Clubs be a two day conference held at Amateur Radio House, with nearby accommodation being provided for country delegates. The 9th Conference of Clubs, which is being hosted by the Central Coast

Amateur Radio Club, will take place on the 8th November at Gosford, and any WIA member may attend as a spectator.

For a trial period of six months, the Divisional Office will be opened on the first Saturday of the month between 11 am and 2 pm. Members are reminded that the office is open each Wednesday night between 7 pm and 9 pm, as well as each weekday between 11 am and 2 pm.

Applications from the Hornsby and District Amateur Radio Club for a continuous 80 metre Morse transmission, and from the Wedden Mountain Amateur Radio Group for a 2 metre repeater were approved for submission to the Department of Communications. The Wagga Amateur Radio Club's application for an ATV repeater was also approved, and will translate from ATV channel 2 in the 70 cm band onto the 50 cm band.

Council gratefully accepted the donation from Rialto International of a Columbus Gray-Line Radio Globe. This globe will be prominently displayed at Amateur Radio House.

### AFFILIATED CLUBS

#### PARKES AND DISTRICT AMATEUR RADIO CLUB

308 Clarinda St, Parkes, NSW 2870.

Meetings: 2nd Tuesday at the Red Cross rooms.

Committee: President — Harry Tuntler VK2DWT, Secretary — Tom Darcy VK2DDD, Vice-President — D Cooper VK2DHR and

T Reece VK2XAQ, Treasurer — B Cooper VK2DHO, Other Committee — Col Brown VK2EEE, Ron Swindley VK2DDQ, Walt Field VK2NNF, John Meagher VK2AMV.

### TUMUT AND DISTRICT AMATEUR RADIO CLUB

93 Lockhart St, Adelong, NSW 2729.

Meetings: Each Wednesday at 7.30 pm at the Tumut High School.

Nets: Sunday mornings on approx 3.590 MHz from 8.15 to 9 am.

Classes: Slow Morse — Ross VK2PN, Theory — Vince VK2ALZ and Keith VK2DLZ.

President: R K Dodd VK2DLZ.

Secretary: A C Dean VK2POD.

Other Committee: R K Weeden, V Nugent, W Minogue, J Hargreaves, T Reeckmann, R Jones, W Robinson.

Information for inclusion in the December Mini Bulletin should reach the Divisional Officer by the 19th October.

Jeff VK2BYY

AR

### STOLEN EQUIPMENT

An Icom IC4E, UHF hand held unit — serial number 1810340 — was stolen from the Eastern Communication Centre's stand during the WCY Expo '83 at Nunawading Civic Centre on Saturday 3rd September.

Anyone with any information about this unit is requested to contact their nearest Police Station or Keith Haslam VK3ACE.



# VK3 WIA NOTES

Jim Linton, VK3PC  
DIVISIONAL PRESIDENT AND  
PUBLIC RELATIONS OFFICER  
412 Brunswick Street, Fitzroy, Vic 3065

## TELEVISION RADIO AND NEWSPAPERS

The month of September has seen our hobby getting publicity unprecedented in many years.

Your president and Kim Wilson VK3CYL had the 'honour' of being interviewed on ATV10's "Good Morning Melbourne" programme.

The main reason for the interview was to publicise the Eastern and Mountain Districts Radio Club's Communications Expo '83 and to generally explain what amateur radio is all about.

Time has not permitted the writing of an article about the TV appearance, but it's hoped something will be published next month.

WCY Activity Week sparked off public events around amateur radio in various parts of the state and some of these too have had media publicity.

Congratulations to the club and zone officials who got right behind the WCY theme and strived for a greater public awareness of our hobby.

A most welcome and valuable form of two-way communication which is to the benefit of the entire membership.

The council minutes are also posted for reading on the noticeboard at the Divisional Headquarters.

## A LOOK AT WICEN IN VICTORIA

A submission running about forty pages long has been made by this Division to the Victorian Government Bushfire Review Committee.

One matter in the wake of Ash Wednesday that the committee is examining concerns communications — and of course this was a golden opportunity to put a comprehensive case for WICEN.

Authors of the submission were the Immediate Past President Alan Noble VK3BBM and WICEN Co-ordinator Peter Mitchell VK3ANX.

With limited time available these two dedicated people worked extremely hard — the result is a dynamic document.

Alan and Peter are WICEN Ash Wednesday veterans which enabled them to draw heavily

guidelines have to be met.

They can only be used with permission of either the president, vice-president or secretary, and details of their use have to be included in council minutes.

The callsigns will help readily identify WICEN in Victoria on the air, and when used for the first time ever on a temporary basis during Ash Wednesday improved net control considerably.

## HISTORY MATTERS — CAN YOU HELP?

The Divisional Council recently decided to "actively pursue historical matter and artifacts" and we are very fortunate to have John Adcock VK3ACA as Historical Officer.

He's a Life Member and former long-time member of council having only retired last term.

Our division, formed in 1911, has an interesting and colourful history that needs to be preserved for future generations.

If you are in possession of historical matter, let John know about it, or donate it to the Institute.

Your president is collecting photographs of all past presidents for an eventual display of portraits at the Divisional Headquarters.

I would like any leads on the 1911-13 president M A K Ryan and S F V Cole 1913-15.

Anyone who has a photograph of a past president, including past presidents themselves, please offer it for copying and possible use in the president's display.

## BUILDING OPTIONS REVIEW COMMITTEE

The Victorian Division's AGM asked that the Divisional Council examine options open to it regarding members' funds and the Divisional Headquarters at Brunswick Street, Fitzroy.

A sub-committee has been formed and aims to complete its work within the term of the current council.

Before any decisions are taken a recommendation would be put to the next AGM so that members will have the ultimate decision. If you feel the Divisional Headquarters should be relocated and have some ideas or perhaps know of an ideal new home for the WIA, write to the Divisional Secretary.

## VICTORIA TO CELEBRATE AR'S 50TH ANNIVERSARY

Unless this is the first page of the magazine you're reading, the fact that AR magazine is fifty years old this month would not have escaped your attention.

This magazine was born in the Victorian Division and it's fitting that a mini-reunion of those involved with it over the years be held this month.

The October general meeting of the Institute will see this division conferring Life Membership on AR's first editor, Harry Kinnear.

Some invitations have been extended to



L to R: Roy Hampson, co-compere of "Good Morning Melbourne", Jim VK3PC and Kim VK3CYL.

## BE MORE INFORMED, SUBSCRIBE TO COUNCIL MINUTES

The Divisional Council recently decided to make available to individual members upon request the minutes of its monthly meetings.

These minutes are ideal for those who want to learn more about what council is doing for the members.

Any member wanting a copy only has to pay for the postage — inquiries should be directed to the Divisional Secretary.

The minutes are routinely sent to each zone for information and in turn the zone committees are now forwarding their minutes to council.

on the experience of last February — and put together a highly professional submission.

They made it clear to divisional council recently that should the submission be "picked-up" by authorities there will be a lot of on-going work needed.

The submission is recommended reading for those keenly interested in the future of WICEN.

Council has obtained permission on a permanent basis for the use of the callsign block VK3WIB-WIZ for WICEN exercises, disaster and emergency situations.

DOC has given council control over the issuing and use of the callsigns and certain

Photograph by Ken Mct. achian

those involved with the magazine, but an open invitation is extended to anyone who would like to attend this historic meeting.

### GET THE CALLBOOK THROUGH YOUR DIVISION

The 1983/84 Australian Radio Amateur Callbook (see review elsewhere in this month's AR) is available through your division at a discount members' price.

Council has decided to make the callbook members' price this year \$5 or \$5.50 posted within Victoria.

This is a sizeable discount from the recommended retail price of \$5.75 — but councillors considered the sale through the division of the callbook was a service to members.

Your division has many other books on sale at discount prices, if you're looking for a publication why not make inquiries at the Divisional Headquarters, the likelihood is that it's being sold by the WIA cheaper than regular retail outlets.

### NOVICE THEORY WEEKEND AND CLASSES NEXT MONTH

A special Novice theory revision weekend is being held on the weekend of 5 and 6 November at the Wireless Institute Centre.

The weekend is ideal for those who consider themselves already well prepared for the DOC exam next month.

Bookings for the weekend are required. The fee is \$25 with ample handout material supplied and a trial exam held under exam conditions.

The next weekly Novice theory and Morse code classes start on Tuesday, 15 November.

These will run for six months — how about you Associate members — make the move to get on air under your own call by joining the Institute's highly successful classes.

For those already with their callsign, keep these classes in mind should you know someone interested in getting into amateur radio.

### SUNDAY BROADCAST REVIEW

Chairman of the Broadcast Committee, David Johnson VK3YWZ is looking at all aspects of the weekly Sunday broadcast.

He says there are some long-term and short-term changes planned for the broadcast, including the provision of news, its presentation, and the broadcast format.

The addition of a "DX News" segment has proved very popular and David is examining the present content of the broadcast to see if there's further room for improvement.

He says a major task will be updating the facilities of VK3BWI — including control equipment, recorders, and transmitters.

The Zones are being asked to comment on the propagation of the broadcast to their parts of the state to see if the frequencies and modes used presently are adequate.

The Divisional Council recognises that AR magazine and the broadcast are major sources of news for Institute members — and it intends to see that members are kept informed on its activities.

David Johnson, wearing his other hat of Council News-Co-ordinator, is also kept busy presenting regular reports on what the Council is doing to administer the Institute's affairs and protect the interests of members.

### AWARDS — ONE BRAND NEW AND ONE NOT SO NEW

The Keith Roget National Parks Award has been revived and updated to reflect the growth in numbers of National Parks in Victoria.

To qualify for the award you need to work into and/or out of sixteen of the national parks — there's no time limit imposed.

If you previously qualified for the award a number of years ago, simply gain the necessary additional parks to make up sixteen.

Why not plan an activation of your nearest national park to help others qualify for the award — please publicise your intentions through the weekly VK3BWI broadcast.

Further details on the award can be obtained from the National Parks Award Manager, Gray Taylor VK3JQ QTHR.

While on the subject of awards, elsewhere in this magazine you'll see details of Bendigo's first ever award — called the Premier Town Award.

Midland Zone Committee members have put a lot of work into getting this award going, help them make it a huge success — particularly you who live in the prescribed Bendigo district.

### DISPOSALS EQUIPMENT POLICY

Last year the division re-introduced a disposals equipment service and this has proved very successful.

The results to date are a credit to the disposals officer, Fred McConnell VK3BOU and those who have helped him collect, check and sell the various pieces of equipment.

One of the major items has been the model 100 Siemens teleprinters. The general practice has been to check these machines before selling them as "tested" and converted to the amateur speed of 45.45 Baud.

The teleprinters have proved very popular with metropolitan members, and any country member or zone committee wanting a good Siemens machine should contact the Wireless Institute Centre while stocks last.

Council has now adopted a policy to cover its disposals service which includes a limited form of guarantee on equipment sold as "modified and tested" or as "tested" — but found not to be working within one week of purchase.

This equipment can be returned to the rooms for checking, and if found faulty due to reasons other than mistreatment will be replaced or a refund given.

Any member interested can get a copy of the disposals equipment policy at the Wireless Institute Centre.

### SOME SERVICES PROVIDED THROUGH VK3 DIVISION

- \* Free world-wide QSL bureau service.
- \* Monthly journal "AR" magazine.
- \* Disposals equipment suitable for hobby use.
- \* Melbourne office open five days a week manned by volunteers to handle book and disposals sales and membership inquiries.
- \* Library of reference books, magazines and publications.
- \* Photocopying facilities for published articles and circuit diagrams.
- \* Appropriate media cover for amateur radio.
- \* Weekly Sunday morning news broadcast of

items interesting to amateurs and SWL's.

- \* Advice on radio mast approval procedures.
- \* AMSAT — communications satellites.
- \* Assistance in dealing with interference problems.
- \* Monthly WIA Melbourne meeting and regular zone meetings.
- \* Theory, Morse, revision, practical and special technique classes.
- \* Trial Novice and AOC exam papers.
- \* Awards, contests and trophies.
- \* Intruder Watch Service protecting the amateur bands.
- \* Most repeaters have their licence, insurance, power, and site costs paid by the WIA.
- \* Co-ordination and fostering of emergency communication activity during natural disasters.
- \* Assistance to members in legal problems arising out of the pursuit of their hobby.
- \* Representation for radio amateurs at a local, national and international level.

AR

## Crystals for Amateur and General Communication Frequencies

Prompt Delivery  
Guaranteed  
Prices On Application

## Quartz Crystal Laboratories

79 Deakin Street,  
East Bengleigh,  
Vic 3165

Phone (03) 570 2354

### SPECIAL NOTE

Unfortunately this special statement was omitted from the article "Practical Digital Control Unit for the ICOM 720A" page 14, September issue.

\* NB: Use of this capability must obviously be restricted to holders of licences appropriate to the frequencies chosen.  
Tech Ed.

AR



# VK4 WIA NOTES

Bud Pounsett, VK4QY  
Box 638, GPO, Brisbane, Qld 4001

## HELP HANDICAPPED ENTER LIFE PROJECT

A new radio club has been formed following the death of Toowoomba amateur, Anthony Burge, VK4BAC, who was a victim of muscular dystrophy. Tony was a very enthusiastic amateur and tried very hard to overcome his terrible handicap but his triumph over the disease was unfortunately short lived.

Now the Burge family have donated Tony's equipment to HHELP with the express wish of promoting the hobby of amateur radio among disabled persons. As a result, a club has been formed to be known as the VK4 Disabled Person's Radio Club with the callsign VK4BTB.

By the time these notes appear, dedication of the equipment and the official opening of VK4BTB will have taken place on Saturday, 27th of August at Toowoomba on the Darling Downs.

The Queensland Division of the Institute wish this new club every success and you may like to make a special effort to contact VK4BTB whenever you hear this station on the air.

## SUNSHINE STATE JACK FILES MEMORIAL CONTEST, 1983

From the VK4 Contest Manager, Joe Ackermann, VK4AIX, here are the results of this year's contest. Included in the sixty two

stations who participated, were nine VK2, seven VK3, one ZL and twenty eight novice callsigns. Some stations claimed points for contacts on the 30 metre band but these were disallowed.

### DIVISION 1

#### Section (a) Tx all bands

VK4AJL 927 Points  
VK4ABY 508 Points

#### Section (b) Tx HF only

VK4YX 712 Points  
VK4VHU 544 Points  
VK4NAS 346 Points  
VK4KAG 241 Points  
VK4AOE/IP 226 Points  
VK4XZ 166 Points

#### Section (c) VHF, UHF only

VK4XZ 36 Points

#### Section (d) Tx all bands — Club Stations

VK4WIR 763 Points

### DIVISION 2

#### Section (a) Tx all bands

VK2BQS 339 Points

VK4ANU, check log only.

## QUEENSLAND RAILWAYS INSTITUTE AMATEUR RADIO CLUB

This club now has its own station with the callsign, VK4BQR. Should you be an old railway man or even just interested in railways,

you might like to talk "railways" on the QRI Club net each Wednesday evening at 0900 UTC on 3.580 MHz or thereabouts.

## VK4 DIVISIONAL BROADCAST

If you are a Queenslander living in exile in some other (lesser?) state, you may like to keep up with happenings at home. Like all the other divisions, we have a Sunday morning broadcast which goes on the air at 2300 UTC (0900 EAST). This broadcast is heard on a number of frequencies in the HF bands: 3.580, 7.120, 14.342, 21.175 and 28.400 MHz. So that distant stations may find the best frequency, we transmit a tuning signal from 2255 UTC on each frequency. This is a voice announcement giving the callsign, VK4WIA and the list of frequencies.

You may not be interested in Queensland affairs but because the Federal news is always up at the beginning, you may like to have the opportunity of listening to that before you go off somewhere for the rest of the day.

We are pretty pleased with the way our news is presented and we do have a lot of listeners, judging by the number of stations calling back on the various frequencies at the end of the broadcast. The average is a total of about 100 stations each Sunday. Give us a call, the operators will be delighted to hear from you.

Bud VK4QY  
AR



# FIVE-EIGHTH WAVE

Jennifer Warrington VK5ANW  
59 Albert Street, Clarence Gardens, SA 5039

Firstly, an apology from me. Due to a change in deadline dates, which I failed to note when they were published in AR, my copy for August failed to arrive in time, hence, no column in the August issue and news that was not exactly "hot off the press" in September.

## MORE QSL CARDS?

Having spent the best part of a day writing out the QSL cards for contacts made at the GPO — all 300 odd, along with Secretary, Dave Clegg VK5AMK, one would have thought that that was enough for one year. But no, such is our dedication (or perhaps we're all masochists!) that when we were asked if we would like to have a stand at the Electronics Exhibition being held at Morphettville Racecourse from the 4th-6th November — we said, yes please! As it will be a weekend this time, there should be no shortage of volunteers, and as the main sponsor is the 'News' we might get some free publicity.

## CONVENTION

At the time of writing, we are pleased to be getting a steady flow of replies and bookings

for our Convention in April. Once we have some idea of the number of VK8 and country members who will be attending, we will have more idea of the number of places available for interested city members, other than club representatives.

## DIVISIONAL PICNIC

The Divisional Picnic, will be held at Bridgewater Oval on Sunday, 20th November. Make a note in your diary or calendar now, and make it a fun day for the whole family. For any new members who may not have been before, all you take is the family and your own lunches (if there is a fire ban that day, it will be a cold lunch instead of a barbecue). The WIA provides ice-creams and soft drinks, prizes for the numerous races and contests, and lollies for the children. Last year the ATV group members made several video tapes, so we were able to laugh at ourselves long after the event!

## SPECIAL NOTE

Please note that although there are five Tuesdays in November, there will NOT be a Buy and Sell meeting on the fifth Tuesday. This is because the Christmas meeting will be

held on the 6th December and that would have meant three Tuesdays in a row. Last year we felt that this accounted for the drop in numbers at the Christmas meeting. This year we have a very special guest speaker. Wally Watkins VK2DEW is returning to Adelaide for the first time in many years, and has timed his visit to coincide with our Christmas meeting. He will be telling us about his recent trip to China, complete with videos. Knowing Wally, I feel fairly certain that this will be a most entertaining evening.

AR

## GRATEFUL THANKS BUT MORE HELP NEEDED!!

Alan Shaws Smith, VK4SS wishes to thank all those who have responded to his request for historical information. So far, over fifty letters have been received. This is most gratifying and he would be happy to receive another fifty. Photographs of amateurs, old or recent, and events are badly needed.

AR

**RR  
???**

**RR IS HERE**

RR being a Radio Rally to be held at the Parkerville Childrens Home, Parkerville on Sunday the 20th November.

The Parkerville Childrens Home is no longer used as a home and has been booked specifically for the Rally. It has extensive grounds, bush walks, play facilities, BBQ area and unrestricted parking available, a large hall with 240V power and toilets.

Parkerville is an hours drive from Perth along the Great Eastern Highway and is convenient for metropolitan members and country members within a wide radius. There are shopping facilities for BBQ packs etc and a tavern is nearby.

The Rally will run from 10 AM to 4 PM with activities throughout the day. Overnight accommodation is available in rooms at the home and bookings must be made ASAP. Camping is permitted and it is intended that the Saturday evening foxhunt will terminate at Parkerville thus allowing a BBQ and overnight happening.

Talk-in stations will be manned from the site on VHF and HF — listen to the news for details.

The Rally is intended to be a family event and YL's and harmonics are particularly welcomed. We are trying to arrange visits by Mr Whippy and refreshment vans and the local store will be notified. Other possibilities being checked are pony rides, foxhunts, etc.

It is intended that the news broadcast will be made from the Rally and stations will be manned throughout the day. Other events will include a swap meet which will commence at 10.30 AM and all visitors are welcome to bring their junk etc for sale or swap.

The main hall will be used for the rally stations and displays including items from the Wireless Hill Museum. Normal WIA facilities will be available including membership queries and booksales.

Commercial houses have been invited and the feedback to date is that there will be a large display of retailers covering the field from radio to computers.

This is your Rally sponsored by your Institute and is a first in recent times. Depending on the support received is the future of further rallies which are planned to take place further afield. Therefore mark the date in your diary, brief your family and participate in the biggest rally held in WA. Country members are particularly welcomed and basic family accommodation can be arranged at the site.

AR

# WANTED TO BUY

*Ham gear, CB equipment, Hi Fi, video, car stereo, large or small quantities.*

**WE BUY AND SELL  
ANYTHING ELECTRONIC  
ANY QUANTITY  
ANY CONDITION**

## HAMRAD

104 Hightett Street,  
Richmond, Victoria.  
Phone: (03) 428 8136

# ELECTRONIC HOBBYIST!

DO YOU LIVE IN . . .  
Ringwood, Lilydale,  
Boronia, Wantirna,  
Bayswater,  
Mooroolbark etc? . . .

We carry a comprehensive range of electronic components at very keen prices.

## Ian J. TRUSCOTT ELECTRONICS

CNR EASTFIELD  
& BAYSWATER ROADS,  
SOUTH CROYDON,  
VIC.  
TELEPHONE  
(03) 723 3860

# RTTY/CW

**Advanced split-screen ASCII, BAUDOT, CW software for Commodore computers . . . \$59**

VIC 20 computer — 5K RAM, 8 colours, hi-res 176\*200 pixel graphics, 4 voice sound generator . . .

**\$295**

Commodore 64 computer — 64K RAM, 16 colours, hi-res 320\*200 pixel graphics, sprites, sound synthesizer . . .

**NOW  
\$299**

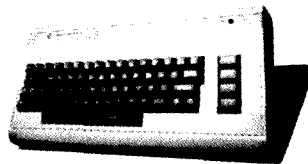

**Both computers feature 20K BASIC & operating system, RS 232, parallel user port — disc drives, printers, joysticks, paddles, light pens, games, utilities etc available.**

**Versions also available for PET/CBM 3000, 4000 and 8000 series (includes SSTV send) — POA.**

## HIGH TECHNOLOGY COMPUTER SYSTEMS PTY LTD

**87 Swan Street, Richmond, Vic 3121 ph (03)  
429 1966 ask for Mike VK3BHM or Joel VK3ZKE**



**AMATEURS:  
CAN YOU MEET  
THE CHALLENGE!**

**'HOME BREW' -  
the very latest  
technology...  
build yourself a  
UHF Transceiver**

**Exclusive to  
Dick Smith  
Electronics**



Unit shown is fitted with optional upgrade kit

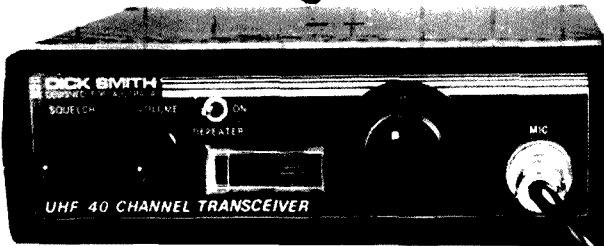

Remember the 'good old days' of amateur radio? When an amateur built his own gear - and was so proud of it! Sadly, those days passed! With incredible advances in technology, it became economically and technically impossible to compete with commercially built equipment. Now home brewing is here again!

And what's more, with the all-new Dick Smith UHF Explorer, you'll end up with a transceiver less than the cost of a commercial unit - and not just as good, it's **better!**

YES! A completely up-to-the-minute design featuring phase-locked-loop frequency synthesis.

It's ready to go simplex as soon as you've finished it - or with the addition of our low-cost upgrade kit, you're able to use repeaters too! Designed in Australia - for Australian conditions, using readily available components - so you'll never have any worries about spares!

And just in case you have any problems building it, we'll even help you out with our 'Sorry Dick, it doesn't work' repair service.

You can't lose!

**SPECIAL INTRODUCTORY OFFER**

For radio clubs, etc - order five or more sets and get a \$30 discount on each! That's right - until October 31 five or more sets will cost just \$169.00 (you can pass the saving on to your members or keep it for the club coffers - a great way to raise money for your club!)

*SPECIAL OFFER MUST END OCTOBER 31 - if stock runs out all orders received before that date will qualify.*

**SPECIFICATIONS**

Frequency Coverage	438.025-439.000MHz in 25kHz steps
No. of Channels	40
Mode of Operation	FM
Supply	13.8v DC. Receiver 340mA with full audio output and all options. Transmitter 2A more (5 watt output)
<b>Receiver</b>	Dual Conversion Superhet
Sensitivity	0.4uV for 20dB quieting
Selectivity	+/-7.5kHz - 6dB +/-15kHz - 60dB Better than 80dB
Adj. Chan. Reject	
<b>Transmitter</b>	
Power Output	5W (typical)
Deviation	+/-5kHz
Spurious Emissions	Better than -60dB

**GREAT  
VALUE!**

**DICK SMITH EXPLORER  
UHF TRANSCEIVER**

Cat K-6300 **\$169\***  
from only

\*for five or more until October 31

Single price \$199

**OPTIONS AVAILABLE:**

**Upgrade Kit (Cat K-6302)**  
(Repeater kit, S meter & kit, additional xtal filter & new front panel) ..... **ONLY \$24.50**

**Antenna Kit (Cat D-4014)**  
1/4 wave stainless steel whip, co-axial fed UHF antenna base, PL-259 plug, 3.5m low loss UHF co-ax. gutter grip mount and cutting instructions ..... **ONLY \$24.50**

**DICK SMITH Electronics**

There's a store near you. (Stocks may be limited in some stores).





# LETTERS TO THE EDITOR

Any opinion expressed under this heading is the individual opinion of the writer and does not necessarily coincide with that of the publisher.



## CENTENARY COMMUNICATIONS HOOK UP

The official Western Australian Boys' Brigade call sign is VK6ABB (Australian Boys' Brigade).

We would like to invite all members to join with us in the communications hook-up, both local, inter-state and international.

Information for the long weekend camp, 1, 2 and 3 October, is as follows:-

There will be approximately 350 boys attending (No 1 Group 8-12 years) and (No 2 Group 14-18 years) at the Sorrento Youth Camp located on the coast 20 kilometres north of Perth.

The main BB Amateur Radio Station will be set up at the camp for early morning and late afternoon transmissions. There will also be a mobile station operating from the Hale School Sports Grounds located 11 kilometres down the coast from Sorrento. This station will be available for the boys to visit as we link up with other local and Eastern States companies, hoping for DX as well.

Yours sincerely

**MALCOLM K JOHNSON VK6NMJ,**  
Communications Officer,  
The Boys' Brigade,  
Box K 842,  
Perth. 6001. **AR**

I consider this quite wrong, as it requires additional wrist pressure and movement which could likely result in ultimate failure of ability to send properly later on. It was quite contrary to what I was taught.

I soon found trouble when it came to receiving, as I could not write fast enough. This seemed a common stumbling block in the classes because we did not normally write much faster than 12 WPM (when we were able to sort out the characters at that speed). Don't panic if you find the sending on air is too fast for you. Ask the other chap to slow down a bit. Remember, your licence does not require you to read at 25 WPM. You will acquire this sort of competence with continued practice.

In view of my lifetime association with telegraphy and the fact that, for something like sixteen years, I provided a slow Morse session, on a "once a week" basis, from the various points where I was stationed, I feel that I am well able to comment on this aspect of our hobby.

I hope this might help somebody who is wondering why he is not making as much headway as he first expected. Don't get upset about it and remember that all the operators had to go through the stage where you are finding difficulty.

If I can be of any help, I will be only too pleased to do so.

Tom Laldlor, VK5TL  
18 Albion Avenue, Gfandore 5037 **AR**

## SEANET CONVENTION TRAVEL GROUP

A group tour is being organised to Singapore for Australian Amateurs to attend the SEANet Convention to be held from the 18th to 20th November at the Hotel Equatorial. The tour package will include air fares, the convention programme, additional tours, sightseeing, and shopping. The tour will only get off the ground if sufficient interest is shown by enough VKs, so come and join the group and save money. For further details contact John, VK3IH QTHR. Tel (03) 531 8601 or 583 8355.

Yours faithfully  
John Sweeney, VK3IH, VS6GG, HS1AML  
99 Warrigal Road, Mentone, Vic **AR**

## JAMBOREE ON THE MOUNTAIN

The 1983 Jamboree of the Air is almost with us again and preparations have begun for a repeat of last years very successful camp with the Hellyer Venturer Scouts of Burnie, Tasmania. For the group of 20 venturers, jamboree camp in a scout hut on the side of Cradle Mountain in the Tasmanian highlands at an elevation of about 4500 feet will be one of the coldest and most unusually located of any Australian station.

The station was operated last year for the first time after deciding that a more unique and challenging location was required than the usual centrally heated school or home.

The station location required a forty minute walk from the car park up the mountain in darkness on the Friday night preceding the jamboree. Weather conditions are known to change rapidly in the highland region and the party last year was met with snow and wind on the trek.

Saturday morning saw a group of scouts returning to the car park in four inches of snow to carry two heavy duty batteries and a hundred pound gas bottle amongst other requirements up the mountain. It was during this time that the

station was assembled and antennas erected and checked.

The station consisted of a Yaesu FT 707 system running into a two element beam on 15 m and dipoles on both 40 and 80 metres. A Yaesu FT 290R and ¼th whip was used on 2 metres and provided our chief link with local stations through repeater 8 at Launceston.

For the following 24 hour period the worth of the exercise was well proven and contacts were made with such stations as WB7VIW maritime mobile on the Pacific Princess, well known on TV as the "Love Boat". K6AV maritime mobile on the Oriana and VK9ZA on Willis Island etc.

Jamboree 1983 will undoubtedly present its own special challenges, a large venturer group will be in attendance, the antenna system shall be upgraded concentrating on the 20 m band, special QSL cards have been printed and last years operator call has been replaced with a personalised scout call VK7SCM (Scouts Cradle Mountain).

The station will again be manned for the 24 hour period using the 2, 15, 20, 40 and 80 metre bands: so if you hear VK7SCM operating please give a call and join in the Jamboree experience.

G Greene, VK7GG  
58 Bird Street, Burnie 7320 **AR**

## REFERENCE DIRECTORY

In the August copy of AR, Letter to the Editor section "Help Needed", John Brennan VK4SZ suggested a reference directory of amateur radio equipment. For some time now I've been contemplating that idea — to put together such a reference directory. The idea seemed sound to me to do just that, but would it appeal to others. John's letter is enough for me to consider it may be feasible.

Through any response by other readers I may gauge the interest to continue onwards in a more positive and serious manner. Any criticism, personal views, creative ideas etc would be most welcomed at my address. Any takers? Initial ideas of my own are:-

- 1 Loose leaf style A4 pages as it would allow for updates easily
- 2 Divide into sections eg receivers, transmitters, transceivers, test equipment etc
- 3 List each equipment with reasonably detailed specifications
- 4 Include items of ancillary equipment eg VFOs, monitor scopes, filters, aerial tuners
- 5 Detailed index or cross index

It should be stressed that these are my ideas only and its really up to you, the reader, to put your thoughts down and advise me. In fact the whole idea of a directory may be pointless. What say ye?

Yours sincerely  
Jeff Archie, VK3VPU  
PO Box 19, Colac, Vic 3250

*A directory of this type would be a sound idea if enough were interested. What do others think of John and Jeff's idea — Ed.*

## WHO AM I??

I wish to draw attention to a situation which is slightly embarrassing to me and possibly one hundred or so other women.

I am the mother of a lad, VK2EFM, and he is fifteen years old. "So what?" you are thinking. Now let me ask a question. *What does that make me?* Apart

## MAKING CW EASIER

About sixty five years ago, I began a long time job — in all nearly fifty one years — with the old PMG Department.

Among other things, I got an early introduction into telegraphy; being taught in a Departmental class by experienced operators of the "old school" and some very competent men they were.

It is worth noting that there are still a few PMG trained operators still in amateur circulation.

At the outset, we were instructed to be seated comfortably, so that the sending hand and arm were neither too low nor too high.

The bar of the key, the hand, wrist and forearm were to be in a straight line and all action was wrist action. The fingers were more of a spring, not the actual sending action.

Adjustment of the key was to be such that the gap between the front contacts was not large (mine, at the present time is one and a half thousandths of an inch measured with a feeler gauge) and the spring had just enough tension to lift the bar when pressure was released.

At least two fingers had to be on top of the knob and the thumb at the side.

Accuracy was considered the essential, because the speed increase would come with practice; bearing in mind that we would be handling traffic paid for by the senders.

We qualified at a first test of twenty words per minute.

Another "aid" point was, if you normally wrote in a large hand and could not keep up then write a little smaller. This was a factor to us who had to stop writing to dip our steel pens into the inkwell. All these little bits counted as it was a long time before "biros" were invented.

This is being written because, while listening on air a few nights ago I heard advice being given to "have a good gap on your key contacts and heavy spring tension".

from being his long-suffering mother, I'm not his XYL, or YL.

I'm in constant demand in the shack, responding to calls of "Hey Mum, this guy is a ——— (callsign), can you find out what country that is, quick! It's in the book." or "Where's his QTH on the map?" or "What's this letter on the QSL card?"

The only problem I couldn't solve was the Arabic or Russian letter on the QSL card. That makes me a fairly accomplished SOMETHING, but I'm not sure what it is.

At fifteen years, VK2EFM doesn't have a driver's licence, so it is often my task to take him to field days, etc, and I enjoy doing it. But it is very embarrassing when I enter the competitions that are provided for the family accompanying the amateur. If I should win one, what title (not XYL, became I'm not his wife) should I claim.

As you might guess, I'm very proud of my young OM and I wish to acquire a title that indicates that I am his OLD LADY. Please regard this as a serious letter. I don't know what I am (amateur wise). The number of mothers in my position is increasing. Seriously, what about OL?

Yours sincerely  
**[Mrs] Gloria Savins**  
21 Yarravel Street  
Kempsey, NSW 2440

AR

### RFI, DOC, EMC. A HAPPY ENDING!

Here is a little feedback about the outcome of a situation which may not be uncommon.

Since I dismantled a trapped vertical antenna last November and erected a tri-band yagi, the DOC has received from several of my neighbours complaints about radio frequency interference. The Department responded by sending officers to check my station and to investigate the complaints with the neighbours. The problems have been solved, the situation is stable and the yagi is just fine.

The purpose of my note is to tell, firstly, how helpful, courteous and effective the officers from the DOC were, on their several visits, both with me and with the neighbours. If my experience is typical, and I have no reason to believe that it is not, then members of the Amateur Radio Service should have no fears in regard to interference investigations by officers of the Department. Secondly, I want to say 'Thanks' to the EMC Advisory Service, for a prompt response to my call, with useful advice and printed material.

A happy ending? I hope so — but what was that I heard about video recorders?

Yours faithfully  
**Fred Naylor, VK3AQN**  
5 Maculosa Court  
Endeavour Hills, Vic 3802

AR

### WHO IS THE REAL VK2EP?

Although a newcomer to Amateur Radio, I first sent "CW" more than fifty five years ago.

I spent live and a half years during World War Two as a Wireless Telegraphist, RAAF. In 1978 I obtained my Novice studying at the WIA in Melbourne. It was very difficult for me but I made it with the help of good instructors.

In 1980 I made the full call with much more "sweat and tears".

Now, to my horror, I am receiving stacks of QSL cards from all over Europe including the usual requests from USSR listeners for QSL cards. Giving times, dates, etc of SSB! Contacts with most of Europe the signal strength is nearly always RST 5 x 9 + 20 dB.

I note that the VK2EP never has a name or QTH. I know immediately he is a "pirate" as I work "CW" only.

I also have worked the world but only with "CW", QRP with a G5RV antenna. I make an appeal to anyone hearing VK2EP on phone to try to find his QTH, name etc.

He certainly has better equipment than I have. Any assistance in locating this person would be appreciated.

73 de  
**Harry Alderson, VK2EP**  
PO Box 1084,  
Caff's Harbour,  
NSW 2450.

AR

### NOVICE OPERATORS

I have discussed the proposition with many on-air acquaintances that Novice operators who have passed Morse code at AOC level should be granted the privilege of working on that portion of the 7 MHz band which is allocated to American Novices. Such operation could be restricted to CW only and should give a boost to those Novices who are well ahead in handling this mode.

I submit there are quite valid grounds for such a development.

- 1 The 7 MHz band has been extended.
- 2 Many Novice operators are VERY competent CW operators.
- 3 There is quite a clear distinction between communicators and technicians.
- 4 Australian Novices would be in a better position to make overseas contacts with American Novices if their allocations overlapped.
- 5 A 7 MHz allocation to Novices would stimulate interest in Morse code as a favoured transmitting mode.
- 6 There would be no need to issue new callsigns. The addition of an oblique stroke and the letter "C" should be adequate.
- 7 Novices have proved to be a very worthwhile addition to the Amateur Service. The Novice movement has shown responsibility and has established itself in a very favourable light. It is REASONABLE to expect concessions for our responsible Novice colleagues.

Yours faithfully  
**Rex Black, VK2YA**

562 Koorlingal Road, Wagga Wagga, 2650

Editors Note: This letter has been shortened.

AR

### BAOGES

Surprise! surprise! has it happened? The diamond logo has been deleted from the editorial and front pages of Amateur Radio.

Is it too much to hope for, will it be deleted from all WIA publications and material in the future? It should never have been adopted at all.

Look at the pot-pourri of badges advertised on page 38, is this what we have come to? Then on page 42 we have the Western District Award of the Victorian Division, featuring the diamond badge.

This division also features a different form of our original badge, much neater in appearance, but not correct. Of the two I prefer the Victorian version because of the neater and clearer outline.

This badge is featured in an article in Amateur Radio Action, Vol 6, Issue 3, page 16. Alongside the New Zealand diamond. I have warned about this in my past correspondence, clean up the mess, we need only one badge of standard design — the old design.

Yours sincerely  
**Leslie Arnold, VK7AM**  
114 Frederick Street, Launceston, 7250

AR

### WORLD COMMUNICATIONS YEAR

At their August meeting, about fifty members of the Probus Club of Ku-ring-gai at Pymble heard brief addresses by Norman VK2DKH and Frank VK2KGI about the purpose of WCY and the activities of amateur radio. Amateur radio communications were demonstrated with HF and VHF equipment

from these two stations using HF antennas hung on bamboo rods and convenient trees.

Yours sincerely,

**Frank Aston, VK2KGI**  
3 Churchill Avenue,  
Wahroonga, 2076.

AR

## A NEW GAME, "WHAT'S MY CALLSIGN?"

When Scott Cundiff, N5ASD arrived in Australia recently on holiday one of the first orders of business was to visit the Townsville branch of the Australian Department of Communications to secure a "VK" amateur call. Minutes after walking into the proper office and \$18 poorer he emerged as VK4BSD and was soon enjoying operation "down under" on the bands.

However, trouble was on the horizon. As Scott was working on two metres in Brisbane a unique contact took place. It began like this: "VK4BSD this is VK4BSD, that's my call, mate!" Somehow this did not seem like the ideal situation so a phone call was made to the Brisbane office of the Department of Communication. They promised to check into the problem and call back.

While awaiting the return call Scott began to tune around the ten metre band and almost immediately heard a friend in San Antonio, Texas calling "CQ". To keep things from getting any more confused (at least that was the thought of the moment) Scott used the call of John White, VK4AAJ who was in the room at the time. The fellow in San Antonio carefully recognised the call of VK4AAJ, realised that it was in reality N5ASD, who was actually at that moment sharing the call VK4BSD. However, during the QSO the phone rang. It was the good people at the Department of Communication with another callsign! So during that QSO VK4AAJ who was actually N5ASD who also had the call VK4BSD finished up as VK4ASY. All in one conversation . . . and everything was legal folks!

Contributed by John White, VK4AAJ

AR

## SEPTEMBER'S BEST PHOTOGRAPHS

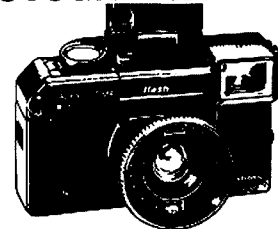

The judges at Quadricolor Industries and Waverley Offset Printing selected the view from 9N1MM's QTH, page 36 and the judges at AGFA-GEVAERT selected the cubs on page 25.

These photographs will now be considered for the AGFA camera prize at the end of the competition in June 1984.

# IONOSPHERIC PREDICTIONS

Len Poynter VK3BYE

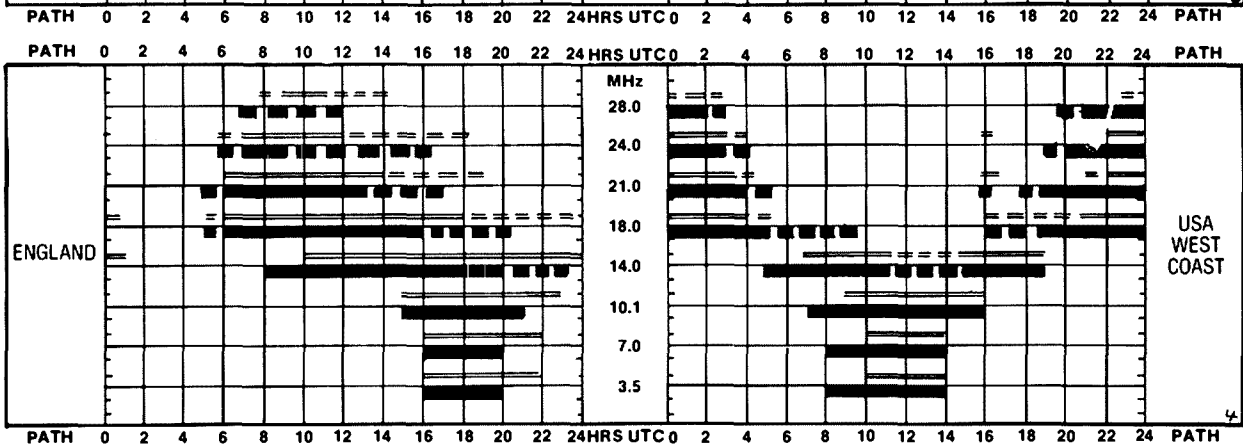
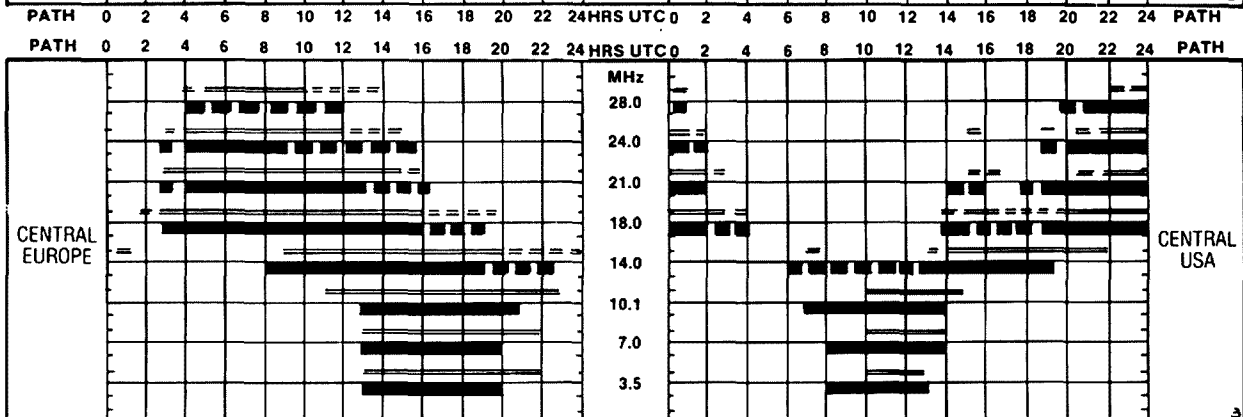
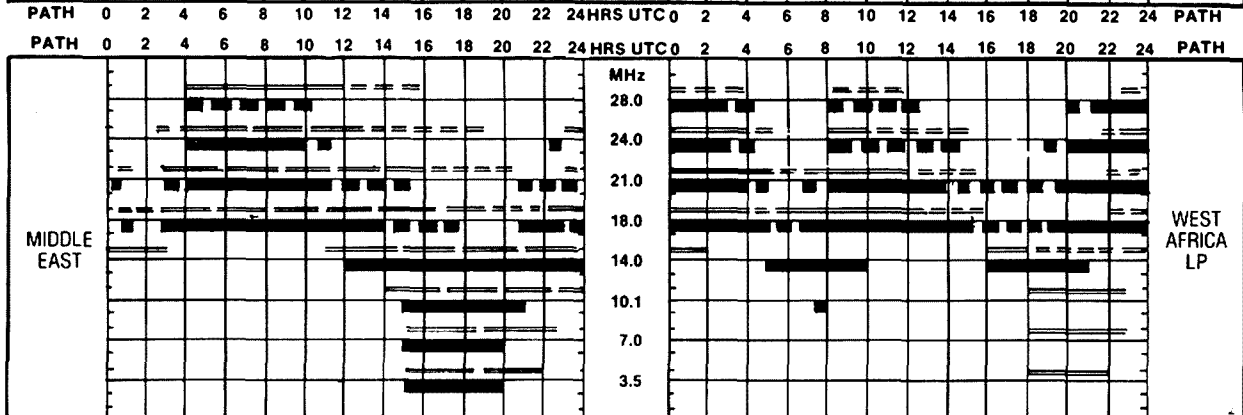
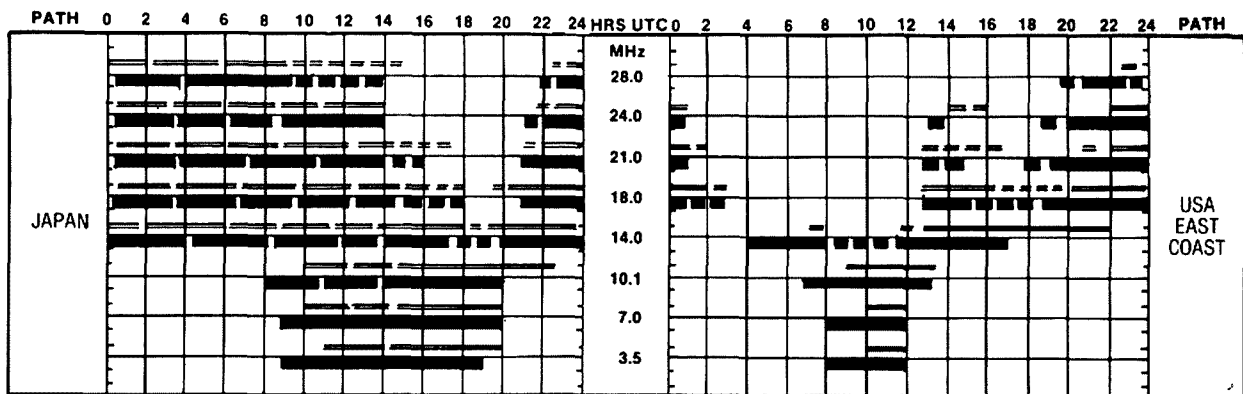

## LEGEND

==== From West Australia

———— From East Australia



Better than 50% of the month, but not every day

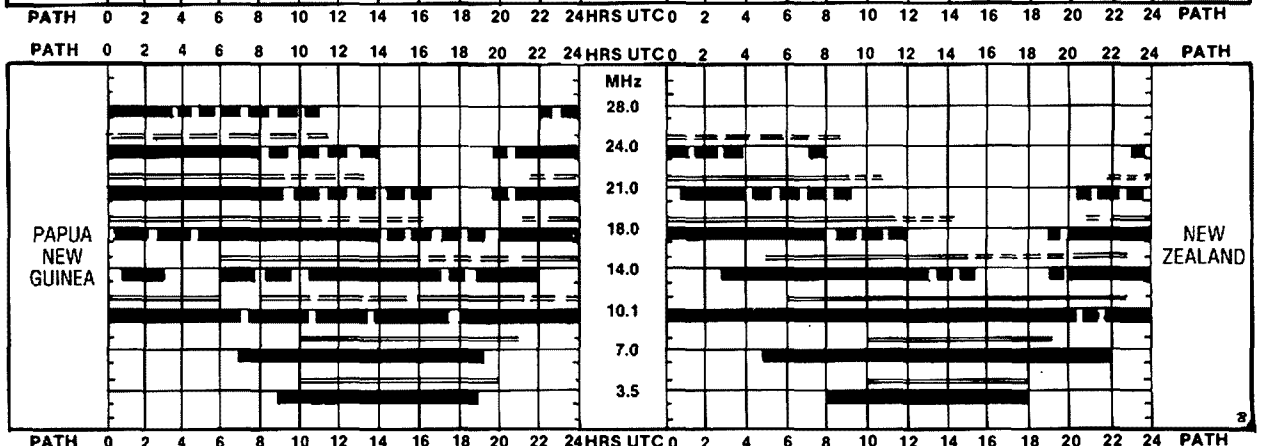
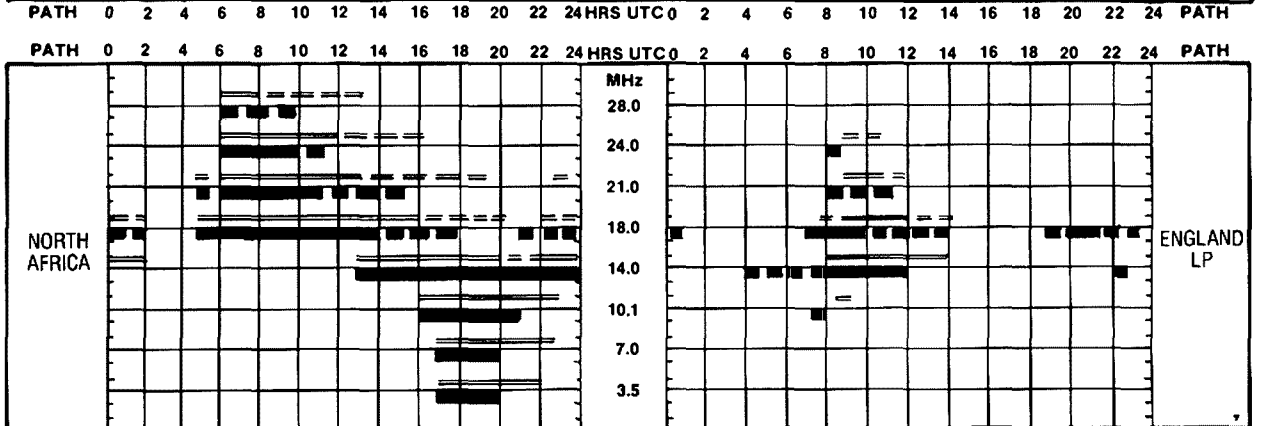
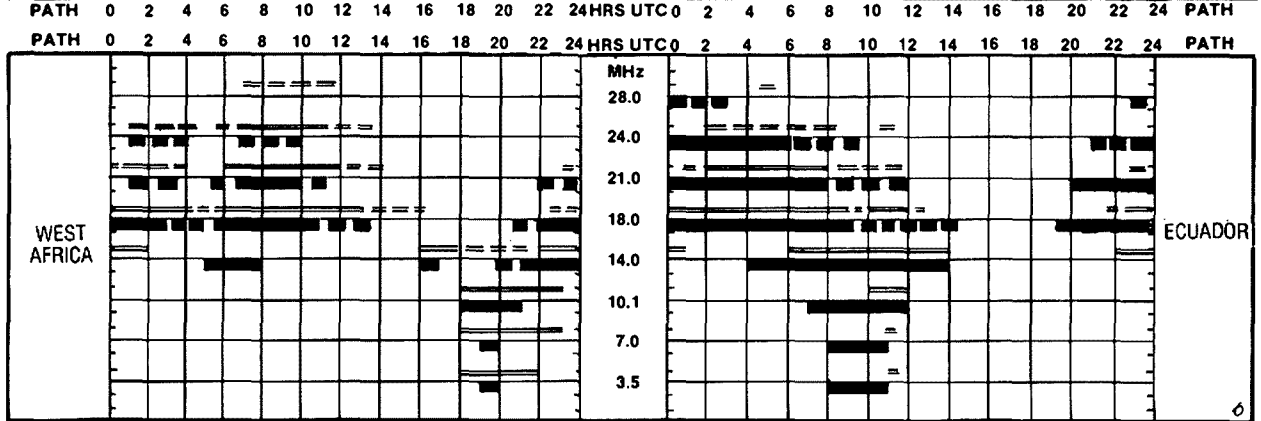
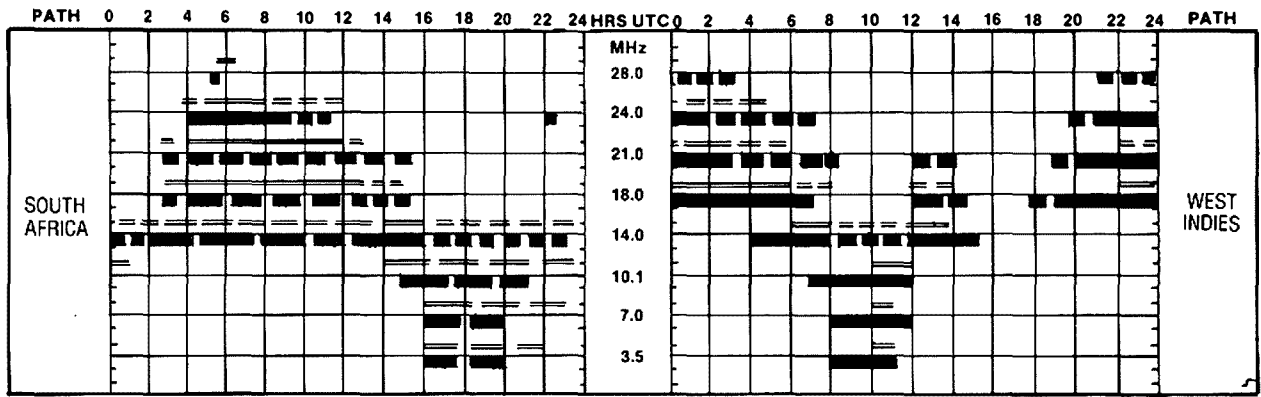

Predictions courtesy Department of Science and Environment IPS Sydney. All times in UTC.



Less than 50% of the month

PATHS — Unless otherwise indicated (ie LP = Long Path) all paths are Short Path.

# Obituaries

## VIC BROWN VK4BJ

Vic Brown VK4BJ became a silent key, on the 27th July 1983 at the age of 76 years. He obtained his ticket during 1927, and up to a few years ago, he remained active.

I first met Vic, in 1928, at ARAMAC in Central Queensland, where he was employed as a wardman at the local hospital.

Sometime in 1929, he gave that job away, and with his brother, started a bakery business. At that time, Don Bradman was in his hey-day, and Vic, being a very enthusiastic radio amateur, and also owning a "warm" bakehouse, was very popular with the local cricket fans, during the test series.

He was a very cheerful chap, and was always there with a helping hand when needed. He pioneered 6 metres in Bundaberg during the late '40s.

To his wife Ethel, two sons, his sister Gladys and all his many friends, we offer our sympathies and condolences. Vic will truly be remembered.

Claud Singleton, VK4UX  
AR

## ANDREW HAROLD GRAY VK2APV

The sudden death of Harold Gray on 14th June came as a great shock to his many and close friends. Harold would be best known as Senior Instructor, Marconi School of Wireless from 1949 to his retirement in 1968.

In his early life he was a cabinet maker by trade, but was attracted to "Radio" and the Marconi School, and on qualifying joined the AWA Marine Service in the early 1920's. During the depression years he saw service in New Guinea, subsequently joining the Marconi School in 1938.

For many years his QTH was Strathfield, operating purely on CW. In latter years he moved to Umina (Gosford District) and continued his DX contacts.

Harold is survived by his wife, Marjorie, to whom we offer our sincere condolences.

Cecil Bardwell, VK2IR  
AR

## WILLIAM SHANNON OTTY VK2ZL

It was with great sorrow that we learned on Monday evening, 8th August, 1983 of the death earlier that day of our old and respected friend, Bill VK2ZL.

Bill had been in indifferent health for some time and had been in and out of hospital but it didn't seem to most of us that long since we had heard his cheery booming voice on the air. It was quite a while of course as Bill had been in the "Riverview" nursing home in Cooranbong and we only managed to see him from time to time. For those of us who remember happier days, it came as a sadness to pass the brick house on the corner of Otty's Lane at night and see no light in the shack, for Bill was a very active amateur and experimenter and he loved his shack, and his trains and his billiards table.

Old timers got to know Bill well in the late 50s when he really became interested in amateur radio again after a lapse of many years during which time he was fully engaged with his brother Norman in running the family business making, among other things the "WILNOR" brand radio receivers. In his early days, business came first and his only opportunity to get on the air came when he broadcast on the 240 metre band every Sunday morning to, who can tell how many, listeners in the Newcastle area. His session, "The Wonderful World of Wireless" nearly always featured a favourite 78 record, "The Electric Girl" and old timers, amateurs and just ordinary listeners looked forward to tuning round on Sundays to hear this and the other selections that he

# Silent Keys

*It is with deep regret we record the passing of —*

MR H A BEHENNA  
MR G A WOOD

VK5BB  
VK7GW

played. It was from this beginning and his displays of some of the "wonders" of wireless from his home at Killingworth that an attraction to visit this master of the new art was roused in many a young lad around the coalfields. They walked or rode their bicycles tens of miles to see and learn about the new mysteries. And Bill showed them all he knew which in those days was everything that was to be known about the hobby and skill of radio. It was at this time that the real old timers, the original two letter calls took his example and got the licence themselves. Bill had been licensed in England as OOX before his arrival in Australia in 1912 and his call sign 2ZL was issued to him shortly after he and his family settled at Killingworth. As the years went on he opened a shop in Wallsend and the name Otty became a family word for the miners and other residents of the coalfields and lakeside.

There are two things that Bill never changed — his call sign, which he held for 71 continuous years and his Geordie accent. Those of us who remember this fine old gentleman personally recall his kind and generous nature, his north country wit and determination and his frequent call, "Why don't ya get on th' air". There are so many things that could be said but most will just have to be remembered.

He had a quiet funeral attended by his immediate family and many of his amateur friends who formed a guard of honour outside the Uniting Church in Toronto on 10th August. So rests a great man, this contemporary of Marconi, who taught a good many of us all we wanted to know about our great hobby.

VALE BILL, VK2ZL, aged 90 years.  
AR

## JOHN FERGUSON PICKLES VK4FP

The many friends of John will be saddened to learn of his sudden passing on Saturday the 9th of July.

John was born in New Zealand and after spending five years in the United States completing his Chiropractic degree, came to Brisbane in the early 30s. He enlisted in the RAAF at the outbreak of World War 2 and spent five years in the radio section. On demobilisation, he started a very successful Chiropractic practice in Brisbane. He obtained his amateur call in the late 40s and was very active in WIA affairs being the Honorary Secretary and also President in the early 50s. He was one of the group instrumental in the birth of the Queensland Divisional monthly newsletter, QTC, cutting the stencils and printing it in the big shack at the Clayfield QTH, which was the meeting place of many convivial gatherings over the years.

Contestants in the monthly Friday night 2 metre transmitter hunts would usually find his low flying Jaguar at the site when they got there with John smoking his pipe waiting for them.

He became interested in SSB very early on, building his own equipment before commercial supplies became available — lawn bowls and go-cart racing were other interests and here again he gave time to help on committees.

His loss will be mourned by many, and to his XYL Belt we offer our sincerest sympathy.

Jack, VK4JO  
AR

# For QSL Cards

Phone  
**(03) 527 7711**

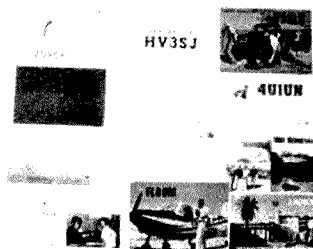

## Williams Printing Service Pty Ltd

12 William Street,  
BALACLAVA 3183

CONTACT US FOR QUOTES

## A Call to all holders of a

# 'NOVICE LICENCE

Now you have joined the ranks of Amateur Radio, why not extend your activities?

### THE WIRELESS INSTITUTE OF AUSTRALIA (N.S.W. DIVISION)

conducts a Bridging Correspondence Course for the AACP and LAACP Examinations.

Throughout the Course, your papers are checked and commented upon to lead you to a **SUCCESSFUL CONCLUSION.**

For further details write to:  
**THE COURSE SUPERVISOR,  
W.I.A.**

P.O. BOX 1066,  
PARRAMATTA, NSW 2150

## C. M. CRYSTALS PTY LTD



Manufacturers of high quality crystals for the Communications Industry.

Compare our prices and delivery with other Australian manufacturers.

27 HAWTHORY ROAD, KILSYTH  
VICTORIA 3137  
PHONE: (03) 725 5415

## ATN ANTENNAS

A Victorian Approved Decentralised Secondary Industry

Registered Office:

56 CAMPBELL STREET,  
BIRCHIP, Vic 3483

Address all correspondence to:

PO BOX 80,  
BIRCHIP, Vic 3483

Phone: (054) 92 2224  
Telex: AA55480 OCOBIR

Contact ATN Antennas, a company with a proven track record for over 35 years, for the most comprehensive range in Radio Astronomy Education and Research Facilities and VHF, HF & UHF Antennas.

Write to us or your local dealer for a free catalogue on our complete range.



## DEADLINE

All copy for December AA must REACH PO Box 300, Caulfield South, 3162 no later than 25th October. Also please note the early deadline for January 1984 is the 18th November.

## HAMADS

**PLEASE NOTE:** If you are advertising items FOR SALE and WANTED please write on separate sheets, including ALL details, eg Name, Address, on both. Please write copy for your Hamad as clearly as possible, preferably typed.

- \* Please insert STD code with phone numbers when you advertise.
- Eight lines free to all WIA members. \$9 per 10 words minimum for non-members.
- Copy in typescript please or in block letters double spaced to PO Box 300, Caulfield South 3162.
- Repeats may be charged at full rates.
- QTHR means address is correct as set out in the WIA current Call Book.

Ordinary Hamads submitted from members who are deemed to be in the general electronics retail and wholesale distributive trades should be certified as referring only to private articles not being resold for merchandising purposes.

## TRADE HAMADS

Conditions for commercial advertising are as follows: The rate is \$15 for four lines, plus \$2 per line (or part thereof) minimum charge \$15 pre-payable. Copy is required by the deadline as stated below indexes on page 1.

**AMIDON FERROMAGNETIC CORES:** Large range for all receiver and transmitter applications. For data and price list send 105 x 220 SASE TO: RJ & US IMPORTS, Box 157, Mortdale, NSW 2223. (No enquiries at office: 11 Macken Street, Oakley, 2223). PLEASE NOTE: Business closed during October.

**CB RADIOS \$69:** Walkie talkies, short wave radios, military, outback, business, amateur, marine, repairs. RTTY Siemens 100 A printer \$120; base mic \$45; ultrasonic alarm \$35; all ham bands on a single 6 ft whip, 1.8 to 30 MHz, for base or mobile \$300; aerials, installation, demonstrations, 40 Ch CB conversions, accessories, new rigs weekly. BRIDGE DISPOSALS, 12 Old Town Plaza, opp Bankstown Railway Station, NSW. Mail order service and all enquiries to 2 Griffith Avenue, Roseville, 2069, or phone Sam VK2BVS, 7 pm to 9 pm only on (02) 407 1066.

**NOVELTY WALL PLAQUE/ASH TRAY.** Special design for Australian radio amateurs individually personalised with your callsign (refer AR Showcase, May 1982). Fully glazed with high quality deep golden brown finish, also available with gold etching. An ideal gift to an amateur friend or just something different for the shack or lounge room. Enquiries to PAM SAXON, VK3NSB, 77 Edithvale Road, Edithvale, Vic 3196. Phone: (03) 772 1975. (Wholly made in Australia).

**QSL CARDS** — Printed to your own individual requirements. Single or double sided on a wide variety of plain or gloss coloured card. For quotations, contact John VK3ZIK. Ph: (03) 337 7518 AH.

**SYNCHRONOUS PACKET RADIO** the software approach volume I by Robert Richardson. 220 Pages. \$28.00 + P&P \$3.00. Northern Digital, PO Box 333, Charlestown 2290. Ph: (049) 43 8981.

## FREE — VIC

**AVAILABLE TO GENUINE COLLECTOR:** WWII vintage RAAF radio Tx, type AT-21 comp with power supply and cables. If no takers it will be stripped for parts. VK3XU QTHR. Ph: (03) 725 0824.

## WANTED — NSW

**ATU** — AT200 or AT180. Pay \$150 plus post. Also DG-5 \$130 plus post. Harry VK2EP QTHR. Ph: (066) 54 1536. Reverse charge.

**C11/R210** txcvr system. Preferably complete but incomplete considered. John VK2ZJF. Ph: (02) 969 4539.

**CIRCUIT DIAGRAMS** for the following rigs. Spartan Courier SSB, Midland International Model 13-882C. Will pay for copies. Bob VK2VMX QTHR. Ph: (063) 51 4217.

**TRANSMIT & RECEIVE CAVITIES** (or diplexer) to suit 430 MHz repeater. Please write to Taree Amateur Radio Club, Box 712, Taree, 2430.

## WANTED — VIC

**ARMY RADIO EQUIPMENT TO RESTORE.** WWII wireless van, No 11, 19, 22 type 3 MkII or similar. Also ATUs, genemotors control gear, amps, whips. Genuine project to restore Chev "blitz" SWB wireless van to tully operative condition. VK3/4CDX, 8 Bristow Drive, Forest Hill, 3131. Ph: (03) 877 1135.

**CIRCUIT & any info on Philips TA-101** signal generator. Ken VK3ZFI QTHR or Ph: (03) 580 5347.

**CIRCUIT &/or operating handbook for Marina** model 150 marine AM txcvr manuf Ferris Industries. Will pay for photocopying and postal charges. Ken VK3KGX, Box 98A, Melbourne. Ph: (03) 527 9029.

## WANTED — QLD

**FLYING DOCTOR PEDAL RADIO** equipment. Any condition for restoration. Would appreciate any information at all that could head me in the right direction to locate equipment. VK3/4CDX, 8 Bristow Drive, Forest Hill, 3131. Ph: (03) 877 1135.

**KENWOOD VFO 520:** external VFO DG5 digi freq disp. SP520 ext speaker to complete 520 station. John VK4NIE QTHR. Ph: Muttaborra 10 or 17 AH.

**LINEAR AMP.** Heathkit HA-14 or similar. Prefer without power supply. Any condition or linear using 811As. Also need 8874 or 8873. W Ryan, 6 Olive Court, Nambour, 4560.

## WANTED — WA

**YAESU FT7 HF mobile txcvr or similar mobile unit.** Bill VK6LT QTHR or Ph: (09) 457 1080.

**Buying or selling Gear  
Use HAMADS first**

**FOR SALE — ACT**

**COLLINS 75S-3C** rx \$950. 30L-1 linear \$950 or offers. These classics have no traffic lights — they just work. George VK1GB. Ph: (062) 54 1985 or 47 3296.

**WIRELESS SET** No 19 MkII txcvr, C/W supply unit, 2-8 MHz plus UHF, \$10 ONO. Crammond "CTR 12" marine txcvr, 4.095 + 4.620 MHz xtals fitted. Inc BC band rx, circuit/diag supplied, \$10 ONO. 10/100 kHz xtal marker generator incl mains power supply and circuit diag, \$10 ONO. VK1ZMJ. Ph: (062) 86 4707 AH.

**XITEX SCT-100 RTTY COMPUTER** plus keyboard and st-6 demod. 45/75 Baud 110/300 ASCII — power supplies built in — manual — \$300 ONO. Theo VK1KV QTHR. Ph: (062) 71 6266 BH or (062) 88 1767 AH.

**FOR SALE — NSW**

**ATLAS 215X** complete with whips 80, 40 & 20, 2 cradles, 2 aerial matching transformers & car cables in exc order plus 12 V 40 W AC power supply. \$400 ONO. CT70 port freq counter to 550 MHz. 5" x 5" x 1 1/2" power 4 "AA" nicads plus AC trickle charger. Near new. Cost \$199 sell \$140. Auto keyer (Dick Smith) exc order + or — keying \$45. University VAC voltmeter. Old but OK \$20. Bruce VK2BEB QTHR. Ph: (044) 72 4285.

**BEAM** for 6 m 5 el. Brand new in box \$75 ONO. Ph: (02) 569 5639.

**FT208R YAESU** 2 m. FM hand held txcvr in orig box with h'book & circuit. LCD display, 10 mems. Scanning 5 or 10 kHz. Keyboard entry, from 143.500 to 148.495 MHz. 2.5 W \$295. Bob VK2JZ QTHR. Ph: (02) 44 7701.

**ICOM IC-701 HF** txcvr with power supply and desk mic. 10-160 m, dual digi VFO, speech processor. Ex cond \$550 ONO. Mike VK2BMR QTHR. Ph: (02) 639 8643.

**KENWOOD TRANSVERTER** for 6 m. Model TV-506, 50-54 MHz. VG cond. All leads and plugs with English manual. Suit TS-520, TS-820 or TS-830S with mod manual supplied \$160. VK2AKU QTHR. Ph: (067) 92 1606.

**KENWOOD TS-120V** with workshop manual. Tokyo Hi-lab ant tuner, MC-50 mic. All for \$500. VK2AZT. Ph: (069) 42 1392. Offers considered.

**KENWOOD TS-520**. AC or DC operation. Orig condition. H'book. No mods. CW filter \$410. ICOM IC-502A 52 MHz txcvr. As new h'book. \$120. VK2HZ QTHR. Ph: (047) 51 1724.

**KENWOOD TS-900 HF** txcvr. C/W h'book, mic exc cond. Oskerblock SWR200 SWR meter. Rgr \$300. SWR \$45. John VK2ANX QTHR. Ph: (02) 638 4191.

**MAST**. Triangular crank-up 17 m with all guys in good cond. Buyer to take away \$300. VK2BKW QTHR or Ph: 636 5101.

**PHILIPS FM-321** 70 cm txcvr, 40ch FM. Good rig, no bugs, mic, manual, small vert ant \$220. Max VK2GE. Ph: (043) 92 4900.

**FOR SALE — VIC**

**AZDEN PCS 3000**. 142-150 MHz, 5/25 W, band and mem scan, auto offset or simplex, remote control mic etc. 2 x 5 el yagis & 21 m RG8 coax inc \$285. Andy VK3UJ QTHR. Ph: (03) 874 5632.

**BEAMS** — all W Wulff 6 el 6 m yagi, still in packing, 2 x 9 el 2 m yagis, 10/15 m duobander yagi, 3 el 20 monoband yagi. All as new. URGENT SALE. Steve VK3QDL. Ph: (050) 37 2391.

**CHIRNSIDE CE 5 SS** multiband vert ant, as new \$55. VK3KK QTHR. Ph: (03) 652 8089 BH or (03) 469 4200 AH.

**ICOM IC-22A** 2 m 1/10 W FM txcvr. Xtals for 7 repeaters and 3 simplex chans. Complete with mic, h'book, mobil mount. As new \$150. VK3RN QTHR. Ph: (03) 25 5315.

**ICOM IC-22S** 2 m FM txcvr. VGC. Together with Scalar maganabase and tuned 3/4hs whip, 2.5 m coax (3/8") \$230. Also an 8 el yagi and KLM 13 dB array. Owner intends to QSY HF. Arrays \$30 each ONO. Can deliver to Melb. Arthur VK3BJR QTHR. Ph: (054) 43 4544.

**ICOM IC-22S** 2 m txcvr with 25 kC spacing switching box, h'book and orig carton. EC \$200. Paul VK3AJJ. Ph: (03) 481 8587.

**ICOM PS-20** switch mode power supply 20 A peak, \$180. Daiwa CNW-218 ATU, cross needle operation, rated at 200 W PEP \$160. Both as new. Ph: (03) 723 3717 AH.

**KENWOOD TS-520S**, one owner. Ex cond. H'book. AC/DC operation. Little use, orig packing. On air test. \$480 ONO. Ross VK3SR.

**KENWOOD TS-520S** txcvr with CW filter and spare valves \$530. Incl with txcvr, 10 m delta loop in need of repair. Also FTC-707 ATU \$130. Ken George VK3DKG QTHR. Ph: (03) 878 7574.

**KENWOOD TS-700A** 2 m txcvr 144-148 MHz all modes, mic, h'book. AC PSU built in, also runs off 12 V DC. Ex cond \$350 ONO. Trevor VK3KEG QTHR. Ph: (03) 789 4911 AH.

**MORSE TAPES** at 2, 3, 4, 5, 7, 8, 9, 10 WPM inc Dick Smith "word method" set, aviation rating course, OOC exams at 5 & 10 WPM plus practice sending, 20 tapes in all \$40. Ken VK3KGX. Box 98A, Melbourne. Ph: (03) 527 9029.

**PRINTER** — Dot matrix printer Dick Smith GP80 suit system 80, TRS 80 etc. As new \$260 ONO. VK3BZC QTHR. Ph: (052) 63 1981.

**TOWER 30-35** feet. C/up \$150. VS41/80 KR trap ver 180-10 m \$50. Plus several long lengths coax, offers. Bruce Kendall VK3WLV. Ph: (03) 542 4346 BH or (03) 741 2382.

**YAESU LINEAR AMP FL-2000B** \$325. ICOM IC-701 txcvr with IC-RM3 computerised remote controller. IC-701PS power supply and IC-SM2 desk mic \$750. Computer boards \$100 Bus Cromenco 8K EPROM board with inbuilt 2708. Programmer new \$125. Applied technology DG-640 VDU board \$90. VK3ARY. Ph: (03) 277 4798.

**YAESU FT-101** early model. GC. Some spares, leads, h'book, few minor mods all documented \$350. VK3KBY QTHR or Ph: (03) 347 3619.

**YAESU FT-707** with scan mic and match FP-707 20A power supply. All cables, book and workshop manual. Sell together only \$650. Geoff VK3DGV QTHR. Ph: (03) 560 3773.

**FOR SALE — QLD**

**COMPUTER**. System 80 blue label. 16 k incls games and general software. As new, only 4 mths old \$350 ONO. Brian VK4ST. Ph: (071) 91 1172.

**EX USN RX AN35B** 220-420 MHz. Qty new pwr xfms. Ex RAAF 4C x 250 B amp coax anode line suit 2 m. Bird 1000-C plug. MTR30A 2 m txcvr 4 sets xtals. Sockets suit 3-1000 or 2-1000A valves (5 pin giant). STC H'band txcvr factory cond 151 series. Qty pwr t'sisters 420-470 MHz 1 W, 4 W, 10 W, 25 W. Qty pwr t'sisters 50-175 MHz 3 W, 10 W, 25 W. 6/40 base tx & P/s. TY4-500 valves, 6/40 etc. VK4ZJB QTHR. Ph: (07) 269 6647.

**MAGAZINES**. Complete set of ARs from October 1970. YK4WR QTHR.

**YAESU FT-7** ex cond \$395. Ph: (075) 43 5418.

**FOR SALE — SA**

**W4KFC** 5 el duo band beam. 3 el on 15 m and 3 el on 10 m. 10 m reflector and 15 m director are common and has dual gamma match system. Can be seen working \$100. VK5ATU (QTHR VK5NTU). Ph: (08) 258 7020.

**FOR SALE — TAS**

**RIGS TO SUIT NOVICE**. 10 m band rigs. Belcom Liner mobile 28 MHz txcvr \$100. Sideband converted CB base station 240 V \$100. Warren VK7KWC QTHR. Ph: (002) 44 1268.

**YAESU FT-7** txcvr with mic, cradle, manual, AC power supply, 13.8 V, 4 A peak and two 28 MHz xtals. All \$380. VK7RF QTHR. Ph: (002) 28 2573.

**TRIAL NOVICE EXAM  
— ANSWERS**

1 a	11 d	21 d	31 d	41 d
2 d	12 b	22 c	32 c	42 a
3 d	13 b	23 b	33 d	43 a
4 d	14 d	24 c	34 b	44 c
5 d	15 c	25 c	35 b	45 d
6 b	16 c	26 d	36 c	46 b
7 a	17 b	27 b	37 c	47 a
8 b	18 b	28 d	38 c	48 d
9 b	19 d	29 a	39 d	49 b
10 b	20 b	30 d	40 b	50 c

**ADVERTISERS'  
INDEX**

ACME ELECTRONICS	67
AGFA-GEVAERT LTD AUSTRALIA	7
AMATEUR RADIO ACTION	67
ANDREWS COMMUNICATIONS SYSTEMS	66
ATN ANTENNAS	79
AUSTRALIAN MARITIME COLLEGE	6
BAIL ELECTRONIC SERVICES	4 & 5
CM CRYSTALS PTY LTD	79
CW ELECTRONICS	7
DICK SMITH ELECTRONICS	73
EASTERN COMMUNICATION CENTRE	IBC
ELECTROMARK PTY LTD	48
EMTRONICS	2 & 3
GFS ELECTRONIC IMPORTS	40 & 41
HAMRAD	72
HIGH TECHNOLOGY COMPUTER SYSTEMS PTY LTD	72
HY-TECH DISTRIBUTORS	31
IAN J TRUSCOTT ELECTRONICS	72
ICOM AUSTRALIA PTY LTD	BC
K BRUCE SMITH	38
NOVICE LICENCE	20
OPTILUX	6
PINKERTON TOWERS	35
QUADRICOLOR INDUSTRIES PTY LTD	7
QUARTZ CRYSTAL LABORATORIES	70
RADIO WORLD PTY LTD	IFC
RAKON AUSTRALIA PTY LTD	38
RIALTO INTERNATIONAL	8
STEWART ELECTRONIC COMPONENTS PTY LTD	31
TRAEGAR DISTRIBUTORS (NSW) PTY LTD	38
TRIO-KENWOOD (AUSTRALIA) PTY LTD	39
VAINS ANTENNA SERVICES PTY LTD	6
VK2 NOVICE LICENCE	78
WATCHMAN ELECTRONICS	6
WAWERLEY OFFSET PRINTING GROUP	7
WILLIAM WILLIS & CO PTY LTD	8
WILLIAMS PRINTING SERVICE PTY LTD	78



# EASTERN

## COMMUNICATION CENTRE

COMMUNICATIONS, ELECTRONICS AND COMPUTERS

168 ELGAR ROAD, BOX HILL SOUTH, 3128

Phone enquiries: 288 3107

CONTACT Keith VK3ACE or David VK3UD

HOURS: Mon.-Fri. 9-5.30, Sat. 9-12

BANKCARD WELCOME OR WE CAN ARRANGE FINANCE

### ALTRONICS DISTRIBUTOR • FULLY EQUIPPED SERVICE CENTRE



#### HF GENERAL COVERAGE RECEIVER

Listen to the world of HF with the R70, a 100kHz to 30MHz commercial grade receiver designed by ICOM Incorporated, the leader in advanced receiver design. Built from knowledge gained by designing receivers for commercial, marine and amateur use, the R70 surpasses other receivers on the market... even receivers costing more than twice as much.

Utilizing ICOM's DFM (Direct Feed Mixer), the R70 is a receiver which in normal usage is virtually immune to intermodulation distortion or cross modulation, yet still maintains superior sensitivity. Whether you are a Short Wave Listener, Amateur Radio Operator, Maritime Operator or Commercial User, the R70 provides the features you need.

The R70 is an ideal general coverage receiver to complement any amateur shack. Use it with your existing transmitter or transceiver to provide dual receiver capability.

The R70's built-in monitor system lets you listen to your own transmitted audio and a mute input automatically mutes the R70's receiver from your signal.

An option for FM allows listening to the 10 metre FM activity.



The TS-430S combines the ultimate in compact styling with its counterparts in advanced circuit design and performance. An all solid-state SSB, CW and AM transceiver, with FM optional, covering the 160-10 metre Amateur bands including the new WARC bands, this remarkable radio also incorporates a 150 kHz-30 MHz general coverage receiver, having an extra wide dynamic range. Key features include dual digital VFO's, eight memory channels, memory scan.



The TR-2500 is a compact, designed for tomorrow, 2 meter FM handheld transceiver, incorporating the latest in electronic technology, including LCD readout, 10 channel memory with improved memory backup, memory scan, programmable automatic band scan, keyboard channel selection, and improved flexibility with a variety of new accessories. Big in features, big in performance, the TR-2500 will surprise you with its small size.

#### TW 4000A - 70cm/2m

#### DUO-BANDER



\$699

#### VS1-VOICE SYNTHESIZER-\$40

#### HAMPACK II MODEM!

Plugs into APPLE® or compatible computers.

Turn your APPLE II into a communication terminal with the Q-tronics MODEM and Software.

\$210

STANDARD BAUDOT TONES  
KANSAS CITY TONES  
CCITT TONES

Designed to plug into the APPLE games I/O.



**EASTERN CODE CONVERTER** — Full break in CW and BAUDOT RTTY converter based on a 2716 EPROM programme, 6802 microprocessor and other associated IC's including a UART for control of the tele type function.

**MORSE CODE** — Full break in, auto speed adjust on receive, transmit speed control via variable resistor input from exit speaker jack on your transceiver three stage filter. With head phone output on two of the filter stages transmission via on board relay to CW jack on your transceiver.

**RTTY** — 45.45 and 50 BAUD, optional auto CR and LF w/shift on space facility input and output at TTL levels, can be connected to any suitable MODEM.

**VISUAL DISPLAY** — Interface to a VDU at RS 232 levels 300 BAUD, ASCII or interface to suitable ASCII teletype 110 BAUD via 20 mA loop. (ASR 33 or sim.)

**RTTY BAUD V7A COMING SOON!!**



#### FAX-80

80 column printer. Bi-directional, graphics printer.

\$495 plus Tax

**EPROMS - COPIED AND PROGRAMMED  
PCB's - MANUFACTURED TO ORDER.**

# NEW!

# ICOM IC-745

## A New Transceiver Worth Celebrating!



**9 AMATEUR BANDS!**

**GENERAL COVERAGE RECEIVER!**

**16 MEMORIES!**

**SCANNING!**

**PASSBAND TUNING!**

**VARIABLE NB & AGC!**

What's the celebration about? The IC-745 ... a new all ham band HF transceiver with SSB, AM, CW, RTTY and an FM option ... plus, a 100KHz - 30MHz general coverage receiver.

And ... the IC-745 has a combination of features found on no other transceiver at such an incredibly low price.

**Compare these exceptional features:**

- 100KHz - 30MHz Receiver
- 16 Memories
- Full function Metering with a built in SWR Bridge
- IF Shift and Pass Band Tuning
- 10Hz / 100Hz / 1KHz Tuning Rates with 1MHz band steps
- Optional Internal AC Power Supply

- Adjustable Noise Blanker (width and level)
- Continuously Adjustable AGC with an OFF position
- Receiver Preamp
- 100% Transmit Duty Cycle

**Other Standard Features:**

- 100 Watt Output Transmitter with exceptionally low IMD
- VOX
- Speech Compressor
- Tunable Notch Filter
- RIT and XIT
- All Mode Squelch
- Scanning
- ICOM System Compatibility

**Optional Accessories:**

- IC-PS15 External Power Supply

- IC-PS740 Internal Power Supply for the ultimate in Portability
- IC-2KL Linear Amplifier
- IC-SP3 External Speaker
- IC-MB12 Mobile Mounting Bracket
- IC-AT100 Antenna Tuner (100W)
- IC-AT500 Antenna Tuner (500W)
- IC-BC10 Memory Backup
- IC-EX241 Marker Module
- IC-EX242 FM Module
- IC-EX243 Electronic Keyer
- IC-FL52A 500Hz 455KHz CW Filter
- IC-FL45 500Hz 9MHz CW Filter

- IC-FL54 270Hz 9MHz CW Filter
- IC-FL53A 250Hz 455MHz CW Filter
- IC-FL44A 2.1KHz 455KHz SSB Filter
- IC-SM6 Desk Mic
- IC-HM12 Hand Mic

The IC-745 is the only transceiver today that has such features standard ... the number of options and accessories available ... and such a low price.

ICOM is ... *Simply the Best* in quality built ham equipment today. See the IC-745 at your local authorized ICOM dealer or contact ICOM for more information.

**Discover a new deal with ICOM AUSTRALIA PTY. LTD.**

7 DUKE STREET WINDSOR 3181 VICTORIA, AUSTRALIA  
TEL: (03) 529 7582 TLX: AA 35521 ICOMAS



## The World System

# AMATEUR RADIO

VOL. 51, No. 11, NOVEMBER 1983

Registered by Australia Post — Publication No. VBH 0569

JOURNAL OF THE WIRELESS INSTITUTE OF AUSTRALIA



Build a Trib and Quad & a Morse Code Trainer  
Try a VOX in a Box  
Microwave Matters  
List of ALARA Members  
EMC — Cure Audio Frequency Interference  
Competition Winner  
VHF UHF — Maidenhead System Explained  
Weekend Project No 3 — Mic Equaliser

# MOVING SALE

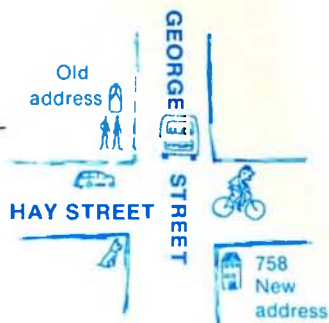

As from 1st November 1983 we shall be located at:  
**758 George Street, Sydney, NSW 2000.**  
 (Next to Radio House). Phone: 211 0531.

And let's celebrate with these specials:

## TELEREADER SALE

- |             |            |              |            |
|-------------|------------|--------------|------------|
| • CWR-685 E | \$1299     | • CWR-610 E  | \$299      |
|             | NOW \$1195 |              | NOW \$265  |
| • CWR-670 E | \$499      | • CWR-675 EP | \$1199     |
|             | NOW \$465  |              | NOW \$1090 |

### New Stock . . . . . ALINCO EC-720 SSTV



Solid State — Send and Receive clear pictures — Write for Specs  
**Only \$799**

### Just Arrived . . . . . INFO-TECH M600A



A unique code receiver/converter — full specs available  
**\$1599 NOW \$1390**

### Fresh Stock Now. . . . . HAL COMMUNICATIONS

- MPT 3100 Message Processor Terminal
- ST 6000 RTTY Demodulator
- DSK 3100 Disk Storage
- OT 2200 Communication Terminal
- ARQ 1000 Error Correction Terminal
- KB 2100 Keyboard

### NEW OATONG AUTOMATIC WOODPECKER BLANKER



Blanks out Woodpecker interference from any receiver or transceiver  
 • Requires no synchronisation or pulse width adjustments  
**TRY THE BEST ONLY \$220**

### NEW DATONG AUTO AUDIO NOTCH FILTER



• Plus CW filter.  
 Clears tune-up whistles from SSB automatically. Top Quality.

**Only \$189**

Ask for Datong catalogue

### NEW DATONG FL-3

Multi-Mode audio filter  
 \* with auto notch filter



• Four State of the Art Audio Filters in one box

**EXCELLENT VALUE  
 ONLY \$299**

### COMPUTER INTERFACE AND SOFTWARE FOR RTTY

- Now available for:
- VIC-20
  - TRS-80C
  - APPLE
  - COMMODORE 64

Receive and Transmit Morse, CW, RTTY and ASCII the easy way!  
 WRITE FOR FULL SPECIFICATIONS

### BOOKS GALORE!!

- Radio Amateurs Handbook . . . . \$24.95
- Antenna Book . . . . . \$19.00
- Tune in the World . . . . . \$13.95
- Understanding Amateur Radio . . \$15.00
- FM and Repeater . . . . . \$15.00
- Operating Manual . . . . . \$15.00
- Antenna Anthology . . . . . \$12.00
- Electronics Data Book . . . . . \$12.00
- Hints and Kinks . . . . . \$12.00
- Weekend Projects . . . . . \$ 9.95
- Solid State Design . . . . . \$19.95

**AND MANY MANY MORE**

### WE ARE AUTHORISED DEALERS FOR:

Kenwood, Yaesu, Icom.  
 See us for best prices and service.

### TOP SELLERS

- EAT-300 Tuner . . . . . \$159
- ENB-1 Noise Bridge . . . . . \$ 89
- ALL BAND Antenna . . . . . \$ 69
- 2 kW Dummy Load . . . . . \$ 69
- FULL RANGE MM Preamps available

Ask for our catalogue  
 Send .65c stamp.



CORRESPONDENCE & MAIL ORDERS:  
 Box K21, Haymarket, NSW. 2000. Australia.  
 WRITE, PHONE OR CALL IN!



Registered Office:  
3/105 Hawthorn Road,  
Caulfield North 3161.  
Tel. (03) 528 5962

# AMATEUR RADIO



Enjoying JOTA '83 are L to R: Tony VK2PNR, Greg Davis from 1st Ermington Scouts, Sherryn Gray of Telopea Guides and Michael Johansen of 1st Ermington Cubs.

Education Notes .....	43
Equipment Review — <i>KB R-X Noise Bridge</i> ..	15
Five-Eighth Wave .....	67
Hamads .....	71
Here's RTTY! .....	52
How's DX .....	26
International News — <i>Space Shuttle STS9 &amp; RSGB 1984 Convention</i> .....	31
Intruder Watch .....	53
Ionospheric Predictions .....	68
Letters to the Editor .....	70
Listening Around .....	60
Magazine Review .....	49
Main QSP .....	9
National EMC Advisory Service — <i>Audio Frequency Interference</i> .....	40
Pounding Brass .....	61
QSP .....	63 & 71
Silent Keys — <i>VK4GD &amp; VK2MT</i> .....	71
Spotlight on SWLing .....	51
Thumbnail Sketches — <i>Ben Grimes and Ock Alder</i> .....	28
Try This — <i>Vox in a Box</i> .....	16
VHF UHF — <i>an expanding world including locator map details</i> .....	46
VK2 Mini Bulletin .....	65
VK3 WIA Notes .....	66
VK4 WIA Notes .....	67
WIA News .....	7

Geomagnetic & Sunspot Activity 1983 .....	71
Japanese DX on Two Metres? .....	14
Morse Code Trainer by <i>Phil Grigg VK3APG</i> ..	18
Murphy by <i>Alan Shawsmith VK4SS</i> .....	21
October's Best Photographs .....	43
Operating Techniques & Hazards by <i>John Aarsse VK4QA</i> .....	22
Overheard on Bundaberg Repeater .....	51
Pioneers of the Spectrum — <i>Part 1 — Discovery of VHF</i> by <i>Stephen Gard VK2ESG</i> .....	25
Radio Amateur Old Timers Club — <i>August QSO Party</i> .....	32
Safety Belts .....	59
Scout Jamboree — <i>ZL2JAM</i> .....	61
Siemens Series One Printers by <i>Dave Prince VK4KDP</i> .....	24
Some More Adventures of <i>Bill Blitheringtwit</i> by <i>Ted Holmes VK3DEH</i> .....	20
Strays .....	49 & 65
Subs for 1984 .....	65
Ten GHz Coupler & other Microwave Matters by <i>Des Cliff VK5ZO</i> .....	12
The Born Loser Goes on Air by <i>Bill Martin VK2EBM</i> .....	31
Triband Cubical Quad by <i>Peter Hewitson VK8PH</i> .....	21
Weekend Project No 3 — <i>Microphone Equaliser</i> by <i>Ivan Hüser VK5QV</i> .....	10

## DEPARTMENTS

A word from your Editor .....	7
Advertisers Index .....	72
ALARA — <i>full list of members</i> .....	56
AMSAT Australia .....	54
AR Showcase — <i>Code Rx, Oscilloscope, All Mode Txvr, Card Holder &amp; 2.3 GHz Kit</i> ..	64
Awards — <i>OSIJEK, Malta and Moorabbin &amp; District rules</i> .....	30
Club Corner — <i>EXPO, ANARTS, TARC &amp; Western Suburbs</i> .....	62
Commercial Chatter .....	32
Contests — <i>VK CW QRP, Ross Hull rules</i> ....	58

## ARTICLES

Commonwealth Contest 1983 Results .....	44
Competition Winner .....	55
DXing to G land by <i>Jim Swann VK2BQS</i> ..	29

## DEADLINE

All copy for January RA must arrive at PO Box 300, Caulfield South, 3162 NO LATER than 18th November.

**EDITOR**  
GIL SONES\* VK3AUI

**TECHNICAL EDITORS**  
RON COOK\* VK3AFW  
PETER GAMBLE\* VK3YRP  
EVAN JARMAN\* VK3ANI  
BILL RICE\* VK3ABP

**CONTRIBUTING EDITORS**  
MIKE BAZELY VK6HD  
RON COOK\* VK3AFW  
REG DWYER VK1BR  
BRENDA EDMUNDS VK3KT  
MARSHALL EMM VK5FN  
RON FISHER\* VK3OM  
BRUCE HANNAFORD VK5XI  
ROY HARTKOPF\* VK3AOH  
ROBIN HARWOOD VK7RH  
COLIN HURST VK5HI  
ERIC JAMIESON VK5LP  
MARGARET LOFT VK3DML  
KEN McLACHLAN VK3AH  
LEN POYNTER\* VK3BYE  
TONY TREGALE VK3QQ

**DRAFTING**  
GEORGE BROOKS  
LIZZ KLINE

**BUSINESS MANAGER & SECRETARY**  
REG MACEY

**ADVERTISING MANAGER**  
JOHN J A HILL VK3WZ  
\*Member of Publications Committee

Enquiries and material to:  
The Editor  
PO Box 300, Caulfield South Vic. 3162  
Material should be sent direct to PO Box 300, Caulfield South Vic., 3162, by the 25th of the second month preceding publication. Phone: (03) 528 5962. Hamads should be sent direct to the same address.  
Acknowledgement may not be made unless specially requested. All important items should be sent by certified mail. The editor reserves the right to edit all material, including Letters to the Editor and Hamads, and reserves the right to refuse acceptance of any material, without specifying a reason.

Trade Practices Act It is impossible for us to ensure that advertisements submitted for publication comply with

the Trade Practices Act 1974. Therefore advertisers and advertising agents will appreciate the absolute need for themselves to ensure that the provisions of the Act are complied with strictly.

Victorian Consumer Affairs Act: All advertisers are advised that advertisements containing only a PO Box number as the address cannot be accepted without the addition of the business or residential address of the box-holder or seller of the goods.

Production: BETKEN PRODUCTIONS  
5 Masefield Avenue, Mooroolbark, 3138.

Laser Scanned Colour Separations by:  
QUADRICOLOR INDUSTRIES PTY LTD,  
Graphic Division  
22-24 Glenvale Crescent, Mulgrave, 3170.  
Tel.: (03) 560 2222

Typesetting by: QUADRICOLOR INDUSTRIES PTY LTD,  
22-24 Glenvale Crescent, Mulgrave, 3170.  
Tel.: (03) 560 2222

Photographic film and processing material courtesy  
AGFA-GEVAERT LTD AUSTRALIA

Printers: WAVERLEY OFFSET PUBLISHING GROUP  
Geddes Street, Mulgrave, 3170  
Tel.: (03) 560 5111



OVER 33,000  
CHANNELS

# JIL SX-200



JIL  
REGD TM

Monitor thousands of  
free channels including  
the AIRBAND  
and Australian Low-  
band.

■ Now available, 32 Memories  
and auto AM on CB/MARINE  
and AIRBAND.

NEW RANGE  
OF  
ACCESSORIES  
See over.

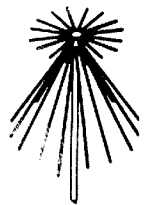
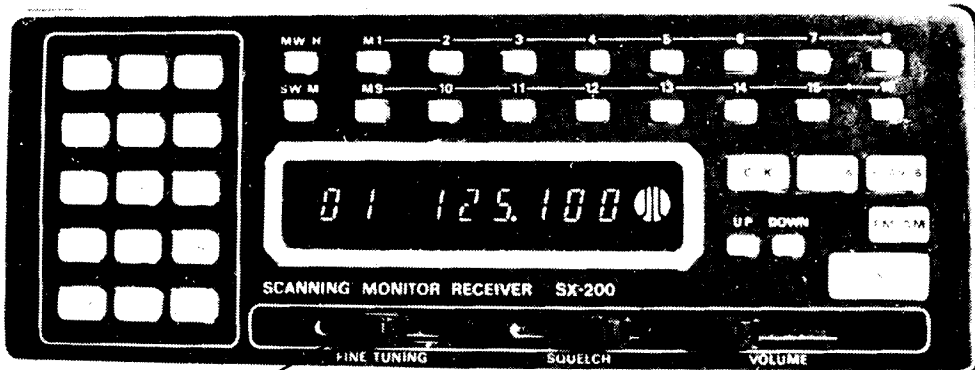

A range of accessories is available including Broadband or High Gain BASE Antennas.

■ FINE TUNING for coverage of all Australian channels on VHF Low.

## THE ONLY SCANNER THAT GOES 26-88, 108-180 & 380-514 MHz

### SPECIFICATIONS

- **Type:** FM & AM
- **Frequency Range:**
  - a) 26-57.995 MHz Space... 5 kHz
  - b) 58-88 MHz Space... 12.5 kHz
  - c) 108-180 MHz Space... 5 kHz
  - d) 380-514 MHz Space... 12.5 kHz
- **Sensitivity:**
  - FM... a) 26-180 MHz 0.4uV S/N 12 dB
  - b) 380-514 MHz 1.0uV S/N 12 dB
  - AM... a) 26-180 MHz 1.0uV S/N 12 dB
  - b) 380-514 MHz 2.0uV S/N 12 dB
- **Selectivity:**
  - FM... More than 60 dB at -25 kHz
  - AM... More than 60 dB at -10 kHz
- **Dimensions:**
  - 210 (W) x 75 (H) x 235 (D) mm
  - 8-1/4 (W) x 3-1/4 (H) x 9-1/8 (D) in.
- **Weight:** 2.8 Kgs.
- **Clock Error:** Within 10 sec./month
- **Memory Channel:** 16 Channels
- **Scan Rate:**
  - Fast ..... 8 Channels/sec.
  - Slow ..... 4 Channels/sec.
- **Seek Rate:**
  - Fast ..... 10 Channels/sec.
  - Slow ..... 5 Channels/sec.
- **Scan Delay:** 0, 3 or 4 seconds
- **Audio Output:** 2 Watts
- **Ant Impedance:** 50-75 ohms  
Whip or External Antenna with LO/DX Control (20 dB ATT.)
- **Freq. Stability:**
  - 26-180 MHz ... Within 300 Hz
  - 380-514 MHz ... Within 1 KHz

The JIL SX-200 represents the latest STATE-OF-THE-ART technology in the development of Scanning Monitor Receivers. It has many features that previous have not been available on receivers of its type.

For example the tremendous frequency coverage, which encompasses all of the following bands: — HF & UHF CB, 27 & 155MHz MARINE, Australian LOW BAND, AIRCRAFT band, VHF SATELLITE band, 10Mx, 6Mx, 2Mx and 70CMx AMATEUR, VHF HIGH BAND and UHF TWO-WAY band — as well as many others. Other features include detection of AM or FM on all bands. Squelch Circuitry that can be used to LOCK OUT carrier only signals. Fine Tuning control for off channel stations. 240 VAC plus 12VDC operation. Squelch Operated Output that may be used to trigger a tape recorder or channel occupancy counter and accurate Quartz Clock.

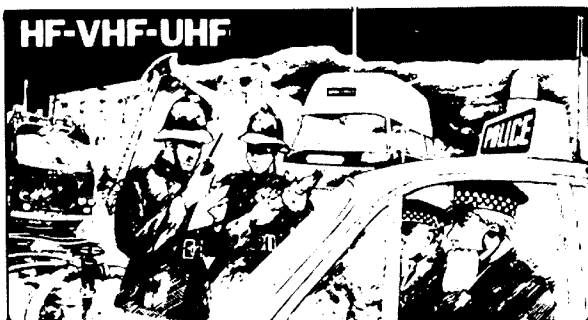

**\$599**



plus \$10  
P & P

### ACCESSORIES

Service Manual \$12 + \$2 P&P  
Scan-X Base Antenna \$62 + \$10 P&P

# JIL SX-200

## A BETTER SCANNING MONITOR RECEIVER

### HIGH QUALITY AND PERFORMANCE

JIL have designed the SX-200 as a high quality, high performance programmable scanning receiver at a realistic price, design criteria which are not born in many other receivers of its type.

### MECHANICALLY RUGGED

The JIL SX-200 is ruggedly built using EPOXY-GLASS printed circuit board and double sided through hole plating techniques. Easy access and servicability is maintained throughout its design.

### 4 BIT MICROPROCESSOR WITH ONBOARD ROM AND RAM

A powerful 4 Bit PMOS Microprocessor, the uPD553, is used as a controller in the SX-200. Its features include 2000 x 8 ROM and 96 x 4 RAM onboard as well as up to 80 instructions with a 3 level subroutine stack.

### EXTREMELY LOW SPURIOUS COUNT

Even though the SX-200 covers over 33,000 Channels JIL, through careful design, have been able to reduce the number of internally generated spurious signals to an extremely low level. Not the case in most other scanning receivers.

Monitor thousands of frequencies including many Military & Civil

**HF-VHF-UHF**

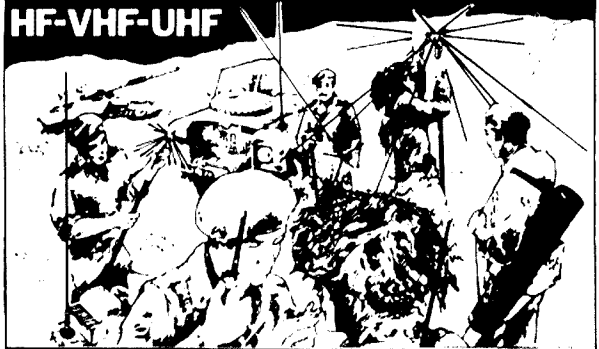

### FULLY TRACKED RF AMPLIFIERS

The SX-200 makes use of 3 separate RF Amplifier Stages. They are divided into 6 bands, each band having its own electronically switched coils which are fully tracked with the receiver frequency using Varicap Diodes. Maximum performance is thus gained over the entire operating range of the set.

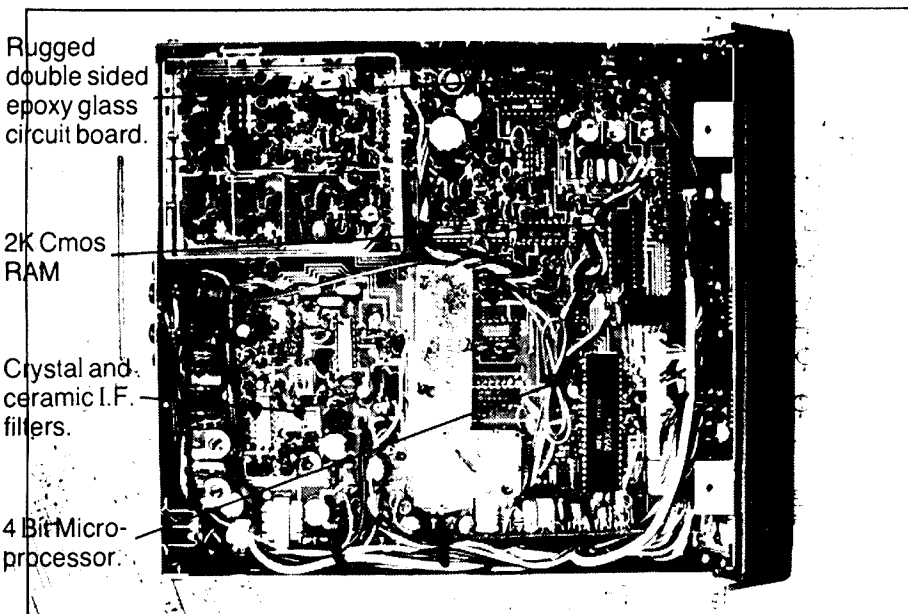

**SX-200, RUGGED CONSTRUCTION AND EASY SERVICABILITY.**

### NEW ACCESSORIES

#### ■ EXP-32 KIT

Increase the memories of your SX-200 to 32 with this memory expander kit.  
\$53 + \$2 P & P

#### ■ A4-AM KIT

Provides automatic AM operation on the 27 MHz CB MARINE and AIRCRAFT bands.  
\$32 + \$2 P & P

#### ■ CVR-1B CONVERTER

allows your SX-200 to cover 180 to 380 MHz (incl. SPACE SHUTTLE frequencies).  
\$199 + \$5 P & P

#### ■ CVR-2 CONVERTER

allows your SX-200 to cover the SHORT WAVE bands, 0.55 to 30 MHz.  
\$189 + \$5 P & P

#### ■ MFJ-332 VLF CONVERTER

allows your SX-200 to cover 5 KHz to 1600 HKz  
\$144 + \$5 P & P

### AVAILABLE FROM

W.A.: Letco Trading Co. (09) 387 4966, N.S.W.: Emtronics (02) 211 0531, QLD: CW Electronics (07) 397 0808, S.A.: Jensen Intersound (08) 269 4744, Plus many other regional outlets, contact GES for your nearest stockist.



## GFS Electronic Imports

17 McKean Road, Mitcham, Victoria, 3132  
PO Box 97, Mitcham, Victoria, 3132 Phone: (03) 873 3939, 873 2652  
Telex: GFS AA 38053 Cable: "Comimports" Melbourne

# When it comes to Transceivers ICOM has

## IC-271A 25 Watts of FM, SSB, CW for 2 Metres.

**Output power:** 25 Watts of power from either 12 Volt DC or from 240 Volt AC with an optional internal power supply.

**Memories:** 32 full function memories for frequency, offset, offset direction.

**PLL locked** to 10Hz

**Display:** 7 digit frequency fluorescent display plus mode, offset, VFO, memory channel and RIT offset

**Memory Scanning:** IC-271A scans programmable memories, programmable band sections or modes

**Dual VFOs:** Allowing transfer from memory to VFO Memory to memory transfer with no frequency change

**New Size:** Only 11 $\frac{1}{2}$ " W x 4 $\frac{3}{8}$ " H x 10 $\frac{1}{4}$ " D.

## Revolutionary New Communications System

### IC-120 Mobile 1.2GHz FM

**Memories:** Six memory channels plus two VFOs. Storing frequency, offset direction and offset frequency.

**Scanning:** Scan memory, all 40MHz or just a segment.

**Duplex:** Work more than repeater offset with IC-120s programmable offset system.

**Tuning Rates:** 3 different rates 10KHz, 20KHz or 1MHz.

**RIT:** On FM allows  $\pm$  5KHz tuning of signals offset from yours.

**Display:** Four digit green LED for day-night visibility.

**Size:** A tiny 2" H x 5 $\frac{1}{2}$ " W x 8 $\frac{3}{4}$ " D.

**Repeater capability:** Team the IC-120 mobile with an IC-RP1210 repeater for a complete system. (More details on IC-RP1210 repeater next page.)

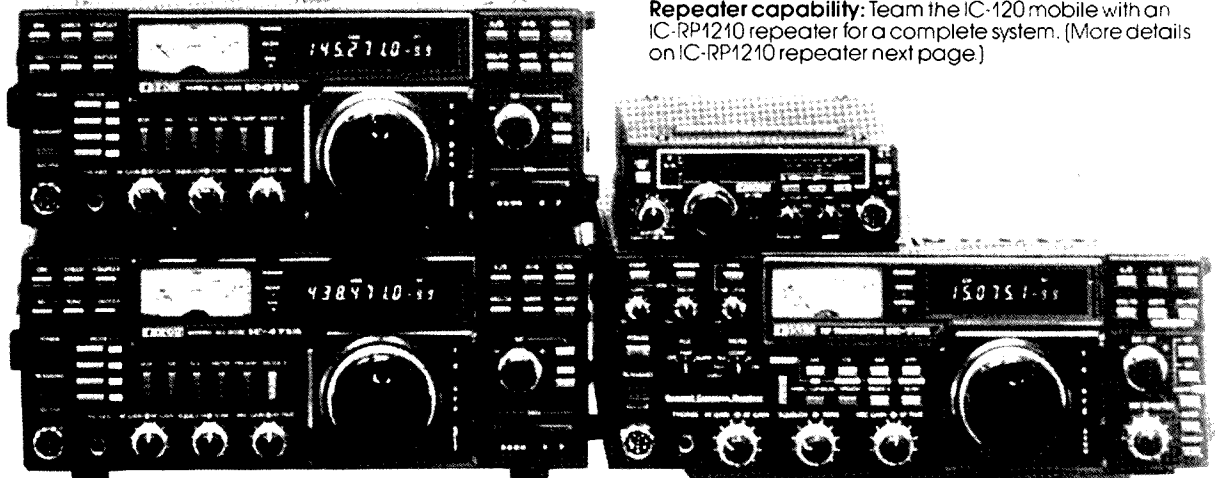

## IC-471A 430-450MHz Base Transceiver.

**Memories:** 32 memory capacity. Storing frequency, mode, offset direction and offset frequency for easy return to any frequency.

**Phase Lock Loop:** Low noise, good signal to noise ratio. PLL allows lock to 10Hz for accuracy.

**New Display:** Easy-to-read two colour fluorescent display shows frequency, mode, offset direction, VFO in use, memory channel and RIT offset.

**Scanning:** IC-471A scans memory, programmable band and mode.

**New Size:** Only 11 $\frac{1}{2}$ " W x 4 $\frac{3}{8}$ " H x 10 $\frac{1}{4}$ " D.

**Repeater Compatibility:** Team the IC471-A with the IC-RP3010 25 Watt FM Repeater. (More details on IC-RP3010 on next page.)

## IC-751 100KHz to 30MHz Competition Grade.

**Receiver:** Has a 105dB dynamic range. The IC-751 has a deep IF notch filter, adjustable AGC and noise blanker audio tone control plus RIT with separate readout.

**Transmitter:** 12 Volt DC design. Quiet relay selection of transmitter LPFs transmit audio tone control, monitor circuit, XIT, and a high performance speech processor enhance the IC-751 operation.

**Dual VFOs:** Controlled by large tuning knob.

**Memories:** 32 tunable memories to store mode, VFO and frequency. Scanning capability of frequencies and memories.

**Display:** High visibility, multi-colour fluorescent display, with frequency in white, other functions in white or red.



# sceivers and Repeaters the range

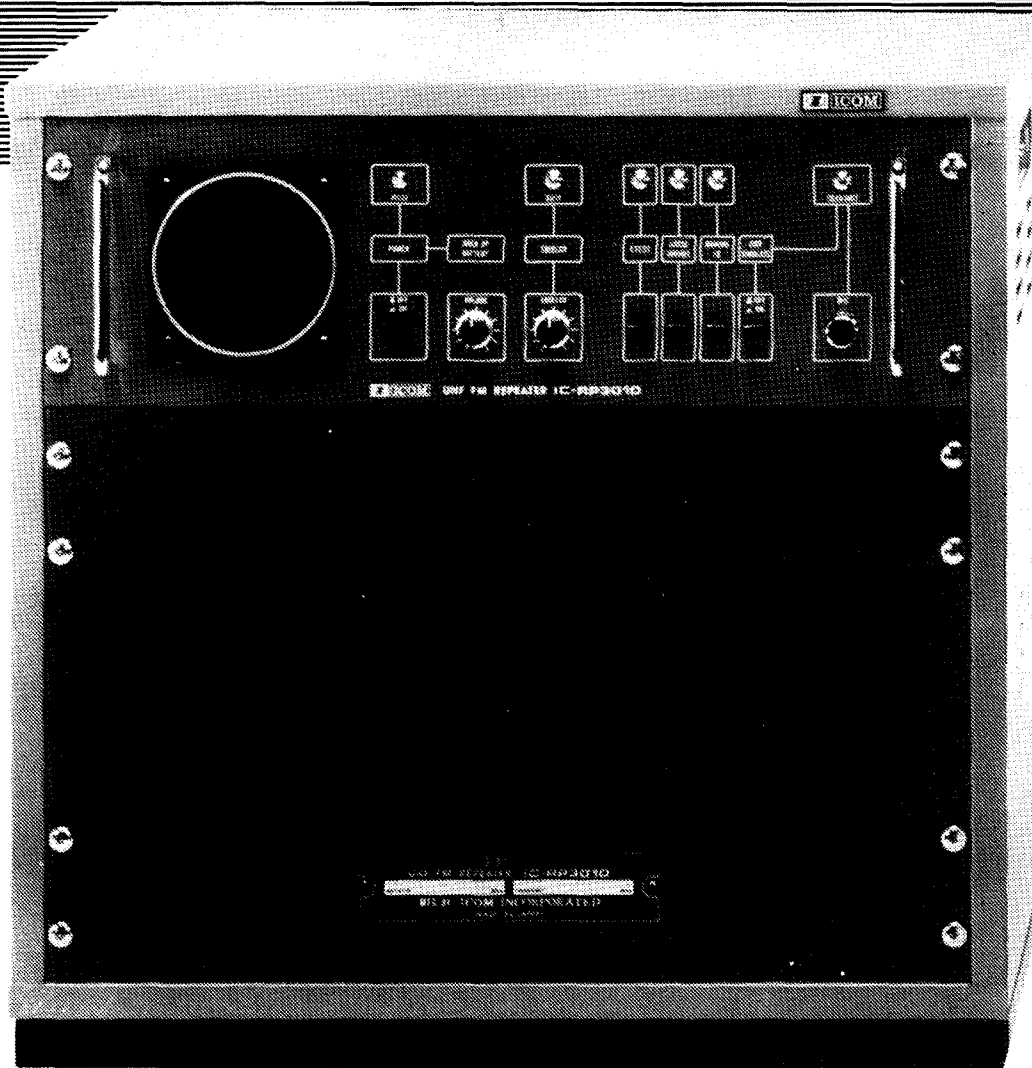

## **IC-RP3010 FM Repeater.**

**Complete your system with the NEW 440 MHz Repeater.** A 10 Watt 400MHz FM repeater. The IC-RP3010 features high stability crystal controlled channels CTCSS system, ID'er, remote control through a DTMF decoder and microprocessor controlled circuitry. Repeater soon to become operative in Melbourne, end of 1983.

## **COMING SOON IC-RP1210 Repeater**

**An all NEW 1.2GHz Repeater for the avid enthusiast.** PLL frequency selection (198 channel, 10KHz steps, DIP switch), High stability PLL (0.5 PPM/ - 30° to + 60°C). Repeater access via CTCSS. DTMF control functions. Selectable hang time. ID'er.

**ICOM AUSTRALIA PTY. LTD.**  
7 Duke Street, Windsor, Victoria 3181,  
Australia. Phone (03) 51 2284  
Telex AA35521 ICOMAS

Discover a new deal  
with ICOM Australia.



**The World System**

All stated specifications are approximate and subject to change without notice or obligation.  
All ICOM radios significantly exceed FCC regulations limiting spurious emissions.  
**WARNING:** When purchasing an ICOM unit, please confirm that you are dealing with an **Authorised ICOM Dealer**  
as the ICOM Warranty applies **only** to units supplied by ICOM Australia Pty Ltd. to Authorised ICOM Dealers.

**AMATEURS:  
CAN YOU MEET  
THE CHALLENGE!**

Remember the 'good old days' of amateur radio? When an amateur built his own gear - and was so proud of it!

Sadly, those days passed! With incredible advances in technology, it became economically and technically impossible to compete with commercially built equipment. Now home brewing is here again!

And what's more, with the all-new Dick Smith UHF Explorer, you'll end up with a transceiver less than the cost of a commercial unit - and not just as good, it's better!

YES! A completely up-to-the-minute design featuring phase-locked-loop frequency synthesis.

**Exclusive to  
Dick Smith  
Electronics**

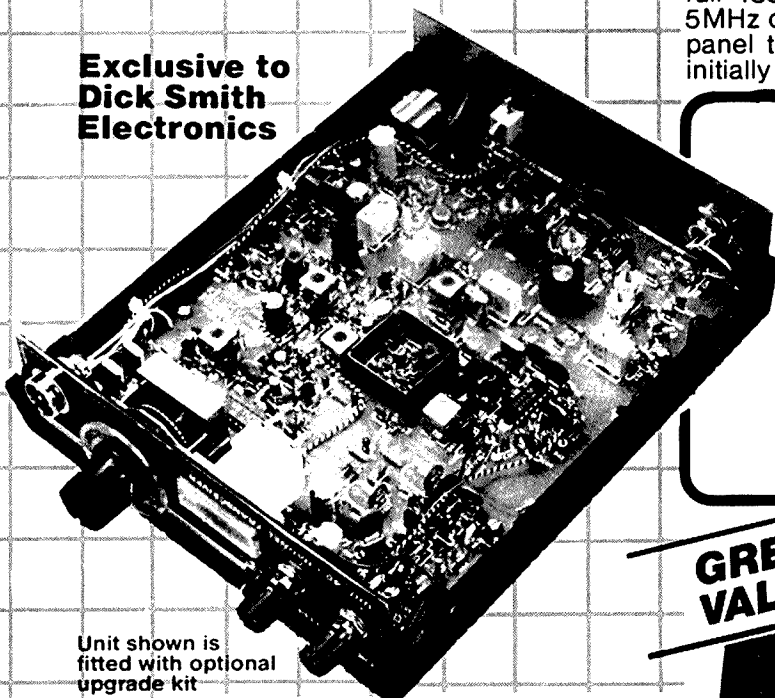

Unit shown is fitted with optional upgrade kit



# 'HOME BREW' - the very latest technology... build yourself a UHF Transceiver

## WE APOLOGISE . . .

Hundreds of amateurs have wanted this outstanding new kit . . . far more than we could supply! Now for the good news:

We've made up some more kits for distribution to our stores and mail order centre. Be warned - some parts are still pretty scarce so we haven't been able to make all the kits we wanted to. To avoid further disappointment, order your kit NOW!

## And for those waiting for the upgrade kit . . .

It's now available! Yes, you can give your transceiver full 438-439MHz repeater capability with standard 5MHz offset, PLUS 'S' meter, and a brand new front panel to suit. Once again, supplies of this kit will initially be limited so hurry in and get yours now!

### SPECIFICATIONS

Frequency Coverage	438.025-439.000MHz in 25kHz steps
No. of Channels	40
Mode of Operation	FM
Supply	13.8v DC. Receiver 340mA with full audio output and all options Transmitter 2A more (5 watt output)
Receiver Sensitivity	Dual Conversion Superhet 0.4uV for 20dB quieting
Selectivity	+/-7.5kHz - 6dB, +/-15kHz - 60dB
Adj. Chan. Reject	Better than 80dB
Transmitter Power Output	5W (typical)
Deviation	+/-5kHz
Spurious Emissions	Better than -60dB

**GREAT  
VALUE!**

## DICK SMITH EXPLORER UHF TRANSCEIVER

**ONLY \$199**

Cat K-6300

### OPTIONS AVAILABLE:

- Upgrade Kit (Cat K-6302) (Repeater, S meter, additional xtal filter & new front panel) **ONLY \$24.50**
- Antenna Kit (Cat D-4014) 1/4 wave stainless steel whip, co-axial fed UHF antenna base, PL-259 plug, 3.5m low loss UHF co-ax, gutter grip mount and cutting instructions **ONLY \$24.50**

# DICK SMITH Electronics

There's a store near you. (Stocks may be limited in some stores).

DSE/A616/LL





# a word from your EDITOR

During this year Oscar 10 has gone aloft and is providing new horizons for satellite operation. Many have made interesting contacts over great distances aided by the satellite borne repeater.

As this issue arrives an amateur will actually be operating from the Space Shuttle Columbia. Dr Owen Garriot, W5LFL will give many a unique, if brief, contact as he passes over in the space shuttle.

With new satellites, an amateur operating from space and new operating privileges the Amateur Radio Service is forging ahead.

Don't forget Amateur Radio Magazine. With all the new frontiers in amateur radio help others enjoy them by writing an article. Good articles are always needed particularly on the new frontiers. However don't forget the newcomer who also needs articles on more basic subjects.

Amateur Radio Magazine is for all and needs a broad spectrum of material. New techniques, general interest, and basics are all equally welcome.

AR



# WIA NEWS

## FESTIVAL

The Fourth International Festival of Telecommunication and Electronic Films is being held in Geneva between the 26th October and the 1st November 1983. Known as the "Golden Antenna" film festival, it is organised by the ITU as part of the Telecom '83 World Telecommunication Exhibition.

The Institute has entered a 16mm film called "Amateur Radio — A National Resource" printed from a video tape made for the WIA video library. The film will be shown in the General Category and is suitable viewing for the general public as it gives an insight into our hobby and many of its aspects.

There are eighty entries from twenty-six countries and three international organisations, our film appears to be the only entry from Australia.

An international jury consisting of experts in either film production, telecommunications and electronics will assess the entries, judging being based on content/purpose achieved, promotion of telecommunications at National and International level.

## INSURANCE

An Insurance brochure is being circulated bearing the Institute's Business name.

Members should be aware that the Institute has no connections whatsoever with this venture.

## PHONE PATCH

A draft of a Discussion Policy on phone patching has been received at Federal Office. Further information will be printed at a later date.

Copies of this draft are available from Telecom Headquarters.



## HELP PREVENT PIRATES

Keep bands for licensed amateurs.

*DO NOT sell transmitting equipment to unlicensed operators.*

## WHAT DO I GET OUT OF THE INSTITUTE?

Shortly all members will be receiving their subscription notice. You may wonder is it worth renewing again this year. "What do I get out of the Institute". Read on . . .

*Why should I pay my annual subscription? I live in the country, so I can't get to a WIA meeting in the city. I don't work DX, so I don't need the QSL bureau. I am not much of a reader, so I don't need the cheap technical books from the bookshop.*

*I live in a provincial centre and my arguments are the same. I belong to the local radio club, and it is affiliated with the Institute. Maybe on the surface, a lot of people don't get a lot from being a member, except a very good magazine once a month. That is if you don't count your amateur licence, or being in an organisation that represents you on a State level with the local office of the DOC and on a national level with the Federal Government.*

*If you don't count the good deal that we got out of WARC 79 or the work done on your behalf regarding the detailed submission on the new radio-communications bill. If you forget the representation on your behalf at the Region 3 Association meetings which influences the IARU, the World Amateur Radio body.*

*If none of this gives you the message, how about the fact that you belong to the oldest amateur radio society in the world and that old one about . . . UNITED WE STAND . . .*

by Bud Pounsett, VK4QY  
in QTC, August 1983

AR

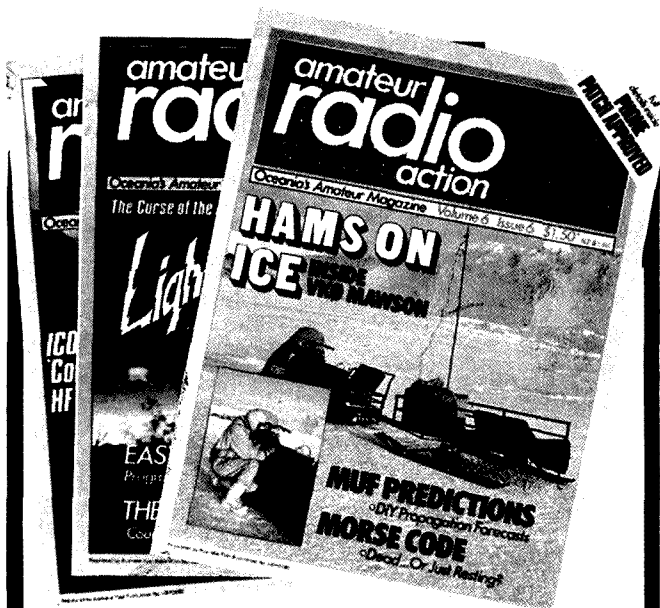

**IF YOU HAVEN'T LOOKED AT**

**amateur  
radio  
action**

**LATELY, THIS IS WHAT  
YOU'VE MISSED**

- Up to date News and Views
- Advance News on the Latest Rigs
- Complete Awards Information
- The Latest DX News & QSL Routes
- Complete Contest Information
- Lab Tests of the Latest Transceivers
- Spratly Island — In Depth.
- Heard Island — The VKOJS Report.
- Computer RTTY the Easy Way.
- Worldwide HF Beacon & Net Listing.
- A Cheap VFO for the FT-707.
- Amateur Operation in the Pacific.
- Radial & Ground Systems for Vertical Antennas.
- The Facts about Lightning & its Effects.

**PLEASE PUT ME DOWN FOR 13 ISSUES  
OF AMATEUR RADIO ACTION  
STARTING NOW!**

I enclose a cheque for \$18.00

Name.....  
 Address.....  
 .....  
 Postcode.....

Send to: **AMATEUR RADIO ACTION  
 SUBSCRIPTIONS, P.O. BOX 628E,  
 GPO MELBOURNE, 3001, AUSTRALIA**

Announcing —  
**SKYTRIM**  
 Today's premier  
 free standing  
 crank up tower line

A range of telescopic towers for amateur and commercial applications, from 6.5m to 20m, with tilt-over facility enabling antennae installation and adjustment to be done at ground level.

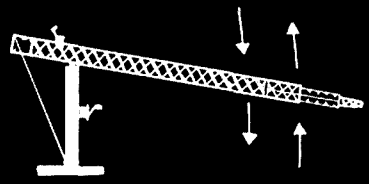

**What other tower can offer you these features?**

- \* Rugged, all welded, diamond web construction.
- \* Hot Dip Galvanized inside and out, after fabrication.
- \* Easily erected on a limited area site.
- \* Only heavy-duty marine fittings used.
- \* Rotator mounts inside tower.
- \* Thrust bearing fitted.
- \* Engineering drawings supplied (including foundation detail).

**SKYTRIM — A Tower of Strength**  
 Further details available from —

**Bruce P. Pinkerton,  
 P.O. Box 428, Parramatta, N.S.W. 2150  
 Australia. Tel. 635 3555, 635 8777**

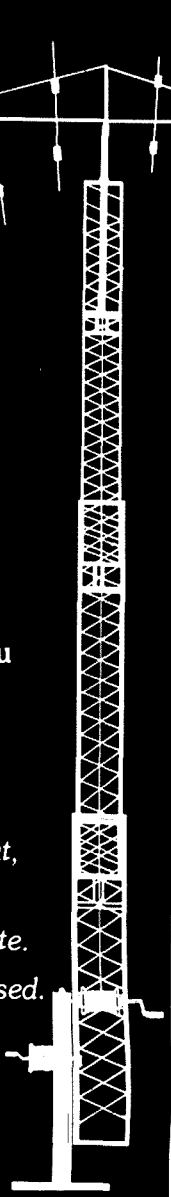



# QSP



## FIFTY MEGACYCLES REVISITED??

The insert to August Amateur Radio and the following month's QSP by the Federal President Bruce Bathols, have caused the sparkle to be returned to the eye of many a hardened six metre operator — especially those old hands who can well remember the "good old days" before Channel 0!!

It is a pity that so many years and so many good opportunities for rare DX have been missed, while the bureaucratic wheels have been turning ever so slowly over the return of this band to amateurs. However the good news of 50-50.150 MHz is certainly a positive first step in the right direction.

All is not over yet! While some Australian six metre operators have little to worry them, as their nearest Channel 0 station is hundreds perhaps thousands of miles away, the vast majority of us have many a potential problem right 'next door', together with restraints imposed by DOC.

A review of the 50-50.150 MHz allocation is to be made in about twelve months. It is obvious that in this case the 'review' is to answer one fundamental question — "*can the Amateur Service and Broadcast Service co-exist in this part of the spectrum??*"

This should not be confused with any sort of "right" question as this is a separate issue.

It would seem logical that any self respecting broadcaster will be trying to "prove" that such co-existence is undesirable because of "observed interference problems"!!

ANY INTERFERENCE to Channel 0 is likely to be labelled 'Amateur', unless we can prove otherwise when the time comes.

So for the next twelve months, ALL six metre operators have a very special responsibility, to themselves and all future amateurs. They have to help to prevent this sort of broad sweeping interference statement becoming THE reason for our loss once again of this valuable band.

## READ ON!

Interference to the broadcasting service in this part of the spectrum is problematical at any time. Interference from an amateur transmitter is only one possible source.

Many viewers have improperly installed receivers and aerials, which experience shows is frequently the case in areas where Channel 0 has been in operation for a relatively short period. Interference from powerlines, especially IN these weak signal cases, is a major problem.

In this part of the VHF spectrum, other forms of electrical interference, including motor vehicle 'ignition noise', can severely disrupt viewing.

Yet another source of interference during the DX season is mutual interference between Channel 0 stations.

So that reasoned debate can take place at the time of review, it is imperative that ALL users of the six metre band — irrespective of which state they are located, and irrespective of whether a Channel 0 station is nearby, *keep accurate and detailed logs for the next twelve months.*

Not only should logs reflect the amateur radio operations but also any television interference observed together with a statement of its possible cause or source. This is most important in the case of suspected, mutual or co-channel interference from another television station.

At this time, we are *not* asking for copies of your logs — we are simply trying to implement an *insurance policy* for the future — for your future use of the 50 MHz band, and like insurance, your logs may not be needed. However, it could well be too late after the event!!

Let's ensure that we are not just re-visiting 50 MHz, but are here to stay with the ultimate aim of recovering the remainder of the 50-52 MHz allocation.

It is all up to you now — the six metre operators.

Peter Wolfenden VK3KAU  
Immediate Past President

AR



# MICROPHONE EQUALISER — A Weekend Project No. 3

Ivan Huser, VK5QV  
7 Bond Street, Mount Gambier, SA 5290

I have long supported the concept of a station microphone mounted on a flexible goose-neck clear of the operating area. The graphic equaliser described in this article resulted from the need to improve the on-air 'sound' of an electret microphone used in this manner. I must admit that an electret was chosen more for its looks than its suitability as a station microphone.

As most will be aware, the human ear is somewhat insensitive to changes in volume but extremely sensitive to changes in pitch. That is to say, sounds of equal intensity but differing in pitch will give the impression of dissimilar intensity. Thus if those frequencies most essential to good speech communication are accentuated and at the same time non-essential frequencies attenuated, an overall improvement in the clarity of the transmission will result.

The use of a graphic equaliser allows the output from a microphone to be tailored to suit the characteristics of the human ear, the speech amplifier in the transmitter and the voice of the operator.

Figure 1 compares the frequency response of the electret microphone with that of a Shure 444D communications microphone which is well respected in amateur circles. The 'woolliness' associated with some signals heard on the air, may be attributed to some extent to the flat frequency response of the microphone or at least to a lack of high frequencies. High quality studio type microphones make poor communication microphones for these reasons. For effective communication, frequencies below about 300 Hz should be attenuated since they contribute nothing to the intelligibility. The mid range and high range frequencies should be accentuated.

## Circuit

A three-filter equaliser was chosen to give about 12 dB of boost or cut at approximately 400 Hz, 1.5 kHz and 2.7 kHz. Depending on the microphone used, some alteration to the value of input capacitor may be required to obtain a smooth roll-off at the low frequency end. Values as low as 0.01 uF can be tried in this position.

The three filter circuits are identical except for the values of the capacitors which determine the centre frequency of the respective filter. Different frequencies to those given may be obtained by using other combinations of capacitors. The resonant frequency (in Hz) for other combinations of capacitors (in uF) may be determined from the formula:

$$f_0 = \frac{15.9}{\sqrt{C_1 C_2}}$$

The on-board gain control has a range of approximately -10 dB to +13 dB allowing for different levels of microphone output. The input impedance is 47 k and the output impedance around 500 ohms which should suit most combinations of microphone and transceiver.

The ferrite beads provide some RF filtering, but additional filtering may be required depending on the installation.

## Components

All components are readily available. Resistors are 1/4 watt and the trim-pot a horizontal mounting cermet type. All polarised capacitors are tantalum, although ordinary electrolytic types should prove satisfactory.

The frequency determining capacitors should be of good quality and close tolerance if no facility for checking the centre frequency of the filters is available.

Components associated with the microphone bias supply may be omitted if a microphone other than an electret is used.

Construction of the printed circuit board should present little problem and a full-size pattern is given in Figure 3.

## Construction

The unit should be enclosed in a metal box to reduce the possibility of RF feedback. Leads to the potentiometers should be as short as possible and if batteries are used to power the equaliser, they should be located inside the box.

If an AC power supply is used, care must be taken to prevent hum loops and the entry of RF. I use a completely floating supply and extensive RF filtering with good results.

If the problem with RF feedback persists, extra filtering of the audio input and output leads may have to be employed. Feed-through capacitors of about 0.001 uF may be all that is necessary.

## Adjustment

Although no audio signal generator and an oscilloscope would be useful for checking the operation of the equaliser, it is not absolutely essential. If close tolerance capacitors have been used in the filters, the centre frequencies should be very near the calculated values.

The easiest way to get the feel of the equaliser is to connect it to the input of a tape recorder and adjust the boost/cut controls to various positions until the desired effect is obtained. Use these final settings for the initial on-air tests.

Connect the equaliser to the transmitter and adjust the on-board gain control to give the same output as is obtained from the microphone without the equaliser. A few minutes with the co-operation of a reliable

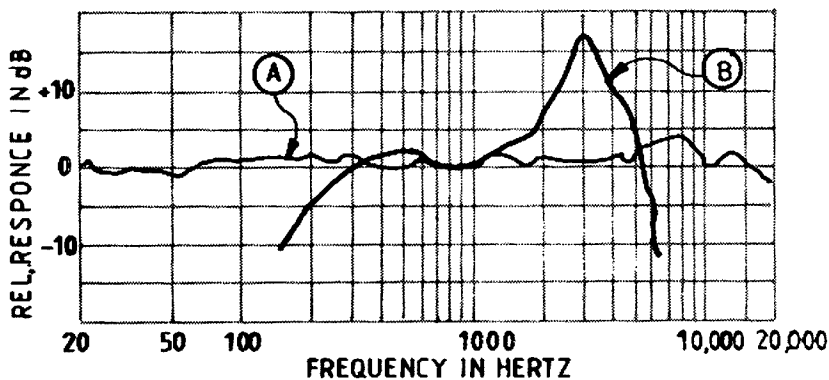

TYPICAL FREQUENCY RESPONSE

Figure 1 — (A) Electret Microphone (B) Communications Microphone (Shure 444D)

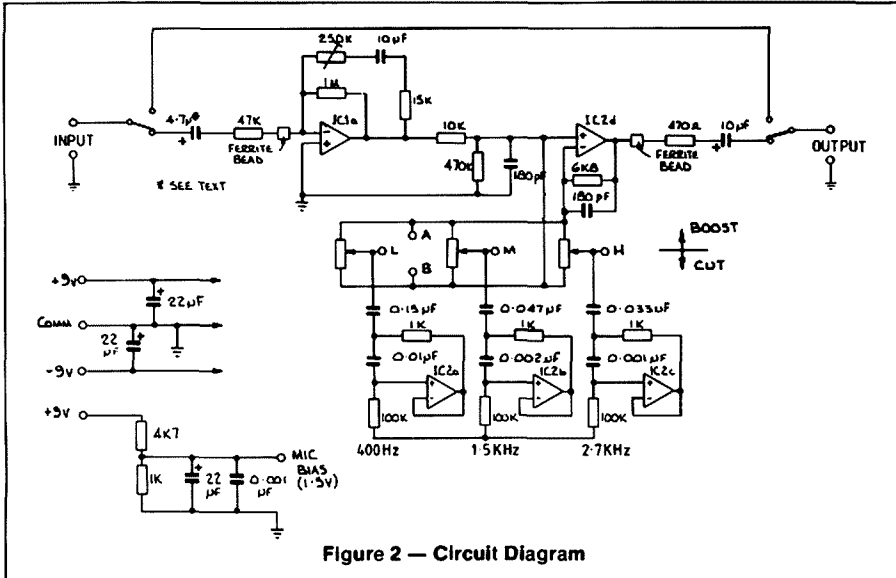

Figure 2 — Circuit Diagram

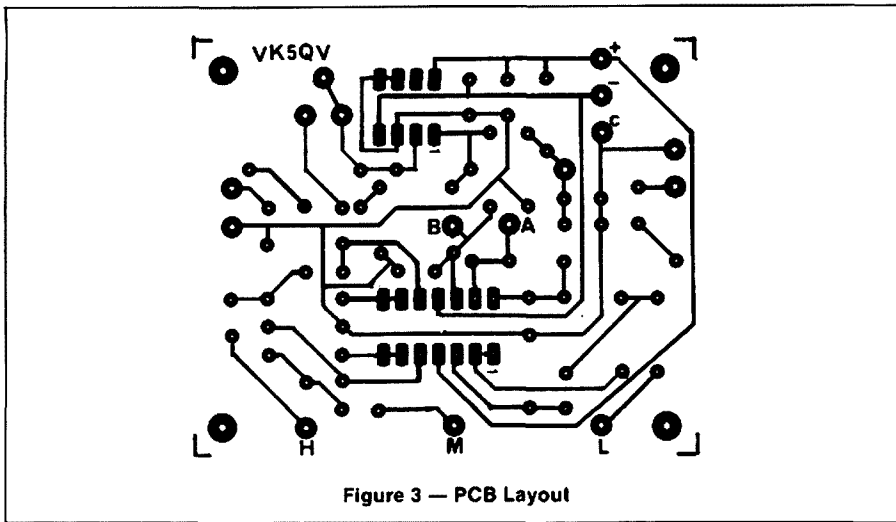

Figure 3 — PCB Layout

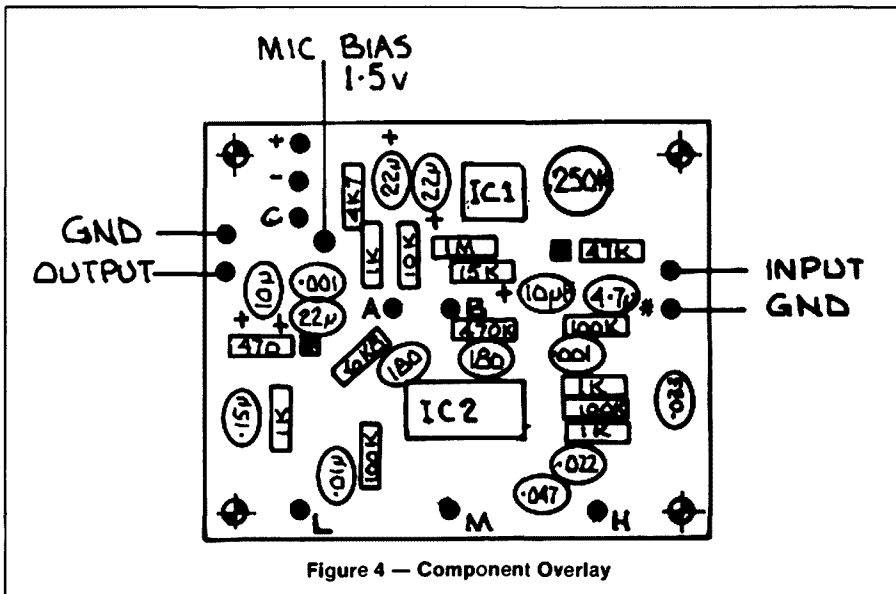

Figure 4 — Component Overlay

friend is all that is necessary for final adjustments to be made.

With my electret microphone, I use about 6 dB cut at the low range, 3 dB boost at mid range and 6 dB boost at the high-range.

**Component List**

- |                        |                    |
|------------------------|--------------------|
| 1/4 WATT               | 1 0.001u greencap  |
| RESISTORS              | 1 0.0022u greencap |
| 1 470R                 | 1 0.01u greencap   |
| 4 1k                   | 1 0.033u greencap  |
| 1 4k7                  | 1 0.047u greencap  |
| 1 6k8                  | 1 0.15u greencap   |
| 1 10k                  | 1 4.7u* tantalum   |
| 1 15k                  | 1 10u tantalum     |
| 1 47k                  | 2 22u tantalum     |
| 3 100k                 |                    |
| 1 470k                 |                    |
| 1 1M                   |                    |
|                        | SEMI-CONDUCTORS    |
|                        | 1 LM358 IC         |
|                        | 1 LM324 IC         |
| VARIABLE RESISTORS     |                    |
| 1 250k cermet trim-pot |                    |
| 3 5k linear slide pots | SUNDRIES           |
|                        | 2 Ferrite beads    |
|                        | 1 DPDT switch      |
| CAPACITORS             |                    |
| 2 180p ceramic         |                    |
| 1 0.001u ceramic       | * See text         |

**Finale**

This completes the trilogy of weekend projects. In the fourth and final article, I intend to present some ideas on how the three projects in the series may be combined in a station control centre.

**Notes**

- 1 *The Voice-band Equaliser* — R. Bradley *WB2GCR* — *Ham Radio* (October 1980)
- 2 *Graphic Equaliser* — *Electronics Today International* (June 1977)
- 3 *Linear Handbook* — *National Semiconductors*

AR

**1983 RD CONTEST**



Remembrance Day Contest 1983. Log keeper Peter Cameron, Operator Mike O'Burtill VK3WW.

Photographer Mrs L Beck, Burracopin, WA

# A Ten GHz Coupler and other Microwave Matters

Des Clift VK5ZO  
PO Box 274, Mount Barker SA 5251

The 3 cm amateur band (10,000-10,500 MHz) which apparently boasts thousands of QSO's per year in Europe, particularly in the UK and Germany, has received little attention from the amateur fraternity in this country.

As G3BAK, I was amongst the first to operate this band in the UK, having a QSO with G3LZ in January 1950 over a range of several miles. Ever since then the fascination of 3 cm has remained, even though the annual QSO rate has ranged from zero, to about ten in a particularly 'active' year. Equipment has been updated and practically all the possible arrangements have been investigated and tried out at some time. Sources of information on equipment for, and operation in this band are:

- The RSGB 'VHF/UHF Manual'.*
- 'Microwaves' — a monthly column in the RSGB's 'Radio Communication'.*
- The German quarterly 'VHF Communication' — available from WIA or direct.*
- A series by the writer in 'Electronics Australia' — May-October 1972.*

A few years ago, with the introduction of the 'Gunnplexer', a state of the art commercial local oscillator/mixer assembly employ-

ing a circulator, all seemed set for an increase in activity in Australia, as this unit provided all the bits that were normally too expensive to purchase new, or so difficult to acquire on the surplus market that all, but the most enthusiastic, tended to give the band away. However, this was relatively short lived as the price of these units has now soared to their true commercial value, around \$400, due to the manufacturer (Microwave Associates) altering their marketing policy on this particular item.

For some time I have been considering what could be done to fill the equipment gap, and finally got around to doing something about it over the Christmas break, following a visit from Frank Sleep VK4CAU who told of lots of interest in the Brisbane area, and, in particular, a desire to use the well known Philips Intruder Alarm Module, which has been sold in quantity for a number of years, and which is probably lying dormant in many a shack.

These modules contain a 10 mW Gunn diode and a high sensitivity video mixer in separate cavities, and normally operates on 10,525 MHz but easily tune down into the top end (10,350-10,500 MHz) of the amateur band.

A few rapid experiments prior to a second visit by Frank, a couple of days later, led to the production of a prototype on which a number of measurements were still required, but which appeared to be the best compromise for getting people on the band with minimum outlay, microwave knowledge or fancy test gear.

The idea adopted was to utilise both halves of the Philips cavity, as opposed to the use of only one half of two units operating as a separate transmitter and receiver, or the use of the Gunn diode section as a self oscillating mixer. It is not feasible to use the cavity in its normal configuration for anything but the most local of contacts.

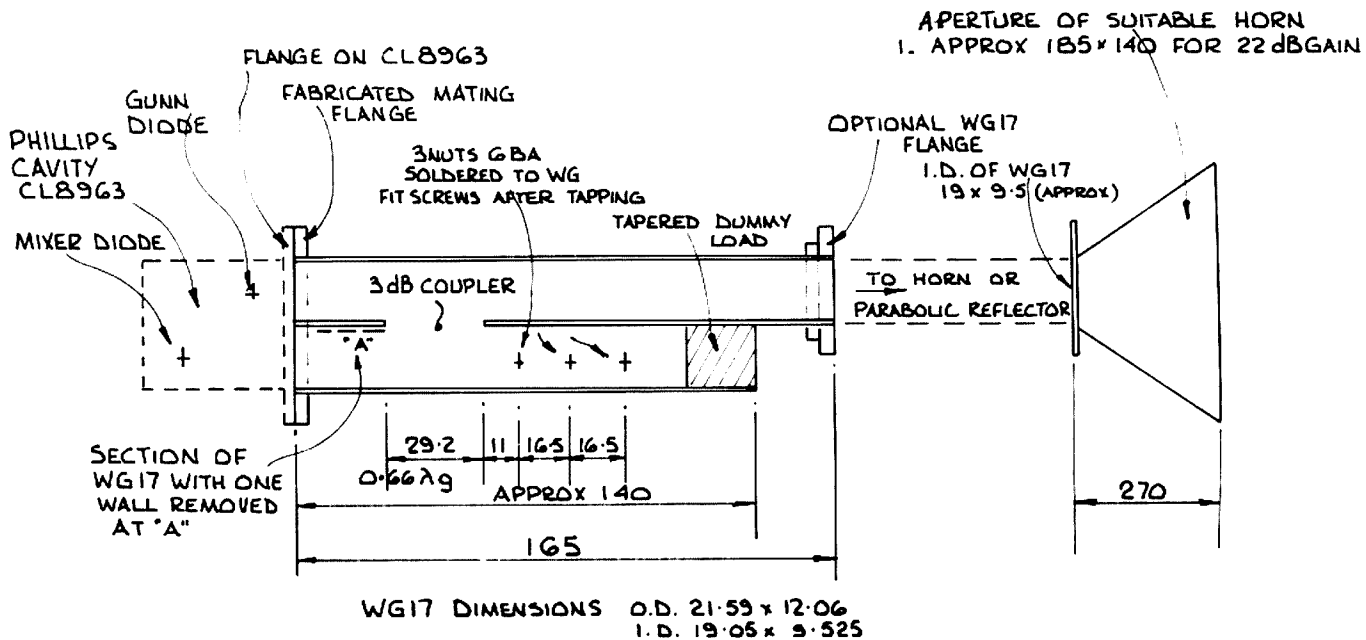

Fig 1 — 10.3-10.5 3 dB Coupler for use with Philips Cavity CL8963.



It was also decided at the outset to replace the Schottky mixer crystal by the standard X band IN23WE, as it was assumed, from bitter experience, that most of the original crystals in the units still around would be unserviceable anyway. The IN23WE is a better choice for the job of a high IF mixer (30 MHz or the FM broadcast frequencies are the standard), and is available at a reasonable price off the shelf.

Now the Philips cavity does not use standard X band waveguide (WG16), but is a diecasting with two outputs whose size closely resemble WG17, some of which I had obtained recently for experiments with the forthcoming Australian Satellite Programme. The use of this particular size of waveguide provided the answer to the problem of how to use the Philips cavity for serious amateur work.

When two pieces of WG17 were placed side by side they were only marginally larger than the Philips cavity flange, so why not separate the Gunn diode and mixer sections by means of a continuation of the Philips cavity in two pieces of WG17, and introduce the well known 3 dB coupler system as the means of providing duplex system operation with its inherent 6 dB system loss? (3 dB of the transmitted signal is lost in the dummy load in the mixer arm, and 3 dB of the incoming signal is lost in the Gunn oscillator).

The mating of the Philips cavity to the 3 dB coupler made from WG17 was made more accurately by removing one wall of one of the waveguides. This is normal practice when making 3 dB couplers of the type used and, therefore was most convenient.

The piece with the wall removed was used for the mixer section, thus allowing the unmodified waveguide to be used for connection to the antenna, either directly or as in the prototype — by means of a WG17 square flange.

The 3 dB coupling is produced by removing  $0.66 \lambda_g$  (29.2 mm) of the joining wall of the main waveguide, and the unused arm in the mixer section is terminated in a dummy load, in front of which is placed a mismatching screw tuner which is used to set the mixer current to about 0.4 mA-0.7 mA. A flange to mate with the Philips cavity flange was designed and fabricated and joins the two units together.

The antenna used for the prototype was a 22 dB gain horn made from cheap PC board. It was fitted with a home made flange to match the WG17 flange on the output of the 3 dB coupler unit.

In order to make sure the prototype was functioning correctly it was necessary to make up an adaptor from WG17 to WG16, which is the size of all the 3 cm test equipment at VK5ZO. Also, an adaptor from WG16 to one half of the Philips cavity was required and produced so that each of these halves could also be introduced into the WG16 test equipment. Some dummy loads of reasonably good performance were also essential, and in fact the fabrication of these bits and pieces and the test of the prototype took 20-30 hours, after the prototype itself was completed.

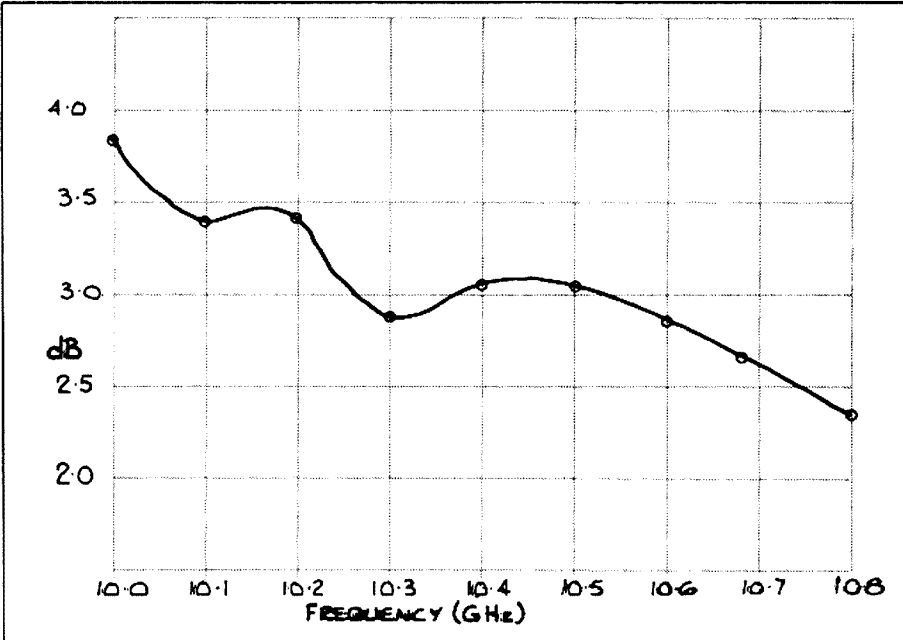

Fig 2 — Insertion Loss of Prototype 3 dB Coupler. (Unused arms terminated).

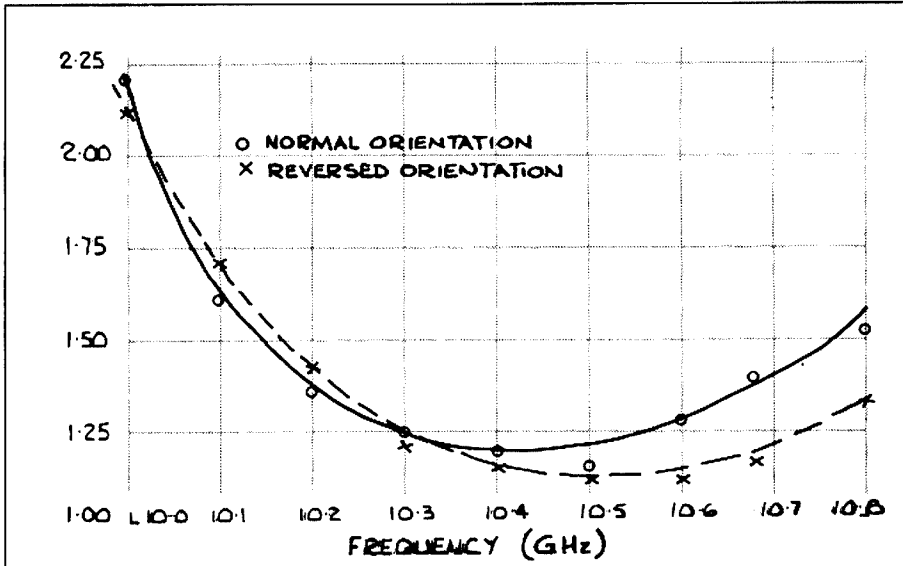

Fig 3 — VSWR of Prototype 3 dB Coupler (all unused arms terminated)

The results were as predicted, and showed the unit was perfectly compatible with the Philips cavity and was suitable for use from 10,300-10,500 MHz. In all probability it will be compatible with some klystron equipment on 10,100 MHz still in use at VK5ZO.

The two graphs, Figs 2 and 3, show the insertion loss and VSWR of the prototype coupler, and the drawing, Fig 1, gives enough information for the 3 dB coupling element to be reproduced. The insertion loss in these measurements was made under ideal conditions, with the two unused arms terminated. In practice both the antenna and crystal ports are not perfect matches, and the three screw tuner, of necessity deteriorates the other port. How-

ever, measurements made with the IN23WE in place showed that, as the crystal current was increased to the normal operating range the insertion loss of the coupler was very near to 3 dB (with the three screw tuner out of circuit the current was about 100  $\mu$ A and the insertion loss had increased to 4 dB).

Obviously this is a point to be borne in mind when adding an IF preamplifier at the crystal as a little forward bias may well serve to optimise the system by providing a useful variable.

In view of the difficulty of obtaining materials such as waveguides and flanges I have, through my own organisation 'Micro-wave Developments', imported a sufficient

quantity of WG17 and flanges to make about 20 sets of equipment, and have added the equipment to my product list. A complete set comprising a Philips Cavity, suitably modified and tuned to the amateur band, the 3 dB coupler assembly (described in the notes), and a 22 dB horn is listed at \$125 inc 20% Sales Tax.

I am also prepared to supply 300 mm length of WG17 plus a square WG17 flange for \$27.50 (including P&P & 20% ST) to those amateurs who would like to make up their own coupler to use with their own Philips cavities, horn or parabola.

To further assist those with no access to a frequency meter I will gladly, for the cost

of the return postage, retune anyone's Philips cavity to either 10,350, 10,380 or 10,450 MHz (allows for both 30 & 100 MHz IF systems) and replace, at my standard list prices, any unserviceable Gunn or mixer diodes I find.

AR

## JAPANESE DX?? ON HEDLAND 2 METRE REPEATER

It's not often that you hear Japanese spoken on 2 metres in Australia but that's the kind of thing you can expect in the North West of Western Australia.

The story started in July 1983, when Dave VK6YA first met Eisuke Yamamoto JA5FJD, a ship's radio operator on the "Shinryu Maru", at Wickham. This and other ore carriers often berth at the North West ports to load iron ore for the Japanese market. From that meeting approaches were made to Glen VK6KY, one of the local DOC representatives, to find out if Eisuke, a first class ships operator, was eligible to obtain a VK callsign. After much work on the part of the people concerned the application was made and approved.

On 23rd August, 1983 the "Shinryu Maru" berthed at Port Hedland where Brian VK6AIH and Dennis VK6CZ collected Eisuke and escorted him to the DOC office where the final papers were waiting to be signed to give him a full AOCPL licence.

The callsign issued was VK6EY, which apart from being a two letter callsign, (not common in Japan) was also his initials. The excitement of the occasion was contagious and with typical Japanese politeness Eisuke shook hands with everyone and with the biggest smile seen in a long time he trooped everyone outside to take photographs.

Later, on board ship with a borrowed 2 metre rig, a converted STC 151, Eisuke fired up with such enthusiasm that for a while he mixed his two callsigns.

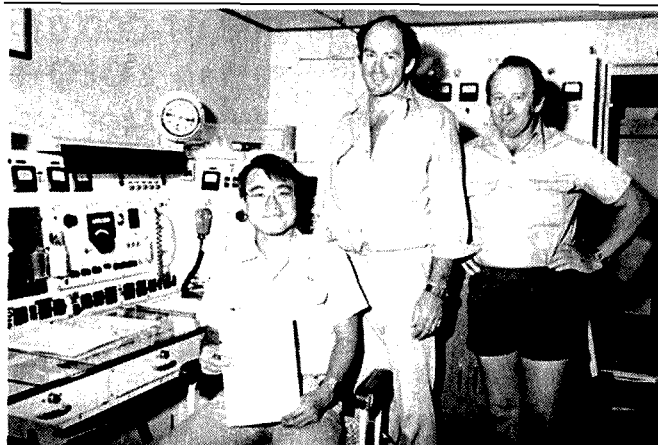

L to R: Eisuke VK6EY/JA5FJD, Dennis VK6CZ and Brian VK6AIH in the radio room of the "Shinryu Maru".

Then the Japanese language lessons started with lots of fun and learning all round. Fortunately the Wickham repeater was "in" so Dave, who did all the organising, was able to congratulate the "new" amateur.

DENNIS, VK6CZ  
AR

## BUTTERNUT ELECTRONICS CO.

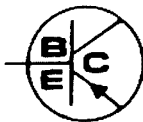

### Still More Usable Antenna For Your Money . . . Plus 30 Metres!

Butternut's new model HF6V\* offers more active radiator on more bands than any other vertical of comparable height. DIFFERENTIAL REACTANCE TUNING™ circuitry lets the 26' antenna work on 80/75, 40, 30, 20 and 10 metres and a loss-free linear decoupler gives full quarter wave unloaded performance on 15 metres. It can also be modified for remaining WARC bands.

- Completely automatic bandswitching 80 through 10 metres including 30 metres (10.1-10.15 MHz): 160 through 10 metres with optional TBR-160 unit.
- Retrolit capability for 18 and 24 MHz bands.
- No lossy traps to rob you of power. The HF6V's three resonator circuits use rugged HV ceramic capacitors and large-diameter self-supporting inductors for unmatched circuit Q and efficiency.
- Eye-level adjustment for precise resonance in any segment of 80/75 metres, incl. MARS and CAP ranges. No need to lower antenna to QSY between phone and CW bands.
- For ground, rooftop, tower installations — no guys required.

Suggested amateur net prices:  
model HF6V (automatic bandswitching 80-10 metres) . . . \$282  
Model TBR-160 (160 metre base resonator)  
(When supplied as part of HF6V) . . . \$88  
For complete information concerning the HF6V and other Butternut products amateur and commercial contact the sole Australian distributor.

**TAEGER DISTRIBUTORS (NSW) PTY LTD**  
PO Box 348, Moree, NSW, 2400.  
Cnr Adelaide & Chester Sts.  
Phone (067) 52 1627

\* Patented device

## VAINS ANTENNA SERVICES PTY. LTD.

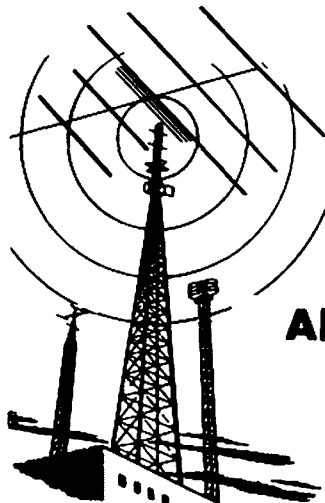

- ★ RADIO CONTROLLED VEHICLES — INSTALLATIONS
- ★ ADDITIONAL OUTLETS FOR TV/FM
- ★ REPAIRS TO EXISTING SERVICES

### ALL SUBURBS

- ★ PHONE FOR ADVICE
- ★ DO IT YOURSELF KITS
- ★ M.A.T.V. SYSTEMS DESIGNED & INSTALLED
- ★ TELESCOPIC MASTING & TOWERS INSTALLED

**874 3333**  
13 McKEON RD., MITCHAM



# EQUIPMENT REVIEW

## THE KB R-X NOISE BRIDGE

Ron Cook, VK3AFW  
 TECHNICAL EDITOR  
 6 Dallas Avenue, Oakleigh, Vic 3166

### WHAT IS IT?

A bridge is a circuit used for measurement of, for example, resistance or impedance. It is provided with appropriate terminals for an energising signal, the unknown resistance (impedance etc) and a null detector. When everything is connected up and switched on the bridge's measuring dials are adjusted until the null detector indicates a minimum reading or null. The value of the component is then read from the dials.

An R-X bridge measures R (resistance) and X (Reactance). It is therefore an AC or RF bridge and needs a null detector such as a wide-band voltmeter or a general coverage communications receiver.

If tests are made on a number of different frequencies quite a lot of time is spent setting up a modulated signal generator and the receiver on each frequency.

A noise generator can be used instead as it generates signals from DC to 1000 MHz or more. An amplifier is required to obtain a sufficiently strong signal. Remember that noise consists of signals of an almost infinite number of frequencies with both AM and FM modulation of random amplitude and frequency.

Thus an R-X Noise Bridge contains a noise generator, a wide band amplifier, a measuring bridge circuit and terminals for connection to the unknown impedance and a external sensitive receiver. Fig. 1 shows the circuit of the KB R-X Noise Bridge.

### WHAT DOES IT DO?

The major applications for a noise bridge in the amateur radio sphere are:

- 1 Measuring components at radio frequencies.
- 2 Measuring the impedance of an antenna.
- 3 Measuring the velocity factor of a transmission line.
- 4 Measuring  $\frac{1}{4}$  and  $\frac{1}{2}$  wavelengths of transmission line.
- 5 Measuring the VSWR of dummy loads.
- 6 Measuring resonant frequencies of antennas, tuned circuits etc.
- 7 Adjusting an ATU for a match without radiating a signal.

### MORE ABOUT THE KB BRIDGE

The KB R-X Noise Bridge is a small instrument suitable for use in the HF region for all the above applications. See Table 1 for the specification. Referring to Fig. 1, you can see that the noise generator is a Zener diode and that a three stage R-C amplifier is used to boost the signal.

A toroidal transformer is used to couple the

Frequency Range:	Over 100 MHz
Power:	9 V Battery, eg Eveready 216 Drain 25 mA $\pm$ 10%
Measurement Range:	Resistance 0-100 ohms Reactance 0- $\pm$ 100 pF

**Table 1 — SPECIFICATIONS**

noise into the bridge and also forms two equal arms of the bridge.

A variable resistor and capacitor in parallel form the measuring network. A fixed capacitor across the unknown impedance terminal ensures that the bridge can measure both positive and negative capacitive excursions. Negative capacitance corresponds to inductance.

The resistance dial is marked in ten steps of 10 ohms and the capacitor has zero marked at mid scale, XC to the left and XL to the right.

The resistance measurement range is 0-100 ohms although readings at the low end of the scale (10 ohms or less) would not be particularly accurate. The reactance range is  $\pm$  100 pF, negative capacitance being equivalent to an inductance of the same reactance.

That this is so becomes obvious when it is realised that increasing the capacitance of the X dial to give a null is resonating the inductance of Z and reducing the capacitance of X is withdrawing a similar amount as is in Z to retain a balance.

As an example if we find a reading of -50 pF at 26 MHz we can calculate the reactance of 50 pF at 28 MHz which is 113.7 ohms and then calculate the value of an inductance which has 113.7 ohms reactance at 28 MHz. This works out to only 0.646  $\mu$ H.

The bridge is fitted with a standard 9 V battery connector and a length of coax fitted with a PL259 plug for the receiver. The unknown impedance can be connected to a PL259 plug which will mate with the SO239 socket on the bridge.

The instrument is very small and displays good workmanship in appearance and finish. The operator's handbook has recently been revised and gives an adequate description of the bridge's operation and use.

### PERFORMANCE

The bridge was used to test some resistors, antennas and the tuning of an ATU. A Kenwood R1000 receiver was used as the detector. Although a receiver capable of operation without AGC action is recommended, no difficulties were encountered. The R1000 had a modified AGC circuit and was used in the AM mode.

The battery drain will cause the cheapest batteries to become flat quite rapidly. For tests where AC mains were available a regulated DC supply was used.

Frequency (MHz)	R100 'S'-metre reading (dB over S9)
2	10
3	20
7	30
10	25
20	15
30	5

**Table 2 — NOISE OUTPUT VS FREQUENCY**  
 "Z" socket open, controls mid range.

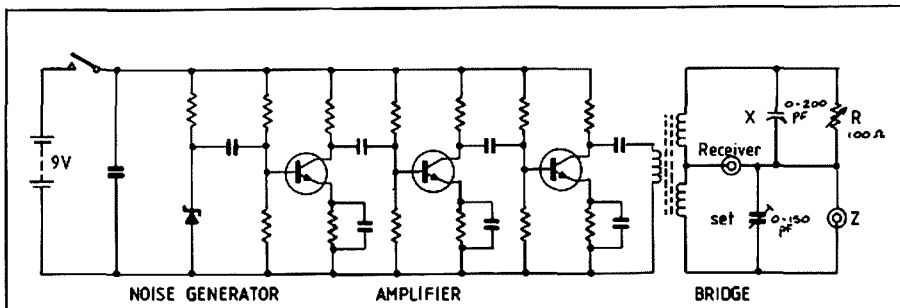

**Figure 1 — Circuit of KB R-X Noise Bridge.**

The "set" capacitor is used to set the "X" capacitor at mid range when the unknown impedance "Z" is purely resistive. It is set by the manufacturer.

Table 2 shows the noise output at various frequencies. No noise output was detected at 144 MHz. The noise output is quite adequate for most tests in the HF range.

Difficulty was experienced on 7 and 3.5 MHz when a trap vertical in a noisy location was measured. The power line noise was S9 and a good null was not possible. Very good nulls were obtained on 14, 21 and 28 MHz and calculations showed the resonant frequencies and impedances to be in good agreement with VSWR measurements.

The bridge was set to 50 ohms and zero reactance and an ATU used for adjusting an antenna to 50 ohms. The antenna was a G5RV and tests were made on 3.5, 7, 10, 14, 21, 28 MHz. The VSWR was then measured. It was close to 1.0:1 in all cases. The differences could be attributed to small errors in the VSWR indicator.

Further tests were carried out using a Wayne Kerr model B801 VHF Admittance Bridge for comparison. The results are given in Table 3. It must be borne in mind that the X values are estimated on the assumptions that the capacitance is proportional to knob angle and that the range is exactly +/- 100 pF. Differences of 10.15 pF are therefore not necessarily of significance.

Also, as the R dial is marked only every 10 ohms it is doubtful if the dial can be read to better than 1-2 ohms at best. Differences of 2 ohms in the readings should not be taken as

Test Frequency (MHz)	KB Bridge		Wayne Kerr Bridge	
	R (ohm)	X* (pF)	R (ohm)	X (pF)
3	45	-56	43	-41
7	46	-44	44	-39
14	47	-33	45	-32
21	49	-22	48	-28
29	55	-10	51	-22
10	35	-33	34	-20
20	60	45	77	48

**Table 3 — COMPARATIVE TEST FIGURES**

*Readings were generally within 10%. Best accuracy was obtained below 15 MHz; accuracy decreased from high VSWR and higher frequencies.*

*\* Estimated readings — see text.*

significant. Variations at low resistance values are to be expected due to the effects of resistor non-linearity and series inductance effects.

The results for tests below 15 MHz were, in a word, excellent. The performance at 30 MHz was very good for low VSWR impedances but noticeable errors appeared for VSWR greater than 2:1.

#### IN CONCLUSION

This is not a precision laboratory instrument and performance is therefore less than state-

of-the-art. The price is also very much less than state-of-the-art impedance measuring equipment. The measurements it will make are of a useful kind. It can be used instead of a VSWR meter and has the great advantage that you need not key up the rig. You can spend days tuning an antenna right alongside a DX net and no-one will be disturbed.

It is well worth considering as an addition to your test equipment.

The test unit was supplied by K. Bruce Smith, 110 Rosemead Road, Hornsby, NSW 2077.

AR



## TRY THIS

# VOX IN A BOX

by Joe K5JB

Did you ever think it would be neat to have a VOX, or voice operated switch, to connect between a headset mounted microphone and a rig to permit hands free operation; specially if it was self contained? Well, I did, and here it is. The ultimate goal was to have it packaged in a small box with self contained power supply that could be clipped on the belt. It could then be plugged into a talkie and hands free operation, at least for short range operation, would be possible on 2 m FM.

Unfortunately, the ultimate goal has not been met yet because I am still looking for a cute little box to put it in. The circuit design is complete enough to tell you, 'cause I couldn't wait.

Three sections of the LM 3900 are used to construct the VOX. Earlier attempts to do it with a mini-dip package containing two op-amps failed because there was insufficient gain available in one op-amp to get a workable switching voltage with the microphone used. Sections A and B, shown in Figure 1 are cascaded amplifiers with a total gain of over 400. The voltage from stage A is sufficient to drive the microphone circuit on nearly any transmitter. The 10 K pot allows for level setting. The output of section B is over 2 volts RMS when the microphone is whistled up. If output of stage A is insufficient to drive the transmitter, connect the 10 K pot and .33 uF capacitor to pin 5 of the op-amp.

The output of section B is rectified by CR1, a germanium diode, and C4 is sufficiently charged, during the first few voice sounds, to put the Darlington, Q1, into conduction. C5 is discharged to near ground potential by Q1 and this voltage is compared to a reference voltage by section C of the LM 3900. If the current flowing in pin 8, the inverting input of the op-amp, is less than the amount of current flowing in pin 13, the output

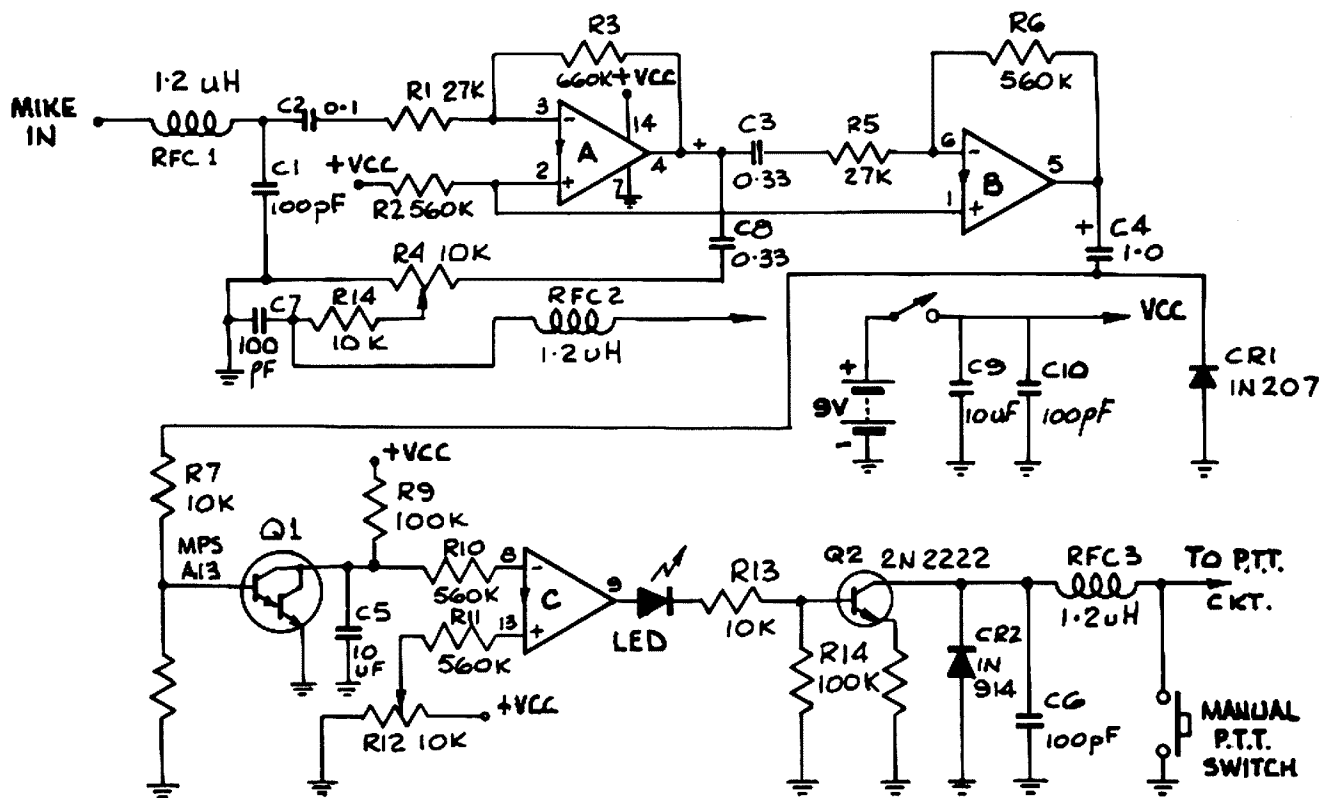

A B & C 3 SECTIONS OF  
LM 3900 OP.AMP

Figure 1. VOX circuit.

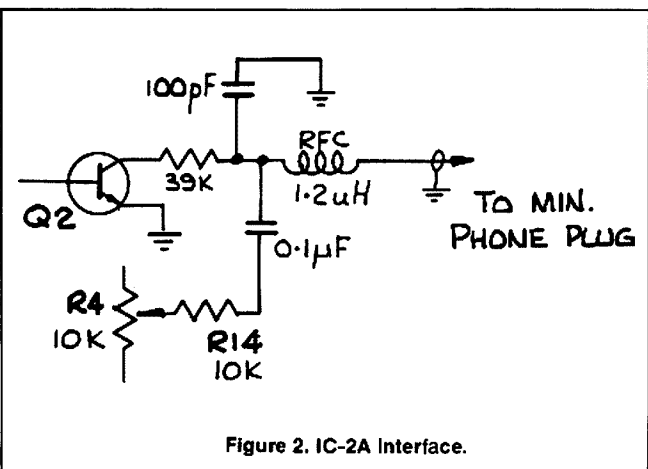

Figure 2. IC-2A Interface.

With the high amplification present, there are potentially serious problems with RF if the circuit is not well shielded or bypassed. Since my intention is to use it in a little box clipped to my belt, I added RFC 1, 2 and 3 and C1, C6, and C7 to keep RF out of the circuit. Since the circuit is battery powered, there is no special RF filtering in the power leads but if external power is to be used, BEWARE!

The microphone I am using has about 3000 ohms impedance. Most microphones should work OK with this circuit. If sensitivity is too high, R1 or R5 can be increased in value to get the desired sensitivity. R12, the hold time adjustment, was added because I was unsure how long I would want it to be, so I thought it best to leave an adjustment that can be diddled.

The connection to the rig depends on the microphone audio circuit used in the rig. In most cases, the connection is direct, as shown in Figure 1. RFC 2 is connected to microphone hot, RFC3 is connected to the PTT line and the grounds are connected. The Icom IC-2A has PTT incorporated in the mike audio circuit so these functions had to be separated as shown in figure 2. Transistor Q2 and pot R4 from figure 1 are reproduced in figure 2 to show alterations that allow connection to the IC-2A. The 39K resistor permits sufficient current to flow from the IC-2A to key the rig. The .1  $\mu$ F capacitor couples the audio from the amplifier to the mike audio circuit.

In haste to start typing, I forgot to measure the current flow when powered by a 9 volt battery. On 10 volts it draws 5 mA in standby, rising to 6 mA when tripped, a bit of a current hog, I would say, but I guess it will do. Now to go find that box.

Reproduced by arrangement from  
"Collector & Emitter" June 1981  
AR

# MORSE CODE TRAINER

Phil Grigg VK3APG

Lot 44, Glenburn Street, Newcombe, Geelong, Vic 3219



*An Erasable Programmable Read Only Memory (EPROM) is used to supply eight tracks of code. There are start, stop and reset functions together with volume, tone and speed adjustments. The code on each track is entered bit by bit, by column programming the EPROM. Each column is first written out on paper in the form of DOTS and DASHES and then entered into the EPROM by operating the programmer MARK or SPACE button. Each column takes less than forty five minutes to programme and can be stopped or started anywhere along the way.*

## EVENT COUNTER

To keep track of the column locations an event counter is used to count the marks and spaces as they are entered into the EPROM. Fig 1 shows how a calculator was modified to do this. First check if the calculator is suitable by operating keys + and 1 then operate the = key; once, twice, thrice, etc. Each time the display should read 1, 2, 3, ie increment by 1. If it does not, then try another calculator.

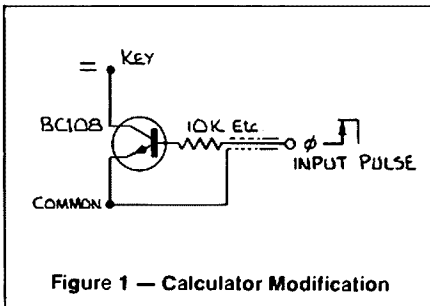

Figure 1 — Calculator Modification

## CONSTRUCTION

This device was built in two sections. One the programming section (fig 3), a flat top box with a cable and octal plug. The other the EPROM and power supply (figs 2 and 4). Viewed from the side the case is 40 mm

vertical to a sloping (35 degree) front panel then a horizontal top. An octal socket is mounted at the rear. The size of each box was made to suit the components on hand. An octal plug with shorting links (fig 4) was provided for use when programming unit is disconnected. Veroboard was used for mounting the components. Control panels were metal but the rest was wood, varnished on the outside. Both boxes had carpet glued underneath.

## POWER SUPPLY

The 50 ohm resistor in the 5V supply (fig 2) is there to reduce heating of the 7805 regulator. The 25V section is only required during programming and would have been mounted in the programming unit had a 10 or more pin plug and socket been on hand when the unit was made. Both regulators are mounted on heat sinks.

## EPROM COLUMN PROGRAMMER

See figure 3. S1 is a 4PDT toggle lever-action break-before-make switch. It is shown in the EPROM READ position. S2 and S3 were selected from a number of switch types. Some switches had contact bounce and mechanical defects and created spurious pulses. Those chosen were snap action micro-switches

fixed to a PVC block mounted on top of the programmer.

Some experimentation may be required here. The mark switch was mounted on the left and the space on the right. Two test points were provided for connecting a piezo oscillator, enabling operation to be checked prior to use.

## PROGRAMMER OPERATION

Operating S1 sets the EPROM to the DATA IN mode and the selected column will be the only one to be programmed. The EPROM DATA LINES all have an in built LOGIC ONE and during programming this is either left at ONE or burnt out to LOGIC ZERO. The selected column has LOGIC ZERO placed on its data line via Q8 (fig 4) and all unused data columns have LOGIC ONE placed on them via Q7. This is a must, otherwise all columns without it will receive the same programme. Operating the space key will start IC5 generating a 50 ms pulse. This pulse does three things. First, it prepares IC6 for operation via Q12 & 13. Second, it goes to the EPROM CE pin, burning out the logic one state. third, at the end of the 50 ms period IC6 starts, also generating a 50 ms pulse. This pulse advances the EPROM address one location via the binary counter, advances the event counter, and pulses the piezo oscillator to give an audible indication. Thus a SPACE has been entered.

To enter a MARK, operate that button. Upon its release IC6 starts, advancing the EPROM address one location; the event counter and piezo oscillator operate, leaving the vacated data line at LOGIC ONE.

If any mistakes are made with the data entered, they must remain, either to be decoded to another character or the entire EPROM memory erased with suitable UV light and programmed again.

## EPROM SECTION OPERATION

See figure 4. When power is turned on Q1 rests the binary counter IC1. Q4 switches on and all other transistors are in the off state. The EPROM IC2 is in the standby state with a HIGH at CE.

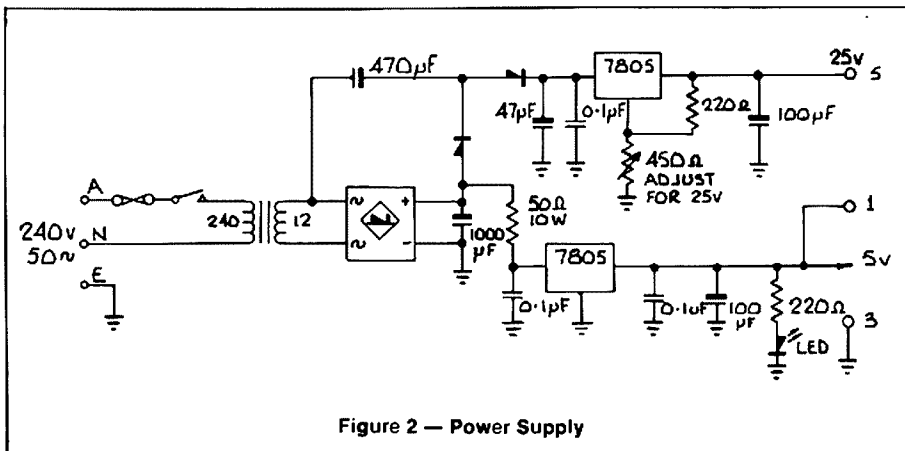

Figure 2 — Power Supply

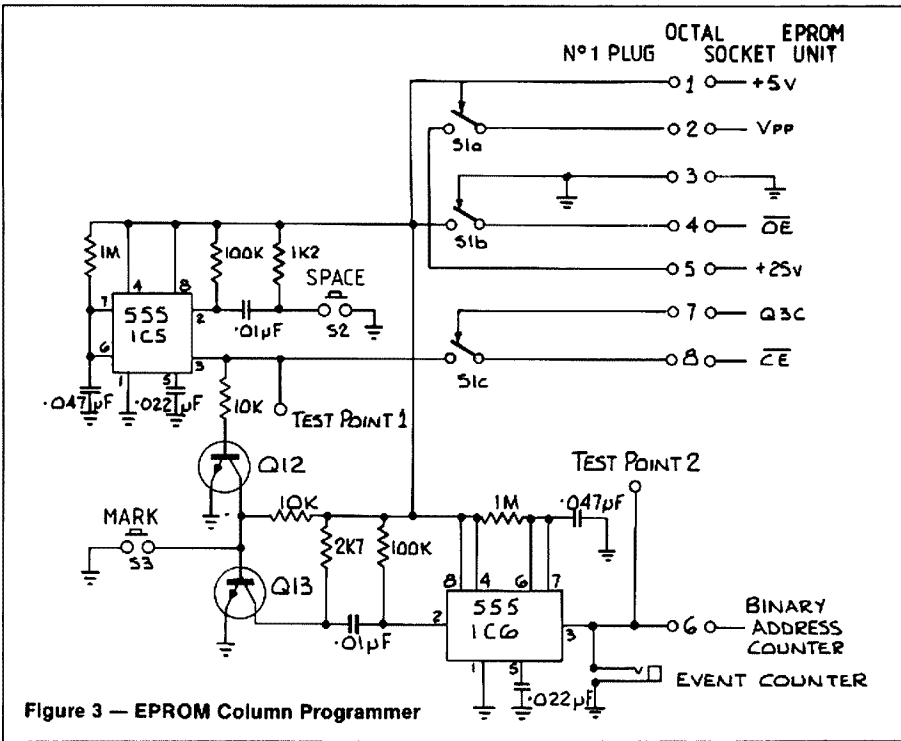

Figure 3 — EPROM Column Programmer

**PROGRAMME MODE**

Operating the programmer switch S1 places the EPROM in the PROGRAMME mode ie Vpp 25 V, CE to IC5 and OE 5 V which triggers the following actions, Q5 holds Q2 off, Q6 disables IC3, Q7 places a ONE on all data lines, Q8 disables IC4 and places a zero on the selected data column, Q9 prepares the clocking circuit and Q10 the piezo oscillator circuit.

**MARK**

Operating the mark button causes a clocking pulse to go via Q9 to shift the address and Q10 to give an audible signal. As CE remains at zero the EPROM internal ONE remains to form the MARK.

**SPACE**

Operating the space button produces the first 50 ms pulse which goes to CE and burns out the inbuilt ONE, producing a zero to form the space.

The clocking pulse from IC6 then shifts the address location and operates the event counter and audible signal. When the final address has been programmed the binary counter output Q11 goes to a ONE. Q2 is already held off, Q11 turns on and in so doing turns Q9 and 10 off. Clocking pulses are now prevented from passing to the binary counter and the lack of an audible signal tells you that

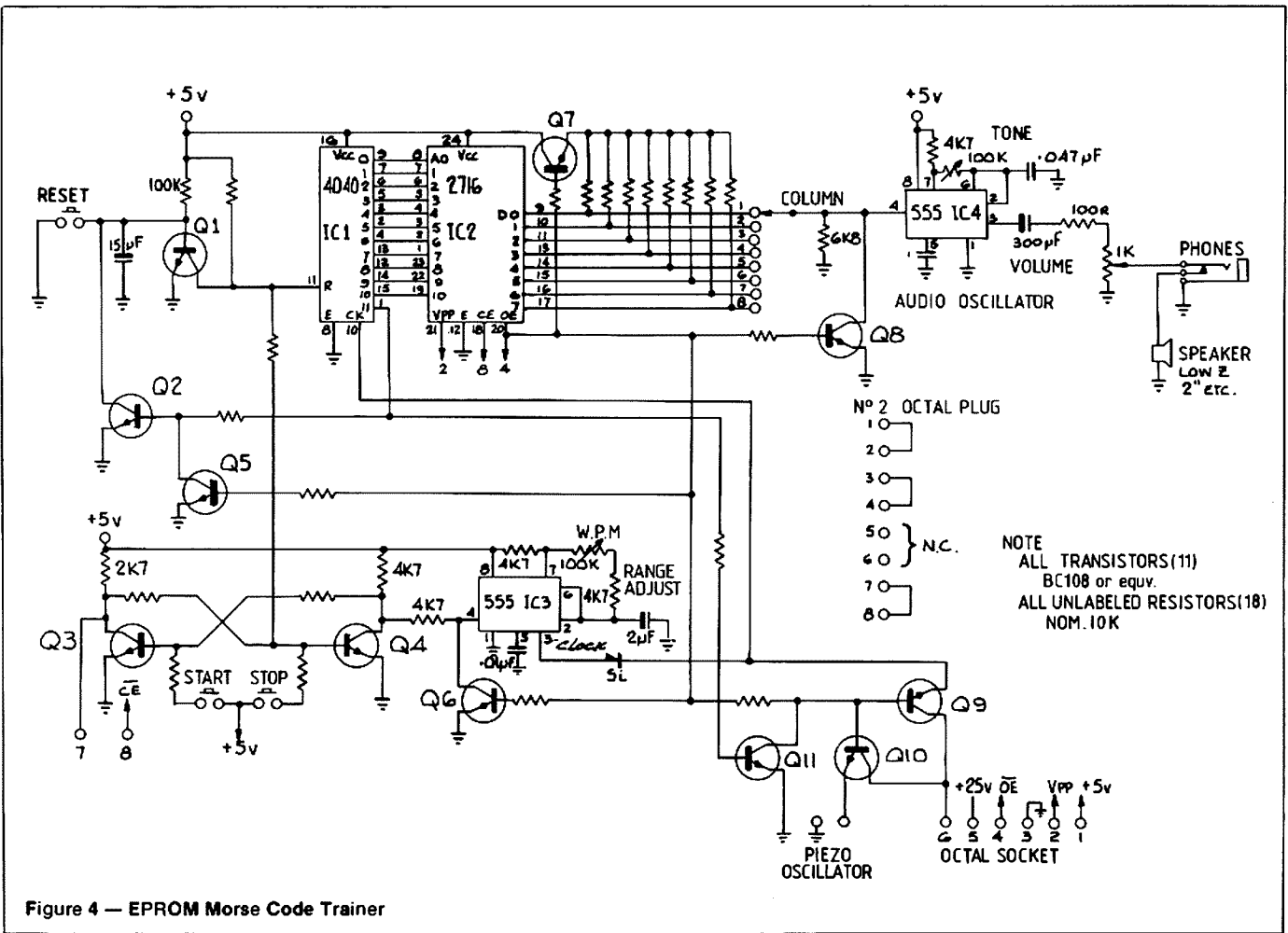

Figure 4 — EPROM Morse Code Trainer

NOTE  
ALL TRANSISTORS (11)  
BC108 or equiv.  
ALL UNLABELED RESISTORS (18)  
NOM. 10K

the column is full up. The event counter will still register, however this is of no further consequence.

## READ MODE

With the programmer switch S1 as shown in figure 3 or No 2 octal plug in place, the EPROM is standing by and drawing low current. Operating the start button turns on Q3 placing a zero on  $\overline{CE}$ . Q4 turns off and the clock IC3 starts, operating the binary counter. As the EPROM address is scanned the output of the selected column operates the audio oscillator IC4 thus producing the programmed Morse Code.

Operating the stop button during a read operation will change the state of Q3 and Q4; the clock stops and the EPROM is standing by. When the start button is again operated the code starts from where it was interrupted. After the final address has been reached the binary counter output Q11 goes to ONE, Q2 operates the reset circuit, IC1 resets, Q3 and Q4 change state and the EPROM goes to standby.

The reset button was provided to allow restarting during a read operation.

## COLUMN PROGRAMMING

Each column of the 2716 EPROM has 2048 bits or memories where the dots and dashes of the Morse code are placed. A dit uses one bit, a dah three bits, character spacing one bit, letter spacing three bits and word spacing seven bits.

At first a chart of the alphabet and numerals was made on paper with horizontal and vertical lines, each square representing one bit. The vertical columns were numbered and the bits consumed by each dit-dah combination were recorded at the end of the line.

It was found that one column of the EPROM would hold the alphabet and numerals three times plus  $\overline{CT}$  and  $\overline{AR}$  using variable letter spacing of 9, 9, 8, repeated. This was considered suitable for learning purposes and was used on the first two columns.

The first column was made with each character repeated three times, first the alphabet then the numerals all in sequence. The second column was jumbled, alphabet then numerals. The third column mixed letters and figures with a spacing of three. After this mixed groups of five with normal spacing (3 and 7). Several columns were held in reserve for future use.

To make programming easy each column was written out on paper in the form of sizable DOTS and DASHES, one character per line with a fine point felt marker, and then programmed into the EPROM. For example, for the letters  $\overline{CT}$  A one might think or say while operating the buttons,  
MARK MARK MARK SPACE MARK SPACE  
MARK MARK MARK SPACE MARK SPACE  
MARK MARK MARK SPACE 7 times MARK  
SPACE MARK MARK MARK.

Some practice is recommended before commencing actual programming using an audible monitor connected to test point 2 of fig 3.

Since completing this project in October 1982, I have found it a most helpful, enjoyable and a convenient method of keeping up with code practice.

AR



# Some More Adventures of Bill Blitheringtwit

Ted Holmes, VK3DEH  
20 Edmond Street, Parkdale, Vic 3195

## BILL GOES SHOOTING

At about 2 o'clock on a somewhat wild and blustery night Bill Blitheringtwit's steel pole, supporting the remains of his now defunct Slim Jim, suddenly fell down, bringing with it most of his wife's clothes hoist. Bill didn't discover this until he ambled out into his yard the following morning to see if his antennas were still up. He found that at least one of them wasn't.

Whilst staring generally skywards he observed several fat and happy pigeons sitting upon the feed point of his corroded copper wire dipole. They were perched contentedly around the casing of his home-brew balun and quite obviously intending to spend the rest of the day there, occasionally dropping friendly messages upon the roof tiles.

Forgetting about the ruins of the clothes hoist for a moment, Bill hurried into his garage and thrashed about looking for his air rifle and some ammunition. He found what he wanted and loaded up. He prided himself on being a good shot and aimed carefully in the direction of the innocent and unsuspecting birds.

He was in fact a good shot. Unfortunately, the weather degraded plastic casing of the balun flew into several pieces as the lead pellet struck it and the pigeons shuffled about, but stayed where they were. Bill fired off another couple of rounds, thus effectively destroying the balun but not even disturbing the feathers of the pigeons, who merely shifted their footing and cooed a bit.

Now he has no antenna at all. Slim Jim was a wreck, not to mention the clothes hoist. First things first. He decided to put up another dipole.

Two hours frantic searching amongst his deeply piled junk failed to reveal any suitable wire, apart from a reel of old fabric covered lighting flex. This would do. Out came a tape measure (stolen from his wife's sewing box) and pretty soon Bill had chopped two suitable lengths.

Now to get the old dipole down. Lucky he had put up a pulley and rope. No need to climb. He undid the rope, but the pulley was rusted up and the tattered remains of the dipole refused to come down. He tugged and the pigeons flew indignantly away. He tugged harder and the complete pulley came off the pole and plunged straight through the fibreglass roof of the outside verandah. The pole wobbled and started to develop a decided lean.

Bill's wife came out of the house just in time to see the pole fall slowly over and demolish the TV antenna.

Without saying a word, she returned to the house, followed by Bill, who was just about ready for breakfast anyway.

## BILL AND THE SLIM JIM

It was certainly a beautiful day. Not a cloud in the sky or a breath of wind. In fact, a perfect day to be outside and messing about with antennas. Bill Blitheringtwit, having consumed his daily breakfast of Weeties and toast, was in the jungle he called his garden and holding on to the end of a 24 ft. steel pole, wondering how he could stand it upright without causing too much harm.

He had made up his Slim Jim out of TV ribbon and a piece of plumber's plastic pipe and wanted to get it in the air and activate a few repeaters. Despite a lengthy search in the covered in rubbish dump he referred to as his garage, he was unable to find any suitable clamps to secure the antenna to the mast. So he decided to snip off a bit of fencing wire from the back fence. This would do, he thought.

As he snipped, there was a loud crash and, peering through the fence, he observed that a piece of timber, which the wire had been holding up, had fallen down squarely on to his back neighbour's bird bath, cleanly dividing it in two and almost decapitating a very surprised pigeon.

Nevertheless, he pressed on and bound the plumber's pipe to the steel pole, afterwards fixing the somewhat tattered coax. This he had found in his junk box. He didn't bother to protect anything with sealant — couldn't find it anyway.

Now he was ready. He wedged the far end of his pole under a rose bush — more like a bramble really — for purchase and started to walk the pole upright. The pole dug in and excavated the rose bush, which fell over. The pole continued on, rather like a plough, removing several other plants on the way and then neatly punctured the asbestos cement sheeting of his wife's laundry extension. Bill continued pushing and the sharp end of the pole then severed the power cord of a recently acquired washing machine which was working at the time. There was a flash and a bang and then silence.

An altercation with his wife interrupted Bill's destructive course at this stage but eventually he was able to get the pole upright, where the plumber's pipe strapped on the end wavered dangerously. He climbed into his shack and keyed up one of the repeaters, or so he thought.

His antenna didn't work at all. He scratched his head and tried everything. Of course, he didn't realise that you don't use grey plumber's pipe to make Slim Jims.

Instead he rang his mate and told him there was something wrong with all the repeaters. None of the rotten things were working!

AR



# A TRIBAND CUBICAL QUAD

Peter Hewitson, VK8PH  
17 Mackillop Street, Parap, NT 5790

Quad antennas are renowned amongst amateurs as effective DX antennas due to their low angle of radiation. The closed loops mean a quad is quieter than open-ended beams.

There are many ways to build a quad but the method described here is simple, effective, requires only one feedline and does not require tuning. I claim no originality for the design which is by W2AU and has been described in the ARRL Handbook. It has been in use at VK8PH, until recently, for about two years.

Spider hubs were obtained from Scalar Industries for about \$30 per pair and the tuning coils are available from William Willis & Co for \$2.60 each. Alternative materials for the hubs could be used but the Scalar units are recommended due to their strength and durability.

The spreaders were made from 1.5 m lengths of aluminium tube into which is inserted 4 m lengths of PVC water pipe. To give it strength and rigidity, identical lengths of dowel are inserted into the water pipe and fastened by suitable self-tapping screws through the aluminium tube. See Figure 3. The construction is strong but flexible and has survived cyclone "Max" in March, 1981!

Wire for the elements is No 14 soft-drawn copper wire and is threaded through holes drilled through the spreaders at the distances shown in Figure 1. The reflector is pre-tuned by counting the number of turns and soldering to pigtails as shown in Figure 2.

To prevent rain entering the open ends of the boom, it is advisable to seal the ends by means of a plug fashioned from a piece of 50 mm square timber or similar material.

A low SWR was obtained on all bands and expected forward gain is in the region of 7.3 dBd. At a total cost of around \$65 for all new components, it must be one of the cheapest DX beams around.

AR

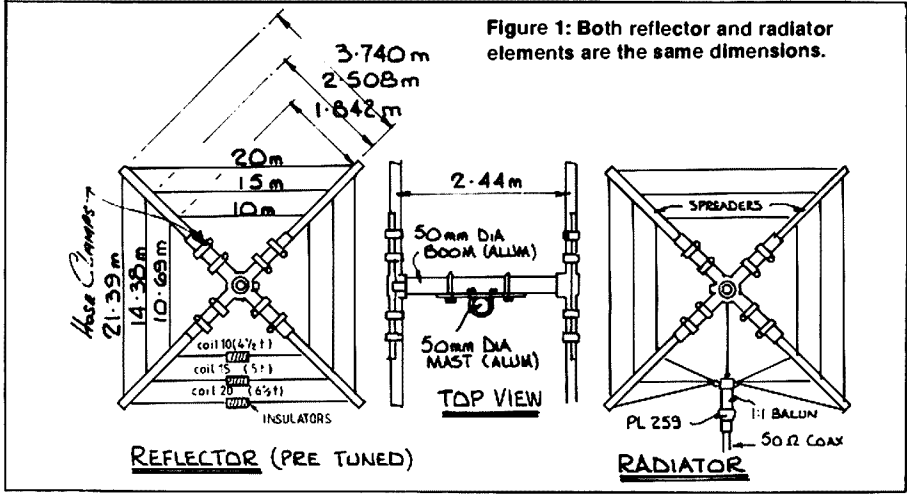

Figure 1: Both reflector and radiator elements are the same dimensions.

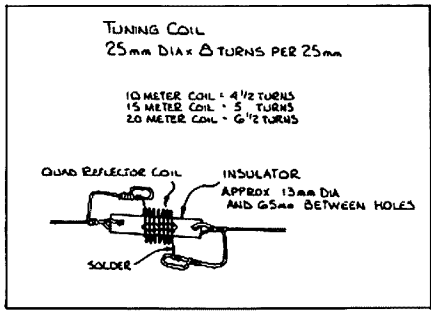

Figure 2: Count the number of turns and solder as shown. The turns are held rigid by the form.

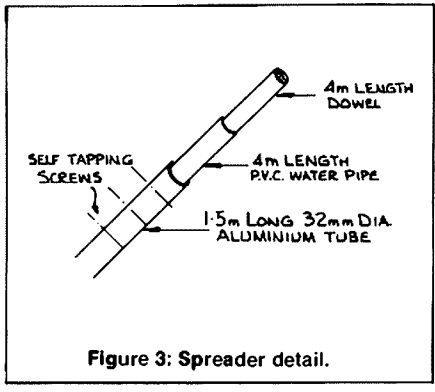

Figure 3: Spreader detail.

# MURPHY

Alan Shawsmith, VK4SS  
35 Whynot Street, West End, Qld 4101

Every amateur living, at one time or another, has toiled manfully against the wiles of MURPHY. Some never seem to be rid of him right up to the time they become SKs (God rest their poor tormented souls). All will agree he's a formidable opponent.

I have often wondered how this unwelcome 'spoiler' came by the name MURPHY — well, at last and quite by chance, I happened on the answer. DX is quiet these days, so I was idling away an hour reading a history of Ireland; curious I was to find out just why so many of these witty and charming people, bred on such a beautiful isle, would choose a life of violence and strife rather than one of co-operation and peace. (An 'all green' bucks party is a perfect example of this.) Suddenly I came upon a reference to the exploits of Murphy's ancestors — or one forebear in particular — so, let me explain.

First of all, it should be known that the Murphy coat of arms carries the outline of three lions. This symbolises, among other things, a great capacity and prowess for

destruction — and who of us would disagree, having seen Murphy at his worst or best! But why lions you may well ask? Well, it seems that Ireland was originally populated by successive groups of genetic misfits (the author's inference, not mine) from countries along the Mediterranean, who simply found it impossible to live peacefully with anyone and were consequently deported. (It would appear that the first Irishman was a Greek and Murphy was an Arab.)

They were thrown out of Egypt, Spain, Greece, Scythia etc. These tribes or groups headed west (come to think of it, there was no other direction to go), past southern England where it was reported the men were blue-skinned (but not from the cold) and settled in Ireland which was the last stop before falling off the edge of the world. As the place was uninhabited, they could resort to their favourite pastimes of killing, spoiling and indulging in a drop of grape at the drop of a hat — all of which they did in fine style!

Murphy's ancestors were part of the NIUL

clan, who may have worked along the river Nile as they had boats. They proved to be such a 'nit picking' aggressive lot, that after a disagreement with one of the Pharaohs (circa Rameses 11), they too were deported. They headed in the same general direction as those before, ie westward, fighting all along the way with anyone they could find. One tiresome day, a clan member named Murphy (but probably spelt Mer-fe or Mur-fi), bored to death with lack of action, went ashore on the African mainland just to stir things up a bit. And busy he was, like a waiter at an Irish Club on St Patrick's Day. Legend has it that by nightfall he had slain three lions, in one-to-one combat.

This same gentleman eventually made it to the Land of the Shamrocks, where it is claimed all those by the name of Murphy are directly descended from him. Hence the lions on Murphy's coat of arms and the genetic inclination to spoil and destroy. So, now you know — and if you don't believe it, read the book, "ARE YOU IRISH OR NORMAL" by Sean O'Grada. (Note the author's lineage to a Mediterranean race).

AR

# Operating Techniques and Hazards

John Aarsse VK4QA  
Box 597, Toowoong, Qld. 4066

First delivered at Redcliffe Radio Club, March 8, 1982.

Revised version at WIAQ General Meeting, Brisbane, March 19, 1982.

## TECHNIQUES

Listen on and around the frequency you wish to use;

Start tuning up your transceiver, BUT DON'T TUNE UP "ON FREQUENCY";

If you insist tuning up your transceiver "live on air", try to find an "official" intruder near the frequency you wish to use;

But . . . you'll be a much better operator and not liable for prosecution due to causing harmful interference . . . if you tune your equipment without causing all this trouble.

## HERE IS A SUGGESTED METHOD:

1. Tune your transceiver on the required frequency, USING A DUMMY LOAD (dummies are good for something).
2. If your antenna has an impedance of around 50 ohms and is tuned, you then connect the transceiver direct to the antenna and any fine tuning is done while you transmit. A pre-recorded tape containing your call followed by "TEST" would be ideal for a short fine tune up, especially if the tape is recorded at a speed of, say, 70 words a minute.
3. If you have to use an ATU, try to remember the settings you used on a previous occasion. For tuning, preferably use CW identification, at least you are doing a test, although the regulations state that you may use a continuous tone for not longer than 30 seconds. Some tune signals appear to last for hours on end.

By rights, an ATU should only be used if your antenna is not resonant for the frequency you wish to use, e.g., using an 80m dipole for 20m. Using an ATU with a beam is not exactly recommended and it only illustrates ONE POINT . . . you didn't resonate the beam on the centre frequency of your favourite section (S) of the band. And you'll be surprised to find out how many amateurs either inadvertently or on purpose keep the ATU in circuit if they switch from a non-resonant antenna to the beam.

## AND HERE IS A SUPER HINT:

If you insist on using an ATU because you have only a piece of wet string and want to save yourself a lot of time and irate flack . . . proceed as follows:—

On a quiet day, that is, if the band is dead or non-active, go through your frequencies, say, 3550, 3560, 3570, 3580, etc., tune up for each frequency and NOTE all the required settings on

your set AND the ATU. Do the same for the other bands . . . and you will not be far out when you change bands in a hurry, any fine tuning to be done while you speak or play that super fast CW tape.

## AND THIS IS THE SUPER DUPER HINT OF THEM ALL:—

Grab your March 1982 issue of "Amateur Radio" and read the article on tuning up for the visually handicapped amateur. It shows the proper way of tuning your system WITHOUT CAUSING INTERFERENCE TO OTHERS, AND YOU'LL BE SPOT ON. Try it and I promise you that you'll use it forever.

## PROCEDURES

WARNING: The discussion on "PROCEDURES" and "HOW TO HANDLE A SITUATION" may cause discomfort to some amateurs. The recommended rating for these two sections is "M" (for mature).

If the equipment is tuned up to specifications, then:—

1. Listen first on the frequency for any other user.
2. If no one "APPEARS" to be using the frequency, ask: "IS THIS FREQUENCY IN USE?", followed by YOUR CALL SIGN. Now . . . here is a catch . . . If someone does come back and tells you: "Sorry OM, but this frequency is reserved for the Billabong net, starting at X hours", please ask him/her for the address to write to, so that you too can reserve a frequency. The answer may stagger you!!!!
3. If no one does answer your "Is this frequency in use?" call, go ahead and use the frequency, although a word of warning, it appears that some VK areas are very deaf and will suddenly come on your frequency during a QSO and conduct their own. No solution has been found yet for this deafness problem.
4. When calling "CQ", please identify yourself a number of times "PHONETICALLY" so that others may hear your call sign correctly through static or local interference.
5. During a QSO, make it a habit to use phonetics at least ONCE per two or three overs. Others may wish to join you but, due to heavy static or interference, are not sure of your call sign, especially if the call is given "as she is spoken mate".
6. Regulations state that station identifications must be given at least every ten minutes, thus in a rag-chew conversation, over use of call signs between overs may seem somewhat superfluous. The word "over" to indi-

cate that you hand the mike over is recommended practice.

7. AND HERE IS A VERY IMPORTANT PLEA: Make it a HABIT, before commencing your over, to listen very briefly—no longer than, say, two seconds—for any possible station wishing to break in . . . it could be an emergency call. This happened to me a few years ago when, during a local net, a Cairns station called in—rather weak—to check propagation at that time into the Brisbane area during an approaching cyclone—SES in Brisbane could not be raised at that time. So it is worthwhile to acquire the habit of listening briefly in between overs.
8. Do not swear or use obnoxious words and/or expressions during your transmission.
9. When participating in a net, or wishing to join one, listen very carefully how it is run. Some nets require a return to net control after each over, others require that you pass the net over to the next in line. Whatever the system, always jot down the call signs of the net in the order as given by net control. A good controller will give the updated order every so often.
10. When using the telephony mode, try to avoid using some of the following Morse code abbreviations:—  
"Handle", use instead "My name is".  
"QTH", use instead "My location is".  
"QRM", use instead "Interference from another station".  
"QRN", use instead "Noise or static".  
"HI", use instead your own belly laughter.  
All this makes your conversation much more natural and enjoyable.  
EXCEPTIONS TO THE ABOVE (without them we would be lost):—  
When contacting an overseas station who conducts a QSO by reading from a sheet of paper, like I once did when speaking to an Italian station. Never again.
11. When contacting an English speaking overseas station, speak rather slowly and distinctly, especially when it is your first contact . . . and why should you do this???? First of all it is more than likely that they have severe interference from other local stations and, secondly, the Aussie language as she is spoken is world renowned for its slurr and pronunciation. You will get a lot more DX if those stations far away get to hear that VK4 such and such speaks understandable English.  
And now over to "HOW TO HANDLE A SITUATION" rated "M" (mature audience only), but could also be rated "X" (extreme caution).

## HOW TO HANDLE SITUATION

### 1. WHERE THE OTHER'S TRANSMISSION SOUNDS AWFUL:—

Tell him outright that he's got a problem somewhere and stay on frequency if an attempt is made to try and rectify the problem. It is often amazing to find out how many listeners there are who suddenly pop up with all sorts of illuminating advice. You could learn a great deal yourself, too.

### 2. WHERE ANOTHER STATION CAUSES UNDUE SPLATTER:—

Tell the station that his transmission appears to cause extreme splatter . . . and be ready to be abused . . . thank him for his remarks and try to find another splatter-free frequency.

If at some other time you hear the same station with the same amount of splatter, check in and ask him what troubles he has with his transmitter, as there appears still to be a large amount of splatter. If he is still abusive, act as described in the following section.

### 3. WHERE A STATION USES OBSCENE AND/OR OBNOXIOUS LANGUAGE DURING A CONVERSATION WITH YOU:—

(a) Listen (and tape record, if possible).

(b) Ask him to repeat the message as you had extreme interference.

(c) If he repeats his "typical language" don't come back.

(d) If a particular station is known for his use of this type of language, try to organise a group of fellow amateurs to join "sequentially", that is, as soon as you "don't come back", number two takes up and tries to make a conversation. If the person still continues to use his own lingo, number two falls out and number three comes in. Only a person with an elephant's hide will persist.

(e) If the person persists in using his lingo and all efforts have failed, each member of the group must write to the secretary of the Amateur Advisory Committee in your State, giving call sign, name (if available), time, frequency, type of language (preferably illustrated with tape recordings) and whoever else was on frequency as witness.

This is NOT DOBBING SOMEONE IN, it is part of self-policing your privileges. You could tell the person to stop using the language, but in nine out of ten times you'll get more abuse. I hate to say this, but in the past when CB was new some CB groups did some self-policing and for a while did clean up the frequency, at least in their own locality.

(f) The Amateur Advisory Committee is a liaison committee between amateurs and the Department, consisting of some eight to ten persons, of which at least three shall be non-WIA members, thus representing the non-member amateurs. Meetings are held every second month and observed or reported misdemeanors discussed. If a report warrants it, the offending station is cautioned by the committee (no further action is implied at this time). If the same station is reported for the second time, the person is informed that the matter has been referred to the Department for further action.

This committee is often accused of "not doing anything". It can't be expected to patrol the frequencies 24 hours a day just listening for any offences. If they hear one, sure that will be discussed and action taken. But if a complaint is received from someone else, then at least the committee can monitor that particular frequency at the approximate time. If one does not know of an offence, how can one take action????

### (g) WHAT IS OBSCENE OR OBNOXIOUS?

This is at times a personal matter, but normally swear words and specific four, five or six letter words are a big no, no. Bloody, damn or worse may be accepted in some sections of the community, but they are offensive to a much larger audience. If a person uses the word blooming or darn, at least he is trying to express himself "forcefully" without offending others.

**OBNOXIOUS:** Liable to harm or evil or attack; offensive, objectionable, disliked.

**OBSCENE:**

(a) Repulsive, filthy, loathsome.

(b) Grossly indecent, lewd.

The Concise Oxford Dictionary.

## WHAT TO DO WITH PIRATES UNDER NO CIRCUMSTANCES TAKE IT UPON YOURSELF TO TELL THEM TO GET OFF THE FREQUENCY BECAUSE:—

- Are they really pirates?
- Who gave you the authority?
- You breach the regulations by interfering with another signal.

### ACTIONS:—

- Take note of the frequency, name and tape record if possible.
- Do not answer a call from a suspected pirate.
- If it turns out that you work a pirate, TERMINATE QSO.
- Inform the Department immediately of the circumstances and include all details. They will answer you.
- Success rate is becoming more positive.
- Forget about overseas pirates, you have no way of knowing whether or not they are pirates, and if you know that they are pirates, ignore them and don't answer. However, you should report them to DOC, who will then take up the matter with the relevant administrations.

That concludes "Operation Techniques and Hazards". If you play the game, the game will treat you as a friend. If not, WATCH IT, MATE. ■

:: ::

Tactful Person: One who comes to your house and makes you feel at home.

:: ::

## SCROGGIE

From "Break-In" January-February 1982

Radio Classes are starting soon

So we'll start our study this afternoon.

Out came "Scroggie"—that veritable sage  
And we struggled on through page after page.

First came "Ohms" and his dratted law  
With Es, Is and Rs till my brain's quite sore.

Then came PI — no, not one to eat,  
The formula for power has near got me beat.

My RESISTANCE is low — my CAPACITANCE too,  
I'll be INDUCED to learn, for his REACTANCE is true.

"You do know the answer. You must do —  
You've read it!"

If that circuit's resonant, I've yet to get it.  
With Farads and Henries, and ohms by the score

And Gigas and Megas and Kilos — For sure.

I'll not remember the millis and micros and puffs

That drop past my circuits while I swot the stuff.

If I ever make it — to elusive Grade three  
Then comes that CW — OH! WOE IS ME!!!

Anon., Branch 42 ■

\* \* \* \*

## TUNE-UP SUGGESTIONS

The simplest method without too much interference. Initial tune-up with dummy load, then fine tune while speaking or sending CW.

Initial tune-up with dummy load. When connected through ATU to non-resonant antenna, try to remember previous ATU setting and do fine tuning then, when speaking or sending CW.

This is the main Non-Interference Method. Initial Tx setting with dummy load. Switch in antenna scope and set same for 50 ohms. Tune ATU for Minimum Audible (and visible) Dip. Fine tune Rx and retune ATU. You are now so close to proper tuning, it isn't funny. Remember: do not transmit while A/Scope is in circuit and prevent RF from coming into the scope at all. It takes some experience to get this set-up going, but once it goes, you'll never ever tune-up on air.

# IDEAS ON SIEMENS SERIES ONE PRINTERS

Dave Prince VK4KDP  
South East Queensland Teletype Group

**It is probable that most machines will be received without a line socket to match the connector on the rear of the machine. Because of this, some re-wiring is necessary.**

A feature of these machines is an auto-start switch termed the TIME DELAY MOTOR SWITCH. If a steady mark signal is received for more than about forty seconds the motor and printer will shut down. Upon receiving a space signal the printer will start up again. When shut down the printer may be manually started by pressing the LETTERS key. If an auto-start is available on the demodulator circuit board, this time delay motor switch may be replaced by a relay controlled by the Demodulator board.

These machines are fitted on the right hand side with a power transformer to power the 6 volt copy light. Two spare windings are also available on this transformer. One is 15 V and the other 60 V. The 60 V winding can be utilised to supply the loop, which consists of 50 volt at 40 mA maximum is required to operate the printer.

If it is planned to make use of this transformer for the loop, the primary winding will have to be reconnected on the supply side of the time delay motor switch (or relay if fitted) so that the loop current is maintained even if the motor has turned off.

Below are some ideas on connecting the MAINS WIRING, (assuming the transformer is required for the loop supply). One way is to remove the following wires from the rear connector and terminate them along with a three core lead to a four terminal barrier strip attached in a convenient place. The power lead can be bought out through the gap in the printer cover above the connector. To assist in rewiring remove the printer base plate by removing four hex head

bolts. Underneath the plate, will be seen, a series of terminal strips.

Remove the strap between terminals 2 and 3 and replace this between terminals 3 and 4. Now to the rear connector. Remove RED wire from pin b2, BLACK from pin b1, BLACK from a3, SLATE from a1 and GREEN from b4/a4. Reconnect these to the barrier strip as below.

Another way to wire the mains is to completely remove the abovementioned wires between the connector and the terminal strips under the base plate. The three core flex is then terminated on these strips. Again remove the strap between terminals 2 and 3 and replace between terminals 3 and 4. Place another strap (insulated) between terminals 2 and 5. The ACTIVE of the power cords is connected to either terminals 2 or 5, the NEUTRAL to terminal 1 and the EARTH to the earth termination on the printer chassis.

If the time delay motor switch is to be replaced by a relay, the switch wires are terminated on terminals 4 and 5. These wires will have to be replaced with the relay contact wires. As can be seen on the circuit diagram, the original line connector socket also contained links to series up the printer receiver, keyboard and tape transmitter. These links will have to be wired in either the connector or across the terminal strips. Two series of connections are shown below, the A & B pin numbers denoting connector pins (and the terminal numbers denoting the terminal strips).

LINK b11 to b12 (term 18 to term 22)  
LINK a12 to a13 (term 21 to term 19)

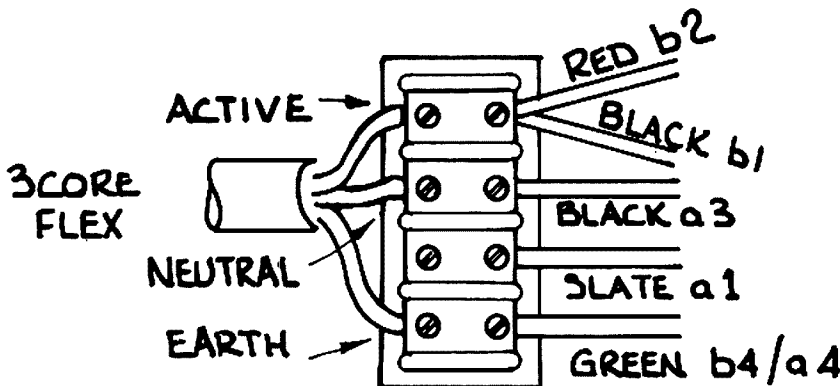

If an ohmmeter is placed across a11 and b13 (term 17 & 20) a reading of approx 310 ohms should be noted if the machine has a keyboard and tape transmitter fitted. If no tape transmitter is fitted a resistance of about 225 ohms will be measured.

I built the following loop supply, the bridge rectifier and the dropping resistor attached to a tag strip screwed to the top of the transformer, the capacitors attached to the printer frame next to the motor, and the preset pot and fuse fitted into the transformer cover. The positive lead was terminated on spare terminal 25 (or connector pin b5), the negative lead to terminal 20 (or connector pin b13). The loop cables from the demodulator are then terminated on terminals 25+ and 17- (connector pins b5+ and a11-).

The preset pot allows setting the loop current to 40 mA. When the printer is connected to the terminal unit (demodulator/modulator). If the South East Queensland Teletype Group demodulator board is to be used, resistors R59 and R58 will have to be changed to 120 ohms and 150 ohms respectively on that board.

A local loop can be set up on the printer temporarily by connecting a 270 ohm 1 watt resistor between terminals 25 and 17 (connector pins b5 and a11).

The next step is to put the motor on speed for 45.45 baud. I was fortunate enough to have a model 14 TD on 45.45 baud and played a test tape through the TD connected to the Siemens teleprinter and adjusted the motor governor until I was printing perfect copy. Once the terminal unit is connected the same trial and error adjustment of the governor can be done while receiving signals from 2 metres FM.

Adjustment of the governor must be done carefully. Remove the governor drum from the motor by undoing two screws on the outer end of the drum. The adjustment screw can then be seen at right angles to the shaft. (To line up with hole in side of drum.) The screw will be seen to pass through what is essentially a horse shoe shaped piece of metal being threaded in both legs. During assembly the two legs are squeezed together while the screw is screwed in. When released the legs tend to spring apart and tend to jam the threads thus stopping the screw from vibrating loose. The adjustment should be done with the drum in place being careful not to

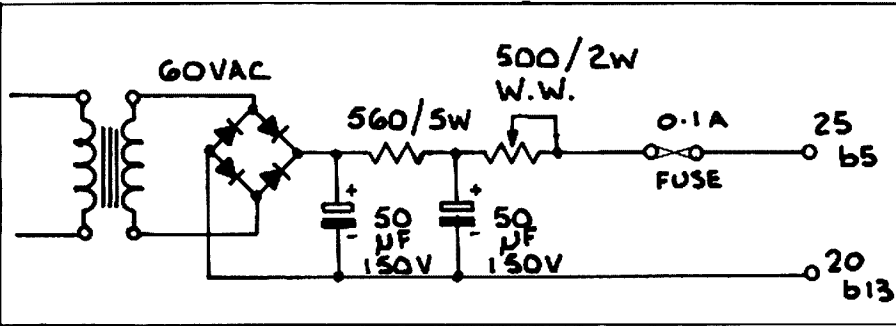

screw the screw out of the horse shoe legs. To reduce the speed from 50 baud, turn anti-clockwise. It does not appear at this stage that the number of turns required is the same for all machines. I had to unscrew mine 3½ turns. At 4 turns the screw came out of the horse shoe leg. BE CAREFUL.

It is not my intention that machines should be modified exactly as I have done with mine. These notes are only a guide. The experimenting is up to you. We would be pleased to hear of your 'modifications'.

AR



## PIONEERS OF THE SPECTRUM

### Part 1: THE DISCOVERY OF VHF

Stephen Gard VK2ESG  
Amateur Historian

*Few know, and fewer will admit, that much early experimentation, discovery and suffering in the cause of radio, was undertaken by diminutive Ukrainian peasant boys. Sitting alone, late into the afternoon, working by a guttering yak-fat candle, careworn and frail from cruel labour in the galena extraction plants, thin slips of lads would make the most stupendous advances in the science of electromagnetic propagation, before toppling from their orange crates to sleep, shivering, on a frozen stone floor. In this article, we salute one of the bravest and coldest of these goose-pimpled pioneers, A C Veeyacheff.*

Little Alexi Veeyacheff was born in 18-- in the town of T-----. His m----- and f----- were honest but poor, and tiny Alexi had to go out to work at the age of two.

The young Veeyacheff, however, was already rabid with the Raddiow Craze, winding his own coils of wolf-hair on reindeer-shin, and wrenching the whiskers from stray tabbies in order to hear the lurid day-time serials which slick Latvian marketing beamed over the borders.

Alexi spent much time fussing with the early cast-iron, pot-bellied valves, trying to discover "Veeyacheff transmission", as he shyly called it. The icy white nights were pierced with his shrill screams as his miniscule body became electrified. His thinning hair stood on edge; his face, scarred by radiation burns, twitched with concentration and an excess of amperes, but with every tremble of his scorched fingertips, the secret seemed to slip further from his grasp.

One day, when Alexi was four, his f----- presented him with a fine communications receiver, a magnificent instrument fitted with a new Western discovery, the Knob. Alexi was underjoyed, since the set required a supply in excess of the

local 7.4 VDC mains (on bad days in the town of T-----, electrons froze in the wire) but he hooked it up to his battery of borscht and bicarbonate accumulators and was soon delightedly listening to the Woodpecker. In those days, the Woodpecker was much fiercer, and had a bandwidth of some 18 Megalexis, but whatever was drifting about in the HF, MF, LF and BLF bands, the young Veeyacheff managed to hear it. He experimented with antennas, using sections of railway track, RSJ and angle iron, but found them inefficient on the F Layer and on the Heaviside. He tried several elements spaced along a boom, and cried "Array — I've found it!"; but his best results were achieved using a centre-fed wire inside a steel cage (now known as a Trapped Dipole).

Yet always at the back of his microscopic mind was the question, "What is beyond the edge of the dial?" Bravely he ignored the scoffing of critics, when he ventured an opinion to the boys breasting the counter at the local Tricksky Dicksky.

"Little radish-brain," they would laugh rudely, "beyond the edge of the known spectrum there be dragons and such-like!"

"Imagine transmitting at anything higher than 30,000 kilovodkas! You'd never get out of your own republic!" belched one.

"Just watch your steppe," grunted another.

"Oblast," muttered Alexi, determinedly.

That night, taking his courage in his hands, and a pair of stilsons, Alexi began to force the Knob on his receiver further to the right than he had ever dared.

What a lonely road is Discovery! The empty chatter of the 80 metre nets slipped behind him, the viciously snapping curs in the dogpiles on 20 metres, the Breakers and Thassa Big Four fraternity on 11 metres — on, on ever onward and upward. We are fortunate enough to possess his notebook, and some of his intense excitement can still be caught from the crabbed and crinkly Cyrillic characters who drink at the Saturated Octode.

"An unearthly crackle... a stellar hiss... here will be a good site for six-metre EMI... what is this, that breaks so sweetly on mine ear? I shall call it 'overdeviation'... Both can be heard on the uplink, yet do they use a repeater!... Beep away! Clearly, the doctor is playing golf... Police! Fire! Ambulance! Tow truck drivers!..."

Little Alexi's hysteria is infectious, and people are still scanning, but he was the world's first Radio Frequency Voyeur, and RFVs everywhere should be upstanding for 16 k of silence in memory of he who gave his life (he was never heard from again) and his name to the exciting VHF band, that men and women everywhere might enjoy, in peace and prosperity, the advantage of a mobile whip short enough not to catch in the branches.

(The next articles will deal with Nikoli Yuacheff and Vladimir Essaycheff, who owned bigger stilsons, and had larger knobs.)

QUM?

AR

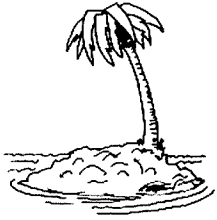

# HOW'S DX

Ken McLachlan, VK3AH  
Box 39, Mooroolbark, Vic 3138

During the last month much correspondence on varying subjects has arrived in the mail box. A number mentioned QSLing, including the whys and wherefores which have been dealt with previously in this column.

Apparently a lot of VK amateurs are ignorant of the facts a QSL card should contain for the recipient so that it is acceptable for awards and DXCC in all countries.

A card for another amateur must confirm a TWO WAY QSO in whichever mode it is issued, otherwise the card is virtually useless for DXCC and other awards.

Until recently, the ARRL unwittingly or otherwise allowed cross mode QSOs (SSB and CW) but this practice has now been outlawed and a QSO is only valid for award purposes in the one mode (CW to CW or SSB to SSB etc) and it is the responsibility of all operators to ensure that their card clearly indicates that the QSO was a TWO WAY by applicable mode.

Other information that is required is the date (day, month and year) and time in UTC, frequency in MHz and your report to them in RS(T) and the operator or QSL manager's signature or initials.

It is the duty of all amateurs to adhere to this policy, so that all cards are acceptable to any award manager. Let us in VK be beyond reproach in this regard with cards leaving our shores.

## KURE ISLAND

A new amateur on the island for the next few months is N2EDQ/KH7 who will be active on SSB and CW. All QSLs to KH6JEB.

## NO QSL BUREAU

According to Long Skip, the following countries have no QSL Bureau for distributing or collecting cards.

A5, A6, A7, BV, C5, C9, D6, HZ, J5, S9, ST, T2, T3, T.J, TL, TR, TT, TY, TZ, V3, VP2E, VP2K, VP5, VR6, XT, XU, XV, XW, YA, YI, YJ, ZA, ZD9, ZK2, ZM7, 1S, 3C, 3V, 3X, 4W, 5H3, 5U7, 5X, 7O, 9N.

Forty five countries, some not active, will have to be QSLed by the operators direction or direct, a costly experience since the increase of postage and a possible increase in IRCs in the near future. The method of "green stamps" is still the cheapest of the few avenues open to the average DXer.

## BANGLADESH

The attempt by JH1RNZ to actuate this much needed area was unsuccessful due to the military administration who will not allow amateur operations. This amateur is also a cardio-vascular surgeon in a Decca hospital, as was his predecessor JK1KSL who operated /S2. Another attempt will be made to obtain permission but hopes are not high.

## REPUBLIC OF GUINEA

It is believed, that QSLs from 3X4EX dated

the 6th June 1983 and after, will be accepted for DXCC. Contacts prior to this date will not count unfortunately with the ARRL.

## SUNSPOT INDEX DATA

Lee KH6BZF, in his publication KH6BZF REPORTS notes the Sunspot Index Data Centre (SIDC) Observatoire de Belgique, Bruxelles, Belgium reports that the provisional sunspot number (mean) for June 1983 = 90.6 as compared to May which equalled 100.2. The SIDAC goes on to report predictions of smoothed monthly sunspot numbers as follows for this month and December as being 74 and 73.

These figures indicate that propagation is unfortunately not going to be good!

## FRENCH POLYNESIA

A note from Ross WB6GFJ/FO0FB who has just returned from French Polynesia gives the QSL status of some of the FO operators.

A new import to the island is Jose FO0JD who used to operate 5T5JD and QSLs for either call may be had by an SAE to Jose Dumoulin, BP 85, Papeete, Tahiti, French Polynesia.

QSL information for other FO/TO calls please refer to the QSL lists.

Ross adds that anyone wishing to take out a FO0 licence can expect in excess of six months waiting before being able to operate.

One wonders, with the above information, how the two stations FO8BI/P and FO8JD/P could be genuine in their claim to be operational from Rapa Island, an island that would become a "new" country.

Rapa Island appears to be located near Tubuai Island, one of the southern areas of French Polynesia and it would not be acceptable to the DXCC scrutineers on current rules.

It succeeded in livening up the quiet DX bands for a while but it is something we could all do without, I am sure.

Jan and Jay O'Brien, who publish the W6GO/K6HHD QSL Manager List will be operational from Moorea as FO0JO and FO0OJ in the last two weeks of this month and the first week of December.

There is a possibility that operations will also be on 160 and 30 metres. QSL for Jay FO0JO to W6GO and Jan FO0OJ via K6HHD.

## ST KITTS-NEVIS

The Caribbean territory of St Kitts-Nevis ended its sixteen year association with Great Britain on the 16th September. Prefix hunters will be happy as the prefix is likely to change to J9. This action will unfortunately not create a new DXCC country.

St Kitts was discovered by Christopher Columbus in 1493, he named it after his patron saint, but in 1623 the name was shortened to St Kitts by English settlers. The name Nevis was derived from las nieves (the snows). Columbus thought that cloud topped Nevis Peak resembled snow.

## HIGH ACTIVITY

The small principality of Liechtenstein (61 square miles in area and located between Switzerland and Austria) was the scene of four DXpeditions during the months of September and October.

Those that operated included DL7NS/HB0 QSL to DL7NS, a French group comprising of F6EYS, EQG, HIX and GTC (QSL via F6EYS), Frank HB9NL as HB0NL and Franz DJ9ZB hoped to fire up during the CQ Worldwide DX Contest.

## MALDIVES

Due back soon after a holiday in G land is Iain 8Q7BT. Iain will be active on 80 thru' ten metres. QSL route is either direct to 8Q7BT, Cable and Wireless, Male', Republic of Maldives or to G4JMM via the bureau.

## DX IN ASIA

Tom YU2DX, was QRV from Kathmandu and Beijing earlier this year. Tom was in Nepal with the Yugoslav mountaineering team who were attempting to climb Mt Manaslu, and was in charge of the Kathmandu base station. YU2SOF was QRV from the group's base camp some 4050 metres up the mountain.

The Yugoslavian government applied for a 9N licence for Tom, but were turned down on the curious grounds that amateur radio is not permitted in Nepal. Fortunately Father Moran 9N1MM came forward to help and invited Tom to set up his equipment at the St Xavier School, 16 kilometres south of Kathmandu, where Tom was able to use Moran's antennas.

The mountaineering expedition ended in tragedy when two of the mountain climbers were killed in an avalanche. Tom was kept busy for a considerable time co-ordinating the search and rescue attempts.

This was not the first time that Father Moran's shack has been used as a communications centre. In 1963 an American Everest expedition, that en route to set up their base camp, encountered a horribly and near fatally burned Nepali lady in one of the villages. They were able to contact the US Embassy in Australia with their transmitter and from there, their call for a helicopter was relayed back to Moran at Godavari. Thanks to the whirly bird, and the men at the microphones, the woman's life was saved.

Instead of returning immediately to Yugoslavia, Tom, who had already received an invitation to operate BY1PK, was given financial support by the Northern California DX Foundation to fly to Beijing for a few days.

In a total of thirteen hours operating, Tom made 1210 contacts including USA-238, JA-243, YU-245, UA-22, OK-27, I-21, F-33, SM-35, VE-19, UA9/0-58, DL-75, OH-48, G-6 and VK-0.

Tom, why didn't you turn that antennae this way for the boys and girls down under?

## W-100-N

Quite a strange heading but it is the title of

World Radio's Worked 100 Nations award. VKs have not missed out on obtaining this excellent award and some that have achieved it and have it proudly displayed in their shack include VK6YL, VK6NE, VK2FD, VK3NSY, VK2DEJ, VK6AJW and VK2HD.

Congratulations to one and all for their interest in an overseas award.

**FIRE PREVENTION WEEK**

Those strange calls of ZV2ACZ and ZV2ADB emanated from Brazil and were for "Fire Prevention Week".

For QSL cards it might be worth trying PO Box 07-0004, Brasilia, DF, 70.000, Brazil.

**ALBANIA**

According to numerous reports, Frank DL7FT, who has, during the last few months, been busy getting donations ready for an expedition to Albania, has found that it is not a proposition this year.

Frank, it is believed, has returned all money donated towards getting Albania on the air this year to all the contributors.

None of the money was used and it is not clear why Frank and Bahri DJ0UJ cancelled their plans, perhaps the true story will come out later this year and we may have an expedition next year. Who knows?

**ICELAND**

A new station on the bands is Ted W3TB/TF from the US Naval Station at Keflavik. Ted will be active during his posting which is for two years and QSLs may be had from W3IVG, either direct or via the bureau.

**IRAQ**

It is reported that Y11BGD now has five operators to man the station and they should be more active than they have been. The operators names are Majid, Kamal, Saad, Mohammed and Arshad.

The equipment they use, a Drake C-Line and L4B Linear, was donated by JY1 whilst the antenna, a tribander came through the courtesy of two US DX associations.

This is one area where "green stamps" are of no real value and three IRC's are sufficient to get a return QSL mailed direct. There is no bureau in Iraq.

**AVES ISLAND**

All indications are that there will be an expedition there next year under the auspices of the Radio Club of Venezuela. The last expedition spent a lot of time working the South Pacific and it is to be hoped that the trend continues.

**SOUTHERN SUDAN**

A club station is now on air from Juba University — 6U0JU.

Also the call 6U1WCY is active until the end of 1983 commencing WCY83.

**JARVIS ISLAND — 5-10 November 1983**

JARVIS ISLAND, Central Pacific Ocean (0° 22' South Latitude, 160° 1' West Longitude)

A planned Jarvis Island trip is nearing reality. A suitable boat has been located and chartered by the expedition group. Jarvis (KH5) is located about 1200 miles south-southwest of Hawaii. It is a wildlife refuge administered by the US Department of the

Interior. 3.2 km long and 1.6 km wide, Jarvis is the home for hermit crabs, feral cats and up to 1.5 million nesting sea birds.,

The team of five operators will leave Christmas Island, Republic of Kiribati on 3 November, 1983 and expect to land on Jarvis by 5 November, 1983. Operation will be on all bands, 10 through 160 metres, with equal attention to CW and SSB modes. Three stations will operate 24 hours a day during the planned five day expedition. Linear amplifiers will probably not be used, but beams are being shipped via the chartered vessel.

The amateurs will be accompanied by a US government biologist, who will study the bird population and feral cat activity while radio operation is underway.

Operating frequencies of AD1S/KH5.

CW — 25 kHz up from band edge, LISTENING UP. Listen to operator for the correct frequency.

- SSB — 10 Metres — 28.600 MHz
15 Metres — 21.300 MHz
20 Metres — 14.195 MHz
14.295 MHz
40 Metres — 7.200 MHz
80 Metres — 3.795 MHz
160 Metres — "window"

LISTENING UP when conditions warrant. Listen to operator for correct frequency. Please do not "spread out" over the entire band!

Operators: George, AD1S, Stuart, WA2MOE, Burton, W0RLX and Stuart, H44SH (G6VUO).

QSL: Direct to AD1S.

**QSL MANAGERS**

3A2GX:I2YAE, 3B8LH:DL9AEJ, 3B8ZV:N6ZV, 3B8ZZ:W2TK, 3B9CD:3B6CD, 3B9FK:3B8FK, 3B9ZV:N6CV, 3C1JA:JA1LFR, 3D2AB:WB8WMS, 3D2BD:ZL1BD, 3D2DX:SM3CXS, 3D2EH:K8VIR, 3V8AA:IS0LYN, 3X4EX:N4CID, 4JIO:UK1OAZ, 4KIA:UA3AEL, 4K1B:UK6LAZ, 4K1D:UA1AFM, 4K1G:UA1XJ, 4K1KH:UA3AEL, 4K1J:UA1ADQ, 4K1QAV:UA1QAV, 4N4MW:YU4LL, 4N4NF:YU4LL, 4N4SA:YU4LL, 4N7ARG:YU7AJW, 4N9I:YU4EFR, 4N8WG:YU4GYZ, 4N9OLY:YU4EXA, 4N9YU:YU4YA, 4S7US:DF2RG, 4S7AJG:K9AJ, 4S7XSG:DL7XS, 4U7ITU:EA2CRX, 6Y5PL:G3SXE, 7X5AB:F6BFH, 7X5AH:F6BFH, 9M2BH:W6RIA, 9M2HB:W4FFW, 9U5DL:ON5QG, 9V0TL:9V1TL, A22MT:ZS6BDL, LA35MB:DF2RG, A82LC:SM4CWW, C30ALA:DL9UV, C30LAI:EA3BKZ, CE0ZAD:WB6WOD, CN8CP:DL8OI, CT2FH:W4JVU, EK0KA:UA90BA, EK1NBR:UA1NBR, EL0AT:WA3HUP, FM7CD:F5VU, F0ODF/TO0DF:WB6GFJ, F0ODF/TO80DF:WB6GFJ, F08HI/TO80HI:WB6GFJ, F08IW/TO80IW:K1CC, F08JP:F1BBD, FY0DD:W3BL, G4LJF/EA9VIA:G4DYO, H44MB:WA2MNM, I2DMK/IG9:I2MQP, JW1UW:LA Buro, KC4AAA:K9AUB, OK0WCY:OK2KGV, OX5JM:KL7GNP, P2PR:UP2BFE, S0SDCA:LA5DCA, T30AT:G3XZF, VK0GC:VK3RK, VK0PK:VK5APK, VK9WCY:VK9NS, VK9CY:G4MBF, VK9ZS:VK6YL, VP2MDB:W2WSE, VP2MFY:K5BDX, VP2MFZ:AK8W, VP5IS:K9DDB, VP5JEX:W4DR, VP5UYX:W4YU, VP8LP:G3VPW, VP8QE:ZL1BIL, VQ9AR:W3RR, VQ9CI:KA4UMB, VQ9GD:KA6MKY, VQ9IB:G6IJB, VQ9EH:WB8KYT, VQ9JD:N6AFD, VQ9MB:WA4YUY, VQ9PG:WB4MTE, VR6KY:LA7JO, VS5AM:JH1FHL, VS5DD:G4EFE, VS5GA:G4CCM, VS5MS:N20O, VU2FBT:JA7NJN, W6IAE/KH0:KG6RT, W6TEX/CT3:W6TEX, W9DCN/C6A:W9DCN, W9HI/J8:W9HI, WA6DJO/KH8:WB6HGS, WA7LUU/HB0:WB1DQC, WB0LQ/DU6:WB7EAE, WB5UW/VE1:VE1ABU, WB8JW/HP1:WB8ZJW, WD8QGQ/KH7:KH6JEB, XE1BGM:WD8NKY, YB0AET:PA0RYS, YB2DI:JH2QFI,

YB5AES:W4BBP, ZD9YL: W4FRU, ZF2AF:W0GI, ZF2GE:WA4WTG, ZK1XG:DB9CH, ZL1BIQ/K:ZL2HE, ZL3HI/A:ZL2QW, ZL4OY/C:VK3DWJ, ZL4PO/C:ZL4KI.

7Q7LW PO Box 24, Mtakataka, Malawi. 8P6OT PO Box 42B, Barbados. 9L1AC PO Box 10, Freetown, Sierra Leone. 9M2FR #5 Lengkok Cavendish, Ipoh, West Malaysia. 9Q5HK BP 9732, Kinshasa, Zaire. 9V1VP Bob Furzer, 12-01 Naga CRT, 355 Bukit Timah, Singapore 1025.

9Y4BA PO Box 1167, Port of Spain. A35JL PO Box 15, Nukualofa, Tonga. A6AQ PO Box 147, Ras Alkaimah, UAE. C21BD PO Box 225, Nauru, Central Pacific. C21RK PO Box 139, Nauru, Central Pacific. CE3YU Apto, 2115, Santiago, Chile. ED8EIA PO Box 898, Las Palmas, Canary Islands. FB8XY Maison Rouge, La Brueresur-Loire, F-72420 Vaas, France.

FO8HL Richard Ley, BP5872, Pirae, Tahiti. FO8HO Joseph Ina, 25 rue Yves Martin, Pirae, Tahiti. FO8KB Gabriel Lan San, BP 926, Papeete, Tahiti. H44SH PO Box 258, Honiara, Solomon Islands. HP1AFL PO Box 9152, Panama City. HZ1AJ PO Box 6177, Jeddah. JT1AS S Nyam, PO Box 639 Ulan Bator 13. KD7P/KH2 PO Box 2124, Everett, Washington 98203 USA.

OD5ZF PO Box 135892, Beirut. T2GSH PO Box 40, Funafuti, Tuvalu, Central Pacific. T30AC PO Box 443, Betio, Tarawa, Rep of West Kiribati. T30DB PO Box 457, Betio, Tarawa, Rep of West Kiribati.

TG9ET PO Box 115, Guatemala City. TG9VT PO Box 296C, Guatemala City. TR8CR PO Box 4356, Libreville. VS5HG, PO Box 980, BSB, Brunei. VU2AUS PO Box 148, Vasanthanagar, Bangalore, 560 052 India.

XT2BP PO Box 548, Ouadoudougou. YB7AK PO Box 15, Singkawang. YC2DNT PO Box 161, Solo, Java, Indonesia. YJ8IND PO Box 665, Port Vila, Vanuatu. ZK21K PO Box 37, Nuie. ZK2JS PO Box 37, Nuie.

ZL2HE Art Law, PB Mangatoro Dannevirke, New Zealand. ZP5JCY PO Box 416, Asuncion. ZS6AF PO Box 8628, Johannesburg, 2000, South Africa.

**WORKED ON THE EAST COAST**

28 MHz WB2QSY, WB5CNZ, XE2MX, XE2WNZ.

21 MHz 4K1B, 5H3DM, 6Y5IA, A4XHZ, C21RK, C02HS, EA80L, F08JP, J37AH, TL8ER, VK0RC, V09EC, V09JD, WA6DJO/KH8, WH2ADG, WLOR, XU1SS, YB0BEG, Z21GJ, Z23JO, ZF2GE, ZK2JS, ZS3JS, ZS5YN, ZS5YO, ZSAIS.

14 MHz 3X4EX, 6W8EX, 6Y5HN, 9V0UV, C21RK, C6ANU, C02HS, CT1FL, CT2CR, CT2FH, CT3BM, DL9WCY\*, EA9KQ, EL0BC, EL2AD, F9ER/FC, F08CX, F08JP, HA2KRP\*, HA500\*, HA60K\*, HA8KQX, HB9BAJ\*, JW1UW, KA7EKC/KL7, KC4AAA, KC4USV, LA1GF\*, LA1GW, LA5YU\*, LA7EU, LA8PF\*, LZ1BC\*, LZ2RF\*, OH3UN\*, OZ5KG\*, OZ8RH\*, SM3AZW, SM3AZW\*, SP40LWP\*, SP4AWE\*, TF3CU\*, T06HRI, TR8CR, UR2RIY, VK0GC, VK9ZS, VP8AEU, VS5DD, WH2ADG, YB3ARK\*, YB8ARM, Y06EX\*, YS1UL, YU2HDE, ZS3GK.

7 MHz 3D2DM, C21RK, CE3ELS, CP8GB, CP8HD, FROFLO, G3FRO\*, G3TMA\*, G10QR, KC4USV, KL7AF, KP4DEX/V2, OK2BFN\*, OZ1E0E\*, T12CF, VK2BCH/JH1, VP2VD, WH2ADG, YV38DS, ZK2IK, ZL4PO/C.

\* Denotes CW.

**WORKED ON THE WEST COAST**

7 MHz 6Y5MJ, DJ6S1/OH0\*, EA5CTX/HB0\*, EA8VV, G4LJF/EA9,

HZ1AB\*, LU80PM.

3.5 MHz  
VP8ANT\*

1.8 MHz  
VK9NS\*, ZS5BK\*, ZS68XB\*.

\* Denotes CW.

### INTERESTING QSLs RECEIVED

A35JL, D44BC, F08FO, SM5AQO, T2GSH, TR8IG, VE6CBN, VE7CXJ, VK0CW, VU2AUS, XE2ADI, YC2DNT, ZL3HI/A, ZL40Y/C, ZS6AF.

### CW SWLing with Eric L30042

28 MHz  
JA (MANY), KH6AQ, N6BJW, WA7BHK, ZL1JR, ZL1LT, ZL2QR.

21 MHz  
BY1PK (0700 UTC), DL1NR, EA7CMP, F6HNR/MM, F08JP, G4ETA, HH2VP, HL1ACW, KC6RN, KA8GWS/KH2, KH6BGE, LA4VL, SK3HK, T30AT, VE1LG, VE7SL, VS6HI, W1AW, WH0AAG, XU1SS, YU1KL, Y30ACF, ZS6BYG, 9M2HB.

14 MHz  
CT4TK, KF6ME/DU2, EA2ALW, G6ZY/EA6, FK8EV, FY7YE/FM7, F08JP, G44AM, HL1CX, HL9SN, HP1AW, IOJX, LA8PF, LX1BJ, LX/DL3MAB/P, LZ1ND, OX5JM, VE1ASJ, VP9DR, VU2BEL, W5RRR/NASA, YB4FN, YB5ASO, YB0AFA, YS1SA, YU4WKZ, 3B9FK, 4S7NS (1130 UTC).

10 MHz  
A35MS (1200 UTC), OK5CP, F6IFG/P, FC8TT, FK8DZ, G3TSA, HB9BCF, JA1XYB, JA5DQH, JA6HW, KH6DQ, VE1BB, VE2DC, W1FZY, W6KP, DL2GG/YV5, ZL0ADS, 9H1BB.

7 MHz  
CO2HT, CT1BNX, EA5SP, EA9JV, F60HB, FK8CE, F08JR, G6LX, GI3GAL, HA7UG/P, HB9BPP, HH2VP, HB0/F6EYS, HI3PC, KH6CF, KP2J, LX1PD, LZ2SC, OE6HZG, OK0WCY, SM6LQG/MM, SM0CCE, VE1AVL, VE3ICR, XE3ARV, YB5ASO, Y03BV, YU5CEF, ZF2DZ, ZL4PO/C, 4N9B, 4X6NKF, 8J1HAM.

3.5 MHz  
FK8CE (1100 UTC), JI1QPU, OK4AWQ/MM (2100 UTC), T32AF (1100 UTC), YU7JDE (2100 UTC).

1.8 MHz  
VK2BHO, VK2DPS, VK2DSG, VK3 (8), VK4WS, VK5AEP, VK5AFA, VK5KL, VK9NS (1100 UTC).

### RECENT QSL CARDS RECEIVED BY L30042

BY1PK, G6ZY/EA6, FG7BP, FK8EB, HR1RC, JA7EYL (10 MHz), P29BR, UA2FCB, UR2RKS, EX5UW0, VK9NS (1.8 MHz), YJ8LT, F08HD.

### THANKS

Assistance with the preparation of this column was gained from magazines including LONG SKIP, KH6BZF REPORTS, RADCOM, JAN and JAY O'BRIEN'S QSL MANAGER LIST, WORLD RADIO, QRZ DX, DXEXPRESS, VERON and the DX NEWS SHEET. Individuals who contributed included VK2PS, 3BY, FR, UX, YJ, YL, ABR, PNL, 6FS, HD, NE, PF and SWL 30042. Information from overseas included amateurs AD1S, G3NBC, ISAT, K6HHD, ON7WW, W6GO, WB6GFJ, ZL1AMN and ZL1AMM.

Thanks to one and all.

AR



# THUMBNAIL SKETCHES

Peter Brown, VK4PJ  
16 Bede Street, Balmoral, Qld 4171

hobbies was boating. Ben served in New Guinea during WW2 with the RAAF. Orchid growing is Ben's present hobby at Hopetown.



### BEN GRIMES 4BD 1926

Ben, born in 1901, is 82 years old. He spent his early days on 75 acres in Tarragindi, Brisbane, and was licensed 4BD in 1926. However like so many others he operated well before then, with a Ford coil etc. While at Brisbane Boys Grammar School he communicated with ships from the old National Bank in Stanley Street, the home of a school friend, Davidson, around 1914. Tuning was with two test tubes part covered with silver paper, sliding one upon the other.

Soon after 1926 Ben began broadcasting music from Tarragindi and appreciative letters from New Zealand attest to his success. Ben had successful contacts with West Coast USA, Hawaii, Peru and Europe, and attributed some of his success to the rolls of wire netting behind his antenna as a screen.

A newspaper item tells that "the power used was ten watts with a UX210 tube, power from a transformer connected to electric light mains, loose coupled Hartley circuit and home made chemical rectifier for DC. Aerial was a large horizontal cage supported on two fifty feet masts. Receiver a Reinartz 2 valve with one soft valve and one power valve."

A wool classer by trade, one of Ben's



### OSCAR "OCK" ALDER VK4JB 1929

Oscar was born in Brisbane, 1896, schooled at Eagle Junction and on to the Central Technical College to learn woolclassing starting at Jondaryn, in 1918, and moving through Isisford, Cunnamulla, Dirranbandi, Blackall and Wyandra.

"Ock" often took his radio gear on his travels, using 201A tubes fed from his car battery and a 90 V "B" battery to give him 1 1/2 watts by key. His antenna would be a wire over the nearest tree branch.

At that time "Ock" was a member of the Queensland Radio Transmitters League and the WIA.

He remembers the late Reg Vickary broadcasting descriptions of football matches, in the late 1930s, from Cunnamulla where Reg had a radio repair shop.

Transport, off the railhead, was often by buckboard and a team of horses and one sometimes got lost among the vast growths of pricklypear.

"Ock" kept regular skeds with Clive, VK4CC, then VK0CC, on Macquarie Island, in the 1920s, to keep Clive in touch with his home.

He cancelled his licence in 1971.

Woolclassing was set aside and he joined the Brisbane City Council Central Purchasing Branch for some thirteen years before retiring in 1965.

Many Happy Returns for your 87th birthday "Ock".

AR



## JOIN A NEW MEMBER NOW!



# DX'ING TO "G"-LAND???

## THOUGHTS FOR THE NEWCOMER

Jim Swan VK2BQS  
PO Box 93, Toongabbie, NSW 2146

**Originally, it was thought that an analysis of all successful DX contacts might provide some interesting patterns, however, the complexity of such a task is mind boggling so it was decided to deal only with contacts into the United Kingdom.**

Contest contacts were not included in the survey, the majority recorded being SSB with a small number of RTTY. Most QSO's were of the rag-chew variety, ranging from fairly brief to very extended duration. Operations were almost daily, usually from half hour to two hours depending on circumstances, as being retired, my non-radio activities are extensive but not to any set pattern.

The graph does not purport to be representative of ionospheric conditions alone, as many other factors must have some effect on results, such as changes to daylight saving time at each end, seasonal weather conditions, holiday periods in UK, individual habits, etc. Almost five hundred QSO's over a five year period were included in the figures.

In the graph, the broad-hatched columns represent "G" contacts, the narrower solid extensions represent contacts with "GM, GW, GI, GD, GJ, GU". Looking at the results, two variations appear which can be explained fairly easily:

- 1 The December peak is probably due to my habit of calling into well-known stations to exchange festive season greetings.
- 2 The August trough is probably caused by the UK holiday season when the country almost closes down.

What I cannot explain is the July peak. Logically this month should have been almost on a par with August. I am inclined to think that it may be that July is the month in which major equipment changes take place in my shack due to the cooler weather and that this increases total operating time. However, I have no proof of this!!!

If a plot is made of contacts only of other than "G" stations, a less significant result is obtained, probably due to the small sample and/or the geographical scatter of the "GM to GU" calls listed above.

Old timers will not gain anything from this exercise, they probably know the position instinctively, but for the newcomers, what it does suggest is that if you want to work "G-land" from VK, the best months are March/April/May and July??/September/October, ie VK autumn equinox plus a few weeks and spring equinox plus a few weeks, with some consideration also to the July funny.

AR

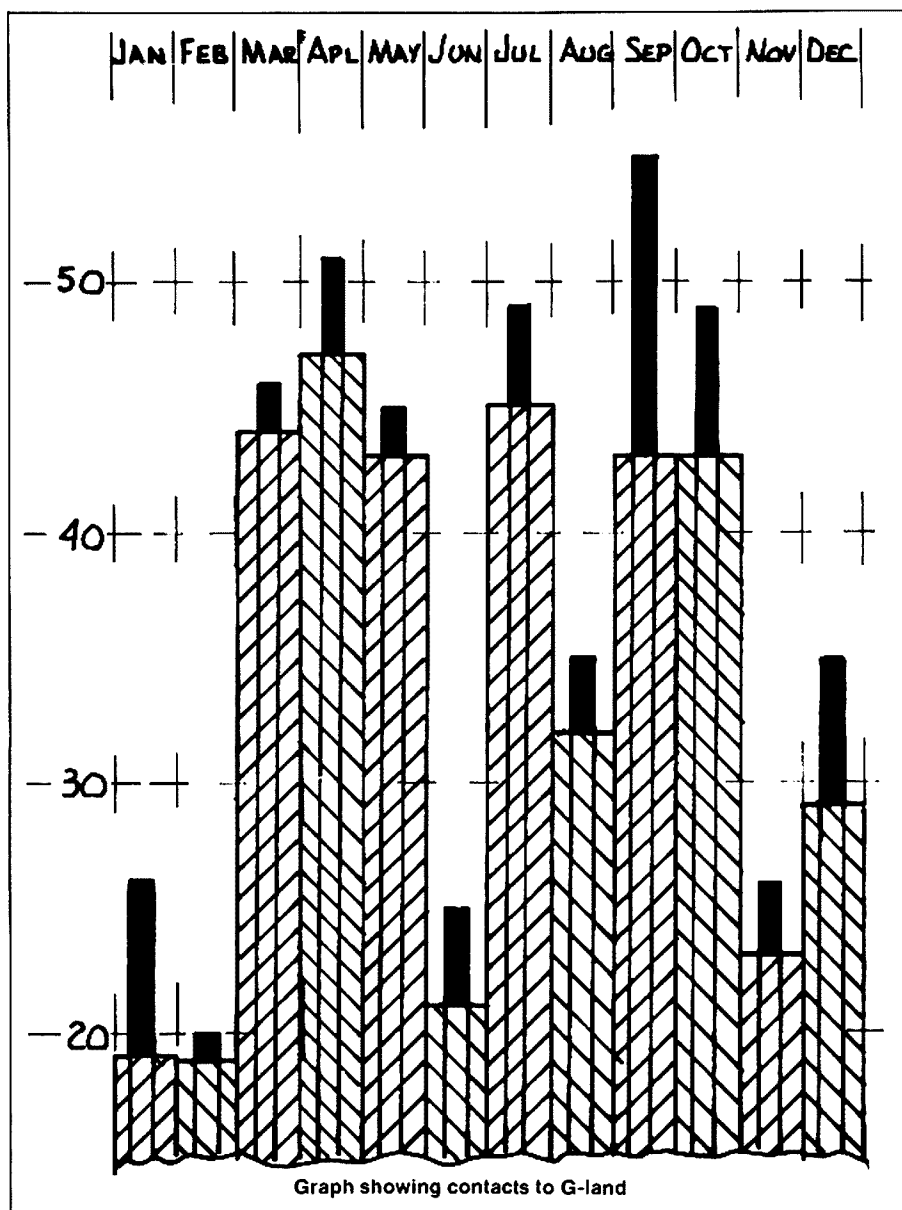



# AWARDS

Mike Bazely, VK6HD  
FEDERAL AWARDS MANAGER  
8 James Road, Kalamunda, WA 6076

Some months ago I wrote about the possibility of introducing a new DXCC Certificate with band/mode stickers. At the present time the decision on the format of the new certificate is with Federal Council. As soon as a decision has been reached I will go ahead with obtaining stickers and notifying members, through this column, of the application procedures.

Hopefully we can get this one on the road by the 1st January, 1984. Has anyone got any information on the "National Parks Award"? If you have I would appreciate details and, if possible, a sample copy of the certificate.

## YUGOSLAVIA

The "OSIJEK" award commemorates thirty five years of amateur radio in the city of Osijek. The award is open to SWL and licenced amateurs with the usual GCR list applying. The cost of the award is 5 IRCs or \$2. Australian stations are required to contact five stations in Osijek and/or Cepin, Dalj, Laslovo and Josipovac. The award measures approximately 40 x 20 centimetres and is printed in red, blue, beige and black. Applications should be sent to: Kruno Feric, YU2OM, via B Kidrica, 102/12, 54000 Osijek, Yugoslavia.

## AUSTRALIA

The rules for the Moorabbin and District Radio Club Award are as follows:

1. This open award is available to any licenced amateur who has submitted evidence of two-way contacts with MDRC Station VK3APC, and/or member stations, identifiable by call sign and number, and to any SWL who submits evidence of having heard

**MOORABBIN & DISTRICT RADIO CLUB**

## Moorabbin Award

**MELBOURNE** • LILYDALE • WARBURTON

MEREDITH • ANAKIE • WERRIBEE • MOORABBIN • NOOJEE

### VK3APC

INVERLEIGH • CORIO • PORTARLINGTON • PORT PHILLIP • DANDENONG • GEMBROOK

• BBY • MORDIALLOC • PAKENHAM • WARRAGUL

• GEELONG • MORNINGTON • KOO WEE RUP • DROUIN

WINCHELSEA • QUEENSCLIFF • FRENCH I. • PHILLIP I.

• BARWON HEADS • PORTSEA • SORRENTO • DROMANA • ROSEBUD

• TORQUAY • RYE • FLINDERS • COWES

• ANGLESEA • BASS STRAIT

LORNE • AWARDED TO: SAMPLE

AWARD NO. \_\_\_\_\_ DATE \_\_\_\_\_ MODE \_\_\_\_\_

PRESIDENT D.W. Waller 3YXE AWARDS MANAGER D. Bazely VK3BY

  
 FOUNDED 1948  
 WONTHAGGI

contacts between amateurs and member stations.

2. Contacts may be made on any band and any mode.
3. The award is issued on a point scoring system. Club members — 20 points required; Non-club members — fifteen points; SWLs — eight points; Overseas stations — live points or one contact with the Club Station VK3APC.
4. Three points scored for working the Club Station VK3APC and one point for working

a member station. Stations to be worked once only.

5. Contacts made as from the 1st June 1983 are valid for award points.
6. Proof of contact to be by log extract showing date, time in UTC, callsign of station worked, frequency, mode of emission, signal report, club identification number and points claimed. This extract must be certified by two other licenced amateurs.
7. Applications for the award to be sent to the Awards Manager, Box 88, East Bentleigh, Vic 3165, together with a fee of \$3.00.
8. Special Endorsement — RTTY — five points; CW — ten points.
9. The MDRC holds a regular Club Net on 3.565 MHz each Monday night at 1000 UTC. This attractive award is printed in blue, green and black and measures approximately 25 x 15 centimetres.

## MALTA

Applicants for the following three Maltese awards need to forward details to the Awards Manager, MARL, PO Box 575, Valetta, Malta GC. The awards are also available to SWLs and the usual GCR applies. The cost of each award is US\$3 or the equivalent in IRCs.

### 9H DIPLOMA

Five points required as under:  
Each QSO with the Island of Malta counts as one point (9H1).  
The Island of Gozo counts as two points (9H4).  
The Club station 9H1MRL or 9H1DC count as two points.

### DIP-MED

Applicants have to work a minimum of



**RADIO CLUB »OSIJEK«**

*SAMPLE*

**DIPLOMA »OSIJEK«**  
**DIPLOMA »OSIJEK«**  
**DIPLOMA »OSIJEK«**  
**DIPLOMA »OSIJEK«**



AWARDED TO.....  
FOR MAKING TWO-WAY COMMUNICATION ON..... WITH AMATEUR  
STATIONS IN THE OSIJEK AREA  
AWARD N°..... DATE..... MANAGER.....  
Kruno Feric - YU 2OM

fifteen of the twenty six Mediterranean countries listed below: 9H is obligatory.

Malta, Spain, Balearic Is., Ceuta & Melilla, France, Corsica, Morocco, Algeria, Tunisia, Monaco, Italy, Sicily, Sardinia, Greece, Cyprus, Crete, Dodecanese Is, Gibraltar, Yugoslavia, Albania, Israel, Lebanon, Egypt, Turkey, Syria, Libya.

**THE MARL GOLDEN JUBILEE — 9H5ODC**  
Fiftieth anniversary of foundation of MARL.  
Period: 1st September, 1983 till 30th September, 1984.

Applicants must work 9H5ODC, the special station, found on 14.297 MHz at 0500 UTC. This station can only be worked once, and any other four 9H stations on any band and in any mode. Other stations may be worked more than once but not on the same day.

Well that's it for this month. Any details of any award would be welcomed by the writer. Hopefully by the time this is read the DXCC chasers will have managed to work HK0TU, Malpelo and BY on phone.

73 de Mike, VK6HD

AR

# INTERNATIONAL NEWS

### SPACE SHUTTLE STS9

Amateur radio on the space shuttle Columbia operated by Dr Owen Garriot W5LFL should be within range of Australia.

Orbits Nos 47 and 63 promise good passes over Australia. Assuming a launch on 28th October which is the current sked, this would put him over Australia on 1st November and on 31st October, some time around 1400 UTC.

Thanks for this information Jim VK2VLO who forwarded a letter from Roy K6DUE.

### RSGB NATIONAL CONVENTION 1984

Every year the Radio Society of Great Britain, the UK IARU national society, has a major amateur radio exhibition at Britain's foremost venue — the National Exhibition Centre in Birmingham. Last year's event, the National Amateur Radio Exhibition and Convention, attracted over 10 000 visitors to a comprehensive trade show and a lecture programme with something of interest for everyone from the beginner to the advanced amateur — many came from overseas and thoroughly enjoyed themselves.

The 1984 event takes place on 28 and 29 April, and an even bigger exhibition is planned. Birmingham is in the heart of England and could not be easier to get to — the exhibition site is two minutes' walk from Birmingham Airport and is five minutes' drive from one of the main British motorways, the M6. If you're staying in London, there's a fast railway service from the British Rail station at Euston in the heart of the city which takes you to a special station (Birmingham International) on the site of the National Exhibition Centre in about an hour and a half. One minute later and you're in the exhibition hall!

The 1984 RSGB National Convention will be one of Europe's foremost amateur radio events.

David A Evans, G3OUF  
SECRETARY/GENERAL MANAGER RSGB

AR

# “THE BORN LOSER GOES TO AIR” (VK2LID)



Bill Martin, VK2EBM

33 Sommerville Road, Hornsby Heights, NSW 2077

“Mmmm-wet day — nothing much doing — think I’ll have a look around the bands.  
“Must do the right thing — listen first . . . let’s try 20 metres.  
“Here’s a clear spot — let’s listen for a bit and see if anyone’s using the frequency.  
— “No, apparently nothing here.  
“Is anyone using the frequency?”  
SILENCE  
“Is the frequency in use?”  
SILENCE  
“CQ, CQ, CQ calling CQ 20 metres; CQ, CQ, CQ — here is VK2LID calling CQ 20 metres and standing by.”  
POW . . . “Fifteen stations on the frequency, but none of them are calling me — typical . . .  
Try again . . .  
“CQ, CQ, CQ calling CQ, CQ, CQ, 20 metres and standing by for a call.”  
“BRLDLBRLDLBRLDLBRLDLBRLDLBRLDLBRLDLBRLDLBRLDLBRLDL”  
“Hmmm — RTTY station — wonder where he is?”  
“Let’s shift frequency a bit and try again.  
“CQ, CQ, CQ calling CQ and standing by.”  
SILENCE  
“CQ, CQ, CQ, here is VK2LID calling CQ and standing by.”  
“Brr Bip Brr, Brr Bip Brr Brr, Brr Brr Bip Bip, Brr, Brr, Brr, Brr.”  
“Hmmm — sounds like an intruder — let’s try the CW segment.  
“Here’s a good spot — nothing seems to be on the frequency.  
“QRL?-QRL? . . .”  
SILENCE  
“Dahdidahdit dahdididah, etc.”  
SILENCE  
“Dahdidahdit dahdididah  
“Good grief — how can so many CW stations be on the same frequency?”

“Wait a minute — none of them are calling me!  
“OK — let’s quit the fooling around and get the linear on.”  
“DAHDIHAHDIT DAHDAHDIDAH”  
“What’s that smell?”  
“QUICK! Get the linear turned off!  
“PHEW. That was close — (must have a look at that linear one of the days)  
“Let’s try some RTTY.  
“Everything seems to be OK — RY RY RY RY RY RY RY RY RY RY RY RY RY.  
“CQ, CQ, CQ, de VK2LID — how print?  
SILENCE  
“CQ, CQ, CQ, de VK2LID — anybody there?”  
“DT-DT-DT-DT-DT-DT-DT-DT-DT-DT-DT-DT-DT-DT”  
“Hmmm — the woodpecker’s about — propagation must be OK.  
“OK — let’s try 2 metres.  
“VK2LID listening on the frequency”  
SILENCE  
“VK2LID testing.  
“Hang the expense — let’s up the power to 3 W.  
“VK2LID listening on the frequency.  
“That’s funny — I don’t seem to be getting into the repeater?  
“Oh — wrong microphone — this one’s hooked up to the HF rig.  
“OK — one last try — back to the DX bands.  
“CQ, CQ, CQ here is VK2LID standing by for a call.”  
“VK2LID — here is the Department of Communications — you are spluttering all over the band; would tomorrow be a convenient time to inspect your station?”  
“Ahh, Ahh — VK2LID going QRT!”  
(I wonder where I put that old stamp collection of mine?)

AR

**\*\*HELP\*\***

**INTRUDER WATCH**

Please help INTRUDER WATCH by reporting all intruders.

**WARNING!!**

Disposing of your old rig?? Please ensure it goes ONLY to someone licensed to use it on YOUR bands.



# COMMERCIAL CHATTER

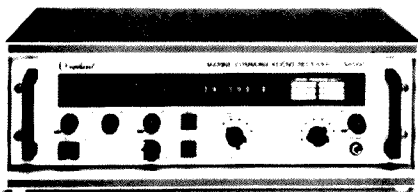

## AUSTRALIAN DISTRIBUTORS FOR VIGILANT COMMUNICATIONS LTD

GFS Electronic Imports were recently appointed distributors for Vigilant Communications Ltd of the UK.

Vigilant manufacture a wide range of commercial and marine HF communications receivers covering 50 kHz through to 30 MHz.

Designed specifically for Military and Marine applications all models are heavily ruggedised to meet the sort of conditions that they will likely be subject to. They are equally at home in a largely salted environment as they are in a steaming jungle.

Top of the range are Vigilant's micro-processor receivers, the SR-532 (Military) and the SR-530 (Marine). Both units feature a 200 channel memory and full remote control facilities via a modern and single pair line.

All eight models in the communications receiver range use Vigilant's tried and proven modular construction techniques, which allows for rapid and easy maintenance.

Shown in the photograph is the Model SR-500 Marine Receiver. It covers from 50 kHz to 30 MHz in 100 Hz steps. In addition it has six programmable memory channels and is approved to the UK Marine specification MPT 1210. It is designed to operate over a temperature range of -15° to +55° C with a relative humidity of 95% at 40° C.

Price of the SR-500 is \$3196 plus sales tax. For full specifications of this and the other seven models in Vigilant's range of HF Communications receivers contact: GFS Electronic Imports, 17 McKeon Road, (PO Box 97) Mitcham, Victoria, 3132. Phone: (03) 873 3777.

AR



## DICK SMITH OPENS IN HORNSBY

As a convenience to many customers who live in the Upper North Shore area of Sydney,

the important retailing centre of Hornsby has become the host of the latest Dick Smith Electronics store.

Now Hornsby's electronics enthusiasts (and enthusiastic beginners as well) will have, at their doorstep, everything from components to kits, home computers, telephone products, Hi-Fi equipment, electronic games, etc.

Located at 4 Florence Street, the phone number is (02) 477 6633. Hornsby store manager, Mark Abicair (pictured here), and his specially trained staff are looking forward to serving you.

So, why not drop into Dicks new Hornsby store, have a look around and take advantage of the fantastic specials and direct import prices.

AR



## LARGEST AND MOST MODERN ELECTRONICS WAREHOUSE IN THE SOUTHERN HEMISPHERE

Late August will see the doors open on the new extensions to the Dick Smith Electronics headquarters at North Ryde, NSW. In excess of \$2 million is being spent on both extending the previous 50 000 sq ft building to the new 85 000 sq ft and remodelling of the former structure.

This massive increase in facilities was necessitated by the unprecedented growth being experienced by Dick Smith Electronics in Australia and New Zealand.

The public stands to benefit greatly from the new and greatly expanded customer services, most of which are already operational.

The Service Department has nearly doubled in size, allowing for the installation of additional highly sophisticated testing equipment. Of invaluable assistance will be a new totally sound-proof testing and research laboratory. There is even a large, air conditioned service reception area.

Also nearly twice its former size is the Kits Department. This ensures a constant supply of top quality electronics kits as well as the development of new exciting and innovative ones.

With the computerisation of the expanded Mail Orders Department, Dick Smith Electronics now has the most technologically advanced, automated Mail Order system in Australia. This means customers will enjoy the fastest possible mail and phone order service.

Double sized receiving and despatch areas, along with the additional warehousing, will

ensure that products are in ready supply and will speed their distribution. 'Speed' is the operative word and 250 metres of new 'airport style' conveyor belts, costing more than \$250 000, will rush goods through the vast expanses and between floors.

Other features include a new staff recreation area overlooking the staff swimming pool, barbecue facilities and Dick's helipad.

AR

## RADIO AMATEUR OLD TIMERS CLUB

### AUGUST QSO PARTY

A survey of the calls revealed in the thirty one logs received shows that about forty seven members of both VK and ZL clubs took part. That makes a percentage log entry of sixty six which is not too bad.

However if some of those members who check only into the monthly net could see the comments of appreciation in the log entries of those who do come to the party they would surely think it worth a try.

Please note that the next party will be on 20 metres, second Monday in March (12th) 0200-0500 UTC.

### SCORES

CALL	MODE	QSOs	AREAS	TOTAL
VK3XB	CW/SSB	28	10	1400
VK3KS	CW/SSB	27	9	1215
VK3JA	SSB	24	10	1200
VK4AEM	SSB	24	9	1080
VK7AL	SSB	23	8	920
VK4AIX	CW/SSB	23	8	920
VK4CJ	CW/SSB	22	8	880
VK4OX	SSB	24	7	840
VK7CH	CW	18	8	720
VK2ADR	CW/SSB	18	8	720
VK4BG	CW/SSB	18	7	630
VK3FC	CW	16	7	560
VK3ZC	CW	14	8	560
VK3LC	CW/SSB	17	6	510
VK3NV	SSB	14	6	420
VK5V	SSB	13	6	390
VK7RY	CW/SSB	15	5	375
VK3XF	CW/SSB	12	5	300
VK7BP	SSB	10	5	250
VK2HQ	SSB	11	4	220
VK7JU	SSB	11	4	220
VK4ALW	CW	7	6	210
VK3YW	CW	5	4	100
VK6EF	CW	6	3	90
ZL2AB		19	9	855
ZL2US		18	9	810
ZL3BJ		16	6	480
ZL1JQ		15	6	450
ZL1VX		12	7	420
ZL3HS		8	5	200
ZL3AY		8	3	120

Next time, could logs be forwarded as soon as possible after the party preferably within a week, so that results can be published earlier.

AR

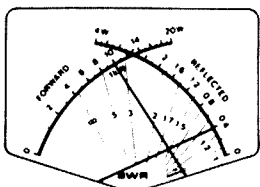

**DAIWA**

# DIRECTIONAL CERTAINTY ... WITH DAIWA

## OAIWA ROTATORS GET AUSTRALIAN AMATEURS GOING IN THE RIGHT DIRECTION WITH AUSTRALIA-BASED GREAT-CIRCLE MAPS.

With Daiwa rotators you have the advantage of control boxes with maps centred on Australia! The best way to get you going in the right direction. Daiwa rotators offer you quality and innovation. And Daiwa rotators offer you all the choices you need!

### A CHOICE OF CONTROL BOXES . . .

There is a round controller (Type R) which is a great-circle map centred on Australia, with area prefixes and paddle-switch control.

Or you can choose the pre-set controller (Type X) which allows you to pre-set the control area you want to work.

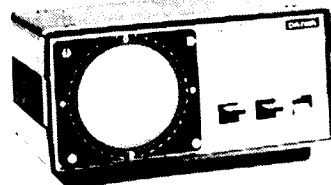
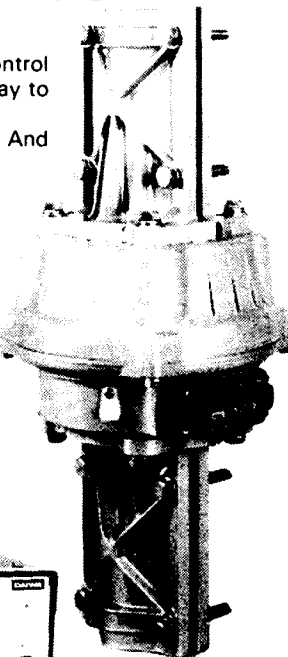
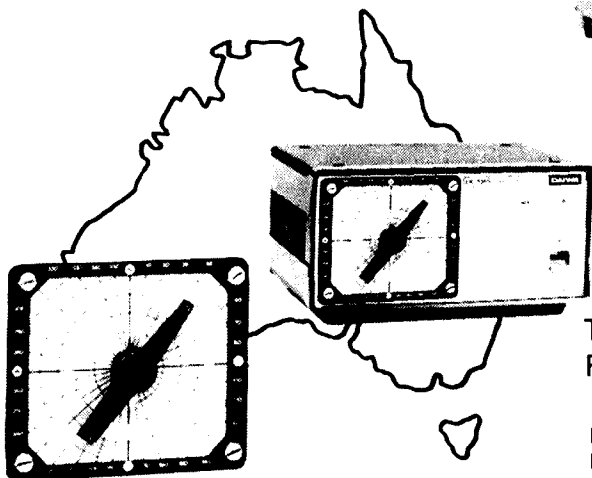

### ... AND A CHOICE OF MEDIUM OR HEAVY-DUTY ROTATORS

You can choose a Medium Duty Rotator (Model 7500) or a Heavy Duty Rotator (Model 7600). The medium duty rotator will handle the average beam with ease. The heavy duty rotator is designed to handle larger amateur and commercial beams and arrays. Compare these specifications.

	Medium Duty (DR7500)	Heavy Duty (DR7600)
Rotation Time	60 sec	64 sec
Brake	Mechanical	Mechanical and Electrical
Stationary Brake Torque	2000kg/cm	4000kg/cm
Vertical Load Permissible	200kg	200kg
Mast Size	38-63m	38-63m
Weight	5.5kg	5.6kg
Motor	24V	24V

THIS GIVES YOU A CHOICE OF **FOUR** DIFFERENT COMBINATIONS . . . TO SUIT YOUR OPERATING STYLE

- DR7500R** MEDIUM DUTY; PADDLE SWITCH CONTROL BOX.
- DR7500X** MEDIUM DUTY; PRE-SET CONTROL BOX.
- DR7600R** HEAVY DUTY; PADDLE SWITCH CONTROL BOX.
- DR7600X** HEAVY DUTY; PRE-SET CONTROL BOX.

Daiwa rotators are made by the innovators who brought you cross-needle meters. They offer long life and quality Daiwa construction, and are the result of a considerable amount of research.

**SO GET YOURSELF GOING IN THE RIGHT DIRECTION. CONTACT VICOM OR ASK YOUR LOCAL VICOM DEALER.**



### MELBOURNE

Vicom International Pty. Ltd.,  
57 City Road,  
SOUTH MELBOURNE, VICTORIA  
PHONE: (03) 62 6931

### SYDNEY

Vicom International Pty. Ltd.,  
6th Floor,  
118 Alfred Street,  
MILSONS POINT, NSW  
PHONE: (02) 436 276

### WELLINGTON, NEW ZEALAND

Malvicom,  
18 Raroa Road,  
Lower Hutt,  
NEW ZEALAND  
PHONE: (4) 69 7625

**DEALER ENQUIRIES INVITED!**

# KENWOOD

## '83 SUMMER SIZZLER

### SALE

**\$1100**

usually \$1150



**TS-43X HF TRANSCEIVER**  
 Complete with MB-430 and MC-42S  
 PS-430 POWER SUPPLY \$210



**INTRODUCTORY  
OFFER**

**\$425**

usually \$440

**AT-250  
AUTOMATIC  
ANTENNA  
TUNER**

Fully automatic, covers 1.8 to 30 MHz, inbuilt 4 position coaxial switch, SWR and Power Meter. 240V AC or 13.8V DC. Slaved by TS-43X or manually band selected for any HF Transceiver.

**Accessories for TS-43X**

- YK-88C 500 Hz CW filter \$60
- YK-88SN 1.8 kHz SSB filter \$60
- YK-88A 6.0 kHz AM filter \$60
- YK-88CN 270 Hz CW filter \$60
- FM-430 \$60

Buy four above accessories and get one FREE.



**MC-85 \$120**  
**BASE MICROPHONE**  
 Has inbuilt amplifier

**\$2099**

**TS-93X MARK II**

The ultimate in HF transceivers.  
 General coverage receiver.  
 Amateur band transmitter.

**\$75 WHEN PURCHASED  
ONLY WITH TS-93X**

**TS-830S**

Valves are still in!!  
 (at least in the finals)  
 Complete with extra set  
 of final valves

**\$1200**

worth \$35

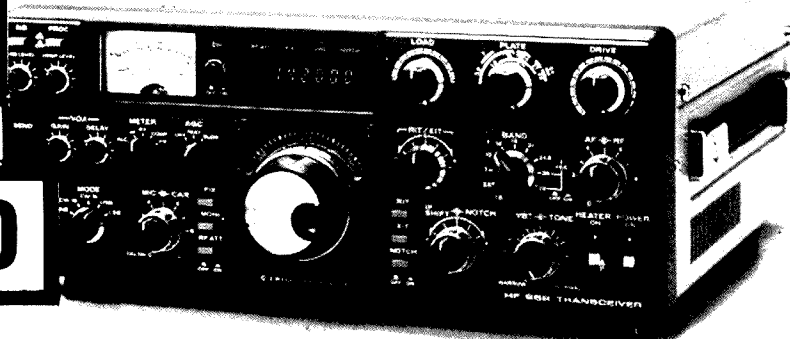

# KENWOOD

## GET INTO SATELLITE COMMUNICATION

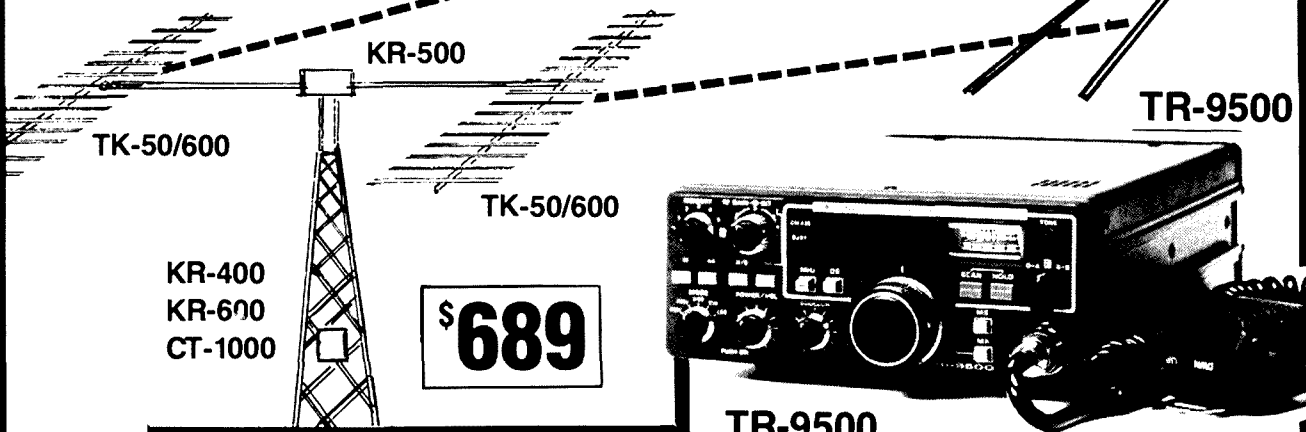

**\$689**



### TR-9500 70CM ALL-MODE TRANSCEIVER

The TR-9500 is a compact 70 cm USB/LSB/CW/FM transceiver providing increased versatility of operation on the UHF bands. It features dual digital VFO's six memory channels, memory scan, automatic band scan, SSB/CW search, high performance receive and transmit, and a host of other features. It should be especially appealing to the OSCAR or 70 cm SSB/CW operator.



**\$680**

### TR-9130

### TR-9130 2M ALL-MODE TRANSCEIVER

The TR-9130 is a powerful, yet compact, 25 watt FM/USB/LSB/CW transceiver. Available with basic UP/DOWN microphone.

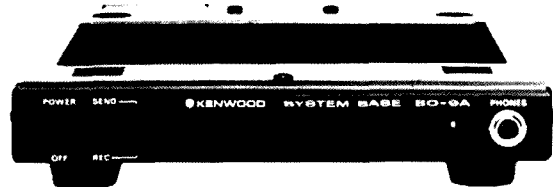

**\$50 FOR 2**

## BONUS! TWO B0-9 BASE STANDS

supplied for an additional \$50 when both the TR-9500 and TR-9130 are purchased together.

### TR-7950 2M FM TRANSCEIVER

Big Power — Big Features — Small Price!  
50 Watts — 20 Memories.  
Buy an SP-40 Mobile Speaker (usually worth \$28) for an additional \$5. The TR-7950 plus SP-40 only \$532 SAVE \$23

**\$530**



# KENWOOD

## FM MICRO MOBILES

Micro Mini Mobiles for either 2 metres or 70 centimetres. 25 watts on 2 metres or 10 watts on 70 centimetres size — 141 mm wide x 158 mm deep x 39.5 mm High. 5 memories — Scan.

**\$450**  
EACH

**BOTH UNITS COME WITH FREE SP-50 REMOTE SPEAKER**



**MC-55**

**SP-50**

**MC-55**

Mobile Microphone with time-out-timer. Electret condenser microphone

**\$65**

**FC-10**

Remote frequency control & display for use on either model. Normally \$70 but only \$57 when purchased with either unit.

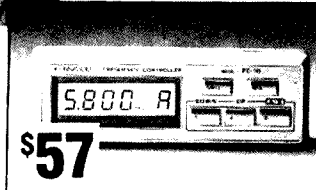

**\$57**

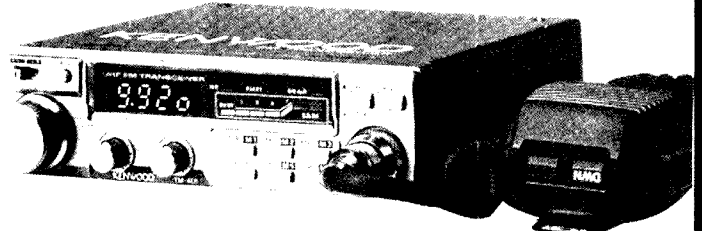

## TS-130SE

**\$800**

Economical mobile. All HF bands. 100 watts. VOX — Calibrator — IF shift — Speech processor — Noise blanker. Exceptional value at \$840. Even better value at \$800 complete with MC-30S mobile microphone.



**SAVE \$73**

## R-2000 RECEIVER

Top of the line — 10 memories, scan, AM/FM/SSB/CW, coverage 2 MHz to 30 MHz. Used by Government Departments and other professional services.

**VC-10**

**VHF ADAPTOR**

NORMALLY \$190 BUT WHEN SUPPLIED WITH R-2000 **\$110**

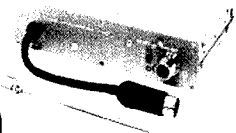

INCLUDES FREE DC LEAD FOR 12 VOLT OPERATING. WORTH OVER \$16.

WAS ~~\$670~~

**NOW \$655**



# KENWOOD

## SWR METERS

WAS  
~~\$58~~

\$56

### SW-100

Mobile model 0-150 W.  
Model (A) 1.8-150 MHz  
Model (B) 140-450 MHz



### TR-3500

70CM FM  
HAND-HELD

### TR-2500

2M FM  
HAND-HELD

Definitely the best Hand-Helds available. Jam packed with features — Memories, Scan etc. includes nicad batteries and charger.

### SW-200

WAS ~~\$123~~ NOW **\$119**

### SW-2000

WAS ~~\$149~~ NOW **\$140**

### SW-2000

Base model 0-200/2000 W  
1.8-54 MHz

### SW-200

Base model 0-200 W.  
Model (A) 1.8-150 MHz  
Model (B) 140-450 MHz

WAS ~~\$395~~ NOW **\$375**

### ST-2 BASE STAND

WAS ~~\$99~~ NOW **\$90**

## ACCESSORIES

SWC-1 Optional coupler 1.8-150 MHz **\$38**  
SWC-2 Optional coupler 140-450 MHz **\$38**  
SWC-3 Optional coupler 1.8-54 MHz **\$38**

### NOTE

Models SW-200 and SW-2000 have provision for connecting three couplers with remote sensing. Ideal for novices — Inbuilt PEP reading meter.

### MA-4000

Dual band mobile antenna for only \$15 with every TW-4000A sold.

WORTH ~~\$55~~ **\$15**

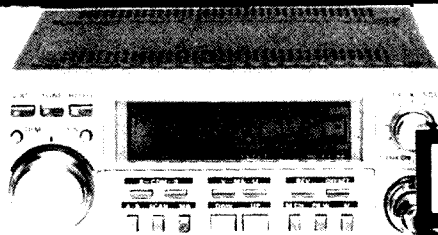

## TW-4000A VHF UHF DUAL BANDER 25W TRANSCEIVER

Mobile — 10 memories — scan

**\$699**

## TR-2400 OWNERS

SMC-24 SPEAKER MICROPHONE

**\$30**



**\$25**

SC-3 SOFT CASE ONLY **\$19**

ST-1 AC-DC BASE STAND



## TRIO TEST EQUIPMENT

CO-1303D	5 MHz CRO	\$300
CS-1352	Portable CRO	\$900
CS-1560A MK2	15 MHz CRO	\$600
CS-1566A	20 MHz CRO	\$730
CS-1577A	35 MHz CRO	\$1130
CS-2070	70 MHz CRO	\$2040
CS-2100A	100 MHz CRO	\$2800
Probes for oscilloscopes (NOT supplied with CRO's)		\$30 (each)
AG-202A	Audio Oscillator	\$220
AG-203	Audio Oscillator	\$300
CG-912	Color Bar Generator	\$860
SG-402	RF Sig. Generator	\$156

Trio Test equipment above is only available direct from Trio-Kenwood (Aust.) and is not available from the Kenwood dealers listed in this advertisement.

## DM 81 DIP METER

The DM-81 dip meter is intended for adjustment of radio equipment and antennas.

It is self-excited oscillator designed for external coupling to the equipment being tested.

### FEATURES

- Measurable frequency range of 700 kHz 250 MHz in seven bands
- Capacitive probe for measurements without removing coil shields
- Storage compartment for all seven dip meter coils, capacitive probe, earphone and ground clip lead
- Convenient for both indoor and outdoor measurements. all solid state and built-in battery

**\$130**  
INCLUDING  
FREE  
BATTERIES



# KENWOOD

## ANTENNAS

### 7 ELEMENT LOG PERIODIC

TK-137. Frequency range 13 MHz to 30 MHz continuous. Boom length 7.3 metres — Weight 18 kg.  
— Twin Radio 6.5 M — 2 Kw Balun included — Average gain 95 dB.

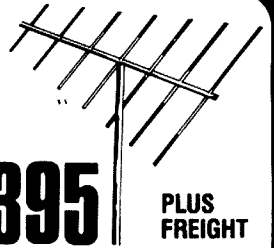

TK-137 **\$395**

PLUS FREIGHT

### TK-50-600

**\$175**

Frequency range 50 MHz to 600 MHz continuous. Use for 6 metres, 2 metres, 70 cm, 50 cm, TV, ATV, FM, Scanners etc. Boom 3 metres — Longest element 6.5 metres — Average gain 8dB — 300 watt balun included.

19 ELEMENT LOG PERIODIC  
PLUS FREIGHT

### KR-500

SATELLITE TRACKING  
VERTICAL POSITIONING

WAS \$220 **\$200**

### KR-250

TV TYPE FOR  
SMALL ANTENNAS

**\$99**

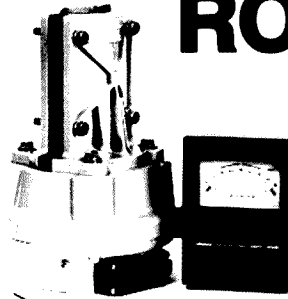

## ROTATORS

### KR-400

WITH BOTTOM CLAMP

**\$170**

WAS \$180

### KR-600RC

WAS \$300 **\$280**

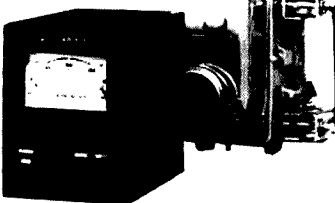

#### NOTE

All Kenwood Rotators supplied by Trio-Kenwood (Aust.) come complete with top and bottom brackets, 3 core flex, correct Aust. plug and correctly wired for Australian requirements.

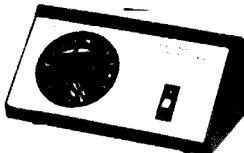

## MANUAL ANTENNA TUNERS

Don't fight with back yard home brew types!! Get the real thing — Commercially made, designed and resaleable with your Kenwood station.



### AT-130

The AT-130 is a compact and lightweight antenna tuner designed for base or mobile use.

**\$140**



### AT-230

The AT-230 antenna tuner includes the three new bands and functional features such as a through-line wattmeter, SWR meter and antenna selector switch.

**\$215**

## ACCESSORIES

AL-1	Lightning arresters SO-239 socket 100 W	\$40
AL-2	Lightning arresters SO-239 socket 1 kW	\$46
DC-25	DC operation of TR-3500/2500 from 12V battery	\$25
HS-4	Headphones	<del>\$24</del> \$20
HS-5	Headphones	<del>\$48</del> \$43
HS-6	Headphones	<del>\$32</del> \$28
LF-30A	Low Pass Filter	<del>\$44</del> \$39
MC-60A	Base Mic. with Amplifier	\$100
MC-85	Base Mic. with Amplifier with provision to select up to three outputs.	<del>\$125</del> \$110
MJ-46	Mic. adaptor Mic. 4 Pin Equipment 6 Pin	<del>\$12</del> \$10
MJ-48	Mic. adaptor Mic. 4 Pin Equipment 8 Pin	<del>\$12</del> \$10
MJ-64	Mic. adaptor Mic. 6 Pin Equipment 4 Pin	<del>\$12</del> \$10
MJ-68	Mic. adaptor Mic. 6 Pin Equipment 8 Pin	<del>\$12</del> \$10
MJ-84	Mic. adaptor Mic. 8 Pin Equipment 4 Pin	<del>\$12</del> \$10
MJ-86	Mic. adaptor Mic. 8 Pin Equipment 6 Pin	<del>\$12</del> \$10

# KENWOOD

## SM-220

The SM-220 station monitor features, in combination with a built-in two-tone generator, a wide variety of waveform-observing capabilities.

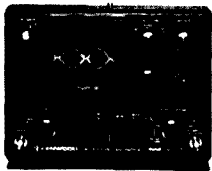

WAS \$460-  
**\$440**

## HC-10 CLOCK

Highly advanced world clock with dual display which can memorize 10 major world cities and two additional regions.



**\$125**

# PROFESSIONAL ROTATOR

The CT-1000 easily handles up to large HF beams and large VHF/UHF arrays. The good-looking Control Console incorporates an 8-bit CMOS Microcomputer Unit and features a digital azimuth readout accurate to  $\pm 0.5^\circ$  and a circular LED heading indicator.

The microcomputer unit automatically releases the electro-magnetic brake even in a strong wind.

With a keyboard command, the microprocessor, controlling turning speed and brake mechanism, turns an antenna accurately to the direction instructed.

**SCANNING.** Scanning Range and Scanning Speed are programmable.

**CONTINUOUS STEPPING.** Turning Range, Stepping Angle and pause duration are programmable.

**SINGLE STEPPING** is available.

The CT-1000 has provision for 10 channels in the battery backed-up memory. Antenna headings stored in the battery backed-up memory can be recalled with a keyboard instruction and are retained even when the external power source is removed.

Scanning operation among the channels in the battery backed-up



USUALLY ~~\$680~~

**\$640**

# KENWOOD COMMERCIAL

The TK-701S is a synthesized FM Two-Way Radio, 32 channel capability at 20-50 watts on 150-174 MHz.

The TK-801S is a synthesized FM Two-Way Radio, 32 channel capability at 15-40 watts on 450-512 MHz.

These units are compact dash-mount mobiles and designed to meet the stringent demands of the mobile market in quality, ruggedness, and flexibility of application. The inherent strength of die-cast chassis construction, the use of only the highest quality parts and sub-assemblies, assures the ultimate in product performance and reliability.

## TK-701S

BASIC MODEL

**\$850**

VHF 150-174 MHz

## TK-801S

BASIC MODEL

**\$900**

UHF 450-512 MHz

# UNITS

Please direct all enquiries to  
Trio-Kenwood (Aust.)  
4E Woodcock Place,  
Lane Cove N.S.W. 2066.

## TRIO-KENWOOD (AUSTRALIA) PTY. LTD.

(INCORPORATED IN N.S.W.)

4E WOODCOCK PLACE, LANE COVE, SYDNEY, N.S.W. 2065.

Ph. (02) 428 1455.

Further, beware of dealers not listed in this advertisement who are selling Trio-Kenwood communications equipment. All Kenwood products offered by them are not supplied by Trio-Kenwood (Aust.) Pty. Ltd. and have no guarantee applicable.

### NEW SOUTH WALES

TRIO-KENWOOD (AUST.) PTY. — 4E WOODCOCK PLACE, LANE COVE (02) 428 1455  
EMTRONICS — 758 GEORGE STREET, SYDNEY (02) 211 0531  
SPRINGWOOD CAR RADIO — SPRINGWOOD (047) 51 4930  
UNIQUE ELECTRONICS — 418 OLD PROSPECT ROAD STH. WENTWORTHVILLE (02) 631 6689  
WASSIL ELECTRICAL — 71 SUMMER STREET, ORANGE (063) 62 6249  
STOCKMAN & HIGGINS — BYRON STREET, INVERELL (067) 22 1300  
ELECTRON 2000 — 3 ELIZABETH STREET, TIGHES HILL, NEWCASTLE (049) 69 6399  
MACELEC PTY. LTD — 99 KENNY STREET, WOLLONGONG (042) 29 1455  
RADIO WORLD PTY. LTD — 81 NEWCASTLE STREET, Fyshwick (062) 80 6550  
E&K COMMUNICATIONS — 14 DUTTON STREET, DICKSON A.C.T. (062) 49 6437  
DX ENGINEERING — 5 JASMINE STREET, PORT MACQUARIE (065) 83 2175  
LAND LINK — MULLALEY ROAD, GUNNEOAH (067) 42 2838  
LAND LINK — 61 BARNES STREET, TANWORTH (067) 65 4622  
FRANK BOUNDY — LISMORE (066) 86 2145

All items are available from stock at the time of preparing this advertisement. All items are only available from 1.11.83 to 31.1.84 or until stocks are sold.

Naturally should a change in duty, sales tax or devaluation occur, these charges must be reflected in final pricing.

### INTERSTATE

VIC: EASTERN COMMUNICATIONS — 168 ELGAR ROAD, BOX HILL (03) 288 3107  
BRIAN STARES — 11 MALMSBURY STREET, BALLARAT (053) 39 2808  
SUMMER ELECTRONICS — 78 KING STREET, BENDIGO (054) 43 1977  
TAS: HOBBY ELECTRONICS — 477 NELSON ROAD, MT. NELSON (002) 23 6751  
GELSTON ELECTRONICS — SUMMER HILL (003) 27 2256  
WATSONS WIRELESS — 72 BRISBANE STREET, HOBART (002) 34 4303  
ADVANCED ELECTRONICS — 5A THE QUADRANT, LAUNCESTON (003) 31 7075  
MARINE & COMMUNICATION — 19 CHARLES STREET, LAUNCESTON (003) 31 2711  
V.K. ELECTRONICS — 214 MOUNT STREET, BURNIE (004) 31 7733  
QLD: MITCHELL RADIO CO — 59 ALBION ROAD, ALBION (07) 57 6830

### S.A. &

N.T.: INTERNATIONAL COMMUNICATIONS SYSTEMS PTY LTD — 8 NILE ST. PORT ADELAIDE (08) 47 3688  
W.A.: ARENA COMMUNICATIONS SERVICES — 642 ALBANY HWY., EAST VICTORIA PARK (09) 361 5422  
TRI-SALES — CNR NEWCASTLE & CHARLES STREETS, PERTH (09) 328 4160  
WILLIS ELECTRONICS — 445 MURRAY STREET, PERTH (09) 321 2207  
BAY RADIO — 18 BANKSIA STREET, BUNBURY (097) 21 2236  
RON DENT — 115 PATON ROAD, SOUTH HEADLAND (091) 72 1112  
SELECT TRONIX — TOM PRICE (091) 89 1564  
FORD ELECTRONICS — 209 HANCOCK STREET, DOUBLE VIEW (09) 446 4705

# NATIONAL EMC ADVISORY SERVICE

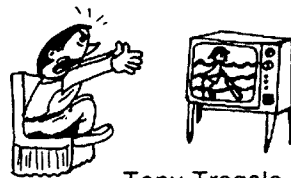

Tony Tregale, VK3QQ  
FEDERAL EMC CO-ORDINATOR  
38 Wattle Drive, Watsonia, Vic 3087

*This month we have reprinted an article which appeared in AR in September 1974. Although the monetary values have increased since this time the basic problems are still the same and the solutions may help many of our younger amateurs and members.*

## Audio frequency interference (AFI)

(Reprinted from Radio Communication, April 1973)  
(Reprinted from Amateur Radio, September 1974)

P W Waters, G3OJV  
8 Gay Bowers, Hockley, Essex, UK

### THE PROBLEM

The current boom in hi-fi sales has led to an increase in the number of cases of interference caused by radio transmitters operating in close proximity to audio equipment. Almost all audio equipment now being produced for the domestic market is entirely solid state and this changeover from valves to transistors has coincided with a hi-fi boom, making it difficult to assess to what extent transistors are responsible for the increase in the number of cases of interference. Certainly transistorised equipment appears to be far more susceptible than the older valve equipment. Also of significance is the now widespread usage of magnetic cartridges which require amplifier sensitivities of the order of 3 or 4 mV. This usually necessitates one or two additional stages of amplification, whereas the older type of crystal and ceramic cartridges having far higher outputs require far less gain from the amplifier.

Unlike television interference, there is usually very little that can be done at the transmitter end to prevent the trouble. Apart from reducing power, moving aerials or switching off altogether, the cure must be at the complainant's end. Like all kinds of interference this poses a social problem. The average cost of a stereo radiogram is around £80-£100, and for a hi-fi installation comprising separate amplifier, speakers, turntable and possibly VHF tuner the price rises to the region of £150 to £200. Any person having spent this amount of money is not going to take kindly to hearing a burst of CW or "distorted" SSB coming through in the middle of his or her favourite record. Unfortunately, telling your neighbour that the interference is not the fault of the transmitter, but his own equipment, is not going to ease the matter even though it is probably true.

Of course, each case has to be dealt with on its merits and no hard and fast rules can be laid down. It is of prime importance to use tact, patience and common sense. A special mention should be made here of the case of interference from an AM transmitter. A sensitive hi-fi system may well be picking up such a signal and relaying it in "full frequency stereo sound" — a situation which calls for special tact.

### THE CAUSE

Before discussing the various ways in which this kind of interference can be prevented, it is necessary to understand how the RF signal reaches the amplifier, is rectified, and emerges at the speaker as an unwanted signal. Fig 1 shows typical audio amplifier low signal stages. In the case of the transistor version notice the base/emitter junction. This forms a fairly effective junction diode and any RF signal that reaches this stage will be rectified and passed on as an audio signal to the following stages. Similar comments apply to the valve stage. RF energy reaching the grid of the valve is likely to be rectified by non-linear action and the resultant demodulated signal passed on through the following stages as an audio signal. With the modern hi-fi amplifier, having a high overall gain and an output rating of 10 to 15 W/channel or even more, RF breakthrough can be dramatic.

There are a number of paths the radio signal can take to reach the circuitry of an audio amplifier. In high RF fields even direct pickup by the circuit board is possible. Normally, however, the signal is fed to the amplifier via the various connecting cables, which make very good "aerials". Two of the most common sources of trouble seem to be the mains cable and the speaker leads. The mains connection, because of the modern ring mains circuits, results in the entire house power wiring being connected to the amplifier and acting as a long-wire "aerial".

As for the speaker leads, stereo reproduction requires a pair of speakers to be separated from the amplifier and turntable unit in order to obtain the stereo effect. In practice this means that the speakers are very often positioned several yards away from the amplifier, the length of twin flex usually used for this purpose making a good "aerial", possibly resonant on or near one of the HF amateur bands. This, of course, ignores the other connecting cables from record turntable, tape unit, VHF tuner etc. It is not surprising, therefore, that a substantial RF signal can find its way into an amplifier several hundred feet distant from the transmitter.

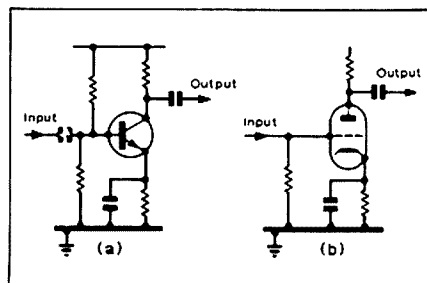

Fig 1. Typical first stages in audio amplifiers which are open to RF interference, (a) transistor, and (b) valve.

### THE TREATMENT

There are two basic ways of tackling interference in audio equipment. Either the circuit can be modified to prevent the rectification occurring, or the RF signals can be prevented from reaching the amplifier circuitry by fitting filters to the various connecting leads.

Dealing firstly with the rectification problem, it has already been shown how, in a transistor amplifier, trouble usually arises when RF reaches the base/emitter junction of a transistor. Similarly, in a valve amplifier, too much RF energy on the grid can also result in rectification. Clearly, if the RF signal can be bypassed to earth without degrading the wanted audio signal then the problem will be solved. The most obvious solution that comes to mind is to fit a capacitor between input and earth of the amplifier of such a value that while it looks like a near short circuit at RF it offers a high impedance to audio frequencies. Unfortunately, between the input and the transistor base or valve grid may be several inches of wire or circuit board, switch contacts with their associated connecting leads and other components. Bypassing at the remote input socket of the amplifier may therefore not be sufficient.

A far more effective method of preventing rectification is to solder a capacitor directly across the base/emitter junction or between control grid and cathode to prevent an RF potential difference between the electrodes.

Fig 2 illustrates the required circuit modification. The capacitance value C can

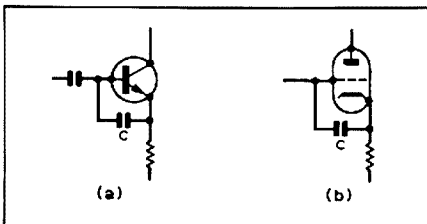

**Fig 2. (a) A suitably chosen capacitor connected between the base and emitter of an early transistor stage will bypass the offending RF to earth without affecting the audio signal. Suitable values are discussed in the text. (b) The analogous modification to a valve stage.**

be around 1000 pF, although it is by no means critical. The British Radio Corporation recently recommended values of 2000 pF for one of their transistorised radiograms. This effected a complete cure without affecting the fidelity of the amplifier. Because of the generally higher impedance of valve amplifiers it would be desirable to keep the capacitance value as low as possible and to include an RF choke or 10 k ohm resistor in series with the grid to prevent too much loss of high frequencies.

In some cases it will be found necessary to fit bypass capacitors to more than one stage. An indication as to exactly where in the amplifier the rectification is taking place can be obtained by noting whether the level of the interference changes when the amplifier volume control is rotated. Similarly a test should be made to ascertain whether or not rotating the tone controls has any effect on the response of the interfering signal. If the signal is affected by adjustment of any one or all of the controls then the rectification is probably taking place in an earlier stage. The word "probably" is used deliberately. In a recent case investigated, the RF signal was getting past the first stage and being fed to the following stage via the volume control which was acting as a variable attenuator. Although the control affected the level of interference, the rectification was taking place after the volume control. In practice the fitting of bypass capacitors as shown in Fig 2 usually results in a complete cure.

Once again there are exceptions to every rule. For reasons which are not clear to the author, there has been a case where the fitting of a capacitor across the base/emitter junction has considerably increased the amount of breakthrough. So as an alternative, one or two ferrite beads can be slipped over the base lead of the transistor. However, this can present practical problems if the transistor happens to be soldered very close to the circuit board. In such cases, therefore, an attempt must be made to keep the RF signal out of the amplifier circuitry.

Up until now various ways of preventing RF rectification by modifying the circuitry have been considered, without making any attempt to keep the RF energy out of the amplifier. Very few domestic amplifiers are housed in a sealed metal box, but in a majority of cases the RF signal is introduced into the amplifier by means of the external connecting cables, so this need not be a drawback. For reasons mentioned later it may not be desirable to attempt to effect a cure by working on the internal circuitry. If, as an alternative, a filter

can be fitted that will either block the path or short circuit the RF signal to earth, then the interference should cease.

The first step is to find out which lead or leads are acting as aerials. Very often this is likely to be a matter of trial and error, but there are two ways in which identification of the offending lead can be revealed. Firstly, with the AF gain advanced, the various signal-carrying leads into the amplifier should be disconnected. If the interference stops or reduces, then the lead concerned is to some extent acting as an aerial and will require attention as detailed later. Obviously the speaker leads and mains lead cannot be disconnected. The second method adopted by the author, very often revealing which of the leads is causing the trouble, is to couple a grid dip oscillator tightly up against each lead and sweep the tuning dial back and forth. The AF gain control on the amplifier should be advanced so that the background noise of the amplifier can be heard from the speakers. If the lead being tested is conveying RF into the amplifier then an increase in background noise in the form of hum or hiss will very often result when the oscillator is brought into close proximity to the lead. For best results the grid dip oscillator should be modulated by a tone. As amplifiers are very often sensitive to certain bands of frequencies only, it is essential that tests be carried out with the grid dip oscillator tuned across the same frequency range as that from which the interference is being experienced.

Before dealing with the individual leads going to and from the amplifier, a few words regarding the earthing of amplifiers may be in order. Often an amplifier will have a separate earth terminal at the back of the casing. It is sometimes recommended that earthing the amplifier to an earth separate from the mains earth by means of this terminal will help reduce RF breakthrough. Unfortunately the hi-fi installation is very often so situated that a fairly long earth lead is necessary to reach the amplifier. Instead of acting as an earth for RF signals it acts as an extra aerial and will sometimes actually increase the amount of breakthrough by increasing RF energy on the chassis. By all means try the effect of earthing the amplifier but similarly also try disconnecting the earth lead if one is already fitted.

The number of separate cables going to an amplifier in a hi-fi installation can be considerable, the actual number varying with the amount of ancillary equipment in use. Fig 3 illustrates a typical layout.

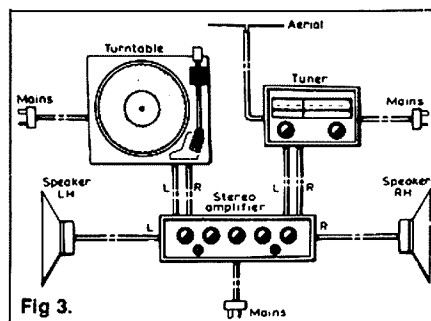

**Fig 3.**

It has already been mentioned that each cable can be regarded as being an aerial capable of picking up RF signals and feeding them into the amplifier. Clearly a device is

needed that will present a high impedance to RF signals while appearing as a low impedance to audio signals. Inductors and capacitors either separately or together in the form of LC networks readily fulfill just this function. The problem with inductors or capacitors is that the former can be bulky items and both often necessitate cables having to be cut and connectors modified during installation.

In recent years ferrite has become a very popular material for use in combating TVI. In particular, it has been found most useful in preventing RF on the outer braiding of coaxial cable finding its way into the TV receiver. In addition to their efficiency, ferrite cores have the major advantage that the existing cable can be used to form the winding, preventing the need to break the cable. One of the most popular ferrite devices is the ferrite ring, on which a very compact winding can be wound. Because of its shape, the cable is self-securing and the complete filter takes only minutes to construct. As a rule of thumb, as many turns as possible should be wound on to the core, with a minimum of 8 or 10 turns.

For combating RF pickup by connecting cables in hi-fi systems the ferrite ring filter is a very effective device. It can be used on speaker cables, leads from the ancillary equipment and main leads. Usually speaker leads and signal leads from record playing units are small diameter cables, and it is quite possible for a common ring to be used for each pair of leads in the case of stereo installations. The actual grade of material does not seem critical and either rod or ring cores can be used. In the author's case great use has been made of Mullard FX1588 rings. It is most important that the filter be installed at the amplifier end of the cable run and as near to the amplifier as possible.

Ferrite inductors are not the only devices for blocking out RF signals although they are probably the neatest and most compact, if not the cheapest. Coaxial cable substituted for the usual twin flex speaker leads will often help considerably where RF is being picked up on the "positive" speaker lead and conveyed back to the early stages of the amplifier via the negative feedback line. See Fig 4.

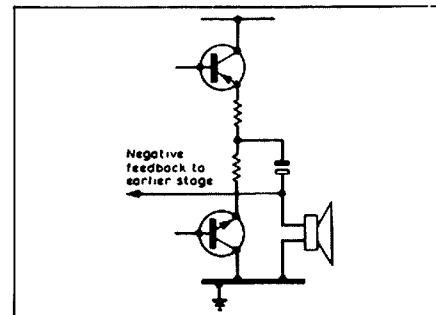

**Fig 4. The normal output configuration of a transistor amplifier incorporates a feedback loop to the earlier stages. Thus any RF picked up by the speaker leads can be fed back to the input stages, where rectification and amplification may take place.**

The use of coaxial cable will also prevent the possibility of RF energy being rectified in the transistor power output stage. This can

occur even with the amplifier switched off. The author has had one such case and there have been similar cases of interference to transistorised TV receivers reported. Even the nocturnal operator is not clear of this problem! In cases where the RF pickup on the speaker leads is not too severe the use of 0.01  $\mu\text{F}$  disc ceramic capacitors connected across the output terminals of the amplifier can be tried (see Fig 5). More effective suppression will be obtained if an inductor is also added as shown in Fig 6.

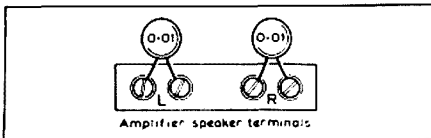

**Fig 5.** To combat mild cases of RF pickup by the speaker leads, 0.01  $\mu\text{F}$  disc ceramic capacitors, connected across the amplifier output terminals, can be tried.

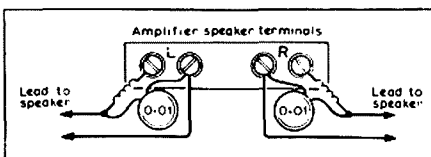
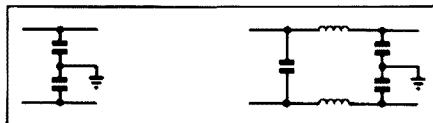

**Fig 6.** In cases of excessive RF pickup by the speaker leads a combination of capacitor and inductor can be tried.

However, the use of capacitors or coaxial cable cannot prevent RF currents from reaching the amplifier chassis by means of the "negative" speaker lead. In such cases some form of inductance is needed to choke the RF, and the use of a ferrite ring will be found effectively to filter both conductors if twin flex is used for speaker leads.

RF energy picked up on the mains lead can be a problem whether dealing with TVI, BCI or AFI. The solution is the same for all three types of domestic equipment, and a number of different mains filter circuits have been published. Two circuits are shown in Fig 7. It is most important that capacitors have an adequate AC rating. The inductors can comprise 18 SWG enamel wire on  $\frac{1}{2}$  in former (wood dowel) 2 in long. Ferrite rod material (such as an old medium wave ferrite aerial with the winding removed) can also be used and will probably be found more satisfactory for the more severe cases. Where a mains filter is used as suggested above, ideally it should be installed inside the amplifier casing, but with the modern tendency to squeeze as much circuitry into as small a space as possible there is very often no room for the inductors required. If this is so, then the filter will have to be installed externally to the amplifier casing and it is most important to make sure that the unit is completely and safely enclosed so that there is no risk of shock. The advantage of the ferrite ring filter mentioned earlier becomes obvious!

Earlier, the popularity of the magnetic cartridge was mentioned. This in itself has brought about a new problem, although it is only likely to manifest itself in very high RF fields. Because a magnetic cartridge contains a small inductance, it is possible for RF signals to be induced in the coil and conveyed down the inner conductor of the screened cable to the amplifier. Unplugging the



**Fig 7.** Two circuits for suppression of RF pickup on mains leads. It is important that the capacitors have an adequate AC rating, and if the components are mounted externally from the cabinet they should be well-insulated to avoid any risk of electric shock.

cartridge head from the arm will confirm whether or not this is the cause of the trouble. Ceramic or crystal cartridges will not suffer in this way. The solution is a small LC network installed either at the cartridge head or at the amplifier input, see Fig 8. Care should be taken to select as low a value of capacitor as practicable to avoid reducing the high frequency response. If the network is installed in the cartridge head, adjustment must be made to the arm counter-balance weight to maintain the correct tracking pressure (often less than 2 gm).

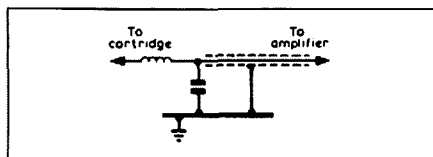

**Fig 8.** Cases of RF pickup via the coil of a magnetic cartridge can be solved by a simple LC network, installed either at the cartridge head or the input to the amplifier. The lowest possible value of capacitance should be chosen, to avoid any reduction in the HF response of the system.

VHF tuners are susceptible to two different forms of interference. The RF energy can either get into the front end of the tuner causing interference to radio programmes only, or alternatively it can be picked up on the VHF coaxial down lead and conveyed back to the amplifier via the chassis of the tuner to cause audio breakthrough. RF energy picked up on the outer coaxial braiding can be prevented from reaching the amplifier either by inserting a ferrite ring filter or using a 1:1 transformer, see Fig 9. Both are familiar devices for TVI sufferers. If, however, the interference is found to be tunable on the VHF tuner, or only present when it is switched on, then there is a strong possibility that the RF signal is being picked up on the FM aerial and a simple high-pass filter as used for TVI should clear the trouble. The need for the receiver to be provided with an aerial adequate for the area applies just as much to FM reception as it does to TV reception. Normally this means an FM band dipole in the loft or on the roof but in some areas, particularly where stereo reception is required, a three- or four-element beam is needed.

When dealing with cases of hi-fi interference it is essential to realise the importance of keeping all leads as short as possible and this applies in particular to speaker leads. A problem which has given the author some trouble in the past is the re-radiation of signals from one cable to another (TVI sufferers please note). If a lead has had to be filtered then keep it as far away as possible from other leads. Try moving the various connecting leads to the amplifier about in

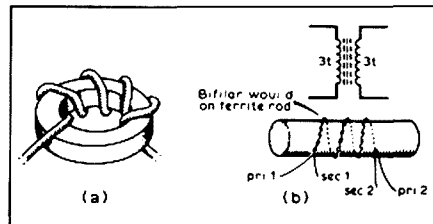

**Fig 9.** RF pickup on the coaxial braiding of the lead from VHF tuner to amplifier can be cured by either a ferrite ring filter or a 1:1 transformer.

relation to one another and if a number of leads have been taped together try unwrapping the tape and separating them. Very often a speaker lead will be tacked along the skirting board with the mains cable and RF will be induced from one to the other. In the author's case laying the TV aerial coaxial lead next to the speaker leads results in severe audio breakthrough while separating them a few inches completely clears the trouble. Never allow any excess cable to trail over the floor. It should either be shortened or coiled up and taped. The importance of this point cannot be over-emphasised.

## THE SOCIAL PROBLEM

There is virtually nothing that the amateur radio operator can do at the station end to prevent causing audio breakthrough, apart from reducing power, unless he is prepared to change his mode of transmission. The latter option has been taken up by a number of VHF operators by switching from AM to FM. The A1 CW operator has the option to change to F1 but this is hardly likely to find much favour on the HF bands and is likely to confuse some operators who may tune to the space instead of the mark. The great difficulty in handling cases of interference is explaining to the sufferer that the fault is with his equipment and not the amateur's. No hard and fast rules can be given as each case is different and personalities and attitudes vary widely. Basically a combination of diplomacy and firmness is required.

The question of whether or not the job of curing the interference is to be undertaken by the amateur concerned is a matter of personal discretion. The author does not favour the idea of carrying out work involving the opening up of amplifiers. This is fine if the amplifier is one's own, but be very careful before deciding to carry out any work on a neighbour's equipment. Really it is a job to be carried out by a paid service engineer, not necessarily because the amateur involved is not capable of doing the work but because anything that goes wrong subsequently is likely to be blamed upon the amateur. If a neighbour does ask an amateur if he would be prepared to carry out the work he should think very carefully before deciding, and if in doubt — refuse.

The question then arises as to who carries out the work. The listener is not likely to have the knowledge to carry out the work himself. He may also be unwilling to pay to have the work done for him if he considers the amateur at fault. Even if he does decide to employ the services of a paid engineer or dealer the time taken up in tracing the trouble is likely to be considerable and many dealers will just have

no idea where to start. A major portion of responsibility must be with the manufacturer who designed and made the equipment. In this respect the British Radio Corporation has been found to be particularly helpful. Unfortunately, many manufacturers seem surprisingly disinterested in the shortcomings of their equipment although some do provide a certain amount of help and advice in the way of technical correspondence, circuits and perhaps a few components. We therefore find ourselves caught in a vicious circle with an embarrassed amateur and an unfortunate and possibly irate sufferer.

It is hoped that this article will encourage rather than deter amateurs trying to solve their audio breakthrough problems. During the 'fifties and 'sixties TVI has been a big problem, but through the persistent work of the RSGB local groups and individuals the problem has been overcome by many. Audio breakthrough looks like being an even bigger problem to be faced in the 'seventies. The solution is mainly with the manufacturers but it is up to the amateur movement as a whole to make them aware of the problem with a view to persuading them to raise their standards.

AR

JOIN A NEW  
MEMBER

For QSL Cards

Phone  
(03) 527 7711

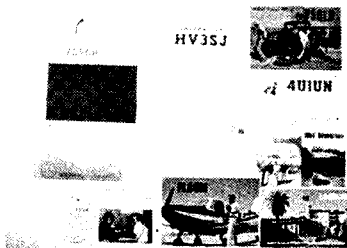

Williams Printing  
Service Pty Ltd

12 William Street,  
BALACLAVA 3183

CONTACT US FOR QUOTES



## EDUCATION NOTES

Brenda Edmonds, VK3KT  
FEDERAL EDUCATION OFFICER  
56 Baden Powell Drive, Frankston, Vic 3199

Later this month a large number of potential amateurs will attempt the NAOCP exam, some for the first time, some after several previous attempts.

There is no shortage of advice on how to pass exams. There are two parts to each exam — knowing the answers, and being able to convince the examiner that you know the answers. It is only too easy in a multiple-choice exam to lose marks by carelessness or lack of adequate consideration.

Despite much comment and criticism, the DOC does not set out to 'get' the candidates, or to limit the number of passes, and there are no deliberate trick questions.

But there are some fairly searching questions on each paper, and this is quite in order. These questions are probably the ones which some candidates remember as too hard or unfair. Questions on each paper cover a range of levels of difficulty. This is not always realised by examinees before they sit their first exam. This is fair, and it is also fair that the AOCB exam contains a higher proportion of the more difficult type than the Novice paper.

Consider these questions.

1. The unit of inductance is the:

- a. farad
- b. ohm
- c. henry
- d. volt

This is a perfectly straightforward, easy to read, basic question from the earliest section of the course — a bit like asking a teenager how many hours in a day. You either know the answer or you do not.

Try again.

2. The unit of capacitive reactance is the:

- a. farad
- b. ohm
- c. henry
- d. volt

This should be almost as simple — still straight knowledge of fact — but it is easy to misread 'capacitive reactance' as 'capacitance' and so lose two marks in a valid, non-trick question.

Now consider.

3. The frequency of a variable frequency oscillator is determined by the:

- a. supply voltage
- b. inductance and capacitance of the tuned circuits.
- c. type of transistor used
- d. circuit design especially the amount of feedback provided

This question is 'harder' because it is more wordy, and all alternatives must be read even though the answer should be obvious once the complete question has been read.

These three questions could be used at either NAOCP or AOCB level. The next applies to the AOCB syllabus only.

4. In an Intermediate Frequency Amplifier using coupled tuned circuits the bandwidth may be altered by:

- a. changing the coupling between the circuits
- b. varying the collector current
- c. bypassing the emitter resistor
- d. screening the amplifier with non-metallic non-conducting shields

This question has a wordy stem and specific but unrelated alternatives all of which must be given consideration. Most examinees would require time to think this out rather than knowing the answer straight away, so would rate it as 'hard'.

5. Because the position of the sun, controls the degree of ionisation of the D layer and ionisation, affects radio propagation at high frequencies:

- a. the 3.5 MHz band is only useful for short range communication during the day
- b. the 3.5 MHz band is useful for very long distances at night
- c. the D layer does not affect propagation at 7 MHz
- d. the 1.8 MHz band is a very good long range daylight band

This is a fairly good example of a thoroughly bad question — too wordy, too many non-specifics ('short', 'long', 'good') and open to varying opinions. It needs to be read at least twice to work out what is actually being asked. This type of question appears in some sets of sample questions, and may be useful for practice for those who tend to read questions carelessly or too quickly. However it is unlikely to appear on an official paper.

Next month we will look at some questions in which the problems are in working out the correct answer rather than in the quality (or faults) of the question wording.

To those sitting for the November exam, best of luck, and once again READ THE QUESTION! The latest sample paper is now available from me or from the Executive Office. Thanks to John VK3AFU for the above questions.

73

Brenda VK3KT  
AR

### October's Best Photographs

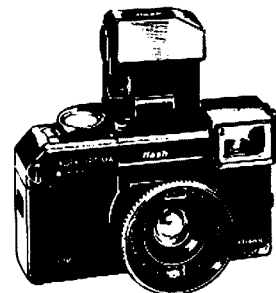

The judges at AGFA-GEVAERT and Quadricolor Industries selected the cover photo. Waverley Offset Printing Group selected photo page 69.

# COMMONWEALTH CONTEST 1983

John Tutton VK3ZC  
31 Denham Street, Hawthorn, Vic 3122

Come on you chaps, we're slipping!

Fifty four VK entries in 1982 and only fifty three this year!

However, considering the propagation conditions which we thought were terrible, but in the light of what we know, were apparently better in this hemisphere than in most other Commonwealth areas, it was really a pretty good show.

Russ Coleston VK4XA more than made up for the small deficiency in our numbers by taking out first place in the Commonwealth with a 551 point margin over ZL1AIZ, the first winner from Eastern Australia since VK2DI in 1949 when Russ, as VK3XK, was placed 14th, and a 13th in 1948 when top place was gained by VK2EO. Our congratulations to Russ on a fine all band performance greatly enhanced by his impeccable operating procedures.

Eric Trebilcock BCRS195 made it a clean sweep for Australia by winning the Receiving Section by 380 points, a not unusual feat for him, the last occasion being in 1980.

## THE LEADERS WERE:

1	VK4XA	4475	6	VK2GW	3395
2	ZL1AIZ	3924	7	VK3XB	3374
3	ZL2RY	3909	8	ZL2BR	3310
4	VK3BLN	3862	9	G3FXB	3221
5	6Y5HN	3828	10	VE5RA	3130

## RECEIVING SECTION

Eric Trebilcock BCRS 195 1974

## AUSTRALIAN SCORES

1	VK4XA	4475	50	VK3VF	1555
4	VK3BLN	3862	51	VK7LZ	1529
6	VK2GW	3395	52	VK3BDH	1494
7	VK3XB	3374	54	VK3XX	1490
11	VK3MR	3087	55	VK2SU	1471
14	VK1CC	2943	56	VK3YK	1449
15	VK3AEW	2739	58	VK3RJ	1309
17	VK2ZC	2593	59	VK3BKU	1303
18	VK8HA	2567	60	VK7RY	1295
19	VK2AQF	2540	61	VK6FS	1294
22	VK3CM	2426	63	VK4SF	1178
23	VK5GZ	2411	65	VK3FC	1148
25	VK3KF	2345	66	VK5FG	1132
30	VK6RZ	2010	68	VK3XU	1070
31	VK2DID	1939	76	VK5B0	924
33	VK2B0Q	1911	81	VK5KL	849
34	VK3AUQ	1884	83	VK3KS	710
35	VK7CH	1862	85	VK2GT	617
36	VK3ZC	1855	86	VK2D0	602
39	VK6IT	1802	88	VK7Z0	513
40	VK3MJ	1784	90	VK3CT	493
41	VK3YD	1775	93	VK5RG	428
41	VK4UR	1775	94	VK3BDU	423
43	VK5BN	1687	100	VK5H0	313
44	VK6RU	1670	103	VK2IC	213
47	VK5DL	1592	104	VK7GB	150
49	VK2BAT	1557			

## Check Log VK3CG

## OTHER PACIFIC AREA RESULTS

2	ZL1AIZ	3924	67	ZL1AZE	1108
3	ZL2RY	3909	71	ZL1MT	1003
8	ZL2BR	3310	79	ZL1BLJ	859
16	ZL1HV	2644	96	ZL2RN	368
26	9V1TL	2282			

Single band entries among the above were 7 MHz VK7GB

## 14 MHz VK6FS Overseas leader, VK2ICVK4SF

The four man team event between VK areas again resulted in a win for Victoria. A table of results on this basis over the past three years is shown, with comparisons with other Commonwealth areas as defined in the rules from which four or more logs were received.

	1983	1982	1981
VK3	13062	15813	10073
VK2	10467	13450	9407
VK5	6822	7760	3250
VK6	6776	9746	—
VK7	5199	9865	7098
VK4	—	—	—
G	10872	20384	17593
ZL1	8679	—	—
VE7	—	14187	—
VO	—	6793	—

## AUSTRALIAN AWARDS

The Gold Medallion for the leading VK entrant — Russ Coleston VK4XA.

The Silver Medallions for the leading State team — John Nakulski VK3BLN, Ivor Stafford VK3XB, Snow Campbell VK3MR, Andy Domjan VK3AEW.

The Bronze Medallion for the middle placed VK entrant — J T McMillan VK2BAT.

## HOW THE LEADERS MADE THEIR SCORES

QSOs/BONUS AREAS per band 80 to 10 (claimed)

	3.5	7	14	21	28
VK4XA	30/20	74/29	139/46	49/34	30/24
ZL1AIZ	42/24	62/32	61/42	33/27	26/22
6Y5HN	9/8	45/25	166/52	47/32	16/9
G3FXB	19/19	55/39	111/54	5/5	—
VE5RA	11/1	40/23	45/30	47/31	46/30
VK3BLN	18/17	38/26	160/47	36/26	14/14
VK2GW	28/19	56/26	35/38	34/25	11/11

## RSGB REMARKS

Despite some of the worst HF conditions for many years, the contest committee was pleased to receive an entry on par with 1981, if somewhat down on last year, when record scores were achieved. Lower entries from the UK and VE were balanced by the increased entry from ZL and the maintenance of the splendid VK contingent.

Apart from call areas appearing among the entries, (G, VE3, 5, 7, VK1-8, VO, Z2, ZB2, 6Y5, 9J2, 9V1) activity was also recorded from VE1, 2, 4, 6, ZL4, J6, T30, T32, VK9Y, VP2K, VU, ZK2, 3D6, 7Q7 and 8P6, though some of these have made only one or two contacts, 9H1 did not appear in logs for the first time we can remember.

A major solar disturbance sent the geomagnetic index from an average of nine or ten to a massive forty nine causing depressed mufs, especially in the northern hemisphere. No transatlantic contacts were made on 21 or 28 MHz and there were only two minor openings from G to VK on 21 MHz. However, these bands provided fair if not outstanding conditions between VK/ZL and VE, a significant feature of the results. The only compensation was 7MHz, where above-average traffic was recorded between G and VK/ZL on both paths.

The unusual conditions created a platform for the first win by a station in Eastern Australia (VK6HD won in 1971) since 1949. Russ Coleston, VK4XA, of Brisbane, broke the recent Canadian domination at

the top with 322 contacts and 153 bonuses, a clear victory. He receives the Senior Rose Bowl, perhaps deservedly going "Down Under" this time after all the work put in to upgrade the VK entry by John, VK3ZC, and Eric, BCRS195.

The Junior Rose Bowl goes to Peter Lake, ZL1AIZ, and is an outstanding achievement in that he does not have a beam antenna! He will be remembered as 5W1BZ in recent years. ZL2RY took third place, while 6Y5HN in his first CC was a welcome entrant making a most creditable score.

Top UK entrant, Al Slater, G3FXB, now has 11 straight wins of the Col Thomas Rose Bowl, but as it is now 31 years since the last outright UK win, one can imagine G3FXB will be around shooting for the top spot for a while yet. Maybe he could use a little support — 32 UK entries with over 300 active is dismal! If the VKs can produce around a 90 per cent entry, we can surely do as well. The committee is looking for a vastly increased home entry next year. If nothing else, at least send a check log so that we can identify the errors in those long lists of Gs worked.

The Receiving Rose Bowl has been regained by Eric Trebilcock, BCRS195, at the expense of last year's winner, "Brad" Bradbury, BRS1066. On 21 and 28MHz scores were "Treb" 250 — "Brad" 0, which rather tells all. Both are to be congratulated on the accuracy of their logs.

Attention has been drawn to the new callsign arrangements in ZL, which appear to be similar to the USA, in that no change is mandatory when someone moves to another call area. The committee will consider the implications of this when framing next year's rules. On the subject of prefixes, some strange ones seem to have joined or rejoined, the Commonwealth. Claimed log points were E1, ZS, 9K2 and, most bizarre of all, BY!

Many entrants are not checking their bonus claims or point additions. As a result some 30 per cent of logs had to be rescored prior to regular checking. Two scores show just a one point difference from the claims — this does not mean your logs received little attention! On the contrary, both were upgraded in points only to fall back in checking, a tiresome addition to the workload.

Only one entrant asked for a slight change to the rules, so apparently everyone else is happy, and indeed the committee do not contemplate any changes in the foreseeable future to this challenging event.

## Comments from entrants

Conditions . . . Worst since 74 — G2QT; since '45 — G3KSH; ever — G3JKY, G5ND and others; one to forget — RS44395; words fail me — GM3OXC; absolutely stinking — G3HZL of G4HMS; took 3h for two OSOs — Z23JO; only heard one G — VE5BAF; no EU heard — VE7BS; basically atrocious — VE3JKZ; Sunday almost blank here in no-mans land — 9V1TL; who stole the ionosphere? — Z26CJ/G3TBK; but . . . good, especially SP to UK — ZL1AZE (He was on 7MHz only!); generally good this end — VK7ZO.

Placings . . . Hard going this year — VK4XA; I'm hoping for the middle placing — VK3YD; Shall I be last again? — VK7ZO; bottom score? — G3TXF.

Miscellany . . . Sorry part-time entry — at 75 this lad needs sleep — VK2ZC; EU callers go on my PEST list (23 of 'em) — VK6FS; beam jammed SE, and no one there — VO1AW; my score is pretty lousy — ZL2BR (he missed off 1000 points on his final addition). Checked all bands and no contest station outside the designated contest segments — RS52868.



Nearly all entrants expressed enjoyment of the event, despite the adverse propagation, including Don, VK2BDU. Let him have the last word . . . "And didn't I have fun too! The antenna blew down the week before. Couldn't get it up because of the heat of the tin roof until Friday night, which I spent scrambling round the roof with a torch like a b...y 'possum'! Finished it Saturday morning, then all I got was a couple of poms — pardon — G stations! Thanks for running the contest — all good fun." Thank you, Don, the spirit lives on.

G3XTJ

It is noted with deep regret that Ed Hodson G3XTJ who was in charge of this year's contest, died on 30th August just before the results were published in Radio Communications.

#### BERU 1984

1200 UTC 10th March to 1200 UTC 11th March. Rules in February AR.

AR

### ULTIMATE MOBILE ANTENNA???

This photograph of an unusual mobile antenna was taken at the International Amateur Radio Gathering held in Frederichafen, Germany on 17-19 July 1983.

The antenna is built of aluminium and telescopes almost to roof level. From left to right are Mike ZS6BUX, Henry GM4FXX, Bob VK2GZ and seated in front is Detlef DL9DAQ.

The Convention attracted approximately 10 000 amateurs.

Contributed by Bob, VK2GZ



## A Call to all holders of a NOVICE LICENCE

Now you have joined the ranks of Amateur Radio, why not extend your activities?

### THE WIRELESS INSTITUTE OF AUSTRALIA (N.S.W. DIVISION)

conducts a Bridging Correspondence Course for the AOCF and LAOCF Examinations.

Throughout the Course, your papers are checked and commented upon to lead you to a **SUCCESSFUL CONCLUSION.**

For further details write to:  
**THE COURSE SUPERVISOR, W.I.A.**

P.O. BOX 1066,  
PARRAMATTA, NSW 2150

## WANTED TO BUY

Ham gear, CB equipment, Hi Fi, video, car stereo, large or small quantities.

**WE BUY AND SELL**

**ANYTHING ELECTRONIC**

**ANY QUANTITY**

**ANY CONDITION**

## HAMRAD

104 Highbett Street,  
Richmond, Victoria.  
Phone: (03) 428 8136



### SHURE MODEL 444-D DUAL IMPEDANCE CONTROLLED MAGNETIC® COMMUNICATIONS MICROPHONE

**GENERAL** The Model 444-D is a pressure-operated CONTROLLED MAGNETIC microphone. It is specifically designed for radio communication applications and provides optimum performance from single sideband transmitters as well as AM and FM units. The response cuts off sharply below 300 and above 3000 Hz with a rising characteristic to 3000 Hz. This special response characteristic results in optimum speech intelligibility and audio punch to cut through noise and interference.

**MICROPHONE FEATURES** • A response tailored for single sideband transmissions • A switch for instantaneous selection of Press-To-Talk or VOX (voice operated relay control) operation • Finger-tip control bar (locking or non-locking action) to actuate microphone and an external relay or control circuit • Long-life switch to satisfy severe requirement of communication systems • Adjustable microphone height • A sturdy, high impact ARMO-DUR® base and microphone case • Dependability under all operating conditions

The "SHURE" MODEL 444 has one of the best sounds on the amateur bands.

**IT'S THE BASE STATION  
MICROPHONE FOR YOUR STATION**

**Price: \$145 (inc post)**

**William Willis & Co Pty Ltd**  
98 Canterbury Road, Canterbury, Vic 3126  
PHONE: 836 0707.

### Microwave Developments

**UHF & MICROWAVE COMPONENTS**

Our improved 70 cm and 23 cm Power/VSWR Meters are priced under \$100. Each has high and low accurately calibrated, switched ranges and a direct reading VSWR scale on low.

1269, 1296 and 1700 MHz Long Loop Yagis, 1, 2 and 4 Bay with splitters. Soldered copper from \$65 (single).

Waveguide, Flanges, Gunn and Detector diodes. All new high quality equipment. Well priced.

3 cm WG Assembly, with 3 dB coupler, 22 dB horn, Gunn oscillator and IN23WE mixer — \$125 complete.

Used, working, Gunn diodes for experimenting and getting the feel of it @ \$1 per mW, tested in our mount prior to delivery.

PTFE PC Board, ER 2.5, double sided, 1 oz Cu/.0625" @ 14 c/sq cm.

P/P extra at cost. All prices included 20% Sales Tax.

DES CLIFT VK5ZO

**6 Netley Road, Mount Barker, South Australia 5251. (PO Box 274). Telephone: (08) 391 1092.**



# VHF UHF - an expanding world

Eric Jamieson, VK5LP  
1 Quinns Road, Forrester, SA 5233

All times are Universal Co-ordinated Time,  
indicated as UTC

## AMATEUR BAND BEACONS

FREQ	CALLSIGN	LOCATION
50.005	H44HIR	Honiara
50.008	JA2IGY	Mie
50.020	GB3SIX	Anglesey
50.035	ZB2VHF	Gibraltar
50.060	KH6EQI	Pearl Harbour
50.075	V56SIX	Hong Kong
50.945	ZS1SIX	South Africa
51.020	ZL1UHF	Auckland
52.013	P29SIX	New Guinea
52.100	VK0AP	Macquarie Island
52.200	VK8VF	Darwin
52.250	ZL2VHP	Palmerston North
52.300	VK6RTV	Perth
52.320	VK6RTT	Carnarvon
52.350	VK6RTU	Kalgoorlie
52.370	VK7RST	Hobart
52.420	VK2RSY	Sydney
52.425	VK2RGB	Gunnedah
52.435	VK3RMV	Hamilton
52.440	VK4RTL	Townsville
52.470	VK7RNT	Launceston
52.510	ZL2MHF	Mount Climie
144.400	VK4RTT	Mount Mowbullan
144.420	VK2RSY	Sydney
144.465	VK6RTW	Albany
144.475	VK1RTA	Canberra
144.480	VK8VF	Darwin
144.550	VK5RSE	Mount Gambier
144.600	VK6RTT	Carnarvon
145.000	VK6RTV	Perth
147.400	VK2RCW	Sydney
432.410	VK6RTT	Carnarvon
432.420	VK2RSY	Sydney
432.425	VK3RMB	Mount Bunninyong
432.440	VK4RBB	Brisbane

There are no changes to the beacon list this month, although I did hear on the grapevine that VK4RTL in Townsville had been destroyed by lightning. Perhaps someone nearer to that area than I might confirm or deny the report!

It appears also that W6IRT the beacon which used to be on 28.887 MHz during the peak of the sunspot cycle may now be on again, but nothing heard here.

Moves are afoot in VK5 to try and get the beacons back on the air. Mark VK5AVQ, who has been doing a lot of the work, dumped a chassis on me a few days ago with a request to build a suitable filter for the 6 metre beacon, or else! When that's done we are hopeful of trying the 6 metre beacon at its usual site on Mount Lofty and we would like it to be on its appointed "Band Plan" frequency of 52.450 MHz which is quite a bit lower than its former frequency of 53.000 MHz.

Naturally we would also like to get the 2 metre beacon operating as well, but there are a number of problems associated with this

one: The previous beacon, if operated much lower than its former 144.800 MHz, caused serious desensitising and overload problems at a few locations in Adelaide. The siting on Mount Lofty is a prime site for placing an enormous signal into Adelaide and for those operators living in areas where they had to look through the beacon to work to Melbourne and the South East had troubles.

One solution would be to have an antenna which attenuated the signal to the Adelaide area, but a problem then arises that Albany in WA, Adelaide and the beacon of Mount Lofty are all in line looking west, so the degree of attenuation to make the signal presentable in Adelaide wouldn't be heard very easily in Albany!

At this stage it seems desirable to put the beacon back again on its former frequency and run some tests in Adelaide to see what happens. A reduction of power to about 10 watts (30 watts previously) might help, and production ideas and techniques have changed considerably since the former beacons were built some twenty years ago, so the new generation beacons may not be the same problem. Whatever the outcome it is not the intention of those doing the job to prevent anyone from enjoying their hobby, but surely we can in return expect to receive a fair hearing and an offer to come part of the way themselves by anyone affected by ensuring the equipment in use is fair and reasonable and using antennas devoid of dry joints and other problems likely to be responsible for any "diode" action! More later.

## NEWS FROM NEW SOUTH WALES

VK2 seems to be featuring rather prominently lately judging by the degree of activity outlined in another letter from Gordon VK2ZAB who is amongst all those interesting contacts in that State.

He writes: "Two metre SSB activity monitored from this QTH (Berowra Heights) appeared to be a bit quiet during August. I made some sixty contacts without Sydney stations, which is about three-fifths the normal rate! Some comments.

"Jock VK2ZQX at Gunnedah and Doug VK2XDH at Uralla put consistent and regular signals into Sydney. Less frequently during August Barry VK2KAY at Gunnedah and Don VK2ADY at Tamworth were also worked. These northern stations may be heard almost any week night on 144.2 MHz at 1030 UTC. Doug VK2XDH was at Armidale where his operations were restricted due to the presence of a Ch 5A translator, his shift to Uralla has released him from this handicap.

"On 31/8 I was pleased to work Dallas VK2ECC at Yetman which is very close to the Queensland border and had not been heard for some months. Whilst on VK4 Bill VK4LC is back from a trip overseas and will resume from Eagle Heights shortly. Hopefully this will

encourage VK4s in Brisbane to attempt to emulate Bill's success at working into Sydney on 2 metres.

"Other VK2 stations to the north are quiet on 2 metres although Tom VK2DDG at Byron Bay is known to be active, closer to Sydney Barry VK2BBA at Newcastle and Ray VK2BVO at Toukley were heard from here during August.

"The only station to the west heard during August was John VK2YEZ at Griffith and is audible in Sydney any time he cares to transmit that way. His 70 cm signal was also heard on one occasion he tried it, although two way contact was not possible due to my 10 watts PEP. The 2 x 4CX250B linear under construction here will change that shortly John's 80 watts on 70 cm has enabled him to make several.

"Jeff VK2EJJ at Wagga was worked several times on 2 m. Sometimes Jeff has only 10 watts PEP and still makes it into Sydney.

"In VK1, Ralph VK1RK and Glen VK1KAA can be heard on 2 m SSB frequently. Eddie VK1VP puts a good 70 cm signal into Sydney as well as his normal S6 on 2 m. Ian VK1ZIF is not favourably located for Sydney contacts but nevertheless was worked again during August when conditions are generally thought to be less than ideal. John VK1CJ doesn't have to wait for good conditions, his signal reached S9 on occasions during the month.

"On 30/8 John VK2ZMX in Cooma was 5 x 4 here. John's signal is always good in Sydney indicating the 2 m SSB path is not as 'conditions' restricted as some may think.

"Scheduled operations with Doug VK3UM on 2 metres continued throughout August. The time is now 2245 UTC on Saturday (local) and Sunday (local) mornings. Frequency 144.200. We made firm contacts on five occasions when signals were from 5 x 2 to 5 x 4 for periods ranging from two minutes to five minutes, down for several minutes then up again for a further five minutes. Signals are always detectable although on those occasions, when firm contact was not established, the norm is only occasional peaks, some words and syllables plus meteor pings. On 20/8 Brian VK2ZHT in Sydney also made contact with Doug again; VK1RK, VK1KAA and VK1VP also worked Doug on a few occasions.

"It seems to be that similar contacts should be possible between Sydney and Brisbane and I would like to hear from anyone there who may be interested in trying. Contacts between Sydney and Adelaide may be a bit to expect from the suspected propagation mode but nevertheless I would also like to try it on a regular basis with any VK5 who has the time and the equipment to try.

"Finally, country stations and VK1s often ask me what 2 m SSB activity there is in Sydney and the answer is that it varies. During August the following 2 m SSB stations

located in or near Sydney appear in my log: VK2ELS, VK2AAS, VK2EDB, VK2KBL, VK2YIF, VK2KBG, VK2ZRG, VK2YEW, VK2ZQA, VK2ZSC, VK2AYF, VK2ZRU, VK2ZHT and VK2NT. Not all are equipped to work long distances but looking at the list I believed about half of those are so equipped and of course there are many other stations so equipped who do not appear in my log for that period."

Thanks for another interesting letter Gordon and I hope there will be some stations in other States able to take up your offer of providing the Sydney end of the connection. I would dearly like to be able to do so myself but my working hours make this difficult. Are they any takers?

### THE VK2AMW MOONBOUNCE REPORT

Lyle VK2ALU in "The Propogator" for September gives a lengthy report on the activities associated with the near completion of the relocations and overhaul of the dish antenna, with one of the sought after achievements at the moment being to have an EME contact with Z25JJ in Zimbabwe before he dismantles his equipment for his move to South Africa later this year. The test was scheduled for 4th and 5th September — I have nothing concrete to report on results at the moment although I did hear from a source that an equipment breakdown had prevented contact being made. I hope I can report this to be wrong next month.

After the feedhorn had been installed, and the sighting telescope mounted on the dish structure, coincident with the true axis, the dish was used to track the Sun's movement optically. This test revealed an error of 0.5 degree of runout in Hour Angle for each hour of dish movement in this plane, and correction will require the whole dish structure to be rotated slightly in an anti-clockwise direction.

Three low noise receiving preamplifiers using GasFETS are installed and with everything temporarily in place initial Sun noise checks were done. These show an initial 14 dB of Sun noise, to be improved later. Antenna radiation angle tests were also done, using the Sun, and it was found the dish had a half power beamwidth of just under 2 degrees! This is equivalent to 38 dBi dish gain!

Lyle says the transmitter is now delivering a measured output of 120 watts into a dummy load and is due to be installed in a waterproof mount at the dish site soon.

Best wishes to you Lyle VK2ALU and your team of helpers, we look forward to hearing more of your activities soon and to learn what contacts are being made.

### SIX METRES COUNTRIES LIST

Last month I mentioned reviving moves to start a 6 metre countries worked listing similar to that already contained in overseas magazines. I repeat it here as another reminder that if you have already sent in your list and it needs updating then by all means update, if you have not yet sent in your list then what about doing so. The information needed is once more: For each contact, Date, Time in UTC, Callsign, Country, Mode, RST Report sent and received, and whether a QSL card or other confirmation has been received. If you are still awaiting confirmation, add that country to the list but indicate no QSL so far

as it will be shown in a separate column. Right, chaps, into it!

### OSCAR 10

When one wonders where all the 2 metre activity has disappeared to it is only necessary to have a look up the band around 145.9 MHz and there it is! A number of operators now have worked more than forty countries and many hundreds of contacts, and their voices must surely be feeling the strain. It has been of interest to me to note that it is possible to get signals out of the machine with much lower than anticipated signals going in, so it speaks well for the design of the equipment and the way it is working. Congratulations to all.

### LOCATOR

Last month I mentioned Steve VK5AIM had offered to underwrite an award or certificate for working stations located in the various locator squares assigned to this country. In an effort to make his offer work it seems desirable to outline in more detail what is involved and how you go about deciding where you live.

**HISTORY:** For a number of years correspondence has passed around the world to various VHF managers (including me) in an effort to arrive at a suitable means of providing an identification in simple terms which would show where anyone on this earth lives. The idea of a "QTH Locator" is not new, having been seen operating in West Germany some thirty years ago, and its use spread rapidly throughout Europe and North Africa. It was originally designed solely for European use where so many countries close together generally ensured its success. Contests of all kinds have been run based on locator squares, and a special listing appears periodically in European radio magazines showing the latest tally of locator squares worked by the highest scoring stations.

Much of the hard ground work must surely go to Folke Rasvall, SM5AGM, of Sweden, who is the DX Record Co-ordinator for Region 1, and who has finally seen the fruits

of his labours arrive at an apparent move to have a locator system adopted largely on a world wide basis. A letter was received from Folke in July, 1983 and this is the first chance I have had to incorporate its contents in this column. It reads:

"The IARU Region 2 Conference was held 6th-11th June, 1983 at Cali, Colombia. The VHF Committee was chaired by ARRL (USA) Communications Manager W1XX, John Lindholm, and the following text was unanimously adopted:

"This Conference adopts the parallel use of (a) longitude and latitude for transmitting station location; and (b) the use of the proposed Region 1 (Maidenhead) Locator System for awards and contest purposes."

"We should note that the Region 3 addition 'when the time is appropriate' is not included, which means that Region 2 is the first region to finally adopt the Maidenhead Locator. My warmest thanks to all that have contributed to this excellent result."

The system is based upon the use of 2° x 1° blocks and it has been concluded that it is the only system likely to have any hope of world wide acceptance. It has evolved from an original proposal of SM5AGM and G4ANB and is often known as the Maidenhead System as it was at a place in England by that name where it was first tabled. The system has received guarded support by Region 3, mainly I believe because of uncertainty on how the system works, and that the Region 3 areas are quite isolated by comparison with most other areas of the world. However, the system does provide for our inclusion.

The system starts off by basically dividing the whole world into a series of squares of the sizes mentioned above each bearing two letters, the first refers to the longitude and the second the latitude. The accompanying map shows how Australia and New Zealand are situated in the world system. From this map you should be able to rapidly determine in which square you live unless you are a borderline case when you may have to be more careful. The remaining figures and letters of the system are arrived at according

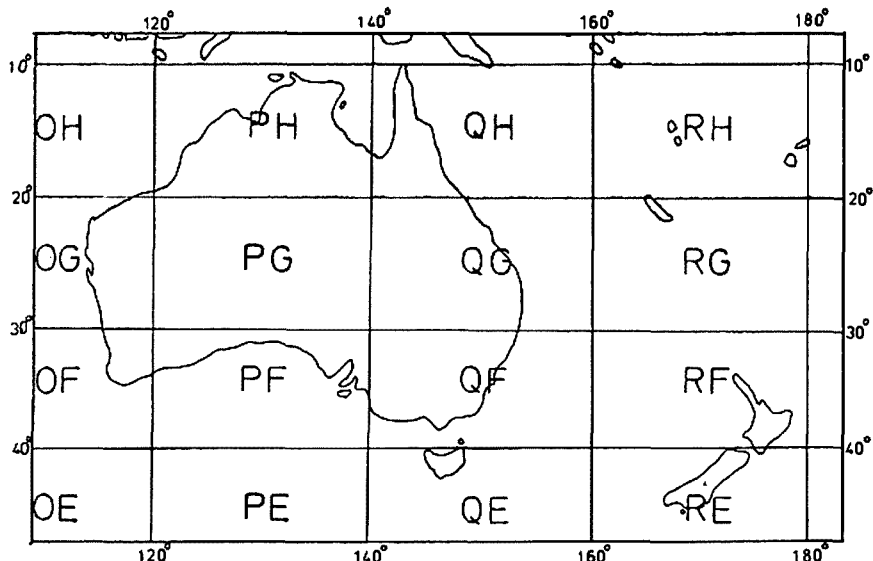

The Longitude/Latitude Locator System Map.

to the accompanying tables, which were originally published in "The Short Wave Magazine" from the UK and I have suitably modified them for use in Australia. I believe I am correct in what I am doing!

**3rd Character:** This will be a number determined by the number of degrees East Longitude you are, so consult the following chart:

Degrees East Long	Third Character		
110-111	4	136-137	1
112-113	3	138-139	0
114-115	2	140-141	9
116-117	1	142-143	8
118-119	0	144-145	7
120-121	9	146-147	6
122-123	8	148-149	5
124-125	7	150-151	4
126-127	6	152-153	3
128-129	5	154-155	2
130-131	4	156-157	1
132-133	3	158-159	0
134-135	2	160-161	9

**4th Character:** This also is a number and is the same as the second digit of your latitude eg if your latitude is 33°N then your second figure is a 3; if your latitude is 18°N then the figure is 8.

These first four characters will be sufficient for the VUCC Awards and for most contests, and is probably as far as most stations need to go.

If for some reason you have to be more specific then two further characters can be obtained in the following manner:

**5th Character:** This is a letter and is determined by the number of "minutes of east longitude" for your location. If your number of degrees (minutes) is an odd number, see Table A. If yours is an even number use Table B.

(A) Odd Longitude		(B) Even Longitude	
Minutes of East Longitude	6th Character	Minutes of East Longitude	6th Character
0-5	L	0-5	X
5-10	K	5-10	W
10-15	J	10-15	V
15-20	I	15-20	U
20-25	H	20-25	T
25-30	G	25-30	S
30-35	F	30-35	R
35-40	E	35-40	Q
40-45	D	40-45	P
45-50	C	45-50	O
50-55	B	50-55	N
55-60	A	55-60	M

**6th Character:** Take the number of minutes of latitude (following the number of degrees) and consult the following chart:

Minutes of South Latitude	5th Character	Minutes of South Latitude	5th Character
0-2.5	A	30.0-32.5	M
2.5-5.0	B	32.5-35.0	N
5.0-7.5	C	35.0-37.5	O
7.5-10.0	D	37.5-40.0	P
10.0-12.5	E	40.0-42.5	Q
12.5-15.0	F	42.5-45.0	R
15.0-17.5	G	45.0-47.5	S
17.5-20.0	H	47.5-50.0	T
20.0-22.5	I	50.0-52.5	U
22.5-25.0	J	52.5-55.0	V
25.0-27.5	K	55.0-57.5	W
27.5-30.0	L	57.5-60.0	X

**EXAMPLE:** The location of VK5LP is Longitude 138° 54' 21.2" and a Latitude of 34°

47' 39.3" and my locator square is PF 04 NS and it is decided this way. The PF is easy by looking at the map and relating my 138° to the appropriate square. The 138 is used again to obtain the 3rd character from the table and falls between 138-139 so I now have 0. The fourth character is the same as the second digit of my latitude which is a 4 from 34°. So now I have the main requirements of my location, namely, to get my final two letters, I refer the 54'(minutes) of longitude to Table B because it is an even number and get the letter N. The last letter comes from the 6th Character Table, and being 47'(minutes) of latitude I get S. This then gives me a very accurate description of my location by being PF 04 NS and by working backwards you can determine readily where a station you have just worked might be located. It will seem a bit awkward for a while but it's pretty straight forward really. Mostly what concerns me at the moment is that I am PF 04.

Perhaps some club or organisation might like to sponsor an award for 100 Locator Squares Worked, with additions for every subsequent 100 squares worked. Are there any takers? If it doesn't do anything else it might get some activity on the bands once more, as there seems to be no reason why such awards could not be for 52, 144 and 432 MHz for starters!

Incidentally, although I have shown my location right down to parts of seconds, this is not necessary for the purposes of the Locator, for average use degrees and minutes is all that is required. If you need to go further you may be able to obtain the figures from good maps, especially the Lands Department maps, or you might be lucky enough to find on referring to the Department that your place is already listed in longitude and latitude.

## SIX METRES OVERSEAS

From "The World Above 50 MHz" in QST with Bill Tynan W3XO, for September 1983, comes news of the first successful 50 MHz two-way crossing of the Atlantic Ocean via Es from the USA to Europe. This followed in the wake of the first such contacts by Canadian stations (which I reported recently). On 1st July WA1OUB in New Hampshire began hearing TV buzz in the band starting as early as 1145 UTC. Bob said 10 metres was dead at the time. At 1840 he noticed European 10 metre beacons coming in and a CQ on 6 metres brought a crossband QSO with SM6PU at 1848. At 1850 G4GLT was worked via the same route. This was followed by GM4COK at 1900 and DF2AO at 1909. Repeat 6 to 10 contacts with SM6PU were made at 1920 and 2033. At 2220 and 2223 WA1OUB crossbanded with GM3DOD and G4GLT. The latter told Bob to listen for him in seven minutes on 50.096. Bob began calling at 2228 and stood by at exactly 2230. Unfortunately he did not hear G4GLT but there was GJ3YHU calling him with 529 signals. WA1OUB received 559 and what is probably the first 50 MHz two-way Es contact between the US and the UK went into the VHF record books. Bob heard no other signals from across the pond, but a report from G5KW at Lands End, Cornwall, notes reception of WA1OUB on 1/7/83. Ken, G5KW, was disappointed not to have been heard in the US as this would have been country number 10, since receiving one of the forty-off-TV hours 6 metre permits in

February. His other countries are G, GW, GM, GJ, GU, ZB2, and I.

The second such contact was between KA1PE and GI3ZSC at 2235. The GB3SIX beacon on 50.018 and the ZB2VHF beacon on 50.035 were being monitored between 2100 and 2229 prior to this contact. Once again this shows the great advantage of having beacons in strategic places! So far the main contacts seem to be limited in the main to 10 to 6 crossband contacts, with CT2EE being included. It will be interesting to see what happens in the next summer Es season in that hemisphere.

Also interesting to note in "QST" that the DX-pedition by W6JKW to the Cocos Islands only netted forty six metre contacts, all from Florida to Maine and then only on 15th June. Rest of the time was spent on HF and 2 metres EME!

## VHF PIONEER: W2AZL

From "QST" comes news of the passing of Carl Scheideler, W2AZL, who became famous through the 1950s and 1960s for his 2 metre converter design which for a long time was virtually a standard of comparison for such converters. Carl contributed much to the improvement to the state of the art at VHF. He was active on 50, 144, 432 MHz as well as 144 MHz EME.

Carl passed away on 18th July after losing a battle to cancer. I am sure I speak for the VK VHF fraternity in offering condolences to his widow Agnes.

## VK2AMW EME STATION AGAIN

In today's mail I received a note from Murray VK2MY, Secretary of the Illawarra Amateur Radio Society, and enclosing last minute news of the VK2AMW EME tests with Z25JJ in Zimbabwe, and mentioned earlier in this month's column.

It reads: "After a construction period of over twelve months, following the relocation of the 9 metre diameter dish of the University of Wollongong in mid 1982, a successful EME test was conducted by the Moonbounce Group, headed by Lyle Patison VK2ALU, on Saturday 10th September, 1983.

"The test was arranged between the IARS station VK2AMW and Z25JJ, operated by Peter Carey in Harare, capital of Zimbabwe. It required a tight construction programme at VK2AMW as Z25JJ was dismantling his dish starting on 11th September, prior to a move of QTH to South Africa.

"Preliminary tests with Z25JJ on the previous weekend, 4th and 5th September were prevented by transmitter power amplifier stability problems and a short in a coaxial relay in the receiving system, but the tests on the 10th September, which was carried out between 0700 and 0830 UTC resulted in a confirmed contact.

"The project team worked under some difficulty during the day due to rainstorms, which required hasty covering up of outdoor equipment not yet made waterproof. By 1600 EAST our first echoes were being received at approx 3 dB above noise level, with visual tracking of the moon. Initial contact with Z25JJ was delayed for approx half an hour after the test was commenced due to frequency counter readout at VK2AMW being approx 15 kHz low at 1296 MHz.

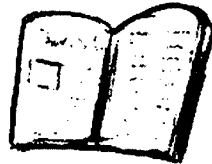

# MAGAZINE REVIEW

Roy Hartkopf, VK3AOH  
34 Toolangi Road, Alphington, Vic 3078

(G) General. (C) Constructional. (P) Practical without detailed constructional information. (T) Theoretical. (N) Of particular interest to the Novice.

**AMSAT-UK OSCAR NEWS. AUGUST 1983 NO 43.** Special Oscar 10 handbook. Details of frequencies, band plans, orbits and data transmission standards.

**73 MAGAZINE. SEPTEMBER 1983.** Packet Radio Revolution. (G) Increasing your QSOs. (N) Simple microwave antenna. (P).

**HAM RADIO. JULY 1983.** Packet Radio Part 1. (G) Modular two band receiver. (C). **CQ. JULY 1983.** Special VHF Issue.

**RADIO COMMUNICATION. AUGUST 1983.** Digital SWR-Power-Peak Meter Part 1. (C).

**CQ. AUGUST 1983.** Special Antenna Issue.

**QST. JULY 1983.** AMTOR (New RTTY Mode). (G) Spread Spectrum Applications. (G) Salvaged Components — A Gold Mine. (GN) Filters. (P).

**1983-1984 AUSTRALIAN CALLBOOK.** Doubtless this will be mentioned at length in other places but I would like to praise two features. First a comprehensive list of all types of coaxial and twin balanced transmission lines and second the provision of space after call sign lists etc for adding new information, notes and alterations. Altogether a big improvement on previous issues.

Since writing this column I have received a number of letters from country readers asking for information re articles etc. I have always felt that those of us who live in the cities get far more for our subscriptions, access to the rooms and facilities, library, data, disposals and so on, and I feel it is up to us to do whatever we can to help the country amateurs. So if you want information, some different component, some disposal item if it turns up write and I'll do my very best to help. Please enclose a SAE appropriate to the request (a large one for data sheets etc).

AR

"When all was peaked up signals were "O" copy both ways. Z25JJ reported via an HF link established via VK2CAG, that our EME signals were 6 dB above noise and good copy. Z25JJ's signals also built up to 5-6 dB above noise which was very satisfactory in view of the equipment not yet all peaked up at this end — although the 10 metre diameter dish and 400 watts at the other end helped!

"As far as is known this is the first 1296 MHz EME contact from NSW and the last hour or so of proceedings were put on to record by Mike VK2DFK with his video equipment.

"We anticipate the equipment will be completed as a permanent installation over the next 4 to 6 weeks, after which contacts are looked forward to with the small group of EME operators on 1296 MHz in various parts of the world. Experiments are also planned with antenna feed systems once a high power permit is obtained and some limited tropo-propagation experiments may also be possible using lower power levels."

Congratulations to the Illawarra team for their efforts and the reward they received in meeting a Z25JJ deadline and having that very special contact with Peter.

And it did seem my spies were correct in saying contact had not been made on the weekend of 4th-5th September, but I am glad it was completed a week later!

## BELGIUM TO LOSE UHF BANDS

From "The Shortwave Magazine" for August 1983, per kind favour Steve VK5AIM, comes news of a serious situation developing in Belgium when, at a meeting on 24/6, the amateur representatives "were shattered to learn it was proposed to withdraw all but the 434-438 MHz part of the 70 cm band, and to take away all amateur bands from 1.24 to 5.85 GHz.

"What has, understandably, incensed Belgian VHFers even more, is that it was proposed to bring these severe restrictions into law by 15th July, leaving no time for them to prepare a case for a fight... This is a very serious matter since, if the Belgian authorities get away with it, then those in other western European and NATO countries might consider the same trick if faced with demands for more UHF allocations. Another blow is a power limit of 30 watts on the remaining part of the 70 cm band, and on 2 metres there were to be power restrictions, thus rubbing further salt into the wounds."

At the 1979 WARC Conference the band 430 to 440 MHz was allocated to Region 1 on a shared basis, equally, with amateurs and radiolocation systems. It seems no footnotes were added at the time by Belgium.

## OF GENERAL INTEREST

By the time you read this we will be starting to get into the early Es openings on 6 metres. May I urge you all to continue to use 52 to 54 MHz for the Es openings we normally get through the summer months, and reserve the 50 to 50.15 MHz segment for true DX operating (outside TV hours for Channel O of course). I understand there is every likelihood the Ross Hull Contest will be conducted above 52 MHz which is a good thing. It is most vital during the next twelve months, or so for us to do the right thing in regard to the new portion of the band if we ever hope to have an increased usage of that portion. Thoughtless

use causing Ch 0 interference will be seen by the TV stations as being irresponsible and they will lobby all the harder to have the privilege removed once and for all. Therefore, please play the game according to the rules; remember, a lot of the former exotic stations from the USA and Pacific areas were heard on 50 MHz from about 2100 to 2400 and on to 0100 or thereabouts, and these times will be outside TV hours. If 50 MHz is not cluttered up with Es operating stations in VK there will be many people who will get their first chance to reply legally to the overseas stations.

If you want to do all your operating on 50 MHz just think about it this way. If everyone did this, we would probably lose 52 to 54 MHz as no longer being needed. Then if the TV stations become snouted because we are causing interference we will also lose 50 MHz. Where do we go then? We may finish up without any spectrum for 6 metre operation, and that would be an even greater tragedy!

For the closing thought for the month I draw on a list sent to me some time ago by Philip VK3YAZ: "He who thinks by the inch, and talks by the yard, should be kicked by the foot." and "Even a short pencil is more reliable than the longest memory." Good DXing this summer, and hope to hear you on the bands. 73. The Voice in the Hills. **AR**

## STRAYS

Basic human nature changes little it seems. Looking back through magazines published a half century ago, the same endemic gripes are well to the fore. Here are just a few: (1) Amateurs whose operating behaviour besmirches our image. (2) Those who won't QSL. (3) Piracy. (4) The use of excess power — and so on.

The 'Wireless' Magazine TELERADIO, of May 25th 1935, in its pages devoted to amateurs has this comment under a title HAMS — MOCK AND REAL:

"There are decent amateurs on the air and others who are not... the operator who asks for reports and then does not reply with his QSL card is not playing the game."

Under another heading of NZ HAMS is this query:

"Have any VK DXers had any experience with ZLs not replying or sending QSLs when NZ stamps or Imperial Reply Coupons have been enclosed?"

(I guess the Kiwis could say the same about some VKs of that period — Al, VK4SS).

On the subject of Piracy, many OOTs, now that age is upon them, confess that they 'tested' their gear on air before gaining their licence. The international raries went one better — they congregated outside the 20 m band, say 13.995 MHz, so they could be better heard. However, most OOTs were then striving to obtain a ticket. Today, we have Piracy for Piracy's Sake, in lots of cases.

A Shawsmith, VK4SS  
**AR**

**SUPPORT YOUR ADVERTISERS**

Remember to say  
you saw their ad in AR

# ATN ANTENNAS

A Victorian Approved Decentralised Secondary Industry providing apprenticeships and training to many young people in the only Secondary Industry in the Shire of Birchip. Situated in NW Victoria, the Shire has an area of 1470 square kilometres and a population of 1470.

We have manufacturing and testing facilities for Satellite, TV, Radio Astronomy, EME and all type of CB, Amateur and Commercial Communications Antennas and supply to many Overseas Countries.

*If our High Gain TV Antennas are unable to solve a particular TV reception problem WITHOUT THE USE OF BOOSTERS on either VHF or UHF, then the problem cannot be solved. (TV Dealer enquiries welcomed.)*

With thirty-five years' experience and the first Amateur Radio Station in the Southern Hemisphere to conduct successful Two-way Radio Contacts via Lunar Reflection on VHF in 1966 and subsequently on UHF (resulting in the only non-American ever to be awarded the ARRL TECHNICAL MERIT AWARD) our record is hard to beat.

FOR A FREE CATALOGUE ON OUR COMPREHENSIVE RANGE OF PRODUCTS WRITE TO:

# ATN ANTENNAS

PO Box 80,  
Lot 11, Morrison Street,  
Birchip, 3483  
Phone: (054) 92 2224 (24 hours)  
Telex: AA 55480 OCOBIR

*Or one of our many approved distributors throughout Australia, New Zealand and the Islands.*

## LEARNING THE MORSE CODE? Try the All New BT-1 — Basic Trainer For Morse Code

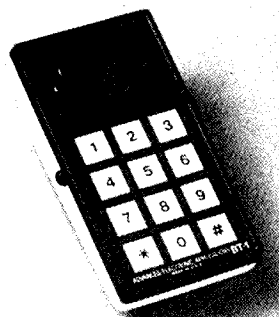

Advanced Electronic Applications in conjunction with ETS (Educational Technology and Services)\*, has developed the BT-1 Code Trainer. ETS methodology, based upon research by a prominent mid-west university, has demonstrated that a typical student using this system and the BT-1, can learn Morse Code to speeds of 20 WPM in four weeks based upon two 20 minutes daily training sessions.

The pre-programmed BT-1 computerised trainer will allow you to achieve proficiency in Morse Code faster than any other known method.

No prior knowledge of Morse Code is required to use the BT-1. There are no tapes to purchase or wear out. The BT-1 operates from a 12 VDC source, the unit can also be used in mobile settings via the 12 VDC system.

\* Education Technology & Services, see page 81 October 1981 issue of Ham Radio Magazine

**Prices and Specifications  
Subject To Change Without  
Notice Or Obligation**

**ADVANCED ELECTRONIC  
APPLICATIONS**

**Brings you the  
Breakthrough!**

**\$134.40 (Inc. of ST) Plus P&P**

### HY-TECH DISTRIBUTORS

Building 51,  
Archerfield Aerodrome, Q 4108  
Tel: (07) 277 5624  
Telex 43318

## RTTY/CW

**Advanced split-screen ASCII, BAUDOT, CW software for  
Commodore computers . . . \$59**

VIC 20 computer — 5K RAM, 8  
colours, hi-res 176\*200 pixel  
graphics, 4 voice sound  
generator . . .

**\$295**

Commodore 64 computer —  
64K RAM, 16 colours, hi-res  
320\*200 pixel graphics,  
sprites, sound synthesizer . . .

**NOW  
\$499**

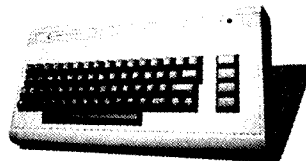

**Both computers feature 20K BASIC & operating system, RS 232, parallel user port — disc drives, printers, joysticks, paddles, light pens, games, utilities etc available.**

**Versions also available for PET/CBM 3000, 4000 and 8000 series (includes SSTV send) — POA.**

## HIGH TECHNOLOGY COMPUTER SYSTEMS PTY LTD

**87 Swan Street, Richmond, Vic 3121 ph (03)  
429 1966**

# SPOTLIGHT

ON

SWLING

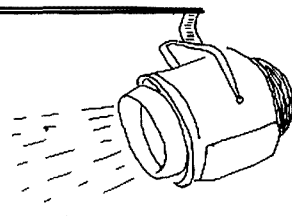
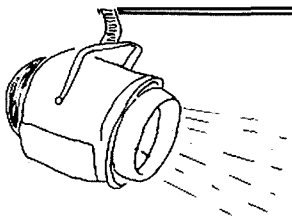

Robin Harwood, VK7RH  
5 Helen Street, Launceston, Tas 7250

On the 31st August, 1983, a Korean Boeing 747 Jumbo jet was en route from Anchorage, Alaska to Seoul, South Korea with 269 passengers and crew aboard. This flight appeared to be normal, judging by reports from the plane at several intervals along the route by air traffic controllers at the two guard stations at Tokyo and Anchorage. The first hint of trouble came when the Jumbo failed to report at a pre-determined plot, triggering a massive air-sea rescue. With no signs of wreckage being found along the pre-planned route, the controllers began to suspect that the plane had veered off course. Initial enquiries to the Soviet Union elicited that they had no knowledge of the Korean flight. But recordings by American and Japanese military intelligence, when processed, provided monitored traffic of the Soviet air defence communications, which gave a different light to the picture.

The plane had strayed off its planned course and had indeed veered into Soviet territory, and had in fact strayed over an extremely sensitive area. Soviet air defence command on the ground assumed it was a spy flight. American military reconnaissance aircraft had been observed on Soviet radar. When the Jumbo failed to respond to interceptor fighters scrambled to investigate the plane, the order was apparently given to fire an air to air missile. The plane was destroyed along with the 269 people on board.

This tragic incident has caused a very sharp escalation in tension between the United States and the USSR, especially after the Americans divulged what happened to the Korean flight, revealing the contents of their electronic intelligence intercepts. The world naturally was stunned. At once, a war of words — accusations, denunciations and statements — were spinning across the frequency spectrum from all sides. The Voice of America as well as their "clandestine" sender Radio Free Europe/Radio Liberty increased the programme output, particularly in Russian. Only a few weeks earlier the two organisations were fighting budget cutbacks with Congressional committees. Funds were very quickly appropriated allowing the "Voice" to increase the number of programme hours in Eastern bloc languages.

It wasn't too long either before the huge array of jammers caught up with the extended hours of the various stations, attempting to drown out the programmes. Unfortunately, many other international and domestic stations broadcasting on shortwave, not directly beaming programmes to that area, suffered interference to their signals from the spillover from these jammers. Those listeners, particularly in Europe, do find it extremely difficult to pick out their desired programmes

among the buzzsaws or distorted audio from narrow band FM signals. These jammers are found on several points within the allocated band.

This makes it very hard for the general listener to shortwave, as the majority of models would not have very good selectivity. The presence of these jammers on several points within a sub-band, would render it useless to those types of models.

Naturally, broadcasters have started using new channels outside those normally allocated for international broadcasts, in an effort to escape the jammers. Unfortunately the jammers follow suit creating a vicious circle. On the 4th September, for example, when stations made various frequency alterations to take account of propagational vagaries, it should have been orderly. But within days it became apparent that some stations would have to hop about to escape the electronic pollution.

One band of frequencies under threat, are those allocated to the amateur service. I will not be surprised to see quite a dramatic increase in the amount or number of stations intruding into our amateur allocations. Recently, I received a note from Jim Davis, VK7OW, Intruder Watch Co-Ordinator for this State, pleading for reports from this region on the ever-increasing amount of intruders. Along with the note and logsheets was a summary of the intruders logged for the month of July.

I have commenced logging intruders and do urge other amateurs and SWLs to do likewise to help our IW co-ordinators to reduce the amount of traffic from these interlopers on our bands. You will find them listed in the 1983 Callbook or elsewhere in this magazine.

And talking of the Callbook, the 1983 issue is now available from your local division. It is perhaps the best VK callbook I have seen. Special thanks are due to the WIA Publications Committee for collating it so admirably. I would, however, like to correct an address of one of the Clubs in the SWL section. The address of "DX Australia" to where you can direct enquiries is: "DX Australia", PO Box 285, Mt Waverley, Vic 3149. I believe that the subscription is \$15.00 per annum within Australia and \$25.00 elsewhere.

There have been changes of personnel at two of the Clubs within Australia. Peter Bunn, well-known DX columnist and broadcaster, has taken over as Chairman of the Australian Radio DX Club from Rob Wagner. Bob Padula is still Executive Secretary while other new committee members have also been included. The Southern Cross DX Club has also regained Keith Barton as President.

Until fairly recently, Keith was secretary of

that Club. We wish them both well in their respective positions.

One of the new sections in the "ADXN" — the monthly newsletter of the Australian Radio DX Club, is devoted to clandestine broadcasts. This bi-monthly section contains details of the ever increasing number of clandestine stations. Some of these clandestine stations have been observed on, or very close to, 7 MHz CW portion of the band. Most of these are located in Central America and/or the Caribbean region.

Two very interesting clandestine stations at the particular moment are on the Korean peninsula. Both of them are broadcasting propaganda to each other. Neither are they officially registered or broadcasting within the portion specified for same. Radio "Echo of Hope" is presumably in South Korea and has been heard on 6.348 MHz at 1000 UTC, naturally in Korean. While the other station called the "Voice of the Revolutionary Reunification Party" claims to be in Seoul, South Korea, it is located within North Korea. It is on 4.119 MHz variable and is pretty close to an international marine distress communications channel of 4.125 MHz. It is in Korean, naturally, but also is heard in English at 1400 UTC. However, I find their diction very hard to follow. I have heard recently another presumed clandestine on 5.968.9 MHz also in Korean but it signs off at 1040 approximately. All indications so far point to the station being South Korean in origin.

Well, that is all for this month. Until next time, the best of 73 and good listening!

Robin, VK7RH  
AR

## OVERHEARD ON THE BUNDABERG REPEATER

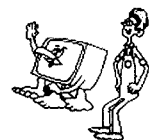

A prominent amateur who has a TV service business was heard on the Bundaberg Repeater telling two friends about a demonstration of a new stretcher he had seen at the local Ambulance Brigade. He saw that a similar product had all the possibilities of being adapted to the carrying of TV sets from the customer's home to the van and into the workshop for service making his life easier. At this point a fourth amateur broke in to cap the story off by saying "I bet you are going to tell us now that when the sets are returned to the owners, they are well enough to get out of the van and walk into the house on their own." Oh well!!!

Keith H Haverfield, VK4APO  
AR

# HERE'S RTTY!

Bruce Hannaford, VK5XJ  
57 Haydown Road, Elizabeth Grove, SA 5112

RTTY pic courtesy Steve VK2BGL



## CODE READERS and CODE CONVERTERS

There are now a considerable number of these units available in Australia and these are interesting to RTTY and CW operators. At the date of writing, the price of a read only unit is about \$300 and a Reader Converter unit about \$630. The small size and weight of these units plus the fact that no bulky VDU is needed makes them attractive for many applications such as portable work.

### CODE READERS

Briefly the display is similar to the LED readout of a digital frequency counter except that letters, figures and punctuation marks are displayed. The readout is a single line so in reception as a new character appears at the right side of the line a character on the left of the line disappears. In effect the display moves slowly from right to left giving plenty of time to read what is displayed. A good example of such a reader is the Advanced Electronic Applications (AEA) MBA-RO Code Reader. This unit features a thirty two character vacuum fluorescent display, large blue characters allow for minimum eye fatigue after long periods of viewing. This thirty two character display is a vast improvement over similar readers with only six to ten character displays.

Input signals can be from receiver audio, from TTL level switching or from a hand key or keyer. The unit will copy Morse, Baudot and ASCII Codes at all normal speeds. There is automatic CW speed following and the received WPM can be displayed if you so desire. There are filters for 800 Hz CW and for 170 or 425 shift RTTY. I quote the following specifications from the AEA Catalogue.

**Display:** Blue thirty two character vacuum fluorescent with 0.29 inch high 14 segment characters.

**Modes:** Morse code, Baudot RTTY, ASCII RTTY.

**Speed:** Automatically tracks Morse code from 3 WPM to 99 WPM. Baudot RTTY speeds are: 60 WPM, 67 WPM, 75 WPM, and 100 WPM. ASCII RTTY speed: 110 Baud.

**Filtering:** 100 Hz CW filter centred at approximately 800 Hz. Narrow shift RTTY filter factory tuned to 970 Hz and 800 Hz (170 Hz shift). Wide shift dual RTTY filter factory tuned to 1225 Hz and 800 Hz (425 Hz shift).

RTTY filters can be easily tuned for other desired shifts. Changing capacitors will allow for tuning higher frequency AFSK tones.

**Input Impedance:** Will work with virtually any receiver or audio output amplifier impedance.

**Integrated Circuits:** 17 plus one micro-computer.

**Power Requirements:** 13 VDC  $\pm$  2 VDC at 500 mA.

**Dimensions:** 8 $\frac{3}{4}$  x 5 $\frac{7}{8}$  x 2 inches.

**Net Weight:** Approximately 2 lbs.

**Specifications Subject to Change Without Notice or Obligation.**

### READER CONVERTER

These units not only read and display incoming signals as in the read only unit, but can additionally, at the same time, convert the incoming mode into a different outgoing mode. eg: A CW operator using such a unit could communicate using two way RTTY. The unit would display the received RTTY and the CW operator sending CW into the unit could switch it's output to Baudot RTTY and his CW would be sent out as RTTY. Or vice versa a RTTY operator could communicate in CW the reader displaying the CW coming in and his Baudot RTTY keyboard signals being converted into outgoing CW signals. A good example of such a unit is the MBA-RC Reader Code Converter by AEA.

I quote the MBA-RC specifications from the AEA Catalogue.

### RECEIVE

**Display:** Blue thirty two character vacuum fluorescent with 0.29 inch high 14 segment characters.

**Modes:** Morse code, Baudot RTTY, ASCII RTTY.

**Speed:** Automatically tracks Morse code from 3 to 80+ WPM, Baudot RTTY speeds 60, 67, 75 100 WPM. ASCII RTTY 110 Baud.

**Filtering:** Four Pole variable CW filter front panel tuned from 900 to 950 H. Can also be used for SPACE ONLY RTTY tuning. RTTY 170 Hz fixed (2125 Mark 2295 Space) Reverse/Normal switch. RTTY Variable 100 to 1000 Hz shift (2125 Mark/2295-3125 space).

**Input Impedance:** Approximately 5K ohms, will work with virtually any receiver or audio amplifier output impedance.

**Printer Outputs:** Serial (current loop) Baudot such as teletype models 15, 19, 28 and 32. Serial current loop ASCII such as teletype models 33 and 35 Parallel ASCII such as EPSON and CENTRONICS.

**Automatic CR/LF:** (defeatable) after first space following 64 characters or after 72 continuous characters (word wrap around).

**USOS:** Automatic down shift on space (defeatable). Anti-Space: Mark-hold after continuous space tone.

### TRANSMIT

**Modes:** Morse code, Baudot RTTY, ASCII

RTTY. Output Speed Morse 3-99 WPM Baudot RTTY 60, 67, 75, 100 WPM, ASCII RTTY 110 Baud.

**Keying Outputs:** CW; Cathode Keyed (to 200 mA) grid block (to -300 volts) or solid state transmitters.

**RTTY:** Photo-isolated contact closure, TTL level transistor switch, or two tone AFSK 170 Hz shift (2125 Mark/2295 Space), 850 Hz shift (2125 Mark/2975 Space).

**Inputs:** Morse; from hand key, bug keyer, memory keyer, Morse keyboard. RTTY: Two tone ASCII or Baudot AFSK, Parallel (TTL compatible) or serial ASCII or serial Baudot.

**Automatic CR/LF:** (switchable) after first space following 64 characters or after 72 continuous characters.

**USOS:** Down shift on space (switchable).

**Auto ID:** Less than 50 Hz Morse shift from programmable ID memory. Can also be used for standard Morse, Baudot or ASCII message transmissions.

### GENERAL

**Power Requirements:** 13 VDC + 2 VDC at 1.2 amps.

**Integrated Circuits:** 43 IC's plus two custom AEA microcomputers with copywritten firmware.

**Size:** 8 $\frac{3}{4}$  W x 4 $\frac{1}{2}$  H x 7 inches D.

**Weight:** Approximately 5 lbs.

**Specifications subject to change without notice or obligation.**

Obviously these are very interesting items and I wish to thank Hy-Tech Distributors for their assistance. Inquiries re these units can be sent to Hy-Tech Distributors, PO Box 136, Archerfield, Qld 4108.

After I have had time for considerable on air testing with these units I will give some further comments re operators convenience etc.

### THE NEW CALL BOOK

The 1983/84 Call Book is an excellent addition and is of great interest to RTTY operators. For the first time RTTY is mentioned in the WIA Gentlemen's Agreement band plans. (Page 122)

The old term "CW Only" has now been replaced by "Narrow-band Modes", thus as RTTY and CW are now grouped together as narrow-band modes we now officially have the same privileges that CW operators always had. (However in some bands there is a "CW Telegraphy" segment for Novices that should be respected).

Narrow-band modes have an exclusive segment in the MF and all HF bands that phone etc must keep clear of. Additionally narrow-band modes can operate anywhere in any of these bands.

There have been many suggested RTTY frequencies mentioned in recent months however we should remember these are only suggestions and that the WIA have now clearly stated provisional RTTY frequencies these being stated on page 122 in the 1983/84 Call Book.



I strongly suggest that RTTY ops should normally stick to these provisional frequencies unless there is a very good reason for operating elsewhere in the band. If we constantly use these frequencies other mode ops will sooner or later accept them as RTTY frequencies but not so if we spend most of our time elsewhere in the bands. I suggest that the only excuses for not using these provisional frequencies would be to contact DX RTTY stations having different RTTY segments to us, or to work cross mode eg: RTTY to phone, or in the case of being QRM'ed by other modes in our own frequencies we need to move elsewhere. RTTY ops have been screaming for a long time for the WIA to guide them as to what frequencies should be used for RTTY so now this has been done let's stick to them as much as possible and make the system work to the benefit of all concerned.

For those who have not got the 1983/84 Call Book the following are the provisional RTTY frequencies in MHz listing the centre frequencies which are extended both  $\pm 5$  kHz making each segment 10 kHz wide.

3.520, 7.045, 10.145, 14.090, 18.105, 21.090, 24.925 and 28.090.

RTTY ops should particularly note the 3.520 frequency and give Novices a fair go, phone ops should especially note the 7.045 frequency and normally use some of those higher frequencies that now extend up to 7.300.

### A HANDY LOOP SUPPLY RESISTOR

One day I was vainly looking for a suitable high wattage resistor for a loop supply to use with a Siemens machine. It dawned on me that a suitable wattage 240V lamp would do the trick. With 110V AC rectified by a single diode followed by a 16 mF capacitor for filtering and this followed by a 15 watt 240 V lamp an almost exact 40 mA flowed in the loop circuit. Small 15 W pilot lamps are probably best to use, I tried three of them and always got about 40 mA loop current. The dimly glowing lamp is also a good indication that normal loop current is flowing or that keying is taking place etc.

### 45.45 OR 50 BAUDS?

There is a move in ZL to standardise 50 Bauds for amateur RTTY. There are about 10 ZL Selcal stations that I know of using 50

Bauds and many ZL simplex contacts are being made using 50 Bauds. I believe it is unfortunate that 45.45 was chosen in the first place and this was no doubt due to FCC Regulations, as presently the vast majority of commercial RTTY is at 50 Bauds. It would be nice if there was some painless way to change to 50 but at present I don't see how this can be done especially so until the FCC change their ideas on this matter. It seems rather hopeless for ZL or VK to try and initiate a change unless the FCC in America permit the change to be made there.

### WORLD PRESS SERVICES FREQUENCIES

The book by this name is just the thing for RTTY printing news hounds. There are three listings in the book, 1. By order of time in UTC, 2. By order of frequency, 3. By country of origin and press service involved. Transmission speeds and shift are also listed making this a very handy, easy to use listing of English transmissions. I obtained my copy from Hy-Tech Distributors, address as above.

Well that's all for this month.

73 from Bruce VK5XJ.

AR

## INTRUDER WATCH



With the current sunspot cycle on the way down, more and more amateurs are turning to the lower frequencies to look for DX. The 40metre band has seen some interesting DX pop up from time to time, if one is prepared to listen. However, the most significant thing to be noticed, as one listens around this band is the domination of the band by broadcast intruders. The 40 metre band, segment 7.0 to 7.1 MHz is listed as 'Primary to the Amateur Service'... very amusing... apparently the amateur population is well aware of this fact, but certainly, as the following information will show, the broadcasters of the world don't seem to display the same expertise on their authorised band limitations.

A random check on ONE DAY showed up the following bad news:

The date was the 13th July, 1983, between 1900 and 1925 UTC. All intruders appearing between 7.0 and 7.1 MHz. THE SECTION of the band designated EXCLUSIVE TO AMATEURS.

Eleven (11) intruders present — all broadcasters.

Now, assuming 2.7 kHz each size of centre frequency gives 59.4 kHz occupation by unauthorised stations. However, as one of these stations is Radio Moscow on 7.1 MHz, with LSB only in the amateur section, we are left with a total of 56.7 kHz occupied by intruders.

Seven (7) of these intruders were suffering jamming signals, and as most jammers are at least 3.7 kHz wide (each side of centre frequency), we move our figure of un-useable band-space up to 70.7 kHz.

As the amateur segment is 100 kHz, this then represents 70.7% of the entire PRIMARY amateur designated band-space! Now, I ask: just who is the PRIMARY Service in this

segment of 40 metres? It would appear to be the broadcast service. Certainly, in practice, it comes out this way. I, personally, am not happy with this state of affairs, and will continue to complain, via the Intruder Watch, to the DOC and through other avenues. I know others feel the same way, and are in fact registering their complaints monthly.

To take all this a step further — not only do intruders arbitrarily use OUR frequencies, but now, it appears, they are attempting to push us aside altogether. Example: On 31st July, 1983, two amateur stations were having a QSO on 14.171 MHz, on SSB. The USSR Intruder 'UMS', a Russian Naval station, came up with RTTY traffic, as he is wont to do (also on 21.032 MHz) and apparently was being caused some problems by the two AMATEUR stations (one a 'W').

After about five minutes, a jamming signal commenced (carrier modulated by two audio tones), and set about jamming the amateur operators. This type of jammer is in common use by the USSR, incidentally. After about another five minutes, the two amateur stations were successfully jammed out, and disappeared, whereupon the intruder 'UMS' came back up with his RTTY traffic, and got his message through. Now, if this is not cause for complaint, what is? I repeat the advice I have given in previous columns — if you are QRM'ed by intruders, stick to your frequency — let them suffer YOUR QRM. They are the ones that shouldn't be there. This is on EXCLUSIVE amateur frequencies ONLY, of course.

I think that most amateurs would not be pushed off their frequency by another amateur, and most decidedly would have something to say to any station which attempted to push them off. Why, then, move

Bill Martin, VK2EBM  
FEDERAL INTRUDER WATCH  
CO-ORDINATOR  
33 Somerville Road, Hornsby Heights, NSW 2077

aside for intruder stations, WHICH DON'T EVEN HAVE THE RIGHT TO BE ON THE FREQUENCY IN THE FIRST PLACE? Don't QSY for intruders. I certainly hope that I will not have any more such reports of bullying to pass on, but will be very surprised if we see any change in current intruder habits if we meekly step aside and let them bluff us. Many thanks to Colin, VK4AKX, for his sterling work with the Intruder Watch, and especially for some of the information regarding the above reports.

Col is one of the many amateurs who wish to pursue his hobby quietly, without any fuss, and certainly without being hassled by illegal operations. We amateurs are bound, by Regulation, as well as our own moral attitudes, to operate on-air as responsible members of a world-wide fraternity of Amateur Radio Operators, and ask no more than to be treated with the same consideration that we show others. Intruders, in my book, are not worthy of any consideration, and should be reported for their behaviour. If they don't know how to behave, let us tell them.

If you do manage to find a clear spot between the intruders, I wish you good DX, and see you next month.

AR

## BUYING, SELLING or WANTING?

Check HAMADS first.  
Eight lines free to all WIA Mem-  
bers.

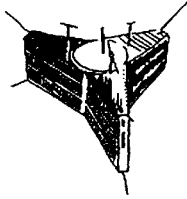

# AMSAT AUSTRALIA

Colin Hurst, VK5HI  
8 Arndell Road, Salisbury Park, SA 5109

## NATIONAL CO-ORDINATOR

Graham Ratcliff VK5AGR

## INFORMATION NETS

### AMSAT AUSTRALIA

Control: VK5AGR

Amateur Checkin: 0945 UTC Sunday

Bulletin Commences: 1000 UTC

Winter: 3.680 MHz

Summer: 7.064 MHz

### AMSAT PACIFIC

Control: JA1ANG

1100 UTC Sunday, 14.035 MHz

### AMSAT SW PACIFIC

Control: W6CG

2200 UTC Saturday, 21.280 MHz

Participating stations and listeners are able to obtain basic orbital data including Keplerian elements from the AMSAT AUSTRALIA net. This information is also included in some WIA Divisional Broadcasts.

## ACKNOWLEDGEMENTS

Contributions were received this month from Bob VK3ZBB and appreciation is extended to AMSAT Telemail and the UOSAT Bulletin Board for excerpts included in this column.

## AMSAT-OSCAR-10

Oscar 10 continues to perform excellently. In recent weeks the activity has increased significantly and contacts as far west as Ireland and as far east as the USA East Coast, have been made by many Australian amateurs. Due to the orbital parameters this area of communication is not available at all times, as the spacecraft drifts slowly eastwards on a day by day basis. At this stage it would appear that the drift is occurring at an approximate nineteen day cycle. An area of concern being expressed by AMSAT is the continued use of HIGH POWER by some operators. Although these operators are in the minority the effect on the majority of users in the passband is very dramatic. Values of AGC at -19 dB have been noted consistently, especially at week-ends. Therefore in order to demonstrate the effects of high signal levels on the transponder AGC circuits, a QRP day has been incorporated in the OSCAR-10 schedule. This is on Mondays, UTC, and a maximum EIRP level of 100 W will be allowed on these days, although many successful contacts have been made using EIRPs of only 1 or 2 W. The QRP day was instigated from the 5th September.

## MODE L TRANSPONDER — Oscar 10

Experimental operation of the mode L (1269 to 436 MHz) transponder is scheduled for commencement on 21st September. The transponder will be activated on the traditional AMSAT experimental day, Wednesday, when OSCAR-10 is within ± 1

hour of apogee on each orbit that day. The frequencies of the Mode L transponder are:

Uplink	Downlink
1269.05	436.95 Upper Limit
1269.10	436.90
1269.20	436.80
1269.30	436.70
1269.40	436.60
1269.45	436.55 Passband Centre
1269.50	436.50
1269.60	436.40
1269.70	436.30
1269.80	436.20
1269.85	436.15 Lower Limit
	436.04 Engineering Beacon
	436.02 General Beacon

These frequencies are based on a trans-  
lating frequency of 1706.00 MHz, (estimated).

## OSCAR 9 OPERATIONS SCHEDULE

The following spacecraft operations schedule is now in use:

Saturday: (1200 bulletin, Atelemetry, digtalker, (2.4 GHz))

Sunday: — 1200 bulletin, telemetry, digtalker, (2.4 GHz)

Monday: — High speed, whole orbit radiation scan

Tuesday: — Check-summed telemetry data

Wednesday: — CCD imager data

Thursday: — Whole orbit telemetry data scan

Friday: — Load bulletin, digtalker, telemetry schedule.

The current spacecraft power budget requires the radiation counters and scientific magnetometer loads to be shed in order to run the 2.4 GHz beacon.

## NEW EXPERIMENTAL SPACECRAFT PROPOSAL — UoSAT-B

An unexpected launch opportunity has appeared due to the premature demise of the LANDSAT-4 spacecraft resulting in the proposed early call-up of the replacement mission (LANDSAT-D') — now currently scheduled for February 1984. A proposal has been prepared by the UoSAT Team and submitted, via AMSAT-USA, to NASA for the launch of a UoSAT-B experimental spacecraft to accompany the LANDSAT-D satellite. In view of the extremely short timescale available to prepare a spacecraft for this launch, the UoSAT-B spacecraft will be based on the UoSAT-1 system design philosophy, but will however carry an exciting new digital communications transponder and include more sophisticated experiments, navigation and attitude control systems. It must be realised that to prepare a spacecraft for launch within six months is a very major undertaking and it may prove necessary to alter the payload complement or modify the mission objectives as the project proceeds. The objectives and payload description below describes the desired goal for which we aim.

## GENERAL MISSION OBJECTIVES

Following the generally successful launch and operation of the OSCAR-10 amateur radio communications satellite, the mission

objectives of UoSAT-B are intended to be complementary to those of AO-10 and a further development of the UoSAT-1 philosophy, as follows:

### a) SPACE EDUCATION:

To stimulate a greater degree of interest and level of knowledge in space science and engineering amongst radio amateurs, amateur scientists and home computer enthusiasts — including students, colleges and universities — by active participation in spacecraft projects requiring only relatively simple, low cost ground equipment. The mission will exploit the foundations laid by the UoSAT-1 mission in this area whilst, in addition, providing a simple-to-use digital communications transponder to encourage the use of, and familiarity with, digital communication techniques.

### b) SPACE SCIENCE:

To provide both amateur and professional scientists with a low earth orbit source of readily available real-time and stored data concerning solar and geomagnetic activity to support radiowave propagation studies. An improved CCD camera will be included to provide images of earth and, specifically, the polar aurorae.

### c) COST-EFFECTIVE SPACECRAFT ENGINEERING:

The mission will advance further the developments in cost-effective spacecraft engineering initiated by UoSAT-1 with a view to establishing a low-cost spacecraft system design for use in future amateur radio STS-GAS launches and other secondary payload opportunities. The mission will investigate specifically the performance of computer hardware, software and memory devices; navigation, attitude control and stabilisation techniques and the development of low-cost groundstations of particular relevance to a flexible, simple-to-use store-and-forward digital communications package for global communications between amateur radio stations to be evaluated in view of a planned PACSAT — PACket radio SATellite.

## MISSION PLAN

The UoSAT-B spacecraft will be prepared for launch by the UoSAT Team at the University of Surrey within the period September 1983 to February 1984, as a secondary payload by a DELTA 3924 vehicle accompanying the LANDSAT-D earth resources spacecraft.

## EXPERIMENT DESCRIPTION

The UoSAT-B spacecraft will carry five specific experimental packages in addition to the engineering systems experiments that will be described separately.

### 1) PARTICLE-WAVE EXPERIMENT

Three Geiger counters; similar to those flown on UoSAT-1, and a single, multi-channel electron spectrometer will be mounted on the spacecraft to serve as a near-

earth reference for magnetospheric studies. Data will be available in either real-time or, for more detailed analysis, from stored measurements over both polar auroral regions to radio amateurs and professional scientists. Specifically, the four detectors will monitor electron precipitation in the energy range 1-100 keV. Two of the Geiger counters will have threshold energies for electrons of 60 keV and be set at different angles in order to give a measure of the angular distribution of the precipitating electrons. The remaining Geiger counter will have a threshold energy for electrons of 100 keV. The electron spectrometer will yield both energy spectra and angular distribution of precipitated electrons of 1-25 keV so that a distribution function can be formed for these particles. The modulations imparted on particles, as a result of wave-particle interactions in the magnetosphere on auroral field lines, will be observed by a Particle Correlator Experiment.

## 2) EARTH IMAGING EXPERIMENT

The Imaging Experiment carried by UoSAT-1 generated a great deal of widespread interest and stimulated many varied studies concerned with low-cost data reception, demodulation, image processing and display. An improved version of the charge-coupled-device imaging experiment will be flown on UoSAT-B. Short time exposures of earth will be gathered by the imager, stored within an on-board memory

and transmitted down to very low-cost groundstations using easily received and demodulated transmission formats. The image data can be transmitted by the spacecraft either immediately, repeatedly or at a later time upon ground command. A specific application of the Earth Imaging Experiment will be to broaden the base of the near-earth magnetospheric studies by recording the luminosity of the aurora, and thereby a measure of electron precipitation, over a region extending for approx 800 km on both sides of the satellite ground track. The intensity and structure of aurora will be particularly valuable in assessing the state of magnetospheric activity and of interest to radio amateur propagation studies.

## 3) SYNTHESISED SPEECH EXPERIMENT

The 'Digitalker' synthesised speech telemetry experiment on UoSAT-1 has been extremely successful — not only with schools and radio amateurs, but also as a valuable operational facility. A second experiment with an expanded vocabulary more suited to spacecraft telemetry and news bulletins will be included on UoSAT-B to develop this unique experiment further.

## 4) PACKET COMMUNICATIONS EXPERIMENT

A store-and-forward digital communications experiment using packet transmission techniques will be included on UoSAT-B to demonstrate the feasibility of,

and to study the characteristics of a global PACSAT communications network based on simple, low-cost radio amateur stations. The experiment will possess a 96 k-byte CMOS random-access memory on board the spacecraft under computer control which will retain data and communications relayed to the spacecraft from a large number of ground stations using packet communications techniques complete with a hierarchy of 'addresses'.

Each radio amateur station will be able to load data/messages into the experiment and collect any data/messages previously deposited there for him using simple 300, 1200 or 9600 BPS AFSK FM or PSK techniques with low transmit power and relatively simple receiving facilities. The results from these experiments will be invaluable in the planning and design of a future mission aimed at providing a comprehensive packet communications spacecraft — eg PACSAT.

## SPACECRAFT SYSTEMS EXPERIMENTS

The UoSAT-B spacecraft will carry a number of systems experiments alongside those described above. These system experiments are concerned with developing an improved, cost-effective spacecraft bus and experiment support facility for future amateur low-earth orbit missions — with special emphasis on low-cost Get-Away-Special (GAS) payloads on the Shuttle.

## ORBITAL PREDICTIONS (prepared 18th September 1983)

Satellite Name	Oscar 9	Oscar 10	RS3	RS4	RS5	RS6	RS7	RS8
Catalogue Number	12888	14129	12997	13000	12999	13002	13001	12998
Bulletin Reference	NASA#507	KA9Q	NASA#75	NASA#136	NASA#112	NASA#62	NASA#121	NASA#240
Epoch Year 83 Day	249.89664982	257.0000	243.17211709	249.33965447	248.19029235	240.33476101	249.61972279	247.54249113
Inclination	97.5525	26.0670	82.9604	82.9629	82.9638	82.9615	82.9616	82.9599
Right Ascension	216.4069	241.3370	294.4397	297.0571	298.6767	297.3576	295.4358	300.3349
Eccentricity	.0003938	.6040293	.0057486	.0016503	.0009817	.0048678	.0020694	.0019341
Argument of Perigee	50.4708	202.7550	236.4112	299.9724	337.8666	259.1047	256.7581	21.9766
Mean Anomaly	309.6876	136.6490	123.1462	59.9729	22.2017	100.4540	103.1170	338.2124
Mean Motion	15.22960257	2.05855890	12.15578985	12.06660831	12.05044818	12.13554895	12.08677709	12.02937841
First Derivative	.00003924	0	.00000004	.00000004	.00000004	.00000004	.00000004	.00000004
Epoch Revolution	10623	190	7573	7573	7549	7507	7589	7528
Ascending Node Reference Orbits for 18 September 1983								
Orbit Number	10792	NA	7771	7714	7705	7758	7727	7691
Time UTC	0000:15	NA	0046:28	0043:33	0125:10	0039:55	0101:17	0022:47
Long Deg W	125.82	NA	83.46	76.60	86.05	80.44	82.53	69.02

AR

## COMPETITION WINNER



The lucky winner of the MFJ VHF Converter, kindly donated by GFS Electronic Imports is:

**J Swann VK2BQS**

Box 93, Toongabbie 2146.

Congratulations and your prize has been forwarded to you by registered post.

The answer to the question was "a die".

Many thanks to GFS for donating the converter and to the many members who submitted entries.

AR



AR editor, Gil VK3AU drawing the winning entry.

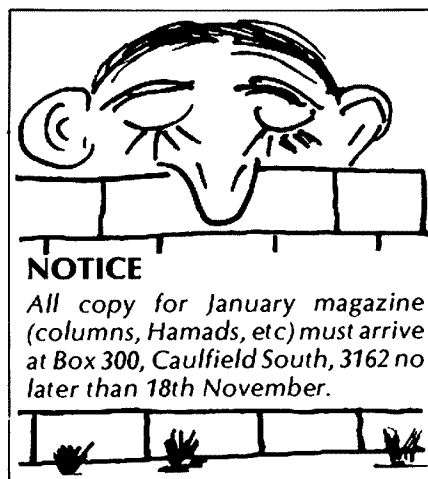

### NOTICE

All copy for January magazine (columns, Hamads, etc) must arrive at Box 300, Caulfield South, 3162 no later than 18th November.



# ALARA

Australian Ladies Amateur Radio Association

Margaret Loft, VK3DML  
28 Lawrence Street, Castlemaine, Vic 3450

Well our main news for this month is of course our Contest No 3 on the 12th November. Rules for the contest are printed on page 50 of September AR and also on contest page in ARA issued September 1983. So please look them up and join us on the suggested frequencies; and YLs remember starting from this year a trophy is to be awarded to the highest score over a five year period. So we look forward to talking to all our regulars on the contest and also to meeting new friends. Look for me as VK3DYF the club station.

Joan VK3NLO game me the following YLs she met at Nunawading in September. Gwen VK3DYL, Mavis VK3KS, Margaret VK3NZD, Kim VK3CYL, also there were Mavis VK3BIR and Jessie VK3VAN.

Joan is now Awards Manager for the Bendigo Premier Town Award and is busy with this.

Mavis VK3KS, Kim VK3CYL and myself were interviewed for New Idea magazine as ALARA and YL amateurs contribution for WCY. The article will appear in November so look out for the results of a very nervous trio.

On Sunday 11th September we attended the field day at Shepparton and had a most enjoyable day meeting old friends and also putting faces to some callsigns we have known for years. Full marks to the Shepparton Radio Club and North-east Zone for an excellent day, the venue was first class and the hospitality was also. YLs present were Peg VK3VPG, Jenny VK3KEI, Joan VK3NLO, Judy VK3ANQ and Alice XYL of VK3PEC.

## NEW MEMBER

Welcome to Cecily VK4QW, previous calls VK4VAC and 4KCG, it was good to hear you on the ALARA net last night.

## NEW CALLSIGNS

Congratulations to Dulcie VK4BDH formerly VK4VAX and also good to meet you on the net last night for the first time.

Congratulations also to Judy VK3ANQ formerly VK3VBP, isn't it a lovely feeling to know all that study is over and it was all worth while.

Poppy VK6YF passed on to us last night on the net to look for a new YL, Alison VK6VC who will be on air soon. Alison is from California and we do hope to meet you soon and welcome you to Australia.

Joy VK2EBX recently won a poetry competition, congratulations to you Joy.

Plans are being made to hold a get-together of ALARA members and OMs at Mildura next September and a number of girls are hoping to get to VK3 land for the weekend. Further details as they are available.

## LIST OF MEMBERS as at 9.9.1983

		JOINING DATE	PREVIOUS CALLSIGNS				
VK1NEJ	Charlene	21. 2.82		VK4ABM	Chris	14. 7.79	
VK1NG	Narelle	13. 5.83	(VK3NMV, VK3DNG)	VK4ACJ	Sandra	22. 7.80	(VK4VCJ)
VK2AHD	Margaret	27. 9.80	(VK2VPO, VK2KES)	VK4AOK	Margaret	10.10.80	(VK4VCE, VK4KAU)
VK2DIX	Joyce	22. 7.80		VK4ATK	Connie	1. 9.82	
VK2DJ0	Norma	20. 8.75	(VK3AYL/2)	VK4AWE	Sharen	17. 9.79	(VK4NWE)
VK2DLT	Elwyn	22. 7.80		VK4BDH	Dulcie	6. 1.81	(VK4VAX)
VK2DOG	Margaret	20. 3.82	(VK2NYG)	VK4BSQ	Wendy	2. 3.82	(VK4NBA)
VK2DVL	Beryl	11. 8.79	(VK2VDS)	VK4KCJ	Valerie	7. 4.83	(VK4ZVR)
VK2EBX	Joy	25. 1.80	(VK2VJV, VK2KJV)	VK4KLJ	Lorraine	20.11.82	(VK4NAQ)
VK2HD	Heather	22.10.76		VK4NAM	Dorothy	21. 5.76	
VK2MI	Joyce	5.11.76		VK4NDG	Phyl	12. 1.81	
VK2MR	Verle	4.11.76		VK4NEZ	Heather	16. 5.83	
VK2NKN	Maree	6. 8.81		VK4NME	Iris	5. 9.82	
VK2NQN	Geraldine	14. 7.79		VK4NNJ	Val	21. 8.79	
VK2NVQ	Dorothy	17. 3.83		VK4NXX	Anne	12. 6.81	
VK2NYL	Betty	9. 3.81		VK4PZ	Marv	9. 3.81	
VK2PAW	Kathleen	1.10.80		VK4VDJ	Roslyn	1.10.80	
VK2PLG	Susan	15. 1.82		VK4VIT	Christine	28. 2.82	
VK2PSC	Suzanne	20.10.82	(VK3VHG/2)	VK4VKT	Valerie	7.10.81	
VK2SU	Freda	26. 7.80		VK4QW	Cecily	9. 9.83	(VK4VAC/KCG)
VK2YQK	Wendy	20. 3.82	(VK2VKD)	VK5ANW	Jennifer	21. 4.76	(VK5ZBI)
Bobbie O'Hare		6.10.77		VK5AVJ	Joan	8. 8.83	(VK5KVJ, VK5NVJ)
VK3AGO	Lorrie	6. 5.79		VK5BJH	Joyanne	30. 3.81	(VK5PJH, VK5KJH)
VK3AYL	Rae	20. 4.76	(VK3VUK)	VK5BYL	Judy	20. 3.82	(VK5NNW)
VK3BBJ	Irma	9. 6.79	(VK3VCF, VK3ZOU)	VK5LM	Lorraine	4. 4.76	
VK3BIR	Mavis	23. 8.75		VK5PWA	Carol	14. 7.83	
VK3BJB	Joan	2. 8.76		VK5QO	Marlene	12. 2.81	(VK5NVO)
VK3BRE	Mona	1. 9.76	(VK2AXS)	VK5YJ	Joy	14. 7.79	(VK5NRQ)
VK3BTU	Janet	1. 9.77	(VK3NMR)	VK5YL	Denise	20. 4.76	(VK1YL, VK1YL/W2)
VK3DML	Margaret	8. 6.77	(VK3NHD, VK3YYL)	Maxine YF/VK5ZCH		7. 4.76	
VK3DMS	Marilyn	24.10.77	(VK3VUA, VK3XAY)	VK6KYL	Diane	2. 3.79	(VK6NGQ/ZYL)
VK3DYL	Gwen	20. 4.81	(VK3VGT, VK3PGT, VK3KYL)	VK6MH	Bobbie	14.12.76	
VK3DVT	Valda	25. 3.81	(VK3VUO)	VK6NKU	Peggy	15. 2.83	
VK3HQ	Marjorie	3.10.76		VK6NSU	Sue	2.10.80	
VK3KS	Mavis	22. 8.75	Hon Life Member	VK6NYL	Bev	2. 3.80	
VK3NLO	Joan	19.10.81		VK6QM	Margaret	21. 6.80	(VK6NFO)
VK3NMM	Nita	17.11.76		VK6YF	Poppy	3. 7.78	(VK6NEB, VK6ZEB)
VK3NTD	Bron	6.11.82		VK6YL	Gillian	15. 9.76	(VK6ZGI)
VK3NZD	Margaret	25. 3.81		Beryl YF/VK6HA		30. 1.81	
VK3PBL	Bonnie	11. 5.83		Olive YF/VK6WT		21.10.77	
VK3PEH	Dale	26.11.82		VK7CC	Christine	10. 6.83	(GI8IBH, GI4CXI)
VK3UE	Clarice	29.10.76	(VK3VB)	VK7HD	Helene	29.12.77	(VK7NHD)
VK3VAN	Jessie	12. 2.81		VK7JM	Jan	23. 1.81	(VK7NJM)
VK3VBK	Joyce	17. 3.79		VK7ZSU	Sue	25. 8.79	(VK7NSU)
VK3YL	Austine	5. 4.76					
Kate Duncan		11. 8.75					
Rita YF/VK3NJB		26. 5.83					
Raedi YF/VK3BHL		16.11.76					
Bronwyn YF/VK3BFP		2.10.80					
Muriel YF/VK3VZY		9. 6.79					

ALARA Club Stations: VK2DYL  
VK3DYF

## OVERSEAS MEMBERS

DF1LV Christel 11.12.82  
DF2SL Anny 2.10.76

## SPONSORED BY

VK3DVT  
VK2HD

DF3LX	Heidi	12. 3.83	VK2HD	VE7BIP	Elizabeth	1.10.79	VK6YL
DJ0EK	Paula	1.11.81	VK4AOE	VY10V	Diana	30. 1.82	VK7HD
DJ1TE	Christa	1.10.75	VK2HO	VK9NL	Kirsti	1. 6.80	VK3YL
DJ5TT	Margot	1.11.81	VK5YL	WA0WOF	Kay	24. 4.81	VK2NQI
G3HCO	Sheila	20. 5.81	VK4ATK	WA1UVJ	Karla	10.12.79	VK2HD
G4EYL	Ann	28. 3.81	VK3YL	WA3HUP	Mary-Ann	6.10.81	VK6YF
G4EZI	Diana	20. 9.78	VK4ABM	WA4SRD	Edith	17.10.79	VK6YL
G4KFP	Jasmine	1. 1.81	VK2NQI	WB0SXN	Pat	14. 7.79	VK2HD
G4KVR	Cilla	1.11.81	VK4NDG	WB2YBA	Christine	1. 6.78	VK3KS
GM4KNQ	Helen	12. 8.81	P29NSF	WB3CQN	Ruthanna	30. 3.81	VK6YL
GM4LUS	Shirley	20.12.80	VK5ANW	WH2ADG	Denise	22.11.82	VK5YL
JD1BBH	Kazuko	20.10.82	P29NSF	W2GLB/7	Phyllis	23. 7.76	VK3BIR
JJ3WWS	Sayoko	1. 9.82	VK4VKT	W3CDQ	Liz	1.11.78	VK3KS
KA6V	Joanie	16.10.82	VK3NLO	W3RXJ	Irene	1.11.78	VK3KS
KA7CRO	Martha	2. 3.82	VK4BSQ	W4KJE	Toni	1.10.80	self paid
KB8RT	Lee	2.10.80	VK3DML	ZL1AJL	Carol	18. 8.76	self paid
KF7F	Jan	1. 6.78	VK3BIR		(previous callsigns ZL1TNR, ZL1AJL/C, ZL1YL/K)		
KK5L	Carol	11. 5.83	VK3VAN	ZL1ALE	Aola	12.12.79	VK2HD
KO7Y	Shirlee	1.10.80	VK2HD	ZL1ALK	Celia	1.11.81	VK2AHD
K9RXK	Ann	22. 8.83	ex call (VK3ANL)	ZL1BDZ	Clarrie	18. 3.77	VK2HD
KC7TE	Daurel	21.12.77	VK5ANW	ZL1BIZ	Elva	17. 4.82	self paid
K11JV	Jean	23. 3.81	VK3KS	ZL1BOR	Leslie	11. 5.80	VK2HD
K6INK	Jerrie	9. 6.79	P29NSF	ZL10C	Vicki	11. 9.77	VK3BIR
N5CFP	Doris	1.10.80	VK3DMS	ZL2ADK	Cathy	30.10.82	VK2NZW
N6GGR	Maxine	28.12.82	VK7HD	ZL2AZY	Sabina	11. 1.81	VK6YF
N7DGP	Joan	11. 4.83	VK2HD	ZL1BAO	Jos	1.11.81	VK3UE
PA0HIL	Hil	12. 6.81	VK2HD	ZL2BOD	Jeanne	26.12.82	VK2DQG
PA3ADR	Agnes	12. 6.81	VK2HD	ZL2PQ	Lynn	25.12.82	VK2NYL
P29NSF	Siegi	2.10.80	self paid	ZL2QY	Pearl	22. 4.76	VK3KS
P29NUN	Margaret	23. 3.81	VK3DVT	ZS5DC	Diane	1. 6.80	VK2NQI
P29NYL	Rae	2. 8.78	self paid	ZS6GH	Diane	1. 6.78	VK500
T30CH	Vicky	9. 3.83	VK4VKT	5Z4CM	Charlotte	20. 2.82	VK6KYL
VE6AUP	Hallie	1.10.80	VK3DML	<b>SUBSCRIBERS TO NEWSLETTER</b>			
VE7CBK	Bobby	28.10.78	VK3KS	VK2BRC	Ross	2. 5.83	
VE7CIX	Rae	28. 5.78	VK3BIR	VK3NTR	Jack	6.11.82	
VE7DKC	Margaret	1. 6.78	VK2NQI				

Until next month 73/33/83 Margaret VK3DML  
AR



**YAESU**

**DAIWA**

**ICOM**

**ATN ANTENNAS**

**AT ONE GREAT STORE**

**CW** PLUS MUCH MUCH MORE

**ELECTRONICS**

CW Electronics is the communication centre of Queensland  
Innovators and pioneers of computer RTTY ASCII CW radio  
interface in Australia

Come in and see our range

**416 LOGAN ROAD STONES CORNER BRISBANE**  
**PHN: (07) 397 0888**

PO BOX 274 SUMNER BANK QLD 4109

**DO YOUR EYES NEED ATTENTION?**



**Why Don't You Direct Yourself To One Of Your Big Family?**

**OPTILUX**  
**Optical Dispensers & Photo Dealers**

**363 Parramatta Road,  
LEICHHARDT, NSW 2040**  
**Phone (02) 560 9415**

**ASK FOR BRUNO VK2BPO**

He can arrange an immediate appointment for a complete eye examination  
without any need of referral

**BIG RANGE OF IMPORTED FRAMES — VERY QUICK SERVICE — DISCOUNT FOR ANY AMATEUR OR SWL AND A CAMERA STORE TOO AT COMPETITIVE PRICES AT YOUR DISPOSITION**

**SEE YOU SOON**

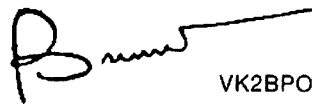

**VK2BPO**



# CONTESTS



Reg Dwyer, VK1BR  
FEDERAL CONTEST MANAGER  
PO Box 236, Jamison, ACT 2614.

## NOVEMBER

- 5-6 YLRL Anniversary Phone Party
- 5-6 ARRL CW Sweepstakes
- 6 Czechoslovakian Contest
- 12-13 DARC WAE RTTY Contest
- 12 ALARA Contest \*\*\*
- 19-20 ARRL Phone Sweepstakes
- 19-20 VK CW QRPp Versus the World CW Test \*\*\*
- 26-27 CQ WW DX CW Test

## DECEMBER

- 3-7 ARRL 160 metre Contest
- 3 Ross Hull Memorial VHF Contest start
- 10-11 ARRL 10 Metre Phone Test

All tests marked with \*\*\* are not yet confirmed . . .

## RULES FOR VK CW QRPp VERSUS THE WORLD TEST

*Note:*  
This is a reprint of the contest rules for 1982 as I have not received any new rules for the contest this year. I therefore assume that the contest for 1983 will largely be the same as the 1982 contest and now reprint these contest rules for your general assistance.

Sponsored by the VK CW QRPp CLUB (Member of the WORLD QRP FEDERATION) this contest is directed to all CW enthusiasts WORLD-WIDE who elect to tackle that extra challenge! Contestants may work DX or OWN COUNTRY for scoring!

QRO stations are invited to participate but must submit contest logs with QRP stations only to qualify for the QRO section of the contest.

QRP stations must sign . . . "QRP" . . . for identification.

DATES — Saturday 19 November and Sunday 20 November 1983.

DURATION — Total of 48 hours (0000UTC 19 November to 2400UTC 20 November).

MODE — CW ONLY.

CONTEST CALL — "CQ QRP TEST".

BANDS — 160m-10m (WARC BANDS NOT ALLOWED).

SECTIONS — Station categories: QRP: Single Operator; Multiband or Singleband. QRP: Multi Operator; Multiband or Singleband. QRO: Single Operator; Multiband or Singleband.

PERIOD CATEGORIES — Full Period: 48 hours. Half Period: ANY 24 consecutive hours.

EXCHANGE — All Stations: FIVE DIGITS RST report plus IARU ZONE NUMBER.

SCORING — QRP Stations i.e. indicated output power into antenna NOT EXCEEDING FIVE WATTS . . . each contact shall score points based on the following table:

0-1 watt:	six points
Over 1 watt-2 watts:	five points
Over 2 watts-3 watts:	four points
Over 3 watts-4 watts:	three points
Over 4 watts-5 watts:	two points

QRO stations using more than 5 watts output to antenna: ONE POINT PER CONTACT (QRO/QRP only allowed).

MULTIPLIERS — Every contact in a different IARU Zone counts as a multiplier on each band.

BONUS SCORE — Field Stations using battery/solar/wind/hand generated power (motor generators excluded) . . . multiply the Grand Total Score by 1.5.

CONDITIONS — Stations may be contacted ONCE ONLY on each band. Separate log sheets required for EACH BAND. Each logged QSO to show: Date/Time UTC . . . Station worked . . . Exchange (Sent/Received) . . . Multiplier . . . Power output . . . Points claimed.

GRAND TOTAL SCORE = Total points from all bands x Total multipliers from all bands (x Bonus Score).

All entries MUST have a FRONT SUMMARY SHEET showing: Calculation of Grand Total Score; Name and Address; Callsign; Signature and Declaration . . . "I certify that all entries in my contest log sheets are true and honest."

Entrants are requested to include a brief description of station equipment and any comments/suggestions. Field stations are requested to include a brief description of operations/location/conditions etc.

CERTIFICATES — To the ORP Single Operator and Multi-Operator in each Country with the highest Grand Total Score in each section. To the QRO operator in each country with the highest Grand Total Score in each section. To the highest scoring VK CW QRPp CLUB MEMBER IN EACH SECTION.

CONTEST ENTRIES TO BE ADDRESSED TO: CONTEST MANAGER . . . VK CW QRPp CLUB PO BOX 109 . . . MT DRUITT, NSW 2770 AUSTRALIA.

All entries must be in the hands of the Contest Manager not later than end-January 1984. Results will be available by end-February 1984 and posted to non-member contestants for 1 IRC (DX stations) or a 30-cent postage stamp (VK stations).

## RULES FOR ROSS HULL MEMORIAL CONTEST

*Note:*

The recent approval of the LIMITED use of the 50 to 50.15 MHz band can and does pose some awkward problems for the amateur with the proviso for operation in this segment without interference with Channel 0.

This point is clearly stated in a letter from Eric VK5LP to me where he makes the following points.

The use of the band for the next twelve months at least is on a conditional basis that amateurs cause no interference to Channel 0. If contacts there are counted in the Contest there is every chance someone, somewhere will transmit during Channel 0 hours and cause interference,

and thereby making it so much more difficult for us to widen the use of the band in due course. Es contacts are quite satisfactory on 52 MHz and we need to keep using that portion in the future in parallel with 50 MHz.

I see the major advantage of having 50 MHz is that it gives us a section of the band compatible with much of the outside world, and gives us a means to share in long distance DX contacts. If 50 MHz is cluttered up with hoards of VK stations during Es openings then there will be little opportunity for DX to be heard in many areas, particularly away from the eastern seaboard areas. The overseas calling frequency is 50.110 MHz and we want to keep it free from much of the QRM associated with Es contacts during a Contest.

Perhaps of less concern, but one which is mentioned is that VK6 can use 50 MHz at any time to the disadvantage of other States. They can also cause Channel 0 QRM at times of high Es activity, and it will be more desirable to have them up with the rest of VK than on 50 MHz and thus overcome too much fragmentation of the use of the six metre band.

With these very valid points in mind all six metre contest activity will be restricted to the 52-5MHz section of the band.

OBJECTS — Australian amateurs will endeavour to contact as many other amateurs as possible. Entrants must operate within the terms of their licences.

PERIOD — 0001 UTC 3 December 1983 to 2400 UTC 8 January 1984.

EXCHANGE — RS(T) plus a three figure serial number starting at 001 and increasing by one for each contact, when 999 is reached a start is made again from 001.

BANDS — All amateur bands above 30 MHz, however cross band contacts are not permitted. Operation via active repeaters and translators is not allowed.

OPERATOR — Single operator only. One transmission only at one time.

CONTACTS — Two contacts per UTC day per band with each station providing 10 hours have elapsed since the previous contact.

DURATION — (a) 7 UTC days — not necessarily consecutive. (b) 2 UTC days consecutive.

SECTIONS — (1) Phone (AM, FM, SSB, ATV and SSTV). (2) CW (CW and RTTY). (3) Receiving (any mode).

LOG SHEET — It is desirable that complete logs for the whole contest be submitted for cross checking purposes; photo copies are very acceptable. The following details must be shown: Time UTC, Band, Emission, Stn worked, Tx exchange, Rx exchange, Points, Bonus. Each page must be totalled at the bottom.

FRONT SHEET — A front sheet must be attached showing the following information in this order: Section, callsign, list of 7 best UTC days with daily score and daily multiple.

daily total plus 7, day total, list of best 2 UTC days with daily score and day multiplier, daily total plus 2 day total, name and postal address.

#### SCORING TABLE — AUSTRALIA

Distance	52	144	432	576	1296	2304 up
Up to 100 km	1	2	5	20	30	50
100-200 km	2	5	10	30	75	100
200-400 km	10	20	40	50	100	200
400-800 km	20	35	60	75	150	300
800-2500 km	10	50	80	100	200	500
2500 +	40	70	100	200	500	700

**BONUS** — (a) For each new call area in Australia, including own call area, 20 points once only per band per UTC day. (b) For each prefix worked outside Australia, 40 points once only per band per day.

**SPECIAL VK6 BONUS** — Note: No bonus for VK6 stations.

**MULTIPLIER** — All stations shall multiply the UTC day score, including the Bonus (a) and (b), by the number of bands used for scoring during that day.

**SCORING TABLE** — Overseas Stations: 52 MHz — fifty points; 144 MHz — 100 points; 432 MHz — 200 points. For contacts with Australian stations only.

**AWARDS** — A perpetual trophy is awarded annually for competition between members of the Wireless Institute of Australia. The winner's name is inscribed on the trophy and he receives a suitable certificate. The entrant with the highest score in either the 7 day or 2 day division will be the winner and his division will hold the trophy for one year. Certificates will be awarded to the highest score in both the 7 day and the 2 day divisions. A winner of a 7 day certificate cannot be awarded a 2 day one as well. Overseas entrants will be awarded certificates on the same basis, one for each call area.

**SUBMISSION OF LOGS** — Entries are to be sent to the FCM, Box 236, Jamison, ACT, and received no later than 20th February, 1984 and endorsed "Ross Hull Memorial Contest".

**RECEIVING SECTION** — Logs must show the same information as a transmitting log except for the second number exchanged. If both stations are heard both can be claimed but on separate lines of the log. Scoring will be as for a transmitting log. Any scoring contacts can be logged, there is no limit to the number of times that one station can be logged. The decision of the FCM is final and no correspondence will be entered into.

#### SPECIAL NOTES

After a number of reports from the entrants of the 1982/83 contest and the exerted effort put in by the more interested of these amateurs to expand the transmitting capabilities of their stations together with the concern shown by the majority of the VHF/UHF enthusiasts to this non-event contest, the following alterations have been made to the rules of the contest to even the battle and to reward the entrants for their efforts in a way more fitting than the method now used.

#### POINTS MADE

If a VK3 makes the initial contact with a VK6 then the VK6 gains twice the points that the VK3 gains.

The contest promotes additional effort to use the more unused frequencies, however the short hop contact at SHF although a

challenge on QRP power earns the VK6 twice the points that all other states earn for the same effort.

Very few 6 metre openings were found during the last contest and contacts from Adelaide and VK6's in Albany is a regular event, again the VK6's scoring twice.

Some additional incentive for double hop sporadic E's over 2500 kms.

State normalising factor for all states to compete on an even footing.

Minimum of ten (10) hours should take precedence over the change of UTC day.

Awards for the top scorer in each state.

With these points in mind, and many of them made by the VK6's themselves, these changes are made and your comments on their effectiveness is sought.

1. To even the scoring, the double points for VK6 stations will be deleted. Although this seems to be a rather harsh overkill of the situation, the results from the past two years show that the wins by the current trophy holder are in the region of twice the scores of the other average contestants. This may work against the VK6's in as much as the lack of amateurs in the near regions when compared to the eastern states however the opportunity for the increased range of bands still applies to all to amplify their score.

2. To allow for the user of the 6 metre 52-54 MHz section of the band and to cover the additional difficulty of 2nd hop sporadic E's, the points score will be increased to include a long distance inter Australia points score. (See last line of scoring table.)

3. CONTACTS. The 10 hour rule will take precedence over the change of the UTC day. Example: contact # 23 time 2330 15-DEC . . . VK1AXX; contact # 24 time 0030 16-DEC . . . VK1AXX. NOT VALID. TEN HOURS MUST ELAPSE BETWEEN CONTACTS.

4. AWARDS. The awards of certificate to the highest scorer in the seven and two day sections in each division is the maximum that can be given at this stage. There are insufficient entrants to give awards to 1st, 2nd and 3rd and there is only one perpetual trophy to commemorate Ross Hull and the work he has done in this region of amateur radio.

These changes are made in an attempt to increase the interest in the VHF/UHF and SHF region of amateur radio and although this is not the complete answer it will greatly improve the anomalies that currently exist in the contest. The lack of amateurs in the surrounding regions of major populations in WA is seen to be the major drawback and handicap for the VK6's. However this shortcoming has successfully been overcome in the last few years and I hope it will not prove to handicap them as a result of the change.

Best of luck to all.

#### SANGSTER SHIELD CONTEST (NZART)

Below is a copy of the award from the NZART for the Sangster Shield Contest. From the reports I have heard about the test it was well worth the effort of entering and a very enjoyable time was had by all.

Congratulations to Ross and to all the other state winners on your efforts.

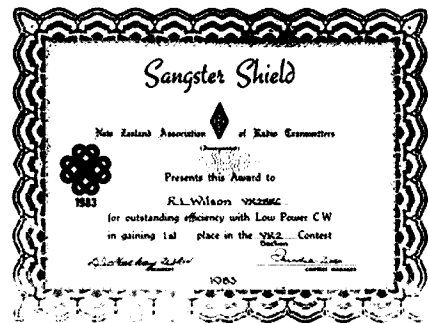

#### NOVICE CONTEST CERTIFICATE DESIGN

The VK Novice Contest ex Westlakes Radio Club Contest, needs new certificates to be designed.

The existing certificate looks like the sample below.

Have you any thoughts for the new certificate, if so, send the design to me for pricing and suitability.



Reg. VK1BR  
AR

#### SAFETY BELTS

All the falderdash and a considerable amount of balderdash about using safety belts when climbing the tower is a complete waste of time. Anyone with an ounce of brain will tell you that by the time you lace up the harness and strap the belt on your body you can be up the tower and back down! If anyone would like further info on the lolly of safety belts you can drop me a line at this address: R F Inshack, Memorial Hospital, 7388 Traction Road, Brokentutu, Pennsylvlucky. — Tamiami ARC, Venice, Florida.

from QST, June 1983  
AR



# LISTENING AROUND

Joe Baker, VK2BJX  
PO Box 2121, Mildura, Vic 3500

In an earlier article, you may remember how I got a job with the Sydney Daily Telegraph about 1941, as a copyboy in the main Castlereagh Street Office, and at the receiving station at Cammeray which was raided when the authorities went hunting for a non-existent transmitter. I thought that before I pass on to other matters, you might like to know more about my experiences at that time.

I was in the main office on the night when news came though about the bombing of Pearl Harbour and America's entry into the war. At this time I was working mainly at the receiving station, yet doing part-time work as copyboy in Castlereagh Street. It was a Sunday night, as I remember, and Roy Philips was on duty at Cammeray. He was due to pick up San Francisco's KGEI at about 9 pm, according to the log book, but the transmitter had gone off the air. Roy was told to keep monitoring and put San Francisco through to Castlereagh Street as soon as he heard it. Some hours passed and when KGEI did come back on air it was to announce that Pearl Harbour had been bombed. This news threw the office into confusion, and instead of the normal three editions going to press, as I can remember seven editions were on the streets as the follow-up news came through.

I was also on duty in Castlereagh Street on the night Japanese submarines got into Sydney Harbour and did much damage. The office staff had been doing an extensive air raid drill and the employees on each floor knew where to assemble and not to use the telephones. In fact, we became pretty good at those air raid precautions, so we were not expecting an attack from beneath the Harbour. On this particular night, I had been summoned to the subs office and given some copy to take down to the printers. Normally I would have gone in the lift, but it wasn't operating this night so I took the stairway. As I reached the landing midway between floors, I thought I could hear the scream of a distant air raid siren, so I paused near a window to listen. Suddenly a siren located on a floor above sprang to life and made me jump about six feet. I raced up the stairs and found the editorial floor in utter confusion.

Lights had been doused and people were racing for candles and torches — that is, when they weren't stumbling over each other in the inky blackness. Many, including myself raced for the nearest available telephone — despite the fact that we had been so well rehearsed not to do so.

I phoned my mother at Ryde to find out what was doing in that suburb. "Your father has gone out with his Air Raid Warden's gear to check that everybody has got their lights out" she said. (Dad was a Sydney tram conductor who took his Air Raid Warden's job very seriously.) Mum then asked me what I was going to do. I said that I thought that I had better not leave the newspaper office as it might not be safe to do so in view of the air raid that we thought was coming. I told her that I would sleep in the office — that is if I

could manage to get to sleep amongst the general pandemonium.

As time passed and no bombs appeared to be exploding, it became clear that something else was happening and it was not long before we found out. Off duty reporters living in harbourside suburbs began ringing in with stories of damage that had been done by the torpedoes fired from the submarines. At the time of the first alert, the Newcastle edition which was normally the first off the presses had been halted and Brian Penton, who was editor that night, said "This is not going to stop us printing — get those presses rolling again as soon as possible" (Brian Penton later achieved fame with a book called "Advance Australia Where?")

The Cammeray radio receiving station was of vital importance to the Telegraph at that time. Yet officially, it was not supposed to exist, and I found that out one day when I sought permission to write an article about the station for the staff paper called "Telegus" ("Telegus was the cable address of the Telegraph") I was not permitted to write about the station — but forty years later, I thought you would all like to hear about it.

On Saturday nights, part of the work at the station was to standby to pick up XGOY, the "Voice of Chunking, China". We could usually hear them quite clearly. They would then call two other newspapers, one of which was in New York, before they called us. Having no transmitter, we could not of course answer, nor did they expect us to, being a shortwave receiving station only.

An English language announcer would then read out at dictation speed press copy from war correspondents stationed in Chungking to the New York paper and the other, and finally there would come a report for us sent by well known journalist William Burchett. Burchett's report was usually received in good time for the next edition of the Telegraph. If we had been forced to rely on the copy being sent by cable, I think we would have been out of luck because many submarine cables had been rendered useless by enemy action.

The time the Philippines were overrun by enemy invaders, is another occasion I well remember. On this night I was on duty at Cammeray, and according to the log book, we were to try for KZRM Manila at about 8.30 pm in the 31 metre band. I told Roy Philips that I was going to try for Manila with the Skyraider set. He said "You might just as well forget about that one — we haven't heard it for weeks." I said "Well I'll have a try for it, anyway — just in case, because the news is hotting up around that area right now". So at the appointed time I panned the cursor up and down across the 31 metre band, not really expecting to hear anything from Manila. But right on the dot of 8.30 pm, I heard a carrier, then a voice said "This is the Philippine Islands Freedom Station KZRM Manila. Here is the news . . ."

"Roy . . . I've got them," I yelled ". . . I've got Manila."

"Well ring Castlereagh Street and ask them if they want it" he said. So I rang the city radio room. They said "Put it through to us at once . . . pronto". So I threw the switches and fed the Philippine Islands Freedom Station to Castlereagh Street. Exactly seven minutes of that all-important news broadcast had gone through, when the station went dead. The city office rang me back — "What has happened to Manila" they asked, "have you been fiddling with that set?" I assured them that I had not even touched the tuning dial of the set, and that the Skyraider was OK. "Just the same" they said "hop to it and get another set on the job pronto". So I fired up another receiver and went across where KZRM should have been but it wasn't there.

Some months later, we found out what had happened. It appears that just at the time we were hearing that broadcast, the invading navy had entered Manila Harbour, and they got a direct hit on the KZRM antenna mast which was by the harbourside.

Years later, when I was serving on Morotai Island in what was then part of the Netherlands East Indies, General MacArthur's forces recaptured the Philippines, and I understand that when KZRM was reopened under American control, he arranged that the first voice to be heard, was that of the news-reader who was on the air when the antenna tower was toppled.

On another night, when I was doubling back in Castlereagh Street on my old job of copyboy to earn a few extra bucks, news reached the office from a Canberra correspondent of the sinking in the Indian Ocean of an Australian warship. At this distance of time, I cannot remember which warship it was, but it was a very important one. The censor put an official "NOT TO BE PUBLISHED" on the story, but although it was then supposed to be in the Top Secret class, within about a week, news of the sinking was common knowledge all over Sydney. Doubtless the news was carried from our office by visiting telegram and Beam Wireless messengers, and as the story got around, relatives of the crew of that ship began besieging our office begging for news that we could not give. They maintained an all night vigil in the office hoping that some scraps of news might come their way, and all that we could do was comfort them as best we could as they sat there crying for their lost relatives.

I was still working on the Telegraph when I got my call-up for the army, so there was no journalistic cadetship for me, and when I returned to my old employer after the war (employers were obliged by law to re-employ their former staff who were now ex-service) they offered me a job assisting a carpenter who was remodelling offices on the editorial floor. So I told them to keep that job, and got a job elsewhere. And I'll tell you all about that another time. *Best of 73 Joe, VK2BJX* **AM**



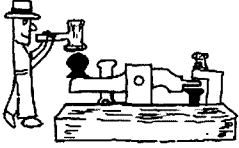

# POUNDRING BRASS

Marshall Emm, VK5FN  
GPO Box 389, Adelaide, SA 5001

## COPY OFF AIR

The best way to learn is to do; the best way to increase your CW copying ability is to copy off air. The Wireless Institute of Australia sponsors slow CW broadcasts every night of the week on 3.550 MHz (NSW at 0930 UTC, SA at 1030 UTC) but I have no information about WA or Qld Divisional Morse Practice. *Could someone from those divisions please advise?*

I would also be very grateful for any information about other services which provide useful practice. Possibilities would be W1AW from the USA, maritime coast stations, commercial and military. Times and frequencies and a description of material to the above address, please — don't keep it to yourself!

## INCREASING YOUR SPEED

Last month we talked about learning the Morse Code, so this month we will assume that you know the code and want to increase your speed — either to pass an examination or to improve your CW operating capabilities. Of the two, the latter motive is the better, because if you are trying to improve your copying ability you are at the same time preparing yourself for the exam; but if your only goal is to pass an examination, you have set too low a target.

There is something like a "sound barrier" in learning Morse Code. For years it was thought that a plane could not possibly break the sound barrier, and similarly, many operators get to a speed of around 8-10 WPM and are convinced they cannot go any further.

This is because there are two basic ways a person can copy code. In the learning stages, the right side of the brain is listening to the signal while the left side of the brain is comparing the received signal with a list of coded meanings — once the meaning has been recognised, an order goes back to the right side of the brain so the hand can write the perceived character. There is a limit to how fast you can do this, but it varies from person to person in the range of about 8 to 15 WPM. Once you reach this barrier you cannot

improve your speed without going on to the other way of copying, which is character recognition.

With character recognition, there is no process of translating between the two hemispheres of the brain. Each sound is recognised for what it is, and the hand writes the character without any conscious thought process involved. This is very much the same procedure as with a foreign language. When you are first learning the language, you translate everything as you go, but as you improve your ability, you find you can "think" in the foreign language without having to translate it. And as with the code, some people never make the transition from translating to thinking.

Extending the analogy to foreign languages a step farther, it has been known for years that if a person begins to learn early enough, by intensive exposure to a foreign language, the chances of his becoming fluent are much greater. This applies equally to learning the code, and if you learn by identifying sounds, rather than counting dits and dahs, the transition to higher speeds is much easier.

It is worth noting that some people cannot get over the hump, no matter how hard they try. Quite often these people suffer (unknowingly) from a mild form of "dyslexia". Dyslexia is a reading dysfunction characterised by mental transposition of characters, and as you might imagine it can present severe problems in learning code. It can exist in varying degrees, and a person who has never suspected he is dyslexic can suddenly find an insurmountable obstacle when trying to copy code at 10 WPM.

Anybody can learn the code, and anybody can pass the 5 WPM exam (given enough practice). But some people simply cannot pass the 10 WPM exam because it is beyond the barrier. These people would be very rare, I'm sure, but asking them to pass the exam is a bit like asking a blind man to sort resistors by means of the colour code — a bit unfair.

The key to improving your speed is to practice with characters sent at a much higher speed than the speed at which you can copy 100%. If you can afford the AEA Morse Trainer BT1, which starts you off with a character speed of 18 WPM with three second pauses between characters, you are "home and hosed". Follow the instructions and you will be a 20 WPM man in no time.

If the technology isn't available, you will have to make do with what is available on the bands, and you will note that I have asked for more information which will be published as it comes to hand. The WIA broadcasts are excellent, but their primary objective is to get people through exams, so they mostly don't go beyond about 12 WPM or so.

Listen to the real brass-pounders on 20 metres. They may be going way too fast for you, but if you concentrate on identifying the odd character, you soon find that you are starting to get more of it.

Practice with the Japanese stations on 15 metres. Call CQ a bit faster than you can copy, and ask for repeats when necessary. A lot is said off air about Japanese domination of HF, but we could do a lot worse. As a group they are the most polite and helpful operators on the air.

Enter a CW contest. You will have to listen to calls and numbers several times at the beginning, but a few hours later you will be picking them up first time.

And one last hint — throw the microphone away. Well, not literally, but when I was trying to get up to speed I made a solemn vow that I would not engage in a phone QSO until after I had made a CW contact. Even now I can sometimes go for a whole week without touching the microphone. To get your speed up you need practice, and to keep it up you need self-discipline. Keep at it, and you'll get there — if you follow all these hints religiously you will be a top operator in next to no time.

73 till next month.

AR



**ZL2JAM**  
**TENTH NEW ZEALAND SCOUT**  
**JAMBOREE AMATEUR RADIO**  
**STATION**

The tenth New Zealand Scout Jamboree will be held at Fielding (about ninety miles north of Wellington) from the 2nd to the 10th of January 1984. About 10 000 Scouts and

leaders including many from Australia, the Pacific Islands and other countries will be camping together under canvas.

A wide range of radio, electronics and computer activities are planned for the Scouts. Not only will there be the traditional amateur radio station (with, it is hoped, RTTY, SSTV, and OSCAR capability), but also a short wave receiving station for SWLs, a kitset radio construction project, fox hunting (radio orienteering), and even a computer system for the Scouts to gain hands-on computer learning experience. A triple screen audio-visual presentation will show how radio and electronics activities can be incorporated into the Scout programme.

There will also be a wide range of other activities offered to the Scouts for them to



enjoy at this 'Jamboree of Discovery'. They will discover new friends, new interests, and new concepts in Scouting.

Listen for ZL2JAM on the 'international' Scout frequencies of: 3.740, 3.940, 7.090, 7.290, 14.290, 21.360 and 28.990 MHz plus or minus to allow for QRM.

Jim Parnell ZL2APE

AR



## COMMUNICATIONS EXPO 83

It was promoted as the largest public WCY event in Victoria (and possibly Australia) and lived up to all expectations.

Held at the Nunawading Civic Centre on 3 September, it was organised by a special committee of the Eastern and Mountain District Radio Club headed by Jack O'Shannassy VK3SP which put six months hard work into planning and organising the event.

The committee with WCY in mind wanted more than just a Hamfest and made it attractive to the general public — the name Communications Expo 83 helped achieve this aim. There were traditional Hamfest activities — foxhunts, trade displays, valve and spoon races, guess the frequencies of helical whips, read Morse code with increasing QRM, radio throwing contest, home-brew competition, flea market, etc.

Five competitions were grouped into a pentathlon with the highest aggregate scorer being Daryl Hergt VK3AKC.

The much heralded Tug O War between radio amateurs and CB operators (Omega Radio Club) saw the Cbers win — but the amateurs and Omega Club members enjoyed the get together resulting in a closer relationship being cemented.

The Omega Club had also spread the word about Comexpo and their efforts meant Cbers hearing talk on the CB bands coming along to see what it was all about.

Some Cbers wanted to study for the Novice licence and were effectively given advice on how to go about becoming a radio amateur.

Comexpo drew a large number of amateurs from throughout Victoria with the trade displays writing up to \$10,000 worth of business.

Among the other commercial displays were Telecom, Hewlett Packard computers, and Tara Systems the phone-patch firm.

The State Emergency Service had a wide-eyed audience when it cut open a car in a simulated rescue — St John Ambulance Brigade displayed its communications bus — and the CFA and Forest Commission were well represented.

Like the Cbers, emergency service personnel wandered around and learnt about the various aspects of amateur radio.

The general public had been attracted by newspaper, television and radio publicity.

Some people also had only arrived to visit the Nunawading Library — but got the bonus of a communications display.

They questioned those manning the various attractions — the special station VK3WCY and the RTTY exhibition run by the Victorian Radio Amateur Group were extremely popular.

The ATV show put on by Peter Cossens VK3BFG attracted considerable attention, king of the Third Party Traffic Net, Sam Voron VK2BVS was on hand to take Amateurgams, DX Australia Shortwave Listener Group explained SWLing, and the Army display communications gear.

Eastern Suburban Scouts did a marvellous job providing refreshments for the crowd of more than 4000.

It's not practical to mention all of the groups which went to make up Comexpo.

At its end, Comexpo was hailed an overwhelming success not only as a Hamfest — but also a Public Relations Exercise for our hobby.

AR

## ANARTS

On Tuesday evening, 6th September, the Australian National Amateur Radio Teleprinter Society had the honour to be host to Mr R Butler, Secretary General to the International Telecommunications Union.

Mr Butler was in Sydney primarily to attend the IREE convention, but he also took the opportunity to meet the committee and guests of ANARTS at a dinner at the Sebel Town House, where he donated and presented the trophies for the ANARTS World Communications Year 1983 RTTY Contest. Mr Butler congratulated ANARTS on their achievements in the International World of Radio Teletype Transmissions, he also pointed out that ANARTS were now one of the leading societies in the world in the field of radio teletype. In his address at the dinner Mr Butler said "Today I am very proud to be invited to honour the winners of the International Radioteletype Contest organised by the Australian National Amateur Radio Teleprinter Society. Your operation and experience on the narrow and well used frequency bands allocated by ITU Administrative Radio Conferences have made it possible that the amateur service has managed to achieve an overall record of innovation, growth and development. You do not measure your services by volume of

traffic, gross revenue, or audience — but simply how well you have served humanity. The amateur radio fraternity is unlike any other social group in the world. It constitutes an ideal example of how people and nations can live together. It makes no distinctions as to race, creed, or colour, political ideology, national origin, male or female, child or adult, healthy or handicapped, professional or unskilled, well-known politician or citizen, king or peasant, missionaries or agnostics."

Other guests at the dinner were Merck Joachim OK1WI consulting engineer to the Ministry of Communications in Czechoslovakia, and Pierce Healy VK2APQ.

AR

## TOWNSVILLE AMATEUR RADIO CLUB

Aspiring amateur radio operators should find studying for their licences a little easier with the assistance of amateurs from Townsville and Charters Towers who recently took part in an education seminar. The Townsville Amateur Radio Club, in conjunction with the WIA(Q), arranged the two-day course for intending instructors.



Oakey High School science teacher Ron Smith VK4AGS was flown to Townsville especially for the course, and conveyed much valuable information on how best to pass on skills and knowledge to beginners. The photo shows Ron, left, instructing Bob Mann VK4WJ in the finer points of preparing overhead transparencies.

Peter Renton, VK4PV  
PUBLICITY OFFICER

(Photo by courtesy of Townsville Daily Bulletin)

AR

## A DAY OF DISAPPOINTMENT

Whilst clubs with large numbers of members can, and do, organise large scale commemorative events for special occasions, one must remember the smaller clubs and appreciate their contributions to such celebrations. One such "small club" is the Western Suburbs Radio Club in Melbourne.

The Club was inaugurated on the 21st November, 1969, with the formation of a four man committee. On the 20th February, 1970,



Pierce VK2APQ

Photo by G Campbell, VK2ZOC



**Ron ('Big Mac') McDonald, a keen new member, shows obvious delight in UHF activities.**

the first general meeting took place. This meeting attracted a healthy thirty two prospective members. Although named the Western Suburbs Radio Club, amateurs from all parts of Melbourne's suburbs became members. Today the same can be said, and although club numbers have ascended and descended over the years, the Western Suburbs Radio Club still boasts around the same number of members as that of the first meeting years ago.

With the growing awareness of World Communications Year, and the knowledge that radio clubs throughout Australia were planning commemorative events, the Western Suburbs Radio Club decided to hold a one day portable field day.



**Mick VK3PFL operating 10 metres using his FT101E and a long wire.**

The Field Day took place amidst glorious sunshine on Sunday, 4th September. Seventeen members, family and friends assembled in the small town of Whittlesea, 50 km north east of Melbourne for the drive to Mount Disappointment.

Mount Disappointment stands 855.98 metres (2810 feet for OT's) above sea level, 50 km north east of Melbourne 'as the crow flies', but around 70 km north east by road. The mountain's name was inspired by the

legendary explorers, Burke and Wills. Three days after leaving Melbourne with supplies, Burke and Wills camped at Mount Disappointment. It was their belief that on the north east side of the mountain lay a large inland lake, and it was their intention to find it. All efforts to find the lake failed, primarily because the lake did not exist. In frustration the mountain was named 'Disappointment'. Had radio been invented in those days Burke and Wills might have called the mountain 'Fantastic', as it is an ideal site for portable field operations, particularly on VHF and UHF.

By 10.30 AM with radio gear unpacked, antenna erected and seating arrangements finalised, (not to mention cold weather gear on!) the first CQ from VK3AWS/P was made. The club callsign could be heard on HF using an FT101E and FT707 with a 90 m long wire/ATU combination and 15/10 m dipoles, on VHF using an IC22A and FT290R with a five element beam and quarter wave whip, and on UHF with an IC4E portable and 1/2 wave whip. Thirty seven contacts were made during four hours of operation, not a bad effort. The Club also gained the Bendigo Premier Town award during the day, and it is hoped the Western Suburbs Radio Club reciprocate in the near future by helping Bendigo amateurs attain our Club award.



**Gordon VK3YOD swings the 2 metre beam —then again it could be the 2 metre beam swinging Gordon!!**

The day's operation closed at 3.30 PM just prior to a cool change in weather, with all adjourning to the PI-warmer for hot coffee and munchies. By general consensus it was agreed the day had been a success, and plans for a return visit made for the near future.

The Western Suburbs Radio Club operated from Mount Disappointment for many years, until pipped at the post one year, and members were pleased to return to their old stamping ground.



**Nell VK3VZY rugged up and ragchewing on 40 metres using the Club callsign VK3AWS.**

One thing for amateurs is sure, operating from a location such as this is never Disappointing!!!

Photographs Mark VK3PI

Mark Stephenson, VK3PI  
PUBLICITY OFFICER  
AR



**QSP**

## JOINING OPTICAL FIBRES

A team of British Telecom engineers has developed a device, said to be the equivalent of micro-surgery, capable of joining hair-thin optical fibres with high accuracy.

Optical fibres, known as lightlines, carry telecommunications by laser light replacing many old cable communications systems.

These fibres must be precisely aligned before they can be joined, which is very difficult, particularly when working underground. The new machine is completely portable and has an accuracy of one micron (one thousandth of a millimetre).

Fibre optic cables are a fraction of the size of normal coaxial cables and have a higher capacity and greater reliability with less maintenance. They also eliminate interference and cross talk on telephone lines and need less repeaters to boost signals.

Adapted from Information Technology from Britain, August 1983.

AR

## CLOSED CIRCUIT TV EXAMINES DAM WALL

The Hunter District Water Board, NSW, recently constructed a 200 metre-long dam near Newcastle and it was decided the wall of the dam should be inspected internally each year. The authority has devised a method using closed circuit TV to examine pipes, boreholes and other narrow channels.

The camera in a 51 mm diameter stainless steel case is lowered into 300 mm diameter inspection holes drilled vertically into the sloping part of the dam wall at intervals of 10 m along the whole of its length. These holes are 80 m deep and pass through the concrete structure into the natural rock on which the dam is built.

Adapted from Information Technology from Britain, August 1983.

AR

# AR SHOWCASE

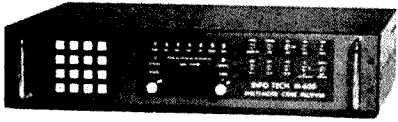

## CODE RECEIVER

The Info-Tech M-600A is a unique code receiver/converter that will accept multiple codes from your shortwave receiver and convert these codes to a display on a video monitor or a hard copy printout on your printer.

The codes accepted by the M-600A are: Morse — 5-60 words per minute, Baudot RTTY — 45, 50, 57, 74 & 100 Baud, ASCII RTTY — 75, 110, 150, 300, 600 & 1200 Baud and TOR (SITOR) — ARQ & FEC modes.

The M-600A uses state of the art Micro-processor circuitry to let you monitor thousands of CW and RTTY signals in Marine, Commercial, Government, Military and Press services.

Simple connections to your shortwave receiver and video monitor or printer will put your system on the air in minutes for new horizons in monitoring.

Further information may be obtained from Emtronics, Box K21, Haymarket, NSW, 2000.

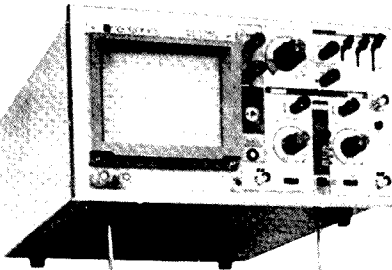

## DUAL TRACE OSCILLOSCOPE

The Model OS620 Dual Trace 20 MHz Oscilloscope is now available ex-stock.

This unit is especially built in Korea, and supplied directly to the end user priced economically at \$495 plus tax, probes included.

A particular feature of the instrument is the component tester which allows the checking of electronic components without the need for an external supply.

Ideal for TV work the trigger coupling includes line and frame synchronisation, circuitry.

The vertical sensitivity ranges from 5 mV/Div to 10 V/Div and the rise time is less than 17 n sec.

This scope makes an ideal general purpose tool for both the hobbyist and the professional.

A 45 MHz model is also available.

For further information contact Neotronics Pty Ltd, PO Box 289, Newport, NSW 2106. Phone: (02) 918 8220.

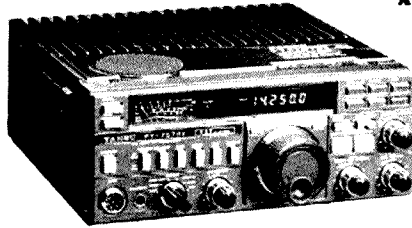

## NEW ALL MODE TRANSCEIVER

The Yaesu FT-757GX all mode transceiver blends the finest features of late model HF transceivers into a volume smaller than any predecessor and actually simplifies the circuitry and construction, at the same time.

Features include three microprocessors, dual VFOs and eight memories, programmable memory scanning, all modes — SSB, QSK, CW, AM and FM, whisper quiet cooling fan, uncluttered front panel with only necessary operating controls — all presettable controls are mounted on rear panel.

All items normally sold as extras are already installed and provided as standard. These include AM, FM modes, a 600 Hz narrow CW filter, iambic keyer with dot-dash memory, 25 kHz marker generator, IF shift and width filters, noise blanker and AF speech processor.

The FT-757GX will be available from Bail Electronic Services, 38 Faithfull Street, Wangaratta, 3677, in October.

## DRESS UP WITH A QSL CARD HOLDER

Now in stock are plastic QSL Card Holders which are designed to neaten up any shack.

Two card holders are supplied with each pack. Each card holder contains twenty pockets. Forty cards can be displayed neatly on the shack wall for \$3 plus \$1 post.

For further details contact: GFS Electronic Imports, 17 McKeon Road, (PO Box 97) Mitcham, Victoria 3132. Phone (03) 873 3939.

## RX-2300-KIT

MICROWAVE DOWNCONVERTER

### ASSEMBLY MANUAL

**TEM** MICROWAVE CORP.

22818 - 97th Avenue North  
Corcoran, MN 55374  
Telephone 612-498-8014

Prices:      Manual only  
                 Hardware only  
                 Electronics only  
                 Complete kit

## Dress up!!

## DOWNCONVERTER KIT FOR 2.3 GIGAHERTZ NOW AVAILABLE

The 2.3 GHz downconverter kit, the Model RX-2300 is designed for easy assembling and may be tuned to any 50 MHz band between 1.69 and 2.7 GHz. Interesting services included within this range are Weather Satellites, NASA's S-Band Space Shuttle Video and Audio link as well as a NASA beacon on the moon. The IF frequency is user selectable between 54 and 220 MHz.

Because use is made of a low noise microwave transistor in the RF Amplifier stage the RX-2300 exhibits an extremely good sensitivity.

All components are supplied with the kit including a comprehensive instruction manual, diecast metal case and BNC Connectors. Price of the kit is \$89 plus \$5 P & P.

For further information contact the distributors: GFS Electronic Imports, 17 McKeon Road, (PO Box 97) Mitcham, Victoria, 3132. Phone (03) 873 3939.



# VK2 MINI BULLETIN

Jeff Pages, VK2BYY  
VK2 MINI BULLETIN EDITOR  
PO Box 1066, Parramatta, NSW 2150

## COUNCIL REPORT

Divisional Council met at Amateur Radio House on the 16th September. Eighteen applications for membership were approved. Council decided that the NSW component of the annual subscriptions would remain at \$7, making the 1984 subscriptions \$30 for full members, \$28 for associates, \$23 for students, \$18 for family members and \$23 for pensioners. VK2 now has the lowest rates of all the Divisions.

Council discussed a member's suggestion that broadcasts be discontinued on 10, 6 and 2 metres SSB to allow the beacons to operate continuously. It was resolved that, as there is a considerable audience to the broadcasts on these frequencies, broadcasts will continue, with the beacons being disabled during broadcast times as is the current practice. Due to technical restrictions the broadcast transceivers cannot operate simultaneously with the beacons.

Dural Officer Jeff Pages VK2BYY reported that approaches to the Department of Communications regarding interference to the Dural 2 metre repeater from a nearby paging transmitter had proved fruitless, as the noise from the transmitter was well within specifications. The paging transmitter is currently undergoing testing and is expected to go into full time service in the near future. The effect of the interference is to cause a significant reduction in the repeater's sensitivity, and as it is caused by wideband noise radiated from the paging transmitter there is nothing that can be done at the repeater site to alleviate the problem. Council decided to refer the matter to the Federal EMC Co-ordinator.

An application from the Central Coast Amateur Radio Club to change the frequency

of their 2 metre repeater VK2RAG from channel 6750 to 6725 was approved for submission to the Department of Communications. A repeater application from the Liverpool and Districts Amateur Radio Club and a beacon application from the Hunter Branch Radio Group were also approved for submission to the Department.

Council appointed Vince Roberts VK2PRB as the VK2 Slow Morse Co-ordinator, replacing Ross Wilson VK2BRC who has been transferred to Canberra. Council records its appreciation for Ross's efforts and wishes Vince well in his new position.

The divisional Librarian, Aub Topp VK2AXT, wishes to thank those members who responded to the request for books and magazines in a recent broadcast. Those who responded were VK2QL, VK2HV, VK2ZAB, VK2PJJ, VK2ZSC and two anonymous members and Council records its thanks for their contributions. The library is always looking for old books, bulletins and especially solid state devices, application notes and manuals.

## EDUCATION SERVICE 1982 ACCOUNTS

These accounts have now been audited by the Division's auditors and they state, in part, that "the accounts . . . are properly drawn up in accordance with the provisions of the Institute's regulations" and that "the accounting and other records . . . have been properly kept in accordance with the rules of the Institute". As at the 31st December, 1982, the Education Service Subcommittee had a balance of \$35,453 and realised a surplus for 1982 of \$1,577. Council feels that the expense of providing each member with a five page booklet of these accounts would be prohibitive, and advise that any member wishing

a copy can either call in at the Divisional Office, write asking for them or ask on broadcast callbacks for a copy to be posted to them. The Education Service committee members had a very successful year in 1982 supplying novice kits to prospective amateurs while writing two new publications — "Into Electronics" and "100 Basic Electronic Projects".

## CONFERENCE OF CLUBS

The 9th Conference of Clubs is being held at the Central Coast Leagues Club, Dane Drive, Gosford, on Sunday 6th November, commencing at 10 AM. Any WIA member is welcome to attend as a spectator. The Conference provides Council with valuable feedback from the large proportion of the members represented by the club delegates, and we thank the Central Coast Amateur Radio Club for providing the venue for this Conference.

## SHOALHAVEN REPEATER

The Shoalhaven Amateur Radio Club has advised that it is rebuilding its repeater VK2RSD into a 496 mm rack panel to be compatible with the new building erected by Shoalhaven City Council. The club has been given sufficient rack space for both its 2 metre and 70 centimetre repeaters. To help cover the costs in providing this service the club is looking for "repeater members" at \$5 per year, particularly from the many mobiles who use the repeater during the holiday periods.

Information from members and clubs for inclusion in the January Mini Bulletin should be forwarded to the Divisional Office at PO Box 1066, Parramatta, NSW 2150, to be received no later than 12th November.

73 from Jeff Pages VK2BYY

AR

## SUBS RATES AND JOINING FEES 1984

	ACT	NSW	VIC	QLD	SA	WA	TAS
<b>Bona Fide Student Pensioner</b>	\$21.5 \$23	\$23 \$23	\$20 \$23	\$11 \$23	\$18 \$24	\$19 \$24	\$12.75 \$23
<b>Associate Member (No Callsign)</b>							
<b>Metropolitan Country</b>	\$32 \$32	\$28 \$28	\$30 \$30	\$30 \$30	\$32 \$32	\$29 \$29	\$31.5 \$31.5
<b>Full Member</b>							
<b>Metropolitan Country</b>	\$32 \$32	\$30 \$30	\$35 \$35	\$30 \$30	\$34 \$34	\$30 \$30	\$31.5 \$31.5
<b>Plus Joining Fee</b>	—	\$4	—	\$3	—	—	\$1

Family Member (eg wife) without AR — deduct \$12.05 from appropriate full or ass rate, except:— ACT — \$20, VIC — \$15, QLD — \$11, NSW — \$18

Subs subject to confirmation.

## STRAYS



In the year 1935 or thereabouts the ARRL magazine 'QST' ran an international contest which offered a prize to the amateur with the most 'hammy' name. There were plenty of applications with all sorts of surnames, eg Volt, Amp, Hertz, Morse, Zenner, Watt, Trap, Shield, Scaler, Corona, Buncher, Bridge, Reinartz, Probe, Ohm, Hartley, Mills, Joule and so on — but the contest was won by an Australian named Robert Francis Burns — RF Burns — it does you know!

Unfortunately, the said RF Burns' call sign has disappeared from the records into limbo land. Maybe some reader can supply it, his QTH and period of operation.

A. Shawsmith, VK4SS

AR



# VK3 WIA NOTES

Jim Linton, VK3PC  
DIVISIONAL PRESIDENT

The Victorian Divisional Council at a special meeting to discuss the Institute's budget for 1984 decided on a modest increase in most of the annual membership subscription rates.

Councillors examined all aspects of the WIA's financial affairs with the Divisional Treasurer Des Clarke, VK3DES giving a detailed run down on expenditure and revenue.

Australia had a wage freeze (now ended) and in line with the freeze the division did freeze its membership subscription rates for 1983.

This freeze included absorbing a \$2 increase in the Federal WIA component. For those who may not know about the make up of the subscriptions — they're really two subscriptions in one. The federal component pays for AR magazine, and the various national and international responsibilities handled by the WIA's Federal Executive.

It was impossible for the VK3 division to continue the freeze and absorb another increase in the federal component — and the considerable cost increases faced by the division in 1984.

State Government taxes, charges and rates have risen, and postage went up last month.

For example the electricity bill for the Institutes' VHF/UHF repeaters alone will be \$1,000 in 1984 — a 30%-35% increase on 1983.

Department of Communications licence fees will cost the division \$800 — repeater licence fees have been increased 25%.

The operation of repeaters is not cheap, but they're an essential service provided by your division.

Radio amateurs who are not WIA members also use the repeaters — perhaps members could encourage those non-members to join the Institute and help pay their share of repeater costs.

Apart from operating costs which include site rentals and insurance, an allocation is made in the budget for some upgrading work on repeaters.

Another major service to members are the inward and outward QSL bureaux. Your division, unlike others, doesn't make a charge to members for each card handled.

Non-members are however charged per card they want sent overseas.

Increased postal charges make the operation of the QSL service more expensive — but at the same time it makes the QSL bureaux a valuable service for radio amateurs and SWLs.

The running of an attended office results in expenditures including wages, postage, power, telephone, office supplies, rates and insurance.

The Wireless Institute Centre is the contact point for the WIA in Victoria — both for the member, the non-member wishing to join, people wanting to enrol in the theory and Morse classes, and for those wanting to make inquiries about our hobby including government agencies and other organisations.

Volunteers man the office on weekdays to handle inquiries, book and disposals equipment sales being a major part of office activities.

The Administrative Secretary, Maxine Conheady attends the office two days a week to handle correspondence and general office duties.

A substantial allocation has been made for upgrading the Divisional Sunday Broadcast through VK3BWI — A major refurbishing of the broadcast facility has begun.

To maintain services to members in a climate of rising costs, and for necessary repeater and broadcast upgrading, the scale of subscription rates had to be changed for 1984.

A full member is now \$35 (an increase of \$3), associates \$30 (up \$2), country full \$35, and country associates \$30.

The student grade is \$20 (unchanged from 1983), pensioner grade \$23 (covers federal component only — nothing retained by division), family member remains at \$15 per additional member.

Despite the subscription increases — I'm sure you'll agree they're still excellent value for money.

The full member grade for example is less than 68 cents per week. Subscription renewal notices are being sent out this month.

73  
Jim Linton  
AR

## STUDYING FOR THE NOVICE LICENCE?

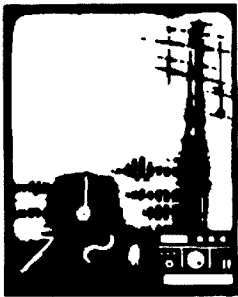

### THEORY BOOK:



- contains all nec. theory
- clear diagrams
- simple-to-follow text
- \$7.50 inc. postage



**\$60**  
POST PAID

### NOISE BRIDGE

Adjust your antenna for maximum performance. Measure resonant frequency, radiation resistance and reactance. Better than an SWR meter. Operates over 100 MHz. Most useful test unit in your shack.

### ANTENNA BALUNS

3 to 30 MHz  
Maximum Power 300 Watts  
Centre support  
Ideal for Dipoles, Beams, Quas  
S0239 connector



**\$26**

### POWER LINE FILTER

240 Volt @ 10 Amp

**\$16**



1000's of Transistors — Ferrites — Hobby Kite — Tag Strips — Switches etc. Send stamped addressed envelope for full list.

### MORSE TAPES:

- 5 WPM novice speed
- 10 WPM exams
- 8/10/15 WPM practice
- 15 WPM practice
- \$5.00 ea. inc post

**K. BRUCESMITH**  
110 Rosemead Road  
Hornsby N.S.W. 2077

**G. SCOTT**  
11 Balmoral Crescent,  
Surry Hills, Melbourne,  
Vict. 3127.





# VK4 WIA NOTES

Bud Pounsett, VK4QY  
Box 638, GPO, Brisbane, Qld 4001

## NORTH QUEENSLAND RADIO CONVENTION

The Townsville Amateur Radio Club staged the North Queensland Radio Convention over the weekend of 23, 24, and 25th of September at James Cook University, Townsville. Our Division President, Guy Minter was there and here is the text of Guy's speech at the convention...

*On behalf of the Wireless Institute of Australia, as Divisional President, I congratulate the Townsville Amateur Radio Club on the proud achievement of once again staging the North Queensland Radio Convention.*

*It is ten years since I attended your first Biennial Convention. It is indeed a proud milestone in the records of amateur radio in North Queensland, and especially of the Townsville Amateur Radio Club, that one club has been able to stage such a large function, so many times, so successfully.*

*TARC as a club is especially fortunate to have the depth of administrative talent it has. It ensures that all the many details are handled without fuss or bother, so that all of us attending this Convention may enjoy the fruits of their labour. Now most of you attending this Convention know the excellent things that TARC has done over the years. However, a few of you may not realise what the Institute has done. The Wireless Institute of Australia was founded in 1910 and is the oldest radio society in the world. Being old does not necessarily mean it is good — look at*

*your radio gear sometimes — but the Institute has a depth of knowledge and experience in looking after the interests of the nearly 15000 amateurs in Australia. The Institute consults and negotiates with overseas bodies, both Amateur and Governmental, on international matters. Within Australia, the Institute has an especially close and friendly relationship with the Department of Communications on matters concerning the regulation of the Amateur Radio Service.*

*Recently, a band segment 10.1 to 10.15 MHz was released, and now 50 to 50.15 MHz for use by Australian amateurs. Further segments in the 18 and 24 MHz bands have also been released for our use. In today's complex society, there is immense pressure on the Electromagnetic Spectrum. Yet, how is it that the Amateur Radio Service is not only retaining its frequency allocations, but is making significant gains?*

*It is because of an immense number of hours of unpaid work put in by many amateurs throughout the world ensuring that our hobby retains the right to exist. The Institute works for all amateurs in Australia, yet only about 60% of current licencees are members. Is the membership fee of \$27 too high, or is it better to let the other fellow pay his fees, and for you to just tag along for a free ride?*

*Do you believe in insurance for your home or car? Naturally, as a responsible citizen, you do. A well known corollary of Murphy's Law states that the day you surrender your car insurance policy, is the day your car hits a Holden Commodore or worse still, a new*

*Mercedes. Yet, with your hobby, you have many hundreds of dollars invested in your radios, antennas, and associated gear. Surely, you should pay just a few dollars a year insurance in your Institute membership fees to ensure that you can enjoy your hobby in the future! Townsville Amateur Radio Club will ensure that we will all enjoy this weekend. The Institute will continue to ensure that we will all enjoy our hobby in the years to come.*

## EVELYN BAHR, VK4EQ

Evelyn Bahr was licenced back in the mid 1950s and was the first lady member of the Townsville Amateur Radio Club. She was Club Treasurer in 1974 and became Editor of the club magazine 'Backscatter' in 1975, a position that she holds today. She has been Net Co-Ordinator of the weekly 80 metre net from VK4WIT and has been active in WICEN, field days, JOTA and other club, amateur radio and social activities for many years.

In presenting an award of great distinction to Evelyn at the North Queensland Convention, President, Guy Minter, VK4ZXZ, had this to say:

*"Evelyn, you are a credit to your club and to the WIA with whom in North Queensland, you have been our ambassadress. Above all you are a credit to our hobby by your excellent examples, both on and off the air. Evelyn, it is with pleasure that I present you with the Queensland Division of the Wireless Institute of Australia Merit Award Badge for 1983, you have truly earned it."*

AR



# FIVE-EIGHTH WAVE

Jennifer Warrington VK5ANW  
59 Albert Street, Clarence Gardens, SA 5039

## PUBLIC RELATIONS!

Last month I reported that we had been offered a stand at the Electronics Exhibition at Morphettville Racecourse on the 4th-6th November. Since then we have also been asked to be part of a display in Westlakes Mall as part of 'Science Week' which is run in co-operation with the Education Department and this year will be from the 24th-28th October during normal shopping hours. Unfortunately, by the time you read this it will be past but hopefully a worthwhile exercise.

## SUBS DUE

By now you will probably all be aware that the 1984 Subscriptions are due and subscription notices will be posted shortly, if they have not been already. In VK5, this year, happily we did not need to raise subscription rates to increase our revenue. However, we did make some changes to bring us in line with other divisions. If you read page 43 of April 1983 Amateur Radio you will note that we are the only division that still differentiates

between country and city members and that with changes in the EDP system being mooted and membership application forms being reprinted this seemed like an appropriate time to bring about these changes. We hope that the country members will not take this as a personal affront, particularly at this time when we are doing our best to improve communications between us. At the same time we have brought the Family Membership into line with some of the other States and with what it should be, which is either Full or Associate membership (depending on whether you have a call sign or not) without the cost of AR.

## MORE PR

A non-amateur friend recently asked me to explain the contents of a tape which her husband had been lent by another amateur. The tape turned out to be the opening address to the RD Contest which, it was felt, they might both be interested in as they are members of an RSL Sub-group. Needless to

say I was only too happy to oblige (including showing her two past copies of AR with photographs of me and the Trophy!) The conclusion of all this was that they decided that they would like someone to speak on amateur radio at one of their meetings, so, never one to miss a PR opportunity, I gave her the President, Bill Wardrop's phone number, as he did such a good job talking to the Kiwanis.

## DIARY DATES

4th-6th November Electronics Exhibition at Morphettville Racecourse.  
20th November WIA Picnic at Bridgewater Oval.  
22nd November WIA General meeting (subject unknown).

**NO BUY AND SELL ON NOVEMBER 29th**  
6th December Christmas meeting — Thebarton Assembly Rooms. The speaker will be Wally Watkins VK2DEW on his recent visit to the Peoples Republic of China.

AR

# IONOSPHERIC PREDICTIONS

Len Poynter VK3BYE

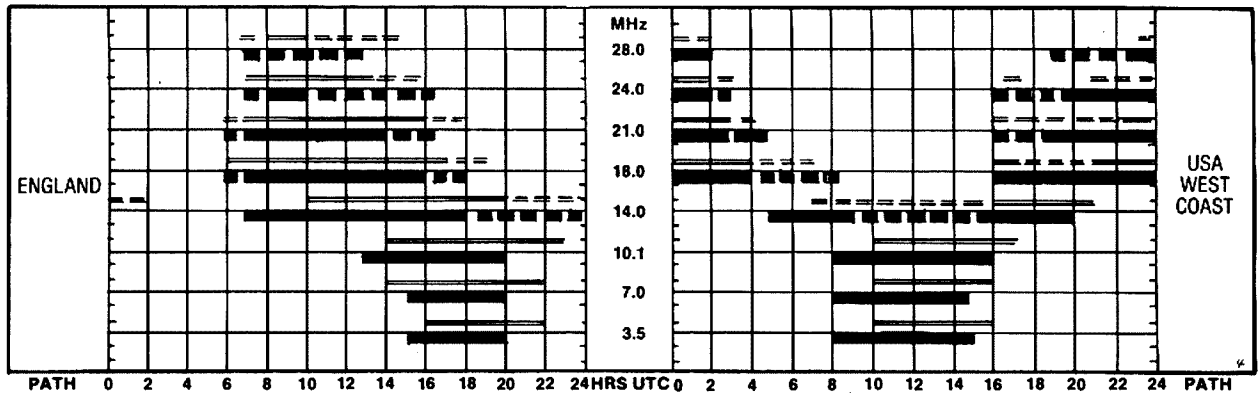
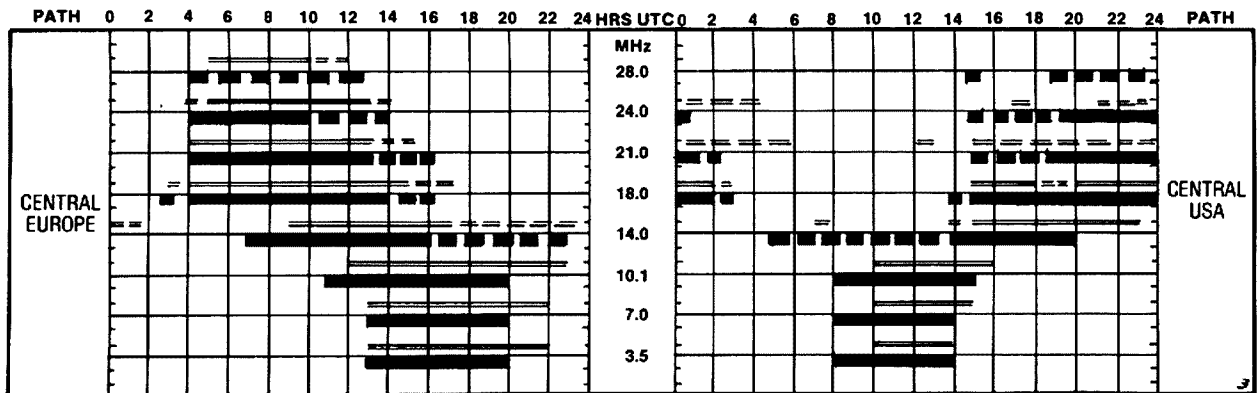
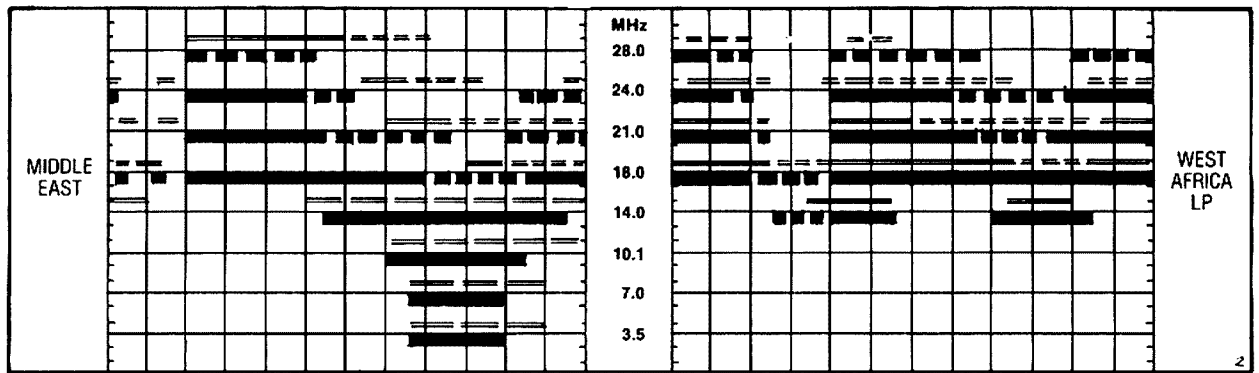
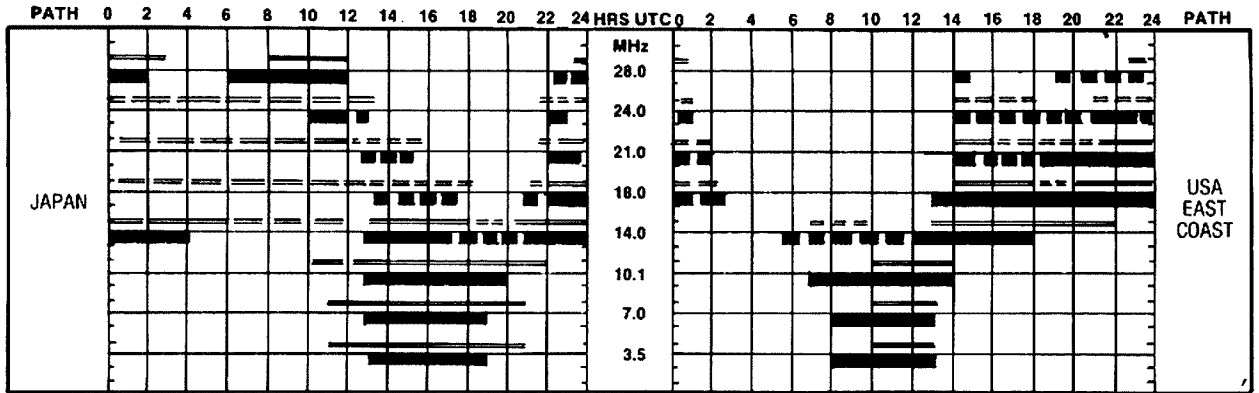

## LEGEND

—— From West Australia

———— From East Australia



Better than 50% of the month, but not every day



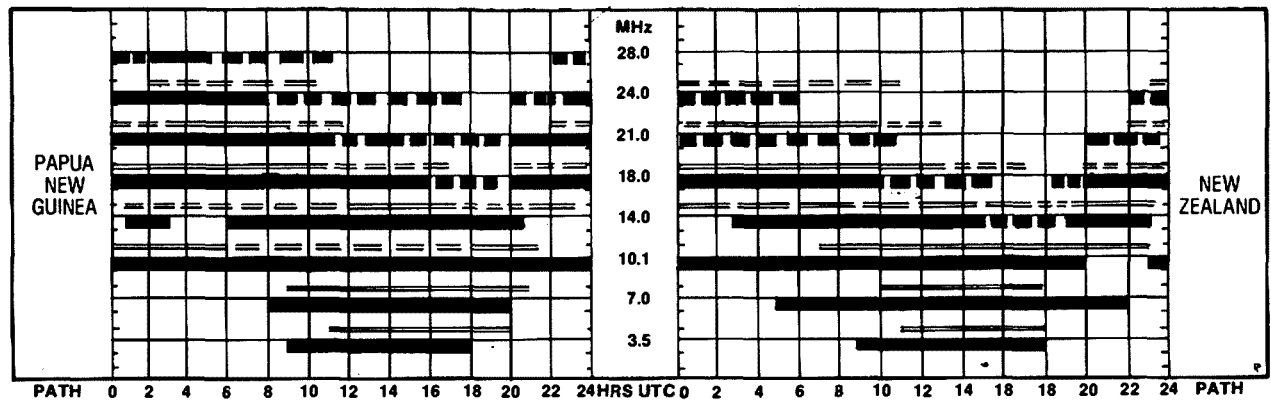
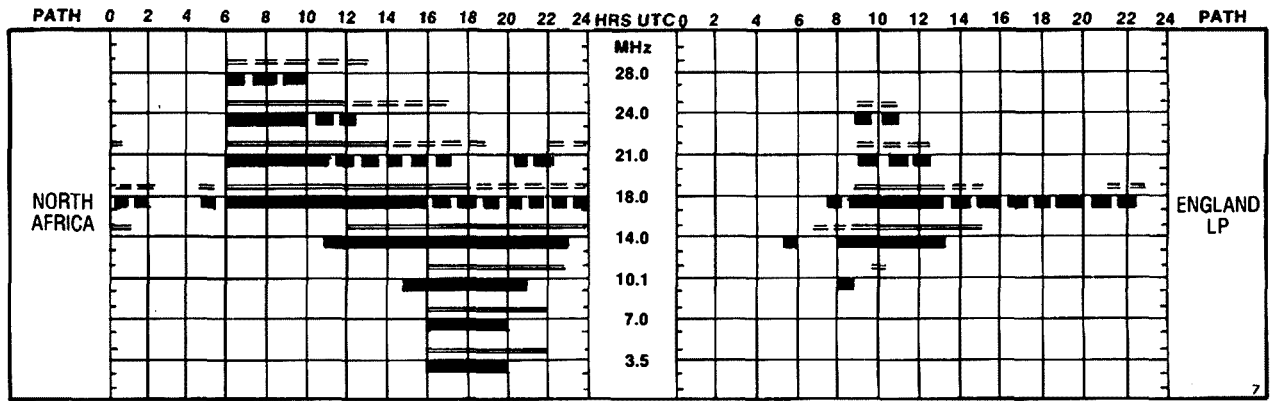
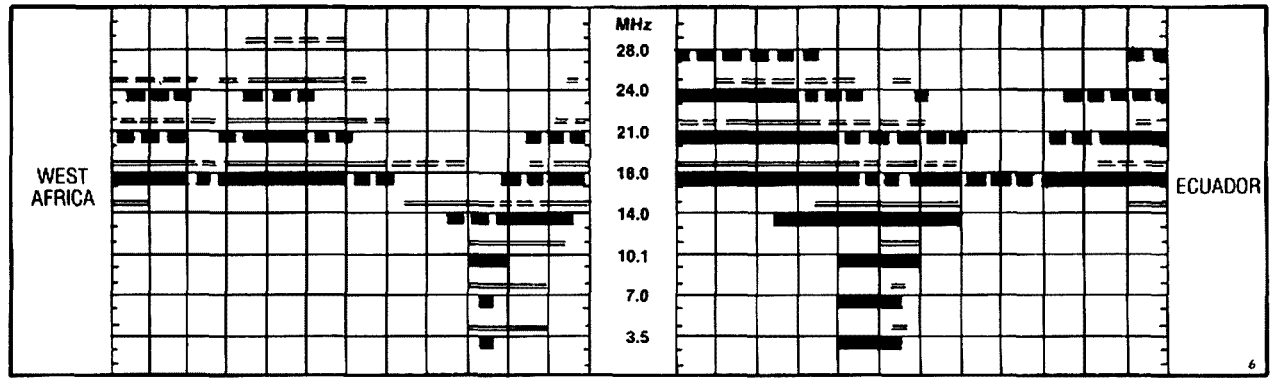
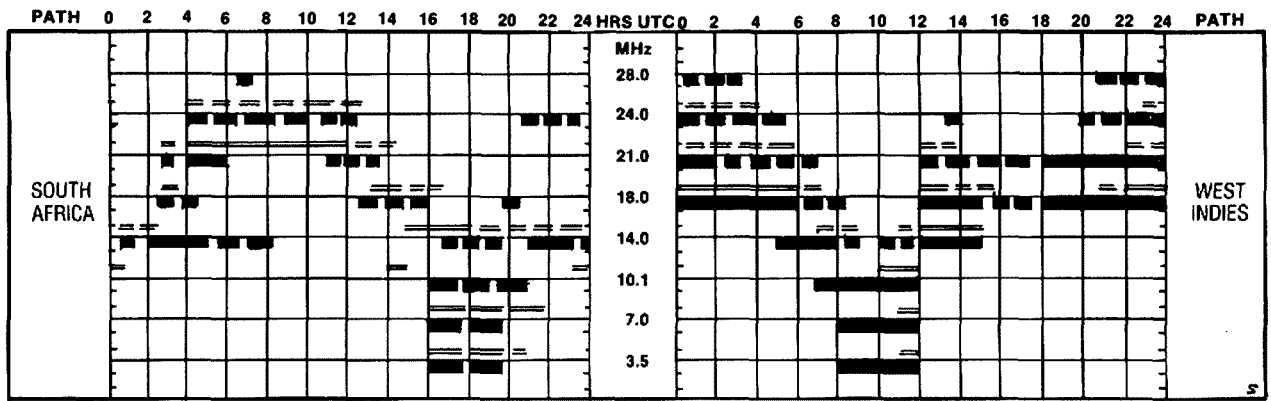

Predictions courtesy Department of Science and Environment (PS Sydney). All times in UTC.



Less than 50% of the month

PATHS — Unless otherwise indicated (ie LP = Long Path) all paths are Short Path.

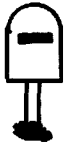

# LETTERS TO THE EDITOR

Any opinion expressed under this heading is the individual opinion of the writer and does not necessarily coincide with that of the publisher.



## CORAL COAST GROUP

I am writing to you to let you know about the Coral Coast Group. The Coral Coast Group which was started by Les Bell VK4LZ of Airlee Beach, Queensland on 28th September, 1967 and has been going every day without a break since. Frequency 7.060 MHz, Time 2100 UTC. The original call signs were VK4QW, VK4QB, VK4XZ and VK4ZW.

During that period there have been over 600 different stations on this group with many other listeners. It is probably the longest running net in the world with Stations from New Guinea down the coast to Victoria and sometimes Tasmania with an occasional ZL.

The net has been averaging lately around sixteen different stations per day. Les Bell's wife Bertha has kept all the records of the net up to date.

Les has been active in quite a few marine rescue operations and was associated with the tracking and communications of the raft, La Balsa. He was very active during the war and is mentioned in the book about the coast watchers. He installed a lot of Radar equipment and has an OBE.

Les Bell VK4LZ will be 80 years old in January.

L E Daniels, VK2AXZ  
9 Highfield Terrace  
Cardiff Heights NSW 2285

## GENTLEMAN'S AGREEMENT

The re-designation of the 'CW only' to 'narrow Bandwidth' on a gentleman's agreement basis will inevitably result in a lot of friction between CW operators, and those using faster baud rates. I cannot understand why the old band plan could not have been simply ratified and made official. Traditionally, RTTY operators, and recently those using AMTOR and ASCII, have sought contacts in the grey area between the CW band and the SSB band, eg on 40 metres between about 7.035 and 7.045 MHz. This idea has worked out quite well, as it means a smaller band need be searched to find contacts.

Just where is the definition of 'Narrow-Band' going to come from? As the baud rate is increased, the occupied bandwidth increases also (Hartley's law). For instance: amateurs with an interest in computers will probably want to send tapes of software to each other over the air at baud rates up to 1500 baud. Such a signal would easily occupy an SSB bandwidth. It can be imagined what sort of feelings would be generated among the die-hard CW crowd down on 7.002 MHz locked in battle for some exotic station with a data signal rattling away close by!

There are indications that the popularity of CW is as great, if not greater than ever (the number of stations in the Sunday CW net proves this). Stations using the only *true* narrow bandwidth mode should not be penalised by having to rub shoulders with the spectrum goblins that we may expect in the years to come. A lot more work has to be done to work out a fair band plan which actually reflects the numbers of operators and their particular interest — and such a band plan made *law*, not simply a 'gentleman's' agreement.

For instance: on 40 metres, 7.000 to 7.035 could be CW only, 7.035 to 7.045, RTTY, data etc. 7.045 and above; all modes. SSB enthusiasts may argue that CW and RTTY should not be allowed in the upper segment. It should be remembered however, that a clean telegraphy signal occupies only a fraction of the space that SSB uses, and it should not be difficult for SSB operators to avoid interference

from this source. This issue of band planning is a very emotional one, and more thought and discussion must be allowed to occur before any band plan is put into force.

Drew Diamond, VK3XU  
43 Boyana Crescent, Croydon, Vic 3136  
AR

## GRATITUDE

I am writing this note to express my gratitude. About four years ago I passed the exam for my novice (just) and I set myself two goals, 'DXCC' and ARRL 'WAS'.

I have both of these awards now and I now realise how much help I needed and received.

Firstly to DOC for giving mugs like myself a chance in amateur radio by bringing in the novice level.

To the wonderful people manning the bureau specially VK2, you were just great.

ARRL were very prompt re WAS.

And last but not least the amateurs in Australia and throughout the world that helped me. I say but one word . . . THANKS.

Leo J Butcher, VK2VUB  
128 Boyce Road  
Maroubra, NSW 2035  
AR

## THANKS AND APPRECIATION

On behalf of the Maryborough West State School P&C, may I extend to the many amateurs who supported our recent art union, our thanks and appreciation.

Unfortunately none of you was successful in winning any of the prizes. All three prizes however went to local residents.

Here are the winning ticket numbers, 1st: Ticket 0683, 2nd: 1801 and 3rd: 3769.

The Micro Bee Computer prize proved very popular among amateurs. With this in mind, may I suggest the WIA could get a computer as a prize in a future competition (perhaps this competition could be associated with the payment of the 1984 WIA membership fee, where each member is given a lucky number on (prompt) payment of their 1984 dues!).

Yours faithfully  
E L King, VK40A  
45 Wilson Street  
Maryborough, 4650  
AR

## TRIBUTE TO NARA, 9M2LN

I have written the enclosed as a tribute to Nara, 9M2LN, who became a silent key on 21st July, 1983. I was wondering if, in view of the great help he has been to so many VKs, it would be possible to print it in AR magazine.

His session is now carried on most ably by Hock, 9M2FR, in the tradition that Nara started.

Regards  
Joy Collis, VK2EBX  
PO Box 22  
Yoeval, NSW 2868  
AR

## TO NARA — 9M2LN

Dear Nara, this must be, to you,  
Our last, our sad "goodbye",  
We always will remember you,  
Though many years go by.

The key you used so expertly,  
Is silent evermore!

We will no longer hear its tone,  
So confident and sure.

And Nara's Group, as we were known,  
Became a growing band,  
Of novices and SWLs,  
All over VK land.

Each day we tuned to 9M2,  
With paper, pen and key;  
And all relying on your help,  
To obtain AOCF.

And at 0200 every day,  
Your CW was heard,  
You listened to our stumbling Morse,  
Without an unkind word!

And when we failed to copy yours,  
Your patience was immense,  
With kindness and encouragement,  
Although we were so dense!

Without your help we never would,  
Have passed telegraphy,  
Your dedication to us all,  
Was very plain to see.

We never met you, Nara,  
And now we never will;  
But through all the VKs you have helped,  
We feel you're with us still!

And we'll just say "Thank you, Nara!"  
And our thoughts to you extend,  
May you rest in peace, dear Nara,  
Terima-Kaseh, our dear friend.

## ELECTRONIC HOBBYIST!

DO YOU LIVE IN . . .  
Ringwood, Lilydale,  
Boronia, Wantirna,  
Bayswater, Mooroolbark etc? . . .

We carry a comprehensive range of electronic components at very keen prices.

Ian J. TRUSCOTT  
ELECTRONICS  
CNR EASTFIELD  
& BAYSWATER ROADS,  
SOUTH CROYDON,  
VIC.  
TELEPHONE  
(03) 723 3860

# GEOMAGNETIC & SUNSPOT ACTIVITY 1983

## Ap INDICES

MONTHLY	MEAN	HIGHEST DAILY
1/83	16	78 10/1
2/83	27	143 5/2
3/83	23	86 2/3
4/83	24	61 24/4
5/83	22	77 24/5
6/83	16	70 13/6
7/83	12	40 24/7

LOWEST	DAILY	DAYS OVER Ap 15
3	6/1	12
5	2/2	18
3	27/3	18
8	11/4	22
5	28/5	13
3	4/6	12
4	11/7	9

## CYCLE 21 RUNNING SMOOTHED SUNSPOT NUMBER

FINAL	SMOOTHED	SUNSPOT	NUMBER
7/81	140.4	1/82	137.1
8/81	141.3	2/82	133.4
9/81	143.0	3/82	129.3
10/81	142.3	4/82	124.4
11/81	138.9	5/82	120.0
12/81	137.9	6/82	117.4

PROV	SMOOTHED	SUNSPOT	NUMBER
7/82	115.3	1/83	92.8
8/82	109.5		
9/82	101.1		
10/82	95.7		
11/82	94.7		
12/82	94.6		

## PROVISIONAL MONTHLY MEAN SUNSPOT NUMBERS 1983

	HIGHEST DAILY	LOWEST DAILY
1/83	85.8 110 6/1	55 3/1
2/83	50.1 98 28/2	10 14/2
3/83	66.5 109 5/3	12 13/3
4/83	79.7 137 30/4	36 5/4
5/83	100.2 132 13/5	60 31/5
6/83	90.6 143 23/6	59 30/6
7/83	82.1 114 22/7	40 28/7

LAST DATA PUBLISHED AR MAY 1983 P53  
Acknowledgement Sunspot Data: Sunspot Index Data Center, Brussels.

Geomagnetic Data: IUGG Assoc of Geomagnetism and Aeronomy, Gottingen.

AR



# QSP

## AMATEUR ON FLIGHT 007

A Korean amateur, Lim Sang Ki HL1IJ was one of the crew members of the Korean airliner which was shot down on 1st September, 1983.

AR

# Silent Keys

It is with deep regret we record the passing of—

MR LEN DODDS  
MR C HEDLEY

VK4GD  
VK2MT

## LEN DODDS VK4GD

Amateur radio, on the 21st September, 1983 lost one of its great members, with the passing away in Brisbane of Len Dodds, VK4GD.

The Townsville Amateur Radio Club were pleased last year to offer Len Life Membership of the club, a position which had pleased him greatly. See p40, January AR. In a press statement at the time Len had intimated that one of the greatest attractions of amateur radio was the brotherhood it created—that all men are equal no matter what work they did. That is how it was with Len. He was a wonderful friend to all—helping the newly licenced Novice or ragchewing, or discussing technical matters.

Len was seventy-five years of age, and had been interested in radio for over sixty years. His first crystal set was built in 1923, although he did not take out an amateur licence until 1927, when he was in the Navy doing a course in signal operating. His call sign then was OA2LO, which later became VK2LD. During World War II, Len was in the RAAF. He settled in Townsville and obtained his present call sign of VK4LO.

Despite the fact that he was somewhat restricted in the past few years by the loss of part of his left leg, Len's cheery nature never left him. He was a wonderful friend to all at the TARC, and monitored the repeater regularly. We will not forget that wonderful infectious chuckle. We will never forget the man who was one of the founders of the Club, and throughout all the years was there to assist and cheer us all. Len Dodds, VK4GD. RIP.

Evelyn VK4EQ

# HAMADS

PLEASE NOTE: If you are advertising items FOR SALE and WANTED please write on separate sheets, including ALL details, eg Name, Address, on both. Please write copy for your Hamad as clearly as possible, preferably typed.

\* Please insert STD code with phone numbers when you advertise.

- Eight lines free to all WIA members. \$9 per 10 words minimum for non-members.
- Copy in typescript please or in block letters double spaced to PO Box 300, Caulfield South 3162.
- Repeats may be charged at full rates.
- QTHR means address is correct as set out in the WIA current Call Book.

Ordinary Hamads submitted from members who are deemed to be in the general electronics retail and wholesale distributive trades should be certified as referring only to private articles not being resold for merchandising purposes.

## TRADE HAMADS

Conditions for commercial advertising are as follows: The rate is \$15 for four lines, plus \$2 per line

(or part thereof) minimum charge \$15 pre-payable. Copy is required by the deadline as stated below indexes on page 1.

**AMIOON FERROMAGNETIC CORES:** Large range for all receiver and transmitter applications. For data and price list send 105 x 220 SASE TO: RJ & US IMPORTS, Box 157, Mortdale, NSW 2223. (No enquiries at office: 11 Macken Street, Oakley, 2223).

**CB RADIOS \$69:** Walkie talkies, short wave radios, military, outback, business, amateur, marine, repairs. RTTY Siemens 100 A printer \$120; base mic \$45; ultrasonic alarm \$35; all ham bands on a single 6 ft whip, 1.8 to 30 MHz, for base or mobile \$300; aerials, installation, demonstrations, 40 Ch CB conversions, accessories, new rigs weekly. **BRIDGE DISPOSALS,** 12 Old Town Plaza, opp Bankstown Railway Station, NSW. Mail order service and all enquiries to 2 Griffith Avenue, Roseville, 2069, or phone Sam VK2BVS, 7 pm to 9 pm only on (02) 407 1066.

## WANTED — NSW

**ATLAS 210X** accessories, VXO, console PS, digi readout. VK2BBG. Ph: (042) 28 8608.

**COIL FORMERS,** 4 & 6 pin UX base ribbed & grooved formers. N Burton, 130 The River Road, Revesby, NSW 2212. Ph: (02) 774 1827.

**COMPUTER SOFTWARE** for Osborne 1 to operate Mactronics M-80 RTTY interface. David Pilley VK2AYD. PO Box 231, Frenchs Forrest, 2086. Ph: (02) 452 5441.

**HF LINEAR AMP** or suitable parts to build same. Also Communications rx. Allan VK2EFM, 21 Yarravel Street, Kempsey 2440. Ph: (065) 62 6265.

**ICOM IC-22S** synthesised 2m 1xcvr. Complete in reliable working order. Top price for good unit. Ph: Sydney (02) 599 1126 anytime.

**KENWOOD SP520** or SP 820 speaker unit. VK2APJ OTHR. Ph: (047) 59 1651.

**XITEX SCT-100** glass RTTY board complete. Either operating or faulty. Ring Geoff VK2AZT with price and condition. Ph: (069) 42 1392.

## WANTED — VIC

**HIGH POWERED TX TUBES.** All types and makes, ie: forced air ceramic, radial beam triodes, tetrodes, pentodes, sockets and chimneys. New or used but must work. For genuine collector. Please no outrageous prices. Collection now at 32 tubes and growing. Chris VK3FY/DHU QTHR.

**HUSTLER 14 MHz** element to supplement existing 7MHz whip unit. Also a 50A moving coil DC centre zero panel mounting meter complete with shunt. VK3AVH QTHR. Ph: (059) 88 8797.

**IC255A** to buy or swap with cash adjustment, IC22S, all Vic repeaters programmed, BNC connected. Internal screw in fuse. VK3DPM QTHR. Ph: (03) 596 3968.

**INTEGRATED CIRCUITS.** Old Motorola RTL, MC's 790, 792, 789, 724, 725, 788. Any would be greatly appreciated. Roy VK3ADH.

**PROP PITCH ROTATOR** complete or parts, any condition. Also selsyns etc for direction indicator. Don VK3DJF QTHR. Ph: (03) 848 3059.

## WANTED — WA

**MANUALS** Kenwood TS520S. Will pay for manual or photocopies & postage. Tony VK6NIA, C/- 34 Dean Street, Mt Barker, 6324.

## FOR SALE — ACT

**ICOM 720A**, CW filter, PS15 power supply and AT100 auto tuner all with manuals & boxes. \$1200 ONO. Yaesu FT208R handheld with box & manual \$220 ONO. Hewlett Packard HP41C calculator with games pack and 2 solution books \$230 ONO. Ten Tec Argonaut Keyer, mike and notch filler \$330 ONO. Glen Torr. Ph: (062) 31 3343. AH.

**ICOM IC730S** 20W output esp for Novice \$450. Kenwood TR7730 2m FMS20R. Tandy 4 pen graphic colour printer \$260. VK1KHY OTHR. Ph: (062) 51 5632.

**YAESU FT101E** CW filter, manual, hand mike, spare finals. \$500. ONO. YO100 monitorscope \$200 ONO. FRG7 communications rx \$250 ONO. YD148 desk mike \$30. Shure 444 desk mike \$60. Jack VK1FM OTHR. Ph: (062) 48 9304.

## FOR SALE — NSW

**ANTENNA TUNER** Ten Tec 247. 1.8-30MHz, built in SWR meter, long wire, bal line, coax output. 100 W continuous 300 W peak. \$110. VK2KSD OTHR. Ph: (02) 456 1577.

**ANTENNA TUNER** Yaesu FC 107 as new with manual \$150. Oskerblok SWR & output twin meter as new \$70. Pair new 7 boxed 6146B RCA valves \$20. Vibroplex Key \$20. Simplex autokey \$10. AWA Morse key \$10. VK2AXR. Ph: (02) 477 6275.

**COLLINS KWM2** as new with spkr & pwr supply. All factory updates plus DX research processor. All manuals and bulletins. Box spare valves. \$600 ONO. VK2PMA OTHR. Ph: (02) 449 8690. BH.

**COLLINS KW380**, Collins R390A. Robot keyboard 800. JIL SX100 scanner. Datong up converter UC-1, Tokyo Hy-Power labs HL-400B 3-30MHz amp. Ph: (02) 787 2958.

**COMPLETE YAESU RIG** in good working order. Txcvr FT301D with CW/AM filters, power supply FP301D, antenna tuner FC902, dummy load-wattmeter YP150, HyGain vertical antenna 14AVQ/WB, vertical antenna mounting kit 14RMQ, 35 feet coax leadin cable, original manuals and boxes. Total price \$1150. Ph: (02) 95 6567.

**FT101E** \$450, 2 Walkie Talkies. 1W 2ch 28.5MHz each \$27. Computer keyboard, encoded ASCII, 7 LED's, 65 keys \$70, valves 6HF5, 2 matched lor \$5, 003A, 00V02-6, ECL80, EM80, PL5723, 6AK5W, 6AU6, 6BA6, 6BE6, 6J7G all \$1 each. Add postage. VK2BMI OTHR. Ph: (02) 771 1657.

**JIL SX-100 SCANNER** \$230 with service manual. Sony ICF-2001 synthesised rx \$175. GOS 955 6.5MHz oscilloscope \$200. Oiawa MC-330 mic compressor \$50. All as new. VK2 L20118 OTHR. Ph: (069) 63 6944.

**MOD 15 TELEPRINTER** \$40. Kilenschmidt TD and reperf. (Reads tape, punches tape & prints on tape) \$40. VK2BOA. Ph: (049) 83 8981.

**PHILIPS FM 321** 70cm FM \$200. Icom IC22S 2m FM with homebuilt external frequency programmer \$220. 2m 80W linear amplifier \$120. All VGC. VK2BOD. Ph: (02) 601 2560 in mornings or weekends.

**SWAN 350** \$200. Yaesu FT101B \$450. Enquire (046) 77 1842.

**TRANSCEIVERS** NEC 3-30MHz AM/SSB \$600. TS130S with filters, 4 memories, VFO \$650. Marconi sig/gen 68-470MHz, AM/FM \$100. Deviation meter FM \$30. Antennae, quad, HyGain 3 band, 2 element. \$200. Ph: (02) 529 3287.

**YAESU FR67** communications rx in immaculate condition, little use. \$220 ONO, plus freight. Can arrange free delivery to VK1 area. Owen. Ph: (0649) 2 1555 BH.

**YAESU FR67** rx with manual. VG condition. \$190 ONO. Bernard VK2NUU. Ph: (02) 70 3871.

## FOR SALE — VIC

**COMPLETE MOBILE/BASE HF** station. Yaesu FT-707 series. FT-707 txcvr, FP-707 power supply, FC-707 ATU/SWR/dummy load, YM-37 mike, MMB-2 mobile bracket, Dick Smith 5-band trapped vertical. Excellent condition, cartons & manuals. \$985. Neil May VK3VZY OTHR. Ph: (03) 478 7660.

**FT-101** comprehensive workshop manual as new \$20. 6-6JS6C final tubes for FT-101 \$9 each. 3-12BY7 driver tubes for FT-101 \$3 each. All tubes unused. FT-101B owners manual \$5. VK3BFB. Ph: (03) 587 1593.

**HIOAKA MULTI-BAND TRAP VERTICAL**. 80-10m VS41/VS80KR. Complete with guys, coils, insulators, VSRG radials, 50ohm lead, instructions. New condition. Dismantled, ready to take away. \$65. Bill VK3GA OTHR. Ph: (03) 29 7256.

**HI-QUAO** by HyGain, triband antenna 10-15-20m. Good condition, on ground. \$200. VK3BDM. Ph: 49 5160 BH.

**IC-22S** 2m FM 10W synthesised txcvr. 1 carelul owner. Supplied with bracket, mike, manual, remote VFO. \$200. TR-3200 70 cm FM 2W port txcvr. Good condition, with mic, nicads, charger, manual. Fitted with 11 ch. \$200. Ray VK1ZJR/3 OTHR. Ph: (03) 368 2285.

**ICOM IC-740**. As new, only 6 months old. Must sell \$825. ONO. Peter VK3PBO/ZDV OTHR. Ph: (058) 21 6070.

**HTTY EQUIPMENT**. Model 15 printer/keyboard. Model 14 typing reperf, complete sets manuals for model 14/15 equipment. 1 spare printer lor parts. 240V/110V 300VA Xformer for above gear. Home brew mod/demod plus CRT tuning display with power supply. All interconnecting cables. 6 rolls paper. Can deliver. \$195 the lot. VK3ZWP, 5 Ironbark Court, Frankston Nth. 3200. Ph: (03) 786 9885.

**SHURE 4440** dual impedance desk mike. VGC \$45. Bill VK3SB OTHR. Ph: (03) 584 3521.

**SIEMANS** model 100 teleprinter. Excellent condition. Has tape reader attached. \$59 ONO. HF Linear amplifier. Yaesu FL 2000. 400W PEP. Good condition. \$300 ONO. Scotty VK3ZR OTHR. (03) 890 4645.

**TRIO CS-1570 CRO** dual trace. DC - 30MHz complete with instruction manual & 2 Trio PC 28 probes. Excellent performer as new. Cost \$950, sell \$650. Peter VK3XDP. Bendigo. (054) 43 8192.

**YAESU FT-101E** AC/DC complete with all accessories, handbook and original box. \$400. VK3DQK OTHR. Ph: (03) 547 5894.

**YAESU FT101E**. GC. IC211, IC551, also Philips colour generator type 550B & AWA volt ohmyst (large meter version). Mike VK3AJD. Ph: (03) 306 9771.

**YAESU FT-290R** 2m all mode txcvr. Brand new incl micad batt. \$300. John VK3XHE. Ph: (03) 879 1773.

## FOR SALE — QLD

**CHIRNSIDE CE 52** duo band yagi beam lor 10m & 15m. 4 elements on 10m & 4 elements on 15m. 5 elements in all on a 6 metre boom. VGC. Retail for \$205, sell \$140. Ph: (07) 205 3238.

**FT-200** rx, preamp, spare tubes. Full 10m \$250. 2m amp, homebrew 2-10W FM \$20. Kevin VK42KE. Ph: (07) 377 3785 BH, (07) 201 3006 AH.

**HIDAKA VS22** 10-15m duoband yagi. 3 element \$150. KR400 Rotator & control, plus 19m of control cable \$120. Also Micronta power supply, 8A \$35. VK4AVR OTHR. Ph: (07) 345 2486.

**TRIO KENWOOD TS-830S**, \$1000. Freight paid anywhere in Qld. Stewart VK4NII. Ph: (071) 71 3600.

**YAESU FT-101B**. Good condition, with manual & mike in original carton. Includes mod for 10MHz operation. \$379 plus freight. Merv VK4ZE OTHR. Ph: (07) 343 5061.

**YAESU FT-101E** txcvr in top condition \$500. Yaesu Linear FL 2100 \$375. D104 crystal mike, new \$75. VK4AGL OTHR. Ph: (071) 41 2315.

## FOR SALE — TAS

**FT-101Z-D** txcvr with YE7A mike & manual. Bought 9 months ago — digi readout, fan & CW narrow filter fitted. Cost \$1200, sell for \$800. Bill VK7VA. Launceston. Aust Maritime College Campus. Room 714 or leave message on (003) 26 2436.

## ADVERTISERS' INDEX

AMATEUR RADIO ACTION .....	8
ATN ANTENNAS .....	50
BAIL ELECTRONIC SERVICES .....	BC
CW ELECTRONICS .....	57
DICK SMITH ELECTRONICS .....	6
EASTERN COMMUNICATION CENTRE ..	IBC
EMTRONICS .....	IFC
GFS ELECTRONIC IMPORTS .....	2 & 3
HAMRAD .....	45
HIGH TECHNOLOGY COMPUTER SYSTEMS PTY LTD .....	50
HY-TECH DISTRIBUTORS .....	50
IAN J TRUSCOTT ELECTRONICS .....	70
ICOM AUSTRALIA PTY LTD .....	4 & 5
MICROWAVE DEVELOPMENTS .....	45
NOVICE LICENCE — VK2 .....	45
OPTILUX .....	57
SCOTT & BRUCE SMITH .....	66
SKYTRIM .....	8
TRAEGER DISTRIBUTORS (NSW) PTY LTD ..	14
TRIO-KENWOOD (AUSTRALIA) PTY LTD ..	34-39
VAINS ANTENNA SERVICES PTY LTD .....	14
VICOM INTERNATIONAL .....	33
WILLIAM WILLIS & CO PTY LTD .....	45
WILLIAMS PRINTING SERVICE PTY LTD ..	43

## HIGH TECHNOLOGY COMPUTER SYSTEMS PTY LTD

Amateur Radio regrets a printing error in the October issue.

We printed the price of the Commodore 64 as being \$229.00 instead of \$499.00.

We apologise for the mistake to High Technology Computer Systems as well as to our readers for any inconvenience caused.

John Hill,  
Advertising Manager

# EASTERN

## COMMUNICATION CENTRE

COMMUNICATIONS, ELECTRONICS AND COMPUTERS

168 ELGAR ROAD, BOX HILL SOUTH, 3128

Phone enquiries: 288 3107

CONTACT Keith VK3ACE or David VK3UD

HOURS: Mon.-Fri. 9-5.30, Sat. 9-12

BANKCARD WELCOME OR WE CAN ARRANGE FINANCE

### ALTRONICS DISTRIBUTOR • FULLY EQUIPPED SERVICE CENTRE

#### ICOM



#### HF GENERAL COVERAGE RECEIVER

Listen to the world of HF with the R70, a 100kHz to 30MHz commercial grade receiver designed by ICOM Incorporated, the leader in advanced receiver design. Built from knowledge gained by designing receivers for commercial, marine and amateur use, the R70 surpasses other receivers on the market... even receivers costing more than twice as much.

Utilizing ICOM's DEM (Direct Feed Mixer), the R70 is a receiver which in normal usage is virtually immune to intermodulation distortion or cross modulation, yet still maintains superior sensitivity. Whether you are a Short Wave Listener, Amateur Radio Operator, Maritime Operator or Commercial User, the R70 provides the features you need.

The R70 is an ideal general coverage receiver to complement any amateur shack. Use it with your existing transmitter or transceiver to provide dual receiver capability.

The R70's built-in monitor system lets you listen to your own transmitted audio and a mute input automatically protects the R70's receiver from your signal.

An option for FM allows listening to the 10 metre FM activity.

#### EASTERN CONVERTER!

#### CW/RTTY

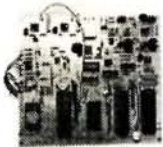

Looks straight up to your RS232 Terminal or Teletype via 20mA loop.

**EASTERN CODE CONVERTER** — Full break in CW and BAUDOT RTTY converter based on a 2716 EPROM programme, 6802 microprocessor and other associated IC's including a UART for control of the teletype function.

**MORSE CODE** — Full break in, auto speed adjust on receive, transmit speed control via variable resistor input from exit speaker jack on your transceiver three stage filter. With head phone output on two of the filter stages transmission via on board relay to CW jack on your transceiver.

**RTTY** — 45.45 and 50 BAUD, optional auto CR and LF unshift on space facility input and output at TTL levels, can be connected to any suitable MODEM.

**VISUAL DISPLAY** — Interface to a VDU at RS 232 levels 300 BAUD, ASCII or interface to suitable ASCII teletype 110 BAUD via 20 mA loop. (ASR 33 or sim.)

**RTTY BAUD V7A COMING SOON!!**

#### KENWOOD



The TS-430S combines the ultimate in compact styling with its counterparts in advanced circuit design and performance. An all solid-state SSB, CW and AM transceiver, with FM optional, covering the 160-10 metre Amateur bands including the new WARC bands, this remarkable radio also incorporates a 150 kHz-30 MHz general coverage receiver, having an extra wide dynamic range. Key features include dual digital VFO's, eight memory channels, memory scan.



The TR-2500 is a compact, designed for tomorrow, 2 meter FM handheld transceiver, incorporating the latest in electronic technology, including LCD readout, 10 channel memory with improved memory backup, memory scan, programmable automatic band scan, keyboard channel selection, and improved flexibility with a variety of new accessories. Big in features, big in performance, the TR-2500 will surprise you with its small size.

#### TW 4000A - 70cm/2m

#### DUO-BANDER



**\$699**

#### VS1-VOICE SYNTHESIZER-\$40

#### HAMPAK II MODEM!

Plugs into APPLE® or compatible computers.

Turn your APPLE II into a communication terminal with the Q-tronics MODEM and Software.

**STANDARD BAUDOT TONES**  
**KANSAS CITY TONES**  
**CCITT TONES**

Designed to plug into the APPLE games I/O.  
Can be modified for use on VIC 20 & 64

**\$210**



#### FAX-80

80 column printer. Bi-directional, graphics printer.

**\$495** plus Tax

EPROMS COPIED & PROGRAMMED \* PRINTED CCT BOARD MANUFACTURED TO ORDER \* FULL RANGE OF APPLE® COMPATIBLE PERIPHERAL CARDS AVAILABLE: REPAIRS TO APPLE® COMPATIBLE, VIC 20, COMMODORE 64, TRS 80 AND MOST COMPUTERS.



## FT726 V/UHF ALL MODE TRIBANDER

- USB, LSB, FM, CW modes
- 10 watt RF output on two metre (6 metre, 70 centimetre units optional)
- 11 memories store mode as well as band
- Programmable limited band seen between memories
- Satellite I.F. unit (optional) for full duplex cross-band
- Squelch on all modes
- GaAs FET RX pre-amp in 70 centimetre unit



## FT980 HF ALL MODE COMPUTER AIDED TRANSCEIVER

Built-in computer control using 8-bit microprocessor  
(80C85)



- General coverage RX 150KHz-29.99MHz
- Power output 100 watt SSB, CW; 25 watt AM; FSK
- Two independent RX front-ends using JFets
- 12 memory channels storing mode and frequency
- Rear panel connections for transverter, linear amplifier and external microcomputer interface



**BAIL ELECTRONIC SERVICES**

**38 FAITHFUL STREET, WANGARATTA 3677**

Telephone: (057) 21 6260 — Telex: 56880

**DISTRIBUTORS AND AGENTS IN ALL STATES**

Stan Roberts  
and Staff —  
VK3BSR

# AMATEUR RADIO

VOL 51, NO 12, DECEMBER 1983

Registered by Australia Post — Publication No. VBH 0569

JOURNAL OF THE WIRELESS INSTITUTE OF AUSTRALIA



*Merry Christmas  
to all*



# ADVANCED ELECTRONIC APPLICATIONS

## Computer Patch™ Interface CP-1

Now you can easily convert your personal computer and transceiver into a full function RTTY station with the new CP-1 Computer Patch™ interface by AEA and appropriate AEA software and cabling. The CP-1 is a professional quality RTTY/CW terminal which cuts no corners on sensitivity, selectivity, and reliability. Software packages include split screen operation and large type-ahead and message (brag) buffers at all the common RTTY and CW speeds.



The CP-1 Computer Patch™ is easy for an inexperienced RTTY operator to hook up and operate, but will still appeal to the more experienced and sophisticated RTTY user. The CP-1 is a moderately priced, high performance, feature packed unit, which utilizes reliable innovative design in the style you have come to expect from Advanced Electronic Applications. It is priced competitively with other popular units, but includes many extras not offered by them.

With the tremendous price drop in personal computers, your total system cost is far below that of dedicated RTTY/CW systems which offer few, if any, additional features. No computer programming knowledge is required to use the CP-1 with your computer and you will still have the opportunity to use your personal computer for a variety of unrelated functions.

The CP-1 demodulator provides greatly improved performance compared to popular single channel RTTY detectors. An easy to use AEA magic-eye bargraph tuning indicator gives the closest thing to scope tuning, but separate Mark/Space scope output jacks are also provided. A state-of-the-art multi-usage active filter is incorporated offering pre and post limiter filtering. Floating comparator (automatic threshold) circuits give the best possible copy under fading and weak signal conditions.

Additionally, the CP-1 offers a variable receiver shift capability for any shift from 100 to 1000 Hz with a NORMAL/REVERSE tone selector switch on the front panel.

A function generator chip is utilized for clean, stable sine wave AFSK tone output to the

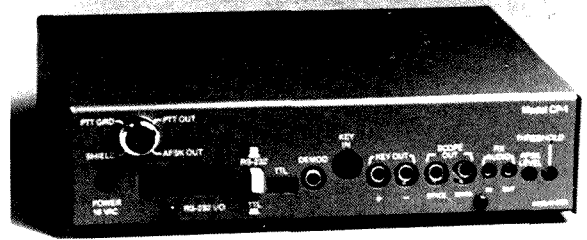

transmitter. Both plus (+) and minus (-) keyed output jacks are provided for CW keying of virtually any popular transceiver. Automatic transmit/receive switching is available under computer control or from a front panel manual transmit button. Output and computer control signals are available in the usual TTL levels (or RS-232 format with an optional low cost RS-232 kit).

Power requirement for the CP-1 is 16 VAC. The CP-1 Computer Patch™ is housed in an attractive all-metal enclosure with extensive R.F. filtering for minimal R.F. susceptibility or radiation, far exceeding Part 15, subpart J, FCC requirements. The CP-1 measures 10" wide x 2¾" x 8¼" deep and weighs approximately 1½ pounds.

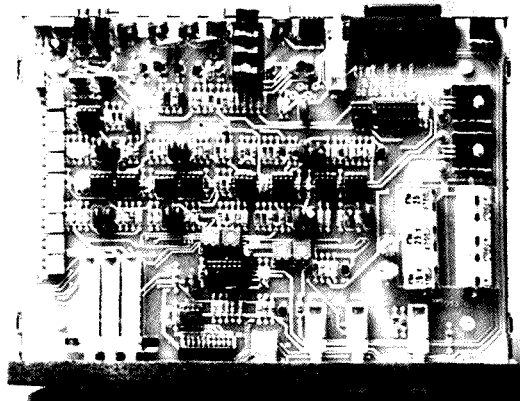

Computer Patch CP-1	\$375 plus P&P
CP-1 240/12VAC Power Supply	\$16 plus P&P
Software - VIC-20 (RTTY only)	\$42 plus P&P
Apple (RTTY-CW-ASCII)	\$55 plus P&P
VIC-20 (RTTY-CW-ASCII)	\$123 plus P&P
Commodore 64 (RTTY-CW-ASCII)	\$123 plus P&P

# Hy-Tech DISTRIBUTORS

Building 51, Archerfield Aerodrome, Qld. 4108 Australia  
P.O. Box 136, Archerfield, Qld. 4108 Australia.

Telephone: (07) 275 3030 Telex: AA43318 RADSEN  
(07) 277 5624



Registered Office:  
3/105 Hawthorn Road,  
Caulfield North 3161.  
Tel. (03) 528 5962



# AMATEUR RADIO



No! It isn't Nipper but Timbo the second op at VK5QV. See article page 13.

## FEATURES

1983 Index	42
A Tricky Calculation? by Ron Cook VK3AFW	38
Amateur Abbreviations	37
Another Country by Alan MacLean VK3ASL	23
Bill Blitheringwit & the Blackout by Ted Holmes VK3DEH	36
DX — Who Pays? by Neil Penfold VK6NE	29
Microprocessor Controlled Antenna System by Ralph Birrell VK3BIP	20
Morse Code & Your Computer by Alan MacLean VK3ASL	32

## EDITOR

GIL SONES\* VK3AUI

## TECHNICAL EDITORS

RON COOK\* VK3AFW  
PETER GAMBLE\* VK3YRP  
EVAN JARMAN\* VK3ANI  
BILL RICE\* VK3ABP

## CONTRIBUTING EDITORS

MIKE BAZELY VK6HD  
RON COOK\* VK3AFW  
REG DWYER VK1BR  
BRENDA EDMONDS VK3KT  
MARSHALL EMM VK5FN  
RON FISHER\* VK3OM  
BRUCE HANNAFORD VK5XI  
ROY HARTKOPF\* VK3AOH  
ROBIN HARWOOD VK7RH  
COLIN HURST VK5HI  
ERIC JAMIESON VK5LP  
MARGARET LOFT VK3DML  
KEN McLACHLAN VK3AH  
LEN POYNTER\* VK3BYE  
TONY TREGALE VK3QQ

Multi-Pin Plugs for Surplus Gear by John Hassell VK6ZGF/NXX	28
November's Best Photographs	67
Regulations & Standards for the New Radio Communications Act	51
Reminiscing & Reality by Leo Weller VK3YX	51
Russian for English Speaking Amateurs by Ian Forster VK3ST	30
Square-Two Converter by Drew Diamond VK3XU	24
Station Control Panel — Not a Weekend Project by Ivan Huser VK5QV	14

## DEPARTMENTS

A word from your Editor	12
Advertisers Index	80
ALARA	59
AMSAT Australia	60
Awards — Pioneer Shire Centenary & Gold Coast ARS award	69
Behind the Mike & Key — F6CVR & WB3CON	54
Book Review — Amateur Radio & Electronics Study Guide, Beginners Guide to AR	50
Club Corner	70
Contests — VK/ZL QSO Party & RTTY results, Rules for 40, 75 & 160 m tests & RTTY	62
Education Notes	69
Equipment Review — Kenwood R-2000 Receiver	16
Equipment Review — Parameters 7040 Digi Multimeter	22
Five-Eighth Wave	72
Hamads	79
Here's RTTY! FSK	66

How's DX	52
International News	44
Intruder Watch	67
Ionospheric Predictions	76
Letters to the Editor	74
Magazine Review	49
National EMC Advisory Service	68
Novice Notes — Build a Better Balun	48
Obituaries — VK5MO, VK2AIS, VK2MT, VK4AQ & Mrs Gene Trebilcock	79
Pounding Brass	64
Presidential Comment	13
QSP	33, 39, 65 & 75
Service Bulletin — Modification for SX200N	31
Silent Keys — VK2GI	79
Spotlight on SWLing	55
Thumbnail Sketches — VK4XN	54
Try This — The Microwave Oven Test by John Hassell VK6ZGF/NXX	21
VHF UHF — an expanding world	56
VK2 Mini Bulletin	72
VK4 WIA Notes	73
Who is this Amateur?	18
WIA News	12
WICEN News — Report on Disaster Communications Study	65

## DEADLINE

All copy for February AR must arrive at PO Box 300, Caulfield South, Vic 3162 at the latest by the 3rd January, 1983.

## DRAFTING

GEORGE BROOKS  
LIZZ KLINE

## BUSINESS MANAGER & SECRETARY

REG MACEY

## ADVERTISING MANAGER

JOHN J A HILL VK3WZ

\*Member of Publications Committee

## Enquiries and material to:

The Editor  
PO Box 300, Caulfield South Vic. 3162  
Material should be sent direct to PO Box 300, Caulfield South Vic., 3162, by the 25th of the second month preceding publication. Phone: (03) 528 5962. Hamads should be sent direct to the same address.  
Acknowledgement may not be made unless specially requested. All important items should be sent by certified mail. The editor reserves the right to edit all material, including Letters to the Editor and Hamads, and reserves the right to refuse acceptance of any material, without specifying a reason.

Trade Practices Act: It is impossible for us to ensure that advertisements submitted for publication comply with

the Trade Practices Act 1974. Therefore advertisers and advertising agents will appreciate the absolute need for themselves to ensure that the provisions of the Act are complied with strictly.

Victorian Consumer Affairs Act: All advertisers are advised that advertisements containing only a PO Box number as the address cannot be accepted without the addition of the business or residential address of the box-holder or seller of the goods.

## Production: BETKEN PRODUCTIONS

5 Masefield Avenue, Mooroolbark, 3138.

## Laser Scanned Colour Separations by:

QUADRICOLOR INDUSTRIES PTY LTD,  
Graphic Division  
22-24 Glenvale Crescent, Mulgrave, 3170.  
Tel.: (03) 560 2222

## Typesetting by: QUADRICOLOR INDUSTRIES PTY LTD.

22-24 Glenvale Crescent, Mulgrave, 3170.  
Tel.: (03) 560 2222

Photographic film and processing material courtesy  
AGFA-GEVAERT LTD AUSTRALIA

## Printers: WAVERLEY OFFSET PUBLISHING GROUP

Geddes Street, Mulgrave, 3170  
Tel.: (03) 560 5111



OVER 33,000  
CHANNELS

# JIL SX-200



JIL  
REGD TM

Monitor thousands of frequencies including the AIRBAND and Australian Low-band.

Now available. 32 Memories and auto AM on CB/MARINE and AIRBAND.

NEW RANGE OF ACCESSORIES See over.

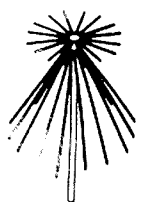
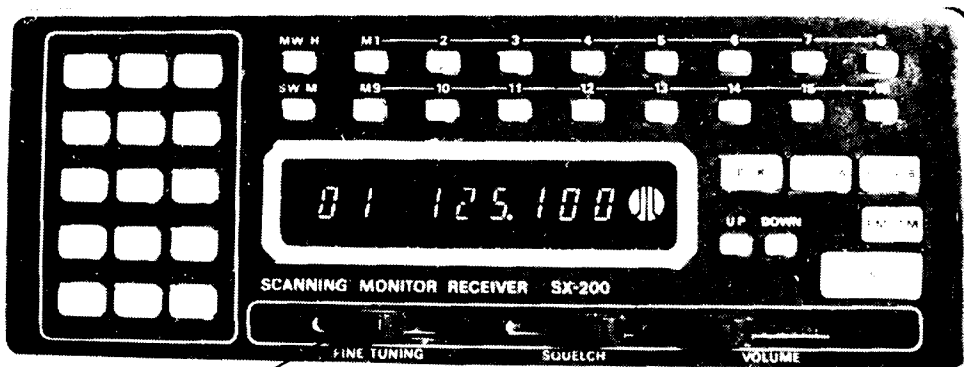

A range of accessories is available including Broadband or High Gain BASE Antennas.

FINE TUNING for coverage of all Australian channels on VHF Low.

## THE ONLY SCANNER THAT GOES 26-88, 108-180 & 380-514 MHz

### SPECIFICATIONS

- Type: FM & AM
- Frequency Range: a) 26-57.995 MHz Space... 5 kHz  
b) 58-88 MHz Space... 12.5 kHz  
c) 108-180 MHz Space... 5 kHz  
d) 380-514 MHz Space... 12.5 kHz
- Sensitivity: FM a) 26-180 MHz 0.4µV S/N 12 dB  
b) 380-514 MHz 1.0µV S/N 12 dB  
AM a) 26-180 MHz 1.0µV S/N 12 dB  
h) 380-514 MHz 2.0µV S/N 12 dB
- Selectivity: FM More than 60 dB at -25 kHz  
AM More than 60 dB at -10 kHz
- Dimensions: 210 (W) x 75 (H) x 235 (D) mm  
8-1/4 (W) x 3-1/4 (H) x 9-1/8 (D) In.
- Weight: 2.8 Kgs.
- Clock Error: Within 10 sec./month
- Memory Channel: 16 Channels
- Scan Rate: Fast ..... 8 Channels/sec.  
Slow ..... 4 Channels/sec.
- Seek Rate: Fast ..... 10 Channels/sec.  
Slow ..... 5 Channels/sec.
- Scan Delay: 0, 3 or 4 seconds
- Audio Output: 2 Watts
- Ant Impedance: 50-75 ohms  
Whip or External Antenna with LO/DX Control (20 dB ATT.)
- Freq. Stability: 26-180 MHz ... Within 300 Hz  
380-514 MHz ... Within 1 KHz

The JIL SX-200 represents the latest STATE-OF-THE-ART technology in the development of Scanning Monitor Receivers. It has many features that previous have not been available on receivers of its type.

For example the tremendous frequency coverage, which encompasses all of the following bands:— HF & UHF CB, 27 & 155MHz MARINE, Australian LOW BAND, AIRCRAFT band, VHF SATELLITE band, 10Mx, 6Mx, 2Mx and 70CMx AMATEUR, VHF HIGH BAND and UHF TWO-WAY band — as well as many others. Other features include detection of AM or FM on all bands. Squelch Circuitry that can be used to LOCK OUT carrier only signals. Fine Tuning control for off channel stations, 240 VAC plus 12VDC operation. Squelch Operated Output that may be used to trigger a tape recorder or channel occupancy counter and accurate Quartz Clock.

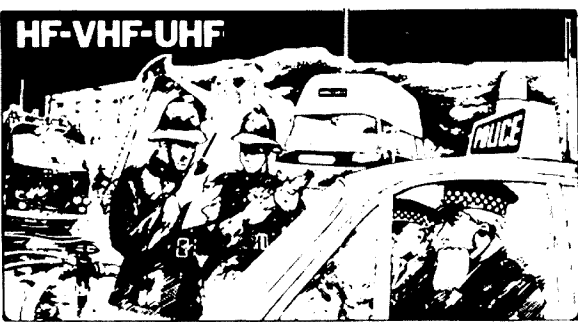

**\$599**



plus \$10  
P & P

### ACCESSORIES

- Service Manual \$12 + \$2 P & P
- Scan-X Base Antenna \$62 + \$10 P & P

# JIL SX-200

## A BETTER SCANNING MONITOR RECEIVER

### HIGH QUALITY AND PERFORMANCE

JIL have designed the SX-200 as a high quality, high performance programmable scanning receiver at a realistic price, design criteria which are not born in many other receivers of its type.

### MECHANICALLY RUGGED

The JIL SX-200 is ruggedly built using EPOXY-GLASS printed circuit board and double sided through hole plating techniques. Easy access and servicability is maintained throughout its design.

### 4 BIT MICROPROCESSOR WITH ONBOARD ROM AND RAM

A powerful 4 Bit PMOS Microprocessor, the uPD553, is used as a controller in the SX-200. Its features include 2000 x 8 ROM and 96 x 4 RAM onboard as well as up to 80 instructions with a 3 level subroutine stack.

### EXTREMELY LOW SPURIOUS COUNT

Even though the SX-200 covers over 33,000 Channels JIL, through careful design, have been able to reduce the number of internally generated spurious signals to an extremely low level. Not the case in most other scanning receivers.

Monitor thousands of frequencies including many Military & Civil

**HF-VHF-UHF**



### FULLY TRACKED RF AMPLIFIERS

The SX-200 makes use of 3 separate RF Amplifier Stages. They are divided into 6 bands, each band having its own electronically switched coils which are fully tracked with the receiver frequency using Varicap Diodes. Maximum performance is thus gained over the entire operating range of the set.

Rugged double sided epoxy glass circuit board.

2K Cmos RAM

Crystal and ceramic I.F. filters.

4 Bit Micro-processor.

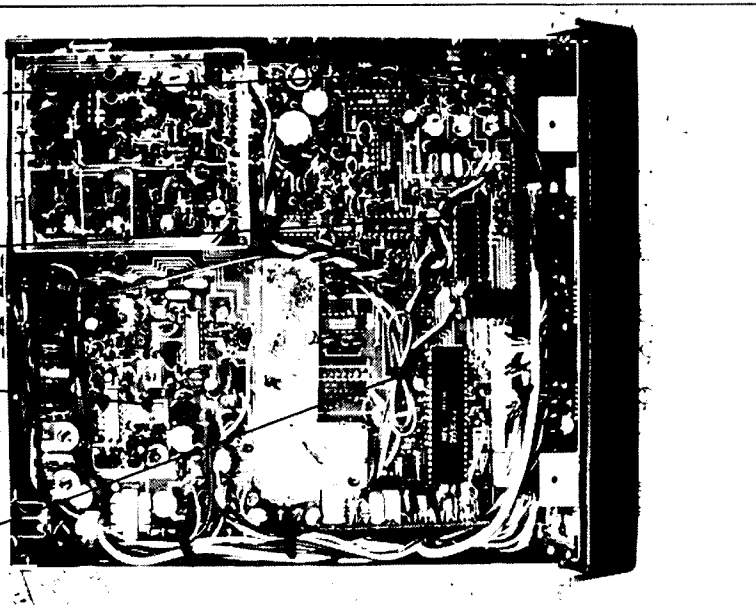

**SX-200, RUGGED CONSTRUCTION AND EASY SERVICABILITY.**

### NEW

### ACCESSORIES

#### ■ EXP-32 KIT

Increase the memories of your SX-200 to 32 with this memory expander kit  
\$53 + \$2 P & P

#### ■ A4-AM KIT

Provides automatic AM operation on the 27 MHz CB MARINE and AIRCRAFT bands.  
\$32 + \$2 P & P

#### ■ CVR-1B CONVERTER

allows your SX-200 to cover 180 to 380 MHz (incl. SPACE SHUTTLE frequencies).  
\$199 + \$5 P & P

#### ■ CVR-2 CONVERTER

allows your SX-200 to cover the SHORT WAVE bands, 0.55 to 30 MHz.  
\$189 + \$5 P & P

#### ■ MFJ-332 VLF CONVERTER

allows your SX-200 to cover 5 KHz to 1600 HKz  
\$144 + \$5 P & P

### AVAILABLE FROM

W.A.: Letco Trading Co. (09) 387 4966, N.S.W.: Emtronics (02) 211 0531, QLD: CW Electronics (07) 397 0808, S.A.: Jensen Intersound (08) 269 4744. Plus many other regional outlets, contact CES for your nearest stockist.



## GFS Electronic Imports

17 McKeon Road, Mitcham, Victoria, 3132  
PO Box 97, Mitcham, Victoria, 3132 Phone: (03) 873 3939, 873 2652  
Telex: GFS AA 38053 Cable: "Comimports" Melbourne

# TELEREADER MOVING SALE

Yes, now you can take it with you! The new CWR-685E Telereader is the smallest RTTY and CW terminal available, complete with CRT display screen. Stay active with your RTTY and CW friends even while travelling. Some of the outstanding features of the CWR-685E are:

- Send and receive ASCII, Baudot, and Morse code.
- RTTY and Morse demodulators are built-in.
- RTTY speeds of 45, 50, 57, 74, 110, and 300 Baud.
- High or Low RTTY tones.
- Send and receive CW at 3 to 40 WPM.
- Built-in 5 inch green CRT display.
- Four page video screen display.
- Six programmable HERE IS messages.
- Pretype up to 15 lines of text.
- External keyboard included.

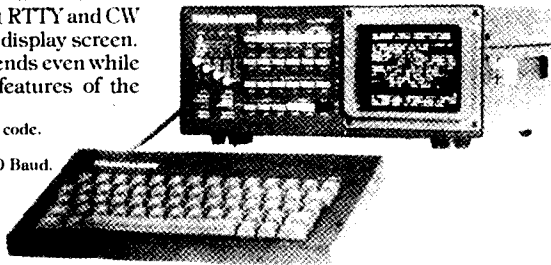

As from 1st DECEMBER, 1983 WE SHALL BE LOCATED AT:  
758 George Street, Sydney, NSW 2000 (Next to Radio House)  
Phone: 211 0531

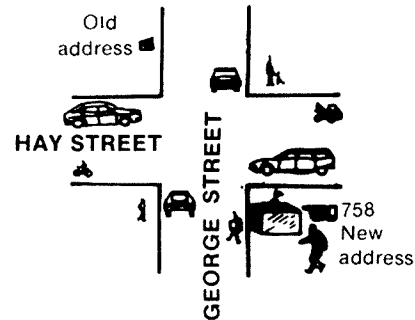

## AZDEN the FM KING

PCS-4000

\$459



- 8 MHz COVERAGE. CAPMARS BUILT IN: 142.000-149.995 MHz in selectable steps of 5 or 10 kHz - COMPARE!
- TINY SIZE: Only 2" H x 5.5" W x 6.6" D. COMPARE!
- MICROCOMPUTER CONTROL: At the forefront of technology.
- UP TO 8 NON-STANDARD SPLITS Ultimate versatility for CAPMARS. COMPARE!
- 16-CHANNEL MEMORY IN TWO 8-CHANNEL BANKS: Retains frequency and standard offset.
- DUAL MEMORY SCAN: Scan memory banks either separately or together. COMPARE!
- TWO RANGES OF PROGRAMMABLE BAND SCANNING: Units are quickly reset. Scan the two segments either separately or together. COMPARE!
- FREE AND VACANT SCAN MODES: Free scanning stops 5 seconds on a busy channel. Vacant scanning stops on unoccupied frequencies.
- DISCRIMINATOR SCAN CENTRING (AZDEN EXCLUSIVE PATENT): Always stops on frequency.
- TWO PRIORITY MEMORIES: Either may be instantly recalled at any time. COMPARE!

JRC:JST-100  
Only After You Have  
Seen Everything Else -  
Come and See the  
Fantastic JST!

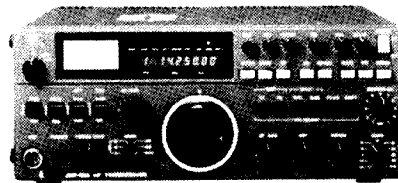

\$1745

The JRC Model JST-100 HF transceiver is a new digitally synthesized, microcomputer based transmitter/receiver. It incorporates an U-channel memory and two digital variable frequency oscillators, allowing various types of operation in all amateur bands in the emission modes of A3J, A1 and F1. The JST-100 is designed for compact and lightweight construction and ease of operation.  
*Write For Brochure*

GO SSTV with the New  
Stock...

ALINCO EC-720  
SSTV

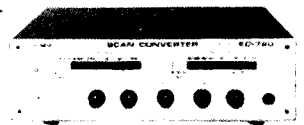

Solid State - Send and Receive clear pictures - Write for Specs.

Only \$799

RF NOISE BRIDGE  
New FROM  
EMTRON



\$89

EMB-1, the professionally made noise bridge for all kinds of RF measurement.  
EMB-1, the best investment in your shack!  
Adjustments of single and multi-band dipole, inverted vee, beam, vertical, mobile whip or random system for maximum performance.  
Range extender, expanded capacitance range (150pF).  
Other uses: tune antenna tuners, adjust tuned circuits, measure inductance, capacitance, RF impedance, baluns, transformers, electrical circuits, velocity factor, impedance of coax, etc.

## PCS-300 - The Standard For Comparison \$359



- 8 MHz Coverage
- Ideal size and weight distribution.
- LCD Display with timed lamp
- 16 Key Autopatch
- PL Tone Switch
- Programmable "odd splits"
- 9 Channel memory with scan
- Automatic inclusive or exclusive programmable band scan
- Busy and vacant scan modes
- Keyboard lock
- Transmit lock
- Digital S/Rf and memory address meter
- High or low power
- True FM
- Automatic front end tuning
- Rugged commercial-grade modular construction
- Superior receiver
- BNC Antenna connector

WE ARE AUTHORISED  
DEALERS FOR:  
KENWOOD, YAESU, ICOM, etc.  
SEE US FOR BEST PRICES  
AND SERVICE

## NEW HAL SYSTEMS

### SYSTEM I

This is the top-of-the-line HAL combination for the serious RTTY enthusiast. It is composed of the MPT3100, ST6000, DSK3100, and optional printer. HAL can supply cable set C-1 to connect this system to your transceiver. Put System I in your shack for the finest in RTTY operation. The ARQ1000 may be added for use in AMTOR or ARQ applications.

### SYSTEM II

This is the attractive and versatile CT2200 system from HAL, which includes the ARQ1000, KB2100, KG12 monitor, RS2100, and optional printer. This combination offers a unique set of features at a reasonable price for the radio amateur or shortwave enthusiast. Cable set C-2 interfaces this system to your transceiver. Complement your shack with this extremely versatile system from HAL.

WRITE FOR YOUR NEW HAL  
CATALOGUE AND PRICES

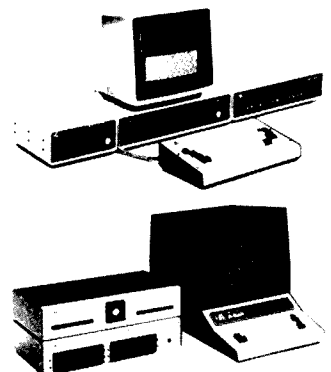

 **emtronics**

CORRESPONDENCE & MAIL ORDERS:  
Box K21, Haymarket, NSW. 2000. Australia.  
WRITE, PHONE OR CALL IN!

# CALLING ALL SWLs!

Besides our extensive range of SWL Accessories, such as Active Audio Filters, Pre-selectors, Active Antennas, etc., we ALSO carry Antenna Tuners for Shortwave and Communications Receivers to improve the reception and efficiency of your receiving system.

## MIZUHO: SX-3 PRE-SELECTOR



\$120

IS YOUR RECEIVER OR TRANSCIVER DEAF? THEN THE ONLY SOLUTION IS THE "SX-3" - AN 18dB PRE-AMPLIFIER

## MIZUHO: KX-3 R x ANT. TUNER

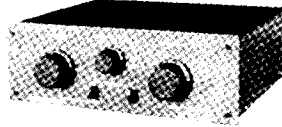

\$99

SWL NOTE! Use an antenna tuner to improve your reception. And increase the sensitivity of your system.

## DATONG- AD 270 \$139 AD370 \$199



ACTIVE RECEIVING ANTENNAS  
MODELS 270 & 370  
ULTRA-COMPACT RECEIVING ANTENNA SYSTEMS GIVING WIDEBAND COVERAGE FROM 200kHz to 30MHz AT HIGH SENSITIVITY.

## NOW YOU CAN RECEIVE: CW, RTTY, ASCII, TOR, SITOR, AMTOR WITH THE NEW INFOTECII-M600A

\$1390

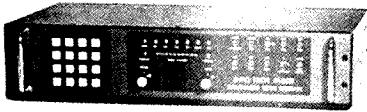

## SPECIAL FOR SWL - THE NEW TELEREADER CWR 670 E



\$465

CWR-670E Telereader Receive Only  
The compact, multi-mode CWR-670E Receiver operates conveniently with display and/or printing equipment.

## THE ECONOMY SWL CODE CONVERTER- TELEREADER CWR 610 E

\$265

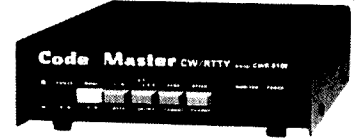

The most compact terminal CWR-610E receives CW/RTTY/ASCII code.

## DRAKE R7A COMM. RECEIVER

\$2350



- CONTINUOUS NO COMPROMISE 0 to 30 MHz frequency coverage.
- Full passband tuning (PBT).
- New! NB7A Noise Blanker supplied as standard.

## JRC-NRD 515 COMM. RECEIVER

\$1795

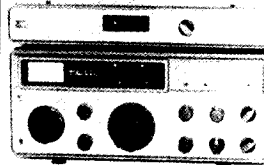

THE INTELLIGENT COMMUNICATION RECEIVER

## ICOM-R70 COMM. RECEIVER

\$699

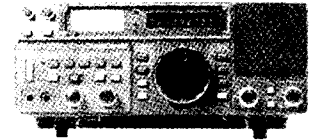

THE IDEAL RECEIVER FOR HAMMING & SWLING

## KENWOOD-R2000 COMM. RECEIVER

\$650



SSB, CW, AM, FM, digital VFO'S, 10 memories, memory and band scan, dual 24-hour clocks. . .

## THE WOODPECKER IS DEATH NEW DATONG AUTO. WOODPECKER BLANKER \$220



## NEW DATONG AUTO AUDIO NOTCH FILTER \$189



Plus CW filter. Clears tune-up whistle from SSB automatically.

ANTENNA BALUNS	
KAUFMAN, 1:1, 2kW for dipoles	\$29
HOKUSHIN HS-50B, 1:1, 2kW for dipoles	\$32
WELZ DP-BU5 BU7, 1:1, 2kW for beams	\$32
SCALAR 4:1, 2kW for beams & dipoles	\$49
SCALAR 1:1, 2kW for beams & dipoles	\$49
EMTRON EBL 300 4:1, 300W for ant.	
tuners	\$19
EMTRON EBL 1000 4:1, 1000W for ant.	
tuners	\$33
EMTRON EBL 2000 4:1, 2000W for ant.	
tuners	\$44
DUMMY LOADS	
TOYO T25, 25W, 200MHz	\$19
TOYO T100, 100W, 200MHz	\$69
TOYO T200, 200W, 200MHz	\$89
WELZ CT15A, 15W, 450MHz	\$22
WELZ CT15N, 15W, 450MHz	\$29

WELZ CT150, 150W, 450MHz	\$85
WELZ CT300, 300W, 250MHz	\$110
ANTENNA ROTATORS	
KR-250 light duty rotator	\$115
KR-400 medium duty rotator	\$149
KR-600RC medium duty rotator	\$259
KR-500 heavy duty rotator	\$459
KR-500 elevation rotators	\$195
KR-050 stay bearing	\$39
8 core rotator cable	\$0.95/metre
SWR & POWER METERS	
SP-600	\$199 + \$10 Post
SP-300	\$185 + \$8.50 Post
SP-350	POA
SP-15	\$68 + \$6.50 Post
SP-45M	\$104 + \$6.50 Post
SP-250	POA
TP-20G	\$269 + \$8.50 Post

TP-05X	\$31 + \$4 Post
RW-151D	\$199 + \$8.50 Post
CN-520	\$79 + \$4 Post
CN-540	\$89 + \$4 Post
CN-550	\$109 + \$6 Post
CN-720	\$185 + \$6 Post
COAXIAL SWITCHES	
TOYOSA-450, 2pos, 2kW, 500MHz	\$26
WELZ CH-20A, 2pos, 2kW, 900 MHz	\$39
WELZ CH-20N, 2pos, 2kW, 1300MHz	\$59
DAIWA CS-201, 2pos, 2kW, 500MHz	\$29
DAIWA CS-401, 4pos, 2kW, 500MHz	\$99
FILTERS	
DRAKE TV 3300 LP filter	\$45
MONITOR TV: HP30 HP filter	\$29
TET HF ANTENNAS	
HB-338P 3el, 3 band beam	\$325
HP-34D 4el, 3 band beam	\$359

HB-35C 5el, 3 band beam	\$439
MV-5BH 6 band vertical	\$179
MV-3BHR 3 band vertical	\$145
TE11F3J 3el, 11m broad band beam	\$97
TE11F5J 5el, 11m broad band beam	\$159
WHITE PORCELAIN - Two Types	
• DOG BONE TYPE, 70mm long	\$1.50
• EGG TYPE	\$1.00
OPEN WIRE TRANSMISSION LINES INSULATED 450 OHM Brown Polyethylene	
AWG Size: 18 Conductor: Solid BCW Norm.	
O.D. 075 x 925	
COAXIAL CABLES	
50 OHM HEAVY DUTY TYPES RG8/U Low Loss	
Loss 10D-2V Extra Low Loss UHF RG-58/U Low Power	
75 OHM TYPE 7C-2V Heavy Duty Low Loss for Dipoles, Inverted "V" etc. This is not a TV cable.	

**emtronics**

CORRESPONDENCE & MAIL ORDERS:  
Box K21, Haymarket, NSW, 2000, Australia.  
WRITE, PHONE OR CALL IN!



**\$2099**

**KENWOOD**

SEE DEALERS  
ON OPPOSITE  
PAGE



**NOTICE TO ALL HAMS**

To comply with the new Government regulations the TS-430S will be known as the TS-43X and the TS-930S Mark II will be known as the TS-93X Mark II

These are not new world models and are for Australian sales only.

The performance and features are identical to the present model numbers and the only difference is that the out-of-Amateur band transmissions are no longer possible. However the Receiving section is totally unchanged.

All equipment capable of transmitting outside of the Amateur Bands rate a 30% duty and this equipment is not in the spirit of Amateur Radio.

**TS-93X MARK II**

The ultimate in HF transceivers. General coverage receiver. Amateur band transmitter.

**\$1100**

usually \$1150

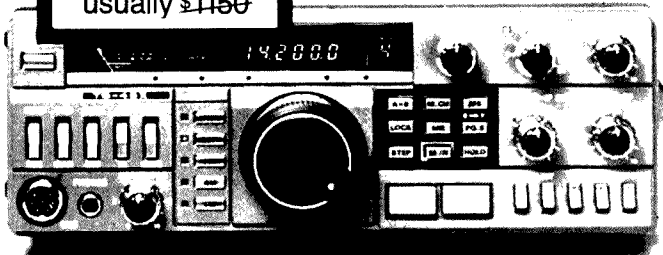

**TS-43X HF TRANSCEIVER**  
Complete with MB-430 and MC-42S

**PLEASE NOTE**

Due to a shipping problem the TR-9500 was not available in November but will be available from mid-December. Also production delays on the AT-230 mean stocks will not be available until after January 1984. All orders placed during the Summer Sizzlers Sale will be honoured at that price for delivery in early February.

**NEW INEXPENSIVE  
BASE STATION  
TS-530SP**

NOW WITH NOTCH FILTER & BUILT-IN AC POWER SUPPLY.

The TS-530SP HF transceiver has all the features of TS-530S but with improvements and the very latest in circuit technology.

**IMPROVED  
MODEL**

**\$950**



**JUST  
RELEASED**



**KENWOOD**

The Dealers and Staff of  
**TRIO-KENWOOD (AUSTRALIA) PTY. LTD.,**  
wish you all a very merry, happy and safe  
Christmas and a prosperous New Year

## SUMMER SIZZLER SPECIALS

CHECK THE NOVEMBER ISSUE OF AMATEUR  
RADIO FOR 6 PAGES OF SUPER DEALS.

REMEMBER THESE LOW PRICES ARE ONLY AVAILABLE  
UNTIL 31-1-84 OR TILL STOCKS ARE SOLD.

**TRIO-KENWOOD (AUSTRALIA) PTY. LTD.**  
(INCORPORATED IN N.S.W.)  
4E WOODCOCK PLACE, LANE COVE, SYDNEY, N.S.W. 2065.  
Ph. (02) 428 1455.

Further, beware of dealers not listed in this advertisement who are selling Trio-Kenwood communications equipment. All Kenwood products offered by them are not supplied by Trio-Kenwood (Aust.) Pty. Ltd. and have no guarantee applicable.

### NEW SOUTH WALES

TRIO-KENWOOD (AUST.) P/L — 4E WOODCOCK PLACE, LANE COVE (02) 428 1455  
EMTRONICS — 758 GEORGE STREET, SYDNEY (02) 211 0531  
SPRINGWOOD CAR RADIO — SPRINGWOOD (047) 51 4930  
UNIQUE ELECTRONICS — 41B OLD PROSPECT ROAD STH. WENTWORTHVILLE (02) 631 6689  
WASSIL ELECTRICAL — 71 SUMMER STREET, ORANGE (063) 62 6249  
STOCKMAN & HIGGINS — BYRON STREET, INVERELL (067) 22 1300  
ELECTRON 2000 — 3 ELIZABETH STREET, TIGHES HILL, NEWCASTLE (049) 69 6399  
MACELEC PTY. LTD. — 99 KENNY STREET, WOLLONGONG (042) 29 1455  
RADIO WORLD PTY. LTD. — 81 NEWCASTLE STREET, Fyshwick (062) 80 6550  
E&K COMMUNICATIONS — 14 DUTTON STREET, DICKSON A CT (062) 49 6437  
DX ENGINEERING — 5 JASMINE STREET, PORT MACQUARIE (065) 83 2175  
LAND LINK — MULLALEY ROAD, GUNNDAH (067) 42 2838  
LAND LINK — 61 BARNES STREET, TAMWORTH (067) 65 4622  
FRANK BOUNDY — LISMORE (066) 86 2145

### INTERSTATE

VIC: EASTERN COMMUNICATIONS — 168 ELGAR ROAD, BOX HILL (03) 288 3107  
BRIAN STARES — 11 MALMSBURY STREET, BALLARAT (053) 39 2808  
SUMMER ELECTRONICS — 78 KING STREET, BENDIGO (054) 43 1977  
TAS: HOBBY ELECTRONICS — 477 NELSON ROAD, MT NELSON (002) 23 6751  
GELSTON ELECTRONICS — SUMMER HILL (003) 27 2256  
WATSONS WIRELESS — 72 BRISBANE STREET, HOBART (002) 34 4303  
ADVANCED ELECTRONICS — 5A THE QUADRANT, LAUNCESTON (003) 31 7075  
MARINE & COMMUNICATION — 19 CHARLES STREET, LAUNCESTON (003) 31 2711  
V K ELECTRONICS — 214 MOUNT STREET, BURNIE (004) 31 7733  
QLD: MITCHELL RADIO CO — 59 ALBION ROAD, ALBION (07) 57 6830  
S.A. &  
N.T.: INTERNATIONAL COMMUNICATIONS SYSTEMS PTY LTD — 8 NILE ST. PORT ADELAIDE (08) 47 3688  
W.A.: ARENA COMMUNICATIONS SERVICES — 642 ALBANY HWY, EAST VICTORIA PARK (09) 361 5422  
TRI-SALES — CNR NEWCASTLE & CHARLES STREETS, PERTH (09) 328 4160  
WILLIS ELECTRONICS — 445 MURRAY STREET, PERTH (09) 321 2207  
BAY RADIO — 18 BANKSIA STREET, BUNBURY (097) 21 2236  
RON DENT — 115 PATON ROAD, SOUTH HEADLAND (091) 72 1112  
SELECT TRONIX — TOM PRICE (091) 89 1564  
FORD ELECTRONICS — 209 HANCOCK STREET, DOUBLE VIEW (09) 446 4705

**LOOK AT THE  
LATEST  
FROM YAESU**



**GO ON -  
TREAT YOURSELF  
FOR CHRISTMAS!**

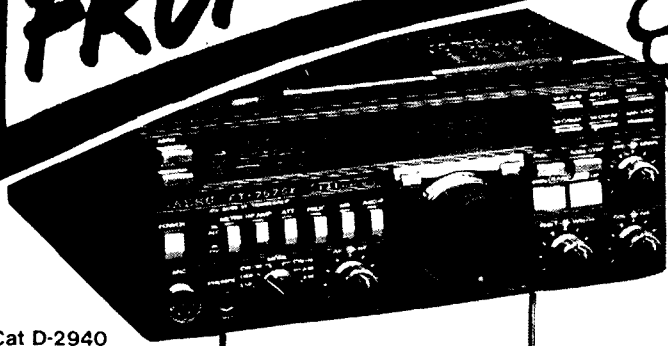

Cat D-2940

**All new, All mode, All powerful . . .  
Computer Aided Transceiver  
FT 757 GX**

Wow! What a transceiver. Everything you could EVER want . . . and then some! Even before its release, Yaesu have over 5000 on back order: that's just from the brochure!

It's the absolute latest state-of-the-art in design - in fact, its CAD/CAM (computer aided design, computer aided manufacture) ensures unbelievable standards of reliability.

**LOOK  
AT THESE  
FEATURES:**

- All mode - including FM with no optional extras
- All HF bands from 160 to 10m including WARC
- General Coverage Receive - 500 to 29.999MHz
- Computer Aided - use with your micro for external control
- Full 100W PEP/DC at 100% duty cycle
- Tiny 238 x 93 x 238mm (smaller than some 2m rigs!)

**NOT \$1399 AS RUMOURED . . .  
NOT EVEN  
\$1199 - ONLY \$999<sup>00</sup>**

**FP 757 GX  
SWITCH MODE SUPPLY**

Neat! Fits under your FT 757 and you'd hardly notice it was there! Designed just for the FT 757, makes your base station really look the part. 240V input.  
Cat D-2941

**\$299<sup>00</sup>**

**FC 757 AT  
Antenna Coupler**

The very latest auto coupler for your 757. Great for mobile & contest use - you can almost work into a piece of wet string!  
Cat D-2942

**\$399<sup>00</sup>**

**FIF 232 C  
RS-232C Interface**

Run your transceiver via your micro. Allows external control of VFO, memory functions, etc. 4800 Baud - so it's fast!  
Cat D-2943

Due in stock next month!  
**\$99<sup>00</sup>**

**STOCKS DUE IN MID  
TO LATE DECEMBER.  
BUT WILL THERE BE  
ANY LEFT FOR YOU?**

*Before  
buying  
elsewhere  
check the  
Dick Smith  
'Invisible  
Extras'*

- ★ We honour Yaesu's 12 month guarantee: beware of others who may only offer you a 90 day warranty!
- ★ We have the largest service centre to back that guarantee! If anything does go wrong with your Yaesu, we can fix it fastest!
- ★ Dick Smith Electronics: Australia's largest supplier and Yaesu factory approved distributor and service centre.
- ★ Dick Smith Electronics have over 40 stores throughout Australia (with more to come!) plus over 200 approved re-sellers. You're never far from friendly help and service!



**AMATEURS:  
CAN YOU MEET  
THE CHALLENGE?**

of a  
**'Home Brew'  
UHF Transceiver**

Remember the good old days of amateur radio? When an amateur built his own gear and was so proud of it! Sadly those days passed! With incredible advances in technology, it became economically and technically impossible to compete with commercially built equipment. **NOW** home brewing is here again! And what's more with the all new Dick Smith UHF Explorer, you'll end up with a transceiver less than the cost of a commercial unit - and not just as good - **better!** YES! A completely up-to-the-minute design featuring phase locked-loop frequency synthesis.

Exclusive to Dick Smith Electronics



Cat K-6300

**\$199**

**SPECIFICATIONS:**

Freq. Cov. 438.025 - 439.000MHz in 25kHz steps  
No. of Channels 40  
Mode of Operation FM  
Supply 13.8v DC Receiver 340mA with full audio output and all options Transmitter 2A more (5 watt output)  
**Receiver**  
Sensitivity 0.4uV for 20dB quieting  
Selectivity +/- 7.5kHz - 6dB  
+/- 15kHz - 60dB  
Better than 80dB  
**Adj Chan Reject**  
**Transmitter**  
Power Output 5W (typical)  
Deviation +/- 5kHz  
Spurious Emissions Better than -60dB

**OPTIONS AVAILABLE**

**Upgrade Kit** (Cat K-6302)  
(Repeater, S meter, additional xtal filter & new front panel)

**ONLY \$24.50**

**UHF Antenna Kit**

Just for your UHF transceiver. Includes deluxe gutter gripper base, UHF co-ax and whip with cutting details. Also suitable for UHF CB.

Cat D-4014

**\$24.50**

**NEW  
70cm Handheld**

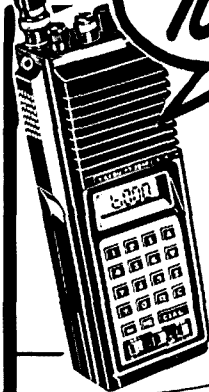

**YAESU  
FT-708R**

Superb hand-held transceiver for those people constantly on the go! Covers full 438-439MHz band in 25kHz steps, with simplex AND standard 5MHz repeater split.

Look at these features:

● 10 memories ● Low 720g weight ● Switchable 200mW/1W output. NiCad battery (and charger!) and rubber duckie whip are included!

Cat D-2930

and it's only

**\$399**

**ECONOMY  
ALL MODE**



**SAVE \$50**

Cat D-2900

THAT'S THE DIRECTLY IMPORTED  
**DICK SMITH SS105S  
HF TRANSCEIVER**

Last chance for a real bargain! All band HF transceiver now reduced to clear - and look at the incredible specs. Where else could you get a transceiver of this type for under \$500? And with optional pcb, it will even do FM (great for 10m and for transverting!). Quick - before they all disappear!

WAS \$549

**\$499**

AMAZING VALUE ONLY

**ACCESSORIES FOR THE SS105S**

**Noise Blanker**

That really works! Minimise most types of pulse noise. Highly recommended for maximum transceiver capability.

**\$29.95**

Cat D-2901

**FM receive IF unit**

FM receive circuit to convert 9MHz to 455kHz and amplify and detect signals; equipped with a built-in squelch circuit.

**\$59.95**

Cat D-2902

**FM transmit IF unit**

IF circuit for FM transmit, consisting of a modulation circuit & IF amplifier.

**\$34.95**

Cat D-2903

**25 kHz monitor**

Plug-in pcb to give 25kHz for accurate calibration.

Cat D-2904

**\$34.95**

**100W Linear Amp**

100W Linear Amplifier. For when you've got that big ticket! Work the world - and more (more?)

Cat D-2905 **\$249**

Phone patching is legal from November 1st! Build your own phone patch and save a fortune... very simple kit, suits most transceivers. Compare our price from built-up units!

**Build your own  
Phone Patch**



Cat K-3054

**\$59.50**

Not Telecom Permitted

**HFC**

WHY NOT USE HFC FINANCE - it's so easy to balance your Xmas budget!  
No repayments until March 1984 (Approved applicants only)



**DICK SMITH  
HAM SHACK**

Dick Smith Ham Shacks are located in the Dick Smith Stores listed below. You'll find a licensed amateur at each Shack.

- Sydney 125 York St 267 9111 ● Sydney 6 Bridge St 27 5051 ● Gore Hill 162 Pacific Hwy 439 5311 ● North Ryde Lane Cove & Waterloo Rds 88 3855 ● Gosford 315 Mann St 25 0235 ● Melbourne 399 Lonsdale St 67 9834 ● Richmond Bridge Rd 428 1614 ● Springvale Springvale & Dandenong Rds 547 0522 ● Brisbane: Buranda 166 Logan Rd 391 6233 ● Townsville Ingham Rd & Cowley St West End 72 5722 ● Toowoomba Bowen & Ruthven Sts 38 4300 ● Adelaide Wright & Market Sts 212 1962 ● Perth William St & Robinson Ave 328 6944 ● Cannington Wharf St & Albany Hwy 451 8666 ● Hobart 25 Barrack St 31 0800 ●

bankcard welcome here

**DICK SMITH Electronics**

All items normally in stock at the 'ham shacks' listed above - other Dick Smith stores may order them for you



One name takes all  
the confusion out of selecting  
a multimeter.

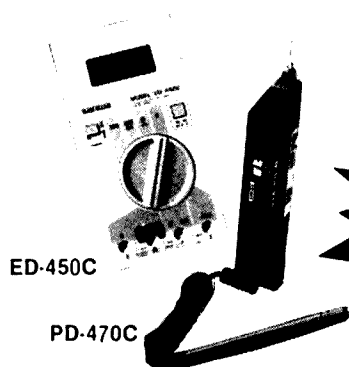

**TWO NEW  
DIGITAL  
MULTIMETERS  
NOW AVAILABLE**

**WARBURTON FRANKI**

A DIVISION OF THE ANI CORPORATION LTD (INCORPORATED IN N.S.W.)

- ADELAIDE (08) 356-7333
- BRISBANE (07) 52-7255
- HOBART (002) 28-0321
- MELBOURNE (03) 699-4999
- PERTH (09) 277-7000
- SYDNEY (02) 648-1711
- AUCKLAND N.Z. (09) 50-4458
- WELLINGTON N.Z. (04) 69-3016



# DO YOUR EYES NEED ATTENTION?



Why Don't You Direct Yourself To One Of Your Big Family?

## OPTILUX Optical Dispensers & Photo Dealers

363 Parramatta Road,  
LEICHHARDT, NSW 2040  
Phone (02) 560 9415

ASK FOR BRUNO VK2BPO

He can arrange an immediate appointment for a complete eye examination without any need of referral

BIG RANGE OF IMPORTED FRAMES — VERY QUICK SERVICE — DISCOUNT FOR ANY AMATEUR OR SWL AND A CAMERA STORE TOO AT COMPETITIVE PRICES AT YOUR DISPOSITION

SEE YOU SOON

*Bruno*  
VK2BPO

# BUTTERNUT ELECTRONICS CO.

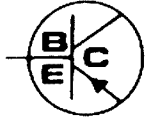

## Still More Usable Antenna For Your Money . . . Plus 30 Metres!

Butternut's new model HF6V\* offers more active radiator on more bands than any other vertical of comparable height. DIFFERENTIAL REACTANCE TUNING™ circuitry lets the 26' antenna work on 80/75, 40, 30, 20 and 10 metres and a loss-free linear decoupler gives full quarter wave unloaded performance on 15 metres. It can also be modified for remaining WARC bands.

- \* Completely automatic bandswitching 80 through 10 metres including 30 metres (10.1-10.15 MHz) — 160 through 10 metres with optional TBR-160 unit.
- \* Retrofit capability for 18 and 24 MHz bands
- \* No lossy traps to rob you of power. The HF6V's three resonator circuits use rugged HV ceramic capacitors and large-diameter self-supporting inductors for unmatched circuit Q and efficiency
- \* Eye-level adjustment for precise resonance in any segment of 80/75 metres, incl. MARS and CAP ranges. No need to lower antenna to QSY between phone and CW bands
- \* For ground, rooftop, tower installations — no guys required

Model HF6V (automatic bandswitching 80-10 metres) . . . \$282

Model TBR-160 (160 metre base resonator)

(When supplied as part of HF6V) . . . \$66

For complete information concerning the HF6V and other Butternut products, amateur and commercial, contact the sole Australian distributor

TRAEGER DISTRIBUTORS (NSW) PTY LTD  
PO Box 348, Moree, NSW. 2400.  
Cnr Adelaide & Chester Sts.  
Phone (067) 52 1627

\* Patented device



# THE WOODPECKER BLANKER

Now sold by mail order to New Zealand, West Germany, Great Britain the Netherlands, Sweden and the U.S.A. (US Patent Pending)

● Available as a kit or fully assembled and tested

● Kit includes fibreglass PCB all components including IC sockets, drilled cabinet and full instructions

**A REAL BARGAIN at \$49 kit and \$75 fully assembled and tested (Plus \$6.50 post and handling)**

— the price has not increased in 18 months — but be warned — 20%

price rise expected from December 15.

● Can be used as both an IF stage blanker and an audio stage blanker.

— as an audio blanker, can be plugged into any receiver or transceiver with no soldering or tinkering required.

— as an IF stage blanker, connects into most existing transceiver noise blankers

## NICHOLLS COMMUNICATIONS

P.O. BOX 246 JAMISON  
A.C.T. 2614 AUSTRALIA  
PHONE (062) 51 4367

Reg Office: 61 Wybalena Gve, Cook ACT 2614

On behalf of our advertisers



WE WISH YOU  
**SEASON'S GREETINGS**

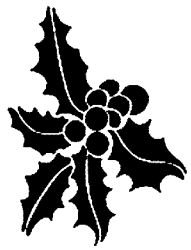



# a word from your EDITOR

## EDITORIAL

The festive season is upon us. Holidays and the Christmas and New Year Festivities are now on everyone's mind.

Many will be thinking of new equipment. Others will be planning portable and mobile operation. Our advertisers have something to suit. Remember to tell them that you saw it in Amateur Radio.

When undertaking mobile and portable operation give a thought for safety. Look up and watch out for power lines when rigging temporary aerials.

Have your extension leads checked. Treat unknown power points with caution. Simple checks may save your life. Some holiday power sources may not be as safe as we have come to expect. A modicum of care and simple checks will keep your holiday happy.

Make this holiday a safe one.

Whilst relaxing and recovering from a hectic 1983 why not write up your premier project. Amateur Radio is always looking for good articles. So take the time and write for your magazine.

I would like to thank the Publications Committee, contributing editors and all contributors for their support during the year. Special thanks also to the staff of the Federal Office and to Betken Productions for all the effort they have put into the production of the magazine.

Last but not least I would like to wish every reader the compliments of the season.

AR



# WIA NEWS

## PHONE PATCHING

The Institute is not happy with the policy currently issued and will be negotiating the details with Telecom.

Below is a precis of the relevant sections.

### 2 CATEGORIES PERMITTED TO INTER-CONNECT

2.1 Radio amateurs operating a fixed or mobile service.

### 4 AUTHORITY TO CONNECT

4.1 For all situations an application for authority to connect will be necessary and would be valid for twelve months.

4.2 When applying for authority, all categories are required to submit documentary evidence of inclusion in para 2.1 above.

### 5 RESALE

5.1 Service that interconnection provides may not be sold, leased or rented.

### 7 RADIO LICENCE

7.1 The radio service to be interconnected and where appropriate must have a licence.

### 8 CHARGES

#### i Call Charges

Natural call rates will be charged.

#### ii Access Charges

Non business telephone service — \$2 per month (per connect point between the radio service and the switched telephone network).

### 9 CONNECTION

The connection of radio equipment as defined will only be permitted via a Telecom provided socket installed exclusively for the purpose. Standard

charges will be applied for installation of the socket.

### 10 TECHNICAL REQUIREMENTS

Equipment used to provide the inter-connect facility must meet the technical requirements of Telecom specifications 1053, 1439, 1302, 1222 and any other specifications that may be produced specifically for this purpose. Details of the equipment will need to be submitted to Telecom for evaluation and a permit for its use issued before it can be considered for use of an authority to connect. Standard charges for evaluation of equipment will apply.

These conditions replace all previous and take effect from 29/9/83.

Naturally, Phone Patch can only be conducted between countries with which Australia has Third Party agreements and Phone Patch facilities.

### LORD HOWE ISLAND

Following representations from the amateur community to DOC, approval has been given for the callsign VK2LHI to be employed by amateur radio clubs or amateur groups engaging in "DX" competitions, for specified limited periods, from Lord Howe Island.

Approval has been given to the Down Under DXers Club to use the callsign VK2LHI during the CQ World Wide DX Contest taking place between 23rd October 1983 and 3rd November 1983. Club station rules apply for the duration of the contest.

### CONVENTION 1984

By the time members read this issue and have recovered from the Christmas holidays,

the next WIA Convention will only be four months away.

Now is the time to bring to the attention of your Division Councils items that you feel need to be discussed at the convention.

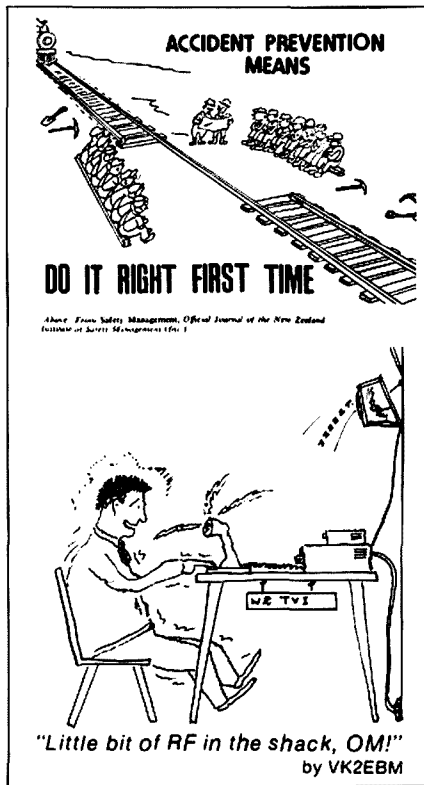

# PRESIDENTIAL COMMENT



## TRADITIONAL CHRISTMAS?

It's that time of the year again, some say "The Silly Season". Children in particular look forward to it. We parents still have vivid memories of last years' Christmas celebrations.

It seems the older we get, the quicker each year seems to pass — something traditional?? One could say that is the price we pay for progress.

Talking of progress, let me reflect on some of the current doings within the Federal Body of the WIA. There are several items on our plate, but two of these require an early "airing" to advise members of our position, while most of you are relaxing and enjoying the holiday festivities, several of your volunteer representatives will be working extremely hard.

Two important items are:

1. *Proposals by Queensland yachtspeople trying to get their foot into the top 50 kHz of the 20 metre band for marine use exclusively.*
2. *Consistent advertising of general coverage transmitting amateur equipment, by an established NSW amateur retailer, and directed towards mariners.*

In both of the above, we are being hampered by articles published in yachting magazines, which condone the use of converted amateur equipment on marine and other commercial frequencies.

This type of activity is not only unethical, it is also illegal to use amateur equipment on marine frequencies.

In my opinion, both of the above items are simply — "not on".

We must be very careful that the power of the "mighty dollar" does not edge its way into the amateur service again.

These continued threats do not enhance relations between the amateur and yachting fraternities. Our complaints are falling on deaf ears, therefore, WE must now be prepared to take action to protect our interests:

- (A) *Closely monitor marine traffic in the amateur bands, particularly 20 metres, (14.313 MHz), then,*
- (B) *Take special note of the joint WIA/NZART statement published in the August issues of AR and Break-In (NZ), and other magazines.*
- (C) *Give consideration to a complete shut down of maritime mobile "traffic nets", except in cases of emergency. (Are they serving any useful "Amateur" purpose??)*
- (D) *Consider a boycott on the retailer(s) who has lined his pockets at our expense, by openly advertising and selling converted amateur transmitting equipment to the yachting fraternity.*

This action alone has been the cause of much frustration, and one of the main reasons for the imposition of the 30% tariff duty.

Make it known to the retailer the reason for the boycott.

The new radio-communications act will assist here, if and when it is finally passed by the Senate. In the meantime, and prior to new regulations being formulated, much harm is being done to the Amateur Service by these parasites.

We therefore must look after our own interests first.

## DON'T FORGET:

Subscriptions for 1984 are now due, please renew promptly to ensure proper continuity.

## A SPECIAL CHRISTMAS NOTE:

Alcohol and cars don't mix — TAKE A TAXI INSTEAD — WE need you TOO!!

A joyous and safe Christmas from Bruce Bathols, VK3UV on behalf of the *WIA Executive*.

AR

# STATION CONTROL PANEL — Not A Weekend Project

Ivan Huser, VK5QV  
7 Bond Street, Mount Gambier, SA 5290



*In this the fourth and final article, I would like to present some ideas for a station control panel and extend the discussion to include some notes on the shack layout.*

My interest in station control panels goes back to an early fascination for the control console associated with broadcasting stations. The panel currently being used at VK5QV is the fifth in a line of such panels which have been constructed over the years and is by far the most complex. This is due in part to the advances made in solid-state electronics and the practicability of packing a lot of electronics into a comparatively small space.

The front of the panel is a standard 19 inch (483 mm) rack and panel width, is 4 3/4 inches (120 mm) high and slopes back from the vertical by about 20°. The panel is positioned centrally under the shelf supporting the HF equipment — see cover photo.

The electronics associated with the control panel is completely shielded in a metal enclosure behind the panel proper. The rear

apron of the enclosure is used for the entry and exit of cables.

Mounted on the apron are two double general-purpose-outlets, a fuse, a key-switch and several sockets. As well as the 240 V, two 12 V regulated supplies and a 9 V regulated supply are brought out. Due to lack of space, most of the connections are made using fly-leads through grommets holes. Shielded compartments are used to isolate the power and audio sections from the rest of the circuitry.

## CONTROLS

Figure 1 shows the placement of controls on the front of the panel.

- 1 Microphone equaliser.<sup>1</sup> The three knobs on the left, control the equalisation of the panel mounted microphone. The fourth knob is a slide switch used to select the

appropriate input to the transceiver — microphone 1, microphone 2, tape recorder, two-tone test signal etc.

- 2 Microphone 1. This is a panel mounted electret microphone permanently connected to the graphic equaliser.
- 3 Microphone 2. This socket is for the connection of an alternative station microphone. The transceiver push-to-talk connections are also brought out to this socket.
- 4 Two-tone oscillator.<sup>2</sup> Frequency, balance and gain controls are brought out.
- 5 Headphone sockets. These sockets are connected so that standard stereo phones can be used. One socket is attenuated such that there is a balance between speaker and headphone volume.
- 6 Digital inside/outside thermometer.<sup>3</sup>
- 7 Speaker switch. This connects the

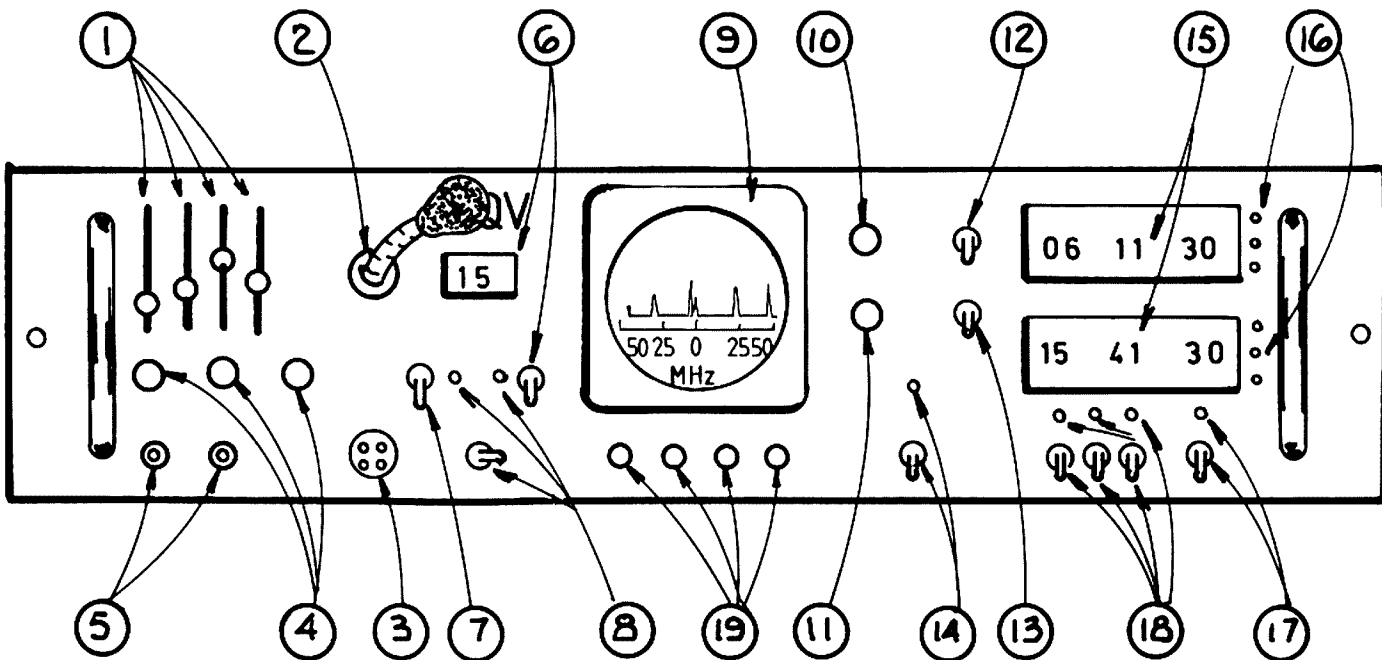
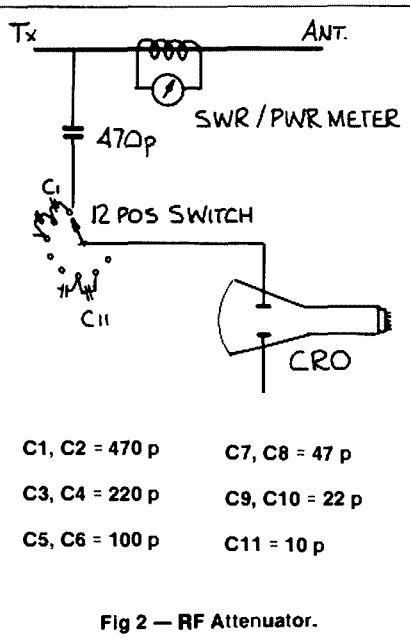

Fig 1 — Panel Layout.

external speaker in parallel with the headphone sockets.

- 8 Beam rotator control. A 'centre-off' type toggle switch is used to control a prop pitch motor via solid state relays. Two light emitting diodes indicate the direction of rotation of the beam. Beam heading is shown on a great circle map located above the equipment.
- 9 Station monitor. This is a copy of commercial 75 mm cathode ray oscilloscope. On receive, it operates as a panoramic monitor using a panoramic adaptor.\* On transmit, it operates as a RF monitor via a capacitive RF attenuator. The time-base has two settings which are automatically selected when going from transmit to receive.
- 10 RF attenuator. See figure 2 for details.
- 11 Display centering. This control centres the panoramic display.
- 12 Tape recorder switch. This allows the tape recorder to be switched between two sources.
- 13 Key select. Either the manual key or the CW keyboard may be selected by this switch.
- 14 Push-to-talk. Moving this switch upwards places the transceiver in the transmit mode. The relay in the transceiver is used to switch on the linear amplifier, a flashing LED above the PTT switch and at the same time select the appropriate time-base rate for the monitor.
- 15 Clocks. Two six-digit clocks showing UTC and local time respectively operate from a single crystal. A battery back-up system maintains correct time during power failures.
- 16 Time setting buttons.
- 17 Main power switch.
- 18 Auxiliary power switches.
- 19 Tape indexing. Although not yet operational, these push-buttons will enable a particular message stored on an endless cassette to be indexed ready for playing. This should be useful for RTTY 'brag' tapes.



## CONSTRUCTION

Although this is by no means meant to be a constructional article, some reference to the problems encountered may be of interest to anyone contemplating such a project.

One major problem associated with such a project of course is the metal-work. Even if one has access to metal-working facilities, the marking out, drilling, filing etc is quite a tedious process.

After the metal-work is completed use a good automotive undercoat before spraying the final colour. I used automotive touch-up lacquer available in spray cans. This produces an excellent finish although rather expensive. My panel is finished in 'Chrysler Mercury Silver' with black rub-on lettering. Plain chrome cabinet handles were fitted to add a professional touch and to allow the unit to be withdrawn from its normal position.

## 'BUGS'

The two main problems encountered with the control system were earth-loops and RF feedback.

Generally speaking, the problem of earth-loops was the easiest to solve. It was simply a matter of earthing the leads between the control panel and the transceiver at one point only — at the transceiver. This means that such things as the headphone sockets and microphones must be insulated from the panel. It may also be necessary to by-pass these floating leads for RF at the point of entry (or exit) to the control panel.

To reduce the possibility of RF feedback, the power flex into the unit should be filtered by passing all three conductors through a ferrite toroid three or four times and then by-passing the individual leads with suitable capacitors. The panel itself should be connected to the station ground via as short a lead as possible.

If RF feedback persists, then the normal procedures for detecting the point of entry of the RF should be adopted and a satisfactory solution effected.

## SHACK LAYOUT

The acquisition of a station control panel allows most of the cables associated with the installation to be routed behind the equipment thus providing an open, tidy, functional operating area.

Also with the equipment raised above the table top, dials and meters are more easily read, and at the same time storage space for

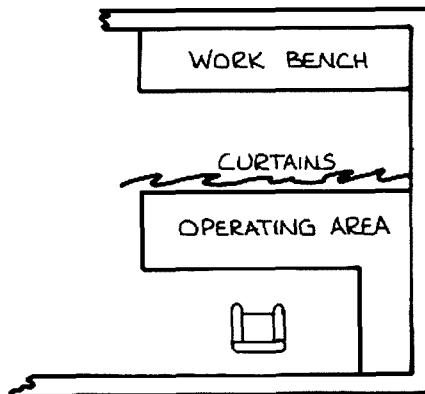

the typewriter, paper or whatever is made available.

Irrespective of how a station is organised, some leads must inevitably be connected to the rear of the equipment making access to them somewhat difficult. This problem may be solved by making the operating table an island.

Figure 3 shows the basic layout of the operating area at VK5QV. Having the work-bench close to the equipment makes maintenance much easier since all inter-connections are close at hand. A curtain attached to nylon runners separates the 'shack' from the 'workshop'.

## FINALE

This series of articles was written in an attempt to show how the writer went about setting up a shack and perhaps to stimulate some ideas among readers. In no way am I saying that 'this is the only way'. For instance, the layout of a shack and the equipment in a shack is an individual thing and to some extent may well be dictated by the amount of real estate assigned by the XYL as 'for amateur radio purposes only'.

## NOTES

- 1 MICROPHONE EQUALISER — A Weekend Project — Amateur Radio November, 1983.
- 2 TWO-TONE OSCILLATOR — ETI July, 1980.
- 3 DIGITAL INSIDE/OUTSIDE THERMOMETER — A Weekend Project — Amateur Radio October, 1983.
- 4 PANORAMIC ADAPTOR — A Weekend Project — Amateur Radio October, 1983.



"I don't do anything much! He calls CQ and answers all the questions."

from 73 Magazine Jan '83

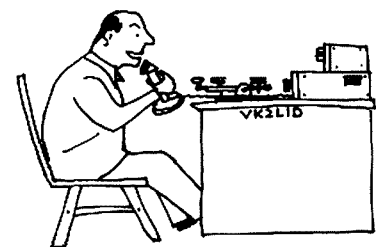

"Verticals?? I had a vertical that was so bad it wouldn't even receive QRM."

by VK2EBM



Ron Fisher VK3OM  
3 Fairview Avenue, Glen Waverley, Vic. 3150

# EQUIPMENT REVIEW

## THE KENWOOD R-2000 GENERAL COVERAGE RECEIVER

Having been a happy owner of an R-1000 now for some years I was most interested to see just what the new R-2000 had to offer. I was not disappointed, it has a lot to offer.

No doubt many present owners of the R-1000 will be considering an update to the 2000 so I am sure that a few comparative comments might be of interest. However lets go back one step before this and look at the evolution of the current model. I am sure many readers will recall the TRIO receivers of the early 1960s. They were single conversion four band valve sets with some-what mediocre performance. I well recall the reams of modifications that were published in AR and other magazines around that time to cure frequency drift and provide better sensitivity, mostly to little avail. In spite of this, many hundreds of these receivers must have been sold and a few still seem to pop up on the second-hand market from time to time. These were followed by a couple of similar design but with transistors instead of valves. In those days this was a mixed blessing. Sensitivity and drift characteristics were better but often cross modulation was almost intolerable.

The R-1000 arrived on the scene in 1979 and at last we had a receiver with all required facilities and a completely professional performance. Many thousands of these receivers must be in current use in both amateur and SWL shacks as well as many professional locations. A couple of years ago, Kenwood released the R-600

which was basically an economy version of the R-1000.

The R-2000 is somewhat larger but the same weight as the 1000. The main difference is in increased width, up by 75 mm. The increased width allows for a good size front facing speaker. The somewhat controversial carry handle come tilt bale of the 1000 has been replaced with a conventional tilt bale and a side mounted carry handle.

Basic specifications remain the same with full coverage from 150 kHz to 30 MHz with reception facilities for SSB, CW and AM plus the added FM mode. But from here on things change somewhat. Band changing is now fully electronic. Band up/down buttons allow for moving in 1 MHz steps either singly or by holding the button down in rapid sequential steps. Ten memories with memory scan or programmed band scan are available with digital readout to indicate memory selection. The digital frequency readout now reads to 100 Hz and also doubles as a clock which can be set for two time zones with a 24 hour readout. Three speed tuning in 50, 500 Hz and 5 kHz steps make for easy tuning across the bands.

Without doubt the Kenwood design engineers have closely followed the electronic design of the TS-430S transceiver. Even the appearance has quite a family resemblance.

### THE R-2000 TECHNICAL FEATURES

As is unfortunately typical these days, no circuit description or details are covered by the instruction manual. However a block diagram is included and a few details from this will be of interest. Six band pass filters are fed from the antenna input via a 10 dB per step front end attenuator. The band pass filters cover two to one frequency ranges with the exception of the low band which covers from 150 kHz to 1 MHz. The RF stage is single dual gate FET followed by a buffer stage into a balanced mixer the first IF of 45.9 MHz. Second conversion is to 9.9 MHz and the third to 455 kHz. Balanced mixers are used throughout. Provision is made for four filters of which three are supplied, a 2.7 kHz for SSB, a 6 kHz for AM and a 15 kHz for FM. The option is a 500 Hz CW filter. Three detectors are switched for SSB/CW, AM or FM. The frequency selection, memory and scanning modes are controlled by the CPU which is powered by a lithium battery when the primary supply either AC or optional DC is removed. This battery has an estimated life of five years.

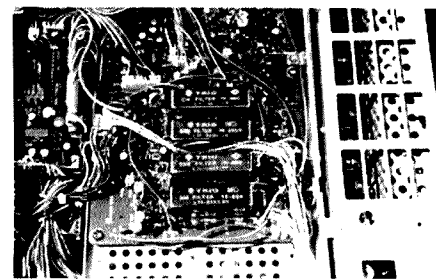

The Filter Section.

### THE R-2000 IN USE.

On initial switch on the 2000 really looks superb. The digital readout is bright and clear enough to read right across the room. The selected memory channel is identified with a bright yellow readout to the left of the frequency readout. A nice feature noted when the receiver was set on my desk where the rubber buffers on the tilt bale, no possibility of scratching my desk this time. Firstly the two clocks were set, one on UTC, the other on local. The clock

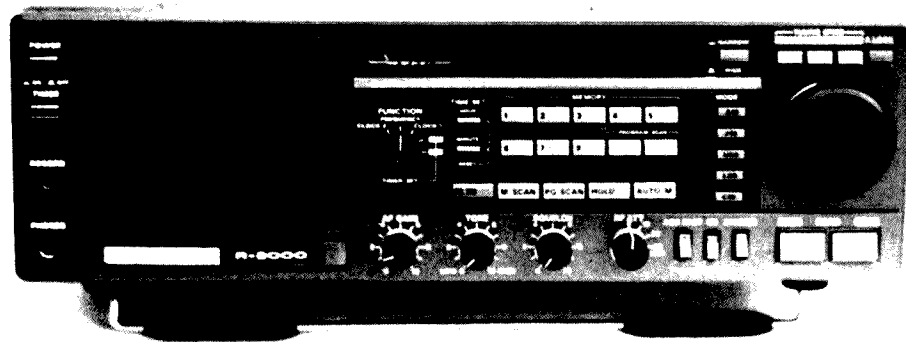



also has a timer function that allows the receiver to be automatically switched on at any pre set time along with a tape recorder if required. It was noted that the SSB BFO frequencies were well out of adjustment as received with LSB signals sounding very high pitched. USB was acceptable but perhaps a little the other way — a bit bassy. Naturally the instruction book contains no information on correcting this, so it was left as was.

The ten memories were programmed for our favourite operating frequencies and a few short wave broadcast channels. As received from the distributor, our R-2000 did not operate below 2 MHz. The instruction manual refers to this as an 'X' model. A note included from Kenwood says that the receiver is capable of receiving 150 kHz to 30 MHz by cutting D59 on the printed circuit board behind the function switch. I was unable to locate D59 during a quick search of the main printed circuit board. During the setting up process, I was rather disappointed to see that Kenwood have done away with the recessed, upward facing rear panel which was quite an innovation on the R-1000.

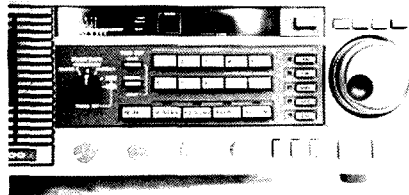

Close-up of Switches.

The tuning system is now fully electronic with three push button selected rates. These are 50 Hz, 500 Hz and 5 kHz steps which give an actual tuning rate of 10, 100 kHz and 1 MHz per knob revolution. These speeds also apply when band scanning is in progress. I feel that Kenwood have not chosen these speeds as well as they might. They are all too fast. I feel that 10, 100 Hz and 1 kHz would have been a better choice. The 1 MHz per tuning knob revolution is after all taken care of with the up/down button. However I must admit that tuning SSB signals is a very simple process, but the next step up, I found a little too fast for AM stations. I wonder if there is a simple modification to change this.

Perhaps the best thing on the R-2000 is the memory system. It is, in fact, almost identical to the TS-430 transceiver. The ten memories are programmed with both frequency and mode. So you can have an USB channel on 20, a LSB memory on say 40 and 80 plus a few AM broadcast stations. It is then possible to select any one by a push of the appropriate memory button or to scan around them sequentially. The system will pause long enough at each memory so that the operator can decide if a stop is required. If so, a push of the hold button will stop the scanning sequence.

The programmed band scan using memories nine and ten can be used to tune automatically between any frequencies entered in them. The scan speed is selected by the tuning rate buttons.

AM reception with the R-2000 is excellent. Kenwood have dropped the wide selectivity

position of the R-1000 and now provide selection between 6 kHz at the -6 dB points or the SSB filter of 2.7 kHz. The narrow/wide button that allows this selection also selects the narrow CW filter or SSB selectivity when the CW mode is in use. Unfortunately during the course of our tests, I was unable to hear any FM transmissions on 10 metres, but a socket at the rear of the 2000 is labelled VHF converter, so maybe Kenwood have something in mind here. Time will no doubt tell.

The squelch control is useable on all modes and works quite well if you happen to like squelch on HF. With fading signals I can never pick the right level to set the control.

My comments on the TS-430S 'S' meter equally apply to the R-2000. It looks great until you try to use it, then you cannot see it. The noise blander is both good and not so good. Not so good on the Woodpecker, in fact no effect at all, but quite good on ignition and general electrical hash. The 'Record' output has a constant level output, unaffected by the AF gain. A great idea, but why only on receivers. How about one on transceive.

### THE R-2000 ON TEST

The following test equipment was used to produce these figures. Daven audio power output meter. AWA F242A noise and distortion meter. A 100 kHz crystal calibrator with multi vibrator output. Sensitivity tests are subjective and are checked by comparative tests with other equipment.

Audio output was taken from the external speaker socket into the power meter terminated in 8 ohms. The crystal calibrator was fed into the antenna input and the tuning set to produce a 1000 Hz tone. Audio output checks were based on this. Maximum power output was 3 watts but with very high distortion. At 2 watts distortion was 3.2% and at 1.5 watts 1.9%. With the audio gain control set at zero, system noise was -65 dBm, a very acceptable figure.

The tone control was checked in the fully on position. At 2.5 kHz the response was down 12 dB. At 2 kHz -9 dB, 1.5 kHz -7 dB, 1.0 kHz -4.5 dB and at 700 Hz -3 dB. This is quite acceptable performance and was useful lopping off some of the excess highs in the LSB position. AGC action was checked by listening to a variety of strong and weak signals. There was no pumping or popping on strong signals and in general SSB reception sounded very smooth. AGC decay is selectable for slow or fast with a front panel switch, but is not automatically selected with a change of mode. Next the crystal calibrator was fed into the antenna input to give an 'S' meter reading of S1. The audio output level was checked and then the RF input was increased to give a reading of S9+30 dB. The audio output increased by 2 dB. This was a quite reasonable figure.

The response of the SSB filter was checked by feeding a weak signal (below the AGC threshold) into the front end and measuring the audio output level while tuning across the signal. The USB setting

was used as this appeared to be reasonably normal compared to the very off frequency LSB. The -6 dB points were 400 Hz and 2.8 kHz with 3 kHz -12 dB. Overall SSB selectivity appeared to be fairly good but perhaps a little wide at the -60 dB points. The R-2000 has no IF shift or band pass tuning to help separate wanted signals from interference.

The optional CW filter was not fitted to our review receiver. From 2 MHz up the performance of the R-2000 was very acceptable. The stability was excellent with little shift over a half hour period from a cold switch on. Pity I was unable to check the low frequency performance. This is where many current receivers fall down badly. While looking around for the elusive D59, I noted that it is possible to have either open scan or scanning that will stop on signal. To arrange this, a jumper is changed on the circuit board accessible with the bottom cover removed. Further details are on page 11 of the instruction manual.

### INSTRUCTION MANUAL

The R-2000 instruction manual is completely disappointing. It is a four language thing with English as the first part. So far as operating procedure and installation goes, it is quite good. Various types of antennas are discussed in relation to their use with the R-2000. However apart from a block diagram and circuit diagram, there is no technical information at all. A short section on short wave propagation is interesting.

The last page discusses the options available for the receiver. These are two different headphones, a CW filter and the very excellent Kenwood World Clock. Installation instructions are provided for the CW filter.

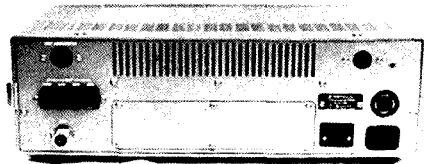

Rear View.

### CONCLUSIONS

The R-2000 receiver is, without doubt, a very advanced piece of equipment. Not only that, but the overall performance is very good in most wanted respects. Some might consider the appearance to be a bit over styled and the S meter is certainly not up to the overall standard of design. The R-2000 will however put Kenwood right out front in the popular general coverage receiver market for some time to come.

Our review model was supplied by KENWOOD AUSTRALIA and all enquiries regarding the R-2000 should be directed to them or one of their local agents.

AB

**A Review of the C8900E coming next month.**

# EVALUATION AND ON AIR TEST OF THE R-2000 RECEIVER

Serial No 3070643

Category	Rating	Comments
Packaging	***	Double carton with foam inserts.
Size	**	Larger than preceding model.
Weight	***	Same as preceding model.
External finish	***	Well finished but slightly over styled.
Construction quality	***	Good quality boards and internal wiring.
<b>FRONT PANEL</b>		
Location of controls	***	No concentric controls. All well laid out.
Size of knobs	***	All very good.
Labelling	***	Clear labelling.
Meter	*	Very over styled. Hard to read.
VFO knob action	**	Very smooth, but tuning rates not ideal.
Dial readout		
Analogue	NA	
Digital	***	Bright and easy to read. Accurate resolution to 100 Hz.
Status indicators	****	One of the best yet.
<b>REAR PANEL</b>		
<b>RECEIVER OPERATION</b>		
VFO stability	****	Hard to fault, see test section.
Digital dial accuracy	****	Spot on.
Memories	****	Recalls both frequency and mode. Best yet seen.
Shift/width	NA	No shift or width controls provided.
Notch filter	NA	No notch filter.
Spurious responses		
S meter	***	Realistic response. Smooth action.
ACC performance	***	Very adequate AGC performance.
Signal handling	***	No problems with strong signals.
RF attenuator	***	10 dB steps. Better chosen than R-1000.
RF gain	NA	No RF gain control.
Sensitivity	***	On subjective test, very good.
Selectivity	***	Good choice offered — adequate selectivity for most purposes.
<b>NOISE BLANKER</b>		
Woodpecker	*	No effect on Woodpecker.
Electrical & ignition noise	***	Worked well on this type of noise.
<b>QUALITY OF RECEIVED SIGNAL</b>		
Internal speaker	**	Front facing speaker. Satisfactory quality.
External speaker	NA	No optional speaker offered.
Headphone output	***	Stereo compatible. Output level good.
Tone control	***	Very useful top cut.
MANUAL (owner's handbook)	**	Satisfactory as operator manual. No technical information.

Rating Code: Poor \* Satisfactory \*\* Very Good \*\*\* Excellent \*\*\*\*

## WHO IS THIS AMATEUR?



He first obtained his licence on 18th September 1936 and immediately began operating from 90 Prince Street, Thompson Estate, Brisbane. In the space of twelve months he had made over 1000 contacts on CW, including DXCC — something few OT amateurs accomplished in their first year of operation. The all-homebrew station was extremely neat and efficient, with the transmitter using a pair of 45s in parallel in the final stage to a half watt vertical on 20 metres and the receiver a three tube TRF.

A WIA Queensland member since pre-war days, he served on executive on more than one occasion, being QSL Officer twice (a duty he discharged with considerable efficiency) and Morse code instructor when the meetings were held in the Celtic Chambers.

During WWII he served as a W/O in the Navy for the full five years of its duration, then commenced working with the PMG as a

technician and moved to Dalby. He later returned to Camp Hill, Brisbane and spent a considerable time at the Frequency Measuring Station at Capalaba until his retirement in 1979. As a 'DXer par excellence' and a member of FOC and RSGB he became known as 'Brisbane's Mr DX', having over 300 countries confirmed to his credit.

The beautiful bushland setting of Loganlea, south-east Queensland is now his chosen place of abode where he has an extensive garden — but still finds time to put his snappy fist or clear voice on the air almost every day. One can best describe him as an amateur who puts in a high key performance in a low key easy manner. His callsign fits in nicely with the work he performed in the PMG — viz Radio Frequency measuring — maybe you've already guessed. Yes, its VK4RF (Romeo Foxtrot or Radio Frequency) and his name is Fred J Lubach.

AR

# MULTI PURPOSE CRIMPING TOOL

## G 30040

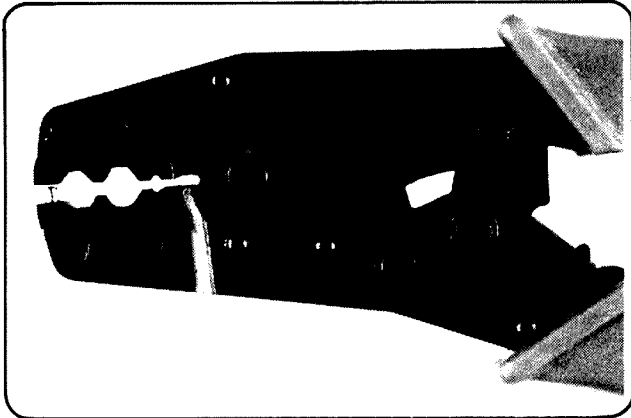

The Greenpar crimping tool G 30040 is a versatile, low-cost tool which enables the small user of BNC, TNC, and UHF connectors to take advantage of the reliability and ease of assembly offered by crimped connections.

- 3 die design permits crimping of both 50 and 75 ohm connectors.
- Full closure mechanism ensures complete crimping operation.
- Rigid high leverage design provides consistent high quality crimped connections.
- Crimps RG-58 C/U, 141 A/U, 142 B/U, RG-174 A/U, 188 A/U, 59 B/U, 62 A/U and RG-55 B/U cable.
- Crimp die sizes to BS 5310 and IEC recommendations.

**ACME<sup>®</sup> ACME ELECTRONICS**  
 A Division of James Hardie Electrical (Hardie Trading Ltd Inc in Vic)

**VIC.** 2-18 Canterbury Rd, Kilsyth 3137. Tel: 729 6211  
**N.S.W.** 120 Beaconsfield St, Auburn 2144. Tel: 648 2255  
**QLD.** Actrol Parts P/L Tel: 358 2011 Brisbane  
**A.C.T.** Electronic Components Tel: 80 4654  
**S.A.** Neil Muller P/L Tel: 272 8011  
**W.A.** J.G. Thomas & Assoc. Tel: 272 7122  
**TAS.** W.P. Martin P/L Tel: 34 2811 Hobart, 31 5545 Laun.

# VAINS ANTENNA SERVICES

PTY. LTD.

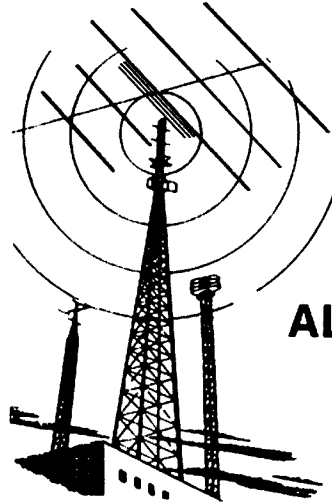





- ★ RADIO CONTROLLED VEHICLES —
- ★ INSTALLATIONS
- ★ ADDITIONAL OUTLETS FOR TV/FM
- ★ REPAIRS TO EXISTING SERVICES

## ALL SUBURBS

- ★ PHONE FOR ADVICE
- ★ DO IT YOURSELF KITS
- ★ M.A.T.V. SYSTEMS DESIGNED & INSTALLED
- ★ TELESCOPIC MASTING & TOWERS INSTALLED

# 874 3333

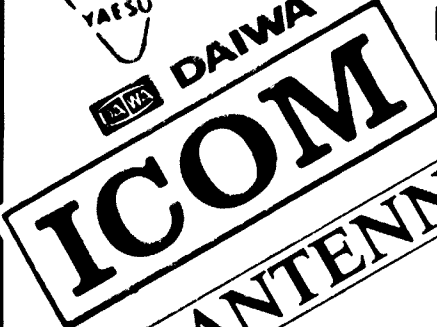
13 McKEON RD., MITCHAM

BIG NAMES

AT ONE GREAT STORE

**CW** PLUS MUCH MUCH MORE

**ELECTRONICS**

CW Electronics is the communication centre of Queensland innovators and pioneers of computer RTTY ASCII CW radio interface in Australia

Come in and see our range

416 LOGAN ROAD STONES CORNER BRISBANE  
 PHN: (07) 397 0888

PO BOX 273 SUNSHINE QLD 4109

# A MICROPROCESSOR CONTROLLED ANTENNA SYSTEM

Ralph Birrell VK3BIP  
11 Turner Road, Strathfieldsaye Vic 3551

*As satellite communication is becoming more commonplace it is desirable that antennas be automatically controlled to follow a satellite in its path across the sky. This will free the amateur from the problems of tracking and enable him to concentrate on communicating with his fellow amateur. This article describes a preliminary design for using a microprocessor for automatic control of an antenna.*

## THE PROBLEM

The 3 dB beamwidth of an antenna is usually several degrees. A five element yagi has a 3 dB beamwidth of about  $\pm 25^\circ$  while a twelve element Yagi at 1296 MHz has a 3 dB beamwidth of about  $\pm 8^\circ$ .

With parabolic antennas the beamwidth depends on the diameter and surface irregularities. Typical values are:

- a) Frequency 1297 MHz  
Diameter 3 m  
3 dB beamwidth  $5^\circ$   
Power gain 30 dB
- b) Frequency 5761 MHz  
Diameter 3 m  
3 dB beamwidth  $2^\circ$   
Power gain 38 dB
- c) Frequency 10,369 MHz  
Diameter 1 m  
3 dB beamwidth  $2^\circ$   
Power gain 38 dB

These figures indicate that an antenna control system which can point the antenna axis to within  $\pm 2^\circ$  of the actual satellite position at any time will suffer very little degradation of signal strength at the receiver input.

The tracking problem is three dimensional but can be simplified into a linear equation for the horizontal plane from 0 to 360 degrees and a parabolic equation in the vertical plane from 0 to 90 degrees. These two combined motions will give complete coverage of any point in the sky.

The vertical elevation above the horizon can be expected to be an inverted parabola of the type

$$\Theta = AT - BT^2$$

where  $\Theta$  = degrees above the horizon  
A, B are constant values  
T = time after the satellite rises above the horizon.

The ability of the computer to do arithmetic will determine how complex an equation can be followed.

For a preliminary design a period above the horizon of 100 minutes was chosen. This is of the same order as that expected for the phase III satellite in the southern hemisphere.

A feedback loop is used to check that the antenna has moved. If not a repeat instruc-

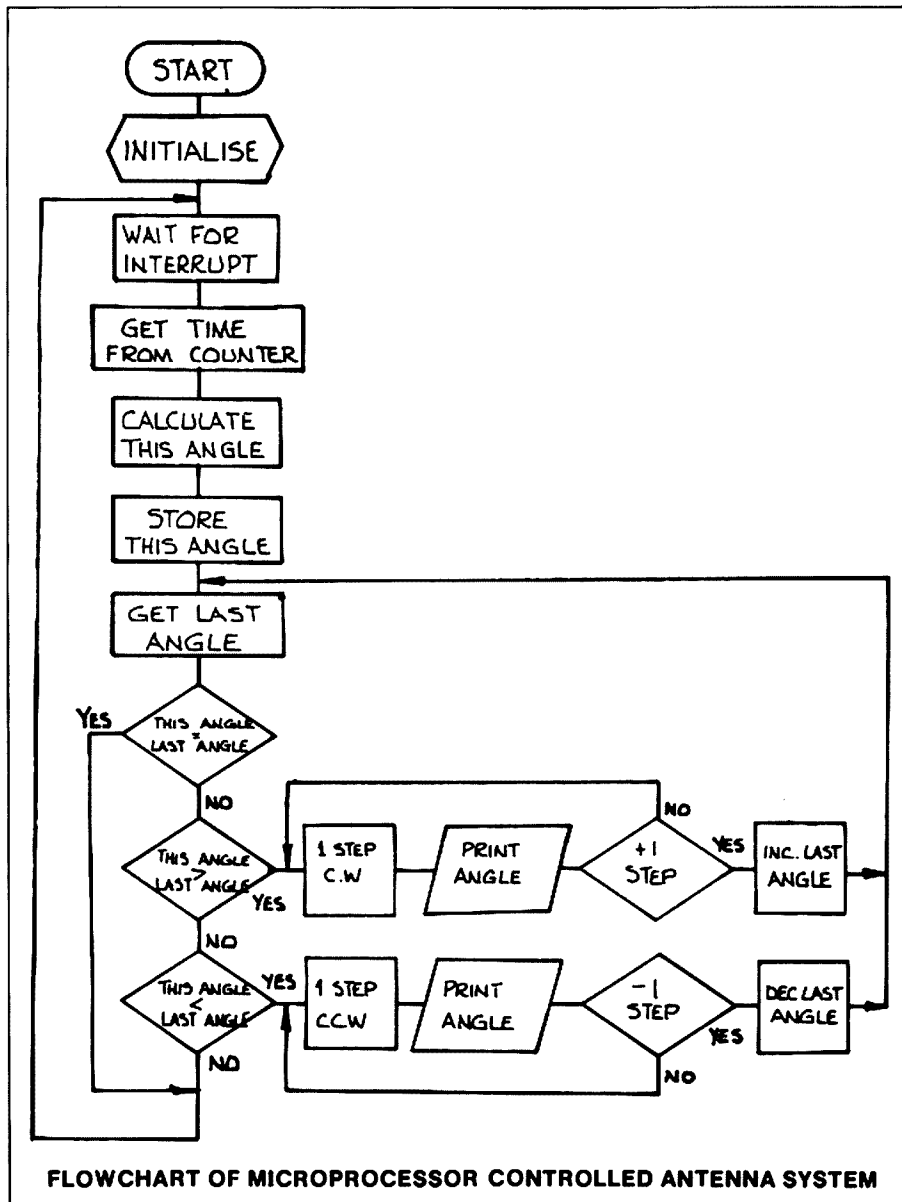

FLOWCHART OF MICROPROCESSOR CONTROLLED ANTENNA SYSTEM

tion is issued until the antenna moves as required. Alternatively an alarm could be given if the antenna fails to move.

A small parabolic dish antenna from a disposals radar system was available. This antenna has gearing for movement in both the horizontal and vertical planes and is suitable to prove the overall design.

### CHOICE OF COMPONENTS

#### STEPPING MOTORS

Sufficient accuracy can be obtained using a stepping motor for each drive. The Philips motor type 9904 112 27001 has a step of 7.5 degrees, using a gear ratio of 75/1 the step becomes 0.1 degrees at the antenna.

The pull out torque at the antenna would then be about 6-7 newton metres.

With a Yagi or large parabolic antenna the torque required to move the antenna on its bearings is relatively small. The worst condition will be where the antenna is being acted on by wind gusts when the drive is required to move the antenna against the force of the wind or to hold the antenna against freewheeling. A brake can be controlled by the computer to be on and hold the antenna stationary against wind forces between the active periods of the drive and to leave the drive free during active periods.

#### STEPPING MOTOR CONTROLLER

A Philips controller chip SAA 1027 can be used to send out a pulse for each step of the motor. Another pulse can give forward or reverse direction as required.

#### MICROPROCESSOR

A National Semiconductor chip, the INS 8073 microprocessor chip is used. This device is an 8 bit microprocessor with a wide range of arithmetic (8 and 16 bit) with a tiny basic interpreter built in to the CPU in an internal 2.5 kiloword PROM.

The availability of Tiny Basic makes programming much more efficient and quicker than using machine language. Tiny Basic is a suitable language for control applications.

The chip is available on a board with various input/output ports from JED Microprocessors at a very reasonable cost. The chip is capable of integer arithmetic (to the nearest whole number) which is suitable for the stepping motor use.

A programmable timer is included on the board and this can be programmed to interrupt the processor at second, minute or hour intervals.

#### FEEDBACK CIRCUITS

A small rotary pulse generator could be used to check the movement of the antenna eg a Philips V 23465 digital shaft encoder with 5000 pulses per revolution.

A Sony Digiruler was available and this was adapted to measure circular motion by wrapping the magnetic strip on a wheel of suitable diameter, the wheel rotating with the antenna. The digiruler emits a pulse every 0.05 mm of movement of the strip past the reading head. The pulses can be counted with a 7492 chip and the computer can be programmed to check the movement after each step. The digiruler can sense forward or reverse rotation.

### PROGRAMMING

The programmable timer was set to provide an interrupt to the processor at minute intervals. For the first trial a time of 100 minutes above the horizon was chosen. The constants A and B of the equation  $\Theta = AT - BT^2$  can be chosen to give the required minimum elevation, for the period of 100 minutes, as required for any satellite.

The flowchart for the programme for the vertical movement is as shown in the illustration.

For the first trial the time and angle of elevation were printed on the console and the angle output to a LED display.

The programme was written in TINY BASIC with machine language subroutines to increment the time and to increment or decrement the angle as required. These subroutines are called up using a LINK instruction.

At each minute interval the processor calculates the value of  $\Theta$  and steps the antenna until this value is reached by forward or reverse stepping as required.

After debugging, the programme was transferred to EPROM which was then plugged into the board with the programme starting at location 2000. The programme was started from the console.

After successfully proving the programme for elevation a new programme is being written which will enable movement for elevation and azimuth for follow any particular equation desired or to move the antenna to point to any position in the sky when the coordinates are fed in from a keyboard.

### CONCLUSION

The INS 8073 microprocessor provides a low cost solution for the control of an antenna system to follow a given equation across the sky or to move immediately to point to a given point in the sky. The availability of the TINY BASIC language on this chip makes programming relatively simple and cost effective.

I will be happy to provide a copy of this listing to experimenters or alternatively programme an EPROM for anyone who wishes to seriously experiment in this field.

**Editors Note: An SASE should be enclosed with any request for information from the Author.**



## URGENT!

**Please let us know of clubs and schools etc. starting theory classes.**

**Where, when, how much and whom to contact.**

**Contact Brenda VK3KT.**



# TRY THIS

## THE MICROWAVE OVEN TEST

John Hassell, VK6ZGF/NXX  
77 Kalinda Drive, City Beach, WA 6015

Many vital pieces of amateur radio gear such as loading coils, antenna traps and RF chokes can be home made using odd bits of PVC piping or various plastic containers as coil formers. One drawback with this practice is that there is no way of knowing the dielectric properties of the PVC pipe or detergent bottle you may have on hand. This is especially a problem if the project is an antenna loading coil through which you intend to run the legal power limit of RF. If the plastic material has poor dielectric properties in strong RF fields, then at best you will end up with a lossy loading coil of indifferent Q, or worse, the whole thing will melt into a gooey mess under sustained high power.

Here is an easy way to test the dielectric properties of various plastic items you may wish to press into service. The only major piece of test gear required is a microwave oven. The method is simple. Place a sample of the material in question on a paper plate. Pop this in the microwave oven for three minutes or so at high power. If the sample is a good dielectric it will remain cool or only get slightly warm. If the dielectric properties are poor, then the sample will get very hot or even melt. Hence the paper plate.

By comparing how warm various types of plastic get, it is possible to select the best for the job.

One word of warning. Be very sure no metal is in the sample you are testing. If you wish to test coax cable, remove the center conductor and A.I. the braid. Even a small whisker of wire will get hot enough to set fire to the plastic being tested.

AR

**JOIN A NEW MEMBER**



# EQUIPMENT REVIEW

Peter Gamble, VK3YRP  
TECHNICAL EDITOR

## THE PARAMETERS 7040 DIGITAL MULTIMETER

The most common piece of test equipment in an amateur's shack used to be a moving coil multimeter with a sensitivity of somewhere between 1000 and 20 000 ohms per volt. When a high impedance measurement was required, a VTVM was usually lifted down from the shelf, plugged in and allowed plenty of time to warm up and stabilise. With valve equipment the norm, these meters provided sufficient accuracy, usually within 2-5%, to build and service amateur radio equipment. But this is changing rapidly. Transistor and integrated circuit equipment often demands more sensitive and accurate measurements, and digital multimeters provide this with high impedance measurement and no 'warm up'. They are also becoming more affordable. One such digital multimeter is the Parameters Model 7040.

### APPEARANCE

The 7040 is a hand size instrument built into a high impact ABS plastic case and weighs less than 400 grams. It also contains a metal shield to minimise RFI problems. The functions are selected by two dark coloured push buttons, and one of six light coloured push buttons is used to select the appropriate range. Change over from volts/ohms to current requires the hot lead to be moved to one socket for up to 2 amps and to a second socket for up to 10 amps.

The 13 mm, 3½ digit liquid crystal display is easy to read from a wide range of viewing angles. A tilt bail enables the multimeter to be raised to approximately 30 degrees. A standard 216 9 volt battery powers the instrument, and a socket is provided on the side of the case for an external regulated power supply. A single sheet leaflet lists the ranges, resolution, accuracy and operating instructions. It also includes a circuit diagram and parts list.

Overrange indication is provided by a leading digit of '1' and the remaining three digits blanked. A 'LO BATT' indicator came on when the battery voltage dropped below 7.1 volts.

### SPECIFICATIONS

The basic accuracy of the multimeter is quoted as  $\pm 0.1\%$  of reading + 1 digit. The accompanying table has been extracted from the detailed specifications, and gives an overall picture of the ranges and accuracy of the instrument.

### PARAMETERS 7040 SPECIFICATIONS SUMMARY

All accuracy figures quoted assume a one year calibration cycle and an operating temperature of 18°C to 28°C.

#### DC VOLTAGE:

Ranges: 200 mV, 2 V, 20 V, 200 V, 1000 V (max DC input)  
Accuracy:  $\pm 0.1\%$  of reading + 1 digit  
Input resistance: 20 Mohm on 20 V to 1000 V ranges.  
(Measured: 0.4 Mohm on 200 mV range, 1 Mohm on 2 V range)

#### DC CURRENT:

Ranges: 200  $\mu$ A, 2 mA, 20 mA, 200 mA, 2 A, 10 A (max DC input)  
Accuracy: up to 200 mA:  $\pm 0.5\%$  of reading + 1 digit

#### AC VOLTAGE:

Ranges: 200 mV, 2 V, 20 V, 200 V, 750 V (max AC input)  
Accuracy:  $\pm 0.5\%$  of reading + 5 digits  
Frequency Range: Up to 20 V — 45 Hz to 500 Hz  
200 V and 750 V — 45 Hz to 120 Hz  
Input impedance: 10 Mohm shunted by less than 100 pF for 20 V to 750 V ranges.  
Response: Average responding, calibrated in RMS of a sine wave.

#### AC CURRENT:

Ranges: 200  $\mu$ A, 2 mA, 20 mA, 200 mA, 2 A, 10 A (max AC input)  
Accuracy: up to 200 mA:  $\pm 1\%$  of reading + 5 digits  
2 A, 10 A ranges:  $\pm 2\%$  of reading + 5 digits  
Overload protection: as for DC.

#### RESISTANCE:

Ranges: 200 ohm, 2 kohm, 20 kohm, 200 kohm, 2 Mohm, 20 Mohm  
Accuracy: 2 kohm-200 kohm:  $\pm 0.3\%$  of reading + 1 digit  
2 Mohm:  $\pm 1.0\%$  or reading + 1 digit  
20 Mohm:  $\pm 2.0\%$  or reading + 1 digit  
Maximum DC source voltage: High — 2.8 V, Low — 280 mV.

### HOW IT PERFORMED

A series of tests were carried out, including comparisons with a more elaborate digital multimeter. A number of DC voltage and current tests were performed over the range 100  $\mu$ V to 20 volts and 5 mA to 0.5 A. No problems were encountered, and accuracy on a comparative basis was well within specifications. The linearity was checked across ranges and was within  $\pm 1$  digit. The voltage drop across the meter when it was measuring current was checked and found to be 0.25 volts at full scale for currents up to 200 mA. However, this rose rapidly on overrange current values.

An audio oscillator was first used for AC voltage tests, and a convenient frequency of 1 kHz selected. The two DMMs were connected and a significant difference noted in the

readings over a wide range of voltages. Connections were double checked and when no explanation could be found, the specification leaflet was consulted! It was here that the explanation was found — accuracy was maintained only up to 500 Hz. Other digital multimeter specifications were consulted and all told a similar story. The frequency response was then investigated and the following results noted for a nominal 1.500 volts:

Frequency	Reading	Difference
500 Hz	1.495 V	0.3%
1.0 kHz	1.470 V	2.0%
2.5 kHz	1.398 V	6.8%
5.0 kHz	1.235 V	17%

The 3 dB point was around 7 kHz. Thus the DMM can be used for approximate comparative measurements over the majority of the audio range, with absolute measurements being confined to below 500 Hz. A number of tests of 50 Hz AC voltages over the range 0.2 to 20 volts were made, and again, accuracy on a comparative basis was well within specifications. Tests were also made on typical audio signal voltages. However, the readings were confused, as the sampling rate, about 3 per second could not cope with a rapidly varying voltage. (The more elaborate DMM also suffered from the same problem). No AC current tests were performed.

A variety of resistors were measured, including a number of 1% types, and accuracy on a comparative basis was well within specification. The 7040 provides a choice of two source voltages for resistance measurements — 2.8 volts and 280 millivolts. The low voltage is useful for in-circuit component checks in the vicinity of semiconductor components, as it is below the 'turn-on' threshold of semiconductor devices. The higher voltage gave better results, especially on low and high resistances.

### CALIBRATION PROCEDURE

Recalibration requires a 190 millivolt DC and pure sine wave AC source. The re-

adjustment procedure, having obtained an accurate source, is simple — adjustment of two potentiometers, one for DC and one for AC.

## ACCESSORIES

The multimeter was supplied in foam packaging, along with a 9 volt battery, a pair of test leads, and an instruction and specification leaflet.

## CONCLUSION

A digital multimeter is a useful addition to the test equipment in an amateur shack once its idiosyncrasies are mastered. As with any piece of sophisticated test equipment, compared to a conventional multimeter, it takes a little time to learn its full potential. The Parameters 7040 is a versatile instrument that can make life a lot easier — no more misread scales, probes round the wrong way, needles embracing the stops, and so on. Its accuracy,

resolution and sensitivity are more than satisfactory for amateur purposes, and at a quoted 100 hours from a carbon-zinc cell, or 200 hours from an alkaline cell, it is economical to operate. Any disadvantages? Well, a good RF probe, say good to 500 MHz would be nice!

The test instrument was supplied by Parameters Pty Ltd, of 53 Grosvenor Street, Mordialloc, Victoria. The Sydney Office is at 41 Herbert Street, Artarmon, NSW.

AR

# ANOTHER COUNTRY

Alan MacLean VK3ASL  
1/138 Bluff Road, Black Rock, Vic 3193

*Whilst on a relaxing holiday the opportunity arose to make the holiday a mini DXpedition. With a little resourceful thinking antennas were quickly erected and a very enjoyable time was spent on the bands to make a simple holiday into a memorable time.*

My XYL and I were travelling north on a holiday, when we found ourselves at Port Macquarie from where there is a regular air service to Lord Howe Island.

My FT101 was in the car with some home brew helical whips, but if I took the rig to the island the whips wouldn't be much use (without the car) so I began to think of what else I could use for an antenna.

Before leaving Port Macquarie I purchased a reel of light nylon fishing line and arranged for the owner of a TV shop (who also happened to be an amateur) to supply me with 10 metres of hook-up wire soldered to the centre conductor of a Belling Lee plug.

Our accommodation at the island was a self contained flat which had some nicely placed palm trees about 10 metres tall. I tied a piece of coral to the fishing line and threw it over a palm, then attached the hook-up wire to the fishing line and hauled it up the tree.

A piece of galvanised wire poked into the ground made an earth connection and I attached this to the earthy side of the Belling Lee plug with some of the hook-up wire. The centre of the plug was, of course, already soldered to the hook-up wire, so now I had a rough 40 metre vertical antenna.

Next, the rig was installed in the flat and connected to the 230 volt power. I had brought my light weight home brew SWR bridge which had Belling Lee sockets, so I fed some RF through the bridge to the antenna.

The antenna was hauled up and down a few times and bits snipped off the top until the SWR was reasonable. Then I called CQ.

It was just on 6 PM EST and strength 5 reports were received from Brisbane, Tweed Heads and Adelaide. Signals improved by 8 PM when strength 9 reports were given by several VK3s.

Next day we met Dick (VK2AGT) and Noell Hoffman. Dick explained that Lord Howe Island was a separate country from the rest of VK for DXCC purposes and that if I came up on 20 metres, I could work a lot of DX.

I scrounged some more hook-up wire and another Belling Lee plug from the island's other resident amateur, Ken VK2BKE, with the aim of making up a 20 metre antenna.

Using the 40 metre antenna as a measure, I cut off two pieces of wire, guessed as being two quarter waves on 20 metres, plus a bit for luck. Using Dick's soldering iron, the Belling Lee plug was fixed as a centre insulator between the two wires to make a dipole on 20 metres.

The centre of the dipole and the co-ax were plugged into the SWR bridge and it was hauled up the palm tree with the fishing line and the ends of the wires were tied back to some bushes with some of the fishing line to make an inverted vee.

The ends of the vee were trimmed to get the SWR good enough to go on the air. The SWR bridge was put back at the bottom of the co-ax and thirty countries were worked during the next four days.

On the fifth day I turned on the rig, but it was very quiet — not even any noise. On looking out the window, the reason was soon apparent. The antenna and co-ax had disappeared — spirited away in the night!

I guess I must have been causing some BCI to someone. It certainly wasn't TVI, because one of the delights of Lord Howe was that there was no TV to interfere with.

That was a bit distressing. Now all I had was about 2 metres of co-ax and about the same length of hook-up wire. An amateur is supposed to be resourceful and I was determined that no antenna snitcher was going to keep me off the air. So back to my friendly supplier of hook-up wire.

The plan now was to make up a 20 metre vertical that could be suspended from a palm tree and retracted into the flat at night for safe keeping.

Using what appeared to be 9 inch vinyl tiles on the kitchen floor as a measure, I cut off 5 metres of wire to make a vertical plus the usual bit for luck. The wire was soldered to a Belling Lee plug and trimmed as before. The vertical wasn't as good as the inverted vee, but it managed to pull in thirteen countries including five new ones.

Back home later, when I measured the antenna, I found it was 4.57 metres from top to plug and had 1.05 metres of earth lead. It was fed with 50 ohm co-ax. The dimensions bear no relation to anything I've heard of before — but it worked.

For many of my contacts, it was their first with Lord Howe, and a number of them said 'Thanks for a new country OM.' I got several new countries myself — including Lord Howe Island (thanks to Dick, VK2AGT) and joined the select band of people who have worked Lord Howe FROM Lord Howe.

There are frequent air services to Lord Howe Island from Sydney and Port Macquarie. The island is administered by New South Wales and is located in the Pacific Ocean about 700 km north east of Sydney. Apart from being a first class DX location, it's a wonderful place to have a holiday and — another country.

AR

# 'SQUARE-TWO' CONVERTER

Drew Diamond, VK3XU  
43 Boyana Crescent, Croydon, Vic 3136

The 'Square-One' receiver described in AR January-March '83 covers 1.8 to 2.0 MHz. Converters will be required to tune other frequency bands. This converter design may be used with any receiver which tunes 1.8 to 2.0 MHz or more.

An example of this application may be for use with a general coverage receiver which tunes perhaps 0.55 to 30 MHz in four or five bands with a 455 kHz IF. Such a receiver may provide adequate performance at low frequencies, but have very poor bandwidth, stability and image rejection at higher frequencies. However, by preceding the receiver (now a tunable IF) with a converter, the bandwidth, stability and image rejection characteristics of the 1.8 to 2.0 MHz range are substantially preserved whilst tuning the higher frequency bands.

The construction of the Square-One receiver allowed space for converter(s) in the under chassis area. With this part added, the receiver becomes a 'full-blown' amateur band receiver. If all bands are not required, then only those bands actually needed may be provided for, and the other bands added later as desired.

## PERFORMANCE

The Square-Two converter when used with the Square-One receiver yielded the performance shown in Table 1.

Signal handling ability is quite good. On-air tests to date have yielded no incidents of cross modulation, 'Square-law effect', or bothersome internally generated intermodulation distortion products.

The second IF (9 MHz) was measured in excess of -100 dB for every band. Only one internally generated spurious signal was noted; a very weak sub-microvolt spur on 28.143 MHz.

## BLOCK DIAGRAM DESCRIPTION

A band-pass filter (BPF) is required for each band. They prevent the introduction into the mixer of frequencies which are images of the desired frequency, and reduce over-

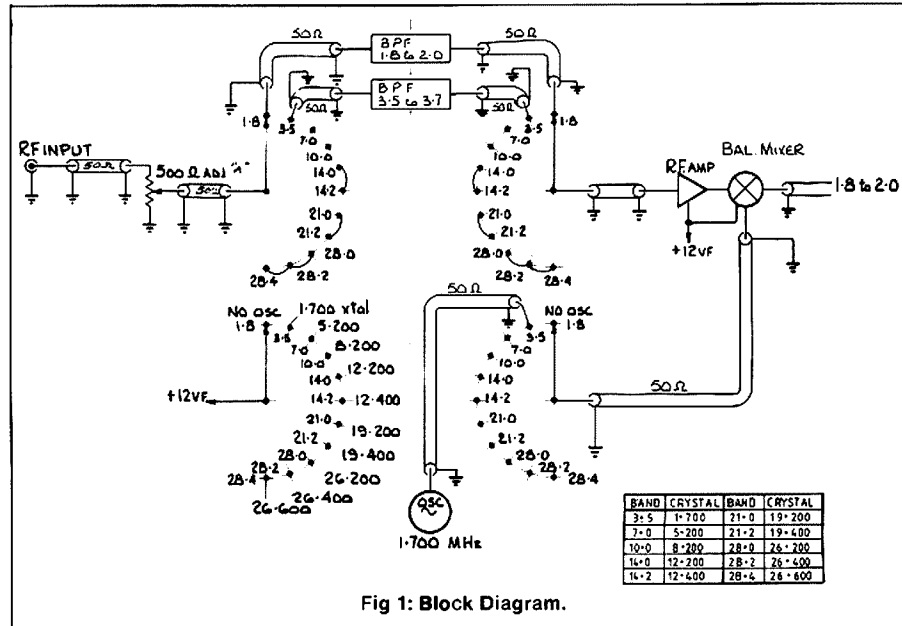

Fig 1: Block Diagram.

loading of the RF amplifier by strong out of band signals. The broadband RF amplifier provides gain to incoming signals before they are applied to the singly balanced mixer.

The oscillator input port of the mixer is supplied with a crystal derived and filtered signal which heterodynes the incoming signal to 1.8-2.0 MHz. For example, to receive 7.0-7.2 MHz, the crystal oscillator must supply 7 - 1.8 = 5.2 MHz. Therefore, an incoming signal on 7.0 MHz will be heterodyned to 1.8 MHz, and a 7.2 MHz to 2.0 MHz. The crystal is always 1.8 MHz less than the lower edge of the band to be received. For input frequencies of 1.8 to 2.0 MHz, no crystal is required. On this band, the signal must negotiate a BPF to

prevent overload by BC stations, and is passed by the mixer (remember, it is singly balanced, and the signal frequency is not suppressed). A look at the overall block diagram will show how the entire receiver operates.

## CIRCUIT DESCRIPTION

The input BPF is necessary to pass only the band of interest. Three top-coupled tuned circuits are used to cover each band, and are switched into operation with two wafers of a four wafer, 11-position switch. Capacitive dividers provide input and output impedances of about 50 ohms so that signals may be routed via miniature 50 ohm coaxial cable. The broadband RF amplifier and mixer are identical to those used in the Square-One receiver. The amplifier has a gain of about 10 dB, and employs a bipolar transistor with feedback. This stage is not easily overloaded or damaged by excessively large signals, and has good linearity.

The mixer is singly balanced, and has about 0 dB gain. U1 a CA3028 differential pair is driven in push-pull via T2. 100 ohm resistors R17 and R18 terminate the balanced secondary of T2 so that the input impedance of the mixer looks like 50 ohms. On all bands except 1.8 MHz, a crystal derived signal is injected into the current source transistor of U1 in common mode, so little or no oscillator signal

TABLE 1:

Frequency Band	Sensitivity for 10 dB S + N: N	1st IF Rejection (1.8 MHz)	Image Rejection
1.8-2.0	-122 dBm (0.2 uV)	NA	Greater than 100 dB
3.5-3.7	-118 dBm (0.3 uV)	70 dB	NA
7.0-7.2	-118 dBm	78 dB	66 dB
10.0-10.2	-119 dBm (0.25 uV)	78 dB	56 dB
14.0-14.2	-119 dBm	83 dB	50 dB
21.0-21.2	-118 dBm	91 dB	47 dB
28.0-28.2	-120 dBm (0.23 uV)	100 dB	45 dB



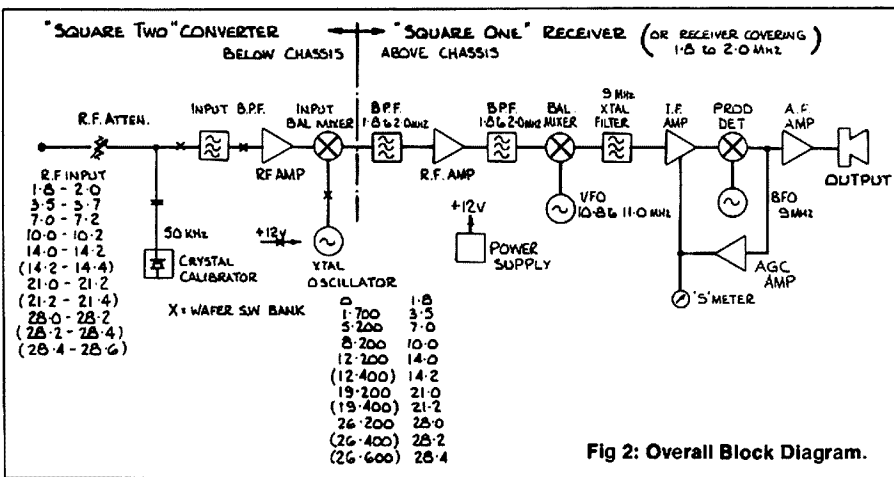

appears at the output of the mixer. 1.8-2.0 MHz signals (first IF) are coupled to the tunable IF via T3. 100 ohm resistors are again used to obtain correct impedance levels. R19 and R20 have the additional function of absorbing mixer products which are not at the IF, so reducing their amplitude and the danger of degrading dynamic range. A diplexer is therefore not required.

An individual crystal oscillator is required for each HF band. This method was used to avoid switching crystals (a messy business). Also, some crystals require a different circuit arrangement for correct operation. The 1.700 MHz crystal for the 3.5 MHz band requires a Pierce oscillator, those for 7.0 to 21 MHz require a Colpitts, and those for the 28 MHz band require an overtone circuit. The crystal frequency applied to the mixer must be very clean to avoid the production of spurious signals, and the reception of harmonic images. For example; on the 7 MHz band the crystal operates on 5.200 MHz. The second harmonic of the crystal (10.4 MHz) may mix with an unwanted signal on 8.6 MHz and produce an IF of 1.8 MHz (10.4 - 8.6 = 1.8). The input BPF will do a good job of attenuating the unwanted signal, but some very strong signals exist in that band, and would be attenuated only 40 or 50 dB, and may appear along with the wanted signals. By reducing the harmonic content of the crystal frequencies, the level of unwanted signals from this cause will be greatly reduced — in this case about 70 dB. Therefore each crystal

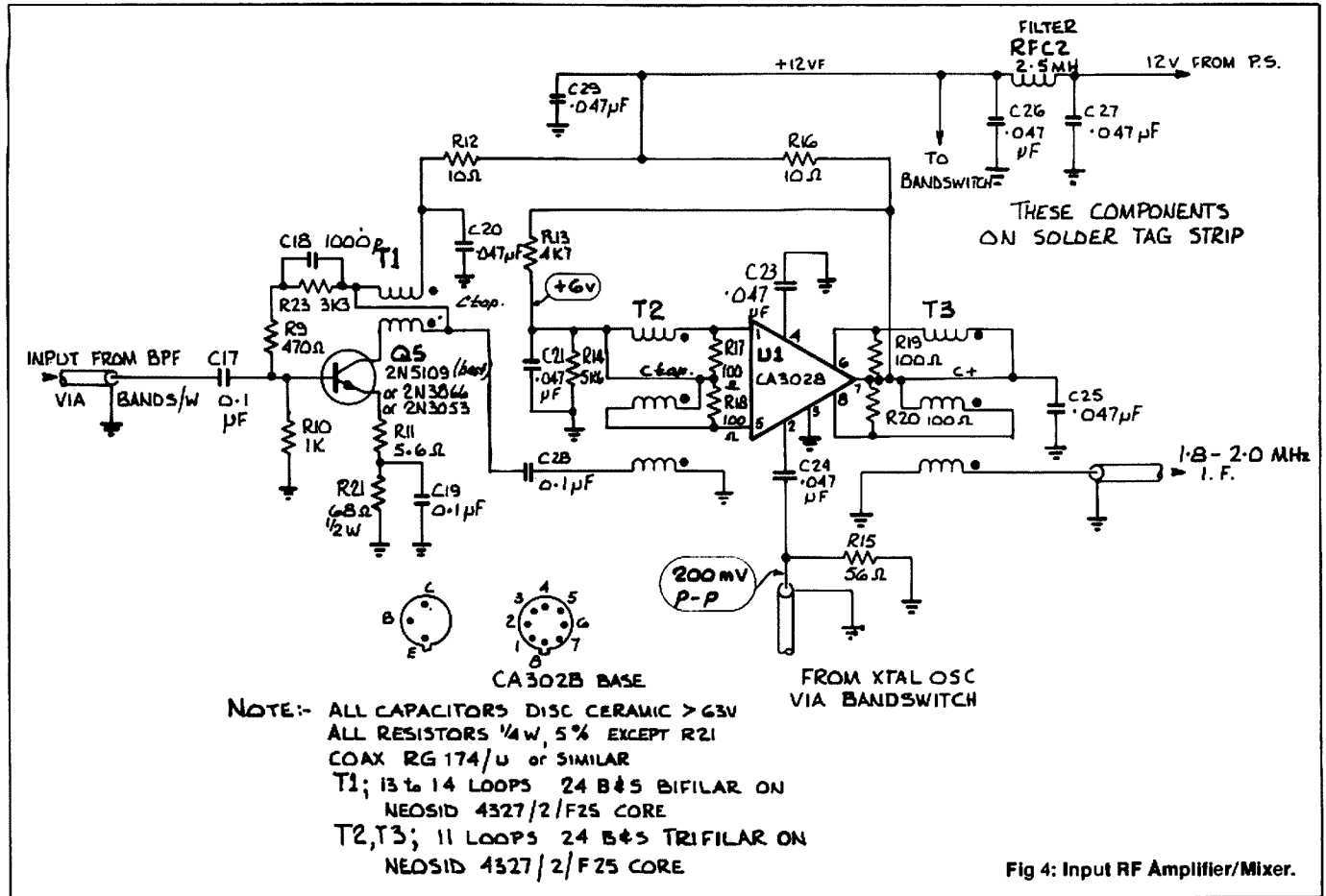
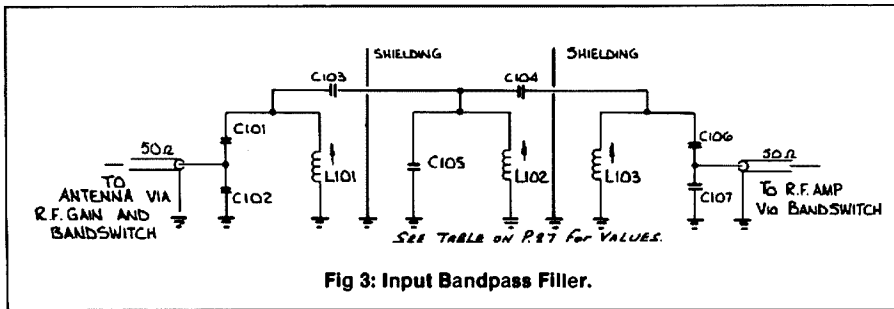

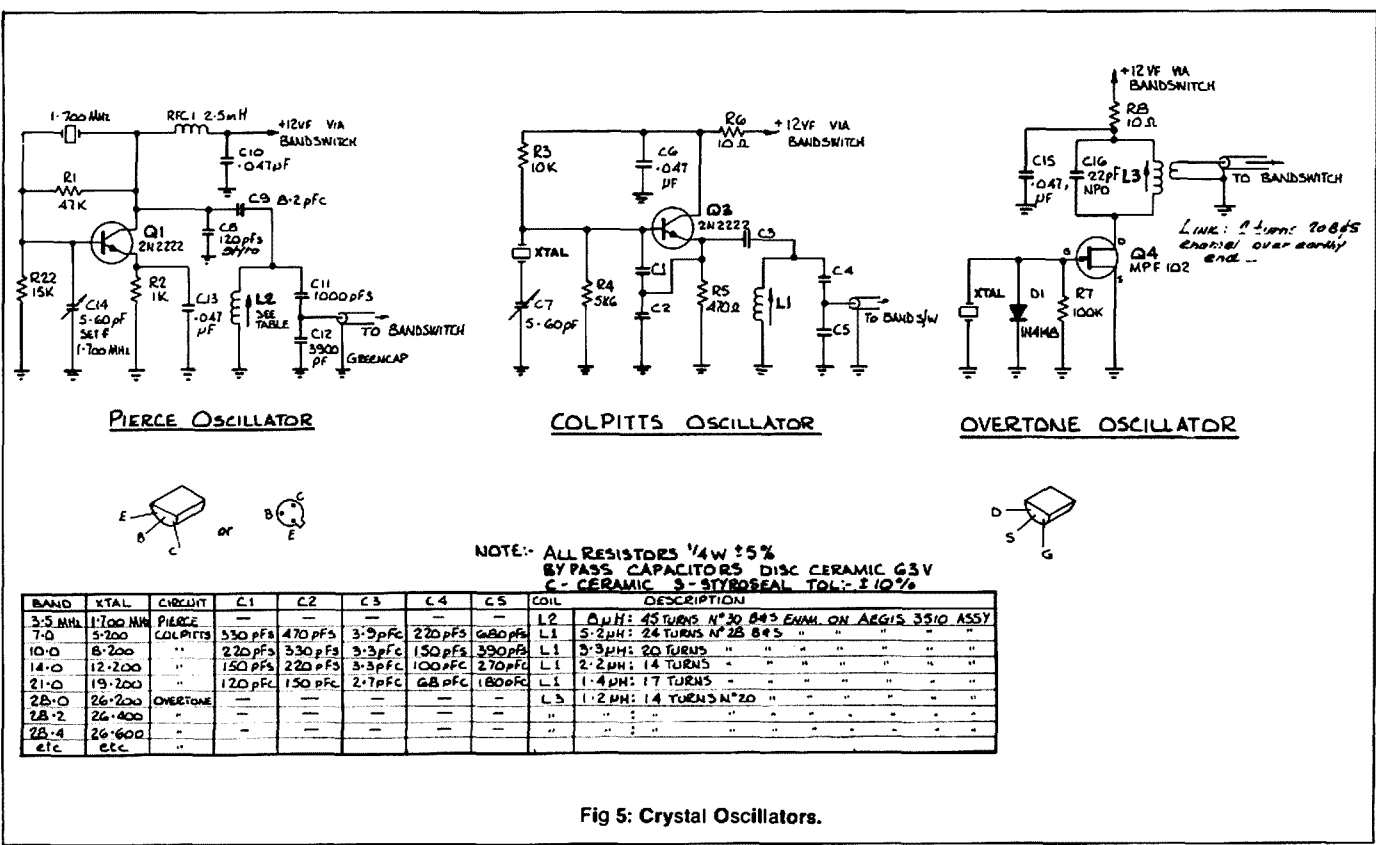
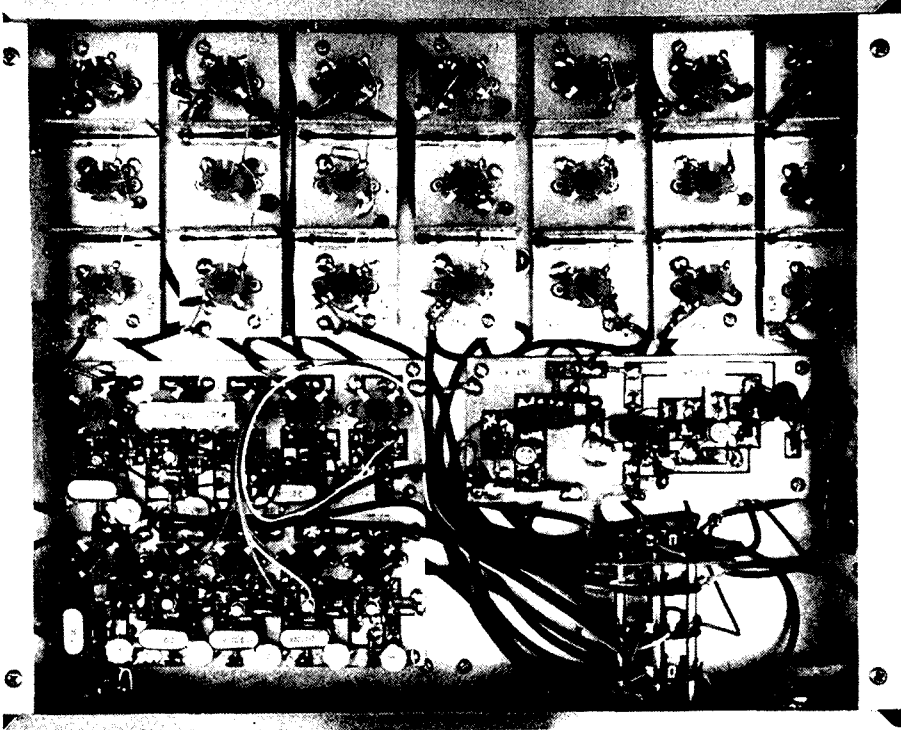

Fig 5: Crystal Oscillators.



oscillator is followed by a tuned circuit to clean up the oscillator signal before it is applied to the mixer.

During final testing of the complete receiver, it was found that the residual noise level of

3.5 MHz was rather higher than expected. It was found that noise from the power supply was being injected into the RF amplifier via the +12 V rail. This problem was eliminated by the inclusion of RF filter; C26, RFC2, C27. So +12 VF designates a filtered supply.

**CONSTRUCTION**

The RF amplifier and mixer components are accommodated upon the copper side of a home made double sided PCB, and the oscillator assembly upon a second board. It is therefore not necessary to drill holes for components. Each BPF is constructed upon a double sided board with a square of PCB material screening each section of each filter. A small hole will be required in each screen so that the leads from the top coupling capacitors may pass through the screen. See photo. Most of the image rejection performance of the receiver derives from the input BPF's, so care must be taken in their construction.

Those who have made the Square-One receiver will have already developed their own way of winding coils upon the Aegis 3510 formers. It is a good idea to firstly select which of the four tags are to be used to terminate the start and finish of each coil, and stick to those tags for every coil. This will reduce the likelihood of any problems later on. Sufficient wire should be removed from the wire spool before fixing the spool in a vice. The start (top) of the winding may be soldered to the selected tag. With the wire taut, and holding the former at the top and bottom with its axis parallel to the floor; the required number of turns are wound onto the former. With the layer complete, the end (finish) may be firmly wrapped around one of the feet and the wire cut off. All coils should be immediately labelled with a pencil upon the tag ring to identify it. Shellac or clear nail varnish must be applied to each winding to hold them in place. When dry, the finish ends may be unwrapped from the foot, cut to length and soldered to the selected tag. A two or three cm

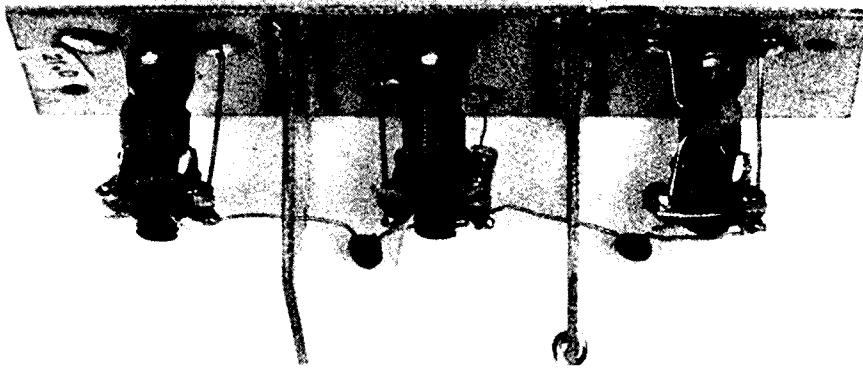

Band	C101, 105, 106	C102, 107	C103, 104	L101, 102, 103
1.8	1000 pF Styro	4700 pF Cer	47 pF Cer	8 uH: 45 turns No 30
3.5	470 pF Styro	2200 pF Cer	22 pF Cer	4.2 uH: 26 turns No 28
7.0	220 pF Styro	1000 pF Cer	10 pF Cer	2.1 uH: 14 turns No 28
10.0	180 pF Styro	680 pF Cer	6.8 pF Cer	1.5 uH: 17 turns No 24
14.0	120 pF Styro	470 pF Cer	4.7 pF Cer	1.0 uH: 14 turns No 24
21.0	82 pF Styro	330 pF Cer	3.3 pF Cer	0.8 uH: 9 turns No 22
28.0	56 pF NPO Cer	220 pF Cer	2.7 pF Cer	0.5 uH: 7 turns No 22

Wire is B & S enam. All coils wound on Aegis 3510 Assemblies.

length of elastic (cotton removed) should be inserted with each slug so that they do not move after adjustment. As up to 31 coils will be required, it is cheaper to buy them from the maker, whose address is given at the end of this article. Some spares should be ordered in case of breakages.

The RF amp/mixer should present no particular problems. The trifilar broadband transformer is made in the same manner as those in the Square-One. T2 and T3 are made as follows: Take three 350 mm lengths of 24 B & S enamel wire, lay them parallel to each other, twist them together at one end, and place that end of the group in a vice. Starting at the vice end of the group, draw a cloth through them to remove any wrinkles. Now twist the free ends together and fix them firmly in the chuck of a hand drill. Turn the drill whilst keeping the wires taut until there are about three twists per cm, then give the drill a tug to set the twists, and remove the twisted group. Carefully thread the group through a Neosid 4327/2/F25 toroidal core until there are about 11 loops. Leave about 2 cm of wire at each end of the winding, and

remove about 1 cm of enamel from each wire. A multimeter set to ohms can be used to identify the separate windings. It is essential that the end of one winding be connected to the start of another winding to form the centre tap for the secondary of T2, and the primary of T3. Bifilar transformer T1 is made in a similar manner. Once again, it is essential that the end of one winding is connected to the start of the other winding to form the centre tap.

The crystal oscillator board assembly can accommodate eight fundamental oscillators (Pierce and Colpitts) and two overtone oscillators. The final number of oscillators depends on the needs of the user. The photo shows the oscillator board fitted with one Pierce for the 3.5 MHz band, seven Colpitts (with crystals installed for 7, 10, 14 and 21 MHz bands), leaving three spare, and one overtone crystal installed for 28 MHz leaving one spare. The crystal frequencies required for each band are calculated:  $Y = f - 1.8$  where  $f$  is the lowest frequency of the band required, eg to tune 28.0 to 28.2;  $Y = 28 - 1.8 = 26.200$  MHz.

It was originally stated in the Square-One article that a 3-section, 11-position wafer

switch would be required for the bandswitch. However, as it turned out, a 4-section, 11-position switch was required. The acquisition of this switch must be left to the resources of the individual, although one or two sources exist. It may be necessary to buy a 3 x 11 and a 1 x 11 switch and add the bank from the 1 x 11 to the 3 x 11 switch. To do this: undo the two rear nuts and carefully remove all the wafers and spacers. Note this positioning of the little fibre washers and the orientation of the wafers. Do the same with the 1 x 11 switch. Cut two of the spacers in half. This will allow the switch to be re-assembled as a 4 x 11 one. Make the wafer nearest the front that which switches the crystal oscillators. The next wafer — close spaced, should be that which switches the +12 V supply to the oscillators. This leaves plenty of room to terminate the miniature coax's for the input BPF's. As will be seen in the photo in Part 1, a square piece of PCB should be inserted between the wafers for the BPF, and used to terminate the braids of each coax and provide a shield between these two wafers. The output side of the BPF's should terminate on the rear wafer. The clicker plate itself may be used to terminate the braids of the coax's which supply the oscillator signals. RG174/U miniature coax may be used for all the coax runs. About seven metres will be required if all bands are to be provided. Ribbon cable was used for the +12 V supplies to the oscillator assembly.

Each PCB and BPF may be mounted upon the under chassis area of the Square-One receiver with threaded spacers. These may be fixed to the chassis with Araldite to save the problem of drilling holes in the chassis with assemblies already mounted on the other side. A short length of braid should be soldered between the oscillator assembly and the RF amplifier.

The crystals should be socketed. A cheap source of sockets are pins removed from miniature tube sockets. Slip the pins onto an old crystal to help with soldering the pins to the PCB with the correct spacing.

## ALIGNMENT

A signal generator which covers the HF bands is desirable, but not essential to get the converter section going. If a generator is available; apply about 10 uV to the input with the RF gain pot set to maximum and see if the signal can be found where expected. The middle section of each BPF will provide the sharpest peak when tuned, and this one should be tweaked first to obtain a signal for each band being so adjusted. The generator level may be steadily reduced whilst adjusting the three sections of the BPF. The two outside sections will be rather broad in their response. Check the sensitivity at each end (1.8 and 2.0 MHz) to make sure the sensitivity response is reasonably flat. Some compromise in settings may be necessary to obtain gain flatness.

If no signal can be obtained at all: check that the oscillator for the problem band is operating. The trimming capacitor for the Colpitts circuits must have some C engaged in order for the oscillator to work. With a weak signal applied, it should be possible to peak the oscillator coil for strongest signal response for each band. It may be found that the overtone circuit will not work immediately.

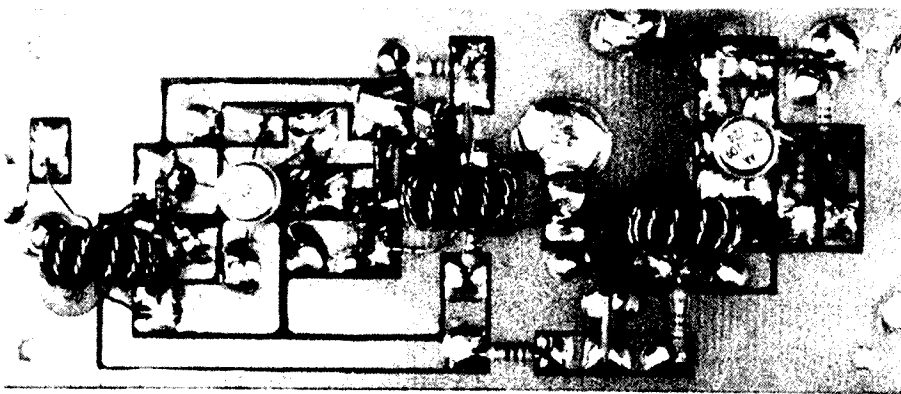

Try adjusting the slug. A point should be reached where the oscillator 'plops' into life, and there will be another point where it will drop out again. Set the slug at some point between these limits where the signal peaks. Check that the oscillator will start each time it is switched out and in. It will be found that the actual frequency will now be very close to that marked on the crystal.

If no generator is available; the calibrator signal (from the Square-One) may be used to align each band. The 50 kHz signals are strong enough on most harmonics to allow

something to be heard. Pick a fairly strong one, and peak the BPF coils as described above. The oscillator coils may also be peaked using the calibrator signal. When the BPF's have been adjusted, the crystal oscillators may be brought onto frequency, either with the help of a counter, or more simply by adjusting each crystal trimming capacitor so that each band lines up with the calibrator signal at the same point from band to band. It will not be possible to accurately align the 28 MHz crystal, but the error will be

small, and the cal pot on the Square-One will allow for this.

The converter may also be adjusted using signals and noise from an antenna. However, this method is more difficult of course due to fading etc. With a reasonable antenna connected to the input, the receiver should sound lively, provided of course that the chosen band is in fair shape.

Please send a large SAE for a copy of circuit board artwork and component location diagrams to the address stated at the beginning of this article.

Photography: Peter Dalliston and Ken McLachlan.

References: Solid-State Design — ARRL.

ARRL Handbook, 1982 and 1980.

Radio Handbook — Editors & Engineers.

Radio Communication Handbook — RSGB.

Parts sources:

Coil formers, RFC's: Aegis (makers), Magraths.

Toroids: Magraths, Ellistronics, Watkin Wynne.

CA3028: Magraths, Ellistronics, Rod Irving.

Band Switch: Radio Parts, Magraths.

Crystals: J & A Crystals.

Coax: Acme Electronics, Ellistronics.

Enamel Wire: Magraths, Ellistronics.

Magraths: 55 A Beckett St, Melbourne, 3000.

Ellistronics: 289 La Trobe St, Melbourne, 3000.

Aegis: 141 Christmas St, Fairfield, 3078.

Rod Irving: 48 A Beckett St, Melbourne, 3000.

Radio Parts: 562 Spencer St, W Melbourne, 3003.

Watkin Wynne: 32 Falcon St, Crows Nest, 2065.

J & A Crystals: 20 Deville St, Mentone, 3194.

Acme Electronics: 2 Canterbury Rd, Kilsyth, 3137.

AR

## MULTI-PIN PLUGS FOR SURPLUS GEAR

John Hassell, VK6ZGF/NXX  
77 Kalinda Drive, City Beach, WA 6015

Most military surplus gear is inter-connected by cables with multi-pin plugs. Usually by the time the gear arrives in the amateur shack the essential cables and plugs are long missing and the equipment has to be haywired together to get it working.

Here is a simple way to make multi-pin plugs, using the socket in the equipment as a template for the pin spacings.

- 1 Tape a square of waxed lunch wrap firmly over the socket.
- 2 Cut from a suitable gauge of bare copper wire the required number of pins. The length of the pins will vary with the type of socket, but about 2 cm will do for most applications. Trim as needed later. Select a wire gauge to give a firm fit in the socket holes.
- 3 Push the wire pins through the wax paper into the socket holes. Check that the pins do not protrude too far through the socket.
- 4 Find a plastic jar or wide mouthed plastic bottle with plastic screw lid. The diameter of the jar should be slightly larger than the socket. Cut the top off the jar about 1.5 cm down from the lid. Drill a hole through the lid to take the cable, and grommet if needed.
- 5 Place the top section from the jar over the socket, centre carefully and tape in place. Ensure the threaded end is uppermost.
- 6 Mix some epoxy filler. (I use PlastiBond.) Pour the epoxy into the jar section and fill until about 5 mm of the pins remain exposed. Allow to set, then withdraw the newly-made plug from the socket. Peel off the wax paper.
- 7 Slide the jar lid on to the cable. Solder the cable wires to the plug pins. Screw the lid on to the body of the now-completed plug.

NOTE. Many multi-pin plugs and sockets use a keyed centre pin to ensure that the plug and socket are mated correctly. As our new plug lacks this refinement it is best to mark with paint the correct orientation of the plug in the socket.



Figure 1.



Figure 2 and 3.

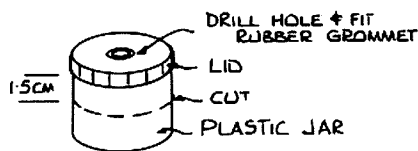

Figure 4.

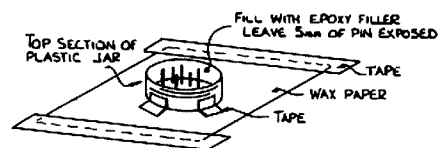

Figure 5.

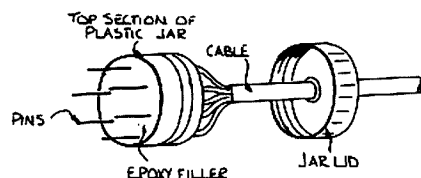

Figure 6.

AR

# DX — WHO PAYS?

Neil Penfold VK6NE  
386 Huntriss Road, Woodlands, WA 6018

**DXers of the amateur fraternity all have their answers to the questions of how to obtain QSL cards from the desired contact, but let us try and have some answers to the questions raised by the DX station.**

An amateur decides to visit an island which has no resident amateur population, for a three months holiday. The island has only recently gained its independence and is off the beaten tourist track.

After various flights by aircraft of vintage years and the customs people being very curious about the transceiver, our amateur is duly installed in a comfortable room overlooking the beach. There is no TV or other entertainment after dinner and as our man is of sober habits and lives a quiet life at home, this looks like a great location for a quiet holiday.

After dinner he decides to try and listen for amateur contacts. The usual long wire strung to a nearby coconut tree, through a tuner to the transceiver and he is ready. The band seems quiet enough — usual gaggle of voices between 200 and 210, a net operating a few kilohertz lower, no recognisable DX callsigns so let's try 195, as he's in a remote location which he considers should count as DX.

His first hour of operating brings a plethora of calls, all calling at once, in an effort to make the contact. This is great. At home on the mainland his calling of "CQ-DX" has only produced one new country in six months and many calls from the more populous areas of the world. Now already in the log are four relatively rare stations and one he's never heard before.

Granted, there hasn't been anyone operating from this island during the last six years but he hasn't anticipated being this popular.

After four hours and eight pages of his log book used, propagation fizzles out and he's ready for bed, contemplating how great it was to be wanted by so many operators. The questions of "who is your QSL manager" and the reply "QSL to my home call" really impressed him. And so it's off to sleep thinking of how he may help his new found fellow DXers by doing some more operating. Perhaps more than he originally thought when he carried his transceiver to the island and the muddling about obtaining a licence to operate. Maybe this is what DXing is really about, not sitting at home hoping some rare station will come back to his "CQ-DX" call or trying to compete with everyone else that wants him too, some of whom are always bragging about how they worked a rare one which he didn't even hear, let alone work.

The weather is great, accommodation and meals fantastic, what more could one want from life, but the three months holiday starts to zip by, with the QSOs mounting every day. As experience is gained in handling the dog piles the QSO rate increases. The suntan is now deeply embedded and his middle appears a little

more rotund than when he arrived on the island.

Departure day duly arrives, clothes and gear are packed along with all those log sheets. Never expecting to have so many contacts, the lone log book he brought with him had to be supplemented with hotel stationary, small school exercise books obtained from the local co-operative store and the back of a wall calendar — the only writing material to be found one evening when all other paper had run out.

On the plane home, watching the pretty hosties and sipping his last duty free drink, the figure of 19,256 QSOs kept appearing in his mind. Of his four years of amateur activity, his total QSOs at home had only filled one and a half log books — nothing compared to the paperwork in his luggage.

Home sweet home!! — One of the first sights to greet him in the shack was a grocery carton. Mum had put all his mail in it and it was half full. Mum had already mentioned that the postman had asked "what was Bob selling".

Slitting open a few envelopes and noting their contents, Bob was amazed. There were two with US dollar bills, three with four International Reply Coupons (IRC) in each and two with just cards and a note on the bottom of the card reading "pse QSL direct". There must be over two hundred envelopes in the carton.

The next day brings another deluge of mail and by the end of the first week at home, three hundred and seventy five envelopes have disgorged nearly four hundred QSL cards, \$155 US, three hundred and forty SAE, five hundred and ten IRCs, some SASEs and mint foreign stamps of various countries. He's opened a Pandora's Box.

Better have some QSL cards printed pretty quick or the Fraud Squad will be around asking questions. Now — what kind of card to print — lets have a look at some good DX cards already received from overseas. Now that's a good one from VPg — looks a little like where the operation took place and in the holiday slides are one or two that could be used for a good card picture. Now for some prices to get the cards printed. Wow — \$875 for five thousand cards. Suppose that will have to do and after all I've already collected \$350 from incoming mail so far. That will surely be enough cards to answer all incoming mail.

Six months later — with the incoming mail drying up, the intrepid holiday DXer begins to count the cost. Practically all his spare time has been taken up with mail opening, sorting, checking contacts in the log, writing return QSLs, enveloping and posting. The local postal clerk tends to shun him now if possible — wonder why.

After all he only had to count and stamp some IRCs whenever there was any posting to be done, then occasionally he did have to look up the Postal Guide to see if a certain place existed and how much it cost to airmail a letter there. Apparently no one else in the district uses IRCs and no one sends out so many confirmations direct. It's so difficult trying to explain about confirming contacts by mail as the postal clerk thinks if I've spoken to them, what's all the mail about. Things that cannot be talked about on the radio?? Weird!! Oh well — that's the last card posted off.

During the last six months, there was only about sixty QSLs received via the bureau. That's good, now to sum up our work to date.

Credit — Envelopes received	4800
QSLs received	5000
SAE received	4300
IRC at 40 cents each	\$6100
\$1 US	\$2000
Total	\$8100

Debit — Postage	\$2880
Print Cards & Envelopes	\$ 900
Total	\$3780

Balance —	\$4320
-----------	--------

Now everyone will say the holiday paid for itself and at the moment this does look to be so. However, time passes and at the following WIA meetings the QSL officer keeps handing over thick wads of cards from the incoming bureau. Heck! with answering the direct cards our friend had forgotten about the bureau. So another printing is necessary but this time it costs \$895 for five thousand cards which should be enough to satisfy the demand.

Twelve months after that glorious holiday on the beautiful tropical isle the tide of bureau cards is almost as strong as the direct QSLs were in those first hectic months of being home. By now there have been five thousand cards sent out at 2 cents a card and the kitty is looking quite different to the early days. Bureau operation and card printing have reduced the profit to \$3000. Still that is quite a handsome profit for doing work that was enjoyed — or was it?

The suntan soon disappeared because weekends were spent answering QSLs and his middle expanded because of lack of exercise. His mum noticed that seldom, if ever, was her favourite evening TV programme jittering as Bob was not transmitting anymore. She had heard him muttering to himself a lot lately too. Words like — never again — all those blasted cards — thirty seconds contact causes five minutes paper work — I'll get a manager next time. Note — All characters are completely fictitious and have no reference to any living persons or DX stations.

AR

# RUSSIAN FOR ENGLISH SPEAKING RADIO AMATEURS

Ian Foster, VK3ST  
Box 77, Bairnsdale, Vic 3875

*Russian shown in this article has not been spelt correctly and this has been done deliberately in order that the pronunciation could be taken literally straight from the text. The other reason why this has been done is that when consulting the various RUSSIAN/ENGLISH guides that are available, it has been found that if the Russian phrases in general as printed in these books are not understood by European Russians, they were perhaps intended for confusion rather than assistance.*

The following phrases will be sufficient to at least allow a very simple contact to be realised and it is certainly not intended as a guide for the experienced linguist or Russian language expert.

It should be remembered that if a contact is to be attempted, one must speak slowly as the accents are worlds apart let alone the languages and in general I have found nearly all Russian speaking people only too willing to assist in respect of language difficulties, provided of course, that they know what is required of them. Remember, most of the English speaking Russians have a limited English vocabulary and also have difficulty in understanding if you speak too fast.

From January to May 1983, I have had over 400 contacts with stations in European Russia and at least 200 of those contacts have been all in the Russian language. I might add that I only started to learn the Russian required to establish contact in January and for a person who was a very poor French scholar many years ago in school, I have found it to be a very rewarding and challenging exercise.

The Russian alphabet is quite different to our own as are various vowel groups and any of the phrases shown in this article are shown purely for pronunciation. Any attempt to write Russian, using the methods shown here, to a Russian speaking person will, quite probably, send the recipient into peals of uncontrollable laughter. If you would like to write in Russian, then I would suggest a more serious look at appropriate courses on the subject as this is not the intent of this article.

## FIRSTLY, THE RUSSIAN PHONETIC ALPHABET

A — ANNA	M — MARÍA
B — BORIS	N — NICKOLÍ
C — CENTRÁLI	P — PARVÍL
D — DÍMA	Q — SHÓOGAR*
E — ELÉNA	R — ROMÁN
F — FEÉDER	S — SÉGAY
G — GRIGÓRY	T — TAKYÁNA
H — HARITON	U — OOLYÁRNA
I — IVÁN	V — ZOOK
J — IVÁN KRÓSKY	W — VASÍLY
K — KÓSTYA	X — ZNÁK
L — LÚBA	Y — EEGRÉK
	Z — ZÉENA

\* Accent

Liabie to be confused with "Sugar" for S

## RUSSIAN NUMBERS

0 — NULL	7 — SYÉ-EM
1 — ODÍN	8 — VÓSYEM
2 — DVA	9 — DYÉVIT
3 — TREE	10 — DYÉSIT
4 — CHITÉRYA	15 — PITNÁTSAT
5 — PYAT	20 — DVÁTSAT
6 — SHEST	30 — TRÍDSAT
	100 — STO
73 — SYE-ÉM DYÉSIT TREE	

The following is a typical very short QSO between VK3ST and UK9ACP. The English will be first to give the guide followed by the "Russian" to be spoken. For the sake of brevity, only the transmission from VK3ST is given and responses will be able to be gauged with practice and useage.

QRZ . . . Who is calling me?  
KTO MENYÁ PRIZIVÁYET?

("QRZ" works just as well)

Thankyou, UK9ACP this is VK3ST  
SPASÍBA UNIFORM KILO DYÉVIT ALPHA  
CHARLIE POPPA YA VICTOR KILO TREE  
SIERRA TANGO

(International Phonetics Preferred)

Good morning — DÓBRI ÓOTRA  
Good afternoon — DÓBRI DÉEN  
Good evening — DÓBRI VYÉCHER

My name is Ian  
MANYA ZOVÓOT IAN (spell phonetically)  
(INDIA ALPHA NOVEMBER)

Your signals are 5 9  
VASH SIGNÁL PYAT DYÉVIT

My city/town is . . . . .  
MOY GÓOROD . . . . .

My receiver is a Drake TR7 and my antenna is a four element yagi  
MOY TRÁNSCEIVER, DRAKE TAKYÁNA  
ROMÁNSYÉ-EM, MOY ANTÉNNA CHITÉRYE  
ELEMENTA YÁGI

UK9ACP this is VK3ST over  
OOLYÁRNA KÓSTYA DYÉVIT ANNA  
CENTRÁLI PARVÍL YA ZOOK KÓSTYA TREE  
SÉGAY TAKYÁNA, PRIÓN

Listen to the reply and with care you should be able to piece together the response using the information already given.

UK9ACP this is VK3ST, thankyou my friend Gene, excellent  
OOLYÁRNA KÓSTYA DYÉVIT ANNA  
CENTRÁLI PARVÍL YA ZOOK KÓSTYA TREE  
SÉGAY TAKYÁNA. SPASÍBA MY DRÓOK  
GENE, PRIKRÁSNA

Thankyou for the signals (report) 5 9  
SPASÍBA ZA SIGNÁL PYAT DYÉVIT

Thankyou my friend Gene for the beaut contact  
MOY DROOK GENE, SPASÍBA ZA HOR-ÓŠIA SE-ÁZ

I will QSL 100% via the bureau to Moscow  
QSL STO PROSYÉTOV BUREAU MOSKVA  
Until we meet again on the air, good luck to you my friend  
DO-NÓV-OY VSTRÉCHIE VA VÉERIE,  
VSYEVÓ VAM DÓBROVÓ MOY DROOK  
SYÉ-EM DYÉSIT TREE

UK9ACP this is VK3ST. Goodbye, thankyou (very much)  
OOLYÁRNA KÓSTYA DYÉVIT ANNA  
CENTRÁLI PARVÍL YA ZOOK KÓSTYA TREE  
SÉGAY TAKYÁNA. DOS-VID-ÁNIA.  
SPASÍBA. (BOLSHYÓYE)

The above should be enough to get you through a very basic QSO and remember that most Russians speak a limited amount of English so don't be afraid to change language if you lose track, can't understand or want to know/respond to some other comment. Some other useful phrases that may help are:

How do you say in Russian the word (or phrase) "EAST"

KAK BÓODET PARÚSKI "EAST" (last work is english for translation or KAK PA-RÚSSKI SLOV "EAST"

Good  
HOR-OSHA-YÓ (HOROSHÓ)

I am sorry  
YA Ó-CHEN SOZ-OLÁYOO

What is your callsign?  
KAKOVÍ VASH POZNÍVOY?

Please  
PAZHÁOOSTA

Please give me your name? (QTH)  
PAZHÁOOSTA DÁITYE SNÓWA VASH  
ÍMYA? (GÓOROD)

Repeat your name? (QTH)  
POV-TOR-ÍTA SNÓWA VASH ÍMYA?  
(GÓOROD)

Thankyou very much my friend.  
BOLSHÓYE SPASÍBA MOY DROOK

I hope to see you again.  
YA NAD-E-YÓOS RAZ-GOV-ÁRIVAT  
SVÁMI SNÓWA

I — YA ... Yes — DA ... No — NIET ...  
Friends (plural) — DROOZ-YÁ ... If speaking  
to a lady, one should say "MOYÁ  
PADRÓOGA" My friend

The temperature is 20 degrees (above  
freezing)

DVÁTSAD GRA-DÚSAF (TIPLÁ) or TEM-  
PERATOÓRA DVÁDSAT GRADOÓSOF

Today is good weather  
SIVÓD-NYA HOR-ÓSHO-YA PA-GÓ-DA

Today it is  
SIVÓD-NYA (Warm) TIPLO ... (Very hot)  
ÓCHEN ZHÁRKO ... (Hot) ZSÁRKO ...  
(Cool) PRA-KHLÁDNA ... (Cold)  
KHOLODNA

Please speak slowly  
PASZÁLSTA GAVA-RÍ-TYE M-YED-  
LYÉNNÁ

I do not understand you  
YA NYE PANI-MÁYU VAS

To those of you who are willing to give it a  
go, I am sure that you will find that contrary to  
popular belief, learning to use a language can  
be very satisfying and will certainly put some  
value on those QSL cards that are received via  
Box 88 in Moscow.

In conclusion, I would like to thank Gene  
Shcumat, UA9AAP and the many other  
Russian speaking amateurs who have assisted  
me during my initial learning period and I feel  
that a special bond grows and develops  
between those who try to help others and this  
should be encouraged wherever and when-  
ever possible. Remember that we are in a  
specialist area that involves communication  
and communicating. Let us get out there and  
communicate and learn from one another.

#### EDITOR'S NOTE

Thanks are due to R Hancock, VK5AFZ, for  
checking and, where necessary, correcting a  
few phonetic equivalents and also for the  
following notes.

Use of the Russian phonetic alphabet is not  
really necessary, as all Russian amateurs are  
familiar with the International Phonetic  
Alphabet. However, the Russian system is  
used to a greater extent between Russians  
themselves so it is handy to know if you want  
to "eavesdrop" on USSR stations. Personally I  
would advocate that everyone uses the  
International Phonetics on all occasions for  
the sake of uniformity and to avoid confusion.

Also, a reminder that VK stations conduc-  
ting a QSO in a foreign language are required  
to identify their call letters in English at the  
appropriate intervals. Identification in the  
foreign language only is not sufficient.

AR

# SERVICE BULLETIN

## or do your own repairs??

### • MODIFICATION TO ALLOW AUTOMATIC MODE SWITCHING

This modification causes the SX200N to automatically switch to AM mode when any Airband frequency in the 108 to 139.995 MHz frequency range (band A4) is programmed into it. Additionally, the front panel mounted AM/FM switch allows manual AM override on any of the other bands (i.e. A1, 2, 3, 5, & 6). So that the

manual AM/FM selection may be used on all bands except A4 where the user is restricted to operation in the AM mode only.

This information has been kindly supplied by GFS Electronic Imports, 15 McKeon Road, Mitcham 3122.

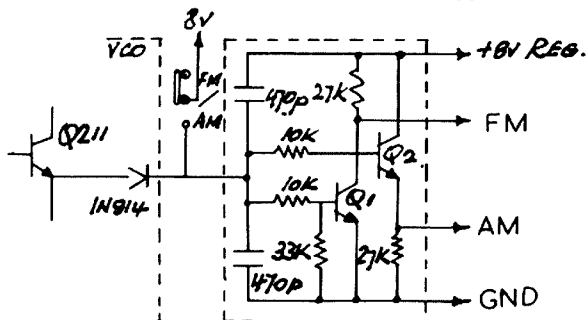
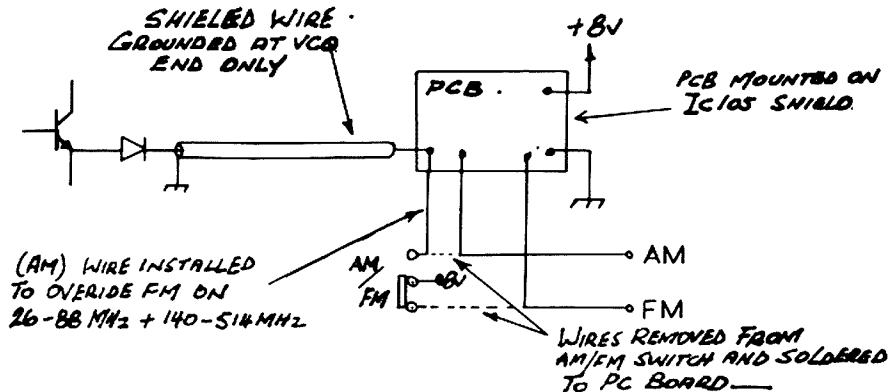

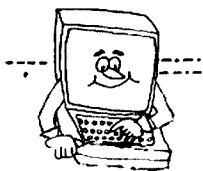

# MORSE CODE AND YOUR COMPUTER

Alan MacLean, VK3ASL  
1/138 Bluff Road, Black Rock, Vic 3193

About two years ago, I become interested in computers and bought myself a TRS-80. There were a number of other computers available and a wide range of prices. Knowing nothing about any of them, I settled for the TRS-80 on the recommendation of a friend who had one.

I learned to programme it by following the excellent instructional manual which came with it, but I found it helped to study a couple of other books on basic programming which were available from the Tandy Store.

I knew computers could be used for sending and receiving Morse code and RTTY but had no idea how to write a programme to do this and enquired about getting a programme already written. The programmes advertised by various software suppliers seemed to be limited to calculating the lengths of elements for antennas or for keeping a log book. There were hardware and software packages that could be bought, but these seemed to be far too expensive.

Finally, I decided to write a programme myself. I looked for guidance in various magazine articles, but the authors were theorising with algorithms about how it could be done or giving programmes in machine language which I didn't understand. I'm strictly a self-taught Basic only programmer.

There seemed to be three problems:

- how to generate Morse
- how to decode Morse
- how to connect (interface) the computer to the rig.

I found out that, without some more expensive hardware, the TRS-80 could only communicate with the outside world through its connections to the cassette tape recorder used for loading and storing programmes. One of the connections is to the remote plug of the recorder and its function is to turn on the recorder's motor during recording or play-back. I set to work to write a programme that would turn on the motor for the length of a dit, turn it off for the same time, then turn it back on for the length of a dah. By connecting the remote plug to an audio oscillator instead of the tape recorder, that would have sent the letter A.

The instruction "OUT 255,04" turns on the motor and "OUT 255,0" turns it off again. A delay loop is needed to determine how long the motor is on or off. As we are not using the motor, it's really a matter of how long the cassette relay in the computer is turned on or off, which governs how long the oscillator is on or off.

I found by experimenting that the Morse speed in WPM when divided into 400 gave the number of loops required for a delay equal to one dit at that speed. I use the expression "X1=(400/B1)", where "X1" is the number of loops and "B1" is the number of WPM. Thus the instruction needed to send a dit is: 10 OUT 255,04: FOR I=1 TO X1: NEXT I: OUT 255,0. There is a need to send a dit length space after

each dit or dah, so the next instruction would be: 20 FOR I=1 TO X1: NEXT I.

Because a dah is three times as long as a dit, the loop needs to be of a length equal to X1\*3 (X1 multiplied by 3 for those who don't read Basic). So a dah followed by a space would be sent by: 30 OUT 255,04: FOR I=1 TO X1\*3: NEXT I: OUT 255,0: FOR I=1 TO X1: NEXT I. If we put in another line: 40 GOTO 10 we have written a programme that will keep on sending DIT DAH until you switch it off.

If we put a space the length of 3 DITS after the DAH, the letter A will be sent continuously, so we'll amend line 40 to read: 40 FOR I=1 TO X1\*3: NEXT I: GO TO 10.

The next thing is to construct a piece of hardware, so that you can hear the Morse sent. For this you will need a small relay, a battery to run it, an audio oscillator module and a separate battery if it happens to use a different voltage from the relay. A small speaker will allow you to hear the oscillator.

Make up the hardware, plug in the remote plug, and enter the programme. If you have a TRS-80 you should now be able to hear continuous A's. If you don't have a TRS-80, but your computer has connections for an external tape recorder, it may work if you find out the number of its cassette port and substitute that for the number 255 in the programme. If your computer doesn't have such a connection, I'm afraid I don't know what you can do.

Being able to send a lot of A's will not be of much practical use, so a bit more programming is needed to send all the other letters of the alphabet, as well as figures and punctuation.

I might say at this stage that since writing my programme, I have learned of several other ways to generate Morse with a programme in Basic, and know that there are a number of machine language programmes that will do it. However, this one is the only one that I have tried, so I'll stick to what I know.

The next step is to write sub-routines for sending one, two and three dits, and one, two and three dahs. Any letter, figure or symbol will be made up of one or more of these. Then we can input a letter to the computer by typing it on the keyboard, and have the computer say to itself "if this is an A, then GOSUB for one dit and GOSUB for one dah and return for the next letter". For the letter C it would be GOSUB for a dah then a dit then a dah and another dit. The input of the letter is achieved by the INKEY\$ function of the computer which strobes the keyboard to find out which letter has been pressed, then calls

up the sub-routine for generating the dits and dahs for that letter.

If you have a look at the programme listing, you will see that line 120 is the INKEY\$ function which determines which key has been pressed. Line 130 converts that letter to its ASCII equivalent (that is — a number which means a letter).

Lines 130 and 131 convert the ASCII numbers so that A to Z equals 1 to 26 and 0 to 9 equals 27 to 36.

Line 137 causes the computer to go to one of the lines between 310 and 650 which means the appropriate letter or figure. That line then calls up the sub-routine that generates the Morse for the letter or figure. Much the same thing happens with lines 170 to 270, which generate some useful phrases and punctuation, etc, and line 180 which sends eight dits to indicate an error. The other parts of the programme do things like sending pre-recorded messages, and if you've been able to follow the explanation so far, you'll have no difficulty in working them out.

The next part of the programme is a bit more difficult. This is the part that decodes Morse. The following short version of the decode portion, which has explanatory statements may help you to understand it. Even though I wrote it, I have to think pretty hard myself to work out what it is doing. I mentioned earlier that there are other programmes available to send Morse. As well, there are programmes you can buy to decode Morse. The ones I have seen are either in machine language so I don't know what is happening or they are in Basic and don't work. At least, I haven't been able to make them work — and I believe that I'm not alone in this. Anyway, mine does work — if the Morse comes from a code oscillator — but I have problems if the Morse comes off the air. To some extent this is due to static and random noise, but I think that to a large extent, it is due to badly keyed Morse.

Anyway programme 1 is a short listing of the decode section of the programme which has Rem statements which may help you to understand what it is doing:

The programme senses whether there is a signal at the input port number 255, which is the cassette input to the computer. If the value of that port is 255 then there is a signal and if there is no signal, the value is 127. I don't really know why, it just works that way. Then the time that the signal is there is measured to find out if the signal is long or short — that is — whether it is a dit or a dah. In between dits and dahs the spaces are measured to find out



```

15 INPUT "SPEED IN W.P.M.":W: REM** OMIT WHEN MERGED WITH SEND ROUTINE, WHICH HAS A SIMILAR INPUT
16 Z=1744/48*1/W: REM** Z=LENGTH OF ONE DIT. LINES 30+31 & 40+41 LOOP 1744 TIMES IN A MINUTE. THE LENGTH OF ONE WORD IS EQUAL TO 48 DITS AT 1 W.P.M. W IS THE NUMBER OF W.P.M.
21 A$=INKEY$:IFA$=" $"GOTO 15 REM** HIT $ TO CHANGE SPEED.
22 REM IF A$="#" GOTO ** START OF 'SEND' ROUTINE
23 V=V+1:IF U=1 AND V>=Z*5 THEN PRINT CHR$(32):U=0: REM**PRINTS A SPACE AT THE END OF A WORD.
25 IF INP(255)=127 THEN 21 ELSE 40 REM**LOOKS TO SEE IF THERE IS A CHANGE OF SPEED OR RETURN TO SEND ROUTINE.
30 V=0:X=0:Y=Y+1::IFY=>Z*3 THEN 101 REM** IF SPACE IS EQUAL TO 3 DITS OR MORE, LETTER IS COMPLETE, SO PRINT IT.
31 IFINP(255)=127 GOTO30 REM **MEASURES TIME KEY IS UP.
40 OUT255,1:XXXXXXXXXXXXXXXXXXXXX=X+1
41 IF INP(255)=255GOTO40 REM **MEASURES TIME KEY IS DOWN. COLONS MAKE LOOP TIME OF 40+41 SAME AS 30+31 - 1744 PER MINUTE.
60 IF X>=ZAND X<Z*3 THEN T$="."
70 IF X>=Z+3 THEN T$="-"
80 W$=W$+T$:GOTO30 REM** ACCUMULATES THE DITS AND DAHS UNTIL A LETTER IS COMPLETE.
101 IF W$=".-"THEN PRINT"A":GOTO150
102 IF W$="-. ."THEN PRINT"B":GOTO150
103 IF W$="-. ."THEN PRINT"C":GOTO150
104 REM LINES 104-140 COVER D-Z AND 1-0
141 IF W$="....."THEN PRINT"ERROR":GOTO150
150 W$="":U=1
160 Y=0:GOTO21 REM** GOES TO LOOK FOR THE NEXT LETTER.

```

**PROGRAMME 1**

whether they are spaces between symbols (one dit length) letters (one dah length) or words (five dit lengths).

If you try the programme and it doesn't seem to work — particularly if you get a lot of E's, I's or S's — change the value of W a little at a time until it comes good. However, unless you have a source of good clear Morse without any static or random noise, you'll get some funny results. The receive programme works quite well on Morse generated by the send portion of the programme and recorded on tape for later playback.

That brings us to the next point of how you get the received Morse into the computer so that you can decode it.

Morse recorded on tape can just be put in through the normal cassette connection to the computer. To hook up a rig, it would probably only be necessary to take a lead from the phone jack or extension speaker socket, or even by a tap across the voice coil

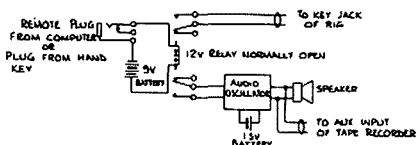

**A small piece of hardware.**

of the speaker, so long as the audio level is the same as it would be if the audio were coming from the cassette recorder. To be on the safe side, I feed the receiver audio into the Aux socket of the tape recorder, which is in the Record mode and has the Remote plug inserted so that the tape won't run. It's best to use the very start of the tape, where there is nothing recorded. That way, the computer is looking into something it is used to.

To record Morse, simply connect the voice coil of the speaker used with the audio

oscillator into the Aux socket of the tape recorder.

To connect the computer to the rig to transmit Morse on the air, connect the spare set of contacts (the normally open ones) on the relay in the piece of hardware mentioned earlier to the key jack of your rig.

No doubt, the receive portion of the programme would work better if it was in machine language, but I don't know how to do that. You may think that the send portion is a bit cumbersome, with all those GOSUB's. However, it is written and it works. If I were doing it again I would do it differently, but isn't that the same with any project we attempt?

If you would like a copy of the programme on cassette tape, I'll be glad to supply it — just send me a Jiffy bag and enclose a cassette tape, your name and address and return postage.

AR

*Computer Programme for Morse Code next page . . .*



**QSP**

**OLYMPIC GAMES 1984**

*Amateurs in California with the numeral 6 in their call sign will have the opportunity to commemorate the 23rd Olympiad in 1984 during the months of July and August.*

*The FCC will permit the amateurs to substitute the number 6 with either "23" for the 23rd Olympiad or "84" on a voluntary basis.*

*from The ARRL Letter, Vol 2 No 20.*

**NEW AWARD**

*The "Lower Eyre Peninsula Amateur Radio Club Inc", based at Port Lincoln, on Lower Eyre Peninsula, will have the official opening of its new club facilities on Sunday, 29th January, 1984.*

*To mark the occasion, a first ever Eyre Peninsula Award will be issued with a special endorsement for opening day. The official opening of the club rooms and the launching of the award will coincide with the city's annual "Tunarama Festival".*

AR

```

10 'TO CHANGE CALL SIGN EDIT LINES 70, 1010 AND 1060
20 CLS
30 PRINT"                                     ***MORSE CODE***"1/4/83.
35 'WRITTEN BY ALAN MACLEAN, VK3ASL, QTHR.
40 INPUT"INSERT SPEED REQUIRED IN WORDS PER MINUTE":B1
50 X1=(400/B1)
60 PRINT"TUNE          !.  SEND          #.  CHANGE SPEED  $.  RECEIVE  %."
70 PRINT"COMMENCE  &.  CALL CO  ?.  FROM          (.  VK3ASL  )."
80 PRINT"END OVER  *.  BREAK  =.  END MESSAGE  @.  ERROR  +."
90 PRINT"TYPE ↑ TO SEND MESSAGE ENTERED IN LINES 910 AND 960"
110 P1=0:K=0:J=0:Q1=0:J1=0:R1=0
120 B$=INKEY$:IFB$=""THEN120
130 A1=ASC(B$):IFA1>64ANDA1<91THEN A1=A1-64:GOTO137
131 IFA1>47ANDA1<58THENA1=A1-21:GOTO137
132 IF A1=32 THEN GOTO 300 ELSE 139
137 ON A1 GOTO 310,320,330,340,350,360,370,380,390,400,410,420,430,440,450,460,4
70,480,490,500,510,520,530,540,550,560,565,570,580,590,600,610,620,630,640,650
139 IF B$="!"GOSUB800:GOTO110
140 IF B$="#"THENPRINTCHR$(10)"**SENDING**":GOTO110
150 IF B$="$"GOTO20
160 IFB$="%"GOTO1120
170 IFB$="&"GOSUB740:GOSUB710:GOSUB740:GOSUB710:GOSUB740:GOTO670
180 IFB$="?"THENQ1=1:GOTO1000
190 IFB$="("GOSUB740:GOSUB710:GOSUB710:GOSUB780:GOSUB710:GOTO670
200 IFB$=")"THEN R1=1:GOTO1050
210 IFB$="*"GOSUB710:GOSUB740:GOSUB710:GOSUB740:GOSUB710:GOTO670
220 IFB$="="GOSUB740:GOSUB730:GOSUB740:GOTO670
230 IFB$="@"GOSUB730:GOSUB740:GOSUB710:GOSUB740:GOTO670
240 IFB$=","GOSUB750:GOSUB720:GOSUB750:GOTO670
250 IFB$="."GOSUB710:GOSUB740:GOSUB710:GOSUB740:GOSUB710:GOSUB740:GOTO670
260 IFB$="?"GOSUB720:GOSUB750:GOSUB720:GOTO670
270 IFB$="/"GOSUB740:GOSUB720:GOSUB740:GOSUB710:GOTO670
280 IFB$="+GOSUB710:GOSUB780:GOSUB710:GOSUB780:GOSUB710:GOSUB780:GOSUB710:GOTO1
700
290 IFB$="↑"THENP1=1:GOTO900
300 GOSUB775:GOTO670
310 GOSUB710:GOSUB740:GOTO670''A
320 GOSUB740:GOSUB730:GOTO670''E
330 GOSUB740:GOSUB710:GOSUB740:GOSUB710:GOTO670''C
340 GOSUB740:GOSUB720:GOTO670''D
350 GOSUB710:GOTO670''E
360 GOSUB720:GOSUB740:GOSUB710:GOTO670''F
370 GOSUB750:GOSUB710:GOTO670''G
380 GOSUB710:GOSUB730:GOTO670''H
390 GOSUB720:GOTO670''I
400 GOSUB710:GOSUB760:GOTO670''J
410 GOSUB740:GOSUB710:GOSUB740:GOTO670''K
420 GOSUB710:GOSUB740:GOSUB720:GOTO670''L
430 GOSUB750:GOTO670''M
440 GOSUB740:GOSUB710:GOTO670''N
450 GOSUB760:GOTO670''O
460 GOSUB710:GOSUB750:GOSUB710:GOTO670''P
470 GOSUB750:GOSUB710:GOSUB740:GOTO670''Q
480 GOSUB710:GOSUB740:GOSUB710:GOTO670''R
490 GOSUB730:GOTO670''S
500 GOSUB740:GOTO670''T
510 GOSUB720:GOSUB740:GOTO670''U
520 GOSUB730:GOSUB740:GOTO670''V
530 GOSUB710:GOSUB750:GOTO670''W
540 GOSUB740:GOSUB720:GOSUB740:GOTO670''X
550 GOSUB740:GOSUB710:GOSUB750:GOTO670''Y
560 GOSUB750:GOSUB720:GOTO670''Z
565 GOSUB760:GOSUB750:GOTO670''O

```

```

570 GOSUB710:GOSUB740:GOSUB760:GOTO670''1
580 GOSUB720:GOSUB760:GOTO670''2
590 GOSUB730:GOSUB750:GOTO670''3
600 GOSUB730:GOSUB710:GOSUB740:GOTO670''4
610 GOSUB730:GOSUB720:GOTO670''5
620 GOSUB740:GOSUB730:GOSUB710:GOTO670''6
630 GOSUB750:GOSUB730:GOTO670''7
640 GOSUB760:GOSUB720:GOTO670''8
650 GOSUB760:GOSUB740:GOSUB710:GOTO670''9
670 GOSUB775:PRINTB$:
680 IF P1=1 THEN GOTO 900
690 IF Q1=1 THEN GOTO1000
695 IF R1=1 THEN GOTO1050
700 GOTO110
710 OUT255,04:GOSUB770:OUT255,0:GOSUB770:RETURN''DIT
720 OUT255,04:GOSUB770:OUT255,0:GOSUB770:OUT255,04:GOSUB770:OUT255,0:GOSUB770:RE
TURN:''2 DITS
730 OUT255,04:GOSUB770:OUT255,0:GOSUB770:OUT255,04:GOSUB770:OUT255,0:GOSUB770:OU
T255,04:GOSUB770:OUT255,0:GOSUB770:RETURN''3DITS
740 OUT255,04:GOSUB780:OUT255,0:GOSUB770:RETURN''DAH
750 OUT255,04:GOSUB780:OUT255,0:GOSUB770:OUT255,04:GOSUB780:OUT255,0:GOSUB770:RE
TURN:''2 DAHS
760 OUT255,04:GOSUB780:OUT255,0:GOSUB770:OUT255,04:GOSUB780:OUT255,0:GOSUB770:OU
T255,04:GOSUB780:OUT255,0:GOSUB770:RETURN''3 DAHS
770 FORA1=1TOX1:NEXT:RETURN''DIT LENGTH
775 FORA1=1TOX1*2:NEXT:RETURN''SYMBOL AND WORD SPACE
780 FORA1=1TOX1*3:NEXT:RETURN''DAH LENGTH
800 OUT255,04:FORA1=1TO3000:NEXT:OUT255,0:RETURN''KEY DOWN 6 SECS
900 J=J+1
910 C$="A MESSAGE OF 255 CHARACTERS MAY BE INSERTED HERE."
920 IFJ>LEN(C$) THEN 950
930 B$=MID$(C$,J,1)
940 GOTO130
950 K=K+1
960 D$=" AND ANOTHER ONE HERE."
970 IF K>LEN(D$) THEN 110
980 B$=MID$(D$,K,1)
990 GOTO 130
1000 J1=J1+1
1010 J1$="CQ CQ CQ DE VK3ASL VK3ASL VK3ASL + K"
1020 IF J1>LEN(J1$) THEN 110
1030 B$=MID$(J1$,J1,1)
1040 GOTO130
1050 J1=J1+1
1060 L1$="VK3ASL"
1070 IFJ1>LEN(L1$) THEN 110
1080 B$=MID$(L1$,J1,1)
1090 GOTO130
1120 PRINTCHR$(10)"**RECEIVING**"
1130 Z=1744/48*1/B1
1150 A$=INKEY$:IFA$="$" GOTO20
1160 IF A$="#" THEN PRINTCHR$(10)"**SENDING**":GOTO110
1170 V=V+1:IF U=1 AND V>=Z*5 THENPRINTCHR$(32):U=0
1180 IF INP(255)=127 THEN1150 ELSE1210
1190 V=0:X=0:Y=Y+1::IFY>Z*3 THEN1260
1200 IFINP(255)=127 GOTO1190
1210 OUT255,1::::::::::X=X+1
1220 IF INP(255)=255GOTO1210
1230 IF X>=ZAND X<Z*3 THENT$="."
1240 IF X>=Z*3 THENT$="-"
1250 W$=W$+T$:GOTO1190
1260 IF W$=".-" THENPRINT"A":GOTO1630
1270 IF W$="..." THENPRINT"B":GOTO1630
1280 IF W$="--." THENPRINT"C":GOTO1630

```

```

1290 IF W$=".." THENPRINT"D":GOTO1630
1300 IF W$="." THENPRINT"E":GOTO1630
1310 IF W$=".-" THENPRINT"F":GOTO1630
1320 IF W$="--" THENPRINT"G":GOTO1630
1330 IF W$="..." THENPRINT"H":GOTO1630
1340 IF W$="..." THENPRINT"I":GOTO1630
1350 IF W$="----" THENPRINT"J":GOTO1630
1360 IF W$="--" THENPRINT"K":GOTO1630
1370 IF W$=".-" THENPRINT"L":GOTO1630
1380 IF W$="--" THENPRINT"M":GOTO1630
1390 IF W$=".." THENPRINT"N":GOTO1630
1400 IF W$="----" THENPRINT"O":GOTO1630
1410 IF W$=".-" THENPRINT"P":GOTO1630
1420 IF W$="--" THENPRINT"Q":GOTO1630
1430 IF W$=".-" THENPRINT"R":GOTO1630
1440 IF W$="..." THENPRINT"S":GOTO1630
1450 IF W$="--" THENPRINT"T":GOTO1630
1460 IF W$=".-" THENPRINT"U":GOTO1630
1470 IF W$="..." THENPRINT"V":GOTO1630
1480 IF W$=".-" THENPRINT"W":GOTO1630
1490 IF W$="----" THENPRINT"X":GOTO1630
1500 IF W$=".-" THENPRINT"Y":GOTO1630
1510 IF W$="--" THENPRINT"Z":GOTO1630
1520 IF W$="----" THENPRINT"1":GOTO1630
1530 IF W$=".-" THENPRINT"2":GOTO1630
1540 IF W$="..." THENPRINT"3":GOTO1630
1550 IF W$="----" THENPRINT"4":GOTO1630
1560 IF W$="....." THENPRINT"5":GOTO1630
1570 IF W$="-----" THENPRINT"6":GOTO1630
1580 IF W$="-----" THENPRINT"7":GOTO1630
1590 IF W$="-----" THENPRINT"8":GOTO1630
1600 IF W$="-----" THENPRINT"9":GOTO1630
1610 IF W$="-----" THENPRINT"0":GOTO1630
1620 IF W$="....." THENPRINT"ERROR":GOTO1630
1630 W$="":U=1
1640 Y=0:GOTO1150
1700 GOSUB780:GOSUB710:GOSUB780:GOSUB710:GOSUB780:GOSUB710:GOSUB780:GOSUB710:GOT
0670

```



## Bill Blitheringwit & the BLACKOUT . . .

Ted Holmes VK3DEH  
20 Edmond Street, Parkdale, Vic 3195

Bill Blitheringwit was thoroughly fed up with the whole mobile situation. It had been nothing but disaster from beginning to end, resulting in a mutilated car and a wrecked antenna, not to mention a microphone trampled beyond redemption. He decided he had had enough of being banned from the house by a determined better half and that it was time he resumed activities inside. Afetr all, it had been weeks since the affair of the ruined antenna and a new one had been erected by then by a tradesman.

A tradesman! Merciful heavens! Couldn't Bill have done that sort of thing himself? Amateur Radio was about doing things yourself and his wife hadn't let him. Instead she had insisted on having the job done "properly" (as she put it). Bill still smarted about this. There the thing stood, shiny and new, right on top of the chimney and Bill still harboured a smouldering resentment about the cost. He could have done

Then the smoke started. Thick, oily and revolting. It camethrough the holes in the top of the power supply box and got steadily thicker.

This caused Bill some alarm. The device had never done this before, even though he could recall hearing unusual pops and squeaks from it last time he had used it. He wasn't sure what to do. It didn't occur to him to switch off the power supply at the socket. Instead he suddenly remembered he had a glass of beer with him. Instantly he tossed the contents of the glass over the supply, so it would fall through the holes and put the fire out.

There was a loud bang as the house fuses blew and Bill's wife, happily watching TV with her brand new antenna, was dramatically plunged into darkness. a better job himself for half the price!

He wandered into his long neglected

shack and stared at his gear. It was covered with a fine film of dust and quite a few cobwebs. This wasn't because of his enforced absence: it always looked like that. Bill felt something stirring within him, a strange longing tinged with frustration and a certain amount of trepidation. There was his ancient Star, the Rolls Royce of rigs, neglected, lonely and calling for him.

Suddenly he sat at the table. Dare he? Why not? After all, Amateur Radio was about doing your thing and why shouldn't he do his? Damn it! A man can stand just so much! He turned on the power supply. It was silent and did not emit the loud hum he was used to. Strange! The plug was in and switched on. He gave the cord a yank and at this stage the smell began. It was a smell like an old incinerator, mixed with burning rubber, together with dust. He wiggled the power cord about a bit and heard odd crackling sounds.

# ABBREVIATIONS IN COMMON USE

*Magazine articles and books dealing with almost any aspect of modern electronics will be found to contain quite a few acronyms and other abbreviations for frequently-used terms. Once the abbreviations are known, communication often becomes easier and more efficient than if they were not used; but until the abbreviations are known, it can be very difficult. Below you will find most of the abbreviations in common use, with their meanings briefly explained. Used as a reference, this should allow you to follow most articles and books. Specialised or less frequently used abbreviations should usually be defined in the articles in which they appear, either in the text at the first appearance, or in a separate glossary. For more complete explanations of meanings than are given here, refer to standard texts.*



**A** — Ampere (Amp)  
**AC, ac** — Alternating current  
**AF, af** — Audio frequency  
**agc** — Automatic gain control  
**AH** — Hamads — at home or private number. After hours  
**ALC, alc** — Automatic level control  
**AM, am** — Amplitude modulation  
**AMSAT** — The Radio Amateur Satellite Corporation  
**anl** — Automatic noise limiter  
**AOCP** — Amateur Operator's Certificate of Proficiency  
**AR, ar (s)** — Amateur radio (service), Amateur Radio magazine  
**ASCII** — American Standard Code for Information Interchange  
**ATV** — Amateur television  
**avc** — Automatic volume control  
**balun** — Balanced to unbalanced transformer  
**bc** — Broadcast  
**BCD, bcd** — Binary coded decimal  
**bci** — Broadcast interference  
**BFO, bfo** — Beat frequency oscillator  
**bit** — Binary digit  
**Bus** — Hamads — business or working hours, office hours  
**CB** — Citizens band  
**CCIR** — ITU — Comité Consultatif International des Radio communications  
**Ch** — Channel  
**cm** — Centimetre  
**coax** — Coaxial cable  
**CRO** — Cathode Ray Oscilloscope  
**CW, cw** — Continuous wave, carrier wave (Morse)  
**dB** — Decibel  
**DC, dc** — Direct current  
**DX, Dx** — Distance (relative)  
**EHF, ehf** — Extra High Frequency (30-300 GHz)  
**EHT, ehl** — Extra High Tension (V)  
**EMC** — Electromagnetic Compatibility  
**EME** — Earth-moon-earth (moonbounce)  
**emf** — Electromotive force (V)  
**ERP, erp** — Effective radiated power  
**F** — Farad  
**FCC** — Federal Communications Commission (USA)  
**FET** — Field effect transistor  
**FM, fm** — Frequency modulation ("NB" — narrow band)  
**fsd** — Full scale deflection  
**FSK** — Frequency shift keying (F1 mode)

**g** — Gram  
**GDO, gdo** — Grid dip oscillator  
**GHz** — Gigahertz (1000 MHz)  
**h** — Hour (24 hour clock), hecto  
**H** — Henry  
**HF, hf** — High frequency (3-30 MHz)  
**HI, hi** — Greetings  
**HT, hf** — High tension (V) (also hV, HV)  
**Hz** — Hertz (cycles per second)  
**IARU** — International Amateur Radio Union  
**IC, ic** — Integrated circuit  
**IF, if** — Intermediate frequency  
**ITU** — International Telecommunications Union  
**k** — Kilo (1000) — e.g. kilo-ohm (1000 ohms)  
**kg** — Kilogram  
**kHz** — Kiloherzt (1000 Hz)  
**km** — Kilometre  
**kV** — Kilovolt  
**kW** — Kilowatt  
**LAOCP** — Limited Amateur Operator's Certificate of Proficiency  
**LC** — Inductance capacitance (ratio)  
**LED** — Light emitting diode  
**LF** — Low frequency (30-300 kHz)  
**LT** — Low tension (V)  
**m** — Metre  
**m** — Milli (one thousandth, 0.001)  
**M** — Mega (1,000,000; e.g. 1 MHz = 1000 kHz)  
**u** — Micro (0.000001) (one millionth)  
**uA** — 0.000001A (also uF, uH, uV)  
**mA** — Milliampere (0.001A) (also mM, mV, mW)  
**MCW** — Modulated CW (A2 mode)  
**meg** — Usually megohm  
**MF** — Medium frequencies (300-3000 kHz) (medium waves)  
**MHz** — Megahertz (1000 kHz)  
**mic** — Hamads — microphone (also mike)  
**micromicro** — Same as pico, obsolete term  
**mm** — Millimetre  
**mox** — Manual operated transmissions  
**MUF** — Maximum usable frequency  
**NL** — Noise limiter  
**ns** — Nanosecond (0.000000001) (one thousand millionth of a second)  
**OSC** — Oscillator  
**OSCAR** — Orbiting Satellite Carrying Amateur Radio  
**om** — Old man  
**P, p** — Power (p page, pp pages)  
**p** — Pico (0.000000000001) (one million millionth)

**PA, pa** — Power amplifier  
**PCB** — Printed circuit board  
**pep** — Peak envelope power  
**pF** — Picofarad  
**Ph** — Hamad — telephone No. (STD code first)  
**Phone** — (fone) Telephony-segment, voice transmission  
**piv** — Peak inverse voltage  
**PM, pm** — Pulse modulation, phase modulation  
**ppi** — Plan position indicator (radar)  
**PSU** — Power supply unit  
**Q** — Reactance-resistance ratio, transistor  
**Q code** — CW abbreviations — see Handbook for amateur operators  
**QTHR** — Hamad — address correct in current WIA call book  
**RF, rl** — Radio frequency  
**RFC, rfc** — Radio frequency choke  
**rfi** — Radio frequency interference  
**RI** — Radio Inspector  
**RMS, rms** — Root-mean-square  
**RST** — Readability, strength, tone (reporting signals) (RS only for telephony)  
**RT** — Radio Telephony  
**RTTY** — Radio teletype (teleprinter)  
**Rx** — Hamads — receiver  
**SAE** — Also sase. Sell Addressed Stamped Envelope  
**SHF** — Super High Frequencies (3-30 GHz) (microwave regions)  
**S/N, s/n** — Signal to noise (ratio)  
**SS** — Solid State  
**SSB** — Single Sideband (suppressed carrier) — A3J mode  
**SSTV** — Slow Scan Television  
**Std** — Standard  
**SWL** — Short Wave Listener  
**SWR** — Standing Wave Ratio  
**Tcwr** — Hamads — transceiver  
**TPI** — Turns per inch  
**tpig** — Tuned plate tuned grid  
**TV, tv** — Television  
**TVI, tvi** — Television interference  
**Tx** — Hamads — transmitter  
**UHF** — Ultra high frequencies (300-3000 MHz)  
**V** — Volt  
**VFO, vfo** — Variable frequency oscillator  
**VHF** — Very high frequencies (30-300 MHz)  
**VLF** — Very low frequencies (3-30 kHz)  
**vox** — Voice operated transmission  
**VOX** — Voice operated transmission  
**VU** — Volume unit  
**VXO** — Variable crystal oscillator  
**W** — Watt

# A TRICKY CALCULATION?

Last year this magazine held a competition which involved a one transistor amplifier. Although the usual rule of no correspondence being entered into applies, I think it might be interesting to look at the problem, which was as follows:

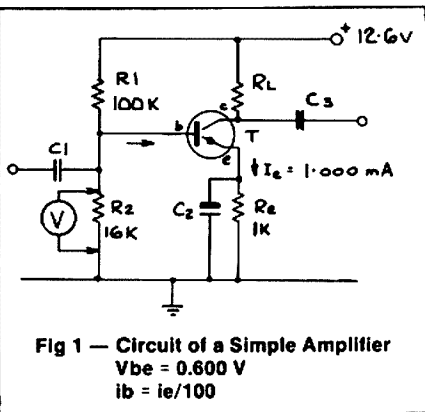

A one transistor amplifier is shown in Fig 1. The question was what readings would be obtained on

- (i) A volt meter with a 20 k ohm per volt sensitivity set on the 10 V range.
- (ii) A volt meter with a 10 M ohm input resistance.

Firstly let us check the voltage across R2 without the volt meter V.

The current through Re is 1 mA thus the voltage across Re,  $V = IR$

$$= 1 \text{ mA} \times 1 \text{ k ohm} \\ = 1 \text{ volt}$$

Now Vbe = 0.600 V

Thus the voltage at the base is 1.600 V positive with respect to ground. This is the same voltage as is across R2.

The current through R2 is

$$I = V/R \\ = 1.600/16 \text{ 000 amp} \\ = 0.1 \text{ mA}$$

The base current of the transistor is 1 mA/100 or 0.01 mA.

As both these currents come through R1 the current through R1 = 0.1 + 0.01 = 0.11

$$\text{The voltage across R1} = IR \\ = 0.11 \text{ mA} \times 100 \text{ k ohm} \\ = 11.000 \text{ V}$$

The voltage across R1 and R2 is thus 11.000 + 1.600 volts or 12.6 volts as shown. (Just as well!)

If we put a volt meter across R2 it will draw some current. For the first part of the question, the volt meter has a resistance of 20 k  $\Omega \times 10 \text{ V} = 200 \text{ k ohm}$ . This in parallel with R2 becomes less than 16 k ohms. It becomes Rp. The result of two resistors Ra, Rb, in parallel  $R_p = Ra Rb / (Ra + Rb)$  or 200 x

16/(200 + 16) k ohms. This works out as 14,814.814 ohms.

Obviously the voltage at the base of the transistor is reduced and consequently as  $V_{bc} = 0.600$  volts the voltage across Re must reduce hence  $I_e$  reduces. Now when  $I_e$  reduces so does  $I_b$  as  $I_b = I_e/100$ .

But  $I_b$  flows through R1 and helps determine the voltage at the base which determines  $I_b$  which . . . See the problem?

For those who don't like algebra this is a good point to stop reading.

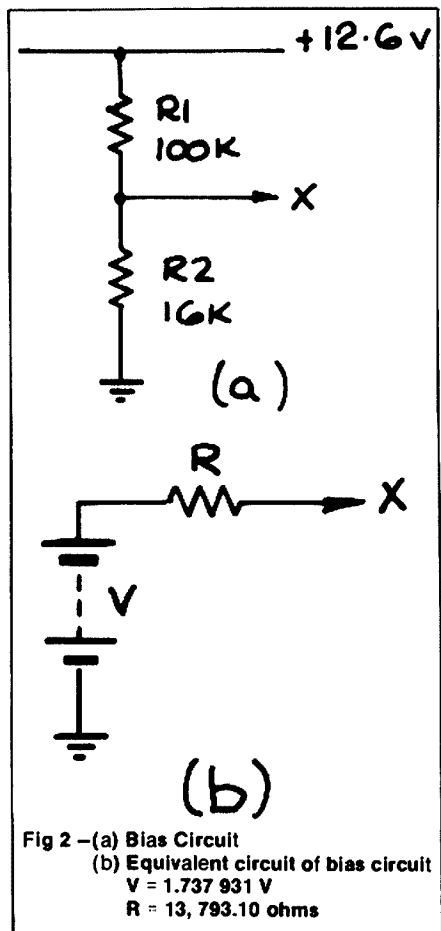

To solve the problem we need to redraw the circuit and to go on step by step. Consider Fig 2(a) which shows the bias resistors R1 and R2.

As drawn the open circuit voltage at X is  $16 \times 12.6 / (16 + 100) = 1.737 \text{ 931 volts}$ .

If we were to short X to ground the short circuit current would be  $12.6/100 \text{ k} = 0.126 \text{ mA}$ .

The bias circuit is equivalent to any circuit that has the same characteristics as itself. Fig 2(b) shows such an equivalent with  $V = 1.737 \text{ 931}$  and  $R = V/0.126 \text{ mA} = 13,793.10 \text{ ohms}$ . measurements between X and ground would not reveal any difference between it and that of 3(a).

Incidentally we have just used Thevenin's Theorem to get the equivalent circuit. Note that we have simplified the circuit so our calculations should be easier. Let's check. In the original circuit only the transistor was connected. The transistor may be represented as a 0.6 V volt drop, drawn as a battery to account for the Vbe drop and a resistor equal to the emitter resistance A, 1 k ohm, multiplied by the current gain = 100,000 ohms. This is shown in Fig 3. Remember that the effect of Re at the base of transistor T is modified by the current gain of the transistor (the principle of the emitter follower).

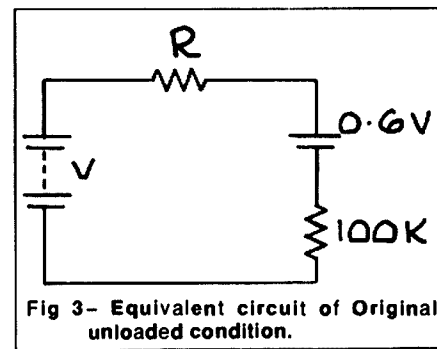

The current flowing in Fig 3 is  $I = V/R = (1.737 \text{ 931} - 0.600) / (100 + 13,793.1) \text{ mA} = 0.01 \text{ mA}$

This is the base current of the transistor T which is the same as we calculated before. So our equivalent circuits are working!

Fig 4 shows the effect of the volt meter. Note that so far, apart from Thevenin's Theorem which is really only a little logic, we have just been using Ohm's Law and a little knowledge of transistors. The next bit requires some algebra.

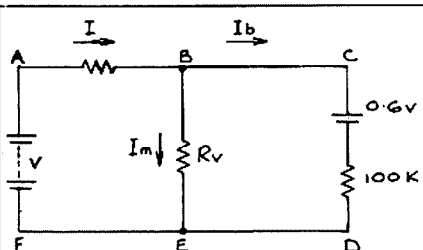

**Fig 4 — Equivalent circuit with volt meter added.**  
 $V = 1.737\ 931\ V$   
 $R = 13,793.10\ \text{ohms}$   
 $I_m = \text{meter current}$   
 $I_b = \text{base current}$   
 $I = I_m + I_b$   
 $R_v = 200\ \text{k ohms or } 10\ \text{M ohms}$

We can proceed several ways but here is one method.

Consider the two current loops. AB EF and ABCDEF.

Firstly (1)  $V - IR - I_m R_v = 0$   
 The volt drops must equal the supply voltage, or in other words the sum of the supply voltage and the volt drops in a closed circuit is zero.

Next (2)  $V - IR - 0.6 - I_b 100,000 = 0$   
 Also (3)  $I = I_b + I_m$

Using equation (3) we can re-write equations (1) and (2) and putting in the numeric values we get  
 $1.737\ 931 - 13,793.10 (I_b + I_m) - 200,000 I_m = 0$   
 $1.737\ 931 - 13,793.10 (I_b + I_m) - 0.6 - 100,000 I_b = 0$

These equations can be solved to get  $I_b$  and  $I_m$ . (Find someone studying year 10 or 11 at High School.)

If you work through it you will get  $I_m = 7.5429\ \mu A$ . The meter reading is of course  $I_m \times R_m = 7.5429\ \mu A \times 200\ \text{k} = 1.509\ \text{volts}$

Similarly for  $R_m = 10\ \text{M ohm}$   $V_m$  is found to be 1.598 volts. Ok so it is not all that easy, but then the prize was well worth a little effort.

Actually the calculations are just a little tedious and not at all tricky. Although it is a practical problem you might encounter, it is beyond the AOCPL syllabus — or at least at the moment the calculations are.

Of course if you have a small computer system that you can use then the task of calculating the voltmeter reading can be much easier. Although initially the answers were worked out longhand and the programme shown here was used to check the answers. Also shown here are the results of three runs for metre resistances of 10 ohms, 200,000 ohms and 10,000 ohms.

Those of you with computers may like to use the programme which is written in BASIC. Expert programmers may find room for improving the programme.

At this stage I too reserve the right to not enter into further correspondence or debate on this topic.

73 de  
 VK3AFW  
 AR

```

5 REM BIAS/VOLTMETER LOADING
10 R1=100000
20 R2=16000
30 RT=1000
40 VBE=0.6
50 HFE=100
60 VCC=12.6
70 INPUT "METER RESIST. ";RM
100 VOC=VCC*R2/(R1+R2)
110 ISC=VCC/R1
120 REQ=VOC/ISC
130 A1=RM+REQ
140 A2=REQ
150 B1=REQ
160 B2=HFE*RT+REQ
170 D1=VOC
180 D2=VOC-VBE
190 GOSUB 1000
200 IM=XNUM/DENOM
210 VM=IM*RM
220 PRINT "READING = ";VM;"V."
230 END
1000 REM SIMIL. EQN SOL.
1010 DENOM=A1*B2-A2*B1
1020 XNUM=D1*B2-D2*B1
1030 YNUM=D2*A1-D1*A2
1040 RETURN
  
```

**Fig 5 — Computer Programme**

```

RUN
METER RESIST.? 10E6
READING =
1.59806295 V.

RUN
METER RESIST.? 200000
READING =
1.50857143 V.

RUN
METER RESIST.? 10000
READING =
.723287671 V.
  
```

**Fig 6 — Typical Printout**



**QSP**

**AMATEUR EXERCISE**

*During the week between the 11th and 18th September the City of Sydney and the Premier's Department of NSW staged a Carnivale Festival. One of the many venues was a fun run on the 18th organised by the Labour Council of NSW. The run was to start at 9 AM at the Botanical Gardens, go past the Opera House through the Rocks area, across the Harbour Bridge and back to the start, about 10 km in all.*

*WICEN were approached to provide emergency communications. Unfortunately owing to a previous commitment, they were not available. A group of nine amateurs then organised themselves to provide a base station and some ten check points along the route. Richard, VK2ANB was monitoring from home and provided the only telephone link.*

*The frequency used was 144.8 MHz FM. Fortunately no emergency occurred and communications were progress reports only.*

*The following amateurs participated with great enthusiasm: Glenys VK2NMH, Bob VK2YPE, Simian VK2AVD, Steve VK2KBL, Gary and YL Carrol VK2ZKT, Peter VK2YDP, Martin VK2PJW, Richard VK2ÄNB, and Kurt VK2KBG.*

*The group received a letter of thanks and congratulations for a competent and professional exercise from the secretary of the Labour Council for NSW.*

*Kurt Reichstadter, VK2KBG*

Did you hear about the send-off party in the completely automated office? The computer got loaded and tried to unfasten the electric typewriter's ribbon.

from "The Lyrebird"

**Search & Rescue TRS-80**

Can a TRS-80 have an important role in a search and rescue mission? Definitely, say several Utah TRS-80 users as they have demonstrated the use of the machine as members of Utah Civil Air Patrol in the USA.

Civil Air Patrol is a nationwide, volunteer organization dedicated to search and rescue, aerospace education and a youth programme.

Some of the functional programmes include compiling search effectiveness reports, listing a day's aircraft search effectiveness and — get this — offer a computer recommendation of best allocation of air search planes for the next day's effort.

Other programmes keep track of up to 50 planes participating on a search (listing pilot information, time launched, time landed and total hours flown), and programmes that convert latitude and longitude to the Air Force standard search grid (based on aircraft sectional maps) or converting the search grid back to latitude and longitude.

There are programmes that teach search and rescue technique by way of game format and programmes that keep track of people participating in search missions.

One of the most useful items of software is the "Aircraft Data" programme that keeps track of Utah Wing CAP's aircraft. This programme shows the status of the aircraft (including member-owned planes), the colour of each plane, and other items involved in search missions concerning pilot qualifications, plane equipment and configuration.

The air data programme runs on TRS-80 Model 1, 32K, with printer and disk. Other programmes will run on Level II, 16K.

The search programmes are easily changed to meet local requirements or even those of other groups apart from CAP involved in Search and Rescue missions.

TRS-80 owners or amateur radio operators who would like to obtain the software with the intent of assisting a search group are invited to contact Lt. Col. Jerry Wellman, Utah Wing Civil Air Patrol, 840 East 6th Avenue, Salt Lake City, Utah 84103, USA.

# A Transceiver

Spoil yourself this Christmas with a speci



**1 MINICOM IC-25A/H** A small package with 25 45 Watt punch, IC-25A H has 5 memories, 2 VFOs, 2 scanner systems and is a full featured 2 meter FM transceiver for the space conscious operator.

**2 MINICOM IC-45A**  
Small size 10 Watt unit featuring 5 memories, dual VFOs and much more. 70cm FM transceiver. The space saver.

**3 IC-745**  
All band, SSB, CW, RTTY, HF transceiver with general coverage receiver. 16 memory channels, IF shift and PBT as standard are just three of its features.

**4 IC-751** **NEW**  
Competition Grade all band HF transceiver with general coverage receiver. 32 memory channels, optional internal power supply, with FM as standard.

**5 IC-4E**  
70cm hand held for convenient FM repeater operation.

**6 IC-290H**  
State of the art 2 meter 25 Watt all mode transceiver with 5 memories and 2 VFOs. This unit provides base station features in a mobile package.

**7 IC-490A**  
A 70cm all mode transceiver with base station features like, full capability scanning, 5 memories, 2 VFOs and more. All of this in a mobile package.

**8 IC-271A** **NEW**  
25 Watts of FM, SSB, CW for 2 meters. Base station with 32 full-function memories for frequency offset, offset direction. AC option.

**9 IC-2KL**  
All solid state 500 Watt HF linear, automatic band change when used with ICOM HF system.

**ICOM AUSTRALIA PTY. LTD. 7 Duke Street, Windsor, Victoria, 3181 Australia. Phone: (03) 51 2284. Telex: AA35521 ICOMAS**



# for "All Seasons"

al deal from your authorized ICOM dealer.



**10 ICOM Scoops the World with IC-120** **NEW**

23 cm. 1 Watt. FM mobile transceiver opening up new horizons in the amateur radio spectrum, in a mini-package.

**11 IC-730**

All band, all mode, all solid state 100 Watt HF transceiver. This go-anywhere mobile has a built-in pre-amp.

**12 IC-471A** **NEW**

Base transceiver 25 Watts, all mode, 430-450 MHz. With 32 memory capacity, storing frequency, mode, offset direction and offset frequency. AC option.

**13 IC-AT500/100**

Automatic couplers for ease of operation with the ICOM HF system.

**14 IC-02A** **NEW**

2 meter hand held FM transceiver with keyboard entry, 10 memory channels, scanning and many sought after features.

**15 IC-04E** **NEW**

70 cm hand held transceiver with keyboard entry, 10 memory channels, and much much more.

**16 IC-R70**

For world wide coverage at its best try this commercial grade communications receiver, covering 2 MHz-30 MHz.

**17 IC-2A**

The ever popular synthesized 2 meter FM hand held, field proven radio.

All stated specifications are approximate and subject to change without notice or obligation. **WARNING:** when purchasing an ICOM unit, please confirm that you are dealing with an Authorized ICOM Dealer as the ICOM Warranty applies only to units supplied by ICOM Australia Pty Ltd to Authorized ICOM Dealers

Discover a new deal  
with ICOM Australia



**ICOM**

# INDEX FOR 1983

## ANTENNAE

TITLE	Month	Page
A 70 cm Base Station Antenna by late New Fenton, VK2ZBQ	Oct	21
A Different Dipole by Ray Wells, VK2BVO	Feb	6
Another Antenna Story reprinted from Jimmy	Jan	18
Another Useful Multiband Antenna — The Delta Loop by Guy Fletcher, VK2BBF	Jun	11
Broadband End Fed Antenna by A M Keightley, VK6YX	Jul	10
For You Antenna Buffs	Jan	23
Ground Plane Antenna by J Gazard, VK5JG	Aug	16
Microprocessor Controlled Antenna System by Ralph Birrell VK3BIP	Dec	20
New Life for the TH6DX by Jim Joyce, VK3YJ	Apr	16
Phased Vertical Antenna Arrays by Gil Sones, VK3AUI	Jan	10
Radiation, Antennas, then what?	Apr	51
Seven Element Yagi — Economy Version by Des Greenham, VK3CO	Jul	8
Triband Cubical Quad by Peter Hewitson, VK8PH	Nov	21
Two by Five Eighth Vertical for 6 m by Colin MacKinnon, VK2DYM	Sep	17
Who Says You Don't Have Room to put up a Long Antenna? reprint CO	Jan	13

## AWARDS

Amendments to Australian Awards	Jun	34
Amendments to Australian Awards	Sep	31
Ballarat & Western Zone Awards	Aug	42
Blue Lake Award	Feb	40
Brazil DX Award	May	42
CAGOU Award	Oct	52
Cape Northumberland Award	Feb	40
DUF Award	May	42
DXCC News & Awards Issued	Jan	34
Diploma del Milenario Award	May	42
Five Band WAP Award	Jan	34
Frankston & Monington Peninsula Award	Jun	34
Gold Coast ARS Award	Dec	69
Hanault's Award	Mar	30
Helvetia Award Rules	Mar	30
Lake Goldsmith Steam Rally Award	Apr	54
Malta Award	Nov	30
Malta Award	Oct	52
Moorabbin & District Award	Nov	30
Nigerian Awards	May	42
OSIJEK Award	Nov	30
Paraguay Award	Oct	52
Pioneer Shire Centenary Award address	Dec	69
Premier Town Award	Oct	52
Proposed Award changes	Feb	40
Ron Wilkinson Achievement Award for 1983	Mar	45
Rule changes for WIA Awards	Jul	46
SARG Award	Jan	34
SWL Award	Oct	52
Two African Award rules	Feb	40
WIA Awards Updated	Mar	30
WIA Special Awards	Feb	43
Work all Y2 Award Rules	Jul	46

## BOOK REVIEWS

100 Basic Projects, Microcomputers in Amateur Radio	May	39
ARRL Antenna Handbook	Feb	52
Amateur Radio & Electronics Study Guide	Dec	50
Beginners Guide to AR	Dec	50
How to buy and convert Surplus Electronic Equipment	Jan	31
Mini/Micro Soldering and Wire Wrapping	Mar	39
New Call Book & 70 Years of Valves	Oct	51

## CLUB CORNER

Eastern Zone Convention	Jul	9
EXPO, ANARTS, TARC & Western Suburbs	Nov	62
FMPARC, Sism Rally, Eastern Zone & Expo '83	Oct	26
Gold Coast Amateur Radio Society	Sep	53
Midland Zone & Mount Gambier Conventions	Apr	65
Moorabbin & District Field Day, EMDRC Expo '83	Aug	38
Repeater Group	Jun	24

## COMMERCIAL KINKS

CW Switching with TS520S	Jan	20
FT290R Battery Pack Blowup Prevention by Theo Vidler, VK1KV	Jan	26

## CONTESTS

ALARA Contest Rules	Sep	50
Airnet India DX CW Rules	Dec	62
Amendments & Corrections for 1982 RD Contest	Feb	30
Amendments to JM Results	Jul	50
Asian Contest Results	Jun	42
Asian DX 23rd Contest Results	May	37
Asian DX 24th Contest Results	May	37
BERU 1983 Contest Rules	Feb	30
CO WW WPX Contest Rules	Mar	32
Commonwealth Contest 1983 Results	Nov	44
Contest Champion	Oct	65
Contest Champion 1982/1983	Mar	32
Contest Champion 1982/1983	Aug	50
Eighty Metre World SSB Championship Rules	Dec	62
European DX Contest Rules	May	37
Forty Metre World SSB Championship Rules	Dec	62
Helvetia Contest Rules	Mar	32
JLRS Contest Rules	Sep	50
John Moyle Contest Rules	Jan	42
John Moyle Results	Jun	42
Keyman's of JA Contest	Jul	50
NZART Field Day Contest Rules	Jan	42
NZART Memorial Contest Rules	Jun	42
Novice Contest Rules	Sep	50
One Sixty Metre World SSB Championship Rules	Dec	62
OLF Activity Contest	Jul	50
RSGB CW & Phone Contest Rules	Sep	50
RSGB RTTY Results	Sep	50
RTTY World Championship Rules	Dec	62
Results 1982 Novice Contest	Feb	30
Ross Hull 1982 Results	May	37
Ross Hull Contest Rules	Nov	58
Rules for 1983 RD Contest	Jun	42
Sangster Shield Contest Rules	Apr	64
VK CW ORP Contest	Nov	58
VK-ZL QSO Results	Dec	62
VK-ZL RTTY WCY Results	Dec	62
VK-ZL Contest 1983	Aug	48
VK-ZL Oceania DX 1982 Contest Results	Apr	62
VK-ZL Oceania 1983 Rules	Apr	64
VK-ZL Oceania DX Contest Overseas Results	May	40
White Rose SWL Contest Rules	Jan	62

## EMC

ESD	Sep	46
A Fair Go	Apr	60
A warning from Canada	Aug	30
Audio Frequency Interference	Nov	40
Computer Car	Jul	48
Power Line Interference	Oct	64
Outlying Switching Power Supplies	Jan	32
Radiocommunications Bill	May	44
Review of RadCom Bill	Jun	54
RSTV, CATV, DBS... Australian Comment	Feb	50
US Gives FCC Power to Regulate EMI/RFI Susceptibility	Mar	42

## EQUIPMENT REVIEWS

Hai CT2100 and KB2100	Mar	14
ICOM IC-R70	Sep	22
KB R-X Noise Bridge	Nov	15
Kenwood R-2000 Receiver	Dec	16
Kenwood TR-7950 & Mobile One Hamtennae M10-1	Jul	20
Kenwood TS430S	Jan	22
Nicholls Woodpecker Blunker	Aug	18
Parameters 7040 Digi Multimeter	Dec	22
VoCom Telescopic 2 m Antenna	May	27

## GENERAL TOPICS

Adelaide's Participation in the departure of Anaconda II by Ian Hunt, VK5QX	Mar	22
ALARA — full list of members	Nov	56
All Men are equal in the eyes of radio enthusiast	Jan	40
Amateur Abbreviations	Dec	37
Amateur Achievement by Mike Provis, VK3KKA	Feb	39
Amateur Radio House by Bruce Bathols, VK3UV	Jul	7
Amateur Radio House by Susan Brown, VK2BSB	Aug	20
Amateur Television Goes Bush by Dick Robbins, VK3ARR/W6VNE	Jun	12
American over the horizon radio* A New Woodpecker by Bill Martin VK2EBM	Apr	59
An Englishman in Australia by Deryck Buckley, G3VLX/VK2EBZ	Apr	32
Anaconda Returns by Neil Penfold, VK6NE	Apr	49
Another Country by Alan MacLean VK3ASL	Dec	23
Bill Blitheringwit by Ted Holmes, VK3DEH	Aug	14
Bill Blitheringwit Goes on Air by Ted Holmes, VK3DEH	May	16
Bill Blitheringwit in trouble again by Ted Holmes, VK3DEH	Jan	17
Bill Blitheringwit & the Blackout by Ted Holmes VK3DEH	Dec	36
Cambridge University 600 kV Electron Microscope from Art & David Smith	Mar	19
DX — Who Pays? by Neil Penfold VK6NE	Dec	29
DXing to G land by Jim Swan, VK2BQS	Nov	29
DXpeditions! Are they worth the trouble? by Hugh Spence, VK6FS	Jan	27
Emergency and Distress Calls	Feb	36
Exercise "SES Mitchell" by Ted Gabriel, VK4YG	Sep	20
Farewell Dinner Function for Peter Dodd	Jan	9
Federal Convention 1983	Jul	24
Geomagnetic & Sunspot Activity 1983	Nov	71
Getting to know you by Tom Delandre, VK2PDT	Jan	14
Golden Jubilee by Jim Linton, VK3PC	Oct	12
Heard Island Expedition '83 by Neil Penfold, VK6NE	Apr	50
Heard Island Expedition by Neil Penfold, VK6NE	Feb	42
Hey-Day of Home Brewing	Oct	53
Hints and Kinks for Contest Operating by Jack, VK6JS	Apr	18
History of RAAF Wireless Reserve by Bob Cunningham, VK3ML	May	43
Horse Endurance Trials — Field Exercise by Ian Jackson, VK3BUF	Jul	16
How Much Can a 290R Take?	May	16
Ionospheric Predictions & Geomagnetic Activity 1982	May	52
Jamboree on the Air	Oct	56
Japanese DX on Two Metres	Nov	14
JM Field Day on an Island by Dennis Hardie, VK6KOZ	Sep	26
JOTA — Jamboree on the Air by Tom Delandre, VK2PDT	Sep	25
Main QSP — Six Metres, Part Returned	Sep	9
Main QSP — WCY 1983	Jan	5
Main QSP — Joint WIA & NZART Statement	Aug	9
Memorial to VK4LK & the Flying Doctor by Peter Renton, VK4PV	Oct	27
Message from the Minister for Communications	Oct	9
Morse Code & Your Computer by Alan MacLean VK3ASL	Dec	32

# INDEX FOR 1983

New Repeater Earns its Keep by Jeanette Wiley, VK2EJW	Sep 12
Night Time VHF Propagation by Graham Baker, VK8GB	Mar 16
Old Timer, Old Rig	Oct 25
Old Timers Meet Again	Jun 37
Open Letter from WIA Videotape Co-ordinator	Sep 47
Operating Techniques & Hazards by John Aarsse, VK4QA	Nov 22
Pocket Radio	Aug 23
Pioneers of Amateur Radio in Australia by Maxwell Hull, VK3ZS	Oct 28
Pioneers of the Spectrum — Part 1 — Discovery of VHF by Stephen Gard, VK2ESG	Nov 25
Presidential Comment — 30% Tariff Duty Imposed on HF Transceivers	Aug 8
Radio Astronaut in Space by Roy Neal, K6DUE	Sep 11
Red Cross Murray Canoe Marathon by Gil Sones, VK3AUI	Feb 17
Regulations & Standards for the New Radio Communications Act	Dec 51
Regulations for Power Lines	Jul 39
Reminiscing 62 years of Wireless by Frank Bridgewater	Oct 34
Reminiscing & Reality by Leo Weller VK3YX	Dec 51
Russian for English Speaking Amateurs by Ian Forster VK3ST	Dec 30
Station Control Panel — Not a Weekend Project by Ivan Huser VK5QV	Dec 14
Scout Jamboree — ZL2JAM	Nov 61
Shack Crawling 1930s Style by Alan Shawsmitth, VK4SS	Aug 15
Some More Adventures of Bill Blitheringwit by Ted Holmes, VK3DEH	Nov 20
Sprattly Island by Balduz Drobnicca, DJ6SI	Sep 28
The Born Loser Goes on Air by Bill Martin, VK2EBM	Nov 31
The Fisk Trophy by Peter Brown, VK4PJ	Jun 46
The Radiocommunications Act	Apr 34
To Hear and Back by Dave Shaw, VK3DHF/VK0HI	May 10
To Hear and Back Part 2 by Dave Shaw, VK3DHF/VK0HI	Jun 14
Videotape Catalogue	Sep 45
VK7AMC — The Australian Maritime College by Broder Tuff, VK7XX	Apr 35
WCY Celebrations in VK4	Jun 37
WCY — Students Celebrate WC Day 1983 by Ron Smith, VK4AGS	Jul 14
WCY — WC Day in Adelaide by David Clegg, VK5AMK	Jul 15
What is the Historical Society of Australia	Oct 33
WIA Representatives Visit NZART Annual Conference by Bruce Bathols, VK3UV	Aug 11
WICEN — The Test of Fire by Jim Linton, VK3PC	Apr 12
World Communications Year 1983	Jan 6
World Communications Year — Amateur Radio in Space	Aug 23

Learning the Code	Oct 62
Pet Hates	Feb 39
Signal Report Amplification	Jun 47
Signal Reporting	May 25
Zero Beating	Aug 47

## RTTY

A new column	Feb 38
Choice of RTTY Gear	Mar 40
Code Readers & Converters	Nov 52
Connecting RTTY Gear	Jul 38
Identifying RTTY	Apr 56
Mechanical Generation of RTTY	May 26
Mechanical Reception of RTTY	Jun 36
Operating Procedures	Aug 40
RTTY Demodulator	Sep 38
Setting the Speed of RTTY Gear	Oct 57
Siemens Series One Printers by Dave Prince, VK4KDP	Nov 24
SWLing on RTTY by Fred Robertson-Mudie, VK1MM	Apr 20
The Ravin — The RTTYers Nightmare	Feb 31

## RECEIVERS

A Square One Receiver part 1 by Drew Diamond, VK3XU	Jan 8
A Square One Receiver part 2 by Drew Diamond, VK3XU	Feb 14
A Square One Receiver part 3 by Drew Diamond, VK3XU	Mar 11
The BC 348 Classic Communications Receiver by Allan Shawsmitth, VK4SS	Oct 32

## TECHNICAL TOPICS

A Nicad Charger by Terry Long, VK3EC	Jan 16
A Sensitive SWR Meter by Drew Diamond, VK3XU	Apr 33
A Tricky Calculation? by Ron Cook VK3AFW	Dec 38
Computer Programme for Log & QSL Card Printing by M Mohan, VE6AZM	Aug 29
Do you know what Bonito is?	Jan 14
How Dangerous is RF Radiation? part 1 Reprinted from Overseas Magazines	Apr 28
How Dangerous is RF Radiation? part 2 Reprinted from RadCom	May 7
How Dangerous is RF Radiation? part 3 Reprinted from RadCom	Jun 20
How to make IC551 NB work on Low Level Impulse Noise by Andrew Martin, VK3KAQ	Apr 24
Improving the FM321 and 320 by Nev Fenlon, VK2ZBQ	Feb 25
Increasing the Sensitivity of Trio Dip Meter DM-800 by P J Grigg, VK3APG	May 17
Mod for IC22S by Keith Heitsch, VK4AHK	Oct 18
Modern Military Surplus Equipment part 1 by Colin MacKinnon, VK2DYM	Apr 29
Modern Military Surplus Equipment part 2 — The R210 by Colin MacKinnon, VK2DYM	May 28
Modern Military Surplus Equipment part 3 — The B47 by Colin MacKinnon, VK2DYM	Jun 18
Modern Military Surplus Equipment part 4 — C42 & C45 by Colin MacKinnon, VK2DYM	Jul 18
Modern Military Surplus Equipment part 5 — The C11 by Colin MacKinnon, VK2DYM	Aug 12
Morse Code Trainer by Phil Grigg, VK3APG	Nov 18
Multi-Pin Plugs for Surplus Gear by John Hassell	Dec 28
VK6ZGF/NXX	Dec 28

Practical Digi Control Unit for the ICOM 720A by Bob Young, VK4BRY	Sep 14
Programmable Keyer by Gil Sones, VK3AUI	Oct 19
Regulated Power Supply for 13.8 Volts by Des Greenham, VK3CO	May 14
Service Bulletin — Yaesu FRG-7700SW Mod	Jan 12
Simple External Frequency Selection for IC22S by Reg Fookes, VK2AKY	Apr 22
Simple Marker Generator by Neville Mattick, VK2QF	Jul 13
Square-Two Converter by Drew Diamond VK3XU	Dec 24
Ten GHz Coupler & other Microwave Matters by Des Clift, VK5ZO	Nov 12
Test Equipment for Radio Experimenters by R S Gurr, VK5RG	Jul 9
The 22S — A Common Fault by Ian Jackson VK3BUF	Mar 15
Two Tone Oscillator by Con Murphy, VK6PM	Feb 29
Two Tone Test Oscillator for SSB by A L Butler, VK5BR	Mar 18
Weekend Project No 1 — Panoramic Adaptor by Ivan Huser, VK5QV	Oct 16
Weekend Project No 2 — Digi Inside/Outside Thermometer by Ivan Huser, VK5QV	Oct 22
Weekend Project No 3 — Microphone Equaliser by Ivan Huser, VK5QV	Nov 10

## THUMBNAIL SKETCHES

2VH, VK4VH, VK2JR	Apr 52
4AN, VK4CH & 4RW	Jan 19
Ben Grimes & Ock Alder	Nov 28
Jim McDermott	Sep 11
Percy Wood and A T Bauer	Jun 13
VK2BWW, VK4YF, VK4ADJ	Oct 24
VK3XEX & 4GW	Mar 27
VK4XN	Dec 54

## TRY THIS

Cassette Player/Transceiver Interface Device by Stephen Gard, VK2PMF	Apr 34
Coaxial Cable Braid Preparation	Jun 35
Folded Mobile Whip by John Teller, VK2BTQ	Jan 21
Phase Shift Frequency Multiplier	Jan 15
Simple Signal Sources by A G Loveday, VK4KAL	Aug 17
The Microwave Oven Test by John Hassell	Dec 21
VK6ZGF/NXX	Nov 16
VOX in a Box	Nov 16

## NOVICE NOTES

A Junk Box ATU	Mar 20
AOCPE Exam	Apr 55
ATUs — Trick or Treat?	Feb 18
Build a Better Balun	Dec 48
More about ATUs	Jul 30
Sticky End for COAX??	Jun 51

## CW

A Retrospective	Jul 40
Getting Rid of the Garbage	Sep 41
Improving Copying	Nov 61
Keys and Keyers part 1	Jan 30
Keys and Keyers part 2	Mar 36
Keys and Keyers part 3	Apr 58





# INTERNATIONAL NEWS

## "HAMS IN SPACE"

To commemorate the amateur radio operation of W5LFL aboard Space Shuttle "COLUMBIA" STS-9, a special philatelic cover (envelope) is to be issued in conjunction with the Solomon Islands Radio Society.

The cover will state "FIRST AMATEUR RADIO OPERATION FROM EARTH ORBIT" within the Amateur Satellite Corporation (AMSAT) logo.

A 45c Solomon Islands postage stamp featuring orbiter COLUMBIA will be affixed to the cover and cancelled on the first day of operation.



Visitors showing great interest in the IARU booth.

The cover will be available from PO Box 81, Honiara, Solomon Islands at a cost of US\$1.00, 5 IRCs or equivalent for direct mailing by air.

Covers can be supplied in mint condition within a sealed envelope, by air, for an additional US\$1.00 for up to 10 covers.

Examples:

1 cover addressed and mailed US\$1.00

1 cover, mint, within envelope US\$2.00

5 covers, mint, within envelope

(5 + 1 =) US\$6.00

Peter Taylor, H44PT

AR

## JARL HAM FAIR '83

The JARL Ham Fair was successful in that it not only recorded the largest number of visitors, about 38 000, but there was also an IARU Region III booth, in commemoration of WCY, for the first time. The WIA was a participant in this booth.



Masayoshi Fujloka, JM1UXU, Secretary Region III, IARU.

These exhibitions contributed to arousing interest in international amateur radio organisations and their importance.

AR

## MALTA

The use of hand-held receivers is now permitted provided that they are used indoors as base stations.

## JAPAN

The Radio Law of Japan has been changed to allow amateur radio operation by aliens in Japan. Main conditions are that the aliens' government permits Japanese citizens to operate similar stations in their country and that the Japanese Government determines the conditions to ensure equality of treatment. The first reciprocal agreement to be made under the new law was with the USA.

ZL1HV in Breakin Oct 83

AR

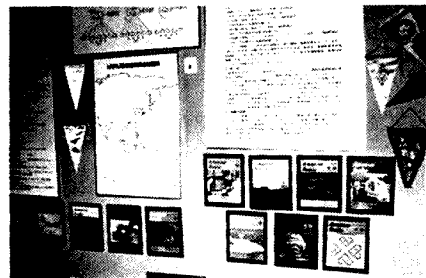

WIA material on wall.

The IARU exhibited several panels, written in Japanese, on the wall of the booth depicting the outline structure of the IARU and its regional organisations, their purposes and

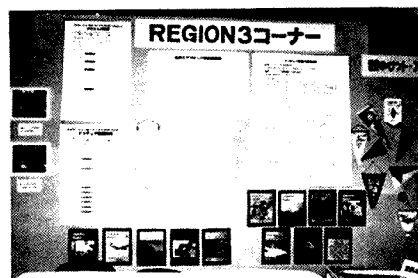

Panels on the rear wall of the booth.

main activities in the past with particular emphasis being placed on the results of WARC-79, new HF bands and new UHF and EHF bands for the amateur satellite service.

## STS-9 UPDATE

The launch date of STS-9 has slipped from the end of October to the end of either November or February. After recovering the Solid-fuel Rocket Boosters (SRBs) from STS-8, NASA discovered excessive erosion of the ablative material lining one exhaust nozzle and funnel. The ablative material protects the metallic portions of the nozzle and funnel from burning through during the burn of the engine. (Once an SRB is ignited, it will burn until the fuel is exhausted.) Should burn-through occur during ascent, the Shuttle would probably be thrown into a violent spin and go off course.

ARRL NEWSLETTER DATED 13th OCTOBER

AR

## TABLE OF AMATEUR RADIO FREQUENCY ALLOCATIONS FOR PAPUA NEW GUINEA AS FROM 14TH JULY 1983

<i>Frequency Band (Category)</i>	<i>Type of Service</i>	<i>Remarks and Restrictions</i>
1800-2000 kHz	AMATEUR	— This band has been extended to reflect the decision of WARC '79. Amateurs will be required to avoid 1870 kHz ± 4 kHz.
3500-3700 kHz (Primary)	AMATEUR	— No change to this band.
7000-7100 kHz (Primary)	AMATEUR AMATEUR-SATELLITE	— This band has been reduced in accordance with WARC '79 requirement. Refer to RES 641.
10 100-10 150 kHz (Secondary)	AMATEUR	— New band, allocate in PNG on 7th December, 1981.
14 000-14 350 kHz (Primary)	AMATEUR AMATEUR-SATELLITE	— No change.
18 068-18 168 kHz	AMATEUR AMATEUR-SATELLITE	— Not allocated at this time due to existing services in neighbouring countries.
21 000-21 450 kHz (Primary)	AMATEUR AMATEUR-SATELLITE	— No change.
24 890-24 990 kHz (Primary)	AMATEUR AMATEUR-SATELLITE	— New Allocation. All Amateurs to avoid the frequency 24 900 kHz ± 4 kHz.
28 000-29 700 kHz	AMATEUR AMATEUR-SATELLITE	— No change.
50-54 MHz (Primary)	AMATEUR	— Change on category of service to the 50-52 MHz band.
144-146 MHz	AMATEUR AMATEUR-SATELLITE	— No change.
146-148 MHz (Primary)	AMATEUR	— No change.
430-440 MHz (Secondary)	AMATEUR*	— *Amateur-Satellite permitted 435-438 MHz in accordance with footnote 664. (Note band reduced from 420-450 MHz.)
440-450 MHz (Secondary)	AMATEUR	— This band is allocated in PNG under footnote 666.
576-585 MHz (*Primary)	AMATEUR	— No change. This band allocated under Regulation 342. *Additional allocation in PNG on a Primary basis until such time as reallocated to the Broadcasting Service.
1240-1300 MHz (Secondary)	AMATEUR*	— Band reduced from 1215-1300 MHz. *Amateur-Satellite permitted 1260-1270 MHz in accordance with footnote 664.
2300-2450 MHz (Secondary)	AMATEUR*	— *Amateur-Satellite permitted 2400-2450 MHz in accordance with footnote 664. Refer also footnote 751.
3300-3500 MHz (Secondary)	AMATEUR*	— No change. *Amateur-Satellite permitted 3400-3410 MHz in accordance with footnote 664.
5650-5850 MHz (Secondary)	AMATEUR*	— No change. *Amateur-Satellite permitted 5650-5670 MHz in accordance with footnote 664.
10-10.45 GHz (Secondary)	AMATEUR	— No change.
10.45-10.5 GHz (Secondary)	AMATEUR AMATEUR-SATELLITE	— New allocation for Amateur-Satellite.
24-24.05 GHz (Primary)	AMATEUR AMATEUR-SATELLITE	— No change.
24.05-24.25 GHz (Secondary)	AMATEUR	— No change.
47-47.2 GHz (Primary)	AMATEUR AMATEUR-SATELLITE	— New Allocation.
75 5-76 GHz (Primary)	AMATEUR AMATEUR-SATELLITE	— New Allocation.
76-81 GHz (Secondary)	AMATEUR AMATEUR-SATELLITE	— New Allocation.
142-144 GHz (Primary)	AMATEUR AMATEUR—SATELLITE	— New Allocation.
144-149 GHz (Secondary)	AMATEUR AMATEUR-SATELLITE	— New Allocation.
248-250 GHz (Primary)	AMATEUR AMATEUR-SATELLITE	— New Allocation.

### SUMMARY OF FOOTNOTES

Below is a reproduction of the footnotes referred to in the Table of Amateur Radio Frequency Allocations for Papua New Guinea.

664 In the bands 435-438 MHz, 1260-1270 MHz, 2400-2450 MHz, 3400-3410 MHz (in Regions 2 and 3 only) and 5650-5670 MHz, the amateur-satellite service may operate subject to not causing harmful interference to other services operating in accordance with the Table (see No 435). Administrations authorising such use shall ensure that any harmful interference caused by emissions from a station in the amateur-satellite service is immediately eliminated in accordance with the provisions of No 2741. The use of the bands 1260-1270 MHz and 5650-5670 MHz by the amateur-satellite service is limited to the Earth-to-space direction.

666 Additional allocation: in Canada, New Zealand and Papua New Guinea, the band 440-450 MHz is also allocated to the amateur service on a secondary basis.

751 In Australia, the United States and Papua New Guinea, the use of the band 2310-2390 MHz by the aeronautical mobile service for telemetry has priority over other uses by the mobile services.

AR

**STS-9 AMATEUR RADIO DEMONSTRATION GROUND TRACK LOCATOR**  
 WORLD OPPORTUNITIES (EXCLUDES U. S. PASSES)

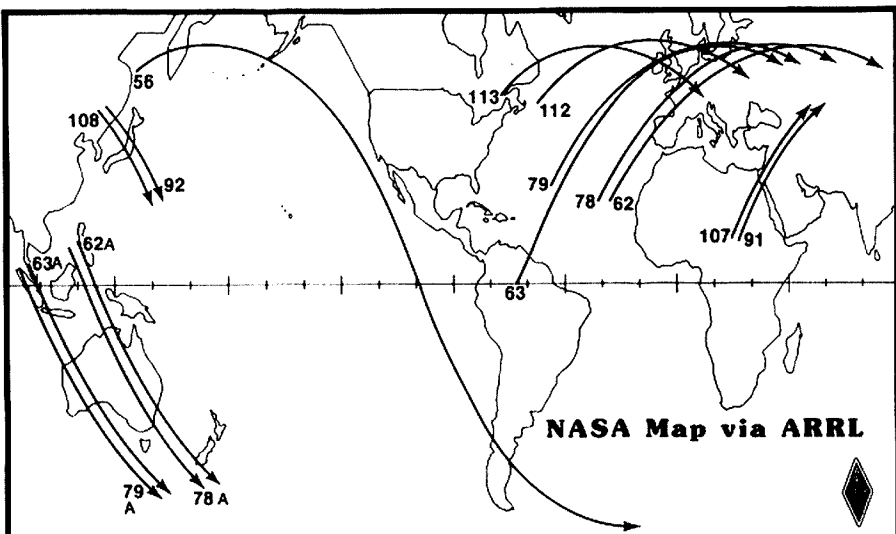

NASA Map via ARRL

START OF OPPORTUNITY MISSION ELAPSED TIME				END OF OPPORTUNITY MISSION ELAPSED TIME				START OF OPPORTUNITY MISSION ELAPSED TIME				END OF OPPORTUNITY MISSION ELAPSED TIME			
ORBIT	DAYS	HRS	MIN	DAYS	HRS	MIN	ORBIT	DAYS	HRS	MIN	DAYS	HRS	MIN		
56	3	10	10	3	10	40	91	5	14	03	5	14	13		
62	3	18	55	3	19	11	92	5	15	55	5	16	05		
62 A	3	19	34	3	19	49	107	6	13	51	6	14	01		
63	3	20	33	3	20	43	108	6	15	40	6	15	55		
63 A	3	21	03	3	21	18	112	6	21	20	6	21	35		
78	4	18	44	4	19	00	113	6	22	54	6	23	10		
79	4	20	17	4	20	30									

**Microwave Developments**

**UHF & MICROWAVE COMPONENTS**

Our improved 70 cm and 23 cm Power/VSWR Meters are priced under \$100. Each has high and low accurately calibrated, switched ranges and a direct reading VSWR scale on low.

1269, 1296 and 1700 MHz Long Loop Yagis. 1, 2 and 4 Bay with splitters. Soldered copper from \$65 (single).

Waveguide, Flanges, Gunn and Detector diodes. All new high quality equipment. Well priced.

3 cm WG Assembly, with 3 dB coupler, 22 dB horn, Gunn oscillator and IN23WE mixer — \$125 complete.

Used, working, Gunn diodes for experimenting and getting the feel of it @ \$1 per mW, tested in our mount prior to delivery.

PTFE PC Board. ER 2.5, double sided, 1 oz Cu/.0625" @ 14 c/sq cm.

P/P extra at cost. All prices included 20% Sales Tax.

DES CLIFT VK5ZO

6 Netley Road, Mount Barker, South Australia 5251. (PO Box 274). Telephone: (08) 391 1092.

**STUDYING FOR THE NOVICE LICENCE?**

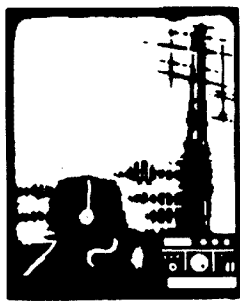

**THEORY BOOK:**



- contains all nec. theory
- clear diagrams
- simple-to-follow text
- \$7.50 inc. postage

**MORSE TAPES:**

- 5 WPM novice speed
- 10 WPM exams
- 8/10/15 WPM practice
- 15 WPM practice
- \$5.00 ea. inc post

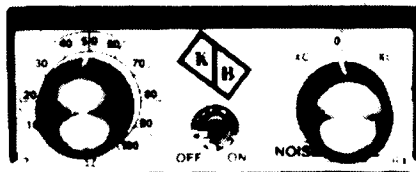

**\$60**  
POST PAID

**NOISE BRIDGE**

Adjust your antenna for maximum performance. Measure resonant frequency, radiation resistance and reactance. Better than an SWR meter. Operates over 100 MHz. Most useful test unit in your shack.

**ANTENNA BALUNS**

3 to 30 MHz  
 Maximum Power: 300 Watts  
 Centre support  
 Ideal for Dipoles, Beams, Ovals  
 SO239 connector



**\$26**

**POWER LINE FILTER**

240 Voh @ 10 Amp

**\$16**



1000's of Transistors — Ferrites — Hobby Kits — Tag Strips — Switches etc. Send stamped addressed envelope for full list.

**K. BRUCESMITH**  
 110 Rosemead Road  
 Hornsby N.S.W. 2077

**G. SCOTT**  
 11 Balmoral Crescent,  
 Surry Hills, Melbourne,  
 Vict. 3127.



Announcing —

# SKYTRIM

Today's premier  
free standing  
crank up tower line

A range of telescopic towers for amateur and commercial applications, from 6.5m to 20m, with tilt-over facility enabling antennae installation and adjustment to be done at ground level.

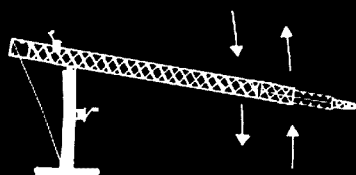

What other tower can offer you these features?

- \* Rugged, all welded, diamond web construction.
- \* Hot Dip Galvanized inside and out, after fabrication.
- \* Easily erected on a limited area site.
- \* Only heavy-duty marine fittings used.
- \* Rotator mounts inside tower.
- \* Thrust bearing fitted.
- \* Engineering drawings supplied (including foundation detail).

**SKYTRIM — A Tower of Strength**  
Further details available from —

Bruce P. Pinkerton,  
P.O. Box 428, Parramatta, N.S.W. 2150  
Australia. Tel. 635 3555, 635 8777



**IF YOU HAVEN'T LOOKED AT**

**amateur  
radio**  
action

**LATELY, THIS IS WHAT  
YOU'VE MISSED**

- Up to date News and Views
- Advance News on the Latest Rigs
- Complete Awards Information
- The Latest DX News & QSL Routes
- Complete Contest Information
- Lab Tests of the Latest Transceivers
- Heard Island — The VKOJS Report.
- Computer RTTY the Easy Way.
- Worldwide HF Beacon & Net Listing.
- A Cheap VFO for the FT-707.
- Amateur Operation in the Pacific.
- Radial & Ground Systems for Vertical Antennas.
- The Facts about Lightning & its Effects.

AND FEATURE ARTICLES  
SUCH AS...

- Spratly Island — In Depth.

PLEASE PUT ME DOWN FOR 13 ISSUES  
OF AMATEUR RADIO ACTION  
STARTING NOW!

I enclose a cheque for \$18.00

Name.....  
Address.....  
.....  
Postcode.....

Send to: **AMATEUR RADIO ACTION**  
**SUBSCRIPTIONS, P.O. BOX 628E,**  
**GPO MELBOURNE, 3001, AUSTRALIA**



# NOVICE NOTES

Ron Cook, VK3AFW  
TECHNICAL EDITOR

## BUILD A BETTER BALUN

Why bother with a balun in the first place you may ask. A balun is a device which transforms a balanced load to an unbalanced load or, looking at it from another angle, it enables a coaxial (unbalanced) feedline to be connected to a balanced dipole antenna without the usual problems.

### WHAT PROBLEMS?

If we refer to Fig 1 we see a transmitter producing an RF signal which is fed into a coaxial cable. A current  $I_1$  flows in the centre conductor of the cable and an equal current  $I_2$  flows in the opposite direction on the inside of the outer conductor. At any instant these currents retain the same relative amplitudes but are  $180^\circ$  out of phase.

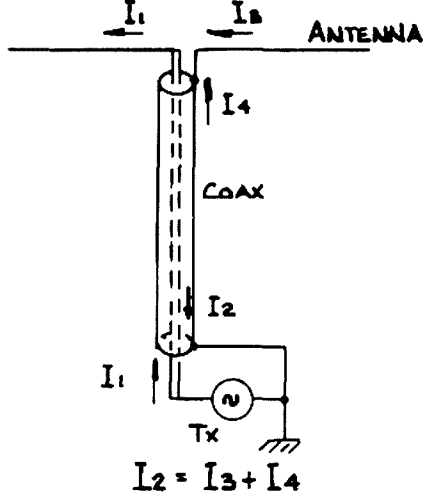

Fig 1. Illustration of the effect of connecting a coaxial feeder to a balanced aerial.

Meanwhile, at the antenna, which we have directly connected to the coaxial cable, we see that at this instant of time  $I_1$  is flowing from the centre conductor out along the antenna. If all were well and compatible we would have a current  $I_2$  flowing from the antenna back inside the coax. Because the current from the antenna does not see any difference between the inside and the outside of the coax a splitting of the current occurs with some current flowing down the outside of the braid and some down the inside. The division ratio, and hence the relative sizes of  $I_3$ .

The antenna current, and  $I_4$ , the outer coax current, is complex. If the coaxial cable is an odd number of quarter-wavelengths long then a high impedance will be seen on the outside and  $I_4$  will be negligible.  $I_3$  will then be equal to  $I_2$  and all will be well. If the cable is a multiple of half-wavelengths then a low

impedance will be seen and  $I_4$  will be much larger than  $I_3$ . The coaxial cable then becomes a significant part of the antenna.

Because of its proximity to the ground for part of its length (or a tower, gutting, etc) it will be lossy. Being largely vertical it will be vertically polarised and so will introduce more noise into the receiving system. Further, if the transceiver is not well grounded for RF, microphones, keys etc can be a source of RF burns due to lots of RF in the shack. The transceiver is connected to a radiating part of the antenna.

Intermediate lengths will produce intermediate effects. A balun can isolate the outer braid from the antenna and allow  $I_3$  to be the same as  $I_2$ . Note that although Fig 1 shows  $I_2 = I_3 + I_4$ .  $I_3$  and  $I_4$  can have large phase angle differences. Remember we are dealing with RF, not DC.  $I_3$  and  $I_4$  could even flow in opposite directions — that is  $I_4$  could have had the arrow pointing down. The situation can become literally quite complex and it is beyond the scope of this article to go into the mathematical proofs.

It is sufficient to say that the overall effect is to alter the antenna in respect to:

- 1 Radiation pattern — shape is changed, vertical radiation increases.
- 2 Received noise level is raised due to pick-up on the outer of the feedline.
- 3 Antenna efficiency drops due to absorption of feedline radiation in nearby conductors.
- 4 Antenna system resonance and impedance are altered giving a different VSWR.

Yes you can connect coaxial cable directly to a dipole and get good results but you can do better by using a balun.

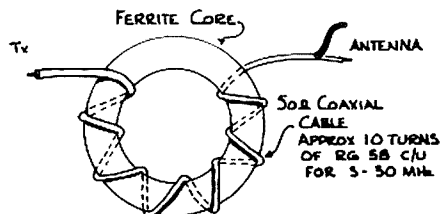

Fig 2. Illustration of method of winding of conventional transmission line 1:1 balun. Two separate insulated wires can be used instead of the coax if they are twisted together with say one twist per cm. (See text.)

A popular balun of conventional design is shown in Fig 2. For a 50 ohm system a 50 ohm cable is wound on a ferrite core to produce an inductance of about 250 ohms reactance at the lowest frequency of use. The large (6 mm dia) red core sold by Dick Smith and others is quite suitable for HF. Even a core from a TV EHT transformer works well.

Note that about a quarter of the core is left free of winding. This is because the high frequency limit is set by resonance of the inductance of the winding and the shunt capacitance. Capacitance across the end of the winding is thus important and is reduced by keeping the ends of the winding apart. The upper frequency limit is the frequency at which the reactance falls below 250 ohms.

In fact the reactance rises with frequency until parallel resonance occurs.

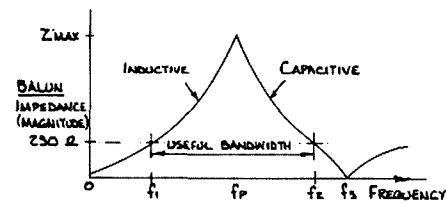

Fig 3. Plot of balun impedance.

- $f_1$  — lower frequency limit
- $f_2$  — upper frequency limit
- $f_p$  — parallel resonant frequency
- $f_s$  — series resonant frequency

Further increases in frequency are accompanied by a fall in reactance magnitude until eventually series resonance occurs. See Fig 3. The useful range extends above the parallel resonant frequency even though the reactance is capacitive — it is the reactance magnitude that is important as this "throttles" the current trying the flow down the outside of the coax.

Actually the coaxial cable winding can be replaced by a two wire transmission line although for the best results (lowest VSWR over greatest bandwidth etc) the transmission line should be the same impedance as the feeder (which will be coaxial) which in turn should be the same as the antenna.

Twin feeder of 50 or even 70 ohm is not as readily available as coax. Commercial baluns often use enamelled wire twisted together. This can be quite satisfactory. I believe that for the home brewer a better alternative is to use a length of figure-8 240 V flexible twin cable. A length of about one metre should be cut off and the two conductors split apart to form two wires. Be careful not to bare the wires except at the ends. Put two ends in a vice and tighten the jaws. Pull the two wires out until taut and fit them into the chuck of a hand drill. Turn the hand drill to twist the wires tightly together. The length of the cable will shorten slightly. When removed from the drill and vice the cable will untwist a little but it should retain at least one twist per cm. If not, repeat the twisting process.

In original form the figure-8 flex (called zip cord in the USA) has an impedance of around 140 ohms and is suitable for use up to 21 MHz. without much loss. When twisted as above it



has an impedance of 60 to 80 ohms and makes a good low loss 3-30 MHz balun.

This balun works well with a dipole which is in the clear. It is not quite so good when the dipole is unbalanced due to say proximity of trees or bends in the dipole legs.

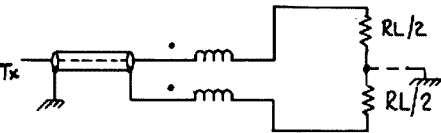

**Fig 4. Schematic diagram of conventional transmission line 1:1 balun. This shows that it provides isolation but balance is not guaranteed unless the centre of the load is grounded.**

Referring to Fig 4 we see a schematic diagram of the balun. If the load is symmetric and grounded in the centre (as is the case with many triband beams) then the balun provides both balance and isolation. If the load is not balanced then isolation (reduction or elimination of the outer coaxial cable current) is obtained but not balance, leading to radiation pattern distortion and changes in VSWR. The bandwidth of the balun may be reduced.

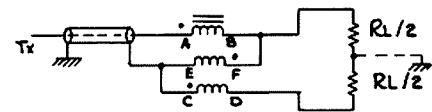

**Fig 5. An improved 1:1 transmission line balun. An additional winding EF has been added to give balanced output as well as isolation. The load need not be grounded in the centre.**

The solution involves adding a third (tertiary) winding to provide a balancing function. Refer to Figs 5 and 6. Fig 5 shows that a third wire is wound in intimate contact with the other two so that it has equal turns and shares the same flux. The start of the winding, F, is connected to the inner conductor at the finish of its winding, B, and the finish of the tertiary winding, E, is connected to C, the start of the outer braid.

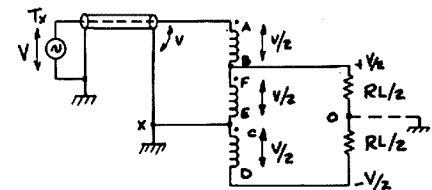

**Fig 6. The improved 1:1 transmission line balun redrawn as an auto-transformer. As with the conventional design twisted wires may be used instead of coax. (See text.)**

This winding carries very little current as the load current flows through AB and CD. The means by which winding EF provides balance can be seen by referring to Fig 6.

Note that Fig 6 should not be taken too literally as representing a complete equivalent circuit for the balun.

As windings AB and FE appear in series across the end of the cable their total voltage is V. If they have the same turns then each has V/2 across it. Winding CD has the same turns as AB and so has V/2 across it also. The load is across FE and CD and has V/2 + V/2 = V across it. The centre point EC is connected to the coax braid which is nominally at ground. It may be grounded to the tower etc. Thus the load at a particular instant will have +V/2 at one end and -V/2 at the other (with respect to ground) whether or not point X is grounded.

If no current flows on the outside of the coax it has ground potential all along its lengths. (No current = no volt drop.)

Removal of winding FE could allow points X to take up a different potential and current would then flow outside the coax.

A tertiary winding may be made using half of a length of flex or a length of enamelled wire of say 22 SWG.

If you have a commercial balun and want to check whether it has a tertiary winding a simple check can be made with an ohm meter. Remove the balun from circuit and measure the resistance between the two input leads. If it is low there is (probably) a tertiary winding. If it is open circuit there is no tertiary winding.

In some baluns the winding is made along a rod of ferrite. This does not alter the operation although more turns will be required for a given inductance.

There are many other forms of balun other than the simple 1:1 device described here. The next most common type gives a 4:1 impedance ratio but many other ratios are possible as can be seen by reading the references.

### SPECIAL NOTE FOR READERS

1. I welcome contributions to this section especially construction articles suitable for beginners, novices and SWLs.

2. If there is something in one of these columns that puzzles you or you want to take issue over a point please re-read the article before putting pen to paper. Then if you still have a need to write please include an SAE. I certainly don't want to discourage reader's letters as they are a most important feedback — I always reply personally — but observance of the above two points will reduce my stationery bill.

73  
Ron, VK3AFW

### References

- 1 ARRL Radio Amateurs Handbook 1982 Ed, Chapters 3, 19.
- 2 Nagle, J J, K4KJ, "Testing Baluns", Ham Radio, Aug 1983, Vol 16, No 8.
- 3 Reiser, J, W2JR, "Simple and Efficient Broadband Balun", Ham Radio, Sept 1978, Vol 11, No 9.
- 4 Nagle, J J, K4KJ, "High Performance Broadband Balun", Ham Radio, Feb 1980.
- 5 ARRL Electronics Data Book, 1976 Ed, Chapter 5.
- 6 "Novice Notes", Amateur Radio, March 1983, Vol 51, No 3.

AR

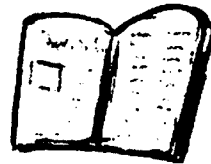

## MAGAZINE REVIEW

Roy Hartkopf, VK3AOH  
34 Toolangi Road, Alphington, Vic 3078

(G) General. (C) Constructional. (P) Practical without detailed constructional information. (T) Theoretical. (N) Of particular interest to the Novice.

**WORLD RADIO. SEPTEMBER 1983.** American magazine-newspaper with news and information. A new "amateur handbook" which should be avoided. (G).

**BREAK IN. SEPTEMBER 1983.** Synthesised Speech readout of frequency. (P).

**WHAT'S NEW IN ELECTRONICS. SEPTEMBER 1983.** General information on new products, components, equipment etc. (G).

**73 MAGAZINE. OCTOBER 1983.** Fourteen new construction projects. (G). Experiments on 1700 metres. (G).

**HAM RADIO. AUGUST 1983.** Packet radio. (T). Testing Baluns. (P).

**QST. AUGUST 1983.** RF Power measurements. (N). Design of Pi networks. (T).

**CQ - TV No 123. AUGUST 1983.** PAL Coder. (P). NBTV. (G). 70 cm Linear. (C). AR

### EXECUTIVE REQUIREMENT

The Federal Executive requires a VIDEO RECORDER in the BETA FORMAT, in excellent working order, for the Federal Video Co-ordinator's use.

Any member that may be able to help should contact:

**THE SECRETARY,  
FEDERAL OFFICE,  
PO BOX 300,  
CAULFIELD SOUTH, 3162.  
or PHONE: (03) 528 5962.**

SUPPORT YOUR ADVERTISERS

Remember to say  
you saw their ad in AR

# BOOK REVIEW

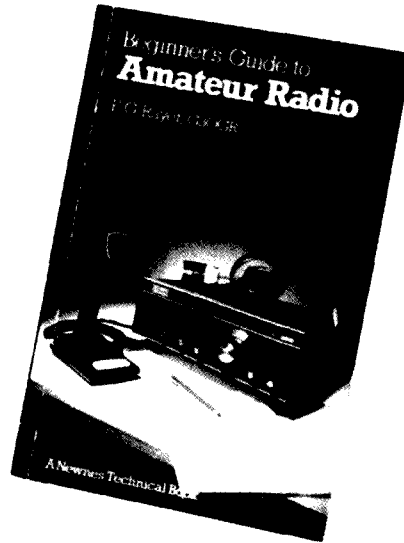
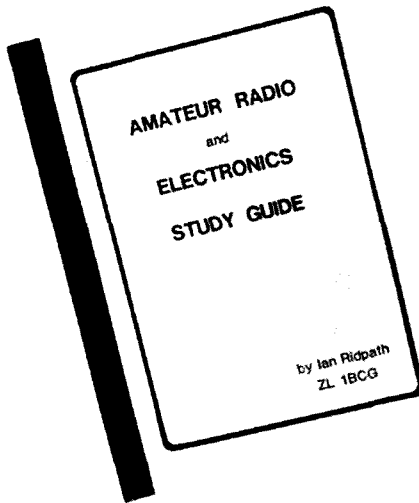

## AMATEUR RADIO AND ELECTRONICS STUDY GUIDE

by Ian Ridpath, ZL 1BCG. ISBN 0-473-00149-7

This excellent book is unusual in that it is entirely handwritten and not typeset. As with the work of the old scribes the text is clearly printed in a neat and individual hand.

It is the author's contention that students learn faster when they have a study guide which presents the theory in a concise and uncluttered way. The text is comprehensive in its coverage and is accompanied by several technical and explanatory drawings on each page. In spite of the author's intention, the format does on occasions get a little cramped.

Sufficient material is included to cover the requirements of the Grade III amateur radio examination conducted by the New Zealand Post Office. In doing so it exceeds the requirements of all grades of Australian amateur licences and fills the gap between simple beginners tracts, Novice study guides and the professional engineering texts. Topics covered include:

- Resistors
- DC, AC, Frequency
- Capacitors, Vectors
- Inductors
- Magnetism
- Transformers
- Reactances in series and parallel
- Resonance
- Semiconductors
- Power supplies
- Amplifiers
- Oscillators
- Valves
- Radio transmitters
- Radio receivers

*Radio waves and propagation*  
*Aerials*

*Transmission lines*

*Test instruments and measurements*

*Problems, with answers and useful formulae.*

Some 10 percent of the book goes beyond the requirements of the AOCPL theory: even so the book would be a valuable aid to anyone studying for either the NAOCPL or AOCPL theory exams. Topics recently appearing in NZPO exams are marked with a flag.

The diagrams are well chosen, each one being worth nearly 1000 words, and help to make the theory more readily absorbed. Overall this book compares most favourably with locally produced texts in the same category. Teachers of courses in amateur radio should seriously consider this book as a standard text.

The review copy was kindly provided by the author. Copies may be available shortly through Magpubs.

AR

## BEGINNER'S GUIDE TO AMATEUR RADIO

by F G Rayer, G3OGR. Newnes Technical Books.  
ISBN 0-408-01126-2

To the outsider, amateur radio may seem to be a form of CB or, on closer acquaintance, a highly technical and mysterious hobby. Any person with a curiosity about amateur radio and "serious" short wave listening would find this book invaluable.

Young budding engineers, scientists and technicians now at secondary school could find an introduction to the prince of hobbies (amateur radio) through reading this book.

Frank Rayer writes with an easy style and covers every significant aspect of amateur radio and short wave listening. A generous number of drawings, circuits and graphs are used to lucidly explain each important aspect. Although this book is written about the hobby as practiced in the UK it will be of value worldwide. The theory of radio communication is painlessly explained to the layman. Indeed, at the end, a casual CB operator would be well on the way to successfully sitting for a Novice licence. The reader would become as well informed about all aspects of amateur radio as most experienced amateurs — at least in the general sense if not in technical details of some complexity.

Those aspects of amateur radio that often baffle the uninitiated are clearly explained. Frank Rayer was well known, through Europe especially, for his technical writings. Sadly he died shortly after completing the manuscript for this book.

It may be that had Frank been able to proof-read the manuscript the minor criticism I have would have been unnecessary. That is that some terms are introduced and used without explanation, for example Hz, S/N, VK, VK7. There may be others that I did not find, but as hundreds of other similar terms are covered it is not a bad score.

If you want to know "all about amateur radio without really trying" (or becoming one) then this is the book for you. Who knows, after reading the book you might find yourself smitten with the bug. If you want to avoid that fate then don't read this book.

The review copy was kindly provided by Butterworths, NSW. Copies can be obtained from most good book stores at a recommended price of around \$12.

AR

## REMINISCING AND REALITY

Leo Weller, VK3YX  
46 Peperell Avenue, Syndal, Vic 3150

### REMINISCING AND REALITY

To divert my inquiring mind after I, at a young age had already wrecked the kitchen clock, the tin opener and the gramophone, my father introduced me to Meccano.

This provided me with many hours of great enjoyment at my "Meccano table" in the corner of my bedroom and an easy choice of presents for my parents, uncles and aunts.

With another birthday coming up soon, I asked my father during dinner if I could have a 20 cm horizontal-thrust ball bearing with gear teeth from the special parts department of Meccano instead of the usual Meccano box 1A. My mother, instantly realising that my father had no idea what I was talking about, suggested that I accompany him to the shop giving me the opportunity to select that item myself.

With this, a tradition was born which lasted many, many years. The only change being from the Meccano to the radio shop, which my father accepted without a blink of an eye — probably realising that I was growing up.

After the radio shop we would go to a coffee lounge and, while sipping coffee my father would listen to me, trying to enter my world of electronics so far removed from his extremely busy business life.

The tradition was accepted and continued by the YL and later the XYL.

Panic station was on when the oldest girl, then three years old, found a hidden 18 AVQ antenna under our bed two days before Christmas. This meant that a substitute present had to be placed under the Christmas tree.

We had no answer to the question "how would Father Christmas know that Dad likes a silly egg slicer?". This being a precious Barker and Williamson splitstator.

Contemplating on all this we are slowly tuning up and down the seemingly closed 15 metre band, an endless desert of white noise.

My good XYL carried the tradition over to our three daughters. However, when I arrive home with the parcel it is instantly confiscated from me with a friendly smile. The next time I see it, it is gift-wrapped and laying underneath the Christmas tree.

Nevertheless, for the girls, presents have a rating. A book is on top. Tools, cable, coax is alright, but who wants to give a crystal, one can hardly see it!

Dreaming of the future I hope our sons-in-law and grandsons again have this privilege and advantage of a then very old family tradition.

Hey! The band is opening up, there is a signal, very weak — dah dit dah dit dah dit dah. Still weak but readable BY1PK. That is the only amateur station in China!

AR

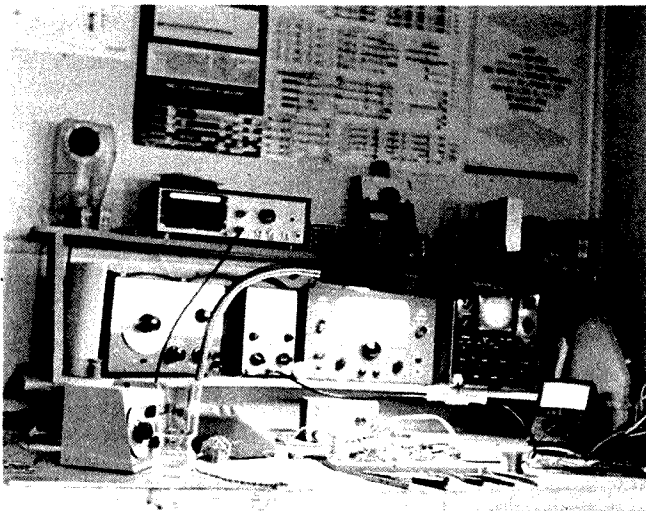

Reality

## REGULATIONS AND STANDARDS FOR THE NEW RADIO-COMMUNICATIONS ACT

Very shortly the Radiocommunications Bill will become an Act. It is essential that we now turn our attention to the associated Regulations and Standards.

The Bill/Act is mainly a legal document and dealing with it was mainly a legal operation. The Regulations and Standards will be far more technical and rather less legal: therefore, far more members of the Amateur Radio Movement will be in a position to contribute with comments, suggestions and material towards ensuring that, wherever possible, the regulations and standards associated with the new Radiocommunications Act are as favourable as possible to the Amateur Radio Service. Of course, we cannot expect to win on every aspect; however, with a concentrated and co-ordinated effort, and the pooling of all available resources by ALL Australian amateurs should ensure that we have the best chance to make a "fair dent" in this most complex area of the new Act.

Yes, the Regulations and Standards will, almost certainly, be highly technical and highly "politically" charged. It will therefore be most advantageous for us, the Amateur Radio Movement, to ensure that we keep our own house in order, ensuring the minimum of internal politics. This is one area where we need to break down any barriers which may exist between various factions within our movement, and present a united front. Let's make sure that ALL the resources available to the Amateur Radio Movement are concentrated behind one central co-ordinated effort. This is one area where, "United we stand — divided we fall".

The Wireless Institute's CASPAR (Communications Act Special Planning And Response) Committee has been instructed by the Federal Executive to provide an independent response to all regulations and standards pertaining to the new Act. The committee has been instructed to co-ordinate and correlate material and information from ALL Australian amateurs and to consider all available information, including overseas information, in relation to the various regulations and standards as and when they are presented by the Department of Communications. The CASPAR Committee recognises the material which was submitted during the review of the Radiocommunications Bill but was held over due to its relevance to regulations and standards.

The CASPAR Committee will require the assistance of ALL Australian amateurs with, what could be, one of the most complex and difficult issues to which the Amateur Radio Movement has ever had to address itself.

All correspondence in connection with any aspect of the Radiocommunications Bill/Act should be directed to: *The CASPAR Co-ordinator, Tony Tregale, VK3QQ, PO Box 300, Caulfield South, Vic 3162.*

AR

### NOTICE

ALL copy for inclusion in February 1984 Amateur Radio must arrive at Box 300, Caulfield South, 3162 no later than 3rd January.



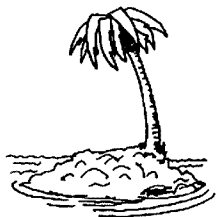

# HOW'S DX

Ken McLachlan, VK3AH  
PO Box 39, Mooroolbark, Vic 3138

Stephen VK2PS, a Federal Councillor and constant contributor to this column has made a number of pertinent comments with reference to my remarks in September AR.

Stephen comments that "VK amateurs are not very good QSLers in general and few make the exception but this phenomenon is not a new development. When I was first licenced in Europe in the late 1930s, it was well known to the fraternity, that to receive a VKQSL card was a pure miracle and that has not changed over the years."

Stephen, quotes the example that he entered the 1982 ALARA contest, had sixteen VK QSOs and QSLed the lot. After twelve months waiting, he is the proud owner of five return cards. Just over a thirty percent return. Not really good for a fellow VK operator! One wonders how an overseas operator would fare.

Another valid remark that is made concerns the VK2 Divisions incoming QSL card cabinet which is bulging to the seams. Stephen writes "I wonder why the recipients are not picking them up? If they do not QSL, why not tell the other party during the QSO that they do not and no card should be sent. If they feel that it is impolite to tell the unfortunate amateur on the other end, that he, the VK amateur, does not QSL, it is definitely rude not to reply to a card, even if it is not wanted."

Further to the above, Stephen remarks "that for many a contact to VK by overseas countries, it is a very valued contact, in many cases their first and that card could be needed for DXCC and other awards. But alas — VKs do not QSL and the few who do, your cards are certainly valued overseas."

Not to be overlooked of course is the SWLer, and as Stephen points out, quite a few VK amateurs are unaware, that it is obligatory in certain countries, before receiving a transmitting licence, that they provide proof that they are adept in the methods of reception and have a general interest in the hobby. Stephen urges all amateurs to reply to all SWL cards if they are legitimate.

Other notes extracted from Stephen's letter include the wane of DXing in this country, which was evident by the multitudes descending on the minority of SSB operators who were evident on the twenty metre band during the recent VK/ZL contest. My personal opinion is that the VK operator has many facets of the hobby available to research, from DXing to RTTY, SSTV, AMSAT, VHF to name a few without considering construction of that "special" project, perhaps we have too much to occupy our leisure time or are we just lethargic.

Another of the comments made in the following letter by Stephen is that "Rag-chewing" is fine, nice and essential, but nothing beats the joy, the elevating feeling of good luck and reward for patient listening and searching, when one has a successful QSO with the one only amateur in a certain

overseas country. An example of this is a QSO with D44BC the only active amateur in that country.

Thankyou Stephen for taking the time to sit down and commit a few of your thoughts to paper. Have we any other takers with any ideas?

## A FIRST

A number of firsts were claimed by Graham VK6RO for CW and SSB on the 18 and 24 MHz bands (refer AR August 1983, p25).

No other amateur has forwarded any documentary evidence that they beat Graham to the honour of being the first, so Graham it appears that it is all yours. Congratulations on your efforts and the use of the new bands so promptly.

## HUNTING LIONS

A contest, which is sponsored by Lions International annually, to promote international relations and further friendship between individuals of different nationalities. The trophy has been won again for the second consecutive year for the SSB section by Lindsay VK6NO. The CW section was won by well known DXer Tim BV2A. Congratulations to both operators.

The 1984 contest will be held on the 14th January and further details may be had from Alan Heath, PO Box 1904, GPO Adelaide, SA 5001.

## CHINA ON SSB

It was pleasant to hear Tom VE7BC, working from BY1PK and trying to satisfy all comers under very arduous conditions.

All countries including VK and ZL were given excellent opportunities to work this much wanted country and the operators took advantage of airing their lungs in the split operation.

Some operators were very critical of the amount of spectrum used for the split operation, but on this occasion it was justified in my book. This amateur was operating under severe difficulties, apparently there was a high QRN level to start with, the QRM was unbearable as propagation was open to many continents at the same time and it necessitated spreading the listening area to 60 kHz. It is a one off occasion really when one thinks of it.

Severe drift was only one of the problems that Tom had to contend with, which was probably caused by fluctuating line voltages. The linear was playing up and arcing to some extent and not once did I hear this gentleman lose his "cool".

Congratulations Tom on a job well done and your assistance to the amateurs of China over a considerable period has culminated in you giving many amateurs, worldwide, a new country on SSB towards the end of WCY 1983.

The self appointed policemen that manned the BY1PK transmit frequency probably meant well in advising everyone of the listening frequency area but one ZL overdid it a bit in my book. If you were lucky enough to be called you would never have heard your call because of the QRM but Tom, as I said before, was very patient.

## NEW PREFIX ALLOCATIONS

The New Zealand Post Office has announced new prefixes which will become effective as from the 1/1/84.

This rearrangement leaves ZL1-4 as it was, ZL5 Antarctic Bases, ZL6 Intruder Watch and Emergency stations, ZL7 Chatham Islands (formerly ZL/C), ZL8 Kermadec Island (formerly ZL/K), ZL9 Auckland and Campbell Islands (formerly ZL/A) and visitors will receive a ZL0 prefix.

Tokelau presently ZM7 will change to ZK3. It is not clear whether existing amateurs in these areas will still retain the calls they are using this year until they finish their tour of duty or revert to the new system immediately.

## BANGLADESH

Apparently the licensing authorities have had a change of heart and have at last decided to allow amateur activity.

This is indeed a breakthrough that another country has officially joined the amateur ranks again and it is a tribute to the amateurs in this country that have been working behind the scenes to bring this event about.

## GLOBETROTTING AGAIN

Iris and Lloyd Colvin, W6QL and W6KG, are on the move again. This time it is down South America way with envisaged stops in Columbia, Ecuador, Peru, Bolivia, Chile, Argentina, Uruguay and Paraguay.

They both hope to be active on all bands, SSB and CW, and will be paying particular attention to the lower bands including thirty metres.

Lloyd and Iris ask that all operators limit QSO's to one per band per mode per country and please QSL to the Yasme Foundation, PO Box 2025, Castro Valley, California 94546.

## ALBANIA???

After a seven week excursion in BY, Marcel F2SA hopes to be in ZA between the 15th January and 15th February.

Marcel who is a UNESCO official thinks that there will be a possibility to obtain an amateur licence.

## DESECHEO ISLAND

At the time of writing these notes there is an unconfirmed report from a reliable source that this island will be activated next month.

Watch out for anyone signing KH5!

## 4U11TU

4U11TU was active on the 23rd October

to celebrate the commencement of the International Telecom '83 Exhibition and Conference.

A special certificate to commemorate this event in World Communications Year will be made available to all amateurs that contacted the station on this day and to SWLers on a heard basis on application to Rudi F8RU, who is the manager of the ITU.

### KERMADEC

Latest reports are that Warwick should be active from this month. For latest reports on this much sought after area it would pay to monitor the International Pacific DX Net on Tuesdays and Fridays at 0600 UTC on 14.265 MHz +/- QRM.

### BURUNDI

Jim "Bull" Bullington ex TYA11, now the American ambassador in that country has obtained an amateur licence. His tour of duty is for two years and his call is 9U5JB QSL ON5NT.

### MALPELO ISLAND

Well this much wanted country was activated as planned and all Pacific island areas were well catered for. The operating techniques used by the group, as found at this QTH were excellent.

Signals were not as strong as anticipated and it is thought that the operators were not able to reach the top of the island which is 375 metres above sea level. To achieve better coverage of the world, it was envisaged that a helicopter, from the Columbian naval boat that took them out, would be necessary to achieve the optimum position. Apparently this facility was not available.

The unnecessary QRM on HK0TU's transmit frequency is something that everybody could have done without. This back chat from the guardians or policemen on the frequency emanated from all continents and many familiar voices, including those of VK operators, were monitored. Gentlemen, no YL operators were monitored, it is completely unethical let alone being illegal to QRM another station.

Maybe it is time that all amateurs brushed up on their DXing techniques, and perhaps it would be a good resolution for 1984, to assist rather than resist rare DXpeditions that cost figures that sound like telephone numbers to launch and that is not taking into account the unpaid hours of all the volunteers.

### AVES ISLAND

This island is located at co-ordinates of 63°38'W and 15°42'N with approximate dimensions being 570 metres long, 130 metres at the widest point narrowing down to thirty metres at the other extremity. The whole area is only three metres above sea level at high tide.

In conjunction with the Radio Club of Venezuela's golden anniversary's celebrations it is hoped to activate this area at the end of February 1984. Actual dates are dependent on the Venezuelan Navy's commitments and a stay of three days is envisaged.

The call will be YV0AA with both SSB and CW modes being used on envisaged frequencies from 160 through to 10 metres. QSL arrangements are in the hands of YV5DFI, PO Box 50332, Caracas 1050-A Venezuela.

### WANTED COUNTRIES

The DX Bulletin conducts an annual "Wanted Countries" survey and in 1983 640 DXers were sampled. The top ten wanted countries according to the survey were ZA — 84%, VU/L — 82%, XU — 78%, 70 — 76%, XZ — 74%, VU7A — 74%, 3Y — 73%, CE0X-San Felix — 72%, BY — 71% and XV — 68%.

Those wanting VK9M were listed at 27%, which looks like that it is now well down the list.

It is wondered how true this sampling would hold for the VK operators. Perhaps it is some form of an indication to the much wanted amateur confirmations for DXCC.

### LIBYA

G3SYM departed for Libya on a year's contract working for the Telecommunication Ministry and will attempt to obtain a licence.

If he is successful, on returning home for leave at Christmas, he will return with a transmitter and antenna to operate during the rest of his stay. Here's hoping for a genuine operation!

### ARRL DXCC

Latest news is that the recent XU operations will be accepted for DXCC according to the DX Advisory Committee vote. Also there was a recommendation that Spratly is to be retained on the current countries list but the final decision will be made by ARRL Headquarters.

Other news is that XZ9A alias 1Z9A etc will not be accepted, as the hobby is banned in Burma.

### QATAR

Mike A71AD, a constant visitor on the International Pacific DX Net, in a letter recently received describes his operating conditions from a very neat "shack".

The upper frequency station uses the FT1 transceiver driving a FL2100 linear which acts as a buffer to drive an Alpha 77SX. (We have

always wondered why you always have a big signal on twenty Mike, now we know!) Mike uses a TH7DX on the higher bands, a 402BA yagi on 40 metres and an inverted "Vee" on 80 metres.

The upper frequency station uses the FT1 and a FTV107R transceiver which drives a Mirage D1010 linear. The uplink antenna is a KLM 420-450-18C. The down link is catered for by a KLM 143-150-14C. The ERP of the system is approximately 800 watts.

Mike mentions that he was the first foreigner to be granted an A7X licence since independence some fourteen years ago and as there is no club or bureau facilities all QSL's must be direct as per the callbook.

### CONFUSION

A note from F6AJA may clarify the confusion that existed in the early 1970's with the operation of VK0HM.

Gerard F2JD, was operating on Kerguelen Island as FB8XX, when a request was made by the Australian government for some assistance to the party that was on Heard Island. This amateur volunteered for the expedition, was accepted, and contacted the VK authorities for permission to operate an amateur station whilst there. Permission was granted in the form of a telex that read "OK for operation on arrival at Heard".

Upon arrival at the island, this amateur saw the call sign VK0HM on the wall of the shack and used it in lieu of his own F2JD or FB8XX/VK0 Heard. At that time all the operators on Kerguelen used FB8XX and he naturally assumed it was the same for this Australian outpost. Gerard used this call during February and March 1971.

The former owner of the call, WA6EAM, complained to the ARRL and the operation was disallowed as being creditable for DXCC purposes.

A genuine unfortunate misunderstanding, that cost quite a few DXers heartbreak on not being allowed credit for a valid contact due to confusion and a possible language barrier.

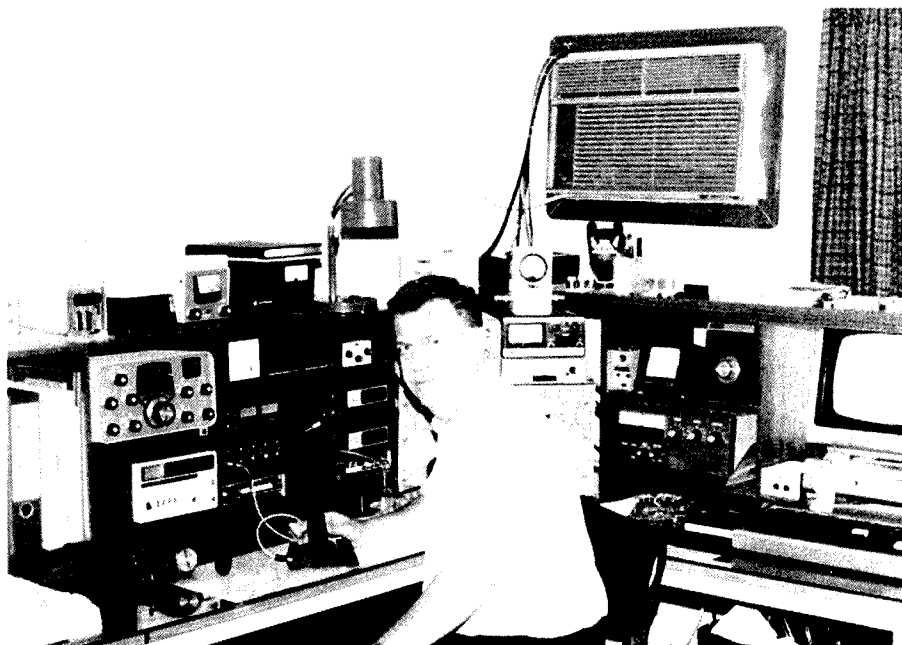

Mike at the controls of his super station.

## ANTARCTIC LOGS

Peter VK3FR, QSL Manager for VKDAP, as with some other QSL Managers for Antarctic stations, will be receiving logs in the near future when the operators return home. This will enable them to process the balance of the cards that are outstanding, including those that have not been verified by the exchanging of logs on the amateur bands, an excellent practice in theory, but one which is not always convenient to all parties.

## JANUARY'S COLUMN

Owing to the early deadlines, due to the holiday season that typesetters and printers enjoy, the January notes have been prepared in advance by Jim VK3YJ. Don't miss Jim's summary of 1983.

## CW SWLING WITH ERIC L30042

28 MHz  
14EAT, JE7JZC, KX6QC, UA0OCI, VE7AAQ, KF1Z, W6TMD, W7LNG, AJ9N.

21 MHz  
DJ6BN, F6FTT, FK8KAA/P, F08HO, HB9BNI, HL0J, KH6DW, LU8DRB, LZ1EA, UK2GAC, UK9HAA, VE7AAQ, VK8NHG, VU83VZ, WL7T, Y54ZA, YJ8MP, 4S7WP.

14 MHz  
CO2HT, CS2ON, CU1CHG, EI9FG, EN6A, FK8BU, FM7BZ, FM7WH, G3ABN, H4SKFL, I2AMH, KH6CF, KP4BBN, OE3NBB, SP5BGA, VP9DR, VU2SKP, YB5ASO, YV5ANT, 3B8FG, 4S7NS, 4Z4MK.

10 MHz  
DJ2XJ, F3NB, G3RHI, OK1DAV, OZ9XD, W1JY, N4SU, W8EGB, VE1BB, Y24DO, Y39XO.

7 MHz  
DL7AFV, EN6A, HA8ZC, I4RYC, LX1PD, ON6BR, TI5BGA, OF2FU, VE2HO, YB4FN, ZK9RW.

3.5 MHz  
GM3JDR, HA7UG, P29PR, SM6CPY, UA1DZ, UK2RDX, ZK9RW.

1.8 MHz  
VK2DSG, VK3(2), VK5(4), VK6HD, VK7(2)

## QSLs RECEIVED BY ERIC L30042

10 MHz CW  
DK5GN, EI4CL, F2BS, G3AAK, HB9AMO, JA5DQH, OE9SLH, OK1DWF/P, K3KA, K4SE, FK8DZ, FM7CF, F08GM, HA7RO (3.5), HC7CM, HL5OC, IS0MVE, LU9FAN, P42E, SM7ALC (3.5), SV1NY, TI2BEV, T30CH, DJ6SI/T5, UW3BF (3.5), VK9NS (1.8), VP9HW, VU2AWL, W5RFR (NASA), ZS4U, 5W1EJ

## WORKED ON THE EAST COAST

28 MHz  
3D2GT, WB2SAY, XE2MX, XE2NNZ, ZK2NU

21 MHz  
3D2GT, BY1AA\*, C6ADJ, F08JP, HK0TU, HL0R, T2ADE, VK0RC, VK4MAL, VQ9EH, VQ9JD, WA6DJO/KH8, XU1SS, YB0BEG, ZC4YC, ZF2GE, ZS4PB.

14 MHz  
3D2DM, 3V8PS, 5N8BKM, 8Q7AV, 8Q7BT, 9H4M, 9M8PW, A92DQ, BY2AA\*, BY1PK, C21FS, C21RK, CE3BH, CO2HS, DF3NZ/S12, FB8WI, FC8TT, G3XPW, GI4NKF, H44SA, HK0TU, HV2VO, I0NKN, J37AH, KA7EKC/KL7, KC4USV, KH2BE, KP2J, KX4PO, KX6PO, LA7EU, LA8PF, LA8PF\*, PY1ZAE, PY3CB, PZ1BZ, SL4ZYX\*, SP9WY, SP9WY\*, ST2SA, T2ADE, T2WCY, T77B, T77V, TR8CR, VE1ASU\*, VE7BBC/KH8, VK8ZS, VP8AGA, VP8ALD, VR6KB, XU1SS, Y23DG, Y24OH\*, Y44ZIP, Y11BGD, ZK2RS.

7 MHz  
3D2DM, 3V8AA, 6Y5JC, C21RK, C21RK, CE3ELS, CP8GB, CP8HD, CP8HD, CT1FL, CT2CB, EA8BH, GI3OQR, JA2BAY, KC4USV, KL7AF, KP4DEX/V2A, LU5AMF, OA4WM, T77B, TI2CF, VK2BCW/LH, VP2VD, WH2ADG, YV3BOS, YV3BOS, ZB2GR, ZK11K, ZK1RS, ZP5PX.

3.5 MHz  
JF11ST, VK9WCY.

\* Denotes CW operation.

1.8 MHz  
VK6HD, ZL1AAS.

## SOME INTERESTING QSLs RECEIVED

BY1PK, FP8AA, G8NF/W4, HA5GP, HA5MA, HV3SJ, LA8PF, OH0KF, OH0W, OH9RW, OZ1EOE, PY1EFM/PY0T, SV1OL, WA3UHK/DU2.

## THANKS

In compiling these notes, information has been gleaned from such sources as RADCOM, QSL MANAGERS LIST, WORLD RADIO, QRZ DX, VERON, DXEXPRESS, QRZ DX, DX NEWS SHEET and LONG SKIP which were used together with reports from VKs 2HD, PS, 3BY, UX, YJ, YL, 6HD, NE and SWL 30042. Amateurs from overseas countries which have contributed include AD1S, G3NBC, I8SAT, ZL1AMM and ZL1AMN. Thanks to one and all.

To all contributors and readers of this column, happy Seasons Greetings to one and all is extended from our QTH to yours, with hopes that 1984 brings health, happiness and lots of DX to one and all.

Remember that the curse of most DXers is that most have to work and miss out on some of the "goodies" that are on the bands.

AR

## Faces Behind the Key and Microphone



Charlie — F6CVR.



Ruthanna WB3CQ, who is presently visiting VK, with Mistl W3DOG.

# THUMBNAIL SKETCHES

Peter Brown, VK4PJ  
16 Bede Street, Balmoral, Qld 4171



ERIC NISSEN  
1930

VK4XN

Eric, who was born in 1905, sat for his AOCIP at the Dalby PO in late 1929 and his Morse test was carried out by Eber Lane who subsequently became a most senior PMG executive. However Eric had been interested in amateur radio well before 1930.

Transmitting equipment comprised a Radiotron UX112A audio output type valve, 1/2 amp filament, in split Colpitts oscillator circuit. Plate supply was approx 135 volts from a number of old 'phone type dry cells, cases punctured and immersed in water in glass jars.

Receiver was a UV200 "soft" type valve regenerative detector with audio amplification.

Antenna a "windom" type single wire feeder, flat top 132 feet and 50 feet high.

Eric was particularly interested in 10 metres in his early days and counts XU2JU, China, among his early DX contacts.

In the late '30s Eric "invested" in a Philips 25 watt transmitting triode, and took the 220 volt anode supply from the DC town mains. Unfortunately little was known of sunspot cycles in those days and there were many disappointments on 10 metres.

In 1929, Brisbane radio identity, Russel F Roberts donated a cup to the VK4 Division for "operating above 14 MHz". Bob Beatson (ex VK4BB), 1929, Rev Delbridge (ex VK4RJ), 1930, and A R (Mac) McKenzie (ex VK4GK) were winners before VK4XN in 1932, 1933, and 1934 who retains the cup.

Among Eric's stories is one of a Puss Moth flight from Brisbane to the Downs and back experimenting with 5 metres.

Over 31 years on the 4QS Dalby staff, from the original 10 kW then high power, until retirement in 1970 was Eric's main work life.

On retirement Eric was awarded the Imperial Service Medal. VK4XN became active in Toowoomba from 1976 with limited activity on HF bands and 2 metres.

AR

# SPOTLIGHT

## ON

## SWLING

Robin Harwood, VK7RH

5 Helen Street, Launceston, Tas 7250

Well, it is the end of the year and the final month of the World Communications Year 1983. There have been several events on shortwave commemorating this, for example both Radio Netherlands and Radio HCJB mounted amateur radio stations from their studios or sites. PA6PCJ was located in the Radio Netherlands studios in Hilversum, while HC1JB was able to utilise the antenna arrays at the Ecuadorean Gospel station site at Pifo, when these were not required for their broadcasts. Unfortunately poor propagation prevented many in this area from either hearing or working them. As well, several administrations released special prefixes to the amateur service to celebrate WCY '83.

It is unfortunate that the amount of deliberate interference or jamming has markedly increased during the year. Ostensibly the celebrations have focused on communications, yet there are some signals designed to deliberately frustrate that endeavour.

As the declining sunspots have caused propagation on the higher frequencies to fall away, there has been an increasing occupancy of lower frequency allocations, with the resulting congestion only too apparent. Fortunately, some traffic is being re-routed via the communications satellites, yet developing nations have found that it is more economical to utilise HF communications.

Perhaps in 1984 we will see a possible growth in traffic and volume over shortwave frequencies. Many countries are modernising and expanding their external broadcasting outlets, wishing to communicate their views to other nations. However, it is a fact that many domestic receivers with SW capabilities, are not able to cope with the congested bands. That is why stations such as Radio Moscow dominate the bands with their super-powered senders and vast antenna arrays, drowning out the competition. Many organisations are either forced into erecting senders and arrays to punch through, or to alter their frequencies to where broadcasting is not normally heard.

Therefore, I believe that the amateur community should get behind the Intruder Watch Service and log any interloper that strays into our exclusive allocations. The amount of traffic from intruders on our bands is increasing and if we don't act and complain, we could lose them by default. Many of the intruders have considerably more power output than a normal amateur is allowed. Often they plonk down on a channel, with a form of frequency shift operation, running reversals, blanks or often an unmodulated carrier. They do this to keep the channel

occupied denying it to other users. This practice by intruders, I must add, is not confined to amateur allocations.

One phenomenon that has been around for a while is Long Delayed Echoes (LDEs). Although I have been aware of them, I haven't personally come into contact with them. Basically what happens is that amateur and commercial operators hear their signals several minutes after they have ceased transmitting.

Of course, this has spawned a variety of theories ranging from time warps to UFOs. However, Robert Freyman, a former scientist with the US government at Los Alamos, has solved the riddle. He proposed that occasionally radio signals became trapped in a conductive duct of plasma, created by the solar wind. This duct extends to the Troposphere, where it "blends" with the Earth's geo-magnetic field. Any radio signals in this region enter the duct. This is determined on the ALF and MUF, and signals are usually propagated into space towards the sun. However, if this duct collapses, the RF signal is reflected back to earth and is heard again, often after a considerable delay.

Scientists at the Soviet Polar Geophysical Institute have researched this theory with experiments and have confirmed that this is in fact what causes the LDEs. This phenomenon is quite common on signals from polar regions, where the earth's magnetic field and the solar wind blend most efficiently. Naturally, because of the USSR's geographic location, signals are subject to LDEs. Mr Freyman was awarded the Commemorative Medal of the Soviet Polar Geophysical Institute for his discovery. No doubt, the OTHR pulses helped the scientists confirm the theory of LDEs.

Only a few months ago, one Melbourne DXer was wondering if there was a correlation between exceptional MW propagation he was observing, and the sightings in central and eastern Victoria of UFOs. However, it is more likely that there is some ionospheric ducting similar to LDEs causing this, rather than the "little green men". This ionospheric ducting could also explain why some UFOs are tracked on radar.

Well, Radio Australia, the overseas service of the ABC has done some programme re-organisation, according to Media Network on Radio Netherlands. They are reportedly dropping transmission to Europe and North America and concentrating instead on the Asian/Pacific region. Their weekly communications magazine — "Spectrum" has been replaced by "Talk-Back" which will continue with more DX information similar to what "Spectrum" had, but with more input from

overseas. You can hear it at 1610 UTC Saturdays repeated at 0210 and 0730 Sundays.

Also the ABC Domestic Shortwave Station in Sydney — VLI — on 6.090 MHz, ceased operations as from Saturday 8th October. It is unlikely to reappear for some time as it was becoming increasingly difficult to procure spare parts for the ageing transmitter. I believe that two regional shortwave transmitters in the Northern Territory will be operational sometime in 1984. With VLI now departed, many SWLs are able to copy the 300 kW transmitter of Radio Luxembourg. I believe that it is in English during the European night time in parallel to their MW outlet, but the majority of programming I hear is in Dutch.

The weekly Southern Cross DX Club net is now heard an hour earlier at 1030 UTC on approx 3.570 MHz each Thursday. The reason being we have decided to keep the net on local time, as it was getting late at 1130 when we are on Daylight Saving Time. This year, only Queensland and the Northern Territory are remaining on Standard Time, as WA is going to try Daylight Saving again. The net will revert to 1130 UTC as from March.

Well, it only remains for me to wish everyone the compliments of the Season and I hope that you have good listening during 1984.

Robin, VK7RH  
AR

**NOW  
AVAILABLE**

**WIA  
BOOK  
VOL 1**

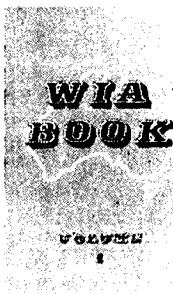

Contains a wealth of historical information and photographs of early "wireless" days and approximately eighty pages of VHF projects to build.

**DON'T MISS OUT!**

**BUY YOUR COPY TODAY from your division or from Magpubs, the book sales department of the Federal Office.**



All times are Universal Co-ordinated Time,  
Indicated as UTC

# VHF UHF - an expanding world

Eric Jamieson, VK5LP  
1 Quinns Road, Forreston, SA 5233

## AMATEUR BAND BEACONS

FREQ	CALLSIGN	LOCATION
50.005	H44HIR	Honiara
50.008	JA2IGY	Mic
50.020	GB3SIX	Anglesey
50.060	KH6EQI	Pearl Harbour
50.075	VS6SIX	Hong Kong
50.945	ZS1SIX	South Africa
51.020	ZL1UHF	Auckland
52.013	P29SIX	New Guinea
52.200	VK8VF	Darwin
52.250	ZL2VHP	Palmerston North
52.300	VK6RTV	Perth
52.320	VK6RTT	Carnarvon
52.350	VK6RTU	Kalgoorlie
52.370	VK7RST	Hobart
52.420	VK2RSY	Sydney
52.425	VK2RGB	Gunnedah
52.435	VK3RMV	Hamilton
52.440	VK4RTL	Townsville
52.470	VK7RNT	Launceston
52.510	ZL2MHF	Mount Climic
144.019	VK6RBS	Busselton
144.400	VK4RTT	Mount Mowbullian
144.420	VK2RSY	Sydney
144.465	VK6RTW	Albany
144.475	VK1RTA	Canberra
144.480	VK8VF	Darwin
144.550	VK5RSE	Mount Gambier
144.600	VK6RTT	Carnarvon
145.000	VK6RTV	Perth
147.400	VK2RCW	Sydney
432.057	VK6RBS	Busselton
432.410	VK6RTT	Carnarvon
432.420	VK6RSY	Sydney
432.425	VK3RMB	Mount Bunninyong
432.440	VK4RBB	Brisbane
1296.171	VK6RBS	Busselton

There are no listed beacon changes this month, although there will be a call sign change in the near future to the Macquarie Island beacon. More on this later. Three new beacons are listed in VK6 — see text for details.

## TWO METRES AND ABOVE

It has been very pleasing of recent times to be continuing to receive detailed reports of what has been happening on 144 MHz and above in New South Wales, and this month an indication of what has been happening in Victoria.

Gordon VK2ZAB has sent along another letter outlining contacts from the Sydney area to various locations throughout NSW. He reports:

"The most interesting happening was the tropospheric refraction opening on 2 metres which occurred on 19th September. (Local day.)

"Bob VK1ZQR advised me at 2245 that there appeared to be an opening to VK5 and

then promptly worked Col VK5RO in Woodville, an Adelaide suburb. I (VK2ZAB) made contact with Col a little later and at 2258 he was 5x2 in Sydney, and I received Q3-5, S2-4. During the contact with Col, Peter VK3XDP in Bendigo called and was 5x3 in Sydney giving me 5x5 in Bendigo.

"The opening continued throughout the day and evening and although some unusual repeater openings were heard there were no further real contacts made to VK5 or VK3 from Sydney. I understand from the VK1 gang that VK5ZO in Mt Barker was heard in Canberra but I am not sure whether a contact was actually made.

"There are two new stations on 2 metres in Canberra, Peter VK3ZQS who is operating portable pending receipt of his VK1 call and Ian VK1BQ who puts a good signal into Sydney on both 2 metres and 70 cm, with 100 watts PEP and 10 watts PEP respectively.

"Two metre contacts with Doug VK3UM at Chirnside Park (Melbourne) have been continued throughout the month. The scheduled attempts at 2230 and 2245 each Saturday and Sunday (local days) on 144.200 MHz have resulted in contacts being made every weekend during September. Participating stations have included Brian VK2QP (formerly VK2ZHT) and myself in Sydney, with VK1RK, VK1KAA and VK1VP in Canberra.

"Particularly interesting was the contact on 23/9 at 2235. Doug was good copy here for 27 minutes and tried 70 cm. His 80 watt PEP signal was heard here in Sydney by myself and Brian VK2QP for a short time on two occasions so it is now only a matter of time before the first 432 MHz SSB contact is made between Melbourne and Sydney.

"VK2YEZ in Griffith can be heard in Sydney any time he transmits with his beam in this direction. John has also continued his 70 cm contacts into Melbourne. He has 150 watts PEP on 70 cm and has so far worked Doug VK3UM.

"Jeff VK2EJJ is another station south west of Sydney at Wagga who can be worked from Sydney at almost any time. Sometimes Jeff is limited to 10 watts but still makes it.

"John VK2ZQX in Gunnedah, Don VK2ADY in Tamworth, Doug VK2XDH in Uralla have all been active on 2 metres during September and can be heard in Sydney on 144.2 at 1030 almost any week night. Les VK2DSG at Duri also puts in an appearance on 2 m SSB after a long absence. He was 5x4 in Sydney at 1047 on 22/9."

Thanks for keeping us informed of your contacts Gordon, by doing so must lead to more eventual contacts as people realise there are stations to be worked on a regular basis.

## THE MELBOURNE SCENE

After a long written absence I have received a massive epistle from Doug VK3UM at Chirnside Park, a Melbourne suburb, giving

details of happenings in that area, and written whilst travelling on the train to work! I have extracted the relevant items of interest to readers, quite a lot being for my personal reading!

On the equipment side Doug says he came back to VHF operating after his sojourn some years ago in VK8, as the result of an occasion when Bob VK4XV scoffed at the fact that he would be able to hear VK3UM on 2 metres meteor scatter. The challenge was sealed naturally when "a couple of dozen" was laid on the line!

Doug writes: "It so happens that on our first sked on 144.020 that we bumped into Eddie VK1VP and Bill VK4LC who had been doing the same thing for months on 144.015. Needless to say, by getting together we all started to hear each other although from Eddie to me was as expected, too close. Many half contacts were had between VK4LC, Angus VK4KAG and myself when we came to meet Gordon VK2ZAB. Bill was consistently hearing Gordon for minutes on end and on what I strongly believe was 'aircraft enhancement!'.

"To cut a long story short, I finally arranged with Gordon to look towards Melbourne. Calculation indicated that with the systems gains at the time that +3 dB forward scatter signals were possible. On our first attempt this was proved correct and although not a full QSO I was able to hear Gordon for 90% of the time and read him Q5 for 10% of the time. My antenna then consisted of two 10 element beams. Next followed replacing the RG214 with heliax and fine tuning the preamps until I was able to realise an 0.8 dB NF (on the HP automatic noise measuring device). This resulted in the first of many Sydney/Melbourne QSOs and the meteor scatter skeds were dropped in favour of a concentrated approach to forward scatter.

"Four ATN 13 element yagis were next tried, spaced 16 feet horizontally and 14½ feet vertically, with open wire phasing sections. This wire was abandoned as it could not be kept tight, so settled for a linear balun on each antenna and a 4 to 1 coaxial power divider. This set up gave great results and the Sydney/Melbourne path became easy. Forward scatter reports received from as far north as Narrabri (1000 km).

"Because the tower was also needed for other antenna commitments, the four came down and were replaced with two 13 elements. But the four had a gain of almost 20 dB with classic side lobes at -14 dB and front to back 35 dB. Sun noise on a quiet sun was up to 9 dB. Having two unused 13 elements on the ground was irksome, so after some further thought it looked as though they might be placed in a four way configuration straddling the TH6 already in place! They were deliberately overcoupled to reduce the side lobes and finished up with 10½ feet vertical, so that now the four are again giving almost 20 dB of forward gain with a slightly wider



front lobe without side lobes. The 3 dB points are about  $\pm 5^\circ$  which raises the old point that a high gain antenna can only be used if you know where and at what time to point the thing! Also, with 300 watts PEP out the ERP is sufficient to cause considerable RFI starting some ¼ mile from the array. Even 10 watts makes a lot of noise!! As a result of this problem, evening skeds were abandoned largely in preference to Saturday and Sunday mornings, with interesting if not predictable results."

### THE VAGARIES OF PROPAGATION

Doug continues: "We became interested in the propagation modes encountered. When you reach a situation of high gain antenna, very low noise front ends and a fair bit of sting, not forgetting reliable guys at the other end with similar setups many things begin to happen that are not all explained in the 'best books'.

"Forward scatter follows the predicted computations that Sydney/Melbourne (distance) will provide signals twenty four hours a day with station system gains as described, but there are many times when there is not a trace of any signal. It is therefore surmised that signals were scattered upwards at times.

"Aircraft enhancement. Here Gordon and I agree to disagree that this provides our basis for the regular (ho hum) contacts. This is our continuing theme for 'research' at this time. But what is certain is the enhancement that does occur. Typically signals (on the noise floor) will rise rapidly over a thirty second period without flutter, and provide signal levels of up to 24 dB on the Sydney path and over 50 dB on the Canberra path for periods approaching five and ten minutes respectively, viz: Gordon can be Q5 S1 which increases to S5 for five minutes, while Canberra is inaudible normally, but signals have been seen to S9 +20 dB (normally S7) for up to ten minutes. Signals disappear as rapidly as they appear. Many times they are disguised by following flights and run into each other. It is not unknown for up to half an hour of continuous enhancement to occur.

"Signals are characteristically steady (viz: no flutter) with generally slow but not deep QSB. When you think about it the cross town aircraft flutter most people know would not be present at these distances so a single signal path will predominate. What causes it? I believe there are three possibilities: (1) Reflection off the condensation trails left by aircraft; (2) Reflection caused by the temperature sheer effect caused by the heat from the aircraft engines; (3) Reflection from the surface of the aircraft. In short, I favour (3) but as mentioned earlier Gordon is not convinced but rather feels another mechanism is responsible. We are both working towards trying to establish what and why or how, and time only will tell."

### INTERESTING SIDELIGHTS

"Try this one. During the widespread opening you reported a couple of months ago, the band was open to Mick VK5ZDR all day on the Saturday, and at 7 PM local I worked Launceston, but the beam heading was 035° and signals S9 +20 dB and the direct path S7!! Definite reflection media which I have never encountered before or since. At the same time Garry VK3ZHP reported

working VK7 on 70 cm on the same heading only on that band the direct path was stronger! Les VK3ZBJ found the same conditions.

"Another interesting 'effect' noticed on odd occasions with Gordon VK2ZAB's signal is a hollow sound, almost to the point of an echo. Queer and unexplained.

"Sun noise is also a problem on early morning skeds and limits the noise floor (which thankfully is either hopeless or excellent with the latter predominating). As most experienced 2 metre operators have found, sun noise can, for short periods (even when elevated well above the horizon) reach S9 proportions.

"The VK5RSE beacon. Generally, Les VK3ZBJ and myself (VK3UM) can always detect the signal but for most others it takes tropo enhancement for them to hear it. I use it for beam alignment and roughly checking meteor counts."

### OSCAR 10

Further from Doug: "Last month installed 'the telephone' (viz: Oscar 10) and what a boon for getting just what is going on around the world and for the setting up of skeds. We have set up 145.960 (down link) as a VK VHF/UHF calling frequency and the group is expanding. Has already proved its worth.

"For Oscar 10 I put up 2 x 16 el on 432 and 2 x 10 el on 145, the former fed with heliax, and run up to 100 watts output and use the system for terrestrial purposes. All antenna horizontal on an AZ/EL mount. Front end is not too bad as I can consistently get about 9 dB of sun noise on 432."

### SKED TIMES AND PROCEDURES

"Gordon VK2ZAB and I (VK3UM) schedule on 144.200. This was chosen to be the best compromise re Ch 5A, beacons etc. Times are 0830 to 0900 EST (2230 to 2300 UTC) with time extended if necessary on each Saturday and Sunday.

"Gordon calls for the first thirty seconds of each minute and I for the last thirty seconds. When contact is established we work normally. We both break to allow for all who can copy to have a go. All overs are kept brief (viz: fifteen seconds) so please, anybody joining in don't give us your rig and family history or the band will have expired!! Another thing, if hearing meteor pings please call by giving your call sign only, (we know ours!!) for it is very frustrating to hear your call six times at S9 without hearing who it is!

"Gordon and I have had Q5 OSOs on each occasion we have had schedules over the past 2½ months (including some evenings) with rare exceptions where I have been Q3. (Power difference). I have now worked five different Sydney stations which is fun considering it had never been done before (going back 5 months).

"As Gordon says, its the forward scatter mode that's more interesting than the 'flash tropo' enhancements. This is always present regardless of 'conditions'. Plenty of guys are improving their systems at present and an 'expanding world' of VHF is resulting. As a well known Frankston station has been heard to say on many occasions 'it's no good having a big mouth but wax in your ears!!'. It still amazes me that people go out and buy 40-100 watt amplifiers for 432, feed it to their 4 by X

element array via RGB and ponder why the band is not open! The economics of the amplifier cost versus that of buying heliax would put them well in front with their existing rigs." (Couldn't agree more Doug . . . 5LP.)

### MELBOURNE ACTIVITY

"On the serious side of things there isn't much at present. Mainly Les VK3ZBJ, Garry VK3ZHP and VK3UM, although many appear out of the woodwork on a good opening. Hopefully some may be inspired to give it a bash but it's the same old thing — 'bands are only open during summer and the shack is shut in winter'."

Thanks for the comprehensive fill in of your activities Doug. I have quoted from your pages of some length as the material is relevant and interesting. Maybe some will be inspired to improve their systems and give it a go. I personally can vouch for the considerable improvements to the ears at the 5LP establishment on 2 metres when the GasFET preamp was added to the 2 x 13 elements at eighty six feet!! And I wouldn't hear much on 432 if it wasn't for the heliax coming from the antenna!

### MULTI-BAND BEACONS IN WA

Wally VK6KZ has written advising of the installation of a new multi-band beacon at Busselton, south of Perth, on 8th October, and operating since 0630 UTC that day. Frequencies are: 144.019 MHz (zero beat, key down); 432.057 MHz and 1296.171 MHz.

"As you can note, these are harmonically related, and the system comprises a common 144.019 MHz drive source. A 72 MHz crystal is used and this is frequency shift keyed. About 40 watts at 144 MHz is fed from the transmitter to a box mounted on the tower adjacent to the antennas. The 23 watts of 144 MHz signal is led through the first power divider with approximately 10 watts fed to two 5 element horizontally polarised yagis. One yagi is pointed at Perth (014°) and the other to Adelaide at 100°.

"The other half of the power goes to a varactor multiplier to produce 432 MHz. A second power divider sends power to the 432 MHz antenna and power to a 1296 MHz varactor tripler. The 432 MHz array is a screen reflector with three lobes favouring Adelaide, Bunbury and Perth. The system efficiency is such that less than ½ a watt is available on 1296 MHz but at least there is only one metre of coax run to the antenna!

"The frequencies were chosen to avoid the EME schedules on 432 MHz and to give reasonable frequencies in the 144 and 1296 MHz bands. The frequencies conform with the WIA Band Plan in that they were chosen because of the special circumstances of this beacon(s).

"Already there have been reports of almost continuous twenty four hour a day reception of the 144 MHz beacon in Albany, Perth and Watheroo (200 km north of Perth and 400 km north of Busselton). The 432 and 1296 MHz beacons were heard in Perth for over two hours the day after they were installed and the 432 beacon has been heard periodically yesterday and this morning (10th October and 11th October). It will be interesting to see how reliable the path is to Perth (and elsewhere) on the higher frequencies.

"The beacon is operated by the WA VHF

Group (and paid for by it) with the help of the Geographe Radio and Electronics Group of Busseiton who have it at their meeting place/radio shack.

"Construction was a team effort with Don Graham VK6HK, Barry Grey VK6ZSB, John Lehmann VK6ZK, Bob Bianco VK6KRC and myself VK6KZ being most involved. A modular design was chosen to provide flexibility and easy maintenance or repair. Shortly a 432/1296 MHz beacon should be installed in Perth and once sites can be finalised there are plans for 144 MHz beacons at Exmouth and Norseman."

#### ACTIVITY IN WA

"The Manjimup (Max VK6FN) to Watheroo (Peter VK6ZPG) path of 400 km on 144 MHz continues to be very dependable with Bob VK6KRC in Perth in the centre and very active. This is an almost nightly sked with those three. John VK6ZK and Ron VK6FM in Perth continue checking 144 MHz propagation to Wally VK6WG in Albany. Last week Steve VK6ASF (Exmouth) was worked via the Geraldton repeater and he indicated Indonesian 2 metre signals were coming in at that time. There were no signs of Steve direct on 144 MHz in Perth but Denis VK6LD 200 km south of Perth was able to work Steve direct on 144 MHz SSB with Steve using two x 5/8 wavelength vertical antenna! People from Bunbury, 470 km south of Geraldton were also able to work Steve in Exmouth via the Geraldton repeater. Roll on summer!

"Don Graham VK6HK and I have pushed our 3.5 GHz working to 80 km and look forward to trying the ducting possibilities when they occur. I understand the 10 GHz beacon in Perth is still running well. Activity on that band has fallen since Roger Nottage VK6NR left for Tasmania.

"Wednesday morning 12th October: We have had at least six hours of 432 and 1296 MHz reception of the beacons from 0900 to 1500 UTC."

Thanks Wally for that latest information, and your new beacons have been added to the beacon list. I hope anyone hearing them will advise Wally as even 2 metre signals don't come too easily from the far west coast of WA.

#### MOBILE VK6RO/M ON HOLIDAYS

Graham VK6RO has once again headed north with his 6 metre equipment and had a good time working JAs, 150 of them on 50 MHz and all from the mobile IC505 and 10 watts output to a quarter wave mobile whip on the roof of the car. There were a total of ten openings starting from 25th August at Carnarvon with one JA at 1027 UTC.

On 26th August at Carnarvon one opening 0700 to 0913 working thirty five JAs. 27th August: Dampier, one opening 0623 to 0820 and nine JAs. 28th August: TV on 49.750 at 0920 and 1130 at Dampier. 29th August: 49.750 TV again at Dampier at 0505 and 0710. 30th August: JA2IGY beacon 5x1 at 0740, with TV on 49.750, at Port Hedland. 31st August: Port Hedland, two openings, 0750-0830 and 0945-1040 with thirty six JAs worked.

1st September: At Dampier, one opening 0836 to 1028 with six JAs. 2nd September: Two openings at Dampier, 0724 to 0823 and 1042 to 1319 with forty JAs. 3rd September: TV on 49.750 0800 and 1000 at Dampier. 4th September: Two openings 0711 to 0735 and

1006 to 1225 and twenty three JAs worked. 5th September: Dampier TV on 49.750 at 0526 and 0803. 6th September: Carnarvon, TV on 49.750 at 0655.

Graham noted the following: "On 26th August JAs were 5x9+ on 50 MHz in QSOs but JAs not hearing VK6RTT beacon only 3 km away on 52.320 MHz. This also happened at other times.

"In many of the day-time openings the MUF probably only reached 50.300 MHz and it certainly never got to 52 MHz.

"Only two night-time TEP openings, on 2nd September and 4th September.

"The difference between 50 and 52 MHz was outstanding. I only heard one JA on 52 MHz and none were worked there. Last year I worked eighty six JAs, this year 150, mainly due to the use of 50 MHz.

"I have now worked 953 JAs while mobile on four holidays in the north-west of VK6 during 1980, 1981, 1982 and 1983, and all worked with 10 to 20 watts output and quarter wave whip."

That's a good effort Graham and thanks for writing. It will be interesting to see what happens over the next few years with the sunspot cycle at a low point, and any comparisons which can be made on 50 and 52 MHz. If you continue to make trips to the north I would expect you to be able to draw some conclusions!

#### NEW ZEALAND VHF FIELD DAY

Readers are reminded of the annual VHF to SHF Field Day being held in New Zealand on 3rd and 4th December. On Saturday 3rd December the field day operates from 0500 to 1100 and Sunday 4th December from 2100 to 0300 UTC and all bands from 6 metres up will be included. It may well be worth while turning your beams in their direction for possible contacts, particularly if you live in the Eastern States.

#### SIX METRES COUNTRIES LIST

It is proposed to have the first listing of countries worked by Australian amateurs in the February 1984 issue of "Amateur Radio". It was decided to not print the list in January because the closing date for copy in Melbourne is 18th November and the consequent problems associated with production over the Christmas holiday period. Therefore, you have one last chance now to upgrade your former list if you have already submitted it to me, or to send your list if you haven't already done so. The method of sending information was published last month and must follow this format. Those lists already to hand include some very good tallies. It is important that any list for inclusion be in my hands no later than 23rd December, after that date I cannot guarantee inclusion this time.

#### MACQUARIE ISLAND

The operation by Peter McLennan VK0AP has now ended. The equipment however has been handed over to David Rasch VK0CK. David's home callsign is VK5CK.

A new EPROM for the keyer with David's call of VK0CK has been provided.

David has also taken his own TS660 with him.

The equipment on loan is courtesy of Lionel

VK3NM who provided the major items and Gil VK3AUJ. The major items are an FT680, a Lunar 100 watt amplifier and a Werner Wulf beam.

The keyer may shift to 52.150 MHz and readers will be advised when operation has commenced.

Those who have still to work this rare six metre country have another year of operation.

#### GENERAL NEWS

The summer DX season is almost upon us and we will probably see an increase in Es activity and number of days for openings whilst in the low part of the sunspot cycle. And don't overlook 2 metres during periods of high Es activity, especially when short skip is around. Two metre openings if any, will probably be only of short duration, so don't waste time talking about yourself or equipment, get the signal reports over and go looking for someone else, so giving as many as possible to share in these unique openings.

This issue starts my fifteenth year of writing these notes. I thank all my faithful correspondents who by their input make the pages possible. The content may not suit everyone, but there are obviously plenty of people out there who do get something from the notes judging by the nice letters I receive. Thanks everyone, I do the best I can for you and for the art of VHF, but much of any success the column may enjoy directly relates to the input which you, the reader, gives it by your letters setting out your exploits and that of others on the VHF bands.

One continuing compounding problem for me as your Sub-Editor is the fact that I still need to work to keep the wolf from the door, and my work as a television technician is very demanding on hours which are frequently very long and hence I run into problems with time to do all that I would like. Hence, I often have long periods without being able to even get on the air which grieves me. Hopefully, this will all change before too long as I propose retiring at the end of 1984 and this should give me time to improve the input to the column if for no other reason that I should be able to fire up the gear more often. I would dearly like to be involved in the scatter work that Gordon VK2ZAB and Doug VK3UM and others are presently conducting, and from 1985 onwards I will be available for specialised work in this field, I already have the equipment capability but not the time to use it!

I take this opportunity of extending Seasons Greetings to all my readers and hope you can work plenty of DX. May Father Christmas be kind and present you with that much longed for transceiver or other piece of equipment, and that it will not cost you a fur coat or new dishwasher for the XYL as well! My thanks to the Editor of "Amateur Radio" and others associated with its publication for bearing with me all these years, and having to put up with my typewritten copy for so long! I must say however, that the treatment given me by the Editor and his staff has always been very generous and there have been very few items submitted which have not been printed, so we must have some mutual understanding!

Closing with the thought for the month: "The reason so many politicians stand on their records is that they are afraid somebody might read them!" 73. The Voice in the Hills.

AR



# ALARA

Australian Ladies Amateur Radio Association

Margaret Loft, VK3DML

28 Lawrence Street, Castlemaine, Vic 3450

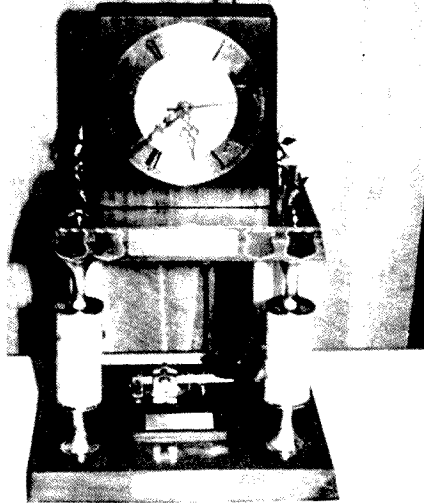

*[Faint, illegible text, likely bleed-through from the reverse side of the page.]*

Ruthanna WB3CQN in late November early December. Mavis VK3BIR is arranging a busy day on 10th December which will give some of the YLs a chance to meet Ruthanna.

I would like to take this opportunity to thank all members of ALARA for your support and news for this column, so very necessary to keep the interest in us alive and well.

ALARA wishes all our readers a very happy and joyous festive season and may 1984 be all you would wish for yourself and families.

Until next year drive safely and I look forward to another year with you all.



33/73/88 Margaret, VK3DML

**"GREEN GINGER NIP" by Joy Collis, VK2EBX**

The heat was oppressive, the blowflies hummed loud,  
The whirly-winds blew up the dust;  
And the plane that the young outback minister flew

Was the colour of reddish-brown rust.  
Three Sundays the little church out in the bush  
With the earth and the sky slept in union,  
But the fourth Sunday woke with a bustle and stir

For the once-a-month Holy Communion.  
The minister, earnest and solemn of face,  
His sermon rehearsed and amended;  
Flew the battered old plane o'er the featureless plain

As the morning sun slowly ascended.  
He bumpily landed, and bounced to a halt  
On the runway 'twas hard to define!  
As he stepped from the plane he was gripped by a thought!

He'd forgot the Communion wine!!  
The people awaited in chattering groups,  
While children played noisily round,  
As the parson approached, and without more ado

His dilemma began to expound.  
A young lad came forward, a freckle-faced kid;  
"Please sir, my dad's got some home brew.  
We live just a little way off from the church,  
I could go get a bottle for you."

"Why, thank you, young Tom, that is really most kind."  
Off he went at a pretty fast clip;  
And returned very quickly with, clutched in his hand,  
A bottle of green ginger nip.

The service proceeded. The wine, duly blessed,  
Was passed round the small congregation,  
But the potency of that nefarious nip  
Was the subject of much speculation!

For 'twas said of that brew that a thimble or two  
Would lay an ox out in his stable;  
So proceedings took on a more boisterous note  
As the cup was returned to the table.

The last hymn was warbled with much voice and pep,  
Though some reached "Amen" far too soon.  
With some of the singers a bit out of step  
And most of them quite out of tune!

The organist's playing, so slow and sedate,  
Took on a more rollicking beat,  
As, the blessing pronounced, the people arose,  
To emerge once again in the heat.

The bottle of Communion "nip" had been large,  
The number of celebrants small.  
The minister sighed as he picked up the cup —  
"Tis my duty to finish it all!"

'Twas late when the little plane started it's run,  
And shakily climbed in the blue,  
And that minister cannot recall to this day  
How he sat in the cockpit and flew!

And he still flies his plane in the heat or the rain,  
But one thing he'll always opine —  
The first thing he always packs into his bag  
Is the Holy Communion wine!

AR

Well another year is nearly over and for ALARA it has been a very eventful one. In July our AGM was a success with all executive positions filled.

In August we celebrated our eighth birthday and plans are progressing well for our first get-together at Mildura in September, 1984. Quite a lot of interest has been shown and hopefully it will be well attended.

Our membership is increasing monthly and we are always pleased to hear from new YLs on air and hope they will join our group. Welcome to new members:— Alice XYL of VK3PEC on 9th October, 1983 and to Lois WB3EFQ on 19th October, 1983 who was sponsored by Gwen VK3DYL. Welcome to Australia to Siegi VK4VSF formerly P29NSF, a member of ALARA for some time.

WCY; some of our members were involved in activities for WCY through their zones and clubs and also a couple of magazine articles have helped to publicise the women's involvement in amateur radio.

1983 has seen a number of women moving forward into more prominent roles in the WIA and this is an encouraging sign that we are being accepted into what was for many years a mainly male domain. Two of our members are now federal councillors and several are now office bearers at zone levels.

ALARA's Contest No 3 will be over when you read this and again I say thank you to all who participated and remind you to please send your log in by 31st December, 1983. Remember this is the first year to be counted for the *Five Year Trophy* so get your log in to me so you are eligible for it.

## MEMORIAL TROPHY

The Townsville Amateur Radio Club has provided a magnificent trophy to commemorate the memory of Mrs Constance McKenzie OBE, formerly VK2FV, the first licensed YL and woman member of WIA. Mrs Mac is well known for her teaching of Morse code to over 10 000 servicemen during WW2.

ALARA feels very honoured to be offered this trophy for a CW section of their contest and the committee is at present working on how best we can incorporate this trophy into our contest next year. Watch this column for details. Our thanks to Mr Bill Woodger and the Townsville ARC.

ALARA's weekly net for the Daylight Saving Time period is at 1000 UTC this hopefully will suit more people and the new net frequency is 3.580 MHz ± QRM.

Congratulations to member Joy VK2EBX, who in June this year learned she had won the Bronze Swagman Award for Bush Verse for 1983 out of 500 entries. Joy and family travelled to Winton Qld for the presentation (see photo). The competition is held every year to promote the writing of Australian bush verse after the style of Henry Lawson and Banjo Patterson. A very talented lady who has won other prizes for her "scribbling" (Joy's words) and this is certainly a delight to read.

Visit to "down under" is anticipated by

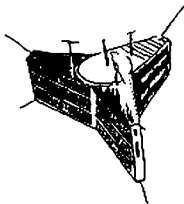

# AMSAT AUSTRALIA

Colin Hurst, VK5HI

8 Arndell Road, Salisbury Park, SA 5109

## NATIONAL CO-ORDINATOR

Graham Ratcliff, VK5AGR

## INFORMATION NETS

AMSAT AUSTRALIA

Control: VK5AGR

Amateur Checkin: 0945 UTC Sunday

Bulletin Commences: 1000 UTC

Winter: 3.680 MHz

Summer: 7.064 MHz

AMSAT PACIFIC

Control: JA1ANG

1100 UTC Sunday, 14.035 MHz

AMSAT SW PACIFIC

Control: W6CG

2200 UTC Saturday, 21.280 MHz

Participating stations and listeners are able to obtain basic orbital data including Keplerian elements from the AMSAT Australia net. This information is also included in some WIA Divisional Broadcasts.

## ACKNOWLEDGEMENTS

Contributions this month are from Bob VK3ZBB, Ron VK5AKJ, AMSAT Telemail and the UoSAT Bulletin.

## OPERATING REPORTS

Ron VK5AKJ and Tom VK5ATA have reported the reception of garbled telemetry from OSCAR 8. It does appear therefore that whilst in periods of sunlight sufficient power is being developed by the solar cells to produce this intermittent operation of the beacon. Ron and Tom are also extremely active on the RS Series and report that there is still a dedicated group of Mode A operators getting the true feel of satellite working prior to tackling Mode B and/or Mode L. OSCAR 9 continues to function excellently with considerable interest centred on the results that HB9RJV and HB9RKR have achieved with the CCD camera experiment. From the picture taken on 21st September, 1983 they have constructed a mosaic using their colour computers and believe that the Sea of Marmara and Istanbul are featured. The 1200 Baud telemetry channel continues to provide a wealth of information either as telemetry or bulletin. OSCAR 10 Mode B operation is becoming increasingly popular and as each day goes by, another "new" country appears on the "bird" which attracts the QRM that one comes to expect on 20 metres during the CQ World Wide DX Contest. QRP days on Mondays and Wednesdays continue to highlight the fact that high uplink powers are not paramount for effective communication. Uplink powers of much less than the QRP maximum 100 watts EIRP are proving most effective. Listening around the passband it does appear that the limiting factor is the ability of operators to HEAR the downlink signals. How about you? OSCAR 10 Mode L is at this stage proving to be difficult to access unless an uplink power of at least 10 kilowatts

EIRP is used. There does appear to be a faulty antenna relay on board the transponder, however, the designers are confident that with time the relay may lose the 10 dB of attenuation currently in the system. Notwithstanding there are operators who can muster that magnitude of power and communicate. Reg VK5QR is the only Australian amateur to QSO through Mode L at this time.

## UoSAT-B

As reported in last month's column a launch has become available for low altitude orbit and the University of Surrey has submitted a proposal to accept that launch. This month we have a description of the system experiments and an update on the status of preparations.

## SPACECRAFT SYSTEMS EXPERIMENTS

The UoSAT-B spacecraft will carry a number of systems experiments alongside the scientific experiments described in last month's column. These system experiments are concerned with developing an improved, cost-effective spacecraft bus and experiment support facility for future amateur low-earth orbit missions — with special emphasis on low-cost Get-Away-Special (GAS payloads on the Shuttle).

### 1) NAVIGATION, ATTITUDE CONTROL AND STABILISATION

A low-cost medium performance stabilisation system is an essential feature for most low earth orbit secondary or GAS payloads. The stabilisation mechanisms most suited to these requirements appear to use spin, magnetic and gravity gradient techniques as none of these need employ expendable spacecraft resources for their long term operation. The UoSAT-1 mission was primarily intended to be earth-pointing utilising gravity gradient methods after an initial inertial, spin stabilised period — the necessary attitude manoeuvres being effected by on-board magnetorquers. The very simple navigation instrumentation and single-axis magnetorquer on UoSAT-1 performed well, if with some difficulty due to their simple nature. The spacecraft was spin stabilised and successful magnetic attitude manoeuvres demonstrated complete control over the spacecraft dynamics and placed it in the correct attitude for gravity gradient stabilisation. The stabilising boom, however, was prevented from deploying fully due to a snag of the cables feeding the scientific magnetometer within the tip-mass on the far end of the boom. Even with only a short (1 m) deployment of the boom, the spacecraft was successfully gravity gradient stabilised for a few days with marginal stability after which it was returned to its spin stabilised state. The experiments carried out with UoSAT-1 demonstrated the basic feasibility of a low-

cost attitude control and earth-pointing stabilisation system, however, the simplicity of the navigation sensors and the partial deployment of the boom prevented the study and evaluation of the operational performance of the system. It is proposed, therefore, to include improved navigation sensors (eg: sun angle sensors, earth horizon sensors, improved navigation magnetometer) on UoSAT-B in addition to spin-axis and spin-plane magnetorquers and a reliable boom. This combination will enable the spacecraft to be navigated to an expected accuracy of within  $\pm 1$  degree and a combination of passive nutation dampers and active magnetic damping (using the on-board computer) will contain the nutation and libration of the spacecraft to within an expected  $\pm 2$  degrees.

### 2) COMPUTER HARDWARE, SOFTWARE AND MEMORY TECHNOLOGY

On-board memory storage has been a perennial requirement for spacecraft and is now highlighted by the proposed Packet Radio Communications Satellite (PACSAT) being studied by AMSAT. Large amounts of solid-state memory (as opposed to tape recorders) is becoming increasingly attractive, however, little experience has been gathered as to the performance of many of these devices in a long-term space environment. As these devices represent the core of a PACSAT type spacecraft, the UoSAT-B mission will provide essential data. In conjunction with the Packet Communications Experiment, various types of CMOS static and dynamic memory devices and a CMOS NSC800 microprocessor will be flown to assess their performance. An RCA 1802 microcomputer will be employed as the main spacecraft computer, as on UoSAT-1. The basic architecture will be unchanged and additional peripheral interfaces will be added to support the UoSAT-B experiments. Software and data will be loaded from the ground command stations into the spacecraft computers as necessary.

### 3) TELEMETRY SYSTEM

The telemetry system used on UoSAT-1 will be upgraded with the addition of an optical hardware-generated checksum for each channel. The ambiguous format of the digital status channels will be resolved by adding 'channel numbers' to each block in the same format as the current analogue channels. An improved dwell facility will allow selection of a number of channels for repeated display. In order to make space for these facilities, the RTTY, 110 Baud ASCII and CW downlink formats will be removed, although some of these can be output through the 1802 computer.

### 4) COMMUNICATION SYSTEMS

The simple and effective transmission formats adopted for UoSAT-1 have proved



Mario Acuna (LU9HBG) has agreed to provide an improved Navigation Magnetometer. Most 1802 computer experiment interfaces have been prototyped in preparation for PCB layout. The PCB layout of the telecommand decoders and multiplexers is under way. Electronic component procurement is progressing well. Detailed specifications of the spacecraft system and interfaces are being prepared. These will be posted once the transients have died away!

### SATELLITE PREDICTIONS

I have received considerable feedback on the subject of predictions and the main area of concern centres on Oscar-10. One positive suggestion was to provide the apogee for the day in the knowledge that for a time period plus and minus three hours of apogee that beam heading remains virtually constant. However, that plus and minus three hour

window only holds for apogees in the centre of the overall (currently 14-15 days) cycle. At the start and finish of each cycle the TOTAL access to Oscar-10 may only be one to two hours maximum.

Acting on this suggestion I have computed the relevant information for Perth, Adelaide and Sydney for December 1983 and January 1984 and comments either for or against the predictions in this form would be appreciated as they will absorb considerable magazine space.

### SATELLITE ORBIT ELEMENT TUTORIAL

An excellent article explaining the significance of elliptical elements has been compiled by Phil Karn KA9Q AMSAT Vice-President, Engineering. It details in the most simplistic manner the elements and considerations for elliptical orbits. In view of its

length and the fact that the erstwhile editor demands copy for the January issue in the next week or so, I intend to include this tutorial along with other operating hints in the January issue and return to the normal column in February.

### UPS AND DOWNS FOR JULY-AUGUST 1983

Once again thanks to Bob VK3ZBB we have the latest listing of launches and re-entries.

### THAT TIME OF YEAR AGAIN

Yes, another year is about to pass, and I can only but conclude this year's contribution by extending to all readers of this column Season's Greetings and a Prosperous Year in 1984 for Satellite Communications.

de Colin VK5HI

AR



# CONTESTS



Reg Dwyer, VK1BR  
FEDERAL CONTEST MANAGER

PO Box 236, Jamison, ACT 2614.

**DECEMBER**  
3-5 ARRL 160 metre Contest  
3 Ross Hull Memorial VHF Contest.  
START.  
10-11 ARRL 10 metre Phone Test

**JANUARY**  
7 Ross Hull Contest. ENDS  
21-22 White Rose SWL Contest  
28 French CW Test  
27-29 CQWW DX 160 metre Test

**FEBRUARY**  
4-5 French 40 metre Phone  
11-12 John Moyle National Field Day  
11-12 Dutch PACC Test  
18-19 ARRL CW DX Test  
25-26 CQ WW 160 metre CW  
25-26 RSGB 40 metre CW

### THE RD CONTEST AND NOVICE CONTEST

Because of the mail strikes affecting the delivery of logs to my post box, I have held the closing date of the contests open for a longer period to allow for the slow logs to arrive.

This means that the results will be delayed and are expected to be published in the February edition of AR providing this strike (current at the date of writing) concludes within the very near future.

### VK-ZL QSO PARTY

The VK-ZL QSO Party held on 40 metres on 8th August between 2000 and 2200 hours was just as enjoyable as in the past in spite of much poorer conditions. Those who used both modes — CW and SSB — certainly had the advantages as copy was very much easier under the prevailing conditions on the CW end of the band.

**RESULTS:**  
Station Contacts Multiplier Score  
ZL2AB 19 9 855

ZL2US 18 9 810  
ZL3BJ 16 6 480  
ZL1JQ 15 6 450  
ZL1VX 12 7 420  
ZL2HS 8 5 200  
ZL3AY 8 3 120

VK3XB 28 10 1400  
VK3KS 27 9 1215  
VK3JA 24 10 1200  
VK4AEM 24 9 1080  
VK4AIX 23 8 920  
VK4CJ 22 8 880  
VK4OX 24 7 840  
VK7CH 18 8 720  
VK2ADR 18 8 720  
VK4BG 18 7 630  
VK3FC 16 7 560  
VK3ZC 15 8 560  
VK3LC 17 6 510  
VK3NV 14 6 420  
VK5KV 13 6 390  
VK3XF 12 5 300  
VK2HO 11 4 220  
VK7JU 11 4 220  
VK4ALW 7 6 210  
VK3YW 5 4 100  
VK6EF 6 3 90

### THE "AIRNET INDIA" INTERNATIONAL DX CONTEST — WCY 1983 — CW SECTION

The purpose of the "AIRNET INDIA" International DX Contest 1983 is to enhance the activity of the amateur radio movement in India and offer an opportunity to all world amateurs to establish on a competitive basis contacts between one another and Indian amateurs.

The contest will further be an effort to commemorate the WCY 1983 and will be run by the organisers of the "AIRNET INDIA" a voluntary net organisation of Indian and DX amateurs. The team for conducting the contest will comprise of the following: VU2AID, VU2BBJ, VU2AIG, VU2RX, VU2NA, VU2TN, VU2TS, VU2YZ.

**PERIOD OF CONTEST OPERATION** — Contest starts on 3rd December, 1983 at 0000 UTC and ends on 4th December, 1983 at 2400 UTC.

**MODES OF OPERATION** — Contest participants will confirm operations on the various amateur bands in accordance with the accepted conventions and practices. Only contacts with amateur stations authorised by the administration will be acceptable. CW operators are expected to use conventional apparatus, in the interest of the hobby.

**ELIGIBILITY** — All licenced CW amateurs of the world are eligible.

**FREQUENCIES OF OPERATION** — All frequencies in the HF band, inclusive of the new WARC bands can be used.

**POWER LIMITS** — Power will be limited to those authorised in each country.

**ENTRY CLASSIFICATIONS** — Category A — Single operator, multi-band. Category B — Single operator, single band. Category C — Multi-operator, multi-band . . . open to clubs only. Category D — Multi-operator, single band . . . open to clubs only. Category E — Family groups . . . OM/YL/YXL teams only.

**OPERATIONAL RESTRAINTS** — Cross band operation, Split Mode operation, Split frequency operation are not permitted. Multi-operator stations may not work simultaneously on the same band, but are permitted to work on different bands at the same time. Countries not permitted under the IARU are ineligible. Working on DXpedition frequencies would be discouraged.

**SCORING DETAILS** — All contacts on 14, 21 and 28 MHz bands with an Indian station counts two points and on the new WARC bands and 3.5 and 7 MHz bands count as four points. Working stations from pincode zones 2, 7 and 8 will double the points above. This is because there are very few active stations in these areas.

**MULTIPLIERS** — Number of zones worked in VU.  
**FINAL COUNTS** — Number of contact points multiplied by the multipliers for each band.

**OPERATION DETAILS** — Give R S (T), and age of operator. Club stations will give instead of age the figures (02).

**SUBMISSION OF LOG SHEETS AND SUMMARIES** — All contest log sheets, summaries will be forwarded to any of the following addresses before 20th December.

Capt D Dasan, "Airtel India", 'CLARA', 5-B, Versova

Cross Roads, off Four Bungalows, Andheri West, Bombay — 400 058, India.

or

Mr K Asutoshan, C/O TVS Limited, TVS Amateur Radio Club, PO Box No 21, Madurai 625 016, India. Handsome certificates will be awarded to the winners.

Note: A phone contest was held on 19th November by this same organisation with the same rules but unfortunately they arrived too late for printing.

### 3RD ANNUAL — 40-METRE WORLD SSB CHAMPIONSHIP CONTEST

SPONSORED BY — 73 Magazine, Peterborough, New Hampshire, 03458.

CONTEST PERIOD — 0000 to 2400 UTC, 7th January, 1984.

RULES — Work as many stations as possible on 40 Metre Phone during the specified times of allowable operation. The same station may be worked ONCE. Crossmode contacts will not count. Single operator stations may operate a total of 16 hours. All the multi-operator stations may operate the entire 24-hour period. Off periods must be noted in your log(s) and on your summary sheet. Off periods are NO LESS THAN THIRTY MINUTES EACH.

OPERATOR CLASSES — (A) Single Operator, Single Transmitter, Phone only. (B) Multi-Operator, Single Transmitter, Phone only.

EXCHANGE — Stations within the Continental forty eight US States and Canada transmit a RS report and State, Province or Territory. All other stations, including Alaska and Hawaii, transmit RS report and DX Country.

POINTS — Five QSO points for contacts with W/VE stations located within the Continental forty eight US States and Canada. All other contacts score ten points each. List points for each contact on your logsheet.

MULTIPLIERS — One Multiplier Point is earned for each US State (forty eight maximum — A District of Columbia contact may be substituted for Maryland multiplier), each Canadian Province or Territory (thirteen maximum), and DX Country (excluding the Continental US and Canada).

FINAL SCORES — Total QSO points times Total Multiplier points equals Claimed Score.

CONTEST ENTRIES — Each entry must include a contest log, a dupesheet, a contest summary and multiplier check list.

CONTEST DEADLINE — Each entry MUST be POST-MARKED no later than 12th February, 1984.

DISQUALIFICATIONS — Omission of any required entry form, operating in excess of legal power, manipulating of contest scores or times to achieve a score advantage or failure to omit duplicate contacts which would reduce the overall score more than two per cent are all grounds for immediate disqualification. Decisions of the contest committee are final.

AWARDS — Contest awards will be issued in each operator class in each DX Country represented, a minimum of 100 QSOs must be worked to be eligible for contest awards.

CONTEST ADDRESS — 40 Metre Contest, Dennis Younker, NE61, 43261 Sixth Street East, Lancaster, CA 93535.

### 3RD ANNUAL — 75-METRE WORLD SSB CHAMPIONSHIP CONTEST

SPONSORED BY — 73 Magazine, Peterborough, New Hampshire, 03458.

CONTEST PERIOD — 0000 to 2400 UTC, 8th January, 1984.

MISC RULES — Work as many stations as possible on 75 Metre Phone during the specified times of allowable operation. All other rules as per 40 Metre Contest.

CONTEST ADDRESS — 75 Metre Contest, Jose A Castillo, N4BAA, 1832 Highland Drive, Amelia Island, FL 32034.

### 5TH ANNUAL — 160-METRE WORLD SSB CHAMPIONSHIP CONTEST

SPONSORED BY — 73 Magazine, Peterborough, New Hampshire, 03458.

CONTEST PERIOD — 0000 14th January, 1984 to 2400 UTC 15th January, 1984.

OBJECT — To work as many stations as possible on 160 Metre Phone in a maximum of 32 hours allowable contest time. Multi-operator stations may operate the entire 48-hour contest period. Stations may be worked only once.

ENTRY CATEGORIES — (1) Single Operator, Single Transmitter, Phone only. (2) Multi-Operator, Single Transmitter, Phone only.

EXCHANGE — Stations within the Continental US and Canada transmit RS report and State or Province/Territory. All others transmit RS report and DX Country.

POINTS — Five QSO points for contact with W/VE stations contacted within the Continental forty eight US States and Canada. All other contacts earn ten points each.

MULTIPLIERS — One Multiplier Point will be earned for each of the Continental US States (forty eight maximum — A District of Columbia contact may be substituted for a State of Maryland multiplier), each of the Canadian Provinces/Territories (thirteen maximum), and each DX Country outside the Continental forty eight US States and Canada.

FINAL SCORES — Total QSO points times Total Multiplier points equals Claimed Score.

CONTEST ENTRIES — Each entry must include logsheet, dupesheet for 100 or more contacts, a contest summary and a multiplier check sheet.

CONTEST DEADLINE — Each entry must be postmarked no later than 19th February, 1984.

DX WINDOW — Stations are expected to observe the DX Window from 1.825-1.830 MHz as mutually agreed by Top Band operators. Stations in the US and Canada are asked not to transmit in this 5 kHz segment of the band. During the contest all W/VE stations are requested to utilise only those frequencies from 1.808-1.825 and 1.830-1.900 MHz.

DISQUALIFICATIONS — Disqualification may result if contestants omits any required entry form, operates in excess of legal power authorised for his/her given area, manipulates operating times to achieve a score advantage or fails to omit duplicate contacts which reduce the overall score more than two per cent. Decisions of the contest committee are final.

AWARDS — Contest awards will be issued in each entry category in each DX Country. A minimum of 100 QSOs must be worked to qualify.

CONTEST ADDRESS — 160 Metre Contest, Harry Arsenault, K1PLR, 603 Powell Avenue, Erie, PA 16505.

### 3RD ANNUAL — RTTY WORLD CHAMPIONSHIP CONTEST

SPONSORED BY — The RTTY Journal and 73 Magazine. CONTEST PERIOD — 0000 to 2400 UTC, 25th February, 1984.

MISC RULES — The same station may be worked ONCE ON EACH BAND. Crossmode contacts do not count. Single operator stations may work 16 hours maximum, while the multi-operator stations may operate the entire 24-hour period. Off times are NO LESS than thirty minutes each and MUST be noted in your log(s).

OPERATOR CLASSES — (A) Single Operator, Single Transmitter. (B) Multi-Operator, Single Transmitter.

ENTRY CATEGORIES — (A) Single Band. (B) All Band, 10-80 Metres.

EXCHANGE — Stations within the forty eight Continental US States and Canada must transmit RST, and State, Province/Territory. All others must transmit RST and consecutive contact number.

QSO POINTS — Five QSO points for contacts with W/VE stations located within the Continental US and Canada. Ten QSO points for all other contacts.

MULTIPLIER POINTS — One Multiplier Point is awarded for each of the forty eight Continental US States. (A District of Columbia contact may be substituted for a State of Maryland multiplier). Canadian Provinces/Territories DX Countries worked on each band (excluding US and Canada).

FINAL SCORES — Total QSO Points times Total Multiplier points equals Claimed Score.

CONTEST ENTRIES — Entries must include a SEPARATE log for EACH BAND, a dupesheet, a summary sheet, a multiplier check list, and a list of equipment used.

ENTRY DEADLINE — All entries MUST be POSTMARKED no later than 15th April, 1984.

DISQUALIFICATIONS — Omission of the required entry forms, operating in excess of legal power, manipulating scores or times to achieve a score advantage or failure to omit duplicate contacts which would reduce the overall score more than two per cent are all grounds for immediate disqualification. Decisions of the contest committee are final.

AWARDS — Contest awards will be issued in each entry category and operator class in each DX Country represented. Other awards may be issued at the discretion of the awards committee. A minimum of 25 QSOs must be worked to be eligible for awards.

CONTEST ADDRESS — RTTY World Championship Contest, C/O The RTTY Journal, PO Box RV, Cardiff, CA 92007.

#### SINGLE OPERATOR:

1 15FZI	2,410,500	37 VK2SG	57,900
2 VK2RT	2,405,976	38 DF6WCY	36,500
3 18JVK	2,012,586	39 KB2VO	34,248
4 JAG6JJ	1,612,256	40 VK2BIS	31,592
5 VK2TTY	1,508,220	41 KGWZ	27,837
6 OZ1CRL	1,290,040	42 DF5BX	26,888
7 14JXE	1,119,668	43 DK4EC	25,850
8 JR2CFD	983,132	44 DL9WCY/P	25,836
9 K4AGC	978,644	45 DL9MBZ	24,036
10 JH2PDS	938,894	46 SP2UU/1	20,340
11 DL1VR	807,896	47 OZ1GRF	20,092
12 18JRA	620,582	48 OK1SPS	17,199
13 VK8HA	613,314	49 JA2VHG	15,798
14 YB2BLI	551,448	50 DK9CK	12,240
15 VK2BQS	483,888	51 TI2DO	12,032
16 W5HEZ	475,690	52 F3IJ	8,875
17 OK3KJF	400,688	53 JF3PLF	8,444
18 G3HJC	368,580	54 OE5PTM	8,120
19 JR6AG	300,315	55 JI3AXU	6,368
20 JA2VFW	285,376	56 JA7ML	4,936
21 JA5TX	258,625	57 PY3IT	3,960
22 VE2QO	237,650	58 PA3BVT	3,664
23 JA1IQV	183,164	59 DK8DB	3,332
24 SM5FU	181,856	60 SM6JQK	3,120
25 SM7AIA	156,730	61 DK5KJ	2,884
26 JA1BYL	152,765	62 Y03RF	2,838
27 SM7SLU	138,890	63 VK2APQ	2,160
28 W2KHQ	136,410	64 JJ1EEA	1,584
29 OE2SNL	131,448	65 HK5BZ	1,519
30 DJ4OP	107,120	66 SM6OEQ	1,188
31 VE7VP	90,936	67 JN1BAX	964
32 VK3BUS	87,480	68 JH3DPB	918
33 WB4UBD	79,060	69 DF7FB	648
34 JF2PZH	65,600	70 VK2BLU	504
35 IK5CKL	62,115	71 SP2FF/1	496
36 VK2EG	62,064	72 VK2AJT	435

#### MULTI-OPERATOR SECTION:

1 VE3UR	316,030	2 JA2YKA	90,615
3 OK3KII	41,310	4 VK2BQK	10

#### SWL SECTION:

1 OZ-DR-2135	1,096,590	2 E L Ludwig	372,310
3 J R Matthews	349,016	4 NL-4483	248,256
5 K Wustner	50,960	6 JA3-30356	40,968
7 JA-25711	31,280	8 DL-H53-1881044	8,034
9 H Ballenberger	3,985	10 JA1-7777	294

Christmas Greetings to all

73 Reg VK1BR  
AR

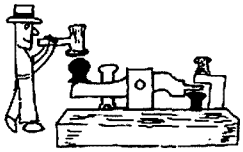

# POUNDING BRASS

Marshall Emm, VK5FN  
GPO Box 389, Adelaide, SA 5001

This month's column is based on a letter received recently from Al Rechner, VK5EK, who has very kindly given permission to use it. The letter is self-explanatory, so without further preamble...

Dear Marshall,

A member of the WIA for over thirty years, a licensed amateur for over twenty five, I have been a keen student of high frequency technique all my life. I have been reading your "Pounding Brass" column in Amateur Radio since its inception some twelve months ago. The column is well written, well researched and very informative. Often as not, it is the first thing I read. You are to be congratulated on it.

I claim to be very well informed on technical matters, and I have been unable to fault you technically, except perhaps for one minor point in the first column (August 1982, p 40). That point is the subject of this letter.

You imply that keyed continuous wave transmissions of the ordinary type; that is, the normal CW we hear on the bottom end of the amateur bands, should be more properly described as ICW or Interrupted Continuous Waves. This is incorrect. Interrupted Continuous Waves are fundamentally different from Keyed Continuous Waves. ICW transmissions are those in which the carrier wave is turned on and off at an audio rate, often by mechanical means. In early days, a simple buzzer was connected in series with the plate supply to the transmitter, so that when the key was pressed the buzzer "interrupted" the power supply at an audio rate. That is, the buzzer turned the power on and off at, say, 500 Hz. The result was a Morse signal on air that sounded very like a buzzer. It needed no BFO on the receiver, it had a piercing, raucous note that carried very well through heavy QRM, and was very easy to copy in the presence of QRM/QRN.

As can probably be imagined, the transmitted signal tended to be very broad and splattery and the system fell into disuse mainly for that reason. Although I can see no technical reason why the signal should be any wider than, say, an SSB signal. The system tended to be rich in audio harmonics, indeed it was this high harmonic content that gave the system its characteristic piercing sound. This would mean that sidebands would extend out for a couple of kHz either side of the carrier, giving a total bandwidth of, say, 3 or 5 kHz, which would be unacceptably wide today, particularly in the CW bands.

A variation of ICW is still in use today and can often be heard with marine traffic on the 500 kHz distress frequency. This variation involves modulating the carrier with a single, sine wave audio tone of about 500/800 Hz. When keyed, these transmissions can be read without a BFO, and when read with a BFO

have an unusual "two-tone" sound which is quite easy to copy.

Thank you, and congratulations once again on an excellent column.

Best regards, Al Rechner, VK5EK.

In thanking Al for his letter, I would like first of all to apologise for the original error. It resulted from my own interpretation of what appeared to be "common knowledge", but Al is 100% correct on both the history of ICW (used more or less interchangeably with MCW for Modulated CW) and the value of the ICW sound in getting through QRM/QRN. In fact, a recent article in an American magazine concerning an audio filtering device suggested that audio harmonics would be a useful addition at the receiver.

But if I could get back to the point of what I was saying in that original article, just for the record, we are still being pretty un-technical when we refer to CW as an operating mode — many amateurs seem to say CW when they

mean Morse code. As an example of this, how often have you heard a reference to how fast someone can "copy CW"? A purist would perhaps have us call the mode KCW for Keyed Continuous Wave, or perhaps even Keyed Un-Modulated Un-Interrupted Continuous Wave! Then again, A1A is perfectly adequate, and I am far less concerned with what we call it than how we use it.

Attached to Al's letter was a schematic for the PA of an ICW transmitter which is reproduced for its historical interest. But please don't try to build it, or if you build it, don't use it. Apart from its wastefulness in terms of bandwidth, ICW is not a permitted mode for amateurs in this country.

Next month we'll be talking about QRPP operation, and I'll include a circuit which you can build from readily available parts and use to your heart's content. Till then, keep pounding brass, and keep the letters coming! 73.

AR

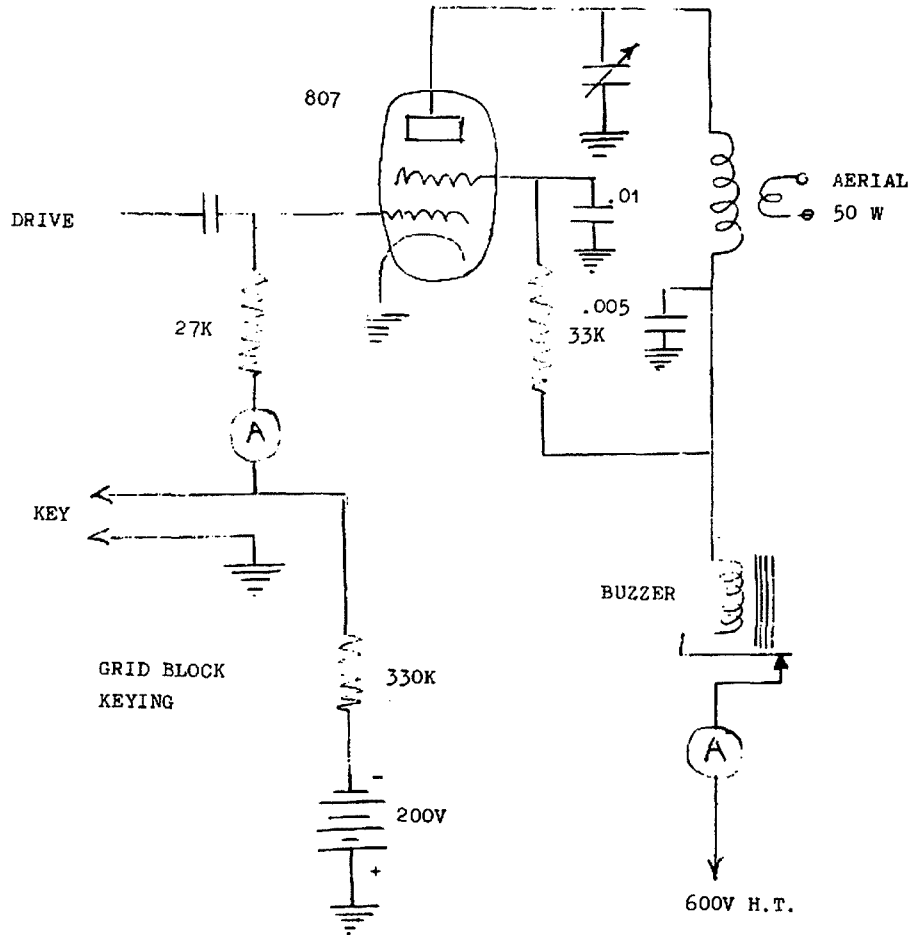

Power Amplifier Section of a 50 W ICW Transmitter.





# WICEN NEWS

Ron Henderson, VK1RH  
FEDERAL WICEN CO-ORDINATOR  
171 Kingsford Smith Drive, Melba, ACT 2615

## REPORT ON COUNTER DISASTER COMMUNICATIONS STUDY JULY 1983

### INTRODUCTION

The Department of Communications and the Natural Disaster Organisation, Department of Defence jointly sponsored a Counter Disaster Communications Study, held at the Australian Counter Disaster College, Macedon, Victoria from 24th to 27th July, 1983.

The Study was attended by representatives from DOC, NDO, OTC, Telecom, Australia Post, State disaster control agencies, the ABC, AUSSAT, the Royal Flying Doctor Service and the WIA. The departments of Transport, Aviation, Industry and Commerce, Defence, Prime Ministers and Cabinet and Science and Technology were also represented.

As Federal WICEN Co-ordinator I attended as the WIA representative.

### STUDY PROGRAMME

The Study opened with a little over a day devoted to briefings by agencies prominent in disaster communications before commencing a series of four seminar topics loosely related to the Study scenario. This was a simultaneous occurrence of a severe earthquake in Adelaide, a tropical cyclone and storm surge in Cairns and major statewide bushfires in Victoria.

### COMMUNICATIONS REQUIREMENTS

The first seminar topic was the production of a list in priority order of counter disaster communications requirements, what could be termed a "wish list". This was then developed across the pre-disaster, disaster and post-disaster phases by levels of activity viz, Commonwealth, state, local authority and industry.

### EXISTING CAPABILITIES

The second topic was the preparation of a summary of Australia's current capabilities, expanded to indicate considered deficiencies in capabilities and proposed solutions. The Study identified fifteen areas of deficiency as follows:

- Potential overload of the public switched telephone network (STN) and cable systems prone to damage.
- Emergency communications not interfaced with the STN.
- Inability to answer public enquiries.
- Broadcasting systems vulnerable.
- Inability of counter disaster (CD) groups to intercommunicate by radio (frequency planning deficiencies).
- Remote and underserved areas exist.
- Insufficient mobile services exist.
- Lack of CD charter for Telecom (including subscriber priorities) and OTC (subscriber priorities and limited capacity).

- Limited capacity for Defence communications network involvement in CD.
- Insufficient defence strategic and tactical capability.
- Lack of physical diversity.
- CB radio lack of range and inexpert operators.
- Lack of interactive capability for national (ABC and commercial) radio and TV.
- Lack of availability of aircraft as a communications tool.
- If cost were no object:
  - more HF capacity for interstate operations and direct contact to NDO.
  - another Transportable Emergency Broadcasting Station (TEBS).
  - improvement of data links.
  - improved access to satellites.
  - provision of video links.
  - more media interface.
  - provide discrete auto telex system.
  - provide more staff and training.

### SHORT TERM IMPROVEMENTS

The deficiencies of topic two led into topic three, "short term improvements" (achievable in a five year period). Generally these were low cost and/or management type fixes and were enumerated in the following areas:

- Telecom.
- Frequency allocations, useage and management.
- Licencing arrangements.
- Operator training.
- Intra-State/Territory liaison and co-ordination.
- Inter-State/Territory/Commonwealth liaison and co-ordination.
- Support from the Australian Defence Force including Defence Communications Network.
- Overseas Telecommunications.
- Broadcasting and other Media Liaison.

### LONG TERM IMPROVEMENTS

The last topic addressed long term (to year 2000) improvements in CD communications and concentrated on seven aspects:

- For Satellites.** Greater flexibility through mobile ground stations; overcome the convergence factor on other communications agencies; mode compatability with mobile radios and in the long term broadcast capability to individual households.
- In the Immediate Disaster Area.** All communications modes, viz, UHF, VHF, telephone, telex, video, FAX. With portable/mobile data systems using intelligent terminals to hold, review and transmit information. Electronic recording for log keeping purposes.
- Federal/State/Territory Communications.** Data, telephone, telex and FAX on a dedicated system with a planned backup system.

**Role of Data Communications.** An aspect of major advancement. Introduce system to control of operations, information gathering and distribution.

**Operator Training.** Through use of friendly equipment and provision of adequate funds for training experience.

**Equipment Commonalty.** By means of user friendly equipment, systems translators and clear specifications followed by effective quality assurance and acceptance procedures.

**Dedicated Backup.** Achieved through reserves and acknowledgement of obligation (ie: dedication to task) by all agencies. Needs lull planning to identify alternatives and define levels of priorities of fall-back options.

### SUMMARY

Throughout the study amateur radio took a low key role which was quite expected in the light of the full range of available communications depicted. However informal discussions with participants indicated a consistent respect for the amateur operator and his involvement, unfortunately coupled with uncertainty as to his role. As all State Emergency Services were represented it is now opportune for State WICEN co-ordinators to follow up with their SES communications officers their role and involvement in the appropriate State counter disaster communications plans.

A full report of the Study will be printed and issued to participants and their parent organisations, hence both FE and I will have copies as will the various SES officers so interested amateurs should have access to copies.

AR



# QSP

### POLICE CARS OF THE 1990s

Will have their own exterior closed-circuit TV camera with video recording facilities, an internal TV monitor and a direct link with its force's headquarters central computer.

A specially converted working model of this type of police car was viewed by senior police officers from Germany, Denmark, USA, Britain and two officials from China at a recent International Police Video Symposium in south east England.

This car, a traffic control duties Ford, was converted at a cost of \$30,000.

from Information Technology from Britain, 23 September 1983.

AR

# HERE'S RTTY!

Bruce Hannaford, VK5XI  
57 Haydown Road, Elizabeth Grove, SA 5112



regulated power supply especially if the RF output is to be higher in frequency than the 7 MHz band.

Crystal oscillator circuits are common place but the RTTY keying methods applied to them are not so well known so I will give at circuit I often use and find very satisfactory. As amateur convention has it that the RF frequency for Mark must be the higher frequency of the RF pair and that the Space frequency must be the lowest one, switching a small capacitor across the crystal for space will establish "normal" (right side up) RTTY. With the circuit shown the closed circuit (Mark) condition switches OUT the capacity allowing the oscillations to be at the highest frequency this giving "normal" RTTY operation. This circuit uses diode switching however for 45.45 Baud RTTY mechanical relays are often quite satisfactory and could be used if desired. We are presupposing that the RTTY keyboard device used to key the transmitter has a switching output and is not limited to audio tones output. All communications computers I have seen do have such an output and mechanical systems can easily be arranged to give switching output.

Looking at the circuit the main points of interest are the switching action of the diode and the effects of capacitors C1 and C2. The diode switching is accomplished by the RTTY keyboard opening and closing the RTTY input connection. When the input circuit is closed the lower end of the diode (it's Anode) is DC earthed through the RF choke and the low value R4 resistor, about +75 volts from R1 and R2 is applied to the top or cathode end. This voltage reverse biases the diode making it non conducting. When the input circuit is open the lower end of the diode is fed from R3, which is connected to +150 volts, the diode now conducts as +150 volts is 75 volts more positive than the +75 volts at the junction of R1 and R2 which is connected to the cathode end of the diode.

When the diode is non conducting C1 is in effect disconnected and has little or no effect on the crystal frequency but when the diode conducts C1 is connected and will pull the

crystal to a slightly lower frequency. The RF voltages present on each side of the diode are confined to the RF switching circuit path by the RF choke and by R1, R2. C3 is a DC blocking capacitor and the ferrite bead is used to prevent VHF parasitics being generated. With C2 set to zero capacity the amount of frequency shift will be determined by the setting of C1. The maximum possible value of C1 should be great enough to give sufficient shift on the lowest frequency band use and this with the most reluctant crystal. It will then be found that on bands such as 28 MHz, even at the minimum setting of C1, more shift than desired will often occur. If C2 is set at a fairly high capacity the switching of C1 will have very little effect and a small shift can then be obtained. Of course the total combined capacity of C1 and C2 must not be too great or the crystal will not oscillate, but with sensible settings 170 Hz shift can be obtained on all bands. Summing it up. On lower frequency bands C2 is set to zero and C1 is set to a rather large capacity to get enough shift. On high frequency bands C2 is set to a rather large capacity and C1 to zero capacity.

Some crystals are more active than others and these will oscillate with large amounts of capacity across them, also some crystals require more capacity than others to shift a given number of Hz. It largely depends on the quality of the crystal used and the type of cut made. Two crystals of identical frequency may give different shifts with the same value of C1 in use. However if you were to order a batch of several crystals of similar frequency most likely all of them would shift in much the same way. I find it is usually easy to get 170 Hz shift on all HF bands but sometimes difficult on 160 metres depending on the cut of the crystal.

I prefer to use the old style large crystals in holders that can be unscrewed rather than modern miniature types using plated crystals in sealed holders. My preference is because the larger crystals can handle more RF Power and their frequency can be changed by grinding them on a piece of glass coated with an abrasive paste. If you want tips about crystal grinding ask old timers, as crystal grinding was common place a few decades ago and most old timers have had a go at it. Often old style crystals can be bought at disposals shops for about \$1 each. Usually amateur band frequencies will have been picked up by "early birds" but often crystals a little lower than an amateur band can be obtained and then ground to the desired frequency in the band.

Of course the same type of keying circuits can be used across a VFO tuned circuit or part thereof and it will be quite easy to get enough shift. The same basic circuit can also be used with solid state crystal oscillators except different resistor values to suit the lower DC supply voltages will be needed. I have found that most VFOs can be RTTY keyed by a slight

## FREQUENCY SHIFT KEYING

As pointed out in the very first RTTY article I wrote in this series a HF bands FSK RTTY transmitter can be a very simple device indeed. There are many advantages in using "DC switched" FSK instead of the more common "Audio generated" FSK as obtained by feeding audio tones into a SSB type transmitter. For "DC switched" FSK there is no need to use any filters, mixers or audio stages etc. The transmitter could be as simple as a crystal oscillator fed into an antenna. In fact I have tried feeding the crystal oscillator stage of one of my transmitters straight into the antenna and did get good results for the low power used. Just think of the delightful simplicity of such a transmitter. I used a valve crystal oscillator, only one RF tuned circuit in the whole transmitter and only a dozen or so components involved. This sort of thing could revive home brewing once again.

I note when you talk about such a set up, most reply "But it is crystal controlled and you need to use a VFO these days". Well a VFO controlled transmission is certainly useful and perhaps almost essential for SSB work but not necessarily so for RTTY. Most RTTY is confined to very small portions of our bands so a few well chosen crystals will often suffice for plenty of enjoyable contacts. Because exceptionally high stability is required for RTTY, home brewing of VFOs is often not successful and the easy way out is to use crystal control. Of course the crystal oscillator should preferably be followed by an amplifier stage or stages to get more power output and better isolation between the antenna and the crystal circuit. Also the crystal oscillator stage will normally need to be fed from a

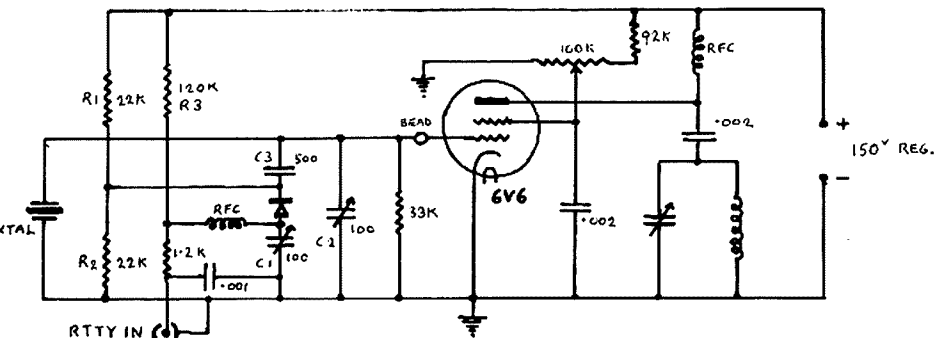

Figure 1 — FSK Crystal Oscillator.

change of supply volts. In one solid state VFO I tried .1 of a volt change in the 9 volts regulated supply gave 170 Hz shift. Of course the voltage changes need to take place very rapidly and if the RF filtering capacitors in the voltage supply line are large their value may need to be reduced. If you wish to build a VFO controlled FSK transmitter an easy way to do this is to buy an External VFO unit intended for a SSB type transceiver. This unit is then heterodyned with a few crystals to cover the desired bands. An easy way to check your shift is to print your own outgoing signals and adjust the shift to give proper mark and space indications. Well I trust the foregoing has encouraged at least a few to build their own RTTY transmitters as it is really quite simple especially with crystal control.

Last month I gave some details of Code Readers and Converters. Well I have spent quite a bit of time using a MBA-RO Code Reader on air and am favourably impressed

by it. For those who obtain one of these units I would like to stress the importance of carefully studying the handbook instructions before attempting to use the unit as some very exact tuning is needed. The instruction book is easy to read and I note only one error on page 5 where, for 14 MHz amateur band RTTY, you are told to be sure to set the receiver switch to USB of course this should be LSB for amateur RTTY and in most cases it would be USB for commercial RTTY. I would have liked to see a normal reverse switch on the unit to save retuning using the other sideband, but for amateur use this is hardly necessary as 99% of the time LSB will give correct copy.

Operating the unit I found it easier to read the one line moving display if it were some distance away and not just under my nose. The threshold control is rather critical but a bit of practice tuning in strong signals soon teaches you how to use the control. The unit operated well on CW, RTTY and ASCII. It

should be a boon to SWLs, intruder watchers, for portable work and for monitoring ones outgoing transmissions. Mechanical RTTY operators would find the unit useful for receiving marginal signals which waste much paper before you get them tuned in, you could save your paper until you decided if the station is worth printing. The filters are tuned to 800 Hz for CW or RTTY Mark with space frequencies of 970 (170 shift) and 1225 (425 shift). The 800 Hz is an advantage for the typical transceiver CW filter but is a disadvantage for AFSK on VHF bands, however the catalogue states that the filter frequencies can be easily changed so this could be overcome.

Summing it all up the MBA-RO will not equal the convenience of a RTTY unit with a VDU page display, but on performance value per dollar spent very good value indeed.

73 from Bruce VK5XI

AR

## INTRUDER WATCH



Bill Martin, VK2EBM  
FEDERAL INTRUDER WATCH  
CO-ORDINATOR

33 Somerville Road, Hornsby Heights, NSW 2077

You may remember in the Intruder Watch column last month, a random check of the 40-metre band, in the amateur segment, 7.0-7.1 MHz, revealed a staggering 70.7% of the segment taken up with intruder transmissions. Taking this a step further, and with many thanks to Col, VK4AKX, for his many hours monitoring intruders, we find that taking some observations over the period 1400 to 2130 UTC, (midnight to 7.30 AM EST) and taking an average of intruder activity, the results show that 49.98% of the amateur segment of 40 metres was occupied by broadcast intruders, and only 50.02% left for amateur use.

In other words, our primary segment of the 40-metre band is effectively reduced by half. Most of these intruders are based in China or Albania — very considerate of them — it would be a great state of affairs if all the radio frequency spectrum users wandered all over the bands at will, as these people do. Hopefully, in January, 1984, at Geneva, the WARC for broadcasters may see some changes. We certainly hope so.

Now for a little information of which, I think, most amateur operators will not be aware, and this one really bears thinking about, hopefully, also, it will drive home the point that every country involved in amateur radio MUST HAVE a working Intruder Watch.

### "THE SIXTY-DAY RULE"

The "60-day Rule" is part of the International Telecommunications Union (ITU) radio regulations. Under the old numbering of the regulations, the rule was No 515 and 526.

This rule allows ANY administration to assign ANY of its stations to ANY frequency, and so long as no reports of harmful inter-

ference are received by the station or the International Frequency Registration Board (IFRB), of the ITU within the 60-day period, the administration can insist on registration of its useage of the frequency. If you think about it, you can see that ALL amateur frequencies are in jeopardy from this rule. It has been used in the past, and no doubt will be used in the future. So you can see that any new intruders heard must be reported quickly, or else we may find that we're stuck with them. Very shortly in the new year, I will make available some statistics on the number and type of reports processed by the Intruder Watch for the period 1st January, 1983 to 31st December, 1983.

Should make some interesting reading, and will be rather alarming for those who are not familiar with intruder activity. Very best wishes for Christmas and the new year to all, and many thanks especially to those who have given strong support to the Intruder Watch in 1983.

AR

## THE RADIO REPAIR SHOP

For quick and reliable servicing of

HF, VHF & UHF TRANSCEIVERS



Contact

ANDY VK3DPJ

Telephone: (03) 553 3483

## NOVEMBER'S BEST PHOTOGRAPHS

The judges at AGFA-GAVAERT, Quadricolor and Waverley Offset Printing Group all select the front cover photograph of the November issue.

This photograph will now be considered for the Optima camera prize at the end of the competition in June 1984.

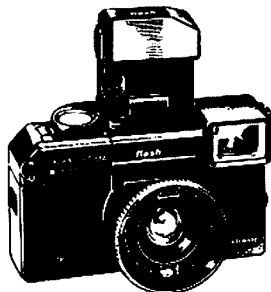

# NATIONAL EMC ADVISORY SERVICE

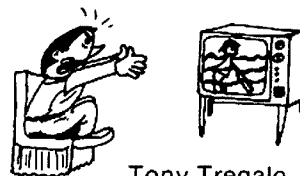

Tony Tregale, VK3QQ  
FEDERAL EMC CO-ORDINATOR

## “THE LIGHT AT THE END OF THE YEAR”

*“The Bill is dead — long live the Act.”* By the time you are sitting down to your Christmas turkey we should have a new Radiocommunications Act.

The EMC aspects of the Act will, we trust, go a long way towards allowing us to see some light at the end of the most difficult political and practical EMC tunnel. The power contained in the Act will, pending the drafting of the regulations and standards, allow the Department of Communications to do the job for which they were appointed. The Department will, for the first time, be in a position to administer one of our most important natural resources, the radio frequency spectrum, with effective legal powers rather than the wishy-washy situation which has existed for so many years under the old Act.

The new Act will advantage the Amateur Service in most areas because the Amateur Service is a very responsible and a very technically qualified user of the radio frequency spectrum. The Amateur Service is very conscious of the need for effective EMC. Indeed, the Amateur Service has been promoting the social, “political” and technical benefits of effective EMC for many years, and is well qualified in both the theoretical and practical aspects of EMC technology.

Nevertheless, members of the Amateur Radio Service should not forget that the Department of Communications does have the power to close down an Amateur Station. The Department of Communications is the government appointed control body for the supervision of the electromagnetic spectrum. In this role they are permitted to close down any communications or broadcast service, and this includes the Amateur Service.

Members of the Amateur Radio Service are most likely to be requested or directed to restrict hours of operation or close down their station in relation to a complaint of interference. However, in these enlightened days of modern communications technology, officers of the Department are well aware of who is to blame for various interference problems — *they do not go out of their way to persecute members of the Amateur Service.*

Amateurs should realise that the Department’s Radio Inspectors, quite often, work under extreme psychological pressure when dealing with the very complex and diverse nature of interference. The situation is compounded by the many and varied problems encountered when dealing with human behaviour, coupled with the social, political and economic issues of our diverse society.

Officers of the Department of Communications may, when investigating a case of interference, find it advantageous to the

smooth progress of the investigation, to request the amateur station to cease operations for a specified period of time, even though the amateur station equipment is not at fault. Under these conditions, members of the Amateur Service should, in the interest of good public relations, co-operate with the Department’s officers in this respect.

However, members of the Amateur Service are entitled to be given reasons for any restrictions imposed by officers of the Department of Communications.

Members of the Amateur Radio Service are advised to contact the National EMC Advisory Service if they consider any action by the Department of Communications, in respect of EMC, is harsh or unjustified.

This may be a good time of the year to give the shack a “bit of a check-over” — perhaps review that “birds nest” of cables behind the equipment racks, shorten the excessively long cables, check the equipment earth bonding and check antennas for loose corroded connections. . . . A complaint of interference can arrive at any time — the new neighbour with his unfiltered equipment, the Christmas present with “rabbit ears”, or the robot with the disc memory.

As most of us know only too well, the majority of interference complaints are not caused by problems in the transmitting equipment but by deficiencies in the receiving equipment. However, it is most important to keep a close eye on those unwanted harmonics, which not only help to cause interference but also become a drain on your hard earned power. Transmitter alignment should be carried out with the aid of a spectrum analyser in order to ensure that all harmonic levels are as low as possible (or within manufacturers specifications) before the signal is fed to the low pass filter arrangement.

Use of a low pass filter alone does not make any provision for dissipation of the unwanted harmonic energy produced by the transmitter. Since there is a high degree of impedance mismatch between the coaxial cable and the input of the low pass filter at frequencies above the cut-off frequency, there is a high VSWR on the feed cable between the transmitter and the filter at harmonic frequencies. Also, since there is usually no provision for external dissipation of this energy, and since harmonic energy is continually being produced, dissipation occurs only in the final amplifier stage and in the cable. Consequently there is a likelihood of harmonic energy radiation from the transmitter itself, as well as possible harmonic energy radiation from the cable because of leakage, faulty connectors and so forth.

An obvious solution is to use a high-pass filter having a 50 ohm resistive load connected in shunt with the feed line, eg by means of a coaxial T connector. Such a high-pass filter should be designed to have the same cut-off frequency as the low-pass filter, to have a 50 ohm input and output impedance, and to have a series M-derived end sections so that its input impedance at frequencies below cut-off will be high.

The result will be that harmonic energy is dissipated in the 50 ohm load connected to the output terminals of the high-pass filter. The shunt effect of the high-pass filter will be negligible at low frequencies because of the high input impedance of the filter below cut-off. There will be no high currents and voltages at harmonic frequencies since the SWR at the harmonic frequencies will be close to unity. Harmonic energy will be dissipated outside of the transmitter chassis, and not all in the final amplifier, so the final stage will run cooler. Of course, all this can lead to less TVI. This concept of complimentary filters has been used for many years in hi-fi installations for separation of high and low frequencies.

Interference problems quite often involve third parties and for this reason members of the Amateur Radio Service should, at all times, be very conscious of the social, legal and “political” implications of entering another person’s property for the purpose of making adjustments, modifications, or just observing any form of interference problem or complaint.

The National EMC Advisory Service warns against any attempt to make adjustments or modifications to any other person’s property or equipment unless you have a positive, preferably written, statement from this person, giving you full authority to make adjustments and/or modifications, etc. The agreement should clearly state that no responsibility for the said person’s property or equipment shall rest on any member of the Amateur Radio Service.

Throughout the year there has been many standard, as well as a number of strange EMC effects which have been brought to our attention. . . . With the approach of summer the case of the “EMI pool” may be of interest — From NSW a VK2 amateur says, *“For some eighteen months I have been troubled with AC arcing type noise reaching S9 on peaks and covering the HF spectrum and above. Evident around 6-7 AM and late afternoon. A pulse of 4 secs duration every 42 secs. I traced*

the problem to a swimming pool automatic chlorinator about 250 yds from my station. The manufacturers replaced the offending unit with a later model solid-state unit."

From Victoria, a report on masthead amplifiers and associated installations. "A well known TV antenna organisation recommends that a MHA not be mounted within the structure of phased array TV antennas. It seems that the amplifier may radiate sufficient signal from its plastic box to be picked-up by the antenna and re-amplified, thereby causing oscillation at 'whatever' frequency. Another problem appears to be the constant use of poor quality coaxial cable. Many of these cables, unlike communications quality, have loose open weave braid. Signal leakage from these type of cables can get back into the MHA input. This is more of a problem where distribution amplifiers are used with high gain and the input and output cables are in the same duct alongside each other. The very high gain of MHA's is not usually required unless a very long output lead is required and/or a number of splitters are needed. About 15-20 dB is more than adequate in most cases."

Again from VK3 is a report on how to transmit computer data on your VHF phone signal. Set yourself up next to a big commercial computer and you could find that the AC supply is modulating your transmitter with information which you could well do without.

Finally, from VK... who was chasing a TVI problem, on and off, for months. Then, for unconnected reasons, VK... decided to give the shack a "bit of a once over". The clean-up revealed crossed antenna feed lines. It was a bit hard to decide how long the shack had been provided with high frequency heating. The moral is — identify your feed lines at both ends.

In conclusion, returning to the Radio-communications Act, I would like to remind all Australian amateurs that the CASPAR (Communications Act Special Planning And Response) Committee will again be co-ordinating and correlating the Institute's response in connection with the Regulations and Standards relating to the new Act. One cannot emphasise too much the importance of good and fair regulations and standards. The Amateur Radio Service will be affected by these, so it is most important that we produce, as far as possible, a truly united effort in the presentation of our case material. The drafting of Standards and Regulations will be a most complex, technical and political operation, and in this respect the CASPAR Committee will need as much assistance as possible from all Australian amateurs in order to try to ensure that the Amateur Service procures the best possible deal.

Any material, suggestions, comments etc in relation to any aspect of the new Act should be sent to — The CASPAR Co-ordinator, PO Box 300, Caulfield South, Vic 3162.

Finally, my thanks to all those who have assisted with the EMC operation throughout the year... Best Wishes for Christmas and the New Year from VK3QQ.

AR

# AWARDS



Mike Bazeley, VK6HD  
FEDERAL AWARDS MANAGER  
8 James Road, Kalamunda, WA 6076

Most of my time, whilst being Federal Awards Manager, seems to be taken up with DXCC matters. There is an obvious interest in this award and updating country totals. Checking through some of these country totals I have come across several errors. These errors, in the main, are caused by deletions not being taken off, or countries claimed which subsequently were not accepted for DXCC purposes. The present DXCC list contains 315 current countries and there is a deleted list of fifty one. The updated DXCC list can be found on pages 148 to 151 in the 1983/84 Australian Callbook. Those of you who are interested in the DXCC listings could you please check your scores against the current list and advise me of any errors, many thanks. Further copies of the DXCC list may be obtained from me — don't forget the SASE please.

Two possible additions to the DXCC lists may be KL7 Pribolof Islands and KH5 Jarvis. The rumourmongers are betting a fifty-fifty chance on the former and little chance on the latter. Hope all that needed them made HK0 Malpelo and BY on SSB.

## PIONEER SHIRE CENTENARY AWARD

The address for claims for this award is Box 1065, Mackay, Qld 4740.

## GOLD COAST AMATEUR RADIO SOCIETY

The new conditions for the two awards sponsored by the above Society are as follows:

**THE GOLD COAST AWARD:** requires five points. Two points for a club station VK4WIG or VK4VGC (one only to count) and one point for any club member. Applications to be sent to: The Awards Manager, PO Box 588, Southport, Qld 4215 and must show: Time, Date, Callsign, Name, Location, Frequency, Mode, and include \$1.00 to cover postage.

**100 REPEATER AWARD:** requires one hundred contacts to be made through the Gold Coast Repeater VK4RGC (VHF or UHF). The same station must not be worked under seven days. Applications to be sent to: The Awards Manager, as above, and must show: Time, Date, Callsign, Name, Location, Frequency (VHF or UHF), and include \$1.00 to cover postage.

To assist stations to obtain the Gold Coast Award the Society will be starting a new club net on 21.175 MHz ± at 1500 UTC every Sunday afternoon commencing in November.

Well once again another year has gone by, may I take this opportunity to wish all a very Happy Xmas and happy DXing in 1984. 73 de Mike VK6HD.

AR

# EDUCATION



# NOTES

The statistics for the August exams were received recently. Readers will be pleased to know that the pass rates recovered somewhat from the very low rates in February this year. The range this time extends from 24.4% (VK6) to 48.8% (VK5) with an overall figure of 39.1% compared to the February figure of 20.9% overall.

Five separate papers were used, some of them a repeat of previous papers, and some with a certain amount of new material added. I have not yet seen the papers, so cannot criticise, but I have not had much adverse comments from candidates.

Candidate numbers for this exam were very close to those for August 1982, but in all states except VK6 pass rates were higher this time — VKs 2 and 3 recorded their highest pass rates of the past three years.

However these top rates of 38.9% and 42.6% respectively are not as high as the top rate for the states with smaller numbers.

The pass rates for the 10 WPM CW exams however are, mostly, significantly lower than they were in February, or even August 1982.

Perhaps these results illustrate the variability that can occur. It is not likely that any particular Morse exam will be much harder than any other, but over the three years for which I have figures, 10 WPM pass rates by state have ranged from 26% to 85%, with the figures for VKs 2 and 3 varying from 26% to 51% and 35% to 43% respectively.

I have recently received a copy of the Instruction Kit prepared by the VK2 Division Education Service. It includes the new publication 'Novice Electronics' which together with the earlier booklet 'Into Electronics' provides a complete Theory course. This appears to provide a useful addition to the available material for students or instructors. It is simply written with clear diagrams and, in general, explanations that are easy to follow. These two books together with the '100 Basic Electronic Projects' from the same source would provide an interesting and effective course for schools looking for some application and extension of their electronic units.

The kit also includes a Morse code instruction book and tape. While I do not personally advocate the learning procedure recommended in the course, I can see the whole kit is a very useful package for the student trying to struggle through without benefit of classes or assistance.

To those of you who may want copies of CW exam tapes, please get them to me as early in December as possible, as my copying facilities tend to be unavailable over the school holidays. Sample exam papers are less difficult. I would like to thank all those who enclose return postage or contributions with their requests for tapes or papers.

Best wishes to you all for the forthcoming holiday season and the New Year. May the bands you want to use be open and your equipment free of problems.

73 Brenda VK3KT AR



# CLUB



# CORNER



## REDCLIFFE RADIO CLUB

The Redcliffe Radio Club's demonstration stand at the Caboolture Sunshine Festival attracted a great deal of interest. Andrew Hite of Caboolture and Steve Howarth of Redcliffe, (from left) looked over one of the many different pieces of equipment.

AR



## AUSTRALIAN CWQRP CLUB

The VK CWQRP Club has been disbanded. There are moves to form a new CWQRP Club and anyone interested, including former members please contact:— Mr Len O'Donnell, VK5ZF, 33 Lucas Street, Richmond, SA 5033.

AR

## VICTORIAN MIDLAND ZONE

The December meeting will be the Christmas breakup at the home of the president Don VK3XBL at Mandurang Sth on Friday 16th from 6 PM onwards. BYO barbecue or cold salads etc if weather not suitable for barbecue. All welcome.

The Annual Midland Zone Convention will be held on Sunday 19th February at the usual venue at Strathfieldsaye near Bendigo. Full details will appear in the February issue of AR but please note this date. Catering etc will be as 1983.

Margaret Loft, VK3DML  
HONORARY SECRETARY  
AR

## ANARTS

This year, being World Communications Year, the Australian National Amateur Radio Teleprinter Society made a special effort with their Annual RTTY Contest. The VK/ZL WCY RTTY Contest, and studying the logs received, it would appear that their efforts were well rewarded and the results most encouraging. We were fortunate to have the backing of the International Telecommunications Union, and were elated when the Secretary General Mr R E Butler offered to donate the trophies for the winners of each section. It was later announced, Mr Butler would be attending the IREE Convention in Sydney, and was particularly anxious to actually present the trophies to the Australian winners, in person, while in Sydney. The committee of ANARTS organised a dinner at one of the leading hotels to meet and entertain Mr Butler, during which he presented trophies to the Australian Single Operator and Multi-Operator winners. He also presen-



Mr Butler presenting trophy to Bruce VK2RT.



Members present at the dinner. L to R Peter VK2ABH, Pierce VK2APQ and Mirek Joachim — technical consultant to ministry of communications in Czechoslovakia.



Mr Butler delivering his speech. Syd VK2SG, President ANARTS is to his left.

ted trophies to representatives of the world single operator and world multi-operator winners. To remind Mr Butler of his meeting with ANARTS, he was presented with a book of Australian scenes.

Following is a brief history of the ANARTS which was formed in 1976 by Bill VK2EG and Syd VK2SG to encourage the use of RTTY and to assist those interested in the mode setting up their gear. Also to further assist members, ANARTS produce kits for modulators (AFSK and FSK), demodulators and power supplies. They also purchased, in bulk lot, machines (Model 15s at the time) for the members, and assisted in getting them operational. To keep members informed on new equipment and the general doings in RTTY, a news letter called 'AREWISE' was produced, this news letter was sent to

members every two months. A news broadcast in RTTY was also commenced at this time, using our official callsign VK2TTY. This broadcast is now transmitted every Sunday at 0030 UTC on 7.045, 14.090, 14.095 and 146.675 MHz. The 14.090 transmission is beamed north and the 14.095 transmission is beamed west. This broadcast is repeated at 0930 UTC on 3.545 and 146.675 MHz. These news broadcasts contain news of interest to the RTTY fraternity from all over the world, plus DX notes for CW, SSB and RTTY. We are one of the very few stations throughout the world who broadcast RTTY DX news, and as such have a big following. The broadcasts are regularly received throughout Australia and South Pacific Islands. Also, news contained in these broadcasts is regularly used during the week by stations in other states.

Syd Molen, VK2SG  
PRESIDENT  
AR

## MOUNT ANAKIE REPEATER

The Geelong Amateur Radio Club, who has the responsibility for the operation and maintenance of the Mt Anakie Repeater VK3RGL, is presently conducting a fund raising effort due to the necessity to rebuild and relocate the Repeater to another site on Mt Anakie.

As a mark of our appreciation this club has produced a certificate, which will be sent to all amateurs and SWLs who assist us with a donation.

Barry Abley, VK3YXK  
HONORARY SECRETARY  
AR

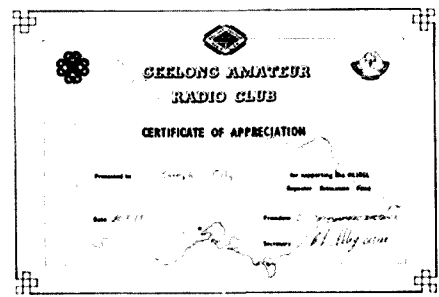

**WIN THIS NOISE BRIDGE**

Details in January Amateur Radio.

# ATN ANTENNAS

A Victorian Approved Decentralised Secondary Industry providing apprenticeships and training to many young people in the only Secondary Industry in the Shire of Birchip. Situated in HW Victoria, the Shire has an area of 1470 square kilometres and a population of 1470.

We have manufacturing and testing facilities for Satellite, TV, Radio Astronomy, EME and all type of CB, Amateur and Commercial Communications Antennas and supply to many Overseas Countries.

*If our High Gain TV Antennas are unable to solve a particular TV reception problem WITHOUT THE USE OF BOOSTERS on either VHF or UHF, then the problem cannot be solved. (TV Dealer enquiries welcomed.)*

With thirty-five years' experience and the first Amateur Radio Station in the Southern Hemisphere to conduct successful Two-way Radio Contacts via Lunar Reflection on VHF in 1966 and subsequently on UHF (resulting in the only non-American ever to be awarded the ARRL TECHNICAL MERIT AWARD) our record is hard to beat.

FOR A FREE CATALOGUE ON OUR COMPREHENSIVE RANGE OF PRODUCTS WRITE TO:

# ATN ANTENNAS

PO Box 80,  
Lot 11, Morrison Street,  
Birchip, 3483  
Phone: (054) 92 2224 (24 hours)  
Telex: AA 55480 OCOBIR

*Or one of our many approved distributors throughout Australia, New Zealand and the Islands.*

## ELECTRONIC HOBBYIST!

DO YOU LIVE IN . . .

Ringwood, Lilydale,  
Boronia, Wantirna,  
Bayswater,  
Mooroolbark etc? . . .

We carry a comprehensive range of electronic components at very keen prices.

### Ian J. TRUSCOTT ELECTRONICS

CNR EASTFIELD  
& BAYSWATER ROADS,  
SOUTH CROYDON,  
VIC.  
TELEPHONE  
(03) 723 3860

## "TRIO" DM801 DIP !! METER



\$145.00  
inc. post & packaging  
**William Willis & Co Pty Ltd**  
98 Canterbury Road,  
Canterbury, Vic. 3126  
Phone: (03) 836 0707

## For QSL Cards

Phone  
(03) 527 7711

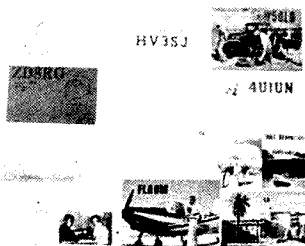

### Williams Printing Service Pty Ltd

12 William Street,  
BALACLAVA 3183

CONTACT US FOR QUOTES

## A Coil to oil holders of a **NOVICE LICENCE**

Now you have joined the ranks of Amateur Radio, why not extend your activities?

### THE WIRELESS INSTITUTE OF AUSTRALIA (N.S.W. DIVISION)

conducts a Bridging Correspondence Course for the AOCF and LAOCF Examinations.

Throughout the Course, your papers are checked and commented upon to lead you to a **SUCCESSFUL CONCLUSION.**

For further details write to:  
**THE COURSE SUPERVISOR,  
W.I.A.**

P.O. BOX 1066,  
PARRAMATTA, NSW 2150



# VK2 MINI BULLETIN

Jeff Pages, VK2BYY  
VK2 MINI BULLETIN EDITOR  
PO Box 1066, Parramatta, NSW 2150

## NOTICE OF MEETING

*The Annual General Meeting of the Wireless Institute of Australia, New South Wales Division will be held at 2 PM on Saturday, 31st March, 1984.*

*Nominations for election to Council and agenda items for this meeting should be directed to The Secretary, PO Box 1066, Parramatta, NSW, 2150 and must reach the Divisional Office no later than Wednesday, 29th February, 1984. Nomination forms may be obtained from the office, either by calling, writing or phoning (02) 689 2417.*

*Any ordinary, ie full, member of the WIA NSW Division may stand for election to the Divisional Council. Would members please note that no business may be discussed or voted on at the AGM unless all members receive notice of such business (see Article 31). Please ensure that any motions you wish discussed reach the office by 29th February, 1984.*

(sgd) David Walters, VK2AYO  
HONORARY SECRETARY WIA NSW DIVISION

## COUNCIL REPORT

Divisional Council met at Amateur Radio House on 14th October, 1983. Fourteen new applications for membership were accepted. Council resolved to adopt the recommendations of Federal Executive on the proposed Radio Communications Bill, and congratulate Michael Owen in particular for his efforts on our behalf.

Council received three nominations for the Dick Smith Educator of the Year Award. After a secret ballot amongst the councillors Keith Howard, VK2AKX was given the award, which was presented at last month's Conference of Clubs.

Council decided to nominate Dick Smith, VK2DIK for the Ron Wilkinson Achievement Award for his outstanding solo around the world flight using and promoting the Amateur Radio Service in the countries he flew over. This Federal Award is made in honour of the late Ron Wilkinson, VK3AKC and is given for special achievement in any facet of amateur radio by any amateur.

## REPEATER INTERFERENCE

Last month's report on interference to the Dural repeater by a new Telecom paging transmitter has a sequel, and it's good news. Shortly after last month's column was written, Telecom advised that, following representations on our behalf by the Department of Communications, they had fitted filters to the paging transmitter. As a result the interference to the repeater has been completely eliminated. Council expresses its appreciation on behalf of all users of this service for the efforts made by the DOC and Telecom officers, particularly as the transmitter concerned was operating well within specifications and Telecom were under no legal obligation to install the filters.

## DIVISIONAL OFFICE

Members are reminded that Bankcard is now accepted for personal, mail or phone purchases from the Divisional Office. If purchasing by mail or phone, please give your name, Bankcard number and address (not a post office box). Note that only payments to the Division may be made by Bankcard; this does NOT include membership renewal, which is paid directly to Federal.

The Divisional Office is open each week day between 11 AM and 2 PM, and in addition each Wednesday night between 7 PM and 9 PM and on the FIRST Saturday of the month between 11 AM and 2 PM. The Saturday openings are for a trial period to establish whether or not a demand exists for this service.

The Office stocks a wide range of publications of interest to the amateur. Send an SAE for a current price list. Membership badges, metal car badges, car stickers and blank QSL cards featuring the WIA emblem are also available to members.

The Office will be closed over the Christmas period, but at the time of writing the exact dates are not yet known. Listen to broadcasts for details.

On behalf of Council I wish all members and their families a happy and healthy Christmas and New Year.

73 from Jeff, VK2BYY  
AR



# FIVE-EIGHTH WAVE

Jennifer Warrington, VK5ANW  
GPO. Box 1234, Adelaide, SA 5001

A few months ago I commented that we had heard 'rumblings of discontent' from VK8 and other sources. Well, although we are doing our best to solve any problems as they occur, and in general improve the lines of communication between divisional council and our far flung members, it did occur to us that perhaps now would be a good time to look at the possibilities of VK8 becoming an autonomous division. I made discreet enquiries to FE as to how one went about it, and Ken Westerman, VK5AGW, our Membership Secretary, made discreet inquiries of some of the members in Alice Springs and Darwin, whilst he was holidaying up there in September. The general impression he received was that they were in favour, however we realised that this was only a very small representation of the total number of VK8s so, on his return to VK5, a questionnaire was sent to all VK8s asking for their opinions.

At the time of writing we are awaiting the results of this, and it may be well into the new year before I can report on the results. It was

made clear in the questionnaire that there was no guarantee of success even if the results were favourable. Although there are 187 licenced amateurs in VK8, only about 50 of these are WIA members. It may be that FE and the other divisions (all of whom must agree to the proposal) will consider that 50 members is not enough to form a division, and that they will have to recruit more members before it can be considered. At this stage there are a great number of hypothetical 'ifs and buts' and nothing will happen 'overnight'. In a lighter vein — there is of course the possibility that VK5 may loose the RD Trophy without the VK8s to help us!

Whilst Ken, VK5AGW was in VK8 he made the tourist pilgrimage to the top of Ayers Rock, complete with 2 metre hand-held. Unfortunately he didn't make any contacts, so he won't have to worry about having a special QSL card printed!

Once again we are advertising a 'Position Vacant'. This time it is for a new Intruder Watch Co-ordinator. Colin Ralph, VK5KCR, who took over the position some 18 months

ago, has had to relinquish it due to personal commitments. We thank you, Colin, for your efforts, and hope that someone out there will also see the need to keep our bands free of pirates. If you would like to help please contact a council member as soon as possible.

## DIARY DATES

*Tuesday, 6th December: Christmas Social — Thebarton Assembly Rooms with guest speaker — Wally Watkins, VK2DEW, talking on China. Bring your partner and a plate of supper.*

*24th January: Check December's Journal and Broadcasts for details.*

Membership Subscriptions for 1984 are now due.

Please pay promptly for continuation of your membership!





# VK4 WIA NOTES

Bud Pounsett, VK4QY  
Box 638, GPO, Brisbane, Qld 4001

*These pictures were taken at the sixth North Queensland Radio Convention held at the James Cook University, Townsville 23rd-25th September, 1983.*



**WIAQ President, Guy, VK4ZXZ bringing best wishes for a successful sixth North Queensland Radio Convention.**



**Hidden transmitter hunt prize to John, VK4NIE/YLG, "The Best Sniffer in North Queensland".**



**A small group of the crowd during the opening ceremony.**



**Bertha, XYL of Les, VK4LZ, receiving the floral art demonstration basket for 100% attendances at North Queensland Conventions.**



**Congratulations to Evelyn, VK4EQ, number 24 Merit Award, presented by Guy, VK4ZXZ, President of the Queensland Division.**

**Rogert, VK4CD, left, presenting prizes to fox hunt winners, Bill, VK4XZ and Terry, VK4ATY.**

Seasons Greetings to all.

73, Bud VK4QY  
AR



# LETTERS TO THE EDITOR

Any opinion expressed under this heading is the individual opinion of the writer and does not necessarily coincide with that of the publisher.



## JUBILEE ISSUE

Your copy of the Golden Jubilee Issue 1933-1983 Amateur Radio was a real credit to the editor and the picture of the OM amateur radio operator just fitted the meaning of what the Golden Jubilee is all about. May I say keep up the good work you are doing a marvellous job. Thanking you once again.

Yours faithfully,  
H C Harmor  
14 Scott Street  
Sefton Park, 5083  
AR

## LETTER OF THANKS

At our last meeting, it was resolved that a special letter of thanks be sent to you expressing our praise for recent issues of Amateur Radio but, in particular for the Golden Jubilee Issue.

It must be difficult to maintain such high standard but you and your team managed to give it that extra lift — a suitable celebration of fifty years of service to AR!

Best 73 es GD!  
Charles Ivin, VK4BPI  
Secretary  
Mackay Amateur Radio Club  
PO Box 1065  
Mackay, 4740  
AR

## ANTARCTIC STATION

I have been selected as a member of the 1984 Antarctic Research Expedition to Mawson station. I have just been granted a licence to operate amateur gear at the base (VK0GL) and would like to advise other amateurs that I will be striving to make many contacts in the period January '84 - February '85.

Here in Australia I am known as VK3YTU and have never operated HF before. I am very excited about the potential for developing my skill and techniques as an amateur, not to mention the joy of being able to speak with my fellow Australians back home.

I am an Electronic Engineer and will be making a detailed study of the ionosphere with the aid of devices such as an ionosonde, riometers, magnetometers etc. Finally, congratulations on an excellent magazine.

Yours faithfully,  
Grant W Lamont, VK3YTU (soon to be VK0GL)  
Ionospheric Prediction Service  
PO Box 702  
Dartinghurst, NSW 2010  
AR

## BOUQUETS

Bouquets to Tom Laidler, VK5TL and Marshall Emm, VK5FN for their helpful hints on how to send and receive CW!

More power to them!

73,  
Les Cullen, VK2WU  
PO Box 31  
Winmalee, NSW 2777  
AR

## NOVICE OPERATORS

I request everyone to re-read the article written by Rex Black, VK2YA on p 75 of October issue of Amateur Radio, where he submits a few quite valid grounds for the CW novices to be given a portion of the 7 MHz band. They could be distinguished by a /C after their callsigns.

Enough havoc has been caused in the offices of the DOC, the VK and Foreign Call Books with amateurs upgrading from novice to K to full call in a matter of six months or so.

This letter is to refresh the memories of the WIA council members who held office for the year 1980/81. I sent a letter to each divisional council containing many extracts from my (VK5NLC) Novice Notes that had been written in the VK5 Journals. It stressed the need for the skilled Novice CW operators being allowed to operate down to 21 and 28 MHz.

With the proposed extension of the 80 metre band, I request the Novice Allocation be extended up to 3.7 MHz (WARC-use the bands or lose them). With so many novices in VK2 and VK5 (myself included) doing slow Morse sessions, I suggest its frequency could also be moved up near the top end of the band, thereby easing local QRM to many stations trying to operate in the same locality, Port Lincoln for example.

Now in 1983 we find that the Third Party Net requires a given and clear frequency as many operators found we were giving it QRM during the recent RD Contest. If novices could go up to 3.7 MHz this contest would be more enjoyable also.

Once again, I strongly recommend that the next Federal Convention give some serious consideration about my proposals, there being NO necessity for any changes to existing novice callsigns etc.

With the use of my CW programmable CQ caller that will be described in this magazine soon, a novice can put out CQ calls on 10 and 15 metres, even when the bands seem dead. By continual use of CW the unskilled Novice Operator would increase his speed up to 10 WPM and bypass the K call.

On page 26, AR July 1983, in "Representation to the DOC" I quote, "Possible use of Morse on VHF by K licencees" unquote. Surely my request would help to cancel out the above quote, also the claim that novices were not expected to upgrade to full call has been proved as false.

Yours faithfully  
Lindsay Collins, VK5GZ  
12 Park Avenue  
Rosslyn Park, 5072  
AR

## EDITOR'S NOTE:

Matters requiring attention at the Federal Convention should be raised with your division. The division, after consideration may then submit an agenda item for the Federal Convention.

## APPRECIATION

I wish to show my appreciation to all concerned in the "Golden Jubilee Issue 1933-83", which in my opinion was an excellent job in all aspects, the old timers photos of past days, very good indeed.

I enjoyed the article on VK2ZL, also Gavin VK3YK and VK3RV, but the article on VK3BQ by VK3ZS was a masterpiece of research and writing, so once again as one person in VK2, I thank all concerned.

Cheerio,  
M E Austin, VK2KZ  
8 Stanford Street  
Kurri Kurri, 2327  
AR

## TAKE A BOW SLOW MORSE OPERATORS

Re your very excellent nightly slow Morse practice broadcasts on 80 metres, I would like to convey my sincere thanks to those tireless operators who must have unlimited patience. It was

largely through these broadcasts that I was able to obtain my novice licence.

If I may, I would like to make a suggestion, which may or may not have been tried before. This being that a simple means of self correction of random type received would be to send simple text backwards. Eg: EDOC ESROM WOLS.

73,  
James Armytage, VK2PNM  
Kelburn  
Gilgandra, 2827  
AR

## ZONAL AWARDS

I agree with John Andersen, VK5ZFO, in the August issue, that the tragic Spratly Islands affair should cause us to reconsider the DXCC so-called countries list. No doubt in earlier days, the DXCC certificate was a genuine proof of one's dedication and operating skills, but in the 1980s, anyone can work a hundred countries over a major contest weekend. So what is the DXCC now worth? The difficulty in working *all* the countries on the list now is a political rather than a technical one, as illustrated by the Burma situation.

Mr Andersen's suggestion to divide the world into areas by latitude and longitude, ignoring the countries concept, is a sound one since it does away with the nonsense of places like the St Peter and Paul Rocks being classed as a country. However, such a worldwide grid system already exists and is in use by the Moonbounce fraternity. It is called the "Maidenhead Locator System" since it evolved in discussions between Region 1 VHF operators in the English town of Maidenhead on 26th and 27th April, 1980.

In this system, the globe is divided into 324 "fields", each 20° from east to west and 10° from north to south, identified by two letters from AA through RR, the origins being latitude 90° south and 180° east. The "numbering" is always from south to north and west to east. (By the way, VK5ZFO's 20° x 20° grid would only give 162 areas.)

For VHF use, the main fields are further subdivided the end result being a locator such as IO 93 WH for my location. Obviously any award based upon this idea would only use the first two letters. So, instead of VK1 through eight only counting as one country, there would be ten fields to work. For example, Victoria is in QF and the Darwin region of NT is PH. There are already two zonal systems — the CQ Magazine one with forty and ITU one with ninety, so it is a moot point whether anyone would wish to sponsor such a new award. However, the Moonbounce folk, in their Lunar Letter Magazine, seem to be keen on listing the fields worked by contributors.

Yours sincerely,  
Norman Fitch, G3FPK  
Editor  
"VHF Bands" Short Wave Magazine  
40 Eskdale Gardens  
Purley  
Surrey, England. GR2 IEZ  
AR

## IN REPLY TO 'WHO AM I', OCTOBER 83, AR.

Firstly may I congratulate you on the interest you show in your son's hobby. I bet there are many other 'sons' around that wish they had a mother like you. Now for your problem.

Out of the thousands of people that your son can

talk to around the world, you are the only one that he can call Mother. So, instead of using OL which I am sure you're not, may I suggest that you tell them all that you are very proudly "My Son's MUM!!!"  
Keep up the good work Madame.

Yours sincerely,  
John Clark, VK2AUZ  
PO Box 198  
Engadine, 2233  
AR



# QSP

## SATELLITE EARTH STATION TESTING TO BEGIN SOON AT INNISFAIL

Earth stations are currently being installed at Innisfail, on the northern coast of Queensland, as part of a test programme to determine which equipment is best suited for receiving signals from Australia's domestic communications satellites which are to be launched in the second half of 1985.

The Minister for Communications, Mr Michael Duffy, said that thirty eight earth stations, ranging in diameter from 0.9 metres to 2.4 metres would be tested at the Joint Tropical Trials Establishment.

A 30-metre mast with a transmitter on the top would be used to simulate signals from a satellite.

The earth stations would be linked to a specially built caravan containing monitoring equipment. Results of tests would be fed automatically into a master computer at the Department of Communications' Canberra headquarters for processing and comparison.

"Results will be used to help decide technical specifications of the earth stations that individual householders will need to buy in order to receive the Homestead and Community Broadcasting Satellite Service (HACBSS)," Mr Duffy said.

"This service will enable all Australians to receive one ABC television service and at least two ABC radio services via the domestic satellites."

Earth stations were also being tested at Port Hedland and Alice Springs to ensure they were subjected to the most extreme weather conditions — high rainfall, cyclonic winds, dust and wide fluctuations in temperatures.

Mr Duffy said DOC engineers would study the performance of the test earth stations under these conditions to determine how they would stand up to harsh weather once the satellite system began operating. Most householders and communities who would invest in earth stations lived in conditions of extreme climatic change, so the 'dishes' had to be particularly resilient.

The smallest of the earth stations was expected to sell for around \$1000 and should be easy to transport, install and maintain on a 'handyman' basis, Mr Duffy said.

"Trials such as the one to be conducted at Innisfail are essential so that when mass production of earth stations begins manufacturers will have proper system standards to follow.

"This is doubly important because Australia is breaking new ground with the HACBSS project — twelve GHz earth stations have never been used for large-scale television and radio reception in climatic conditions as varied and extreme as Australia's."

## MULTICULTURAL TELEVISION SERVICE TO TRANSMIT ON UHF ONLY

The Multicultural Television Service, currently transmitted in Sydney and Melbourne on both VHF on Channel 0 and UHF Channel 28, would only be shown on UHF Channel 28 from 1st January, 1985, the Minister for Communications, Mr Michael Duffy, announced on 31st August, 1983.

Mr Duffy said the announcement was being made at such an early date to ensure that all viewers of multicultural television could familiarise themselves with Ultra High Frequency (UHF) reception and equipment by the time Channel 0 was phased out.

"When the decision was taken to establish the Multicultural Television Service few people in Sydney and Melbourne had UHF receivers and antennas," the Minister said. "That situation is changing quite rapidly and today most receivers produced have both VHF and UHF capability.

"It was always intended that transmissions on VHF Channel 0 would be an interim step to allow people to receive it first on VHF and have time to learn about reception of Ultra High Frequency signals.

"As it is proposed that prospective new developments — such as supplementary licences, RSTV services and public television — could be established on UHF, the Government considers it is time that existing and new multicultural television services should be transmitted solely on UHF."

Mr Duffy said that Channel 28 transmissions currently covered 96% of the population in the Melbourne metropolitan television area. Recently completed work on the UHF aerial on the Gore Hill tower in Sydney would ensure coverage similar to that of the other television channels in that city.

Extension of multicultural television to Canberra, Goulburn and Cooma in September/October this year, and to other metropolitan centres over the next few years, would be solely in the UHF band.

"The phasing out of Channel 0 is part of the Government's policy to ensure the orderly development of use of the radio frequency spectrum," Mr Duffy said.

"The VHF band is becoming crowded as new FM radio stations join the increasing number of television stations using this band. The result can be poor reception as one station interferes with another.

"On the other hand, the UHF band is less crowded and can accommodate more television services."

Mr Duffy said UHF television provided extremely high quality reception, but viewers would have to ensure they had the correct receiving equipment. It was necessary for all sets to be connected to a special outdoor UHF antenna via a low-loss UHF cable.

Most modern television sets were equipped to receive UHF channels. Older VHF-only sets would require a small UHF/VHF down-converter to allow UHF reception.

The Minister said: "Most households with the appropriate equipment will have no difficulty in receiving the UHF signals. The quality of both the picture and sound will be as good as that offered by stations in the VHF band."

## BEREAVEMENT

9M2LN Nara . . . passed away 21st July, 1983 in Kuala Lumpur, Malaysia.

I have been requested by Nara's widow Kuttyma, and family, to pass on their sincere thanks and gratitude to the many Australian and overseas radio amateurs, for their letters, cards, and messages of sympathy, following the sad loss of a line husband, father, grandfather, and dedicated radio amateur.

It is impossible to thank everyone individually, so please accept this as their personal message to each and everyone for their kind thoughts.

Nara will be sadly missed, but remembered always but all who knew him.

Arthur Pritchard, VK3DPA  
45 McCulloch Street, Nunawading 3131  
For Kuttyma Narayana and family,  
Kuala Lumpur, Malaysia  
AR

## VISIT TO UJUNG PANDANG

Recently I visited the city of Ujung Pandang in South Sulawesi, YB8. This visit was arranged by John YB8AX and myself as a contribution to WCY activities.

The cities of Lismore, NSW and Ujung Pandang have a twin city agreement and my XYL and myself were the first private visitors since the signing of the agreement. John took the opportunity of this visit to promote WCY and amateur radio to the authorities in South Sulawesi.

Two informal evenings were arranged during which I met about 100 amateurs and was able to tell them about amateur radio in VK land. I was surprised to learn that they were riding the crest of the CB boom and had recruited about 600 students into classes for amateur licences. It is anticipated their amateur population will be approximately 400 by the year 1985.

I believe my visit under the banner of WCY had the following effect:

- The authorities of South Sulawesi became aware of what WCY was about and support the concept.
- They also became very much aware of ORARI (similar to WIA but not a member of the IARU).
- Through the concept of WCY the twin cities agreement was considerably enhanced as many of the communications problems were overcome during the visit.

The Indonesian amateurs were very easy to communicate with and are very courteous and hospitable.

The photograph shows myself with a group of Ujung Pandang amateurs. John YB8AX is third from the left.

73,  
Gordon Dowse, VK2AGE  
Lot 2 Bruxner Highway  
Goonellabah, 2480  
AR



# IONOSPHERIC PREDICTIONS

Len Poynter VK3BYE

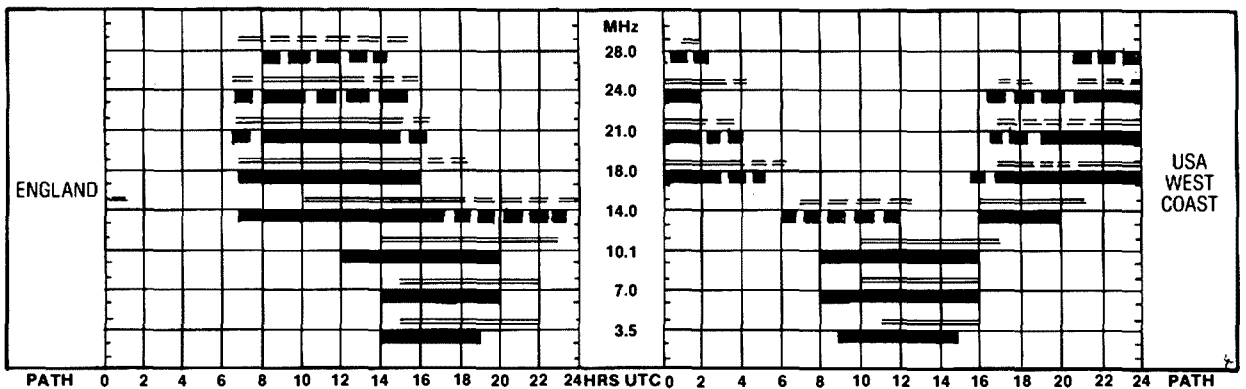
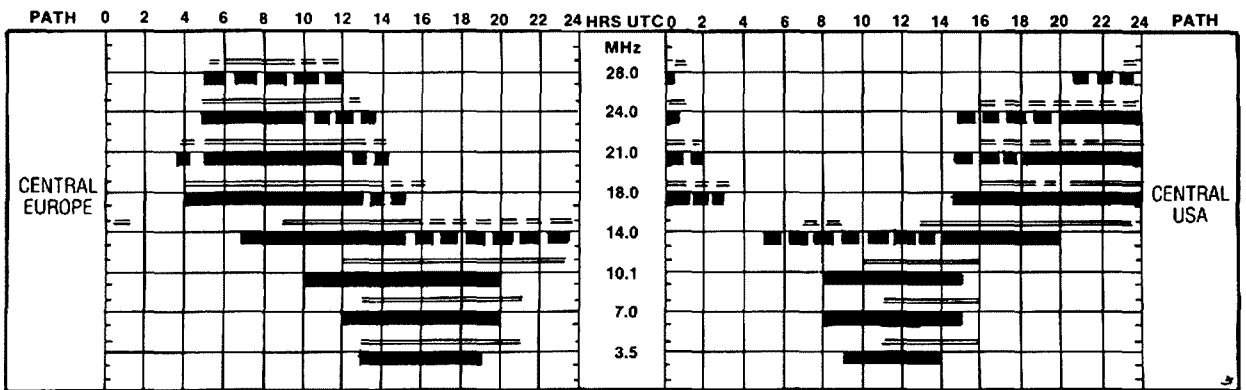
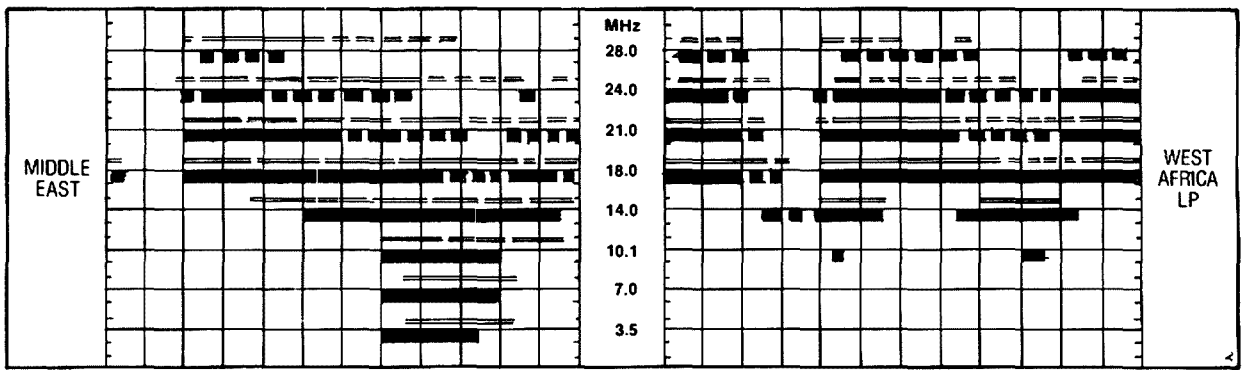
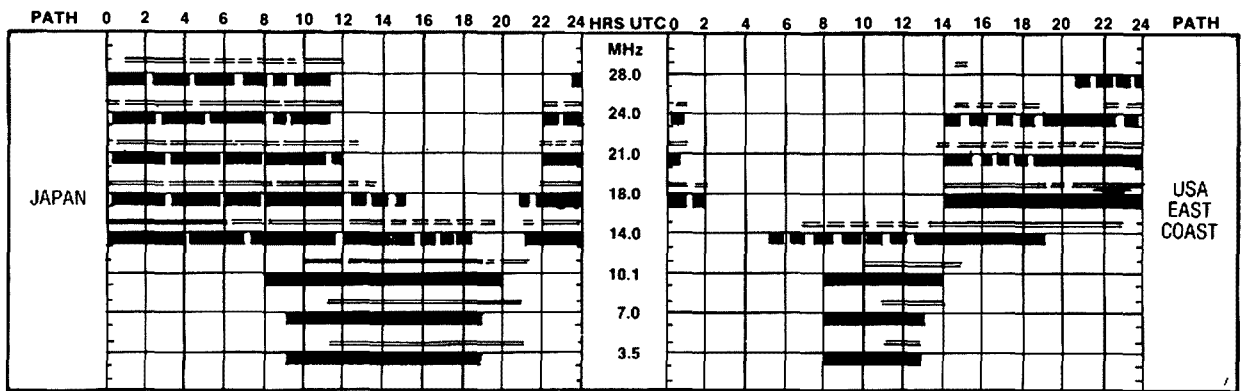

## LEGEND

— From West Australia

■ From East Australia



Better than 50% of the month, but not every day

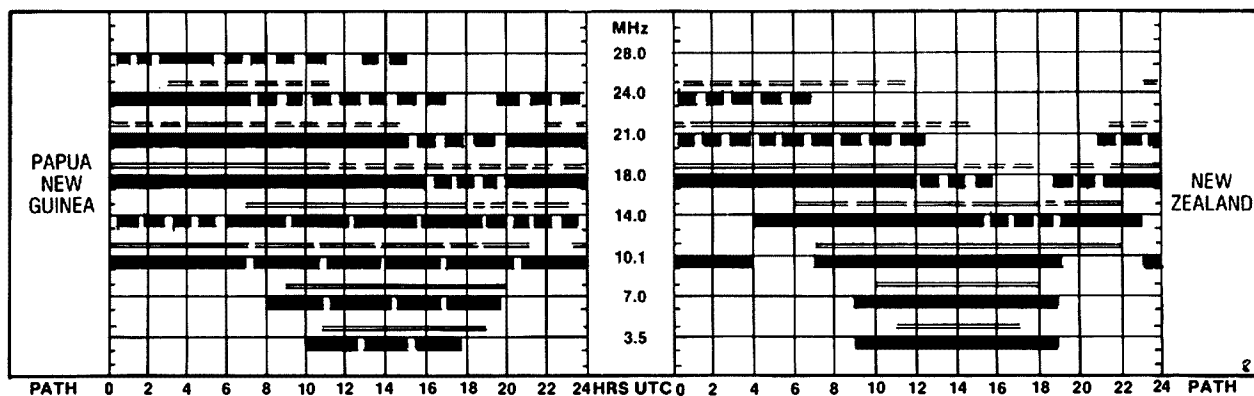
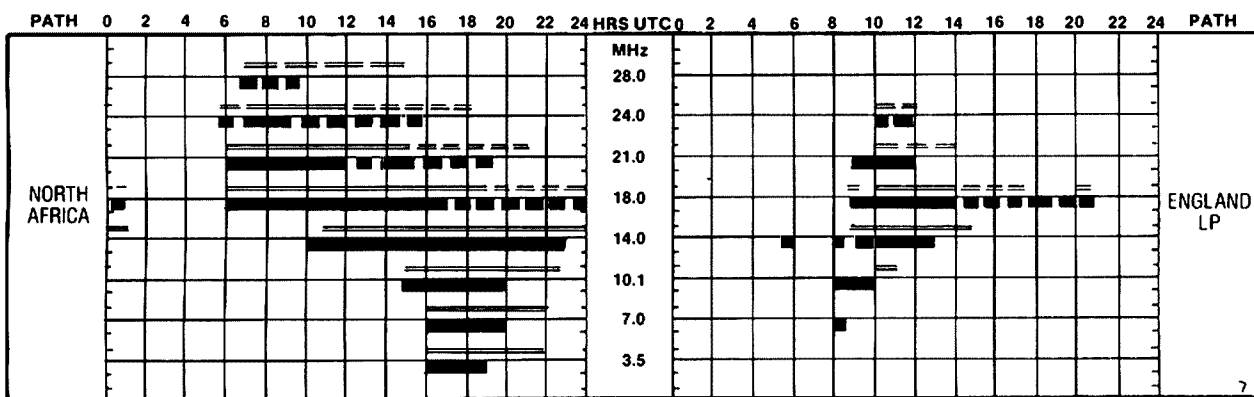
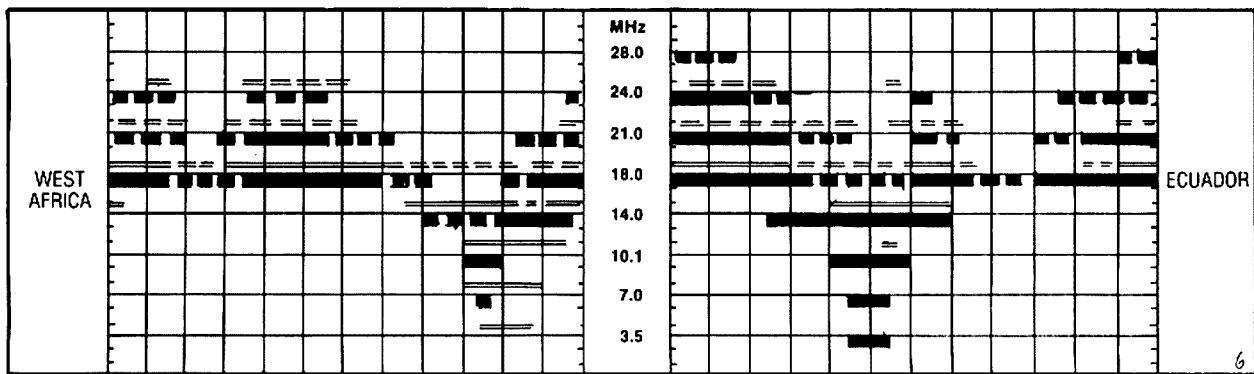
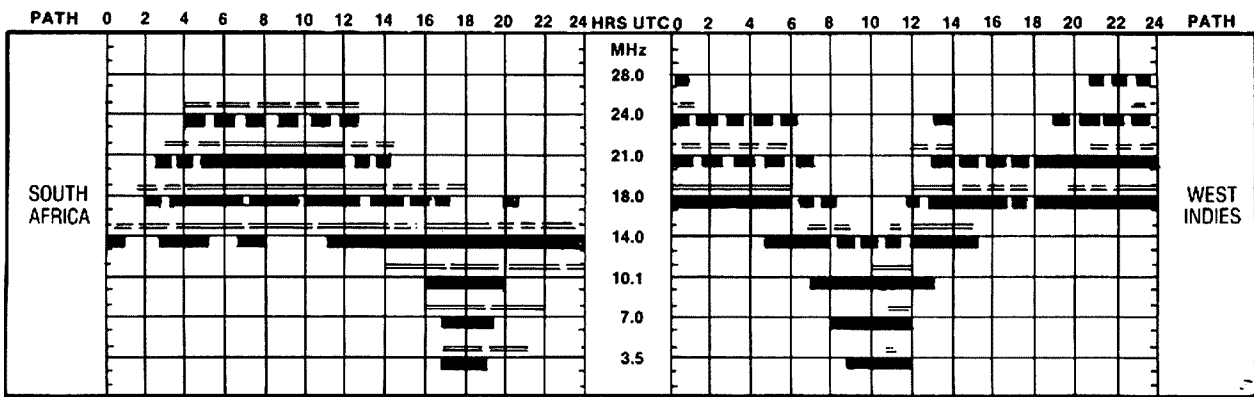

Predictions courtesy Department of Science and Environment IPS Sydney. All times in UTC.



Less than 50% of the month

PATHS — Unless otherwise indicated (ie LP = Long Path) all paths are Short Path.

# WANTED TO BUY

Ham gear, CB equipment, Hi Fi, video, car stereo, large or small quantities.

WE BUY AND SELL  
ANYTHING ELECTRONIC  
ANY QUANTITY  
ANY CONDITION

## HAMRAD

104 Highett Street,  
Richmond, Victoria.  
Phone: (03) 428 8136

## ASCII BAUDOT CW SSTV

Why be locked in with an expensive dedicated communications terminal? The COMMODORE 64 or VIC-20, with our software, offers advanced ASCII, BAUDOT AND CW operation (plus SSTV keyboard on the C64) on two of the world's most popular fully programmable home computers.

**VIC-20 computer - 5K RAM, 8 colours, hi-res 176\*200 pixel graphics, 4 voice sound generator \$295.**

**Commodore 64 computer - 64K RAM, 16 colours, hi-res 320\*200 pixel graphics, sprites, sound synthesizer \$499.**

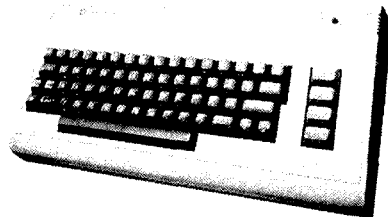

Both computers feature 20K BASIC and operating system, RS-232, serial IEEE-488 and parallel ports, video to standard TV or direct to monitor - disk and tape drives, printers, modems, light pens, etc. available plus hundreds of programmes for home and business - games, utilities, word processors, databases, home finance, education.

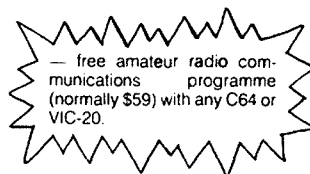

## HIGH TECHNOLOGY COMPUTER SYSTEMS PTY. LTD.

87 SWAN STREET, RICHMOND VIC., 3121  
TELEPHONE: (03) 429 1966

### Crown remote control antenna rotator.

DISTRIBUTED BY

**MOBILE ONE**  
COMMUNICATIONS SYSTEMS

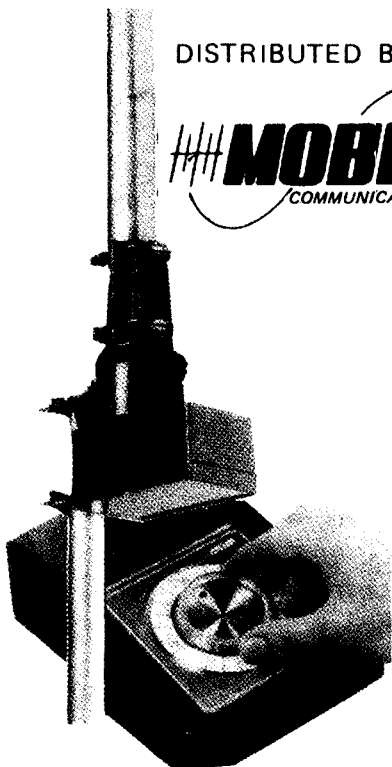

### IT'S EASY TO SEE WHY CROWN IS AUSTRALIA'S MOST POPULAR ROTATOR

- ★ **EASY INSTALLATION**  
Simply follow the instructions. Installation is a very easy Do-It-Yourself operation that requires no special Electronic or Electrical Skills.
- ★ **ALL BRACKETS AND MOUNTING HARDWARE SUPPLIED**  
Easy to follow instructions are included with the kit, together with Service, Parts and Wiring Diagrams. Nothing else to buy.
- ★ **COMPLETE WITH ALL CABLES**  
Full 70 feet of Harness supplied for Control Unit to Mast connection.
- ★ **FULLY APPROVED**  
By the Electricity Authority of N.S.W.
- ★ **INBUILT POWER SUPPLY**  
Control Unit just plugs into the mains and is ready to go.
- ★ **RUGGED DRIVE UNIT**  
Steel ball thrust bearing Rotor. Precision machined gears.
- ★ **STILL UNDER \$150**  
Vertical loading to 13.6 kg. Wind tested to 110 Km/h
- ★ **WILL ROTATE A COMET**

**MOBILE ONE**  
COMMUNICATIONS SYSTEMS

17 Sloane St.,  
Marrickville, 2204  
N.S.W. Australia  
Phone: (02) 516 4500

Cables: 'MOBILEONE', Sydney  
Telex: AA27908, MOBILE  
P.O. Box 166, Randwick, NSW 2031

Available Only From The Finest Dealers — Nationwide

# Silent Keys

It is with deep regret we record the passing of —

MR CECIL KEITH BLANCH VK2GI

## Obituaries

### DICK BATY VK5MD

Dick Baty, VK5MD became a silent key on 16th September, 1983, he was 70 years old. Born in 1913, he obtained his licence in 1931 with the callsign VK5MH. He had joined the Naval Reserve, and at the outbreak of war had to regrettably decline a position with the then School of Mines (now the Institute of Technology) as a Radio Instructor, as he was called into the Navy as a Warrant Telegraphist.

At the end of the war (1946) he left the Navy with the rank of Commissioned Telegraphist and joined the Commercial Broadcasting station 5RM. In 1949 he joined Philips Electrical Industries where he remained until his retirement.

Around 1965 he again found time to become involved with amateur radio and unable to regain his old callsign, took the nearest available which was VK5MD. A keen CW operator, Dick was active on the bands until only a few months before his death, despite an illness which for many years had left him a semi-invalid.

A member of the WIA and RNARS, possibly Dick's best known achievement was the winning of the 1934 Fisk Trophy for a six stage relay between states. (See '5/8 Wave' for September and November, 1982, also p 8 AR 1.2.35.) Dick presented the trophy to the division in July, 1982 and it is on display in the BGB.

Although Dick's passing has taken from us a well liked and respected member of the fraternity, we would not have wished his continued suffering and can only be grateful that he sleeps peacefully at last.

Our sympathies are extended to his wife Bette and sons Ian and Ashley.

Jack Coulter, VK5JK  
Jenny Warrington, VK5ANW

### JOHN GRAYDON VK2AIS

John's amateur operations began on 7th February, 1938 with a QSO on 80 metres with VK2AHC. Operating on HF and VHF, John pursued his interest in amateur radio up to the day of his untimely death on 10th July of this year.

Most of John's working life was spent in the field of radio communications. A member of the permanent RAAF at the outbreak of war, he served through the war in many locations at home and abroad. He attained the rank of Flight Lieutenant in the Signals Branch.

In the post war years John joined the PMG Engineering Branch and later the ABC. He worked on the technical side of radio and television in the

Sydney area. He retired from the ABC some few years ago.

To John's wife Gladys we extend our sincere sympathy.  
Keith VK2EKH (originally VK2TO)

### CHARLES HEDLEY VK2MT 1908-1983

It is with deep regret we record the passing of Charles Hedley, VK2MT.

Charles was first licenced in January 1933 and maintained an active interest in amateur radio for half a century.

A CW enthusiast, Charles participated in the pioneering days of Australian radio communications.

Charles retired in 1973 from John Lysaght (Aust) Ltd at Port Kembla where he was employed as a Planning and Scheduling Engineer following a career which began at the Lysaght Newcastle plant in 1929.

Since the death of his wife several years ago, Charles, a quiet unassuming man, found comfort and companionship through his church and through the amateur fraternity.

An extensive traveller in his latter years, Charles had visited and befriended amateurs in Hawaii, USA and Canada.

To his daughter, granddaughter and son-in-law we share our feelings of sympathy.

Barry Hartley, VK2FE

### RON W HOLLAND VK4AQ

Ron, VK4AQ, passed away on 30th September this year. Ron was born on 8th June, 1914, and due to the war, he had to wait until it finished before he could go on the air. He obtained his "ticket" in September 1939. He suffered considerably, during the latter part of his life.

He was a dedicated experimenter, and in his quiet way, was respected by all who knew him.

Our condolences to his wife and family.

VK4UX

### MRS GENE TREBILCOCK

Victorian members will be saddened to learn of the passing of Gene Trebilcock. Gene and her OM Eric operated the Victorian Inwards QSL Bureau for many years.

Deepest sympathy is extended to Eric and family.



DEADLINE

All copy for February AR must arrive at PO Box 300, Caulfield South, Vic 3162 at the latest by the 3rd January, 1983.

## HAMADS

PLEASE NOTE: If you are advertising items FOR SALE and WANTED please write on separate sheets, including ALL details, eg Name, Address, on both. Please write copy for your Hamad as clearly as possible, preferably typed.

\* Please insert STD code with phone numbers when you advertise.

• Eight lines free to all WIA members. \$9 per 10 words minimum for non-members.

• Copy in typescript please or in block letters double spaced to PO Box 300, Caulfield South 3162.

• Repeats may be charged at full rates.

• QTHR means address is correct as set out in the WIA current Call Book.

Ordinary Hamads submitted from members who are deemed to be in the general electronics retail and wholesale distributive trades should be certified as referring only to private articles not being resold for merchandising purposes.

## TRADE HAMADS

Conditions for commercial advertising are as follows: The rate is \$15 for four lines, plus \$2 per line (or part thereof) minimum charge \$15 pre-payable. Copy is required by the deadline as stated below indexes on page 1.

AMIDON FERROMAGNETIC CORES: Large range for all receiver and transmitter applications. For data and price list send 105 x 220 SASE TO: RJ & US IMPORTS, Box 157, Mortdale, NSW 2223. (No enquiries at office: 11 Macken Street, Oakley, 2223).

CB RADIOS S69: Walkie talkies, short wave radios, military, outback, business, amateur, marine, repairs, RTTY Siemens 100 A printer \$120; base mic \$45; ultrasonic alarm S35; all ham bands on a single 6 ft whip, 1.8 to 30 MHz, for base or mobile \$300; aerials, installation, demonstrations, 40 Ch CB conversions, accessories, new rigs weekly. BRIDGE DISPOSALS, 12 Old Town Plaza, opp Bankstown Railway Station, NSW. Mail order service and all enquiries to 2 Griffith Avenue, Roseville, 2069, or phone Sam VK2BVS, 7 pm to 9 pm only on (02) 407 1066.

## WANTED — ACT

TELEREADER or similar CW monitor. Dave VK1GD, QTHR. Phone: (062) 54 1798.

## WANTED — NSW

ATLAS 215 HF TRANSCEIVER, Paul VK2ATR, QTHR. Phone: (049) 59 3748.

## WANTED — VIC

BROADCAST CARTRIDGE MACHINES. Any condition. Advise price and details to G Scott, 11 Balmoral Crs, Surrey Hills, 3127. Phone: (03) 890 4645.

YOUNG ENTHUSIAST requires any old Morse code related items. Keys, bugs, sounders, tape and inker machines etc. Will pay cash. Maurie VK3CWB, Box 115, Fairfield, 3078. Phone: (050) 23 0038.

## WANTED — QLD

YAESU FTDX-401 or FTDX-560 transceiver in good clean condition, also Collins 30S-1 linear amplifier, and copies of AR Magazine from January to December 1970 inclusive. VK4ZJL, QTHR. Phone: (07) 44 1749.

KINGSLEY AR7 RECEIVER. Coil boxes band "E" and band "D". Will pay reasonable price. Write John VK4NZ, QTHR. Phone: (071) 46 1458.

**WANTED — SA**

**SOCKET AND CHIMNEY** for 4CX250B. Details to VK5KUG. Box 1337, Stirling North, 5710. Phone: (086) 43 6455.

**WANTED — WA**

**VFO 30G** for Kenwood TR-7200G. Art VK6MX. Phone: (099) 23 1808

**FOR SALE — ACT**

**TRAPPED VERTICAL**, V5JR in VGC. 2 full 1/4 wave earth radial sets. 8 m RG58 coax, barge board mount and original packing and instructions. S115. VK1NET, QTHR. Phone: (062) 54 7960 AH.

**FOR SALE — NSW**

**COMPLETE STATION**, FT200, FP200, FC903. Clipsal key, 2 mics, earphones, dummy load, digi clock, log, 4 way mains sockets. See it in action at 321 Rouse St, Tenterfield. S500. VK2EES, QTHR. Phone: (067) 36 1394 BH.

**DECEASED ESTATE** of John VK2AIS late of Killara NSW. Kenwood TS820S and remote VFO S700. Kenwood TS520 and remote VFO S490. Kenwood antenna tuner AT200 S130. Tcvr IC-202 S150. All with h'books. Other gear incl pre-selector, tcvrs, recorder etc. What offers? Enquiries to (02) 46 3159 or VK2EKH (047) 57 1927.

**FT620B, TS700A, TR7400A, S27, TRB300, LSG11**. Offers R Graham. Phone: (02) 764 8139.

**ICOM IC701, PS701**, mic, RM3 controller, all S780. Icom IC211, S450 Icom IC511 with all optional boards, microwave modules linear, yagi and vert antennas S620. Icom IC245 S210, AR240 h'held, case charger S200. Tram XL5 modified on 10 m S80. Macrotronics RTTY interface, software for Apple, MDK17 modem, all cost over S500, sell S300. Roger VK2DNX, QTHR. Phone: (02) 546 1927.

**LINEAR AMP** Yaesu FL2100Z, 18 mths old. Surplus now beam has gone up another 2800 ft! 10 to 160 m inc WARC. Only used on lowest power. S350 ONO. VK2A00, QTHR. Phone: (063) 68 2283.

**KENWOOD TR2400** 2 m H'held synthesised tcvr complete with mains charger, ni-cads, H'book, orig box. Little use, ex cond S300 ONO. Uniden 2020 HF tcvr plus Uniden VFO, ex cond, Orig box and H'book. Will separate. Offers? Terry VK2ALG, QTHR. Phone: (060) 25 3292.

**KENWOOD TS820S** with remote VFO, DC, power supply and MC50 mic. Ex cond S600 ONO. Greg VK2KEO. Phone: (02) 982 3827 AH.

**KYOKUTO FM144-10SXRII** 2 m FM 10 W tcvr with mic, mobile mount and DC cables S150. Also RAAF sig gen S20. RAAF UHF wavemeter S20. VK2BQN, QTHR. Phone: (02) 411 6092.

**RCA AR88D** rx with 3 kHz mech filter, 100 kHz marker and instl man. S175 ONO. Prop pitch motor (brake removed) S100 ONO. Healthkit GDO 2-260 MHz S35. Xformer P240V, S1875/1875V 500 mA S50. Xformer P240V S 115V 2000VA S50. Collins 75A3 rx with 800 Hz, 3 kHz and 6 kHz mech filters. Inst man S250 ONO. Art VK2AS, QTHR. Phone: (02) 467 1784.

**SWAN 700CX HF tcvr**, complete with power supply, VOX, mic, manual and spare set of lubes. Unmodified S550. VK2BSM. Phone: (02) 869 2402.

**TH3JR TRIBAND ANTENNA** needs cleaning and balun. Special price as is. S75. VK2AIT, QTHR. Phone: (02) 86 4785.

**TOWER**, Triangular crankup, 4 x 15 ft sections, needs only "earth toning" paint job. Includes rotator, engineers certificate council approved. S475 ex QTH. TH3 jnr. Ex cond, last 2 years under cover. S150 incl balun. Kenwood TS520S mint cond, spare finals with MC50 desk mic S490. John VK2VJO. Phone: (047) 51 4257.

**TRANSCEIVER TS 520** with 500 Hz CW filter S395. VFO S20 ext VFO S125. TV506 6 m transverter S125 or S600 the lot. All ex cond with owners manuals and orig pack. IC225 in good order with owners manual and orig pack S175. VK2WE, QTHR. Phone: (02) 487 1273.

**YAESU FT7 HF Mobile tcvr** in ex cond with 10 m fitted. S375 ONO. Yaesu FRG7 comm rx in ex cond S280 ONO. Offers to VK2POT, 27 Elizabeth St, Mayfield, 2304.

**FOR SALE — VIC**

**COLLINS S-LINE 32S1, 75S1, 516F2**. Collins noise blanker and DX speech processor incl. Linear amp, Heath SB200, perf cond. S350 firm. Rotator, Ham 2 with 240 V control S200. KW E-ZEE match S50. Bob VK3SK. Phone: (03) 527 1861.

**IC22A** 2 m tcvr together with digi scanning VFO and interconnections. Also 240 V power supply. S200 the lot. Roy VK3A0H, QTHR. Phone: (03) 49 6224.

**ICOM 45A UHF, FM tcvr**. Unmarked box. Incl snapin bracket. S370. VK3BSM, QTHR. Phone: (051) 27 4229 AH.

**SX-200 SCANNING RECEIVER**. Covers 26 MHz to 514 MHz, FM and AM. 13.8 VDC power, service manual incl S450. Power supply is avail it req'd S30. Steve. Phone: (03) 573 2266 BH.

**YAESU FT-7 HF tcvr** in ex cond S375. Kenwood TV502 2 m transverter (suit TS520 or 820) ex cond S150. Both items compl with cables, H'books etc. Laurie VK3KLF. Phone: (03) 417 5908 BH or (03) 337 3249 AH.

**YAESU FT-2FB, VHF FM tcvr** and FP-2 DC supply in good cond. Kenwood TS-520 HF tcvr. Needs alignment and VFO-520 remote VFO and SP-520 spkr. All with manuals. All available for reasonable offer. Melbourne sale only. Buyer to collect. Roy VK3XY, QTHR. Phone: (03) 557 1265.

**YAESU FT-7**. Good cond, complete with H'book S375. VK3VBI. Phone: (03) 762 2119.

**YAESU FT707** incl WARC freqs with Yaesu FC707 ant tuner. Little use S700. Will not separate. Honda 12 V, 20 A charger unit in good cond. S100. Keith VK3SS. Phone: (051) 47 2265.

**FOR SALE — QLD**

**TRANSCEIVER**, 2 m SSB/CW IC202 port tcvr with satellite xtal, H'book, orig box. In GC S150. 2 m FM IC2-A synthesised H'held tcvr with nicad pack and charger, DC-1 pwr pck for auto use, hb ext mic, stubby ant, H'book, orig box. In GC S220. VK4AIZ, QTHR. Phone: 224 6875 BH or (07) 391 5526 AH.

**TV VALVES**: The following new (or near new) Television valves, valued around S300, at S95 ONO. 11AR11(1), 12AD6(1), 12AT7(1), 12AU7(1), 12BL6(2), 12BY7(3), 12FK6(1), 15BD11(1), 1B3GT(3), 152A(4), 1X2B(1), 5A5A(2), 6AL3(1), 6AL5(1), 6AQ5(1), 6AQ6(1), 6AU4(2), 6AU6(2), 6AV6(2), 6BA6(1), 6BA8(1), 6BE6(1), 6BM8(2), 6BQ7(2), 6BU8(1), 6BX6(3), 6BY7A(2), 6BZ6(1), 6CA7(2), 6CG7(2), 6CG8A(1), 6CK6(2), 6CM7(2), 6CQ8(4), 6CS6(2), 6CW5(2), 6CW7(4), 6D06B(3), 6DT6(3), 6DX8(3), 6EA8(1), 6EB6(1), 6EH7(2), 6EJ7(4), 6EM7(1), 6FC7(2), 6GL7(1), 6GV8(1), 6GW8(1), 6HG5(1), 6JW8(1), 6KV8(2), 6N3(1), 6U8(2), 6U9(2), 6Y9(3), PL36(1) and PY88(1). Geoff VK4CET, QTHR. Phone: (069) 22 4305.

**TS120V KENWOOD** tcvr, TL120 Kenwood linear, SC22DX5 band trap vert ant, 75 mm (3") oscilloscope to 6.5 MHz bandwidth 5 mV/div, SWR meter and power dummy load, 20 W. VK4NBY, QTHR. Phone: (07) 284 1127 after 6.00 PM only.

**TS130V HF tcvr**, 10 W with WARC bands. Little use in good cond. S400. VK4AQK, QTHR. Phone: (075) 65 1445 at weekends.

**YAESU FTDX560** in good cond. New finals, manuals and some spares S350 ONO. Trio 9R59D gen cov rx S80. Dave VK4ASB, QTHR. Phone: (07) 203 5585.

**FOR SALE — SA**

**KENWOOD TS520S HF tcvr** fitted with CW filter S550. Kenwood TS130S HF all band tcvr complete with Kenwood P/S30 (power supply) S700. Daiwa ant coupler, model CNW217 S100. Equipment perfect cond., no mods. Bert VK5AUS, Phone: (08) 44 5011.

**FOR SALE — WA**

**ICOM IC2152** m tcvr. Xtals for 2, 4, 8. Rep 50, 51 channels. Icom 20L linear amp. Icom BC20 batt charger and nicad batts. Icom vehicle mount bracket, 2 x 1/2 whips, 1 x 1/4 whip and H'books. Hardly used. S300 ONO. Phone: (09) 323 6743 BH or (09) 44 3707.

**KENWOOD TS-700A** 2 m 144-148 MHz all mode tcvr. AC and 12 V DC S350. Kenwood TR7400A 25 W 2 m synth FM mobile/base station S200. Yaesu FTV-650 6 m transverter S100. All ex cond in orig cartons. Danny VK6ZKV, QTHR. Phone: (09) 381 7877 BH or (09) 457 2421 AH.

**ADVERTISERS' INDEX**

ACME ELECTRONICS	19
AMATEUR RADIO ACTION	47
ANDY'S RADIO REPAIR SHOP	67
ATN ANTENNAS	71
BAIL ELECTRONIC SERVICES	19
CW ELECTRONICS	BC
DICK SMITH ELECTRONICS	8 & 9
EMTRONICS	4 & 5
GFS ELECTRONIC IMPORTS	2 & 3
HAMRAD	78
HIGH TECHNOLOGY COMPUTER SYSTEMS	78
HY-TECH DISTRIBUTORS	IFC
IAN J TRUSCOTT ELECTRONICS	71
ICOM AUSTRALIA PTY LTD	40 & 41
K BRUCESMITH & G SCOTT	46
MICROWAVE DEVELOPMENTS	46
MOBILE ONE COMMUNICATIONS SYSTEMS	78
NICHOLLS COMMUNICATIONS	11
NOVICE LICENCE — VK2	71
OPTILUX	11
RADIO WORLD PTY LTD	IBC
SKYTRIM	47
TRAEGER DISTRIBUTORS (NSW) PTY LTD	11
TRIO-KENWOOD (AUSTRALIA) PTY LTD	6 & 7
VAINS ANTENNA SERVICES PTY LTD	19
WARBURTON FRANKI	10
WILLIAM WILLIS & CO PTY LTD	71
WILLIAMS PRINTING SERVICE PTY LTD	71



# RADIO WORLD PTY LTD

81 NEWCASTLE STREET, FYSHWICK A.C.T. 2609  
PHONE 062-806550. TELEX AA62097

KENWOOD  
TS430S  
HF  
TRANSCEIVER

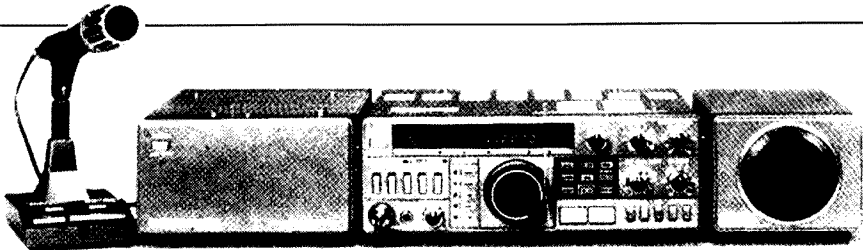

MC-60A

PS-430

TS-430S

SP-430

COMPAQ 386



COMPAQ 386  
COMPUTER

NOW  
ONLY  
\$299

CPU: 1802A, user RAM: 32k, extended basic, built-in editor, forth (optional) text display 40 col X 24 lines, graphics, color, sound, and much more.

ICOM HF TRANSCEIVER

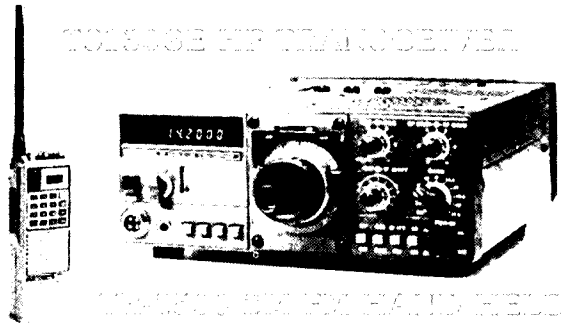

ICOM HF TRANSCEIVER

## CB RADIOS — MARINE RADIOS

PRESIDENT 710  
55 CHANNEL  
VHF  
SEA PHONE



uniden  
AX144  
27 MHz  
CB Radio

40 CHANNELS AM-LSB-USB

We also carry a very comprehensive range of all types of plugs, VHF/UHF, 'N' type, BNC, etc. We have a good range of Japanese transistors, ICs, spare parts for CB radios and car stereos. We do all types of electronic repairs and all modifications on CB radios and amateur equipment. If you can't get your unit repaired send it to us for expert repairs.

MAIL ORDER COUPON/ENQUIRY  
PLEASE SEND ME THE FOLLOWING INFORMATION  
SEND \$1.00 EACH FOR POSTAGE ON PAMPHLETS

- TRIO-KENWOOD     ICOM     YAESU  
 CB RADIOS/CAR SOUND     ATN ANTENNAS

NAME

PHONE NO.

ADDRESS

P/CODE

PLEASE SEND ME THE FOLLOWING ITEM/S

PRICE

FREIGHT

BANKCARD/C.O.D./TELEGRAPHIC TRANSFER

BANKCARD NO.

EXPIRY DATE

SIGNATURE

## CAR RADIOS AND STEREO THE ULTIMATE IN CAR HI-FI STEREO

CONCORD  
HPL-532



CAR STEREO

1780 ROAD RATED XL RECEIVER/CASSETTE PLAYER



## FT726 V/UHF ALL MODE TRIBANDER

- USB, LSB, FM, CW modes
- 10 watt RF output on two metre (6 metre, 70 centimetre units optional)
- 11 memories store mode as well as band
- Programmable limited band seen between memories
- Satellite I.F. unit (optional) for full duplex cross-band
- Squelch on all modes
- GaAs FET RX pre-amp in 70 centimetre unit



## FT980 HF ALL MODE COMPUTER AIDED TRANSCEIVER

Built-in computer control using 8-bit microprocessor  
(80C85)



- General coverage RX 150KHz-29.99MHz
- Power output 100 watt SSB, CW; 25 watt AM; FSK
- Two independent RX front-ends using JFets
- 12 memory channels storing mode and frequency
- Rear panel connections for transverter, linear amplifier and external microcomputer interface



**BAIL ELECTRONIC SERVICES**

**38 FAITHFUL STREET, WANGARATTA 3677**

Telephone: (057) 21 6260 — Telex: 56880

**DISTRIBUTORS AND AGENTS IN ALL STATES**

Stan Roberts  
and Staff —  
VK3BSR