

The **WIRELESS** & **GRAMOPHONE** **TRADER**

Incorporating "The **WIRELESS** and **ALLIED TRADES REVIEW**" "The **RADIO**
TRADE JOURNAL" and "The **WIRELESS DEALER**"

VOL. XXIII. (NEW SERIES) No. 310.

July 26th, 1930.

8/- PER ANNUM, POST FREE.
SINGLE COPIES 1/- EACH.

**NEW HIRE PURCHASE SCHEME FOR
VARLEY ALL-ELECTRIC RECEIVERS**



Advertisement of Oliver Pell Control Ltd.,
Kingsway House, 103, Kingsway, London, W.C.2.
Telephone: Holborn 5303

**TO MANUFACTURERS OF
RADIO RECEIVING SETS
RADIO GRAMOPHONES
AND
HIGH TENSION ELIMINATORS**

NEW
WESTINGHOUSE
METAL RECTIFIER
UNMOUNTED UNITS,
Specially developed
for set manufacturers,
are now available.

Enquiries invited.

The Westinghouse Brake & Saxby Signal C^o. L^{td}.

82 York Road, King's Cross, London, N.1

This Free Book

will show you the profit-earning capacity of

EFFICIENT BATTERY CHARGING PLANT

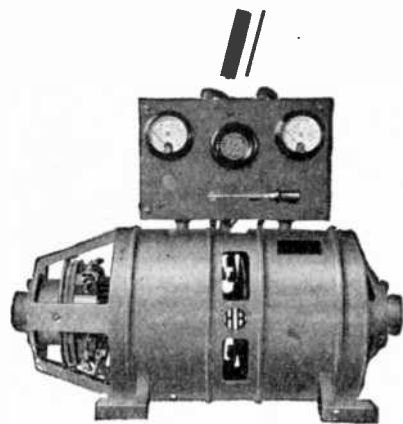

Actual figures—not fancies! In this booklet you are given details of initial cost of equipment; number of accumulators handled; cost in current consumption, and finally, the actual profit to be made.

Nine different makes of apparatus covering various methods of Accumulator Charging are shown: Constant Potential; Valve, Rotary and Metal Rectifiers; and for use where Electric supply is not available, Petrol-oil-driven plant.

Get a copy of this valuable little booklet. Work out the figures for yourself. You will then understand why we reiterate that

BATTERY CHARGING IS PROFITABLE

Post the coupon now!

Brown Brothers Limited

—Allied Companies—

THOMSON & BROWN BROTHERS Ltd.
BROWN BROTHERS (Ireland) Ltd.

Wholesale only:

GREAT EASTERN ST., LONDON, E.C.2
126 GEORGE STREET, EDINBURGH

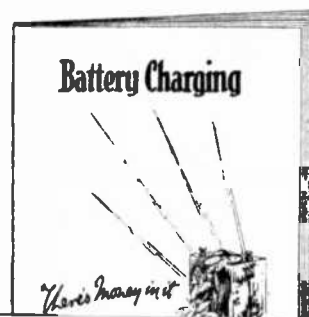

HERE ARE SOME OF THE NEW DULCETTOS!

"Give yourself a pat on the back!"—

—and you will too, if you stock the new season's Dulcettos. Last year was a real bumper for sales but 1930-31 Dulcettos are better than ever. A year's further experience has resulted in many refinements—tone has been enriched yet again and new cabinets designed on very modern lines, in addition to many detail improvements such as the fitting of a "non-set" automatic stop.

Just think how your customers will appreciate these guaranteed models at such ridiculously low prices and don't forget the special "deferred terms" arrangement we can offer your business.

Seen the new range? Just look in when next you're round our way and learn the prospect of further "pats on the back" for yourself from satisfied customers—or if you can't manage this, drop us a line and we shall be pleased to post full details to you.



Model 680—
Oak Pedestal,
Retail Price,
£5 19 6
Model 681—
In Mahogany,
6 guineas.



Model 870—
Oak Console, Retail
Price, 14 guineas.
Model 871—In Mahogany,
15 guineas.



Model "M"
Dimensions 15 in.
by 11½ by 6½ in.
Retail Price,
£2 12 6



Model 740—
Oak Console, Retail
Price, 8½ guineas.
Model 741—
In Mahogany,
9 guineas.

SPECIFICATION.

Cabinets.
Dulcetto double-spring (Garrard made) motor, 12 in. turntable. Non-set automatic stop. New Dulcetto shielded Duraluminium soundbox, hermetic tone arm and perfected exponential amplifier giving even richer tone and volume than last



EVERYTHING **The G.E.C.** ELECTRICAL
your guarantee

Osram Valves

MADE ENTIRELY IN ENGLAND. REDUCED PRICES

The following types of OSRAM VALVES are REDUCED IN PRICE as shown, the reductions becoming operative immediately.

TYPES		OLD PRICES	NEW PRICES	TYPES		OLD PRICES	NEW PRICES
Osram	H.L. 210	10/6	8/6	Osram	P. 2	15/-	13/6
"	H. 210			"	P. 240		
"	L. 210			"	P. 425		
"	H.L. 410			"	P. 625		
"	H. 410			"	P. 625A		
"	L. 410			Osram	S. 215	22/6	20/-
"	H.L. 610			"	S. 410		
"	H. 610			"	S. 610		
"	L. 610	Osram	P.T. 240	25/-	22/6		
Osram	P. 215	"	P.T. 425				
"	P. 410	"	P.X. 4				
"	P. 610	Osram	P.T. 625	30/-	27/6		

Prices apply only in Great Britain and Northern Ireland

Suit your appeal to your customers' pockets

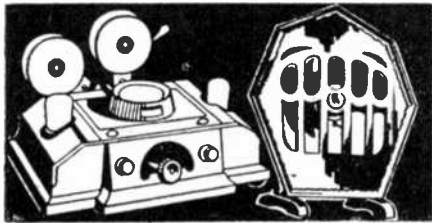
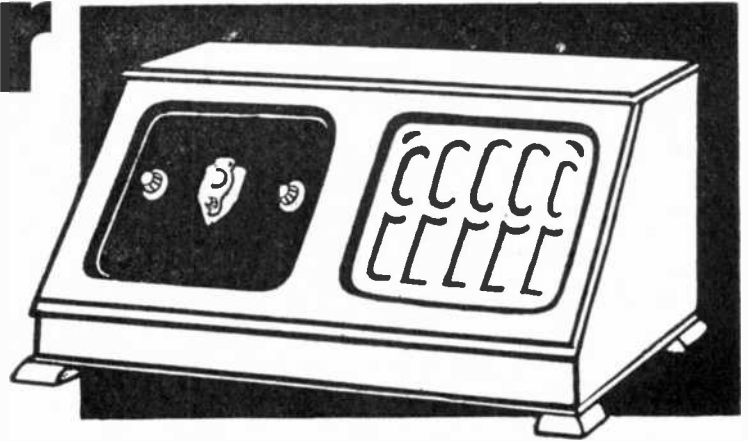

BROWNIE 2-VALVER. Absolutely complete, absolutely fool-proof. Cash price, including royalty, speaker and all accessories, ready for listening-in, only £6 1s. Deferred payments price only **11⁶ DOWN**

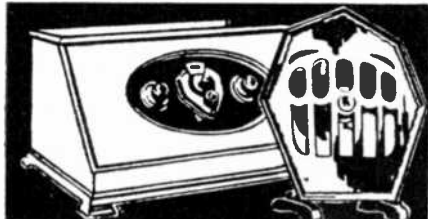

BROWNIE DOMINION 3. An amazing 3-valver that simply bristles with selling points. Cash price, including royalty, speaker and all accessories, ready for listening-in, only £10 15s. Deferred payments price only **19⁶ DOWN**

FEATURE BROWNIE DEFERRED PAYMENTS

When business is slack only real value can hope to reach your customers' pockets. Suit your appeal accordingly. Feature Brownie For not only is Brownie value unparalleled, but the Brownie Deferred Payments System makes the selling as easy as A.B.C. Take the Brownie Dominion Console, for instance. It's worth every penny of its cash price of 12 guineas. But you needn't lose a sale because your customer hasn't the cash. Offer it to him for only 22/- down. Secure the sale—and we'll make the balance up to you in cash. Could anything be more straightforward! WE offer you the deferred payments and YOU make an immediate *cash* profit. Dealers everywhere are featuring Brownie sets . . . displaying, demonstrating and *SELLING*. Are you getting your share of this business!

BROWNIE DOMINION CONSOLE (illustrated above). Completely self-contained in a large, handsome, solid mahogany cabinet. Its cash price, including royalty, 3 Cossor New Process valves, long-life batteries, 4-pole balanced armature speaker and best quality components, is only £12 12s. Without valves and batteries (including royalty), £9 15s. Deferred payments price only **22⁶ DOWN**

Display **BROWNIE**

Write for striking window bill in colours to:

BROWNIE WIRELESS CO. (G.B.) Ltd., NELSON STREET WORKS, LONDON, N.W.1

THE NUMBERS THAT MULTIPLY SALES



These are the three type numbers that mean everything to the sale of pentode radio valves. Radio design is making more and more use of the pentode valve for the output stage of a receiver and sales are steadily increasing in this direction. Mullard Pentode Valves are unapproachable for performance and service—this fact in addition to continual advertising has created a demand that means steady profit to the Trade.

MULLARD PENTODE

USE NATIONAL ACCUMULATORS



ASHLEY

Bold striking advertisements like this are already telling the whole country the news of National Accumulators.

AND I WILL DO STILL MORE FOR YOU!

I am the crackle of thunder. I am the power that moves the world. There is no limit to what I will do for you. But what I can do for you — depends on you. Use National Accumulators — and I will give you still better wireless, still brighter lights on your car, still quicker starting. Famous British firms have joined all their resources to make these wonderful accumulators. Never before have I had such a chance to show you what I can do. Look for the name "National" on the next accumulator you buy. I am electricity — and I ought to know.

NATIONAL ACCUMULATOR CO LTD / AMALGAMATING PETO & RADFORD and HART ACCUMULATOR CO LTD
93 GREAT PORTLAND STREET LONDON W 1

1052. 2

Exhibit at the Fair!



THE 1931 BRITISH INDUSTRIES FAIR

will be held at
OLYMPIA, LONDON *and at*
CASTLE BROMWICH, BIRMINGHAM
FEBRUARY 16TH-27TH 1931

NO wireless goods manufacturers can afford to miss showing their goods. It will be the finest opportunity you have had to increase your sales. Trade buyers from every country in the world will be present in record numbers. Book your space at once or you will lose your opportunity.

Write now to:
THE DEPARTMENT OF OVERSEAS TRADE, 35. OLD
QUEEN STREET, LONDON, S.W.1.

or to
THE SECRETARY, CHAMBER OF COMMERCE,
BIRMINGHAM.

C.F.H.



DARIO VALVES

*Best way to
all Stations!*

DARIO VALVES

Bivolt or Forvolt

UNIVERSAL	}	- 5/6	SUPER POWER	- 7/6
RESISTRON			HYPER POWER	- 9/6
SUPER H.F.			<i>Super Power</i>	
SUPER DETECTOR		6/6	PENTODION	- 18/6
DARIO TRANSFORMER			DARIO Non-Microphonic	
Ratios 3-1 or 5-1		- 5/-	VALVEHOLDER	- 1/-

SCREENODION 15 1/6

*Write for supply of leaflets,
together with showcards, to:*

IMPEX ELECTRICAL LTD.,
Dept. W.T., 538, High Rd., Leytonstone, London, E.11

Scottish Travelling Representative:
Mr. D. C. Fielding, Broomyknowes, Linlithgow, W. Lothian.

Irish Free State Agents: Burwoods of Cork.

THE PORTABLE OF THE SEASON

The *NEW*

Geisha

No. 3.

OUTSTANDING IN:—

**TONE
VOLUME
APPEARANCE
NEW IDEAS.**

CABINET IN BLUE OR BLACK WITH
GILT EDGING IN EACH CASE.

PATENT STARTING AND
STOPPING MOVEMENT.

CARRIES EIGHT 10" RE-
CORDS IN DETACHABLE
ALBUM.

PATENT SELF-CLOSING
NEEDLE CUP.



RETAIL PRICE

£3/10/-

Subject to usual Trade Discount.

Measurements—
HEIGHT 7 ins.
LENGTH 16½ ins.
WIDTH 12 ins.

**THERE'S BIG BUSINESS IN THE "GEISHA." A SAMPLE WILL CONVINCe YOU.
SEND YOUR ORDER NOW.**

Manufacturers—C. GILBERT & Co. Ltd., Arundel St., Sheffield, and at South St., Hull.



A BETTER UNIT



27/6

F. A. HUGHES & CO., LIMITED, 204-6 Great Portland Street, W.1
 Distributors for Northern England, Scotland and North Wales: H. C. RAWSON (Sheffield and London), LTD., 100, London Road, Sneffield. 22, St. Mary's Parsonage Manchester.

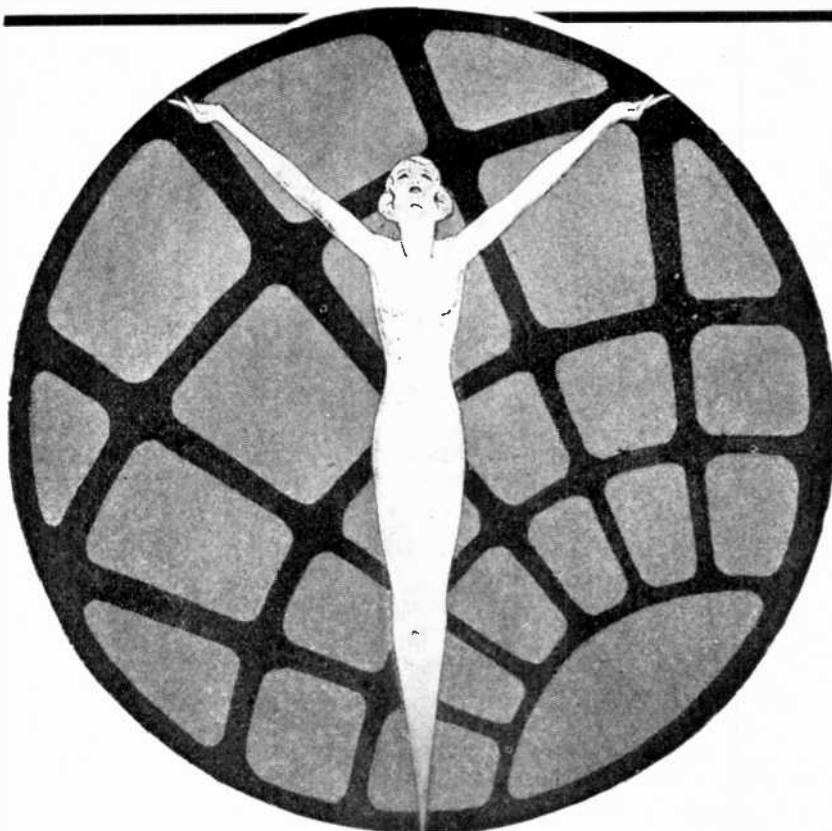

THE LURE of the ETHER

Public interest in world-wide broadcasting calls you to stock the receiver that will give the greatest variety of programmes at will. The ultra selectivity of the McMichael Super Range Portable Four is the key to satisfied customers. It will bring in the station desired with a power of volume and beauty of tone hitherto unrealised.

This magnificent Portable is perfected to a fine degree—the result of many years of radio research. Not only accomplishing a most satisfactory performance, but possessing the additional advantages of real portability and refined appearance, the McMichael 1930 Super Range Portable Four proves absolutely supreme.

Here are some outstanding details:

1. Screened Grid Amplification rendering the set highly selective and wide in range.
2. Single dial tuning and volume control making simplicity the keynote of its operation.
3. Low battery consumption ensuring economy of upkeep.
4. Fitted in a handsome furniture hide suitcase with patent locking clips which makes the set not only extremely convenient for picnics and parties, but quite suitable for the most luxurious surroundings.

The McMICHAEL 1930 SUPER RANGE FOUR (TABLE MODEL)

A model for the home where an outdoor aerial and earth are not desirable. Comprises a handsome walnut cabinet on a directional turntable fitted with an exactly similar circuit to the Suitcase Portable. The whole is completely self-contained with Frame Aerial and Loud-speaker ready for immediate use. An additional aerial and earth may be attached to add to the normal and very remarkable range.

RETAIL PRICE **26 GNS.**

(Including all equipment and Royalties.)

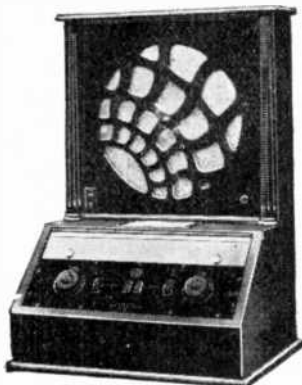

The McMICHAEL 1930 SUPER RANGE PORTABLE FOUR

Owing to the high degree of selectivity in this, and our other Screened Grid Portable Receivers, we are able to guarantee complete selectivity between all main B.B.C. stations under the new scheme of wavelengths, as proved by an actual test under the twin aeriels at Brookman's Park, when both programmes were received separately without interference, and in addition a number of other British and foreign stations. This test was made on a standard "Super Range Four" receiver, under an independent Press observer, and was repeated at half-mile intervals with similar results.

Sell more McMICHAEL Receivers by means of our special deferred payments on the Hire Purchase system. If you are not already stocking and demonstrating this popular Portable, write us or your Factors for terms, Showcards and attractive leaflets. The Receiver will prove a revelation to you.



L.M. MICHAEL LTD

Manufacturers of Wireless and Scientific Apparatus
WEXHAM ROAD, SLOUGH, BUCKS.
 Telephone: Slough 447-442 Telegrams: Radiether, Slough.
 London Showrooms: 179 Strand, W.C.2—Telephone: Holborn 2466

RETAIL PRICE **22 GNS.**

(Including all Equipment and Royalties)

Manufacturers!



CARRINGTON MANUFACTURING CO., LTD.
New Showrooms: 24 Hatton Garden, London, E.C.1

WHETHER your requirements are for plain or highly veneered cabinets, CAMCO can supply your needs. CAMCO Cabinets have for over 10 years been adopted and used by Manufacturers who know that cabinets designed and manufactured by CAMCO are better after all!

Let us know your requirements; we shall be glad to submit exclusive designs for Portables, Radiograms, Loudspeakers, Pedestal Cabinets, etc.



Radio Casework
Sets the World's Standard.



Telephone: Holborn 8202.
Factory: Camco Works, South Croydon.

5301

LONG RANGE

Two Strong Selling Sets

SELECTIVE

POPULAR

CABINET THREE

REGIONAL THREE



£5 : 15 : 6 (subject)

This set incorporates a unique device to sharpen tuning to any degree of selectivity. The Cabinet is designed to hold all the necessary batteries.

FIXED
RETAIL
PRICES
INCLUDING
VALVES
FREE FROM
ROYALTIES

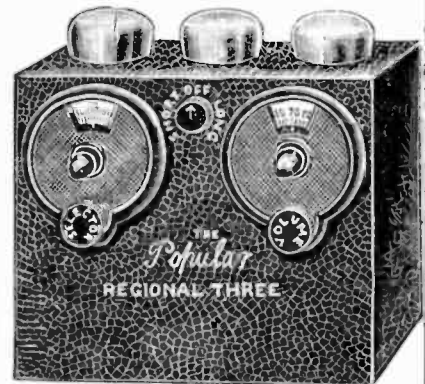

4 GUINEAS (subject)

Completely screened. Cuts out Regional Stations as required, and brings in ALL EUROPE. Size only 7 x 6 x 3 in. Supplied in three finishes, Bronze, Gilt and Black. A unique proposition every Dealer should stock.

FULLY GUARANTEED
FOR ONE YEAR

Write for Details and Other Price Lists

THE DANIPAD RUBBER Co., Ltd.,
5 & 7, Market Street, Finsbury, London, E.C.2

Telephones: Bishopsgate 7322 & 7323

EFFICIENT

LOW PRICE

QUALITY COMPONENTS



**IGRANIC "INDIGRAPH"
KNOB AND DIAL**
Midget Size, 3/-.
Price 6/-.



**IGRANIC SHORT-WAVE
H.F. CHOKES**
An essential component for your short-wave receiver. Designed for use over a wavelength range of 10-80 metres.
Price 2/-

Price
17/6

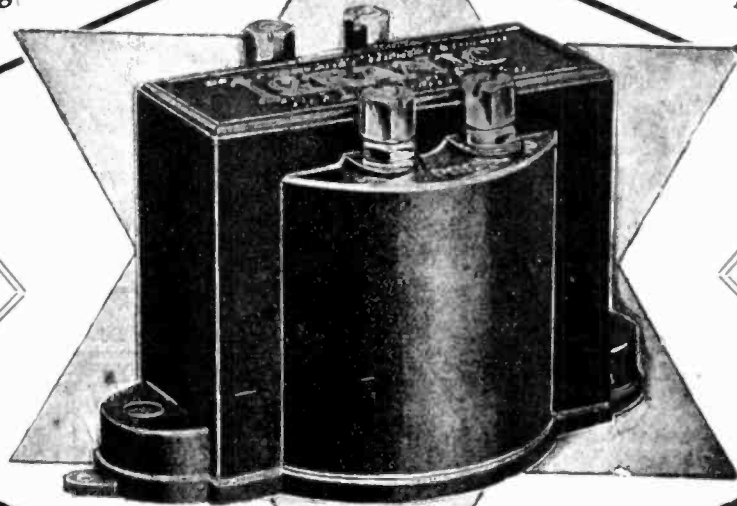

Type "J"

L.F. Transformer

Price
17/6



**IGRANIC WIRE-WOUND
RESISTOR**
Shielded to prevent interaction. Silent in operation and constant in value. From 250,000 ohms. Holder for above 20,000 ohms.
From 2/9 to 7/6 each.



**IGRANIC SPRINGMORE
WANDER PLUG**
Fits all sockets and stays where it's put.
Price 3d. each.

May we send you particulars?
Send your request to Dept. T.153.



149 Queen Victoria Street, LONDON

Branches:
Birmingham, Bristol, Cardiff, Glasgow, Leeds, Newcastle, Manchester.

The experience of over ten years' successful business is behind all

WEARITE COMPONENTS

and this is at your service, Mr. Manufacturer and Merchant.
Below are illustrations of some of our lines.

3-point Wave-change Switch.

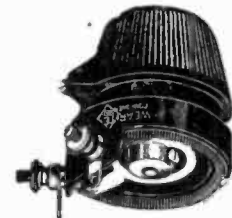

Rheostat Potentiometer or Volume Control.

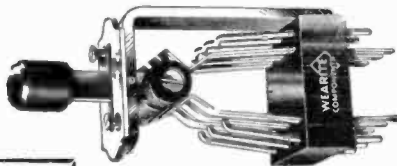

Wearite Anti-capacity Switches, 1 to 6 way as used in most popular sets. Can be supplied lever controlled or ganged.

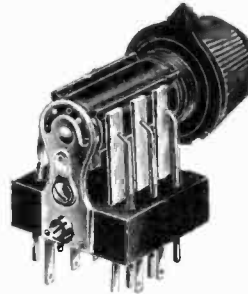

Miniature Type Rotary A.C. Switches can now be supplied.



Valve Holder for A.C. or 3-electrode valves.

- H.F. By-pass Unit 4/6
- Standard 6 x 6 x 6 1/2 Screening Box in heavy gauge aluminium, grey finish 6/6, polished 7/6
- Special Mains Transformer for "Orgola" H.T. Supply Unit 30/-

WRIGHT & WEAIRE LIMITED

740 HIGH ROAD, TOTTENHAM, N.17

Phone : Tottenham 3847/8

338

REGISTERED

STALLOY

BRAND

TRANSFORMER LAMINATIONS of every description.



DIAPHRAGMS, CONE UNIT REEDS:

JOSEPH SANKEY & SONS L^{TD.}

Works : Bilston.

London Office : 168, Regent St., W. 1.

YET ANOTHER NEW HALCYON MODEL

AN ALL-MAINS TRANSPORTABLE 4-Valve Radio Receiver

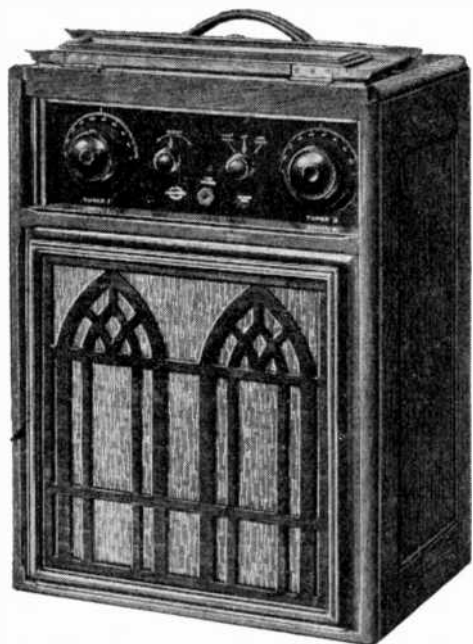

This set is a worthy successor to the famous line of Halcyon Cabinet Receivers—pioneers of portable wireless. It can be used off the mains or with batteries with the assurance of perfect reproduction, absolute reliability, and that wonderful purity of tone for which the name Halcyon has always been noted. Every modern improvement in Radio design has been incorporated to ensure a very wide range and pronounced selectivity combined with great ease of control. *Another Halcyon triumph!*

SPECIFICATION :—Figured Walnut Cabinet, beautifully finished and fitted. Air-chrome Speaker, specially designed for use with circuit employed. Four-valve circuit comprising Screened-Grid, Detector and two Amplifying Valves. Special Halcyon Mains Units for A.C. or D.C. supply.

Battery equipment : Two 60 V H.T. Batteries, Two 6 V Grid Bias Batteries and 2 V Jelly-electrolyte Accumulator.

NOTE.—Either Mains Unit, and the Battery Equipment are interchangeable and removable from the set. Consequently, when both equipments are purchased, batteries can be employed when it is desired to take the set out of doors, the Mains equipment being used indoors. If purchased with Battery equipment only, it can be converted for use off the mains by purchasing the requisite A.C. or D.C. Units at an additional price of 10 guineas.

PRICE complete including Royalties { 40 Guineas or £6 down and 12 Monthly Payments of £3 7s. each.

FULLY EQUIPPED FOR A.C. OR D.C. MAINS

PRICE complete including Royalties { 42 Guineas or £6 down and 12 monthly Payments of £3 11s. each.

WITH BATTERIES AND A.C. OR D.C. UNITS

PRICE complete including Royalties { 32 Guineas or £5 down and 12 monthly Payments of £2 13s. each.

WITH BATTERIES ONLY

An Invitation!

Our many good friends in the Trade are cordially invited to see and hear this new Halcyon All-Mains 4-valve Transportable in comfort at our

West End Trade Showrooms :

72 NEWMAN ST.

OXFORD STREET, W.1

where we have arranged a special advance display and at which the services of capable demonstrators will be available to answer any questions. May we have the pleasure of a visit from you?

THE HALCYON WIRELESS CO., LTD.

27a PEMBRIDGE VILLAS, NOTTING HILL GATE, W.11

Telephone : PARK 6541-2-3

Telegrams : HALCYON, WESTBOURNE, LONDON.

BIRMINGHAM SERVICE DEPOT: 6 RYDER ST., CORPORATION STREET.



PRECISION CONDENSERS

For Selectivity

The public are insisting on Precision Condensers to-day—they know that precision is essential if they are to overcome existing selectivity problems and effectively separate the new regional stations.

That is why J.B. Condensers maintain their popularity and keep on selling during the Summer months.

You need never be afraid to keep up your stocks of J.B. Condensers, they are always being specified for well-known Circuits.

J.B. D TYPE SLOW MOTION S.L.F.

Prices, complete with dial :—

.0005	14/-	.00035	13/-
.00025	12/6	.00015	12/6

J.B.
SLOW MOTION
CONDENSER

PRECISION INSTRUMENTS

Advertisement of Jackson Bros., 72, St. Thomas' Street, London, S.E.1. Telephone: 110p 1837.

Of course you could do with more and more profitable business!

AND it isn't hard. Look at the "National" and "Symphony" proposition. Here you have the two leaders of the 5-valve portable world offered to the public at guineas below last season's prices. Over forty thousand pounds have been spent on publicity, and the new advertising campaign has already created a very live interest among all sections of the trade and public.

There's going to be a real boom in the "Super pair," and the dealers who are already stocking these sets are making a very handsome profit. Illustrated lists, price tickets, and details of H.P. system will be forwarded on receipt of your request.

NATIONAL AND SYMPHONY

The leading 5-valve portables at the new reduced prices are the sensational sellers of the year

The **BRITISH RADIOPHONE LTD.**, Aldwych House, Aldwych, London, W.C.2

Telephone: Holborn 6744.

HOW TO MAKE BIG PROFITS ON ELIMINATOR SALES!

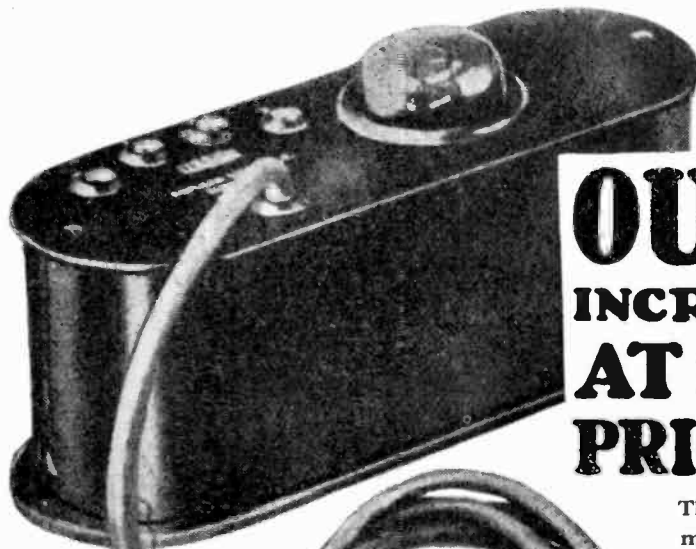

30% + 10%

OUTPUT 20^m/_A INCREASED TO AT SAME RETAIL PRICES



A.C.
60%
Model A

D.C.
27/6
Model A

This increased output is a feature which will make Lissen Eliminators appeal to more people. The output is sufficient to cater for practically 90% of the valve sets in use. Think of the simplification of stock—the quick turnover—the constant stream of sales. Push Lissen Eliminators—they're worth stocking and worth selling, also they carry the generous Lissen discount of 30% and 10%.

There is big advertising behind the sales of Lissen Eliminators—advertising that makes Lissen the easiest popular-priced eliminator for you to sell.

Remember this when arranging stock for the season—you need a *smaller* stock of Lissen to meet an assured *bigger* demand—and there are *always enquiries* from our advertising which no other eliminator will satisfy—and we hand these enquiries over to dealers we know are stocking.

LISSEN

ELIMINATORS PLUS BIG ADVERTISING THAT CREATES DEMAND

LISSEN LTD Worplesdon Rd. Isleworth Middlesex

for delivery
ex stock of the
McMICHAEL



**SUPER RANGE
PORTABLE FOUR**

one of the best
sellers in the trade!

A Four-valve Leather Case Port-
able Receiver, complete with
Royalties and all equipment.

22 GUINEAS

Order from

**L. E. S.
DISTRIBUTORS LTD.**

9 ST. MARTIN'S STREET, LEICESTER SQ., LONDON, W.C.2
Telephone : Regent 7515 Telegrams : "Electomar, Westrand, London"

PHILIPS
RECTIFYING
VALVES



Arrangements have now been made with Philips Lamps Limited to fix their new type 1701 Rectifying Valve, in this Charger. This valve has been specially developed for this class of work, and further, has been manufactured as an exact equivalent of the valve previously fitted. It renders the operation of the Charger efficient and absolutely dependable. Stocks are available for renewals in existing Chargers, whilst, in future, new plants of this type will be fitted with these valves as part of their standard equipments.

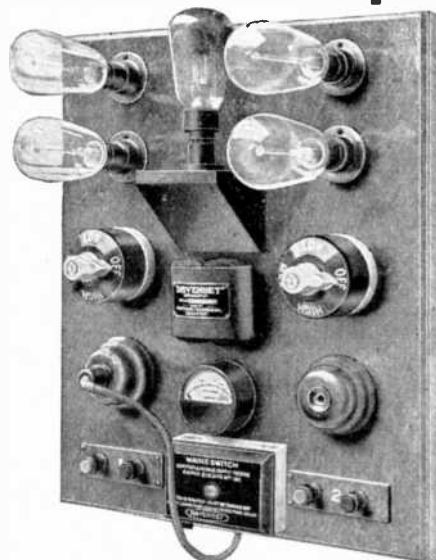

Davenset
High Tension
Accumulator
Charger
Type H.T. 2.

Max. D.C.
Output 300
m.a. at 200
volts.

Price:
£8 8s. 0d.
nett trade.

This Charger
Manufactured
by :-

**PARTRIDGE, WILSON & CO.
LEICESTER.**

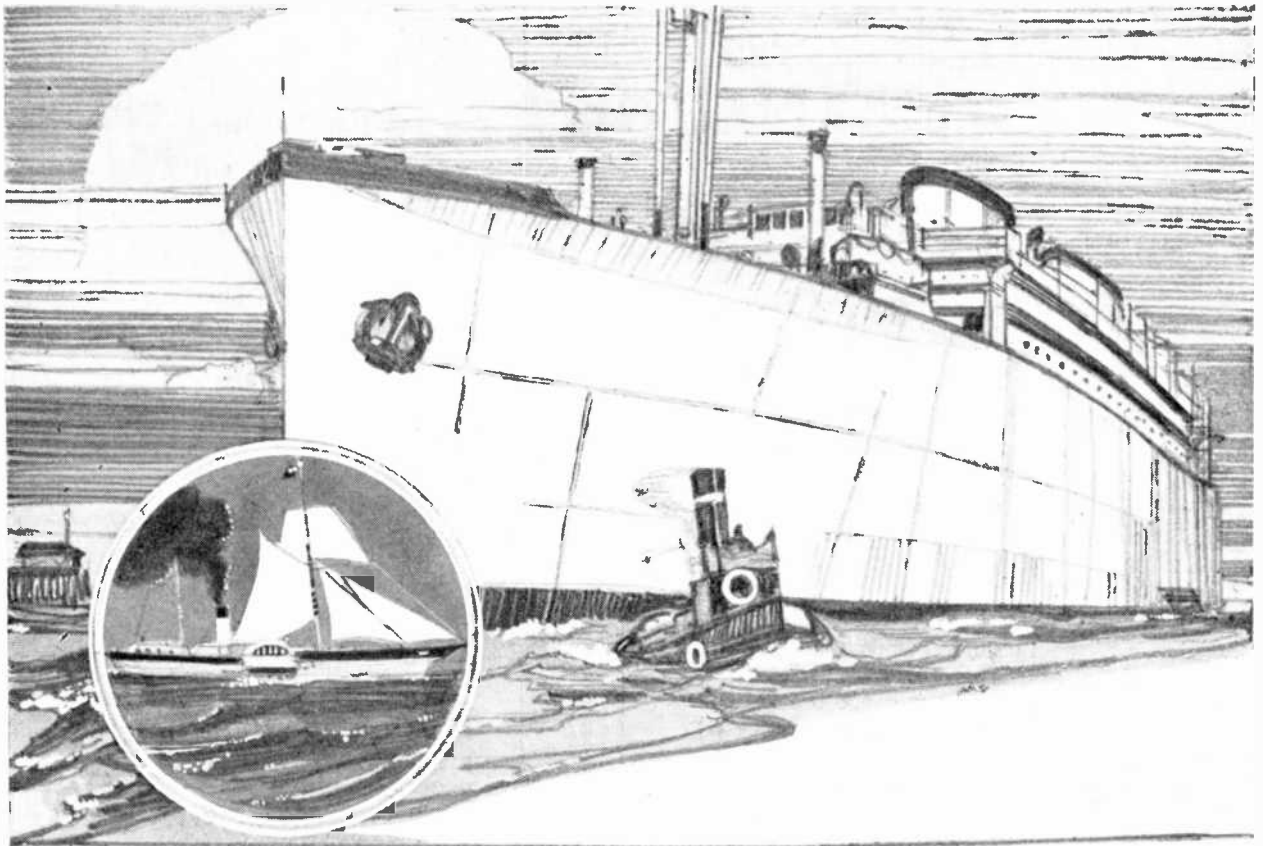

P R O G R E S S

Your battery replacement business won't slacken, in spite of all-mains competition, if you sell only Pertrix.

Pertrix is already famous because it contains

NO SAL-AMMONIAC

has definitely 60% longer life and is perfectly silent in operation. Follow up our convincing advertising—display our window bills and showcards—test Pertrix—talk Pertrix—sell Pertrix.

PRICES						
STANDARD.		DISCHARGE 12 MILLIAMPS			GRID BIAS.	
Size in inches.						
Volts.	L.	B.	H.	s.	d.	Volts.
80	5 1/4	6 1/2	3 3/4	8	0	9
100	8 1/2	6 1/2	3 3/4	13	0	12
120	10 1/2	6 1/2	3 3/4	15	6	15

PERTRIX LTD. D
 Britannia House, Shaftesbury Avenue, London, W.C.2.
 Please send me full particulars of the Pertrix Patent Dry Battery, together with your Trade terms.
 Name.....
 Address.....

What a life!



60% Longer Life

PERTRIX

NON SAL-AMMONIAC
DRY BATTERY

PERTRIX, LTD, Britannia House, 233 Shaftesbury Avenue, W.C.2

BRING BACK THE BOOM DAYS

IN these times of ready made sets and readily assembled components, much of the old friendship between the dealer and his customer has virtually disappeared.

That friendship was valuable to both. It should come back. Bring it back by selling STAL H.T. Eliminator Kits.

90 per cent. of people who buy these kits from you will discuss the building details with you. If they have any small difficulty they will come to you for guidance. They will get the habit of coming to you for *all* service work and they will buy many things from you in the course of a twelvemonth. *This one sale will anchor your customers to you and re-establish the old, profitable friendly relations of a year or two ago.*

The reduced spending power of the public must be taken into account and Stal H.T. Eliminator Kits save the builder 40 per cent.—we will help you drive that home—and every battery user is a potential customer.

STAL H.T. ELIMINATOR KITS



Here is the kit which will enable any amateur to build an efficient H.T. Eliminator in less than two hours, using only a screwdriver and pliers. Sold in a neat box with full instructions for building and use.

RETAIL PRICE
42/-

plus 9/6 for Triotron
G.N. 14 rectifying
valve.
OUTPUT Volts 140
m/a 20

ELECTRIC LAMP SERVICE CO. LTD., 39-41 Parker St., KINGSWAY, W.C.2
Phone: Holborn 6634.
Northern Agents: Charlton Metal Co., Ltd., 18, Amber St., Shudehill, Manchester.

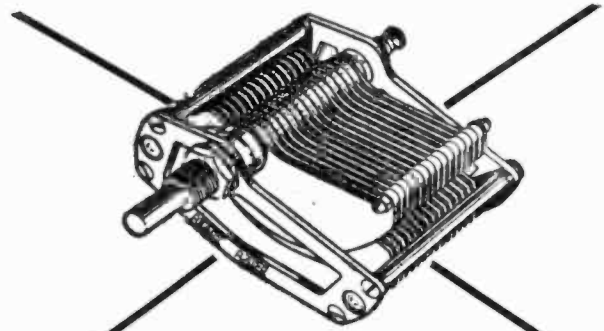

**SETMAKERS
RETAILERS
WHOLESALEERS** !

**A VARIABLE
CONDENSER**

AT **4/6** .0003
.0005
Made at London Bridge, England.

POPULAR WIRELESS SAYS:
The Ready Radio people are now manufacturing a Logarithmic condenser which retails at 4/6 in either .0003 or .0005 mfd. maximum capacity. This will be good news for all constructors, and not only those whose pockets are lean, for the Ready Radio variable is cheap only as regards price.

Finally, the movement is consistently smooth. Altogether it is a distinctly commendable proposition.

Ready Radio

159, BOROUGH HIGH STREET
LONDON BRIDGE - - - S.E.1

Telephone: HOP 5555. (Private Exchange)

FROM STOCK



TERMINALS, SCREWS,
NUTS ETC.

RALPH PRIDEAUX JUNR.
101, HATTON GARDEN, E.C.1

TELEPHONE: HOLBORN 6244

The Vital Link—



H.T. Radio Accumulators

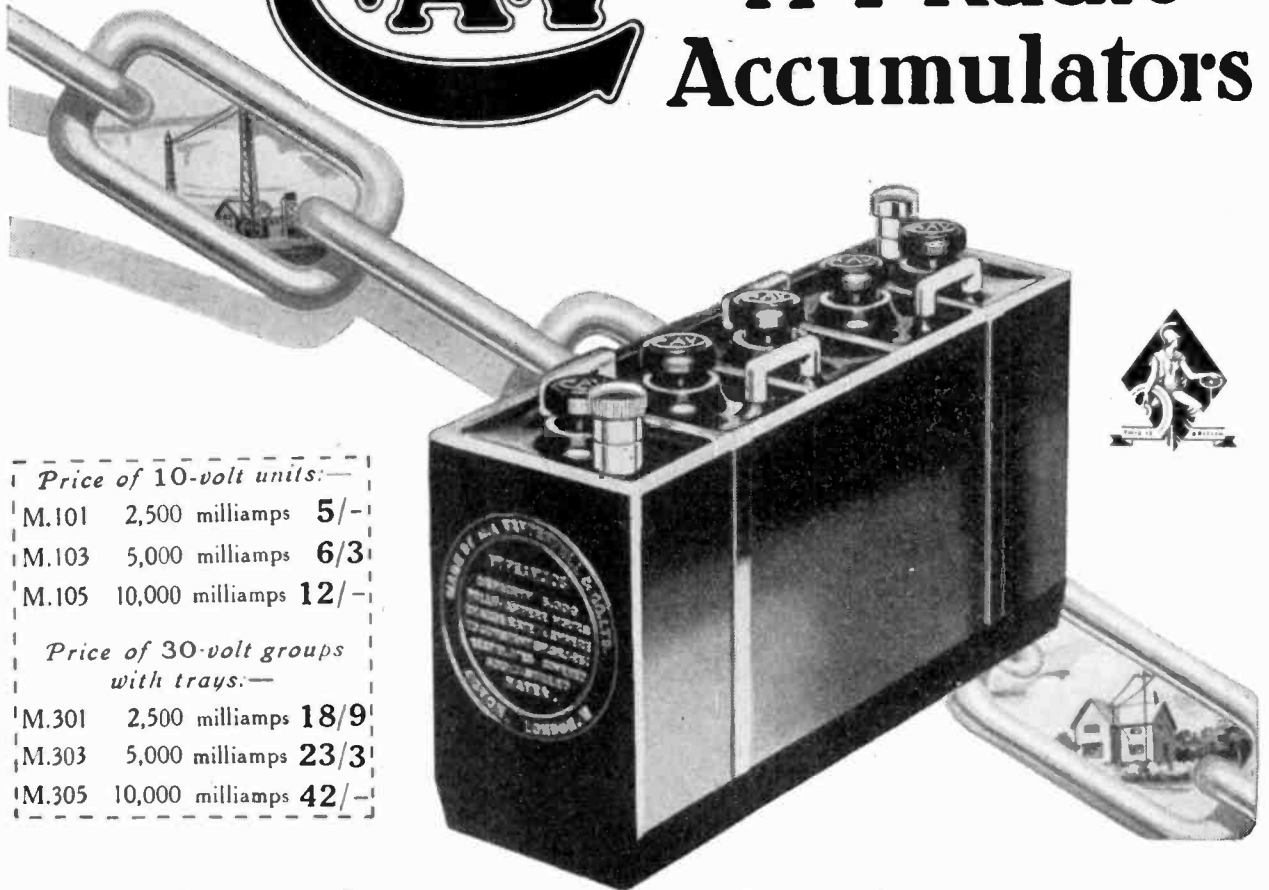

<i>Price of 10-volt units:—</i>		
M.101	2,500 milliamps	5/-
M.103	5,000 milliamps	6/3
M.105	10,000 milliamps	12/-
<i>Price of 30-volt groups with trays:—</i>		
M.301	2,500 milliamps	18/9
M.303	5,000 milliamps	23/3
M.305	10,000 milliamps	42/-

The inability of an H.T. Battery to provide smooth, unstinted current will mar the performance of the most perfect radio receiver.

No other form of H.T. current supply equals the C.A.V. H.T. Accumulator. The demands of the small set and the multi-valve set are satisfied with equal ease. Current is delivered smoothly, constantly, without a ripple or a crackle to disturb the perfection of the broadcast.

It costs a few pence for recharging three or four times a year, and because of it's long life proves not only the most efficient, but also the cheapest form of H.T. current available.

Catalogue No. G.4. and Posters will be forwarded upon application.

C.A.V. Vandervell & Co., Ltd.
ACTON, LONDON, W. 3.

FORMO
ARTHUR PREEM & CO LTD

for all
CONDENSERS

3- VERNIER DIAL	15'6 0005 DUAL GANG	FORMO- DENSOR	MAX. F 0001 2- J 0005 2- C 001 2- M 002 3-
CAPS. 0005 00035 00025 00015	3'9 DIFFERENTIAL	2'9 CAPS. 00015	CAPS 0002 0001
4'6 MID LOG LINE	GOLDEN SQUARE PICCADILLY CIRCUS LONDON	MIDGET REACTION	GERRARD 1863.

COPPER WIRE
Tinned, Cotton Covered, Etc.



LARGE STOCKS.
WRITE FOR CATALOGUE.

London Metal Warehouses Ltd.

HILL ST., POCOCK ST., BLACKFRIARS RD., LONDON, S.E.1
Departments:—Wireless Brass Parts, Copper Wire, etc.
Brass and Copper Sheets, Tubes, Rods, etc., Brass Foundry
Telegrams and Cables: "Stebraware, Sedist, London."

**THURINGIA
BATTERIES**



Quality Unrivalled.
Record Life in Use.
Longest Guarantee.

Labelled to Instructions Gratis.
Factors Enquiries Invited.
Reduction in Price.

SOLE AGENTS:
E. H. MAISNER & CO. LTD.
4 Attneave St., Farringdon Rd.,
LONDON - - - W.C.1

OLDEST MANUFACTURERS,
HUGO FALK,
G.M.B.H.,
TABARZ



TUNGSRAM

QUALITY THAT COSTS LESS

Not another valve has better quality than the Tungsram Barium Valve. That is why Tungsram satisfies your customers. And valves of the same quality cost nearly twice as much as the Tungsram Barium Valve. That is why they save your customers money. Sell Tungsram Barium Valves—they mean an increased turnover.

L.F., 5/6; H.F., 5/6; R.C., 5/6; Power, 7/3; Super-Power, 8/-; A.C. Indirectly Heated H.F. and L.F., 9/6 each; A.C. Directly Heated Power, 8/6 each; A.C. Directly Heated H.F. and L.F., 8/-; Rectifying Valves 10/- each. Tungsram Photo-Electric Cells (3 types): Standard, £2 10s.; Nava E., £2 17s. 6d.; Nava R., £2 17s. 6d.

BARIUM VALVES



TUNGSRAM ELECTRIC LAMP WORKS (GT. BRITAIN) LTD.
RADIO DEPT. COMMERCE HOUSE, 72, OXFORD STREET, LONDON, W.1.

Factories in Austria, Czechoslovakia, Hungary, Italy and Poland. Branches: Belfast, Birmingham, Bristol, Cardiff, Glasgow, Leeds, Manchester, Newcastle, Nottingham and Southampton.

PROGRESS
 is not only
NECESSARY...
 it is
INEVITABLE

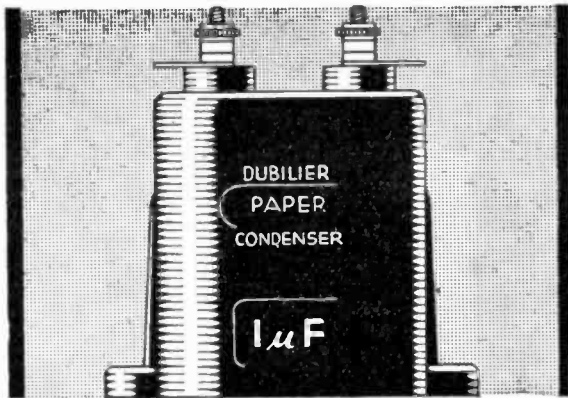

THE unique research facilities of the leading condenser manufacturers of the country have been employed on a new process for producing **PAPER CONDENSERS** of all types, to give greatly increased life, reliable operation, and a guaranteed immunity from breakdown.

PARTICULARS WILL BE GLADLY SUPPLIED ON REQUEST

DUBILIER
 RADIO PRODUCTS

DUBILIER CONDENSER CO. (1925), LTD.,
 Ducon Works, Victoria Road, N. Acton, London, W.3

COPPER WIRES

ENAMEL

KENT Bros. ELECTRIC WIRE CO. & E. H. PHILLIPS, LTD.
 KEW WORKS, SURREY.
 Telephone: Richmond 2844-2845. Telegrams: "Encosil, Richmond, Surrey."

THE BEST — REGARDLESS!

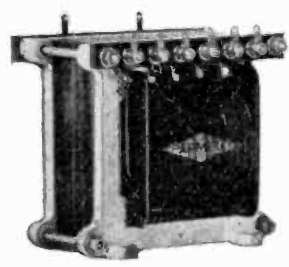

Write for Price List of Wireless Mains Apparatus.

Our motto, which you see above, means that the Diamond trade mark of **PARMEKO** appears on only the finest apparatus you can buy. It is our boast that **PARMEKO** components are fit for laboratory use. The best designers, the best workmen, the best machinery, and the best materials enable them to pass the stringent tests to which they are submitted before they are allowed to leave the factory, backed by our guarantee of perfection. There is a **PARMEKO** Transformer and Choke for every circuit featured in the technical press — and we make to specification.

PARMEKO

PARTRIDGE & MEE LIMITED
 26 Dover Street, LEICESTER
 74 New Oxford Street, LONDON, W.C.1
 CENT. 22276. Museum 5070.

The only weekly Trade Journal circulating to Bona-Fide Wireless & Gramophone Traders.

EDITORIAL VIEWS.

The Valve-Price Rebate.

TWO of the many letters we have received which deals with the incidence on traders of last week's reduction in valve prices are published in another page. One of them unfortunately appears only over a *nom-de-plume*, but we may say here that the writer is a Northern trader whose name and business have been well known to us for a considerable time.

At first sight, of course, it would seem that circumstances such as our correspondents reveal involve considerable hardship for the trader; but there is one consideration which must not be overlooked. While it is true that many dealers may have in stock valves which were bought more than two months ago, and on which therefore they can claim no rebate, it must also be the case that most dealers have recently sold at the old prices numbers of valves which have been bought in the period specified, and on which they will now receive rebate—or, as the B.V.A. puts it, double discount. It is only reasonable to believe that in numbers of cases this will compensate for the loss of allowance on values purchased longer than two months ago.

We have discussed the entire problem with several of the valve manufacturers and with the B.V.A., and we are assured that the rebate system which has been adopted is the best and most practicable of several alternatives. We ourselves know definitely that in the days when valve price reductions were accompanied by a rebate on all stocks held at the date of the reduction, considerable liberties (to put it in the kindest way) were taken with the stock returns called for by the B.V.A. It was, of course, impossible for the Association to check individually the stocks of everyone of their six thousand dealers, and even in the comparatively small number of cases where they did institute inquiries, a regrettably high proportion of false figures was discovered. Believing themselves to be safe from detection, numbers of traders unfortunately seized the opportunity to exaggerate their stock returns, and thus secured rebate on goods which they had already sold at the higher prices.

Abuses of that sort almost invariably recoil on the heads of the miscreants; and it is unfortunately inevitable, in the present case, that the effects should also be felt by a few innocent individuals beside. Even so, however, the period of two months in this rebate scheme was decided upon because the sales

records of the manufacturers showed it to cover fairly the circumstances of a vast majority of the retailers involved, and for ourselves we cannot at the moment think of any alternative method which would have been accompanied by less disadvantage to the trade as a whole.

Stockport and the W.R.A.

IT is a grave pity that the excellent forward step which the Wireless Retailers' Association has recently taken, in developing along sound lines its organisation in the country, should have been accompanied by dissension in its own ranks. The full story of the dispute is related in this issue, and it is unnecessary here to comment on the merits or otherwise of either side of the case. Such a course, in fact, might aggravate the trouble, whereas we still possess the hope that the difference may be compounded and unity restored.

Our point in dealing with the question at all is to put forward the suggestion that, in other circumstances, it might have been possible to avoid entirely the break which has occurred, or at least to have provided means whereby the justice of either side might have been established beyond all question.

In other words, if the trade press had been present at the momentous meeting in London from which the trouble has fomented, there could then have been no question of a delegate's version of what took place differing (as is now the case) on essential points from the Association's own record of the proceedings.

The trade press itself would have compiled and published accounts of the meeting, on the accuracy of which no shadow of doubt could have been cast. Members then hearing a different story from a delegate, who may have misunderstood something of what took place, would have turned to the independent pages of the press to satisfy themselves.

We are not by any means suggesting that the facts of the case cannot be satisfactorily established even as things are; but there will inevitably be a conflict between local patriotism and the opinion of the majority—all of which, as we have said, could not have arisen if the source of published reports was invariably one that is free from direct interest in the Association.

At any rate, in view of the unfortunate situation that has arisen, the Council of the W.R.A. may care to reconsider their views on the difficult problem of allowing the admittance of the press to their deliberations.

8th Year of Publication.
Editorial, Advertisement and Publishing Offices—
**ST. BRIDE'S HOUSE, SALISBURY SQ.,
FLEET STREET, LONDON, E.C.4.**
Telephone Numbers—
CENTRAL 7713 (5 lines). CITY 4011 (4 lines).
Telegrams—
"WIRELESTRA," FLEET, LONDON.
Branch Offices:
BIRMINGHAM: Central House, New Street.
Telegrams: "Trapress, Birmingham."
Telephone: Central 4026 and 4027.
MANCHESTER: 260, Deansgate.
Telegrams: "Motrader, Manchester."
Telephone: City 8970 (4 lines).
Annual Subscription Rates:
United Kingdom, Canada and Newfoundland. All other Countries Abroad.
8/- Post free. 10/-
Published Every Saturday.

Trade News

A Novel "Ekco" Window Display. SIMPLE BUT EFFECTIVE, AND FREE TO ALL DEALERS.

A NEW type of window display—at least so far as "standard" designs are concerned—has just been made available to dealers by E. K. Cole, Ltd., from whom it may be obtained quite free of charge on application to the firm's publicity department at Southend-on-Sea.

Flexibility is the keynote of the new "Ekco" display, which, by reason of its simplicity, can be effectively employed by even the most unskilled display man. It consists of a number of large cardboard boxes of various dimensions, each bearing the familiar "Ekco" sign and carried out in striking colours—orange, black and silver being predominant. These boxes can be built up in "brick" fashion in some fifty different ways, and mains units and receivers can then be placed to best advantage on them. Surmounting the whole is the "Ekco-lectric" symbol "Plug in—that's all!" One suggestion for such a display is illustrated on this page, though naturally the trader's own initiative will come into play to a large extent.

As an example of the flexibility of this display may be mentioned the fact that it is adaptable to suit large or small windows, and, furthermore, can be used in two entirely separate windows if desired. All the boxes are collapsible—an important point for the dealer with little space available. Thus the display can be used again and again, being easily stored in the intervals.

Traders who have not already received a copy of the "Ekco" progress and policy folder, which has also just been issued, would be well advised to write for one. They will then learn of some interesting facts about E. K. Cole, Ltd., whose phenomenal growth during the past five years has been one of the romances of the radio industry. Starting with a few hundred square feet of floor space, the firm have expanded at such a rate that they now have 80,000 square feet at their new factory, which has just been occupied at Southend. Nine additional acres are available for extensions. An announcement regarding the firm's trading policy also appears in the folder, and it is stated that every effort is made to combat price-cutting.

One interesting fact should be mentioned here, since it is by no means common knowledge. E. K. Cole, Ltd., is a public company, although application has not been made to the Stock Exchange for a quotation. Customers are encouraged to hold an interest in the company, and can obtain details of the terms upon which shares are available from the Secretary of the firm.

The Philips Van South Coast Tour.

As reported in last week's TRADER, the Philips publicity van, now touring the South Coast, is giving a concert at Beachy Head to-day, from 2 p.m. to 5.30 p.m.
• On Monday (July 28th), the van will be at Bexhill; on July 29th, at Hastings; on July 30th, at Rye and New Romney, and Folkestone in the evening; July 30th, Folkestone; August 1st, small places in the Folkestone district. On August 2nd the vehicle will not be operating.

B 12



Here is a suggested use of the display designed by E. K. Cole, Ltd. As stated above, this display is available free to dealers, and is equally suitable for large or small windows.

Olympia Halls Re-named.

The trade will learn with interest that the older halls at Olympia have just been re-named. The former Main Hall, the largest of the three, is now known as the Grand Hall, and the New Hall, where the National Radio Exhibition is held, is now the National Hall.

The Empire Hall, first used at the B.I.F. this year, and part of the first floor of which will be used at the forthcoming Radio Exhibition, retains its name.

All three buildings are to be used for the British Industries Fair of 1931.

STREET TRADING OUTSIDE RETAIL PREMISES.

A case which has a measure of interest for every retailer was heard at Bow County Court recently, when a shop-keeper sued a street trader for having placed his stall outside the plaintiff's shop. It was alleged that defendant was thus trespassing on plaintiff's land. Although the actual question of a street trader selling the same goods outside an established retailer's premises is seldom likely to arise in the radio trade, the influence of any distraction on these lines should probably be quite appreciable.

For the prosecution in this case it was stated that a local authority could very well place a street trader outside a shop dealing in the same goods, but as the plaintiff owned the land up to half of the roadway, his permission had to be secured before a stall could be set up on that land. For the defence, however, it was suggested that the roadway belonged to public by right of user.

After a seven hours' hearing, the judge decided that the defendant's contention was correct, and consequently found for the defendant, with costs. A stay of execution was granted, with a view to an appeal.

Falk, Stadelmann & Co.

The profit of Falk, Stadelmann & Co., manufacturers of wireless apparatus, etc., amounted to £107,495 for the year to March 31st (against £97,708 for 1928-29), and £13,261 was brought forward. The sum of £8,318 (against £14,835) is provided for income-tax reserve. A dividend of 7½ per cent. is again proposed on the ordinary shares, and £10,000 (against nil) is written off goodwill of gas mantle undertakings acquired during the year, and £4,603 (against nil) is written off patents, but nothing is to be placed to reserve (against £10,000) and the balance of £25,085 is to be carried forward.

"LOTUS" NEWS.

Following upon our announcement a short time ago of the opening of extensive London premises by Garnett, Whiteley & Co., Ltd., comes the news that the well-known Liverpool manufacturers have now established a depot in Birmingham. Situated at 34, Dale End. The "Lotus" Birmingham branch is under the management of Mr. B. A. Steel, who has an efficient technical staff for service purposes. We understand that Garnett, Whiteley intend to open similar depots in Leeds and Glasgow.

Incidentally, the firm's factory at Liverpool will be closed, on account of holidays, from the evening of August 1st until Monday morning August 11th.

Business, however, comes before pleasure, and last week Garnett, Whiteley & Co., Ltd., held their annual sales conference in Liverpool. All the sales representatives attended, and great enthusiasm was evinced in the various "Lotus" receivers that were demonstrated.

Dealer's P.A. Installation at Hospital Fete. Dancing on the Lawn and a Novel Broadcast.

MOST of the London newspapers featured a happy photograph of Heather Thatcher last week when she attended the Walton-on-Thames Hospital Fete. Readers will be interested to know that the P.A. equipment at this fete, which was responsible for much of the success, was installed by Mr. G. A. Blandford, the well-known local dealer, whose premises are at "The Halfway Shop," Hersham Road, Walton-on-Thames.

Marius B. Winter's famous dance band was relayed over the whole garden, and later by means of the microphone, Mr. Leslie Henson kept the crowd vastly entertained in



Help for the Hospital. The important part that Mr. Blandford's P.A. equipment played in the Walton hospital fete can be judged from this photograph. Mr. Blandford is announcing the prizewinners via the microphone as they are chatting with Heather Thatcher and Leslie Henson.

one of his usual "quick-fire" speeches. Incidentally, in a more serious moment, Mr. Henson told Mr. Blandford how impressed he was by the performance of the equipment.

Dance music was relayed during the evening from 8.30-11 p.m., except for a short special broadcast—by a live pig—who grunted an appeal on behalf of the hospital!

The photograph reproduced on this page shows Miss Heather Thatcher and Mr. Leslie Henson chatting to one of the competitors.

The B.T.H. microphone can be seen on the right, and Mr. Blandford is standing immediately behind it announcing the prizewinners.

Arctic Expedition's Radio Outfit.

Claude Lyons, Ltd., inform us that two G.R. short-wave wavemeters are being used in the wireless equipment of the British Arctic Air Route expedition, which is now on its way to map out an aerial route between England and Canada.

The receiving equipment taken with the expedition consists of two Eddystone 3-valve receivers, and two Eddystone 4-valve receivers.

Both the transmitting and receiving equipment are fitted with Mullard valves, and the intervalve transformers in the receiving gear are "Permacore" transformers.

The expedition is taking with it two Moth aeroplanes, while, as previously mentioned, the wireless receiving installation has been contributed by Stratton & Co., Ltd., and the Mullard Wireless Service Co., Ltd., have supplied transmitting and receiving valves, and transformers.

Official Wireless Orders.

Very few orders for wireless material were given out by Government Departments during May last. The War Office placed one for valves with the Edison Swan Electric Co., Ltd.

The Crown Agents for the Colonies gave one for apparatus with Marconi Wireless Telegraph Co., Ltd., and the G.P.O. authorities one for a short-wave telephony transmitter for the Rugby wireless station with Standard Telegraphs & Cables, Ltd.

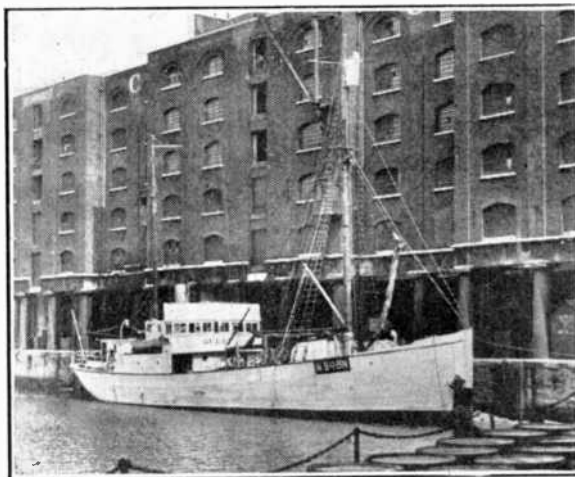

This "Times" picture illustrates the "Quest" just before she left on her Arctic expedition. Radio will play a big part in the venture.

THE TRADE ON HOLIDAY.

The K-B staff are holding their first sports meeting to-day (July 26th) at Sidcup. It is hoped to make this an annual event.

* * *

The first outing of the Goodson Gramophone Record Co., Ltd., took place on Saturday last, when all of the head office and works employees were present.

An enjoyable journey was made by motor coach to Cliftonville, where luncheon was served at the Victoria Restaurant, and at which the Managing Director, Mr. Jack Goodson, presided. After the luncheon the silver challenge cup, presented to the company's sports club by Mr. Jack Goodson, was exhibited. The party then sampled the various amusements that Cliftonville offers.

* * *

Southern Factors, Ltd., of Eastbourne, and branches, inform us that their staff recently enjoyed a delightful trip to Fernhurst, near Haslemere, where they spent a most enjoyable day.

New Shop Legislation Needed.

That further legislation was necessary to protect shop assistants, was the view put forward by Dr. Marion Phillips, J.P., M.P., secretary of the Standing Joint Committee of Industrial Women's Organisations, at the meeting of the Select Committee on Shop Assistants last week. She said that in her opinion, there was no reason why shop-workers should not have shorter hours.

At the present time, a large number of assistants were kept late to put the shop in order, for stock-taking, and for getting out orders for the following day. Dr. Phillips considered there was urgent need for legislation similar to the Factory Act.

She would favourably consider the question of setting up a National Joint Council with representatives of employers and assistants to consider questions affecting shop assistants. In her opinion, the case would not be met by tightening up existing legislation, but that fresh laws were required.

She said she had had cases of assistants working until 2 a.m. in order to complete stock-taking, which she maintained should be done in shop hours.

The Committee then adjourned.

Personalia.

MR. HEROD JOINS MURPHY RADIO.

Mr. Herod, we understand, has just recently joined the staff of Murphy Radio, Ltd., as a representative.

LEEDS TRADER'S RECOVERY.

The many friends of Mr. J. W. Whitaker, of Harehills Road and Victoria Road, Holbeck, Leeds, will be glad to know that he is now back at business after his recent illness. He is greatly improved in health as a result of his operation.

Mr. Whitaker is one of the oldest traders in Leeds, and does a considerable amount of business in wireless sets and components, as well as electrical contracting.

The New Varley Hire-Purchase Scheme. Full Details of the Arrangements.

NEXT week, Messrs. Varley, of 103, Kingsway, London, W.C.2, will be issuing to the trade a folder giving details of their new hire-purchase scheme which comes into operation as from August 1.

From an advance copy of the folder, which we have seen, we understand that, by means of the scheme, all Varley all-electric sets and radio-gramophones may be obtained by the public on a first payment of not more than 25 per cent., even in the case of the most expensive models. In all cases, the payments are to be spread over a period of twelve months.

The procedure is quite simple, and after signing the agreement and the promissory note, and paying the initial instalment, the customer sends the future monthly payments to the United Dominions Trust, Ltd., who will have authority to collect instalments for Varley.

The dealer must, of course, satisfy himself that the hire-purchaser is one who may be expected to meet his obligations, and when the necessary documents have been filled in by the customer, the proposal card and agreement must be sent immediately to Varley, who will then issue orders that the set may be delivered or that they are sending one, if the dealer does not have the particular model in stock.

Lastly, Varley will issue a credit note for the list price of the instrument, less 2½ per cent. accommodation fee, as soon as the customer signs a receipt note acknowledging delivery. The credit note will be sent through the dealer's wholesalers, if he does not deal direct with the manufacturers.

Later on the public will have the opportunity of obtaining a well-produced folder giving details of the terms available. This will be distributed mainly through dealers to whom Varley are prepared to send supplies in any quantity, while factors can also obtain supplies for distribution to the trade.

From this we learn that a 2-valve all-electric set, cash price £17 11s., will be available on a first payment of £1 19s. Other sets are obtainable at a proportionate figure.

Any dealer who intends to avail himself of the Varley H.P. arrangements must register his name with the firm, giving his name and address, and name of wholesaler, if he wishes to obtain his supplies through them. A card for doing this is incorporated in the trade folder to be issued in the immediate future.

A Topical Glasgow Display.

Considerable interest was caused in Glasgow recently by the window display staged by Consulting & Radio Service, Ltd., of 112, Hope Street, in conjunction with Mullard's Glasgow depot.

As will be seen from the photograph reproduced on this page, the display tied up with the "Southern Cross" transatlantic flight and the "Transylvania"—the ship that guided the aeroplane safely through the fog by means of its radio messages.

When the "Transylvania" docked at Glasgow, Mr. Dewar, the Mullard depot manager, obtained the actual valves used on the ship, and these were shown in the window together with a graphic account of the messages interchanged between the aeroplane and the ship.

Excellent models and appropriate photographs completed this very topical display.

Relay Service Wires Forbidden.

Brierfield Urban District Council have prohibited the erection of wireless relay service wires across Colne Road, Burnley Road, Halifax Road, and Clitheroe Road, in that town.

Seaford Dislikes Noise.

Seaford Urban Council has requested the East Sussex County Council to make a by-law prohibiting the use of noisy loud-speakers and gramophones in the town.

Ferranti on Holiday.

Recently three trains arrived in Blackpool, and two in London, from Hollinwood, Lancs., where the Ferranti works are situated.

These excursion trains were conveying a large proportion of Ferranti's 5,000 employees, who are taken by special trains to resorts of their own choice for a day's outing.

A TRADER'S "PAPER."

Distributed Free to Customers.

Some time ago—in our issue of April 26th to be exact—the "Selling Side" feature dealt with the possibilities and usefulness of a small house organ for distribution among customers.

A particularly happy example of such an enterprise is "Radio Show," issued by Storry's, Ltd., of 143, Eastbank Street, Southport.

At present "Radio Show" is published fortnightly, and is, of course, distributed gratis. Readers' wireless problems are answered free of charge, and interesting items of radio news are published. Another bright feature is the offer to put radio amateurs in touch with enthusiasts of other nations.

Dealers who might think that such a scheme is too ambitious for them should realise that "Radio Show" is duplicated by one of the popular typewriter methods—not printed—and we have no doubt that Storry's find the moderate expenditure involved in its production is well worth while.

Two Hospital Installations.

A wireless equipment, the gift of the hospital governors of the British Thomson-Houston Co., Ltd., and the subscribers of the English Electric Co., has been installed at the Hospital of St. Cross at Rugby. It consists of a central set, which operates 70 pairs of headphones in the wards.

A wireless set has also been installed at the Rugby poor law institution and hospital, and is the gift of the members of the local branch of Toc H.

Another Theft.

The Crossley Radio Co., Ltd., inform us that a Crossley 4-valve S.G. portable, in a leather-covered case, was stolen from one of the firm's cars. The theft took place at noon on July 21st while the car was standing outside the premises of Stockall Marples in Clerkenwell Road, E.C.

As the missing set is an experimental sample model the firm are particularly anxious to trace it, and those able to supply information that will lead to its recovery are asked to communicate with Crossley's, at 15, Miller Street, London, N.W.1.

Dealer Carnival Wins Prize.

At a carnival held in connection with the Wallingford shopping week, the third prize in the class for decorated trade vehicles was awarded to R. J. & H. Wilder, wireless dealers.



The topical display of Mullard valves made by Consulting & Radio Service Ltd., of Glasgow. (See column two.)



Here are a few of the Ferranti employees leaving Blackpool Station on the occasion of the firm's annual outing. Three trains were required for the Blackpool party and two for the London visitors.

A NEW IDEA ABOUT PROGRAMMES.

Teach your customers to "Make
a date with their radio."

By "S.A.P."



I SUPPOSE I shall call down upon my head the wrath of the entire trade if I suggest that, leaving apart the difficult question of trade demonstration and service facilities, the programmes now provided by the B.B.C. are of a pretty high order from the public's point of view. However, that definitely is my opinion—particularly after comparing our *average* programme material with the everyday standards of some of the Continental countries.

The whole trouble, in my opinion, is that the listener is never taught to use his radio intelligently. At the beginning the novelty of the thing and the pride of ownership led him (and his wife) to have the set switched on continuously from the Shipping Forecast first thing in the morning right up to the end of the dance-music at night. It is not realised that that is the surest and quickest method to become familiar with, and therefore careless of, the whole thing; and in a few months the new listener has joined the ranks of the confirmed "grousers"—the people who travel up in the trains and grumble because the whole of the previous evening's programmes, from six o'clock to midnight, were not devoted exclusively to exactly the sort of entertainment they happen to prefer.

Value for Money.

Just what *do* these people expect for ten shillings a year—assuming, for the sake of charitableness, that all those who grumble have paid the small sum which gives them the right to do so? Even the cinema—probably the cheapest available form of popular entertainment, enjoying even larger public support than radio—cannot do better than provide about three hours' entertainment for a shilling.

I know these arguments can be countered with others that probably sound equally plausible, but I am convinced that the only real test of any entertainment is the value for money it gives in comparison with existing standards in other fields.

Having studied carefully the question of the "poor-programme" grouser for some time (and having seen many of the class actually in their own homes), I have come to some very definite conclusions about them—including some with regard to their effect upon the trade. So far as the last point is concerned, while I believe that it is possible to find for every single grumbler five or ten people who are satisfied with the value they are getting for their money, there is no doubt that the grumblers make themselves heard more plainly.

It has often been emphasised in this journal that, whatever their private opinions of the programmes may be, the members of the trade owe it to their own livelihood to present the B.B.C.'s efforts in the best possible light, and if this article doesn't actually persuade the trader that the programmes are fairly good (from the *public's* point of view), it should at least provide him with a new and sound argument in their favour which he can put forward with all sincerity.

The whole thing hinges on this value-for-money question, and, after all, the average radio user must be as reasonable a man as the average member of any other class. Ten shillings

a year is the nominal cost to the listener of the broadcast programmes, and even if we add to that a proportion of the initial cost of the receiver (spread over two years, say), together with an allowance for maintenance and renewals, the total cost of radio entertainment still comes only to a shilling or two a week.

Now, is it reasonable that the listener should expect for that expenditure several hours' entertainment every day of every week throughout the year that will suit his particular tastes? That, let us say, is the abstract view of the matter, and is one which the trader should put forward whenever he comes into personal contact with any of his customers who are not satisfied.

How Indifference Comes.

But there is still another aspect to be considered. I have already mentioned what happens in many homes when a new set is installed. Switched on from morning to night from the very first day it is bought, the "wireless" quickly assumes a position in the household about as dominating as that of the kitchen clock. It is there, and if anyone wants to notice it for a moment or two, they may. Otherwise it gets no direct, concentrated attention at all.

I have actually been in houses where it is the regular thing for the set to be switched on from six in the evening until Big Ben strikes the midnight hour—the speaker working throughout dinner, during a game of cards or billiards, through the whole evening's conversation—and at the end of it not one person in the household could name a single item that had been transmitted. And then one hears people of that sort with the temerity to grumble at the programmes—more than half of which, without a doubt, they don't really hear.

Could anyone enjoy a cinema performance, a concert at Queen's Hall, or a programme at the London Palladium, while carrying on a conversation, reading a newspaper or engaging in any of the other normal occupations of the evening at home? Obviously they could not, and I cannot for the life of me see how they expect to enjoy exactly similar items by radio without giving the same degree of close attention.

A Lesson for the Public.

It seems obvious to me that the only intelligent way to use radio is to select from the programmes those particular items that appeal directly to one's own taste; then listen to them properly, without trying to do three or four other things at the same time; and when they are finished, switch off until the next evening—or the one after if there happens to be nothing until then with a *direct appeal* to the individuals concerned.

"Selective listening," I myself call the idea, and it is aptly summed up in the slogan "Make a date with your radio!"

If the dealer would devote his personal contact with listeners to the spreading of this suggestion, putting it into straightforward and unmistakable terms, I am convinced that it would rapidly curtail the ranks of the grousers. The trader should suggest in just so many words that the listener, to get fullest

(Concluded on page 86.)

PROVINCIAL TRADE NOTES

Brighton's Four "Radio Exchanges."

THE sale of portables in Brighton has not been quite up to last year's standard, although in some quarters a good trade is reported in this respect. There is still steady demand for replacement lines.

The premises recently occupied by Messrs. Galliers, known as the Electric Shop, in North Street, Brighton, have now been vacated. This is due to the fact that several buildings in the vicinity are being demolished to permit of road widening.

The wireless relay exchange firms continue to be active. There are at present no less than four such relay stations in Brighton and Hove, all of which appear to be doing well. The average weekly rental for the service is 1s. 6d.

On the night of July 16th there was a slight outbreak of fire at the premises of the Edison Swan Electric Company, Ltd., Duke Street, Brighton. After an entry had been forced by the fire brigade in response to a call at 11.50 p.m., a quantity of packing and cases and rubbish was found to be alight. The cases were stacked in front of a window that leads into a warehouse, but the danger was quickly averted by the prompt methods of the brigade, and I understand that no serious damage was done.

Gloucester Philanthropist's Radio Gifts.

THE radio trade and public throughout the West Country were recently interested in the magnificent gift of receiving sets to the blind people of Gloucestershire, through the munificence of Mr. Schroder on the occasion of his marriage. The sets chosen are Philips 3-valve receivers, Type 2502, and some 200 of these sets, with a similar number of Type 2016 loud-speakers, have been, or are being, installed. Philips sets, by the way, have been installed in many institutions in the West of England, and have given complete satisfaction.

Philips' new trading policy has been enthusiastically received by the trade here. As a result of the visit of their publicity van, business has benefited very considerably and sales continue to be steady, states Mr. G. D. Jutsum, Branch Manager at Bristol.

The majority of radio dealers report that trade generally is rather slow at the moment. There is still a fair demand for mains equipment and for all-mains sets and portables. Press advertising has not been entirely neglected by enterprising traders. The component trade, strange to say, though quiet, is by no means dead. Home construction locally is still fairly popular. Portable gramophones are popular with river and motor parties, and the music shops are maintaining sales in this department. Records, too, are moving steadily.

Leicester Trade Slow.

TRADE in Leicester is at a somewhat low ebb, due probably to the fact that the staple industries of the city have fallen off in prosperity, and the unemployment figures have touched a new high level. The main demand is for H.T. batteries and small components.

In addition to his activities as principal of the firm of Charles Moore & Son, South Wigston, Leicester, Mr. C. Moore is well known as conductor of the Wigston Temperance Band, often heard on radio. Mr. Moore's band has won several trophies and has been brought to a high pitch of efficiency.

Manx Radio-Gramophone Displays.

RECEPTION conditions on the whole in the Isle of Man are very good—so much so that dealers hope the B.B.C. will never choose the island as the site for a Regional station! Nevertheless, restaurants and hotel proprietors appear to favour electrical gramophone music for visitors, reserving wireless reception for the private apartments.

Messrs. Cowell's, Castle Street, Douglas, in their wireless and gramophone show-rooms, are exhibiting models of the Columbia 302 D.C. Junior radio-gramophone, as well as the H.M.V. 551 A.C. model.

At the stores of Mr. T. Cartwright, Windsor Road, an inductor loud-speaker built to the specifications published by the *Wireless Magazine* is being demonstrated, and has drawn attention by its good reproduction.

Mr. E. H. Dickinson, The Wireless Exchange, North Quay, regrets that no local association of wireless traders has been formed up to the moment. At present he finds Kolster-Brandes mains sets and "Blue Spot" pick-ups good sellers.

Gellings Foundry, Ltd., Victoria Street, have a large and well-laid-out window display. It includes many Lissen products, and "Ekco" H.T. units.

Colebourne & Kermode and Mr. S. Hinton, whose shops face each other at the corners of Victoria Street, are displaying console sets of their own respective designs and manufacture.

Lockerby & Moore, of Finch Road, are busy with set repairs at the moment. They receive many orders from boarding-house proprietors whose receivers need overhauling. The principal of this firm echoed the opinion so often heard in the trade nowadays that the B.B.C. programmes go from bad to worse, and are, furthermore, seldom suitable for demonstration work.

Mr. Caren, of Athol Street, is displaying a testimonial from Miss Mercedes Gleitze, expressing her appreciation of the portable set he supplied. This is a useful piece of publicity, in view of the interest aroused in Miss Gleitze's recent record swim round the island.

A wireless week is proposed for November next in Douglas—the time when hotel proprietors return from visits to England, following their close attention to the needs of guests during July and August.

Most of the business this year has been effected with the aid of H.P. agreements.

A Plymouth P.A. Competition.

THE Plymouth depot of the Edison Swan Co. recently held a successful demonstration with their P.A. equipment in the Plymouth Guildhall. This demonstration follows those of Marconi-phonograph and Philips earlier in the year, as an outcome of the Land Committee's intention to remedy acoustic defects in the building by means of amplifiers. Messrs. Moons, George Street, made the preliminary arrangements, Capt. Sydney Moon coming from London especially to witness the experiment. Mr. C. C. McCullum, of the London engineering staff of Edison Swan, and Mr. A. J. E. Hoyten, of the Plymouth branch, superintended, and satisfactory results were obtained, speech being heard distinctly in every part of the hall. The Land Committee are expected shortly to announce which of the three equipments they have heard will be adopted.

Messrs. J. Deeble, of Falmouth, by the way, are demonstrating B.T.H.-Ediswan equipment in Truro Cathedral, where it has been installed for test by the Edison Swan Co.

Traders report a slackness in trade, although portables are still selling well. Messrs. Gibson, Tavistock Road, are running a summer "stunt," offering by means of a special window-show to put up new aerials for customers at an inclusive charge of £1, to ensure uninterrupted programmes when winter comes again. "Have That Aerial Overhauled" is a good slogan to assist trade during the summer.

Radio-Gramophones in Portsmouth.

PORTSMOUTH traders are showing much interest in the efforts of the R.M.A. to put an end to price-cutting, and most would welcome the publication of a stop list. During the last few weeks trade has been quiet, but the decision of the local justices to allow wireless and gramophone music in public-houses came just at the right time to give an impetus to summer sales. Installations are being made both of radio-gramophones and of all-mains sets with pick-ups, but more than one trader is complaining that sales are going outside the trade, and it is alleged that these have been effected by splitting discounts. An effort is being made to trace the source of supply.

One of the most popular installations is the Kolster-Brandes radio-gramophone at £37 10s., and several are being installed. Comparatively few of the higher-priced radio-gramophones are being put out.

Mr. A. Wyatt, of Queen's Road, who

ROUND AND ABOUT

More than the R.I. works are new. The Days of Old.

EVEN though his is one of the oldest and soundest concerns in the entire radio industry, I think Mr. Joseph himself will forgive me for saying that it was a new "R.I." which I saw at Croydon last week—new works, new staff, new sales force, new ideas—and, by no means the least important, new lines for the trade to sell. But all of this "newness" is built round the corner-stone of the established tradition of Radio Instruments, Ltd., who for so long have been established in the heart of London in Hyde Street, Shaftesbury Avenue.

Latterly I had often thought, when visiting the R.I. works, that the compensations of a central location must have been to some extent off-set by the absence (after all the available space had been occupied) of room for normal expansion. Nevertheless, I hardly expected the metamorphosis which has actually accompanied the firm's recent transfer to their fine new premises (specially built to Mr. Joseph's own specifications) at Purley Way, Croydon.

All those members of the radio trade who journey from London to Brighton for the week-end (among whom will, no doubt, be "P.G." in the death-dealing Alvis!) will see the new R.I. works, on a commanding corner site, with a dignified facade, neatly laid-out gardens in the front and surmounted by an imposing clock-tower bearing the characteristic two-letter sign—to say nothing of the 5XX-like aerial at one side of the building. And if they are tempted by the outside view to seek an acquaintance with the inside, I can assure them that they will not be disappointed.

There is a pleasing note both of novelty and dignity in the appointment of the executive offices and showroom, where the R.I. staff has carried out a very attractive scheme of panelled decoration. The works, too, are well laid out, with some excellent ideas in the actual erection and disposition of the plant.

Turning from the works to the personal side, the trade already knows that Mr. W. Lawson, so long associated with the radio activities of Brown Brothers, Ltd., has taken over the sales supervision of R.I., and while this year he is planning no revolutionary departures from the R.I. tradition of the past, he has already taken a large share in the introduction of the two new lines in mains units, which are dealt with in the appropriate page in this issue.

There are very few people in the industry who are in a position to know more about what the trade wants to sell, and what it can sell, than the man who for years controlled one of the largest wholesale turnovers in the country. Moreover, knowing the reasons lying behind Mr. Lawson's severance of his long connection with the wholesale trade, in order to enter the manufacturing field, I think it is inevitable that the advantage his knowledge and experience may be expected to bring to Radio Instruments will be shared by those dealers handling the firm's goods.

* * *

TO the uncouth Londoner, Birmingham is an excellent place—to come away from. Anyhow, after a somewhat wearing day there this week (incidentally, why do all the taxis stick round the stations, instead of roaming about in search of fares?) the tedium of the homeward journey was most pleasantly and unexpectedly relieved by encountering no less a person than Mr. W. F. Shearing, of London Metal Warehouses.

Mr. Shearing's firm were also among the earliest starters in the radio trade, as anyone who has handled "Lunmet" terminals and accessories knows.

Nowadays Mr. Shearing's personal interest in radio business is rather less close, but his recollection of those "bad old days," seven or eight years ago, would make decidedly interesting reading. Fancy a dealer at the present time going to a manufacturer's warehouse, seeing a stack of small goods about as big as a motor omnibus, and, without enquiry as to the quantity or the price, saying: "Yes, I'll take the lot!"

Just fancy! But in those days it happened as a fact, Mr. Shearing told me, and he has often, over such a transaction, seen a buyer take a fat wad of notes from his pocket and pay out a hundred pounds or more for the goods on the spot! The demand for small parts, too, was of such an order then that it was quite a usual thing for London Metal Warehouses to have ten tons of brass on the floor at one time for machining up into terminals and similar items.

Still, that was the best part of a considerable time ago, and I think everyone agrees that, although business is keener all round, the trade is now a lot better than it was in those distant days.

S. G. W.

At the top right is a view of the fine frontage of the new R.I. works, while below is the machine-shop side of the main building. Stores and other departments are beyond the wall on the left.

The test-room at the R.I. works is both large and excellently equipped. The front bench shows the multi-power (A.C., D.C. and battery output) distribution system, with the switch-gear at the back.



Standing in this group are (left to right) Messrs. F. E. Brewer, G. W. Hale and W. L. Shaw, of the sales, research and test depts. respectively. Seated are (left) Mr. J. Joseph, Managing Director, and Mr. W. Lawson, now in control of R.I. sales.

"TRADER" TEST REPORTS

Conducted by our
Technical Department.



Manufacturers are invited to submit apparatus for test under this heading.

A. W. Griffin & Co., Ltd., Old Factory, Bates Hill, Redditch.

"Terralto" S.G. 3 Receiver.

DESCRIPTION AND PRICE.—This receiver has been designed, as far as possible with three valves, to meet the requirements of present day broadcasting conditions. It is housed in a mahogany finished all-metal cabinet, which is in two parts, the bottom, of aluminium, forming the chassis, and the top, of sheet iron, being simply a screening cover held in place by two spring clips. All the controls are mounted at the front of the chassis, the two tuning knobs working the condensers through slow-motion friction drives. The two dials are visible through celluloid "windows" in the sloping part of the cover. Wave-changing is effected by a lever switch which works in a vertical slot in the chassis. A rheostat is wired in the filament circuit of the S.G. valve to act as a volume control.

When the cover is removed, the coils, condensers, valve-holders and the L.F. transformer can be seen mounted on top of the chassis, in three compartments separated by vertical aluminium screens. The remaining components are situated on the underside of the "deck." The circuit employed incorporates an S.G. H.F. stage, a detector and a transformer coupled L.F. stage, reaction being controlled by a differential condenser. The coils are wound on vertical cylindrical formers, and the wave ranges are changed by a four-contact switch controlled by the lever mentioned above. A "Gripco" L.F. transformer is utilised, and a G.B. battery clip is mounted beside it.

A 3 ft. multiple battery cord is provided for H.T. and L.T. connections, and the aerial, earth and speaker leads are taken to large insulated terminals which are located at the back of the chassis.

The price of the receiver, without valves, is £6 16s.

TEST RESULTS.—The "Terralto" was tested in South London, where, for a set of its class, it gave quite a good account of itself. Mullard valves of the recommended types were employed (PM 12, PM 2 DX and PM 22), and the set possessed a pleasant feeling of "liveliness" which was assisted by a smooth reaction control—this remaining effective over the whole tuning range.

The instrument brought in a good "bag" of the usual

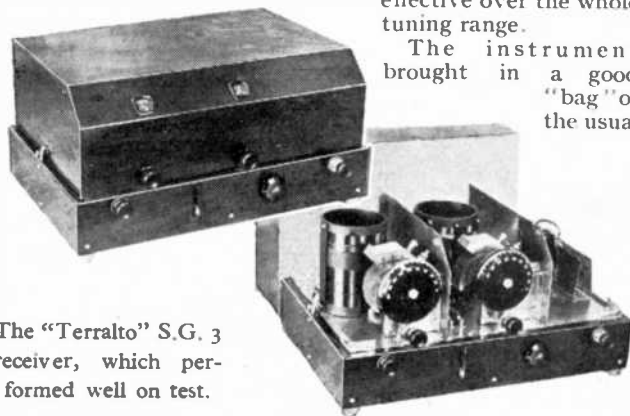

The "Terralto" S.G. 3 receiver, which performed well on test.

medium wave Continentals and, of course, the two Regionals and the National programme. Using the least selective of the two alternative aerial terminals, the standard

of selectivity was sufficiently high for most ordinary circumstances, but where more was required the use of the second terminal solved the problem. It was naturally inclined to reduce the volume of the desired station, but this could nearly always be brought up to strength by a reasonable increase in the reaction setting. The long wave selectivity was found to be quite adequate, and Radio Paris could be heard free from the 5 XX transmissions.

With suitable values of H.T. and G.B. on the output valve, the tone was perfectly satisfactory for ordinary purposes, but although we did not actually test by substitution, we think that some attention to the L.F. transformer might bring the tone up to a very high standard.

The general performance of the set, therefore, leaves little to be desired, and we have only one or two minor comments in connection with the construction. We should like to see some slight alterations in the dials. The movement is excellent, but it is rather difficult to read the scales, which would be improved by the use of black divisions on a white ground. Furthermore, the wave-change switch should be marked (the set receives on the short waves when the lever is down), and on our sample, at any rate, the volume control rheostat was excessively stiff.

Our experience with the "Terralto" left us with the opinion that it possesses an efficiency quite in keeping with its modern appearance, and the workmanship—both interior and exterior—is good.

Burne-Jones & Co., Ltd., 296, Borough High Street, London, S.E.1

"Magnum" Grid Leak Holder.

DESCRIPTION AND PRICE.—The base is composed of a strip of brown paxolin-like material which measures 1½ ins. by ½ in. by ½ in., and the clips, of a springy metal, are mounted near the ends. These are bent in the usual way, and are spaced sufficiently to hold a standard cartridge-type grid leak. The ends of the clips are shaped and drilled to form soldering tags and terminals of the usual "Magnum" hexagonal type are fitted to the two screws holding the clips. Two holes, for fixing purposes, are drilled in the base. The price of this component is 6d.

TEST RESULTS.—We tried several different makes of cartridge grid leaks in our sample holder, and each of them was gripped securely in the clips, and showed no tendency to spring out. The insulation resistance between the clips proved to be of a very high order, which is a good

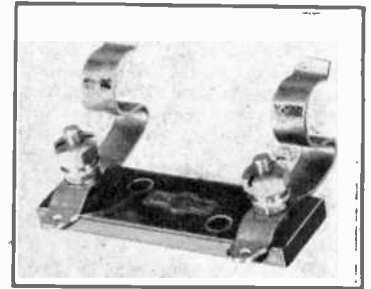

Priced at 6d., this "Magnum" grid-leak holder is reviewed below.

point where high resistances are to be used. We noticed, in the case of our holder, that after some use the clips worked loose, and, being held by single screws, they could be rotated. In our opinion, the clips should be locked in some way. Otherwise, it is a satisfactory component, at a reasonable price.

Dulcetto-Polyphon, Ltd., 2, Newman St., London, W.I. Moving-Coil Speaker Chassis.

DESCRIPTION AND PRICES.—The Dulcetto moving-coil speaker is available in chassis form, or in a cabinet, and can be supplied for accumulator, A.C. or D.C. mains operation. The chassis is composed of pressed steel stampings, finished in dark brown and held together by screws and rivets. In our D.C. mains model one stamping forms the base and back and front supports for the field magnet and cone chassis, and the latter, another pressed stamping, supports the magnet at the front.



A neat chassis type of moving-coil speaker—the Dulcetto. This is a robust product, and includes its own input transformer.

The field magnet consists, at the back, of two plates of iron, screwed to a flange on a hollow cylindrical cup of the same metal. A rod, $1\frac{1}{4}$ ins. in diameter, is riveted to the back plates and passes through a hole in the front of the cup, thus forming the gap for the coil. The exciting coil is wound on a bobbin, the connections being taken to two soldering tags mounted on a strip of ebonite at the back.

A low resistance speech coil is wound on an aluminium former, and the connections are led out along the surface of the cone for a short way, and then soldered to thick flexes which are connected to the secondary of an input transformer, mounted inside the framework underneath the electro-magnet. The primary winding of this transformer is connected to two more tags on the ebonite strip. The centring device, of the "cut-out disc" type, outside the moving coil, is screwed to the front of the magnet.

The cone, $7\frac{1}{2}$ ins. across at the front, is ridged concentrically, and is suspended on a ring of thin leather. Felt pads are attached to the rim of the cone chassis, and holes are provided for fixing the speaker to a baffle.

The D.C. chassis models, for all the usual voltages, are supplied complete with leads at the retail price of £6, while the A.C. chassis model is priced at £7 10s., and includes rectifying equipment.

TEST RESULTS.—The D.C. mains chassis was tested in conjunction with a 4 ft. square baffle, on 205 V D.C. mains, when the current consumption was 33 mA, giving a power consumption of about 6.8 watts. Compared with one of our standard moving-coil speakers having about the same consumption, the sensitivity of the Dulcetto was slightly less, but not seriously so.

The tone of the Dulcetto, taken on the whole, was very satisfactory. The low note response was good, without too much "thump," though a slight suspicion of this was audible at times. The speaker seemed, to the ear, to go down lower than several other similar speakers we have tested. The high note response was good, but not up to that of our standard. The overall tone, though well-balanced, was not quite so crisp and full of "attack" as that of the standard. There was, however, no noticeable colouration of speech and music, and no over-emphasis of sibilants. Altogether, it appears to be a robust production, and being relatively small, it is particularly suitable for use in radio-gramophones, and so forth.

Watmel Wireless Co., Ltd., Imperial Works, High Street, Edgware.

Watmel Universal Dual Range Tuner, Type 31.

DESCRIPTION AND PRICE.—This tuner is of the vertical type, and is mounted on a rectangular hollow base, moulded in a brown and black mottled bakelite.

The combined long and short wave grid coil, which is tapped in three places, is wound with green silk-covered wire on a skeleton former of the same moulded bakelite as the base, and the reaction coil, and an aperiodic aerial coil, are wound on a cylindrical paxolin former. This fits closely inside the grid coil, and is held in place by a disc of bakelite at the top.

Connections are taken to terminals mounted at opposite ends of the base, three at one end being in contact with the grid coil, and four at the other end for aerial, earth, anode, and reaction condenser connections respectively.

Wave changing is effected in an ingenious manner by means of a specially designed push-pull switch of very sturdy construction, which operates inside the hollow base. Two extension rods, one with a bakelite knob, are supplied for use with the switch.

The retail price is 17s. 6d.

TEST RESULTS.—On test this tuner gave very good results when tested in a straight receiver, using it as the aerial tuner, with capacity reaction. We made use of the aperiodic aerial coil, and found that with this the selectivity was above the average for this type of circuit. The two Brookman's Park stations were very easily separated, using an aerial which, with some similar coils, often causes these two stations to overlap. On the long waves, Radio Paris was quite clear of 5XX. Both the usual wavebands were adequately covered by the tuner used in conjunction with a .0005 μ F tuning condenser.

The volume obtainable on the short waves was perhaps a little below the average, but in view of the excellent selectivity, this is probably unavoidable, and in any case is not important. We did not find the use of a series aerial condenser to be necessary. On the long waves, the efficiency was found to be, if anything, above the average.

The reaction control, with a suitable detector valve correctly operated, was smooth on both wavebands.

A feature of this tuner is that the high powered short-wave stations do not come through at the lower end of the long-wave band as is sometimes the case. The wave-change switch, too, is a very robust affair, and is not likely to get out of order. Those who, like us, have at times had to disconnect large quantities of wiring to get at a faulty wave-change switch in a dual wave coil, will appreciate this point very much. The price, considering the excellent construction and good results obtainable, is reasonable, and this Watmel tuner can be recommended.

A view of the new Watmel dual range tuner. Inset is a diagram showing the ingenious and sturdily constructed wave-change switch.

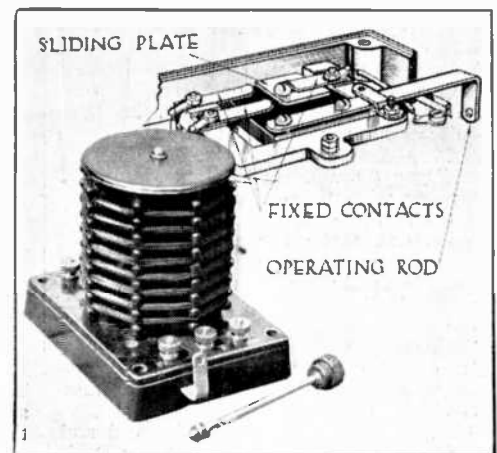

Still more *Power!*

Here's new power! With the progress of radio, valves are required to do more—much more—for the modern circuit is designed to produce a better performance with fewer valve stages. That's a good reason for marketing the new Mullard power amplifier. More important still are the opportunities created for radio development by the tremendous possibilities of this new valve.

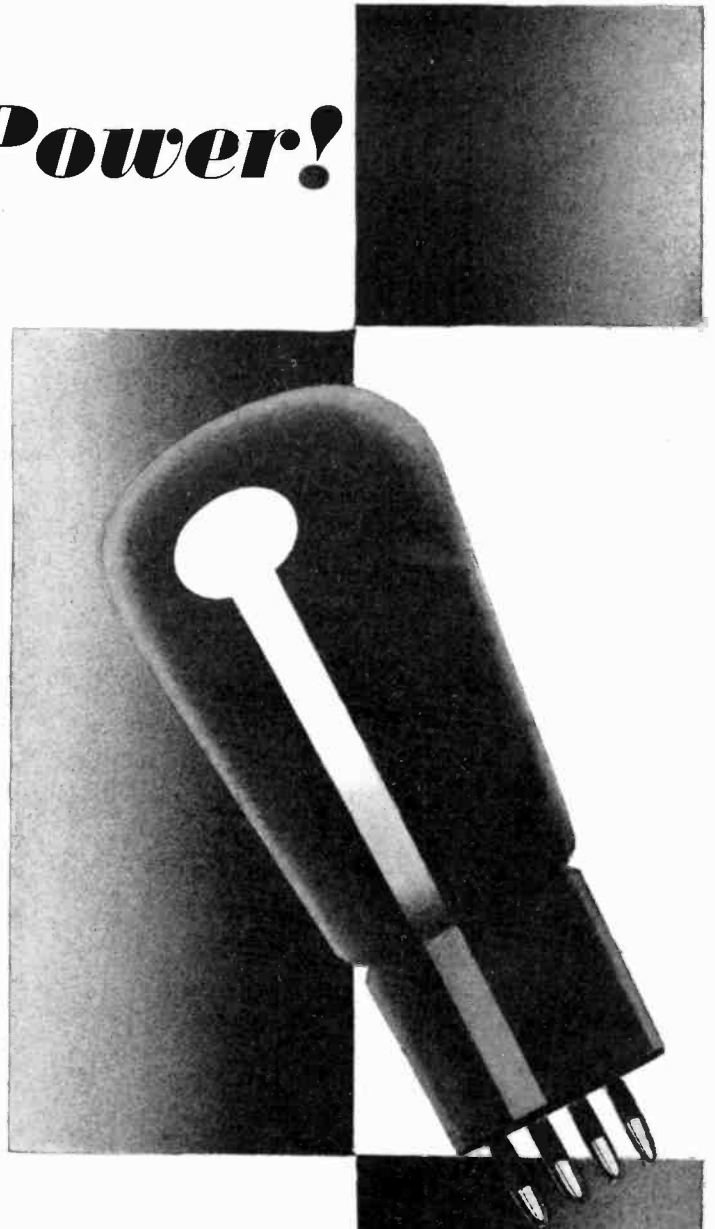

Mullard

THE MASTER VALVE

P.M.

256^A

I Feel You Near Me (W.*), by Jack Payne and his B.B.C. Dance Orchestra.

The first foxtrot, from the "International Revue," is one of the best that Jack Payne has done for some time. The number itself is excellent, and it is cleverly orchestrated and played in a sparkling style, with a very good dance rhythm. "Blue is the Night," from the film "Their Own Desire," is not up to the same standard—noticeably in the vocal work.

The foxtrot is again the most successful of the pair on CB 85—both from McCormack's film "Song o' My Heart." The band have recorded a nicely played version which should go well. Both songs are decidedly popular.

CB 95.—Sing You Sinners (Blues*) by the Charleston Chasers, and **In My Little Hope Chest (F.T.*)**, by the Columbia Photo Players.

The Charleston Chasers adopt their usual style and give this blues number a first-class hot rendering, with a very sound rhythm and some interesting solo work.

The foxtrot—a good tuneless number—is quite a contrast, being given in a steady, straightforward but thoroughly pleasing manner by one of the Columbia "house" combinations. The chorus is sung by a lady. Both numbers are from the film "Honey."

CB 96.—When I Passed the Old Church Door (W.*) and **My Love Affair (F.T.*)**, by Ray Starita and his band.

The waltz is being featured fairly extensively, but at the best it is mournful and over-sentimental as a number. It does not give a lot of scope for clever arrangements, but it is very well played in a steady manner, complete with organ effects to create the required atmosphere. The foxtrot on the reverse is a bright effort with plenty of life and interest. Good recording.

CB 97.—The Crowning of the Cotton Queen (O.S.*) by Debroy Somers Band, and **Reach Out for a Rainbow (F.T.*)**, by Van Phillips and his band.

The one-step can be classed as a novelty number, and as such it is managed very well by Debroy Somers Band, playing in their usual precise and polished manner. The foxtrot on the reverse is a good standard number from the film "Mirth and Melody." The arrangement is symphonic in style, but not to the point of obliterating the rhythm. The accompaniment to the vocal chorus is most effective. Good recording.

* * *

A Polydor August Supplement.

Although it was not originally intended to issue the next bulletin of "Polydor" records until September, Keith Prowse, Ltd., we understand, are issuing a special August supplement of "Polydors," in which several interesting releases appear. Among them should be noted two "Carmen" discs, 27190 and 27191, while several other operatic numbers are included. A record that will probably prove popular is 95206, on which Mozart's "Figaro" and "Titus" overtures are played by the Berlin Philharmonic Orchestra.

These are due for review in our next issue.

GRAMOPHONE NOTES AND NEWS.

Edison Bell Leave the West End.

It is announced that Edison Bell, Ltd., are closing down their West End show-rooms situated at 109, Regent Street, London, W.

Edison Bell were among the first firms in the trade to establish premises in Regent Street, and thus help to make that thoroughfare the virtual centre of radio and gramophone activity in the West End. The fact that Edison Bell are now vacating No. 109 will, we think, be regretted both by the trade and the public.

Selecta's Profit.

A profit of £13,041 is reported by Selecta Gramophones, Ltd., for the year ended April 30th, 1930. This compares with £18,325 for 1928-29. Out of this £13,041, the sum of £1,733 (against £2,733) has been written off for preliminary expenses, while for depreciation £1,246 (against £1,242) has been allotted. Income tax takes £1,786 (against £1,900).

With the final payment of 2½ per cent. proposed, the total dividend for the year is 7½ per cent., as against 10 per cent., leaving the carry-forward at £1,476, against £1,450.

H.M.V. at the Press Conference.

Several times in the past the Gramophone Co., Ltd., have made records of historical speeches and events. The latest were taken at the recent Imperial Press Conference in London, when the H.M.V. recording van was used. It was placed outside Grosvenor House, Park Lane, and the addresses, relayed through microphones in the Conference Hall, were recorded on wax discs in the van.

The records thus taken were not intended for sale, but were presented to each delegate to commemorate the event, and were sent to their respective homes.

Mr. Rex Palmer acted as introducer, and the speakers included were Lord Riddell, London; The Hon. Frank Carrel, Quebec; Sir Augustus Bartol, Malta; Mr. R. T. Barrett, Hong Kong; Mr. C. Brunsdon Fletcher, Sydney; Mr. J. H. Woods, Calgary; Mr. T. W. Mackenzie, O.B.E., South Africa; Mr. E. E. Edwards, Brisbane; and the Chairman, Major The Hon. J. J. Astor, M.P.

Vocalion's Annual Meeting.

The annual general meeting of the Vocalion Gramophone Co., Ltd., was held on July 18th at the Hotel Metropole, London, Mr. Charles K. Sugden being in the chair.

Opening his speech, the chairman mentioned the success the firm had achieved against great competition. Having regard to this competition, and also to the company's activities in the new sphere of talking films, the Board recommended that no distribution should be made.

We dealt with the profit and loss accounts last week, and stated that the year's profit amounted to £71,079, which, after making due provision for income

tax, depreciation, amortization of copyrights, etc., leaves £27,310. This, with the balance of £38,653 brought in from 1928-29, makes available £65,963 for carrying forward.

Continuing, the chairman said that the considerable fall in sales which occurred in the earlier part of the trading year, although apparently due even more to the general conditions than to competition, seriously exercised the minds of the Board and energetic steps were taken to arrest this decline; so successful did these prove that the sales in the latter part of the year equalled, and in certain months exceeded, those of the previous year.

Nevertheless, a higher ratio of gross profit was shown. This was probably due to the fact that, although owing to the severe summer slump the number of records sold was reduced by some 20 per cent., values decreased only 13 per cent. This is attributable to the success of the "Broadcast Twelve" disc, which yields a better margin of profit than the 8 in. "Broadcast." The production of 16 in. "talkie" records has already proved profitable, and promises to be more so.

The chairman stated that the company's investments in subsidiary and other companies stand at £130,701, an increase of £41,401. The chairman further stated that a dividend of 9 per cent. per annum on the £95,000 invested was received from the Vincent Manufacturing Co., Ltd.

Mr. Ashley, a shareholder, seconded the motion for the approval and adoption of the report and accounts for the year. The motion was carried and the meeting terminated with a vote of thanks to the chairman.

"The Voice" in New Guise.

With its July issue, *The Voice*, the house magazine of the Gramophone Co., Ltd., takes on a new and enlarged appearance, and bright though the original version certainly was, *The Voice* in its new form is even better.

In the July number appears a most interesting article on "The Broadcasting of Gramophone Records," by Christopher Stone, as well as several features—technical and sales—that should arouse the attention of all dealers. A "double-spread" of pictures in the centre of the magazine gives an admirable finishing touch.

Your Needles, Sir!

There are few automatic needle containers on the market at the present time, so that just put out by Joseph Lecker, of 119-125, Finsbury Pavement, London, E.C.2, does not enter a crowded field. Cylindrical in shape, it is 2½ ins. in height, and is apparently constructed of aluminium. It is most ingenious in construction, and presents one with a needle when the lid is depressed.

Provision is made so that the container can be built into the motor board of a gramophone. The price is 3s. 9d.

THE SELLING SIDE

Dealer's Guarantee as an Effective Aid to Sales.

IN present-day selling, more and more importance is being attached to the offer of guarantees. Before a sale can be effected it is essential that the customer shall be convinced that the goods will do what is claimed for them; low prices, attractive terms, and so forth, may make some appeal, but they can never outweigh the sales-resistance that is set up by lack of faith in the goods. This can only be done by establishing the buyer's confidence in the supplier's integrity and good faith, and the guarantee is one of the most effective of all means of achieving this desired end.

The guarantee has hitherto been employed largely by manufacturers, and the dealer's connection with it has mainly been as an intermediary between the maker and the public. A newer development, however, and one that holds out to the enterprising dealer a promising method of achieving still higher standing in his territory, and of building an increased business on a solid foundation, is the offer of a personal guarantee, applying to his goods generally, or to a specific selection of them, and backed by his own name.

The adoption of the policy of issuing a personal guarantee should be practical for the dealer conducting a good-class business, and handling goods of repute. The difficulties of making such a guarantee comprehensive are obvious. Its terms will have to vary as between, say, sets, and such accessories as valves and batteries.

It should be possible for the dealer to prepare a form of guarantee which, while adequately protecting himself, offers the customer a definite safeguard against dissatisfaction from all but unreasonable causes.

An example of this policy in actual operation can be given. Messrs. C. Webb, Ltd., who have several radio stores in Birmingham, have adopted the plan of issuing a specific guarantee in combination with a free service scheme, and they state that the method is highly effective.

It has already been found to be an excellent point in their favour when demonstrating to prospective customers, and gives the latter, in the firm's own words, "a feeling of assurance that we have their welfare

at heart, and tends to create mutual confidence."

Messrs. Webb's guarantee is attractively printed in legal style, and a copy is handed to the set-buyer on completion of the sale. It covers all receivers sold, and states that the firm will make good the breakdown of any component part or parts of the instrument itself, excluding accessories, within a period of twelve months, providing the breakdown is due to faulty workmanship and is not the result of mis-use.

Although accessories are not included in this general guarantee, they receive attention in a separate clause, which states that any fault developing in accessories supplied with the receiver, such as valves, batteries, headphones, loudspeakers, are covered by such guarantee as the makers of the article themselves give.

It is also added that such apparatus that may give cause for complaint can be forwarded to the manufacturer through the dealers, who promise to use every endeavour to assist customers when placing a legitimate claim.

An important part of the guarantee is the inclusion of a stated number of Free Service visits to ensure the correct working of the receiver. These are made by a skilled engineer at any time within the period of the guarantee that best suits the customer's convenience.

The number of visits to which a customer is entitled depends upon the value of the instrument, and

varies from one to three or more at the dealers' discretion. Free Service Vouchers, printed on differently-tinted cards and numbered from one to three, are supplied to the customer, who posts them to the dealers when attention is required. This provides a simple method of ensuring that no customer receives more than his proper number of free visits, but avoids any unpleasantness that might arise if it were necessary to point out to a customer that no further visits could be made without charge.

When the conditions of Free Service do not apply, instruments returned to the dealers under the guarantee have to be either taken to one of the branches, or despatched to them carriage paid. If it is desired that the engineer makes a personal visit to the customer's address, a nominal charge is made for his time and expenses.

In interpreting the spirit of their guarantee, Messrs. Webb's often are not concerned to adhere strictly to the letter, and the only charges ever made under the scheme are very nominal ones covering the bare cost of travelling, labour, and materials. In many instances these charges are waived so that there shall be no dissatisfaction on the part of the customer. Even after the free vouchers have expired, they still maintain a system of free visits, which are made periodically when their engineer happens to be in the vicinity of a customer's home.

A well-planned scheme of this character cannot fail to appeal to customers, and it provides a "talking point" of the most effective kind for all advertising and sales promotion matter.

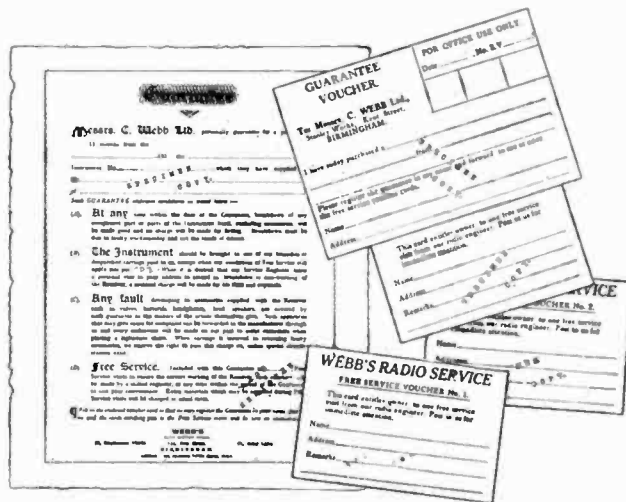

Illustrated here are facsimile reproductions of the guarantee vouchers issued by C. Webb, Ltd., to their customers. The smaller cards on the right entitle customers to free service visits. The method employed by the firm is described in the adjoining columns.

An easily - constructed "puzzle" window display which offers an effective means of arousing public interest. Here the programme item "hidden" in the display is "The First News," and the clue is given by the news-bill.

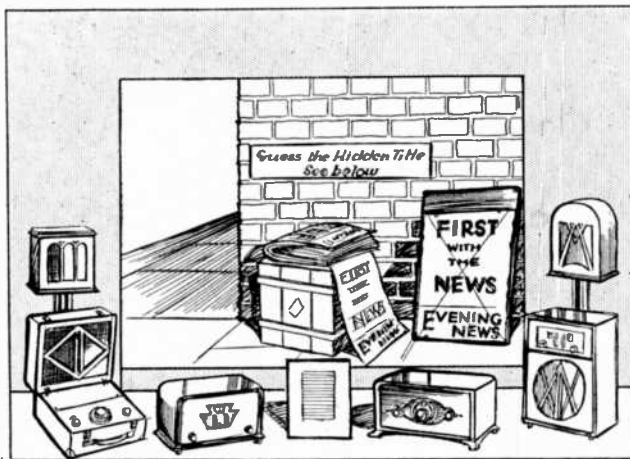

"Puzzle" Displays to Arouse Interest.

A DISPLAY idea that can always be relied upon to arouse a great deal of interest when it is first used in a district is that of staging a "Hidden Title" window.

This notion is not entirely new, as it had quite a run many years ago in other trades, when the titles of popular Academy pictures were often used for the purpose. It will be novel to many people at the present time, however, and it is especially valuable to the wireless and gramophone trader.

To put the plan into practice, the trader should select the title of a popular programme item, or that of one of the latest records, and stage a display representing the title chosen. As a clue, it should be explained that the title is to be found in the current issue of *The Radio Times*, or in the list of new records issued by one of the well-known gramophone companies.

Added interest may be aroused offering prizes to the first two or three customers who state correctly the title of the window.

One example of such a display is given in the sketch on this page. Here, a portion of the window is dressed to represent a street news-vendor's pitch, and the posters displayed are those of a well-known London evening newspaper. The programme item "hidden" in this window, the title of which is to be found in any issue of *The Radio Times*, is "The First News."

This is quite an easy display to carry out. The wall can be introduced by means of brick pattern display paper stretched taut on a light wooden frame, and the pavement should be suggested with stone-coloured display paper spread on the bed of the window. An old wooden box (suggesting the seat used by the absent news-vendor), a bundle of newspapers, and two contents bills, complete the accessories necessary for this part of the display.

In order to provide a more appropriate setting for a foreground display of apparatus, the trader should introduce a crepe or display paper surround which will also "frame" the central feature and add to its effect, while concealing the rough edges of the decorative materials. The two side pieces should be fastened at the top of the window, stretched thoroughly taut, and fastened at the lower edge, while the strips at the top and bottom should be securely attached at the side of the window, and similarly stretched taut before being fastened at the opposite ends.

Not all programme items lend themselves to treatment in this way, but the trader should have little difficulty in finding other suitable subjects of sufficient importance to justify their being featured. As an example, it is stated that arrangements are being made to transmit an adaptation of "The Silver King." In this case, the mystery window might contain an enlarged representation of a shilling, with the side bearing the King's head turned toward the front of the window. This would again provide an eye-catching centre-piece, in conjunction with a card reading, "Famous Melodrama to be Broadcast."

As we have said, the same idea is applicable to popular records, and for current use the trader might turn to such titles as the "Stein Song" or "A Cottage for Sale." The former, as was mentioned in THE TRADER a week or two ago, is an old drinking song that originated among German students, and could probably be represented by a picture of students engaged in a carousal. "A Cottage for Sale," could be suggested by means of a painted cut-out of a picturesque cottage, with a "To be Sold" board outside, or a similar effect could be obtained with crepe papers of various colours.

A Convincing Sales Letter.

AN inexpensive and very effective form of publicity that has been regularly advocated in this feature is the circular sent by post to a selected number of "prospects."

We know that a large number of dealers use this form of sales argument, but we have never seen the idea advanced in a more convincing manner than in a circular now being issued by Everyman's Radio Service, 7, Sutton Parade, Church Road, London, N.W.4.

As will be seen from the letter, which is published at the foot of the column, a clever heading, "Domestic Lubrication" immediately attracts attention, while the actual "sales talk" explains to the reader why he should purchase at least one extra loud-speaker.

It should be mentioned that the idea of pushing the idea of "more than one loud-speaker per household" has been advocated in the last three issues of *The Philips Announcer*.

Mr. Brooker tells us that he has quite often used this form of publicity before, and in this case he intends to despatch about 1,000 letters of the same type as that produced below.

The "prospects" names and addresses were in most instances already known to the firm through previous purchases, battery charging, enquiries and so on; and all available details of these people are carefully filed by the firm. Thus a very useful number of names of people who are definitely interested in radio is available for circularisation purposes. There is only one small point upon which we consider this circular could have been improved, and that is as regards the appeal and design of the noteheading used.

DOMESTIC LUBRICATION.

Dear Sir,

A smooth-running household means that you are free from domestic "squeaks." A "lubricant" at the right spot will ensure this.

Now! An extra loud-speaker in the nursery will keep the children good when you least want to explain "Why this" or "What that." Or when guests arrive to tea, you are not interested in the "intimate" conversation, after a suitable interval you can retire with your extra speaker and enjoy a quiet pipe in your den.

Entertaining a party on the lawn will be magically easier if an extra loud-speaker can provide music for an impromptu dance.

And in the sickroom, how many free hours will be afforded the rest of the household if during convalescence the extra speaker can entertain the invalid!

Then the kitchen. We all know the difficulties of securing good maids, of retaining their services. An inexpensive speaker might be regarded AS AN ASSURANCE. The low cost will give tremendous return on goodwill.

And this extra loud-speaker (or perhaps two) will not only enable you to get the fullest possible service from your set, but will itself give you years of service. What will be the cost? Anything you choose—17s. 6d., 29s. 6d., £2 2s., £2 10s., £3 15s., and upwards. A phone call or a postcard will bring a man to demonstrate. No obligation, of course, so please let us hear from you.

Yours faithfully,

EVERYMAN'S RADIO SERVICE.

FROM ALL QUARTERS

Notes and News for the Radio Exporter.

Notes from Paris.

By Our Own Correspondent.

DISCOUNT abuses seem to flourish in France as much as ever, in spite of the efforts made to put an end to them by the traders' and manufacturers' association (the S.P.I.R.). One authority states that the present state of affairs constitutes a case of "everybody for himself." One house offers 25 per cent., another gives 5 per cent. more, a third 40 per cent., and others only stop short of absolute gratuity in order not to miss an order! Thus customers go from one factor to another, hoping to get a better discount. The big departmental stores appear to be "cornering" the radio market, and have no difficulty in getting almost any discount they please.

A New Short Wave Station.

In November next we are promised a new station that will bear the name of Radio-Branly. A company has been formed with the object of working a station, the technical management of which will be in the hands of M. E. Branly, the French pioneer of wireless. It does not seem quite certain, however, that the aged French professor, who has always been disinterested in such matters, will consent to assume the position and take charge of the up-to-date transmitter offered to him.

The capital of this broadcasting company (approximately £120,000) has already been subscribed. The transmitter will have an aerial power of 12 kW, according to the present project, and will be erected 65 miles from Paris, in the Eure Department. The transmissions will take place simultaneously on short and ultra-short waves.

The studio will be situated in Paris, and the artists will perform in a hall seating 60 persons.

The Radio-Paris Station.

The new Radio-Paris station will begin its trial transmissions about the end of September. It is rapidly being finished on its site at Essarts-le-Roi outside Paris. The first experimental broadcast will be made with an aerial power of 85 kW.

This station is planned to be the most powerful in France. It will have a nation wide range.

Lille is also to have a new broadcasting station and work has already commenced on the site.

S.P.I.R. President's Success.

M. Paul Brenot, President of the S.P.I.R., who occupies an important post in the great Associated Companies (Radio-Paris Co., Radiola, etc.) has been awarded the Sobier-Arnoud prize by the French Academy of Science, for his book on "The Conquest of the Waves," recently published. This work deals in an attractive way with the growth and development of wireless.

Britain Best for Radio Tourists.

In Belgium, tourists arriving with wireless sets pay a tax of 12 francs per 2½ lbs., plus 2 francs ad valorem duty. This tax is re-imbursed on the return journey, but only by the office that collects it.

In Spain, the import tax of 2 pesetas 88, per 2½ lbs. is not refunded. A temporary licence is obtainable in any post office there. In Germany there is no entrance duty, but a licence has to be taken out.

In France there is an ad valorem tax of 22 per cent. on each receiver plus 6 per cent. if the set is over the 700 francs value limit, and it the speaker is worth more than 32s. England, it is considered, offers in this respect the greatest attraction to the tourist, as only a declaration is required. This fact is noted by visitors taking wireless sets with them.

The Paris Wireless Salon.

The Paris Wireless Salon, which will be held in September next in the new hall at present being built in the Boulevard Raspail, has attracted numerous entries. To counterbalance the high price per square metre, large and striking stand frontages will be available.

The rival to the S.P.I.R., the Syndicat National des Industries Radio-Electriques, will be permitted to participate in the Show. It was intended to exclude its members, but the latter then threatened to organise a separate international show. This would certainly have been a failure, judging by last year's experience, though prejudicial to the S.P.I.R. Salon as well. The question was settled in the best interests of all after laborious negotiations.

From Other Countries.

Gold Coast Wireless Imports.

PENDING modifications of the law, the Comptroller of Customs of the Gold Coast Colony has issued instructions to permit the importation of all wireless sets and component parts. Formerly the importation of foreign-made radio equipment was prohibited, except when imported by the Imperial or Colonial Government.

Austrian Imports Increase.

During last year the imports of wireless apparatus into Austria attained a value of £220,900 as compared with only £123,360 in 1928, an increase of nearly 80 per cent. The import trade is mainly in the hands of Dutch and German producers.

Some Bulgarian Gramophone Statistics.

From an official report issued in France it is learned that neither gramophones nor records are manufactured in Bulgaria. As a result, the import of such goods has, during recent years, shown a constant increase. The popularity of the gramophone, and particularly the portable model, is in every way as great in Bulgaria as in other countries.

It is impossible to ascertain exactly the import figures for records. The official Customs Statistics classify them under the heading of "parts of musical instruments, with the exception of stringed instruments." Figures under this heading for the last three years so far available give some idea of the rapid extension of business:—

Country of Origin.	1928. Levas.	1927. Levas.	1926. Levas.
Germany	9,469,415	4,888,590	1,973,672
Great Britain	2,476,780	1,801,710	320,390
France	2,300,630	1,882,900	1,315,670
Austria	1,333,295	1,881,299	530,210
Czecho-Slovakia	1,134,630	1,666,230	443,930
Other countries	911,330	550,020	129,010
Total	17,626,080	12,670,749	4,717,882

(The pound sterling is worth about 670 levas.)

It is pleasing to note from these figures the rapid advance that has been made as a supplier by this country. It must be remembered, however, that the bulk of the United States trade is not done direct, but that many American records pass through Germany, France, or England, on their way to Bulgaria, and the Customs officials in the latter country are not able to state their real country of origin.

Retail prices of records vary according to the make, the diameter of the record, and the label affixed. Generally, prices range from 120 to 320 levas apiece, but for celebrity records from 220 to 400 levas each is charged. Records for the teaching of foreign languages find no opening in Bulgaria.

Importing firms usually pay for records ordered on arrival. The import duty is 300 gold levas per 100 kilos, plus a surtax of 25 per cent. to cover various charges. In reckoning the duty, one gold leva is taken to be the equivalent of 20 paper levas.

Canada Empire Shopping Week.

A telegram has been received by the Department of Overseas Trade from His Majesty's Trade Commissioner in Toronto, stating that the executive committee of the Empire Shopping Week which, it was proposed, should be held in Canada in September next, has recommended the postponement of the Week.

It is understood that the committee have suggested the possibility of holding an Empire-wide Week at some later date.

WITH THE TRADE ASSOCIATIONS.

STOCKPORT BREAKS FROM W.R.A.

LOCAL ACTIVITY IN BIRMINGHAM, PORTSMOUTH & BRIGHTON.

Stockport Radio Retailers' Association.

FOLLOWING upon the brief announcement given in last week's issue of THE TRADER, of the resolution of the Stockport branch of the W.R.A. to resign from the parent organisation, we give below extensive extracts of the discussion which led up to this decision.

The meeting was the usual fortnightly one held at Aerial House by permission of the Chairman, Mr. J. W. Heaps, who opened the proceedings by reminding members that since the last gathering Mr. Carter had attended the London headquarters as a special delegate to a meeting called to consider the questions of branch status and provincial organisation generally.

Mr. Carter then gave his impressions of the London meeting, and explained that its object was to consider the question of dividing the whole country into areas. Resolutions were passed by the meeting, which, however, would not come into operation until approved by the Council.

Mr. Carter continued: "The first resolution agreed to the country being split into areas, the formation of more branches through the efforts of existing branches which would do their own recruiting and would also pay for a canvasser out of their own funds, and not out of the Headquarter's finances.

"The second resolution was that the yearly subscription be increased to two guineas.

"It was fortunate that Stockport had sent a representative," added Mr. Carter, "as the meeting opened and closed with considerable discussion about the branch and its criticism of Headquarters affairs."

A further point about which Mr. Carter found it necessary to comment was: "Out of twenty on the National Council, twelve are London men, which is a ridiculous representation."

The Proposed Increased Subscription.

"From observations about increasing the subscription," he went on, "it was apparent that the extra guinea would be used by Headquarters. On pointing out that this would not be acceptable to northern branches, I was told that in that case Stockport could be done without, from which it would appear that the south intends to rule the north in this matter—as in other affairs. It was surprising that Liverpool had nothing to say, as this matter of subscriptions was brought up by them. The only people to speak plainly were Mr. Jenkinson, of Manchester, and myself.

"As to discipline in the Association, Mr. Pinto, of Ramsgate, said that the way that they were going on would lead to ruin; there was no discipline. Other speakers said that the south ruled, and they must 'put their foot down.'

"Out of about 1,650 members, not more than 300 are attached to branches, so it is proposed that in future members be attached to the nearest branch. So far as I can see, they are not keen on more branches."

After Mr. Carter had reviewed at length the matter of publicity given to W.R.A. affairs, the meeting discussed his report.

The chairman said that, regarding the proposal of increased subscriptions, they paid enough to London. The present guinea subscription should be quite sufficient to pay for the proposed stand at the Radio Exhibition. London, however, seemed to want as much money as possible without doing anything. Mr. Heaps added that the trade press are not allowed to attend Headquarters meetings, and that a report is supplied to the trade journals, thus permitting things to be said which may, as such, not be reported to members generally.

During further discussion, it was emphasised that the Stockport

branch had been established weeks before allying itself with the National body, under the title of Stockport Radio Retailers' Association. They still retained that independent status.

The Branch's Resolution.

Mr. Mottershead then suggested that London was not capable of directing the branch with the energy that the members demanded, and he proposed the resolution given in last week's TRADER, namely, that "We, the Stockport Radio Retailers' Association, having fully discussed at length the relations between the W.R.A. and ourselves as a body, in respect of representation, action, dues and propaganda, have come to the conclusion that we are at considerable variance, and therefore do herewith sever our relations with the W.R.A. from this date. This action has been decided on because we feel that we can handle our general position as retailers in a quicker and more expedite manner than was the case before our affiliation with the W.R.A."

The resolution was carried.

Mr. Norcross later read a message from the Bucks branch, in which it was pointed out that their branch had been a flourishing one for three years, solely as the result of local effort. The letter also stated that there were gentlemen on the Council who did not represent any branch.

Turning to other matters, a letter was read from Ferranti, Ltd., stating that a party would be welcome for a tour of the firm's works at Hollinwood and Stalybridge on July 31st.

The Secretary also announced the receipt of a letter from Preston on the subject of branch organisation, stating that the matter would come up for discussion at the meeting on August 26th.

Finally, the attention of the meeting was drawn to the fact that a well-known battery manufacturer's name did not appear in a published list of firms who were fighting price-cutting.

The W.R.A.'s Reply.

IN view of the fact that some of the statements made by Mr. Carter to his fellow members in Stockport were at considerable variance with the official version of the discussion and decisions on these points supplied to us by the W.R.A. and published in last week's issue of THE TRADER, we approached the Executive of the Association in London for a clear statement on the points where differences occur. The following is a letter which we have received from the Association in reply:—

TO THE EDITOR.

Sir,—Relative to the extracts from Mr. H. Carter's alleged statements at the Stockport branch meeting, we regret that confusion has arisen over a subject upon which the final decisions are clearly enumerated in the account of the meeting held in London, which appeared coincident with the report of the secession of the Stockport branch in last Saturday's issue of THE TRADER.

The very point which Mr. Carter appears to have raised with regard to the country being split into areas was the unanimous recommendation of the meeting, while the hope that branches would organise themselves, both in the matter of membership and directing a canvasser, was unanimously approved by the branch delegates themselves—of whom Mr. Carter was one.

Respecting finance, it surely was made quite clear that Headquarters would not receive the extra dues from the increased subscriptions, since, as reported under Item 3, it was recommended that 2s. per head should be allocated to the branches, instead of the present rate of 5s. per head.

Dealing with the instance in which Mr. Carter is reported to

have said that Stockport "could well be done without" this probably refers to a statement by Mr. Pinto that it seemed that Stockport was holding an ultimatum at the whole membership of the W.R.A., when Mr. Carter repeated his assertion that the W.R.A. was on "a year's trial so far as Stockport was concerned," and that Stockport would part company if the Association did not advance in the way that Stockport thought it should. Mr. Pinto said that he disagreed with such an attitude, and the difference of opinion, *irrespective* of the fact that it reflected the general view of the other members present, was entirely between Mr. Carter, of Stockport, and Mr. Pinto, of Thanet—and not, as seems to have been suggested, between Mr. Carter and the W.R.A. Executive.

It is inconceivable that Mr. Carter should seriously assert that southern members endeavour to dictate to the north. Considering the fact that they meet very irregularly it is difficult to see how this could be so, and in any case the Executive Committee consider it impossible to introduce legislation that would not affect southern and northern people alike.

The Executive Committee deprecate the general trend of Mr. Carter's reported comments, and intend to have the report of the meeting as supplied to you verified by the actual members present. Accordingly those who attended the meeting will receive a request to substantiate—or otherwise—the report as sent to the press, and at the same time comment upon the points with which we have already dealt.

The Executive Committee desire to thank you most sincerely for the trouble you are obviously taking to put this matter thoroughly in order.

A. E. BETAMBEAU, *Chairman*, W.R.A.

H. A. SHEARMAN DYER, *Vice-Chairman*, W.R.A.

LONDON, E.C.2.

AT the meeting of the Manchester branch, W.R.A., held on Monday (which, owing to heavy pressure on space cannot be reported fully until next week) Mr. H. G. Jenkinson, Chairman of the branch and delegate to the London meeting, said: "I suppose you will have read the report in THE WIRELESS AND GRAMOPHONE TRADER. It gives the gist of the proceedings very accurately and concisely; and it is quite a full report."

During conversation prior to the meeting, and in the presence of members, in reply to a query as to whether the report represented the actual decisions or recommendations, he said that it was an accurate record.

Readers should note that Mr. Jenkinson's opinions are more fully expressed in our Correspondence columns this week where we also refer very briefly to the written opinions on these questions of eight other gentlemen who attended the London meeting. The Editor perused their letters to the W.R.A. in his own office a day or two ago.

Birmingham Branch, W.R.A.

MR. J. WELLINGS (Chairman) presided at the last meeting of the Birmingham branch of the W.R.A. at the White Horse Hotel, when, in a discussion on radio clubs in relation to large firms, it was reported that an interview had taken place with representatives of the Dunlop Rubber Co. This interview followed some correspondence which was summarised in the report published in THE TRADER of June 28th, and a free interchange of opinion on the matter took place. As a result the deputation was able to announce that a very satisfactory understanding had been arrived at, and it was therefore decided to withdraw the resolution passed regarding radio clubs connected with large industrial concerns so far as Fort Dunlop was concerned.

The new policy of the Marconiphone Co. came under review, the Chairman welcoming the stand which was being taken. The general opinion of the meeting was that this action by the company would be of great benefit in regularising the trade.

Radio Club Trading.

Returning to the question of radio club trading, it was thought that the most effective way of dealing with the problem was through the manufacturers' organisations. It was, however, recognised that industrial and commercial concerns could not be expected to interfere when members of radio clubs connected with the works made private purchases.

In a reference to the complaints lodged at the last meeting over a firm advertising by leaflet that radio goods of all kinds—including valves—could be had at bargain prices, the Secretary reported that there was no fresh development.

As to the case of a Harborne post-office worker dealing in

wireless goods, the Secretary stated that they were awaiting a reply from the Postmaster.

The question of co-operative advertising among members was again brought forward, Mr. Wright and several members urging that such a scheme was highly desirable. The Secretary mentioned that Mr. Dagnall had obtained some figures of the cost of such a scheme, which would embrace newspaper insertions and the supply of a sign or poster for the participating dealers. Unfortunately, Mr. Dagnall could not be present, but he would give the figures at the next meeting. Meanwhile it was thought advisable to secure quotations for a shop sign, and an indication of its design was desirable in order to incorporate the sign in any newspaper advertising they had.

A proposal was down for discussion as to the best methods of securing a wider membership for the Association, and the question of a paid canvasser arose. However, Mr. Spain mentioned that since the subject was mooted a London headquarters meeting had dealt with the matter and had put forward a similar proposal, as was shown by a subsequent announcement in THE WIRELESS AND GRAMOPHONE TRADER.

The idea was to divide the country into areas for the purpose of this national canvass, a suitable person to be engaged for each area. It was thought that the plan would prove beneficial, and in welcoming an effort of this national description, the meeting considered that it would be advisable to review the whole scheme later.

Portsmouth and District W.T.A.

ALTHOUGH no meetings of the Portsmouth and District Wireless Traders' Association are being held during August, correspondence which has reached the hon. secretary (Mr. G. W. Palmer) shows that the representations which have been made through the Association with regard to various trade abuses continue to have a satisfactory outcome.

Following upon the alleged complaint that Pertrix batteries were being sold at cut prices, a letter has been received from the Sales Manager stating that steps would be taken to stop it.

Information was also sent to E. K. Cole, Ltd., with reference to a tailor and outfitter believed to be trading in their goods. Replying, the firm state that they will be prepared to take the usual steps to stop any such malpractices.

Another complaint taken up by the Association had reference to the alleged price-cutting on Triotron valves. In regard to this matter, the Triotron Radio Co., Ltd., wrote: "We have already instructed our solicitors to start legal proceedings against certain price-cutters in the East End of London. . . We trust that the advertising of the injunction which we intend to enforce against such people will have a wholesale effect. We then intend to proceed against certain dealers elsewhere."

Attention was drawn, through a representative of Kolster-Brandes, Ltd., to a case of alleged price-cutting by one of their dealers. Having gone thoroughly into this matter, the firm have now written through their Sales Department stating that the dealer in question had decided to act upon their suggestion, and return the sets which he had in stock to Sidcup to be re-conditioned. The reason why the price was reduced, it was added, was because the sets were shop-soiled.

Brighton and District Branch, N.F.R.R.

WE have received a report from the Hon. Organising Secretary of the N.F.R.R. which states that an inaugural meeting of a Brighton and district branch was held at the Royal Pavilion last week.

The report states that, after Mr. de Villiers had explained the aims of the Federation to the meeting, he proposed that a branch be formed, and this was seconded by Mr. W. Allwright. The motion was then carried unanimously.

This resolution was followed by much discussion on local price-cutting. One gentleman enquired who had been sent notices of this meeting, and the Chairman then read out the list, which was much altered and corrected, and only recognised people with proper trading premises were left on it.

The matter of the responsibility for the present state of the radio retail trade was fully discussed, and it was decided that there was need for immediate action in the Brighton district.

Then followed the enrolment of six new members and the election of officers as follow: Mr. C. H. Browne (C. H. & M. L. Browne), Chairman; Mr. W. A. Allwright (Allwrights, of Lewes), Secretary; and Mr. North (Barnes, North & Muncney), Treasurer.

COMMERCIAL INFORMATION

GAZETTE.

The Bordesley Electrical Accessories Co. Ltd. At an extraordinary meeting held at Daimler House, Paradise Street, Birmingham, on July 11th, it was resolved that the company be wound up voluntarily, and that Mr. Archibald Brown, of Daimler House, Paradise Street, and Mr. Wm. Hand, of Cherry Street, Birmingham, chartered accountants, be appointed joint liquidators.

Ramsbottom Electrical Heating and Lighting Co. Ltd. At an extraordinary general meeting held on July 16th at 52, Bolton Street, Ramsbottom, it was resolved that the company be wound up voluntarily, and that Mr. Harold R. Disley, of Messrs. Burton & Disley, C.A., 29, Brown Street, Manchester, be appointed liquidator.

Premier Electric Co. (Stockport) Ltd. and Premier Wholesale Electric Co. (Stockport), Ltd. Meetings of creditors were held on July 23rd, at 12, St. Peter's Square, Stockport.

D. A. Jones, Ltd. Meeting of creditors will be held at The Oak Room, Kingsway Hall, Kingsway, London, W.C.2, at 2.30 p.m., July 28th. For the purpose of voting, secured creditors are required (unless they surrender their security) to lodge at the company's registered office before the meeting a statement giving particulars of their security, the date when it was given, and the value at which it is assessed.

Gatesboro' Gramophones, Ltd. (in voluntary liquidation). Creditors must send on or before August 6th, their names and addresses (and those of their solicitors, if any), together with particulars of their debts and claims, to Henry G. Large, I.A., 2-3, Philpot Lane, London, E.C.3, liquidator, otherwise they will be excluded from the benefit of any distribution made before such debts are proved.

Vee Cee Dry Cell Co., Ltd. (in voluntary liquidation). A general meeting of the members will be held at 1, Station Road, Reading, on August 20th at 10.30 a.m. to hear how the winding-up has been conducted, and how the company's property has been disposed of. Liquidator: H. M. West.

Receiving Orders and Adjudications.

Crane, Frank M., 11, Kirkley Road, Merton Park, Surrey, trading as **C. S. Mayfield & Co., and The Sutton Electrical Installation Co., 67, Carshalton Road, Carshalton, Surrey,** and **38, Brighton Road, Sutton, Surrey,** electrician, etc. Court: Croydon. Date of petition and order: July 16th. Debtor's petition.

Wood, Ernest W., 253, Kettering Road, Northampton, trading at 69B, Kettering Road, Northampton, electrical engineer, etc. Court: Northampton. Date of petition and order: July 18th. Debtor's petition.

Receiving Orders.

Jackson, Esther Buckley (married

woman), 165, Love Lane, Heaton Norris, Stockport, and trading at 140 and 165, Love Lane, Heaton Norris, Stockport, gramophone dealer, etc. Court: Stockport. Date of petition: March 29th. Date of order: July 16th. Creditors' petition.

Monk, W. T. (male), 9, Rosedale Road, Romford, Essex, electrical engineer, etc. Court: Chelmsford. Date of petition: June 4th. Date of order: July 16th. Creditor's petition.

Adjudication.

Le Butt, Ralph C., 177, Regent Street, London, W.1, and trading at 53, Great Marlborough Street, London, W.1, electrical engineer. Court: High Court of Justice. Date of petition: February 19th. Date of order: July 16th.

Winding-up Orders.

Duophone (Foreign), Ltd., 153-155, Regent Street, London, W.1. Court: High Court of Justice. Date of petition: July 1st. Date of order: July 14th.

Truphonic Radio, Ltd., Truphonic House, Hanover Park, Peckham, London. Court: High Court of Justice. Date of petition: July 2nd. Date of order: July 14th. Date of resolution for voluntary winding-up: January 12th, 1929.

Appointment of Trustee.

Britton, Joseph A., 362, Edgware Road, London, W., trading as **The Boleyn Gramophone Co., 31, Barking Road, London, E.,** gramophone and radio dealer. Court: High Court of Justice. Trustee: S. G. Crimes, C.A., Premier House, 150, Southampton Row, London, W.C.1. Date of appointment: July 17th.

Orders made on Application for Discharge.

Lee, Edward Francis, 34, Beaufort Street, London, S.W.3, and trading as **Francis Newton,** electrical engineer, etc., 304A, King's Road, London, S.W.3. Court: High Court of Justice. Date of order: June 20th. Bankrupt's discharge, suspended for one month, and he was discharged as from July 20th.

Edghill, Harry George, 3, College Road, Harrow, and trading at 13, Wembley Hill Road, Wembley, wireless engineer, etc. Court: St. Albans. Date of order: June 24th. Discharge suspended for two months. Discharged as from August 24th.

Intended Dividends.

Atack, Handel A., 442, Borough Road, Birkenhead, wireless dealer, etc. Court: Birkenhead. Last day for proofs: August 2nd. Trustee: James Allcorn, Government Buildings, Victoria Street, Liverpool, Official Receiver.

Tempest, Colonel, Nursery House, Clayton Heights, Clayton, Yorks., trading at 4, Mann's Court, Bradford, electrician, etc. Court: Bradford. Last day for proofs: August 5th. Trustee: Rupert Lindley, 21-22, Prudential Buildings, Bradford.

Ideal Wireless Co., Ltd., Dorland House, 14, Regent Street, London, S.W.1. Court: High Court of Justice. Last day for proofs: August 5th. Liquidator: Herbert James Eldridge, 133, Moorgate, London, E.C.2.

Shapland, Albert Edwin, Chippenham Cottages, Exmouth, formerly trading at 13A, High Street, Budleigh Salterton, electrical engineer, etc. Court: Exeter. Last day for proofs: August 2nd. Trustee: Walter R. Cocks, Exeter Bank Chambers, Broadgate, Exeter, Official Receiver.

Gardner, Kenneth L., 7, Bridge Street, Wisbech, wireless dealer, etc. Court: King's Lynn. Last day for proofs: August 1st. Trustee: Fred H. Langmaid, 41, Sidney Street, Cambridge, Official Receiver.

Dissolutions of Partnerships.

Brosse, Hugh A. A., and Banson, Frank B., trading as **The B. & J. Wireless Co., Athelstane Mews, London, N.4,** wireless component manufacturers. Dissolved: July 1st. Debts: Hugh A. A. Brosse.

Irving, Murray, and Willeringhouse, Dudley W., trading as **Irving Willeringhouse & Co., Duke Street Chambers, Duke Street, Brighton,** electrical merchants and manufacturers, etc. Dissolved: June 21st.

Waite, Albert E., and Waite, George L., both of Bradford Road, Menston, Yorks., trading as **Waite Bros.,** electrical engineers, etc. Dissolved: January 31st. Debts: G. L. Waite, who continues the business.

Receiverships—Appointments

Flexible Electric Cords, Ltd. F. Kniveton, of 7B, London Road, Enfield, was appointed Receiver and Manager on July 5th, 1930, under powers contained in second debenture dated May 30th, 1929.

Aeonic Radio, Ltd. C. J. G. Palmour, of 4B, Frederick's Place, Old Jewry, E.C.2, was appointed Receiver and Manager on June 27th, 1930, under powers contained in debentures dated February 26th and 28th, 1930.

Mortgages and Charges.

C. A. Carter & Co., Ltd. Particulars filed of £3,000 debentures authorised July 9th, 1930, charged on the company's property, present and future, including uncalled capital, the whole amount being now issued.

Martins (Heckmondwike), Ltd. Charge on certain lands, workshops, etc., at Heckmondwike, Yorkshire, dated June 28th, 1930, to secure all moneys due or to become due from the company to the National Provincial Bank, Ltd.

Satisfaction.

Note: Where the amount "originally secured" is stated, that is not necessarily the amount outstanding at the date of the satisfactions recorded below. There may have been previous partial satisfactions, registered or unregistered. The registration of Satisfaction is not compulsory.

Fraser, Son & Mackenzie, Ltd. Satisfaction to the extent of £1,000 on May

30th, 1930, of debentures authorised August 11th, 1927, and registered August 20th, 1927.

(According to the register of mortgages the debentures registered August 20th, 1927, originally secured £15,000.)

County Court Judgments.

The following returns have been received from the Registry of County Court Judgments, Treasury, Whitehall, which purports to contain lists of judgments entered up in the respective County Courts of England and Wales, but no distinction is made on the register between actions for debts or damages or properly disputed cases; neither is it known which of the judgments remain unpaid at the present time; and it is probable that a large proportion of them have been settled between the parties or paid. It may also be observed that some of the judgments registered are against defendants in a representative capacity. The name given is that of the defendants; the amount is that for which judgment was given, and the date is that on which it was given.

Cooper R. H., 9, Kingsley Road, Brighton, wireless dealer. Court: Clerkenwell. £22 4s. 7d. May 26th.

The Battery Dynamo Co., 124, North End Road, Fulham, London, W., wireless dealers. Court: Clerkenwell. £15 2s. 2d. May 26th.

Brosan R., 267, High Road, Willesden Green, N.W., wireless and electrical dealer. Court: Clerkenwell. £43 7s. 6d. May 29th.

Norbiton Electrical & Wireless Supplies, 190, London Road, Kingston, Surrey, wireless engineers. Court: Whitechapel. £21 9s. 9d. June 20th.

Parry, L. M., 17, The Promenade, Church End, Finchley, N., wireless factor. Court: Southampton. £11 18s. 6d. June 17th.

The Radio Box, 18-18a, Blackheath Road, Greenwich, wireless dealers. Court: Bloomsbury. £17 1s. 8d. June 24th.

Langham Radio, Ltd., R/O, 14, Windsor Street, London, N.1, wireless manufacturers. Court: Leeds. £11 18s. June 25th.

The Popular Wireless Stores, 55, Duke Street, Sheffield, wireless dealers. Court: Sheffield. £20 16s. 8d. June 27th.

Popular Wireless Stores, address as above. Court: Sheffield. £12 19s. 4d. June 17th.

Campbell & Addison, Ltd., R/O, 79a, Rochester Row, London, S.W.1, wireless instrument manufacturers. Court: Clerkenwell. £49 10s. 5d. June 11th.

Fulcharge Radio Battery Service, 130, Lorrimer Road, Walworth, London, S.E.17, wireless and motor accessory dealers. Court: Clerkenwell. £10 14s. 1d. June 12th.

Hooker, J., South Road, Haywards Heath, Sussex, wireless dealer. Court: Ashford. £18 7s. 6d. June 27th.

Kerry, R., 8, Post Office Parade, Parkstone Dorset, wireless dealer. Court: Bedford. £15 10s. June 28th.

Rubens, Maurice (otherwise Rubenstein, trading as the **Popular Wireless Co.**) 55, Duke Street, Sheffield, wireless dealers. Court: Bloomsbury. £10 18s. 10d. June 25th.

Apple B., 87, Tottenham Court Road, London, W.1, wireless dealer. Court: Lambeth. £15 15s. 5d. June 18th.

Radford, Charles Leslie, 19, Brockley Road, Chiswick, London, W., wireless dealer. Court: West London (Brompton). £13 19s. 4d. June 25th.

Weinbaum, P., 28, Sidney Square, Commercial Road, E.1, wireless dealer. Court: Whitechapel. £14 3s. 6d. June 27th.

Private Arrangement.

Peto Scott Co., Ltd., manufacturers and distributors of wireless apparatus and electrical goods, 77, City Road, London, E.C., 62, High Holborn, London, W.C., and at Liverpool and Manchester.

A meeting of creditors was held on July 16th at the Hall of Incorporated Accountants, Victoria Embankment, London, E.C., for the purpose of considering a scheme of arrangement. The scheme provided for the payment of preferential claims in full, while Mrs. Worthington and the British Radio Gramophone Co., Ltd., who were creditors for the aggregate amount of £14,718, would not participate in the proposed composition. They would allow the amounts due to them to remain unpaid and without interest until first debentures to be created had been paid off. In addition, Associated Distributors, Ltd., and the Bankers Commercial Security, Ltd., who were creditors for an aggregate amount of £15,500 in respect of current H.P. agreements financed by them on behalf of the company, would not take any steps to enforce payment of their claims against the company, nor participate in the proposed composition. The remaining unsecured creditors of the company were asked to accept a composition of 5s. in the £ in full discharge of their claims. Mrs. A. M. Worthington and Associated Distributors, Ltd., were each to advance to the company £2,000 on the security of first debentures, carrying interest at the rate of 7½ per cent. per annum.

The Chairman of the meeting explained that 88 proxies had been received in favour of the scheme, amounting to £4,155 3s. 11d., and there was one against for £16 18s. Alternative schemes had been considered by the committee appointed by the creditors. They were very strongly in favour of the scheme before the meeting. Considerable discussion took place, and several creditors present said that they did not favour the scheme in any way. They would prefer that the scheme should provide, as well as the 5s. in the £, a further amount by way of debentures to be redeemed at a later date. Voting then took place upon the scheme, and the Chairman said that those in favour of the proposed scheme amounted to £9,456, and those against £4,284. He declared the resolution for the scheme carried.

Voluntary Liquidation.

United Gramophone Fittings Co., Ltd., Great Eastern Street, London, E.C., radio and gramophone dealers, etc.

The statutory meeting of the creditors of the above was held on July 17th at the Cannon Street Hotel, London, E.C. The chair was occupied by one of the directors of the company, who reported that the shareholders had previously met, and had appointed Mr. E. Pidduck of 60, Queen Victoria Street, E.C., to act as liquidator.

The statement of affairs showed ranking liabilities of £1,239 4s. 4d., all due to unsecured creditors. After allowing £65 17s. for preferential claims, the net assets were £570 10s. 4d., or a deficiency so far as the creditors were concerned of £668 14s. It was reported that the

company was only formed in March of the present year. The issued capital was £1,000 of which £500 was allotted as a consideration payable to the vendor. The company acquired certain assets including stock valued at £535, and agreed to discharge the existing liabilities. Shares for £500 were also issued for cash and £250 was owing, and would be paid to the liquidator. It was believed that an offer would be made to the liquidator for the assets. A creditor enquired what business the company had transacted, and the chairman said creditors knew that the trade had been going through a bad time.

In answer to questions regarding the sales of the business it was stated that figures were prepared covering the period from January to May of the present year, and they showed sales of £1,188, with a gross profit of £74, while the expenses were £408. After a short discussion, it was decided to confirm the voluntary liquidation of the company with Mr. Pidduck as liquidator, while a committee of three of the principal creditors was also appointed.

The following are some of the creditors:

Berlyn, M. H. & Co.	£156
Emmett, George (Pawsons), Ltd.	127
Collaro, Ltd.	104
Gatesboro Gramophones, Ltd.	76
Cowey Engineering Co.	72
Universal Gramophone & Radio Co.	42
Dominion Gramophone Records, Ltd.	33
Amplifiers, Ltd.	27
Waviola, Ltd.	14
Taylor's (Huddersfield), Ltd.	14
Radio Gramophone Development Co.	10
Perfecta Radio, Ltd.	10

Bankruptcies.

Joseph Abraham Britton, 362, Edgware Road, London, W., trading as **The Boleyn Gramophone Co.**, 31, Barking Road, London, E.6., wireless and gramophone dealer.

The statutory first meeting of creditors under a receiving order recently made against the estate of this debtor was held on July 15th at Bankruptcy Buildings, Carey Street, London, W.C. It appears from the debtor's statements that from 1927 until April, 1929, he was employed as general manager to a radio firm. On the death of his father in November, 1928, he arranged with the bank for an advance of £350, with which he bought the lease of 31, Barking Road. He expended a considerable sum in fitting up the premises, which he opened at Easter, 1929, as the Boleyn Gramophone Co. That business never proved a success. Some three years ago he began business from his private address, 362, Edgware Road, as a wholesale radio merchant.

He eventually decided to file his petition owing to pressure by creditors. He attributes his failure to bad trade and lack of capital. A statement of the debtor's affairs showed liabilities of £2,410, of which £584 are expected to rank for dividend, and estimated net assets £105. The meeting passed a resolution for the appointment of Mr. S. G. Crimes (Thompson, Kingdon, Marbeck & Co.) as trustee.

Richard Perkins, 103, Markhouse Road, Walthamstow, London, E., gramophone dealer, etc.

In this bankruptcy the Official Receiver has now issued to the creditors a summary of the debtor's statement of affairs.

This shows liabilities of £685, of which £600 are unsecured, and net assets of £21. In his accompanying observations the Official Receiver reports that the bankrupt states that in July, 1914, with approximately £100 cash capital and a little stock, he started business on his own account, under his own name, as a gramophone dealer from 103, Markhouse Road, Walthamstow, London, E. When he was in the army his wife managed the business. Afterwards he carried on with success until 1922, when, in consequence of trade depression, he left the business in charge of his wife, and obtained employment in the ironmongery trade until 1926, when he returned again to his business. In March, 1930, creditors started pressing, and acting on advice he called his creditors together, but the offer submitted was not accepted. A creditor filed the petition upon which the Receiving Order has been founded.

Selwyn Kershaw, Broad Lane, West Derby, and **Harold Ormian**, 4, Daulby Street, lately trading as **S. Kershaw & Co.**, Broad Lane, West Derby, and 4, Daulby Street, all Liverpool, radio engineers, etc.

The public examination of these debtors was held on July 15th at the Court House, Government Buildings, Victoria Street, Liverpool. A joint statement of affairs presented showed unsecured liabilities of £147 18s. 4d., and there were no assets. In reply to questions, the debtor S. Kershaw stated that he had formerly been employed as an electrical engineer. In January, 1929, the debtor H. Ormian commenced business at Broad Lane, West Derby. The stock consisted of electrical goods worth £75, provided by him, and £45 borrowed by his partner from a money-lender. That amount had since been repaid. In December, 1929, they rented additional premises at 4, Daulby Street, which they stocked with goods obtained on credit, and carried on business at both places. Their small amount of capital was not sufficient, this being the reason for their obtaining goods on credit. The debtors soon found that owing to competition they did very little trade. They became aware of their position in September, 1929, and were only able to carry on after by borrowing from two money-lenders and from a relative. In February last they executed a deed of assignment, at which time their unsecured liabilities were put down at £444 16s. 6d. and their assets amounted to £240. All the creditors, with the exception of five scheduled in the present statement, had assented to the deed, which was duly registered. The debtor Kershaw stated that the deed of assignment had not been disturbed by the present proceedings, and as the trustee under the deed held the assets for the benefit of the assenting creditors, there was nothing left for those creditors who did not consent to it. He added that he had no separate assets or liabilities apart from those of the firm. He attributed their failure to insufficient capital, overbuying stock, and to competition. The debtor Ormian confirmed his partner's evidence, and said that he had nothing to add except that the branch business at Daulby Street was responsible to a great extent for their failure. He admitted that he had no experience of

May Export Figures.

A Big Increase over April.

£124,215.

IN spite of the continued depression of British trade generally, it is encouraging to note that the latest total returns for radio exports indicate an increase of £22,690 over the figures for the previous month.

British goods have been exported in larger quantities to a number of European countries. Empire trade remains steady, but the Australian market shows the most serious fall, due, of course, to the heavy tariff recently imposed.

EXPORTS.		Country.	Apparatus.	Valves.
Country	Apparatus Value		Value	Value
Foreign Countries—	£		£	£
(Russia) Soviet Union	75	Nigeria	58	17
Finland	1,084	Union of S. Africa	4,599	1,752
Sweden	1,525	Northern Rhodesia	802	6
Norway	861	Tanganyika Territory	59	12
Iceland	7,239	Kenya	71	319
Denmark (inclgd. Faroe Is.)	438	Mauritius & Dependencies	38	—
Poland (inclgd. Dantzig)	292	Bombay via Karachi	3,001	179
Germany	220	Bombay via Other Ports	682	154
Netherlands	9,547	Madras	43	2
Sumatra	12	Bengal, Assam, Bihar Orissa	872	194
Java	247	Burmah	110	3
Other Dutch Possessions	3	Straits Settlements	619	59
Dutch W. India Islands	40	Malay States	277	28
Belgium	3,319	Ceylon and Dependencies	220	111
Belgian Congo	36	Sarawak	8	—
France	2,613	Hong Kong	332	105
Tunis	36	Australia	3,056	8,271
French W. India Islands	—	New Zealand	1,357	434
Switzerland	518	Nauru & Western Samoa	12	—
Portugal	391	Fiji Islands	10	—
Azores	15	Canada	248	421
Madeira	20	Newfoundland & Labrador	48	3
Portuguese West Africa	10	Bermudas	493	8
Portuguese East Africa	10	Bahamas	112	127
Spain	366	Jamaica & Dependencies	—	2
Canary Islands	14	Other Islands	89	10
Spanish North African	—	British Guiana	29	—
Ports	31	Falkland Islands	43	8
Italy	5,955			
Austria	276			£61,022 £27,595
Hungary	63			
Czecho-Slovakia	260			
Yugoslavia	17			
Greece	259			
Albania	19			
Bulgaria	75			
Roumania	171			
Turkey, European	91			
Egypt	411			
Iraq	55			
Persia	36			
Siam	578			
China	90			
Japan	137			
United States of America	117			
Panama	23			
Venezuela	—			
Peru	169			
Chile	70			
Brazil	994			
Uruguay	—			
Bolivia	55			
Argentine Republic	740			
British Possessions—				
Irish Free State	1,954			
Channel Islands	1,175			
Gibraltar	145			
Malta and Gozo	516			
Cyprus	30			
Palestine	116			
Sierra Leone	50			
Gold Coast	71			

RE-EXPORTS.		Country.	Apparatus.	Valves.
	Value		Value	Value
Foreign Countries—	£		£	£
Sweden	2		2	—
Norway	1,215		1,215	90
Germany	592		592	—
Netherlands	29,352		29,352	83
Belgium	1,809		1,809	—
France	584		584	2
Switzerland	386		386	—
Italy	315		315	—
Persia	12		12	—
Siam	7		7	2
Japan	58		58	—
U.S.A.	—		—	37
Honduras (not British)	72		72	—
Chile	92		92	4
British Possessions—				
Channel Isles	68		68	2
Malta and Gozo	—		—	3
Palestine	27		27	—
Union of South Africa	4		4	214
Tanganyika	1		1	—
Bengal	—		—	3
Australia	19		19	—
New Zealand	288		288	1
Canada	70		70	—
Irish Free State	182		182	2
Total..	£35,155		£35,155	£443

the business when he joined his partner, and that the working of it was left to Kershaw. He also had no separate estate. The examination was closed.

Charles Kendrick, 52, George Street, and 94, Bright Street, both Kingston-upon-Hull, wireless goods dealer, etc.

Among the creditors in this failure, which was reported in these columns in our issue for July 12th, are the following:—

Chorton Metal Co., Manchester	£	10
Cosser, A. C., Ltd., London	..	19
Fonteyn & Co., Ltd., London	..	30
General Electric Co., Ltd., Newcastle	..	44
Gilbert, C., & Co., Hull	..	147
Kremner, S., Manchester	..	88
Mullard Wireless Service Co., London	..	28
Radio Clearance Co., Manchester	..	143
Richardson & Co., Ltd., Sheffield	..	20
Tolsen Electric Co., Ltd., Birmingham	..	10
Webster, S., & Co., Hull	..	55
Arthurs, London	..	19
Gledhill, G. H., & Sons, Ltd., Halifax	..	11
Pettriv, Ltd., London	..	37
Parker Phone Co., Ltd., Bradford	..	10

Business Names Registered.

Particulars are given below of wireless and allied businesses recently registered at Somerset House under the Business Names Act of 1916. The name appearing in bold type is the trading name, while in brackets are given the name of the proprietor (or proprietors) and the date of the registration.

J. Sear, 41, Settles Street, Commercial Road, E.1, wireless and gramophone dealer. (Joseph Sirotkin, address as above. March 24th, 1930.)

The British Battery Supply Co., Mitre Chambers, Mitre Street, London, E.C.2, wireless dealers. (Arthur F. Masterman, 125, Parkanour Avenue, Thorpe Bay, Essex, and George J. B. Millest, "Capri," Church Road, Harold Wood, Essex. March 24th, 1930.)

The Westerham Wireless Stores, High Street, Westerham, Kent, wireless dealer. (Hilda Hindley, 75, Coniston Road, Addiscombe, Surrey. March 12th, 1930.)

Progress Radio Exclusives, 37, Borough High Street, London, S.E., wireless dealer. (Alexander Greenberg, 68, Boundary Road, St. John's Wood, N.W. March 21st, 1930.)

Tower Hamlets Radio Service, 55A, Tower Hamlets Road, London, E.17, wireless dealer. (John J. Simons, 92, Mount View Road, London, N.4. March 20th, 1930.)

Willoughby Bros., Couching Street, Watlington, Oxford, electrical and wireless engineers. (Francis Willoughby, "Brooklyn," Brook Street, Watlington, Oxford, and David Willoughby, Couching Street, Watlington, Oxford. March 5th, 1930.)

The Electroset Radio Co., Workshops, Turners End House, Rowington, Warwickshire, wireless receiver manufacturers. (Geoffrey Alderson, "West Mount," Manor Road, Dorridge, Birmingham, and Alban W. Smith, Turners End House, Rowington. March 5th, 1930.)

Brook Walker & Co., 360, Stratford Road, Sparkbrook, Birmingham, wireless manufacturers and retailers. (Frank C. Brook, 6, Hollybrook Road, Hall Green, Birmingham, and Alfred G. Walker, 12, Vincent Parade, Balsall Heath, Birmingham.)

A South London Change.

We are informed that Mr. W. Neal has moved from 127, Dulwich Road, to larger and more conveniently situated premises at 57, Norwood Road, Herne Hill, London, S.E.24.

A "Fotos" Holiday.

The premises of Concerton Radio will be closed for the annual vacation during the whole of Bank Holiday week.

Live Ideas in Falkirk.

We give on this page an illustration of the recently extended premises of Hart Radio Supplies, who run a progressive radio and gramophone business at East High Street, Falkirk. The firm actually own the site, which is one of the most important in the town, and they tell us that they have refused many offers for it. Plans for further extensions are already in hand.

The appearance of the shop front of Hart Radio Supplies affords an example of that bright attractiveness which should characterise every radio dealer's premises. Valuable publicity is obtained by having a clock, registering B.B.C. time, above the shop front; passers-by instinctively remember the name "Hart Radio Supplies." It is estimated that 15,000 people look at the clock every day. The idea of having one installed was promoted as the result of a study of our "Selling Side" feature. The firm write: "It struck us as one of the best 'Selling Side' ideas, and we acted very promptly. The clock is a very good one; and although it cost roughly £20, it is the best advertisement we every had."

Hart Radio Supplies commenced trading some eight years ago, but are "still going strong." They have no special summer line, but term the period from June to August "reorganisation time," when they prepare for the rush of winter business.

Among the radio products carried are those of Kolster-Brandes, to which the firm largely attribute their success, though they tell us that Marconiphone lines also sell well. An important feature of their activities is the maintenance of a well-organised battery charging service, which, we are told, pays very well.

BUSINESS ITEMS.

New Cleethorpes Shop.

Mr. N. Woodhouse it is learned has opened an electrical and radio business at 99, Cambridge Street, Cleethorpes, Lincolnshire. He was formerly manager of the Lincolnshire Electrical Co., Ltd., of Cleethorpes.

Celluloid Printers, Ltd.

We learn that the offices and works of the above firm at 204, South Park Road, Wimbledon, S.W.19, are to be closed from August 2nd-11th.

New Number.

The phone number of the British Radiostat Corporation, Ltd., has been changed to Mayfair 4438-4439.

A Change in Crewe.

We learn that the whole of the stock, assets and liabilities (with certain exceptions), of Henry Parker & Co.'s branch at Radio Corner, Edleston Road, Crewe, have been taken over by the firm's former manager, Mr. John V. Taylor.

Mr. Taylor has devoted all his energies to the business since its opening, and customers will be assured of its continued good service under his able control. The company from whom he takes over pay tribute to his excellent abilities.

"Wiretron" in the South.

We have been asked to announce that the Southern distributors of "Wiretron" aerial wire are the Electric Lamp Service Co., of 39, Parker Street, Kingsway, London, W.C.2.

New Radio Wholesalers.

Ward & Co., of Axtell House, Warwick Street, London, W.1, who are already well known as wholesalers, are anxious to enter the wireless trade, and they intend to deal especially in high-class radio sets and the latest lines.

At the moment they are chiefly interested in all-mains sets, and would be glad to receive manufacturers' latest lists and terms for these products, in addition to any other good quality lines.

Manufacturers who propose to develop their European export trade will be interested to know that Ward & Co., have branches in Paris, Berlin, Vienna and Florence.



Some idea of the tasteful window displays carried out by Hart Radio Supplies, of Falkirk, can be obtained from this photograph of the firm's shop. See note above.

MAKING WIRELESS SIMPLE



THE NEW MURPHY RADIO PORTABLE.

A real selling point

4 - VALVE SCREENED GRID RECEIVER

SINGLE TUNING CONTROL—COMPLETELY GANGED CIRCUITS CALIBRATED IN WAVELENGTHS.
 Fitted in Walnut Cabinet; Weight 32 lbs.
 B.R.V.M.A. valves.
 No aerial or earth required.
 2-Volt 23 A.H. unspillable Accumulator mounted on acid-proof rack.
 108-Volt H.T. Battery 12 m/a rating.
 Average H.T. Consumption 8-9 m a Gramophone Jack.
 External Loud-speaker Jack.
 External Aerial and Earth Sockets.
 Excellent loud-speaker reproduction, giving very enjoyable music and particularly clear speech.
 Range and Selectivity, equal to, if not better than, any other portable set on the market.

PRICE **17** GUINEAS

including valves, batteries, turntable and Royalties

THE Murphy Radio receivers are the only Portable sets with *single tuning control ganged circuits calibrated in actual wavelengths.*

This point alone gives you a wonderful selling argument for these sets. But when this is combined with all the other points in favour of the Murphy Radio Set it is very easy to convince your customers that there is no other set as good or as reasonable in price.

Send the coupon for particulars and a demonstration.

MURPHY RADIO LTD

WELWYN GARDEN CITY, HERTS

Frank Murphy

B.Sc., A.M.I.E.E.,
A.I. Rad. E.,
Chartered Elect. Engineer.

COUPON

Murphy Radio, Ltd., Welwyn Garden City, Herts
MURPHY RADIO PORTABLE
 Please send Particulars and Trade Terms
 Please send a Representative

NAME
ADDRESS

Cross out line which does not apply. W.T. July 26

A Quick Seller!

A Good Profit-Maker!

The Lotus 3 valve Set Kit

Easy to assemble, quick to build, the Lotus 3 valve S.G.P. Battery Kit is ideal for the amateur set-builder. The famous Lotus Components are used throughout—the main parts being already mounted in position, thus saving time and ensuring success.

Easy-to-follow diagrams supplied with each Kit eliminate the possibility of mistakes. Your customers appreciate the name of Lotus—a guarantee of success and reliability.

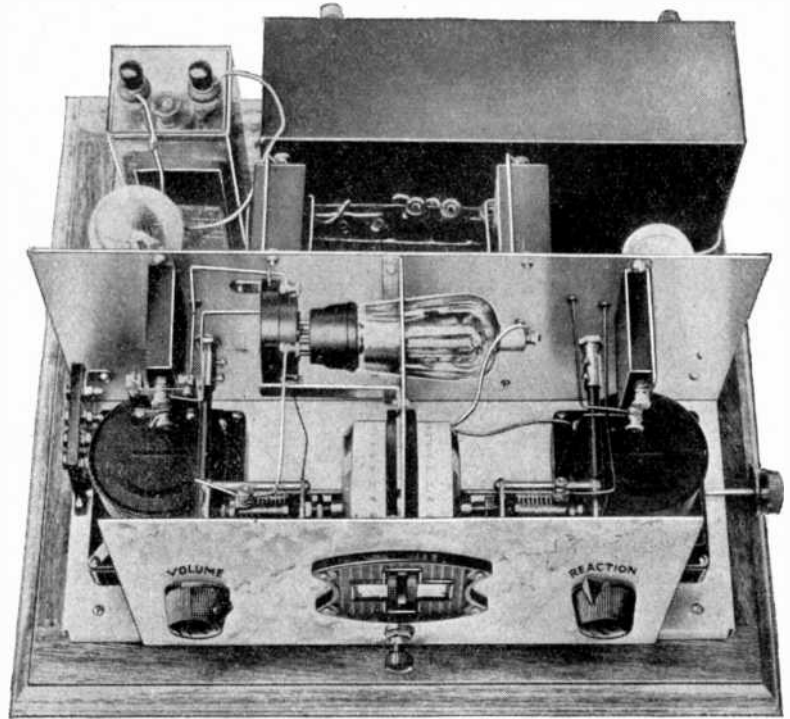

Take advantage of the generous Lotus Hire Purchase Terms, which give you a wide margin of profit.

Retail Price £7 12s. 6d. (excluding valves, cabinet and batteries), or 14s. 9d. down and 11 similar monthly instalments.

Full details and trade terms on request

LOTUS 3 VALVE SET KIT

GARNETT, WHITELEY & CO., LTD., Lotus Works, Mill Lane, Liverpool

London Depot: 183 Old Street, E.C.2
Telephone: Clerkenwell 2580

AMPLION



each in
its class,
the **best**



It has always been the Policy of Graham Amplion to produce the very best that modern science, coupled with their many years of experience, could design.

No matter whether it has been a Loud Speaker or a Receiver, the Policy has been strictly adhered to.

Every model is subjected to the most exacting tests both during and after manufacture—and on this knowledge has been built up the enormous confidence in the name of AMPLION, which is held to-day both by the Trade and the Listening Public alike. It is needless to add that this Policy will remain unaltered.

POLICY... ..

THE PORTABLE WITH THE BEST PERFORMANCE

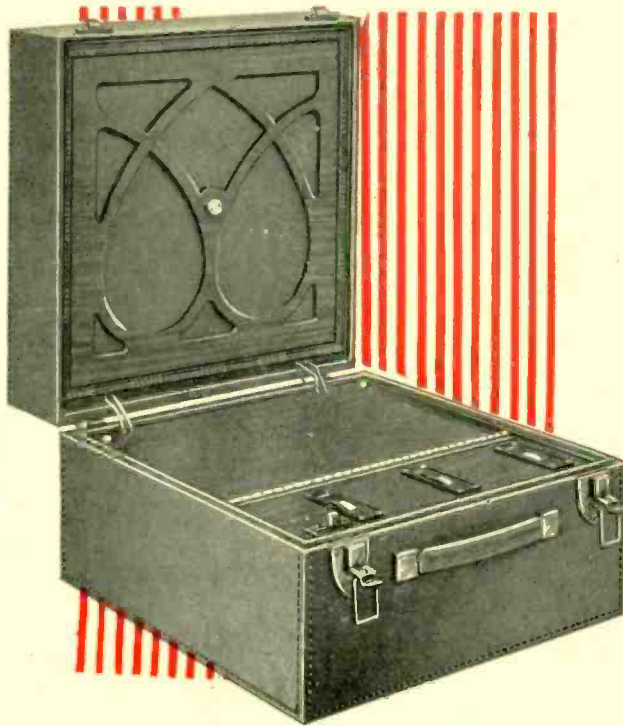

Here is proof from independent sources:—

"Sensitivity on long waves is exceptionally high . . . the tuning dials remained closely in step over the whole of the scale, a point which greatly simplifies tuning . . . thoroughness of screening," says the "Wireless World."

"The bass is very well in evidence, while the high notes are crisp . . . the output obtainable is also above the average, particularly in view of the relatively low H.T. consumption," says the "Wireless Trader."

"Tremendous reaching out power . . . extremely selective . . . very efficient screening . . . reproduction is of the very purest . . . bass notes round and full, the upper register clean and sharp," says "The Manchester Evening Chronicle."

£ 24 · 15 · 0

AMPLION

TWO SCREEN-GRID

PORTABLE

THE BEST ALL MAINS CABINET SET

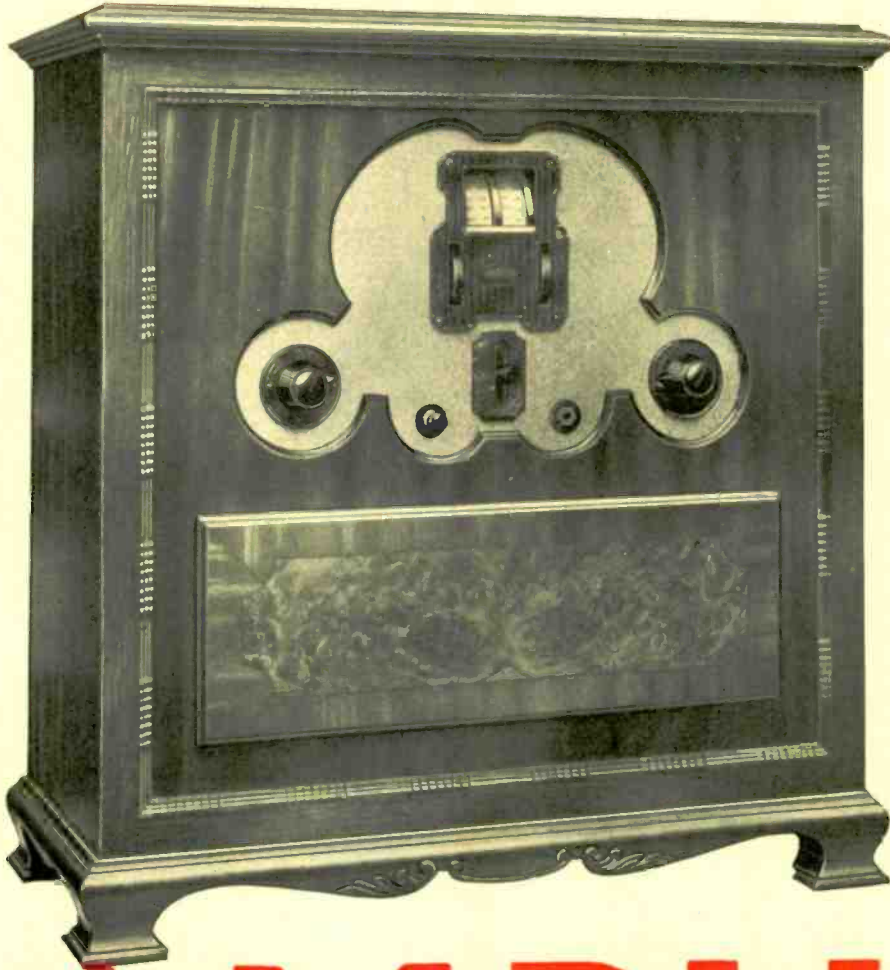

Although AMPLION Radio Sets are a more recent institution than AMPLION Speakers, yet in the short time since they were first introduced, they have come to be accepted, by reason of their all round excellence, as being definitely the best that exist.

For a Receiver to be at the same time both selective and capable of really wonderful reproduction is unusual, but in the AMPLION all-mains set this has been achieved most decidedly.

It is now supplied in a very handsome cabinet, the appearance of which can truthfully be said to do justice to the amazing performance of the receiver which it contains.

£55.0.0

AMPLION A . C . M A I N S CABINET SET

THE **BEST** BALANCED ARMATURE CABINET SPEAKERS

AB 41.M.

Here again Amplion have proved that their vast experience has enabled them to produce a range of speakers of the balanced armature type, which have the uncommon property of being able to be matched to the output of whatever set they are working with.

Alternative sets of terminals make this possible, and the speakers are housed in most attractive cabinets of several sizes.

The A.B.6 type can be supplied in cabinets with a finish of Oak, Mahogany or Walnut . . . The A.B.41 and A.B.45 Type with the Special unit are supplied in the well-known "Lion" type Cabinets in Oak and Mahogany.

Both types of unit are capable of giving very excellent reproduction and are worthy products of the name AMPLION, and are indeed the BEST of their class.

PRICES:

A.B.41.	Oak	- -	£5 : 15 : 0
A.B.41.	Mahogany	- -	£6 : 6 : 0
A.B.45.	Oak	- -	£6 : 15 : 0
A.B.45.	Mahogany	- -	£7 : 7 : 0
A.B.6.	Oak	- -	£4 : 10 : 0
A.B.6.	Mahogany	- -	£4 : 17 : 6
A.B.6.	Walnut	- -	£4 : 17 : 6

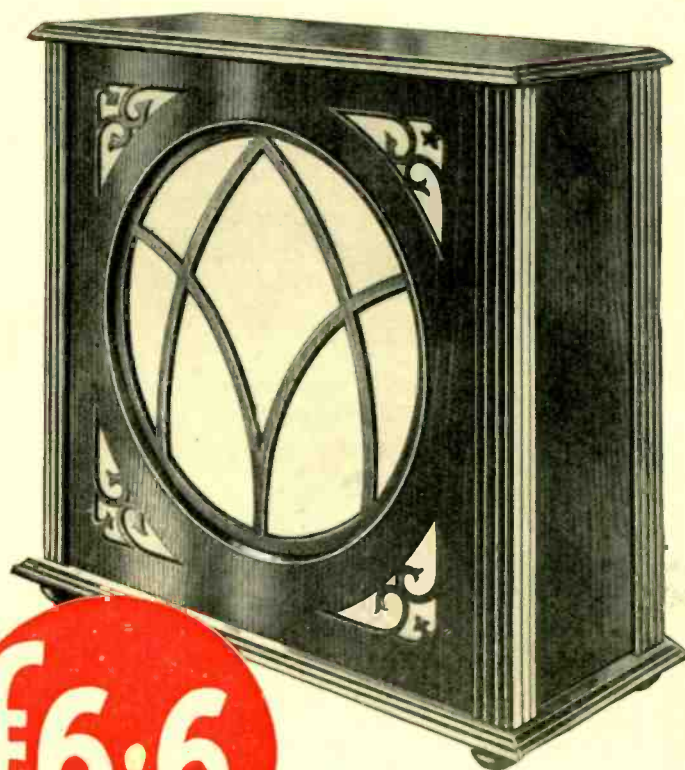

£6.6

AMPLION

has been done quite well with the Marconiphone portable during the summer, is making a feature of the Marconiphone 5-valve all-mains receiver, with moving-coil speaker, gramophone pick-up, and H.M.V. gramophone complete at £57 10s. The Philips 4-valve all-mains (one of the sets which, it is alleged, has got into outside hands) is also being installed in many licensed houses.

A rather curious situation has arisen in regard to an order which was placed for a Columbia radio-gramophone. It was given to a local radio engineer, who is an authorised Columbia dealer and holds a stock of their radio goods. He has now been informed, however, by the Columbia Graphophone Co. that the radio-gramophones are only issued for re-sale to authorised Columbia dealers officially appointed on their undertaking to order

and maintain throughout the year a representative range of Columbia models together with an agreed quantity of their records. "It is a further condition," the letter adds, "that such dealers have retail shop premises devoted partly or wholly to the sale of music and/or musical accessories. We are extensively represented in Portsmouth, and this may preclude any further authorised dealerships being granted, but if you are interested in a proposition such as we outline, and if your premises conform with our proviso, we shall be pleased upon hearing from you to take the matter a step further."

The suggestion that the radio-gramophone should be confined to music firms raises an issue of considerable interest to the wireless trade generally, in view of the fact that the instrument is

probably 75 per cent. wireless, and that the persons best qualified to service such sets are certainly radio engineers. Few wireless dealers would be prepared to carry a music stock as wireless goods.

During the visit of the Philips van to Portsmouth, a very fine trailer was arranged by Messrs. Chappell & Churchill, of Russell Street, Southsea, and Lake Road, Landport. The van stayed at Portsmouth three days, and it was followed round the city by Messrs. Chappell & Churchill's car, upon which was staged an admirable window display. It was designed, in fact, to give the public the impression, after their attention had been first drawn by the van, of looking into a travelling shop window, with fascia board over the top, and the line "For Philips Sales and Service" at the bottom.

IN THE COURTS.

Pye Granted Injunction Against a Price-cutter.

IN the Chancery Division last week before Mr. Justice Farwell, Pye Radio, Ltd., of Radio Works, Cambridge, asked for an injunction against the London Radio Co. (Leeds), Ltd., of Queen's Gate, Leeds, restraining them from infringing plaintiffs' letters patent and selling Pye receiving sets below the listed price of £19 19s. each.

Mr. Upjohn, Jun., for the plaintiffs, said it had come to the notice of the plaintiffs that the defendants had been selling these sets in Leeds and elsewhere for seventeen and eighteen guineas. Defendants had been communicated with, but as plaintiffs received no satisfactory answer, the action was commenced. Now, however, the defendants had agreed to treat the motion as the trial of the action, submit to a perpetual injunction and pay the taxed costs, the plaintiffs waiving all claims to damages.

Mr. Tatham, who appeared for the defendants, said he agreed to this course.

His lordship said there would be a consent judgment in the agreed terms.

[NOTE.—In this case we are informed by Pye Radio, Ltd., that the firm in question were proceeded against because they were selling a product involving certain patents—and, therefore, subject to limited licence regulations—at less than the manufacturer's list price.—EDITOR.]

WINDING-UP PETITION ADJOURNED.

APETITION to wind up Symphony Gramophone & Radio (Foreign), Ltd., presented by Darmstadter und Nationalbank Kommanditgesellschaft auf Aktien, of Berlin, came before Mr. Justice Bennett in the Chancery Division this week.

Mr. Buckmaster said the petition had been standing over on the footing that a scheme was to be put forward. It was now proposed that the company should go into voluntary liquidation to enable it to realise its assets on the footing that it was solvent. He asked the judge to let the petition stand over until the first petition day next sittings.

Mr. Braund said he appeared for creditors and supported the adjournment.

His lordship adjourned the petition until the first day next sittings.

DOMINION GRAMOPHONE RECORDS, LTD., IN DISPUTE.

IN the Chancery Division on Tuesday, Mr. Justice Farwell had before him a motion for judgment in the debenture holders' action, Godfrey Phillips, Ltd., v. the Dominion Gramophone Records, Ltd.

Mr. Arthur Sims, who appeared for the plaintiffs, said there was appearance by the defendants and a defence had been put in. He, however, asked for judgment for the amount claimed. The real issue was whether the company was insolvent when the

debentures were issued to Messrs. Godfrey Phillips & Co.

Mr. Justice Farwell said the defendant company did not admit that the plaintiffs had first charge on the debentures. He could not hear a motion for judgment in view of that.

Mr. Radcliffe, for the defendant company, suggested that there should be an inquiry as to whether the company at the date when the debentures were issued was insolvent.

Mr. Sims replied that he did not object to any inquiry. He was only anxious that the real facts should come out.

Mr. Justice Farwell said he thought an inquiry was desirable and made an order accordingly.

CABINET-MAKERS SUED.

LAST week, at Shoreditch County Court, Robert Howe, trading as John Wilkinson, sawmill engineer, of Durrant Street, Bethnal Green, London, E., sued the Tudor Wireless Cabinet Manufacturing Co., of Tower Hamlets Road, Walthamstow, E., to recover £56 8s., being eight months' instalments at £7 1s. under a hire-purchase agreement to buy a motor starter and dust plant.

The defence, as filed, was that the agreement had been to pay by instalments only, as goods to the value of £400 were purchased under a contract, but the work had not been satisfactory. It was further alleged that when the agreement was signed it was not known that it was a hire-purchase agreement, and it was signed by threats.

Mr. Fletcher, for the defence, said he was contending that it was a sale outright under a contract, payable by instalments, and had nothing to do with hire-purchase at all. Mr. Pensotti, for the plaintiff, replied by saying that he was claiming under a hire-purchase agreement, which he produced.

The plaintiff's case was then presented. It appeared that in 1929 the defendants had a fire, and a lot of machinery was destroyed. It was arranged that for £400 the plaintiff should put in new machinery at their premises, and there were also £29 7s. extras. The defendants paid £350, and the balance of £79 7s. was not pressed for until July 10th, but defendants could not pay. On July 18th it was suggested that a hire-purchase agreement for the whole sum of £428 should be made out, taking the £350 as a deposit, but defendants failed to agree to this.

Mr. John Symons, son of the proprietor of the defendants, said their case was that they had purchased outright under a contract for the work done for £400, and that, therefore, the machinery belonged to them.

The defendant, John Symons, then gave evidence, and said he only signed to pay instalments for the £50 that he owed, and he only did that because the plaintiff told him that if he did not sign it they would clear the whole lot out. He could not read, and it was not until afterwards that he discovered that he had signed a hire-purchase agreement.

In giving judgment, his Honour said he could not believe the story told by the defendants, and there was positively no evidence of threats to get the agreement signed. There would be judgment for the plaintiff for the amount claimed and costs.

Leading Manufacturers Announce Their

NEW LINES

The "Empire Melody Maker."

Cossor Again Go After the Kit Trade.

FOLLOWING our exclusive preliminary announcement last week regarding the latest guise of the Cossor "Melody Maker" receiver, we are now able to go a step further and give some more definite information about the set in its new and improved form.

The basic design of the set—in so far as it makes use of a Screened grid 3-valve circuit with individual aerial and H.F. tuning controls—remains as it was originally introduced, but there are many very desirable detail improvements and a real big increase in the value for money offered to prospective buyers.



A glance at the illustration herewith will give a general idea of the appearance of the "Empire Melody Maker." It resembles the earlier model which had a brown crystalline metal case rather than last year's set with its blue finish and central escutcheon plate. The most apparent alteration is the cabinet, which is now a neat and simple design carried out in wood, the metal panel remaining.

The original moulded friction-drive tuning dials have been superseded by high class slow motion condensers, and, furthermore, the receiver incorporates dual wave coils which enable both medium and long wave stations to be received without all the trouble

of changing the coils themselves.

The most important change, and one of which A. C. Cossor are justifiably proud, lies in the direction of the price. This has now been reduced from last year's figure of £8 15s. to £6 17s. 6d., inclusive of cabinet and valves, and at this new price level the instrument should command a much wider sales field.

It is anticipated that the first samples of the "Empire Melody Maker" will begin to make their way round the trade very shortly, and in the near future they will become available in larger quantities, with a view to obviating trouble in connection with deliveries.

The New "Truvox" Programme.

The Universal Gramophone and Radio Co., Ltd., of Ryland Road, Kentish Town, London, N.W.5, announce that several interesting "Truvox" features will be included in their new season's programme.

In the first place, there is a "fool-proof" electric gramophone, listed at £30. This is an all-mains machine, and will be available for either A.C. or D.C. operation. The unique point about it is that it is switched on and off by the action of the pick-up arm.

The "Baby-Grand" radio-gramophone, which was marketed last season, will be

replaced by the "Junior Grand"—an all-electric model priced at £50. This model will also be available in battery-driven form at £38.

The range of "Truvox" radio-gramophones will vary a little in price, but the "De Luxe" and "Concert Grand" models, although greatly improved, will be listed as before. The "Bijou" model, introduced late last year, has also been improved and brought up to date, and will be offered in several types, ranging in prices from £22 to £30.

Finally, speakers, including exponential horn types, will be marketed at prices 25 per cent. less than last year.

Westinghouse Cater for Manufacturers.

Manufacturers of all-mains receivers and of mains units should note that the Westinghouse Brake & Saxby Signal Co., Ltd., of 82, York Road, London, N.1, are now producing a type of metal rectifier especially for their use. At the time of writing, four models, known as Style C, have been made available, and the general appearance of them can be gathered from our illustration on this page. Brief specifications will not be out of place, especially since firms will then be able to decide exactly upon the type of rectifier required.

First will be mentioned the C9 rectifier. This is 3 ins. in length, and with an applied A.C. voltage of 165, for half-wave rectification, or 85 V in a voltage doubling circuit, will give 120 V at 20 mA.

Style C11, which is 3½ ins. in length, will take 200 V half-wave, or 105 V voltage doubler, and will deliver 150 V at 125 mA.

What is, perhaps, the mains voltage most used at the moment, namely 240, is covered by the C13 rectifier, which is about 4 ins. long, and can also be used on 120 V voltage doubling circuits. Its output is 175 V at 25 mA.

Finally, we come to the Style 15 metal rectifier, which is designed to handle higher voltages than any of the three other types under review. Measuring approximately 4½ ins., it will rectify 285 V half-wave or 145 V full wave, and will give an output of 200 V 28 mA.

Each of these style C rectifiers has a red washer at the positive end and a black one at the negative end.

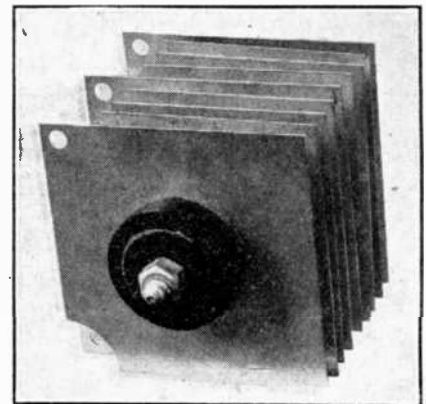

A three-quarter view of the new Westinghouse rectifier for manufacturers.

News
while
it IS
News !

FOR 1930-31.

Amplion 2-Valve Mains Set.

We are able to announce that an important addition to the present range of Amplion products may be expected in the near future in the shape of a compact 2-valve all-mains receiver.

Simplicity and compactness will be the chief features of the new model, which will be built into a cabinet measuring approximately 7½ ins. high, by 17 ins. wide by 11 ins. deep, the standard finish being walnut. These dimensions have been chosen so that it will be possible to stand a walnut Amplion AB.6 cone speaker on the top of the set.

Unobtrusive controls will be provided in the form of a small central escutcheon plate with tuning and reaction adjustments, and a pair of switches—one operating the wavelength change-over and the other being the main on-off switch. A straightforward detector and pentode circuit is employed, and a neat external appearance is ensured by taking all the connections out at the rear.

The actual valves employed will be of the Mullard PM 354 and PM 24 A types, and the eliminator portion of the set will incorporate a Westinghouse metal rectifier, large chokes, resistance stoppers, and condensers to prevent any possibility of hum. The primary of the input transformer will be tapped for 100-110, 200-230 and 230-250 V, and, in addition, two aerial tapplings will be provided. A pick-up socket will be another feature.

Deliveries of the new model may be expected to commence towards the end of August, and although the price has not yet been finally decided, we understand that it will be £15 15s. inclusive.

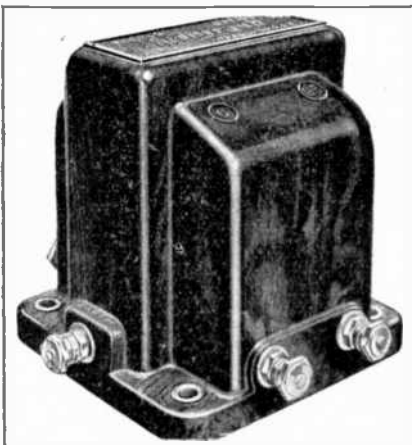

The redesigned Telsen "Radiogrand" transformer with its polished bakelite case and earthing terminal.

Telsen Extend their Activities.

Transformers Supplemented by Range of Components.

SOME time ago, in one of our "Round and About" features, we announced that the Telsen Electric Co., Ltd., intended in the near future to join the ranks of component manufacturers by introducing further lines in addition to their transformers. The latter have been marketed for several years now, and have become very widely known. Further particulars of the new components are now to hand, together with the news that the range of Telsen inter-valve transformers on the market has been redesigned, and the instruments are now presented in an entirely new and improved form.

Whereas, up to the present, Telsen transformers have been enclosed in metal shrouds, the re-designed types have genuine bakelite cases with a first-class finish. The design of the windings and core has been considerably improved, and each model is now fitted with a core earthing terminal as standard. The prices and ratios of the various models remain unaltered, the 7-1 ratio "Radiogrand" being priced at 17s. 6d., the 5-1 and 3-1 models at 12s. 6d., and the 5-1 and 3-1 "Ace" models at 8s. 6d.

The first of the new products is a fixed mica condenser, available in a series of capacities up to .001μF. These have moulded cases with provision for either horizontal or vertical mounting, and are supplied with patented grid leak clips which enable series or parallel connections to be made quite easily. The price for each of the range is 1s.

Secondly, Telsen have produced an H.F. choke retailing at the extremely low price of 2s. 6d. This also has a moulded case, and is designed to cover the whole wave range from 18 to 4,000 metres. The rated inductance is 150,000 μH and the D.C. resistance 400 Ω, while the choke

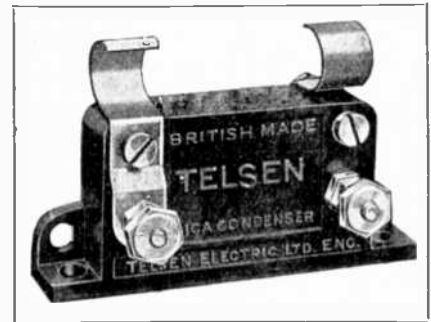

is claimed to have a very low self-capacity.

A valve-holder incorporating special metal spring contacts is the third new component to make its appearance. The contacts have been designed with the intention of providing the most efficient contact with valve pins of any type, at the same time allowing the valve to be inserted and removed without undue strain on the base. The holder is fitted with soldering tags and hexagonal terminal nuts, and retails at 1s.

Two New R.I. Eliminators.

In two or three weeks' time deliveries are expected to commence of two brand new mains units, produced by Radio Instruments, Ltd., of Purley Way, Croydon. These accessories, together with the new 4-valve "Madrigal" receiver, will form the chief R.I. selling lines for the coming season, and as such they will be strongly featured.

The eliminators—one for A.C. and the other for D.C.—are suitable for operating ordinary receivers employing an external aerial, and at the same time they will also fit into most portable instruments, the overall dimensions being approximately similar to those of an ordinary 100 V H.T. battery. Of especial interest are the moulded bakelite cases—in a mottled brown finish—which have

ventilation louvres and recesses to keep the terminals and voltage adjusting controls flush with the surface.

Both models will be provided with three tapplings—one variable 0-150 V for the detector; one fixed, 50-80 V for the screened grid; and a fixed tapping for the output valve, giving 150 V, 20-25 mA. The A.C. model makes use of the new and improved form of Westinghouse metal rectifier, and in addition, special precautions are stated to have been adopted to ensure the absolute elimination of mains hum.

The prices have only been fixed approximately at the moment, but we understand that the A.C. unit will not exceed £4 17s. 6d., while the D.C. model will be in the immediate neighbourhood of £2 15s.

CORRESPONDENCE

The Editor is pleased to receive communications on matters of interest to the Trade. Letters intended for insertion must be accompanied by the name and address of the writer as a guarantee of good faith. No responsibility is taken by the Editor for opinions expressed by correspondents.

The W.R.A. Meeting Controversy.

To the Editor.

SIR,—A copy of your letter addressed to the Secretaries of the W.R.A. with reference to the meeting recently held to discuss provincial organisation has been passed to me, as I attended the meeting as a representative of the Manchester branch.

I would most emphatically dissociate myself from the report which was apparently given by Mr. Carter to the Stockport branch. Moreover, I think it will be generally agreed that the report issued by the Secretaries to the press was an admirably concise and accurate record of the proceedings.

I personally moved the resolution which was unanimously passed by the meeting, and as it was debated for fully an hour, I fail to see how any ambiguity could possibly arise—unless it was intentional. The suggestion that the London members were antagonistic to the north is entirely false, and I found that the Chairman and all the officials were only too anxious to hear the provincial point of view; but, while appreciating constructive criticism, they did deprecate destructive criticism. Such a suggestion as that "the south intends to rule the north" is ridiculous, and only tends to create a factional spirit in the Association. It would, however, appear that certain members did wish to reverse this order, and, finding that the meeting would not allow domination by any branch, have childishly withdrawn their support, and have ceased to work for the common good.

In conclusion, I would say that it is very regrettable that such a controversy has arisen, and I would appeal to every member to support the W.R.A. loyally, for in unity only is there real strength.

MANCHESTER.

H. G. JENKINSON.

[NOTE.—This letter, of course, refers to the report of the last Stockport Association meeting published on another page this week, and accompanied by some comments from the Chairman and the Vice-Chairman of the W.R.A. on the points of divergence in Mr. H. Carter's remarks to his fellow Stockport members from the statements made on the same subjects in the officially supplied report which we published last week.

We may also say here that we have seen the actual written comments passed on the circumstances by all but one of the delegates at the London meeting. Without exception, they express the view that our published report was a "fair and accurate" record of what took place, and in most cases they express surprise that misunderstanding or misconception should have been possible on the part of anyone present.

A short Editorial comment is devoted to the subject on our first page this week.—EDITOR.]

Reduced Prices of "Ring" Valves.

To the Editor.

SIR,—Once again we are to have a reduction in the price of certain types of valves—the reduction to operate immediately on the receipt of the notification from the makers.

This in itself would not be such a hardship, but we are informed that rebates will be allowed on the past two months' purchases—two of the slackest months of the year, when the demand is very slow.

We ourselves have to maintain a stock of over 300 valves constantly, a considerable proportion of which cannot have been bought during the last two months, meaning a big loss to us.

What an encouragement to support British enterprise! What an antidote to unemployment! We can only assume that the B.R.V.M.A. have no interest in either problem.

NEWBURY, BERKS.

L. SQUIRE & Co.

To the Editor.

SIR,—Futile though it may be, we wish to protest with all the feeling which a hard cash loss engenders in a trader against the unfair way in which even dealers who are agreement-holders with the B.R.V.M.A. have to shoulder the greater part of another valve price reduction.

We know that a benevolent association (which so generously allows us, if we agree to stock only their valves, a whole 25 per cent. discount) also allows us a rebate on our purchases during the past two months, but what does this amount to at the quietest time of the year? Speaking for ourselves—this being the only way we can give facts and not generalities—we try to be representative of the better type of trader, who endeavours to meet all reasonable customers' demands from stock . . . and what a stock is required! A census taken on the day of the reduction revealed the fact that we had in store one hundred and fourteen distinct types of valves, all current types, and excluding rectifiers; all are types which we may be asked for any day; and we have to stock at least two of almost every type, and any number up to half a dozen of the more popular ones. This brings our total stock somewhere in the neighbourhood of four hundred valves without being overstocked for possible demands.

Now to come to the crux of the matter: what chance is there that we have bought even half of these valves during the last two months? Every trader knows, and so must the B.R.V.M.A., that we shall be lucky if half our stock qualifies for rebate, and the price reduction on the rest is dead loss to us. Surely if the valve manufacturers can afford to reduce prices (and who doubts that they can?) they can equally well afford to give a complete rebate, at least to those who support them by selling only "ring" valves. Are we bound to bow our heads to these losses which occur so regularly or is it possible for something to be done? There must be hundreds of traders who are suffering from the same unfair conditions as us.

"VALVULAR."

A New Idea About Programmes. (Continued from page 81.)

enjoyment from his radio, must select each day from the programme those particular items to which he wants to listen, and see to it that nothing in the way of counter-attraction is permitted to interfere with his enjoyment of them. The whole idea is typified in the heading illustration to this article.

Manufacturers, too, can valuably employ the same angle in their advertising to the public, and I see no real reason why the B.B.C. itself should not put out some propaganda with the same object. The argument does not cut across the trade's normal appeal to the public for radio as an "all-seasons, all-occasions entertainer," since even the thousands who are undoubtedly affected by this publicity cannot really interpret the word "all" in its literal and comprehensive sense.

There is much here that the trade can do both to counteract the ill-effect on existing listeners of the confirmed grumbler, and to help the new listener to retain his early enthusiasm for, and appreciation of, the radio movement.

Something to tell your Customers !



New Prices that mean Bigger

Sales!

Reductions in the retail prices of certain types of Marconi Valves came into operation on July 18th.

The effect of these reductions in price, combined with the unanswerable arguments in favour of Marconi Valves, i.e., that they are used by :

The B.B.C., Imperial Airways, Empire Communications, Metropolitan Police, Passenger Liners, in fact in almost every important British service, will lead to a very heavy increase in demand.

Remember these facts and particularly that Marconi Valves are all British. We are preparing a large variety of window displays, counter and window pieces, catalogues, lists, etc., to aid our Dealers in developing sales, and in addition, steps are being taken to bring the obvious superiority of these valves to the notice of the public throughout the country.



Marconi Valves

Sell the Valves the Experts use !

Sell Oldham— this quick easy way...

every customer means
12 weeks' steady sales...

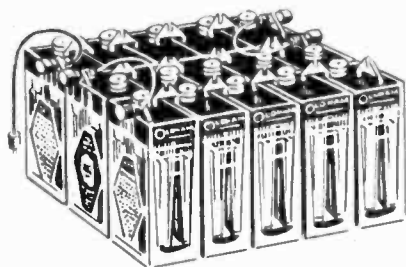
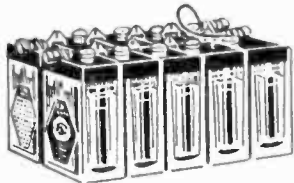
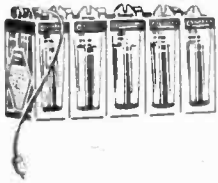

The Oldham week-by-week purchase scheme has definitely proved itself a real profit maker. All over the country traders report steady business in Oldham Accumulators.

The Oldham "Air-Spaced" H.T. Accumulator is the finest source of H.T. current yet devised—a source of profit you cannot afford to miss!

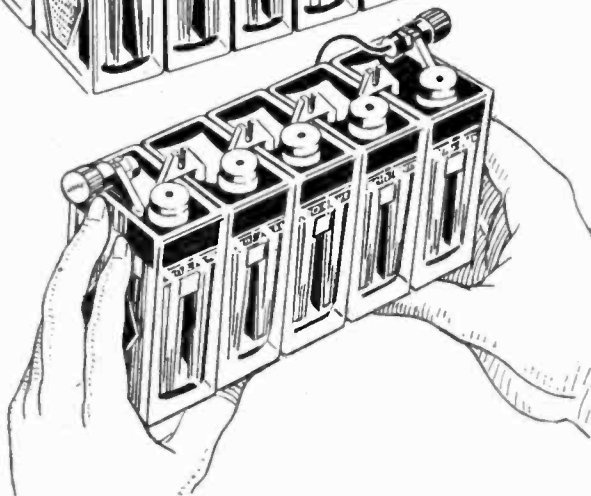
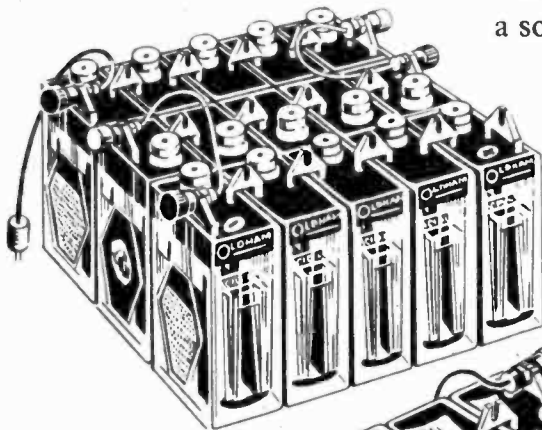

OLDHAM

The Pioneers of "Air-Spaced"
H.T. ACCUMULATORS

Standard 10-volt Unit
Capacity 2,750. milliamps

5/6

Extra Large Capacity
(5,500 milliamps)
Per 10-volt Unit

6/9

OLDHAM & SON, LTD., Denton, Manchester.
Telephone: Denton 301 (4 lines).

Glasgow: 200 St. Vincent Street.
Telephone: Central 4015.

London Office:
40 Wicklow Street, King's Cross, W.C.1
Telephone: Terminus 4446 (3 lines).

♡ 5305

FOR HE'S A JOLLY
GOOD SELLER

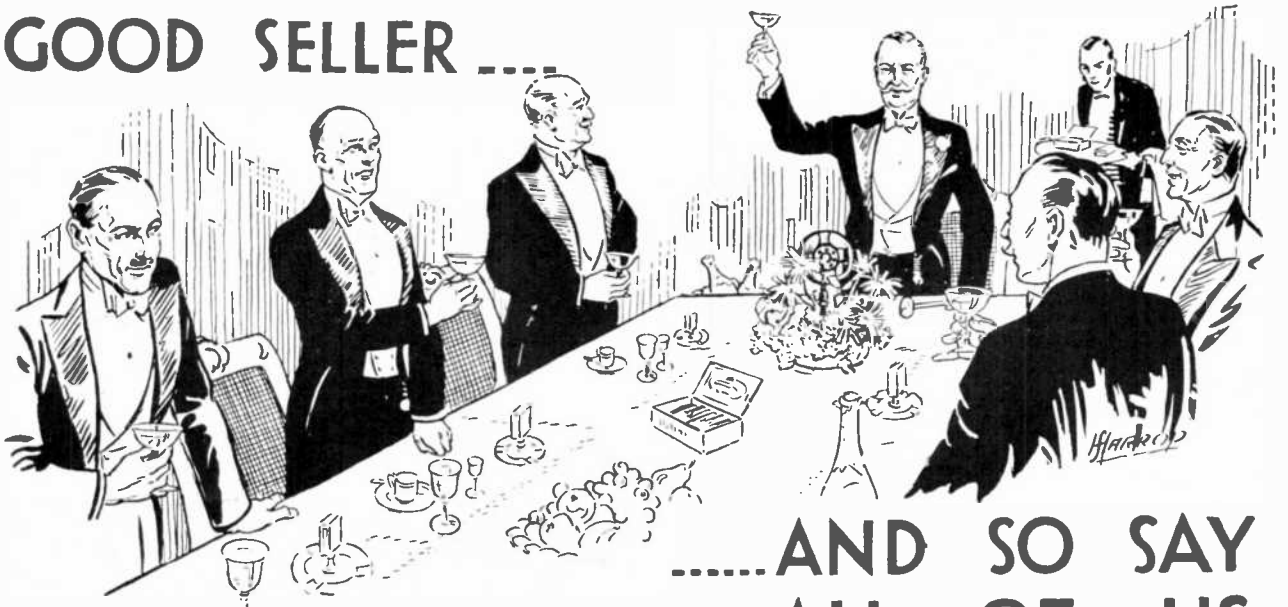

.....AND SO SAY
ALL OF US

**“GENTLEMEN—PRAY CHARGE
YOUR GLASSES AND DRINK
TO DETEX———”**

8 gns.

On every hand Detex Stockists are congratulating themselves on their foresight in demanding Detex—happy in the knowledge that Detex has paid for their summer holidays!

RETAIL

While “trade” has been dull in many ways Detex has more than justified the claims made for it as a real wonder-set, and wonder-seller. And now with increased advertising and public recommendation Detex is going to make still bigger profits for those wise traders who show and sell this famous Straight-Five Portable.

Complete and ready for use
12 Months Guarantee
LIBERAL TRADE TERMS

Telephone
Victoria 1303
(6 line.)

DETEx
PORTABLE RADIO
DETEx LTD.

161 Vauxhall Bridge Road, S.W.1

Telegrams :
Dextexacrys,
Churton, London



RADIO FOR EVERYBODY!

COMING



**WILL CREATE A
NEW BOOM IN RADIO, IT
WILL STAGGER THE WORLD**

**TALK
TELSEN
TRANSFORMERS
and MAKE
MONEY**

Talk about the quality of reproduction... talk about the amplification... talk about the enormous public demand... about the prices — and sales are made! Telsen Transformers are being specified in most of the modern circuits to-day. Their popularity has been gained by merit alone—
—Talk "Telsen" and ready sales are assured
.....with handsome profits.

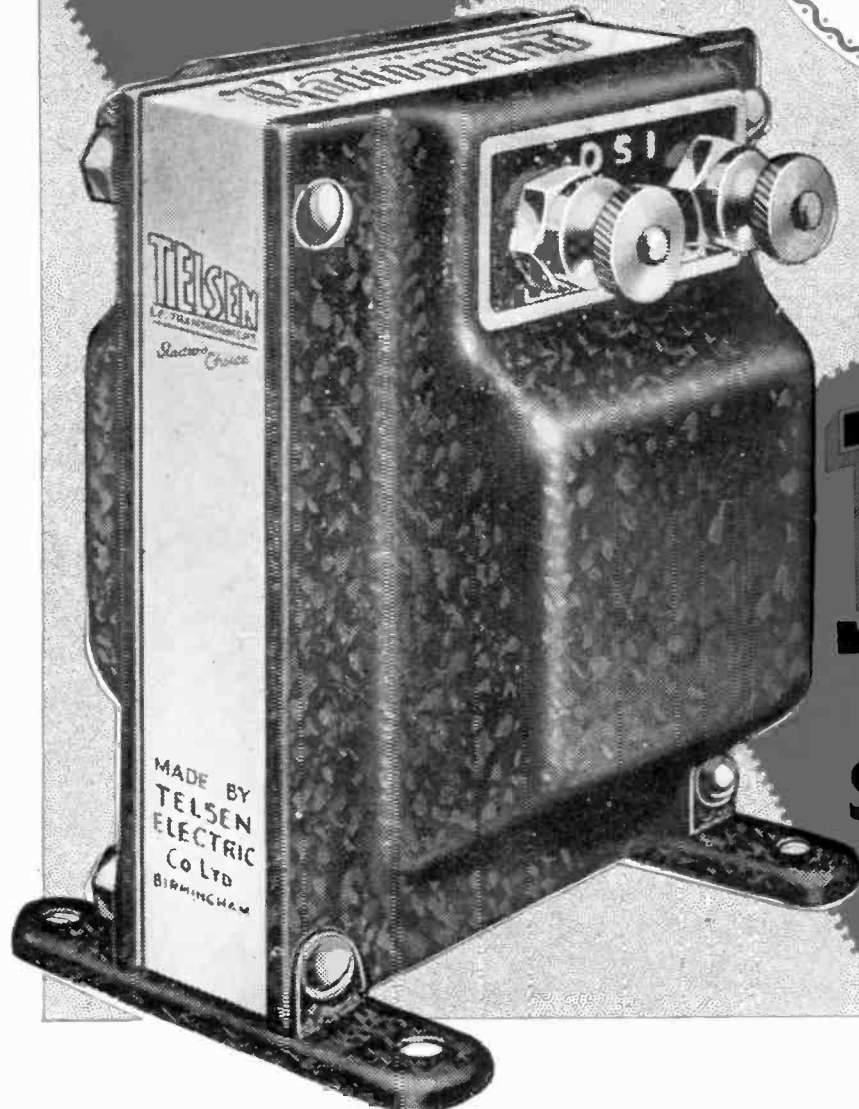

**STOCK
TELSEN
TRANSFORMERS
and SELL
SATISFACTION**

Dept. of
**TELSEN ELECTRIC Co. Ltd.
BIRMINGHAM**



*“Three men went to mow,
Went to mow a meadow,
Three men, two men, one man,
and his dog,
Went to mow a meadow.”*

He's forgotten he's a hard-headed business man. He's ceased to worry whether Rubber rises or falls. He's become just one of a crowd. But dash it! If he can sing, why not you? His voice is nothing to boast about, anyway. Well, why not? How does it go? “. . . four men, three men, two men, one man, and his dog . . .” Now you're both singing and trying to outdo the other. Happy in 'letting yourselves go' without being conspicuous. Lost in the crowd of holiday-makers until the announcer's voice reminds you that actually you are at home, joining in the community-singing which your Pye Portable has made so vividly alive.

Another of the present series of Pye advertisements depicting the realism enjoyed by Pye owners . . . creating a still bigger demand for the Pye Portable . . . Sending the public to you to see and hear Pye Radio.

Are you making a good display? Have you a full range of Pye Receivers always ready for demonstration?

Concentrate on Pye and enjoy good business right through the summer.



PYE RADIO — MADE IN CAMBRIDGE

PYE RADIO LTD., Sales Organisation, Paris House, Oxtord Circus, W.1

AUG-16TH

THE AUTUMN BUYING & SUPPLIES NUMBER

of
The **WIRELESS**
 & GRAMOPHONE
TRADER

IT is designed to promote the maximum retail activity during the pre-Show weeks by bringing into the compass of one issue a comprehensive survey of new lines and at the same time providing a reference to components and materials which will enable manufacturers to fix up their contracts for the coming season.

Don't "lie low" till Showtime and so lose four or five weeks of opportunity for brisk sales!

Press Dates :

Copy and blocks should be in our hands not later than :
 If proofs are required, by August 6th.
 If proofs are not required, by August 11th.
 Pages in 2-colour, two days earlier than the above dates.

THE WIRELESS & GRAMOPHONE TRADER
 St. Bride's House, Salisbury Square, Fleet St., London, E.C.4
 Telephone : Central 7713 (9 lines). Telegrams : "Wirelestru, Fleet, London."

SEPARATE THOSE STATIONS



AN essential accessory under the modern Regional Scheme conditions whereby sets which are now incapable of separating transmissions may be made highly selective. An adjustable device permits this instrument to be successfully used with various types of aerial tuning arrangements and all sizes of aeri-als. Of neat appearance, enclosed in a polished mahogany case.

Cat. No. 435.

PRICE 22/6

With the

EDISON BELL

STATION REJECTOR

Famous throughout the country for

PUNCH POWER & PURITY

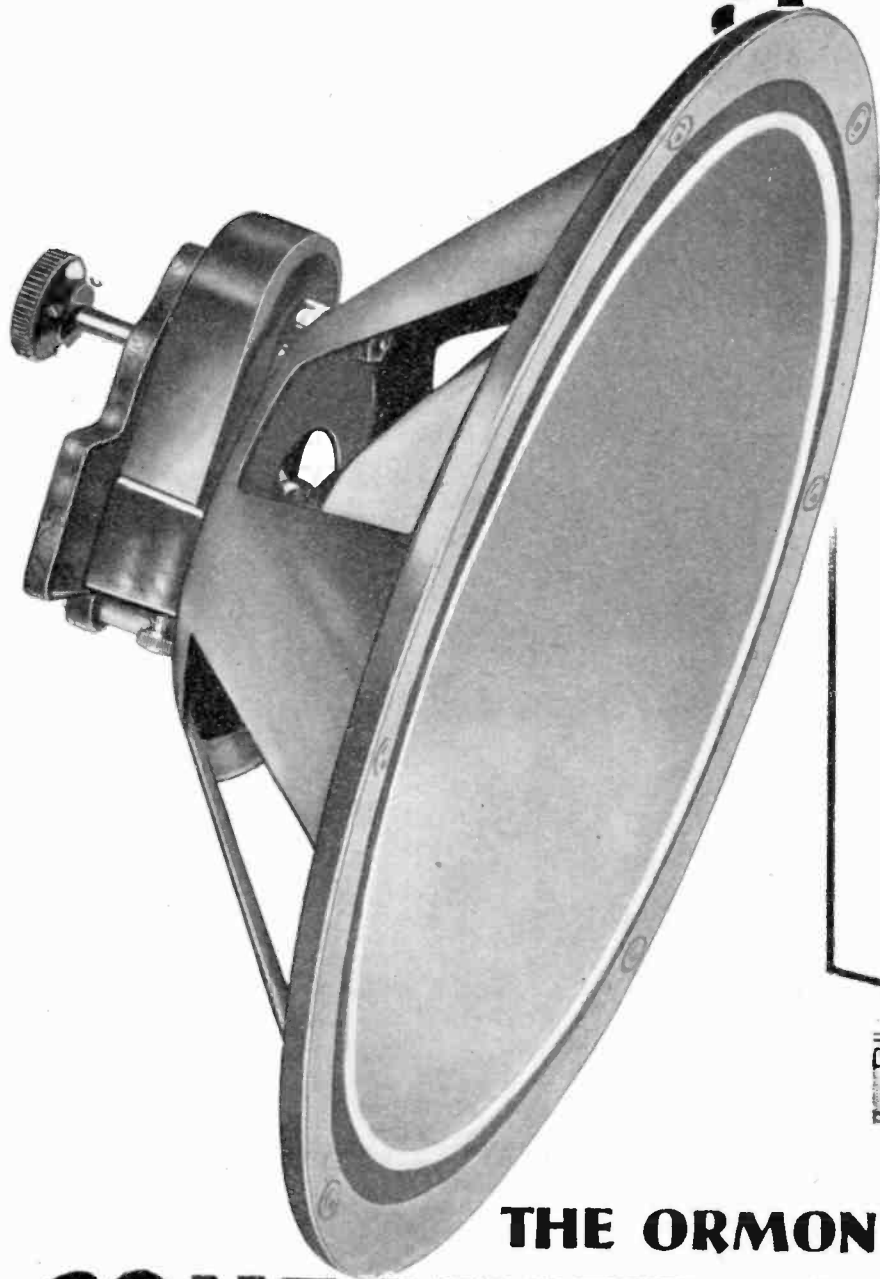

The Ormond Cone Unit and Chassis has by reason of its amazing worth and value proved to be the most popular. It is a product worthy of the Ormond reputation and one you will sell with ease.

Amazing performance combined with remarkable low price make the Ormond Cone Unit and Chassis a most attractive line to handle.

20'

COMPLETE

Also supplied separately:

Chassis and Cone	7/6
Unit	12/6



THE ORMOND CONE UNIT & CHASSIS

THE ORMOND ENGINEERING CO., LTD., ORMOND HOUSE, ROSEBERY AVENUE, LONDON, E.C.1

Telephone: Clerkenwell 5334-5-6 & 9344-5-6

Telegrams: Ormondeng i Smith

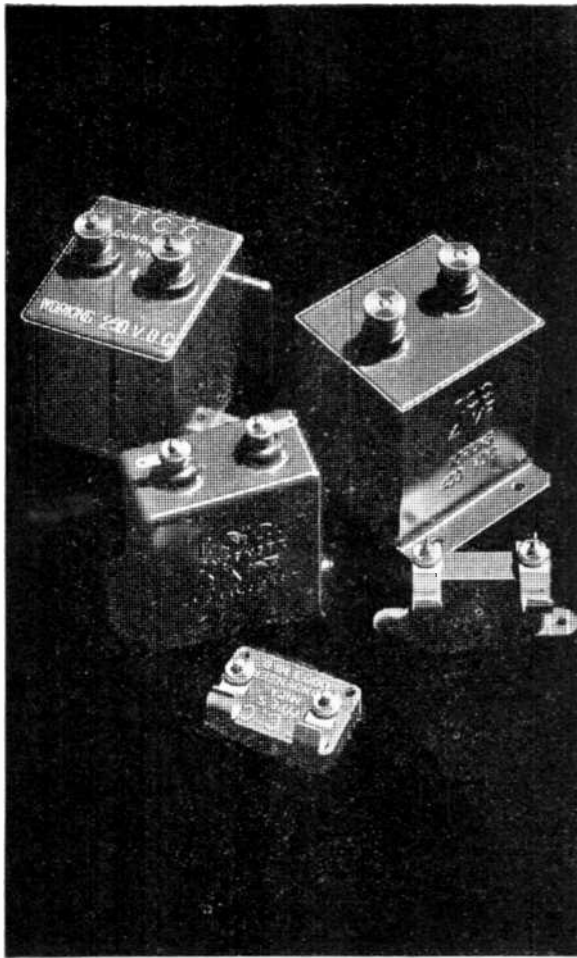

Condensers of unfailing accuracy..

Here's a condenser that has withstood the most exacting of tests, and come through with flying colours — it's a condenser that is the hall-mark of accuracy and reliability.

The letters T.C.C. might well stand for . . . They — Command — Confidence . . . they are the initials of the Telegraph Condenser Co., who have been making condensers—nothing but condensers for over 25 years! And remember, every T.C.C. you sell adds to your reputation.



ADVERTISEMENT OF THE TELEGRAPH CONDENSER CO., LTD., WALES FARM ROAD, N. ACTON

♥ 3584

PREPAID PARAGRAPH ADVERTISEMENTS.

SCALE OF CHARGES.

AUCTIONEERS' & OFFICIAL ANNOUNCEMENTS.—Advertisements under this heading are inserted at a charge of 11s. per single column inch.

TRADE & MISCELLANEOUS.—3s. for 12 words and 3d. for each additional word.

SITUATIONS VACANT & WANTED.—2s. for 12 words and 2d. for each additional word.

SERIES DISCOUNTS.—On contracts for consecutive insertions the above rates are subject to discounts as follow: 13 insertions 5 per cent., 26 insertions 10 per cent., and 52 insertions 15 per cent.

BOX NUMBERS.—If replies are sent to the office of the publishers, 6d. extra per insertion is charged to cover cost of forwarding them. The Box Office address is counted as six words and charged accordingly.

PRESS DAY.—Copy should reach us not later than first post Tuesday Morning, four days before publication, and should be addressed to The Advertisement Manager, St. Bride's House, Salisbury Square, Fleet Street, London, E.C.4. Phone: Central 7713 (9 lines.)

COPY FOR ADVERTISEMENTS is subject to the approval of the Proprietors, who retain the liberty to withhold any advertisement which they regard as unsuitable for publication in this journal. The Proprietors are not responsible for clerical or printers' errors, although every care is taken to avoid mistakes.

NOTE.—The insertion of an advertisement ordinarily constitutes acknowledgment of the remittance, but for remittances covering contracts for 13 insertions or more a receipt will be sent.

ORDERS AND CHEQUES should be made payable to THE TRADER PUBLISHING CO., LTD., and crossed "and Co." Treasury Notes, being untraceable if lost in transit, should not be sent as remittances.

ALL ADVERTISEMENTS MUST BE PREPAID.

DEPOSIT SYSTEM.

To facilitate business between advertisers and unknown or distant readers, we have a "Deposit Department." The buyer sends us the money, and we advise both parties of its receipt. The seller then sends the goods carriage paid to the buyer, who must within three days of receiving them either accept them or return them carriage paid. If he accepts them we forward his money to the seller; if he rejects them we return his money when advised by the seller that the goods have come to hand. We cannot, however, accept any liability in a dispute. Our charges payable by the buyer for this service are:—

- 1/- on transactions up to £5.
- 2/6 " " between £5 and £20.
- 5/- " " " £20 and £50.

And thereafter 6d. for every £5 or part thereof.

AGENCIES.

GERMAN manufacturer of first-class quality loud-speaker systems, loud-speaker chassis and loud-speakers, wishes to get into touch with well-connected concern capable of taking over the general agency. Write, giving full particulars and references, to L. Z. 814, c/o. Rudolf Mosse, Leipzig, Germany. (164)

BUSINESSES FOR SALE.

GROSS profit 33 1/2 per cent. Wireless and music. Thriving business, prosperous seaside resort. Genuine concern bearing every investigation. Large turnover. Easily managed; good class trade; old-established. Goodwill £300 s.a.v. Freehold or lease. Personally recommended by Claude C. Cowell, Auctioneer, Maldon, Essex. (172)

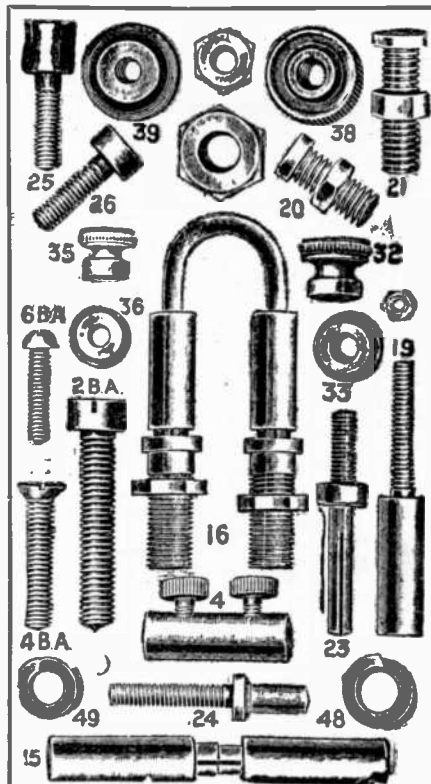

E. J. FRANCOIS,

89, Clerkenwell Road, London, E.C.1

B.A. Screws, Nuts and Washers, Brass and N.P. General Stamping (Spades and Soldering Tags, etc.) — Brass and N.P. Terminals. — Red and Black Insulated Spades, Pins, Wander Plugs, etc.

Turned Special Parts to sample or sketch

"ALWAYS"

POTENTIAL DIVIDERS

Stocked in all values from 1,000 ohms to 100,000 ohms. Five variable tappings. Will carry 20 M.A.

PRICE 2/- retail.

Makers of H.T. Eliminators, etc., should write for full list.

"ALWAYS" used by the best Makers.

Large Stocks Quick Deliveries.

ABINGDON WIRELESS SUPPLIES
ABINGDON - - - - - BERKS.

Sell 'HOLDFAST' Now!

EXTENSION UNIT

The best extension unit for every type of balanced armatures. Post price 1/-. Special price for large quantities.

DAYZITE LTD.

17, Lisle St., Leicester Square, London, W.C.

"TRADER" PAYMENT CARDS: For customer's receipts in connection with Hire-purchase arrangements—
Prices 1 25 50 100 cards
Post Free 2d. 2/6 4/6 6/6
THE WIRELESS & GRAMOPHONE TRADER,
St. Bride's House, Salisbury Sq., Fleet St., E.C.4

Businesses for Sale.—continued.

FOR sale as going concern. Well-established wireless retail business in main road, City of London. Long lease.—Box 1337. WIRELESS TRADER Office. (169)

FOR SALE.

CASH register, "National." Total Cadder. In good condition. Suit cash and credit business. Bargain. Write for details to A. E. Spinks, 56, White Hart Lane, Wood Green, N.22. (163)

HIGGS motor generator, 400 V, 3-phase. Output 100 V. 15 A. 3-circuit charging board, dynamo shunt resistance, starter, etc. Nearly new. £35. Cost over double.—Bradley, Market Street, Thornton, Bradford. (166)

MISCELLANEOUS.

LOUD-SPEAKERS, headphones and transformers. Trade repairs.—Howell, 91, Morley Hill, Enfield, Middlesex. (117)

TUNERS. Multi-circuit 13s., straight 11s. 6d., retail. Push-pull 4s. nett, singles.—Charles G. Chalkley, 6, Grove Street, Wellingborough.

PATENTS.

PATENTS obtained, trade marks and designs registered at home and abroad. Gee & Co., patent and trade mark agents, trade mark advisers to THE WIRELESS TRADER, H. T. P. Gee, Member Radio Society, Great Britain, A.M.Inst., Radio Engineers, 52-54, Chancery Lane, Holborn, W.C.2. Telephone: Holborn 1525.

SITUATIONS VACANT.

NEW line for salesmen calling on retailers and wholesalers. Profit basis. British made penny razor blade. Details "A. G.," Ace of Blades, Ltd., 36, Basinghall Street, E.C.2. (161)

WIRELESS engineer wanted. Good theoretical and practical knowledge essential. Permanent.—Fagin, 13, Union Street, Aldershot. (167)

REPRESENTATIVE wanted for Midland and northern counties by well known firm manufacturing ebonite, components and sets. Established connection and car essential. Details in confidence to Box No. 1335, WIRELESS TRADER Office. (171)

RADIO.—Experienced salesman required as representative for London and the South.—Applications, stating age, qualifications, experience, and salary required, should be addressed to Chorlton Metal Co., Ltd., "Millgate" House, 18, Amber Street, Shudehill, Manchester. (174)

WIRELESS. Representatives required for London territory. Only men with first-class connection please apply. Give fullest details of experience, age, salary required.—Box No. 1334, WIRELESS TRADER Office. (173)



Heavy Stocks are not necessary

Hobdays Catalogue of "all popular lines at rock-bottom prices—QUICK DESPATCH and FREE VAN DELIVERY embracing 36 Counties enables you to supply all your customers' requirements with minimum delay. **22 CARRIAGE PAID** (England & Wales with certain exceptions.)

Let OUR SERVICE increase YOUR GOODWILL.

HOBDDAYS
HOBDDAY BROTHERS LTD.

The "QUICK DESPATCH" FACTORS
 LONDON — MANCHESTER — WOLVERHAMPTON

REALISTIC REPRODUCTION

Write now for free 36-page Booklet, "Sound Advice"

BAKER'S 'SELHURST' RADIO PIONEER MANUFACTURERS OF MOVING COIL SPEAKERS
 Offices: 89 Selhurst Rd., S. Norwood, S.E.25
 Works: 42 Cherry Orchard Rd., E. Croydon

Actual size **ELELEX**
WANDER PLUGS
 Nickel plated. 8 Colours. Standard size 2DW or Midget 2d. each.
 Write for List W.70.
J. J. EASTICK & SONS
 118 Bunhill Row, LONDON, E.C.1

EPOCH
 MOVING COIL SPEAKERS
 Write for new booklet — 10 models
EPOCH RADIO MANUFACTURING CO., LTD.
 3 Farringdon Ave., London, E.C.4. Phone: Central 1971

Patents . Designs . Trade Marks

ERIC POTTER,
 Patent Agent.

3, Staple Inn, LONDON, W.C.
 Phone: Holb. 0632.

11, Park Row, NOTTINGHAM.
 Phone: 352, 5

SITUATIONS WANTED.

LATE general manager Bellows Magneto and Wireless Company, Ltd., of Park Royal, for fourteen years, seeks responsible position, owing to liquidation of company. Age 38. Sound all-round experience. Well known in the trade.—Box No. 1338, WIRELESS TRADER Office.

ADVERTISER wishes to represent a wireless or gramophone company, as distributive agent for Devon, Cornwall and Somerset, on salary and commission basis. Own showrooms (in Exeter), car, etc.—R. B. Fulford, 31, Queen Street, Exeter. (165)

PRACTICAL wireless engineer with sales ability to acquire interest in established photographic and wireless business. North-East coast. Full information given to genuine enquirer.—Apply in the first instance to F. C. Gardiner & Co., Incorporated Accountants, Scarborough. (158)

GEORGE H. MANDER (late Northern Garca representative of the British Radio Gramophone Co., Ltd.) desires post with manufacturers of high-class receivers, etc. Splendid connection with radio trade (wholesale and retail), piano and gramophone stores, etc. Own car (Armstrong saloon). Expert demonstrator. First-class references. Address: Grosvenor Road, Tarvin, Chester. (108)

TRADE MARKS & DESIGNS.

TRADe marks and names, designs. Registrations effected in all countries.—Trade Marks Registration Agency, Monument Station Buildings, London, E.C.4. Telephone: Royal 2379. (T1)

WANTED.

MANUFACTURERS' discontinued stocks wanted. Any quantities.—Box No. 947, WIRELESS TRADER Office.

WIRELESS GOODS

Clearance or Surplus
WANTED FOR CASH

P. Kay, 34 Craven Walk, N.16

SCRAP H.T. batteries wanted. Flash Stamps, etc.—Particulars 157, Bromford Lane, Erdington, Birmingham. (159)

POWERFUL amplifier for public address and gramophone suitable for working six loud-speakers.—Box No. 1339, WIRELESS TRADER Office. (170)

WANTED. Two National cash registers. Required for quick trade. Keys 30s. Parties, to Box No. 2.40, Willings, 86, Strand, W.C.2. (162)

WANTED. Marconi 2 in. loud-speakers, type S.P.G.2. State particulars and price.—Box No. 1322, WIRELESS TRADER Office. (100)

BOOKS, WIRELESS FORMS, ETC.

COUNTY Court Practice Made Easy (debt collection simplified).—Written by a solicitor, this book deals with all the steps necessary for the collection of debts, from the preliminary letter to the enforcement of judgment and recovering of money. New edition (revised), 5s. 3d., post free, from The Trader Publishing Co., Ltd., St. Bride's House, Salisbury Square, Fleet Street, E.C.4.

Manufacturers of

**METAL CABINETS
 METAL CHASSIS
 ELIMINATOR CASES
 SCREENING BOXES**
 Experts in Wood Finishes on METAL

CRYSTALLISING AND CRINKLE FINISHES A SPECIALITY

All Classes of Stove enamelling
 TRADE ENQUIRIES INVITED
RIGBY & WOOLFENDEN
 Millnrow Road, ROCHDALE
 Phone: 2948

Retails at **6d.**
 ALL HEADS FLOAT FULLY CHARGED
 MIDDLE HEAD HALF DISCHARGE
 ALL HEADS 51/2" RECHARGE
 51/2" CELLS
Manfrs. Vitaklor Co., NELSON.
The "SOPRANIST" ACCUMULATOR TESTER
 Tests all kinds of Lead-Sulphuric Acid Batteries.
 Efficient, Simple, Handy
See Dts.
S. KALISKY (Aldgate) LD.
 Aldgate High St., London, E.C. and 16 Withy Grove, Manchester.

GRIPSO
 "STANDARD" PUSH-PULL INDICATING SWITCH
 ADAPTABLE DOUBLE DIAL READINGS ON AND OFF-LONG AND SHORT WAVE
 ROBUST CONSTRUCTION LISTS FROM MARKERS
THE GRIPSO COY.
 32, VICTORIA STREET, LONDON, S.W.1

It is for you to obtain the best possible CONDENSERS for any given outlay **TEST THEM!**
 1 MFD. 500V. D.C. test ... 2/0
 1 MFD. 500V. A.C. test ... 2/6
 1 MFD. 1000V. D.C. test ... 3/4
FRANKLIN CONDENSERS
FRANKLIN ELECTRIC CO., 187-189, Ilford Lane, ILFORD, Essex. Phone: Ilford 0281.

EMKABE
 HAVE YOU HAD particulars of Emkabe precision components — and pleasing Terms? If not write now.
EMKABE RADIO CO. LTD.
 47, Farringdon Road, London, E.C.1

Send Your Orders to:—
T. FIELDING & Co. Ltd
 The EAST ANGLIAN RADIO FACTORS
 King St., GT. YARMOUTH
 Factors of all the best known makes of Radio Components

POLAR TUNING GRAPHS
 Trade 1/6 Doz.
 Retail 2 1/2 each.
 Place same on your counter
WINGROVE & ROGERS LTD.
 188-9 Strand, London, W.C.2



When its a question of TIME

EAST LONDON RUBBER CO.

The Promptest Factors
 29-33, Great Eastern Street, London, E.C.3
 Telephone: Bishopsgate 4321 (20 lines)
 Telegram: "Akerene, Phone, London."

EXACT TUNERS

THOUSANDS IN USE
 STOCKED BY ALL THE LEADING FACTORS

THE EXACT MANUFACTURING CO.
 Croft Works, Priory Street,
 COVENTRY, England.

Books, Wireless Forms, etc.—
continued.

YOUR Business at a Glance.—A simple account enabling you to see at a glance the position of your business without any knowledge of bookkeeping. Ruled for entries for a period of one year, with profit and loss summary, and balance sheet at end of each quarter, 2s. 3d. post free, obtainable from The Trader Publishing Co., Ltd., St. Bride's House, Salisbury Square, Fleet Street, E.C.4.

AGREEMENT Forms (Hire Purchase).—These forms have been specially prepared for THE WIRELESS AND GRAMOPHONE TRADER by a solicitor of the Supreme Court. If you sell on hire purchase they are indispensable. Prices, post free, 4d. each, 25 for 5s., 50 for 7s. 6d., and 100 for 10s. 6d. All orders should be accompanied by remittance and addressed to the Trader Publishing Co., Ltd., St. Bride's House, Salisbury Square, Fleet Street, E.C.4.

PLESSEY PRODUCTS PRECISION PAY

Coilwinding

LAYER WINDING
 LEESONA WINDING
 PILE WINDING, ETC

PHONE US, WRITE US, OR WE WILL SEND ONE OF OUR REPRESENTATIVES AT ANY TIME TO SUIT YOUR CONVENIENCE

THE PLESSEY CO. LTD.
 VICARAGE LANE, ILFORD, ESSEX
 PHONE:—ILFORD 0041

"Craven House,"
 Kingsway,
 London, W.C.2

Sirs,

SATISFIED?

If you have an Advertising Agent whose services are satisfactory, this advertisement is not intended for you.

If you have not an Advertising Agent or are not satisfied with the way your publicity is being handled, THEN we would like an opportunity of proving our abilities.

Yours faithfully,
 HORACE FREEMAN
 Managing Director.



Parrs Advertising Ltd.
 Telephone: Holborn 2494

TANNOY
Mains Units

NEED NO ATTENTION
 MORE VOLUME
 GREATER SELECTIVITY

CHEAPER THAN DRY BATTERIES

for **PORTABLE**
 OR TRANSPORTABLE
 RADIO RECEIVERS

Type P.D.2
 L.T.
 £1 19s. 6d.

Type P.2
 H.T. £3 15s.

Type H.L.2
 H.T. & L.T.
 £6 10s.

Advt. of TANNOY PRODUCTS, 1-7 DALTON ST., S.E.27

THE NEW NASSAK DIAL

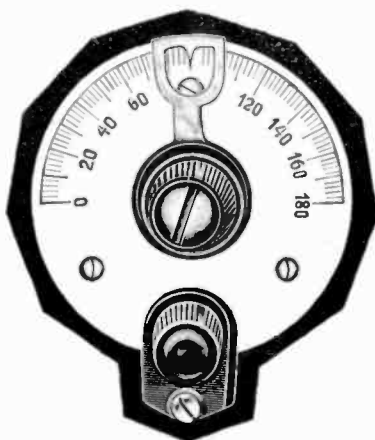

IMPROVED GEARING
 IMPROVED EFFICIENCY
 IMPROVED APPEARANCE

Fast and Slow
 :: Motion ::

Patent A.F. No. 1553. Regd. No. 752465.

No. 6. 3 inch. PRICE 3/6 EACH
 No. 7. 5 inch. PRICE 5/- EACH

THE NASSAK MANUFACTURING CO. LTD.
 119/125, FINSBURY PAVEMENT, LONDON, E.C.2



TAKE NO MORE RISKS—SPECIFY "NEDAP" COMPONENTS



TRADE  MARK

N
E
D
A
P

HIGH RESISTANCE
From 2,000-500,000 ohms.
2 Terminals Retail 5/6 each
3 do. Retail 6,- each

VOLUME CONTROL
Plug Type or fitted 4 terminals.
Retail Price 7/- each

4-PIN VALVE HOLDER
Retail Price 1/- each
Do. without Insulated Pins
Retail Price 8½d. each

N
E
D
A
P



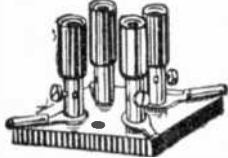



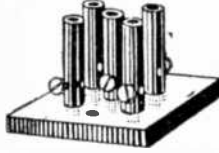

N
E
D
A
P

SWITCH (2-pole change-over)
Anti-capacity guaranteed. Practical mounting with large terminals.
Retail Price 5/- each
Made also in 3, 4 and 5 pole, etc.

ANTI-MICROPHONIC VALVE HOLDER
Special Phosphor Bronze Nickelled Springs.
Retail Price 1/3 each

5-PIN VALVE HOLDER
Retail Price 10d. each
Do. with Insulated Pins.
Retail Price 1/3 each

ALL ARTICLES FIRST-CLASS BAKELITE AND FULLY GUARANTEED.
MANUFACTURER:
NEDERLANDSCHE APPARATENFABRIEK "NAFA"
1e SCHINKELSTRAAT 30, AMSTERDAM.

ONLY WHOLESALE AND MANUFACTURERS SUPPLIED.
For trade discount and particulars apply Sole Agent for the United Kingdom:
E. ENDERLEIN 16 CHARTERHOUSE STREET, LONDON, E.C.1

INDEX TO DISPLAYED ADVERTISEMENTS—Continued from Back Page.

	PAGE		PAGE		PAGE
M. C. I. & Repetition, Ltd.	48	Partridge & Mee, Ltd.	24	Red Star Radio	39, 37
McMichael, L., Ltd.	11	Partridge, Wilson & Co.	48	Rigby & Woolfenden	45
Maisner, E. H., & Co., Ltd.	22	Parr's Advertising, Ltd.	46	Sankey, Joseph & Sons, Ltd.	14
Marconiphone Co., Ltd., The	31	Pertrix, Ltd.	19	Tannoy Products	46
Mullard Wireless Service Co., Ltd.	Inset, 5, 34	Philips Lamps, Ltd.	18	Telegraph Condenser Co., Ltd., The	34
Murdoch Trading Co.	31	Plessey & Co.	46	Telsen Electric Co., Ltd.	38
Murphy Radio, Ltd.	25	Potter, E.	45	Tungsram Electric Lamp Works (Gt. Britain), Ltd.	23
Nassak Mfg. Co., Ltd., The	46	Prideaux Junior, Ralph	20	Vandervell, C. A., & Co., Ltd.	21
National Accumulator Co., Ltd.	6	Pye Radio, Ltd.	39	Varley (Oliver Pell Control, Ltd.)	Front cover
Oldham & Son, Ltd.	32	Radio Instruments, Ltd.	Back cover	Westinghouse Brake & Saxby Signal Co., Ltd.	Inside front cover
Ormond Eng. Co., Ltd.	42	Ready Radio Supplies	20	Wingrove & Rogers, Ltd.	45
				Wright & Weaire, Ltd.	16

Special Facilities for Readers

IF you desire further particulars of several items advertised in this issue, place a tick against the names of the advertisers in the index above and overleaf, and forward the page to the "Trader Information Bureau," St. Bride's House, Salisbury Square, Fleet Street, London, E.C.4, who will see that your request is forwarded.

Sign here

Address

W.T. 26/7/30

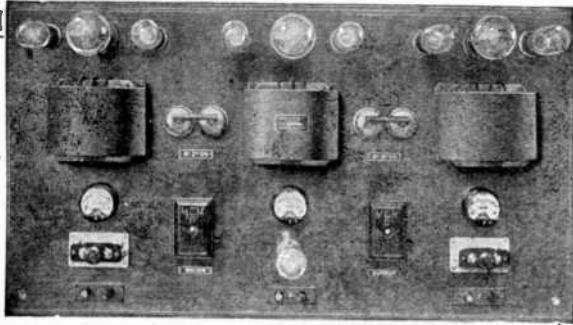

DAVENSET SERVICE STATION CHARGER
 Price £25 net.
 Max. D.C. Output 75 volts at 6 amperes

DAVENSET
COMMERCIAL ACCUMULATOR CHARGERS
AND RECTIFIERS FOR A.C. MAINS ARE
THE PRESENT DAY EQUIPMENTS

BECAUSE THEY ARE

1. HIGHLY EFFICIENT.
 2. SIMPLE TO OPERATE.
 3. PERFECTLY SILENT.
 4. NON-RADIATING.
 5. REASONABLE IN PRICE,
- e.g. from £8:8:0 net

TECHNICAL BOOK ISSUED FREE.
 A 49-page copy of the 3rd Edition (reprinted April, 1930) of the booklet entitled "Commercial Accumulator Charging and the Efficiency of A.C. Rectifying Equipment," in which 7 models of Davenport Chargers are both described and illustrated, may be had on application to your usual wholesaler, or direct from the manufacturers **FREE OF CHARGE.** This offer applies to bona-fide traders only.

PARTRIDGE, WILSON & CO.
 LOUGHBOROUGH ROAD, LEICESTER

INDEX TO DISPLAYED ADVERTISEMENTS.

(Continued on Page 47.)

	PAGE		PAGE		PAGE	
Abingdon Wireless Supplies.	44	Edison Bell, Ltd.	41	Gilbert C., & Co.	9	
Baker's "Selhurst" Radio	45	Electric Lamp Service Co.	20	Graham Amplion, Ltd.	27, 28, 29, 30	
British Industries Fair	7	Emkabe Radio Co., Ltd.	45	Gripso Co.	45	
British Radiophone, Ltd., The	16	Enderlain, E.	47	Halcyon Wireless Co., Ltd., The	15	
Brown Bros., Ltd.	1	Epoch Radio Mfg. Co., Ltd.	45	Hobday Bros., Ltd.	45	
Brownie Wireless Co. (Gr. Britain), Ltd.	4	Exact Mfg. Co.	46	Houghtons	33	
Carrington Mfg. Co., Ltd.	12	Fielding, T., & Co., Ltd.	45	Hughes, F. A., & Co., Ltd.	10	
Concerton Radio & Electrical Co., The	Inside back cover	Formo Co. (Arthur Preen & Co., Ltd.)	22	Igranic Electric Co., Ltd.	13	
Danipad Rubber Co., Ltd.	12	Francois, E. J.	44	Impex Electrical, Ltd.	8	
Dayzite, Ltd.	44	Franklin Electric Co.	45	Jackson Bros.	16	
Detex, Ltd.	35	Garnett Whiteley & Co., Ltd.	26	Kalisky, S. (Aldgate), Ltd.	45	
Dubilier Condenser Co. (1925), Ltd.	24	General Electric Co., Ltd.	3	Kent Bros. Electric Wire Co. & E. H. Phillips, Ltd.	24	
Dulcetto-Polyphon, Ltd.	2	TO obtain particulars of several items advertised in this issue place a tick against the name of the advertiser in the index above and overleaf and sign coupon at foot of index on the previous page.			L.E.S. Distributors, Ltd.	18
East London Rubber Co.	46				Lissen, Ltd.	17
Eastick, J. J., & Sons	46	London Metal Warehouses, Ltd.	22			

B.A. BRASS HEXAGON NUTS
 STRICTLY TO B.E.S.A. STANDARD

SGREW MACHINE MCL PRODUCTS OF EXCELLENCE

M.C.L. & REPETITION LTD
 POOL LANE, LANGLEY, BIRMINGHAM.
 TELEGRAMS: KARLYTEKO, LANGLEYWORKS. TELEPHONE: BLACKHEATH 1115 (2 LINES)

County Court Practice
Made Easy [DEBT COLLECTION SIMPLIFIED.]

New Edition (revised) 5/3 post free.

A complete but simple guide to the collection of debts from the preliminary request to the enforcement of judgment and the recovery of the debt. Part 11 gives advice for the defence and preparation for trial of the unlucky reader who is to be the defendant.

Remittance must accompany order. If C.O.D. is desired, fee will be added to all orders under £5 in value.

Obtainable from
THE TRADER PUBLISHING COMPANY, LTD.,
 St. Bride's House, Salisbury Square, Fleet St., E.C.4

RELIABLE

ECONOMICAL

Unfailing Quality

*and continuous
advertising have produced
a great demand*

The consistent demand by the public for FOTOS Valves has proved them to be Radio valves of exceptional quality. Wireless enthusiasts want the best—FOTOS gives it to them. Stock up now if you haven't already done so, and be ready to meet the demand when your customers ask

for

fotos

CONCERT VALVES
Trade Mark
THE HEART OF EVERY SET



FROM
5/6

GENERAL PURPOSE
AND POWER

CONCERTON RADIO & ELECTRICAL COMPANY, LTD.

256/7 Bank Chambers, 329 High Holborn, W.C.1

Telephone: Holborn 8667



Demonstrate!

in their homes and gardens

Slack time is demonstration time—demonstrate the "Madrigal" Transportable Receiver, and it is sold. No other set will get home and stay home so surely.

The "Madrigal" has individuality because it is built by craftsmen. No mass produced Receiver can give the effect of realism that is such a striking feature of the "Madrigal." Many who have heard the "Madrigal" believe they were listening to the actual orchestra. The illusion is pardonable.

Remember a Receiver may get every station under the sun, but the "Madrigal," in addition to exceptional selectivity has the finest quality of tone that has ever been reached. It is difficult to believe there is room for improvement.



Patent No. 317566

The "Madrigal" requires—
NO AERIAL, FRAME AERIAL OR EARTH.
 It is
TRANSPORTABLE to any room or anywhere there is an electric light socket;
POSITIVELY TROUBLE PROOF;
 Housed in a **BEAUTIFUL CABINET** in Walnut or Mahogany;
 Available on the most **ATTRACTIVE H.P. TERMS.**

"Madrigal" All Mains Receiver only in Walnut or Mahogany, handsomely figured and polished. Price including all rates and royalties. For A.C. or D.C. Mains or deposit £4 and 12 monthly payments of £2-10-0

£30

"Madrigal" All Mains Receiver and Coil Driven loud speaker, complete in Walnut or Mahogany. **£45-15** any. For D.C. Mains or deposit £6-5-0 and 12 monthly payments of £3-15-0. For A.C. Mains £48-18-0 or deposit £7-4-0 & 12 monthly payments of £4-1-6



R.I. Ltd., MADRIGAL WORKS

LTD

PURLEY WAY, CROYDON