

The **WIRELESS** & **GRAMOPHONE** **TRADER**

Incorporating "The **WIRELESS** and **ALLIED TRADES REVIEW**" "The **RADIO**
TRADE JOURNAL" and "The **WIRELESS DEALER**"

VOL. XXII. (NEW SERIES) No. 305.

June 21st, 1930.

8/- PER ANNUM. POST FREE.
SINGLE COPIES 1/- EACH.

VARLEY **BIG NEW EXTENSION** **TO FACTORY**



FOR ALL-ELECTRIC SETS AND **RADIO-GRAMOPHONES**

For
RADIO
MANUFACTURE
Varley

Advertisement of Oliver Fell Control Ltd., Kingway House, 103, Kingway, London, W.C.2

Telephone: Holborn 5503

Engine Trouble!

**He's telling them
with Marconi Valves**

In Air Liners—on the Sea—wherever
Human safety depends on Radio—
Marconi Valves are used ★



★
**Tell your customers this
when selling them Valves**

MARCONI VALVES

The All-British Valves with the All-Better Performance



THE PORTABLE OF THE SEASON

The *NEW*

Geisha

No. 3.

OUTSTANDING IN:—

**TONE
VOLUME
APPEARANCE
NEW IDEAS.**

CABINET IN BLUE OR BLACK WITH GILT EDGING IN EACH CASE.

PATENT STARTING AND STOPPING MOVEMENT.

CARRIES EIGHT 10" RECORDS IN DETACHABLE ALBUM.

PATENT SELF-CLOSING NEEDLE CUP.



RETAIL PRICE

£3/10/-

Subject to usual Trade Discount.

Measurements—
HEIGHT 7 ins.
LENGTH 16½ ins.
WIDTH 12 ins.

**THERE'S BIG BUSINESS IN THE "GEISHA." A SAMPLE WILL CONVINCe YOU.
SEND YOUR ORDER NOW.**

Manufacturers—C. GILBERT & Co. Ltd., Arundel St., Sheffield, and at South St., Hull.



Beethoven

the Portables that are Different



The **BEETHOVEN MINOR**

price £10 - 10 - 0
inclusive

Stocked by all the leading factors

OTHER MODELS

BEETHOVEN
SCREENED GRID SUPER 4 25 GNS
BEETHOVEN
Q.C.R. PORTABLE 21 GNS

MONTAGUE RADIO
INVENTIONS
& DEVELOPMENT Co. LTD
Beethoven Street : : London W.10
Telephone : Willesden 1200.

THIS SUMMER CUSTOMERS WILL ASK FOR



PORTABLE ACCUMULATORS



TYPE T.F.S.2.
Capacity 24 Amp.
Hours. Price 16/6



TYPE S.Y.6.
Capacity 24
Amp. Hours.
Price 14/6

The popularity of Portable Sets will ensure a steady demand for replacement Accumulators—recommend "THREE STAR," the best of all; free acid type and absolutely unspillable. Standard on the best sets.

Write for detailed list to:—

THREE STAR ACCUMULATORS LTD.
Rosebery Avenue, Tottenham, N. 17



UNSPILLABLE ACCUMULATORS

"NATIONAL"

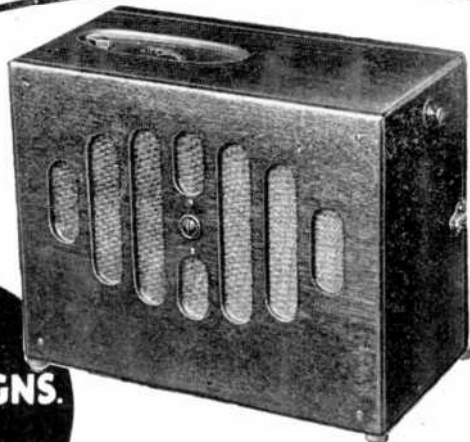

**REDUCED PRICES
WHICH MEAN QUICK-
STEADY-SALES - AND
BIG PROFITS
FOR YOU!**

12 GNS.
OAK

"SYMPHONY"



By arrangement with the manufacturers, we are able to announce these sensational price reductions in the famous "National" and "Symphony" 5-valve portable receiving sets. Special trade terms make them the most profitable proposition of all for you to handle.

THE HIGHEST STANDARD OF QUALITY IN RADIO.

SUBSTANTIAL Advertising Support.

**THE RIGHT SETS AT THE RIGHT PRICE
BACKED BY THE RIGHT SALES AND
SERVICE ORGANISATION**

13 GNS.
MAHOGANY

WRITE TO-DAY for full particulars of generous trade terms, service, etc.

The BRITISH RADIOPHONE LTD.

ALDWYCH HOUSE — ALDWYCH — LONDON — W.C.2

Telephone : Holborn 6744.



*Sent Carriage Paid on 7 days
Free Trial to any address
in the United Kingdom.*

"MONARCH" RECEIVERS ARE SELLING BEST

The MONARCH III, Type "T"

This "Straight Three" table model is in great demand.

It is simple to operate, of attractive design, and gives the desired results in all districts. Ample room in cabinet for all batteries.

PRICE . . . £5 5 0
LIBERAL DISCOUNTS (ROYALTY EXTRA)

W.M. DIBBEN & SONS, LTD.
ST. MARY'S ROAD SOUTHAMPTON

REGISTERED

STALLOY

BRAND

TRANSFORMER LAMINATIONS of every description.



DIAPHRAGMS, CONE UNIT REEDS:

JOSEPH SANKEY & SONS L^{TD}.

Works : Bilston.

London Office : 168, Regent St.. W. 1.

Only 14 days Left!

TO RAISE

We will pay
50% of your
Advertising
bill!



Co-operate
in Selling
the New

EKO

POWER SUPPLY UNITS for PORTABLES

Write now for
Free Folder giving
full details of this
amazing free offer!

E. K. COLE, LTD
"EKO" Works, Dept "F"
Leigh-on-Sea.

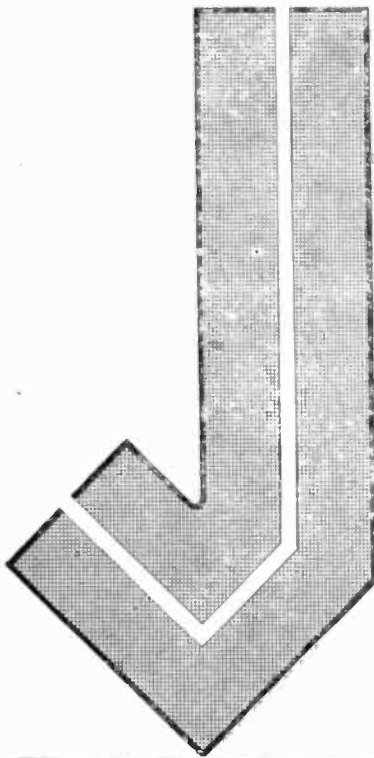

JUNIT

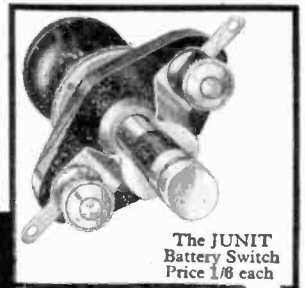

The JUNIT Battery Switch
Price 1/8 each

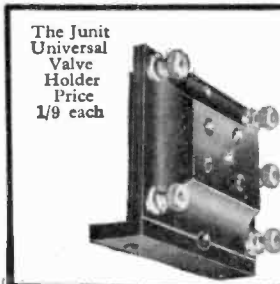

The Junit Universal Valve Holder
Price 1/9 each

RADIO FOR THE MILLION

THE MULLARD ORGOLA MASTER 3
The following Junit Components have been specified for this set :
2 5-Pin Valve Holders.
3 Switches
2 Terminal Mounts

1 5-Pin Valve Holder and 1 Black knob Switch specified for **THE MULLARD MASTER S.G. H.F. UNIT**
2 Terminal Mounts, 2 Switches and 1 5-Pin Valve Holder specified for **THE MULLARD MASTER 2**



The Junit Terminal Mount
Price 8d. each

RADIO FOR THE MILLION

2 5-Pin Valve Holders specified for **THE MULLARD A.C. MASTER 3 CONVERSION**
1 5-Pin Valve Holder specified for **THE ORGOLA HIGH POWER H.T. SUPPLY UNIT**

JUNIT MANUFACTURING COMPANY, LTD.,

2, RAVENSCOURT SQUARE, LONDON, W.8

Telephone : RIVERSIDE 0274

M.C.3

LONG RANGE

Two Strong Selling Sets

SELECTIVE

POPULAR

CABINET THREE

REGIONAL THREE



£5 : 15 : 6 (subject)

This set incorporates a unique device to sharpen tuning to any degree of selectivity. The Cabinet is designed to hold all the necessary batteries.

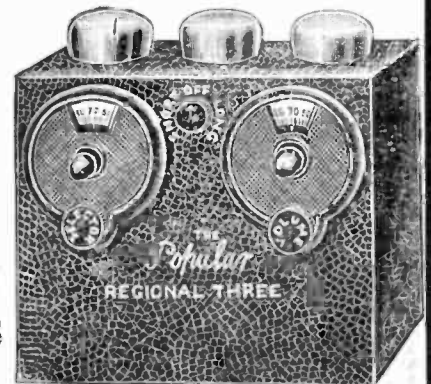

4 GUINEAS (subject)

FIXED
RETAIL
PRICES
INCLUDING
VALVES
FREE FROM
ROYALTIES

Completely screened. Cuts out Regional Stations as required, and brings in ALL EUROPE. Size only 7 x 6 x 3 in. Supplied in three finishes, Bronze, Gilt and Black. A unique proposition every Dealer should stock.

FULLY GUARANTEED FOR ONE YEAR

Write for Details and Other Price Lists

THE DANIPAD RUBBER Co., Ltd.,
5 & 7, Market Street, Finsbury, London, E.C.2

Telephones: Bishopsgate 7322 & 7323

EFFICIENT

LOW PRICE

CELESTION LEADERSHIP

The Daily Express Wireless Correspondent wrote, on June 10th, 1930:—

“Another refinement to be looked for in the Autumn is a new system of Tone Control, as apart from Volume Control with which we are all familiar.

This Tone Control will enable the operator to bring out the high and low notes at their precise musical value according to acoustic conditions of the room in which the set is installed or the character of the music which is being reproduced.”

**CELESTION has
refinement—THE**

already produced this

TILTATONE

AMPLIFIES

CORRECTS — CONTROLS

both

TONE and VOLUME

THE TILTATONE

The Greatest modern contribution to the World of
:: Gramophone Music ::

£4 : 17 : 6

SEND FOR FULL PARTICULARS

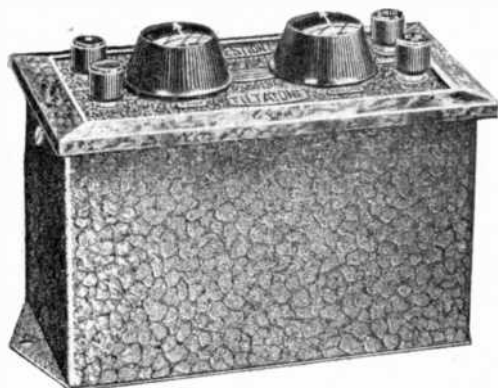

Allows the output curve of an electrical gramophone to be varied merely by turning a single control and volume to be regulated without cutting the high frequencies. Accentuates or subdues middle frequencies as desired. Incorporates exclusive features never before offered to the radio public.

CELESTION

The Very Soul of Music

CELESTION LTD., KINGSTON-ON-THAMES

Phone: Kingston 5656.



FOR A.C. & D.C.

The SELECTOR ELECTRIC "42"

THE Selector Electric "42" is a completely self-contained receiver for operation off A.C. or D.C. mains.

Selectivity has been developed even to the degree of separating stations almost within sight of the aerial. British and foreign programmes are received with ease and the quality of reproduction is superb.

At 42 guineas complete this new Selector model is commanding a ready market.

Selector
Quality Supreme

SELECTORS LTD., 206, Bedford Avenue, Slough Trading Estate, Slough, Bucks. 'Phone: Slough 818. 'Grams: Selectors, Slough. London Office: 1, Dover Street, W.1. Telephone: Regent 4771.

NEW DEFERRED PAYMENT PLAN. The Selector scheme of deferred payments helps you to maintain summer sales.

THE ATTACHE "32"
£5 DOWN, 12 monthly payments of £2-12-6

THE CABINET "32"
£5 DOWN, 12 monthly payments of £2-12-6

THE ELECTRIC "42"
£7 DOWN, 12 monthly payments of £3-8-0

THE ELECTRIC "55"
£8 DOWN, 12 monthly payments of £4-10-6

You get your profit immediately and take no responsibility.

Efescaphone REGIONAL PORTABLE 3 VALVE

Price £12.15.0

H.P. terms £1 down and 12 monthly payments of £1.0.7

This set has been specially designed for receiving the dual programmes from the Brookman's Park Station. It will separate the Regional from the National wavelength clear of interference, as close as one mile, and gives good loud-speaker strength within a radius of approximately 40 miles.

It serves a large population, and offers, therefore, a rich potential market to the enterprising dealer.

Its price—£12 15s. complete—is within the reach of households of quite modest means, while H.P. facilities are available, if required.

Only three Valves are employed, and Battery consumption and cost of upkeep generally is therefore much more economical than the average Portable Set.

The Efescaphone Regional Three is entirely self-contained and requires neither an Indoor nor Outdoor Aerial.

**Breaks
new
ground**



FALK STADELMANN & CO. LTD.

83-93, FARRINGTON ROAD, LONDON, E.C. 1

THE WHOLE RANGE OF MELODY

THE EDISON BELL

**ALL MAINS
RADIO
GRAMOPHONE**

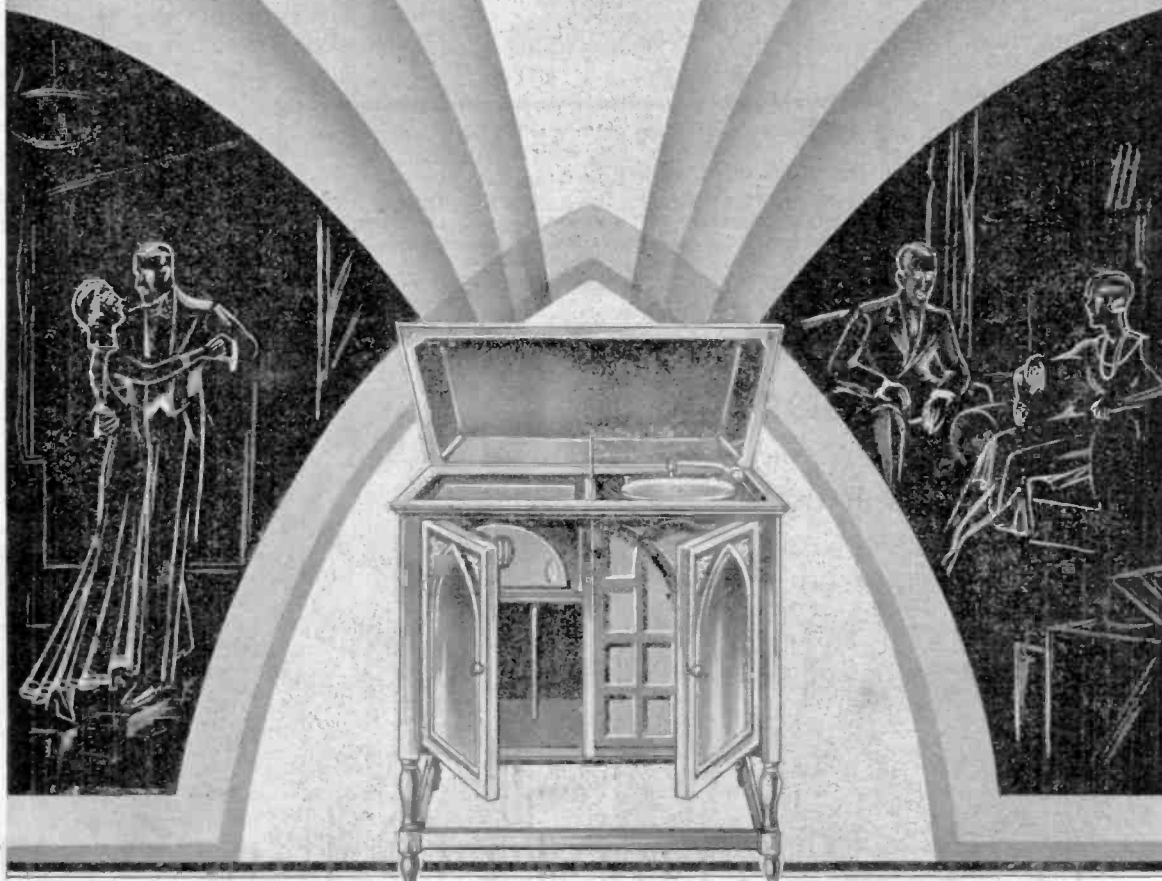

The Edison Bell All-Mains Radio Gramophone, as its name implies, has been developed to operate entirely from the ordinary lighting mains, requiring no batteries whatsoever. Cabinets are fitted with ample storage space for Records and are beautifully finished in Oak, Mahogany or Walnut. (A.C. or D.C. Mains).

Ask for full particulars.

	PRICE	
	A.C.	D.C.
Oak	£65 0 0	£84 0 0
Mahogany	£68 10 0	£87 10 0
Walnut	£72 10 0	£91 10 0

Complete, Including Marconi Royalties

EDISON BELL, LIMITED

LONDON, S.E.15

WESTINGHOUSE RECTIFIERS FOR HIGH-TENSION UNITS

200 volts. 100 m.a.



Type H.T.1 75/-

150 volts. 50 m.a.



Type H.T.4 37/6

120 volts. 20 m.a.



Type H.T.3 21/-



METAL RECTIFIERS

are unquestionably the most convenient and efficient rectifiers at present available for A.C. Mains working. That is why they are used in such large numbers by the leading set manufacturers.

Also Type H.T.2
350 volts. 100 m.a.

and

various low-tension types for
:: :: all purposes :: ::

Full details of these Units and how to use them are given in our 32-page book "The All-Metal Way, 1930."

Supplies for distribution to your customers can be obtained from:
THE WESTINGHOUSE BRAKE & SAXBY SIGNAL CO., LTD.
82 YORK ROAD, KING'S CROSS :: LONDON, N.1



**Straightforward
Emission Tests**
on
2 = 4 or 6 volt Valves



PRICE
42/-
SUBJECT

PLUG in the valves—press the button, and the meter will indicate the condition of any valve. There are no calculations to work out. It is so simple to operate that no dealer or service man should be without a BULGIN DEALERS VALVE EMISSION TESTER.

Catalogues on application to

A. F. BULGIN & CO., LTD.
9-10-11, Cursitor Street, Chancery Lane, London, E.C.4

TANNOY Mains Units give **TROUBLE FREE RADIO**

Tannoy mains units are now available for practically any set. Either for A.C. or D.C. mains of any voltages.

Type 12c H.T. 120v @ 10/15 m/amps \$2 17 6
Type L.W.A. L.T. for 2, 4, or 8v. \$2 12 6

New models for Portable and any type of suitcase receiver (incorporating Westinghouse Rectifier)

Type P.2 H.T. 120v @ 15 m/amps. \$3 15 0
Type L.W.L.T. for 2, 4, or 8v @ 5 amp \$1 19 6

all models made for immediate installation, simply **'SWITCH ON' THAT'S ALL.**

Write for illustrated lists to:—
TANNOY PRODUCTS
1/7, DALTON STREET. S.E. 27.

**one battery
GIVEN AWAY**

Free!

OFFER EXTENDED

Owing to the extremely satisfactory response to our offer of one 108 volt AEONIC Battery free with all purchases of Batteries to the value of £5 (gross) or over, we have decided to extend this Introductory Offer for one week more.

The recent large extensions to our battery manufacturing plant put us in a position to supply to the Trade, with immediate delivery, the AEONIC Batteries which have previously been available only in Aeonie Radio Sets.

These Batteries are of the highest possible quality and are in every way equal to the most expensive standard batteries on the market.

This offer closes on June 28th. Take advantage of it NOW!

Trade terms and full particulars from

AEONIC

Aeonie Radio Ltd.,
Radio & Switchgear Manufacturers,
AEONIC WORKS, HORLEY, SURREY.

Telephone: Horley 400.

Telegrams: "Ammeter" Surrey.

and now
A SILK LINED FRET
NEW 20" CHASSIS
CABINET REDUCED
SPEAKER IN PRICE

Carry the full **Wates** range and keep Summer turnover and profit up.

Write for leaflets and trade terms to:-
THE STANDARD BATTERY CO., (Dept. W.T.)
 184/188, SHAFTESBURY AVENUE, LONDON, W.C.2
 Phone: Temple Bar 6195.

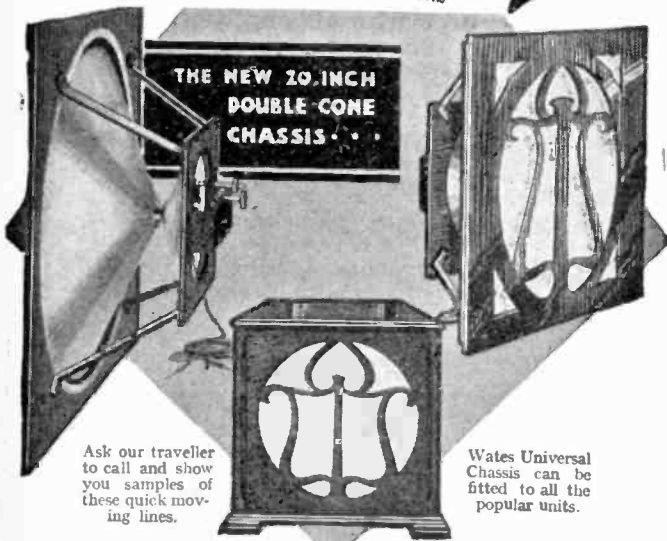

PRICES

Chassis with Universal Bracket in- structions, screws and supporting leg ready for use.	Cone Chassis complete in handsome cabinet fitted with Wates Star Unit Speaker ready for use.
12" Chassis 11/6	14" in Oak £3 10 0
14" Chassis 12/6	In Mahogany £3 15 0
Not fitted with supporting leg	20" in Oak £4 10 0
20" Chassis 17/6	In Mahogany £4 17 6
Silk lined fret in polished wood	
For 12" Chassis 4/0	Universal Bracket only with screws and full instructions 2/0
For 14" Chassis 5/0	

WATES
UNIVERSAL
DOUBLE CONE CHASSIS

PATENT No. 309214

An ideal valve for
PORTABLES

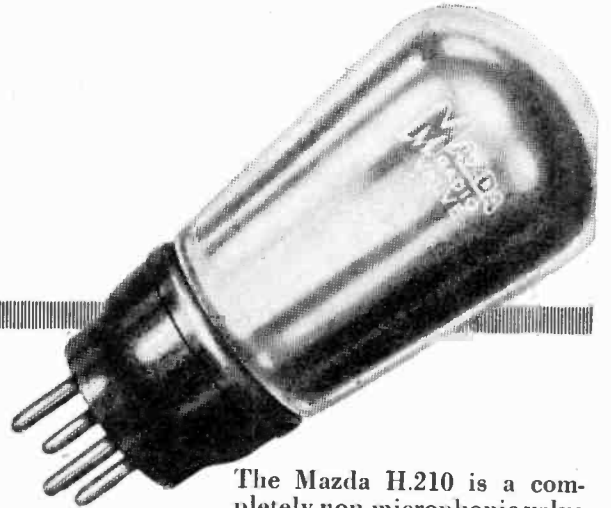

The Mazda H.210 is a completely non-microphonic valve which in addition to having a high amplification factor, has a comparatively low impedance thus making it ideal for use as a detector in S.G. Portable Sets with one H.F. Stage or in the H.F. positions in portables with two stages of H.F. amplification employing triodes.

H.210
PRICE
10/6

High amplification means great sensitivity while the low impedance allows a large input to be handled without distortion.

Let your customers know that these facts, together with its complete absence of microphony, render the H.210 the ideal valve for all portable sets.

The Amazing

MAZDA
RADIO VALVES



THE EDISON SWAN ELECTRIC CO., LTD.
 Radio Division,
 1a Newman Street, Oxford Street, W.1
 Showrooms in all the Principal Towns

EDISWAN

V. 54

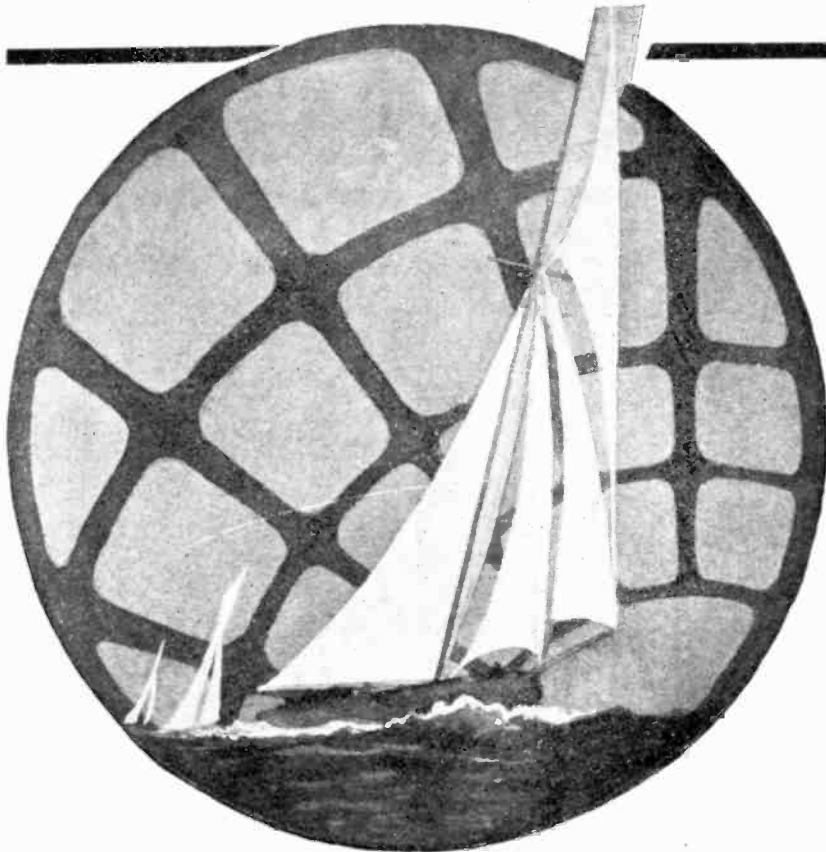

WELL AHEAD OF ITS RIVALS

Right in the forefront of radio—the McMichael Super Range Portable Four is paramount in its class. Not only for reception at exceptional loudspeaker strength of a far more than usual number of stations, but for the tonal quality of its reproduction this receiver proves easily supreme. A fine suitcase model which combines handsome appearance with unique convenience.

Read this, one of many unsolicited testimonials

Dear Sirs,

This afternoon I purchased one of your 22 guinea Portable Receivers. Within ten minutes of getting it home I tuned in not only Daventry but several foreign stations at full loudspeaker strength.

Needless to say, I was amazed, particularly as I have a 4-valve Set which is supposed to be a particularly good one, and when I tell you that your Receiver easily licks mine hollow, it is saying a lot.

To-night I anticipate that I shall bag at least 40 stations. I have always heard that your firm turned out "the goods," but I honestly did not expect such amazing results. The wonder is that any other make of Portable is ever sold whilst yours is on the market.

You have my permission to make use of this letter if you wish.

Wishing your firm every success.

Yours faithfully, E.H.

THE McMICHAEL 1930 SUPER RANGE PORTABLE FOUR

Incorporating the very latest improvements of radio science, this receiver is sparkling with selling points.

HERE ARE A FEW:—

Screened Grid Amplification. Single Dial Control. Superlative Tonal Quality. Easy Control of Volume. Lowest Possible Upkeep Cost. Wide Range.

High Selectivity.

Fitted in Handsome Suitcase with Patent Locking Clips. In every way the McMichael Super Range Portable Four proves a most attractive proposition—good for prestige—and an effective aid to the production of increased business.

Owing to the high degree of selectivity in this and our other Screened Grid Portable Receivers, we are able to guarantee complete selectivity between all main B.B.C. stations under the new scheme of wavelengths, as proved by an actual test under the twin aeriols at Brookman's Park, when both programmes were received separately without interference, and in addition a number of other British and foreign stations.

This test was made on a standard "Super Range Four" Receiver, under an independent Press observer and was repeated at half-mile intervals with similar results.

Sell more McMichael Receivers by means of our special "Deferred Payments on Hire Purchase Terms" system and if you have not a demonstration set write for one. It will prove a revelation in your store. Write at once for full particulars.



L.M. MICHAEL LTD

Manufacturers of Wireless and Scientific Apparatus
WEXHAM ROAD, SLOUGH, BUCKS.

Telephone: Slough 441-442. Telegrams: Radiether, Slough.
London Showrooms: 179, STRAND, W.C.2 (Telephone: Holborn 2466)

RETAIL PRICE: **22 GNS.**
(Including all equipment and Royalties)



IMPORTANT NOTICE OF REMOVAL

On and after June 21st, 1930, the whole of the business of Radio Instruments Ltd. will be transferred to the New Premises, comprising Works, Offices and Show-rooms, which have been built for us in

**PURLEY WAY
CROYDON**

where all future goods and correspondence should be sent.

★

Our new Telephone Number is
THORNTON HEATH 3211 (3 lines)
Private Branch Exchange

and our Telegraphic Address
"INSTRADIO - CROYDON"



'MADRIGAL' WORKS, PURLEY WAY, CROYDON

A 14

Portadyne

PERFORMANCE



GUARANTEED for 5 YEARS.

It's got to be a really good set before you can give a guarantee for five years. The Portadyne is a really good set—good on performance—good to look at—sells fast and gives satisfaction.

And once sold a Portadyne never comes back to you for service—it goes on giving satisfaction—building up prestige for you. Stock Portadyne—our five years' guarantee is a safeguard for you as well as for your customers.

THE PORTADYNE SCREENED GRID "FOUR"
(as illustrated)

S.G. valve, detector, and two transformer coupled L.F. stages. Two geared G.E.C. condensers. Reaction and volume control. Finest cow-hide case, grained crocodile.

(Price complete including Royalties) **22 Gns.**

THE NEW REGIONAL "FIVE"

(Price complete including Royalties) **17 Gns.**

Portadyne

PORTABLE RADIO RECEIVERS

Sole Manufacturers: WHITTINGHAM SMITH & CO.,
"Portadyne" Works, Chase Estate, Park Royal, London, N.W.10.
Telephone: Willesden 7541/2.

66P A BETTER UNIT



More Blue Spot units have been sold throughout the world than of any other make, and the opinion of the millions of satisfied Blue Spot listeners is the genesis of the world-wide reputation of Blue Spot units and speakers. Here it is. The new 66P Unit! It is the logical development of the famous 66K unit embodying among other improvements, all covered by patents and therefore only obtainable in Blue Spot products, an entirely new method of moving the anchor between the four poles. The precision of adjustment is so keen that it is now possible, practically, to place the anchor the exact distance from the poles, as is theoretically necessary to obtain the best effects as yielded by a magnetic unit under the best conditions.

The noticeable result of this increased sensitivity is the larger range of frequencies obtainable. In addition to the powerful reproduction of the bass register with its full beauty, the higher frequencies which largely determine the character of speech and music are also reproduced faithfully.

Blue Spot Power Unit	Type 66P	27/6
Blue Spot Major Chassis	Type 37P	15/-
Blue Spot Special Chassis	Type 31P	10/6
Blue Spot Minor Chassis	Type 28P	9/-
Permissible D.C. Current	30 m/a				
D.C. Resistance 1,000 ohms				

F. A. HUGHES & CO., LIMITED

204-6 Great Portland Street, London, W.1
Phone: Museum 8630 (4 lines)

Distributors for Northern England, Scotland, and North Wales: H. C. RAWSON (Sheffield and London), Ltd., 100 London Road, Sheffield, (Phone: Sheffield 26006), and 22 St. Mary's Parsonage, Manchester, (Phone: Manchester City 3329)

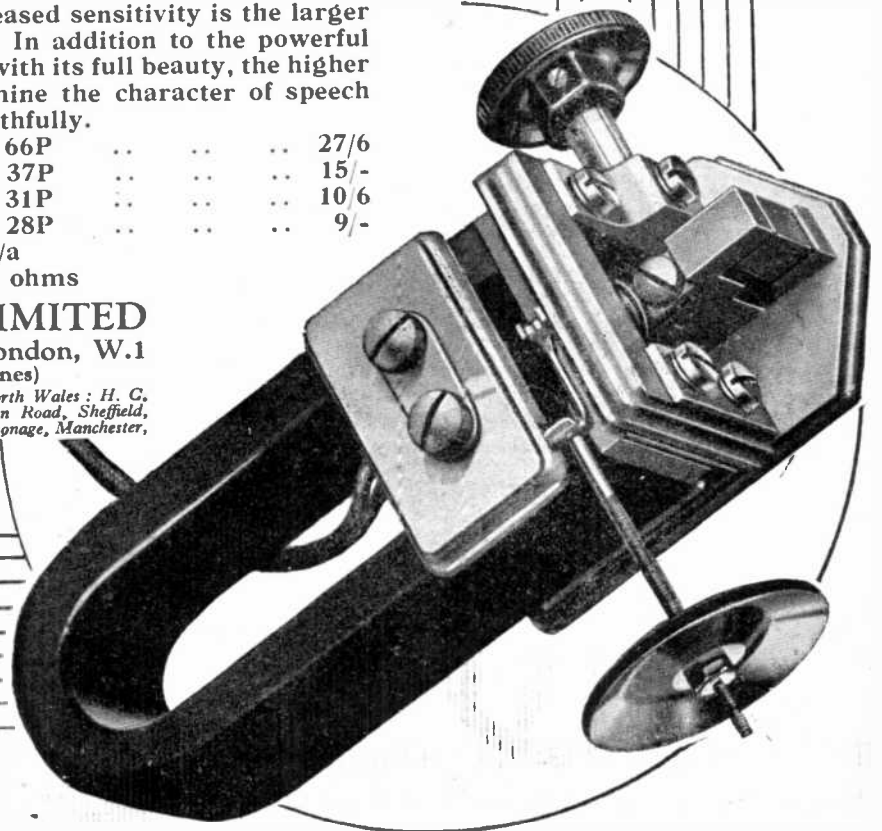

BARGAINS FOR CASH BUYERS

2000 MODERN WIRELESS SETS

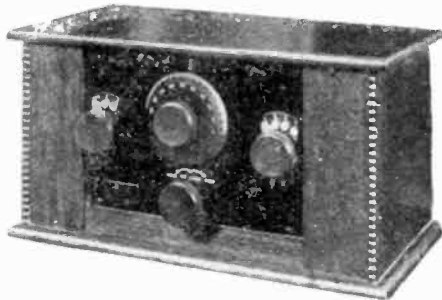

2-Valve Sets in beautifully polished oak cabinets, with all leads clearly tagged. Space to insert your own name on panel. Each, net cash **25/6**

3-Valve Sets as above, but in larger cabinets. Each, net cash **35/6**

(Small quantities carriage and packing 2/6 each extra.)

Short Specification. Very efficient receivers, giving excellent loud-speaker reproduction and selectivity. A thoroughly well-made and finished article. Long and short wave stations by turning a switch. First-class components.

SELL THEM WITH YOUR OWN NAME AT YOUR OWN PRICE.

CARRIAGE PAID ON ORDERS OF 12 OR MORE.

Write, 'phone or call at once. Cash with order only.

ARTHUR G. HEROD & CO.

115/117 CANNON ST., LONDON, E.C.4

Telephone No. : Mansion House 7249.

COUPON

ARTHUR G. HEROD & CO.

Please send me 2-Valve Sets } for
..... 3-Valve Sets }

which I enclose £.....
(Carriage and packing free on orders of 12 or more.)

Name

Address

Sales are growing —so will your profits

Hundreds of people already enjoy the perfect reception given by the Dubilier All-Electric Receiver : hundreds more — many of them customers of yours—will be buying this best of all Sets. Don't have to refuse a sale because you're not stocking. And don't wait to be asked — demonstrate a model. It's a sure way to more sales—and bigger profits.

The Dubilier All-Electric Receiver works without batteries or accumulators, entirely from the electric mains. It gives British and Foreign programmes on an outdoor or indoor aerial.

33 1/3% Retail Trade Discount

Retail Price
£25
A.C. & D.C. MODELS
Attractive Hire Purchase Terms available, providing for immediate trade profit
Initial payment £3-17-0



DUBILIER ALL-ELECTRIC RADIO

Dubilier Condenser Co. (1925) Ltd., Ducon Works, Victoria Rd., North Acton, W.3

STOCK and SELL

FOTOS Valves that guarantee you repeat orders, because each valve is consistently a valve masterpiece.

BIG DISCOUNTS PROFITS

are yours if you stock and sell this widely advertised valve.

Do not delay—send your stock order in now.

GENERAL PURPOSE & POWER

5'6

<i>Super Power</i>	7'6
<i>Screened Grid</i>	15'6
<i>Pentode</i>	18'6



fotos
CONCERT VALVES
Trade Mark
THE HEART OF EVERY SET

CONCERTON RADIO & ELECTRICAL CO., LTD.

256/7, Bank Chambers, 329, High Holborn, W.C.1

Telephone: Holborn 8667



NEW!

An unparalleled proposition

**DEFINITELY
SUPERSEDES
THE MOVING
COIL SPEAKER**

—not merely an imitation
to get moving-coil effect!



EVERY PART
BRITISH MADE. *Licensed under FARRAND and LEKTOPHONE Patents.*

**Exceptional discounts to "Traders"
and Set Manufacturers!**

Retail Price: **COMPLETE CHASSIS £3 · 10**
SPECIAL CABINET MODEL £6 · 10

In production, ready for delivery end of July. Orders are now being received and will be executed in strict rotation.

**SOLD UNDER 12
MONTHS GUARANTEE**

THE TRADE TAKEN BY SURPRISE

for "Traders" — and "Set" manufacturers

The "Silver Ghost" INDUCTOR Dynamic Speaker

This is the latest conception of the Inductor Principle invented by the American Radio Pioneer FARRAND, and is as great a step forward over present known types of Speakers—whether Balanced Armature or Moving Coil—as the original Cone was over the Horn type. It possesses all the advantages of a Moving Coil Speaker, has a better response at the lower frequencies and has none of the disadvantages associated with the M.C. Type.

ADVANTAGES

- There is no moving coil to pick up field current.
- There is no field excitation coil, therefore no introduction of Hum from that source.
- There is no heat generated.
- Requires no Rectifier, Transformer, Smoothing Condenser associated with Moving Coil Speakers on A.C. operated Sets.
- Only a quarter of the weight of a M.C. Speaker.

SET MANUFACTURERS

will realise at once the enormous saving in cost that the Lamplugh Inductor Dynamic offers without sacrifice in performance—which is indistinguishable from that of the Finest M.C. Speaker. It must not be confused with the many Balanced Armature Movements on the market at the moment designed to give Moving Coil effect by artificial methods.

There is nothing to get out of order: it is beautifully finished and of robust construction

The trend of Progress in the Radio Industry has been toward Simplicity and reduced cost as well as improved quality of Reception. The Inductor Dynamic is a signal achievement in keeping with this worthy aim.

Send to-day for full particulars

LAMPLUGH

**INDUCTOR
DYNAMIC
SPEAKER**

To: S. A. LAMPLUGH LIMITED,
King's Rd., Tyseley, BIRMINGHAM.
Please send me full details of the new
Lamplugh INDUCTOR Dynamic
Speaker.

Name _____

Address _____

WIRELESS DEALER

BIG L·S·D FOR THE

IN THESE TRANSFORMERS



Telsen "Radiogrand"
Standard Model made
in Ratios 3-1 and 5-1.
Price 12/6.

The most wonderful "selling line" of Transformers radio has ever known, transformers you know you can afford to stock because they are consistent in their "Sales" throughout each season; this is a very happy frame of mind for the Dealer to be in when placing renewal orders.

This demand has been created through us offering to the public a first-class component at a reasonable price, together with our consistent advertising to the public and the fact that Telsen Transformers are regularly incorporated in the leading "Sets" in the various Radio Journals throughout the country.

TELSEN

TRANSFORMERS

TELSEN ELECTRIC CO., LTD., BIRMINGHAM.



A Helping Hand

Every Pertrix dealer receives our whole-hearted support. We do all we can to help him to increase his profits :

1. By powerful advertising in the leading national and wireless papers.
2. By sending a complete Display Box, which enables every dealer to arrange his own window and counter displays, so that the public knows he is a Pertrix stockist. This attractive display material is specially designed to tie up with our advertising and will greatly add to the artistic appearance of any shop.

★ **GUARANTEE** If an unused Pertrix battery is tested with a voltmeter of not less than 50 ohms resistance per volt, and shows a voltage less than that stated on the label, we shall replace it free of all charge if it is returned to us, carriage paid, within 4 months of invoice date.

EVERY DEALER GETS THIS DISPLAY BOX FREE

PERTRIX
PATENT
DRY BATTERY
NO SAL-AMMONIAC

60%
LONGER LIFE

What a life!



Fill in this Coupon
PERTRIX LTD., Britannia House, 233, Shaftesbury Avenue,
London, W.C.2

I want to stock "Pertrix" Batteries
I stock "Pertrix" Batteries—send me a complete Display Box.
Mark x in which interests you most.

Name _____ Address _____ My usual supplier is _____

(5)

(D)

†d. stamp only is sufficient if posted in unsealed envelope

Pertrix Ltd., Britannia House, 233, Shaftesbury Avenue, London, W.C.2

Telephone : Temple Bar 7971.

ELITE

RANGE OF COMPONENTS

INDUCTANCE COILS.

60 x	-	-	-	-	each	2/4
250 x	-	-	-	-	"	4/-
Titan Coils	-	-	-	-		12/6
Dual Range, 6-pin	-	-	-	-		6/-
H. F. Chokes, 200 to 2,000 metres						3/6
Binocular, ditto	-	-	-	-		3/6
L. F. Transformers, 3-1 and 5-1						6/6
Double Reading Voltmeters	-	-	-	-		5/6
Spring Aerials	-	-	-	-		9d.

TRADE DISCOUNT 33 1/3%

THE BEAVER ELECTRICAL SUPPLY COMPANY
5, GREAT CHAPEL STREET, W.1.

PILOT TRANSFORMERS of QUALITY

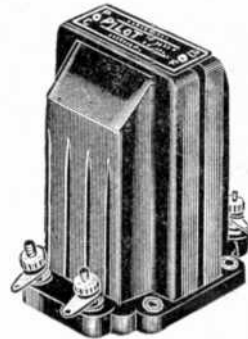

Clear and crisp reproduction of both bass and high notes. No resonance.

The very finest Transformers at competitive prices. Give Pilot Transformers a trial and you will use no others.

THE PILOT LEADS!

In three ratios 2-1, 3 1/2-1, 5-1.

Bakelite Case 11/6 Metal Case 9/6

Also all Components manufactured by The Pilot Radio and Tube Corporation of New York.

Write for Catalogues to:-

THOMAS A. ROWLEY LTD.
59 SKINNER LANE, BIRMINGHAM
SOLE AGENTS FOR GREAT BRITAIN AND IRELAND



Has your Customer seen THESE?

Type W.14
21/-

The best transformer for the eliminator that he must eventually build. The best from your point of view, too. Good discounts and goodwill will be built up if you recommend a transformer that will serve him faithfully, unflinchingly for years. Build up prestige and good sales with



POWER TRANSFORMERS

F. C. HEAYBERD & CO.
10 FINSBURY STREET, E.C.
Telephone: Clerkenwell 7216.

WHY HOLD HUGE STOCK? —let us do it for you!

Distributors of all the famous Portable Receivers Sets, Kits and Accessories by all the leading Makers, ready for immediate delivery.

Our speedy service will enable you to supply practically on demand any of the 100 sets of 1000 components shown in our catalogue.

Get the MURDOCH Catalogue To-day—and make it YOURS!

Simply take out the Discount pages—that's all. You can show the Murdoch Catalogue without fear knowing that you are relying upon the most reliable radio and the most speedy radio service. Get YOUR copy of our catalogue TO-DAY—write NOW.

THE **MURDOCH Trading Co.**

(Incorporated with John G. Murdoch & Co. Ltd.)

59-61 CLERKENWELL Rd., LONDON, E.C.1

FACTORS of everything WIRELESS

Gramophones, Records, Pianos, etc.

Phone: Clerkenwell 6144, 6145, 6146.

Grams: Putiel, Smith, London.

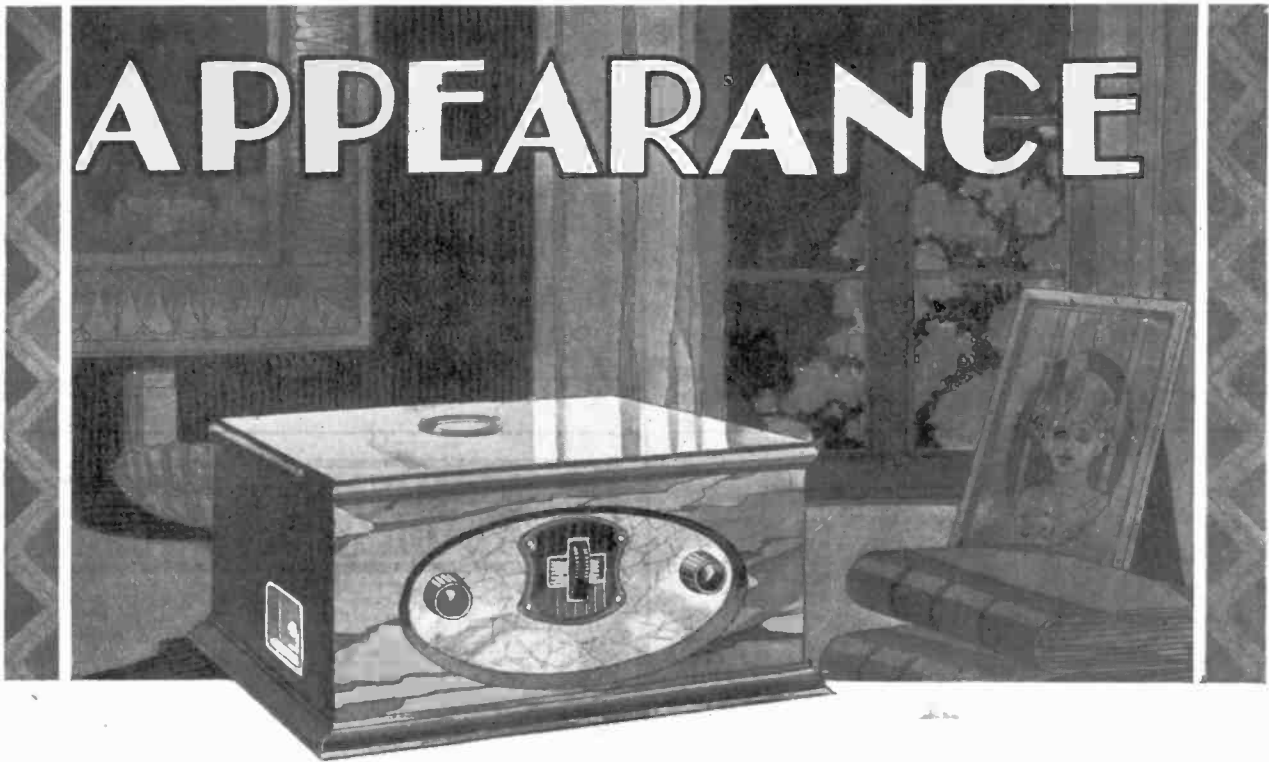

APPEARANCE

Appearance is a telling factor in the sale of a set. For a set that looks good, attracts attention and is a set more than half sold. Stock this Lotus Set—the set that is as good in performance as it is in looks!

The Lotus 3-valve S.G.P. All Electric Receiver is obtainable in a Cabinet of polished Oak or Mahogany, beautifully built and finished. The controls, which are neat and easily operated,

are grouped on a handsome panel which greatly enhances the beauty of the set.

Retail Price £21 cash, or £1:19:9 down and 11 similar monthly payments. Also available as Battery Model at £13:15:0, or £1:6:6 down and 11 similar monthly payments.

Another good seller is the Lotus 3-valve All Mains Transportable, which retails at £25:4. Write for details.

LOTUS ALL ELECTRIC RECEIVER

GARNETT, WHITELEY & CO., LTD., Lotus Works, Mill Lane, Liverpool

London Depot: 183 Old Street, E.C.2
Telephone: Clerkenwell 2580

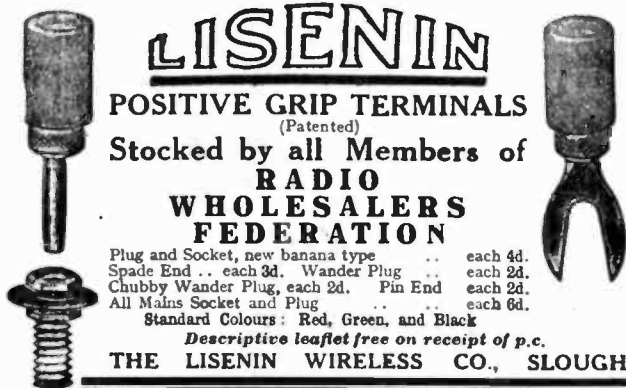

LISENIN

POSITIVE GRIP TERMINALS
(Patented)

Stocked by all Members of
RADIO WHOLESALE FEDERATION

Plug and Socket, new banana type .. each 4d.
Spade End .. each 3d. Wander Plug .. each 2d.
Chubby Wander Plug, each 2d. Pin End .. each 2d.
All Mains Socket and Plug .. each 6d.
Standard Colours: Red, Green, and Black

Descriptive leaflet free on receipt of p.c.

THE LISENIN WIRELESS CO., SLOUGH

"FONATEX" FABRIC GAUZE

The perfect fabric for gramophones, speakers, etc.

Write for samples and prices

ASHTON & CO. (Estd. 1787), LTD.
45, Chorlton Street, Manchester.

PARFAIT

THE PERFECT EBONITE

SUPPLIED IN SIX FINISHES

Semi-Polished Black Semi-Polished Mahogany Highly Polished Black
Highly Polished Mahogany Matt Cube Surface

Send for price list and generous trade terms.

H. B. POTTER & Co., Ltd. Station Buildings, ROCHDALE.

BECOL EBONITE

is RELIABLE

LOW LOSS FORMERS Eleven Sizes

SHEET PANELS TO SIZE

STOCK BECOL EBONITE AND SATISFY CUSTOMERS

Look for Trade Mark. Sole makers:

The British Ebonite Co., Ltd., Hanwell,
LONDON, W.7



METAL THREAD SCREWS, NUTS & WASHERS

Brass or Steel. B.A. or Whitworth Thread

WOOD SCREWS

IRON OR BRASS

BRIGHT, NICKEL PLATED or JAPANED FINISH

TORMO Ltd., 57, OLD ST., LONDON, E.C.1

SIMPLIFY YOUR ACCUMULATOR CHARGING

By using any of the following you can tell at a glance when your customer's accumulator was left, when it is being called for, and how much it will be, etc. No further book-keeping is needed.

ACCUMULATOR CHARGING TAGS
printed in 3 sections, 1 to be attached to accumulator, 1 to file for reference, 1 for customer. 5/9 per 1,000

ACCUMULATOR CHARGING PADS
100 leaves in duplicate. 1/6 per Pad

BOOKS OF 100 LEAVES
in triplicate with your name on each leaf. 21/6 12 Books

These are printed with all necessary details such as name, address of customer, when wanted, etc.

TRANSPARENT LABELS
for fixing permanently to accumulators printed with your name and address 10/6 per 100

Send for Free Samples to:
BURALL BROS.

THE PATENT LABEL FACTORY, WISBECH.

Postage on small Orders 9d. extra in U.K. only All Foreign orders must include sufficient to cover cost of postage



THE "BABY" THEY'LL BUY



Behind each "ISO" Baby 75 (2 1/2") is a big demand—a demand that is solely due to the exceptional quality and extremely low price. The friction drive of the Baby 75 dial is pleasingly smooth and reliable and entirely devoid of backlash. Specially strengthened scale. In Black or Brown 2/4 each retail. Full range of ISO Products on request.

"ISO" BABY 75 "ISO" DIALS

HAW & CO., LTD., 20 Cheapside, London, E.C.2
Phone: CITY 9510. Grams: "Hawoon, Cent."

MOULDINGS

of Guaranteed Accuracy

in
BAKELITE AND EBONITE

Ebonite Sheet, Rods & Tubes

UNITED EBONITE MANUFACTURERS LTD.

Phone:—
Seven Kings 2171/3 Chadwell Heath, ESSEX

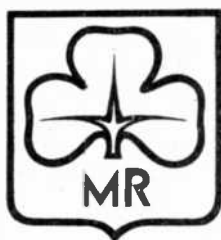

MAKING
WIRELESS
SIMPLE

4-VALVE SCREENED GRID RECEIVER.

SINGLE TUNING CONTROL COMPLETELY GANGED CIRCUITS CALIBRATED IN WAVE LENGTHS.

Fitted in Walnut Cabinet; weight 32 lbs.

2-volt 23 A.H. unspillable Accumulator mounted on acid-proof rack.

108-volt H.T. Battery 12 m/a rating.

Average H.T. consumption 8-9 m a.

Gramophone Jack.

External Loudspeaker Jack.

External Aerial and Earth Sockets.

Excellent Loudspeaker reproduction, giving very enjoyable music and particularly clear speech.

Range and selectivity equal to, if not better than, any other portable set on the market.

Price 17 Guineas

including valves, batteries, turntable and Royalties.

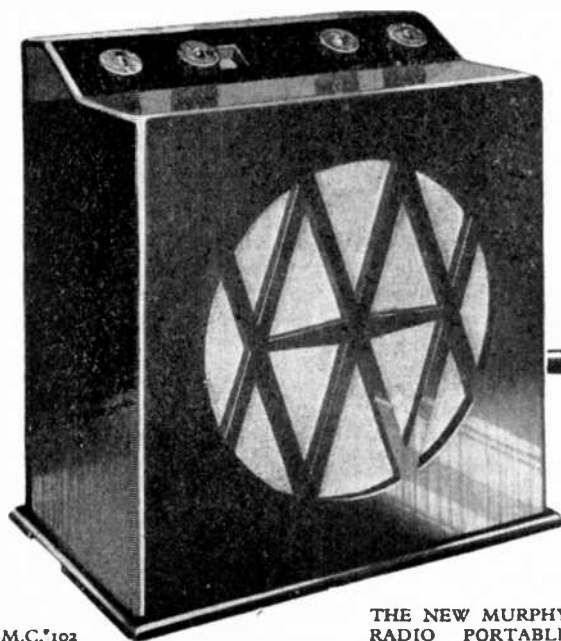

THE NEW MURPHY RADIO PORTABLE

The only sets with ganged tuning calibrated in wave lengths!

NOW that's a big point worth noticing, isn't it? But we didn't stop at the big things when we were designing Murphy Radio Sets. We considered *every* detail big and small, because we had two aims in view—two aims which I considered to be of the utmost importance.

Firstly, to make wireless receiving sets absolutely simple to control; and secondly, to sell them to the public at prices which you and I know to be reasonable.

And we have done both of those things in this first set of ours which is a 4-valve Screened Grid Portable.

I will send you full particulars and shall be pleased to demonstrate this really excellent set to you if you will send the coupon to us.

Frank Murphy

B.Sc., A.M.I.E.E., A.I. Rad. E.,
Chartered Elect. Engineer.

MURPHY RADIO LTD

WELWYN GARDEN CITY, HERTS

C O U P O N

Murphy Radio, Ltd., Welwyn Garden City, Herts

MURPHY RADIO PORTABLE

Please send Particulars and Trade Terms.
Please send a Representative.

NAME

ADDRESS

W.T. June 21

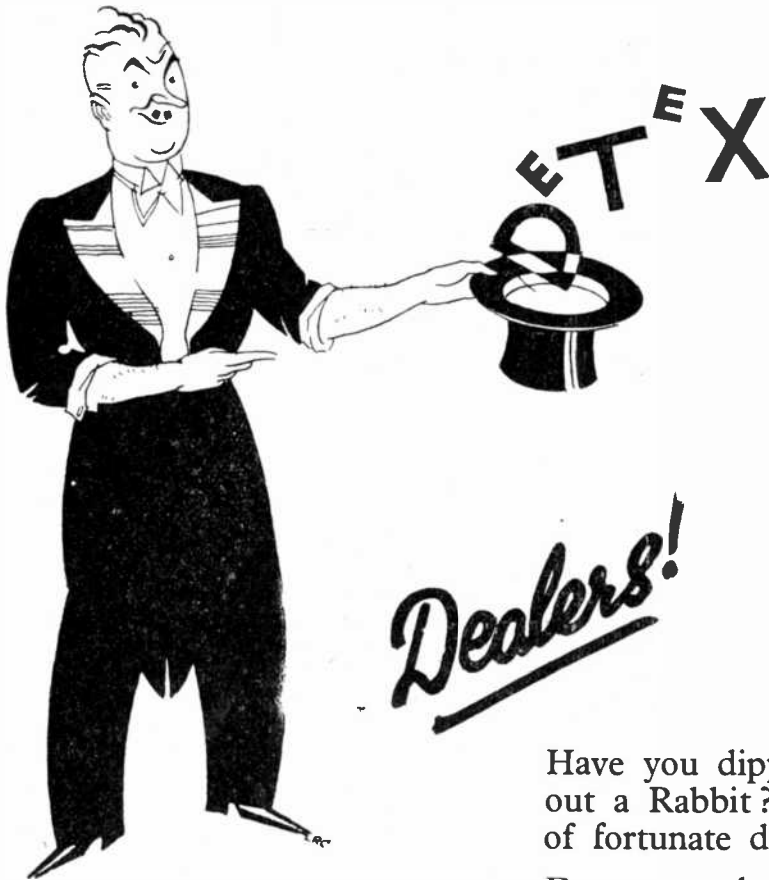

A NAME TO CONJURE WITH

WHAT ARE YOU
TAKING OUT
OF THE HAT?

Have you dipped in the trade hat and pulled out a Rabbit? Or have you joined the ranks of fortunate dealers who have drawn Detex?

Do not stock your shelves with unsaleable goods that will never move except at a suicidal "cut prices": *but demand Detex!*

You can depend upon this new DETEX Straight Five Portable as a ready seller and a handsome profit maker. It is backed by a good name and generous advertising. *Detex sells itself.*

For full details of trade terms write to:—

RETAIL PRICE

GNS **8** GNS

COMPLETE

DETEX
PORTABLE RADIO

DETEX LTD.,
161, VAUXHALL BRIDGE
ROAD, S.W.1

Phone: Victoria 1303.



The only weekly Trade Journal circulating to Bona-Fide Wireless & Gramophone Traders.

EDITORIAL VIEWS.

A Question for Factors to Answer.

IN a letter commenting on the recent welcome tendency among manufacturers to safeguard the distribution of their goods and the interests of the traders handling them, a northern dealer-correspondent puts forward the view that approval of the various schemes on foot must be tempered by the reflection that they are too late. By now, he suggests, there are so many other distributing trades with a finger in the radio industry's pie—ranging from chemists' sundries-men through garage-owners to ladies' outfitters—that individual action cannot hope to be effective.

He adds the opinion that many of these other traders, whose interest in radio is often of the slightest, and who frequently secure recognition without just claim to it, have been introduced and encouraged by wholesalers who themselves cater largely for more than one industry.

We cannot agree that our correspondent's general conclusion is a right one; we are firm supporters of the idea that it is "never too late to mend" and, moreover, there is already evidence in the trade to show that conditions are improving. The other point which has been brought up, however, does merit some consideration, and there is a point of equity involved on which the trade would undoubtedly like to hear the views of some of our leading wholesalers, and, too, of the R.W.F.

There is no doubt that in all-too-many cases, although there are exceptions, the multi-trade factor is quite prepared to grant trade terms on radio goods to those of his customers—let us say—in the motor trade, who care to ask for them—irrespective of whether the goods are required for *bona-fide* re-sale, or merely for private use by the buyer or some of his friends. On the other hand, we have heard of very many parallel cases indeed where the radio dealer has been flatly refused any concession whatever on motor or other goods, handled jointly with radio, by his factor.

This latter principle, of course, is unquestionably correct, and factors who have such a wholesome respect for manufacturers' conditions of sale are to be commended. But we should like the same degree of integrity to be manifested in connection with the radio industry's merchandise. As it is, "mixed" wholesalers generally seem easily able in one direction to compromise with the very conscience that admits no question when taxed from the opposite direction. In point of fact, we have for consideration at the very moment the action of a northern motor-radio wholesaler who has told a well-

known dealer quite frankly that "it is generally accepted that people in the motor trade are entitled to discount on radio goods!"

A shrewd observer might suggest that, due to their greater strength and determination, manufacturers in the older trades involved in these circumstances are able to instil into their wholesalers a livelier fear of the consequences of indiscretion than the radio manufacturers have so far been able to do. But surely he is a poor man who plays the game solely to avoid punishment!

No. There is a vital question of policy and ethics involved here, and, as we said in the beginning, we should like to hear what factors and the R.W.F. really feel about it themselves.

The Joint Licence.

THE task of settling all the small points of detail involved in a pooling of patents and licensing interests between two great companies must inevitably be tedious and difficult. Such has been the case, we believe, with the Marconi and Gramophone Companies, on the one hand, and Standard Telephones & Cables, Ltd., on the other, whose experts are still engaged in the preparation of the joint licence which they are to issue.

Early in May, it will be recalled, when we exclusively announced the successful termination of negotiations between the three companies concerned, we stated that it was hoped to approach the trade with a single licence covering all of their joint radio receiver patents in a month's time. Rather more than six weeks have now elapsed, and the task is still, we understand, some way from completion.

For ourselves, however, we believe that all possible speed is being employed, and at any time in the next week or two the final stages, may be reached. Perhaps we may remind the trade, in view of misconceptions which have come to our ears, that when the new licence is issued, it will make available, under one agreement, all the existing radio receiver patents owned or controlled in this country by Marconi's Wireless Telegraph Co., Ltd., the Gramophone Co., Ltd. (His Master's Voice), and Standard Telephones & Cables, Ltd.—the royalty payable remaining at the present flat rate of 5s. per valve-holder.

This, apart from any future benefits which may accrue under the licence (and these should not be negligible), will mean a definite saving to those makers who, for example, are now paying separately for such items as push-pull amplification or the supersonic circuit.

8th Year of Publication.

Editorial, Advertisement and Publishing Offices:—

**ST. BRIDE'S HOUSE, SALISBURY SQ.,
FLEET STREET, LONDON, E.C.4.**

Telephone Numbers—

CENTRAL 7713 (5 lines). CITY 4011 (4 lines)

Telegrams—

"WIRELESTRA," FLEET, LONDON.

Branch Offices:

BIRMINGHAM: Central House, New Street. Telegrams: "Trapress, Birmingham." Telephone: Central 4026 and 4027.	MANCHESTER: 260, Deansgate. Telegrams: "Motrader, Manchester." Telephone: City 8970 (4 lines).
---	--

Annual Subscription Rates:

United Kingdom, Canada and Newfoundland. All other countries Abroad.

4/- Post free. 10/-

Published Every Saturday.

Trade News

Some Facts about Regional Broadcasting.

How Sites for Transmitters are Chosen.

THERE are some important facts for the trader, and also points which he can convey to his customers, in a recent statement sent out by the B.B.C. on the question of Regional Broadcasting. Explaining the policy which has governed the progress of the scheme up to the present, it is stated that the total number of licence-holders included in the service area of the new London dual-programme transmitter is approximately one million. This total represents approximately one-third of the total number of licences held in the British Isles. It is for this reason that the first dual-programme Regional station was built for the service of London and the Home Counties.

Considering the North region, the service area, with its centre near Huddersfield, will embrace nearly 700,000 licence-holders. It thus follows that more than one-half of the total number of licence-holders can be served with alternative programmes by two high-power medium wavelength stations built near London and Huddersfield. On this account, then, the London and North Regional transmitters were built before the Scottish or South-West Regional transmitters. With the completion of the North Regional station, the three dual-programme transmitting centres (London, Midland and North Regional) will supply approximately three-quarters of the total number of licence-holders with alternative programmes.

The Scottish dual-programme station will be built before the South-West Regional station, partly because it will embrace more licence-holders and partly because South Wales and the West Country already obtain a better service from the Daventry transmitters than does Scotland. The total number of licences held in Wales is only about four per cent. of the total held in the whole of the British Isles.

It may appear that the actual sites which are being chosen for the various regional stations could be improved by moving the stations closer to the main centres of population, and thereby reducing the sensitivity dislocation consequent upon the withdrawal of the previous stations which were erected centrally. The finding of a satisfactory site for a regional station, however, is governed by the following main factors: (1) that it must be in open country and on ground from which a reasonably circular polar diagram can be obtained. (2) that it is close to a first-class trunk telephone, of the cable type. (3) the ground must be reasonably flat over a considerable area and the subsoil suitable for making foundations and (4) that it can be purchased at a reasonable figure.

Dealer's Prize Window Display.

At a window-dressing competition held at Thirsk, Yorks, a second prize was awarded to Mr. Eric Thompson, wireless dealer, Kirkgate, who had on view a wide selection of radio and electrical goods.

Mr. Thompson, it will be recalled, won a prize in our Radio Week selling scheme competition this year.

RADIO IN DURHAM HOTELS. An Increasingly Popular Practice.

An application on behalf of five Durham public houses for permission to have wireless sets installed for the entertainment of their customers came before the local Bench recently. Permission to use the sets in unlicensed hours was also applied for.

The Bench decided to permit the reception of programmes in licensed hours, but not on Sundays or at other times. It was, however, intimated that special applications could be made for times when outstanding events were included in the broadcast programme.

It will be recalled that a number of other provincial licensing committees have granted similar applications to public houses and hotels, and since the practice is likely to become popular, it represents a lucrative avenue which the trade should follow up intensively.

A Maidstone Robbery.

We learn that the premises of Mr. Smith, wireless dealer, Lower Stone Street, Maidstone, were broken into last week, and a portable wireless set, valued at 16 guineas was taken from the window.

Marconiphone Prize-winners Filmed.

Result of the "Ideal Home" Competition.

ON Friday afternoon, last week, three people had a pleasant surprise when Mr. J. H. Williams, the Marconiphone Co.'s sales manager, accompanied by a cinematograph camera man, arrived at their homes to present the prizes they had won in the competition organised by the Marconiphone Co. at the recent Ideal Home Exhibition. Readers will recall that three prizes were offered for the three nearest estimates of the number of visitors attending the Marconiphone demonstration room during the Exhibition. Some exceedingly accurate forecasts were received as the following results show: *Actual visitors*, 10,898; *nearest estimates*, 10,900 (first prize) Mrs. Britton, 1, Dunoon Road, Forest Hill, S.E.23; 10,901 (second prize) Miss E. Fox, 19, Acris Street, Wandsworth, S.W.18; 10,895 (third prize) Mr. W. Adcock, 74, Carlton Vale, Kilburn, N.W.

As the second and third competitors were level on the result, it was decided to increase the value of the third prize by offering a Model 60 cone-speaker instead of the Octagon model originally announced. Mrs. Britton therefore receives a moving-coil speaker, Miss E. Fox a gramophone pick-up, and Mr. W. Adcock a Model 60 cone.

The film was made possible by the courtesy of Ensign, Ltd. (Cine Production Department), and it is hoped to arrange that a copy of it will be available for any dealers who may also possess the necessary projecting apparatus. Application for the film should be made to the Marconiphone Co., Ltd.



Good for Trade. The publicity value attaching to broadcasts of popular events is turned to good account by Varley. This will be appreciated from this photo, which was taken outside their London showrooms during a recent B.B.C. running commentary.

Trade Exhibition of Cabinets.

"Camco" Products for Next Season On Show.

FROM June 27th until July 5th the Carrington Manufacturing Co., Ltd., are holding a special trade exhibition of "Camco" products for manufacturers interested in radio and gramophone casework and cabinets at their new sales offices and show-rooms at 24, Hatton Garden, London, E.C.1.

The primary object of the exhibition, we are informed by the company, is to encourage the trade to place their orders earlier than in previous seasons, and a full range of "Camco" products for the 1930-31 season will be on view.

Besides showing the large number of "Camco" lines already familiar to manufacturers, there will be several new lines, including a radio-gramophone cabinet, known as the "Waverley." This has been designed to incorporate any normal size electric or spring gramophone motor, and a moving-coil speaker can be fitted if desired.

As has already been mentioned, the exhibition is open to manufacturers only, who are invited to call at any time between 9.30 a.m. and 6 p.m. (Saturday 12.30 p.m.).

A similar exhibition will be held for wholesalers at a date which will be announced later.

This action on the part of the Carrington Manufacturing Co., Ltd., will be of particular value to those set makers who are well ahead with their designs for the coming season, and who wish to incorporate their products in cabinets of standard design.

Television in Dublin.

A few weeks ago we published details of the reception of television from Brookman's Park by Mr. Tom Payne, of the Newcastle, wholesale firm of Payne & Hornsby, Ltd. News is now to hand that this firm have added to their laurels in this field by receiving television of excellent quality at their Dublin branch, both during the morning and evening transmissions.

Bowyer-Lowe Sale.

We learn that the trade took a great interest in the recent auction sale of the Bowyer-Lowe plant and machinery conducted at Letchworth by Fuller Hall & Foulsham, of Holborn, E.C.

Two hundred people attended, and examples of the prices obtained are a Pallas universal miller, £160; "Taylor Hobson" engraving machines, £57; four auto screw machines, £248; a pair of hydraulic presses, £124.

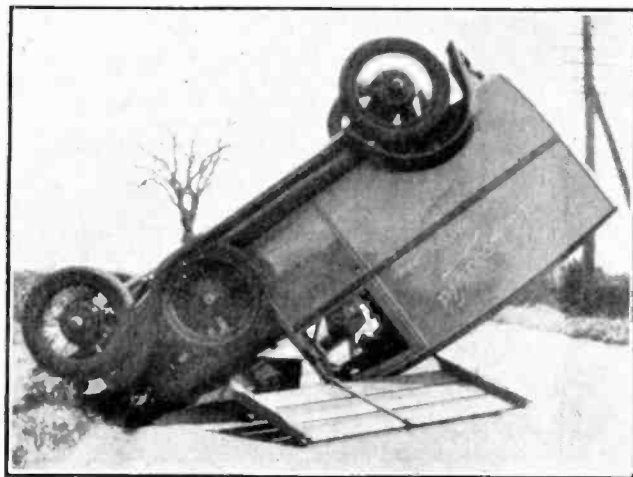

Crash! While returning to Grimsby this P.A. van, belonging to Fred. W. Wood Ltd. of that town, turned turtle. Fortunately the driver had a remarkable escape without injury, and the apparatus, though of considerable value, was not damaged in the slightest.

ENGLISH BROADCASTING'S BIRTHDAY

Last Sunday (June 15th) was an historic date in the development of broadcasting, for on this date ten years ago Dame Melba broadcast her memorable concert from the Marconi Co.'s experimental station at Chelmsford on a wavelength of 2,800 metres.

This was the first occasion on which a programme was radiated for entertainment as distinct from experimental purposes.

Sale of Celebritone Works.

Manufacturers are reminded that the auction sale of Celebritone, Ltd. (in voluntary liquidation) takes place next Tuesday (June 24th) at 11 a.m. on the premises at Chase Estate, Park Royal, London, N.W.

After the goodwill of the business has been offered for sale, the stock of gramophone and radio accessories will be auctioned.

Longer Business Hours.

Weston-super-Mare Urban Council have issued an order suspending half-day closing by wireless dealers and other tradesmen until September 20th.

Colchester's Civic Week.

A scheme of shop window dressing competitions has been decided upon in connection with Colchester's Civic and Empire Week to take place early in July.

The Empire Exhibition is under the auspices of the Empire Marketing Board, the Department of Overseas Trade, the Ministry of Agriculture and Fisheries, the various Dominion Governments and the Borough of Colchester, and many valuable cups are being offered to traders for shop window displays and outside decorations.

In the exhibition and throughout the grounds music will be supplied and relayed free by the Mullard Wireless Service Co. Ltd., in conjunction with the *Essex County Standard*.

The programme also includes pageantry and carnival, and in the carnival procession prizes are to be awarded in onesession for tradesmen's decorated vehicles.

PORTSMOUTH MAN FINED.

Radio Exchange Wires "Tapped."

One way of combating the influence of the "radio exchange" competition—though not one to be generally adopted, we fear—is suggested by a case heard at the Portsmouth Police Court recently, when, arising out of the short circuiting of about sixty subscribers to a local radio exchange, William Charles Harris, of Keswick Avenue, Copnor, was summoned for fraudulently diverting electricity contrary to Section 10 of the Larceny Act.

Defendant was not a subscriber, and it was alleged that he "tapped" the wire, with the result that about sixty subscribers were short-circuited.

Harris, for whom Mr. G. H. King appeared, pleaded not guilty. When cleaning up his garden defendant saw two wires running along his steel fence, and later, on May 20th, he noticed that the insulation had worn off and the wires were shorting on the fence. He decided to tap the wires to see if they were the cause of the interference with ordinary radio reception in the district. He did not complete the job.

The magistrates, however, found the case proved, and defendant was fined £5.

PHILIPS VAN AT STAFFORD.

Big Crowds Enjoy Concert.

The trade at Stafford received a welcome fillip as a result of a visit to the town of the Philips Radio Van in the course of its tour of the Midlands.

Arriving from the Potteries, where a concert was given outside the Michelin Works, the van was drawn up in Gaol Square, and during the evening a concert was given as arranged; but so large did the crowd become that the traffic was hindered, and at the request of the police the van was moved to the more spacious Market Square. Hundreds of people followed it there, and for two hours enjoyed the concert. Finally the van drove through the main streets brilliantly illuminated, with the loud-speakers still in action.

Radio on the "Southern Cross."

The receiving set installed on the "Southern Cross" in which Captain Kingsford Smith is, at the time of writing, preparing to fly the Atlantic, is one specially made up prior to his flight from Australia as a result of co-operation between the General Electric Co., Ltd., and the New Systems Telephones Co., of Australia. It has been reconditioned by the G.E.C. research laboratories in preparation for the trans-Atlantic flight. It is equipped with Standard Osram Valves, i.e., S.215, HL.210 and L.210, and "Gecophone" headphones will be used.

The installation comprises a 3-valve receiver and a short wave transmitter operating on a wavelength of approximately 33 metres at 250 watts, and another transmitter operating on a wavelength of 600 metres. The call sign is VMZAB and the transmission will be telegraphy on raw A.C.

Amplifier in Carnival Procession.

A feature of a carnival procession at Sittingbourne last week was a car decorated with coloured balloons entered by Mr. W. E. Nailor, of the Radio Stores, High Street. Band amplifying equipment, was mounted on the car, by which band music was reproduced en route with striking effect.

Symphony and National Portables to be Continued. Cheaper Prices and R.W.F. Distribution.

DURING the period when the Symphony and National portable receivers were enjoying considerable popularity among both the trade and public, a good deal of the output was being manufactured by the Plessey Co., Ltd., of Ilford, who, in addition to being well known as contractors to Government Departments, have been actively engaged in the commercial manufacture of radio since the very early days.

The Plessey Co. are now planning to continue the production of the two portables, and we learn that the distribution and service are being taken over by an associated organisation, British Radiophone, Ltd., of Aldwych House, Aldwych, London, W.C.2. In a talk with Mr. P. Attwood, who has been connected with the trade for a long time, and is now Sales Manager of British Radiophone, we learn that his Company will, if they secure the future support of the trade, assume the obligations of service in connection with those Symphony and National portable sets already in commission.

It has been arranged that the future sale of both receivers shall be carried out solely through wholesalers who are members of the R.W.F., and, in addition, both instruments are to be sold at considerably lower prices. The Symphony set will retail at £13 13s. instead of £17 17s. 6d., and the National at £12 12s. instead of £15 15s. British Radiophone point out that it is now nearly six months since the Symphony Gramophone & Radio Co. discontinued active distribution of these sets, and, therefore, it is unlikely that there are many still unsold in the trade. In view of this circumstance, and also of the fact that future prices are to be much more attractive, they do not propose to make a rebate offer to the trade.

It is understood that the distribution by British Radiophone will commence almost immediately, and interested dealers are invited to get in touch with them.

"Wired Wireless" Pending in Blackburn.

An application to the Blackburn Town Council by Mr. J. E. Lynch for permission to establish a wireless relay system in the Devonport Road district of Blackburn has been referred to a special committee for consideration.

LOOK

JUNE 27

AT 7.30 P.M.

WIRELESS-GRAMOPHONE RECITAL

WILL BE HELD AT THE

PUBLIC HALL, BECKENHAM

HICKING

The
Marconiphone
Co.

ADMISSION FREE.

(Including Running Buffet.)

The striking coloured poster issued by Mr. H. B. Hicking, the Beckenham dealer, in connection with a forthcoming radio and gramophone recital which he has organised.

C 10

Phillips at Wimbledon.

Philips Lamps, Ltd. have installed P.A. equipment for use by the Automobile Association at the Wimbledon Tennis Championship, June 23rd-July 5th.

A 60-watt amplifier and microphone have been installed in the A.A. box in the Centre Court, feeding speakers in the car park whence any car can be summoned.

PERSONALIA.

R.I.'S ACQUISITION.

IT will probably come as a surprise to many people in the industry to learn that the "well-known trade personality" to whom we referred last week as shortly taking control of the Sales Organisation of Radio Instruments, Ltd., is none other than Mr. W. C. Lawson, for so long associated with Brown Bros., Ltd., the Great Eastern Street factors.

Mr. Lawson joined Brown Bros. in 1922, and while latterly he has devoted



Mr. W. C. Lawson—an excellent impression by Lear.

himself largely to the buying side, he has also had very considerable experience in the selling of radio since broadcasting commenced. His knowledge of every section of the trade is remarkably comprehensive, and R.I. naturally feel that in him they have secured a valuable acquisition.

Mr. Lawson actually takes up his new duties in the middle of July, to coincide with the company's final occupation of their new works at Croydon.

CHANGES AT CLIMAX RADIO.

Climax Radio Electric, Ltd., Haverstock Works, Parkhill Road, London, N.W.3, inform us that Mr. H. G. Marsh,

K.B. Staff Outing.

The annual outing of the Kolster-Brandes works at Sidcup, will take place on June 28th. This function has become a very popular one among all the employees at Sidcup, and it is the intention of the directors to make this year's outing better than ever. Special coaches will leave the factory early in the morning, and after running through Kent, will proceed to Margate via Canterbury.

On Taking Sets Abroad.

The International Broadcasting Union which has just held its annual general assembly at Ouchy, Switzerland, is arranging to distribute to organisations interested in touring a booklet containing the conditions on which wireless receiving sets may be introduced into, and operated in, the various European countries. The publication is expected to be available shortly, when we hope to have a copy. It should provide useful information for the dealer to have available in the interests of better-class customers.

of Sheffield, late representative for Yorkshire, Nottinghamshire and Derbyshire, has been appointed sales manager.

Mr. G. W. Ashley, 25, Thompson Road, Sheffield, has been appointed

Mr. H. G. Marsh, Climax representative for Yorkshire, Notts, and Derbyshire, and Mr. F. J. Kingwell, "Zuyder Zee," Whitehouse Avenue, Boreham Wood, is now acting as representative for the Home Counties.

A YORKSHIRE WEDDING.

Congratulations are due to Miss M. E. H. Smith, who was married recently at St. Edmund's Church, Roundhay, Leeds, to Mr. A. E. Rhodes, Miss Smith is well known in the Yorkshire trade, as she has been for several years manageress of the Leeds branch of Ensign, Ltd. (Houghton's), the wireless and photographic wholesalers. She was appointed when she was only 23 years old.

CHANGES AT K.B.

MR. S. WILDING COLE, who until recently was sales director of Kolster-Brandes, has now taken over complete control of the works and factory at Sidcup. Mr. W. A. Bartlett now becomes the director of the sales and marketing organisation.

A NEW "EKCO" REPRESENTATIVE.
THE increasing popularity of "Ekco" products has made it necessary to increase the outside selling staff, and Mr. V. P. Cole, of 23, Carolina Road, Thornton Heath, Surrey, has been appointed additional London representative.

Mr. Jones, the former London representative, will restrict his activities to a smaller area of London, so that he may give even more attention to traders.



ROUND AND ABOUT—

The "Trader" Staff on Tour.

HERE you see some views of the biggest solely-radio works in the United Kingdom—the new "Ekco" premises now nearing completion at Prittlewell, just outside Southend-on-Sea.

The spot itself is practically ideal—facing the arterial London road, so that all the week-end traffic will see the factory and the name of E. K. Cole prominently in view; with a railway siding from the main London line immediately at the rear; a gorgeous natural park almost opposite; and plenty of labour living no more than a quarter of a mile away.

The works themselves are built on two acres of land with nine more in reserve; they measure 400 feet long by 200 feet wide—80,000 square feet on one floor; and the finished premises will include a two-storey office building in front of the present huge erection. The wonderful Plenum system of air-heating and cooling is employed throughout the building—as it is in the R.I. works at Croydon—and a large plant has been installed for this alone.

Ekco's is one of the most romantic stories of industrial expansion ever told, since in five years they have developed from a three-man concern, established in the tiny room shown below, to the large concern now spread out in Southend and Leigh, but shortly to be consolidated under one roof again. Even now, in the middle of the summer, we have seen 700 workpeople hard at it to meet the surprisingly high current demand, and to build stocks for the coming autumn. Incidentally, one of the buildings we visited was an amusement hall, which had to be converted in a tremendous rush last Show-time to accommodate 300 workers required to meet the extra demand occasioned by Olympia. The place bears the signs of having been put into commission in three weeks, but even so it was a triumph of hasty organisation.

A tremendous programme is being planned for the coming season. The works are being equipped for real mass production throughout, using moving conveyors wherever possible, and it is intended to absorb nearly the whole of Southend's unemployed when the staff is brought up to full strength—that is, nearly 2,000 employees.

Prominent in the scheme is a new 3-valve A.C. set, which

we have seen and heard and which is to be turned out in large numbers—with other new lines to come later. The set promises remarkably well and appears to be an excellent price-and-class line, about which the trade shall hear in detail as soon as we are permitted to handle a sample in our "lab."—which has been promised for a date not very far distant.

The characteristics of youth and "go" are stamped all over the Ekco personnel, and their progress is undoubtedly due in large measure to this fact. Added to which there is a really friendly spirit between Directors Cole and Verrells and the general staff, while finally, of course, the goods have played their part in this remarkable industrial adventure.

SPEAKING of works expansion calls to mind not only the fine new building of Radio Instruments, Ltd.—almost similarly situated on the Croydon by-pass road to Brighton—but also the fact that several other manufacturers are extending in anticipation of increased trade this year.

The Varley additions, of which we published a photograph a short time ago, are nearly complete; and now Belling & Lee, Ltd., the well-known terminal manufacturers, are carrying out a good deal of internal rearrangement to accommodate a new batch of rapid-output machinery. Mr. Lee himself was on the spot throughout Whitsuntide supervising Herculean operations by a sweltering staff of engineers.

U' in the North recently we met the usual Lancashire optimism. Mr. Potter, of Tonex, in Blackpool, has overcome entirely unexpected—and, he maintains, avoidable—difficulties in getting one or two suppliers to meet his requirements and is at last under way with the "Unibox" screened grid unit. Production and delivery are now going ahead.

But if he has been forced to "mark time" in this direction, Mr. Potter has not been *wasting* his time. He has, in the meanwhile, blossomed into a very able newspaper editor, publisher and proprietor. The Spring Issue of "Tonex Topics"—a four-page news-sheet, with headlines, blocks, "boxes," pithy items and "Stop Press" included—is a really bright affair, calculated to interest the reader in Tonex components.

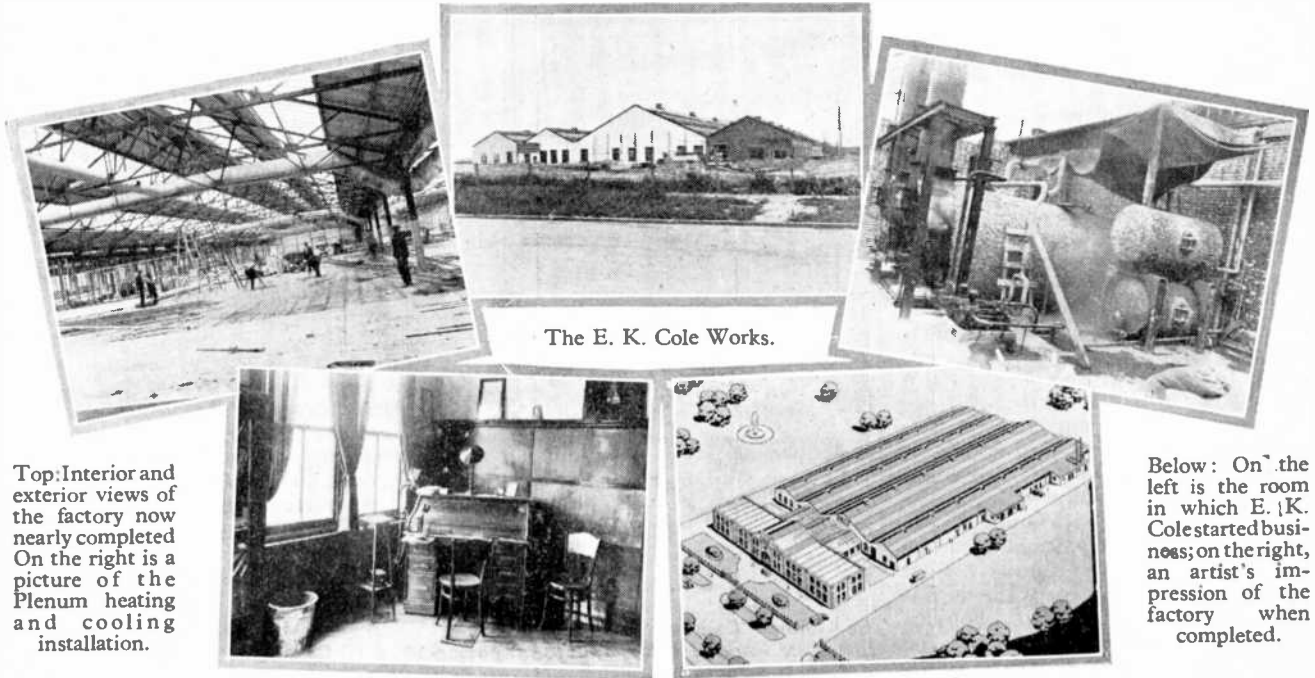

The E. K. Cole Works.

Top: Interior and exterior views of the factory now nearly completed. On the right is a picture of the Plenum heating and cooling installation.

Below: On the left is the room in which E. K. Cole started business; on the right, an artist's impression of the factory when completed.

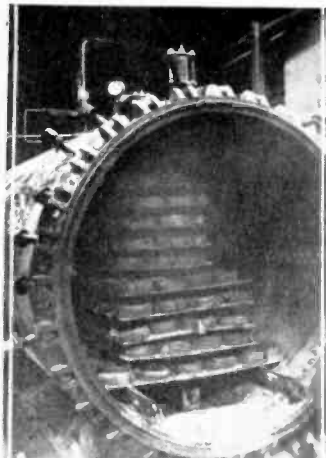

In the Ward & Goldstone Works

OUR impressions of the works of Ward & Goldstone, Ltd., followed by a report on the "No-Mast" aerial. The illustration on the left shows a steam-heated drum in which rubber-covered wire is vulcanised.

A RECENT visit to the Manchester district prompted us to call at the Pendleton works of Ward & Goldstone, Ltd., and while there we were afforded an opportunity of inspecting the numerous interesting processes carried on in the manufacture of the various "Goltone" products.

First and foremost, the mass production of connecting wires for every electrical purpose must be described, since the main part of the works is devoted to this. The processes include covering in silk, cotton and rubber, stranding and braiding, starting from the bare drawn wire.

The Stranding Process.

On emerging from the offices into the works one is met by the roar of hundreds of whirling bobbins which at first makes conversation rather difficult, but the ears soon become accustomed to the noise, though, taken in conjunction with the sight of the myriads of revolving machines, it is an experience not soon forgotten.

The stranding machines, on which such wires as the standard 27/42 Litzendraht, 7/22 aerial wire and the 49 wire core for Negrolac are made, are very interesting. Each wire is drawn from a separate bobbin through a die pierced with as many holes as there are wires, the whole die and bobbin assembly rotating while the stranded wire is drawn off on to a reel. This is true of cables like 7/22 aerial wire, but Litz and Negrolac wire stranding is more complicated, since the wires are not all stranded together in one operation. Instead, to take the case of the Negrolac, the wires are first stranded in sevens, and each 7-strand cable is then drawn through another 7-hole die, giving the 49 strands as seven sevens.

It will be realised that this machine looks very complicated in operation, and great care has to be taken to make sure that no single wire breaks.

Covering and Braiding.

Passing to the cotton and silk covering department, we find bare copper wire being covered with single or double cotton or silk windings. The wire is fed along with one or two bobbins of the covering material rotating continuously round it at a high speed. In the case of the double covered wire, the two bobbins revolve in opposite directions. The same method is used for wires of

all gauges, but naturally the machines vary in size roughly according to the gauge. It is very intriguing to watch the familiar coverings being so smoothly and rapidly wound on the wire core. In some cases cotton coverings are wound on rubber covered wires.

Another interesting department is that in which the external braided covering is put on certain types of cable, such as ordinary flex, battery leads, and so forth. Here we find the cable being drawn through the machines, with numbers of bobbins containing the braid threads rotating round it. Now if a piece of braid covering is examined, it will be noticed that it is woven or plaited in a rather complicated pattern. This is achieved in the machine in an ingenious way whereby the bobbins not only rotate round the cable, but also pass inside and outside each other as they go round, moving in "figure of eight" tracks. It is nothing more than an application of the principle of the maypole on a small scale, in which the relatively rigid cable is the pole, and the braid threads the ribbons.

It is obvious now how multi-coloured braids are produced, the various bobbins containing different coloured threads. Where a single "tracer" thread is required for identifying a lead, one bobbin carrying a thread of the particular colour needed is employed.

Rubber-Covering Process.

The manufacture of rubber covered cables next claimed our attention. Here a number of wire cores are covered at the same time by feeding them between two rollers, each carrying semi-circular grooves round their periphery, and arranged so that the grooves in the two rollers are opposite each other. These rollers are rotated, and through them is passed a number of wire cores, one in each groove, with a sheet of white rubber, as wide as the rollers, above and below the wires. The result is that on passing through the rollers the rubber is moulded by the pressure round the wires to form a cylindrical covering of a diameter depending on the size of the grooves in the rollers.

The rubber used in this process is of the pure, raw unvulcanised type, and this being soft and without elasticity, it is easily moulded round the wire cores, and is joined together by the pressure of the ridges in the rollers between the grooves.

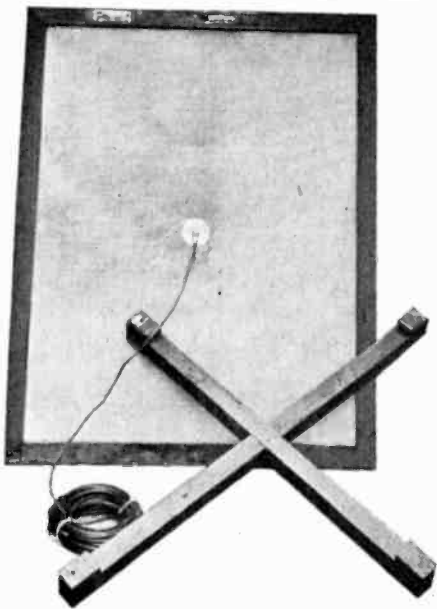

The Goltone No-Mast aerial, showing the cross-piece used for mounting purposes. Note the coil of Negrolac down-lead.

Naturally, the various wires are joined together by thin webs of rubber which are afterwards cut and the rough edges trimmed off. If a piece of rubber-covered wire is examined, the marks of the joins will often be visible. Very often two rubber coverings are applied, the first of pure white rubber and the second of grey rubber.

Another method of rubber covering is to extrude the soft rubber through a die with the wire core passing through the centre. This exhibits no marks of joins.

After being covered as described above, the wire is treated with french chalk to prevent adjacent turns sticking together when they are wound on the drums. The next process is devoted to "curing" the unvulcanised rubber. The coils of wire are removed from the drums and placed in a large steam-heated cylinder, a circular door being opened at one end for this purpose. When the cylinder is fully charged, the door is shut, and the temperature raised by means of a steam jacket. The rubber-covered wire is then left to "cook" for a certain time,

seen in course of manufacture, while the "Easifix" Radio Assemblies, or multiple connecting cords, are specialised products of the wire departments.

The "No-Mast" Aerial.

The latest product of the wireless side of the business is the "Goltone" patent "No-Mast" plate aerial, of which we have since received a sample for test. This consists of a rectangular wooden framework about 2 ft. by 2 ft. 6 ins., in which is mounted a sheet of perforated metal finished in bronze. To the centre of the metal sheet is attached one end of a coil of wire which serves as the downlead. This wire may either be ordinary heavy rubber-covered wire or a 50 ft. coil of Negrolac, the latter type costing 6s. extra. The attachment at the centre is made very strongly so that it cannot pull away or corrode if the aerial is used out-of-doors. In addition to the rectangular plate aerial, a cross of wood is supplied for mounting purposes. This cross is first mounted on the brickwork or chimney of the house,

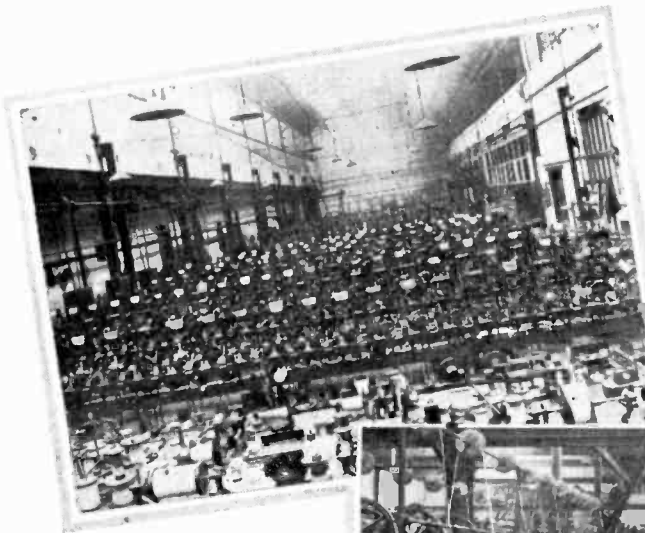

Some views in the Ward & Goldstone works, showing their large extent. Above is the silk and cotton covering bay with hundreds of machines.



On the left is one of eight corridors in the braiding department, while above is the rubber-covered cable and automobile wire department.



and when the process is finished, the rubber has become tough and elastic.

Another interesting department is that in which braided and cotton-covered wires are coated with insulating varnish. It is here that the fine black varnish coating of Negrolac is put on, while Lacoline insulated connecting wire is also made from tinned copper wire previously cotton-covered.

Other Departments.

This covers the main processes in connection with the manufacture of wires, although there are numerous small details with which we have no space to deal here.

It should not be forgotten that besides the wire business, Ward & Goldstone, Ltd., manufacture many other lines for the wireless, motor and electrical trades. For instance, they have an up-to-date moulding department where we saw bakelite mouldings being turned out in the special presses. The latest method, using compressed pellets of the moulding material, is used.

The various "Goltone" wireless components and units were

or on the rafters under the roof, by means of four 3 in. nails supplied.

Test Results.

We installed our sample of the aerial under a tiled roof 11 miles from Brookman's Park, where it is giving good results. A good deal of the pick-up is on the down-lead, of course, but the plate is evidently acting in a capacitative fashion not unlike that of the original Hertz plate aerials, and is definitely adding to the efficiency. The latter is rather greater than that of a small aerial previously used inside the roof. As far as we can judge, the selectivity is as good as that of the small indoor aerial.

The No-Mast has a great advantage in that it is inconspicuous and occupies very little space, making it very suitable for use by flat dwellers and others who cannot or do not wish to erect an ordinary aerial. Also, mounted flat against a wall or chimney, it is not likely to be blown down in a storm. The price is 24s. (with rubber-covered downlead) or 30s. with a 50-ft. Negrolac down lead.

PROVINCIAL TRADE NOTES

Essex Business Contrasts.

INQUIRIES in Mid- and South-Essex trade circles reveal a rather peculiar contrast in present trade conditions. In Mid-Essex, taking Chelmsford as the centre, there is a generally quiet spell, except in regard to repairs and the sale of replacement parts. There is a small demand for portables, chiefly for the Pye model. A summer sales push is badly wanted at Chelmsford; window displays are neglected (some are entirely given over to electrical and other goods), and public advertising is practically non-existent. One exception that should be mentioned concerns a trader whose summer accounts compare very favourably with his winter takings. This dealer said to me "Those who slow down for the summer are missing a great chance. They also injure their winter business. The public want consistency, and if they find a shop window filled one day with wireless goods and the next with reading lamps or bicycles they are not going to pay much attention to that shop. Summer radio business must be made attractive and if you go all out for it you will get it." His summer business methods might be summed up as follows: A useful hire purchase system; free delivery and personal attention to domestic receivers; a bright out-of-doors atmosphere in the shop window, novel and regular notices in the local newspapers; a daily distribution of leaflets at a near-by car park, inviting visitors to the demonstration room, and ready and obliging service always.

I found a pleasant contrast in South Essex, in the Southend district. Here nine traders out of ten say that, since Easter, business has been more satisfactory than at any corresponding period for many years past. Pye and McMichael portables are keeping well to the fore, and many hotel installations have been made. Repairs too, are keeping the workshops busy. The new "Ekco" factory is proving a capital advertisement for local radio, and several new shops are opening up in the district in the hope of sharing some of the new business. Several restaurants have now gone over to broadcast music in the place of orchestras.

Wireless played a large part in the success of the Essex Agricultural show at Epping last week, the whole ground being fitted up with P.A. apparatus. At the recent Chelmsford Y.M.C.A. fete, Mullard P.A. apparatus was successfully used, and the organisers cordially thanked the Company. The Y.M.C.A. have formed a strong wireless section, and members of the trade are giving a series of lectures and demonstrations, which are open to the public.

Hereford Shows.

WIRELESS interest in Hereford appears to be on the wane, and business is slow. Some dealers have given in without a struggle, and their windows are devoted to photographic

and sports goods. Others, however, are paying greater attention to window displays and Press advertising. Original holiday displays featuring portable sets are drawing attention at Messrs. King, of Eign Street; Messrs. Marriott, St. Owen's Street; Messrs. Wallis, Eign Street; and at Mr. Scrivens, Union Street. Portables are in fairly good demand, and all-mains sets are increasing in popularity. Philips and G.E.C. products are meeting with a fairly steady demand.

Radio exhibits at a recent Home Exhibition at the Drill Hall, Hereford, were only to be found on the stand of Messrs. C. F. King, who were the only wireless exhibitors. Their stand, set out on elaborate lines under the direction of Mr. Critchley, the sales manager, was one of the most attractive in the hall, and good business was done. The firm's P.A. equipment was used for musical reproduction during the five days of the exhibition.

At the Shropshire, Worcester and Stafford Electrical Exhibition at the Shirehall, Hereford, last month, however, radio dealers were present in good numbers. The local exhibitors were Messrs. Daffern & Edwards, High Town; Harding Bros., Ltd., Commercial Street; Mr. W. Rowberry, St. Owen's Street, and the Wyeside Welding Co., Whitecross Street.

On the gramophone side business is steady and quite satisfactory. There is an exceptionally good demand for the cheaper makes of portables and cheap 10-inch records are going well. Heins & Co. have been making some very tasteful displays of H.M.V. and Columbia machines and records at their Broad Street show-rooms.

Duck, Son and Pinker, the well-known music firm, also have an excellent display of good class machines and records. One of the local newspapers is devoting nearly two columns a week to record reviews in conjunction with local dealers, who are supporting the feature with small but telling advertisements.

Hull Asks for Standardisation.

TRADE is rather slow in Hull just now. Any outstanding broadcast is reflected in an increased demand for batteries and valves. In particular, Miss Amy Johnson's talk from Australia resulted in a big rise in the sale of accessories. Public address equipment was used to broadcast the talk in the centre of the city.

The reduction in the price of certain Ever Ready batteries is consolidating the position of this firm's products and will still further decrease the demand for cheap continental batteries.

The restricted trading facilities foreshadowed by Philips and Marconiphone has been well received, as it is felt that greater security will be afforded against price cutting.

The lack of standardisation in wireless accessories appears to be long overdue. The recent new "Blue Spot" units and chassis entail the stocking of some eight

or nine new lines in place of the old unit and chassis, and it is felt that it would have been an easy matter for the manufacturers to have produced a chassis with a standard fitting to take three units. Another source of annoyance to retailers concerns the special H.T. batteries required for the various portable sets. It would be a simple matter to standardise one size of battery which would enable the dealer to give prompt service for replacements, instead of waiting for the special size to be ordered.

Nottingham Cutting Declines.

DURING the past few weeks there has been a slight improvement in business at Nottingham. Portable receivers especially have been selling better than usual.

The wholesale houses report steady turnovers, the chief demands being for all-mains sets and units. Of the latter, "Ekco," "Atlas," and "Regentone" are the most popular, while of sets, Pye, G.E.C. and Marconiphone are the leading lines. T. Beadle & Co., Ltd., again report good business with Pertrix H.T. batteries, but apart from these, sales are spread over components and valves.

Of major importance at the moment is the diminution of price-cutting, which has been so rife for some time. Where price-cutting is most prevalent, it is concerned chiefly with lines that are not well known. At one time the "cutting" over here reached such a pitch that one concern was publicly advertising a discount of 25 per cent. on all Philips' products. Happily this has now disappeared, and prices are once again normal. There is a great deal of obsolete apparatus in some of the city stores, and much is being made of the "cut" prices at which they are offered. However, the public is becoming very wary, and confining itself to the purchase of guaranteed goods.

A large amount of P.A. work is now being undertaken by Pearson Bros., Long Row. They have recently completed an elaborate P.A. equipment at the Olympic Speedway. A battery of moving-coil units is housed in a raised tower in the centre of the arena.

Mr. Pillow, of the Wireless Store, Goosegate, has a very fine window display of complete receivers. This follows a recent show of all the latest components. This dealer has cash and H.P. prices clearly marked on all goods, considerable H.P. business being done.

Manufacturers' Publicity in South Wales.

TRADE is on the slow side so far as complete sets are concerned, but McMichael and Pye portables are selling well. The "Ekco" mains unit is also very popular and traders comment on the very consistent aid given by the makers' sustained publicity in the area. Many other manufacturers, of course, indulge in intensive publicity, but some of

them are inclined to be spasmodic in this matter, whereas "Ekco" and one or two others carry on advertising with unfailing regularity.

Some time ago THE TRADER reported the inauguration of a Llanely Branch of the W.R.A. I understand that although the loyalty of individual traders to the W.R.A. remains unabated, the development of a local branch, apart from the South Wales W.R.A., is in abeyance for the time being. Nevertheless traders are co-operating for trade improvement. They are, as becomes W.R.A. members, acting in concert against dabblers, and exchange views on local problems.

The hiring out of P.A. apparatus for social functions and the like, is proving a useful adjunct to business. The demand would undoubtedly be greater if the public were more aware that such facilities are available from traders.

James Howell & Co., Ltd., the Cardiff traders, have just added an attraction that is proving to be a great draw. This is the "Recordavox" machine by which customers are enabled for 1s. to obtain a complete gramophone record of their own voices. The record is ready to take away within a few minutes of recording.

At Mr. H. N. Kirk's premises at Gower Street, Swansea, "Exide" H.T. accumulators have recently been featured

with success and are selling excellently. Western Radio & Supplies, Ltd., 10, Working Street, Cardiff, have found "Ekco" power supply units for portables a leading sales feature of late.

Wakefield Private Trading.

TRADERS in the West Riding are asking if it is possible to produce an all mains set at lower prices than those ruling at present. Experience has shown that there is a demand for a set more within the reach of the artisan's pocket, and several sales have been lost owing to the high price of the most modest set at present manufactured. Trade in all-electric sets in the Dewsbury district has been retarded by the action of the Town Council, who announced some months ago that they intended changing the mains to A.C. but since then nothing has been done. Traders are waiting for something definite to be decided in order that they can complete orders.

Trouble in the textile trade, and unemployment generally are having a bad effect on business in this industrial district. Up to the present sales in portables have been disappointing, but in certain districts a fair demand for mains units is reported. Enterprising traders are considering ways and means of stimulating trade, and in the next few

months several interesting "stunts" will be made.

Not only are radio traders having to meet heavier rate demands in consequence of the increasing expenditure on the part of the West Riding County Council, but they are also having to contend with a condition of affairs from this source which calls for immediate action. Officials in good positions at the County Hall, Wakefield, are allowed, for some mysterious reason, to trade in radio goods. An order amounting to nearly £20 was recently cancelled by a man who said he could get a set, complete with manufacturer's guarantee, through the County Hall. It is hardly necessary to add that the trader who was "fleece" in this manner is so disgusted with the policy of the firm who allow this to be done that he is boycotting their goods in future. It is significant that among the few things that cannot be purchased in this way are gramophones. Dealers are naturally asking why wireless manufacturers do not tighten up their distributing methods as the gramophone manufacturers have done. Apart from this aspect of the question, however, the whole question of the unfair competition from the County Hall calls for united action. The Chamber of Trade has discussed it at various times, but nothing definite seems to have resulted.

The Kolster-Brandes Super Radio-Gramophone.

A VISIT to the recently opened showrooms of the above-mentioned company enabled us to inspect and hear their super radio-gramophone (Models 188 and 189). This instrument, a pedestal model, is handsomely made, and housed in a walnut cabinet. It retails at £95 complete.

Description.

The loud-speaker is of the moving-coil type manufactured by the company. The flat type pick-up is likewise of Kolster-Brandes' own design and manufacture. The radio side consists of one H.F. stage, transformer coupled to a grid-leak detector. This, in turn, is transformer coupled to the first L.F. valve, the latter being transformer coupled to two L.S.5.A.s in parallel taking 400 V on the plates. The instrument is quite capable of an undistorted output of 6 watts. Two jacks are fitted in the back of the cabinet for connecting an external loud-speaker. With this plugged into one jack, both speakers are connected, whilst the second jack enables the self-contained speaker to be cut out.

A short aerial and an earth are necessary, the leads from these being plugged into sockets at the back of the cabinet. The gramophone circuit employs the two L.F. stages.

Above the grille of the speaker is located a tastefully shaped panel containing three tuning dials, the H.F. and aerial tuning, with fine adjustment. Below are situated the short to long wave switch, volume control and reaction knob. At the front of the motor-board there is a gramophone volume control, an "on" and "off" switch and one for changing from radio to gramophone. Both volume controls operate on the radio side, whilst gramophone reproduction is controlled by that on the motor-board only.

The machine is for use on A.C. mains only, two models being made for voltages from 100 to 240 V, 40-60 cycles. The motor is of the Kolster-Brandes induction type with automatic stop.

Tests.

We noticed first that the mains hum on both radio and gramophone reproduction was very unobtrusive. We understand that the instrument takes 80 watts on the radio side, and 200 watts on the gramophone side, including the current used by the turntable motor. The tracking of the pick-up on the model seen was not all that is desirable, the needlepoint passing through the turntable spindle. Two other machines examined exhibited this fault, but we were assured that the latest models were better provided for in this respect.

We were enabled to hear various records, and the general impression gleaned was a very favourable one. High notes were present and the bass was full without boom. No pronounced resonance peaks were audible. The machine handled transients in a satisfactory manner. We varied the position of the volume control, but the reproduction was unaffected in quality. In the maximum position there was ample volume for a hall. The motor was quite steady and quiet.

On the wireless side the set showed itself to possess adequate selectivity for modern needs, and it is claimed that 40 stations are obtainable at least. The reproduction was clear on speech.

The machines are in production, and we understand that, in addition to a repair depot in London, there are three engineers "on the road" for speedy help if it should be needed.

A view of the Kolster-Brandes Super Radio-gramophone reported upon herewith.



WITH THE TRADE ASSOCIATIONS.

THIS week we report the usual monthly meeting of the Manchester branch of the W.R.A., the last meeting of the Scottish traders' organisation, and meetings of the new Bolton and Blackburn branches of the N.F.R.R.

Manchester Branch, W.R.A.

THE usual monthly meeting of the Manchester branch was held at the Deansgate Hotel this week, among those present being Messrs. J. R. Carter (Hon. Secretary), A. G. Egginton, H. G. Jenkins, C. F. Thatcher, F. H. Loft, and J. Webster (Hon. Secretary, Liverpool Branch, W.R.A.).

Arising out of a resolution passed at the previous meeting, scheduling prices deemed reasonable for service charges, Mr. Carter explained that the object of the debate and the decision arrived at was to ascertain how long a trader ought to be ready to maintain any set he sold. Mr. Carter thought the matter was really one for individuals to decide upon, rather than for hard and fast rules to be drawn up.

Discussion next took place on the Bucks branch proposal for establishing County Executives (formed of delegates from branches in such counties). Mr. Carter explained that Manchester had not hitherto found it practicable to send delegates to London meetings; but if the county scheme became operative, it might be possible for two or three delegates to be deputed to attend from Lancashire as a whole.

Mr. Webster said that the Liverpool branch could not afford additional expense; if a County Executive were formed, where would the money come from? In his own case, he himself paid his expenses when attending headquarters, costing about £5 per meeting. At present London headquarters retained 16s. out of the guinea subscription, leaving 5s. for branch funds. Suppose Manchester decided on a levy of 10s. 6d. per head for its branch purposes, some men might refuse to pay; nevertheless, having paid their guineas, they would remain as members of the W.R.A.

Extra Levy on Branch Members.

It was pointed out that Manchester's existing scheme was a 5s. levy per member (10s. last year), plus the 5s. allocation from London; a total of 10s. per head for working expenses. There were only four members in arrears.

After a discussion as to whether a guinea was a sufficiently large subscription, it was mentioned that Headquarters retained the whole guinea in cases where a member had no local branch for attachment; and an observation was made that a 5s. allocation should be made in such cases to the nearest branch.

It was felt that County Executives would be a success, and the fact of a trader being in the W.R.A. was regarded as adding tone, status and self-respect. At the same time it was stressed that some members showed too little interest in the Association.

It was stated that certain manufacturers had applied for a list of branch members. Mr. Carter remarked that these firms might be anxious to get in touch with reputable dealers in connection with some marketing policy. That showed the prestige gained by becoming a W.R.A. member.

Approval of Price Maintenance Schemes.

Mr. Jenkins gave notice that he would propose the following resolution at the next meeting in connection with the Marconiphone price maintenance arrangements:

"That this meeting approves the method of selling retail goods under a definite price maintenance agreement with the manufacturer, and individual registration under such agreement, either direct through the manufacturer or through limited factorship agencies. We put on record the determination of the members of this branch to support loyally all manufacturers introducing such a selling policy, and we see in such a scheme the only sound method of eliminating 'dabblers' and price-cutting, and affording real protection to legitimate dealers."

Mr. Jenkins added that he had written to the Marconiphone Co., and to Kolster-Brandes, commending them on their attitude to price control.

Mr. Webster mentioned that he intended to take a course of instruction under the Marconiphone training scheme.

After considerable further discussion on the question of subscriptions, the canvassing of new members and other branch matters, it was agreed in further debate that Stockport, Liver-

pool, Preston and other Lancashire branches should be asked to express approval of the County Executive scheme.

No resolutions were passed on any of the topics referred to, which were merely debated, leaving the subjects to come up at the next monthly meeting.

Scottish Radio Retailers' Association.

MR. JAMES PLUCKNETT, the President, presided at a meeting of the Scottish Radio Retailers' Association, held in Dowell's Rooms, George Street, Edinburgh, last week.

The Chairman said that he had sent a letter to the Secretary of the National Federation of Radio Retailers and the Secretary of the Wireless Retailers' Association. The following are substantial extracts from the letter.

"SIR,—I recently received a request from Mr. A. de Villiers to send him copies of the *Scottish Radio Dealer*, the official monthly journal of the Scottish Radio Retailers' Association, in exchange for the *National Radio Retailer*, which I am asking our Secretary to do.

"In reading through the *National Radio Retailer*, I cannot help deploring that so much animosity should exist between the two Associations, both of which profess to be working in the interest of the radio retail trade. May I venture to suggest that these two Associations should agree to sink their differences and work as separate concerns for the common good?"

"We are affiliated to the Wireless Retailers' Association and are only too ready to work in conjunction with them and we expect that from time to time they will assist us when requested. There is surely no reason for the continued animosity of the two Associations. The aims and objects of both are the same, and while they are fighting one another they are apt to lose sight of the best interests of the whole trade.

"May I, therefore, suggest that with the Exhibition coming on, an endeavour is made to sink these differences or, at any rate, to camouflage them. Let each Association agree to work as a separate concern for the common good of all"

"There is no doubt that matters are shaping better and the united efforts of all of us are having some effect at any rate with the manufacturers, but this unfortunate parliamentary interference with price maintenance calls for the united action of every one of us, and if the various associations are all at 'sixes and sevens' no proper action is likely to be taken to oppose it."

JAMES PLUCKNETT, *Chairman,*

SCOTTISH RADIO RETAILERS' ASSOCIATION.

It was agreed to recommend members to support the Wireless Retailers' Association in their endeavour to stop the movement for legalised price-cutting.

Bolton and Blackburn Branches, N.F.R.R.

A REPORT that we have received from the Hon. Organising Secretary of the N.F.R.R., states that a successful inaugural meeting of the Bolton branch of the Federation was held at the Empress Hall, Bolton, on Monday.

Seven new members were enrolled, in addition to those present who were already members, and the election of officers resulted in Mr. J. Grimshaw (Messrs. J. & R. Grimshaw) being appointed Chairman, and Mr. G. Good, local Hon. Secretary.

It was decided to hold over the election of Treasurer and other items of business until the next meeting, which will be held at the Empress Hall, Bolton, in three weeks time.

IT is also reported that an inaugural meeting of a branch at Blackburn was held on Tuesday, when Mr. J. E. Hargreaves acted as Chairman and Mr. Mallinson once again acted as Secretary.

At the end of the meeting it is stated that eleven new members joined, and Mr. J. E. Hargreaves and Mr. Hugh Boyle were elected Chairman and Secretary *pro tem*.

ITS **P**ERFORMANCE IS ABOVE THE ORDINARY

THE SET THAT **P**ROVES ITS CLAIMS

PROVOKES ENTHUSIASM

THE SET THE **P**UBLIC WILL DEMAND

CUSTOMERS WILL BE **P**ROUD TO OWN THIS SET

AMPLION

P *two screen-grid*
PORTABLE

The secret of success.

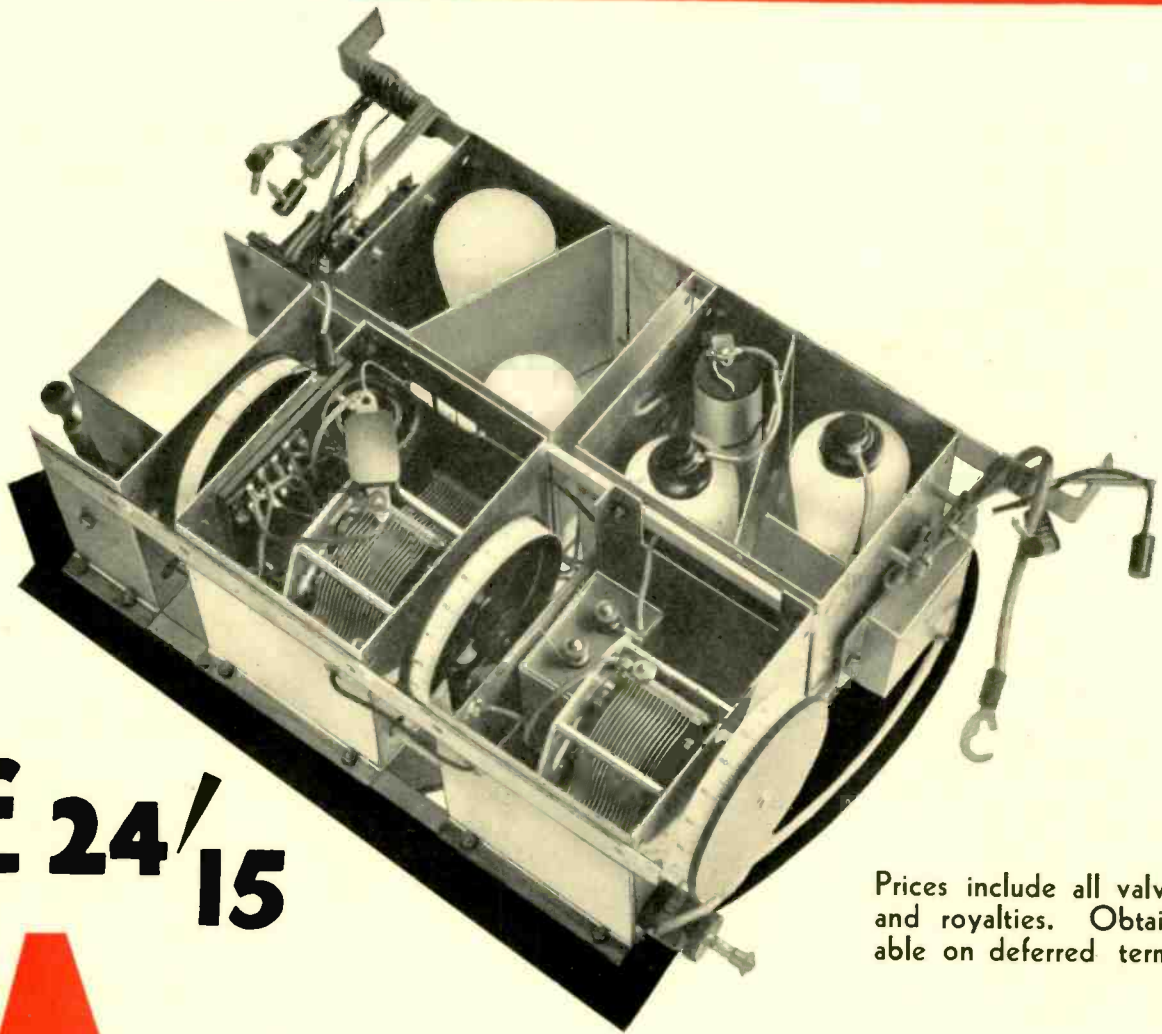

£ 24' / 15

Prices include all valves and royalties. Obtainable on deferred terms.

AMPLION

REVEALED!

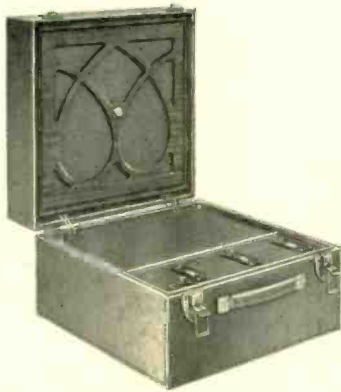

A MPLION, having every reason to be proud of their new Portable's performance, do not hesitate to make public the complete design and layout of their set. They *invite* inspection by illustrating the chassis. Further, they give below a few of the points which have aroused such enthusiasm among traders and the Wireless Press alike:—

1. Thoroughness of metal screening for all valves and components, which ensures great stability in handling. Note the compact layout and design.
2. With two stages of H.F., the input to the detector valve is sufficient to necessitate only one stage of L.F. being used.
3. The Balanced Armature Unit is specially wound to match the impedance of the pentode valve in the output stage.
4. Individual aerials are used for long and short wave. Thus no long wave loading coil is needed.
5. The assembly being of an unusually high order, there is no risk of connections causing trouble or breaking. Your customers are saved annoyance and disappointment, and you are saved the costs and trouble of servicing.

P TWO SCREEN - GRID
PORTABLE



Test Reports..

From the "Wireless Trader"

OUT OF THE ORDINARY

"We soon realised that it was something out of the ordinary. In the first place, the tone was much better than one normally expects from a portable."

TONE CLEAR, CRISP

"... the designer has managed to secure an overall tone which is very satisfactory. The bass is very well in evidence and is at the same time clear, while the high notes are crisp."

POWERFUL BUT ECONOMICAL

"The output obtainable is also above the average, particularly in view of the relatively low H.T. consumption."

From the "Wireless World"

SENSITIVITY

"The sensitivity on long waves is exceptionally high."

BASS PARTICULARLY GOOD

"The general quality of reproduction is pleasing, the bass being particularly good."

SIMPLIFIED TUNING

"The tuning dials remained closely in step over the whole of the scale, a point which greatly simplifies tuning."

INGENIOUS

"The frame aerial connections are ingenious The braided covering of the loud speaker performs the dual function of screening the loud speaker leads and completing the frame aerial circuits."

. . . "thoroughness of the screening . . ."

AMPLION

CORRESPONDENCE

The Editor is pleased to receive communications on matters of interest to the Trade. Letters intended for insertion must be accompanied by the name and address of the writer as a guarantee of good faith. No responsibility is taken by the Editor for opinions expressed by correspondents.

The R.M.A. Show Ballot.

To the Editor.

SIR,—We enclose herewith a copy of a letter we have to-day addressed to the Radio Manufacturers' Association, and as we think that this will possibly be of considerable interest to your readers, many of whom will be in entire agreement with the contents, we shall be glad if you will find space for it in your valuable columns.

LONDON, S.W.1.

R. EISLER,
DETEX DISTRIBUTORS, LTD.

COPY OF LETTER TO SECRETARY, R.M.A.

DEAR SIR,—After due consideration, we have decided not to apply for space at the National Radio Exhibition, our reasons being that we take very great exception to the method in which the stands are being allocated.

Last year there was a considerable amount of criticism levelled against you on account of your allowing the larger manufacturers to apply for multiple stands, thus precluding the smaller manufacturer from obtaining the space to which he should be entitled in an exhibition which claims to be "National." This year you have very cleverly evaded this issue by lumping together several small stands in all the most attractive positions, forming a lesser number of large stands, the prices of which are not an economical proposition to firms with limited capitals, and are obviously for the benefit of the large public companies.

A further criticism we have is that practically all the Demonstration Rooms appear to be let, and how you have achieved this without waiting for the ballot is a matter of some considerable interest to us.

From the foregoing you cannot help agreeing that the smaller manufacturer would not appear to be welcomed by you, and, as we are rather sensitive people, we do not like to be accused in any way of "gate-crashing."

R. EISLER,
DETEX DISTRIBUTORS, LTD.

[NOTE.—The method of dividing and allocating the space at Olympia has come in for a good deal of criticism in the past, but we believe that more favourable arrangements for the majority have been made this year. We anticipate being able to publish next week a full statement on the subject from the Exhibitions Organiser of the R.M.A.—EDITOR.]

The Value of Works Visits.

To the Editor.

SIR,—I was extremely interested in your leading article last week suggesting that manufacturers should conduct parties of dealers over their works, and I fully endorse every sentiment expressed.

Two seasons ago I proposed such a visit to the sales manager of a large accumulator company, with the result that their service agents in a certain area were conducted over the works and shown the various processes of manufacture. The visit was a complete success, both from the business and social viewpoint, and the firm were so pleased with the result that they are extending the idea this year.

Three weeks ago I was one of a party that visited a large electric lamp manufacturing firm. Here, again, we were escorted over the entire works, and entertained afterwards. The firm in question are not large public advertisers, but, nevertheless, they always seem to be prospering—possibly due to their policy of keeping in personal touch with the retail trade.

The Marconiphone Co. are to be congratulated on going a step further by opening a training-school for dealers, and I can see big possibilities in such a scheme for the furtherance of efficient repair and maintenance service.

The sooner manufacturers realise that the retailer does

matter in the marketing of their products, the sooner will a better understanding exist between the two sections of the trade.

COVENTRY.

F. W. NICHOLLS.

British Trade Exhibition at Buenos Aires.

THE letter printed below, drawing attention to the British Empire Trade Exhibition to be held at Buenos Aires in March and April next year, is now being sent by the Department of Overseas Trade to British manufacturers. Firms who are anxious to establish contact with one of the most important future markets of the world are invited to get in touch with the organisers at the address given in the letter.

To the Editor.

SIR,—As a result of the initiative of the British Chamber of Commerce in Buenos Aires, a British Empire Trade Exhibition is, as you are probably aware, to be held in Buenos Aires from March 14th to April 27th, 1931. This exhibition—the first of its kind to be held in any foreign country—is a project of the first importance from the point of view of British trade with the Argentine Republic.

It is being officially supported by His Majesty's Government, and the Department of Overseas Trade are organising an exhibit in a building which has been provided by the Exhibition management. The British banks, railways, shipping and cable companies, and other British commercial undertakings in the Argentine are giving their warm approval and financial support, and the Argentine Rural Society have placed their grounds adjoining Palermo Park, in the centre of Buenos Aires, and the buildings which they contain, at the disposal of the organisers. In addition, temporary buildings are being erected as the needs of the enterprise dictate.

The exhibition will be organised in a series of industrial sections which will include practically every important British industry.

A large amount of the available space has already been taken by British firms and commercial organisations, who realise the value of the opportunity afforded by the Exhibition. His Majesty's Government hope that nothing will be left undone by British firms to secure a larger share of the trade with a market which has great future opportunities and which is exceedingly well disposed to British goods and British methods.

Those manufacturers who have not already decided to take part are urged to get in touch with the General Manager, British Empire Trade Exhibition, Buenos Aires, 1931, 5, Parliament Mansions, Orchard Street, Victoria Street, London, S.W.1 (Victoria 0877), from whom full information as to the scope of the Exhibition, the cost of exhibiting space, details as to stand erection, services and supplies, and the transport of exhibits, etc., can be obtained.

LONDON, S.W.1. DEPARTMENT OF OVERSEAS TRADE,
A. R. FRASER,

for the Comptroller-General.

Demonstrations from A.C. and D.C. Mains.

To the Editor.

SIR,—We read the note in your recent issue to the effect that the Loud-Speaker Co., Palmer Street, London, S.W.1, are of the opinion that they are one of the first factors to be able to demonstrate both on A.C. and D.C. mains in their showrooms.

In this connection we would like to point out that we have been giving this service for over two years, having

had a rotary transformer of 2 A output in use since March, 1928.

The transformer was installed for the purpose of demonstrating Tungar chargers on D.C. mains and we consider this method, apart from its slightly higher first cost, is the cheapest and safest way of charging from D.C. mains with the added advantage of having A.C. available when required.

Those of your readers who are still on D.C. mains may be interested in this matter, and we should be most pleased to answer enquiries and give advice on the subject.

COLCHESTER.

FLINDERS (WHOLESALE), LTD.,
A. F. HITCHCOCK, Director

"Gift" Schemes and Radio Goods.

To the Editor.

SIR,—My attention has been drawn to the growing practice of cigarette manufacturers in offering coupons with cigarettes, which may be exchanged for "gifts," among which are gramophones, records and wireless sets. There appears to be a traffic in these coupons, for, according to advertisements, they are to be bought at so much per hundred from people who seem to be able to collect them *en masse*.

It seems that the original purposes of the schemes are being blatantly abused, to the immediate loss of the

retailer and, of course, the factor as well. Whatever may be the publicity value to the cigarette manufacturers, these "gift" schemes involve a direct encroachment upon the living of thousands of traders, and result in an unwarrantable reduction in the ranks of the buying public. Furthermore, it is doubtful if these schemes reflect well upon the goods "given" away. No dealer can afford to have stock in his shop that is the butt of a "something for nothing" stunt, and the sooner all those trades affected make this known to the actual manufacturers of articles used as gifts, the better it will be for the stability of our every-day "lines."

It seems that the high-water mark of freak business has apparently been reached by one firm, who offer a radio set upon hire-purchase terms, and will accept a specified number of coupons in lieu of cash instalments! As a proposition that beggars description—and traders at the same time—I think that this one is hard to beat.

There is a serious menace to traders in these "gift" schemes and the attention of all is directed to the obvious advantages that a thoroughly representative membership of the trade associations would have in taking the strong steps necessary to check the effects of such indirect trading.

LONDON, S.E.

H. A. J. SHEARMAN DYER,

Vice-Chairman W.R.A. of Great Britain.

Where Will Discount Trading End?

ANOTHER FLAGRANT CASE AND THE NEED FOR STRONG TRADE ACTION.

ALMOST daily it is becoming more and more apparent that discount-trading—a subject of frequent reference in our columns—is increasing to such an extent that only united action by all the trades involved can put a stop to it.

The latest example has just been brought to our notice by Mr. F. H. Pond, of the Pond Tool Co., well-known radio and hardware merchants in Chancery Lane, London, W.C.2. In his capacity as a private individual Mr. Pond entered for the Derby prize contest organised by *The Daily Mail* in conjunction with the British Charities Association.

One of the conditions of entry was that the competitor should send a subscription of 5s. to the British Charities Association, an institution operating as a limited company and distributing its profits to hospitals and other charities. The Association raises money for these purposes by schemes under which the contributor himself receives benefit—for example by means of competitions.

The B.C.A. Shopping Bureau.

When Mr. Pond received his receipt for the 5s. subscription, it was accompanied by a leaflet showing another apparently lucrative source of revenue operated by the Association. To quote their own leaflet:

"The British Charities Association runs a Shopping Bureau for the purpose of serving its supporters and of raising money for the voluntary hospitals. The Association has over a million supporters and can arrange favourable terms with wholesalers.

"For all articles without a fixed retail price the buyers are introduced direct to the manufacturers or wholesale distributors, where they can select their own goods, which will be delivered to them at prices below the ordinary retail price. *For some standard articles with a fixed retail price, the manufacturers will only supply us on condition that we do not break their retail price, but buyers have the satisfaction of knowing that a margin of profit has been secured by them for distribution to the Voluntary Hospitals. . . . Enquiries can only be considered for articles valued at £2 or over.*"

Radio sets and gramophones are among the goods which, it is claimed, can be purchased under this scheme, but we should like to believe that any manufacturer in these fields who support the scheme are included among the class to which the B.C.A. refers in the sentence we have italicised above.

Even if this is the case, however, and no actual price-cutting to the public or radio and gramophone goods is permitted, the

fact still remains that a considerable volume of business is possibly still being diverted from the proper channels of retail distribution.

This is the fact to which Mr. Pond naturally took the strongest exception, and this he voiced in no uncertain terms in a letter to *The Daily Mail*. In this communication Mr. Pond says: "I shall probably not be over-estimating the number of readers who received these leaflets if I put the figure at nearly half a million. Activity by the B.C.A. on this scale is a serious thing for the retail shop-keeper, and I am sending a copy of this leaflet to my trade association. No doubt they will make their own investigations and take appropriate action.

"In the meantime I should like to know whether *The Daily Mail* is aware of this offer to buy below retail prices. *The Daily Mail* supports legitimate competition, and I cannot understand its booming this invitation to the public to stop buying at retail shops.

"Any considerable development of the B.C.A. Shopping Bureau would not only render the shopkeeper unable to help the hospitals, but would eventually drive him to require either hospital aid himself, or, more likely, out-relief or the shelter of his local workhouse. . . ."

"The Daily Mail" replies:

Mr. Pond subsequently received a reply from *The Daily Mail* assuring him that they were entirely unaware of the B.C.A. action in sending out the leaflet, and adding that they had insisted on no further copies being distributed. As Mr. Pond points out, however, the damage was then clearly done.

It is difficult, of course, to comment on this particular scheme as it affects our own trade without knowing which, if any, of our manufacturers and wholesalers are prepared to support it. This, as Mr. Pond pointed out in his letter to *The Daily Mail*, is a point for the trade associations to investigate. Dealers in their contact with customers may also encounter specific cases, and in either case, we should be interested to hear the facts and to use our influence to limit the practice so far as it affects the radio and gramophone trade.

Apart from this aspect of the situation the apparent success of the B.C.A. Shopping Bureau indicates the growing tendency among the manufacturing and wholesale trades generally to divert much-needed trade from the businesses of properly established retailers. There is a definite menace in these schemes, affecting the entire trading community, and very strong and united action should be directed towards their suppression.

New

Lines

Two New Portables.

Two new portable receivers, first described in brief in our Portable Number of May 10th, have just been added to the "Chakophone" range of sets by the Eagle Engineering Co., Ltd., of Eagle Works, Warwick. One of these is a suitcase model, and the other an upright cabinet set.

Dealing first with the suitcase portable; this utilises an S.G. 4-valve circuit, working on the long and medium wave-bands and operating a patent Chakophone Colossi speaker. A calibration chart is, of course, provided, and is screwed in the usual way on the cover of the battery compartment. Although a self-contained aerial is utilised generally, an outside aerial and earth can be used if desired. The case, fitted with oxy-copper fittings, lock fasteners, and a snap-flat handle, is finished in antique leather rexine. Priced at £17 17s., including royalties, this set is supplied complete, with a guarantee.

The cabinet receiver, known as the "All-in-Three," incorporates two transformer-coupled L.F. stages, and has a tuning range of 200-2,000 metres. Occupying the major portion of the front of the set is the loud-speaker fret, the speaker itself again being of the Chakophone-Colossi type. The "All-in-Three" will function satisfactorily with or without an external aerial. Contained in a figured oak cabinet with a snap-flat handle, this set sells at £11. It is also available as a 2-valve model, with a pentode output, in which form it retails at £9 9s.

Mullard S.M. Resistances.

These resistances are supplied to commercial set makers only, and are not available to the public or to traders for resale to the public. They must not be sold, except when incorporated in complete receivers.

Two types are made, one rated for a maximum dissipation of 0.4 W, and the other rated up to 1 W. The 0.4 W type has recently been substituted for the previous 0.1 W type, and is made in various resistances, ranging from .025 to 5 MO. It is equipped with tinned copper wire ends, and the resistance element measures about 1 1/4 ins. in length, while the diameter is just over 3/16 in.

The resistance is covered by red insulating sleeving on which the value is plainly marked, and the body is formed of a piece of porcelain tubing, with the resistance element, grey in colour, deposited on the outside surface. Tight fitting metal end-caps, to which the wires are attached, provide the necessary contacts with the element.

The 1 W type is similar in construction only on a slightly larger scale. It measures 1 3/4 ins. in length and 1/2 in. in diameter. Only two standard resistance values are made, namely, 0.1 and 0.25 MO, although other sizes can be manufactured.



The new cabinet portable by the Eagle Engineering Co.—see column one.

On test, we found the values of the various resistances to be within a few per cent. of their rated values. One of the 0.1 MO, 0.4 W type resistances was placed across a 200 V supply, thus giving a full loading of 0.4 W, and after a time it was found to heat up. We measured the resistance while hot and found it to be just under its normal value, although not enough to be of consequence, and when the resistance was allowed to cool, its value rose to normal.

The makers state that these resistances are constructed of a material which is unaffected by climatic changes, and are therefore suitable for inclusion in sets designed for both home and overseas markets.

Firms who desire to incorporate these resistances in their new season's sets are requested to write to the Mullard Wireless Service Co., Ltd., of Mullard House, Charing Cross Road, London, W.C.2, for quotations.

Some Loewe Lines—and Price Changes.

The Loewe Radio Co., Ltd., of 4, Fountayne Road, London, N.15, have just placed on the market three new lines in the loud-speaker field, namely, a 4-pole speaker unit, Type LS85; a similar unit with a chassis, Type LCh85; and a complete 4-pole cabinet speaker, Type EB85. The latter instrument sells at a retail price of 42s., and it incorporates

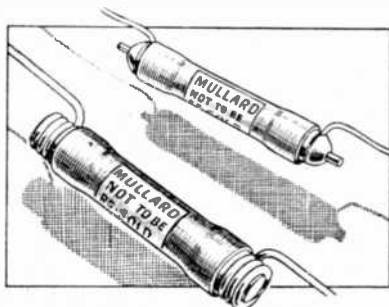

Two of the Mullard S.M. resistances, supplied to set manufacturers only. The upper one is the 0.4 W type, while the lower one will dissipate up to 1.0 W.

the LCh 85 speaker unit and chassis.

The 4-pole speaker unit is, of course, of the balanced armature type, and is adjustable by means of a knob and spindle. The drive spindle, which is detachable, can be screwed in so as to protrude on either side of the magnet. The D.C. resistance of the unit is approximately 2,000 O, and the price, complete with lead, is 12s.

Embodying a 12-inch free edge cone, the chassis instrument, LCh85, is of wooden construction. A wooden "bridge" spans the diameter of the cone and to it the unit is clamped. The actual position of the unit is inside the cone, with the adjusting knob and spindle protruding through a hole specially cut in the cone itself. Complete with lead, the chassis sells at 16s. 6d.

Several price reductions of Loewe apparatus should now be mentioned. These are as follows:—

	From	To
Speaker E.B.71	45/-	39/-
Speaker unit L.S.71	13/6	10/6
Gramophone pick-up L.R.92	18/6	15/-
Gramophone pick-up volume control	7/6	5/6
High vacuum condensers V.C.100:—		
.001 to .001 with caps for clips ..	1/3	1/-
.001 to .001 with screw caps ..	1/5	1/2
.002 to .005 with caps for clips ..	1/6	1/3
.002 to .005 with screw caps ..	1/8	1/5

The trade are accordingly asked to note these changes.

A New Lisenin Wander Plug.

The Lisenin Wireless Co., of 5, Central Buildings, High Street, Slough, who are well known for their various wander plugs, spade ends and other such useful fittings, have recently introduced a new type of wander plug, which, at present, they are supplying to receiver manufacturers only. This new plug can be supplied in seven different colours. The overall height is 3/4 ins., and the insulating sleeve is only 3/8 in. high, which fact makes it particularly useful for portables, where height is limited.

It should be noted that the usual type of Lisenin cone chuck is used for clamping the end of the lead.

Several unique points in the construction of the contact shank should be mentioned. This is doubly split and tapers towards the end. The extreme end is in the form of a flattened sphere, the idea being that the plug makes good contact with the socket both at the top and at the bottom. We tried our sample plugs in various sockets, which varied appreciably in internal diameter, and we found in every case very good and rigid contact was assured. Also, the plugs did not show any tendency to pull out with a tug on the leads as is the case with some types.

Manufacturers who are interested are invited to write to the Lisenin Wireless Co. for samples and prices. Later on the plugs will be available for sale by the retail trade, and we shall then give the prices.

"TRADER" TEST REPORTS

Conducted by our
Technical Department.

*Manufacturers are invited to submit
apparatus for test under this heading.*

Burndept Wireless (1928), Ltd., London, S.E.3. Burndept Super-Screened Portable Receiver.

DESCRIPTION AND PRICE.—This portable is housed in a real leather (crocodile grained) covered container of the suitcase type, measuring 15 ins. by 15 ins. by 8½ ins. Our sample has a walnut interior finish, and all its fittings are oxidised. The back of the case is equipped with four rubber "feet," and at the bottom, fitted towards the rear for purposes of balance, is an unobtrusive turntable. In the lid, the frame aerial and adjustable speaker are situated behind an attractive grille, with a "Gothic" design.

The receiver takes up the front portion of the body of the case, with the four valves arranged on a platform behind, and the batteries fit into the remaining space. A circuit incorporating an S.G. H.F. stage, tuned anode coupled to a detector and followed by two transformer-coupled L.F. stages is employed, the valves, all Mazdas, being an S.G.215, H.210, H.L.210 and P.240, respectively. The control panel and valve platform are of metal with a polished walnut "photographed wood" finish, and there are four controls, two drum dials for tuning, a reaction control, and a combined "off" and wavechange switch. The drum dials are both graduated to 100 degs., and the left-hand dial is also calibrated in wavelengths. Two terminals, for an external aerial and earth, are provided.

The batteries used are, for H.T., a 118 V Siemens battery with a combined 18 V G.B. battery, and for L.T., a "Three Star" 2 V 21 A.H. non-spill accumulator.

The retail price of this Burndept Super Screened portable is £23 10s., and it is a de-luxe version of the well-known Burndept Screened portable.

TEST RESULTS.—The set was tested about 11 miles from Brookman's Park. The makers state that the bias to the last valve can be varied to suit the user's needs, from 10½ to 18 V. With the smaller bias, the tone is

improved, but the H.T. consumption is increased, and vice versa. As a matter of fact, even with only 10½ V bias, the total consumption is low for a set of this type, and it was found to be considerably less than is stated by the makers. Thus with a 10½ V bias, the total consumption was only 9.7 mA, with 12 V, 8 mA; with 15 V, 5.6 mA, and with 18 V, 4.6 mA. As the makers quote 14-16 mA with a bias of 10½ V, it is possible that the power valve in our set had an emission below normal.

Nevertheless, with the smaller bias, the tone of the set was very satisfactory. It was clear and brilliant, and not at all muffled. The high note response was good, while the bass was not very prominent, though probably up to the average for a portable set. With a higher bias, the tone became rather shrill and "strangled," especially when the volume was pushed up. Speech is fairly clear, providing that the volume is kept down to reasonable levels. With the smaller bias, the set will handle quite a good volume without distortion.

The selectivity and range of the set were found to be very good, and well up to the standard of the best modern 4 V S.G. portables. On the short waves, making use of the frame to cut out the B.P. transmitters as much as possible, the London National station spread about 10 degrees above and rather more below its own setting, while the interference from the London Regional extended altogether over a band of about 16 degrees only. Langenberg was just obtained at loud-speaker strength during daylight, and was clear of 5GB, using the frame to eliminate this station as far as possible.

On the long waves the performance was excellent, and Koenigswusterhausen could be obtained at fair loud-speaker strength during daylight, clear of 5XX and Radio Paris. The other well-known long wave stations could also be obtained at entertainment strength during daylight.

We suggest that a stop be fitted to the reaction control at the minimum position, as this is not definitely marked, although with the pointer at "9 o'clock" the minimum reaction effects appear to be obtained. Incidentally, the reaction control was very smooth in operation. The calibration of the left-hand scale was not entirely accurate, especially at the lower ends of the scales, but it was near enough to serve as a rough guide. The two scales, also, were not altogether in step with each other.

The general construction and finish of the set are excellent, and it is sent out with a very well written instruction booklet giving a good deal of information, technical and otherwise.

London Electric Wire Co. & Smiths, Ltd., Church Road, London, E.10.

Lewcos Wavetraps.

DESCRIPTION AND PRICES.—There are two "Lewcos" wavetraps, one of the absorption type, and the other a rejector trap, these being similar in external appearance. Each trap has a short hollow cylindrical former, about 2½ ins. in diameter, with a closed top on which is mounted a "Lewcodenser." The coil is wound, with the familiar

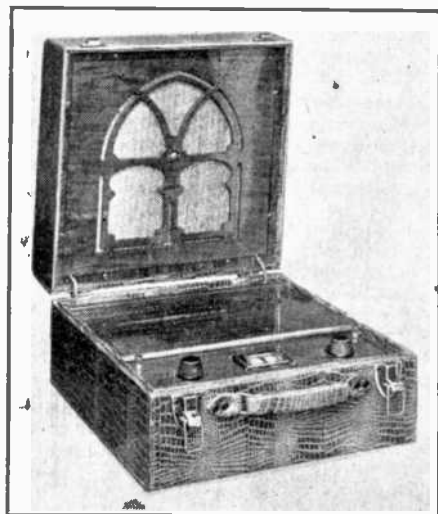

The Burndept Super-Screened Portable, a 4-valve model giving very good results. Note the handsome grained leather case.

blue covered "Lewcos" Litzendraht wire, round the former mentioned, connections being taken, inside the former, to the semi variable condenser.

In the case of the absorption type trap, which, by the way, is made in two models, for short and long waves respectively, it should be noted that this is only suitable for use in sets where the aerial coil is of the 6-pin or "Q" type. When being used, this type of trap has to be placed



Left: The Wearite 600 O decoupling resistance, a well-made little component.



Right: The Lewcos retractor type of wavetrap. The absorption type is similar in appearance, but has no terminals.

on top of the coil, and the condenser operated with it in this position.

The retractor trap is slightly different in construction. Two terminals and soldering tags are fitted on the condenser, and inside the former a small .001 μ F fixed condenser is mounted. This capacity is connected in series with the two halves of the coil and the semi-variable condenser is shunted across the whole of the coil, thus forming a circuit of the retractor type. This trap is connected in series with the aerial.

The absorption traps, types A.W.5 and A.W.20, which are for use on the 235 to 550 metre and 1,000 to 2,000 metre bands respectively, both sell at 6s., while the retractor type is priced at 7s. 6d. The latter type is catalogued as the R.W.4 and is for use only from 235 to 425 metres.

TEST RESULTS.—The absorption trap was found to be effective in operation when used in a receiver employing suitable coils on which the trap can be stood. No actual connections to the receiver are, of course, necessary. Both the Brookman's Park transmitters could be practically completely eliminated, and the trap has the advantage that it absorbs not only the signal due to pick-up from the aerial, but also that which is picked up directly by the receiver coil. We found in the case of our sample that it would not tune down to 235 metres, its minimum being almost exactly 261 metres. The maximum, too, was higher than the rated value of 550 metres. One or two turns removed from the winding might help, or perhaps the Lewcodenser fitted is rather above its rating.

The retractor trap functioned normally, and enabled the two B.P. transmissions to be cut down to a negligible value 11 miles away.

Both traps affected the tuning of the receiver to some extent, but they did not seriously affect the signal strength of stations slightly removed from the wavelength to which the traps were adjusted. They are well-made products at reasonable prices.

Wright & Weaire, Ltd., 740, High Road, London, N.17.
"Wearite" De-coupling Resistances.

DESCRIPTION AND PRICE.—These resistances are made in three values—100 O, 500 O, and 600 O. Our sample has a rated resistance of 600 O and has a body formed of a

piece of ebonite rod, $\frac{3}{8}$ in. in diameter, about 1 in. in length. A hole, deeply countersunk, is drilled down the length of the rod, to take a screw for fixing. At the bottom of the body two slots, about $\frac{1}{4}$ in. in width, are cut, and carry the silk-covered resistance wire, which is protected by a layer of green tape. The ends of the winding are taken to two terminals and soldering tags.

All values retail at the same price—1s. 6d.

TEST RESULTS.—Our sample, rated at 600 O, had an actual value of about 612 O, or only 2 per cent. error. The gauge of wire used is sufficient for the use for which the resistance is designed, while the general construction is beyond reproach. The tags are arranged so that it is impossible for them to rotate and work loose, a useful feature. As several resistance values are made, it would be as well to indicate the resistance somewhere on the former. The component is intended mainly for H.F. decoupling.

The Rothermel Corporation, Ltd., 24-26 Maddox Street, London, W.1.

"Test-O-Lite" Neon Tester.

DESCRIPTION AND PRICE.—The "Test-O-Lite" is simply a neon tester working on a similar principle to the familiar sparking plug tester, and is marketed in a form which adapts itself for use in radio and electrical engineering. Our sample is designed for testing A.C. or D.C. circuits with voltages of from 110 to 550. The contact leads are of a very heavily insulated flexible wire, and are bared and soldered for about $\frac{3}{4}$ ins. at their lower ends. The other ends are clamped between two moulded insulating plates.

The small neon tube can be seen from both sides through holes in the plates, and, to prevent breakage, it is held in position by pieces of soft rubber. As the neon tube is constructed of clear glass, the electrodes are visible, thus allowing the tester to be used as a polarity indicator. When used in this capacity, the negative side of the circuit is indicated by the electrode with the brightest glow.

The dimensions of the "Test-O-Lite" are 6 ins. by $\frac{3}{4}$ ins. by $\frac{3}{8}$ ins. Price, 8s. 6d.

TEST RESULTS.—On test, the neon tube could be made to glow with an applied D.C. voltage as low as 85, and with A.C. even less. We applied various higher D.C. voltages, with corresponding increases in the brightness of the neon glow, and on reaching 500 V, that is, 50 V more than the rated D.C. maximum, the neon tube showed no signs of breaking down. As a polarity indicator the "Test-O-Lite" proved quite satisfactory.

This instrument can also be used to indicate whether A.C. or D.C. is flowing in a circuit. When the neon glows brightly round one electrode, the current flowing is direct, and when there is an even glow around each electrode, the current is alternating. Then, of course, if the neon tube is connected in series with an H.T. battery, quite an efficient open and closed circuit tester is formed.

We notice that, in the unlikely event of the neon tube breaking down, or of the glass being broken, there is no means of easily replacing it, short of breaking open the whole instrument. Finally, in our opinion, the "Test-O-Lite" at 8s. 6d. is rather highly priced, though it may appeal to the service man and dealer who carries out testing.

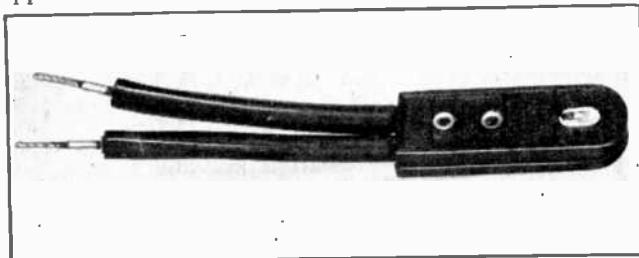

The Test-o-Lite neon tester, a useful product for the service man, sold by the Rothermel Corporation, Ltd.

THE KING OF JAZZ LEADS THE WAY!

NEW FILMS WITH GOOD THEME SONGS.

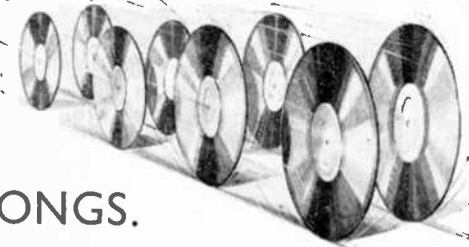

"The King of Jazz."

Starring Paul Whiteman and His Band.

THE long-awaited Universal film, "The King of Jazz," which was privately shown recently, proved itself to be one of the most lavish, spectacular and imaginative productions yet to reach the screen. It is a revue produced by John Murray Anderson and having as its central figure Paul Whiteman and his band of world-famous musicians, assisted by various well-known stars, including John Boles and Laura La Plante. With the production side of the film and its many brilliantly-conceived scenes we will not concern ourselves here, but would only make it clear to traders that, by reason of its sheer entertainment value, the film cannot very well fail to be a success, and there is no fear that it will "let down" the most ambitious "tie-up" schemes.

With Paul Whiteman as its figure-head the show naturally excels in its musical appeal and is likely to have considerable influence on the sales of gramophone records. The titles of the important musical numbers which are featured are as follows: "Happy Feet," a very bright toe-tickling foxtrot; "It Happened in Monterey," a sentimental number sung by John Boles; "I Like to Do Things for You," "Song of the Dawn," "A Bench in the Park" and "The Bridal Veil," the latter forming the basis of one of the many gorgeously executed stage settings.

In addition to the above numbers, most of which are first-class hits, the film includes a performance of Gershwin's "Rhapsody in Blue," which will quite probably revive interest in some of the existing recordings of this composition. In any case the production will draw all who have any interest in the Whiteman combination, if only for the opportunity of seeing some of its world-famous members at work. "The King of Jazz" will be generally released on March 2nd, 1931.

As an indication of the probable appeal of the musical numbers, it is of interest to note that "Happy Feet" and "It Happened in Monterey" have already been included in the repertoire of Jack Hylton and his band, and are being regularly featured.

"Paramount on Parade."

THIS is Paramount's contribution to the long list of talkie revues, and, true to tradition, it features all the well-known Paramount stars, with special emphasis on Maurice Chevalier, who has already scored big successes in "Innocents of Paris" and "The Love

Parade." The film has just succeeded "The Vagabond King" at the Carlton in London.

The production is full of light-hearted comedy and music, the chief songs being "Sweepin' the Clouds Away" and "All I Want is Just One Girl," by Chevalier himself, "I'm True to the Navy Now" sung by Clara Bow, with chorus, and "I'm in Training for You," which is given by Zelma O'Neal and Jack Oakie.

"Movietone Follies of 1930."

Featuring El Brendel and Marjorie White.

THOSE who recall the excellence of the first Movietone Follies will not be disappointed in the second edition. While the show as a whole is not quite so elaborate, there is more entertainment in the way of dialogue and comedy generally. There is a slight story, enough to sustain the interest, and the song numbers do not appear to intrude on the action as they frequently do in other musical "talkies."

Conrad Sterling finds his engagement to Mary Mason broken off owing to his name having appeared too prominently in the reports of a night-club raid. Determined not to miss a Sunday of her company, since they had always spent them together, he hires the entire show in which Mary is playing for a benefit performance at his uncle's estate where he is living. This is mainly the story. The scenes where the show takes place on the estate are particularly well done.

The musical numbers in this edition are not quite so haunting as in the 1929 version. There are none to equal "Breakaway" or "Walking With Susie." However, there are three likely favourites in "Movietonia," "I'd Love to be a Talking Picture Queen" and "Emily Brown." Others are "Doing the Derby" (sung, by the way, as Derby, and not Darby), and "Cheer U'p and Smile," the latter a bright finale.

"Song of the Flame."

Featuring Bernice Claire and Noah Beery.

IT would be unkind to write exactly of the reception this film received when it was recently shown to an invited audience (mostly press). Probably, a less sophisticated audience would accept it more readily. "Song of the Flame" has a Russian background, with the revolt of the Reds as the main thrill. A royal prince is involved, and, of course, he falls in love with a young peasant girl who, incidentally, is the leader of the Reds.

The girl, to aid her friends to victory, sings them a song of her own composition ("Song of the Flame"). This is a well-

written number, but it is plugged so often throughout the picture, that the audience will be liable to tire of it.

There is a fine spectacle of a village harvest festival, with folk-dancing and singing. This is full of life and colour, and a rollicking ballad-song, "The Goose Hangs High," is well recorded. Alice Gentle, Bernice Claire and Alexander Gray appear to be the leading singers, while Noah Beery, whom we have hitherto only heard in talking parts, sings a drinking song rather well. The effect is made ludicrous, however, when he sings the song while going to his death. There are numerous bad patches similar to this that few audiences would be expected to take seriously. But for these, the picture might have reached a very high standard.

"The Brat."

Starring Betty Balfour.

THE "Brat," Betty Balfour's first independent "talkie," is quite the best thing she has done. She has gone back to the type of characterisation that brought her fame—that of the little cockney girl with a rare sense of humour. The story tells of a quaint little East Ender who sings lively songs in a Dock-side "pub." She is discovered by a young composer (played by John Stuart) who has ambitions to make a star out of her. He nearly succeeds, and Betty is almost on the point of sailing for America to star in a show on Broadway, when she decides to go back to her old gang at the "pub." It is interesting to note that in one scene quite a lot of fun is got out of an "H.M.V." radio-gramophone.

Quite apart from her excellent acting, Betty Balfour blossoms out as a very pleasant singer of light-comedy songs. She has not a big voice, but it has personality in it. The songs she sings are "We're Uncomfortable," "Back to Gay Paree" and "Here In My Heart," the latter being a highly attractive waltz-tango. We predict a huge success for this. Campbell, Connelly are the publishers of all three.

Talkie Topics.

Among the theme songs issued by Feldmans' this month there are four attractive numbers. "Like a Breath of Spring-Time" (from "Hearts in Exile"), "Love Will Find a Way" (from "In the Headlines"), "Melody Divine" (from "The Careless Age" and "Since I Found You" (from "A Fast Life").

DETEX

PORTABLE RADIO

AN INDEMNITY

With reference to the warning issued by the Mullard Radio Valve Company Ltd. to users of Tungram Valves, we would call the attention of our trade friends to the announcement of the Tungram Electric Lamp Works (G.B.) Ltd. in this issue. Their indemnity fully covers our customers, whose particular attention we would draw to the fact that Messrs. Tungram hold that their valves do not infringe any of Messrs. Mullard's Patents, and/or that the respective Patents are invalid.

**DETEX LTD.,
161 Vauxhall Bridge Road,
London, S.W.1**

TUNGSRAM BARIUM VALVES.

INDEMNITY IN RESPECT OF SALE OF TUNGSRAM VALVES.

We wish to inform our trade friends that the opportunity is now being afforded us by Messrs. Mullards of testing in Open Court the question of the alleged infringement by our Valves of certain Mullard Patents Nos. 209730, 229622, 245146 and 245147, and at the same time of contesting the validity of these Patents.

We shall defend the action and do all we can to ensure that the questions at issue be contested as speedily as possible.

In the meantime, we are confident that the Patents sued on are not infringed by our Valves and/or are invalid and we wish to assure our friends that they need have no hesitation in selling our Wireless Valves as we are prepared to give the following Indemnity:—

We undertake that if we are immediately notified of any communication to or objection or proceedings against any distributor of Tungram Valves in respect of alleged infringement of any Patents covering Wireless Valves by the distribution of Tungram Valves we will at once take the matter up on his behalf and at our expense and keep him indemnified against any legal costs and expenses which may be incurred in any proceedings taken against him under any such Valve Patents provided

of course that he authorises our Solicitors to act for him in any controversy which may arise, or in any proceedings which may be commenced so that we have unfettered control and discretion in dealing with any such proceedings.

We would like to make it clear that under this Indemnity every distributor is entitled to call upon us for his defence in respect to any alleged infringement by the distribution of Tungram Valves. Should any of our friends receive information of certain firms having submitted to judgments or injunctions we would like to make it clear that these have been obtained against firms who have chosen not to defend the action, and have not offered us the opportunity of defending on their behalf. Such judgments or injunctions have effect only between the particular parties and the material questions of alleged infringement by our Valves and of the validity of these Mullard Patents Nos. 209730, 229622, 245146 and 245147 have not been tested in such actions.

**TUNGSRAM ELECTRIC LAMP WORKS
(GT. BRITAIN), LTD.,
72, Oxford Street, London, W.1.**

BRANCHES :—	BELFAST	48, Upper Church Lane.
	BIRMINGHAM	34/35, Imperial Buildings, Dale End.
	BRISTOL	54/66, Victoria Street.
	CARDIFF	Tungram House, 16/17 Hills Terrace.
	GLASGOW	139a, St. Vincent Street.
	LEEDS	Britannia House, Wellington Street.
	MANCHESTER	9, South Street.
	NEWCASTLE	Milburn House.
	NOTTINGHAM	35/39, South Sherwood Street.

Factories in Austria, Czechoslovakia, Hungary, Italy and Poland.

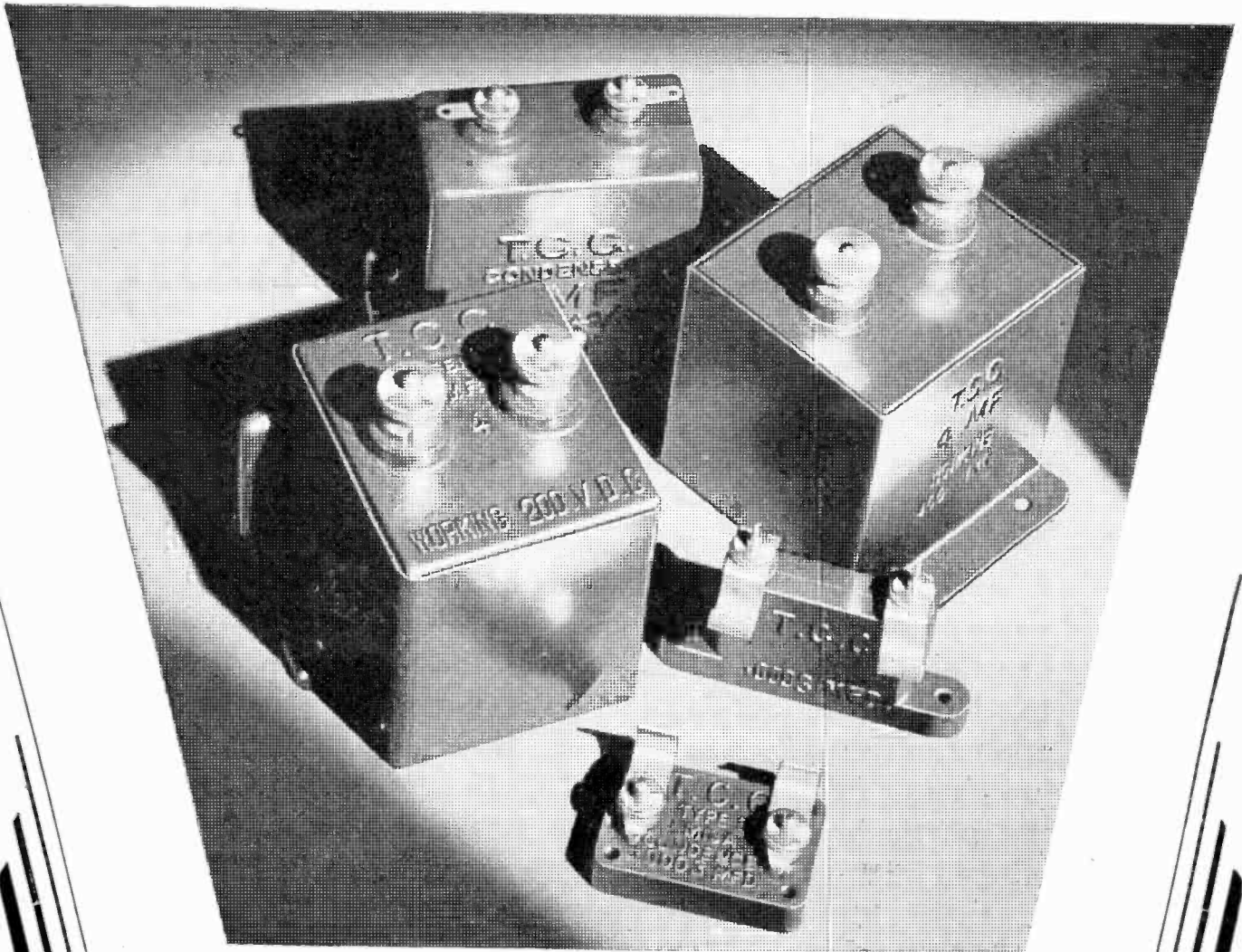

T.C.C. might . .

.. well stand for . . "They—
Command—Confidence,"
—it is the initials of the
Telegraph Condenser Co.,
who have been making
condensers—solely con-
densers—for a quarter
of a century.

A condenser of proved
merit — of absolute reli-
ability. Stock T.C.C. "the
condenser in the green
case" — and, remember,
it is a condenser with
a guarantee.

TELEGRAPH CONDENSER CO., LTD.
WALES FARM ROAD, N. ACTON.

TCC
CONDENSERS

THE ARGENTINE MARKET.

A Chance for British Firms, Despite Foreign Domination.

THE wireless trade in the Argentine has shown a rapid development during the past few years, exports from the United States of wireless material to the Republic having increased from a value of £139,308 in 1926 to £355,106 in 1929. These figures give a good idea of the extent of sales, since it has been estimated that from 75 to 90 per cent. of the radio apparatus in use in the Argentine is of American manufacture. The market has not yet been developed, however, to anything like the full importance it will have in the future, when broadcasting will have been given more attention and study, and the improvement in the quality of programmes attracts greater numbers of listeners. In this connection, the attention of manufacturers is specially drawn to a letter on another page this week from the D.O.T., who give us some details of the forthcoming British Empire Exhibition at Buenos Aires.

The Goods Required.

Low-priced components and accessories are supplied by Germany, while Holland now practically controls the trade in valves. Among receivers, the greatest demand has been for a table model set at approximately from £23 to £25 complete. Console instruments are increasing in popularity. Several cabinet makers and furniture manufacturers in the Argentine produce high-grade cabinets, but a study of comparative costs has shown that locally-made cabinets cost more, given the same quality and appearance, than those imported.

While all-electric sets are preferred, many towns in the country are supplied with 220 V direct current only (which is not well catered for in American production) and in these districts battery sets are almost the only type in demand. Furthermore, where A.C. is available voltage fluctuations are often very bad, and in many cases the supply is said to be unsatisfactory for operating receivers. It is likely, therefore, that an active and possibly increasing demand for battery and D.C. sets will continue for some time.

A good potential market exists for short-wave receivers capable of bringing in broadcasts from Europe and the United States. Up to the present time no really satisfactory short-wave set seems to have been placed upon the Argentine market in any quantities. An extremely wide variety of loud-speakers is being sold in the Argentine. The greatest demand seems to be for low-priced cone instruments, which are mostly imported from Europe, Germany supplying the greatest proportion.

The question of the local manufacture or assembling of sets has been under discussion for some time and will probably be given further attention very soon.

Marketing Methods.

The extent of the success to be met with by individual wireless manufacturers in selling in the Argentine market will be largely measured by the sales methods they pursue. Local firms or agents always prefer to deal directly with the manufacturer rather than through an intermediary. The most successful firms have found it preferable to spend some time studying the market, finally appointing a large concern of good standing and, if possible, with connections throughout the interior of the country, to act as their sole distributor. The latter then appoint their own sub-distributors in Buenos Aires and other important centres and supervise sales, and control prices.

The distributor imports and maintains a suitable stock, and it is therefore only necessary for the sub-distributors or dealers to have a few models for display, as all orders may be filled directly by the distributor from his warehouse. Retail sales are made by the large department stores and musical-instrument houses. Up to a few months ago servicing was practically never considered, except by one or two of the largest distributors in Buenos Aires. It has since been found necessary to pay more attention to this feature, as it is known to have some influence on sales.

It has recently been announced that the National Council of Education has decided to establish its own broadcasting station, which is to be used in making more general the spread of knowledge throughout the country. This plan also provides for the distribution of receiving sets in the schools within the range of the station.

A significant event concerning broadcasting is the formation some months ago in Buenos Aires of a club called the English Speaking Radio Club, the membership of which now stands at about 600. This club is trying to improve the quality of local broadcasting and has as its special object the broadcasting of programmes in English.

American Domination in Argentina.

Another correspondent informs us that in the course of a report recently drawn up by the British Acting Commercial Counsellor in Buenos Aires on the economic conditions in the Argentine, it is stated that the market for wireless apparatus is largely controlled by American manufacturers. Broadcasting conditions locally are in such a confused state that only highly selective sets find a sale, but that should not mean that British manufacturers are likely to waste their efforts in this attractive market.

An Overseas Opening.

AN opening in South Africa presents itself, where a firm of manufacturers' agents in Johannesburg desire to secure the representation of British manufacturers of all-mains wireless sets. Firms in this country writing to the D.O.T. for further particulars should quote the reference number 462.

Irish Free State Notes.

TRADERS who regarded wireless as a seasonal trade and who consequently paid less attention to sales efforts during the summer months were, in previous years, rebuked by the manufacturers for their lack of imagination. This year, however, the lax and unimaginative trader is aided and abetted by ninety per cent. of the manufacturers, so far as the Irish market is concerned. Publicity efforts are now negligible; small wonder that the public are apathetic. Of the few big manufacturing firms who can claim exception to this "don't care" attitude, Philips Lamps, Ltd., stand out prominently. This firm are all out for Irish sales during the summer, and are advertising extensively—especially in the press. They are making a feature of their 3-valve all-mains receiver.

Marconiphone for Ireland.

When one mentions sales efforts in Ireland one must not forget those of Marconi (Ireland), Ltd. This firm, who for the past few years have been controlled by Mr. F. T. Clark, have earned a big name for themselves by reason of their activities in the public address field.

I understand that new developments, so far as this well-known firm are concerned, will be officially announced shortly. It appears that the Marconiphone Co. will, in effect, come to Dublin, and set up new Irish headquarters, while Marconi (Ireland), Ltd., will largely devote themselves to the retail side of the business. This states the case in a nutshell.

Baird Television in Dublin.

So far two televisioners have reached Dublin. Mr. W. D. Hogan ("Hogan for Wireless"), in conjunction with the *Irish Radio News*, made some experiments a few weeks ago. Mr. Hogan hopes, when really satisfactory results have been obtained, to give a public demonstration. Messrs. Payne & Hornsby gave a demonstration before the Press some days ago, which, it was reported, was quite up to the standard of reception in London.

From another correspondent we learn that in the detailed import and export returns for last year, which have just been issued, there was a slight increase in the wireless trade in the Irish Free State during 1929. Thus, the value of the aggregate imports of receiving sets and parts is given as £93,115, as contrasted with £84,431 in 1928. Of the total, £90,656 is credited to Great Britain and £893 to Northern Ireland, leaving only £1,566 as the value of the directly-imported foreign wireless material.

Although they include goods for general electrical purposes, it may be of interest to mention that the Free State imports of batteries and accumulators during the periods under review declined from £30,710 to £28,204, and those of electric insulated wires and cables from £224,745 to £198,850.

LATEST RECORD REVIEWS

This week we review the mid-June Columbia and Decca Bulletins and the July issue of Broadcast Twelve and Broadcast records.

Dance numbers having vocal refrains are marked with an asterisk ()*

The Columbia Graphophone Co.,
 Ltd., 102-8, Clerkenwell Road,
 London, E.C.1.

COLUMBIA

12 IN., DARK BLUE LABEL, 4S. 6D.

DX 44.—Trooping the Colour—Descriptive, Parts 1 and 2, by The Regimental Band of H.M. Grenadier Guards.

A very good descriptive record of Trooping the Colour, recorded in a hall. All the words of command are given, and the click of the rifles and other noises are faithfully heard. The record includes the parade, assembly, inspection, slow march, quick march, drummer's call, escort for the colour, present arms and march past. On the first side the Fifes and Drums of the 1st Batt. Grenadier Guards are heard. The whole is very well done, with excellent recording, rather heavy in places.

DX 57.—All Thro' the Night (Trad; arr. Pierce) and (a) **The Cloud-Capt Towers** (Glee), (b) **Sigh No More, Ladies** (Glee), by Barclays Bank Male Voice Choir.

A good choral disc of well-known pieces, sung with precision and plenty of light and shade. The first side has a piano accompaniment, with some bell notes, but the second side is unaccompanied. The recording is clear, with a nice spaciousness. Nevertheless, the disc will probably only appeal to those who are keen on choral music, a rather limited field.

DX 58.—The Three Musketeers—March of the Musketeers and The Three Musketeers—Ma Belle, by the original artists and orchestra at the Drury Lane Theatre, London.

The first side is sung by Dennis King, with Raymond Newell, Jack Livesey, Robert Woollard and musketeers, while the second side is by Raymond Newell and chorus. Both songs are popular ones from the musical show now running at Drury Lane and based on the novel of the same name. The song on the first side is virile and thrilling, and it is well sung, while Ma Belle is equally good, though naturally in a different style. The disc is heavily recorded, particularly where the chorus comes in, and we are afraid that its life will be short.

10 IN., DARK BLUE LABEL, 3S.

DB 120.—The Woman in the Shoe and Dancing Butterfly, by Rudy Starita, xylophone solos, with piano and saxophone.

The well-known number on the first side, from "What Price Melody," makes an excellent xylophone solo, while "Dancing Butterfly" is also a particularly appropriate little trifle. Rudy Starita plays well, but we do not think this is one of his best efforts. The piano and saxophone are useful additions. Recording good.

DB 121.—Moanin' For You and We'll Cling Together, duets by Norah Blaney and Gwen Farrar.

Norah Blaney and Gwen Farrar are now in partnership, and here they give us two songs from sound films, the first being very popular at the moment. On this side there is a piano accompaniment by Arthur Young, and Gwen plays her 'cello. On the reverse Norah Blaney is at the piano. The first side is really a solo by Norah Blaney, as the 'cello is not heard until nearly two-thirds of the disc is played, while Gwen's voice is only heard in the last few grooves. The second is a duet, and Gwen sings in a straight style without her usual vocal noises. Good.

DB 125.—Caribbean Love Song ("Hell's Harbour") and **Dream Lover** ("The Love Parade"), cinema organ solos by Quentin M. Maclean at the Regal Cinema, London.

Two good cinema organ solos. The first is from the film "Hell's Harbour," now generally released. "Dream Lover" is now getting a little old, but those who still want it will like this version. Recording is excellent.

DB 127.—The Three Musketeers—Gascony and My Sword and I, by Dennis King and Chorus, with the Drury Lane Theatre Orchestra.

DB 128.—The Three Musketeers—Your Eyes and One Kiss, duets by Dennis King and Adrienne Brune, with the Drury Lane Theatre Orchestra.

Four songs from "The Three Musketeers," now running at Drury Lane, by the original artists and orchestra. The first two songs are spirited affairs, with chorus, while the last two introduce the love element. All four are very well done, the duets being excellent. Recording is good, but, particularly in the case of the first disc, too heavy.

CB 74.—Singing a Vagabond Song (Slow F.T.*) and **On the Sunny Side of the Street** (Slow F.T.*), by Ted Lewis and his band.

Two good slow foxtrots. The first, from "Puttin on the Ritz," has some hot instrumental work, particularly towards the end. The second is played in a quiet melody style. Both have the usual type of semi-recitative vocal choruses by Ted Lewis, which to our mind do not greatly improve the general effect.

CB 86.—Happy Feet (F.T.*) ("King of Jazz") and **A Bench in the Park** (F.T.*) ("King of Jazz").

CB 87.—Song of the Dawn (F.T.*) ("King of Jazz") and **I Like to Do Things for You** (F.T.*), all by Paul Whiteman and his orchestra.

The "King of Jazz" is the sound film featuring Paul Whiteman and his orchestra, so that these discs should be in demand. CB 86 will probably be the better seller of the two, both numbers being already quite well known. The second has an unusual refrain. The

second side of CB 87 contains a foxtrot not from the film. In all cases the orchestration is brilliant and interesting, while the playing is snappy and the recording is excellent. Two good discs of dance music.

The Decca Record Co., Ltd.,
 1-3, Brixton Road, London, S.W.9.

DECCA

10 IN. BLUE LABEL, 2S.

F 1739.—On With the Motley (Leoncavallo's "Pagliacci") and **Siciliana** (Mascagni's "Cavalleria Rusticana"), by Frank Titterton, tenor.

This disc, combining two well-known and ever popular tunes, offers good value. On the first side, Titterton, supported by the Hastings Municipal Orchestra, under Basil Cameron, gives a sober rendering of Canio's song. Plenty of expression is put into the number, but it is not overdone and the voice is delightful. The Lola piece on the reverse, with harp accompaniment, is likewise excellently managed. Both are sung in English and the recording is very good.

F 1761.—Nautical Moments (arr. White), Parts 1 and 2, by the Schwiller Octet.

This disc is filled with a number of songs usually associated with the navy, and very well rendered by this octet. The themes are skilfully blended and the playing is extremely clear. A very effective piano part is incorporated.

The recording is good, and as is the case with many Deccas, a good full bass can be clearly heard, giving "body" to the reproduction.

F 1776.—I Feel You Near Me (Hanley) and **Song O' My Heart** (Hanley).

F 1777.—The Rose of Tralee (Glover) and **A Pair of Blue Eyes** (Kernell), all by Peter Flynn, tenor, with orchestra.

These are four tenor songs from the sound film "Song O' My Heart," which are sung in the film by John McCormack, the famous tenor. Peter Flynn here gives excellent renderings of them all, and there is a good orchestral accompaniment. "The Rose of Tralee," of course, is a well-known Irish song. These versions of the songs can be recommended.

F 1778.—Singing a Vagabond Song and Good for Nothing but Love, by Lou Abelardo, with Claude Ivy at the piano.

Lou Abelardo here sings in his usual "intimate" crooning style. The first number is the popular one from "Puttin on the Ritz," while the second is from "The Big Party." The first is attractive, and the second quite good except that it does not sound very original. The piano accompaniments are excellent, while the singer's voice is very "forward." Recording is exceedingly good.

F 1726.—It Must Be Heaven ("Heads

Up") (F.T.*) and **Ma Belle** ("The Three Musketeers") (F.T.*).

F 1782.—Lawrence Wright's Seaside Hits (1930), Parts 1 and 2.

F 1783.—Feldman's Seaside Hits (1930), Parts 1 and 2.

F 1784.—Campbell Connelly's Seaside Hits (1930), Parts 1 and 2, all by the Rhythm Maniacs, with vocal refrains.

If the first disc sells, it will be for the second side, as the foxtrot on the first side is not very well known. The playing is fairly straight and the recording good.

The remaining three discs are all similar, being selections of dance and theme songs published by three well-known publishing houses, which are likely to be popular during the coming holiday season. Most of the recent successes have been included, and these discs provide three excellent selections of modern dance tunes. The playing is straight and melodious, and most numbers have vocal refrains. These three discs will probably be good sellers if brought to the notice of customers. The recording is good in each case.

F 1785.—A Pair of Blue Eyes ("Song O' My Heart") and **High Society Blues** ("High Society Blues"), by the Jovial Four, vocal quartet, with piano.

The first is one of the many songs from the film featuring John McCormack, and is quite attractively and harmoniously sung here by this vocal quartet, although some of the humming effects sound a little off the note at times. The second number is the blues from the film of the same name, which the son of the house sings to his social climbing parents and sister who have just been snubbed by their neighbours. Quite a good disc.

F 1786.—The Stein Song—March and The Empire—March, by a Military Band.

This disc will sell for the first side, containing the latest hit, the Stein Song, which, although played for dances as a one-step, is really a good march. The Military Band (unnamed) gives quite a good rendering, with a vocal refrain at the beginning, and the tone is fair, though not as clear as could be desired. The second side contains a pleasant, straightforward march. Both these marches were played in the recent Military Tournament at Olympia.

F 1787.—The Mouchi (B) and St. James' Infirmary (Slow F.T.*), by Spike Hughes and his Dance Orchestra.

Two curiously named dance numbers by Spike Hughes. "The Mouchi" (whatever that may be) relies mainly on trumpet work, with a very marked and heavy bass to give the blues rhythm. There is no melody here to speak of. The foxtrot on the reverse reminds us of "The Man from the South," and has a maudlin vocal chorus about "marble slabs." Again there is a pronounced bass of drums and plucked strings, with a good deal of hot trumpet work. Essentially a record for dance purposes, and as such, a successful one.

F 1788.—The Masher and the Monkey (Gordon) and **Killaloe** (Martin), by Bert Gordon, with piano accompaniment.

These songs are of the light comic order and are capably managed by the singer. The second is well known.

The singer has clear enunciation, but we feel that a little more punch would have yielded a more outstanding disc.

The recording is clear, both of the voice and piano.

F 1789.—A Banjo Oddity and The Jovial Huntsman (both by Morley), by George Morris, with piano accompaniment.

Some smart banjo playing is to be heard on this record. Both pieces are bright, but more variety would be welcome. The second item introduces "John Peel."

Recording of banjo and accompanying piano is clear and forward.

The Vocalion Gramophone Co., Ltd.,
Hayes, Middlesex.

BROADCAST TWELVE

10 IN., BLUE LABEL, 2S.

5161-2.—Excerpts from "La Boheme," Parts 1 to 4 (Puccini), by a Grand Opera Company with full orchestra.

On these two records a much condensed version of Puccini's greatest opera is happily arranged. Besides the outstanding vocal numbers some of the recitative passages are included.

The voices are clear in the main, words can be made out without much difficulty, but the soprano is occasionally hard in her tone. Among the numbers incorporated may be mentioned "Your Tiny Hand is Frozen," "They Call Me Mimi," and the famous duet, "Ah, Mimi, You Will Never Come Back to Me."

The principal vocalists are well backed up by the chorus and orchestra under Stanley Chapple. Recording is good in the main.

5163.—Scotland's Pride, by the Band of H.M. Welsh Guards.

In spite of the fact that this regimental band is playing tunes not indigenous to its native land, the renderings are well given and plenty of spirit is put into the efforts.

The playing is crisp and well modulated. Many of the better known Scottish songs are incorporated and the recording is good.

5164.—Nazareth (Gounod) and **The Holy City** (Adams), by Scout Teddy James, with organ accompaniment.

We are not too impressed with this record. The boy's voice, as here recorded at any rate, is not pleasing, and, moreover, there is a sense that he is struggling with these old time favourites. Recording is clear in the main.

5165.—Happy Days—Selection and Paris—Selection, by Bidgood's Symphonic Dance Band.

Two selections from popular sound films, in which each number is played in strict tempo, though this varies from one number to another. "Happy Days" contains the most familiar music, such as "I'm on a Diet of Love." Vocal refrains are included, but the recording is a little indistinct in places. Otherwise good.

5166.—The Bugginses' Picnic, Parts 1 and 2, descriptive sketch by Mabel Constanduros and Michael Hogan.

Another delightful sketch concerning the Bugginses, very appropriate at the present time of the year. As usual, everything goes wrong, and the picnic ends with the family walking to the nearest station, with father hopping with a salmon tin fixed to one foot and two children stuck together with flypapers. It is all very amusing, and the words are quite clear.

10 IN. SUPER DANCE ORANGE LABEL, 2S.

2563.—Just Like in a Story Book (F.T.*) and **I'm in the Market for You** (F.T.*).

2564.—Should I? (F.T.*) and **The One I Love** (Slow F.T.*).

2565.—If I Can't Have You (F.T.*) and **Good-bye to All That** (F.T.*).

2566.—Moonshine is Better Than Sunshine (F.T.*) and **There Will Never be Another Mary** (W.*), all by the Manhattan Melodymakers.

These four discs contain a good selection of up-to-date theme songs and popular dance numbers. The first two are from "High Society Blues," and should make this disc a good seller. 2564 should also be noted, as "Should I," from "What Price Melody," is popular, as is also "The One I Love" ("Just Can't be Bothered with Me.") The first side of 2565 is from "Footlights and Fools" and is quite good, but "Goodbye to All That" is, in our opinion, the best of the batch. It has a nice melody, and is attractively played. 2566 contains two fairly good numbers, of which the first has attained a measure of popularity.



Here is a general view of the fine premises of W. H. Trace & Son, at Birkenhead. In this new shop they are featuring an attractive display of radio sets and gramophones.

The waltz on the reverse is from "They Learned About Women," and is not too successful. The first three discs are the best.

For the most part the playing is fairly straight and melodious, and all numbers have vocal refrains. Sometimes a little more "pep" would be advantageous.

2567.—Moanin' For You (F.T.*) and Lazy Louisiana Moon (W.*).

2568.—Ro—Ro—Rollin' Along (Slow F.T.*) and Vagabond King—Waltz Selection, all by Al Benny's Broadway Boys.

"Moanin' For You," from "The Grand Parade," is a big hit. This version introduces "Alone in the Rain" from the same film. The number on the reverse is a favourite waltz of the moment, and is nicely played, a harp being introduced into the orchestration. This disc should sell.

The first side of 2568 is becoming well known, and is played in fairly slow foxtrot tempo. This number goes with a nice swing, while the harp is prominent. The waltz selection of Friml's music from the "Vagabond King" should also help to create a demand for the disc, containing as it does many tuneful numbers. The harp is again very effective. Recording fair.

BROADCAST TEN

8 IN., 1S. 3D.

558.—The Merry Widow (Lehar), Parts 1 and 2, by Soloists, Chorus and Orchestra.

This will probably be popular with the older generation. It embodies most of the tunes from this light musical piece, the solos being sung by a male and female voice respectively. These are well backed up by the chorus and orchestra. The famous waltz, of course, is included. The recording is good in the main, though the soprano voice is rather hard at times.

560.—Back to Gay Paree and You Die If You Worry, by Bobbie Comber, comedian, with orchestra.

Two more comedy songs by Bobbie Comber. The first has been recorded a good deal, but the second is new to us. Neither is very outstanding, the second, with a good deal of introductory dialogue, being perhaps the better. Recording quite good.

562.—O Sole Mio and Mari Mari (both by Di Capua), by The Hawaiian Melody-makers.

Two well-known pieces are smoothly and serenely played on this disc. The combination consists of Hawaiian guitars and a violin, and the effects are good. This is just the record for the river. The recording is clear and of good volume, and at the price the disc is to be recommended.

563.—Liebesfreud (Kreisler) and Hornpipe (Rosse), by Teddy Brown, xylophone, with piano accompaniment.

This somewhat unusual departure from dance music on Teddy Brown's part has given us an interesting record. The Kreisler "Love's Joy" is very effective, and it is backed by Frederick Rosse's

"Hornpipe," which has a decidedly catchy tune. Playing is what we should expect from this master of the xylophone, and the recording is clear and forward.

564.—A Voyage in a Troopship, Parts 1 and 2, by the Band of H.M. Welsh Guards.

This consists of several tunes blended together. It is, in fact, more completely musical than one might expect, and there are not many "effects" in it. Recording is good in the main.

565.—Molly ("The Grand Parade") (W.*) and Alone in the Rain ("The Grand Parade") (F.T.*).

566.—Mona ("Happy Days") (F.T.*) and I'm On a Diet of Love ("Happy Days") (F.T.*), all by Nat Lewis and his dance band.

Nat Lewis here gives us two of the popular numbers from "The Grand Parade" and two from "Happy Days." All have vocal refrains. The second side of 565 introduces the hit "Moanin' for You." All the numbers are played in a straight, melodious and quite interesting style. A special word of praise can be accorded to the vocal refrains, the singing of which is clear and not dragged out. The pianist is also good. Recording for the most part good, but there is a slight tendency towards wooliness in places.

568.—Cryin' for the Carolines ("Spring is Here") (Slow F.T.*) and Beside an Open Fireplace (F.T.*), by the Riverside Dance Band.

The first number, which is played in

moderately slow tempo, is a hit, and will sell the disc. The second is a good melodious number, also quite popular, and both are here played in a melodious style with a well-marked rhythm. Recording quite good.

569.—Oh-Oh-Oh-Oh-Oh! (F.T.*) and We're Uncomfortable (F.T.*), by Bidgood's Broadcasters, featuring Jack Morrison.

Harry Bidgood's contributions this month are two comedy numbers. The first has possibilities for seaside concert parties, as the chorus is well adapted to community singing, and the humour is a little broad. The second number is getting rather old now, but it is well rendered, with suitable orchestral effects. Recording quite good. The words of the refrains are very clear.

570.—Amy (F.T.*) and There Will Never Be Another Mary (W.*), by Nat Lewis' Dance Band.

Broadcast are early out with this special release of the foxtrot dedicated to Amy Johnson, which should have a good sale. Dealers, particularly those in Hull, should feature it. Unlike most numbers of this type, the tune is very good, and it should be a success quite apart from its sentimental interest. It is nicely rendered here, with appropriate engine noises and cheers by the orchestra. The waltz on the reverse is one of the seven numbers from the film "They Learned About Women." It is not outstanding. This disc should be stocked and featured.

Decca Record Co.'s Accounts.

Difficulties Now Stated to Have Been Overcome.

THE first accounts of the Decca Record Co., Ltd., have recently been issued, and they show a net loss for the period ended March 31st last of £89,683, this figure including abnormal expenditure on re-organisation, £29,394, and advertising, etc., £30,438.

It will be recalled that in the prospectus of the company published last year the profits from records was expected to be £160,000, and from the Decca Gramophone Co., Ltd., £61,134, or a total of £221,134.

The directors state in the report that the company have encountered initial difficulties of a particularly severe nature which could not have been foreseen.

The results were arrived at by charging every possible item of expenditure to the period under review and without opening any development or suspense account.

They also state that the difficulties of manufacture, organisation and control which seriously handicapped the business in the first place have now been corrected, and the directors feel assured that the company can now be regarded as a profit-earning business.

In the balance sheet the holding of 369,790 ordinary shares of 10s. each in the Decca Gramophone Co., Ltd., is shown at cost, £750,025. Investments amount to £107,733, and preliminary expenses, etc., total £95,317.

We have followed the progress in Decca recording right from the first bulletin, and have noted a steady improvement since the first few issues, a fact which has been mentioned in our reviews from time to time. There is no doubt that at present Decca records are up to first-class standards in recording, and the statements of the directors regarding the improvement can be endorsed by us.

Gramophone Provincial Trade Displays.

The comprehensive range of gramophones marketed by Thompson, Diamond & Butcher, 34, Farringdon Road, London, E.C.1, are included in the firm's special display at the Deansgate Hotel, Manchester, which is open for traders in the district until June 27th.

From June 30th until July 4th another display will be at Kenilworth Hotel, Glasgow, and others will be held in the autumn at places and dates to be given later.

Mayfair Electric Gramophones.

The first accounts of Mayfair Electric Gramophones from November 2nd, 1928, to December 31st, 1929, disclose a loss of £7,199. Expenses on advertising and other preliminaries figure in the balance sheet at £29,998.

The auditors in their report state that in consequence of changes in administration, certain records have not been made available for their inspection. Certain of the assets are stated to have been realised at prices below those at which they stand in the balance sheet, but no provision has been made in the accounts for depreciation or loss on realisation of such assets.

The meeting was held on June 20th.

SOME RECENT PATENTS.

The following abridgments of recently issued Patent Specifications have been made by "The Trader" technical staff. Permission to publish has been obtained from the Controller of His Majesty's Stationery Office. Copies of the Specifications in full can be obtained from the Patents Office, 25, Southampton Buildings, London, W.C.1, price 1/- each.

Reducing Inter-electrode Capacity in a Triode.

No. 324,175.—The effective capacity between the control grid and anode of a four-electrode valve has been successfully reduced by the use of the screening grid, but this is not so in the case of a high-vacuum three-electrode valve, and it is the object of this invention to provide a construction of such a triode, in which the inter-electrode capacity is greatly reduced.

This is accomplished by arranging the cathode and cathode leads round the

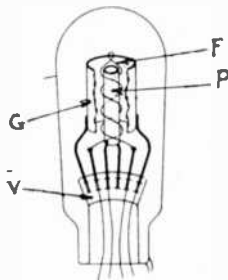

anode, in such a manner that the anode and grid are electrically screened from each other. In one construction, shown in the diagram, P is the anode, preferably a hollow cylinder of nickel, which is surrounded by a filamentary cathode F. This cathode may be of tungsten, tantalum or other such metal, and is, in turn, surrounded by a cylindrical grid electrode G which may be of nickel. All these electrodes are mounted on a vitreous stem V and are enclosed in the usual type of glass bulb which is evacuated.

Specification accepted from P. Freedman.

Centring Moving-Coil Diaphragms.

No. 324,826.—Many forms of flexible centring devices have been used in moving-coil loud-speakers, but difficulty has been experienced in obtaining a sufficiently flexible device which will offer very little restraint to the diaphragm, and which will not distort in use. In this invention supporting means for diaphragms are formed of two layers of woven material arranged with their threads at about 45 degs. to one another, and cemented together with rubber solution. When applying this idea to centring means for the diaphragm of a moving-coil speaker, two discs of unbleached muslin may be used, and their edges fixed to the smaller end of the frusto-conical diaphragm, while their centres may be attached, by means of a

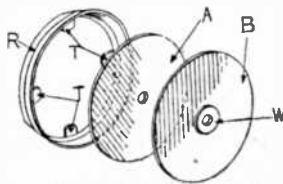

screw and washer, to a pillar carried on the central magnet pole.

The diagram shows an "exploded" view of this construction. The two discs, which are glued together, are shown at A and B respectively, the washer at W, and R is a paper ring which is glued in the smaller end of the diaphragm and provided with inwardly projecting tongues T, to which the discs are attached.

Specification accepted from The Gramophone Co., Ltd. (communicated by the Victor Talking Machine Co.).

A Microphone Pick-up.

No. 324,698.—One of the objects of this invention is the provision of a micro-

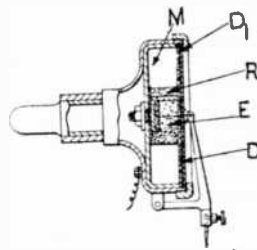

phone gramophone pick-up suitable for use with an amplifier and loud-speaker, and in carrying this out, a construction such as that shown may be used. The exterior casing of the instrument is adapted to be secured to the tone-arm of a gramophone, or to a separate arm. One of the electrodes E, consists of a carbon disc, which is secured to the casing by a screw and nut. The annular ring R of cotton wool is mounted on a mica disc M, and holds the carbon granules in place.

There are two diaphragms, one of carbon, which forms the second electrode, and one of mica, to which the stylus bar is attached. These two, D and D1, are spaced apart by a ring of thin paper, and are clamped together at their peripheries in such a manner that the air cushion between them, which gives the necessary damping effect, is completely enclosed. To help in this, rubber gaskets or washers may be used.

This patent also covers the use of microphones constructed on the same principle, which may utilise one granule chamber, or two or more chambers suitably spaced.

Specification accepted from S. Canthery, S. C. Winfield-Smith, and Burovox, Ltd.

The "Kukoo" Loud-Speaker Unit.

No. 324,608.—This invention provides in a four-pole magnetic system an improved means for adjusting the setting of the armature to obtain the most efficient reproduction conditions.

This is achieved by mounting the armature upon a frame which is connected to the diaphragm of the loud-speaker, and is carried on the end of a lever. This lever does not vibrate with the transmission end of the frame, but can be adjusted in position about its fulcrum so as to alter the armature setting without varying the stress in the frame.

The magnetic system is mounted upon a non-magnetic frame A, the pole pieces P, and the magnets M being screwed to it. The armature R, carried by a non-magnetic frame N, is surrounded by a coil C. N has a front member F connected by the link L to the diaphragm D, so that the full vibratory movements of the armature are transmitted to D. The armature frame is attached at its rear to the end of a rigid lever L, fulcrumed about a knife-edge K, and is loaded on one side by a spring S and on the other by a screw T. This lever does not vibrate with the armature, as the vibrations are absorbed between the front member of the frame and the part where it is attached to the lever, the material being sufficiently resilient to allow this. The setting of the armature may be adjusted by turning the screw T, which moves the lever L, thus causing the armature to move.

The small diagram shows a perspective view of the armature and its carrying frame (see below).

Specification accepted from C. A. Gardner, and A. C. Gardner.

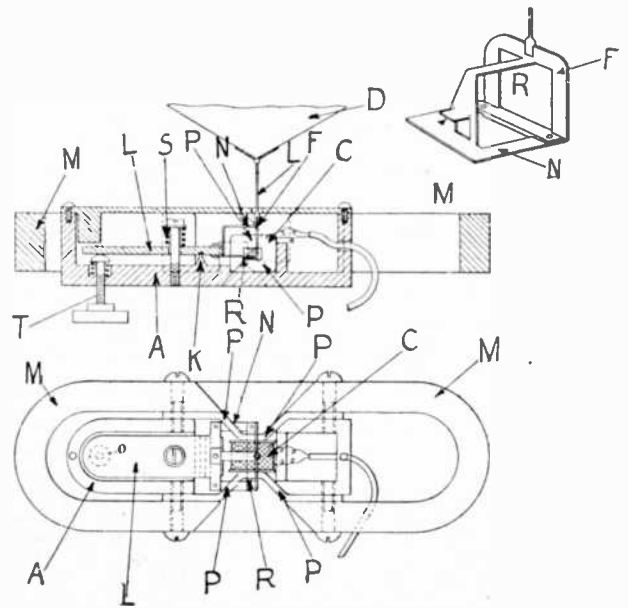

COMPANY MEETINGS.

Aeonic Radio to be Reconstructed.

LENGTHY MEETING AT HORLEY THIS WEEK.

THE first ordinary general meeting of Aeonic Radio, Ltd., was held on Monday this week, at Aeonic Works, Horley, Surrey, Mr. H. W. Wayne, F.I.S.M.A., presiding.

In his speech the Chairman said: I propose to deal with the report and balance sheet in great detail because I feel that you will want to know why the promises made in the prospectus have not been fulfilled. Also you will naturally be wanting to hear why a net profit of £35,000, *vide* Sir William Kay's statement at the statutory meeting held on February 14th, 1929, has been reduced to £2,369 16s. 2d. for a working period of fifteen months, in spite of the fact that the capital of the company was increased by £225,000 on May 14th, 1929, of which £125,000 was issued.

For the first three months of your company's existence the prospectus estimates of sales and profits were not only realised but greatly exceeded. The report gives three main reasons, and the first, which deals with the competition with which the company was faced, was undoubtedly a serious factor. Panic selling at prices that were unprofitable was indulged in by many of the company's competitors.

The second reason given in the report as to the difficulty of obtaining labour, and the attempt by your Board to import and train men from the distressed mining areas, was undoubtedly one of the principal causes of the present position.

Then there was the acquisition of the shares of Kramolin & Co., of Berlin. The decision to purchase this business was made after careful consideration as to its value and possibilities. The Board took the precaution to engage a leading firm of chartered accountants to conduct a close investigation into the books and accounts of the German company, and the completion was conditional upon a satisfactory report thereon. The report was considered satisfactory by your Board and the purchase was completed.

Unfortunately, your Board are not able to report that the German business was the success hoped for, owing to a series of circumstances that it could not have foreseen. The Kramolin Co. is now in liquidation and a receiver has been appointed. There is still a possibility that the business may be saved.

The Chairman then dealt with the various items in the balance sheet. Continuing, he said: In the profit and loss account the item that calls for comment is that of "administration expenses." This is extremely high, but I have satisfied myself that steps have since been taken by the Board which have resulted in a reduction of 50 per cent.

As you have already been informed, the operations of the company extend con-

siderably beyond radio work. We make and supply general electrical equipment. We are also developing television in conjunction with our receivers, radio-gramophones and a complete "talkie" apparatus.

Finally, I desire to deal with the proposals that will be submitted to you at the extraordinary general meeting. The company possesses many tangible assets, which are, however, at the moment in pawn to the bank and to the debenture holder. It is therefore essential and urgent that more capital be immediately obtained.

Your Board have decided that the best to be submitted to you later is the one possible way to (a) get rid of intangible assets; (b) obtain the necessary finance; and (c) make it easier to be in such a profit-earning position as to ensure early and continuous dividends.

In conclusion, let me frankly admit that

mistakes have been made, but such mistakes have been the result of a super-abundance of enthusiasm. After all, a business that is capable in the first fifteen months of its existence of selling goods to the value of £164,000, in spite of many difficulties, is evidence of its tremendous possibilities.

A protracted discussion ensued in the course of which a number of shareholders criticised the Board and management, and urged the appointment of a committee of shareholders to investigate the affairs of the company.

Ultimately the report and accounts were unanimously adopted and the meeting was thereupon adjourned sine die.

An extraordinary general meeting was then held to consider a resolution for the reconstruction of the company. The resolution, as printed in the notice convening the meeting, was amended so as to provide for the appointment of a committee of inspection, consisting of Col. John Williams, Mr. Watts, and Mr. Latham, and the resolution, as amended, was passed.

Electramonic Extraordinary Meeting.

AN extraordinary general meeting of the Electramonic Co., was held at the Cannon Street Hotel, London, E.C., last week. Mr. A. Jerrold Nathan (chairman of the company), who presided, said that in consequence of the shareholders' decision at the last meeting to accept the resignation of the then directors and to appoint the present Board as a committee of inspection, it to-day placed before them the report and accounts of the company as at October 31st.

Mr. Nathan attributed the position in which the company now found itself in part to the fact that shortly after the commencement of manufacture some new models came on the market, which caught the fancy of the public. The Electramonic

Board had either to alter the models already made or to scrap them. It was decided to adopt the former course, and this had cost the company thousands of pounds. A great deal of money would have been saved if the directors had exercised more caution than they actually had.

Mr. Nathan then put to the meeting resolutions providing for the winding up of the old company, and for the registration of a new undertaking to be called the Electramonic Company (1930), and for the appointment of Mr. George E. Seaman as liquidator.

The resolutions were then put to the meeting and were carried with one dissentient.

Dominion Gramophone Records (Foreign) Ltd.

IN the course of a speech made by Mr. G. R. Hall Caine, C.B.E. (Chairman), at the first annual general meeting of Dominion Gramophone Records (Foreign & Colonial), Ltd., this week, he stated that the delay in presenting the accounts had been caused mainly by reason of inability of the company to reconcile the account between themselves and the parent company, Dominion Gramophone Records, Ltd.

Mr. D. MacDonald Browne, financial adviser, said that the position of the French Company at the moment was that there were creditors for £1,000, and unless they were paid, the company would be

put into liquidation. The Italian Company had ceased to function, and unless £500 were forthcoming, it would have to be wound up. In Germany, the managing director found that shortage of capital had precluded them from obtaining a licence to manufacture records.

Dealing with the Phantom Orchestra, he said that this was exhibited and played for periods at various places, and a revenue of £667 15s. had been received, but the expenses were £2,560.

After discussion and a poll, the necessary resolution was moved by the Chairman, who announced that it was carried by 21 votes to 15 against.

COMMERCIAL INFORMATION

GAZETTE.

Kings Inventions (Electric), Ltd.—Creditors must send, on or before July 1st, their names and addresses (and those of their solicitors, if any) to G. H. Ashworth, of Blease & Sons, C.A., India Buildings, Water Street, Liverpool, liquidator, as well as particulars of their debts or claims, which they must prove, if necessary, otherwise they will be excluded from the benefit of any distribution that may be made.

Gatesboro' Gramophones, Ltd.—At an extraordinary general meeting held on June 10th at 55, Curtain Road, London, E.C.2, it was resolved that the company be wound up voluntarily, and Mr. Henry George Large, 2-3, Philpot Lane, London, E.C.3, be appointed liquidator.

Lambert Laws, Ltd.—At an extraordinary general meeting held at 15, Gloucester Place, Brighton, on June 10th, it was resolved that the company be wound up voluntarily. At a statutory meeting of the creditors held at 6-7, Old Steine, Brighton, on the same day, Mr. Alfred Everard Orbell, 6-7, Old Steine, Brighton, and Mr. W. A. J. Osborne, Balfour House, Finsbury Pavement, London, E.C., were appointed liquidators.

Worldecho Records, Limited.—At an adjourned meeting of creditors, Mr. Bernard Collett, 46, Basinghall Street, London, E.C.2, and Mr. William McLaughlin, 173, St. Vincent Street, Glasgow, and Pomeroy House, 28A, Basinghall Street, London, E.C.2, were appointed joint liquidators.

Receiving Order, Adjudication, First Meeting and Public Examination.

Hunt, Jonathan William, 220, Wells Road, Bristol, electrical engineer, etc. Court: Bristol. Date of petition and order: June 5th. Debtor's petition. First meeting: 12 noon June 25th, at the Official Receiver's offices, 26, Baldwin Street, Bristol. Public examination: 11 a.m., July 4th, at the Guildhall, Bristol. Date of order for summary administration: June 12th.

Receiving Orders and Adjudications.

Anderson, Cyril M., 1556, Stratford Road, Hall Green, Birmingham, trading there as the **Robin Hood Electrical Co.**, electrical contractor, etc. Court: Birmingham. Date of petition and order: June 12th. Debtor's petition.

Kendrick, Charles, 12, Newcomen Street, trading at 52, George Street, and 94, Bright Street, all Hull, wireless dealer, etc. Court: Kingston-upon-Hull. Date of petition and order: June 12th. Debtor's petition.

Blackmore, Glanville, 8, Granville Street, Market Harboro', Leicester, trading at 62, Coventry Road, Market Harborough, wireless engineer. Court: Leicester. Date of petition and order: June 13th. Debtor's petition.

Turner, Harry, 20, Battersea Rise, Clapham Common, London, S.W.11, radio and electrical contractor. Court:

Wandsworth. Date of petition and order: June 11th. Debtor's petition.

First Meetings and Public Examinations.

Tucker, Joseph, 30, Lower Ashley Road, formerly trading at 876, Filton Avenue, both Bristol, trading as **The Bristol Radiator Coy.**, wireless dealer. Court: Bristol. First meeting: 11.30 a.m., June 25th, at the Official Receiver's offices, 26, Baldwin Street, Bristol. Public examination: 11 a.m., July 4th, at the Guildhall, Bristol. Date of order for summary administration: June 6th.

Davies, Daniel J., 36, Cambrian Street, Aberystwyth, late of Tegfan, Adpar Llandyfriog, Cardigan, and lately trading at Market Place, Newcastle-Emlyn, Cernarh, Carm., wireless engineer. Court: Carmarthen. First meeting: 11.30 a.m., June 24th, at the Official Receiver's office, 4, Queen Street, Carmarthen. Public examination: 12 noon, July 8th, at the Guildhall, Carmarthen. Date of order for summary administration: June 14th.

Hanson, Thomas S., 26, Nether Hall Road, Doncaster, electrical contractor, etc. Court: Sheffield. First meeting: 12 noon, June 25th, at the Official Receiver's offices, Figtree Lane, Sheffield. Public examination: 2 p.m., July 3rd, at the County Court Hall, Bank Street, Sheffield.

First Meetings.

Barraud, Thomas, Ltd., 35, Bond Street, South Shore, Blackpool. Court: Blackpool. Creditors: 11 a.m., July 1st, at the Official Receiver's office, 9, Cannon Street, Preston, Lancs. Contributories: 11.30 a.m., same day and place.

Winding-up Order.

Barraud, Thomas, Ltd., 35, Bond Street, South Shore, Blackpool. Court: Blackpool. Date of petition: May 6th. Date of order: June 4th.

Order made on Application for Discharge.

Morphy, Donal W., 4-5, Dorset Mews, North, Upper Gloucester Place, London, N.W.1, wireless apparatus manufacturer, residing at 14, Collinette Road, London, S.W.15. Court: High Court of Justice. Date of order: May 23rd. Bankrupt's discharge suspended for six months; he will be discharged as from November 23rd next.

Releases of Trustees.

Douglas, Henry David, 42, Bromley Road, Catford, London, S.E.6, trading as **H. D. Douglas & Co.** wireless factors, etc., at 32, Queen Victoria Street, London, E.C.4. Court: High Court of Justice. Date of release: May 16th. Trustee: E. H. Hawkins, 4, Charterhouse Square, London, E.C.1.

Baines, Gerald Talbot, 66, High Street, Gorleston, electrical engineer, etc. Court: Great Yarmouth. Date of release: May 23rd. Trustee: C. B. L. Prior, 4, Eastbourne Place, Prince of Wales Road, Norwich, Official Receiver.

Latham, John James, 3, Brickhouse Street, Burslem, Stoke-on-Trent, wireless

dealer, etc. Court: Hanley and Stoke-on-Trent. Date of release: May 26th. Trustee: Cyril John Pyke, 12, Lonsdale Street, Stoke-on-Trent, Official Receiver.

Amos, Edward, 185, Upper Parliament Street, Walton, and **Wright, Ernest Charles**, 21, Church Road East, Walton, trading as **Amos & Wright**, 32, Slater Street, Liverpool, electrical engineers, etc. Court: Liverpool. Date of release: April 2nd. Trustee: Charles Turner, 155, Norfolk Street, Sheffield.

Fraser, Harold Joseph, 28, Southborne Road, trading at 135, Pinstone Street, and 101, London Road, Sheffield, gramophone dealer, etc. Court: Sheffield. Date of release: May 2nd. Trustee: Charles Turner, F.C.A., 155, Norfolk Street, Sheffield.

Cave, Frederick Edward, 57, Beaumont House, Church Vale, and trading as **F. E. Cave & Son**, electrical goods dealer, etc., 40, Paradise Street, both West Bromwich. Court: West Bromwich. Date of release: May 23rd. Trustee: Clement Hoult, 191, Corporation Street, Birmingham, Official Receiver.

Intended Dividends.

Durant, Thomas William Baron, 143, Wortley Road, High Green, trading at Coit Lane, Chapelton, nr. Sheffield, electrical engineer, etc. Court: Barnsley. Last day for proofs: June 28th. Trustee: Basil Shaw Briggs, County Chambers, King Street, Wakefield, Official Receiver.

Smith, Harold Rowles, The Mount, Wiston Lane, and trading as **Smiths**, 22, Westgate, Elland, gramophone dealer, etc. Court: Halifax. Last day for proofs: June 27th. Trustee: John Osborne Morris, 12, Duke Street, Bradford, Official Receiver.

Dividends.

Horsfall, William M., Heath Lodge, Hootan, Chester, trading at 7, Redcross Street, Liverpool, electrical engineer, etc. Court: Birkenhead. Sixth dividend of 4½d. in the £ payable on June 24th, at the Official Receiver's offices, Government Buildings, Victoria Street, Liverpool.

Maddox, Victor F., 6, Homend Street, Ledbury, Hereford, wireless engineer, etc. Court: Hereford. First and final dividend of 1s. 2½d. in the £, payable on June 25th, at the Official Receiver's office, 133, St. Owen Street, Hereford.

Dissolution of Partnership.

Raybould, May, and **Carter, John H.**, trading as **M. Grundy & Co.**, 54, Clerkenwell Road, London, E.C., wireless accessories dealers. Dissolved: June 7th. Debts May Raybould, who continues the business under the same style.

County Court Judgments.

The following returns have been received from the Registry of County Court Judgments, Treasury, Whitehall, which purports to contain lists of judgments entered up in the respective County Courts of England and Wales, but no distinction is made on the register between actions for debts or damages or properly disputed cases; neither is it known which of the judgments remain unpaid at the present time; and it is probable that a large proportion of them have been settled between the parties or paid. It may also be observed that some of

the judgments registered are against defendants in a representative capacity. The name given is that of the defendants; the amount is that for which judgment was given, and the date is that on which it was given.

Jelly, A., Mrs., 138, Osborne Road, Pontypool, Mon., wireless dealer. Court: Newport. £10 13s. 7d. May 6th.

Gilophone, Ltd., R/O, Ebor House, 76, City Road, Manchester, wireless and gramophone manufacturers. Court: Wigan. £26 10s. 10d. May 1st.

Walsall Radio Co., 140, Lichfield Street, Walsall, wireless dealers. Court: Birmingham. £14 14s. 10d. May 13th.

The Triumph Radio Co., Ltd., 233, Vauxhall Bridge Road, London, S.W.1, wireless dealers. Court: Westminster. £11 3s. 10d. April 28th.

Cartwright, Mr., 55, Wilbury Crescent, Hove, Sussex, wireless dealer. Court: Brighton. £13 18s. 6d. May 15th.

Henwood, W. R., Camel's Head Garage, Devonport, wireless dealer. Court: Plymouth. £40 11s. 2d. May 15th.

South London Radio & Gramophone Stores, 68, Old Kent Road, London, S.E., gramophone dealers. Court: Westminster. £22 15s. 8d. April 30th.

Edwards, W., Abbey Garage, Denbigh, wireless dealer. Court: Westminster. £13 9s. 2d. April 29th.

Newman, J. W., Upper St., James Street, Brighton, wireless dealer. Court: Westminster. £10 17s. 7d. April 29th.

Rubins, M. (proprietor of Popular Wireless Stores below), 55, Duke Street, Sheffield, wireless engineer. Court: Westminster. £29 12s. 6d. May 5th.

The Popular Wireless Stores, address as above, wireless retailers. Court: Leeds. £57 11s. 5d. May 12th.

Moody, Alfred, over 47, Abington Street, Northampton, wireless engineer. Court: Northampton. £15 9s. 8d. May 14th.

Endel, Bertram, 55, Laurel Road, Leicester, wireless dealer. Court: Leicester. £27 3s. 3d. May 6th.

Receiverships (Appointment).

Rissik Fraser & Co., Ltd.—C. O. Skey, of 10, St. Swithins Lane, E.C.4, was appointed Receiver and Manager on June 2nd, 1930, under powers contained in mortgage and charge dated December 8th, 1928, in place of H. A. Brown, who died on May 30th, 1930.

Deophone (Foreign), Ltd.—C. Latham, of 78, New Oxford Street, W.C.1, was appointed Receiver on May 30th, 1930, under powers contained in mortgage debenture dated May 15th, 1930.

Truphonic Radio, Ltd. E. D. Basden, F.C.A., of 73, Basinghall Street, E.C., was appointed Receiver on May 31st, 1930, under powers contained in debenture dated October 30th, 1929.

Mortgage and Charge.

Ridings Reliance, Ltd.—Mortgage dated May 16th, 1930, to secure £2,500, charged on properties in Stockport Road and Etruria Street, Chorlton on Medlock, Manchester, and three yearly rent charges. Holders: Mrs. K. Greatorex, Mytton Hall, nr. Shrewsbury.

Satisfactions.

Note:—Where the amount "originally secured" is stated, that is not necessarily the amount outstanding at the date of the satisfactions recorded below. There may have been previous partial satisfactions, registered or unregistered. The registration of Satisfactions is not compulsory.

Ridings Reliance, Ltd. Satisfaction

in full—(1) on May 14th, 1930, of mortgage dated August 28th, 1925, and registered February 6th, 1930; and (2) on May 15th, 1930, of mortgage dated August 27th, 1925, and registered February 6th, 1930. (According to the register of mortgages, the amounts owing on November 1st, 1929, of mortgages registered February 6th, 1930, was £837 14s. 4d., and £700.)

Johnson Talking Machine Co., Ltd. Satisfaction in full on March 3rd, 1930, of debenture dated September 28th, 1927, and registered October 6th, 1927, securing all moneys due or to become due.

Private Arrangement.

Ernest Rogers, trading as **The Stamford Cycle Stores**, wireless dealer, etc, Stamford Street, Mossley, and at Hyde.

The creditors interested herein were called together recently at the offices of Harry L. Price & Co., accountants and auditors, Mosley Street, Manchester. The statement of affairs showed ranking liabilities of £502 9s. 2d., of which £467 9s. 2d. was due to the trade and £35 to a cash creditor. There was also a fully secured creditor for £2. After allowing £6 10s. for preferential claims the net assets were £110 6s. 6d., or a deficiency of £392 2s. 8d. It was reported that the debtor commenced trading in April, 1929, when he took over an existing business, paying £80 for the stock, fixtures and goodwill. The branch at Hyde was opened in August of last year. The takings at Mossley had been £18 to £20 a week, but they had now fallen to £8 weekly. The Hyde turnover had fallen from £12 to £5 a week. The present position was attributed to bad trade, lack of capital, and loss incurred in opening the Hyde business.

In the absence of any offer it was decided that a deed of assignment should be executed to Mr. A. T. Eaves, of Harry L. Price & Co., Manchester.

The following are among the creditors:

Bold, W., & Co., Ltd., Liverpool	£103
Brown Bros., Manchester	23
Moscoe, H., Ltd., Manchester	11
Goldsmith, J., & Co., Manchester	24
Richardson & Co., Manchester	167

Voluntary Liquidations.

Lambert Laws, Ltd., radio experts, etc. 15, Gloucester Place, Brighton, and 109A, Chapel Road, Worthing.

The statutory meeting of the creditors of the above was held on June 10th, at the offices of Mr. A. E. Orbell, accountant and auditor, 6 and 7, Old Steine, Brighton. The statement of affairs showed ranking liabilities of £2,687 4s. 6d., of which £2,665 4s. 6d., was due to the trade and £22 was owing in respect of rent. After allowing £13 11s. 3d. for preferential claims, the net assets were £2,323 11s., or a deficiency so far as the creditors were concerned of £363 13s. 6d. Among the assets are stock at cost, £1,756 6s. 2d.; book debts, £749 2s. 4d., estimated to produce £350; cash at bank, £52 10s. 5d.; and cash in hand, £149 19s. 8d.

Mr. Orbell reported that the company was registered on March 20th, 1928, with a capital of £2,000, for the purpose of taking over a business which had previously been carried on by Mr. Ernest

Lambert at 15, Gloucester Place, Brighton. The company took over the assets of the business which were valued at £2,670, agreed to discharge liabilities of £670, and to allot to the vendor or his nominee fully paid shares to the value of £2,000. The first directors were Mr. and Mrs. Lambert, and subsequently Mr. A. W. Finn, joined the board. The business at Worthing was opened on May 25th, 1928. Between June, 1928, and March, 1929, the turnover at Worthing was £1,841, while in the following twelve months it increased to £2,206. The accounts of the company for the year to March, 1929, showed sales, etc., of £6,682, against purchases of £5,030. There was a gross profit of £1,024, but a net loss of £537. During the year to March, 1930, sales were £8,392, purchases £7,717, with a further net loss of £180. Mr. Orbell added that the deficiency was attributed to the loss on trading and the depreciation written off the assets in the statement of affairs.

A resolution was passed confirming the voluntary liquidation of the company with Mr. Orbell and Mr. W. A. J. Osborne, of Messrs. Corfield & Crippwell, Balfour House, Finsbury Pavement, E.C., as joint liquidators with a committee.

The following are among the creditors:

Ferranti, Ltd., Hollinwood	£108
Revo Electric, Ltd., Tipton	102
Siemens Bros. & Co., Ltd., London	93
Cole, E. K., Ltd., Leigh-on-Sea	53
Burton, C. F., & H., Walsall	71
Lever, Eric J., Ltd., London	82
London Electric Wire Co. & Smiths, Ltd., London	38
Three Star Accumulators, Ltd., London	63
Ward & Goldstone, Manchester	31
Dubilier Condenser Co., Ltd., Acton	48
Hughes, F. A., & Co., Ltd., London	37
Wholesale Fittings Co., Ltd., The London	43
Edison Swan Electric Co., Ltd., Ponders End	37
Formo Co., London	27
General Electric Co., Ltd., London	22
Ultra Electric Ltd., London	20
Foster Engineering Co., Ltd., London	22
Tunggram Electric Lamp Works (G.B.), Ltd., London	62

Leo Taylor, Ltd., Lytham Road, South Shore, Blackpool, radio engineers.

The statutory meeting of the creditors of the above was held on June 12th, at the offices of Mr. W. Latham, C.A., 27, Birley Street, Blackpool. Mr. J. L. Taylor occupied the chair, and a statement of affairs was submitted which showed ranking liabilities of £1,286 17s. 9d., due to unsecured creditors. After allowing £8 5s. 8d. for preferential claims the net assets were £409 7s. 4d., or a deficiency so far as the creditors were concerned of £877 10s. 5d. The issued capital of the company was £900, and there was a deficiency of £1,777 10s. 5d., as regards the shareholders. It was reported that there was a contingent liability in respect of rent for a year and a half at £120 per annum.

The company was registered in 1928 with a nominal capital of £1,000, divided into shares of the face value of £1 each. The accounts showed that there had been a loss on the trading and when proceedings were commenced by a creditor voluntary liquidation was deemed advisable. The ranking liabilities included a sum of £302 due to the bank, in respect of which third party guarantees were held. A resolution was passed in favour of the voluntary liquidation of the company being continued, with Mr. Latham as

MULLARD A.C. SCREEN GRID VALVE



PRICE
25/=

Max. Heater Voltage - 4.0 volts.

Heater Current - 1.0 amp.

Max. Anode Voltage - 200 volts.

Positive Screen Voltage
75-100 volts.

Anode Impedance - 430,000 ohms.

AMPLIFICATION FACTOR - 1500

MUTUAL CONDUCTANCE
3.5 mA/Volts.

THE • MASTER • VALVE

Advert. The Mullard Wireless Service Co., Limited, Mullard House, Charing Cross Road, London, W.C.2.

EVER READY

REGD TRADE MARK

REDUCED PRICES



The fall in the values of metals and raw materials and increased production enables us to reduce the prices of the following batteries. We believe these reductions will assist in further stimulating the demand for our goods, and we trust you will carry sufficient stocks to meet the demands.

	Old Price.	New Price.
Winner 60-volt	7/-	6/6
” 66 ”	7/6	7/-
” 99 ”	11/6	10/9
” 120 ”	14/-	13/-

WINNER H.T. BATTERIES



	Old Price.	New Price.
No. 1689 3-cell P.L.(Green)	9d.	7 1/2d.
” 1289 do. (Red)	6d.	5d.
” I do. large torch	1/-	10 1/2d.
” 1829 2-cell do.	8d.	7d.
” U.2 Unit cell do.	4 1/2d.	3 1/2d.
” 1839 2-cell Baby torch	7d.	6d.
” 12, 15, 1215 3-cell box type	1/6	1/3
” 126 do. (2 terms.)	1/6	1/3

REFILL DRY BATTERIES



No. 2036 Electric Cycle Lamp Now 3/-
Complete with "Long Life" battery giving 18 hours lighting service

No. 800 Refill Battery 9d.

The "LONG LIFE" CYCLE LAMP

THE EVER READY CO. (G.B.) LTD., Hercules Place, Holloway, London, N.7

liquidator, and a committee was also appointed.

The following are among the creditors :

Bankers, Blackpool	£302
Hollingsdrake, H., & Son, Ltd., Stockport .. .	361
Ellis & Mort, Ltd., Blackpool	123
Kolster-Brandes, Ltd., Sidcup	67
Hardman & Co., Ltd., Rochdale	78
Baxendale & Co., Ltd., Manchester	67
General Electric Co., Ltd., Manchester	46
Brown Bros., Ltd., London	38
Marconiphone, Ltd., Dagenham	33
Mullard Wireless Service Co., Ltd., London .. .	15
Hartley, R. A., Blackpool	30
Taylor, J. L., Blackpool	30

Bankruptcies.

William Spurr, 3, Arcade, Kirkgate, Wakefield, gramophone dealer, etc.

The receiving order against this debtor was made on May 15th on his own petition. At the first meeting of creditors held on May 30th, at the Official Receiver's office, County Chambers, King Street, Wakefield, the case, being a summary one, was left in the hands of the Official Receiver as trustee.

The following are creditors :—

Appletons, Leeds	£193
Spurr, Mrs., Wakefield	180
Hoptonstall, Mrs., Wakefield	50
Parker Phone Co., Bradford	21
Smith & Sons, W. H., Bradford	16
Jacksons Stores, Ltd., Wakefield	20

Sydney Ernest Richards and Alan Kelson Neilson, trading as **Richards & Neilson**, wireless and electrical engineers, 182, Tulse Hill, London, S.W.2.

The debtors filed their petition on May 5th, and the statutory first meeting of their creditors was held recently at Bankruptcy Buildings, Carey Street, W.C. A joint statement of their affairs was submitted showing liabilities £554 and assets nil. It appears from statements that had been made by Richards that in 1924 a wireless and electrical engineer carrying on business at the above address then suggested that they should enter into partnership, and that in consideration of investing £250 in the business the debtor should receive a one-half share in it. In November, 1924, he ascertained that Neilson was a partner in the business, and within four months of his original agreement with the aforementioned engineer the latter retired, surrendering his interest in the business in consideration of certain promissory notes. In October, 1925, there was a disagreement with this person, who died in July last, and proceedings were afterwards taken against Neilson in respect of a separate promissory note which he had given and judgment was recovered. At the date of the receiving order proceedings were pending in reference to those notes which were joint and several. In February it was decided to dispose of the business as a going concern to his (Richards') wife for £65 of which £33 was paid away to pressing creditors and £20 went on account of the costs of the defence of the action brought by the widow of the before-mentioned person against Neilson.

It appeared that the court had already made an order adjudging the debtors bankrupt and a further order for the summary administration of their estate. No resolution was now passed and the meeting was closed, the estate remaining

(Continued on page 334.)

April Export Figures.
Figures for British Goods Increase.

£101,525

B*OTH the total overseas trade returns and also those for British goods exclusively indicate that our wireless exports in April were greater than in the preceding month, the actual figures being £94,527 and £76,857 respectively. In February the value of British goods exported was £91,537; and in January—the "boom" month—£120,908. In comparison with March, countries purchasing more from this country during April included Poland, the Netherlands, Belgium, Switzerland, Japan, U.S.A., Mexico and Peru.*

EXPORTS.

Country	Apparatus Value	Valves Value		
	£	£		
Foreign Countries.				
Soviet Union (Russia)	9	—		
Finland	62	108		
Estonia	28	1		
Latvia	22	—		
Sweden	920	321		
Norway	307	26		
Iceland	97	—		
Denmark (inclgd. Faroe Is.)	733	12		
Poland (inclgd. Dantzic)	405	364		
Germany	195	65		
Netherlands	16,132	189		
Java	21	2		
Dutch West India Islands	85	—		
Dutch Guiana	25	—		
Belgium	1,906	2,832		
Belgian Congo	5	169		
France	1,243	3,189		
Algeria	20	—		
French West and Equatorial Africa	58	—		
Syria	9	—		
Switzerland	545	68		
Portugal	—	—		
Portugal	266	11		
Azores	—	10		
Madeira	31	12		
Portuguese W. Africa	74	21		
Portuguese E. Africa	24	—		
Spain	1,205	470		
Canary Islands	241	3		
Spanish W. Africa (inclgd. Fernando Po.)	3	—		
Italy	7,220	1,017		
Tripoli	10	—		
Austria	91	115		
Hungary	238	18		
Czecho-Slovakia	238	155		
Greece	145	80		
Roumania	85	33		
Turkey, European	—	5		
Egypt	976	159		
Iraq	9	—		
Persia	1	7		
Siam	121	181		
China	23	12		
Japan	138	—		
U.S. America	515	466		
Mexica	1,034	92		
Colombia	145	17		
Panama	3	—		
Venezuela	8	209		
Peru	1,062	92		
Chile	203	239		
Brazil	267	245		
Argentine Republic	65	418		
British Possessions.				
Irish Free State	2,834	989		
Channel Islands	1,119	120		
Gibraltar	—	28	£	£
Malta and Gozo	326	112		
Cyprus	49	17		
Palestine	101	—		
Sierra Leone	25	5		
Gold Coast	256	56		
Nigeria	184	15		
St. Helena	1	—		
Union of South Africa	8,899	1,446		
Southern Rhodesia	39	6		
Zanzibar and Pemba	25	—		
Kenya	129	200		
Anglo-Egyptian Sudan	—	70		
Mauritius & Dependencies	17	9		
Bombay via Karachi	150	85		
Bombay via Other Ports	524	427		
Madras	25	—		
Bengal, Assam, Bihar & Orissa	477	19		
Burmah	104	—		
Straits Settlements & Dependencies (inclgd. Labuan)	568	75		
Federated Malay States	121	18		
Ceylon & Dependencies	207	79		
State of North Borneo	9	2		
Hong Kong	531	140		
Australia	13,317	7,861		
New Zealand	1,173	896		
Canada	625	381		
Jamaica & Dependencies	55	4		
Trinidad and Tobago	26	—		
Other B. W. I. Islands	149	20		
British Guiana	93	9		
Falkland Islands	—	73		
Total	69,454	25,073		

RE-EXPORTS.

Foreign Countries.				
Denmark	18	—		
Germany	364	—		
Netherlands	1,193	3,463		
Belgium	590	40		
France	245	2		
Switzerland	94	—		
Portugal	7	—		
Spain	19	8		
Hungary	20	—		
Iraq	9	—		
U.S. America	100	—		
British Possessions.				
Channel Islands	3	11		
Kenya	1	—		
Anglo-Egyptian Sudan	9	—		
Bombay via Karachi	3	—		
Australia	182	—		
New Zealand	65	—		
British Guiana	17	—		
Irish Free State	489	46		
Total	3,428	3,570		

(Continued from page 333, column 1)

in the hands of the Official Receiver.

The following are among the creditors:—
 General Electric Co., Ltd., London £35
 Hurman, J. A., London 14
 Lyon, Victor F. (deceased), London 350
 Sun Electrical Co., Ltd., London 132

Frederick James Burden, 19, Durngate Street, Dorchester, wireless dealer, etc.

The public examination of this debtor was held recently at the County Hall, Dorchester, when the statement of affairs produced showed liabilities of £342 3s. 11d. against assets estimated at £49 12s. 7d. It would seem that the debtor commenced trading in August, 1922, having a capital of £10. The debtor had not taken any regular drawings from the business. Two years ago the debtor had traded with another, who put £10 into the business, which, however, did not prosper, and subsequently the partner retired. The hearing was concluded.

Edward Doudney, 93, East Street, and 40, South Street, Chichester, wireless wholesale and retail salesman.

The public examination of the above was held recently at the Court House, Church Street, Brighton. From the statement of affairs submitted there were liabilities amounting to £2,427 12s. 7d. and assets of £349 17s. 6d., thus leaving a deficiency of £2,077 15s. 1d. The debtor started business in May, 1919, as a wireless dealer. The business, however, was not successful and he was allowed an overdraft from the bank. In February, 1928, he gave the guarantor a mortgage on the premises at Chichester, for £750. At that time he was responsible to the bank for an overdraft and that liability had not been discharged. He did not think there was much value in the lease of the premises. In June, 1929, he found that the retail business was unsuccessful and then commenced a wholesale business, borrowing £500 from his sister. The examination was adjourned.

Robert Stanley Poynton, "Kinross," Watling Street, Long Shoot, Nuneaton, Warwickshire, lately 3, Lower Bond Street, Hinckley, and 11, Hotel Street, Coalville, lately trading as **The Birmingham Cycle Company**, wireless dealer, etc.

The receiving order herein was made on May 20th on the debtor's own petition. The first meeting of the creditors was held recently at the Official Receiver's office, 1, Berridge Street, Leicester, when the case, being a summary one, was left in the hands of the Official Receiver, as trustee of the estate.

The public examination of this debtor was held on June 6th at the Castle, Leicester. According to the statement of affairs produced, there was a deficiency of £891 5s. The debtor, replying to questions, said that he had lost £100 through an explosion in his shop. He had only received £25 from the insurance company, being informed that the policy covered normal fire, and not explosions. The debtor was directed to post the policy to the Official Receiver, who would endeavour to get more for the creditors. The hearing was concluded.

The following are creditors:—
 Brown Bros., Ltd., London £51
 Edison Swan Electric Co., Ltd., Ponders End .. 13
 Hobday Bros., Ltd., London 67
 Tungsram Electric Lamp Co., Ltd., London .. 17
 Weston Electric Lamp Co., London 11
 Bankers, Coalville 62

BUSINESS ITEMS.

Mullard's Leeds Depot.

The Mullard Wireless Service Co., Ltd., announce that their Leeds Depot has been removed from 33, York Place, to 33, Park Place, Leeds. The new telephone number is Leeds 29771.

Wrong Number.

Owing to an error in the notice circulated to the trade regarding Radio Instruments' removal to Purley Way, Croydon, the 'phone number was wrongly given as Croydon 3211 instead of Thornton Heath 3211.

Two Portables Stolen.

Dulcetto-Polyphon, Ltd., 2-3, Newman Street, London, W.1 ('phone: Museum 2660), inform us that two portables were stolen from their van early this week. One was a Burndept S.G.4, No. 45521, and the other an old type Edison Bell 5-valve portable, No. 968.

As these sets were being taken away for repair at the time, it is thought that they may be brought to dealers in the London area.

Marconiphone Holiday Arrangements.

The attention of the trade is drawn to the fact that the Marconiphone works at Dagenham, Essex, will be closed for the annual holidays from Thursday evening, July 31st, until Monday morning, August 11th.

The firm's Orders and Credits Department will, however, remain open with a skeleton staff to deal with urgent matters during this period, but the Central Service Depot at Dagenham will be closed. The London service depot in Tottenham Court Road, and the provincial service depots at Birmingham, Bristol, Glasgow, Manchester, and Cardiff, will all remain open as usual.

"£2 Carriage Paid," by Hobdays.

Retailers who do business with Hobday Bros., Ltd., will learn with interest that that well-known wholesale house now pay carriage in England and Wales on all orders over £2, subject to conditions and exceptions published in the firm's current catalogues. This facility was previously only available on orders of £5 and over.

A boldly printed stick-on label is attached to all Hobday's correspondence, drawing attention to this facility.

Aeonic Battery Offer Continued.

It will be recalled that, in order to introduce their high-tension batteries to the trade, Aeonic Radio, Ltd., recently offered to all purchasers of batteries to the gross value of £5 or more one 108 V Aeonic battery free of charge. The

firm were enabled to place their batteries on the general market by reason of the fact that they have just made large extensions to their battery manufacturing plant, and are now delivering the batteries separately from their receivers.

Although it was intended that this offer should terminate to-day (June 21st), we understand that it will be continued for another week, and that deliveries can be effected immediately.

Receivers for the Blind.

The first fruits of the British Wireless for the Blind appeal, launched last Christmas by the Rt. Hon. Mr. Winston Churchill and supported with considerable enthusiasm by many people in the trade, take the form of 6,000 crystal receivers specially designed for ease of operation by blind persons.

A contract for the manufacture of these has just been awarded to Burne-Jones & Co., Ltd., of 296, Borough High Street, London, S.E.1, and we learn that production is well in hand. Three or four other well-known firms have been given sub-contracts for the supply of important components, including the Jewel Pen Co., Ltd., for crystal detectors; the Carrington Manufacturing Co., Ltd., for cabinets; the Igranic Electric Co., Ltd., whose coils will be used; and the Ormond Engineering Co., Ltd., who are to supply the condensers.

Errata.

Four slight errors unfortunately occurred in our mains number, dated June 7th. The first of these refers to the price of the A.C. mains unit handled by Dr. Nesper, Ltd., the price of this unit being incorrectly printed on page 260 as £4 13s. 6d., instead of £4 19s. 6d. The second relates to the Neophone unit, which, illustrated on page 267, was described in the caption as the A.C. model. Actually, this was the D.C. unit.

Some facts about the Itonia radio-gramophone were not quite correct. We stated that a B.T.H. motor was used. Actually, however, the motor is a Garrard electric type with a B.T.H. pick-up and arm. The standard radio-gramophone, with an air-chrome speaker, sells at 65 guineas for A.C. or D.C. mains. For an extra 5 guineas a "Rola" moving-coil speaker can be fitted—not a "Magnavox," as was originally stated.

Through a printer's error, the price of the Ferranti table model speaker type AT1 was given on page 262 of our "All Mains" issue of June 7th as £8 16s. This should have been £18 16s.

Liverpool Factors Move.

S. Hathaway & Co., Ltd., the Liverpool wholesalers, have now moved to more commodious premises at 287, Edge Lane, Edge Hill, Liverpool, where their new 'phone number is Anfield 844.

Distributors for "Hegra" Lines.

J. H. Lewarn & Son, 2A, Bath Parade, Temple Gate, Bristol, inform us that they have been appointed wholesale distributors in Bristol and the West of England of "Hegra" products, and full stocks are now carried for immediate despatch.

Their new wireless list is now ready, and will be sent to traders on application.



Mr. R. E. Bonass, the recently appointed K-B representative in Devon and Cornwall.

K-B DUAL MOTORS

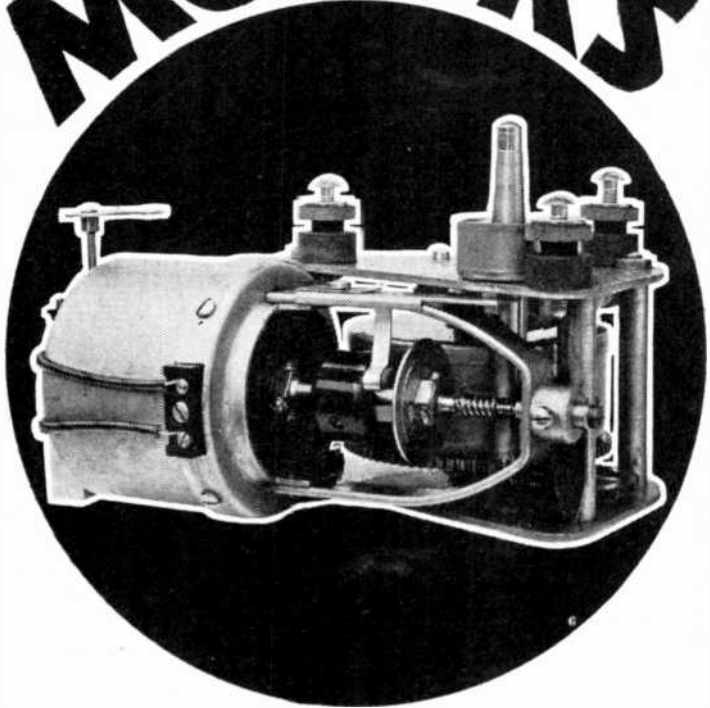

On account of the number of enquiries received for the Gramophone Motor fitted as standard in K-B Radio-Gramophones, Messrs. Kolster-Brandes have decided to supply as separate units, this and other models of Gramophone Motors. All types can be operated from the electric supply mains. Models K-B 220 and 225 are also equipped with a spring-driven clock mechanism, the change-over from one form of drive to the other being automatic.

K.B. "Dual" Motors are manufactured under one or more of the following patents: 290,954; 302,523; 305,841; 311,853; 312,885; 315,175; 324,425. Other patents pending.

ALL
PRICES
INCLUDE
10 OR 12 INCH
TURN TABLES

K-B 210	"Dual" Universal Motor	-	£4	2	6
K-B 215	" Induction Motor	-	£4	2	6
K-B 220	" Combined Universal Motor	-	£5	2	6
	(Clockwork & Electric Drive)				
K-B 225	" Combined Induction Motor	-	£5	2	6
	(Clockwork & Electric Drive)				
K-B 230	" Super Universal Motor	£5	12	6	
K-B 235	" Super Induction Motor	£5	12	6	

WRITE FOR FULL PARTICULARS
AND ILLUSTRATED LEAFLET
TO KOLSTER-BRANDES LTD.
CRAY WORKS, SIDCUP, KENT.

The model illustrated is the K-B 220. "DUAL" Combined Universal Motor. Suitable for both D.C. and A.C. mains and adjustable to any voltage from 100-250 volts. Has both electric and clockwork drive—the change-over being automatic. Net weight 5½ lbs. Price £5 2s. 6d. (including turntable).

Kolster Brandes
CRAY WORKS  SIDCUP, KENT

PREPAID PARAGRAPH ADVERTISEMENTS.

SCALE OF CHARGES.

AUCTIONEERS' & OFFICIAL ANNOUNCEMENTS.—

Advertisements under this heading are inserted at a charge of 11s. per single column inch.

TRADE & MISCELLANEOUS.—3s. for 12 words and 3d. for each additional word.

SITUATIONS VACANT & WANTED.—2s. for 12 words and 2d. for each additional word.

SERIES DISCOUNTS.—On contracts for consecutive insertions the above rates are subject to discounts as follow: 13 insertions 5 per cent., 26 insertions 10 per cent., and 52 insertions 15 per cent.

BOX NUMBERS.—If replies are sent to the office of the publishers, 6d. extra per insertion is charged to cover cost of forwarding them. The Box Office address is counted as six words and charged accordingly.

PRESS DAY.—Copy should reach us not later than first post Tuesday Morning, four days before publication, and should be addressed to The Advertisement Manager, St. Bride's House, Salisbury Square, Fleet Street, London, E.C.4. Phone: Central 7713 (9 lines.)

COPY FOR ADVERTISEMENTS is subject to the approval of the Proprietors, who retain the liberty to withhold any advertisement which they regard as unsuitable for publication in this journal. The Proprietors are not responsible for clerical or printers' errors, although every care is taken to avoid mistakes.

NOTE.—The insertion of an advertisement ordinarily constitutes acknowledgment of the remittance, but for remittances covering contracts for 13 insertions or more a receipt will be sent.

ORDERS AND CHEQUES should be made payable to THE TRADER PUBLISHING CO., LTD., and crossed "and Co." Treasury Notes, being untraceable if lost in transit, should not be sent as remittances.

ALL ADVERTISEMENTS MUST BE PREPAID. DEPOSIT SYSTEM.

To facilitate business between advertisers and unknown or distant readers, we have a "Deposit Department." The buyer sends us the money, and we advise both parties of its receipt. The seller then sends the goods carriage paid to the buyer, who must within three days of receiving them either accept them or return them carriage paid. If he accepts them we forward his money to the seller; if he rejects them we return his money when advised by the seller that the goods have come to hand. We cannot, however, accept any liability in a dispute. Our charges payable by the buyer for this service are:—

1/- on transactions up to £5.
2/6 " " between £5 and £20.
5/- " " " £20 and £50.

And thereafter 6d. for every £5 or part thereof.

AUCTIONS.

By Order of H. A. Allison, Esq., F.C.A.
Re Submersible Motors, Ltd.
(in Liquidation)

FELTHAM

HENRY BUTCHER & CO.,

will offer for Sale by Auction (unless previously disposed of by Private Treaty) at The London Auction Mart, 155, Queen Victoria Street, E.C.4, on THURSDAY, JULY 10th, 1930, at 2.30 p.m.

A MODERN FREEHOLD FACTORY

situate in **Browells Lane**, comprising an exceptionally lofty single storey building of substantial brick construction with a first floor gallery containing a total **FLOOR SPACE of 11,500 SQUARE FEET** including outbuildings.

SITE AREA ½ ACRE

Affording considerable room for extension. Company's Water. Electric Light and Power. Gas. Central Heating.

Particulars of Messrs. J. DIX LEWIS, CAESAR & CO., Chartered Accountants, Kennan's House, Crown Court, Cheapside, London, E.C.2, and of Messrs. E. F. TURNER & SONS, Solicitors, 28, St. Mary Axe, London, E.C.3, and of Messrs. HENRY BUTCHER & CO., Factory Auctioneers, 63 and 64, Chancery Lane, London, W.C.2.

CLIX

The Cure for Clicks!

CLIX RING TERMINALS CLIX FIT-ALL SPADE TERMINALS CLIX HOOK TERMINALS

Engraved or Plain Insulators.
Full range of standard markings.

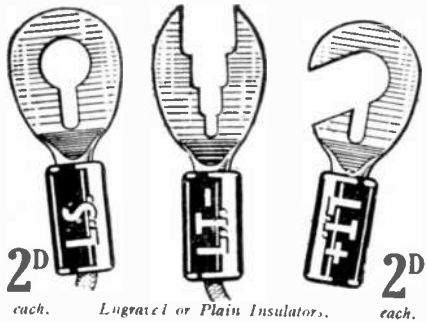

Write for Illustrated Price List of
CLIX 21 VARIETIES
for perfect contact.

LECTRO LINX LTD. 254 Vauxhall Bridge Rd., Victoria, S.W.1
Telephone—VIC 3541.

PORTABLE SET MANUFACTURERS

SEND to-day for our List of "ALWAYS" Resistances. Special types for Portables. Samples free to genuine manufacturers. "ALWAYS" the most reliable Resistance.

Large Stocks. Quick Deliveries.

ABINGDON · WIRELESS · SUPPLIES
ABINGDON · · · · · BERKS.

ASHTON PERFECT AERIAL SPREADERS
15/- New Model 15/-
Per Set

WONDERFUL RECEPTION

ASHTON PERFECT AERIAL SPREADERS
"THE BEST SET" 15/-
MADE A PERFECT AERIAL
IN FIFTEEN MINUTES

In carton. From all wireless dealers and
ASHTON'S
8-10, BULL'S HEAD
YARD, MANCHESTER

Re CELEBRITONE LTD.

(In Voluntary Liquidation).

By Order of the Joint Liquidators,
Charles Latham, Esq., F.L.A.A., and
Eric F. Wilkins, Esq., A.C.A.

Messrs.

FULLER HALL & FOULSHAM
are instructed to offer for SALE by AUCTION ON THE PREMISES situate on the CHASE ESTATE, PARK ROYAL ROAD, WILLEDEN, N.W., on TUESDAY, JUNE 24TH, 1930, at 11 o'clock precisely, FIRSTLY, the

GOODWILL OF THE BUSINESS of CELEBRITONE, LTD., including the Patents, and immediately afterwards in Lots in detail the Stock of

GRAMOPHONE and WIRELESS ACCESSORIES, including:—

CINEMA, DOUBLE CLUB and SINGLE GRAMOPHONES. SIMPLEX PROJECTOR. Gramophone Motors. Oak and Walnut Cabinets. CRYPTO DC/AC CONVERTERS up to 200/240 volts. Philips Chargers, Kuprox Trickle Chargers. CRYPTO MOTORS and GENERATORS up to 110/240 volts. M.I. GENERATORS. WESTINGHOUSE RECTIFIERS. Variable and Non-Variable ELIMINATORS. 4- to 12-VALVE AMPLIFIERS. MOVING COIL LOUD SPEAKERS by Brown and others. FERRANTI TRANSFORMERS, Valves by Mullard and others. Accumulators, H.T. Batteries, Fixed and Variable Condensers, Grid Leaks, Frame Aerials, Switches, Plugs and Sockets, Large quantities of D.S.C., D.C.C. and enamelled Copper Wire and the ENGINEERS' MACHINE TOOLS comprising Capstan and other Lathes; DRILLING MACHINES, Grinders, GUILLOTINE, Screw Fly Presses, ELECTRIC MOTORS UP TO 15 H.P. Benches. 25-CWT. MORRIS MOTOR VAN, OFFICE FURNITURE and other effects.

Catalogues (when ready) may be obtained of:—

CHARLES LATHAM, ESQ.,
Certified Accountant,
78, New Oxford Street, W.C.1

ERIC F. WILKINS, ESQ.,
Chartered Accountant,
8, Queen Street, E.C.4
and of

Messrs. FULLER HALL & FOULSHAM,
Auctioneers,
125, High Holborn, W.C.1

READER CONFIDENCE

A TRADE Journal makes a definite appeal to the business men and women engaged in a particular industry.

Apart from the many side issues, the fundamental duty is to present to its readers reliable reports of the progress and developments of the industry which it serves.

It must faithfully reflect all opinions on every matter of trade importance, and fearlessly support measures that it conceives to be for the well-being of the industry.

This has been the policy of THE WIRELESS AND GRAMOPHONE TRADER from the time of its inception; the same policy that was decided upon over thirty years ago, when we first commenced to publish Trade Journals.

It is thus that readers have obtained confidence in THE WIRELESS AND GRAMOPHONE TRADER, a firmly-established confidence which is reflected in the Advertisement Columns

W.T.A. 10.

BUSINESS FOR SALE.

WIRELESS manufacturing business for sale. Registered trade name. Factory London district. Principals only.—Box No. 1193, WIRELESS TRADER Office. (909)

MISCELLANEOUS.

LOUD-SPEAKERS, headphones and transformers. Trade repairs.—Howell, 9, Morley Hill, Enfield, Middlesex. (H7)

FORTY lines and every one a seller. Send for lists now and keep busy.—A. J. Hewitt, 21, South Street, Greenwich, S.E.10. (H4)

FLEXIBLES.—Radio, R.B. (two types), cotton braided; rubber covered. Lighting, heavy quality. Maroon cotton braided. Tapes—Pure rubber; black adhesive. Keen prices and samples from A. J. Andrews, 9, Charterhouse Street, London, E.C.1. (A)

PARTNERSHIP

WANTED, principal or leading hand who would take up an active interest in the development of a small factory in Cambridge district.—Box No. 1101, WIRELESS TRADER Office. (913)

PATENTS.

PATENTS obtained, trade marks and designs registered at home and abroad. Gee & Co., patent and trade mark agents, trade mark advisers to THE WIRELESS TRADER, H. T. P. Gee, Member Radio Society, Great Britain, A.M.Inst. Radio Engineers, 52-54, Chancery Lane, Holborn, W.C.2. Telephone: Holborn 1525.

SITUATIONS VACANT.

DUNHAMS, Ltd., require travellers with experience and a good connection. Must not carry competitive lines. Salary and commission. Only first class men need apply.—Write fully and in confidence, Sales Manager, Dunhams, Ltd., Bellerophon Works, New Wharf Road, London, N.1. (D1)

REPRESENTATIVES wanted for London and the country with connection among the retail trade, by well-known manufacturers and importers. Applicants must have own car.—Write stating ground covered and previous experience to Box No. 1194, WIRELESS TRADER Office.

ASSISTANT required, S.E. London, radio and elec. Real knowledge radio. Neat constructor. Experience elec. trade advantage.—Write age, wages required and experience to British Monomark NKY6. (997)

SITUATION WANTED.

TRAVELLER with good connection desires position with a house for gramophones, records, wireless or cycle and motor goods. First class references.—Box No. 1192, WIRELESS TRADER Office. (992)

WANTED.

MANUFACTURERS' discontinued stocks wanted. Any quantities.—Box No. 947, WIRELESS TRADER Office. (C9)

WANTED, all types of electrical and wireless apparatus: purchased for cash; large quantities only.—T. W. Thompson & Co., 17, Strutton Ground, S.W.1.

EXPERT ADVICE

Without Charge

When you are in perplexity,
When you are not quite sure,
When you are "up against"
the hundred and one little
technical, commercial, or legal
worries that beset the trader
in wireless and gramophones
remember that

"THE
WIRELESS & GRAMOPHONE
TRADER"

INFORMATION BUREAU

solves all these worries for you. There is no charge made for this service. It has proved invaluable to hundreds of perplexed traders, and is freely extended to all Overseas Traders.

Remember this when you are in difficulty and ring up or write.

'Phone :
CENTRAL 7713
(9 lines)

THE WIRELESS AND GRAMOPHONE TRADER

St. Bride's House, Salisbury Sq.
Fleet St., London, E.C.4



W.T.6

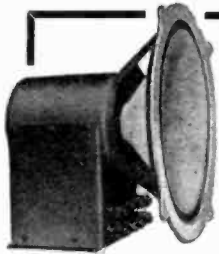

"THE MUSIC LOVER'S CHOICE"

Radio - Gramophone music and speech reproduced with amazing and uncanny realism. The most efficient speaker money can buy.

SEND TO-DAY FOR OUR FREE 36-PAGE BOOK-LET "SOUND ADVICE."

BAKERS
Selhurst
RADIO

Offices: 89 Selhurst Road, S. Norwood, S.E.25
Works: 42 Cherry Orchard Road, E. Croydon



DIALS and CONDENSERS

Precision Instruments for Set Manufacturers
EMKABE RADIO CO. LTD.
47 Farringdon Road, London, E.C.1

EXACT TUNERS

THOUSANDS IN USE
STOCKED BY ALL THE LEADING FACTORS
THE EXACT MANUFACTURING CO.
Croft Works, Priory Street,
COVENTRY, England.

"ORGOLA" panels, M.2, 12/-; M.3, 18/- doz.
"ORGOLA" COILS M.2, 3/9; M.3, 7/6 pair.
NEW DESIGN DUAL COILS, special, 30/- doz.
PANEL BRACKETS 3/-, G.B. Clips 1/3 doz.
6 pin COILS 19/-, BASES 7/- doz.
(We are keen makers of all parts.)

A. E. ANDREWS & CO., "OBO,"
31 TOLLINGTON PARK, N.4



CONDENSERS
EXCEPTIONAL
QUANTITY
TERMS TO
MANUFACTURERS

GEO. BECKER LTD.
39, GRAFTON ST. W. 1
Museum 7-39



E.ELEX

T. 14 PLUGS & SOCKETS

Sockets 1d. each. Plugs 3d. each. 5 colours.
Name Plates, 40 kinds, 1d. each.
Write for list W 69



J. J. EASTICK & SONS, 118, Bushill Row, London, E.C.1

Sell 'HOLDFAST' Now!

EXTENSION UNIT

The best extension unit for every type of balanced armatures. Post price 1/-. Special price for large quantities.

DAYZITE LTD.

17, Lisle St., Leicester Square, London, W.C.

BOOKS, WIRELESS FORMS, ETC.

AGREEMENT Forms (Hire Purchase).—These forms have been specially prepared for THE WIRELESS AND GRAMOPHONE TRADER by a solicitor of the Supreme Court. If you sell on hire purchase they are indispensable. Prices, post free, 4d. each, 25 for 5s., 50 for 7s. 6d., and 100 for 10s. 6d. All orders should be accompanied by remittance and addressed to the Trader Publishing Co., Ltd., St. Bride's House, Salisbury Square, Fleet Street, E.C.4.

COUNTY Court Practice Made Easy (debt collection simplified).—Written by a solicitor, this book deals with all the steps necessary for the collection of debts, from the preliminary letter to the enforcement of judgment and recovering of money. New edition (revised), 5s. 3d., post free, from The Trader Publishing Co., Ltd., St. Bride's House, Salisbury Square, Fleet Street, E.C.4.

THE Slide Rule Simplified. Written in a simple and practical way, this book will prove of great value to every student of engineering and commerce, and all, in fact, to whom an intimate knowledge of the Slide Rule is necessary. It explains the value of the Slide Rule as a time-saving device, for use in engineering calculations of all kinds. Many examples are given and fully worked out and no algebraical or trigonometrical formulæ are introduced. Price 5s. 3d. post free.—The Trader Publishing Co., Ltd., St. Bride's House, Salisbury Square, Fleet Street, E.C.4.

YOUR Business at a Glance.—A simple account enabling you to see at a glance the position of your business without any knowledge of bookkeeping. Ruled for entries for a period of one year, with profit and loss summary, and balance sheet at end of each quarter, 2s. 3d. post free, obtainable from The Trader Publishing Co., Ltd., St. Bride's House, Salisbury Square, Fleet Street, E.C.4.

Blocks for your Advertising ..

We have a selection of new and attractive designs at specially low prices, that have been prepared to assist our readers in the production of advertise-
:: ments, bills, folders, etc. ::

Illustrated List containing prices and sizes will be forwarded with pleasure. :: :: Write:—

THE TRADER PUBLISHING CO. LTD.
St. Bride's House, Salisbury Square,
Fleet St., London, E.C.4.

NEW Polar Condensers.

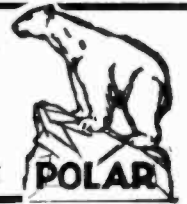

Write now for details.

WINGROVE & ROGERS, Ltd.
188-9 Strand, London, W.C.2

C.F. Radio Controller finds faults in your set

Write for Illustrated Leaflet to
 FONTEYN & CO. LTD.
2 to 6, Blandford Mews, Baker St., W.1

SISTOLEX

INSULATING FLEXIBLE TUBES.
Esalite Connecting Wires
Ebonite and Lebakite Panels
SPICERS LIMITED
19 New Bridge St., London
Tel. City 6251. Pic. Ex. 40.

Retails at **The "SOPRANIST" ACCUMULATOR TESTER** 6d.

ALL READS FULLY CHARGED
MIDDLE HEAD HALF RECHARGE
SERVING SINK RECHARGE
ALL READS SINK RECHARGE
SPECIAL CELL

Tests all kinds of Lead-Sulphuric Acid Batteries.
Efficient, Simple, Handy
Sole Dis.:
S. KALISKY (Aldgate) LD.
Aldgate High St., London, E.C.1
and
Vitaclor Co., NELSON, 16 Withy Grove, Manchester.

We solicit your enquiries for
METAL CABINETS
Eliminator Boxes, Transformer Cases, etc. We can supply any colour in Crystalline finish.
G. HOUNSLOW & CO.,
Sheet Metal Workers,
96a, Coleridge Street, Hove, Brighton.

Send Your Orders to:—
T. FIELDING & Co. Ltd
The EAST ANGLIAN RADIO FACTORS
King St., GT. YARMOUTH
Factors of all the best known makes of Radio Components

EPOCH
MOVING COIL SPEAKERS

Write for new booklet — 19 models
EPOCH RADIO MANUFACTURING CO., LTD.,
3 Farringdon Ave., London, E.C.4. Phone: Central 1971

"TRADER" PAYMENT CARDS: For customer's receipts in connection with Hire-purchase arrangements—

Prices	1	25	50	100 cards
Post Free	2d.	2/6	4/8	6/8

THE WIRELESS & GRAMOPHONE TRADER,
St. Bride's House, Salisbury Sq., Fleet St., E.C.4

SEL-EZI for SERVICE!

WE ARE THE SOLE LONDON AND SOUTHERN AGENTS FOR TELSEN TRANSFORMERS AND CAN GIVE IMMEDIATE DELIVERY OF ALL MODELS.

Orders received by First Post are delivered to London and Suburbs the same day.



SEL-EZI, LTD.
6 Greek Street, London, W.1
Phone: Regent 6661.

In Your Interests

and for all those engaged bona-fide in the Wireless, Radio & Allied Industries

A non-profit Association to protect and assist legitimate manufacturers and traders to regulate credit conditions and report on the status of persons or concerns requiring credit.

Annual Subscriptions:—
SEND FOR PARTICULARS **£2 - 2 - 0** JOIN NOW

THE WIRELESS & RADIO TRADES GUARDIAN ASSOCIATION LTD.
(By Guarantee)

78 NEW OXFORD STREET, LONDON, W.C.1

THURINGIA BATTERIES

**Quality Unrivalled.
Record Life in Use.
Longest Guarantee.**

Labelled to Instructions Gratis.
Factors Enquiries Invited.
Reduction in Price.

SOLE AGENTS:
E. H. MAISNER & CO. LTD.
4 Attneave St., Farringdon Rd.,
LONDON - - - W.C.1

OLDEST MANUFACTURERS,
HUGO FALK,
G.M.B.H.,
TABARZ

INDEX TO DISPLAYED ADVERTISEMENTS—Continued from Back Page.

	PAGE		PAGE		PAGE
Herod, Arthur G., & Co.	16	Murdoch Trading Co.	22	Telegraph Condenser Co., Ltd., The	34
Hounslow, C., & Co.	40	Murphy Radio, Ltd.	25	Telsen Electric Co., Ltd.	20
Hughes, F. A., & Co., Ltd.	15	Ormond Eng. Co., Ltd.	Back Cover	Three Star Accumulators, Ltd.	2
Junit Mfg. Co., Ltd.	6	Partridge, Wilson & Co.	42	Tormo, Ltd.	24
Kalisky, S. (Aldgate), Ltd.	40	Pertrix, Ltd.	21	Tulsemere Mfg. Co.	10
Kolster-Brandes, Ltd.	37	Portadyne	14	Tungram Electric Lamp Works (Great Britain), Ltd.	32, 33
Lamplugh, S. A., Ltd.	18, 19	Potter, H. B., & Co., Ltd.	24	United Ebonite Mfrs., Ltd.	24
Lectro Linx, Ltd.	38	Radio Instruments, Ltd.	14	Varley (Oliver Pell Control, Ltd.)	Front Cover
Lisenin Wireless Co., The	24	Rowley, Thomas A., Ltd.	22	Westinghouse Brake & Saxby Signal Co., Ltd.	10
McMichael, L., Ltd.	13	Sankey, Joseph, & Sons, Ltd.	4	Whittingham Smith & Co.	14
Maisner, E. H., & Co., Ltd.	41	Sel-Ezi Wireless Supply Co., Ltd.	41	Wilkins & Wright, Ltd.	42
Marconiphone Co., Ltd., The	Inside Front Cover	Selectors, Ltd.	8	Wingrove & Rogers, Ltd.	40
Montague Radio Inventions & Development Co., Ltd.	2	Spicers, Ltd.	40	Wireless & Radio Trades Guardians Association, Ltd., The	41
Mullard Wireless Service Co., Ltd.	Inside Back Cover and 35	Standard Battery Co.	12		

Special Facilities for Readers

IF you desire further particulars of several items advertised in this issue, place a tick against the names of the advertisers in the index above and overleaf, and forward the page to the "Trader Information Bureau," St. Bride's House, Salisbury Square, Fleet Street, London, E.C.4, who will see that your request is forwarded.

Sign here

Address

W.T. 21/6/30

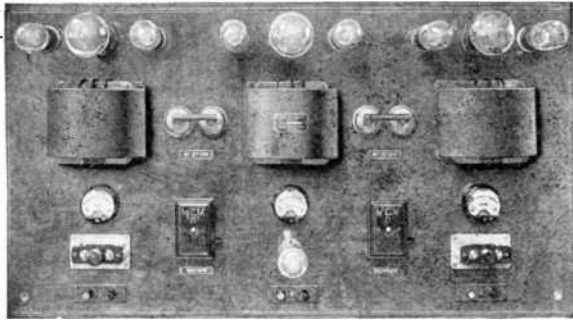

DAVENSET SERVICE STATION CHARGER
 Price £25 net.
 Max. D.C. Output 75 volts at 6 amperes

DAVENSET

COMMERCIAL ACCUMULATOR CHARGERS AND RECTIFIERS FOR A.C. MAINS ARE THE PRESENT DAY EQUIPMENTS

BECAUSE THEY ARE

- 1. HIGHLY EFFICIENT.
 - 2. SIMPLE TO OPERATE.
 - 3. PERFECTLY SILENT.
 - 4. NON-RADIATING.
 - 5. REASONABLE IN PRICE.
- e.g. from **£8 : 8 : 0 net**

TECHNICAL BOOK ISSUED FREE.

A 40-page copy of the 3rd Edition (reprinted April, 1930) of the booklet entitled "Commercial Accumulator Charging and the Efficiency of A.C. Rectifying Equipment," in which 7 models of Davenset Chargers are both described and illustrated, may be had on application to your usual wholesaler, or direct from the manufacturers FREE OF CHARGE. This offer applies to bona-fide traders only.

PARTRIDGE, WILSON & CO.
 LOUGHBOROUGH ROAD, LEICESTER

INDEX TO DISPLAYED ADVERTISEMENTS.

(Continued on Page 41.)

	PAGE		PAGE		PAGE
Abingdon Wireless Supplies ..	38	Cole, E. K., Ltd ..	5	Edison Swan Electric Co., Ltd. ..	12
Aeonic Radio, Ltd. ..	11	Concerton Radio & Electrical Co., The	17	Emkabe Radio Co., Ltd. ..	40
Andrews, A. E., & Co. ..	40	Danipad Rubber Co., Ltd. ..	6	Epoch Radio Mfg. Co., Ltd. ..	40
Ashton, Harold, A.M.I.E.E. ..	38	Dayzite, Ltd. ..	40	Ever Ready Co. (Great Britain), Ltd.	30
Ashton & Co. ..	24	Detex, Ltd. ..	26, 31	Exact Mfg. Co. ..	40
Baker's "Selhurst" Radio ..	40	Dibben, Wm., & Sons, Ltd. ..	4	Falk, Stadelmann & Co., Ltd. ..	8
Beaver Electrical Supply Co. ..	22	Dubilier Condenser Co. (1925), Ltd.	10	Fielding, T., & Co., Ltd. ..	40
Becker, George, Ltd. ..	40	Eastick, J. J., & Sons ..	40	Fonteyn & Co., Ltd. ..	40
British Ebonite Co., Ltd., The ..	24	Edison Bell, Ltd ..	9	Garnett Whiteley & Co., Ltd. ..	23
British Radiophone, Ltd., The ..	3			Gilbert, C., & Co. ..	1
Bulgin, A. F., & Co. ..	10			Graham Amplion, Ltd. ..	27, 28, 29, 30
Burall Bros. ..	24			Haw & Co., Ltd. ..	24
Celestion, Ltd. ..	7			Heyberd, F. C., & Co. ..	22

To obtain particulars of several items advertised in this issue place a tick against the name of the advertiser in the index above and overleaf and sign coupon at foot of index on the previous page.

YOUR SALES ARE SAFE — AND SATISFACTION ASSURED

BY "Utility"

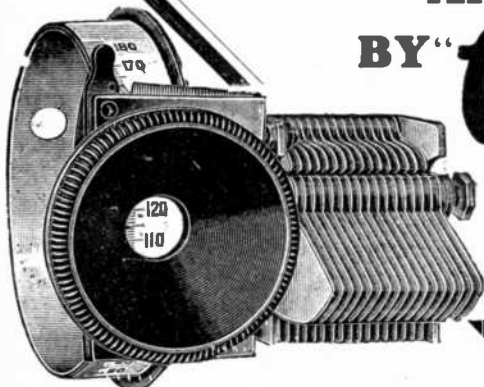

"MITE" CONDENSER
 (with Drum Dial) as illustrated.

Cat. No.	Capacity	Price
W.203	.0002	10/6
W.202	.0003	11/-
W.201	.0005	11/6

"The high quality of these Components will instantly recommend them, the prices are no higher than customers usually pay. In addition, of course, your sale is backed by the "Utility" Guarantee . . . why not write to-day for the latest illustrated List and consider the value offered?"

WILKINS & WRIGHT LTD
 HOLYHEAD  BIRMINGHAM

Agents: London: A. E. R. Morton, Ltd., 22 Bartlett's Buildings, Holborn Circus, E.C.1.
 Scottish: E. B. Hammond, 113 St. Vincent Street, GLASGOW.

HALT!



Your orders will be coming from the Mullard Rectifier Valve market. You must be prepared for them. We have thought this out. Week in, week out we have advertised Mullard Master Rectifiers—caught and held public imagination. All A.C. radio owners have heard of them—know them and will buy them from you.

MULLARD • RECTIFIER • VALVES

ORMOND *for* RESULTS!

SMALL LOG LAW CONDENSER

WITH POINTER DIAL

Similar in design to our standard model small Log Law Condenser, but constructed mainly of aluminium. The Pointer Dial is a metal disc with a gold finish marked plainly in a 0-180 degree scale. Dial readings are shown by the pointer, the spindle of condenser being controlled by the smaller knob. The upper knob is the slow-motion adjustment on friction control condensers. The pointer dial can only be used with condensers with a modified spindle, and is not supplied separately.

With Friction Control (as illustrated).			
Cat. No. R/370, Cap. .00025	9/-
Cat. No. R/371, Cap. .00035	9/3
Cat. No. R/372, Cap. .0005	9/6
Without Friction Control.			
Cat. No. R/373, Cap. .00025	6/6
Cat. No. R/374, Cap. .00035	6/9
Cat. No. R/375, Cap. .0005	7/-

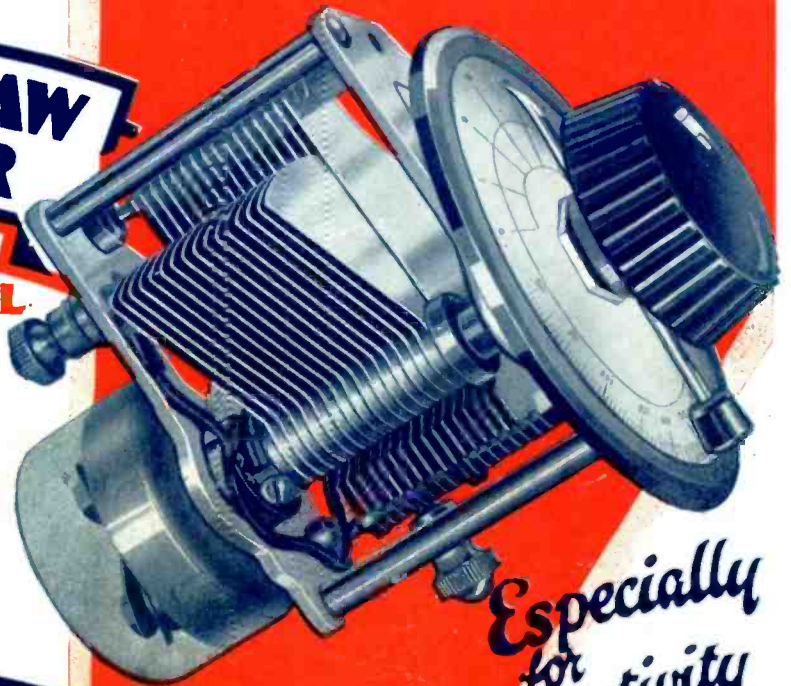

*Especially
for
Selectivity*

N° 3 S-L-F CONDENSER

This is the precision Straight Line Frequency Condenser, with a greatly reduced frame and highly finished Bakelite End Plates. Specially shaped vanes give high maximum and low minimum capacity, with TRUE S.L.F. readings throughout full 180 degrees. Easy to mount. One-hole fixing. Terminals and soldering tags for connection.

Complete with 4-in. Knob and Dial.

Cat. No. R/214, Cap. .00025	5/6
Cat. No. R/215, Cap. .00035	5/9
Cat. No. R/216, Cap. .0005	6/-

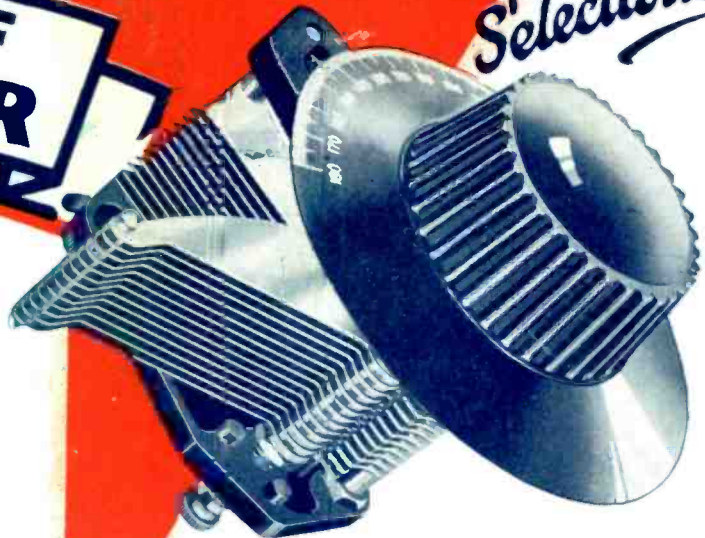

THE ORMOND ENGINEERING CO. LTD.
Ormond House, Rosebery Avenue London, E.C.1
Phone: Clerkenwell 5334-5-6 & 9344-5-6 Grams: Ormondeng; Smith

Rely upon



for Quality!