

LATEST TELEVISION APPARATUS DESCRIBED

# Wireless Magazine

APRIL

AND MODERN TELEVISION

Edited by PERCY W. HARRIS M.I.R.E.

GEORGE  
NEWNES  
LTD. LONDON

Tweeter Speakers  
and Quality

More About the  
"H.K." Four

Television Facts  
and Figures

Selectivity  
Simply Explained

Short-wave  
Notes and News

All About the  
Iconoscope

Five New  
Sets Tested

1/-

## CAR RADIO *in* 1935

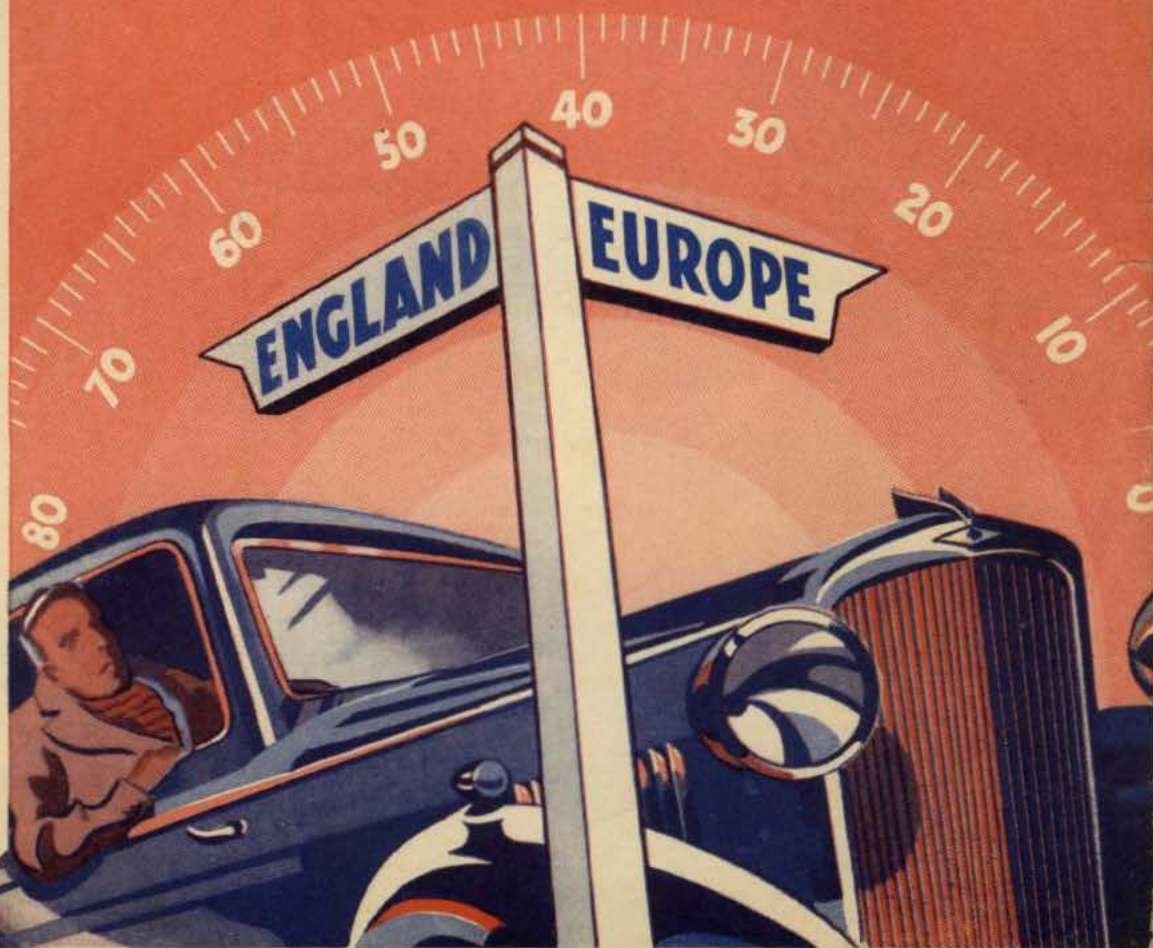

HOW TO BUILD THE 1935 STENODE



# The EDUCATIONAL FILM REVIEW



- FOR THE PARENT.....
- FOR THE SCHOOLMASTER
- FOR THE BUSINESS MAN..
- FOR THE CLERGYMAN AND MINISTER..

Children are being taught by educational films! Films are now in use for religious instruction, social and medical work, and business propaganda. There are cinemas devoted almost entirely to educational pictures. Such is the trend to-day, and so great is the interest in this form of cinematography, that there has been an insistent demand for an independent magazine devoted entirely to the subject.

THE EDUCATIONAL FILM REVIEW is designed to help and serve all those interested in and connected with the development of the cinema for educational purposes. No. 1 of this new monthly is on sale to-day, at news-agents and bookstalls, price 6d.

**NO. 1 OUT TO-DAY**



A woman prays for the recovery of her husband. From a film dealing with the customs of Java.



Scene from "Wings over Everest"—the film of the famous Everest flight.

## SPECIAL CONTENTS OF No. 1

### SCHOOL FILMS AND SCHOOL DISCIPLINE

A provocative article which should be read by all interested in educational work.

### THE FILM AND THE CHURCHES

How the cinema succeeded when everything else had failed.

### FILMING YOUR OWN BUSINESS

An important article in the Industrial Film section.

### MIND OR THE EMOTIONS

Some constructive thoughts on a recent demonstration of educational films in London.



Native warriors in Africa. The films from which these pictures are reproduced are discussed in No. 1 of THE EDUCATIONAL FILM REVIEW.

THE **EDUCATIONAL FILM REVIEW** MONTHLY **6<sup>d</sup>**  
**AND INDUSTRIAL CINEMATOGRAPHY**

# Wireless Magazine

Technical Editor :

AND MODERN TELEVISION

Assistant Editor :

G. P. KENDALL, B.Sc. Vol. XXI : APRIL, 1935 : No. 123

T. F. HENN.

Edited by Percy W. Harris, M.I.R.E.

## FOR THE CONSTRUCTOR

THE 1935 A.C. STENODE. Designed for "W.M." by Paul D. Tyers	171
MORE ABOUT THE "H.K." FOUR. By G. P. Kendall, B.Sc.	190
OPERATING THE STANDARD FOUR-VALVE SHORT-WAVER. By G. Howard Barry	225
IMPRESSIONS OF THE STANDARD FOUR-VALVE SHORT-WAVER	228
TUNING GUIDE TO THE "H.K." FOUR	233

## TECHNICAL ARTICLES

ALL ABOUT 1935 CAR RADIO SETS. By G. P. Kendall, B.Sc.	167
IMPROVING QUALITY WITH A TWEETER. By P. Wilson, M.A.	193
PROBLEMS OF AMPLIFICATION. By G. HOWARD BARRY	198
HINTS FOR THE SERVICE ENGINEER. By G. P. Kendall, B.Sc.	201
TUNING AND SELECTIVITY. By Percy W. Harris, M.I.R.E.	208

## Contents

STANDARD VALVE-HOLDER CONNECTIONS	216
OUR TESTS OF THE NEW SETS. By the "W.M."	
Set Selection Bureau	217
EKCO AC85 SUPER-HET	219
G.E.C. DROITWICH SUPER FIVE	220
PYE SE/AC/CONSOLE SUPER-HET	221
AMPLION RADIOLUX A.C. RADIOGRAM	222
PHILIPS FIVE-EIGHTY	223
TESTS OF NEW APPARATUS	237

## GENERAL ARTICLES

OUR APRIL ISSUE The Editor's Page	163
CAR RADIO IN 1935. By the Editor	165
B.B.C. PLANS FOR JUBILEE YEAR. By T. F. Henn	178
STOKOWSKI'S VIEW	200
REALLY "STRAIGHT-LINE"	200
MAKE SHORT-WAVE LISTENING YOUR HOBBY! By J. Godchaux Abrahams	203

MR. EVERYMAN'S WIRELESS JOBS. By R. W. Hallows, M.A.	205
RADIO NEWS FROM ABROAD. By Jay Coote	213
HEINRICH HERTZ	214
"W.M." BOOK REVIEWS	224
NEWS FROM THE RADIO SOCIETIES. By G6QB	230
AVOMINOR COMPETITION	233
WORLD'S BROADCAST WAVELENGTHS	234
NOTES AND JOTTINGS	235
DIRECTOR OF TELECOMMUNICATIONS	235
IN TUNE WITH THE TRADE. By EXAMINER	238
COUPONS : INDEX TO ADVERTISERS	240

## TELEVISION SECTION

THE ICONSCOPE. By the Editor	180
TELEVISION FACTS AND FIGURES. By Percy W. Harris, M.I.R.E.	182
THE INTERMEDIATE FILM PROCESS	185
SIMPLE FACTS ABOUT THE CATHODE-RAY TUBE	
By P. Woodward	187

## GRAMO-RADIO FEATURES

RECORDS FOR YOUR RADIOGRAM. By T. F. Henn	188
---	-----

Subscription Rates: Inland and Abroad, 15s. 6d. per annum; Canada, 13s. 6d. per annum.

Editorial and Advertisement Offices—"Wireless Magazine," George Newnes, Ltd., Southampton Street, Strand, London, W.C.2. Registered at the G.P.O. for transmission by Canadian Magazine Post.



**QUICKLY** <sup>THE</sup> **TRUTH**

A sudden noise—or an equally aggravating silence . . . inefficiency somewhere in your set! Take your AvoMinor and find out at once. The AvoMinor is an investment in permanent security, for it is a precision instrument, accurate to a critical degree, and made to stand up to hard usage and even abuse. It is, in fact, a younger brother of the famous Avometer, the instrument used by all the leading manufacturers and their service engineers. With the AvoMinor you can test circuits, valves, components, batteries and power units with the dependable accuracy of the technical expert.

### TEN ACCURATE METERS IN ONE

<b>CURRENT</b>	<b>VOLTAGE</b>
●0-6 milliamps	●0-6 volts
●0-30 "	●0-120 "
●0-120 "	●0-300 "

### RESISTANCE

●0-10,000ohms	●0-60,000ohms
●0-1,200,000 "	●0-3 megohms

**40%** Size 4" x 3" x 11"  
Total Resistance : 100,000 ohms.  
Full scale deflection on 3 milliamps.

Deferred Terms if desired.

THE D.C.

# AVOMINOR

REGD. TRADE MARK

TELLS THE WHOLE TRUTH

There is no substitute for the AvoMinor It is a moving-coil combination testing meter—ten accurate instruments in one. Supplied in convenient case with leads and interchangeable testing prods and crocodile clips, and complete instruction booklet adequately illustrated.

Fully descriptive Folder post free from:—

THE AUTOMATIC COIL WINDER & ELECTRICAL EQUIPMENT CO., LTD  
Winder House, Douglas Street, London, S.W.1. Telephone: Vic. 3404/7.

**"RADIO SERVICING SIMPLIFIED"**  
Everyone should have this invaluable book. It explains every phase of fault-tracing step by step in non-technical language. The numerous diagrams make testing a matter of straightforward procedure.

**2/6**  
post free  
2/9



IT PAYS TO INSIST ON

**SIEMENS**

**FULL O'POWER**

**RADIO BATTERIES**

**FULL O'POWER BATTERIES**  
are specified for  
**H. K. FOUR**

The designers of the Set definitely chose **FULL O'POWER** for their well-known reliability and long Service life.

*Obtainable from all Electrical Dealers*

SIEMENS ELECTRIC LAMPS & SUPPLIES LTD., 38-9 Upper Thames St., E.C.4

**Your  
Reproduction  
is only as good  
as your speaker**

*that's why the  
technicians choose*  
**GRAMPIAN**

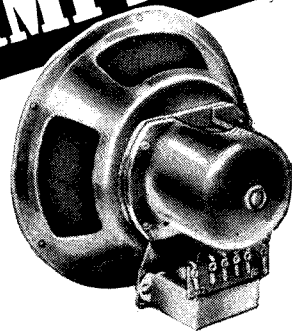

No matter how good the rest of your set may be . . . no matter how much you spend on your receiver . . . if your Speaker is not a Gram pian, then you will never reach peak performance.

Technicians know the merits of Gram pian Speakers. Leading Set manufacturers use them consistently. Could you have greater proof than that of their superiority? For whatever purpose you need a Speaker, make it a Gram pian.

**Gram pian Electric Dynamic Speakers. Standard models, E1.**

**25/-**

**Special Stenode Model, E1/5.**

**29/6**

**BUILDING THE  
STENODE ?**

If you are building the Stenode Receiver, beware the dangers of substitution. Gram pian are specified. Only with Gram pian will you get the best results.

We are exclusively licensed by the British Radiostat Corporation for Amateur Constructed Stenodes.

**GRAMPIAN REPRODUCERS LTD.,  
STATION AVENUE, KEW, SURREY**

*Better service results from mentioning "Wireless Magazine" when writing to advertisers*



# Wireless Magazine

and Modern Television

The Editor's Page

April, 1935.

## Our April Issue

IT would be most unseemly if we failed to begin this month by thanking readers far and near for the numerous expressions of appreciation and congratulation which have poured into this office since the publication of the March number. We value those letters which contain suggestions for future numbers and many of these are being acted upon immediately.

To old friends and new, then, thank you for your letters! Write again whenever you have suggestions to make, for every letter is given the most careful consideration. This month the menu, from hors d'oeuvres to savoury constitutes, we think, a well-balanced meal.

In the television section you will find an important article, "Television Facts and Figures," which clears the air a good deal and will help you to consider this rapidly developing art from the point of view of the amateur. The Iconoscope—that remarkable device which has been adopted in this country by the Marconi-E.M.I. group for television work—is described in simple language, while other features help in more senses than one to complete the picture.

Here it may be said, "Wireless Magazine" proposes to devote little space to 30-line television. We hold the view that 30-line television has no future, practically no entertainment value and little relation to the important problems which we must face in connection with high-definition television.

In the past, experiments with low-definition television have provided a great deal of interest to a number of enthusiastic experimenters, and we should be the last to belittle the work this keen band has done. But the fact remains that this phase of television is passing, after having served a very useful purpose; and there is no point in prolonging it.

There is plenty for the amateur to do in studying and experimenting in high-definition television, and as "Wireless Magazine" stands for the new days in radio we shall concentrate almost entirely on the high-definition type.

For the home constructor, the "piece de resistance" in the menu this month is the 1935 Stenode, specially designed for "W.M." by Mr. Paul D. Tyers. The Stenodes described in this magazine last year were some of the most popular sets ever published, and in the new model advantage has been taken of the wide practical experience gained with the prev-

ious models to improve the performance still further.

Mr. Tyers is one of the most experienced designers of up-to-date wireless receivers and acts as consulting engineer to many well-known radio firms. All the experience he has gained in this way has been placed at the disposal of readers in this new design.

As we place high quality of reproduction in the forefront of our policy, we strongly advise readers to study Mr. P. Wilson's article in the present issue on the "Tweeter" loud-speaker. Far too many people have become so accustomed to a low standard of reproduction that they scarcely realise anything better is obtainable; they will change this view after studying the article in question.

A final word. Two or three issues back there appeared in "Wireless Magazine" an article, written in rather a jocular vein, which seemed to suggest that the valves sold to the public by members of the British Radio Valve Manufacturers' Association were far below the standard of those supplied to the set manufacturers, and were, in fact, "left-overs."

This article might quite easily be taken more seriously than was intended and in fairness to the British valve makers we should state that after investigation we find that the valves sold through the dealers to members of the public are of just as high a standard as those sold to set manufacturers.

Valve prices are very much more reasonable than they were, and while at times a valve is found to fall somewhat below its published characteristics, so occasionally one may run above them. Faulty valves slip through at times—it is inevitable with the present enormous production—but we have yet to hear of a case where a valve found to be faulty in manufacture has not been replaced without question.

Furthermore, we hear fewer complaints from the public than from the set manufacturers on the matter of faulty valves.

We hold no brief for any valve manufacturer or ring of valve manufacturers, but we think it only fair to place on record the result of our inquiry.

*Percy W. Harris.*

**A New A.C. Stenode by Paul D. Tyers—See Page 171**

# MORE AND MORE

PEOPLE ARE BUYING "HIS MASTER'S VOICE" RADIO  
EVERY DAY—RADIO YOU, TOO, WILL BE PROUD TO OWN



"His Master's Voice" radio instruments have 37 years' experience of sound reproduction behind them. They are made in the largest radio factory in the Empire. Almost every single part is made under the one roof, to "His Master's Voice" own design, to suit their own *exceptional* requirements. Five hundred research engineers work at Hayes to ensure that, in "His Master's Voice," you get the finest value possible in radio to-day.

# "HIS MASTER'S VOICE" RADIO

THE GRAMOPHONE CO. LTD., 98-108 CLERKENWELL ROAD, LONDON, E.C.1

Advertisers like to know you "saw it in the 'Wireless Magazine'"



## By the Editor

Car radio can add hours of pleasure to your motoring. Have you considered it yet? This special article will answer any questions you may put forward regarding its advisability from a safety point of view

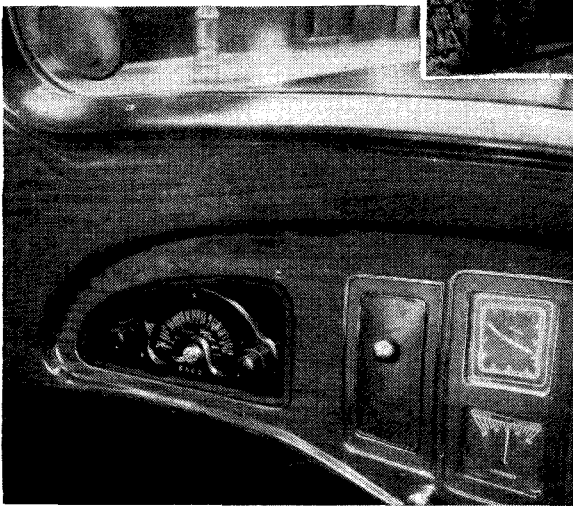

The Ekco car radio set fits neatly into a recess on the dashboard of the car. This car outfit is unique in that the tuning scale is marked in both wavelengths and stations. (Top) A fine view of the countryside, the village of Shere in Surrey

# Car Radio in 1935

## A Boon to the Motorist!

CAR RADIO first made its appearance in the United States six or seven years ago. It made a halting start, for, as usual with a new invention, the first products were full of faults, while the public was both sceptical as to its value and dubious about its influence on the safety of driving.

The difficulties of production were gradually overcome, the alleged dangers of car radio proved illusory and, largely due to the pioneering work of one particular firm, car radio soon became firmly established.

Over here comparatively few cars are as yet fitted with radio sets. British motorists are rather conservative, but I venture to predict that 1935 will see a big increase in the popularity of car radio in this country. First-class sets, specifically designed for installation in cars, are now available in several reliable makes, while those pioneer motorists who have had such receivers fitted in the last year or so are rapidly converting their friends by their enthusiasm.

And here I will ask you a pertinent question. You have probably heard criticism of car radio from the safety point of view, and you may have discussed the matter in the tube or the train, but have you ever heard such criticism come from a motorist who has *himself*

adopted radio in his car? I have put this question to dozens of people and not once have I had an affirmative answer.

Another point. Have you ever met a motorist who has had a car radio installed and who has subsequently removed it? Again I have yet to receive an affirmative answer.

There is, indeed, so much uninstructed criticism that it may be well to traverse the arguments pro and con and to see what basis there is for the objections sometimes raised. Let us start with the "antis."

The first argument put forward against car radio is that it distracts the attention of the driver from his proper duties and, therefore, leads to accidents. Let us examine this carefully. When you are using a wireless set at home *why* do you turn it on? As a relaxation, as a quiet amusement, or in a very large number of cases as a "background."

Only occasionally do you turn it on—for example, in the case of an important lecture—for the purpose of paying close attention to what the speaker is saying; in such a case you do not attempt any other task than to concentrate upon the particular speech or lecture. In most other instances you may be doing your work,

talking to your friends, or performing a-hundred-and-one tasks without any worry whatever.

Now in the case of a family car you will always or nearly always have someone with you. If you are driving through the heart of a city, in and among a maze of traffic, do you start, or allow to be continued, a serious discussion on some important scientific or legal point with your passenger? Of course not! Nor do you in such circumstances turn on the wireless and listen to an important lecture.

Long experience of car radio has shown me that it is a safety rather than a danger device. Two or three passengers all trying to distract the driver from his proper task are far more dangerous than any car radio set can be in the worst conditions, while the quiet background of music that such a receiver can provide has a soothing effect on both driver and passengers alike.

And this answer is not purely theoretical. I am speaking from personal experience, and although millions of car radio sets are in use throughout the world I have not yet heard of a single case where the car radio has been shown to be the cause of an accident, which is *not* the case with interfering and talkative passengers!

Argument number two is that the noise from the car-radio loud-speaker prevents the driver hearing exterior noises such as warning signals, whistles, and other car horns. That this is not so in practice will be vouched for by anyone who has driven a closed car fitted with radio and, incidentally, a radio set is rarely used in an open car—at least when it is on the road.

The level of sound from a radio set in a car becomes unpleasant if it is raised high enough to mask exterior noises and in any case if this objection were a true one (which it is not), Mr. Hore-Belisha is doing all he can to discourage the use of motor horns and sound signals!

The third argument is that if car radio comes into general use the roads will be made hideous by the different programmes from hundreds of radio sets touring up and down the country and the peace of the countryside will be lost for ever. I suppose the critics who put forward this argument think that a car radio set is a kind of "public-address system."

How little truth there is in their argument is proved by the following facts. My family and I often use our saloon car for shopping and I, as the driver, have frequent waits for long periods outside shops while the family are disporting themselves within.

In the old days I was generally bored, but now I just turn on the car radio and enjoy the programmes until the family return. Although the engine is generally switched off, the car alongside the kerb and the driver's window right down, you might think the programmes would cause a little disturbance.

Actually, they are inaudible outside of the car and none of the passers-by ever know the set is running! On the road it is impossible to tell whether a car radio set is working in another vehicle, so there is nothing more to be said for *that* argument.

The only real argument against car radio—and being a genuine one it is rarely put forward by critics—is that if unintelligently used, it makes a heavy drain on the car batteries. Most car radio sets derive all their power from the starter and lighting battery, both low- and

high-tension being provided in this way by means of a rotary converter or a vibrator and rectifier.

If the car is not used much in the daytime and mainly after dark, the current taken by both headlights and car radio set may exceed that given by the charging dynamo and the battery may run down through insufficient charging. Some of the bigger car radio sets take as much current as the headlamps, but not all are so wasteful.

The makers of the various sets will tell you their current consumption, and on smaller cars it may be wise to have a bigger accumulator fitted and to arrange for an increase in the charging rate. Again, the car manufacturers will give you advice on this point.

However, many cars are now designed in such a way that current supply is adequate not only for normal use but also for car radio sets, while an increasing number of cars are built with radio sets already installed. This particularly applies to those of trans-Atlantic origin.

Now let us look on the other side of the picture and the numerous advantages which car radio can give. In heavy traffic driving one does not use it in any case, but on the open road and on long tedious journeys a car radio set is the greatest boon. It not only passes the time pleasantly but, more important than this, it keeps the driver alert and prevents that somnolent and drowsy feeling which has in the past caused accidents.

Both driver and passengers are comfortably entertained, one has no fear of missing the important items which otherwise might keep you in the house, the news bulletin is available at once in any part of the country (this is a great boon during a motoring holiday) and in fact one has all the conveniences of the home radio set wherever you happen to be.

As will be seen from the detailed descriptions on other pages, a complete set can be fitted out of sight with a small control dial just where you need it, and in no circumstances will its installation cause any inconvenience whatever. There is nothing new to learn and once the set has been fitted, you will not know it is there until you want it.

Only recently I was talking with a well-known business man who, I should say, is not in any way connected with the car radio business. Both of us have had car radio sets for some time and both are delighted with the results we get.

"If I ran a business employing travellers who drive about the country getting orders," he said, "I would insist that every car be fitted with a radio set. Consider the case of a man who has to drive many miles on the way to his last customer of the day. Perhaps he has had not too good a time with the previous customer and is a little worried as to whether he'll get an order from the next man.

"The road is a long and desolate one, he broods on his problems and the nearer he gets to his destination, the farther away the order seems. I know salesmen well enough to realise that he will be in none too good a shape after all this brooding.

"If now, he has a car radio set, the journey for him will pass pleasantly, his mind will be taken off his work, and the relaxation will bring him fresh to his next customer. I know I should recoup myself of the cost of those radio sets by the additional orders received."



In this article our Technical Editor outlines the principles of the design of radio sets for use in cars, and shows what special precautions have to be taken to prevent interference from the car's electrical apparatus. He also reviews many of the sets now on the market and gives the results of actual tests



This shows the C.A.C. car-radio set installed. The remote control unit is fitted in a handy place on the steering column of the car, while the set chassis and loud-speaker unit is placed on the floor-boards

# All About 1935 Car Radio Sets

By G. P. KENDALL, B.Sc.

**B**EFORE making any attempt to review the many excellent car radio outfits now on the market, I think it will be of interest to outline briefly some of the principal technical characteristics of car sets in general.

First, I would draw attention to the fact that the conditions under

which a car receiver works are considerably more difficult than those of a domestic set; it has to withstand any amount of vibration, it has no proper earth, only a very small aerial, and it is surrounded by all sorts of interference-producers.

It must, therefore, be characterized by a degree of stability by no means

easy to achieve in combination with the extremely high sensitivity necessitated by the small aerial. It must be robustly built, completely com-microphonic in all its details, and elaborately screened against interference.

All these requirements present acute technical difficulties, but the interference problem is, perhaps, the hardest to solve. Not merely is there the danger of radiation from the ignition circuits of the car, which is particularly severe with the coil ignition systems so popular with car manufacturers to-day, but the modern car carries quite a collection of electrical auxiliaries all contributing their quota of noise.

## Sources of Noise

There is, for example, the dynamo, which is continuously in action, and must be expected to run with a certain amount of sparking at its brushes. Then there are the accessories which work only intermittently, such as the horn and the screen-wiper, not to mention that arch-offender—the starter. Conditions, in fact, which would put any ordinary high-sensitivity receiver out of commission altogether.

It is necessary to bear these problems in mind when considering the car set from the point of view of the prospective purchaser, for one

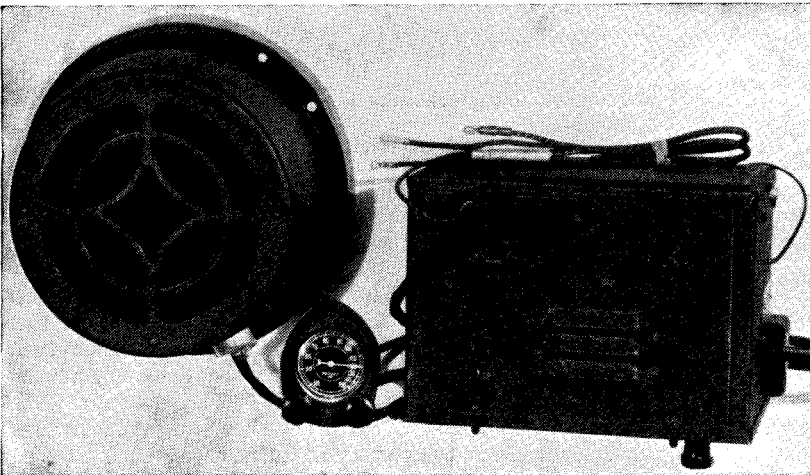

The Philco car radio set is in three separate sections, the loud-speaker, which can be fitted in a convenient place, the control unit for fitting to the car's steering column, and the set itself

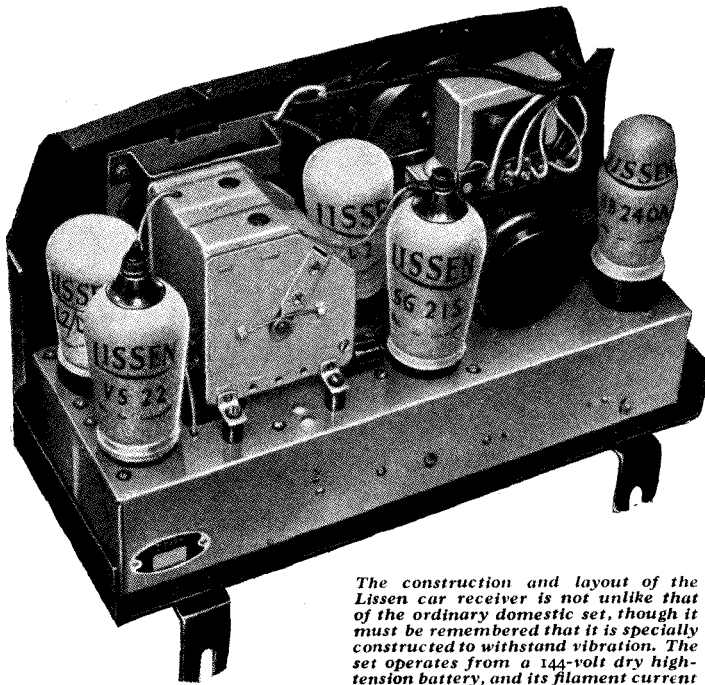

*The construction and layout of the Lissen car receiver is not unlike that of the ordinary domestic set, though it must be remembered that it is specially constructed to withstand vibration. The set operates from a 144-volt dry high-tension battery, and its filament current is derived from the car accumulator*

which can be run straight from the car battery, and some device for generating the high-tension supply from the same source.

This often takes the form of an actual motor-generator, but in some cases the vibrator system is used; this consists commonly of a vibrator or other form of interruptor which feeds intermittent current to a transformer which in turn raises the voltage and passes the current on to a rectifier and smoothing circuit.

### Design Problems

In actual physical make-up, the car radio set must differ from the domestic type even more than it does in its electrical characteristics. Space is limited, and, moreover, it is often thought advisable to separate the receiver proper from the power supply device.

Current practice varies somewhat, but in the majority of cases the power unit is placed beneath the

does not otherwise obtain a true perspective on the values now offered. Prices are definitely higher than those ruling in the case of the simpler equivalent types of domestic receivers, for the reasons which I have enumerated.

### Rather Expensive !

Increased production resulting from the more general adoption of radio on the car will, no doubt, have its accustomed effect in time, but it seems inevitable that the car set will always remain a somewhat more expensive instrument than its ordinary equivalent.

The interference problem is generally attacked in two different ways: first, the complete radio installation, including its auxiliaries, is screened with great thoroughness, and second, what are called "suppressors" are fitted at the points of origin of all the principal forms of interference.

### An Important Factor

This last method enters as a very important factor into the whole car radio situation. It means, in effect, that the installation of a car outfit of the high-sensitivity type must be carried out by qualified personnel, for upon the care and skill with which the work is done will depend the ultimate success of the receiver.

This aspect of the matter obviously imposes certain obligations upon the manufacturer of car radio sets, and

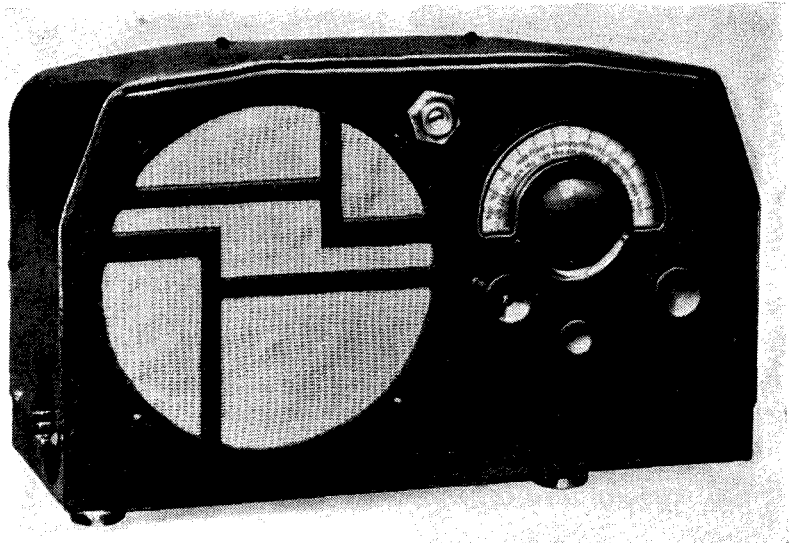

*A front view of the Lissen set showing the cabinet specially shaped so that the outfit can be conveniently fitted to the Ford 8 and 10 h.p. cars*

it is interesting to note that measures are already being taken to enable the public to get the necessary skilled installation work done with the minimum of delay and inconvenience.

Ekco, for example, are already developing an organization to cover the whole country with centres at which the work can be done expeditiously by a fully qualified staff.

The question of power supply presents a certain amount of difficulty, too, for the car set tends to be a large one requiring considerable current. The general practice now is to employ indirectly-heated valves,

floorboards of the car, while the receiver itself is fitted into or behind the dashboard. The loud-speaker is commonly a separate unit, often placed somewhere near the set.

There are two opposing schools of thought regarding the question of the position of the controls of the receiver; one party maintains that the set should be definitely under the sole control of the driver, so that he may switch it off whenever he considers that it is becoming a distraction, while the other theory is that the passenger, being able to give his whole attention to the matter,



is the proper person to operate the instrument.

A set intended for operation by the driver is usually provided with a remote-control unit fitted to the steering column or in some other handy position. The necessary flexible cable connections from the control unit to the receiver provide the manufacturer with some extremely difficult problems, but it seems that they are quite capable of satisfactory solution.

### Direct Possible

Receivers for operation by the passenger carry their controls in a more or less conventional position as a rule, that is, acting direct upon the tuning condenser spindle, volume control, and so forth. All remote-control troubles are thus avoided, but there is the possible objection that if the driver is alone in the car and wants the radio turned on, it may be difficult for him to reach it without loss of concentration on the road.

### Question of Aerials

This would seem to be very much a matter of the exact position chosen for the control panel; in most cases it would most probably be quite easy to find a location accessible to both driver and passenger.

Some considerable technical interest attaches to the question of aerials for car use. They are very often concealed in the roof, but in certain cases when difficulty is experienced, as it may be in some types of all-steel car bodies, an alternative position along the running-boards

may be used. Whichever location is used, the aerial is completely concealed, and the lead therefrom to the set is very often screened.

In America, where car radio is considerably more popular than in this country, certain car manufacturers fit aerials to their vehicles before they are sold, so that installation becomes a relatively simple matter. This practice is at present com-

the interested reader a pretty good idea of the lie of the land.

The outfit produced by Ekco is a good example of the direct-control type. Here the receiver unit is designed for mounting in the glove-box or other recess in the dashboard, and carries its controls upon a neat panel.

The loud-speaker forms a separate unit which can be mounted where-



*Though one is travelling far away from home in the heart of Britain's beautiful countryside, it is possible through the medium of car radio to keep in touch with happenings elsewhere*

paratively rare among British firms.

Turning now to the actual receivers already on the market and available to purchasers, I should first explain that it is not possible here to present a complete catalogue: I must content myself with an account of some of the more typical examples, but I think that this will suffice to give

ever convenient, the most usual location, of course, being somewhere in the vicinity of the receiver chassis. The power generating unit is normally placed under the floor-boards.

The circuit is a seven-stage super-het, covering the usual medium and long wavebands, and provided with an up-to-date form of A.V.C. This is a good example of the more advanced kind of car installation, since it incorporates such refinements as a dial marked both in wavelengths and with station names, a two-position tone control, and an adjustable noise suppressor arrangement.

### Ekco Tests

The price of the complete outfit is £21, a figure including all the necessary "suppression" equipment but not the installation charge.

We have had a demonstration of this receiver, and formed a very favourable opinion of its capabilities. Quality is definitely pleasing, sensitivity is high, and the A.V.C. arrangements do their job well.

The Philips set is of the remote-control type, the little control unit being designed to harmonize as

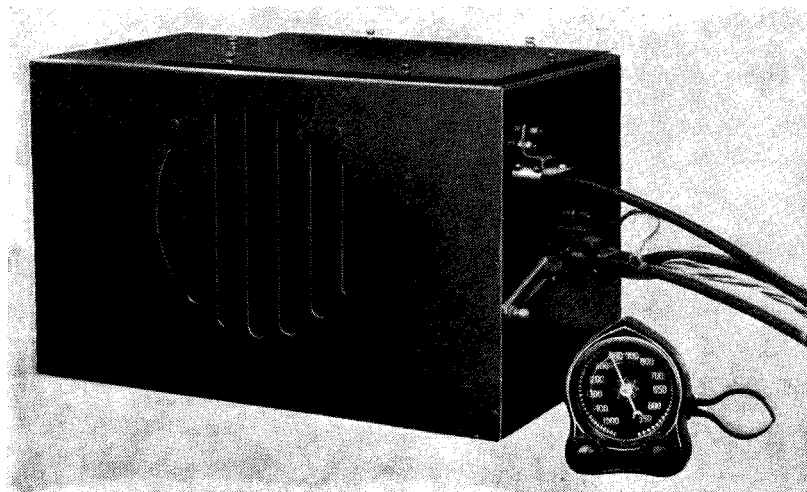

*The C.A.C. car radio set consists only of a control for the steering column and a unit which incorporates the set chassis, the converter and the loud-speaker. Our tests showed this outfit to possess high sensitivity. The performance was, indeed, remarkably good*

closely as may be with the usual type of car instruments, such as speedometers and revolution indicators. This unit carries the tuning and wave-range switching control (combined in one knob), and the volume control is similarly combined with the on-off switch.

Power supply is from a vibrator-type unit, the total consumption being remarkably low, being only 2.6 amperes, a figure which the makers claim to constitute a record.

### Philips Circuits

The circuit is a seven-valve super-het with A.V.C. backed up with a three-position sensitivity adjustment. Both long and medium wave-ranges are covered and there is a tone-control device on the loud-speaker. Priced at £21, it is a good specimen of the modern high-sensitivity car receiver.

The Lissen outfit is of particular interest in that it is run directly from batteries and makes very small demands upon the car supply. The high tension comes from a battery giving 144 volts carried under the floor and the car accumulator runs the filaments, this current also serving to energise the field of the moving-coil loud-speaker, the field winding being connected in series with the filaments.

### Lissen Outfit

The receiver, which covers both wavebands, is of the smaller type, incorporates five valves and costs only £10. It has two high-frequency stages and a class-B output stage. It is provided with A.V.C., and this appeared on test to do quite a creditable amount of work, although naturally it could not be expected to produce such a marked degree of control as can be obtained in the case of one of the really big sets.

This outfit is of the direct-control

type, the receiver unit being intended for mounting in an opening in the dash-board and carrying the various controls upon its front panel.

On test we found the receiver to give very satisfactory quality, and a general level of performance which makes the outfit a really remarkable value-for-money proposition. It is available, by the way, *only* for the Ford 8 and 10 h.p. models.

The C.A.C. receiver, produced by the City Accumulator Co., is interesting for several reasons, one of them being that it is a single-unit outfit; receiver chassis, loud-speaker and rotary generator are all housed in one steel case. This system

diode-triode second detector and a three-watt pentode output valve, and tunes over both wave-bands.

The price of this model is £25 4s., and it has proved itself on test to possess a performance which must be described as remarkable. It is well known for its quality of reproduction, the sensitivity is extremely high and the A.V.C. functions admirably.

Finally, we come to the Philco receiver, one of the pioneers in the field. The present model costs £16 16s. and uses six valves. Full A.V.C. is provided with four different "audibility ranges."

Control is on the remote system,

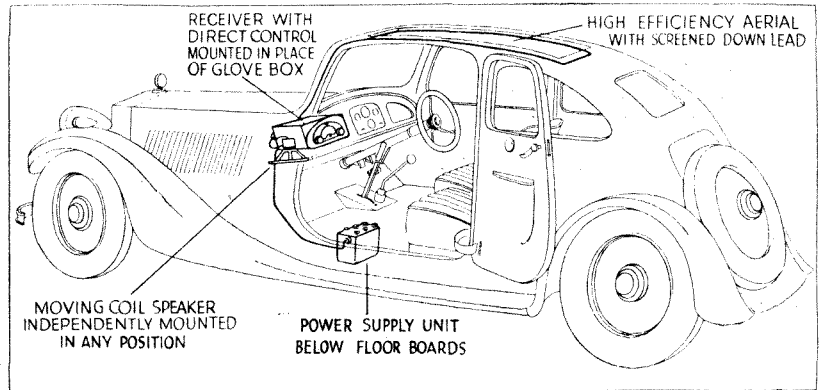

An interesting example of current practice in the installation of a car receiver. Note the position of the power supply unit beneath the floor boards and the receiver chassis in the dashboard

certainly has advantages from the installation point of view and reduces any risk there might be of damage to the inter-connections of a multiple unit outfit.

The single unit is of some size, but since the receiver is of the remote-control type, this is of little importance.

The circuit is a five-valve super-het using 13-volt indirectly-heated valves run from the car battery. It incorporates full delayed A.V.C., a heptode frequency-changer, double-

the unit carrying the usual tuning, on-off, and volume controls. Power is supplied by a separate unit of the vibrator type.

### Philco Improvement

Philco car radio sets are well-known to me for their excellent performance, and it was interesting for us to discover that this model at a much reduced price is very definitely ahead, both in sensitivity and power output, of last year's receiver, with which I am most familiar.

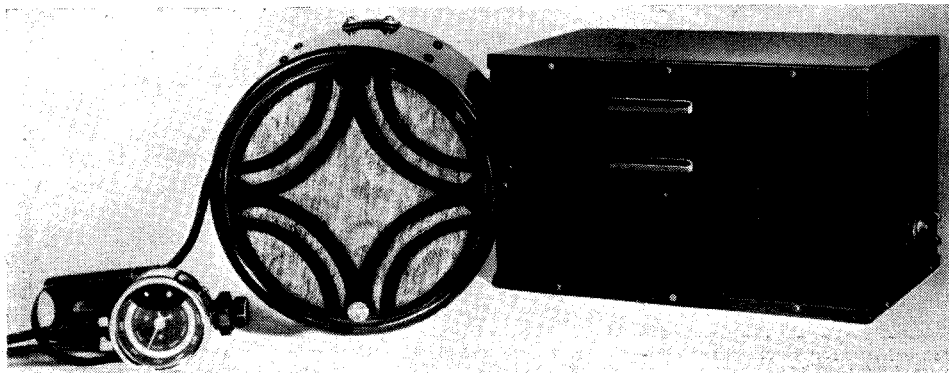

This is the car radio set marketed by Philips Lamps at twenty guineas. The loud-speaker and set are housed in separate containers and the remote control unit is designed to harmonise with other accessories, such as speedometers, etc., in the car's interior



Specially  
Designed for  
"W.M." by  
PAUL D. TYERS

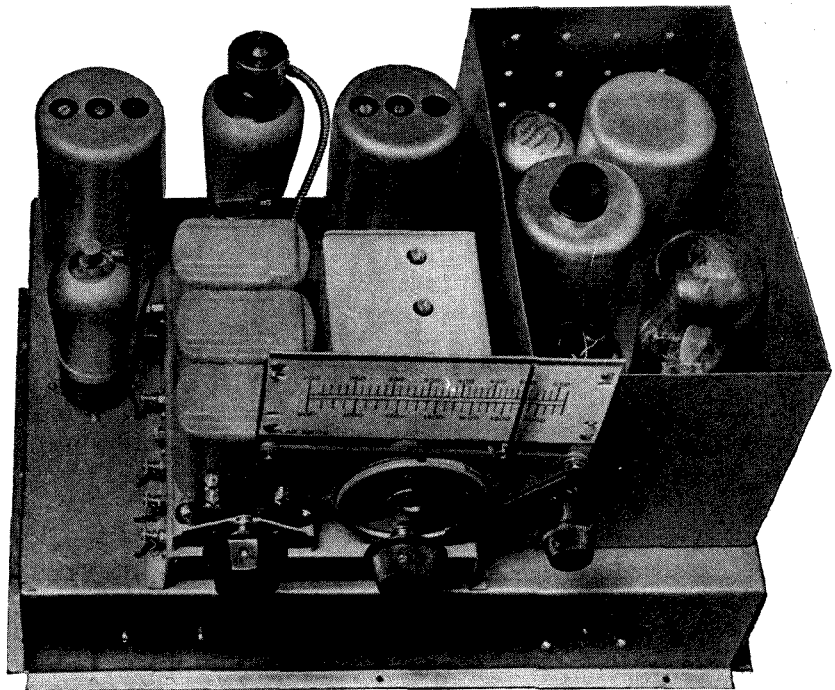

# The 1935 A.C. Stenode

*Builders of the 1935 A.C. Stenode need not fear comparison with the finest commercial productions on the score of appearance and performance*

*Here we have pleasure in presenting a new A.C. Stenode designed by Paul D. Tyers, who has done so much pioneer work on this outstanding branch of radio-receiver design. "Wireless Magazine" assures its readers that the results are truly remarkable; in fact this is the best A.C. receiver ever offered to the home constructor. In this connection we must warn new readers that the designer's modesty never allows him to use in his description of the set the superlatives which we consider justified!*

**W**HY a 1935 Stenode? This is a question which may well be asked. Having built a Stenode about six months ago, and having found it to give exceptional selectivity and extraordinary sensitivity, why build another one in 1935? Is there any radical change in Stenode design or has some development occurred which has rendered the previous Stenode obsolete?

### Justification

The answer to this is very definitely no. A wireless set, like a motor car, or for that matter almost anything else which is manufactured

and sold, never stays up-to-date. There is always the urge for something new, something which shows some little improvement or advantage over the previous type.

It is this which amply justifies the building of a 1935 Stenode.

Last year's Stenode receivers made no provision for a pick-up connection, and many requests have been received for information concerning pick-up connections.

At the time the original Stenodes were designed, all-steel chassis could not be made available, and accordingly very great precautions had to be taken in guarding against introduction of inductive A.C. hum.

The 1935 Stenode is closely similar to the previous type, which achieved such outstanding success, with the exception that an all-steel chassis is used and the circuit is arranged for pick-up work.

### Little Expense

Readers who have built the earlier type can re-model it on the lines of the new set at very little expense, it being simply necessary to buy an all-steel chassis and the few extra components required for the pick-up.

The advantages of a pick-up are therefore obtained together with the assurance of a low hum level.

The reader who has never built a

---

## Reconciles Quality with Selectivity

---

Stenode, of course, is not concerned with these matters of comparison. To him I would merely point out that this instrument offers a truly remarkable combination of ultra-selectivity and high sensitivity with particularly satisfying quality.

Experience with the past Stenodes has shown that many readers have obtained exceptionally satisfactory results. It appears, however, that a few did not realise the importance of adhering very rigidly to the exact wiring positions and as a result they

previous model. Structurally this is the case, but the values of the various components are practically identical throughout, which means that readers who convert the earlier model will find that they have practically nothing with which to dispense. The main constructional difference between the two models is perhaps the use of a Colvern tuning pack instead of a British Radiophone Radiopak. The use of the two tuners is optional, and the Colvern tuning pack was used partly because

lower percentage of second channel and heterodyne interference.

I must here point out once more that second channel and heterodyne interference is a type of defect over which the Stenode system has no control, and the constructor is simply in the hands of the manufacturers of the tuning apparatus, provided, of course, that the signal-frequency circuits are suitably associated with a good aerial and earth and a correctly operating mixing valve.

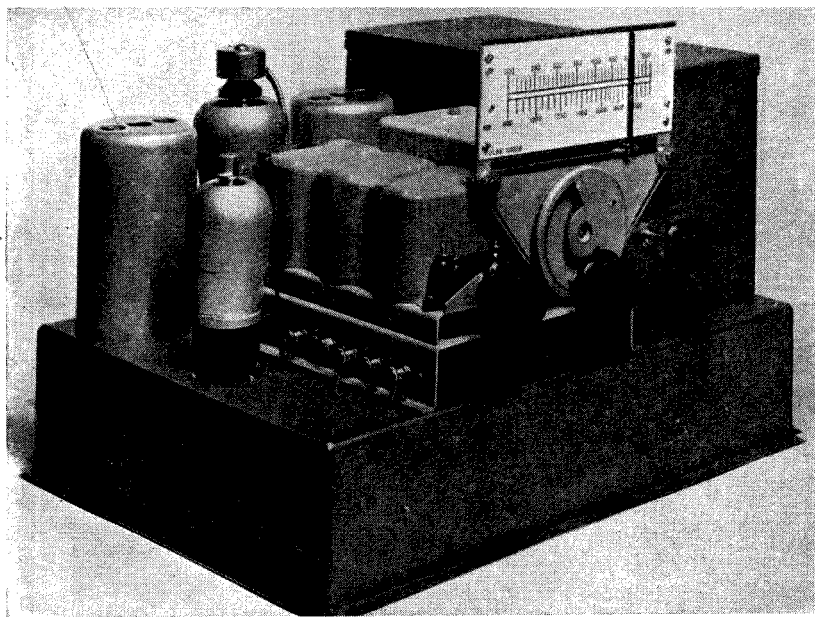

Showing the few controls of the 1935 A.C. Stenode. From left to right they are: wave-change switch, tuning and volume control. The radiogram switch is fitted to the back of the chassis. The set looks a fine job doesn't it?

probably obtained a rather high hum level and also a decreased gain.

As it has now been possible to obtain an all-steel chassis, the need for adhering very closely to the run of several of the leads is not nearly so great, and constructors can actually take far greater liberties with the wiring without fear of running into any trouble.

### No Haphazard Wiring

It is not suggested, however, that the relative positions of the various components should be altered or that long wires should be run in a haphazard manner.

In the case of a high-gain receiver of any type, however elaborate may be the screening, it is essential that the main constructional features should be adhered to very rigidly.

It will be seen from the photographs that the new Stenode bears very little resemblance to the pre-

vious model. Structurally this is the case, but the values of the various components are practically identical throughout, which means that readers who convert the earlier model will find that they have practically nothing with which to dispense. The main constructional difference between the two models is perhaps the use of a Colvern tuning pack instead of a British Radiophone Radiopak. The use of the two tuners is optional, and the Colvern tuning pack was used partly because

lower percentage of second channel and heterodyne interference. I must here point out once more that second channel and heterodyne interference is a type of defect over which the Stenode system has no control, and the constructor is simply in the hands of the manufacturers of the tuning apparatus, provided, of course, that the signal-frequency circuits are suitably associated with a good aerial and earth and a correctly operating mixing valve.

### Conversion Chassis

The new steel chassis has been designed to take the Colvern tuning pack, and readers who decide to modernise their earlier Stenode will require a conversion chassis which is wide enough to take the Radiopak tuning unit. It is most important to obtain the right type of chassis when ordering components.

The same remark, of course, applies to the cabinet.

When the earlier Stenode was designed, use was made of an ordinary high-frequency choke in the diode filter circuit. An inductive winding in this position is likely to give tremendous trouble from A.C. pick-up, and it was necessary to shield the choke with an additional iron screen.

### Screened H.F. Choke

A high-frequency choke suitable for 110 k.c. working with an iron screen particularly suitable for Stenode circuits has now been produced by Belling & Lee, Ltd., and accordingly this has been utilised.

It will be seen that the whole of the low-frequency amplifier from the diode onwards is enclosed in a separate screening box. This definitely prevents the possibility of any

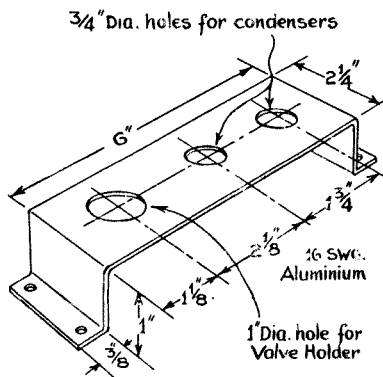

This metal bracket is for mounting the mains rectifying valve and the principal smoothing condensers in the power unit

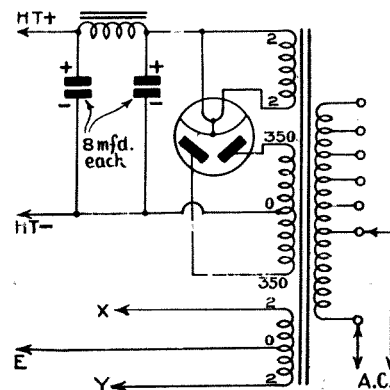

Showing the very simple circuit of the power unit. Note that a valve rectifier is used





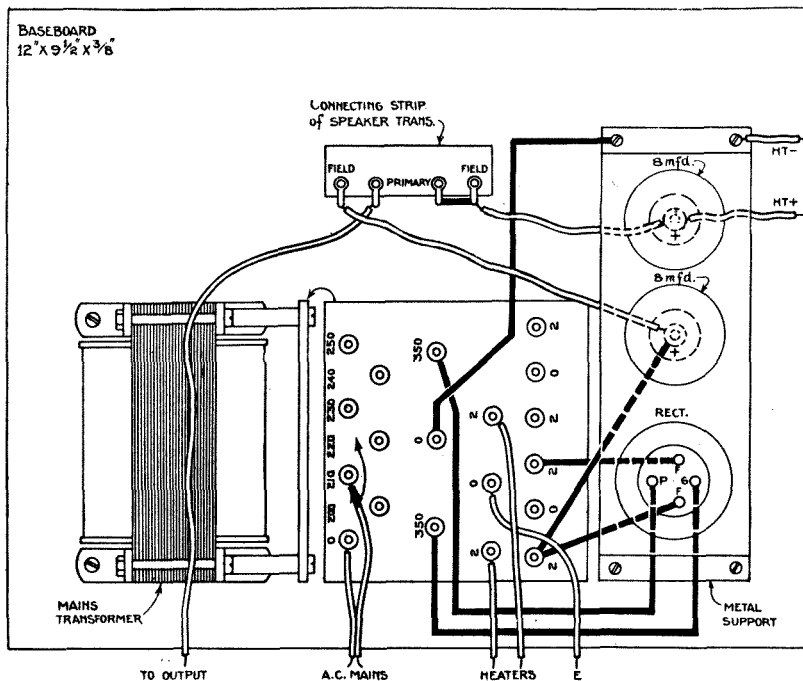

Showing the layout and the wiring of the power-supply unit. Note that the lead shown connected to the 210 terminal on the power transformer must be connected according to the voltage of the user's mains

The two low-frequency tone-correcting units are used in conjunction with a 354V triode and a Pen4VA output valve. Valves of very similar characteristics were used in the earlier Stenode, and these of course can be employed in the new model with every satisfaction.

Final tone correction is obtained by means of a special loud-speaker made by Grampian Reproducers, Ltd., which accentuates the upper frequencies.

### Suitable Components

So far as components are concerned, it should be understood that a Stenode receiver can be built with any reliable condensers or resistances, and it is only necessary to adhere to special Stenode components which are designed to give the necessary radio-frequency and audio-frequency characteristics.

### Separate Power Pack

As in the previous model, the power pack is built as a separate unit, the receiver being arranged for a vertical rectangular cabinet. The power pack therefore stands on the base and is arranged around the speaker, the chassis being mounted at the top.

The construction and wiring of the new chassis is very simple. I have designed this on more or less

production engineering lines, the main components being screwed to the chassis and the various condensers and resistances simply being arranged as sub-assemblies.

The leads from the heaters, negative high tension, positive high tension, and earth are brought out from the chassis and are connected to the power pack.

The first operation in building the receiver is to bolt the screening box

to the top of the chassis. After this the tuning pack, Stenode couplers and valve holders and the two large fixed condensers should be fixed in position. The next step is to wire the heater sockets.

### Heater-circuit Wiring

These should be joined up with thick gauge wire and the two leads must be twisted well together to reduce the stray field. Actually the wires should be run as close to the inside of the chassis as possible, and the method should be quite clear on studying the photographs.

The next step is to wire the sub-assemblies of condensers and resistances which are carried on the two paxolin strips. Before these are bolted in position and the various leads connected, the flexible wires on the Stenode couplers which are connected to the anode and grids should be soldered in position.

### Final Wiring

The two sub-assemblies can then be fixed and the remaining wires connected. The order of connecting these wires is not very important, and it will be found that the strips have been so designed that the connecting leads are quite short.

There are, in fact, no long straggling leads anywhere in the receiver and everything is really very accessible.

Before wiring the sub-assemblies there are one or two condensers and resistances which should be connected adjacent to the mixing valve

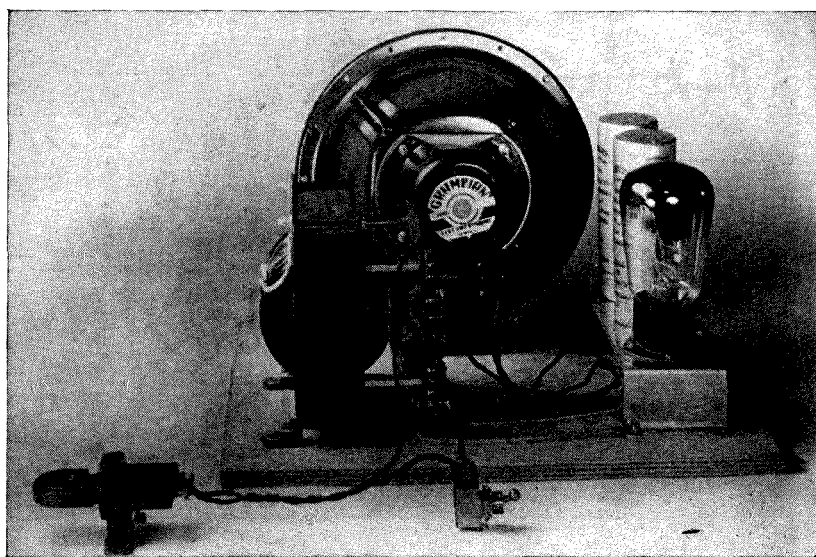

Showing the separate power-supply unit with the mains on-off switch and a plug and socket in circuit. The on-off switch is attached to the side or back of the cabinet. More about the cabinet next month

socket. This small network is wired directly to the socket so as to keep the length of the leads and stray capacities as small as possible. This is essential because otherwise it might upset the correct ganging of the receiver, the success of which depends upon the tracking of the ganged condenser remaining accurate.

Inspection of the wiring diagram clearly shows the positions of these components and by comparing this with the photographs it will be seen that they are actually directly

underneath the sub-assembly strips. Unless the networks are wired in position at the outset it will be practically impossible to solder them into position after the strips have been bolted to the chassis.

It will be found convenient to mount the strip which lies beneath the mixing valve before mounting and wiring the second strip. It will be noted that there are two main outlets in the bottom of the chassis, which is screened by a cover plate. One provides for the two leads to

the speaker and the other accommodates the wires from the power pack.

It does not matter very much how the wires are taken from the chassis to the power pack, but it is important that the wire which comes from the anode of the last valve is taken directly away so that it is not adjacent to the high-frequency side of the set or the input of the low-frequency amplifier. If this lead is pulled across the bottom of the wiring it will immediately cause instability.

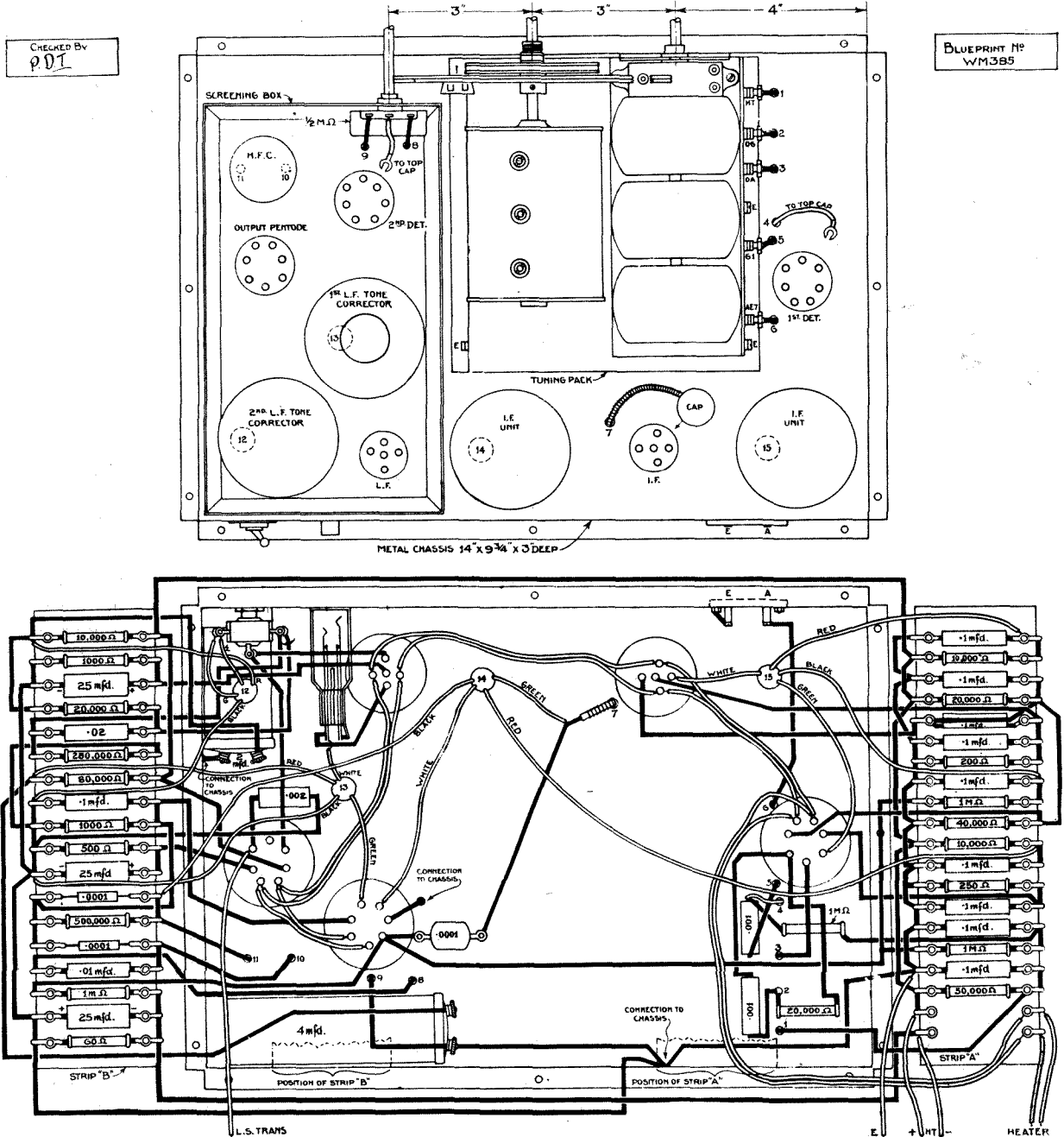

This is a scale reproduction of the layout and wiring plan. A full-size blueprint, No. WM385, can be obtained for half price, that is 9d. post paid, if the conditions to be found with the coupon on the last page are complied with

The power pack is a very simple assembly consisting of nothing other than a small bridge carrying the rectifier valve and the electrolytic condensers. This assembly, together with the mains transformer, is mounted on a small wooden base which is finally screwed into the bottom of the cabinet.

Before connecting the wired chassis to the power pack it is advisable

the low-frequency circuits. The reader will find that on orienting the transformer the hum can be reduced to a minimum, and the experiment should prove very instructive.

It will be found that when the transformer is placed beneath the chassis in the position it will actually occupy in the cabinet, substantially no hum whatever will be introduced,

method in detail next month. At the moment I will merely outline the procedure.

Assuming everything is correctly wired, the set should function immediately. The dial fitted to this receiver is designed to work with the tuning pack used, and accordingly the calibration is substantially correct.

Tests should be carried out with the Stenode couplers left exactly as they are when unpacked from the cartons; *no attempt should be made to touch any of the trimmers*. This is vitally important.

### Dial Calibration

It should be found that local stations tune in practically at the correct dial setting. I would advise tuning down to a low wavelength at the beginning of the medium-wave band, such as that of Fécamp. If Fécamp does not tune in exactly at the correct position the oscillator trimmer, which is the one nearest the dial, should be moved slightly and the main condenser re-set until the correct tuning position is obtained.

A rough check should then be made of the tuning position of several "local" stations, and slight adjustment may be necessary for the best compromise for accurate setting points. Strength is then brought to a maximum by adjusting the other two trimmers.

Not until this has been done should any adjustment be made on the Stenode couplers. These should be ganged by tuning in a weak station and bringing the strength to maximum. Only a *very slight* movement of the trimmers is necessary.

### Tone Control

The correct setting of the coupling and tone correction is vitally important in order to obtain maximum selectivity from the set, and this is a matter which I will deal with in some considerable detail in the next issue.

It will be remembered that the weaker the coupling, the greater will be the side-band cutting, and accordingly the greater will be the need for tone correction. Anti-clockwise rotation of the tone control coupler decreases the bass response. The actual amount of sideband cutting and tone correction that is required depends largely upon the locality in which the set is used.

Readers living very close to the

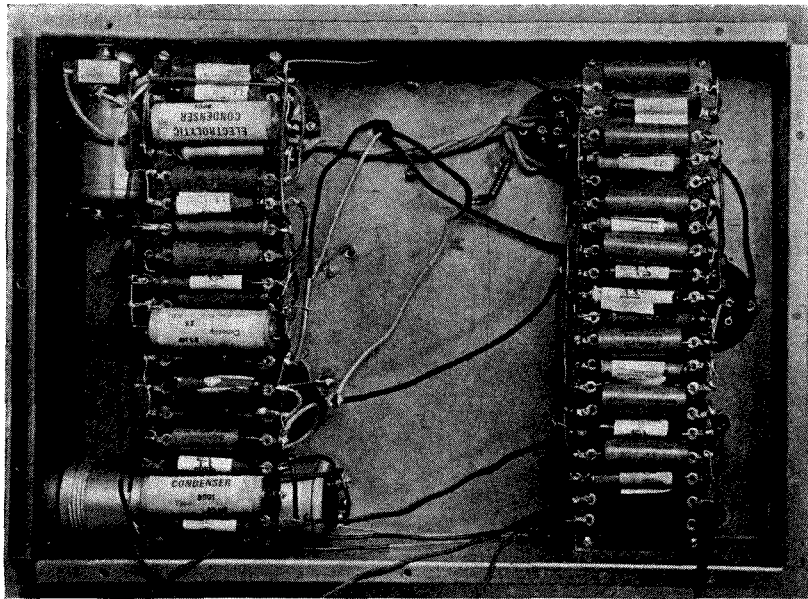

The construction is not difficult. Most of the resistances and condensers are arranged on two sub-strips, so facilitating easy mounting and wiring

to check the circuit over to make quite sure there is no fault in the wiring. I would advise readers to apply a small dry cell to the two heater leads and check the voltage with a voltmeter at all the heater sockets in turn.

A test should also be made to see that there is no possibility of the high-tension circuits having been incorrectly wired so that the full high-tension voltage could be applied to any of the grid sockets, or, for that matter, the cathodes or heaters.

### First Tests

Assuming that everything is correct the chassis should then be wired to the power pack and a test of the receiver can be carried out. For test purposes it is quite in order to lay the chassis, speaker and power pack on a bench, and there is no need to mount them in the cabinet.

When carrying out the tests on the bench it is quite possible that there will be a very loud hum. This will be due to the stray field from the mains transformer linking with

assuming, of course, that the base plate is screwed to the chassis.

When dealing with the original Stenode receivers I explained very fully the correct method of ganging and testing, but for the benefit of readers who have not previously built a Stenode I will describe the

### COMPONENTS— OUR POLICY

**C**OMPONENTS used in receiver designs published in "Wireless Magazine" are chosen for their suitability, efficiency and reliability. Their selection must not be taken to indicate any more than this, nor that other good-quality components are not equally suitable, save in a few cases clearly indicated where there are no suitable alternatives.

In a large number of cases there exist numerous good alternatives, as a study of the advertisement pages of this journal will show



local transmitter will be in a region of very great field strength. As a result it is essential to obtain the utmost selectivity.

It follows that if the coupling is reduced between the high-frequency valves the gain will be correspondingly lowered. Now, this overall reduction in the gain is a matter which need cause no alarm because the reserve power of the receiver is quite great and it will be found that with practically every transmission of any programme value there is an ample reserve on the volume control.

### Variable Coupling

Those who live fifty miles or more away from the local station will be able to increase the coupling, lessen the side band cutting and reduce the tone correction, and in so doing they will have a receiver of exceptional gain.

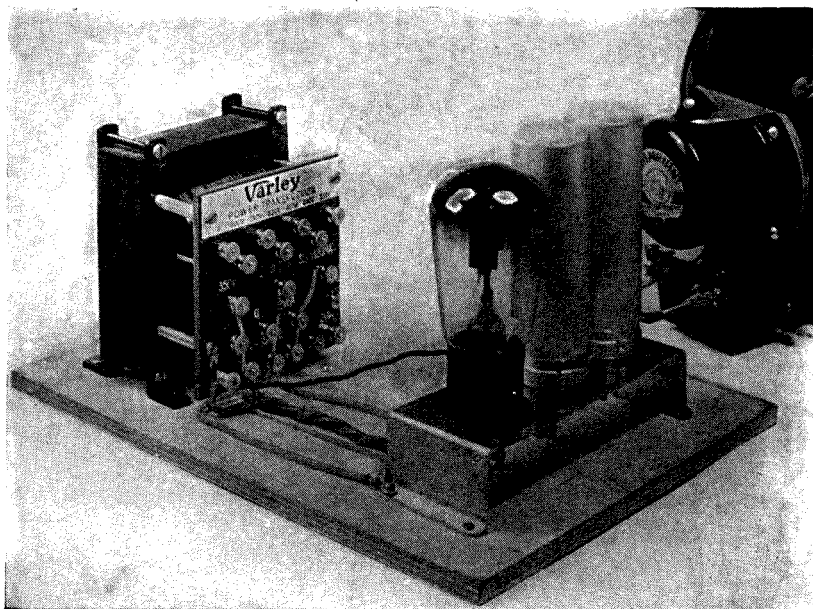

Another view of the power-supply unit showing principally the terminal board on the mains transformer

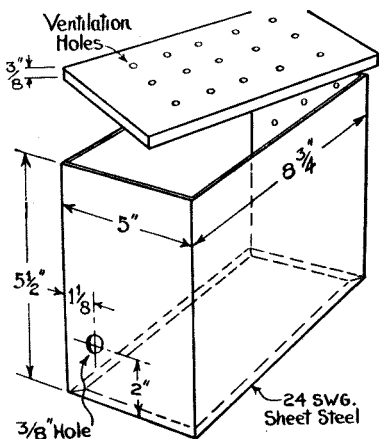

This sketch gives the dimensions of the screening box fitted on the upper side of the chassis. It is essential that this box is made of sheet iron or steel

This means that in practically every case it will be possible to work the set under these conditions and obtain separation of all the channels.

It is here interesting to recall that as I have already explained the selectivity of adjacent channels depends upon the relative strengths of the adjacent transmissions. If the coupling is increased too much the set would then tend to become similar to an ordinary super-heterodyne and as a result the full benefits of the Stenode system would be lost.

Readers may be interested to learn that I have made special arrangements with Messrs. Belling and Lee, Ltd., whereby those who

may have inadvertently upset the initial trimming of the couplers can have these corrected. It is only necessary for them to return the two high-frequency couplers to Belling & Lee, Ltd., together with the necessary remittance to cover return postage.

### Coupler Re-trimming

The couplers will then be returned to 110 kilocycles. Accordingly, readers will be able to build the 1935 Stenode with the assurance that the intermediate frequency is accurately adjusted.

There will be more news about this fine set next month.

## COMPONENTS NEEDED FOR THE 1935 A.C. STENODE

CHASSIS		HOLDERS, FUSE		SUNDRIES	
	£ s. d.		£ s. d.		£ s. d.
1—Peto-Scott to specification, steel, with screening box, power pack platform, and piece of wood 12 in. by 9 1/2 in., by 3/4 in., also extension spindle for volume control ...	19 6	1—Bulgin fuse holder and mains connector, type F15 ...	3 0	1—Belling-Lee terminal strip with plugs and sockets ...	9
<b>CHOKE, HIGH-FREQUENCY</b>		<b>HOLDERS, VALVE</b>		1—Belling-Lee low-loss screened lead and cap ...	1 6
1—Belling-Lee screened super-het high-frequency choke ...	6 6	3—Clix Air-sprung 7-pin valve-holders with soldering ends ...	4 0	1—Polar dial, type 110, 2B ...	6 6
<b>CONDENSERS, FIXED</b>		2—Clix Air-sprung 5-pin valve-holders with soldering ends ...	2 6	1—B.T.S. stenode type jack and plug ...	3 0
3—Dubilier .0001-microfarad, type 665 ...	1 6	1—Clix Air-sprung 4-pin valve-holder with soldering ends ...	1 2	2—Stenode sub-assembly panels ...	4 9
2—Dubilier .001-microfarad, type 4501 ...	2 0	<b>RESISTANCES, FIXED</b>		Suitable wire and sleeving, say ...	2 0
1—Dubilier .002-microfarad, type 4501 ...	1 0	21—Erie 1-watt resistors, values: 60, 200, 250, 500, 1,000(2), 10,000(3), 20,000(3), 40,000, 50,000, 80,000 ohms, .25-megohm, .5-megohm, and 1-megohm(4) ...	1 1 0	<b>SWITCH</b>	
1—Dubilier .01-microfarad, type 4501 ...	1 0	<b>RESISTANCES, VARIABLE</b>		1—Bulgin switch, type S98 ...	2 3
1—Dubilier .02-microfarad, type 4503 ...	1 4	1—Erie .5-megohm volume control with insulated spindle, without switch ...	3 6	1—Bulgin switch, type S80 ...	1 6
10—Dubilier .1-microfarad, type 4503 ...	13 4	<b>STENODE COUPLING UNITS</b>		<b>TRANSFORMER, MAINS</b>	
1—Dubilier 2-microfarad, type 9200 ...	3 6	1 set of Belling-Lee Stenode couplers	3 5 0	1—Varley EP33 ...	1 17 6
1—Dubilier 4-microfarad, type 9200 ...	7 0	<b>VALVES</b>		<b>TUNING UNIT</b>	
2—Dubilier 8-microfarad, type .0281, 8/500 v. ...	11 0	1—Mullard FC4 ...	1 0 0	1—Colvern super-het tuning pack, type H super-het Pentagrid, 110 kilocycles ...	2 17 6
3—Dubilier 25-microfarad, type 3001 ...	6 0	1—Mullard VP4 ...	17 6	<b>LOUD-SPEAKER</b>	
		1—Mullard TDD4 ...	15 6	1—Grampian Type E1/Stenode loud-speaker ...	1 19 6
		1—Mullard 354v. ...	13 6		
		1—Pen 4VA. ...	18 6		
		1—Mullard IW3 ...	15 0		



Above is George Barclay, the popular vocalist of Charlie Kunz's Casani Club Orchestra

(Right) Serge Kritsh, who is known to listeners for his quintet broadcasts, is also conductor of the Metropolitan Symphony Orchestra, a combination of eighty musicians that gives occasional performances in London

# B.B.C. Plans for Jubilee Year

By T. F. HENN

THAT the B.B.C. intends to make Jubilee Year a red-letter mark in the history of broadcasting is evident by the activity going on at Broadcasting House. Every responsible person is on the alert for ideas that will make 1935 programmes the best yet!

I had a long conversation with a leading official at the "Big House" who told me that the B.B.C. "would strain resources to the uttermost." Broadcast festivities are to start before Jubilee Day. Final details are not available and, in fact, there will be little definite news until the middle of April. However, I can give you a brief outline.

On Jubilee Day, May 6, the morning broadcast will consist of a relay of the Thanksgiving Service at St. Paul's Cathedral. The relay, I understand, will be arranged on similar lines of that when the Duke of Kent and Princess Marina were married at Westminster Abbey. Sound pictures of the procession, of the scenes outside the cathedral as well as the actual service will be broadcast.

In the evening there will be a review of



the King's reign, loyal messages of greeting from all parts of the Empire, leading up to the King's message from Buckingham Palace.

The King will go to Westminster Hall to receive greetings from both members of the Commons and Lords; it is hoped permission will be granted to broadcast this ceremony.

Broadcasting this summer will be a series of sound pictures of notable events. The King is reviewing the Army, Navy and Air Force; here again it is hoped to relay commentaries. Next month I hope to be in the position of giving a guide in miniature to the Jubilee broadcasts.



Introducing the Radio Three: Ann Canning, Kay Cavendish and Joy Worth. They have made frequent appearances in light programmes this last two or three months

Those many readers overseas can rest assured that every effort will be made to get advance details of all the "big" broadcasts.

The variety department is to make a big "drive" during the spring season and Jubilee festivities, and its object is to make variety hours among the "highest peaks of broadcast entertainment"—to quote an official announcement.

I understand that the ground work has already begun; John Watt being one of the leading lights in this movement.

Incidentally there is a movement on foot to floodlight the B.B.C.'s headquarters in London. It will be a most imposing sight, I am sure.

On April 3, the B.B.C. Orchestra—the full complement of 119 players—is visiting Dundee. Before even the programme was arranged far bigger problems had to be settled. The biggest of these was transport.

A special train, complete with sleepers, dining cars and kitchens, has been chartered. The train will leave London at 10 p.m. and will arrive at Dundee between 8 and 9 the following morning. The orchestra will entrain again immediately after the concert and will be back in London the following morning at breakfast time.

Besides the orchestra, B.B.C. porters will accompany the party and will be responsible for the packing and unpacking of the valu-

able instruments and for placing them in position on the platform of the Caird Hall at Dundee.

The sheet music will be in envelopes, each with the name of the player, and music librarians will travel with it and be responsible for arranging it on the platform stands. By the way, did you know that the B.B.C.'s Orchestral Library is the largest in the world, and that some twenty assistants are permanently employed looking after it!

What a huge picnic this Dundee visit will be; and what a bill the B.B.C. will have to foot. The B.B.C. must have a high respect for Dundee residents!

Talking about picnics, Jack Payne seemed to thoroughly enjoy every minute of his four broadcasts in February last. Don't you think listeners would, as a whole, appreciate the permanent engagement of a dance band of this kind.

Such a scheme would cost a lot of money, but, funnily enough, the money would be spent to some entertainment advantage!

Already plans are being made for the special pre-Easter broadcasts. On April 4 there will be a relay of the Royal Philharmonic Society's performance of Verdi's *Requiem* from Queen's Hall. On April 9 Filson Young is producing *The Upper Room*—a Passion play—which will be relayed from St. Hilary's Church in Cornwall.

The B.B.C. is giving its usual concert at Queen's Hall on Good Friday evening. This year Bach's *St. John Passion* has been chosen.

The customary liveliness will be observed on Easter Saturday. There is to be a super music hall programme and this will be backed up by a concert by the band of the Welsh Guards and the Theatre Orchestra, while on the Regional wavelengths *Cavalleria Rusticana* will be relayed from the Old Vic.

Don't forget to listen to J. I. Taylor's broadcast on the B.B.C. organ—April 11 at 8 p.m. J. I. Taylor is one of the few organists who really understands the intricate working of the B.B.C.'s instrument and his recitals are always worth hearing.

I have been listening very carefully to the *Soft Lights and Sweet Music* broadcasts lately and have come to the conclusion that they are probably one of the few outstanding light features. In nearly every case it appears that this programme is sandwiched between others.

I think *Soft Lights and Sweet Music* justly deserves at least three quarters of an hour, don't you?



One of the most popular providers of light music, Reginald King. Besides being conductor of his own orchestra he is an accomplished pianist and composer

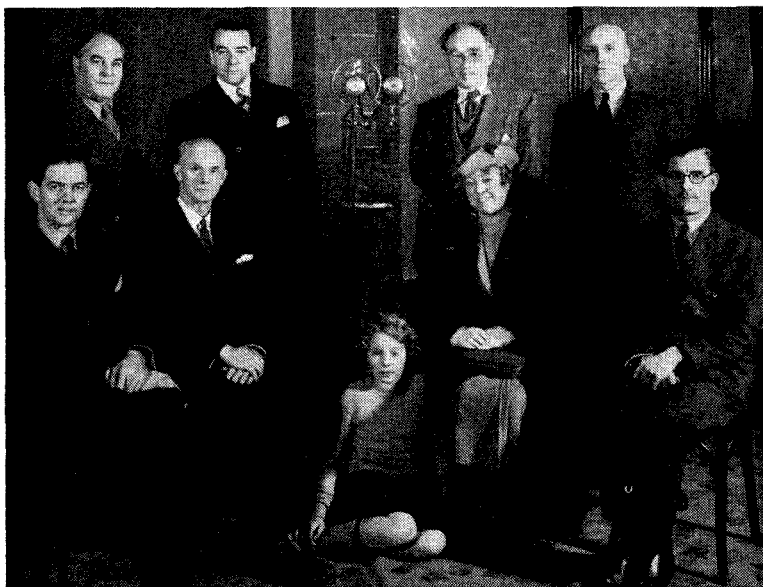

Excerpts of Leslie Bailly's "Scrapbook of 1910" have been recorded by Columbia. In the back row from left to right are Robert Atkin, Claude Graham-White, Joe Coyne, Patric Curwen. In the front row are Charles Brewer (producer), Commander Kendall, Muriel George and the author, Leslie Bailly



# The Iconoscope

## An Interesting Part of the Marconi-E.M.I. System

THERE are at present only two practical methods by which an outdoor scene can be televised—by filming the scene with a cinema camera and then scanning the film, or by means of some form of electron camera. Last month, in "Wireless Magazine," we described one form of the electron camera—the Farnsworth Dissector tube, in which an electron image is formed by the light focused upon the photo-electric surface, the whole image being scanned across a small aperture. The Farnsworth tube is now being used in England by the Baird Company.

### Integral Part

This month we shall describe the Iconoscope—an integral part of the Marconi-E.M.I. system which obtains a similar effect by quite a different method.

The Iconoscope was invented by V. K. Zworykin, of the R.C.A. - Victor Company, of Camden, New Jersey, with whom the Marconi-E.M.I. people are working very closely. The general principles of the Iconoscope can be understood from Fig. 1, which does not purport to be anything other than a purely diagrammatic sketch.

### How the Iconoscope Works

Here, in the front of a light-tight case *C*, is a lens *L*, similar to that used in an ordinary photographic camera, which projects its image on a screen *S* just as in an ordinary camera an image is formed upon the sensitive plate. This screen is made up of a metallic backing connected to a wire leading out of the tube (which, incidentally, is highly

evacuated), the surface of the plate being covered with a thin layer of insulating material such as a sheet of thin, high-grade mica.

The surface of the mica is covered with a multitude of spots of pure silver—tiny globules, in fact—which have been treated with caesium so that they become photo-electric. This means that when light falls upon them they emit electrons in proportion to the intensity of the light.

Now, when an image is formed upon the screens, each of these tiny

supply and *A* the anode of the tube *T*. Imagine for a moment that the screen *S*, instead of being made up of a large number of tiny little separate cells, is just one big cell, and that light from the lens is falling upon it.

### Discharge Currents

The condenser *C* will now be charged. If, now, we discharge it, in some manner or other, a current will flow through the resistance *R* and a voltage will be available across its two terminals. Sub-divide the cell of the screen *S* into a very large number and if we discharge any one of them there will be set up across the resistance *R* a voltage depending upon the charge on the condenser.

Now return to Fig. 1 and consider that the "gun" *G* of the Iconoscope tube is emitting a cathode ray (shown by the dotted line) which is focused upon the top left-hand corner of the screen. The effect of this cathode ray falling upon a cell will be, effectively, to discharge it, and if now we sweep the cathode ray across the screen strip by strip so as to scan it, then progressively we shall

discharge one after another all the little cells which are holding charges depending upon the strength of the light falling upon them.

The discharge of each little cell will bring about a voltage change across the resistance *R* of Fig. 3, this voltage being strictly proportional to the amount of light falling upon the particular portion of the picture. Thus, by amplifying the voltages and transmitting them as television signals we can bring about fluctuations of intensity of a

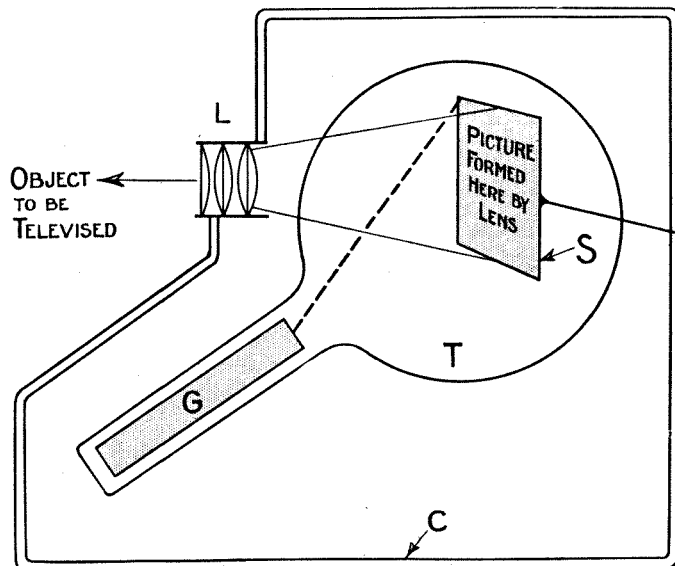

Fig. 1.—A diagram showing the arrangement of the Iconoscope. *L*—lens; *C*—light-tight casing; *S*—screen on which image is formed by lens; and *G*—the cathode-ray gun

globules in emitting electrons becomes effectively charged with electricity, forming one plate of a condenser, the other plate of which is common to all the other little condensers, being, in point of fact, the back plate behind the mica. A diagram of a small portion of this plate is shown in Fig. 2.

In Fig. 3 is shown a simple circuit in which *s* represents the screen of the Iconoscope, *c* a fixed condenser (the equivalent of one globule), *R* a resistance, *H* a source of high tension

cathode-ray beam at the receiving end.

If this receiving beam is made to traverse the usual target of a cathode-ray tube in synchronism with the transmitter, then we shall receive a correct television image

**Limits of Definition**

For 240-line scanning the size of the individual cells scattered over the screen end must obviously be not more than the width of the scanning beam. Actually they are very much smaller. If you refer back to Fig. 2 you will see a circle corresponding roughly to the diameter of the scanning beam from which you will

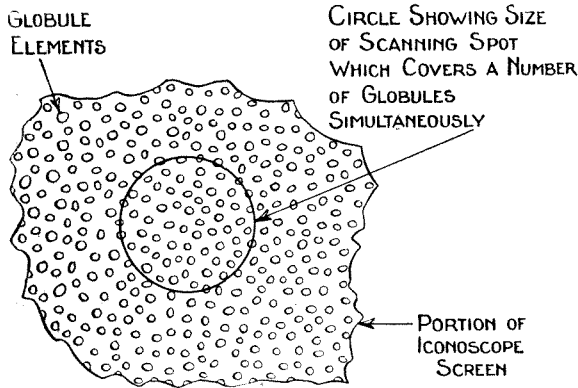

Fig. 2.—This sketch shows the size of the sensitive globules of the Iconoscope screen in relation to the size of the cathode-ray scanning spot

see that the cells are individually much smaller than is necessary for this degree of resolution. Indeed, experimentally it has been found possible to scan up to as many as 500 lines while still coming within the resolving powers of the tube.

One of the great advantages of the photo-electric type of transmitter is

that there are no mechanically moving parts. The Iconoscope is sufficiently sensitive for ordinary outdoor scenes, such as cricket and football matches, race meetings and the like, to be televised, so long as there is enough light to use an ordinary cinema camera.

It does not follow, however, that in all cases direct television of the scene is necessarily advisable for a television service. With the delayed-action film method cinema pictures can be taken, developed, fixed, and washed ready for scanning in thirty seconds while the sound can be similarly recorded and similarly delayed, so that with this brief delay the image can be televised just as if the pick-up were direct.

In very few cases would this slight delay be noticed and the film method of transmission has the advantage that the programme can be repeated at a later hour in the day or as many times as required, from the film already taken.

There is, therefore, a permanent record of the scene televised, whereas with direct pick-up the scene cannot be repeated.

As a very large number of the important ceremonies and activities which it is desired to televise occur at hours which are not convenient to the ordinary listening public, the delayed film method will un-

doubtedly be used extensively, even when other methods are available. The position, indeed, will be very similar to that which occurs in sound broadcasting at the present time when a good deal of the programme is broadcast direct, but certain items are recorded and re-transmitted on later occasions.

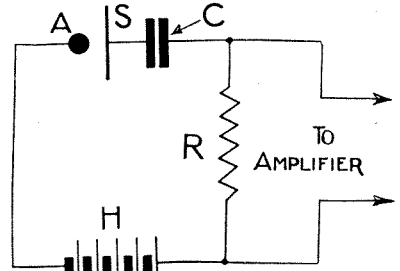

Fig. 3.—Theoretical circuit showing how the discharge of the condenser C by an electron beam causes a variation of voltage across R

It is interesting to speculate whether there are other electron scanning possibilities. In the Iconoscope the electron image is static, being scanned by a thin pencil of electrons, and, so to speak, momentarily cancelled out, only to be reformed immediately.

In the Farnsworth Dissector tube the electron image is focused or re-formed at a distance from the photo-electric surface and then bodily moved rhythmically across a scanning aperture.

Thus while superficially the two devices may seem to be similar, actually they differ widely in principle, the only common feature being that the focused light image of the scene to be televised is made to produce an electron image proportional to the light density.

Not far from the huge factories of Electrical and Musical Industries at Hayes, Middlesex, stands this fine old mansion. It is here that the E.M.I. research engineers have been hard at work perfecting their system of high-definition television.



H.M.V. photo

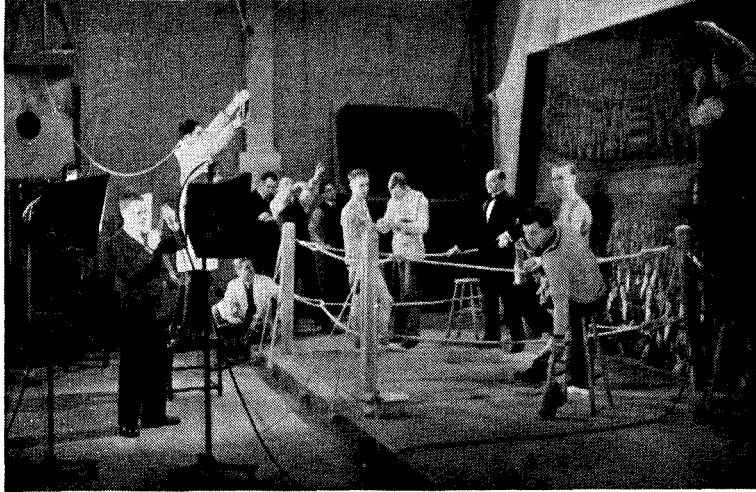

*This boxing match, staged in the Baird studios at the Crystal Palace, was a popular feature at recent demonstrations*

What kind of amplifier do we need for television? Can an ordinary set be converted? Why must we use short waves for high-definition television? All these questions, and more, are answered in this article. Photographs are by courtesy of Baird Television, Ltd.

# Television Facts and Figures

By PERCY W. HARRIS, M.I.R.E.

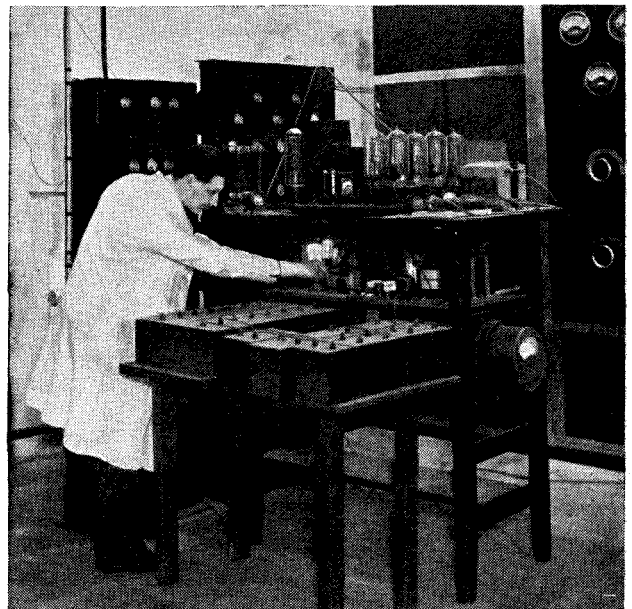

*Showing the Baird modulation amplifier for the 7-metre vision transmitter*

**A** WIRELESS amateur who is considering the construction of television apparatus naturally wants to know in what way the apparatus used differs in technique from that to which he is already accustomed. In this article we shall endeavour to make those differences clear.

## Frequencies for 240-line

First of all, let us glance at the frequencies required for high-definition television using 240-line scanning. Assuming the proportion of the picture to be kept approximately that of the ordinary talking film (this is really essential, otherwise commercial films could not be televised satisfactorily), then the picture will

be a third as long again as it is high, or, in other words, the proportion will be 4 to 3.

It is probable that television will be standardised at twenty-four or twenty-five pictures per second, for this, too, will enable films to be televised, while that frequency is sufficient to overcome any troubles due to persistence of vision and flicker. On page 183 we have reproduced a picture made up of rows of dots to simulate the appearance of a televised picture with 240-line scanning.

Actually, the appearance is not quite accurate, because in a television received image the picture laterally is not cut up into separate dots but into smoothly progressive

variations of light and shade, only the horizontal lines being clearly cut.

However, so far as definition is concerned the pictures are strictly comparable, and probably for the first time many readers will realise the high degree of definition obtainable with 240-line scanning.

## 76,800 Dots!

Now, the picture reproduced has 240 lines of dots from top to bottom and approximately 320 dots to each horizontal line. This makes in all 76,800 dots to the picture! This means that in order to get this degree of definition in television the scanning spot or beam must make 76,800 variations of light per picture, or, at the rate of twenty-five pictures



per second no less than 1,920,000 variations per second. To send out these variations as a radio signal we must modulate our carrier wave at at least half this frequency.

### Synchronising Requirements

You may wonder why we say, "at least half this frequency." A point that is sometimes overlooked in discussing television figures of this kind is that firstly only half a cycle is required per dot and secondly there has to be a small pause after the television of each scene to allow for the transmission of a synchronising signal. This time has to be subtracted from the total time, and therefore the modulation frequencies to which we have referred have to be speeded up about 10 per cent so that the actual rate of change is higher than would at first be thought.

### Sidebands

Furthermore, when we modulate our carrier wave at the frequency of, say 1,000,000 (we will keep to this figure now as it is easier to remember), then we produce side bands or side-frequencies of 1,000,000 on *each side* of the carrier wave.

It is interesting to compare this with

ordinary sound broadcasting in which we may send out frequencies up to 8,000 if it is well done. This occupies a frequency band of 16,000 in the ether, but owing to the necessity of placing stations close together only 9,000 cycles are allowed for each station, so that if we modulate above 4,500 and our receiver will receive frequencies much above this, then we are in danger of having interference from an adjacent channel.

By spacing stations geographically so that transmitters on adjacent channels do not come near to one another on the map we can avoid a good deal of this trouble, but it will still exist.

One sometimes reads statements

in the newspapers that this or that inventor is working upon a system to give high definition on the ordinary broadcast band. This is rather amusing when one considers the figures concerned. The ordinary medium-wave broadcast band can be considered as roughly from 200- to 600 metres.

### Frequency Limitations

If, now, we modulate with a 1,000,000 frequency we find that there are only 1,000,000 cycles available, anyhow, between 200 and 600 metres! Even from 200 to 2,000 metres there are only 1,350,000 cycles, so there would not be room on both broadcast bands and all those between for both sidebands!

Another rather interesting point, which many of the technical writers have overlooked, is that you cannot modulate a carrier wave at a higher frequency than that of the carrier itself, which is also an insuperable difficulty in the use of high definition on the ordinary broadcast band.

What can we do, then? The answer is that we can go right down to the ultra-short waves, where frequencies are extremely high

and where there are plenty of bands 2,000,000-cycles wide available for television. It has been found in practice that round about 6 or 7 metres is a good part of the etheric spectrum, the frequency of 7 metres being approximately 43,000,000.

### Special Problems

High-definition television, then, will utilise the short wavelengths and short-wave receivers will have to be built. What are the special problems here? First of all, the tuning of our circuits must be sufficiently flat to embrace not only the carrier wave but sideband frequencies at least 1,000,000 on each side without any substantial falling off in strength. To the ordinary broadcast experimenter this may sound particularly difficult, but, actually, even a sharply resonant circuit on these wavelengths



*An attempt to show the detail available in a 240-line television picture. This illustration is made up with 240 horizontal lines of dots. In a televised picture there is no dot effect*

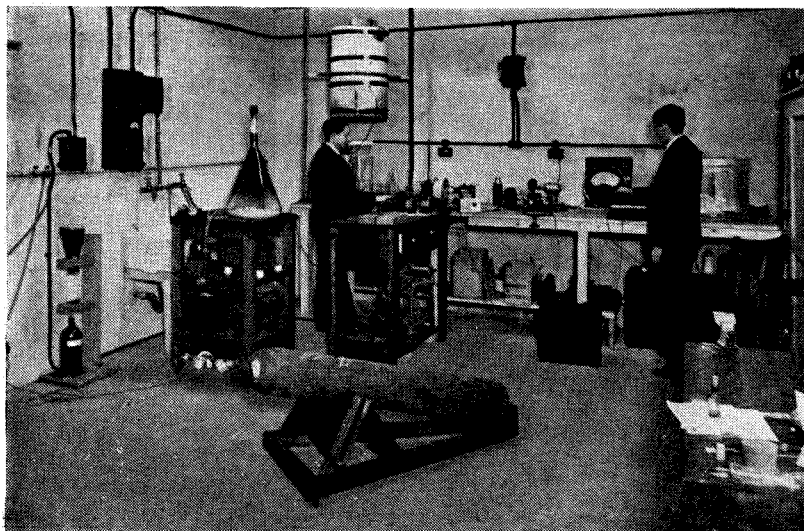

*This is one of the research laboratories at the Baird Crystal Palace headquarters where cathode-ray tube research work is carried out*

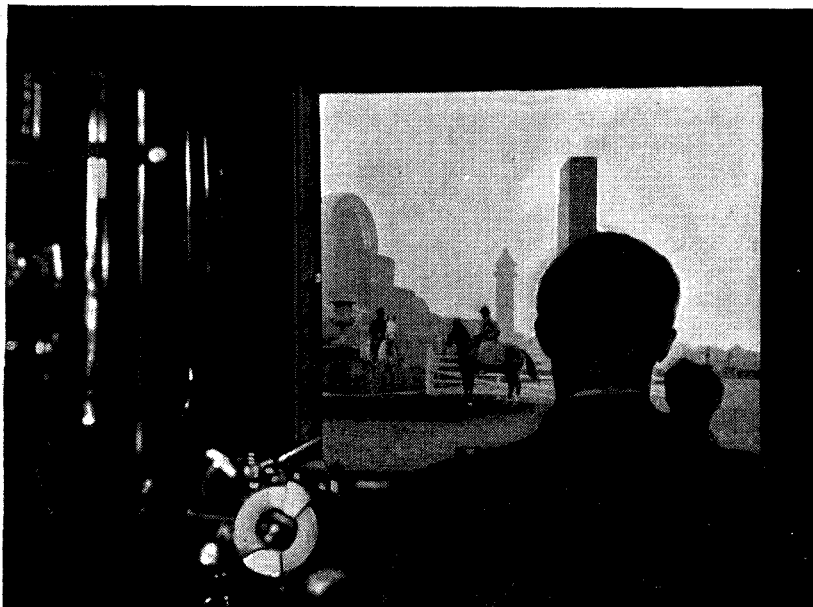

Televising horse-jumping scenes on the terrace of the Crystal Palace by means of the intermediate-film scanner

includes a very wide band of frequencies.

When you think it out, selectivity concerns a question of *proportion* of modulation frequencies in the carrier wave. You will understand this when you consider how easy it is, in long-wave broadcasting circuits, to lose quality through sideband cutting even when they are not particularly sharp in tuning.

### Relatively Simple

If, on the ordinary medium wave-band, you are receiving modulations up to 10,000 cycles on each side of a 300-metre carrier then the modulation frequencies you are receiving are one-hundredth of the carrier-wave frequency.

Down on 7 metres a modulation frequency of 1,000,000 is roughly one-fortieth of the carrier frequency, or roughly speaking only two and a half times as flat in tuning as the medium-wave broadcast circuit to which we have just referred.

Care is required in design, but not so much as would be thought.

### Big Worry !

The big worry in a television receiver comes in the design of the amplifier following the detector, for here we have to receive without distortion or much attenuation all frequencies up to 1,000,000! This rather makes one's hair stand on end, when you think of the difficulties in designing an audio-frequency amplifier which is even

reasonably flat up to 10,000 cycles. In practice a television amplifier is made with resistance coupling with a very small gain per stage.

We shall have more to say about this type of amplifier in future issues, but meanwhile these facts will completely remove from your head any ideas of using short-wave adaptors on ordinary broadcast sets and hooking on a high-definition television scanning scheme to the loud-speaker terminals! They will also provide you with several large quantities of salt to be taken with statements made that any of the

present 30-line television receivers can be subsequently "altered" to 240-line scanning.

### Design Problems

The problem of designing a television receiver, then, is first of all to make a good short-wave receiver with the radio-frequency circuit sufficiently flat to avoid much attenuation up to 1,000,000 cycles on either side of the carrier; to build an amplifier which will be substantially flat up to 1,000,000 cycles; to provide some form of cathode-ray tube which will focus a sharp point of light upon the target, the tube being provided with circuits which will respond to the synchronising signals and will scan in synchronism with the transmitter.

### For Experimenters

Well-made cathode-ray tubes giving a good, bright, sharply defined spot together with circuits which will respond to the synchronising signals, will be available before long for amateur experimenters. "Wireless Magazine" will see that its readers are provided with the necessary data regarding both radio-frequency and picture-frequency amplifiers.

Of course, so far as the sound accompanying television is concerned, the technique of this is already well known, for although it is highly probable that the sound signals will be sent out on short waves very close to those of picture signals, no particularly wide frequency band is needed.



Televising a Spanish cafe scene at the Baird studios. Mr. Baird is seen on the left of the picture and Sir Ambrose Fleming on the right

# How Speed Photography Helps Television

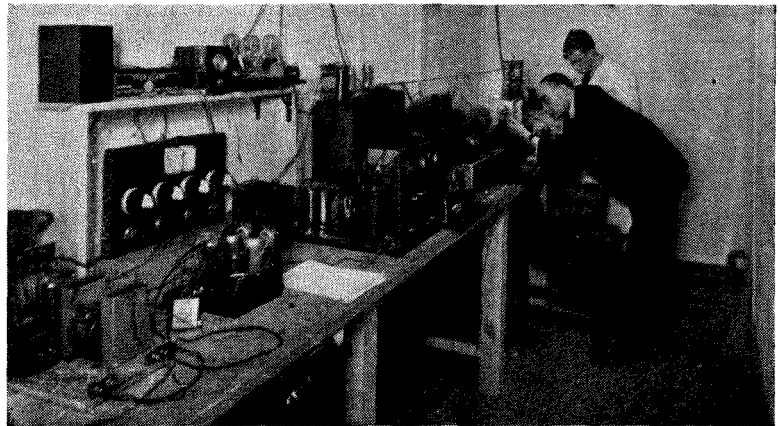

Showing the apparatus used to film the received image so that televised pictures can be projected on a cinema screen

# The Intermediate Film Process

WHAT do you call quick service for roll-film developing? Perhaps during the summer holidays you take your spool into the seaside chemist before ten and collect your finished photographs about tea-time, and you think this is pretty quick work!

### Quick Work

Or possibly you are an amateur photographer yourself and develop your own, in which case, with the aid of an electric fan to dry the film after you have developed, fixed and washed it, you can cut down the time between finishing the roll and showing the prints still further.

Let us say five minutes for developing, ten minutes for fixing,

half an hour washing, and perhaps three-quarters of an hour for drying if you are lucky. This makes an hour and a half in all for obtaining a finished negative (without the prints!) and, while I do not say it is not possible to work quicker than this, most readers will admit that it is pretty good going.

A year or two ago rumours first came out of Germany of a new television process in which the subject to be televised was first of all filmed with an ordinary cinema camera, the film developed immediately, fixed and washed, partially dried and then, without further delay, scanned for transmission.

The film next passed on, without stopping, through a machine which

removed the photographic emulsion, washed the film base, re-coated it with a fresh emulsion, dried it and brought it back to the camera again, so that once more the process of filming, developing, fixing and washing could be repeated!

In this machine the film used was one long continuous loop, and such was the speed of processing that the film picture could be televised with a delay of only a minute or two from the time of taking!

### Strange But True

It is understandable that some doubt was cast upon this story by those who were fully acquainted with photographic technique, for it seemed impossible to work so quickly, but before long the story was confirmed and the results obtained were found to be quite satisfactory.

Since that time the technique has been improved considerably and the Baird people, who have themselves contributed much to the development of this process, have given a number of demonstrations with their inter-

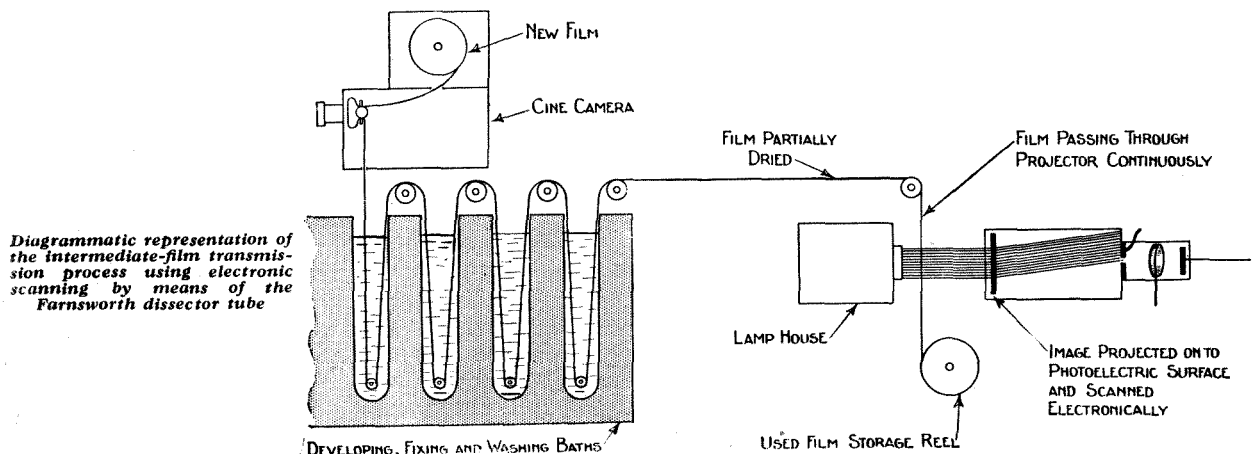

Diagrammatic representation of the intermediate-film transmission process using electronic scanning by means of the Farnsworth dissector tube

mediate film apparatus, the delay between actual taking and televising the scene being less than thirty seconds!

### Permanent Record

Before dealing with the actual methods used, let us consider a few of the advantages of the intermediate film system. First of all, it is very much easier to scan a film than an actual scene, there being no problems of illumination to be solved. Secondly, any scene sufficiently well lit to enable an ordinary cinema picture to be taken can be televised in this manner; and thirdly, it is possible (if the film taken is kept and not cleaned and re-emulsified) to have a permanent

film for every scene televised, the film being dried completely after it has been scanned, and stored for future use. While this method is slightly more expensive in operation, the advantages of the permanent record outweigh the disadvantage of the slightly higher expense.

Standard size of film stock is *not* used and various sizes have been experimented with, including the  $9\frac{1}{2}$ -mm. gauge, which is so popular with amateurs. In the demonstrations we have witnessed the Baird company has used standard 35-mm. stock split in half so as to give two strips  $17\frac{1}{2}$  mm. wide. This was found to be very satisfactory in practice. Later, perhaps, special sizes may be made.

the "taking" speed. Forty-five feet per minute is about the speed used at the present time.

After passing through the developing solution the film traverses another tube containing the washing water, thence into a rapid fixing bath, through another wash, and with the bulk of the water removed in a drying chamber the damp film passes up into the scanning aperture, only thirty seconds after it has passed through the camera.

### Partial Washing

Needless to say, only a portion of the hypo- or fixing solution has been removed from the emulsion in the quick wash, but the presence of the residue of fixing salts in the emulsion does not bring about any immediate deterioration and therefore has no effect upon the image when it is scanned. A more prolonged wash can always be given when it is desired to keep the film.

It is interesting to note that, while the film passes through the camera gate intermittently picture by picture, in passing through the scanning aperture it moves continuously and *not* intermittently.

The reason for this is that instead of the scanning line moving down the picture a distance equal to its width after each traverse and then, as soon as the bottom of the picture frame is reached, jumping to the top again, the film moves steadily downward at such a speed that when the scanning spot returns to its starting point after each line the film has moved down a distance exactly equal to the spot width.

### Line Scanning

As soon as the film has moved a distance equal to one frame the spot is ready to start at the top of the next frame, and so scanning is simplified.

Incidentally, this method of scanning a continuously moving film is adopted also for the televising of ordinary commercial films. The scanning can either be by means of a high-speed disc or by some electronic method. Illustrations of both types of apparatus were given in last month's "W.M." (page 86).

At the receiving end the image on the cathode-ray tube can be similarly filmed, the film processed at once and projected on to a large screen with a delay of only thirty seconds, thus providing a screen image big enough for the largest audience.

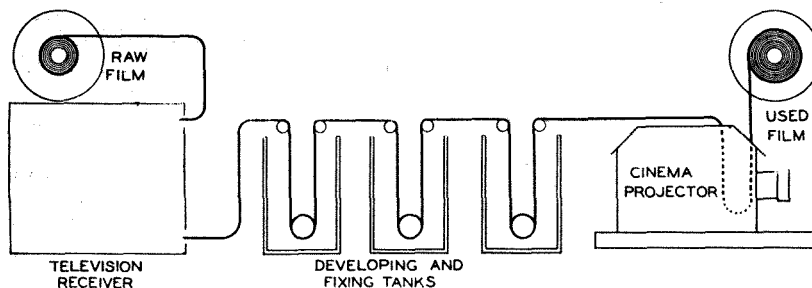

A diagram showing the intermediate film process used for reception

record of the scene, so that it can be televised at a latter time just as often as required.

This last advantage is a very important one in the case of ceremonies and events which occur during times which are not convenient for television reception by the ordinary public.

### Two Systems

The system, therefore, corresponds with the use of special records of a broadcast by the B.B.C. so that events can be re-broadcast later in the day. Such records are made on all important national occasions.

There are, as you will have gathered, two methods of intermediate film transmission. In the first, which originated in Germany and described above, a continuous loop of film is used, the old emulsion being cleaned off immediately after the picture is televised and a new emulsion substituted. The advantage of this method is that the cost of film stock is kept down but the disadvantage is that there is no permanent record.

The second method is to use fresh

The camera used very closely resembles the standard cinema camera, the new film being stored in a light-tight case from which it is fed into the "gate" and exposed. After the film comes away from the gate, instead of going on to a take-up reel it passes through a light-tight aperture down to the bottom of a tube filled with developer, round the roller at the bottom of this tube, up again over another roller, down a second tube, up to the top, and so on through various liquids and as many tubes as are necessary for the process.

The photographic emulsion used has been specially evolved by the film makers for this process and the developer has also been specially compounded after numerous experiments. It works, incidentally, quite hot—at a temperature which would melt the emulsion with ordinary film—and this special form of emulsion, the special developer, and the high temperature all contribute to make the developing time extremely short—a matter of seconds.

The speed at which the film travels through these tubes full of solution is, of course, governed by



# Simple Facts About the Cathode-ray Tube

by P. WOODWARD



An engineer explaining the function of the new Cossor giant cathode-ray tube to three B.B.C. variety artists

IT is probably unwise to dogmatise about anything that is developing as rapidly as television, but so far as one may judge the cathode-ray tube is an almost essential feature of a high-definition receiver.

It is therefore advisable for those who are just taking up this branch of the art to familiarise themselves with the main facts about these tubes. The notes on this page are intended to provide an introduction to the tube as a practical article of everyday use; they make no attempt to explain the theory of its working.

## Main Objections

Now, it has been fashionable in certain quarters to decry the cathode tube, so let us first deal with the main objections to its use: (a) that it is fragile and costly; (b) that it calls for dangerously high voltages.

It is quite true that the tube does at present cost a certain amount of money; but then so did the moving-coil loud-speaker when first introduced. History is likely to be repeated here.

## Breakage Argument

The argument about the tube being easy to break is a little difficult to understand. True, it is made of glass, but does one expect an article to get broken merely because of that? Valves are mostly made of glass, too, but how often does one

hear of a breakage? Very rarely, and it seems likely that with an object of the size of the cathode tube (it is quite large) the answer would be never.

Dangerous voltages? Well, they do run quite high, even in the case of the modest-sized tubes available for amateur use: they may be of the order of 800 to 2,000 volts. That certainly sounds alarming, and has been made the excuse for many gloomy prognostications.

The fact is, however, that although a high voltage is needed the *current* required is extremely small. It is, therefore, possible so to design the supply circuits that they will deliver only a tiny trickle of current and yet do their work satisfactorily.

The problem has hardly been touched from the amateur user's point of view, but it seems probable that it will be found practicable to arrange these power-supply circuits in such a fashion so that although they will be capable of administering an intensely painful shock, they will not be dangerous. The actual quantity of current delivered would be too small to affect seriously a person in normal health.

Finally, let us take a look at one of the actual types of tubes now on the market, taking as our example the Ediswan "BH." This is of the usual funnel shape, with a circular sensitised screen at the larger end.

The overall length of the tube is

45 centimetres (approximately 18 in.) while the diameter of the screen is 10 cm. (4 in.). It is fitted with the standard 4-pin base, extra terminals for certain of the electrodes being attached round the rim of this.

## Operating Figures

The cathode heater, which is connected to a pair of the pins, requires a current of about 1 ampere at a pressure of approximately .5 volt (.4 is an average figure). It is customary, of course, to use either a voltmeter or an ammeter here, in order to facilitate the repetition of a favourable adjustment which may have been found experimentally.

Of the various electrodes, the "first accelerator" requires an operating potential of 250 to 800 volts, the "second accelerator" calls for 800 to 2,000, while the negative shield needs 50 to 150 volts.

The price of this tube is £8 8s.

## New Cossor Tube

At the time of writing Cossor has just announced a new cathode tube which promises to be of great interest. It is of the much larger type, and is stated to allow for a picture 9 in. high. Its length is 27 in.

Full details of this tube have not as yet been released, but it is quite evident from the information already supplied that this new Cossor production will be of great interest.

# Records for

A Review of the Latest—



Columbia photo

Here are Layton and Johnstone in the Columbia studios. In a recent record they sung the chorus twice; later the two recordings were superimposed to make a quartet sung by two singers

brilliant works and reproduce well on an electric gramophone.

Eric Coates comes into the limelight again with a recording of *The Three Men*, a suite in three parts, depicting the man from the country, the man about town, and the man from the sea. Those of you who revel in his *In Town Tonight* and *London Bridge* marches will enjoy this. Style is the same; the work is full of vitality and the recording is good.

On the second side of the second record we find a recording of one of Eric Coates' most delightful waltzes from *Wood Nymphs* (H.M.V. C2722 and C2723, 4s. each). Some good H.M.V. records this month.

IT is my pleasure to introduce, first of all, the best orchestral record that has been released for some long while. This is H.M.V. DB2275; Stokowski's arrangement of two of Bach's lesser-known works, *Sarabande* from the Third English Suite for the piano and *Siciliano* from a violin and cembalon sonata, both played by the Philadelphia Symphony Orchestra under Stokowski.

Never in my life have I heard such marvellous string tone on a gramophone record. Crescendos and diminuendos by violins and 'cellos and double basses are recorded with such fidelity as to be almost unbelievable.

The record costs six shillings, but it is worth every penny of it. The least you can do is to hear it; then you'll get it.

Everyone, highbrows and lowbrows, has heard of Beethoven's famous *Moonlight Sonata*. Wilhelm Backhaus has recorded it for H.M.V. on DB2405 and 2406 (6s. each). Fine recording and a super performance. As I played the two records I could not help thinking of the advantages of a good high-quality radiogram. A perfect illusion of the real thing!

Two new Decca-Polydor records which I strongly recommend are the *Roman Carnival* overture by Berlioz played by the Berlin State Opera Orchestra on CA8197 and the second movement of a Mozart sonata played by Gerhard Bunk, organ, and the Dortmund State Music School Orchestra on CA8195. Both are

Now, here are two interesting Parlophone discs—Tauber singing *The Forbidden Song* and *The Last Greeting* on RO20270, 4s., and the overture *Sicilian Vespers* (Verdi) played by the Milan Symphony Orchestra on E11266, 4s. I like the Tauber record; the songs

are of the quiet ballad type—nice tunes—and one can enjoy the beauty of Tauber's voice much better than in the type of greater vocal exertion. At least, I think so.

There are, I believe, a number of people who enjoy listening to popular semi-classics, such as *Blue Danube Waltz*, in vocal form. Personally, I prefer plain orchestral renderings. Here is a typical example again this month. Miliza Korjus, a brilliant German soprano, sings Weber's *Invitation to the Dance* marvellously done, but give me the Philadelphia Orchestra's rendering any day. On the other side Korjus sings *The Maiden's Wish*, a Chopin mazurka. Quite nice, this. (H.M.V. C2721, 4s.)

Now for something cheerful. The B.B.C.'s military band plays two marches on



Harry Roy in a cheeky mood! His splendid recordings on Parlophone can now be obtained for 1s. 6d.

# Your Radiogram

—Releases by T. F. HENN

Columbia DB1506 (2s. 6d.)—one an arrangement of the hit, *Sing As We Go*, and the other *Ship Ahoy*. You're right, *All the Nice Girls Love a Sailor* is included!

Sandler's orchestra plays the *Merry Widow Waltz* and *Vilia* on another Columbia (DB1484). I thoroughly enjoyed his *Vilia*, but somehow or other he seemed to miss the mark with the other. I may be mistaken.

The Commodore Grand Orchestra plays Liszt's *Hungarian Rhapsody, No. 2*, on Regal-Zonophone MR1594 (1s. 6d.). This work for 1s. 6d. is, I suppose, good value especially when it is played by such a favourite broadcasting orchestra. It is a work for a big orchestra, methinks!

A record I did enjoy was Alfredo Campoli playing *La Petite Tonkinoise* and *Poppies* on Decca F5450. Here the work suits the orchestra. A delightful couple of light tunes.

The most ticklish of recording jobs is, I imagine, making a funny record. Columbia provide us with two this month. A discourse on *Cycling* by John Tilley, DB1508, and another by Hugh E. Wright, the latter giving a burlesque of a B.B.C. commentary on a Test Match at the Oval (DB1511). Tilley has, to my mind, got the knack of recording humour. He starts off with one thing, and before the listener knows where he is, Tilley is talking about buying pictures and a coffee-stall

owner putting his hand in a pan of frying sausages.

I believe that the mere fact that I am alone listening to a seemingly droll commentary on an imaginary Test Match puts me off straight away. Honestly, the Test Match record bored me. Lucky we are not all affected in the same way!

## Light Records

Of the light records I pick out two as being especially good. One is Valaida, of Lew Leslie's Blackbirds, playing two trumpet solos on Parlophone F118 (1s. 6d.) and the other of two contrasted banjo selections by Ken Harvey, on H.M.V. B8289 (2s. 6d.). Valaida's star



Here is Charlie Kunz photographed at his piano at Casani's Restaurant from which he broadcasts. He records for Sterno



Miliza Korjus records for H.M.V. She has a fine soprano voice. Her latest record is reviewed here Sandau, Berlin

hit is *I Wish I Were Twins*; what wind she must have! Simply wonderful.

Harvey's selections are of present-day hits on one side, and a medley, *On a Southern Plantation*, including a number of universally known plantation songs, on the other. Both are recommended.

Of the light vocal records I recommend Russ Colombo singing *Too Beautiful for Words* and *When You're in Love* on Decca F5405. There is, however, a tragic story behind this record. The day after it was recorded Russ Colombo was accidentally shot dead.

And now for dance music. Not a brilliant collection this month; we need some new catchy tunes badly.

Parlophone sends me two fairly good ones. Harry Roy playing *Blue Moon*, a fox trot, and *No Moon, No Stars, Just You*, a waltz, on F124 and Nat Gonella and his Georgians in *I'm Gonna Wash My Hands of You* and *Georgia's Gorgeous Girl* on F116.

Regal Zonophone: *Missus Lowborough-Goodby* and *Too Beautiful for Words* on MR1581 and *Sidewalks of Cuba* (a rumba) and *Because of Once Upon a Time* on MR1583 are Lew Stone's fox trot contributions.

One of the best is Decca's *Hitchy Koo* and *He's a Rag-Picker* played by the Embassy Rhythm Eight.

# More About the "H.K." Four

Designed by  
**PERCY W.  
HARRIS, M.I.R.E.**  
and  
**G.P. KENDALL,  
B.Sc.**

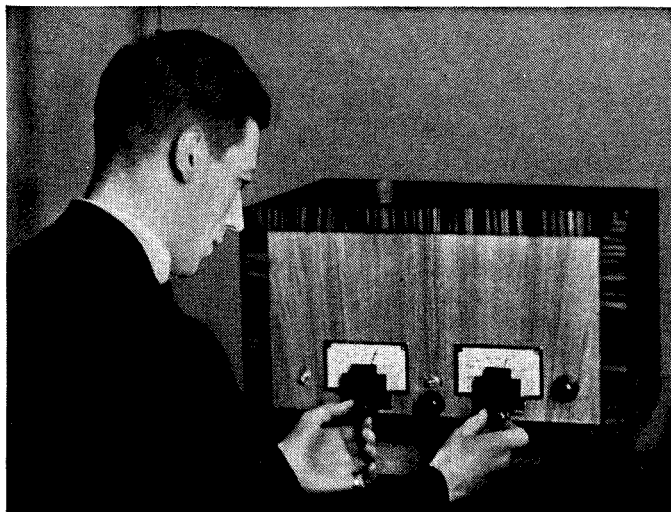

Describing the  
Finer Points of  
Construction  
and Operation

*Two-dial tuning is an art which is easily learnt; once acquired it enables the operator to obtain results rarely equalled with a single-control receiver. The tuning guide throws interesting light on this question*

**I**N presenting the "H.K." Four last month we endeavoured to deal comprehensively with the general theoretical aspect of the design and at the same time give a brief account of the main constructional points. We had to make it *very* brief, so before discussing operating details I ought, perhaps, to deal with one or two practical matters which we were able to cover only in outline last time.

First, I must emphasise that the metal coating on the surface of the baseboard must be scraped away under *each* of the brackets supporting controls. These are the brackets for the reaction condenser, the low-tension switch, the A.V.C. controls, and the tone controls. This was stipulated on the wiring diagram, but since something unfortunate happens if it is forgotten I want to make certain that this point is fully understood!

Then there are the connections which run beneath the baseboard: this is really quite a simple matter, but since the set may well be built by some of our many readers who have not had a great deal of

constructional experience, I had perhaps better just run over the question again.

An example will probably make the point clear. On reference to the wiring diagram you will find that a wire leaves one end of the .1 megohm resistance near the  $V_1$  valve holder and disappears through a hole in the baseboard marked "R."

Then near a 50,000-ohm resistance located between the two gang condensers you will find a wire coming up through another hole also marked

"R." This simply means, of course, that the wire went down through the first hole, ran along under the baseboard, and came up through the second hole. In the same way you can trace the run of all the other wires following a hidden route.

A very similar method was adopted in marking the leads running between parts on the baseboard and those on the "bridge" on which the coils are mounted. Where the wire leaves the lower level it is shown broken, with an arrow head on the end; this

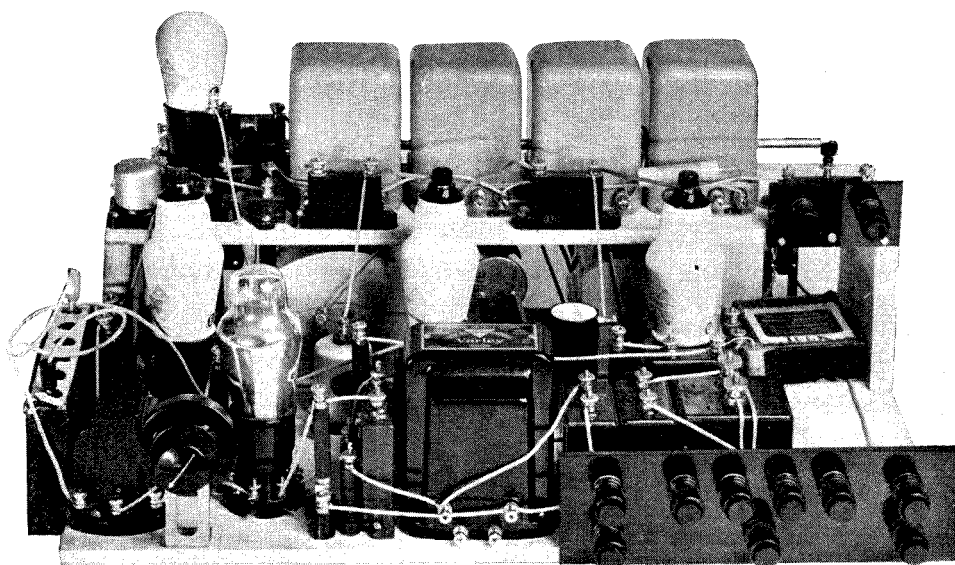

*The smaller grid-bias unit can be tucked away under the aerial and earth end of the coil shelf, while the larger one can stand inside the cabinet at the opposite end*



is given a reference letter, and the same letter will be found on the corresponding end coming down from the upper level.

The fitting of the finished set into its cabinet calls for just a word or two. The first step is to mark out the front panel, which will presumably be of wood, and drill it for the various control spindles which will project through it.

### Drilling the Panel

The lateral spacing for all these holes can be obtained from the wiring plan, which is dimensioned where required; the correct height for each hole is best determined by actual measurement. The fitting of

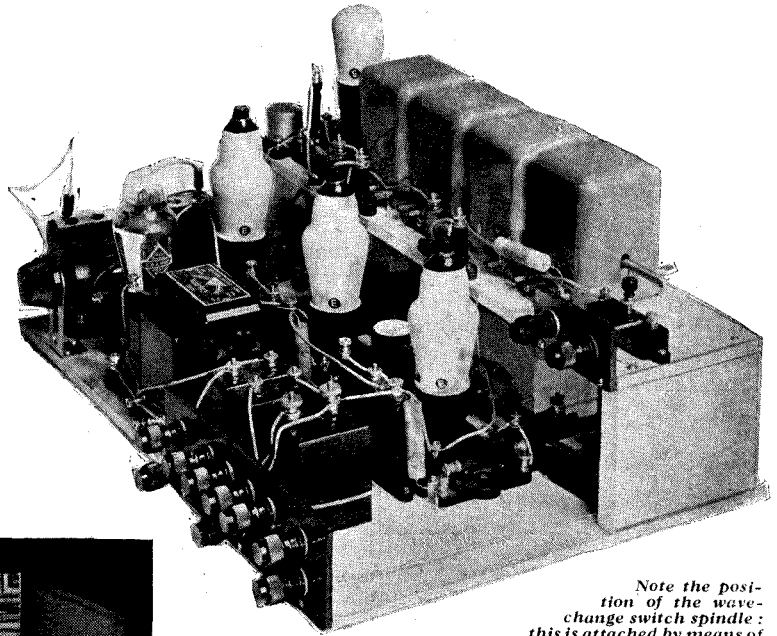

Note the position of the wave-change switch spindle: this is attached by means of a coupling piece to a short extension which passes through a hole in the side of the cabinet

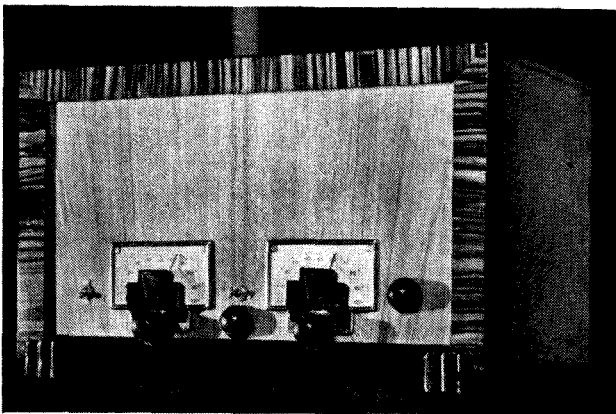

Housed in a cabinet worthy of its quality: the "H.K. Four" fitted in the special Peto-Scott table cabinet

should rarely be necessary, since in practically all cases the required volume can be obtained by using just a trifle of reaction.

### Degrees of Selectivity

Several different degrees of selectivity can be obtained by varying the position of the tapping leads on the coil units. These control, first, the aerial coupling (lead from .0003-microfarad compression condenser to points 1, 2, or 3 on first coil) and, secondly, the high-frequency inter-valve coupling (flexible leads from .0001-microfarad fixed condensers to points 1, 2, or 3 on third and fourth units). The rule in each case is that the lower numbers give higher selectivity.

Higher numbers, on the other hand, give slightly greater volume, so a little experimenting is advised. In general it will be found that No. 1 on the first unit and 2 on the others will give a good compromise for normal conditions.

### A.V.C. Valve

A list of recommended valve types was given last month, but it may perhaps be as well to explain the matter of the A.V.C. valve in greater detail. This actually consists of a triode or screen-grid type with certain of its electrodes joined together to make it into a diode; the point is that practically any kind of valve will serve the purpose.

the dial parts is, of course, carried out quite simply with the aid of the paper templates supplied with the condensers. This should be done, by the way, before the panel is finally attached to the baseboard of the set.

### Into the Cabinet

After the panel has been fitted, the set can be slid into the cabinet from the back and secured in place. This is done in two ways: first, some screws are driven up through the bottom of the cabinet into the set's baseboard, and secondly a couple of screws are passed through the upper edge of the panel into the cabinet front from the inside. These notes, by the way, are based on the assumption that a cabinet of the type shown in the photographs is used. (This is a Peto-Scott model specially designed for the "H.K." Four.)

Fitting up the various battery leads is, I think, a quite obvious matter, but it is to be noted that sufficient length should be provided for the G.B. leads to reach a suitable spot for the location of the two batteries required. These, by the

way, comprise a 9-volt unit for the output valve (marked G.B.2 on the diagrams) and a 4.5-volt unit for volume-control purposes (marked G.B.1). Space for both these can be found inside the cabinet.

Now for sundry points about the operation of the receiver. The tone control should at first be set to a mid-way position, the final setting to an adjustment to suit individual requirements being made only after the receiver has been tried out on several different transmissions.

The volume control will be found to reduce strength when it is turned to the left (anti-clockwise). When it is turned fully to the right the set works at its maximum power, subject only to the limiting effect of the A.V.C., which serves to prevent severe "blasting" when the operator incautiously tunes in a very powerful station, and to choke down the squeal when reaction is pressed too far and the set is made to oscillate.

For very weak stations, by the way, the A.V.C. can be put out of action by pressing the knob of the control switch to the right; this

When a triode is employed the effect of the inter-connecting wiring shown is to join together plate and grid, while in the case of a screen-grid type it is the control grid and screening electrode which are joined.

**Try Old Valves !**

The best tip I can give here is that the user should try out all his old valves in the A.V.C. position and see whether he can discover one which is a little better than the rest.

**A Tuning Guide of the "H.K." Four will be found on Page 233**

The trial should be made on a very strong station, preferably on long waves, the best valve being the one which cuts down the volume most and so gives the best protection against overloading. (Without the A.V.C. in action the set will probably be found to blast badly on such transmissions as those of Droitwich and the local stations.)

**Suitable Types**

In the course of our own tests we found that the best results were usually obtained from a valve of the screened-grid or variable-mu type. This might be borne in mind by anyone who finds it necessary to

buy a valve specially for use in this position. The anode of these types will, of course, be left unconnected.

Finally, there is the question of the setting of the trimmers on the gang condensers. This is very important, for the full performance of the set will not be obtained until it has been correctly done. Probably the best procedure is to tune in a weak station with the panel-controlled trimming knobs at a mid-way setting, then adjust the internal trimmers for maximum volume.

The object should be to find such a setting for the latter that an exact tuning point can always be found on the main dials with a little final adjustment on the panel trimmers. Once found it will be observed to hold quite well over the tuning range.

In making the trimming adjustment one should note whether it is possible to find a true maximum-volume position with a definite reduction of strength on either side. If it is found that volume increases all the way to the end of the travel of the control, it is possible that the true setting is not being located.

If this happens it simply means that an unsuitable position has been chosen for the panel control. The remedy is to reset the latter to a different adjustment, retune on the dial and then try the rear trimmer again.

On the original receiver, by the way, the settings were these: Both front and rear trimmers on the right-hand condenser unit were quite near to their midway points. Those on the left-hand unit were found to require quite different treatment; the panel knob was turned fully to the left as seen from the front of the set, while the control at the back was turned almost as far as it would go to the right (as seen from the back of the receiver).

This information may be of use as a preliminary guide, and it is to be noted that it was under these conditions that the dial readings on page 233 were obtained.

**Dial Reading**

The readings in question, of course, are not likely to be repeated with any great accuracy in the case of sets built by readers, but they should be of some assistance as a general indication of the positions at which one may expect to find the principal stations.

Once a few of these have been found and their actual readings obtained, it will be possible to deduce a sort of correction factor which can be applied to the rest of the list.

This will make it easy to log the rest of the key stations and make out a proper calibration sheet.

—G. P. K.

**COMPONENTS NEEDED FOR THE "H.K." FOUR**

BASEBOARD ASSEMBLY		£ s. d.	CONDENSERS, FIXED:		s. d.	TERMINALS		s. d.
1—Peto Scott metal-coated base-board, 18 in. by 12 in., 3/8 in. thick		2 6	3—T.C.C. .0001-microfarad, edge-wise mounting, type 34		3 9	11—Belling-Lee, marked as follows: A., E., L.S., L.S., H.T.+1, H.T.+2, H.T.+3, H.T.+4, L.T.+1, L.T.+2		5 6
MISCELLANEOUS WOODWORK			3—T.C.C. .001-microfarad, edge-wise mounting, type 34		4 6			
1—piece 18 in. by 4 1/4 in., 3/8 in. thick, also metal-coated.			1—T.C.C. .002-microfarad, edge-wise mounting, type 34		1 6	SUNDRIES		
2—pieces 4 1/4 in. by 3 in., 5/8 in. or 3/4 in. thick. (These need not be metal coated, since they are merely the supports for the coil "bridge.")			1—T.C.C. .02-microfarad, type 300		1 0	4—Peto Scott mounting brackets — for supporting switches, reaction condenser, volume control.		1 4
CHOKES, HIGH-FREQUENCY			3—T.C.C. 1-microfarad, type 250 (Cartridge)		4 0	(Note. The slots in these may need enlarging to take the bushes of the switches. This is easily done with a file.)		
1—Varley Multicellular Junior (First high-frequency stage)		3 6	2—T.C.C. 5-microfarad, type 50		4 8	4—Wander plugs for grid-bias leads (two red and two black).		
1—Varley Nicore (Second high-frequency stage)		4 6	2—T.C.C. 1-microfarad, type 50		5 0	1—Terminal strip, 8 in. by 2 1/2 in.		
1—Wearite type HFPJ (Detector stage)		2 0	2—T.C.C. 2-microfarad, type 50		7 0	1—Terminal strip, 2 in. by 1 1/2 in.		
CHOKES, LOW-FREQUENCY			1—T.C.C. 4-microfarad, type 61		5 6	Wire, sleeving, flex, screws, etc.		
1—Varley pentode output, type DP9		15 0	HOLDERS, RESISTANCE			ACCESSORIES		
COILS			6—Graham-Farish horizontal type		3 0	BATTERIES		
1—Set of Wearite Nucleon coils, comprising one BP1, one BP2, and two TG types, with special extension piece and coupler for wave-change switch		2 10 0	5—Graham-Farish vertical type...		2 6	1—Full o' Power 120-volt		17 6
CONDENSERS, VARIABLE			HOLDERS, VALVE			1—Full o' Power grid-bias unit, 9-volt		1 3
2—Formo double-gang type, with slow-motion drives and dust covers		1 5 0	4—Benjamin sprung 4-pin type		6 0	1—Full o' Power 4.5-volt		1 0
1—Graham-Farish .0003-microfarad reaction		2 0	1—Benjamin 5-pin		10	1—Smith's 2-volt accumulator, type 2RGN7		10 6
1—Formo compression type, .0001-microfarad		1 6	RESISTANCES, FIXED			LOUD-SPEAKER		
1—Formo .0003-microfarad compression		1 6	4—Graham-Farish 1-megohm Ohmites		6 0	1—W.B. Senior Stentorian (Or in cabinet)		2 2 0
			1—Graham-Farish 100,000-ohm		1 6	VALVES		
			3—Graham-Farish 50,000-ohm		4 6	3—Cossor 220 VS		1 17 6
			4—Graham-Farish 5,000-ohm		6 0	(Note.—One of these is used for A.V.C. purposes, and any available type can be tried here.)		
			RESISTANCES, VARIABLE			1—Cossor 210HF		5 6
			1—Multitone potentiometer for tone control		3 6	1—Cossor 220PT		13 6
			1—Erie .25-megohm volume control		3 6			
			SWITCHES					
			2—Bulgin on-off, type S80		3 0			
			TRANSFORMER, LOW-FREQUENCY					
			1—Multitone, ratio 1 to 4		17 6			

Last month we presented an article by P. Wilson showing how the piezo-electric crystal was playing a large part in improving the characteristics of pick-ups. The same principle has been applied to a special tweeter loud-speaker which, when used in conjunction with an ordinary moving-coil reproducer, ensures really life-like reproduction

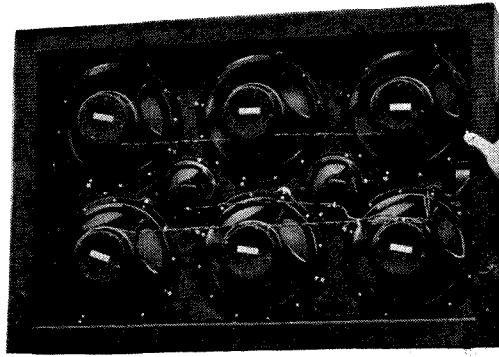

A. L. Williams, chief engineer of the Brush Development Co., with a battery of piezo-electric reproducers used for public-address work

# Improving Quality With a Tweeter

How to Get Lifelike Reproduction—by P. WILSON, M.A.

THE electrical characteristics of a piezo-electric crystal are in the main those of a capacity. I say in the main, because the impedance curve is not quite identical with that of a condenser. It corresponds more nearly to that of a condenser in series with a resistance of the order of 3,000 ohms.

This fact, however, is not sufficient to modify to any material degree the conclusions that may be arrived at by treating the impedance as capacitive in character.

At this point let us just recall to mind the impedance characteristics of inductances, capacities and resistances singly and in combination.

A resistance, of course, has a straight-line characteristic and its impedance is constant for all frequencies. The impedance of an inductance increases with frequency and is measured, in ohms, by multiplying

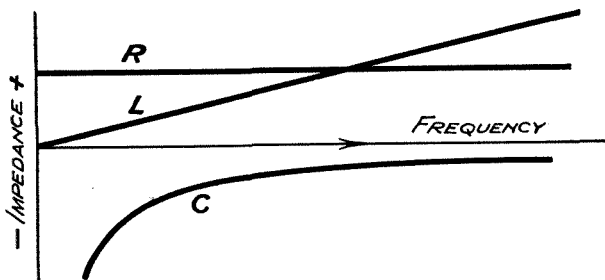

Fig. 1.—Showing the relation between impedance and frequency for a pure resistance  $R$ , an inductance  $L$ , and a capacity  $C$

together  $2\pi$  ( $= 6.28$ ), the inductance in henries, and the frequency in cycles per second.

The impedance of a capacity decreases with frequency and is measured in ohms by taking the reciprocal of the product of  $2\pi$ , the capacity in farads, and the frequency in cycles per second. Typical impedance curves are given in Fig. 1.

When these elements are used in combination the impedance relations may become rather complicated because of differences of phase.

### Three Important Combinations

For the present purpose, however, only three combinations are of importance:

- (1) An inductance and a capacity in series.
- (2) An inductance and a capacity in parallel.
- (3) A capacity and a resistance in series.

In the first case, the combined impedance is the difference of the two separate impedances. Written in formula form,

$$z = 2\pi fL - 1/2\pi fC.$$

There is obviously some particular frequency at which the combined impedance  $z$  is zero, and this frequency is given by the familiar formula for resonance  $2\pi f = 1/\sqrt{LC}$ .

In practice, the conditions assumed by this example are never fully realised because every inductance has a certain amount of resistance. The result is that at the resonance frequency the impedance does not become zero, but is equal to the resistance of the coil.

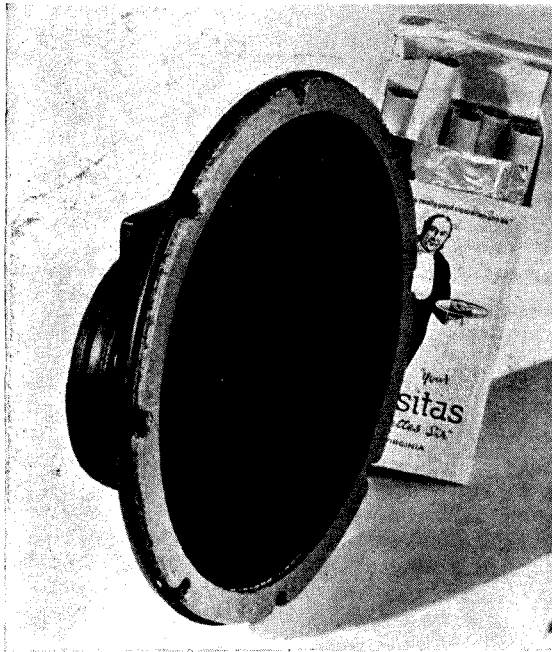

**A TWEETER FOR HIGH-NOTE REPRODUCTION**  
 The Rothermel-Brush tweeter loud-speaker operates on the piezo-electric principle. Its small size can be estimated by its comparison with a cigarette packet

This particular combination is found in a moving-coil loud-speaker. The speech coil has inductance and resistance, and the series capacity is due to the reflection of the mechanical load back into the electrical circuit. Consequently this capacity is usually known as the "motional capacity" of the loud-speaker.

The result is that the electrical impedance of a moving-coil loud-speaker has a characteristic of the type shown in Fig. 2.

Before we pass on to the other combinations just consider for a moment what this means.

Most readers nowadays will be familiar with the notion of matching the loud-speaker load to the output stage of a receiver. For any combination of valves in the output stage there is an "optimum load," expressed in ohms, for which the power handling capacity of the output stage is greatest and the energy transfer is a maximum.

If the loud-speaker impedance is different from this optimum load we use a matching transformer to put matters right.

### Impedance of a Moving-coil Loud-speaker

But what is the impedance of a moving-coil loud-speaker for this purpose? The actual impedance follows the curve shown in Fig. 2 and correct matching for all frequencies cannot therefore be secured. The compromise we take in practice is an impedance about double the minimum impedance (or D.C. resistance) of the speech coil. This is shown in the figure by the dotted line. Seeing that the minimum comes somewhere about 400 cycles the matching may go badly wrong for high frequencies.

It would not be difficult to arrange a balancing circuit to compensate for the curve in Fig. 2, but such a circuit would absorb a considerable proportion of the energy available for working the loud-speaker; and there are other reasons why it would not be really satisfactory.

What is wanted is some arrangement which will level up the impedance characteristic and at the same time will ensure a good reproduction of high notes, which are not as a rule effectively dealt with by moving-coil loud-speakers.

One method of doing this is to use a moving-coil reproducer working into a large horn. But large speaker horns are cumbersome, and very few homes would accommodate them even if the ladies were willing.

### Advantages of the Capacitative Loud-speaker

Another method is to use a capacitative loud-speaker in conjunction with a moving-coil speaker, and in this respect the piezo-electric loud-speaker has substantial advantages over other types.

Now let us look at the impedance curve of a capacity in series with a resistance. The formula for the combined impedance is

$$z = \sqrt{R^2 + 1/4\pi^2 f^2 c^2}$$

At very high frequencies the second term under the square root sign is very small, and the impedance is sensibly equal to the resistance  $R$ . At low frequencies, however, the second term may have an appreciable effect if the capacity  $c$  is small enough.

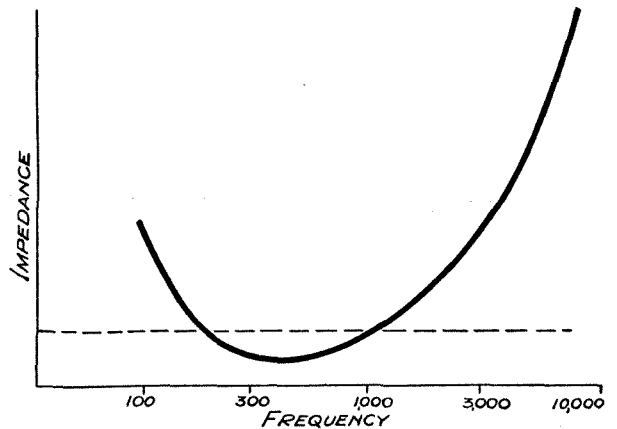

Fig. 2.—The impedance of a moving-coil loud-speaker varies considerably with frequency

As an illustration let us take the normal values for a Rochelle Salt crystal of the type used in crystal loud-speakers.

Here  $c = .001$  microfarad  
 $= 1/1,000,000,000$  farad  
 $1/c = 1,000,000,000 (10^9)$   
 $1/c^2 = 10^{18}$

when  $f = 100$ ,  $4\pi^2 f^2$  is of the order of  $4 \times 10^5$  and therefore the second term in the formula is of the order of  $\frac{1}{4} \times 10^{13}$  which is very large compared with the first term even when  $R$  is of the order of 100,000 ohms ( $10^5$ ). When  $f = 1,000$ ,  $4\pi^2 f^2$  is of the order of  $4 \times 10^7$  and the second term in the formula is of the order of  $\frac{1}{4} \times 10^{11}$  and is still more than double the first term, when  $R$  is of the order of 100,000 ohms.

When  $f = 10,000$  the second term is of the order of  $\frac{1}{4} \times 10^9$ .

From these calculations the statement I made at the beginning of this article (that although the electrical characteristics of the crystal are those of a capacity in series with a resistance, the resistance effect can for practical purposes be neglected) is easily verified.



In the result, the impedance characteristic of the combination of a resistance and capacity in series is of the nature shown in Fig. 3.

It will at once be appreciated that this combination shunted across an electrical circuit will have the effect of by-passing the high notes more than the low. And if the original circuit had an impedance increasing with frequency, the effect of the shunt will, in general, be such as to make the impedance of the whole arrangement more nearly uniform.

Two applications can be noted in illustration. A resistance in series with a condenser is (or should be) always used across the output load of a pentode valve when that load increases with frequency, as it does when a moving-coil (and still more a moving-iron) loud-speaker is used.

**Serves as a Tone Control**

Its function is to level up the load on the valve for high notes since otherwise the load might be so great as to cause damage to the valve. If suitable values are chosen for the resistance and the condenser and the resistance is made variable the arrangement also serves as a tone control, the high notes being more attenuated as the resistance is reduced. In this form, too, the combination is often used as a scratch filter with pick-ups.

The complete circuit of a condenser in series with a resistance being shunted across a moving-coil loud-speaker is shown in Fig. 4. The impedance of the

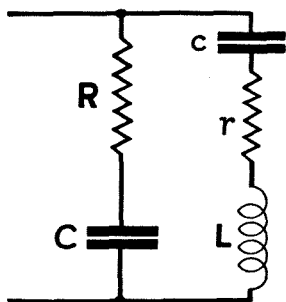

Fig. 4.—Equivalent circuit of a standard tone-control arrangement for a moving-coil loud-speaker

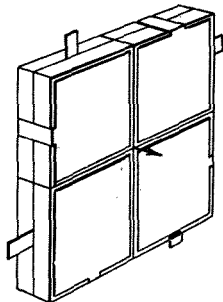

Fig. 6.—A composite piezo-electric system made up of four separate crystal units

combination is somewhat complicated. To write down the formula would take up the greater part of this column. I can only ask readers, therefore, to take my word for it that by suitable choice of the quantities it is possible to obtain a general impedance characteristic which is more nearly uniform than that of the loud-speaker alone.

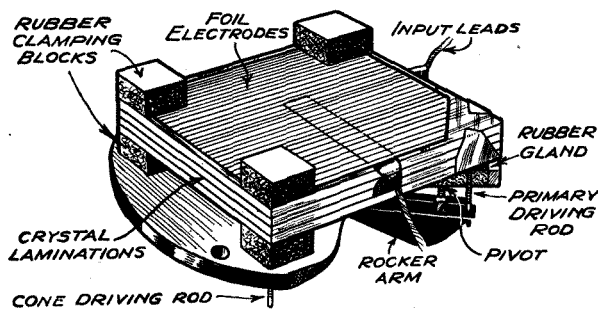

Fig. 5.—Showing the elements of the construction of a piezo-electric driving unit

I have entered so fully into these explanations of circuit theory because they lead directly to a satisfactory answer to the question: What is the best way to use a crystal loud-speaker?

First of all let us look at some of the features of such a speaker.

The driving unit is made up of a number of square crystal laminations cemented together in such a way

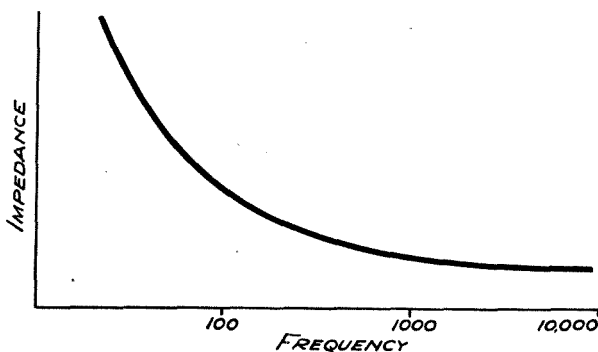

Fig. 3.—When a resistance is connected in series with a condenser, the combination shows a frequency-impedance characteristic of this type

as to avoid the hysteresis and temperature effects which I mentioned in a previous article.

When three corners of the square are clamped between rubber surfaces, so as to avoid dangers of rattle or fracture, and voltages are applied to the electrodes, the fourth corner moves at right angles to the faces of the laminae. One can accordingly attach a reed to this corner and use it to drive a cone.

This is what is done in the Rothermel-Brush "Tweeter," the connection between reed and cone being effected by means of a shaped piece of balsa wood which is very light and stiff (Fig. 5).

**Electrophone Horn Type**

In another form of tweeter (the Electrophone horn type) four such units are cemented together so as to form a single disc with the moving corners of the four units in the centre of the disc. In this form the disc acts as a self-actuating diaphragm and is used to work into a small high-frequency horn (Fig. 6).

In both these forms the possible amount of movement of the moving corner is very small even though large changes of voltage are fed to the electrodes. The unit can exert a large force but only over a small distance.

So far as high notes are concerned this is all that is required. But, in the absence of special devices, its effectiveness decreases as we come down the scale.

**Two Ways of Reproducing Low Notes**

In general, there are two ways of reproducing low notes: by large pressure and by large motion. The former method is utilised in large horn loud-speakers where the acoustic load of the horn causes the actuating diaphragm to develop large pressures with quite small movements.

An alternative system is to use a very large diaphragm in order to set a large amount of air in motion for small movements, but this system usually defeats itself because large diaphragms are massive and flexible and wave-motion is set up in the diaphragm itself.

The second method, and the one employed in moving-coil speakers, is to move a moderately sized diaphragm over relatively large distances.

Used as a direct drive the crystal unit is of no use for this purpose.

### Overcoming the Difficulty

Two devices, however, may be used to overcome this difficulty. In the first place, the drive may be transmitted to the diaphragm through a pivoted lever, the leverage ratio being so chosen that a large pressure and small motion at the crystal end is converted into a smaller pressure and large motion at the diaphragm end.

This is the device employed in the Rothermel R95 and R105 type reproducers. Used on a baffle with a

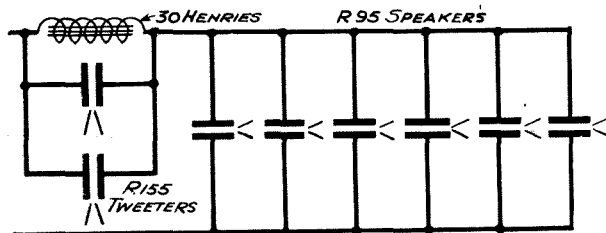

Fig. 7.—The circuit of a multiple public-address system employing various types of piezo-electric loud-speakers

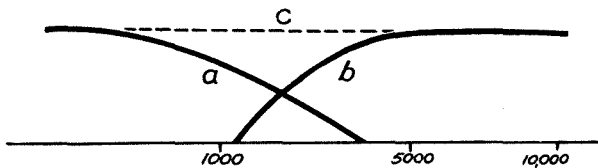

Fig. 8.—With a moving coil of characteristic A and a tweeter of characteristic B, the overlapping portions of the curve give the level response C

suitable output choke (the inductance of which, in conjunction with the capacity (.03 microfarad) of the speakers, serves to keep the load on the output stage from becoming unreasonably large or unreasonably small) these loud-speakers give quite a respectable bass output though on the whole the treble frequencies are much more in evidence than they are in moving-coil speakers.

For speech this may be an advantage, and when these speakers are used in conjunction with large horns it is a great boon. Most moving-coil speakers in such circumstances (there are a few exceptions) are very bassy. I have, however, used both these crystal speakers to drive a horn 5 ft. long and with a mouth area of 6 ft. square, and in those circumstances the balance between high and low notes is most impressive.

### Large Output from a Single PX4 Triode

The surprising thing, however, was the efficiency: the output from a single PX4 valve would be sufficient to fill quite a large hall, and without any sense of oppressiveness close up to the horn.

The second method to increase the bass response is to use a number of these speakers in parallel so as to obtain the effect of a large area of diaphragm without the disadvantage of the resonances caused by a single diaphragm of large area.

In order to preserve a good balance in these circumstances it is found desirable to use the speakers in combination with tweeters and with a choke so as to form a double-tuned circuit as shown in Fig. 7.

For use in some of the older cinemas, for example, where there is only a small space between screen and back wall this combination has very definite advantages. Its frequency response is good, its efficiency is unusually high, and a foot of space from back to front is ample.

For the ordinary man, however, it is the tweeter loud-speaker that has the greatest attraction. It is not a difficult matter to obtain good bass by means of a moving-coil speaker, so why resort to ingenious devices to make a crystal speaker perform the same function? Why not use the two in conjunction and get the benefit of a better load characteristic for the output valves?

Alternatively, why go to a lot of trouble and expense to make a moving-coil speaker reproduce the high notes (which it can only do by virtue of diaphragm resonances, anyhow) when the addition of a crystal tweeter will absolve it from that function and leave it to deal more adequately with the low and middle register notes.

### Strong Case for the Tweeter

The case for using a tweeter is even stronger than that. For if we only ask the moving-coil loud-speaker to respond up to about 4,000 cycles and to have a diminishing response even then at the top of the range, we shall find the speaker much easier to design and we shall be able to avoid many of the faults at the bass end of the scale that normally we have to put up with.

The only difficulty we are likely to have to deal with is that of the overlapping between the two speakers in the 2,000-3,000 cycle region. That has been a serious difficulty with all dual loud-speaker systems hitherto, and it has so rarely been overcome that many people, the present writer included, have regarded such systems with suspicion and mistrust.

A little consideration, however, shows that the difficulty hardly exists when one speaker is inductive and the other capacitive. All we need do is to arrange for the inductive speaker to have a response as shown in Fig. 8, curve (a), which apart from high-note resonances is the natural sort of response for a moving-coil speaker; and, in addition, to arrange for the tweeter to have a response as shown in curve (b). The two together will give a combined response shown in curve (c).

### Resonant Frequency of the Crystal

Now the frequency response of the R155 tweeter, in isolation, is of the character shown in Fig. 9. The crystal has a resonant frequency between 8,000 and 8,500 cycles. But that response is modified in practical circuits by virtue of the fact that there is inductance in the circuit.

In any case, it is a very easy matter to flatten the peak and carry on the response to 12,000 cycles by putting a high-frequency choke in series with the tweeter so that the two have an electrical resonance at, say, 10,000 cycles.

With a value of .001 microfarad for the tweeter capacity, a .25-henry choke would tune with it at a frequency given by.

$$2\pi f = \frac{1}{\sqrt{\frac{1}{4} \times 10^{-9}}}$$

$$f = \frac{10^4 \sqrt{10}}{\pi}$$

$$= 10,000 \text{ cycles nearly.}$$

All we have to make sure of, then, is that :

(1) The response of the moving-coil loud-speaker is gradually reduced at the higher frequencies.

(2) The crossing point between the two response curves is at the right place.

(3) The level of the flattened tweeter response above the crossing point is not very different from that of the moving-coil below it.

All this can be done by a circuit with but one single control. It depends on the shape of the impedance curve of a capacity in series with a resistance (this was discussed earlier in this article). When such a combination is used in parallel with a moving-coil speaker it reduces the high-note response of the speaker. We therefore have only to arrange to feed as much of the lost response to the tweeter as we desire.

The twin condenser-resistance circuit shown in Fig. 10 does this. According to the setting of the slider of the potentiometer, so more or less of the shunted high notes are fed into the tweeter or into the balancing condenser.

### Determining Appropriate Values

In determining the appropriate values we have to note that the capacity of the tweeter corresponds most nearly with that used in a tone-control across the primary of the output transformer: it is a high impedance.

We are thus led to the circuit shown in Fig. 11. The two condensers are shown in the leads from the primary to the tweeter so as to block the D.C. high-tension from the tweeter thereby avoiding possible damage to it. Simple, is it not?

The one stroke of luck about the whole arrangement is that the efficiency of the tweeter to high notes is greater than that of any ordinary moving-coil speaker to lows. Had it not been so we might have had to duplicate the tweeters.

So much for the circuit arrangement. Now for some practical considerations. Obviously, the tweeter must be placed in close proximity to the moving-coil loud-speaker. It would be queer to have one part of the scale coming from one place and the other part from another.

A distance of 6 in. or 1ft. is quite satisfactory.

The obvious thing to do, then, is to mount the tweeter on the loud-speaker baffle just above the moving-coil.

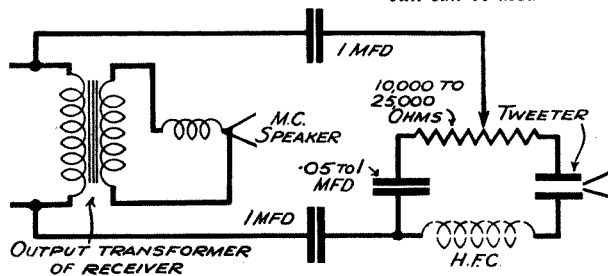

Fig. 11.—A complete output circuit for tweeter and moving-coil loud-speakers in combination

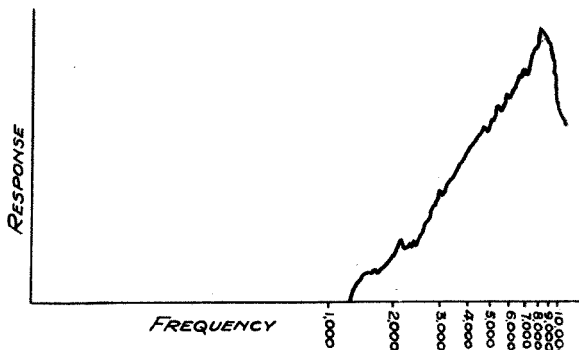

Fig. 9.—The response curve of a typical tweeter loud-speaker designed to cover the upper harmonic range

This is where you will begin to strike trouble if you are not careful. The whole tweeter chassis is quite a small affair and can easily vibrate as a whole.

Now if you feel at your baffle-board you will possibly find that it vibrates markedly on heavy notes. If this vibration is transmitted to the tweeter chassis you will probably get a rattle in the reproduction.

In my experiments I avoided this by good luck rather than by intention. My speakers are mounted in the wall between two rooms, and I had taken special care, by the plentiful use of dead material, such as Cellotex and slag wool, to avoid baffle vibration.

### Simple Method of Avoiding Rattle

There is, fortunately, a very simple method of obviating the trouble. The hole in the baffle for the tweeter should be cut about 2 in. larger in diameter than the tweeter chassis, and the latter can then be suspended in it on a flexible surround 1 in. wide. The surround can be of leather or rubber or other material insensitive to vibrations.

It is quite possible, however, that you may get a rattle even after taking this precaution. One of the prices you have to pay for having a loud-speaker combination which goes very high in the scale is that it will show up faults in your receiver, sometimes even in the transmission, which you may not have suspected before.

### Causes of Tweeter Rattle

For instance, a rattle in the tweeter may be caused by the moving-coil rubbing in its gap; by bad contacts either in the receiver, in the aerial, or particularly in the earthing system; by any of the causes of amplitude distortion in the receiver, such as valve overloading, grid-choking, and the like; by man-made static, whether in the aerial or the mains; or it may be due to faults in transmission, such as microphone blasting—and some of the B.B.C. microphones are by no means above suspicion in this respect.

If you are unlucky, then, the fitting of a tweeter may necessitate a renovation of your receiving system with the utmost care, carefully searching out faults.

A bore, maybe. But the result is decidedly worth it. No one who has heard the naturalness, the human quality, of speech; the delicacy of high strings; and the detail, definition and musical perspective generally, when high notes are adequately reproduced, without marked peaks or troughs; no one who has experienced these things will wish for one moment to go back to the standard of yesterday.

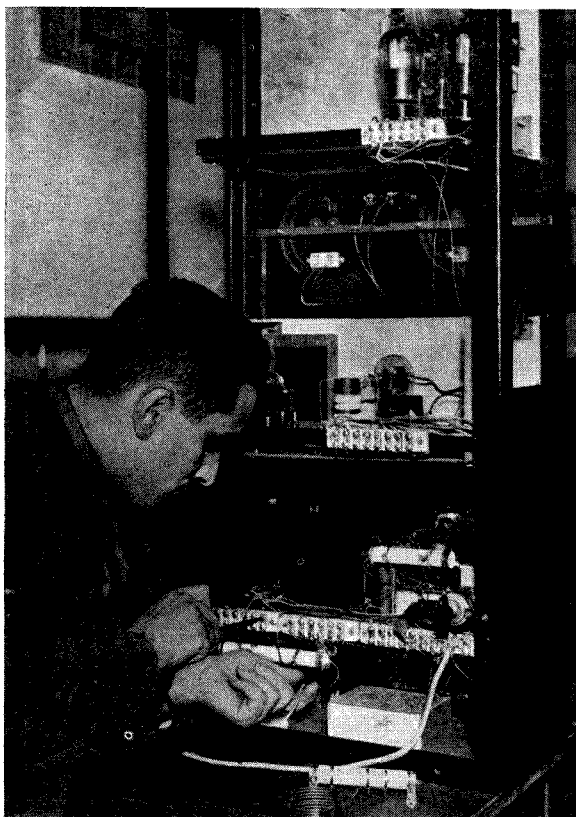

N.P. photo

Layout and appearance do not always go hand in hand where short-wave sets are concerned. Here you see an unusual—and probably very efficient—layout adopted by a German short-wave enthusiast

**L**AST month I dealt fairly exhaustively with short-wave detector circuits and stated definitely that, in my opinion, the signal-to-noise ratio obtainable with a detector alone is about as favourable as anything that one can obtain.

This view, incidentally, is backed up by several authorities on short-wave work, and the American journal *QST*, in the course of a description of one of the new single-signal super-hets, made the same statement.

### A Dilemma

We are therefore starting with a dilemma. (a) With whatever form of amplification used we shall, unfortunately, spoil the quiet background to some degree; (b) We *must* use some form of amplification!

A single-valve receiver is admirable for the man who is content to copy weak morse signals on headphones. He will probably receive anything on his solitary detector that most of us would hear on a super-het. Obviously, though, we cannot allow the detector to become the last word in short-wave design

and we have got to develop efficient forms of amplification that will not spoil the signal-noise ratio.

Let us therefore start with a survey of the high-frequency side. Fig. 1 shows the form of high-frequency amplifier in common use. As a matter of fact it does everything but amplify! We are gradually becoming accustomed to calling it a buffer stage (the Americans call it an aerial decoupler), but some short-wave enthusiasts still seem to expect it to give a noticeable gain.

Sometimes a small amount of amplification *will* be obtained—but even if it is not, the buffer stage earns its keep handsomely. It improves the handling of the detector stage out of all recognition. It is possible, as I hinted last month, to design a detector that is completely free from all vicious habits. Unfortunately, the average short-wave enthusiast doesn't seem to have found the knack yet.

Very rarely have I come across a home-constructed short-waver that has not shown up badly in some particular way. Hand-capacity, threshold-howl, dead-spots—all the familiar forms of trouble—cause the

## WHAT YOU SHOULD KNOW ABOUT SHORT-WAVE DESIGN—No. 5

# Problems of Amplification

By G. HOWARD BARRY

This is the fifth article of a series in which the problems of short-wave receiver design are being investigated and the recommended methods explained. Here G. Howard Barry discusses the relative merits of high- and low-frequency amplification in short-wave sets and shows which is the better method to use in certain circumstances

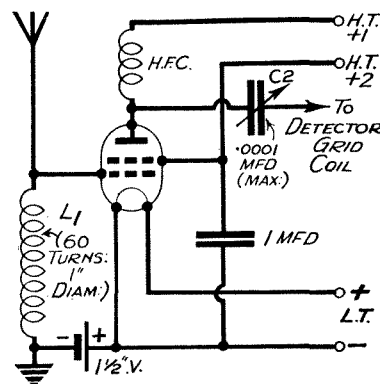

Fig. 1.—Showing the usual form of high-frequency amplifier used in short-wave receivers. It is usually called a buffer stage and makes for easy handling of the detector stage

novice a tremendous amount of worry. The buffer stage is an insurance policy against them all.

Hand-capacity effects in a short-wave detector are often caused by the *aerial*. This is not generally realised but, nevertheless, is true. If one tunes to a particular wavelength and the aerial happens to be of such a length that a current node occurs at the lead-in, then the aerial may be coupled fairly tightly to the detector without upsetting the balance of the circuit. In other words,



the aerial represents a high impedance at that particular frequency.

As we tune away from that setting, on either side, the aerial will be either too long or too short and the current node will start moving about. A certain setting will be found on one side at which severe hand-capacity effects are noted, *even on the earth terminal*. Probably if the earth connection is removed, things will become easier to handle.

**Buffer Stage Advantages**

The use of an untuned buffer stage obviates all these difficulties with the aerial. It also does away with any trouble that might arise from an aerial swinging in a gale and, moreover, it kills those devastating crackles that sometimes set in when a guy wire starts rubbing round a metal hook, or something of that sort.

I once found myself unable to hold anything weaker than an R6 signal owing to irregular crackles which started whenever a gust of wind came along. I traced the trouble eventually, not to my aerial, but to a loose connection in my neighbour's. Nothing would persuade a straightforward detector to work straight off my aerial without making noises. A buffer stage cured things at once.

**Further Aids**

So far we have written off hand-capacity effects, swinging signals and crackles. To these we may add

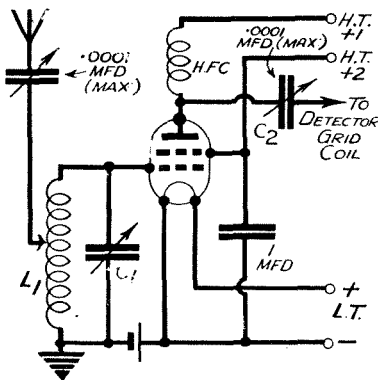

Fig. 2.—By substituting the tuned circuit for the choke L1 of Fig. 1, we turn the buffer stage into a useful high-frequency amplifying stage

aerial dead spots and, finally, several troubles with the reaction circuit.

Yes, undoubtedly the buffer stage is worth while, even if it does introduce a *little* more noise in proportion to the signals. We may turn it into a real stage of high-frequency

amplification simply by substituting a tuned circuit for the choke L1 and by arranging a suitable degree of aerial coupling.

There is nothing difficult, or even tricky, about the operation of a high-frequency stage on the short waves. If instability is present it is readily cured by the somewhat inefficient method of increasing the aerial

even better by preceding it with a high-frequency stage.

I have never been able to make up my mind on this vexed question of background noise with a stage of H.F. One is adding components to the existing set and one of them is a valve which, in the present state of the art, produces a small amount of filament-hiss. At the same time

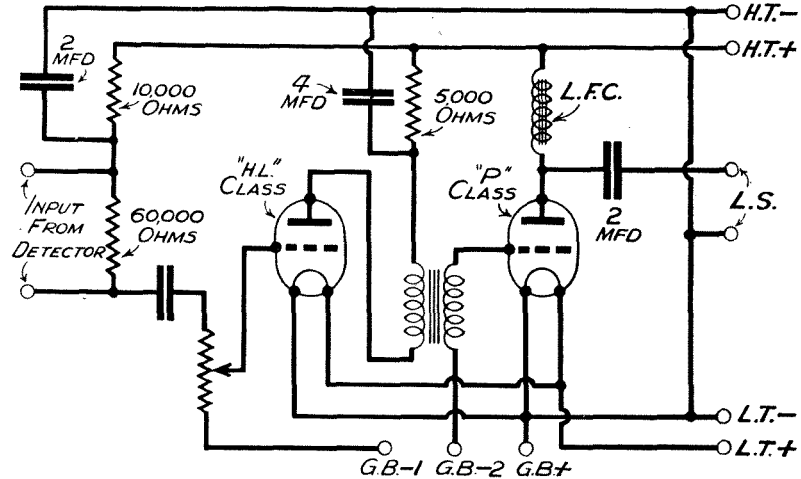

Fig. 3.—A two-valve amplifier designed by the author, who claims it to give quality comparable to that of the ordinary broadcast battery set. Such an amplifier will convert an ordinary headphone set into an efficient loud-speaker short-waver

coupling to the first valve. This may seem all wrong in theory, but, in practice, is definitely *right*.

We cannot tolerate two interlocking controls, short-wave tuning already being fairly critical. If we introduce high-frequency amplification we want the extra control to be independent of the tuning and reaction controls.

This works out admirably. With a reasonably tight degree of coupling from the aerial to our first tuned circuit, the tuning of c1, without becoming too flat, becomes independent of detector settings. Any signal may be tuned in on the detector controls whether c1 is correctly set or not. When it is finally brought into tune, the effect is more that of rotating a volume control than anything else.

This state of affairs can *always* be achieved with a little perseverance. A contributory factor to it, by the way, is the setting of the coupling condenser c2 controlling the transfer of energy from the amplifier to the detector.

The detector circuit has been left out of the picture, by the way, simply because, for the purpose of this article, it doesn't matter. If your detector *works* then you will, eventually, be able to make it work

one is improving the selectivity of the receiver and therefore narrowing the door through which extraneous noises are admitted.

For C.W. reception I think I prefer the plain detector (if it is a really good one!). For telephony the H.F. stage is *always* worth while, since it reduces the tyranny of the reaction control.

**"Something in Hand"**

One has the reassuring feeling of "something in hand"; the reaction condenser is not always set just on the very verge of oscillation. I would go so far as to say that if I were to be confined for a long period to a two-valve receiver, I would rather use a screen-grid high-frequency stage and a detector than a detector and a low-frequency stage.

Low - frequency amplification, however, is necessary when loud-speaker reproduction is desired; therefore we must deal with it. I do very strongly urge readers to make an effort to dispense with it altogether when they are using headphones or, at least, to compromise by using one resistance-coupled stage only.

If I may be dogmatic for a moment without going fully into my reasons, I should like to pass on this very

strong recommendation: *Never* follow the detector with a transformer-coupled stage unless parallel-feed is used. Last month I dealt with threshold howl and explained that it seems to be a function of the inductance included in the anode circuit of the detector.

### After the Detector

Always try to use a stage of resistance-capacity coupling after the detector; or if you only want one stage—and that has to be a fairly efficient one—use a resistance-fed transformer.

Fig. 3 shows a complete two-stage low-frequency amplifier that should be altogether admirable for converting a headphone receiver into a real loud-speaker set. It is a very convenient plan to go back to the ancient unit system and to install the amplifier as a separate piece of apparatus, possibly with plug-and-jack switching.

### "One Unit"

Once a satisfactory low-frequency amplifier has been built it requires very little adjustment; there is no point in incorporating it with the high-frequency part of the set. If that is done, the chances are that experimental work on the latter section will involve the former as well. Regard the low-frequency amplifier as if it were in one unit with the loud-speaker.

Note that the values of the grid-leak and condenser associated with the first valve are not those that one would normally employ in a broadcast receiver. Short-wave signals are not, as a general rule, comparable in strength with medium-wave broadcast transmissions, and one has to use considerably more reaction on the short waves than one would ever do on a broadcast receiver.

### Short-wave Quality

Accordingly, the general effect of reproduction is rather on the deep side. It does not seem to strike one as being deficient in the higher frequencies, but rather as having a preponderance of "boomy" bass.

The small grid condenser and low value of grid leak compensate for this, and my own amplifier, laid out on the same lines as that in Fig. 3, produces quality that is really comparable with that of a good broadcast set.

The whole question of high-quality reproduction on short-waves

has been badly neglected. Most listeners still seem to be satisfied with mere intelligibility. The standard of short-wave transmission is so very high nowadays that this seems a great pity, and I see no reason why we should not be more particular.

Very often, too, the short-wave set has its output effectively strangled by being fed into an ancient loud-speaker that has long been discarded from the broadcast receiver. Give it a good moving-coil loud-speaker and don't be satisfied with anything but first-class reproduction. The programme-value of short waves will be enormously improved if you do.

I have not mentioned the pentode. It certainly has its uses in a small set, and a three-valver using a tuned screen-grid stage, detector, and resistance-coupled pentode is admirable in many ways. Some people seem to be able to use headphones with a set of this type, but I am convinced that either their 'phones or their ears must be defective, unless they make constant use of the volume control.

Even a good two-valver using a detector and a pentode should operate a loud-speaker on all the

stronger transmissions. If one tries to use headphones for the weaker stations, one has rather a painful time crossing the tracks of the others!

The awkward part of short-wave designing is the fact that there are, and always will be, two completely different classes of listener. There is the man who only wants the stations that are strong enough to be free of interference—and he wants those with reasonable quality on a loud-speaker.

### A Matter of Taste

At the opposite pole is the enthusiast who, frankly, can't be bothered with all these well-known stations that *everybody* receives. He is interested chiefly in the weak ones, and prefers to use headphones on them. The small set (preferably without low-frequency amplification) is ideal for him.

Next month I propose to deal briefly with C.W. reception, since the amateur DX fraternity has quite a good following these days. A really efficient C.W. receiver is a more difficult proposition than a good broadcast set as certain special requirements make it necessary to modify the design in several respects.

### STOKOWSKI'S VIEW

IN view of the current agitation for fewer broadcasting stations and better quality—that is, a wider channel for each transmission—it is interesting to see Leopold Stokowski, the famous conductor, giving his views in *The Atlantic Monthly*. Mr. Stokowski, who is, of course, well known as the conductor of the Philadelphia Symphony Orchestra, is one of the few eminent musicians who studies the technical scientific bases of his art, and his views carry much weight.

He is definitely of the opinion that a much wider range of frequencies is an urgent need of modern broadcasting, and considers that 30 to 13,000 cycles should be regarded as a minimum requirement.

He says: "The first step toward making it possible to include the missing vibrations between 5,000 and 13,000 is, in my opinion, to widen the channels that were apportioned some years ago . . . The first and fundamental need is for Washington to revise its allotment of channels so that they can be broader."

### REALLY "STRAIGHT-LINE"!

WE are so accustomed to think of the audio-frequency transformer as a device with a severely limited frequency range that it may come as a surprise to many to learn of the characteristics which can be obtained when required for specialised purposes.

As an example, take the new line of Precision de Luxe transformers produced by the American Transformer Company, of Newark, N.J. This is a range containing no fewer than thirty-eight types, intended for use in broadcast transmission, recording, and laboratory work, and designed to yield a characteristic uniform to within half a decibel over a range of 30 to 16,000 cycles.

Such transformers would, of course, be of little advantage in an ordinary broadcast receiver, where the frequency range is at present kept within much narrower limits by other considerations, but it is interesting to see what *can* be done when the need arises. And, it may be added, when cost is a matter of minor importance!

The H.M.V. organisation employs a large staff of competent radio engineers for outside servicing. Here one of them is seen at work on a seven-valve super-het radiogram

This new "W.M." feature is primarily intended to assist the radio service engineer. However, so many interesting points are dealt with that every keen radio fan who makes his own "running repairs" will find something to interest him. The author, who is known to you as a practical man, will be pleased to discuss points sent to him by readers

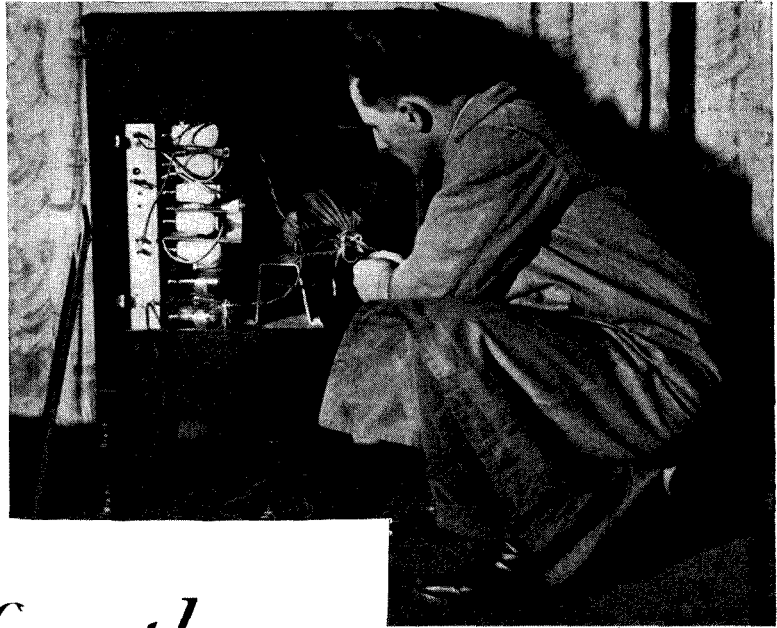

# Hints for the Service Engineer

By G. P. KENDALL, B.Sc.

## Stopping the Boom

IT does not often happen, but occasionally one finds a customer who complains that his set booms unpleasantly on the bass, and asks for something to be done about it. The procedure in such cases will naturally depend to some considerable extent on circumstances, but as a general rule it is not wise to make any attempt to modify the loud-speaker itself; one may often be perfectly certain that the boom is due to the "surround resonance" of the unit, but this is definitely a dangerous thing to meddle with.

One of the oldest methods of reducing the bass reproduction is still perhaps as good as any for use in these cases; all that one has to do is to dismount the speaker unit from the baffle surface (usually the cabinet front, of course) and then replace it with spacing washers inserted in such a way that when the screws are tightened up again there

is a small gap all round between the rim of the unit and the baffle.

A gap of perhaps  $\frac{1}{4}$  in. will usually produce a perceptible drop in the volume of the bass, but larger spaces are sometimes necessary. The method is not perhaps very commendable in theory, because it reduces the whole bass range and not merely the boom frequency, but it works well in practice.

## Measuring Grid Leaks

THE exact value of the grid leak in a modern receiver is not, as a rule, very critical, but there are occasions on which it has to be checked. To measure the resistance of a leak of one of the higher values (e.g. 2 megohms) is not nearly such a simple operation as it looks. The ordinary type of ohm-meter circuit is scarcely applicable, because unless the instrument is of very high sensitivity the test voltage requires to be raised to an undesirable figure.

This last point is an important one; many leaks will not stand high voltages, and, of course, there is no reason why they should, since in no ordinary circuit are they submitted to such treatment. (This is a point to be borne in mind by those who are tempted to try to measure leak resistances with the aid of a high-voltage megger!)

## A Difficult Problem

Lacking some such handy instrument as an Avominor or one of the other specialised testers, or a microammeter, the problem is certainly a difficult one.

It so happens, however, that it is relatively easy to rig up a valve circuit which will give quite good approximations with only a very low test voltage across the leak. The basic idea is to connect the leak into the grid circuit in such a way that it forms part of a potential-divider system, which governs the voltage applied to the grid from a bias battery.

## Varying Grid Voltage

The voltage on the grid can thus be made to vary according to the value of the resistance, the anode current being controlled proportionately.

The circuit is shown in the diagram on the next page, and it will be seen that the grid circuit of the valve contains a battery and three resistances in series, so arranged that the

voltage developed across one of them RX is applied between grid and filament of the valve. If everything else is kept constant, the anode current of the valve will depend upon the voltage across RX, which in turn is fixed by the resistance of this component.

### Calibration

It is possible, therefore, to calibrate the circuit in terms of the resistance of RX by the simple expedient of inserting a series of leaks of known resistance and noting the anode current with each. These points can then either be marked on the dial of the milliammeter in

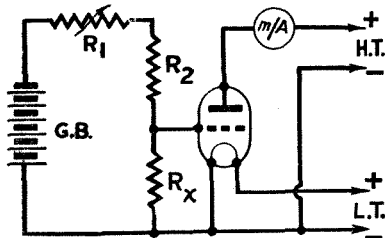

A valve circuit arrangement by means of which the values of grid leaks can be measured

the plate circuit, or set out in the form of a calibration curve.

The resistance  $R_2$  should be of 2 megohms for most purposes, while  $R_1$  can be of any value from 50,000 to 100,000 ohms, variable, of course. Clips should be provided for RX, and the first step is to insert here a 2-megohm leak believed to be of correct value, and adjust the voltage of "G.B." to bring the reading of the milliammeter comfortably on to the scale. (A valve of the high-frequency type is suitable, and for this a meter reading 0-2 milliamperes is suitable; for a valve of the low-frequency type the meter may read, say, 0-5 milliamperes.)

### High-tension Adjustment

The high-tension voltage should be adjusted with the aid of a voltmeter to some exact figure, such as 100 volts, final adjustment being made with the aid of a few volts tapped out of a spare grid-bias battery if necessary. This figure should be recorded, since it must be duplicated whenever the tester is used in the future.

A series of leaks of known accuracy can be obtained for a small extra charge from any of the leading makers, suitable values being  $\frac{1}{2}$ , 1, 2, 3, 4, and 5 megohms. These should be inserted in the RX position in

turn and the meter reading recorded. Then, when the tester is put into use at any time in the future it is only necessary to set the high-tension voltage to the standard figure and adjust  $R_1$  until a correct reading is obtained with one of the known resistances in place.

The unknown resistance may then be measured with a degree of accuracy sufficient for most servicing purposes. Variations in the voltage of the filament battery may introduce errors, but these will not be of great magnitude so long as the accumulator is neither just off charge nor nearly run down.

### Portable Testing Gear

Wisely chosen apparatus for test work is of vital importance to the man who wants the utmost in speed and accuracy in his servicing business. This is especially true of the gear which he takes out with him when paying calls, for here lightness and compactness are essential, yet it is necessary to get results of a certain standard of accuracy quickly and easily.

Cost must obviously be the deciding factor, but some technical notes on the available apparatus may be helpful.

For a start we are dealing with one of the lower-priced testers, this being the Avomitor, a combination instrument, priced at £2, reading several ranges of milliamperes, volts, and ohms.

For its low cost one does not expect laboratory precision, but on test the instrument showed a standard of accuracy considerably

above our expectations. It is actually fully adequate for all normal test purposes.

The actual ranges are as follows: Milliampères, 0-6, 0-30, and 0-120; volts, 0-6, 0-120, and 0-300; ohms, 0-10,000, 0-60,000, 0-1.2 megohms, and 0-3 megohms.

### Simple Range Selection

The various ranges are brought into use by manipulating certain plug connections on the front of the instrument. An external battery is needed for the three higher ranges of resistance measurements. (The cell contained in the instrument serves for the 0-10,000-ohm scale, and also for ordinary continuity testing.)

Provided as it is with a neat case and a set of leads and test prods, the Avomitor is excellent value for money. Naturally, it cannot be expected to do all that can be done by an instrument costing three or four times as much, but in actual practice its limitations are slight.

### Minor Limitations

These are the only ones which appear to be of any importance: First, the current for a full scale reading on the voltmeter ranges is 3 milliamperes, which figure is sufficiently large to be taken into account in certain circumstances connected with mains circuits.

Second, the external voltage required for resistance measurements on the 0-3 megohm range is 300, which, apart from its inconvenience, is somewhat high for grid-leak testing.



One of the handiest—and cheapest—of testing instruments is the Avomitor. It is a combination meter which gives measurements in ohms, volts, and milliamperes: the actual ranges are given in the article

We make no excuse for publishing an article describing the field of exploration open to those radio enthusiasts who will turn their hand to listening on wavebands other than those we now call the medium and long. J. Godchaux Abrahams here gives an introduction to a fascinating, but by no means new hobby. Short-wave listening—to use a much hackneyed expression—will bring the world to your fireside

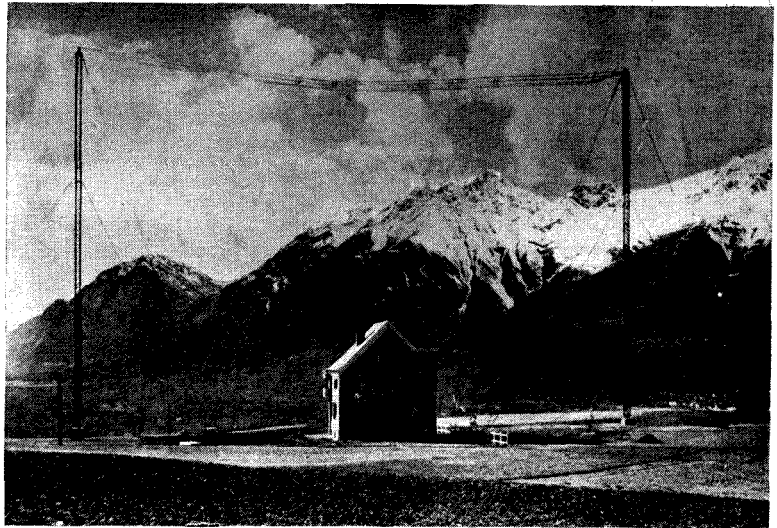

Photopress photo

Short waves will enable you to learn more of world happenings. This lone radio station is to be found in the heart of the Alps

# Make Short-wave Listening Your Hobby!

By J. GODCHAUX ABRAHAMMS

**W**HEN the question is put to me: "Why should I trouble with the short waves?" invariably I give as a reply: "There is no trouble."

It is a fallacy to believe that listening on channels below the broadcasting band is only rightly the occupation of an expert experimenter. The reasons for which the short wavebands are peculiarly attractive may be set out as follows:—

(1) They offer a new field of exploration, and in consequence, today provide the listener with thrills to which he has been unaccustomed since broadcasting became a matter-of-fact everyday occurrence.

(2) It is through these channels, barring casual and

fitful captures on the medium waveband, that we can tune in direct to transmissions made from really distant countries overseas with some guarantee of success.

(3) In many instances, the short-wave receiver enables you to pick up programmes which are not available to the listening public confined to the medium or long broadcast bands.

**A**nd finally, apart from ordinary entertainments, the search on these higher frequencies will bring to the possessor of even a modest short-wave set, a plethora of interesting transmissions emanating from all quarters of the earth.

But there are other advantages of which you will

soon realise the benefit when you have taken up this hobby. The ownership of an ordinary radio instrument may afford pleasure, but it can no longer supply the excitement experienced in the early days when broadcasting was in its infancy.

We tune in daily European transmissions emanating from cities up to, say, 1,500 miles away—I refer to Moscow—and on a favourable night or in the early morning hours, we may succeed in hearing a

*And the set to use for short-wave reception is the Standard Four-valve Short-waver described last month. No tricky operation; with just a little care in tuning you should hear signals from the other end of the earth*

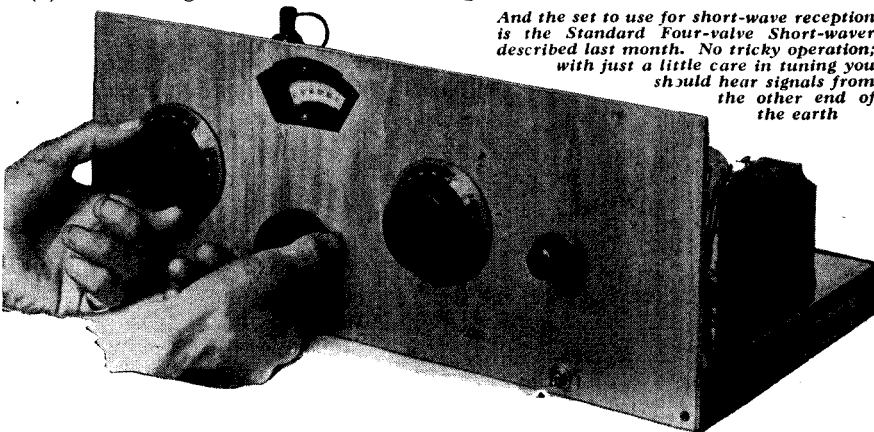



portion of a radio entertainment on the medium waves from a studio in the United States, Argentine Republic or Mexico. Unfortunately, however, it is seldom we can hold the broadcast for any length of time ; atmospherics or kindred electric disturbances render its reception difficult. There is no certainty in these captures; we cannot promise to get these stations on any particular occasion. They are just lucky dips in the ether!

On the other hand, such transmissions on the higher frequencies or wavelengths below 50 metres are much more reliable and we may expect to pull them in at an audible strength—if not at loud-speaker volume—with more assurance. Moreover, taking all in all, they are less liable to interference and, in many instances, to fading than the broadcasts on the 200-500-metre band.

The mention of short waves, with few exceptions, has aroused in the minds of people I have met a vista of difficulties: an expensive outlay on new components and skilful construction if the set is to be made at home, or the parting with a big fat cheque if a factory-constructed model is to be bought outright. In addition, I have been told that when the set is completed or the purchased one delivered and installed, it would spell tricky handling and laborious tuning before any results are obtained. As John Henry used to say: "It's all wrong," and if amongst your friends and acquaintances you count a short-wave fan, he will have no difficulty in demonstrating this fact.

Further proof of this statement was given to you by Howard Barry in the last issue with the special four-valve receiver he has designed for the short waves. It is of a simple yet efficient construction; there are no snags and the set is capable of giving not only to the tyro, but also to the more advanced worker, all the results required to fire his enthusiasm for the wavelets; that is, of course, providing the right times are chosen for searching the various metre-bands. Even the knob-twiddling beginner should log a fair number of catches in his first attempt.

Possibly I am wrong in using the words knob-twiddling, as it is the worst method to adopt. It may, within reason, work out all right when dealing with the

broadcast band, but except for a lucky strike it is seldom that transmissions on short waves will be found in this manner. Tuning must be carried out by a more systematic method.

If you are ever given an opportunity of seeing an official list of frequencies, you will soon realise the vast number of transmitters (telegraphy and telephony) which are now operating daily on the short waves. You will readily understand, from a mere glimpse of the list, how easy it must be, when searching, to miss a host of transmissions.

If your set is tuned to a section of the band comprising channels of from, say, 30 to 40 metres, almost every degree of the condenser dial can bring in a carrier wave. Tuning must be carried out very slowly, and the band-spread device incorporated in the circuit of the short-waver will prove of invaluable assistance inasmuch as it facilitates the separation of transmissions.

It is more than likely that at the outset you will not manage to log some little broadcaster in Venezuela, Cuba or equally distant part, but this need not discourage you. Europe alone offers you ample opportunities for trying out your hand at delicate tuning; the Continent possesses a number of high-power short-wave stations, the logging of which is an easy matter. A series of captures of this nature will afford much help, inasmuch as if against their advertised wavelength or frequency you note the dial readings, you will obtain a series of signposts which will assist in determining the approximate dial degrees of any transmitter of which you know the channel. In this way the search is limited to a strictly restricted portion of the condenser dial, and in most instances avoids loss of both time and temper.

At the start, therefore, try for such well-known transmitters as Zeesen, Rome, Moscow, Skamlebaek, Madrid, Lisbon, League of Nations (Prangins), which will supply useful jumping-off places for more distant and possibly more difficult loggings. In the course of these searches you will doubtless find other broadcasts, and if I may give any advice, do not fail to jot down immediately the condenser readings and all data you can collect from what you hear.

You may not, at the start, prove capable of tracing the transmission to its source, but the details gathered will allow you to return to that channel at a later moment and on the second visit probably the broadcaster will be identified.

The ether teems with signals of every description and in the course of one sitting you will pick up innumerable calls and conversations emanating from amateur broadcasting and commercial stations. This, combined with the fact that if conditions are passable the world is your playground, soon arouses the enthusiasm of the listener.

In radio it is the unexpected which pleases most, and in the case of short waves there is unlimited scope for such transmissions.

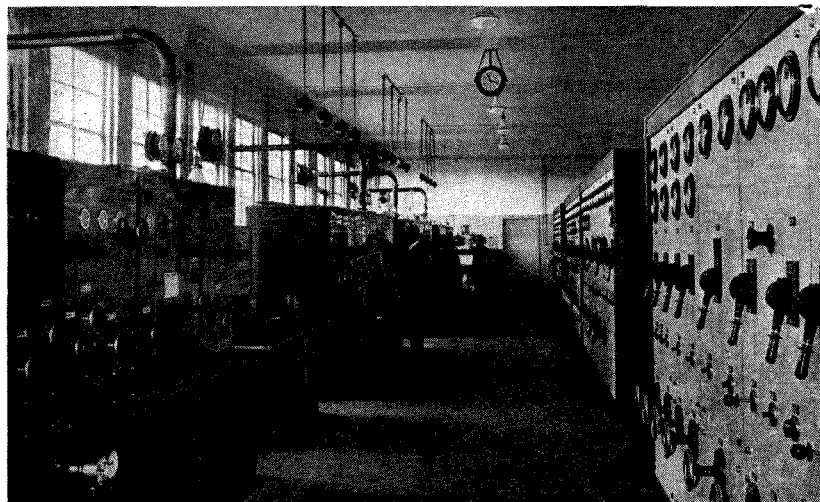

Germany has a powerful short-wave station at Zeesen which broadcasts on various wavelengths so that its signals can be heard with equal clarity in all parts of the world. Zeesen is heard very well in this country on a single-valve short-waver. Here you see one of the huge transmitters at the station

There is little doubt that good connections play a tremendous part in the satisfactory operation of a modern radio receiver. R. W. Hallows, an accepted expert on the subject, is a firm believer in soldering whenever possible. In his article this month Mr. Hallows gives some useful tips for those who prefer the easy method of terminal connections



Coscor photo

Years ago the constructor spent hours cutting and shaping pieces of metal into variable condenser vanes. Nowadays the modern hydraulic press stamps out condenser vanes at the rate of many dozens a minute

# Mr. Everyman's Wireless Jobs

By R. W. HALLOWS, M.A.

IN last month's notes I had something to say about the value of soldering connections in the home-constructed set. I had in mind the use, whenever possible, of stripped components, which are now obtainable from a good many makers. These have no terminals: either differently coloured leads are brought out from the "innards" of the component or soldering tags are provided.

With such components the business of making connections by soldering is perfectly straightforward; but a good many readers have asked me what is to be done about components of the more familiar pattern having terminals and nothing else for their connections.

## Soldering and Terminals

Let me say at once that I do not recommend the soldering of wires direct to terminals. It *can* be done,

but it is a process which demands considerable skill, and there is always the risk of doing extensive damage.

Take the kind of terminal illustrated in considerably enlarged form in Fig. 1. It consists of a screw passed through an insulating bush in the metal body of the component. The manufacturer, you will see, has soldered his internal leads to a tag beneath the head of the screw which forms the shank of the terminal. And that is the wise and proper course to adopt.

If you try to solder a lead straight on to the tip of such a terminal you will, unless you are particularly quick and neat wielder of the soldering iron, heat up the shank of the terminal to a quite undesirable temperature. By so doing you may injure the insulating bush, and you are not unlikely to loosen the screw in its seating.

And there is another type of terminal still more difficult to deal

with by direct soldering. This is illustrated in Fig. 2. It is the terminal sometimes used in low-frequency transformers and other components with a moulded casing. Usually it passes through a clearance hole in the casing, being retained in position only by the clamping nut.

The head of the screw forming the shank may be embedded in a pitch sealing. Any attempt to solder directly almost invariably results in a loosening of the terminal and the only certain way to tighten it up again is to scoop out the pitch sealing (in the course of which performance you are more than likely to break the fine internal leads) so as to be able to get at the nick in the head with a screwdriver.

## The Use of Tags

Makers, as I have indicated, almost always use tags for their connections to terminals. The lead is soldered to the tag and the tag is clamped by screwing the terminal tight.

By far the best way of making a connection to a screw-down terminal when building a wireless set is that illustrated in Fig. 3. The original knurled headed nut is discarded, an ordinary hexagon nut being used in its place. This is turned down really tight with a box spanner, so as to clamp the

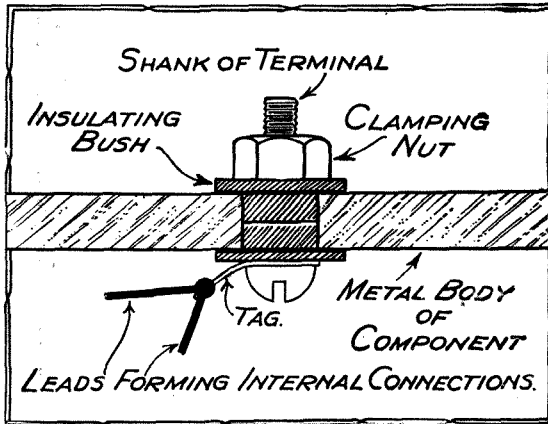

**WHERE TO SOLDER TO TERMINALS**

Fig. 1.—It is unwise to solder leads directly to the tip of a terminal. The reasons why are explained here

tag in position, and to the tip of the tag the wire is soldered.

**An Objection . . .**

The reader may say: "How is that better than making a loop in the wire and clamping this loop between the two nuts? You told us last month that a joint of that kind was not reliable because it was apt to shake or work loose. You mentioned that the wire loses its elasticity through fatigue so that the pressure between it and the nuts above and below become relaxed.

"Don't tags also lose their elasticity? And are not such joints therefore equally unreliable? Further, the joint that you are now recommending is a double one. You are suggesting a screw-down connection for the tag and a soldered connection between it and the wire. Surely this makes such a joint much more liable to give way?"

**. . . And the Answer**

It is a perfectly reasonable objection, but there is a perfectly good answer to it. Tags are made of very soft metal with little elasticity. When you turn down the top nut upon a tag you actually squash it a little. The nut beds down into it and there is no tendency for the joint to work loose.

Further, wires are round, and the actual contact surface between them and the clamping nuts is small. A tag has a broad flat surface and therefore makes an excellent contact.

Then there is the point about the joint being a double one. I have already shown that the tag makes good contact with the terminal, and there is very little resistance about a

well-soldered joint. Nor is such a joint at all liable to give way. If it is really well made it will last indefinitely—certainly as long as the set of which it forms part.

**Well-made Joints**

The whole secret about soldering to tags lies in remembering and putting into operation one or two very simple rules. The first is that both the end of the wire and the tag must

browned the iron is at the right temperature for good work.

**How to Set to Work**

The old motto that cleanliness is next to godliness applies with particular force to soldering. You will never make neat joints if the surface of the work or the point of the bit are dirty. Most of the tags provided nowadays are ready tinned, and all the preparation required with them is brightening by just a touch with a piece of fine emery cloth or a scrape with the blade of an old knife.

The same applies to tinned copper wire. But if the wire is not tinned, brighten it first of all, then apply a minute quantity of flux and tin the end by touching it with the soldering iron. All of these things take far longer to describe than they do to perform.

Now lay the end of your wire on the tip of the tag, take a little solder

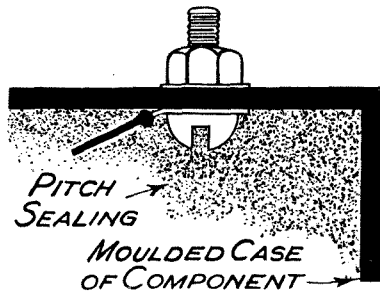

Fig. 2.—This type of terminal makes direct soldering almost impossible

be clean; the second that the iron must be clean; the third that the iron must be hot.

Nine-tenths of the rickety, clumsy soldered joints that some constructors make owe their unsatisfactory nature to the fact that their soldering irons are insufficiently hot. One of the readiest tests of a good solderer is speed—he will unite a wire to a tag in the twinkling of an eye—and you can't do quick work with a cool iron.

How can one tell when the temperature of the iron is just right? Obviously it mustn't be over-hot or the tinning on its point will be burnt off. Heat your iron always in a clean flame such as a gas ring, a bunsen burner, or a spirit lamp. Watch it whilst it is warming up.

When you see the flame taking on a vivid bluish or greenish tint the temperature is probably just about right. Have a folded newspaper beside you and lay the bit for an instant upon it. If the surface of the paper is immediately

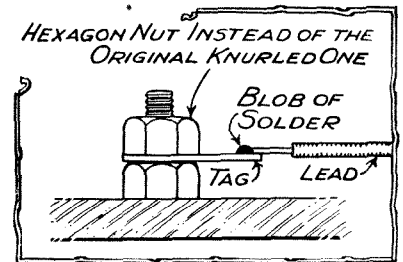

**CONNECTIONS TO SCREW-DOWN TERMINALS**

Fig. 3.—Here is explained the best method of connecting wire to a screw-down terminal

on to the bit and apply it to the point of junction. It will run on without the slightest trouble and before you can say "knife" a first-rate joint results.

One last hint about soldering. Even in the cleanest of flames a small but undesirable amount of solid matter is deposited on the tinned point of the bit. I always keep beside me a piece of rag and every now and then the bit is wiped with this. With an electric soldering

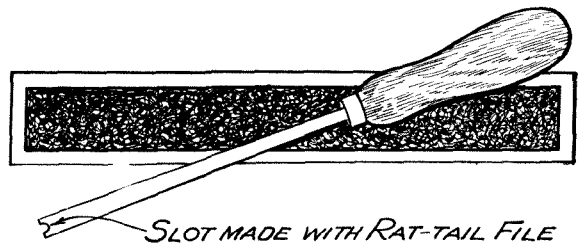

Fig. 4.—A screwdriver with a slot made with a rat-tail file is ideal for terminals of the slotted variety

iron the point keeps much cleaner, but even so an occasional wiping is an advantage.

### Tightening Down

In a previous paragraph I mentioned the scrapping of knurled headed nuts and the substitution of the hexagon type. This is, of course, unnecessary when makers are kind enough to supply their components with hexagon-shaped terminal tops. Many of these are slotted, the idea being that a screwdriver may be used for the final tightening down.

Unfortunately it is found in many cases that the terminal shank protrudes so far that an ordinary screwdriver is prevented by it from biting in the nick provided. One can hardly blame the maker, for he has to cater for all eventualities. To some terminals two, three or more leads have to be connected, and were he to shorten the shank there would not be room for these.

One firm has for some little time used a particularly deep hexagon nut which leaves the slot free even if the shank is fairly long; others, however, have not been so kind to the home constructor.

Fig. 4 shows how a cheap screwdriver—the kind that you can buy at Woolworth's for sixpence—is easily adapted for the purpose of tightening down slotted nuts when the shank protrudes a little. All that you have to do on the face of it is to take a small rat-tailed file and with it make a notch of suitable depth in the blade. But like many other apparently simple workshop jobs, this is not quite so easy (for the

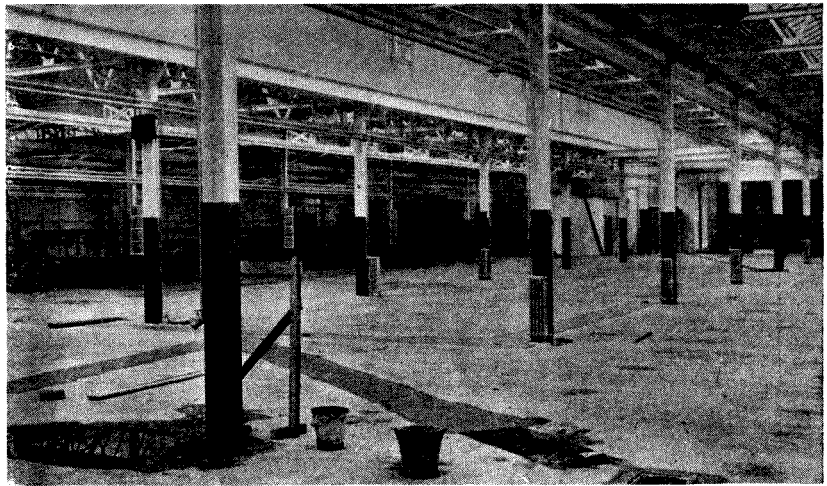

### READY FOR THOUSANDS OF RADIO WORKERS

This is one of the huge buildings erected by Ferranti, Ltd., at Moston, Lancs., for the manufacture of radio components. The new works will give welcome employment to thousands of people in the district

beginner, at any rate) as it looks.

If he just picks up the rat-tail and sets to work without further ado the odds are that the slot produced will not be in the middle of the blade. To make quite sure that it is begun by making a pilot cut with the hacksaw. You will then have no difficulty in cutting the notch just where it should be.

### Box Spanners

Whatever else the tool kit con-

comes to dealing with nuts.

If you try to make a nut reasonably tight with pliers it is almost certain that there will be a minor happening with two major results. The minor happening is that the pliers will slip at the critical moment; the first of the major results is that your finger will be more or less badly nipped. The second is that the "flats" of the nut will be damaged.

With the box spanner these things just don't happen. A good type is illustrated in Fig. 5. The business end of its tubular body is drawn down into hexagon form and the other end is flattened out for a grip

### "Nest" of Spanners

There are awkward spots in which it is impossible to apply the box spanner. In such cases the flat spanner must be used, and it is very handy to have in the tool kit a nest such as that illustrated in Fig. 6. At many good tool shops nests of four from 0BA to 6BA can be purchased for a few pence, though sometimes it may be found that only Whitworth sizes are available.

A Whitworth nest can usually be adapted quite easily by a handyman to take BA nuts. The only tools required for the operation are a small flat file and one of either square or triangular section. The jaws of each little spanner are first of all opened out with the flat file until they are a good fit for the opposite flats of the nuts that they are required to tackle.

This done, the square or triangular file comes into action for shaping the recess behind the jaws.

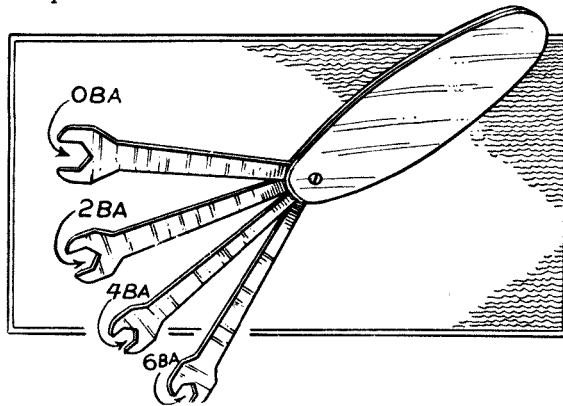

A NEST OF FLAT SPANNERS

Fig. 6—Useful for getting into awkward places is the flat spanner. They can be purchased in 'nests' for a shilling or eighteenpence

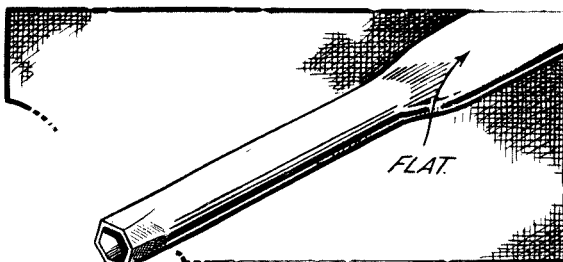

A USEFUL TOOL FOR WIRELESS JOBS

Fig. 5.—One of the most useful tools for wireless jobs is the box spanner. It is impossible for a well-fitting box spanner to slip

tains it should certainly have box spanners for 2BA, 4BA and 6BA nuts. They are not expensive: a set can, in fact, be bought from any reasonably good toolshop for a shilling or less. And they are genuinely useful whenever it

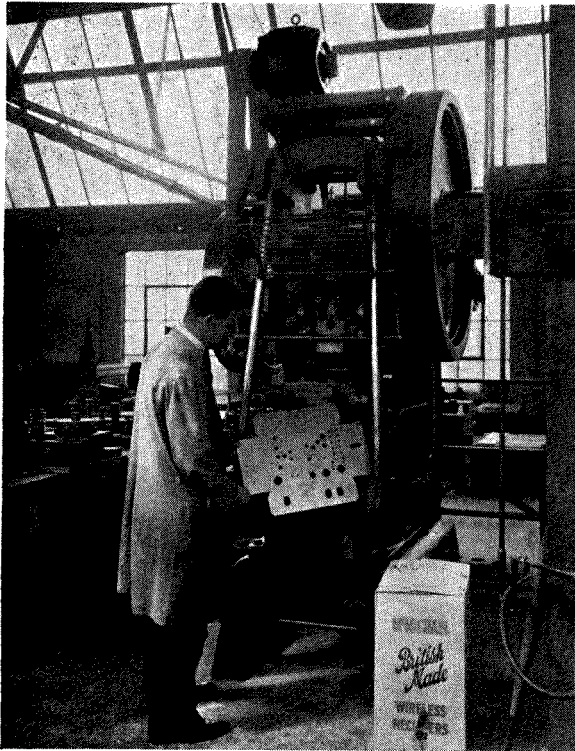

Most commercial sets nowadays are built up on a metal chassis. Here you see the 120-ton press used at Slough for stamping out chassis for McMichael sets

# Tuning and Selectivity

By PERCY W. HARRIS,  
M.I.R.E.

IMAGINE yourself standing on the floor of any one of the great produce exchanges with forty or fifty people all talking loudly at once, and some of them shouting at the top of their voices to make themselves heard. At first the sound is nothing but a meaningless jumble, but then you hear your name called. Immediately you concentrate on the characteristics of a particular voice and are able, though perhaps with considerable difficulty, to distinguish the remarks addressed to you.

This concentration upon one particular voice to the exclusion of others requires a considerable mental effort, but you can manage to do it after a little practice.

## Principles of Selectivity

You are, in effect, applying the principles of selectivity to the conversation, although you may not know just how you are doing it. Obviously some special principle of selectivity must be used in wireless, for there are hundreds of stations of differing powers all working at the same time, yet with a modern good-quality receiver you can pick out

*In the past it has been assumed, quite erroneously, that the radio public is divided into two classes—those who build their own sets and are interested in technicalities, and those who buy their sets ready-made and have no interest in how they work. "Wireless Magazine" believes that hundreds of thousands of listeners who do not care to build their own sets are anxious to learn the principles of wireless without delving too deeply into technical matters. This series of articles—the first appeared last month—is designed to remedy the omission and to provide suitable instruction. This month's article deals with the principles of tuning.*

the station you want to the exclusion of all others.

At least, you can do this in the majority of cases, although there are instances where interference between two stations is so great that your set will not separate them. This month we want to discover just what is this remarkable principle of selectivity.

Let us come back once more to the floor of the exchange where pandemonium reigns. Someone calls your name, and you mentally concentrate upon his voice and separate it out from all the others by its slight but perceptible differences of tone and, possibly, of strength.

You will realise, if you think for a moment, that if *all* the voices were of exactly the same strength and *all*

exactly the same tone, you would not be able to follow what was being said to you by the person addressing you. It is the *differences* in his voice (both in tone and strength) from that of the others surrounding him which enable you to follow what is being said.

Now consider the wireless situation. Dozens of wireless stations are simultaneously pouring out their streams of waves, and all of these waves are falling upon your aerial. How strong will be any given particular station depends on two main factors—the *power* of the station sending out the speech and music, and its *distance*. As we saw last month, only a portion of the wave-front—a very small one at that—strikes your aerial, so that how much



you get out of a given wave will depend on the *proportion* of the part you abstract, to the *total* wave surface.

Remember, as I explained last month, that the waves of a transmitting aerial spread out in every direction like giant half bubbles, so that if you are very close to a transmitting station the wave-front will not have grown to a very big hemisphere by the time it reaches you, and the slice you take out of it will contain quite a lot of energy.

**Imaginary !**

Imagine you are only ten miles away from the transmitter and that by some magic we could stop the wave for a moment just at the time when it reaches your aerial. If we take a map and a pair of compasses, placing the points of the compass in the spot marking the transmitting station and the pencil on the spot marking your aerial, then the circle we can draw around the station will be ten miles in radius and therefore about thirty-one or thirty-two miles in circumference. This is drawing everything in one plane.

**A Better Picture**

In order to get a better picture we could take a ball of glass of the same diameter as the pencil circle, cut it into two hemispheres like a couple of glass basins and place one of them edge down on the pencil circle. The energy of the wave is now distributed all over the area corresponding to that of the glass hemisphere. Keep this half globe idea clearly in your mind, it will

help you much more than the conventional diagrams in understanding the action of the wireless waves.

We have to consider a stationary wave for the moment, although this is somewhat in the nature of an anomaly. Actually the wave or half globe is growing with tremendous rapidity, getting bigger and bigger as it spreads. If you imagine that your aerial when cut by the passing hemisphere abstracts energy from it for a distance of ten or fifteen feet all round the wire you will realise that this abstraction of energy has brought about some kind of "wound" in the wave-front.

Actually it closes up again after passing your aerial, the energy to fill the gap being abstracted from the rest of the wave surface. The important point to remember at the moment is that this gash in the wave-front at ten miles is a much bigger proportion of the total energy than the same size gash at twenty miles. This is why, other things being equal, the energy in the wave-front falls off as the *square* of the distance from the transmitting station.

So far we have considered only one isolated wave, but you will remember from our last article that each transmitting aerial is sending off a continuous stream of waves. The closer the waves are to one another the shorter the *wavelength*. From a given transmitting station the spacing of the waves is constant.

They all travel tremendously fast at the constant speed of 186,400 miles per second, and they all follow one another very closely in time,

but the time interval or frequency is made different for every station so as to enable us by special devices to differentiate between the varying transmissions. We shall see how this is done a little later.

**Spacing and Wavelength**

Now, as all the waves travel at constant speed we can show there is a definite relationship between the *wavelength*, or spacing between individual waves, and the *frequency*

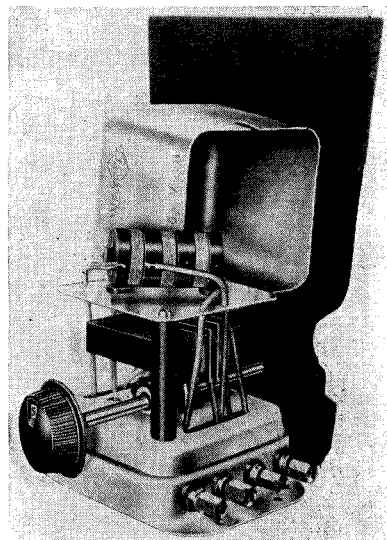

A typical example of the modern compact tuning coil. You will see that there is one coil above a metal plate, and another below. One is for medium and the other for long wavelengths

with which these waves are emitted from the aerial. If, for example, there is a 1,000-ft. spacing between two successive waves from one station and only 500-ft. between successive waves of another, then the station which is emitting the 500-ft. wavelength must obviously be sending off these waves twice as frequently as the station which is emitting the 1,000-ft. waves.

**Wavelengths—Frequency**

You will thus see that as frequency goes up so wavelengths go down and *vice versa*. To give you an idea of some real figures: if a transmitting serial emits 1,000,000 waves a second the spacing between them will be 300 metres or roughly 1,000 ft.

We don't seem to be getting much nearer to an understanding of tuning, you say? Well, we are not so very far off because by now you are in a position to understand one of the main peculiarities of a wireless transmitter.

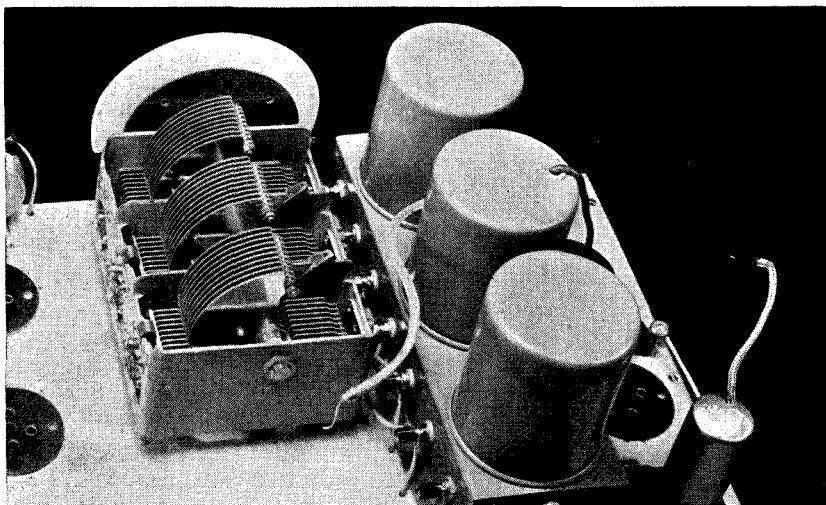

The heart of every set is the tuning coils and the variable condensers. A tuned circuit is said to consist of one coil and one condenser, but modern sets, to get selectivity, make use of considerably more than one tuned circuit

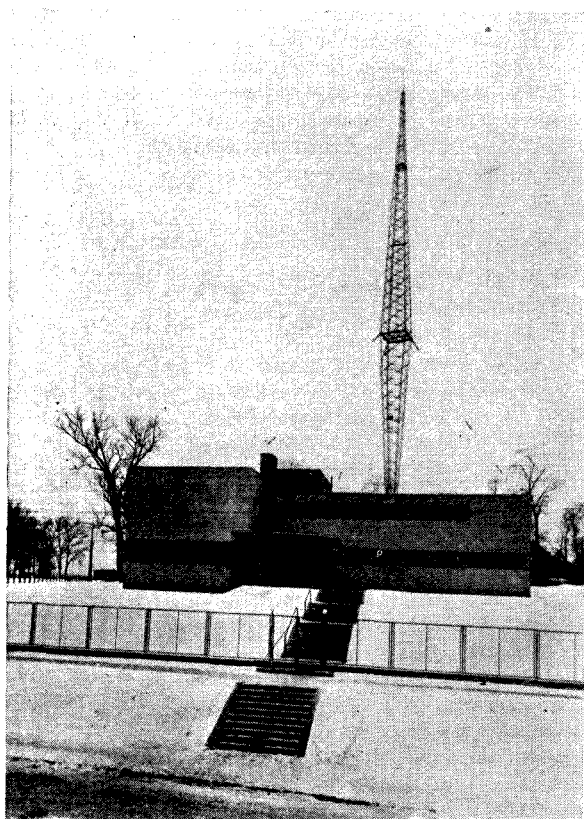

*Gulliland photo*  
 Torun, a new Polish station, the reception of which is difficult even for selective sets, works on a wavelength of 304 metres. The aerial is of the latest anti-fading type

Now, although it has never been so expressed before, we can truthfully say that a wireless transmitter in sending out its continuous stream of waves, the average strength of which is varying up and down in accordance with our speech and music, is really radiating a kind of high-pitched note so very high in frequency as to be utterly beyond the reach of any human ear.

#### Limitations of the Ear

Actually very few human beings can hear a note higher in pitch or frequency than 8,000 or 9,000, and if we hear nothing above 5,000 or 6,000 from a gramophone record it sounds remarkably good, for even the best modern electric gramophones do not reproduce much above this—even if frequencies of this order were in the average gramophone record, which they rarely are!

The lowest frequency used for a broadcast wave is about 150,000 per second, while in modern ultra-short-wave work such as is used for television, the frequency may rise as high as 40,000,000 per second. I particularly want to emphasise at the moment that a main radiation

from a broadcast station so far as what we call the "carrier wave" is concerned is well beyond the range of human audibility.

As all wireless stations work on different frequencies (practically all, that is, because although some pairs of stations work on the same frequency they are widely separated from one another geographically so as to cause little interference) what we want to devise is some kind of receiving apparatus which will respond as closely as possible only to one frequency at a time, ignoring the others. Fortunately the old-established principle of resonance comes in here and for this electrical resonance we have many

analogies in the mechanical resonances found in any household.

Have you noticed, for example, that when a piano is being played there is sometimes an ornament in the room which vibrates strongly or "dithers" whenever a particular note on the piano is struck? This is because the particular note on the piano operates a hammer which strikes a particular wire, and this wire in vibrating sends out a continuous stream of air waves or pressure waves which radiate all over the room.

The first wave-front reaching the vibrating ornament compresses it slightly and it immediately swings back, then just as it has swung back the second wave-front arrives and compresses it once more, and it so happens that the vibration period of the ornament exactly corresponds with the frequency at which the waves of sound arrive.

For this reason each wave adds to the effect of the previous one and very soon the whole thing is mechanically vibrating at sufficient strength until the ornament itself radiates waves, and this gives that "dithering" effect which is so irritating.

Why is it that all the other ornaments in the room do not dither in the same way? Simply because there happens to be no other ornament with a natural vibration period or note that when struck exactly corresponds to any note in the piano.

#### An Old Analogy

I hate to use old and worn-out analogies which have been done to death in wireless literature, but I cannot in this circumstance refrain from referring to the good old analogy of the child's swing: unless we time our pushes correctly we shall not get any build-up effect in the swing, but merely an unpleasant collision which will bring the swing to rest.

It was found quite early on in wireless experiments that an electrically resonating circuit can be made in which, once the electric charge has been disturbed, it swings backwards and forwards at a regular rate until it finally comes to rest.

#### Wireless Tuning Circuit

A tuning circuit in wireless is made up of two parts, a coil of wire and a device known as a condenser. The coil of wire is a path for the flow of electric current and the longer the coil the longer it will take current to traverse it. The condenser is a kind of reservoir which becomes charged up by the flow of current; when the flow is completed and the current stops it will discharge itself again, sending the current back in the opposite direction.

Fortunately for us the cycle of operations does not cease here, for the current always tends to overrun itself and charge the condenser, so to speak, the opposite way round, whereupon once more it discharges. Each time the charge in the condenser lessens until finally it dies down.

#### Pendulum Example

There are several mechanical analogies for this. For example, in the case of a pendulum we hold the bob back on one side and then let it go, it swings to the bottom but overruns itself, swings up on the other side, returns once more and so on, oscillating backwards and forwards until it finally comes to rest.

Again, if we suspend a weight on the bottom of a coiled spring and pull the weight down, the spring resists this, and as soon as the weight

is released pulls it up. The momentum of the weight overshoots the mark, compresses the spring, whereupon it falls down again, elongates the spring, returns back to the normal point and so on until finally it dies down.

Just as in the case of the pendulum, the longer the pendulum the slower the backward and forward movement so in the case of a wireless coil and condenser the longer the coil also the slower the movement.

### Impacts of Energy

Remember that we are receiving on our aerial or pick-up device a series of impacts of energy from the passing wave, these impacts being accurately timed to follow one another at exactly the same intervals. If now we cause these electrical impacts

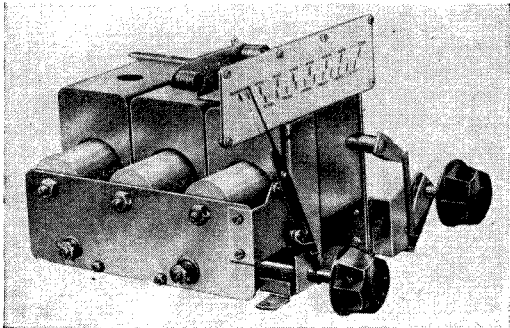

The usual method of tuning is by means of a coil and a variable condenser. In certain cases, however, the desired variation of wavelength can be obtained by varying the inductance of the coil. The illustration shows such a variable coil unit, actually a Varley permeability tuner

to affect our coil of wire and condenser, each little impact will send a charge into the condenser which will discharge again and overrun the mark. If now the second wave arriving comes at just the right moment, each successive charge will add to the effect of the previous one and so we can build up quite a large oscillating current, as we call it, in our coil and condenser circuit.

### Selectivity

This building-up effect, however, will come only from correctly timed waves; any others not correctly timed (there are dozens of this kind falling on our aerial) will be more or less rejected and so our simple little circuit will give some measure of *selectivity* in picking up only the waves we want.

The time taken to charge a condenser depends upon the area of the plate, and the bigger the area of the intermeshed plates in the condenser the longer it will take to charge. If you look at a wireless tuning con-

denser you will find it consists of two sets of intermeshed plates, one on a moving spindle which is so arranged that the amount of intermeshing can be regulated from practically nothing to a full intermesh.

Only the intermeshed parts of the plates of a condenser are of any use in tuning, and so you can see that we can vary the time taken to charge a condenser by varying the intermesh.

Coils in wireless sets are usually fixed for a given wave range, and so the *tuning* or resonance time of the particular circuit is controlled by the intermeshing of the plates. On what is known as the medium band of wavelengths running from 200 to 550 metres or so we can progressively vary the condenser so that the whole circuit resonates to any frequencies between 1,500,000 and about 550,000.

We can't go beyond this with one coil and condenser; so when we want to go on to the longer waveband we use the same condenser but with a much bigger coil which is brought in by means of a switch. This gives us a new range of frequencies in the long waveband. Similarly for very short waves we have

coils with far fewer turns.

Once we have adjusted our receiving circuit to resonate only to one particular frequency or wavelength, variations of strength of this wavelength brought about by the modulations of speech and music will, of course, occur in this circuit, but if it tunes sharply enough other frequencies or wavelengths, no matter what their modulations or speech and music variations, will not come in.

I have said, "If it tunes sharply enough." But to what extent it

tune depends on several things. If you are very close indeed to a transmitting station there is enough energy in only one wavefront to set up quite a strong current in your aerial and tuning set even when it is off tune, but if you are listening to distant and weak stations no one wave of any of them will be sufficient to influence your receiver; it requires the cumulative effect of a lot.

### Sharper Tuning

We can sharpen up our tuning a good deal by using more than one tuned circuit. For example, if we have not differentiated enough between the stations we want to receive and the stations we do not want to receive in one tuned circuit, we can pass the current on to a further tuned circuit and do more selection still.

### The Super-het

A modern highly selective wireless set such as a super-heterodyne uses quite a number of tuned circuits to get its sharpness, and in this way is able to separate out a desired weak station from a very strong station separated by only a slight frequency difference (or small wavelength change).

The need for high selectivity increases as we increase the sensitivity or range of our receiver. If our receiver is only sensitive enough to receive one or two local



Even busy women make frequent use of modern radio sets. Here you see Zelma O'Neil, the B.I.P. film actress, with her Marconiphone Jubilee console receiver

stations, the signals of which are strong, then obviously there can be no interference from weak distant ones. If, however, we have a very sensitive set which should pick up very weak distant signals then our need for differentiation between what we want and what we do not want increases correspondingly.

### Another Problem

Similarly, if there were only a few stations widely separated in wavelength or frequency from one another (as was the case in the early days of broadcasting) there would not be much need for selectivity because there would be nothing much to select! Another problem of interference comes in when a station increases its power. In the past it may not have been strong enough to cause any interference at a given place, but then an increase of power may come along and cause interference where previously there was none.

### Geographical Importance

The actual geographical position of the listener is an important one. A set may be quite selective enough for use in, say, Cornwall, where there is no powerful station near by, and if it is sufficiently sensitive it may bring in a whole range of programmes with no interference from one another.

The same set, however, placed in North London, Manchester or

Glasgow, might be so close to the local transmitter that this would "swamp" all wavelengths over quite a considerable area.

The broadcasting authorities in various countries working in conjunction with one another have decided that so far as Europe is concerned a separation of 9,000 cycles between station frequencies is a good working arrangement. This enables a modern selective set to separate one station from another. Almost any fairly good modern set will separate stations 9 kilocycles apart provided they are of about equal strength, but it requires a *very highly selective set* to enable one to listen to a weak station only 9 kilocycles from a powerful local one.

Sometimes you will notice I have been speaking about wavelengths in metres, sometimes about frequency, sometimes about cycles, and sometimes about kilocycles. Just to make these points quite clear I should say that you can either refer to a station adjustment by its wavelength, or distance between the successive waves sent out; or by its frequency, which means the number of waves emitted per second.

Again, 1,000 cycles or complete vibrations are referred to as a kilocycle. To give you some idea of the relation between wavelengths and kilocycles, I may say that 1,000 kilocycles or one million cycles per second, corresponds to

a wavelength of 300 metres, and 500 kilocycles corresponds with 600 metres.

In very short-wave work where the frequencies become very high we are becoming accustomed to the term "megacycle," meaning a million cycles. For example, in the ultra-short wavelength of 10 metres the actual frequency is 30,000,000 cycles per second, and this can be expressed as 30,000 kilocycles or 30 megacycles.

### Resonance Adjustor

Summarising, then, we have seen this month that tuning a wireless receiver is really a resonance adjustment, and this resonance adjustment or selectivity is dependent upon the fact that different wireless transmissions send out waves of different frequencies or different wavelengths.

We have also seen that selectivity is dependent on the strength of the signal, one's own location, the number of stations we are able to receive on our set, and many other factors.

### Next Month

We have also seen that the more tuned circuits we have the higher our selectivity will be. Next month we will discuss how we magnify these tiny currents received by the aerial and how we thereby increase the range and sensitivity of our receivers.



*All the stations in the ether must keep to their allotted wavelengths, or there would be absolute chaos and no amount of tuning would stop mutual interference. Here is a checking station at Berlin where an eye is kept on the wavelengths of all European stations using the medium (200-550 metres) waveband*

*N.P. photo*

**BELGIUM**

MANY plans have been put forward for the reorganisation of Belgian broadcasting, but lack of funds apparently has prevented their fruition. Following a recent decision, it is expected that instead of building a third transmitter the State will satisfy listeners by doubling the existing power of the two Brussels stations. The work will be carried out during the summer.

**BULGARIA**

A sum of some forty million levas (roughly £95,000) has been voted by



*Culliland photo*

*Berlin Reichssender keeps a flying squad of radio engineers whose job it is to keep outside broadcasts up to scratch. Here the squad is seen with Intendant Beumelburg, their chief (with white armband) at a Regatta*

# Radio News From Abroad

By JAY COOTE

*Belgium Doubling Power :: High-power Station for Bulgaria :: French Call Signs :: Powerful Manchukuo Station :: Swiss Improvements*

the Government to defray the expense of erecting a high-power broadcasting station at Ikhtiman, some thirty-five miles south-east of Sofia. In addition, 2-kilowatt transmitters are to be erected at Varna and Stara Zagora. Local programmes will be broadcast from the provincial stations, but for the supply of news bulletins, official communiques, or portions of the capital transmissions, the relays will be effected by wireless link, land-lines not being suitable.

**EGYPT**

Notwithstanding the fact that the Cairo station shares a wavelength with Brussels, it is frequently possible to listen to the Egyptian broadcasts on 483.9 metres (620 kilocycles) in the early morning and occasionally during the afternoon hours. At G.M.T. 06.45 the station opens with a course of physical exercises, followed by a short reading.

The announcer calls frequently in English, French, and Arabic. Local time is two hours in advance of G.M.T. and the station closes down about G.M.T. 21.30 or 22.00.

**FRANCE**

When listening to French stations listeners will do well to bear in mind that all studios do not give the name of the city from which the programme emanates. Radio Paris now calls "*Poste National*," but does not always make it clear that it is the high-power long-wave station which is broadcasting.

Vitus (Paris) has altered its name to "*Poste de l'Île de France*"; Lille styles itself "*Radio P.T.T. du Nord*," and the Rennes station has been renamed "*Radio Bretagne*." The policy of indicating the district is likely to become official for all the State-owned regional transmitters.

Following a series of moves, the Radio Agen station, in an endeavour to seek a channel which would cause no interference to other French transmitters, has now been ordered to move by the French Ministry of Posts and Telegraphs to 345.6 metres (668 kilocycles). As this position is in the immediate neighbourhood of London Regional it is to be hoped that no trouble will result through Agen "*wobbling*."

**MANCHUKUO**

The most powerful station in the Far East is MTCY, the new 100-kilowatt which has recently been opened at Kuangchengtzu, near Manchukuo's capital city, Hsinking. It operates daily on 535.7 metres (560 kilocycles), between G.M.T. 22.00 and 14.30. Although most of the programme is in the Chinese and Japanese languages, an English news bulletin is given out daily at 13.40.

**POLAND**

With the opening of the new 16-kilowatt Torun (Thorn) station it has been found impossible to synchronise its broadcasts with Cracow on the same channel, namely, 304.3 metres (986 kilocycles). Although the wavelength was not allotted to them, the Polish authorities have, as a temporary measure, now placed Cracow on 293.5 metres (1,022 kilocycles), a channel hitherto occupied by EAJ15, Barcelona.

**SWITZERLAND**

The vast improvement in the reception of the Beromuenster transmissions has induced the Swiss Broadcasting Association to turn its attention to boosting signals from Sottens. According to a report from Geneva, the station will be closed throughout next August with a view to doubling its power.

Later in the year the Sottens broadcaster may develop into a 100-kilowatt.



# Heinrich

Radio has always been a science of rapid mental laws of the propagation and properties discovered within a period of only some four or Heinrich Hertz. These special photographs most famous and

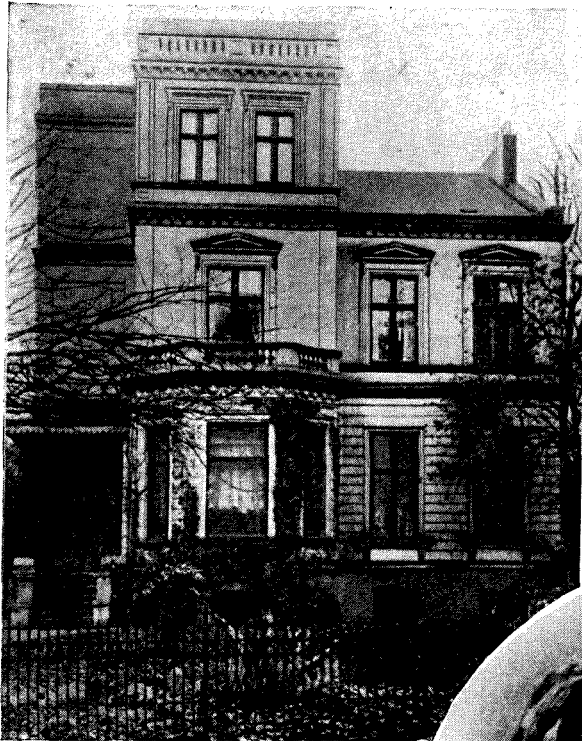

Hertz' birthplace: his parents' house in Hamburg

always spoke of "Hertzian-wave" telegraphy, and felt that in so doing we were but giving bare acknowledgment to a man to whom we owe our knowledge of the fundamental principles which make radio possible.

On these pages we are reproducing some photographs bearing upon the life and achievements of Hertz, some of them actually contemporary, and some, we believe, hitherto unpublished. In conjunction with them some biographical notes may be of interest.



A portrait of Hertz taken in 1877

IN these days of radio as an exact science, with research work done in laboratories equipped with all kinds of precision measuring apparatus, it is sometimes salutary to reflect upon the work done by the great pioneers—men who achieved their epoch-making discoveries under very different conditions.

Of them all, perhaps Heinrich Hertz was the greatest explorer of the unknown. So basic were his discoveries that for many years we

Born in 1857 in Hamburg, Hertz early showed a bent for physics, and in his student days he worked under the great Helmholtz in Berlin. The influence of that inspiring teacher and discoverer confirmed him in his early inclination towards the natural sciences and, indeed, decided the course of his life's studies.

In 1883 he went to Kiel, and began the study of Clerk Maxwell's theory of the electro-magnetic

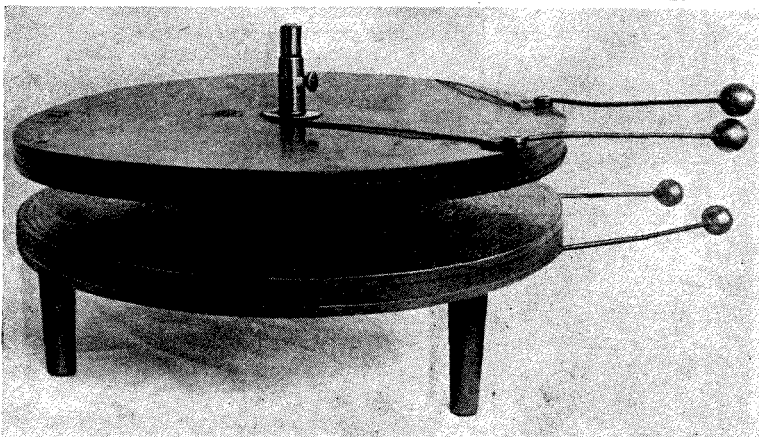

Much of Hertz' work on the properties of high-frequency currents concerned their inductive actions, for which investigations he used such simple pieces of apparatus as the device illustrated here

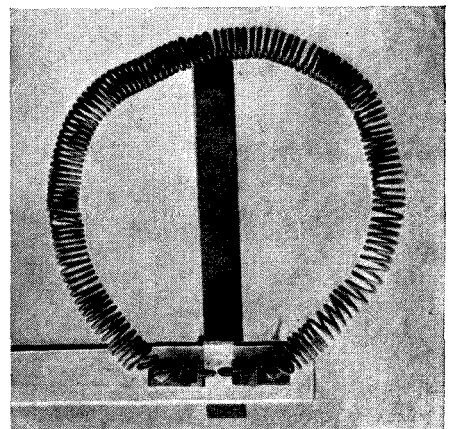

A simple type of "resonator" employed by Hertz for detecting electro-magnetic radiations

# Hertz

progress and it is characteristic that the foundation of electro-magnetic waves should have been five years by that great investigator, show, among other things, some of Hertz's early apparatus

nature of light which led to his great discoveries in the realm of etheric radiation. Those discoveries were mostly made between the years 1885 and 1889 when Hertz was a Professor.

It seems that Helmholtz had early realised the calibre of his brilliant pupil, for quite soon after Hertz had begun his researches Helmholtz drew his attention to the fact that a prize was being offered by

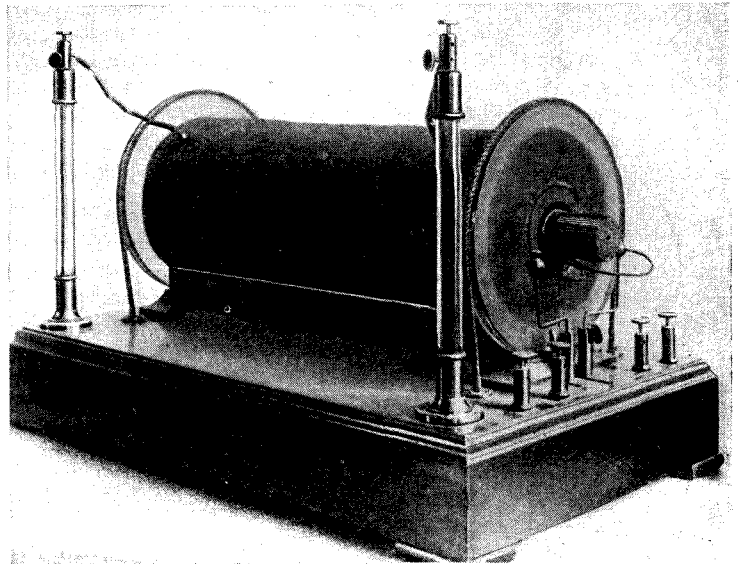

The original induction coil employed by Hertz as a source of high voltages for much of his work

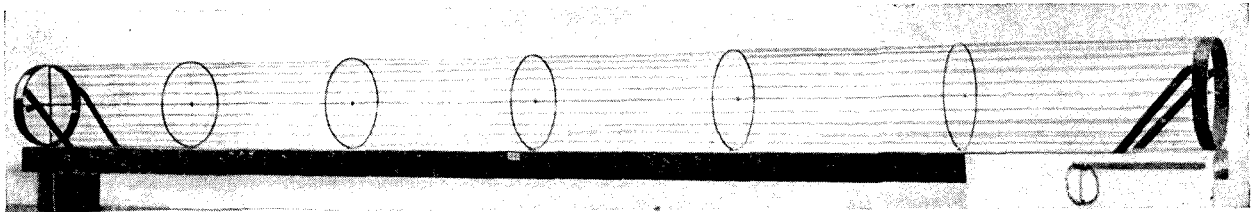

This system of spaced wires was used in Hertz's experiments on the "skin effect" which characterises the flow of high-frequency currents



A reproduction from a contemporary photograph of Hertz in his schooldays, December 1865. An interesting contrast with usual portraits showing him as a bearded professor!

the Berlin Academy of Science for an experimental demonstration of the relation between electro-magnetic actions and the polarisation of a dielectric.

At that time Hertz's investigations had not progressed sufficiently far to enable him to see how the required experiment could be arranged, but soon there came his fundamental discoveries of such things as the radiation of electro-magnetic disturbances in space.

Once having established the general nature of these radiations he proceeded to measure their wavelengths and frequencies, and thereby discovered some of the fundamental relations which we now accept as the alphabet of the science.

Some of his most vitally important discoveries came when he proceeded to investigate the properties of the electro-magnetic radiations. Experiments showed him that they were capable of being reflected and refracted, and these facts, and others which he deduced theoretically regarding the mode of vibration of etheric disturbances, indicated a similarity with the corresponding characteristics of heat and light waves.

To complete our biographical notes; in 1889 Hertz was appointed Professor of Physics at the University of Bonn, and there continued his researches, making study of electrical discharges in rarified gases.

Great as were the achievements of Hertz, he was still a young man when he died in 1894 at Bonn.

# Standard Valve-holder Connections

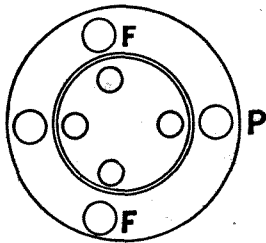

3-PIN RECTIFIER (HALF WAVE)  
(4-PIN HOLDER)  
(DIRECTLY HEATED)

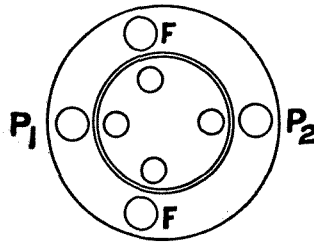

4-PIN RECTIFIER  
(FULL WAVE)  
(DIRECTLY HEATED)

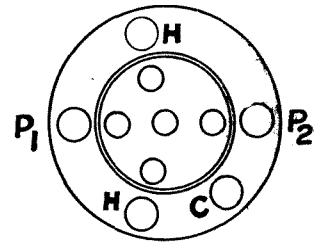

5-PIN RECTIFIER  
(FULL WAVE)  
(INDIRECTLY HEATED)

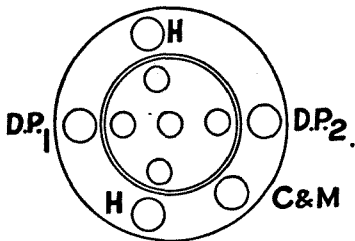

5-PIN DOUBLE-DIODE  
(INDIRECTLY HEATED)

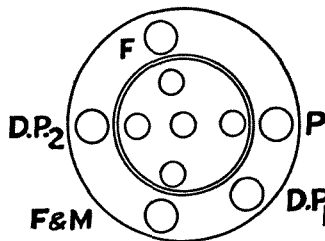

5-PIN DOUBLE-DIODE-TRIODE  
(DIRECTLY HEATED)

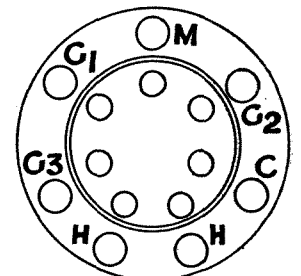

7-PIN H.F. PENTODE  
(INDIRECTLY HEATED)

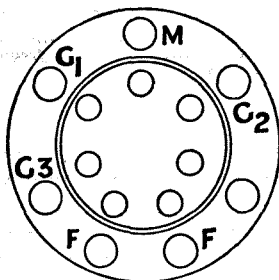

7-PIN H.F. PENTODE  
(DIRECTLY HEATED)

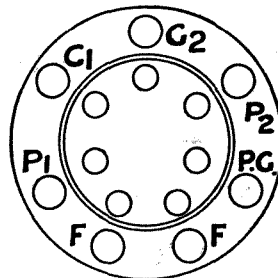

7-PIN DOUBLE PENTODE  
(Q.P.P.) (DIRECTLY HEATED)

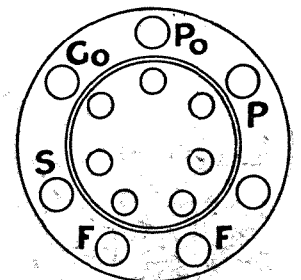

7-PIN HEPTODE  
(DIRECTLY HEATED)

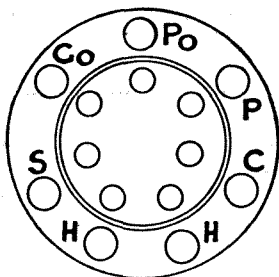

7-PIN HEPTODE  
(INDIRECTLY HEATED)

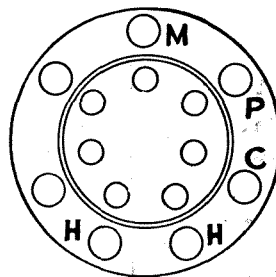

7-PIN 'UNIVERSAL' TRIODE  
(INDIRECTLY HEATED)

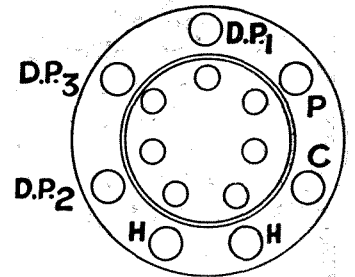

7-PIN TRIPLE-DIODE  
-TRIODE  
(INDIRECTLY HEATED)

There are now so many kinds of multi-pin valves that few constructors can memorise the connections of all the types with which they have to deal. We are, therefore, preparing a series of handy reference diagrams showing the connections of the more important types; the second selection appearing above. It is important to note that these diagrams show the connections of the valve holder, that is, the actual wiring. The following abbreviations are employed: G for grid, F for filament, P for plate, S for screening grid, H for heater, C for cathode, P.G. for priming grid, D.P. for diode plate, and M for metallising

**Q**UESTIONS of accessibility of certain components in commercial radio sets come up for discussion this month. We have tried out several different makes of radio receiver during the past six or seven months and in a certain number of them we have experienced slight difficulties. When we applied the recognised remedy we came up against this question of accessibility of components.

For example; after one set had been in operation for a few days the dial light went out—presumably burnt out. With all good intention we thought we would replace this bulb. But we found that we had to remove the chassis to get at the seat of the trouble. The result was that the set was

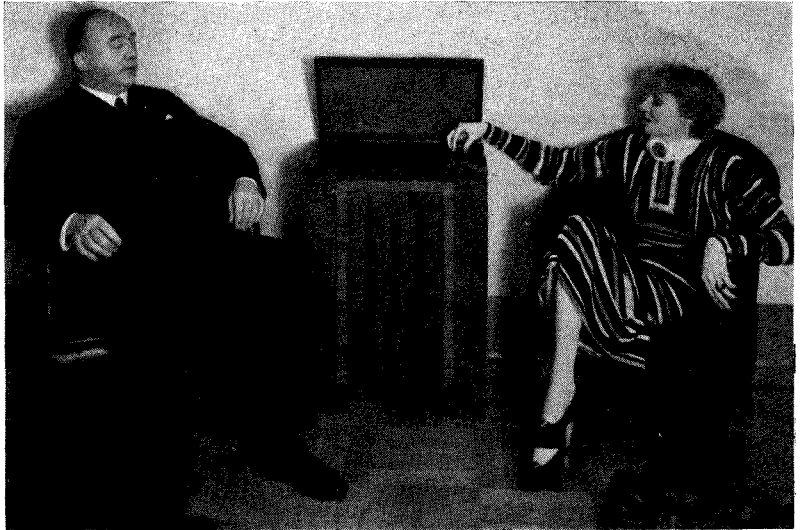

*Pye photo*

*Lawrence Wright, the well-known music publisher, listens-in on a new Pye radiogram. His companion is Miss Marion Harris, a famous variety artist*

# Our Tests of the New Sets

By the "W.M."

SET SELECTION BUREAU

returned to the manufacturer with the burnt-out bulb still in its holder behind the tuning scale.

The moral of this from our point of view is that the ordinary set user would have to call in his local dealer to put the matter right, with the result that a bill of three shillings or even more would have to be footed by the set user.

**A**nd is a dial light worth three shillings? Whether it is or not, the dark-coloured scales of today make it a necessity. Surely it is up to the set maker to guard against such unnecessary replacement costs.

Another question of accessibility arises with the position of the mains transformer inside the set, though this is not so serious. With one set, a floor model which we tested recently, the writer had to lie on the floor, with a candle inside the set, to get to the mains-voltage adjustment panel.

There is surely no need for this, although the voltage panel has to be

adjusted once only. We hope that the set maker who finds candle grease on the inside of a set we have returned will think of the trouble he has caused us!

**I**t is quite a while since we mentioned the advantages offered to readers by the "W.M." Set Selection Bureau. No doubt many are "pukka" technical people and need little help from us, but there are hundreds and hundreds of listeners who go into a shop, ask for a wireless set to get London and the best foreigners and leave it to the dealer to pick out a set

which he thinks might suit his prospective client.

For many years the members of this Bureau have studied local conditions and the needs of the average listener. The Bureau is in the fortunate position that every worthwhile set is tested in its laboratories and it can advise with authority and experience.

**W**e can judge, for instance, by sensitivity tests whether a certain set would be suitable for use, say, in Cornwall; we can advise a Northumberland reader who is prepared to spend £50 on the best method of disposing of his cash; we can advise readers in Wales of the most sensitive sets for their mountainous localities, and so on.

We do ask readers to pass this information on to their friends. Tell them that the "Wireless Magazine" Set Selection Bureau can and will help them to get the best out of radio listening. The only expense incurred is a stamped-addressed envelope, but we must

## FREE ADVICE TO PROSPECTIVE SET BUYERS

To make the most of this free advice service, we ask you to answer the following questions:—

(1) The maximum price you wish to pay, and whether you are prepared to exceed this if there is no suitable set at your desired price.

(2) The locality in which the set will be installed.

(3) The stations required, that is, locals only or a selection of foreigners.

(4) Whether you want an entirely self-contained set or one with external aerial and earth.

(5) Whether battery or mains driven. if the latter, whether A.C. or D.C.

A stamped-addressed envelope for our reply is your only expense. Address your inquiry to Set Selection Bureau, "Wireless Magazine," 8-11 Southampton Street, Strand, W.C.2. Tell your friends about this useful service, exclusive to "W.M."

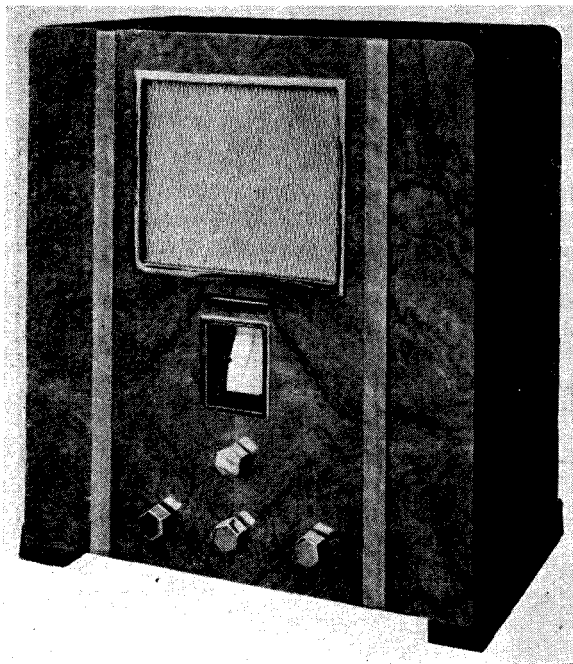

Above is the new Kolster Brandes model 935, a six-valve A.C. super-het having a tuning indicator above the tuning escutcheon. (Right) The Ekco AD36, a three-valve A.C./D.C. receiver in a circular bakelite cabinet

ask readers to answer fully the questions in the panel on the previous page.

Through lack of space we were obliged to hold over from our last issue details of several new and interesting sets that have freshly made their appearance in shop windows. We are not placing them in any particular order of merit, but here are a few of the most outstanding new 1935 models.

First of all, there is the new Ekco three-valve A.C./D.C. set, model AD36, which has made its bow in the familiar Ekco circular bakelite cabinet. Perhaps the most interesting point about this set is its price. At £8 8s. it brings mains-operated radio within the reach of everyone.

The circuit is a straightforward screen-grid, detector and pentode output with a fourth valve as mains rectifier. This mains output pentode, by the way, gives an undistorted output of 2.5 watts. To the uninitiated this way of expressing volume may seem vague. But when one remembers that the common or garden battery set usually gives less than half a watt, the power obtained from this Ekco set is really something to talk about.

Another equally important point is that the AD36 can be used on either A.C. or D.C. mains without any alteration whatsoever being made to the receiver. A point to be remembered now that so many supplies are being changed from D.C. to A.C. with the extension of the country-wide grid system.

Cossor's too, have just released a three-valve set with

a similar circuit for A.C. and D.C. mains at eight and a half guineas. This firm prefers the standard horizontal wooden cabinet finished in walnut—the type with the set controls at one end and the loud-speaker fret at the other.

Radio Instruments, Ltd., have just released a straight three-valver priced at £8 15s., but this set, known as the Micrisonic, is for A.C.-mains operation only. After the great craze for super-hets, it is quite interesting to watch set makers "sneakingly" introducing the old straight three-valver again.

A test report on an A.C. three-valver appeared last month and from it you will have noticed that in spite of all the talk about a congested ether we were able to report interference-free reception of the locals and fair reception of the best and most powerful foreigners. No doubt careful handling is necessary, but this handling is a knack that can be accomplished by the ordinary listener who has had little set-handling experience.

We are going to make special tests of these new three-valvers and it will be interesting to see how they stand up to modern-day conditions.

Returning to the R.I. Micrisonic. The set has a variable- $\mu$  high-frequency pentode as a high-frequency amplifier, another high-frequency pentode arranged as an anode-bend detector, and this is resistance-capacity coupled to a 3-watt output pentode. At first sight it appears to be a remarkably ambitious combination.

Another receiver that we hope will be shortly reported upon in these columns is the K.B. 935—a six-valve (including rectifier) super-het with a preliminary high-frequency stage before the first detector.

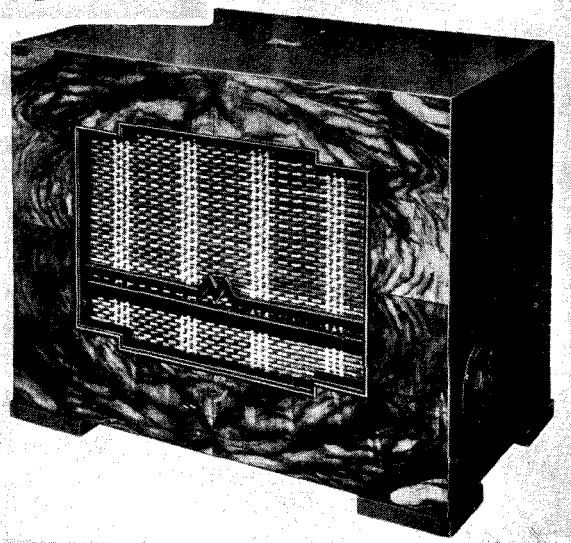
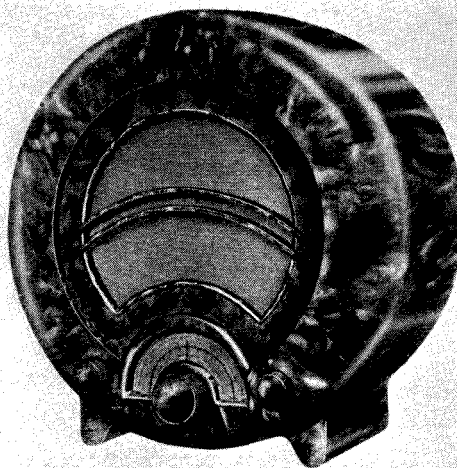

A recently released Marconiphone moving-coil extension loud-speaker for use with sets having a low-resistance output. This reproducer, which incorporates its own volume control, costs £8 8s.



# Ekco AC85

## Super-het

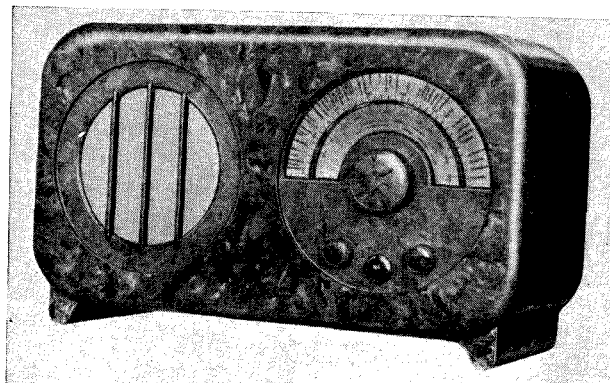

"For those with modern tastes about cabinets. Bakelite . . . and big circular tuning scales"

HERE is a set for those with modern tastes about cabinets. There are no other sets on the market with appearances like these Ekco models with their bakelite cabinets and big circular tuning scales. The model tested has a bakelite cabinet finished in a walnut shade, but it is possible, we believe, to get sets having cabinets in all colours of the rainbow.

A particularly nice-looking model is that finished in black with chromium knobs and which costs thirteen guineas. Neat wooden pedestals are available as well.

This receiver under review has quite an exhaustive specification. It is a six-valve super-het (five receiving valves and a rectifier) for operation from A.C. mains of voltages between 200 and 250.

The valve combination is given in the panel on this page—a modern arrangement that gives satisfactory results under all conditions. Wrapped up in this arrangement are several noteworthy refinements. First of all, on the front we have the three main tuning controls—tuner, the big knob; on-off switch and volume control at the bottom left; and the wave-change and gramo-radio switch at the bottom right.

The knob in the centre, at the bottom, is—to give it the makers' title—a station pre-selector and automatic noise suppressor. This is a most useful control. The knob has a small surround and on it is engraved "All stations," "Medium," and "Strong." With the control set in the first position the set is in its most sensitive state, that is to say, it will pick up all the strong signals, all the stations that come in fairly well, and all the weak ones together with a certain amount of background noise.

In the next position all weak stations and noise are automatically cut out, leaving the listener with only the very strong and medium-power signals. Now, when the control is

turned so that the word "Strong" shows uppermost only stations that give a high entertainment value, that is the local B.B.C. stations and, say, half a dozen really powerful foreigners, are received to the exclusion of all others and mush noise.

In this position and using only a small indoor aerial we logged twelve stations in all, but at quality of a particularly high standard. In fact, during the whole of our tests we were distinctly impressed with the clean-cut tone of this set.



Here is another of Ekco's sets—modern-looking in a bakelite cabinet—on a specially-designed wooden pedestal

One can adjust the tone by means of a plug and three sockets fitted on the back of the set chassis. Some listeners who like a soft and mellow tone will prefer the low and medium settings, but our preference was definitely for the socket marked "High."

Another point of interest is that on the back of the chassis, just near the aerial socket, is a slotted screw head which, when turned, adjusts a small trimmer underneath the chassis. If the listener comes across a bad heterodyne whistle—we did not find one during our tests—the makers state that a small adjustment of this screw will at least reduce if not eliminate the interference.

While on the subject of the chassis, we must say a good word for the clean layout and the accessibility of all the components, especially the mains transformer on which is the mains-voltage adjustment panel.

A word about the tuning scale. There is no visible pointer. When the set is switched on a white illuminated band, about an inch wide, appears on the scale, and in the middle of this band of light is a thin black line. All one has to do when tuning the set is to turn the tuning knob until the thin line crosses the station it is desired to receive, and then adjust the volume control. And that is simple tuning, if you like! Our log, made in South London and using a standard outdoor aerial, included over sixty-five stations.

Altogether we feel that this is a "star" receiver and well worth consideration by prospective set buyers.

### BRIEF SPECIFICATION

BRAND NAME: Ekco.  
 MODEL: AC85.  
 PRICE: £13 2s. 6d., walnut finish; black and chromium finish, £13 13s.  
 TECHNICAL SPECIFICATION: Six-valve (with rectifier) A.C. super-het receiver in bakelite horizontal-type cabinet. The valve combination consists of a detector/oscillator (Mullard FCA), intermediate-frequency amplifier (Mazda ACJVP1), double-diode second detector (Mullard 2D4A), low-frequency amplifier (Mullard 354V) and pentode output (Mazda ACJPen). The valve rectifier is a Mullard IW3.  
 POWER SUPPLY: A.C. mains 200-250 volts.  
 MAKERS: E. K. Cole, Ltd., Southend-on-Sea, Essex.

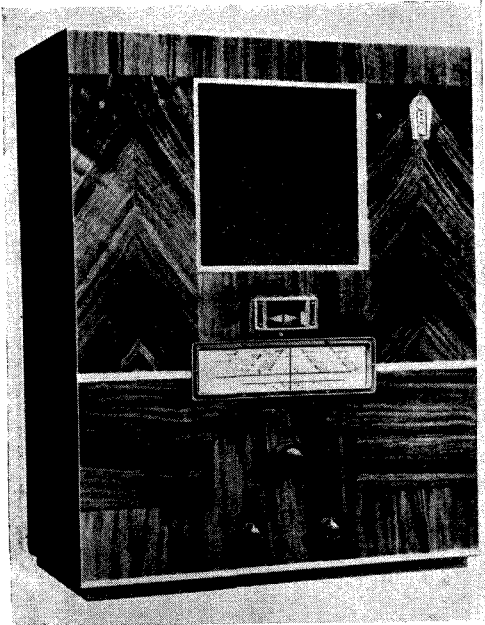

"The cabinet . . . built with the usual G.E.C. solidity, finished in walnut and relieved with white-coloured inlays"

**T**HIS G.E.C. set is another of the new sets introduced a few weeks ago. Let us say at the offset that it is a noteworthy production; the testing of the set has given us genuine pleasure.

Like all products from this firm, the Droitwich Super Five is an engineering production from start to finish. There is nothing slipshod about the way it is built!

#### BRIEF SPECIFICATION

BRAND NAME: G.E.C.

MODEL: Droitwich Super Five, BC3550.

PRICE: £13 2s. 6d.

TECHNICAL SPECIFICATION: Four-valve A.C. super-het (fifth valve as rectifier) in table cabinet. The valve combination consists of a heptode frequency-changer (Osram MX40), one intermediate-frequency amplifier (Osram VMP4K), double-diode-triode second detector and low-frequency amplifier (Osram MHD4), and pentode output (Osram MPT4). The rectifier is a bi-phase type (Osram UI2).

POWER SUPPLY: A.C. mains, 190-250 volts, 40-100 cycles.

MAKERS: The General Electric Co., Ltd., Magnet House, Kingsway, London, W.C.2.

We do not propose to go through the circuit in detail; you can get the technical specification from the panel on this page. The set is an A.C. super-het utilising four up-to-date receiving valves and a fifth as a valve rectifier.

If you look closely at the front view illustration you will see a small diamond-shaped slot above the full-vision scale. This is the most important part of the set from the non-technical user's point of view.

# G.E.C. Droitwich Super Five

When the set is switched on this slot is illuminated and in the centre of it is a black band which occupies about a third of the available space.

When a station is being tuned in the width of this band contracts; and when the band is at its narrowest the station is correctly tuned in. Without some form of visual indicator it is difficult to tune

correctly a set having automatic volume control.

There is no excuse for bad tuning with this set; and, believe us, correct tuning makes all the difference to the quality of reproduction. The tuning scale is a sensible one; the aperture itself being 7 in. wide and 2 in. high. Furthermore, there is black lettering on a white background—so if the dial light should burn out the user won't be "in total darkness."

**T**here are thirty-two markings for medium-wave stations, and ten for long. All British stations are marked "British"; the G.E.C. having a wise eye to present and future changes among British broadcasters. There are wavelength calibrations as well.

Underneath this scale are three controls: tuner at the top, volume and on-off switch on the left underneath, the third knob being the wave-change and gramoradio switch.

About the cabinet itself we need say little. It is built with the usual G.E.C. solidity, finished in walnut and relieved by white-coloured inlays.

On the back is quite a multitude of accessories. There is a tone control that really works; a switch for cutting out the internal loud-speaker in favour of an external

one for which sockets are provided; then there is the sensitivity control which when set to minimum, only allows the reception of the more powerful signals, cutting out all mush and crackle. With this control at minimum we logged over thirty signals on the medium waveband alone at entertainment value.

**O**nly a glance is needed inside the set to appreciate the clean and businesslike layout. Most notice-

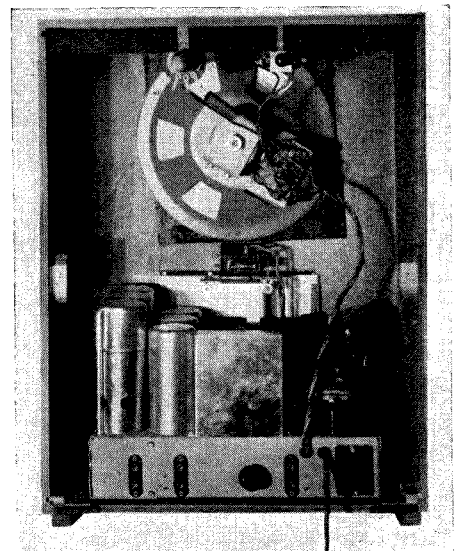

"The Droitwich Super Five is an engineering production from start to finish. There is nothing slipshod about the way it is built"

able is the big energised moving-coil loud-speaker.

With an ordinary 60 ft. outdoor aerial the results were more than satisfactory; they were the last word, considering present-day conditions. Every station, if it had any entertainment value at all, could be logged at good strength with quality which was good even for the G.E.C.

Quality means such a lot nowadays. With an A.C. super-het one has to take hum and background noise into consideration. Here there was no hum, and a silent background.

# Pye SE/AC Console Super-het

**P**YE, of Cambridge. From these manufacturers, whose name is a household word in radio, comes a console A.C. super-het. Our tests have shown that this console is one of the neatest—yes, and most efficient—sets of its type on the market.

It has a figured walnut cabinet that has been "designed." The "refined" appearance is due to the loud-speaker fret occupying the whole front without a single control

second-channel (heterodyne) whistles.

The double-diode pentode—the last valve—is not in common use. It is a three-purpose valve: one diode acts as the second detector, the other diode provides the voltage feedback for A.V.C., while the pentode section acts as a normal output valve.

Now about the controls—underneath the lid, you will remember.

There are two knobs on each side of a big tuning scale—a most lavish affair. It consists of a list of long-wave stations and wavelengths on one side, and medium-wave stations and wavelengths on the other, while in the centre are two white strips, one running by the side of each set of markings. A strip is illuminated according to the waveband in use.

The unusual part about this scale—and one which makes for dignity—is that the station names and wavelengths are in white on a black background, the scales being illuminated from underneath. The four controls grouped round this scale follow the fashion of the day.

showing. All controls are—radio-gram fashion—on a board under the hinged lid. And a handy convenient size is this cabinet—30 in. high, 21 in. wide, and 12½ in. deep.

**L**et us confine remarks to essential facts. First of all, the loud-speaker. This is especially large, the cone measuring some 9½ in. in diameter. The speaker, of course, is a moving-coil of the energised type.

The circuit used, as a glance at the specification will show, is unusual in some respects, but highly efficient. The high-frequency stage before the frequency-changer ensures, among other things, absence of

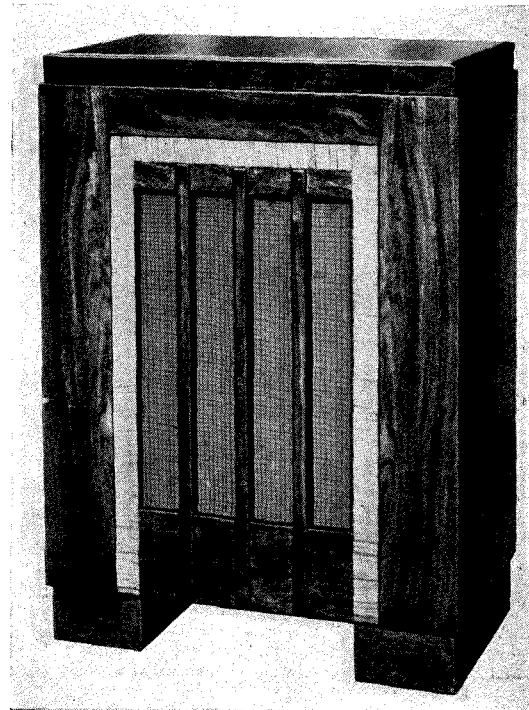

"It has a figured walnut cabinet that has been 'designed.' And a handy convenient size is this cabinet"

## BRIEF SPECIFICATION

BRAND NAME: Pye.

MODEL: SE/AC/Console.

PRICE: £18 10s.

TECHNICAL SPECIFICATION: Four valves in super-het sequence. An A.C. receiver with a metal rectifier for supplying high tension. The valve combination consists of a pre-high-frequency stage (Mazda AC/VPI), triode pentode frequency changer (Mazda AC/TP), single intermediate-frequency amplifier (Mazda AC/VPI) and double-diode pentode (Mazda AC2/Pen/DD).

POWER SUPPLY: A.C. mains 200-250 volts, 40-100 cycles. Model for 100-110 volts available.

MAKERS: Pye Radio, Ltd., Cambridge.

At the foot of the scale one finds the Pye "tuning compass"—a visual tuning indicator with an adjustment so critical that any slight movement of the tuner causes the needle to move. This is a splendid sign, because one can get an absolute minute tuning adjustment—so essential for good quality reception.

**R**esults: The first point that struck us after the set had been connected up on our standard aerial and tuned to our local Regional station was quality. This Pye quality seemed strange on the local for two reasons. One: there was absolutely no background; and, two, not a trace of mains hum. And the two together—no wonder it seemed strange.

Station-getting. A few facts. Thirty-six markings on the medium wave—we logged all those stations. Fourteen markings on the long waves—we logged ten well. In addition to the thirty-six on the medium we logged at least another couple of dozen. Quite good for an hour's work!

This is a notable 1935 radio set!

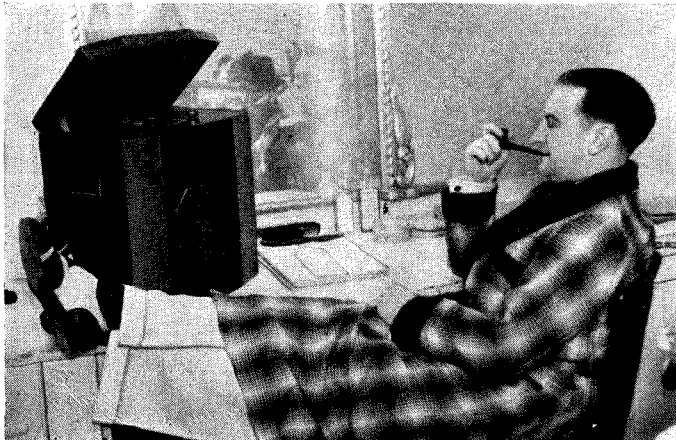

Harold Ramsay, known as the organist who broadcasts from the Tooting Granada, uses a Pye SE/AC table model in his dressing room at the theatre

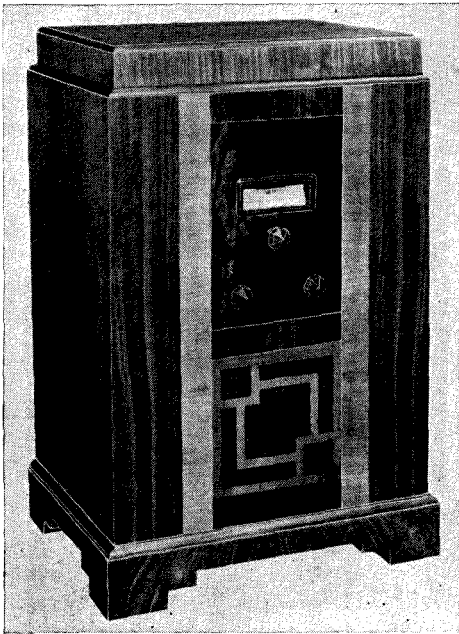

"Altogether our examination showed that we had come across a specialised production at a reasonable price"

**H**ERE is a radiogram that will find a ready market among set buyers. We think that one of its chief points of interest is its large and roomy cabinet. Unlike most present-day fashions, the cabinet is finished in a light shade of figured walnut. The illustration shows all that.

But that is not all by a long way. Inside we have found a most efficient four-valve set chassis. Five valves are used—four for receiving and a

#### BRIEF SPECIFICATION

BRAND NAME: Radiolux.

MODEL: A.C. Radiogram.

PRICE: £22 1s.

TECHNICAL SPECIFICATION: Five-valve (including rectifier) super-het radiogram. The four receiving valves are an octode oscillator/detector (Mullard FC4), high-frequency pentode intermediate-frequency stage (Mullard VP4A), high-frequency pentode second detector (Mullard SP4), and a power pentode output (Mullard Pen4VA). The rectifier—a full-wave indirectly-heated type—(Mullard IW3).

POWER SUPPLY: A.C. mains 190-265 volts, 40-100 cycles.

MAKERS: Amplion (1932), Ltd., 82-84 Rosoman Street, London, E.C.1.

rectifier. The first is an octode frequency-changer, then comes a high-frequency pentode for the intermediate-frequency stage, and another for the second detector. The output valve—also a pentode—gives an undistorted output of about 3 watts.

The Amplion people are to be congratulated for one extra control, which they have fitted on the back of the chassis. They call it a trimmer, but in effect it is an aerial-

# Amplion Radiolux A.C. Radiogram

coupling condenser. It can be adjusted so that the set works well over both wavebands, but if it is adjusted, say, for long waves and for top and bottom of the medium waves, it is surprising what fine results can be obtained.

In other words, this set has been designed to get the utmost from the circuit used—and we have found that the designers have achieved their object.

The three controls on the front of the cabinet follow general practice. Immediately underneath the full-vision scale—calibrated in wavelengths from 200-550 and 850 to 2,000 metres—is the main tuner, underneath to the left is a combined on-off switch and volume control, and on the right is the wave-change and gramo-radio switch.

On the motor-board is nothing but a gramophone motor with an automatic stopping device and a pick-up together with needle cups and a pick-up rest. It looks particularly neat!

A special feature is the provision of a visual tuning indicator above the tuning scale. This takes the form of a neon tube—a very easy device for the ordinary user to understand. All one does when tuning in a station is to tune to the point where the glow from the neon tube is at its brightest; then one can rest assured that the station is dead in tune; the result being the best quality.

As we have pointed out elsewhere, it is important to accurately tune a set which incorporates a form of automatic volume control if the best quality is to be obtained.

Altogether our ex-

amination of the cabinet work, set chassis, and general design showed that we had come across a specialised production at a reasonable price.

Our tests were made in South London. We have had so many requests for advice about sets with a self-contained aerial that we decided to put this set through a stringent test using *no* earth and the mains-aerial device.

We were agreeably surprised with the set's station-getting capabilities under these conditions. On the medium waves we logged the two locals at full strength with the volume control at about the half-way position.

On a normal outdoor aerial we adjusted the trimmer for the best results, and then let it "stay put" for both medium and long-wave tests. Altogether our log for both wavebands exceeded sixty signals, of which at least forty provided good listening value.

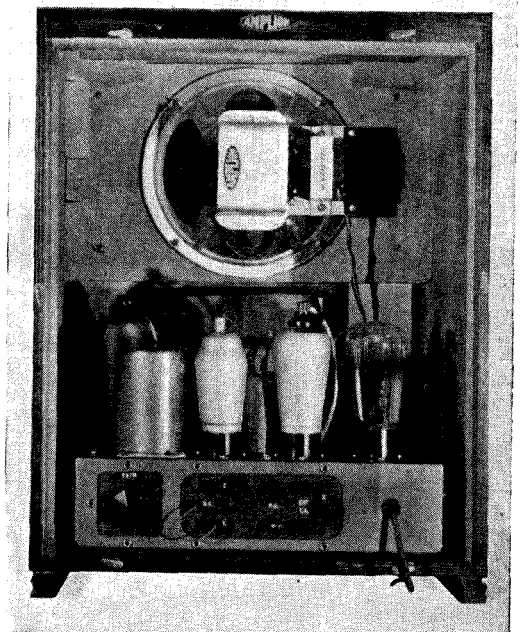

The same chassis as that used in the Amplion Radiolux radiogram is incorporated in the Amplion table model which sells at £12 12s.

# Philips Five-Eighty

WE were especially interested to try this new Philips Five-Eighty super-het because it is, we think, the set with the most comprehensive specification in the ten-guinea price range.

If you look at the technical specification you will see that there are five receiving valves, three pentodes, one octode, and a diode, and a sixth as a mains rectifier. Quite frankly, we were especially pleased with the performance of the set, taking into consideration, of course, its price and the rather small cabinet, some

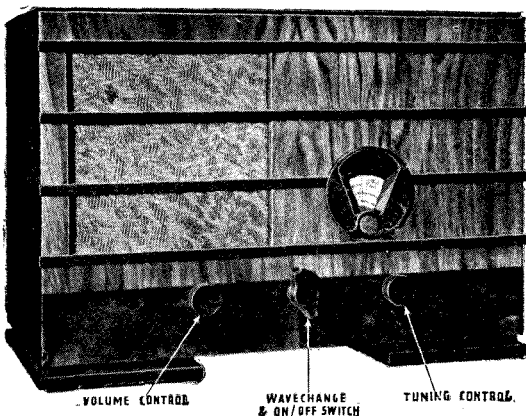

"An example of a set with an ambitious specification housed in a really small space"

16 in. wide, 7½ in. deep, and 11¾ in. high.

In the highly polished walnut cabinet there is the compact set chassis and a fairly small permanent-magnet moving-coil loud-speaker. In fact, this Philips Five-Eighty is an example of a set with an ambitious specification housed in a really small space.

Inside the cabinet the layout is typical of Philips. Every component is screened, and every valve is of the metallised type with the exception of the output pentode and the rectifier.

About the circuit. This is, perhaps, rather unusual in that there are two pentodes after the second detector. The input from the aerial is taken to a band-pass tuning cir-

cuit, then to the octode frequency changer; there is one stage of intermediate-frequency amplification before the detector, a double diode, one diode of which provides a feedback voltage for automatic volume control. In all there are eight tuned circuits.

As is usual with Philips sets, the back shows pictorially to where the various external leads are connected, even to a drawing of a pick-up showing the pick-up sockets. A commendable idea of the makers is that the set can only be operated when the back is in position; the mains leads being connected to a plug and socket arrangement on the back and connection is only made to the set when this back is in position.

As can be seen from the specification, the set is suitable for all A.C. voltages between 100 and 250. The necessary adjustment to suit voltages between these limits is made by setting four clips in position on the adjustment panel. There are twelve different settings in the 100-250-volt range, and these settings are shown pictorially on a diagram on the back of the cabinet.

The actual job of adjusting this panel to suit individual voltages is quite easy, but it is wise to check very carefully before the back is finally put into position.

That the cabinet is really a neat piece of work can be seen from

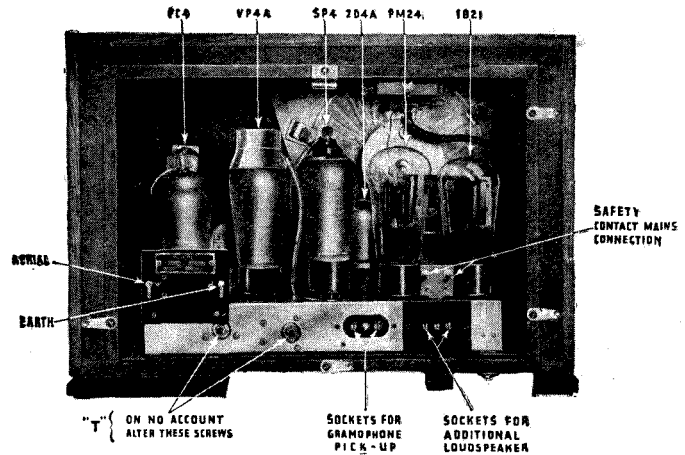

"Inside . . . layout is typical of Philips. Every component is screened"

the illustrations on this page. There are only three controls: volume control on the left, wave-change and on-off switch in the centre, and the tuning control on the right. The pick-up, when it is desired to use one, is brought into operation by simply plugging it into the sockets provided on the back of the cabinet.

Using the outdoor aerial we had no difficulty whatsoever in logging just over sixty stations in the course of a two-hour test. Of these at least half provided real listening enter-

#### BRIEF SPECIFICATION

BRAND NAME: Philips.

MODEL: Five-Eighty.

PRICE: £10 10s.

TECHNICAL SPECIFICATION: Five-valve A.C. super-het plus a valve rectifier. Arrangement is an octode frequency-changer (Mullard FC4), pentode intermediate-frequency amplifier (Mullard VP4A), diode detector (Mullard 2D4A), first low-frequency amplifier (Mullard SP4) and pentode output (Mullard.) PM24M). The valve rectifier is a Philips 1821.

POWER SUPPLY: A.C. mains, 100-250 volts, 40-100 cycles.

MAKERS: Philips Lamps, Ltd., 145 Charing Cross Road, London, W.C.2.

tainment. On the medium waves we could get Strasbourg quite free from London Regional; this is no mean feat when it is remembered that the separation is 9 kilocycles.

On the whole selectivity was really notable. Fécamp on 206 metres was as good as our two locals. On the long waves we heard about six station which passed the acid test, that is, fit for enjoyable listening. Luxembourg, notable nowadays for a bad heterodyne whistle, was nearly clear, the interference being so slight as to be negligible.

Quality was, we must say, pleasant; very little hum considering the compact nature of the set.



# "W.M." Book Reviews

So many readers have written asking for authoritative books dealing with technical subjects that we have decided to publish occasionally reviews of new books of radio interest. Publishers are invited to send books for review in these columns

**"Elementary Loudspeaker Practice,"** by N. W. McLachlan, D.Sc., M.I.E.E. (Oxford University Press, 5s.)

THE publication of a new book on loud-speakers by Dr. McLachlan is always an interesting event, for he is one of our leading authorities on the subject. Moreover, he has the happy gift of dealing with quite abstruse matters in a way which makes them seem simple.

He has in the past written chiefly for those who possess some considerable technical knowledge, but his occasional more popular contributions have shown him to possess a gift of lucid exposition.

## Popular Appeal

Dr. McLachlan's latest book is, consequently, of particular interest since it is intended especially for those with slight technical knowledge; indeed, he assumes no more than quite simple general electrical theory and such a knowledge of radio as may be expected of every keen constructor. From this starting point he takes his readers over the whole ground with a thoroughness truly remarkable within the limits of a volume of quite modest size.

Probably a list of the chapter headings will best indicate the wide scope of the book: The Function of a Loud-speaker, Driving Mechanisms; Cantilever Reed Type, Balanced-armature Type, Hornless Moving-coil and Blatthaller Speakers, Directional-baffle and Condenser Speakers, Kyle Condenser Speaker; Voigt Membrane Condenser Speaker, Loud-speaker Baffles, Loud-speaker Magnets, Power-valve Circuits for Loud-speakers, Vibrational Characteristics of Conical Diaphragms, Behaviour of Conical Diaphragms at Low Frequencies, Distribution of Sound from Diaphragms, The Func-

tion and Design of Horns, The Design of Hornless Moving-coil Speakers, Room Effects in Reproduction, Importance of the Range 5,000 to 10,000 Cycles: Horn Speaker for this Range, Points in the Design of Public-address Speakers, Amplitude Distortion, Recent Development.

The book is definitely one which should be in the hands of every radio amateur who aims at a really intelligent understanding of his hobby.

G. P. K.

**"Television Theory and Practice,"** by J. H. Reyner, B.Sc., A.M.I.E.E. (Chapman & Hall, 12s. 6d.)

IN any art or science advancing so rapidly as is television it takes a bold man to undertake to write a full-length text-book; by the time that the author has reached the end of his work he is almost certain to find that some of his earlier matter has gone out of date.

Mr. Reyner has taken the risk, and it says much for the skill and care with which he wrote his very substantial work on television that even now, some months after its publication, and in the changed atmosphere produced by the issue of the Report of the Television Commission, it contains comparatively little which seems definitely dated.

As a whole, the book represents quite a sound introduction to a study of television theory and practice. While much space is devoted to early systems, it is to be remembered that these historical matters provide an extremely easy path along which the reader can approach his goal of an exact knowledge of the fundamental principles.

## "W.M." INFORMATION SERVICE

"Wireless Magazine" offers an unrivalled information service to its readers. With the exception of the "Technical Information" service, queries on general topics, advice on buying a new set, or the catalogue service, are entirely free.

We must ask readers who require technical information to send the coupon, which will be found on the back page, and to conform strictly to the rules set out thereon.

It must in fairness be added that the book includes chapters on some of the latest developments also. There is, for example, some mention of the inventions of Farnsworth, and a chapter on the use of ultra-short waves.

Mr. Reyner was perhaps unlucky in having to pen this latter chapter at the time at which we surmise it to have been written, since it would appear to have been just prior to the discovery that the "optical-range" theory was fallacious. (It is now known, of course, that while a really strong radiation extends only as far as the optical horizon, there is another component which travels far beyond, and is quite adequate for the operation of sensitive receivers.)

Such criticisms, however, must not be allowed to obscure our perception of the fact that this is one of the first attempts to produce an actual text-book of television theory. As such it must inevitably have its weaknesses, but it should likewise receive the credit due to a pioneer effort.

G. E.

**"Broadcasting in My Time,"** by Sydney A. Moseley. (Rich and Cowan, 6s.)

TO write a book of some 240 sizeable pages all about broadcasting from the strictly non-technical point of view may seem something of an achievement to those of us who are apt to think of radio as a matter of band-pass circuits and screened-grid valves. That, however, merely indicates a tendency to get a little too settled down in our technical groove.

In the volume under review Mr. Moseley presents what is in effect an historical survey of the first twelve years of the development of broadcasting as a service. Those who know his journalistic capabilities will not be surprised to learn that he has done his work in most entertaining fashion; it may be broadcasting as seen through one particular pair of spectacles, but it cannot be denied that the view is an interesting one. The book gives glimpses of the inwardness of matters little known to the general public. H.W.

**G. HOWARD BARRY**  
Explains How to Get the  
Best Results, and when and  
where to Listen

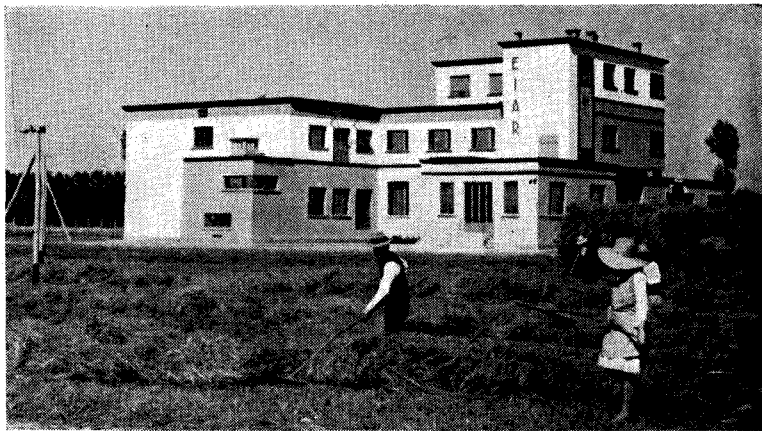

Gulliland photo  
An easy short-wave signal to receive is Rome on 25.4 metres

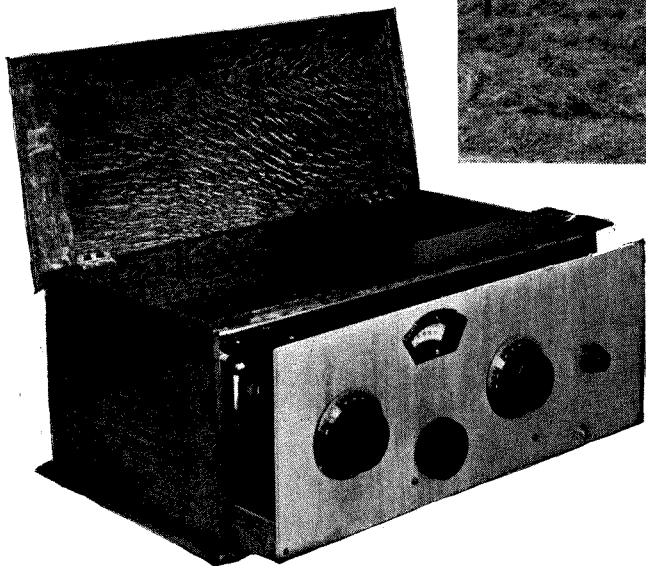

# Operating the Standard Four-valve Short-waver

**S**INCE the chief aim and object of the Standard Short-wave Four-valver described last month was to provide really easy operation, it naturally follows that there is not very much to be said on that subject. It is to be hoped that everyone who has built the receiver is, by now, feeling thoroughly at home on the short waves.

There are, however, some points of operation entirely bound up with the characteristics of short waves themselves and independent of the set that one uses. I propose to deal briefly with some of these.

## Number of Wavebands

First of all, it is necessary to have an understanding of the fact that the part of the spectrum which we dismiss as "short waves" includes a number of wavebands each having entirely different characteristics. The behaviour of the 40-metre band, for instance, does not bear the slightest resemblance to that of 20 metres.

They are much further apart than are the long and medium broadcast bands—and the 10-metre band is almost a law unto itself!

From this it follows that one must explore each waveband thoroughly and try to become used to its particular habits. Very briefly, I propose to divide up the spectrum and to analyse the chief points that one must understand about each part of it.

Study the following table and plan your listening accordingly. If you have not been keeping to something like the suggested plan, you cannot possibly judge the success of your set—you may have been listening assiduously on a band where the best set in the world would bring in nothing!

13, 16 and 19 metres (broadcast):

Good during early and middle afternoon. Unreliable, but *very good* when conditions are right.

20 metres (amateur): Generally good from mid-day until about 7 p.m.

25 metres (broadcast): Interesting from 6 p.m. till midnight.

31 metres (broadcast): Not too good at any time, but the Australians usually come in well between 6 and 9 a.m. Americans may be heard late in the evening.

40 metres (amateur): Excellent at nearly all times of day, particularly between 5 and 10 p.m. Americans all night.

49 metres (broadcast): Good for "locals" at all times, and for "DX" from 6 p.m. till 2 a.m. or later.

75-85 metres (amateur): American telephony very good at night. Europeans good all day, but not very active except at week-ends.

## Vitally Important

All this may seem a little out of place in an "operating" article, but it really is of vital importance to make sure that you choose your bands correctly. One could easily spend the greater part of the day

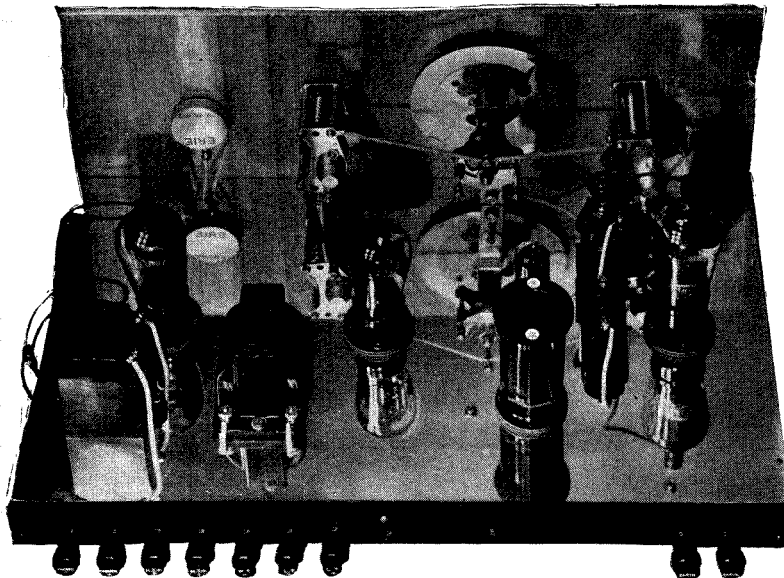

This shows the simple and clean layout of the Standard Four-valve Short-waver

listening without hearing a single transmission, simply by persistently choosing the wrong part of the spectrum.

Now for the set itself. The reaction control should be really silky, without the slightest tendency to become unruly on any wave band.

Mine, on the original set, has just started a kind of motor-boating effect in the region of 30 metres. It didn't do this when the set was new, and the trouble has eventually been traced to a faulty decoupling resistance, replacement of which has entirely cured the trouble.

**De-coupling Importance**

This just shows how important the de-coupling is; now that it is in order again I can use a really ancient high-tension battery without noticing any ill effects, other than the slight hiss introduced by the bad cells.

I have quite got into the habit of tuning on the .00015-microfarad condenser, with the band-spreader set at 90 degrees, ready for final tuning over a degree or so in either direction.

**Simple Operation**

The chief point about this procedure is that one can calibrate the receiver quite easily from the main dial, facilitating the identification of stations that show no sign of making announcements.

Tuning with the band-spreader is really ridiculously simple, and is actually less critical above 30 metres than the tuning of the average commercial broadcast receiver.

Hand-capacity troubles should simply not exist. I have found it quite impossible to detect the slightest trace of them and can invariably pick the receiver up off the bench while it is tuned to a station without perceptibly shifting the tuning—signals remaining constant.

too tightly coupled to the detector and, for this reason, the neutralising condenser should be adjusted to as low a capacity as is consistent with good reception.

Another point concerning this condenser, of course, is calibration. If any attempt is made to calibrate the set, the adjustment must never be altered. It introduces a variable amount of damping into the detector-grid circuit and naturally alters the entire tuning range.

**Wavelength Ranges**

The wavelength figures given on the coils appear to indicate the ranges that they will cover when no additional load of this kind is introduced. In use in the set, the coils marked "24-52" does not tune much below 26 metres, while that marked "46-96" appears to start off just above 47 metres.

The maximum wavelengths in each case are a little higher than those stated. The splitting up of the various ranges resolves itself into the following arrangement: the 13-, 16-, 19-, 20- and 25-metre bands are all covered by the smallest coil; the 31-, 40- and 49-metre bands are found on the next; and the largest covers the

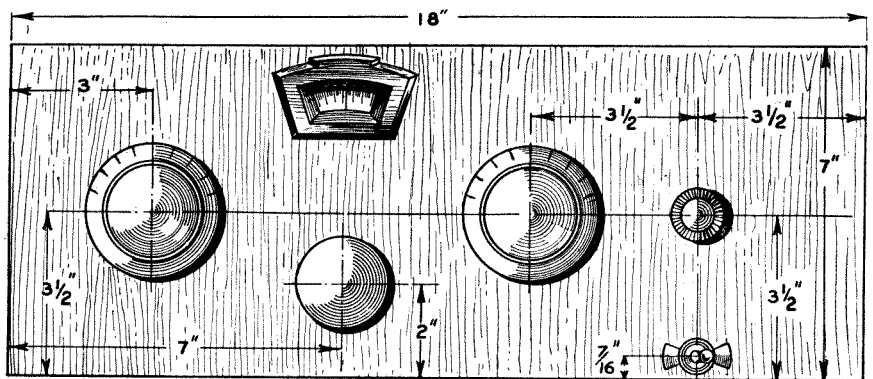

Reading from left to right the five controls are: approximate-tuning condenser, band-spreader tuner, reaction, and volume control—for use with 'phones—above the on-off switch

In my case the addition of an earth connection does not make the slightest difference in any way. The earth can, as a matter of fact, be lightly touched on the baseboard during reception and not even a click is heard.

It is almost impossible to produce hand-capacity effects when a buffer stage, as used in this set, is employed. Similarly, aerial dead-spots should not be present. The size of choke used in the grid circuit of the buffer should guard against them. They may, however, show up to a very slight extent if the first valve is

49-metre band at the minimum end of the tuning scale, very little else of interest being found on the range except the 75-85 metre amateur band.

Concerning the 49-metre band, it may be said that the efficiency is improved by receiving it at the bottom of the scale with the large coil, rather than on the top with the medium-sized one; but selectivity with the larger coil is apt to be poor and the other will, generally, be preferable.

Now I must deal with some of the externals. First, the aerial. All my tests have been carried out with an

outdoor aerial of medium length—about 36 ft. long. It is, I admit, quite a good one as it is 45 ft. high at the far end and the lead-in arrangement is quite efficient.

**Indoor-aerial Results**

Once or twice, however, I have disconnected the outside part from the lead-in tube and simply used 10 ft. of wire inside the room and all but the very weakest stations can be found with this arrangement. I am not one to advocate the use of an indoor aerial, however, as you are sure to lose something. Erect as good an outside aerial as you possibly can; you will not regret it.

Furthermore, by "good" I don't mean big, or even long. Keep it clear of all surrounding objects and as high as possible; in short, see that its capacity to earth is as low as it can possibly be made. We used to say that a good aerial was worth an extra valve, and it still is where short waves are concerned.

**Efficient Aerial Advised**

The owner of a much-hotter-up headphone receiver can usually log everything that is going with a few feet of wire, but if you want reliable broadcast reception on the short waves it will pay you to use an efficient aerial.

Next, the high tension. At the moment I am using one small 120-volt battery, with the full voltage on the H.T.+2 terminal and 66 volts on H.T.+1. An increase up to 135 or 150 volts will certainly mean an increase in signal strength, but this will be almost entirely due to the

Continued on next page

**G. Howard Barry's Log of Stations Heard on the Standard Four-valve Short-waver**

The following list of some of the more interesting stations heard, together with the dial readings recorded, should prove useful as a comparison with your own results. I have not mentioned the times of day, but it may be taken for granted that they all conformed fairly well with the times given at the beginning of this article.

Coil Used	Station	Wavelength in Metres	Dial Reading
75-85—metre Band			
			About 70-85
" 46-96 "	Rugby ... ..	60	54
	GSA Daventry ... ..	49.59	24
	VQ7LO Nairobi ... ..	49.5	23
	W8XAL Cincinnati ... ..	49.5	23
	OXY Skamlebaek ... ..	49.4	22
(Remaining readings for this band given with next coil.)			
" 24-52 "	GSA Daventry ... ..	49.59	92
	W3XAL Bound Brook ... ..	49.18	90.5
	W2XE Wayne ... ..	49.02	90
	W8XK Pittsburgh ... ..	48.86	89
	YV4RC Caracas ... ..	47.1	85
	W3XL Bound Brook ... ..	46.69	84
40—metre Band			
(Ships) ... ..	36	45-50	
VK2ME Sydney ... ..	31.23	23	
31—metre Band			
" 13-26 "	FYA Pontoise ... ..	25.6	98
	GSD Daventry ... ..	25.53	97
	W8XK Pittsburgh ... ..	25.27	96
	(Ships) ... ..	23-24	85-90
	20—metre Band		
			70-80
GSF Daventry ... ..	19.82	62	
W8XK Pittsburgh ... ..	19.72	60	
W2XAD Schenectady ... ..	19.55	58.5	
W3XAL Bound Brook ... ..	16.87	43	
W8XK Pittsburgh ... ..	13.92	5	

Scores of stations with readings within a few degrees of those given have been received at various times. I have simply given the readings of those that anyone might expect to hear on a casual test with the receiver. The crowded 49-metre band, late at night, will probably produce seven or eight stations within four degrees on the dial, making calibration a rather difficult matter. G.H.B.

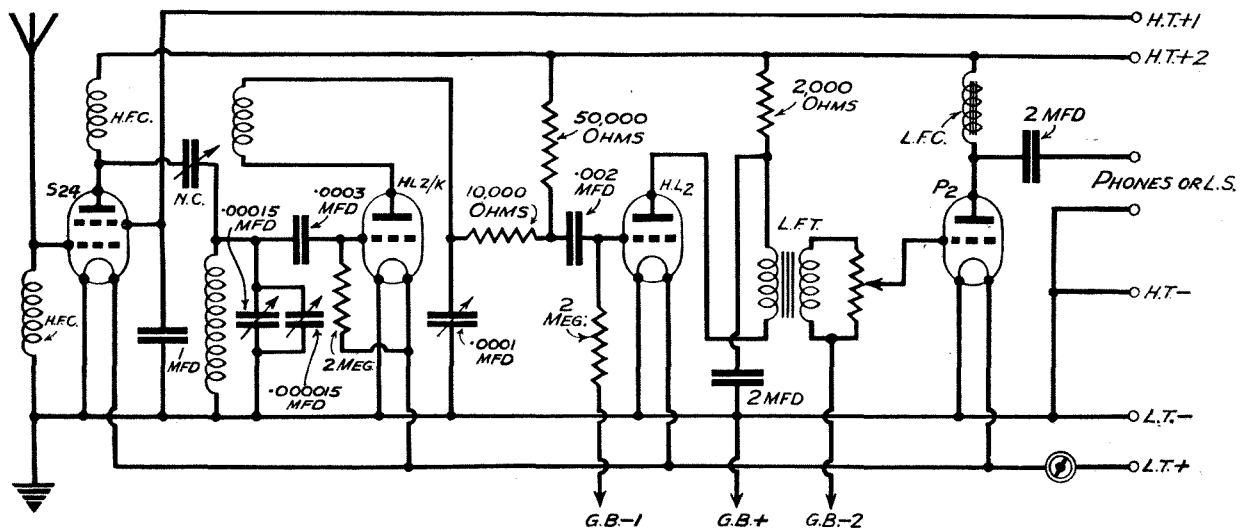

The circuit of the Standard Four-valve Short-waver consists of a screen-grid buffer stage, leaky-grid detector and two low-frequency stages

# Impressions of the Standard Short-wave Four-valver

By G. P. KENDALL, B.Sc.

**M**Y recollections of short-wave listening go back to the days when the one great ambition of all of us was to receive KDKA, then working on a wavelength of some 60 metres. We regarded that wavelength as something really ultra-short, presenting acute technical difficulties and calling for something very special in the way of circuits.

Make no mistake, the difficulties were there all right; really effective short-wave receivers did not exist then and we were driven to all sorts of comical schemes to enable us to get some measure of control over the fierce and intractable circuits we were obliged to use.

## "Atrocious Manners"

My own hopes were pinned to a super-het characterised by an unpleasant disposition and atrocious manners. Good slow-motion dials did not exist and the only way I could get results of any sort was to use extension handles of a length which nowadays would suggest something of the order of a micro-wave.

It is perhaps natural that I should very early have reached the conclusion that before we could take proper advantage of the great possibilities of short waves it would be necessary to produce receivers that were reasonably easy to handle.

Such sets have been a long time coming, but there is no doubt that we have them now. A properly designed modern short-wave re-

ceiver quite definitely handles in a fashion which differs but little from the behaviour of a broadcast set of the simpler and less powerful type.

Of this new family of well-mannered short-wave receivers the Standard Short-waver is decidedly the best representative that I have yet handled. Actually, it is so good that I must in fairness confess that it has contributed in some measure to my own education on the point!

Testing it early one evening I was able within a few minutes to satisfy myself that the tuning on the band-spreading condenser was strictly comparable with that of the main control of a broadcast set of the single high-frequency stage type.

## OPERATING THE STANDARD SHORT-WAVE FOUR-VALVER

*Continued from previous page*

low-frequency side, as the detector is at its best when the full voltage is 120. This, of course, is substantially dropped before it reaches the detector anode, because of de-coupling and the anode resistance.

Reaction control does not appear to be adversely affected by an increase in high tension, but I should imagine that it would usually be at its best with 120 volts only.

I have dealt with the question of low-frequency amplification in another article in this issue, but I should

By using the larger condenser simply as a means of setting the circuit to the desired waveband and performing actual tuning on the band-spreader, there was absolutely nothing critical or difficult about the working of the set. I believe that it would be possible for the quite non-technical domestic listener to operate it with entire success after only a few minutes' practice.

## Good Sensitivity

Sensitivity I found to be of a very high order. The more powerful European stations came in with a volume and reserve of strength that guaranteed real programme value from quite a number. The really distant stations called for no more than a little care in tuning: there was none of that squeezing and straining which is such a familiar feature of the older kind of set.

## Truly Excellent

Quality was much above the ordinary, and altogether I consider the "Standard Short Waver" a truly excellent piece of work.

just like to suggest here that you do use a really good loud-speaker. The W.B. Stentorian that I am using has the merit of being sensitive, and I find that even the weakest C.W. signals may be copied from the loud-speaker with almost as much ease as if headphones are used.

The detector valve used is absolutely non-microphonic, and although I don't favour the practice of mounting the loud-speaker in the same cabinet as the receiver, it *can* be done in this case without the slightest trouble. Actually, I use a loud-speaker on a large baffle in one corner of the room—*not too far* from the set.

## COMPONENTS NEEDED FOR THE STANDARD SHORT-WAVE FOUR-VALVER

### CHASSIS

- 1—Peto-Scott chassis to specification.

### CHOKE, HIGH-FREQUENCY

- 1—Home-made short-wave choke as described in text.  
1—Bulgin short-wave high-frequency choke.

### CHOKE, LOW-FREQUENCY

- 1—Varley, type DP23 output choke.

### COILS

- 1—set British Television Supplies short-wave coils.

### CONDENSERS, FIXED

- 1—T.C.C. .002-microfarad.  
1—T.C.C. .0003-microfarad.  
2—T.M.C./Hydra 2-microfarad, 250-volt working.  
1—T.M.C./Hydra 1-microfarad, 250-volt working.

### CONDENSERS, VARIABLE

- 1—Polar short-wave .00015-microfarad slow-motion, type C.  
1—Polar short-wave .0001-microfarad slow-motion, type C.  
1—Eddystone .000015-microfarad short-wave condenser, type 900.  
1—J.B. neutralising condenser.  
1—Eddystone vernier slow-motion drive, type 933B.

### HOLDERS, VALVE

- 5—Clix 4-pin Airsprung.

### RESISTANCES, FIXED

- 1—Erie 10,000-ohm, 1-watt type.  
1—Erie 2,000-ohm, 1-watt type.  
1—Erie 50,000-ohm, 1-watt type.  
2—Erie 2-megohm, 1-watt type.

### RESISTANCE, VARIABLE

- 1—Erie 250,000-ohm potentiometer.

### SUNDRIES

- Tinned wire for connecting.  
Oiled cotton sleeving.  
3-Clix wander plugs for grid-bias connections.

### SWITCH

- 1—Bulgin on-off single-pole toggle.

### TERMINALS

- 1—Peto-Scott terminal strip, complete with terminals to specification.

### TRANSFORMER, LOW-FREQUENCY

- 1—Ferranti AF8.

### VALVES

- 1—Marconi S24.  
1—Marconi HL2/K.  
1—Marconi HL2.  
1—Marconi P2.

### LOUD-SPEAKER

- 1—W.B. Stentorian, Standard model.



# B.I. WIRELESS CONDENSERS

**B.I. FIXED CAPACITY CONDENSERS** for Wireless Receivers, Battery Eliminators, Smoothing Circuits, etc., are made in several different types to suit the various uses for which Condensers are required in connection with Wireless circuits.

These Condensers are the result of over 30 years' experience in the manufacture of all kinds of Condensers from the smallest sizes up to Condensers weighing more than 2 tons.

All Condensers except tubular are fitted with fixing feet and screw terminals or soldering tags. All **B.I.** Wireless Condensers are vacuum dried and impregnated with a **specially selected non-hygroscopic material** which ensures that their initial insulation value is maintained indefinitely. All Condensers are tested before dispatch at **three times working pressure** and the actual capacity is guaranteed to be correct within **10 per cent.**, except that of the tubular type, which is guaranteed within **15 per cent.**

In addition to the Standard Types, **B.I.** Condensers can be supplied in special forms to suit requirements.

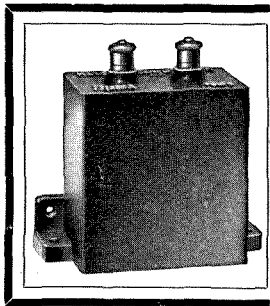

**BRITISH INSULATED CABLES LTD.**

**Cablemakers and Electrical Engineers**

**PRESCOT - LANCASHIRE**

Telephone No. **PRESCOT 6571**

London Office:

Tel. Nos.:

**Surrey House, Embankment, W.C.2. Temple Bar 4793-4-5-6**

# UNIFORMITY

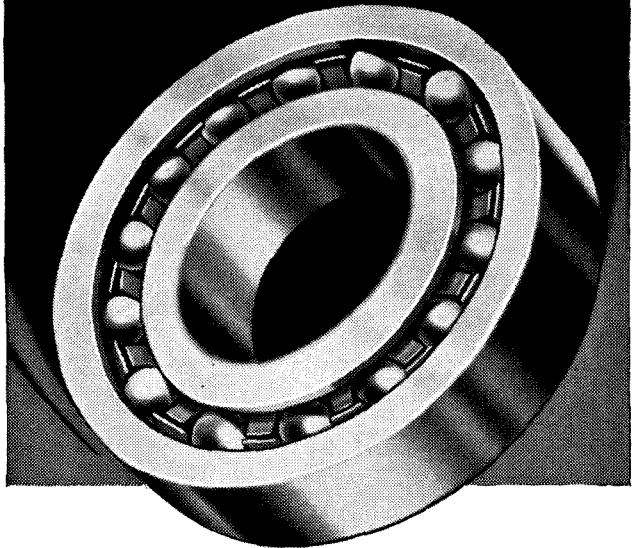

There's no room for individuality inside a ball-bearing. Every ball in it must be the same shape, the same size, the same material, the same weight—in a word, **UNIFORM**. So with **T.M.C.-HYDRA** condensers. Here, too, individuality is barred. Every **T.M.C.-HYDRA** condenser of the same rating is the same—exactly! Stringent testing ensures it. Take advantage of this greater precision when next you buy condensers.

**T.M.C. BRITISH MADE HYDRA CONDENSERS**

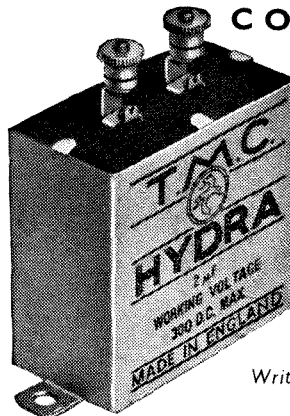

The special method of sealing **T.M.C.-HYDRA** condensers definitely prevents the penetration of moisture and so maintains their high electrical properties.

Write for a copy of the new illustrated price list.

**T.M.C.-HARWELL (SALES) LTD**

Britannia House, 233 Shaftesbury Avenue London, W.C.2. (A few doors from New Oxford Street)

Telephone: Temple Bar 0055 (3 lines)

Made by **TELEPHONE MANUFACTURING Co.Ltd**

Better service results from mentioning "Wireless Magazine" when writing to advertisers.

# News from the Radio Societies

Conducted by  
G6QB

*Under this heading we propose to publish reports every month of the activities of short-wave and transmitting societies. We shall be pleased to give publicity to any announcement of forthcoming events, etc., and secretaries of short-wave societies, whether national or local, are asked to make the fullest use of this space*

## Radio Society of Great Britain

THE B.E.R.U. contest, which occupied the four week-ends in February, was better supported than ever. Incidentally, it was favoured with very good conditions; the first week-end started badly, but the other three were uniformly good.

Scores are not yet officially released for publication, but the probability is that the leading British stations will be quite low down in the final order. SU1EC, operated by Lieutenant Cole in Cairo, scored well over 1,000 points during the first week-end, the highest British score being below 500.

This does not reflect upon the efficiency of British stations, neither is it detrimental to SU1EC's fine performance to say that the method of scoring turned out to be rather in favour of a "central" station putting up a big total. SU1EC, for instance, can count one point for every British station worked—and there are several hundred of them. The

British station can likewise claim one point for each contact with Egypt, but there are only a mere half-dozen stations on the air in that country.

The next big event to be held by R.S.G.B. is National Field Day, in June. Each R.S.G.B. district is responsible for running two portable transmitters, one of which operates on 20 to 40 metres, and the other on 80 and 160 metres. One station may be utilised for both jobs, if desired, but naturally this puts a severe handicap on a district.

The rules impose restrictions on the height of aerial, the distance from a permanent building, the power used, and the stations which can be worked to score points. Full details will be given next month.

The current issue of the *Bulletin* contains an appreciation of the work of the late Mr. Donald Price, whose tragic death in the Baird Television Co.'s laboratories was a severe blow to the society.

Mr. Price was a very prominent

member and was always an active participator in all the organised tests. He actually put up a very high score in the B.E.R.U. contest a few days before his death. He was also a District Representative for the South London Area. His place will be extremely hard to fill.

## Society of Wireless Pioneers

This society was not mentioned in these columns last month, but news has come to hand about its activities. The Director of European Publicity is R. L. Rawles, Blackwater Corner, Newport, I.O.W., and membership is open only to those who can claim to have been interested in short-wave work during, or prior to, 1924.

A new chapter in the N.E. district has been formed and anyone in that part of the country who is interested should get into touch with R. W. Stewart, 8 East View Terrace, Seaton Carew, West Hartlepool.

The "Chief Scribe" of the society is Miss Alice Bourke, operator of the American station W9DXX, and her station may be heard on the air in the 20-metre and 40-metre bands. A list of the society's test transmitters will be available shortly.

## Coventry Short-wave Radio Club

I am asked to announce that the Coventry Short-wave Radio Club is

*(Continued on page 232)*

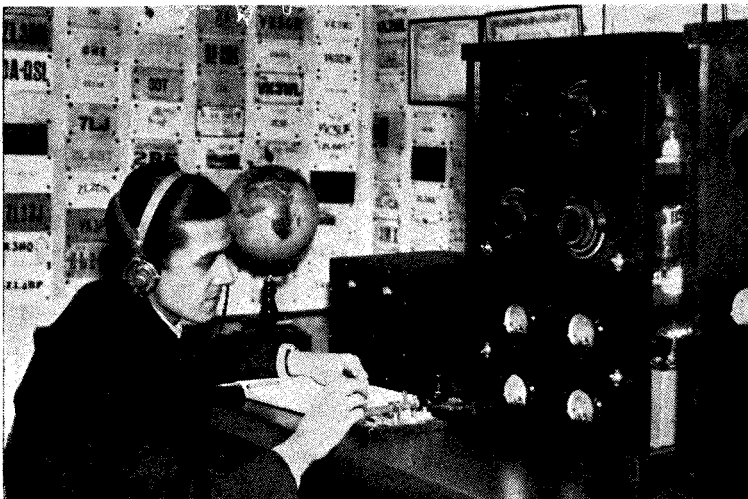

By the death of Mr. H. D. Price, recorded in another column, short-wave research loses one of its most promising young experimenters. He had many fine achievements already to his credit and all those who knew him must feel that his tragic death has robbed us of one who would undoubtedly have done much to advance the science in the future

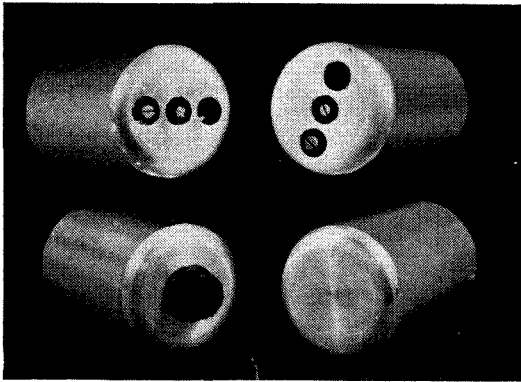

A properly designed stenode receiver is the last word in selectivity with quality, but to achieve this every care must be taken to cut losses to an absolute minimum.

The design of these stenode components has been supervised, step by step, by the set designer, and are manufactured under sole licence of the British Radiostat Corporation.

The coupler kit comprises:

- 2 variable coupling side-band-cutting intermediate-frequency tuned-transformer units,
- 2 tone-compensating low-frequency units (1 fixed and 1 variable), all specially screened.

The specially designed H.F. choke is iron screened (non-ferrous screening is unsuitable for this receiver).

A special screened valve plug top connection is also specified, and is constructed throughout from low-loss insulating materials, extra large low-loss heads, etc.

## COMPONENTS for The "WIRELESS MAG." STENODE RECEIVER

	£	s.	d.
1 Stenode kit	3	5	0
1 H.F. choke, No. 1,226	6	6	
1 Screened plug top connection, No. 1,224	1	6	
2 Plug top connectors, No. 1,175...		2	
1 Pair special stenode resistance-mounting tag strips, per pair	4	9	
1 Aerial and earth socket strip with lettered plugs, No. 1,047			9

**£3 18 8**



CAMBRIDGE ARTERIAL ROAD, ENFIELD, MIDD.

## SPECIFIED FOR THE 1935 A.C. STENODE

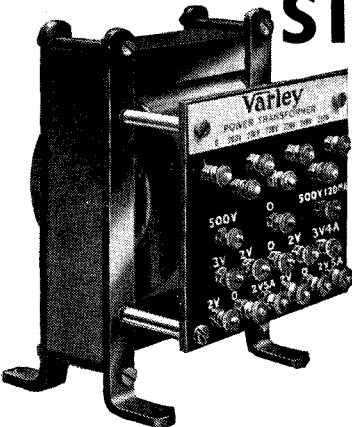

Mr. Paul D. Tyers, in designing the "Wireless Magazine" 1935 A.C. Stenode, has specified the Varley E.P.33 Multi-volt transformer. Take the advice of the designer and get an E.P.33 for your set.

Write now for further information and Catalogue.

**E-P. 33 Mains Transformer 37/6**

# Varley

Bloomfield Road, Woolwich, London, S.E.18.  
Tel.: Woolwich 2345.

Registered Trade Mark

## WEARITE IRON-CORED COILS

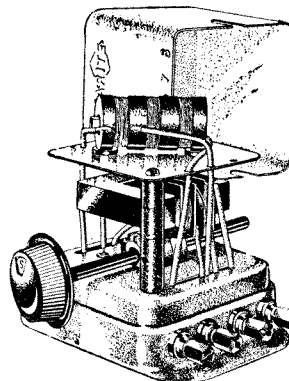

Specified for the

## H.K. FOUR

ONE TYPE B.P.1. 12s. 6d.  
ONE TYPE B.P.2. 12s. 6d.  
TWO TYPE T.G.

each 12s. 6d.

Extension Spindle - 6d.

Also Specified  
ONE H.F. CHOKE TYPE  
H.F.P.J. - - 2s. 0d.

To Messrs. Wright & Weaire, Ltd.  
740 High Rd., Tottenham, London N.17

NAME .....  
ADDRESS .....  
W.M. 4/35 .....

Please send me a copy of your new booklet No. 834 giving full technical details of coils, transformers, chokes, etc., and also circuit diagrams and constructional details of the "Teamster" (L.P.) Series of Circuits.

CA 6524

Mention of the "Wireless Magazine" will ensure prompt attention

**NEWS FROM THE RADIO SOCIETIES**  
Continued from page 230

very active nowadays. Its membership includes sixteen fully licensed transmitters in Coventry alone. It has recently become affiliated to the R.S.G.B., and its membership is increasing apace.

Prospective members should write to C. Taylor (G2ZT), 28 Emerson Road, Coventry. The headquarters are situated at Stevens Memorial Hall, New Buildings, Coventry.

**Pembury Short-wave Club**

Short-wave enthusiasts in North London are invited to make themselves known to the secretary of the above club at 57 Pembury Road, London, N.17. The object of the club is to increase its numbers with members between the ages of 16 and 20.

**Hoddesdon and District Radio Society**

This society has recently been authorised to use the call-sign G5HO with its headquarters station. The power is 10 watts, wavelength 168 metres (1,785 kilocycles), and a 40-metre transmission is contemplated shortly.

All reports or inquiries should be addressed to T. L. Franklin, G5HO, Station Road, Broxbourne, Herts.

**South London and District Radio Transmitters' Society**

The S.L.D.R.T.S. (commonly known amongst members as the Sliders) welcomes to its membership all short-wave enthusiasts who are interested in amateur transmission. One need not be a transmitter to join—many of the members are, as yet, only in the "hopeful" stage.

Meetings are held on the first Wednesday of each month at the Brotherhood Hall, West Norwood, S.E.27, and combine a lecture (usually by a member) with an informal discussion.

The plan adopted is as follows: meeting commences at 8 p.m. Preliminary business for a few minutes; lecture commencing about 8.10 p.m.; 9.30 p.m., chairman leaves the chair and free discussion follows until 10 p.m.

**OTHER LOCAL SOCIETIES**

**M**ANY of the old-established local radio societies are known to have changed their titles, and

it is significant that most of them are now "Short-wave and Television Societies." One of these is the former Thornton Heath Radio Society.

Transmitters' societies, run on similar lines to the S.L.D.R.T.S., are in existence in large towns such as Birmingham, Manchester and (I believe) Bristol.

Practically all districts of the R.S.G.B. held their own meetings at some convenient place, and a full calendar of these events is printed each month in the

**AN INVITATION**

Secretaries of short-wave and transmitting societies are invited to make full use of this new feature in "W.M." Contributions and notices should be addressed to G6QB, c/o the Editor, "Wireless Magazine," George Newnes, Ltd., 8-11 Southampton Street, Strand, London, W.C.2

Bulletin, which is received by all members.

Next month I hope to publish notes from the individual chapters of the larger short-wave clubs and also from certain recently-formed transmitters' societies.

Now available... **ROTHERMEL-BRUSH**  
**PIEZO-ELECTRIC**  
**"TWEETER KIT"**

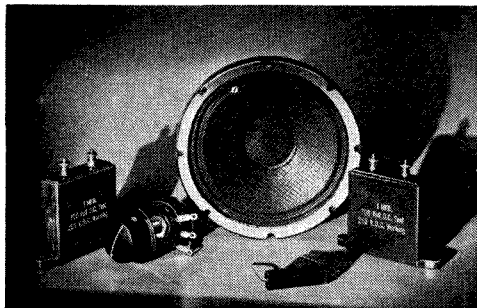

Get to know more about our tweeters, speakers, pickups and microphones by writing to-day for a copy of "PIEZO-ELECTRICITY," a technical treatise on the application of Rochelle Salts to high-fidelity reproducers. Price 9d. post free.

To secure the best possible performance from a "Tweeter" when used in conjunction with a moving-coil speaker a filter circuit is recommended in order to level out the combined response.

The new Rothermel-Brush "Tweeter Kit" contains the following essential units:—

- 1 R155 Rothermel-Brush Piezo-Electric Tweeter.
- 2 1.-mfd. By-pass condensers.
- 1 Centralab graded Radiohm volume control, 25,000 ohm.
- 1.05 non-induction condenser.

PRICE **32/6** COMPLETE

*R.A. Rothermel* LTD

Rothermel House,  
Canterbury Road, High Road, Kilburn, N.W.6.  
Phone: Maida Vale 6066.

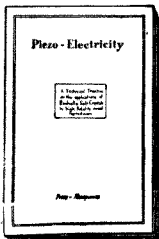

Consider which resistances  
are used most—consider  
which are most reliable—  
consider, and you'll certainly say 'Dubilier' when  
next you buy Resistances

**DUBILIER**  
RESISTANCES

- 1 watt type - 1/- each
- 2 watt type - 2/- each
- 3 watt type - 3/- each

DUBILIER CONDENSER CO. (1925) LTD., DUCON WORKS, VICTORIA ROAD, NORTH ACTON, W.3

R6

## Result of the Avo Minor Competition

### LIST OF PRIZE WINNERS

#### FIRST PRIZE of £1 a Week for One Year:

Mr. Peter Bowers, Pages Hill, Whepstead, Bury St. Edmunds.

#### SECOND PRIZE of 10s. a Week for One Year:

Mr. Krikor Ghazaros, University College Hall, Queen's Walk, Ealing, W.5.

#### THIRD PRIZE of £10 Cash:

Mr. W. H. Stimson, 74a Miller Road, Bedford.

#### CONSOLATION PRIZES TO THE VALUE OF 25s.

##### Class "A"

- Mr. G. A. Harris, 655 Wells Road, Whitchurch, nr. Bristol.  
 Mr. F. L. Laurence, 24 Baffins Road, Copnor, Portsmouth.  
 Mr. E. H. Griffiths, 50 Hillside Gardens, Barnet, Herts.  
 Mr. A. E. Dunn, 15 Pottington Road, Barnstaple, N. Devon.  
 Mr. W. H. Trott, 53 Fleeming Road, Walthamstow, E.17.  
 Mr. J. P. Tourle, "St. Ives," Leicester Road, Laindon, Essex.  
 Mr. J. Thorley, 9 Florence Street, Moss Side, Manchester.  
 Mr. J. Gordon Gerds, "Dalmuir," 23 Leicester Road, Wanstead, E.11.  
 Mr. L. Norman, 78 Galdervale Avenue, Varlow-Moor-Estate, Chorlton-cum-Hardy, Manchester.  
 Mr. H. I. Peel, "St. Georges," Tranby Avenue, Barrow Lane, Hessle, E. Yorks.  
 Mr. N. Howarth, 10 Chesterfield Street, Liverpool, 8.  
 Mr. P. W. Crouch, 86 Broadlands Avenue, Newton Abbot.  
 Mr. F. Bevan, Beech House, Micle Trafford, Chester, Cheshire.  
 Mr. R. C. Payn, 10 Melbourne Terrace, Saltcoats, Ayrshire.  
 Mr. I. M. Ryalls, 19 Templemore Road, Oxtou, Cheshire.  
 Mr. J. H. Rundle, 47 Paternoster Row, E.C.4.  
 Mr. F. G. Ingleton, 22 Cecil Road, Muswell Hill, N.10.  
 Mr. J. Halton, jun., Bluestone Lane, Mawdesley, nr. Ormskirk, Lancs.  
 Mr. W. T. Fellows, 12 Derby Road, North End, Portsmouth.  
 Mr. G. W. Champion, 115 Valdegrave Road, Brighton.
- ##### Class "B."
- Mr. C. Kingston, 62 Hillingdon Road, Gravesend, Kent.  
 Mr. S. Jackman, 6 Eliot Street, Weston Mill Estate, Devonport, Devon.  
 Mr. T. Samson, 16 Prestwick Road, Ayr.  
 Mr. F. Stowell, 1 Frewin Road, Wandsworth Common, S.W.18.  
 Mr. J. Patchton, 67 Eastfield Road, Bordesley Green East, Birmingham 9.

# BIG PAY for TRAINED RADIO MEN

**T**HE Radio Industry offers rich rewards to the trained man. Men with radio knowledge are also needed by Talkie and Gramophone Companies and other important industries.

Leading manufacturers are now preparing for TELEVISION, and there will be wonderful opportunities for the trained man.

**Are you content to remain an on-looker whilst others seize the highly-paid jobs? Are you wasting precious hours when you should be preparing for well-paid employment and an assured future?**

T.C.R.C. Training will give you the knowledge which brings success. It will teach you how to earn a good income or add to your present one. The T.C.R.C. can help you to find employment or teach you how to earn money in your spare time. What it has done for others it can do for you.

#### Qualify for Highly-paid Work.

*A student writes:* "I am indebted to you for this situation. Without the Course I should not have lasted five minutes."

*Another writes:* "He engaged me at a big increase in salary."

*Another:* "Since enrolling I have taken over practically all the battery-set work for a local dealer." (*Spare-time work.*)

*And another:* "I would have been lost had I not covered most of the Course when I was engaged."

(*Many others testify to the value of T.C.R.C. training.*)

#### Trained Men Urgently Needed.

McMichael Radio stated: "The need for good and well-trained men is a very urgent one."

EKCO Radio stated: "Those who complete the thorough Course will be well equipped with

the valuable knowledge so essential to the modern radio craftsman."

(*Other leading manufacturers and the Technical Press also recommend T.C.R.C. Training.*)

#### Personal Tuition by British Experts.

The T.C.R.C. is praised so highly because it specialises in **Radio**. It is a **Radio College** conducted by practical **Radio Experts**.

"Practical Wireless" stated: "The lessons are prepared from first-hand knowledge and practical experience by men who know what they are writing about and how to impart their knowledge to others. **Good positions in the realm of radio are being obtained by students.**"

"Popular Wireless" stated: "The student is then a fully-qualified technician, ready to take a professional appointment."

T.C.R.C. Training is conducted by correspondence. In your own home you can learn how to become a radio expert capable of demanding big money.

#### ACT NOW. Success Awaits You.

Send now for **free book** which tells you how you can become a radio expert. Post coupon below.



R. HEATH BRADLEY, Principal of T.C.R.C.

## TECHNICAL & COMMERCIAL RADIO COLLEGE

Cromwell House, High Holborn, London, W.C.1.

Telephone: Chancery 7054 and 7055.

(Post in unsealed envelope, 3d. stamp.) W.M.7.

To: T. & C. RADIO COLLEGE, Cromwell House, High Holborn, London, W.C.1.

Please send me free copy of book describing your training.

NAME .....

ADDRESS .....

## Tuning Guide for the "H.K." Four

Station	Wave-length	Left-hand Dial	Right-hand Dial	Station	Wave-length	Left-hand Dial	Right-hand Dial
Huizen ... ..	1,875	100	98	Rome ... ..	420.8	64	64
Moscow ... ..	1,724	85	83	Munich ... ..	405.4	60	60
Radio Paris ... ..	1,648	80	78	Scottish Regional	391.1	56	56
Deutschlandsender	1,571	73	70	Leipzig ... ..	382.2	54	54
Droitwich ... ..	1,500	66	63	West Regional ...	373.1	51	51
Eiffel Tower ... ..	1,395	59	56	Berlin ... ..	356.7	46	46
Warsaw ... ..	1,339	55	52	London Regional ...	342.1	44	43
Luxembourg ... ..	1,304	49	46	Hamburg ... ..	331.9	39	39
Kalundborg ... ..	1,261	46	42	Poste Parisien ...	312.8	34	34
Oslo ... ..	1,154	40	37	Midland Regional	296.2	30	30
Stuttgart ... ..	552.6	95	94	Scottish National	285.7	27	27
Vienna ... ..	506.8	90	90	London and West			
Florence ... ..	491.8	85	85	Nationals ... ..	261.1	22	22
Prague ... ..	470.2	79	79	Juan-les-Pins ...	240.2	17	16
North Regional ...	449.1	73	73	Fecamp ... ..	206	12	9

Conditions of calibration: Aerial (compression) condenser screwed right down; detector by-pass (compression) also at maximum. (Note: This is the normal setting here; reduce only if there is difficulty in getting reaction.) Valves and voltages as specified.



# World's Broadcast Wavelengths

Stations best received in the British Isles are indicated in bold type. This list is corrected up to the time of going to press

Note: Names in brackets are those of the main stations from which the greater part of the programmes are relayed

Wave-length	Name of Station	Dial Readings	Country	Wave-length	Name of Station	Dial Readings	Country
13.93	Pittsburgh W8XK		United States	31.45	Zeesen (DJN)		Germany
13.97	<b>Daventry (Empire) GSH</b>		Great Britain	21.48	<b>Schenectady W2XAF (WGY)</b>		United States
14.49	<b>Buenos Aires LSY</b>		Argentina	31.55	<b>Daventry (Empire) GSB</b>		Great Britain
15.92	Bandoeng PLE		Java	31.55	Melbourne VK3ME		Victoria
16.36	Lawrenceville (N.J.) WLA		United States	31.55	Caracas YV3BC		Venezuela
16.38	<b>Rugby GAS</b>		Great Britain	31.58	Rio de Janeiro PSA		Brazil
16.5	Drummondville (CFA8)		Canada	31.6	<b>Skamleback</b>		Denmark
16.56	Bandoeng PMC		Java	31.71	New Brunswick WKJ		United States
16.56	Buenos Aires LSY3		Argentina	31.9	Bandoeng PLV		Java
16.81	Bandoeng PLF		Java	32.71	<b>Lawrenceville WNA</b>		United States
16.85	Kootwijk PCV		Holland	32.79	Maracay YVQ		Venezuela
16.86	Daventry Empire GSG		Great Britain	32.88	Szekesfehervar HAT4		Hungary
16.878	<b>Boundbrook W3XAL (WJZ)</b>		United States	33.26	Rugby GCS		Great Britain
16.88	<b>Eindhoven PHI</b>		Holland	33.59	Rocky Point (N.J.) WEC		United States
19.47	Riobamba PRADO		Ecuador	34.68	London VE9BY		Canada
19.52	<b>Szekesfehervar</b>		Hungary	36.65	Rio de Janeiro PSK (PRA3)		Brazil
19.56	<b>Schenectady W2XAD (WGY)</b>		United States	37.04	Quito HCJB		Ecuador
19.61	La Paz CP4		Bolivia	37.33	Rabat (CNR)		Morocco
19.63	<b>New York W2XE (WABC)</b>		United States	37.41	Suva VPD		Fiji Isles
19.66	<b>Daventry (Empire) GSI</b>		Great Britain	38.07	Tokio JIAA		Japan
19.67	Coytesville N.J. WIXAL (WEEI)		United States	38.47	<b>Radio Nations HBP</b>		Switzerland
19.67	Tashkent (Rim)		U.S.S.R.	38.65	Kootwijk PDM		Holland
19.68	<b>Radio Coloniale FYA</b>		France	39.34	Tashkent RIM		U.S.S.R.
19.72	<b>Saxonburg W8XK (KDKA)</b>		United States	39.76	Moscow RKI		U.S.S.R.
19.74	<b>Zeesen DJB</b>		Germany	39.82	Riobamba PRADO		Ecuador
19.82	Daventry (Empire) GSF		Great Britain	40.3	Radio Nations HBQ		Switzerland
19.84	Rome (Vatican) HVJ		Italy	40.5	Bogota HJ3ABB		Colombia
19.88	Moscow (RKI)		U.S.S.R.	40.54	Rocky Point WEN		U.S.A.
19.93	<b>W8XK, Saxonburg (KDKA)</b>		United States	41.55	Bogota HKE		Colombia
20.27	Rocky Point WQV		United States	41.6	Las Palmas EA8AB		Canary Isles
20.31	Rocky Point N.Y. (WEB)		United States	41.67	Singapore VSIAB		Sis. Sett'l mts.
21.43	Cairo SUV		Egypt	41.84	Grenada YN6RD		Nicaragua
21.53	Rocky Point WIK		United States	41.9	Manizales HJ4ABB		Colombia
21.58	Rocky Point WQP		United States	43	Madrid EA4AQ		Spain
21.605	Rocky Point WQT		United States	43.86	Budapest HAT2		Hungary
21.83	Drummondville CJA8		Canada	44.61	Rocky Point WQO		United States
22.26	Rocky Point WAJ		United States	44.96	Maracay YVQ		Venezuela
22.48	Santa Rita YVQ		Venezuela	45	Constantine FM8KR		Tunis
22.684	<b>Zeesen (DHB)</b>		Germany	45	Guayaquil HC2RL		Ecuador
23.39	<b>Radio Maroc (Rabat) CNR</b>		Morocco	45.38	Moscow RW72		U.S.S.R.
24.41	Rugby GBU		Great Britain	46.53	Barranquilla (HJ1ABB)		Colombia
24.9	Kootwijk PDV		Holland	46.69	<b>Boundbrook W3XAL (WJZ)</b>		United States
25	Moscow RNE		U.S.S.R.	46.7	Boston WIXAL		United States
25.25	Radio Coloniale, Paris (FYA)		France	47	Cali HJ5ABB		Colombia
25.27	<b>Saxonburg (Pa.) W8XK (KDKA)</b>		United States	47.5	S. Domingo HIZ		Dominican R.
25.28	<b>Daventry (Empire) GSE</b>		Great Britain	47.8	Domingo HIAA		Dominican R.
25.34	Wayne W2XE (WABC)		United States	48.75	Winnipeg CJRO		Canada
25.4	<b>Rome 2RO</b>		Italy	48.78	Caracas YV3BC		Venezuela
25.45	Boston WIXAL (WEEI)		United States	48.86	<b>Saxonburg (Pa.) W8XK (KDKA)</b>		United States
25.47	<b>Zeesen DJD</b>		Germany	48.86	Moscow (RKK)		U.S.S.R.
25.532	<b>Daventry (Empire) GSD</b>		Great Britain	49	Johannesburg ZTJ		South Africa
25.63	Radio Coloniale FYA		France	49.02	Wayne W2XE (WABC)		United States
26.83	Funchal CT3AQ		Madeira	49.08	<b>Caracas YVIBC</b>		Venezuela
27.65	Nauen DFL		Germany	49.1	<b>Daventry (Empire) GSL</b>		Great Britain
27.86	Rugby GBP		Great Britain	49.18	<b>Boundbrook W3XAL (WJZ)</b>		United States
27.88	Marapicu PSG		Brazil	49.22	Chicago W9XF (WENR)		United States
28.28	Rocky Point (N.J.) WEA		United States	49.22	Bowmanville VE9GW (CRCT)		Canada
28.5	Sydney VLK		N.S. Wales	49.26	St. John VE9BJ (CFBL)		N. Brunswick
28.98	Buenos Aires LSX		Argentina	49.3	La Paz CP5		Bolivia
29.03	Bermuda ZFD		West Indies	49.34	Chicago W9XAA (WCFL)		United States
29.04	Ruyselede (ORK)		Belgium	49.35	<b>Zeesen (D9M)</b>		Germany
29.35	Marapicu PSH		Brazil	49.39	Maracaibo V5BMO		Venezuela
29.59	Leopoldville OPM		Belgian Congo	49.4	Vienna OER2		Austria
29.64	Marapicu PSI		Brazil	49.43	Vancouver VE9CS (CKFC)		Brit. Columbia
29.84	Abu Zabel, Cairo SUV		Egypt	49.47	Nairobi VQ7LO		Kenya Colony
30	Radio Excelsior LR5		Argentina	49.5	<b>Skamleback</b>		Denmark
30.1	Rome IRS		Italy	49.5	<b>Philadelphia W4XAU (WCAU)</b>		United States
30.4	Lawrenceville WON		United States	49.5	Cincinnati W8XAL (WLW)		United States
30.4	Tokio JIAA		Japan	49.586	<b>Daventry (Empire) GSA</b>		Great Britain
30.00	Madrid EAQ		Spain	49.6	Bogota HJ3ABI		Colombia
30.77	Lawrenceville WOF		United States	49.67	Boston WIXAL (WEEI)		United States
30.9	<b>Rugby GCA</b>		Great Britain	49.83	<b>Zeesen DJC</b>		Germany
31.23	Mexico City XE1E		Mexico	49.9	Singapore ZHI		F.M. States
31.25	<b>Lisbon CTIAA</b>		Portugal	49.92	Havana COC		Cuba
31.26	Radio Nations HBL		Switzerland	49.96	<b>Drummondville VE9DN (CFCF)</b>		Canada
31.28	<b>Philadelphia W3XAU (WCAU)</b>		United States	50	<b>Moscow RNE</b>		U.S.S.R.
31.28	<b>Sydney VK2ME</b>		N.S. Wales	50.8	Barcelona EA3AB		Spain
31.32	<b>Daventry (Empire) GSC</b>		Great Britain				
31.35	<b>Millis W1XAZ (WBZ)</b>		United States				
31.38	<b>Zeesen DJA</b>		Germany				
31.41	Jeløy LCL		Norway				

Continued on page 236

## Notes and Jottings

**B**URNE-JONES & CO., LTD., of 296 Borough High Street, London, S.E.1, has now supplied 25,000 sets for the use of blind people. All sets are fitted with special tuning dials in Braille characters.

Oldham & Sons, Ltd., has just marketed a new range of high-tension batteries known as the red-band type. A 60-volt type costs 4s. 6d., a 100-volt, 7s., and the 120-volt size retails at 8s. 6d.

Look Out for Another Fine Issue of  
**"WIRELESS MAGAZINE"**  
 On Thursday, April 18  
 It Is Wise To Order Your Copy  
 From Your Newsagent in Advance

Listeners to Söttens will be interested to hear that the power is to be increased from 25 to 100 kilowatts. The contract for the work has been placed with Standard Telephones & Cables of Connaught House, Aldwych, London, W.C.2. The new station will open in the autumn.

Marconiphone announce the release of a new valve—the N41—a power pentode with an indirectly-heated cathode for use in the output stage of radio receivers and amplifiers. The valve has a high mutual conductance figure and can be fed directly from a diode detector.

A new Drydex battery, type H1116, is now available and is suitable for the Bush SB4 receiver.

### DIRECTOR OF TELECOMMUNICATIONS

The Post Office announces that the Departments of Telegraphs and Telephones will in future be known as the Department of Telecommunications embracing two branches dealing with telegraphs and telephones respectively.

F. W. Philips, Assist. Secretary, has been appointed director of the department. Mr. Philips entered the Post Office as a telegraphist some forty years ago. He was head of the British delegation to the Lucerne Radio Conference and was a member of the commission set up to report on television.

He is a member of the new Television Advisory Commission.

# SPECIFIED FOR BOTH

THE "H.K." FOUR AND THE STANDARD 4-VALVE SHORT WAVE



Whether your set be "super-het" or "straight," old or new, the remarkable performance of the W.B. STENTORIAN will give you a new conception of radio realism.

Its new "Whiteley" speech coil will bring a new and amazing realism, and its *exclusive* magnetic material, giving nearly double strength at equal cost, will provide a majestic volume that will surprise you.

A W.B. STENTORIAN has been specified exclusively, or as author's first choice, for 95 per cent. of "straight" and "super-het" receivers published since the Exhibition. Ask your dealer to demonstrate to-day, and you will realise why!

#### READ WHAT USERS SAY

"... In fact, no words of mine can express my feelings about this masterpiece of loud-speaker art, and I can only say that from henceforth W.B. Stentorian is my motto and I am proud of it."

—A. H. K., Brierley Hill.  
 "I have at last got the perfection I have always wanted—through getting your W.B. Stentorian."—H. McA., Sheffield.

"The claims you make are in every way justified. Reproduction is almost unbelievably natural."

—D. D., Chesham.

Stentorian Senior (PMS1) 42/-  
 (100 per cent. dust protection. Oversize cone.)

Stentorian Standard (PMS2) 32/6  
 Stentorian Baby (PMS6) 22/6



# STENTORIAN

PERMANENT MAGNET MOVING COIL SPEAKERS

Whiteley Electrical Radio Co., Ltd., Radio Works, Mansfield, Notts

Sole Agents in Scotland:  
 Radiovision Ltd., 233 St. Vincent Street, Glasgow, C.2

Sole Agents in I.F.S.:  
 Kelly and Shiel, Ltd., 47, Fleet Street, Dublin

## Every Specification demands ERIE quality—See all three Sets in this issue

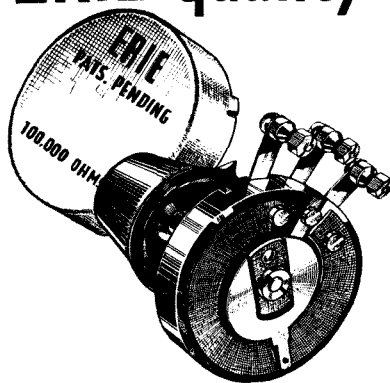

The ERIE  
 Volume Control  
 SPECIFIED for the "H.K." FOUR

Whatever your set, fit the Erie Variable Resistance. With the bone-hard Erie resistance element and Erie precision construction, it is a definite improvement on everything else of its kind. Contact is smooth and positive; there are no hop-off noises; its absolutely noiseless efficiency is permanent. Made in all values, 5,000 ohms to 2 megohms. At all dealers.

3/6 Or with built-in mains switch, 5/-

# ERIE RESISTORS

Mr. Paul D. Tyers specifies Eries throughout his special "Stenode" Set. Make sure that you get genuine Erie impregnated Carbon Resistors, for there are cheaper colour-coded resistances which are definitely not the same thing. Look for the Erie label; it identifies guaranteed reliability.

FREE.—Send for the helpful "Erie Servic" Instruction Booklet."

THE RADIO RESISTOR CO., LTD., 1 Golden Square, London, W.1

1/-  
 Per Watt  
 in all  
 Values

ERIES Specified  
 for the Paul Tyers  
 Special "STENODE"  
 Receiver

ERIES Specified  
 FOR THE  
 4-Valve Short-Waver  
 "Your Second Set"

# WORLD'S BROADCAST WAVELENGTHS Continued from page 234

Note Specially the Re-arrangement of British Wavelengths

Wave-length	Name of Station	Dial Readings	Country	Wave-length	Name of Station	Dial Readings	Country
50.26	Rome (Vatican) HVJ ..		Italy	298.8	Bratislava .. ..		Czechoslovakia
50.42	Domingo HIX .. ..		Dominican R.	301.5	Hilversum .. ..		Holland
50.6	Medellin HJ4ABE ..		Colombia	304.3	Genoa .. ..		Italy
55.56	Szehesfehar .. ..		Hungary	307.1	Belfast .. ..		N. Ireland
56.9	Königswusterhausen (DTG)		Germany	309.9	Odessa .. ..		U.S.S.R.
57.03	Rocky Point WQN ..		United States	312.8	Poste Parisien, Paris		France
58.03	Bandoeng PMY .. ..		Java	315.8	Breslau .. ..		Germany
58.31	Prague .. ..		Czechoslovakia	318.8	Goteborg .. ..		Sweden
60.3	Rugby GBC .. ..		Great Britain	321.9	Algiers .. ..		North Africa
62.5	Long Island (N.J.) W2X		United States	325.4	Brussels (2) ..		Belgium
62.5.1	London .. ..		Ontario	325.4	Brno .. ..		Czechoslovakia
65.93	Rocky Point WAD ..		United States	328.6	Radio Toulouse ..		France
68.18	Moscow (RFCK) .. ..		U.S.S.R.	331.9	Hamburg .. ..		Germany
69.44	Rugby GDB .. ..		Great Britain	335.2	Helsinki .. ..		Finland
70.2	Khabarovsk RV15 ..		U.S.S.R.	338.6	Graz .. ..		Austria
73	Quito (HCJB) .. ..		Ecuador	342.1	London Regional		Great Britain
76	Maracay (YV11AM)		Venezuela	345.6	Poznan .. ..		Poland
80	Lisbon C'FICT .. ..		Portugal	349.2	Strasbourg .. ..		France
84.5	Berlin D4AGE .. ..		Germany	352.9	Bergen .. ..		Norway
84.67	Mozambique CR7AA ..		East Africa	356.7	Valencia .. ..		Spain
85.9	Boston WIXAL .. ..		United States	360.6	Berlin .. ..		Germany
203.5	Plymouth .. ..		Great Britain	360.6	Moscow (4) .. ..		U.S.S.R.
204.8	Bournemouth .. ..		Great Britain	364.5	Bucharest .. ..		Roumania
206	Pecc .. ..		Hungary	368.6	Milan .. ..		Italy
207.3	Fécamp .. ..		France	373.1	West Regional ..		Great Britain
209.9	Miskolcz .. ..		Hungary	377.4	Salonika .. ..		Greece
209.9	Beziers .. ..		France	377.4	Lvov .. ..		Poland
211.3	Alexandria .. ..		Egypt	382.2	Barcelona (EAJ1)		Spain
214	Tampere .. ..		Finland	382.2	Leipzig .. ..		Germany
215.1	Sofia .. ..		Bulgaria	386.6	Toulouse PTT ..		France
216.8	Radio Lyons .. ..		France	391.1	Scottish Regional		Great Britain
218.2	Warsaw No. 2 .. ..		Poland	395.8	Katowice .. ..		Poland
219.6	Basle, Berne .. ..		Switzerland	400.5	Marseilles PTT ..		France
221.1	Torun .. ..		Poland	405.4	Munich .. ..		Germany
221.1	Turin (2) .. ..		Italy	410.4	Seville .. ..		Spain
222.5	Milan (2) .. ..		Italy	410.4	Tallinn .. ..		Estonia
222.6	Dublin .. ..		Irish F. State	415.5	Madrid (España)		Spain
222.6	Bordeaux S.O. .. ..		France	420.8	Kiev .. ..		U.S.S.R.
224	Königsberg .. ..		Germany	420.8	Rome .. ..		Italy
224	Montpellier .. ..		France	426.1	Stockholm .. ..		Sweden
225.6	Lodz .. ..		Poland	431.7	Paris PTT .. ..		France
225.6	Hanover .. ..		Germany	437.3	Belgrade .. ..		Yugoslavia
225.6	Bremen .. ..		Germany	443.1	Sottens .. ..		Switzerland
230.2	Flensburg .. ..		Germany	449.1	North Regional		Great Britain
230.2	Stettin .. ..		Germany	455.9	Cologne .. ..		Germany
230.2	Magdeburg .. ..		Germany	463	Lyons PTT .. ..		France
231.8	Danzig .. ..		Germany	470.2	Prague (1) .. ..		Czechoslovakia
231.8	Linz .. ..		Austria	476.9	Trondheim .. ..		Norway
231.8	Salzburg .. ..		Austria	483.9	Brussels (1) ..		Belgium
233.5	Dornbirn .. ..		Austria	492	Florence .. ..		Italy
233.5	Aberdeen .. ..		Great Britain	499.2	Sundsvall .. ..		Sweden
235.1	Dresden .. ..		Germany	506.8	Rabat .. ..		Morocco
236.8	Stavanger .. ..		Norway	514.6	Vienna .. ..		Austria
238.5	Nurnberg .. ..		Germany	514.6	Agen .. ..		France
240.2	San Sebastian .. ..		Spain	522.6	Riga .. ..		Latvia
242	Rome (3) .. ..		Italy	531	Stuttgart .. ..		Germany
242.7	Juan-les-Pins .. ..		France	539.6	Athlone .. ..		Irish F. State
243.7	Cork .. ..		Irish F. State	549.5	Beromünster ..		Switzerland
245.5	Gleitwitz .. ..		Germany	559.7	Budapest .. ..		Hungary
247.5	Trieste .. ..		Italy	569.3	Wilno .. ..		Poland
249.2	Lille PTT .. ..		France	569.3	Bolzano .. ..		Italy
249.2	Prague Strasnice (2)		Czechoslovakia	578	Viipuri .. ..		Finland
251	Frankfurt-am-Main ..		Germany	578	Ljubljana .. ..		Yugoslavia
251	Trier .. ..		Germany	578	Innsbruck .. ..		Austria
251	Freiburg-im-Breisgau		Germany	578	Hamar .. ..		Norway
253.2	Cassel .. ..		Germany	696	Oulu .. ..		Finland
253.2	Kaiserslautern .. ..		Germany	748	Moscow .. ..		U.S.S.R.
255.1	Kharkov (2) .. ..		U.S.S.R.	765	Geneva .. ..		Switzerland
257.1	Copenhagen .. ..		Denmark	834	Boden .. ..		Sweden
259.1	Monte Ceneri .. ..		Switzerland	845	Budapest No. 2		Hungary
261.1	Kosice .. ..		Czechoslovakia	845	Finnmark .. ..		Norway
261.1	London National ..		Great Britain	1,107	Moscow (2) ..		U.S.S.R.
263.2	North National ..		Great Britain	1,134	Oslo .. ..		Norway
265.3	West National .. ..		Great Britain	1,224	Leningrad .. ..		U.S.S.R.
267.4	Turin (1) .. ..		Italy	1,261	Kalundborg .. ..		Denmark
267.4	Horby .. ..		Sweden	1,304	Luxembourg ..		Luxembourg
270	Newcastle .. ..		Great Britain	1,339	Ankara .. ..		Turkey
270	Nyiregyhaza .. ..		Hungary	1,389	Warsaw .. ..		Poland
271.7	Moravska-Ostrava ..		Czechoslovakia	1,389	Motala .. ..		Sweden
274	Madona .. ..		Latvia	1,395	Eiffel Tower ..		France
276.2	Madrid EAJ7 .. ..		Spain	1,442	Minsk .. ..		U.S.S.R.
276.2	Falun .. ..		Sweden	1,500	Droitwich National		Great Britain
278.6	Zagreb .. ..		Yugoslavia	1,571	Deutschlandsender		Germany
280.9	Bordeaux PTT .. ..		France	1,600	Istanbul .. ..		Turkey
283.3	Tiraspol .. ..		U.S.S.R.	1,648	Radio Paris ..		France
285.7	Bari .. ..		Italy	1,724	Moscow No. 1 ..		U.S.S.R.
288.5	Scottish National ..		Great Britain	1,807	Lahti .. ..		Finland
288.5	Leningrad (2) .. ..		U.S.S.R.	1,875	Kootwijk .. ..		Holland
291	Rennes PTT .. ..		France	1,875	Huizen .. ..		Holland
291	Königsberg .. ..		Germany	1,935	Brasov .. ..		Roumania
293.5	Paredes .. ..		Portugal	1,935	Kaunas .. ..		Lithuania
296.2	Barcelona (EAJ15) ..		Spain				
296.2	Midland Regional ..		Great Britain				

# AMPLION

## "RADIOLUX" RADIOGRAM

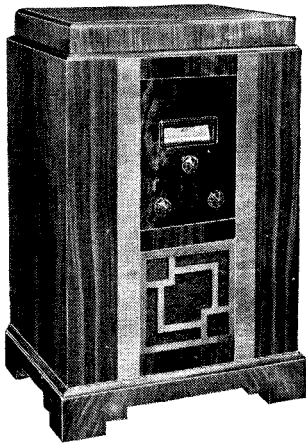

This is a remarkably fine instrument with many outstanding features.

Automatic Volume Control, Neon Light Visual Tuning, Full Vision Scale Illuminated, and Calibrated in Metres and Degrees, Energised Moving-coil Speaker.

Collaro Gramophone Motor is electrically operated. Fitted with full Automatic Stop. Pick-up is the well-known Amplion Unit. Beautiful Cabinet veneered in two-tone walnut with burr walnut control panel.

5-Valve, including rectifier. For A.C. Mains 190/265 or 110 volts, 40/100 cycles.

H.P. Terms: £2 17s. 9d.  
Deposit and 12 payments of £1 15s.

**21 Gns.**

See test report on page 222.

# 50 ohms to 100,000

WIRE-WOUND RESISTORS

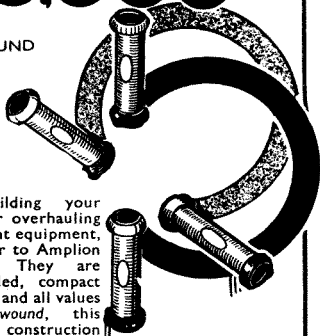

When building your next set or overhauling your present equipment, change over to Amplion resistors. They are colour coded, compact and sturdy, and all values are wire-wound, this method of construction giving the most reliable and constant form of resistance.

See Test Report on pages 158-9 of March Issue

Price 1/- each, all values

AMPLION 1-watt WIRE-WOUND RESISTORS  
Obtainable from all dealers

Descriptive Literature "W.M." Free on Request.

**AMPLION (1932) LTD,**  
82-84, Rosoman Street, Rosebery Ave.,  
London, E.C.1

Telephone: Clerkenwell 5440/1.

## Tests of New Apparatus

### W.B. BABY CABINET LOUD-SPEAKER

**W**HITLEY Electrical Radio Co., Ltd., have produced a small cabinet loud-speaker of universal type.

The universal input transformer is screwed to the base of the cabinet, and connections are made by means of plugs and sockets, while there are also a number of terminals. Provision is made for a low-resistance connection to the coil, and there are terminals providing for a centre

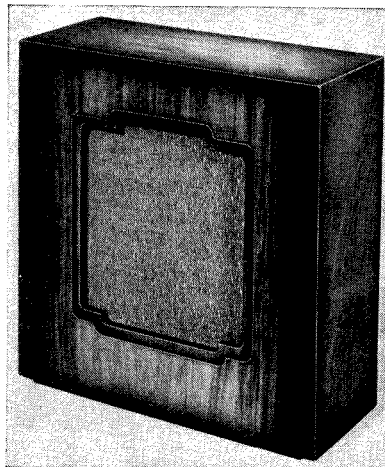

The W.B. Baby cabinet loud-speaker which sells at £1 9s. 6d.

tap and five alternative sockets. This enables ratios to be obtained between  $97\frac{1}{2}$  to 1, and 1 to 1. The arrangement of the leads is such that class-B, Q.P.P., and ordinary push-pull working is possible.

The general construction of the speaker appears to be quite sound, and the various ratios which are obtainable seem to represent a good compromise suitable for average working conditions.

Considering the small size of the speaker the performance is very creditable. As might be imagined, the speaker is very good in the upper registers, and it has crisp, clean attack. The low-note radiation cannot be compared with that of a full-size speaker, but reproduction below 200 cycles is very satisfactory. The resonances are not very marked, a few being noticed in the region of 140, 300, 1,200 and 3,000 cycles.

In short, the speaker is a satisfactory example of a small universal model; it should have many uses.

# PETO-SCOTT

IMMEDIATE DELIVERY CASH C.O.D.

## PILOT AUTHOR KITS

SEND US YOUR ENQUIRIES FOR EVERYTHING RADIO

Build with a Pilot Author Kit and make a 100 per cent. success certain. Since 1919 the most popular Kits with Home Constructors the whole world over because they are exact to the designer's specification and are complete down to the last screw.

### 1935 A.C. STENODE

Described in this month's issue.

**KIT "A"** Author's Kit of first specified parts, less Valves, cabinet and speaker. **Cash or C.O.D. £14 12 6**  
Or 12 monthly payments of 26/9 Carriage Paid

**KIT "B"** As for Kit "A," but including set of 6 specified Valves, less Cabinet. **Cash or C.O.D. £19 12 6**  
Or 12 monthly payments of 38/-

**KIT "C"** As for Kit "A," but including set of specified Valves and Peto-Scott Console Cabinet. **Cash or C.O.D. £21 7 6**  
Or 12 monthly payments of 39 3.

### KIT-BITS

You pay the Postman. We pay post charges on orders value over 10/- **GREAT BRITAIN ONLY.**

	£ s. d.
1 Peto-Scott ready drilled power pack platform, Plywood baseboard, brass extension spindle and Coupling piece	2 0
1 Belling Lee set of stenode couplers	3 5 0
1 Varley Mains transformer, type EP.33	1 17 6
1 Colvern Super-hot tuning pack	2 17 6
1 B.T.S. stenode Jack with plug	3 0

### EXCLUSIVELY SPECIFIED

### PETO-SCOTT

### CHASSIS and SCREENING BOX

**ASSEMBLY** Constructed from sheet iron. Ready drilled to specification. Finished in battleship grey.

**17/6**

Cash or C.O.D. Carriage Paid

### H. K. 4

**KIT "A"** Cash or C.O.D. **£10:10:0**  
Carriage Paid

Or 12 monthly payments of 19/3

**KIT "B"** Cash or C.O.D. Carriage Paid, **£13/6/6**,

or 12 monthly payments of 24/6.

**KIT "C"** Cash or C.O.D. Carriage Paid, **£15/1/6**,

or 12 monthly payments of 27/9.

Peto-Scott HK4 Table Cabinet, complete with Polished Walnut Plywood Panel. **Cash or C.O.D., Carriage Paid, £1/15/0.**

### STANDARD 4-V SHORT WAVE

**KIT "A"** Cash or C.O.D. **£5:15:0**  
Carriage Paid

Or 12 monthly payments of 10/6

**KIT "B"** Cash or C.O.D. Carriage Paid, **£7/10/6**,

or 12 monthly payments of 13/9.

**KIT "C"** Cash or C.O.D. Carriage Paid, **£8/10/0**,

or 12 monthly payments of 15/6.

### "W.M." 3-VALVER

**KIT "A"** Cash or C.O.D. **£1:19:6**  
Carriage Paid

Or 5/- deposit and 6 monthly payments of 6/6

**KIT "B"** Cash or C.O.D. Carriage Paid, **£2/16/6**, or

7/6 deposit and 7 monthly payments of 7/9.

**KIT "C"** Cash or C.O.D. Carriage Paid, **£3/11/6**, or

deposit 7/6 and 9 monthly payments of 8/-.

### 1935 SUPER FIVE

**KIT "A"** Cash or C.O.D. **£8:11:6**  
Carriage Paid

Or 12 monthly payments of 15/9

**KIT "B"** Cash or C.O.D. Carriage Paid, **£11/19/6**,

or 12 monthly payments of 22/-.

**KIT "C"** Cash or C.O.D. Carriage Paid, **£13/2/0**,

or 12 monthly payments of 24/-.

### PETO-SCOTT CO. LTD.

77 (W.M.4) CITY ROAD, LONDON, E.C.1

Telephone: Clerkenwell 9406/7

West End Showrooms: 62 High Holborn, London, W.C.1

EST. 1919

# EASY TERMS

We specialise in the supply of all good quality kits, components and accessories. Send list of requirements and keen quotation will be sent promptly. Cash and C.O.D. orders despatched by return of post. *Price lists FREE.*

## SEND 2/6 W.B. STENTORIAN

Revitalise your set with **SENIOR PM S.1 UNIT.**  
Cash price **£2 2s.**, or 2/6 with order and 11 monthly payments of 4/-.

**STANDARD PM SPEAKER**  
Cash price **£1 12s. 6d.** or 2/6 with order and 11 monthly payments of 3/-.

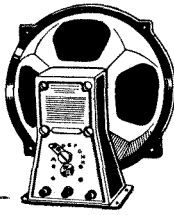

## SEND 7/- GARRARD RADIO-GRAM UNIT

Model A.C.6, complete with volume control, ready for use. This unit converts any radio receiver into a high-class radio-gram for A.C. mains. Cash price **£4 0 0** or 7/- with order and 11 monthly payments of 7/4. All other GARRARD motors supplied on similar terms. Illustrated list free.



Estd. 1925 **THE LONDON RADIO SUPPLY COMPANY** 'PHONE NATIONAL 1977  
11, OAT LANE - NOBLE STREET - LONDON, E.C.2

# 3 Short Wave BLUEPRINTS FREE!

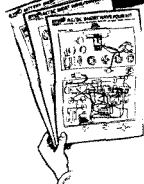

- B.T.S. A.C.-D.C. SHORT WAVE 4.
- B.T.S. BATTERY SHORT WAVE 4.
- B.T.S. A.C.-D.C. SHORT WAVE CONVERTER.

To introduce to readers of "Wireless Magazine" these latest B.T.S. Short Wave Circuits, designed by leading British Short Wave Experts, we will gladly send you descriptive leaflets and BLUEPRINTS of the above 3 Short Wave Sets. Simply send the Coupon. If you are a keen Short Wave Enthusiast you cannot afford to miss this wonderful opportunity.

If it's Short Waves or Television, ask your local Radio Dealer for B.T.S. and follow the experts' choice.



## COUPON SPECIALISTS IN SHORT WAVE TECHNIQUE

BRITISH TELEVISION SUPPLIES, LTD., Bush House, Dept. W.M.1, London, W.C.2.

Please send me descriptive literature of the B.T.S. Short Wave Kits, and FREE BLUEPRINTS, for which I enclose 3d. in stamps to cover postage.

NAME .....

ADDRESS .....

W.M.1.

# In Tune with the Trade

By EXAMINER

## SEND TO US FOR THESE CATALOGUES!

Here we review the newest booklets and folders issued by six manufacturers. If you want copies of any or all of them, just cut out this coupon and send it to us. We will see that you get all the literature you desire.

Please indicate the numbers (seen at the end of each paragraph) of the catalogues you want below:—

My name and address are :—

Send this coupon in an unsealed envelope, bearing i.d. stamp, to "Catalogue Service," WIRELESS MAGAZINE, 8-11 Southampton St., W.C.2. Valid till April 30.

## CONDENSERS BY DUBILIER

THERE is no need for me to say much about the reliability of Dubilier condensers and resistances. But I do feel that I should bring to your notice this firm's latest booklet in which all the various types and sizes of condenser are illustrated and priced.

This is a veritable goldmine of information for the enthusiastic amateur. Dubilier makes all sorts and sizes to suit all conditions of work and all sizes of pocket. For instance, the ordinary man building his battery set can get such popular sizes as the .0001 to .0003 for as little as 6d.—these condensers are rated as 250-volt D.C. working.

I noticed that a large space is devoted to electrolytic condensers. Dubilier makes an extensive range of dry electrolytics, notably the low-voltage type.

Among the resistances are the famous Spirohm types, ranging from 200 ohms to carry 200 milliamperes, to 50,000 ohms types carrying 10 milliamperes.

Then there is another section dealing with suppressor arrangements for car-radio use. This will be found of practical value for Dubilier devotes a whole page of this catalogue to a drawing showing how the various bits and pieces are distributed round the car engine.

Altogether a booklet that should be in the possession of every constructor. **449**

Continued on next page

# CLIX Specified for the "1935 A.C. STENODE"

The designer has chosen and you require these CLIX CHASSIS MOUNTING VALVEHOLDERS

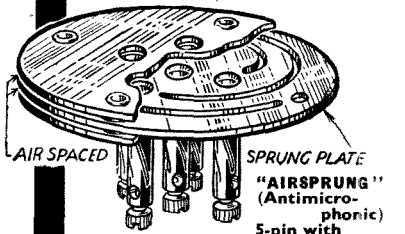

Clix "Airsprung" Anti-microphonic Valveholder is designed to—

- Damp out actual physical shocks to the valve.
- Insulate the valve from consistent vibration set up by the transformer on the chassis.
- Counteract and absorb the air pulsations set up by the increased acoustic output of modern receivers.



Lectro Linx Ltd., 79a Rochester Row, London, S.W.1

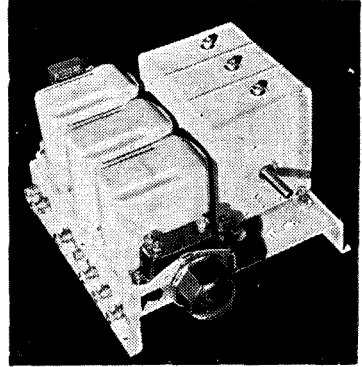

# GOLPAK

finest tuning unit of all

chosen for the

# 1935 A.C. STENODE

Type H. Price complete 57/6  
You must fit one in yours!

## COLVERN LTD.

Romford, - - - Essex.  
London office:—150 King's Cross Road, W.C.1



IN TUNE WITH THE TRADE

Continued from page 238

SHORT-WAVE KITS

I HAVE been looking through leaflets sent to me by British Television Supplies in which short-wave sets (in kit form) and components are listed.

Of rather special interest is a four-valve A.C./D.C. kit which will tune from 13 to 260 metres. The set is built up on both sides of a metal chassis and is provided with a metal panel.

B.T.S. make a complete range of short-wave components such as low-loss coils, high-frequency chokes. I suggest that you drop a line for these leaflets—you will find them most interesting and useful. **450**

KINVA SPECIALITIES

KINVA — otherwise Postlethwaite Brothers, of Kinver, Stourbridge—has issued a broad-sheet setting out this firm's present range of radio components.

Of special interest are the whistle filters. One, the model A3 costing 13s. 6d. cuts off all frequencies above 3,500. The filter is connected in the detector or low-frequency anode circuits and is capable of passing a current of 20 milliamperes.

Other components in the Kiva range include screened high-frequency chokes, tuning coils, screened and otherwise, and a complete range of mains transformers and smoothing chokes. **451**

ALL-WAVE RECEIVERS

DURING the past few weeks many readers have written asking for details of all-wave receivers working on either A.C. or D.C. mains.

In a batch on new catalogues I have come across one issued by Universal High Voltage Radio, in which are details of two all-wave receivers of the A.C./D.C. variety. These sets cover three distinct wavebands — from 19 to 52 metres. *Continued on next page*

**1935 A.C. TENOUE HK 4**  
 Complete First Specified Specified Kit Complete  
 Kit £8 - 5 - 0 £7 - 5 - 0  
**MELFO-RAD QUEEN'S HOVE**  
 PLACE  
 —FOR ALL SPECIFIED KITS.—LISTS F.E.E.—

When writing to Advertisers  
 please mention  
**WIRELESS MAGAZINE**

Service your own Radio  
**IT'S CHEAPER!**

Many an owner of a Pifco test-meter has found that its original cost has been saved time and time again by its easy and quick indication of the faults in a radio receiver, thus enabling the owner to replace only the actual component which is faulty instead of paying expensive service bills and replacement costs. With a Pifco Rotameter or Radiometer, trouble-tracing becomes simple and certain.

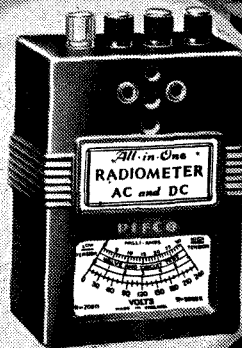

The "All-in-One" RADIOMETER for A.C. or D.C. For testing electric or battery radio sets. Anybody can trace faults with this wonder instrument. Finished in black bakelite, size of dial 1 1/2 in. by 1/2 in., complete with leads. Price 12s. 6d. Case 2s. 6d. extra.

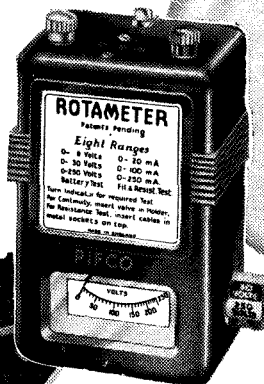

ROTAMETER (9 Ranges). Eight separate dials and valve test available at the turn of a knob. Size of each dial, 1 in. by 1/2 in. Finished in black bakelite, complete with leads. Price, 29s. 6d. Case 2s. 6d. extra.

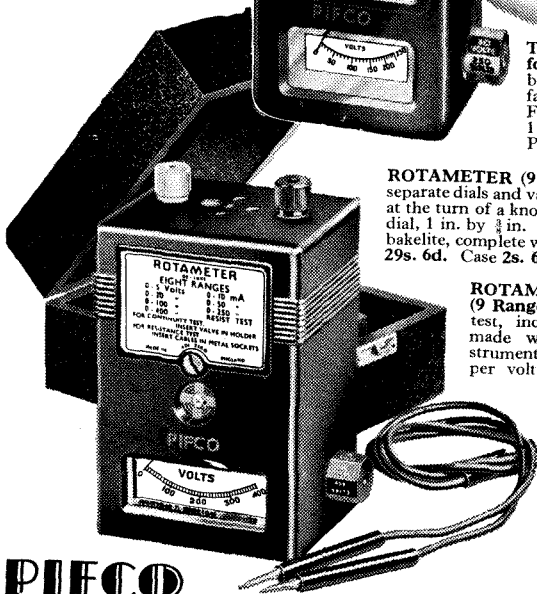

ROTAMETER - DE - LUXE (9 Ranges). Every conceivable test, including valves can be made with this amazing instrument (400 volts—500 ohms per volt). Finished in black bakelite, complete with leads and fitted in handsome velvet-lined case. Price 42s. complete.

Ask your dealer to-day to show you one, or write for Pifco Test-meter Folder, post free, from—**PIFCO, LTD., SHUDEHILL, MANCHESTER,** or 150 Charing Cross Road, London, W.C.2.

**PIFCO**  
**ROTAMETERS and RADIOMETERS**  
**PIFCO ON THE SPOT WILL TRACE YOUR TROUBLES LIKE A SHOT**

**1935 EDITION... FREE!**

A new and greatly enlarged edition of "ENGINEERING OPPORTUNITIES" is just published. It describes the easy way in which you may become an A.M.I.C.E., A.M.I.Mech.E., A.M.I.E.E., A.M.I.A.E., A.M.I.W.T., etc., under our "NO PASS—NO FEE" guarantee, and contains the world's widest selection of courses in all branches of Civil, Mech., Elec., Motor, Aero., and Radio Engineering, Television, Building, etc.

If you are earning less than £10 per week, you cannot afford to miss this unique guide to a first-class job.



DON'T DELAY—send for your FREE copy of the Handbook to-day. No cost or obligation of any kind.

THE BRITISH INSTITUTE OF ENGINEERING TECHNOLOGY, 285 Shakespeare House, 29-31 Oxford Street, London.

**ELEMENTS OF LOUD SPEAKER PRACTICE**

by **N. W. McLACHLAN, D.Sc., M.I.E.E.**  
 (168 pages, with 92 figures)

**5s. net**

OXFORD UNIVERSITY PRESS

## BLUEPRINT COUPON

Valid only until April 30, 1935 (or until May 31, 1935, for overseas readers)

### FOR ONE BLUEPRINT ONLY

If you want a full-size blueprint of any ONE of the sets constructionally described in this issue for half price, cut out the above coupon and send it, together with a postal order, to Blueprint Department, WIRELESS MAGAZINE, 8-11 Southampton Street, Strand, London, W.C.2.

This coupon is valid for a blueprint of any ONE only of the following sets at the prices indicated:—

THE 1935 A.C. STENODE (page 171), No. WM385, price 9d., post paid.

## INFORMATION COUPON

Valid only until April 30, 1935 (or until May 31, 1935, for overseas readers)

If you want to ask any questions, cut out the above coupon and send it, together with a postal order for 1s. and stamped, addressed envelope, to the Information Bureau, WIRELESS MAGAZINE, 8-11 Southampton Street, Strand, London, W.C.2.

Note that not more than two questions may be asked at a time and that queries should be written on one side of the paper only.

Under no circumstances can questions be answered personally or by telephone. All inquiries must be made by letter so that every reader gets exactly the same treatment.

Alterations to blueprints or special designs cannot be undertaken: nor can readers' sets or components be tested.

If you want advice on buying a set, a stamped, addressed envelope only (without coupon or fee) should be sent to the Set Selection Bureau, WIRELESS MAGAZINE, 8-11 Southampton Street, Strand, London, W.C.2.

## IN TUNE WITH THE TRADE

Continued from page 239

200 to 550 metres, and 800 to 2,000 metres.

A useful point is that a set can be supplied rigged up as a complete radio gramophone, or in chassis form with valves. The Hyvoltstar catalogue also gives details of a universal self-contained short-wave converter covering a wave-band of from 12 to 85 metres. The circuit consists of an aperiodic high-frequency stage and an autodyne detector/oscillator. Of importance is the fact that it is for use on A.C. or D.C. between 100 and 250 volts. **452**

### PHILIPS MAGAZINE

"BRINGING Home the Radio Stars" is the title of a 12-page magazine-catalogue issued by Philips Lamps. The unusual thing about this catalogue is that only two pages are devoted to descriptions of Philips' range of receivers, the rest being more or less biographies of such famous radio artists as Henry Hall and Reginald Foort, the cinema organist.

Val Gielgud, the B.B.C.'s Dramatic Director, writes an article on broadcast plays, while Christopher Stone tells how he first came to broadcast. **453**

### GOLTONE'S COMPONENT RANGE

THE 1935 edition of the Goltone catalogue is a bulky affair—85 pages crammed full of useful information and lists of gadgets and components for the radio man. The list includes a wide range of chokes, iron-core tuning coils, and general electrical accessories, besides certain items of special interest to set makers.

The bugbear of man-made static justly receives a deal of attention. Goltone makes special metal-screened downleads, which are recommended by the Post Office.

I would advise you to get this Goltone list if you happen to be one of those poor souls troubled by the vacuum cleaner next door! **454**

There was a young student named Reed

At Wireless—an EXPERT indeed! His advice for perfection—Is—SOLDER each connection—And FLUXITE—is all that you need!



See that FLUXITE is always by you—in the house—garage—workshop—anywhere where simple speedy soldering is needed. Used for 30 years in government works and by the leading engineers and manufacturers. Of all Ironmongers—in tins, 4d., 8d., 1/4 and 2/8.

Ask to see the FLUXITE SMALL-SPACE SOLDERING SET—compact but substantial—complete with full instructions, 7/6.

Ask also for Leaflet on CASE HARDENING STEEL and TEMPERING TOOLS with FLUXITE.

## THE FLUXITE GUN

is always ready to put "Fluxite" on the soldering job instantly. A little pressure places the right quantity on the right spot and one charging lasts for ages.

The Gun also serves for grease as an oil can does for oil. Price 1/6.



ALL MECHANICS WILL HAVE

# FLUXITE

IT SIMPLIFIES ALL SOLDERING

Write for Free Book on the art of "Soft" Soldering—Dept. 332.

Fluxite Ltd., Dragon Works, Bermondsey St., S.E.1

## INDEX TO ADVERTISERS

	Page
Amplion, Ltd.	237
Automatic Coil Winder Co.	161
Belling & Lee, Ltd.	231
British Inst. of Eng. Tech.	219
British Insulated Cables	229
British Television Supplies, Ltd.	238
Colvern Ltd.	238
Dubilier Condenser Co., Ltd.	232
Educational Film Review	Cover ii
Fluxite, Ltd.	240
Gramphon Reproducers Ltd.	162
H.M.V.	164
Jackson Bros.	153
Lectro Linx, Ltd.	238
London and Lancashire Insur. Co., Ltd.	Back Cover
London Radio Supply	238
Melfo-Rad	239
Ostar Ganz	240
Oxford University Press	239
Peto-Scott Co., Ltd.	237
Pifco Ltd.	239
Radio Resistor Co.	235
Rothermel, Ltd.	232
Siemens Electric Lamps & Supplies, Ltd.	162
Technical & Commercial Radio College	233
Telephone Mfg. Co., Ltd.	229
Varley (Oliver Pell Control, Ltd.)	231
Whiteley Electrical Radio Co., Ltd.	235
Wright & Weaire, Ltd.	231

## HYVOLTSTAR 4-VALVE AC/DC BEDSIDE RADIO with Lamp 9 GNS.

The complete HYVOLTSTAR Range of UNIVERSAL All-Mains Receivers Covers ALL WAVES from 13 to 2,000 metres. Table and Console models, Radiograms and Amplifiers each incorporates every up-to-date refinement and represents the finest value in the Radio World. ALL BRITISH MADE with components of the highest grade. Write for Leaflet F.

UNIVERSAL HIGH VOLTAGE RADIO LTD. 28/29 Southampton Street, Strand, W.C.2 Telephone: TEMple Bar 4985

### BRING NEW LIFE TO YOUR OLD RECEIVER!

We offer to CONVERT YOUR OLD SET, any type, any make, TO A MODERN "UNIVERSAL" AC/DC ALL MAINS RECEIVER, with Ostar Ganz Universal High Voltage Valves. Send your set carriage paid, and we will quote you free without any obligation on your part, or write for full particulars to: THE CONVERSION DEPT (F)

E. J. FORBAT, 28/29 Southampton St., Strand, W.C. Telephone: TEMple Bar 8608.

### 2 NEW UNIVERSAL ALL-WAVE KITS

So popular have these Universal Kits proved that 2 INTERESTING NEW KITS will shortly be added to the range—a 3-valve including Rectifier and a 6-valve including Rectifier. These new Kits will be the only kits of their kind on the market. Write for details now of these and full range of our UNIVERSAL RECEIVER AMPLIFIER & RADIOGRAM KITS Telephone: TEMple Bar 8608.



# "Wireless Magazine" Blueprint Service

These blueprints are full-size. Copies of appropriate issues of "Practical Wireless," "Amateur Wireless," and of "Wireless Magazine" containing descriptions of most of these sets can be obtained at 4d. and 1s. 3d. each, respectively, post paid. Index letters "P.W." refer to "Practical Wireless" sets, "A.W." refer to "Amateur Wireless" sets, and "W.M." to "Wireless Magazine" sets. Send, preferably, a postal order (stamps over sixpence unacceptable) to "Wireless Magazine" Blueprint Dept., Geo. Newnes, Ltd., 8-11 Southampton Street, Strand, W.C.2.

## CRYSTAL SETS

### Blueprints, 6d. each.

Four-station Crystal Set ... 31.3.34 AW427

## STRAIGHT SETS (Battery Operated)

### Two-valvers: Blueprints, 1s. each.

Iron-core Two (D, QPP) ... 12.8.33 AW396

### Three-valvers: Blueprints, 1s. each.

Transportable Three (SG, D, Pen) ... Feb. '32 WM271

Multi-mag Three (D, 2 Trans) ... June '32 WM288

Percy Harris Radiogram (HF, D, Trans) ... Aug. '32 WM294

£6 6s. Radiogram (D, RC, Trans) ... Apr. '33 WM318

Simple-tune Three (SG, D, Pen) ... June '33 WM327

Tyers Iron-core Three (SG, D, Pen) ... July '33 WM330

Economy-pentode Three (SG, D, Pen) ... Oct. '33 WM337

All-wave Three (D, 2LF) ... Jan. '34 WM348

"W.M." 1934 Standard Three (SG, D, Pen) ... Feb. '34 WM351

£3 3s. Three (SG, D, Trans) ... Mar. '34 WM354

Iron-core Band-pass Three (SG, D, QP21) ... June '34 WM362

1935 £6 6s. Battery Three (SG, D, Pen) ... Oct. '34 WM371

Class-B Three (D, Trans, Class B) ... 22.4.33 AW386

New Britain's Favourite Three (D, Trans, Class B) ... 15.7.33 AW394

Home-built Coil Three (SG, D, Trans) ... 14.10.33 AW404

Fan and Family Three (D, Trans, Class B) ... 25.11.33 AW410

£5 5s. S.G.3 (SG, D, Trans) ... 2.12.33 AW412

1934 Ether Searcher: Baseboard Model (SG, D, Pen) ... 20.1.34 AW417

1934 Ether Searcher: Chassis Model (SG, D, Pen) ... 3.2.34 AW419

P.W.H. Mascot with Lucerne Coils (Det, R.C., Trans) ... 17.3.34 AW337A

Mullard Master Three with Lucerne Coils ... AW424

Pentaquester (HF, Pen, D, Pen) ... 14.4.34 AW431

£5 5s. Three: De-luxe Version (SG, D, Trans) ... 19.5.34 AW435

Lucerne Straight Three (D, RC, Trans) ... 9.6.34 AW437

"Wireless League" Three (HF Pen, D, Pen) ... 3.11.34 AW451

Graduating to a Low-frequency Stage (D, 2LF) ... Jan. '35 WM378

### Four-valvers: Blueprints, 1s. 6d. each.

Quadradyne (2 SG, D, Pen) ... Feb. '32 WM273

Calibrator (SG, D, RC, Trans) ... Oct. '32 WM300

Table Quad (SG, D, RC, Trans) ... Nov. '32 WM303

Calibrator de Luxe (SG, D, RC, Trans) ... Apr. '33 WM316

Self-contained Four (SG, D, LF, Class-B) ... Aug. '33 WM331

Lucerne Straight Four (SG, D, LF, Trans) ... Feb. '34 WM350

£5 5s. Battery Four (HF, D, 2LF) ... Feb. '35 WM381

The "HK" Four (2HF, D, LF) ... Mar. '35 WM384

"A.W." Ideal Four (2 SG, D, Pen) ... 16.9.33 AW402

Crusaders' A.V.C. 4 (2 HF, D, QP21) ... 18.8.34 AW445

(Pentode and Class-B outputs for above; blueprints 6d. each) ... 25.8.34 AW445A

### Five-valvers: Blueprints, 1s. 6d. each.

Super-quality Five (2 HF, D, RC, Trans) ... May '33 WM320

New Class-B Five (SG, D, LF, Class B) ... Nov. '33 WM340

Class-B Quadradyne (2 SG, D, LF, Class B) ... Dec. '33 WM344

1935 Super Five (Battery Superhet) ... Jan. '35 WM379

## Mains Operated

### Two-valvers: Blueprints, 1s. each.

Economy A.C. Two (D, Trans) A.C. ... June '32 WM286

Consolectric Two (D, Pen) A.C. ... 23.9.33 AW403



### SPECIAL HALF-PRICE OFFER

A Blueprint of the following "Wireless Magazine" set described in this issue is obtainable at the special price, given below, if the coupon on facing page is used before April 30. The 1935 A.C. Stenode (A.C. Super-het) WM385 ... 9d.

### Three-valvers: Blueprints, 1s. each.

D.C. Calibrator (SG, D, Push-pull Pen) D.C. ... July '33 WM328

Simplicity A.C. Radiogram (SG, D, Pen) A.C. ... Oct. '33 WM338

Six-guinea AC/DC Three (HF Pen, D, Trans) A.C./D.C. ... July '34 WM364

Mantovani A.C. Three (HF Pen, D, Pen) A.C. ... Nov. '34 WM374

Home-lovers' New All-electric Three (SG, D, Trans) A.C. ... 25.3.33 AW383

S.G. Three (SG, D, Pen) A.C. ... 3.6.33 AW390

A.C. Triodyne (SG, D, Pen) A.C. ... 19.8.33 AW399

A.C. Pentaquester (HF Pen, D, Pen) A.C. ... 26.6.34 AW439

### Four-valvers: Blueprints, 1s. 6d. each.

A.C. Quadradyne (2 SG, D, Trans) A.C. ... Apr. '32 WM279

All Metal Four (2 SG, D, Pen) A.C. ... July '33 WM329

AC/DC Straight A.V.C. 4 (2 HF, D, Pen) A.C./D.C. ... 8.9.34 AW446

"W.M." A.C./D.C. Super Four ... Feb. '35 WM382

## SUPER-HETS

### Battery Sets: Blueprints, 1s. 6d. each.

Super Senior ... Oct. '31 WM256

1932 Super 60 ... Jan. '32 WM269

Q.P.P. Super 60 ... Apr. '33 WM319

"W.M." Stenode ... Oct. '34 WM373

Modern Super Senior ... Nov. '34 WM375

1934 Century Super ... 9.12.33 AW413

### Mains Sets: Blueprints, 1s. 6d. each.

1932 A.C. Super 60, A.C. ... Feb. '32 WM272

Seventy-seven Super, A.C. ... Dec. '32 WM305

"W.M." D.C. Super, D.C. ... May. '33 WM321

Merrymaker Super, A.C. ... Dec. '33 WM345

Heptode Super Three, A.C. ... May '34 WM359

"W.M." Radiogram Super, A.C. ... July '34 WM366

"W.M." Stenode, A.C. ... Sep. '34 WM370

1934 A.C. Century Super, A.C. ... 10.3.34 AW425

## SHORT-WAVERS (Battery Operated)

### One-valvers: Blueprints, 1s. each.

Roma Short-waver ... 10.11.34 AW452

### Two-valvers: Blueprints, 1s. each.

Home-made Coil Two (D, Pen) ... 14.7.34 AW440

### Three-valvers: Blueprints, 1s. each

Experimenter's 5-metre Set (D, Trans. Super-reges) ... 30.6.34 AW438

Experimenter's Short-waver ... 19.1.35 AW463

### Four-valvers: Blueprints, 1s. 6d. each.

"A.W." Short-wave World Beater (HF Pen, D, RC, Trans) ... 2.6.34 AW436

Empire Short-waver (SG, D, RC, Trans) ... Mar. '33 WM318

Standard Four-valve Short-waver (SG, D, 2LF) ... Mar. '35 WM383

### Super-hets: Blueprints, 1s. 6d. each.

Quartz-crystal Super ... Oct. '34 WM372

## Mains Operated

### Two-valvers: Blueprints, 1s. each.

Two-valve Mains Short-waver (D, Pen) A.C. ... 10.10.34 AW453

"W.M." Band-spread Short-waver (D, Pen) A.C./D.C. ... Aug. '34 WM368

### Three-valvers: Blueprints, 1s. each.

Emigrator (SG, D, Pen), A.C. ... Feb. '34 WM352

### Four-valvers: Blueprints, 1s. 6d. each.

Gold Coaster (SG, D, RC, Trans), A.C. ... Aug. '32 WM292

Tri-ble Charger ... Jan. 5, '35 AW462

## "PRACTICAL WIRELESS"

A.C.-D.C. Two ... 7.10.33 PW31

All-wave Unipen ... 14.10.33 PW31A

F.J.C. 3-valve A.V.C. (Transfer Print) ... 4.11.33 PW32

Luxus A.C. Superhet ... 14.10.33 PW33

A.C. Quadpak ... 2.12.33 PW34

Sixty-shilling Three ... 2.12.33 PW34A

Nucleon Class-B Four ... 6.1.34 PW34B

Fury Four Super ... 27.1.34 PW34C

A.C. Fury Four Super ... 10.2.34 PW34D

Leader Three ... 10.3.34 PW35

D.C. Premier ... 31.3.34 PW35B

A.C. Leader ... 7.4.34 PW35C

Master Midget Two ... 12.5.34 PW35E

Atom Lightweight Portable ... 2.6.34 PW36

Ubique ... 28.7.34 PW36A

Four-range Super-mag, Two ... 11.8.34 PW36B

Summit Three ... 18.8.34 PW37

Armada Mains Three ... 18.8.34 PW38

Midget Short-wave Two ... 15.9.34 PW38A

All-pentode Three ... 22.9.34 PW39

£5 Superhet Three ... 27.01.34 PW40

A.C. £5 Superhet Three ... 24.11.34 PW43

D.C. £5 Superhet Three ... 1.12.34 PW42

Hall-mark Three ... 8.12.34 PW41

Universal £5 Superhet ... 15.12.34 PW44

A.C. Hall-mark ... 26.1.35 PW45

Battery Hall-Mark 4 ... 2.2.35 PW46

Universal Hall Mark ... 9.2.35 PW47

"Wireless Magazine" Blueprint Service

George Newnes, Ltd., 8-11 Southampton Street, Strand, W.C.2





# INSURANCES

of every description

COMPREHENSIVE POLICIES — MODERATE PREMIUMS  
PROMPT SETTLEMENTS

---

## ABSOLUTE SECURITY

---

Full particulars may be obtained from any of the  
Company's Numerous Branches

**THE LONDON & LANCASHIRE INSURANCE CO., LTD.**

Head Office

155 LEADENHALL ST., LONDON

Chief Administration,

5 CHANCERY LANE, LONDON