

COMPLETE GUIDE FOR EVERY SET BUYER *IN THIS ISSUE*

Wireless Magazine 1'

Magazine

NOVEMBER, 1934

**SET-BUYERS'
SUPPLEMENT**

*Easy-to-compare
Details of All
the Leading Sets*

EXTENDED TESTS OF THE "WM." STENODE RECEIVERS

Revitalise your set

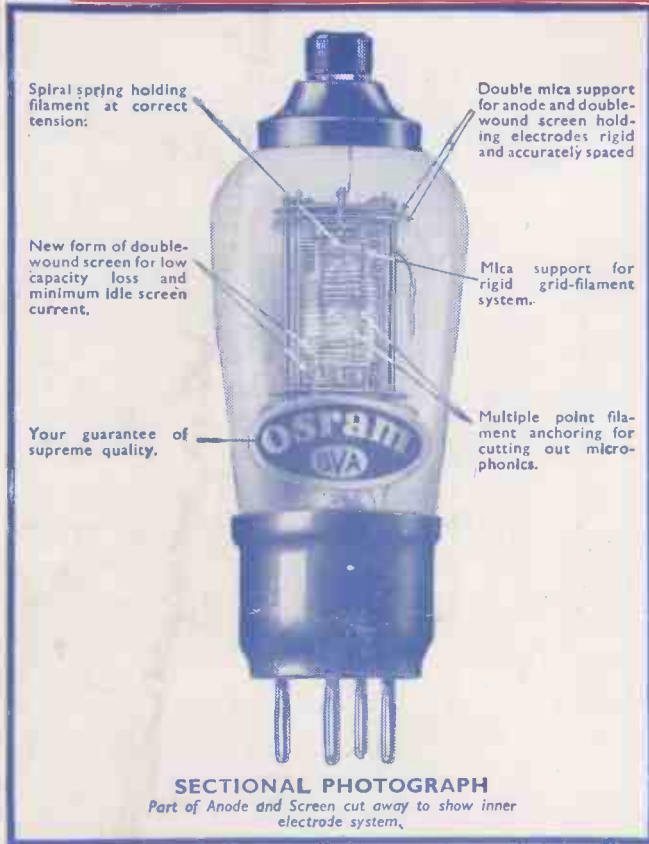

3 2-VOLT SCREEN-GRID VALVES mean —

- 1** GREATER SENSITIVITY WITH COMPLETE STABILITY—owing to low capacity and higher impedance.
- 2** ENTIRE ABSENCE OF MICROPHONICS— due to latest multiple anchored filament.
- 3** H.T. CURRENT CONSUMPTION FROM 1.5 M.A. ONLY.

S23 A low H.T. non-microphonic screen-grid valve for kit sets and portables employing one or more screen-grid valves. Mutual conductance 1.1 ma/volt
Price 12/6

S24 A high slope, non-microphonic screen-grid for all single stage H.F. sets using screened coils. Mutual conductance. 1.4 ma/volt
Price 12/6

VS24 A "variable mu" screen-grid to give full and distortionless control of volume with only a 9 volt bias battery. Mutual conductance 1.5 to 0.01 ma/volt
Price 12/6

These Valves can be supplied metallised or plain.

Osram

2 VOLT BATTERY

Valves

MADE IN ENGLAND

SOLD BY ALL RADIO DEALERS

WRITE for the OSRAM VALVE GUIDE
(1934 Edition) sent post free.

Editor-in-Chief:
BERNARD E. JONES

Technical Editor:
J. H. REYNER
B.Sc. (Hons.), A.M.I.E.E.

Radiovision Editor:
H. CORBISHLEY

Wireless Magazine

The Best Shillingworth in Radio

Vol. XX : NOVEMBER 1934 : No. 118

Editor:
D. SISSON RELPH

Research Consultants:
W. JAMES and
PERCY W. HARRIS

Assistant Editor:
T. F. HENN

Published by EERNARD JONES PUBLICATIONS, LTD., 58/61 Fetter Lane, London, E.C.4. Telephone: Central 4341 (four lines). Telegrams: "Beejapes, Fleet, London." Subscription: Great Britain and abroad, 15s. 6d. a year, post paid (Canada only, 13s. 6d.). Next issue published on Wednesday, November 28.

Something for Everybody!

I'M afraid there is a little too much truth in J. H. Reyner's generalisation in his article on the German Radio Exhibition that "competition in Germany is directed towards improvement. In this country it is directed towards a continual cheapening of the product."

J. H. Reyner is a close and qualified observer, and we must give him credit for knowing what he is talking about, but I believe that in this country there is a steady tendency towards improvement; but we lose sight of it in the more definite trend towards cheapening.

Sets have, of course, gone forward during the last two or three years, but Mr. Reyner will be thinking of the lop-sided way in which the development has taken place—too much time and thought spent on frills and finish, too little to what is vulgarly, but succinctly, known as guts.

This month we present the reader with a 10-page guide including information on some 300 leading sets, amply illustrated. Every useful kind of detail is given: model, price, dial calibrations, power supply, valve combination, and special comments about the circuit. And if there is a reader who finds the information in any respect lacking he has only to appeal to our Set Selection Bureau, which is always ready and willing to be of service.

Trade and public gave an amazing welcome to our A.C. and battery models of the Stenode in the September and October issues. Captain E. H. Robinson, who saw straight enough a few years ago to win the King's Prize at Bisley, tells the reader in our pages what he saw when he looked at our Stenodes and what he found when he put them through their paces. He reports, as you will read for yourself, that the "W.M." Stenodes are very selective and that they set a new standard for the home constructor.

We know there is no other set anywhere that beats them. Every constructor will find the operation of ganging the three-gang condenser and adjusting trimmers of the special Stenode couplers quite a simple job

if he follows the explanation given in this issue by Paul Tyers, who gave a year of his time to the development of the Stenode and is, as you know, the designer of the two "W.M." versions.

A modern three-valver, extremely simple to construct and possessing fine quality and selectivity, is the Mantovani A.C. Three. If you turn to page 321 you will see that the home constructor will have a simple job in producing a first-rate set.

And then this month we have also an eight-valve battery super-het—of particular interest to the many thousands of readers who built the original Super 60 and the Super Senior, because many of the components and valves of those sets can be used in producing the more modern super-het now described in this issue.

The new Midland Regional transmitter is being installed in the same building as the Droitwich transmitter, and at the moment of writing is nearly ready for its first tests. Alan Hunter, in a special article, discusses the effect of moving Midland Regional westwards to Droitwich and has something to say on the problem of giving the Eastern Midlands a good signal.

He explains that a simple vertical aerial has been suspended from one of the Droitwich 700-ft. masts for the special purpose of transmitting a directional signal to aerials in the Eastern Midlands. In which connection, our friend Percy Harris, who has toured Devon and Cornwall in his radio-fitted car, comes to the conclusion, which he gives our readers this month, that the Regional and National transmitters at Watchet, Somerset, do not provide an efficient service in the West Country.

Two essentially modern touches in this issue! Morton Barr's article entitled "Visual Indicators for Better Tuning," and a highly interesting and practical section on television, including an article on how to start and another devoted to a simple explanation of the cathode-ray system.

My best wishes to every reader for a most enjoyable winter season!

B. E. J.

FOR THE CONSTRUCTOR

- THE MANTOVANI A.C. THREE. Designed by the "W.M." Technical Staff .. 321
- TESTING THE SET WITH MANTOVANI .. 323
- OPERATING THE QUARTZ-CRYSTAL SUPER. —By Kenneth Jowers .. 333
- RADIOGRAM FOR SCHOOLS. By Captain E. H. Robinson .. 344
- GETTING THE BEST FROM THE "W.M." STENODES. By Paul D. Tyers .. 349
- THE MODERN SUPER SENIOR. By the "W.M." Technical Staff .. 360

TECHNICAL FEATURES

- THE STENODE HITS THE MARK! By Captain E. H. Robinson .. 307
- A CHAT ABOUT YOUR VALVES. By Captain H. J. Round, M.I.E.E. .. 312
- NEWS OF THE SHORT WAVES. By Kenneth Jowers .. 315
- ALL ABOUT PICK-UP RESPONSE CURVES. By P. Wilson, M.A. .. 317

Contents

- VISUAL INDICATORS FOR BETTER TUNING .. 347
- IS DELAYED A.V.C. WORTH WHILE? .. 367
- TESTS OF NEW APPARATUS .. 372

GENERAL ARTICLES

- WAVELENGTHS OF THE WORLD'S BROADCASTERS .. 290
- IN TUNE WITH THE TRADE. By Fetter Lane .. 294
- SET BUYER'S SUPPLEMENT .. 297
- CHOOSING THAT NEW SET! .. 300
- YOUR GUIDE TO THE NEW SETS .. 300
- DIRECTORY OF BRAND NAMES .. 370
- AND NOW FOR DROITWICH JUNIOR. By Alan Hunter .. 310
- WIRELESS JOBS MADE EASY FOR MR. EVERYMAN. By R. W. Hallows, M.A. .. 327
- RADIO MEDLEY. By BM/PRESS .. 330
- WHAT THEY THINK OF WIRELESS. By Jay Coote .. 336
- WHAT READERS SAY ABOUT "W.M." SETS .. 338

- ON THE CREST OF THE WAVES. By Jay Coote .. 339
- MOBILE RADIO AT BRITISH AIRPORTS .. 346
- CAR RADIO IN THE WEST COUNTRY. By Percy W. Harris, M.Inst. Rad. E. .. 353
- PROGRAMME NOTES AND NEWS. By T. F. Henn .. 358
- WHAT I THINK OF THE NEW GERMAN RADIO. By J. H. Reyner, A.M.I.E.E. .. 365
- WHAT IS THIS QUEEN'S HALL ATMOSPHERE. By Whitaker-Wilson .. 376
- NEWS FROM ALL QUARTERS .. 380
- A QUICK AND RELIABLE SERVICE .. 380
- COUPONS: INDEX TO ADVERTISERS .. 384

TELEVISION SECTION

- HOW TO START TELEVISION .. 340
- CATHODE-RAY TELEVISION SIMPLY EXPLAINED .. 342

GRAMO-RADIO FEATURES

- CHOOSING YOUR RECORDS. By Whitaker-Wilson .. 368
- RECORDS REVIEWED. By Chopstick .. 369

THE STENODE IS THE SET THAT SETS A NEW STANDARD—see page 307

Registered at the General Post Office for transmission by Canadian Magazine Post

Postage on this issue 3d. (inland and abroad)



WORLD'S BROADCAST WAVELENGTHS

Stations best received in the British Isles are indicated in bold type

Note: Names in brackets are those of stations relayed

Wave-length	Name of Station	Dial Readings	Country	Wave-length	Name of Station	Dial Readings	Country
14.00	Deal W2XDJ		United States	31.41	Jeløy LCL		Norway
14.49	Buenos Aires LSY		Argentina	31.48	Schenectady W2XAF (WGY)		United States
14.58	Bandoeng PMB		Java	31.545	Daventry (Empire) GSB		Great Britain
15.92	Bandoeng PLE		Java	31.55	Melbourne VK3ME		Victoria
16.36	Lawrenceville (N.J.) WLA		United States	31.55	Caracas YV3BC		Venezuela
16.38	Rugby GAS		Great Britain	31.58	Rio de Janeiro PSA		Brazil
16.5	Drummondville (CFA8)		Canada	31.71	New Brunswick WKJ		United States
16.56	Bandoeng PMC		Java	31.9	Bandoeng PLV		Java
16.56	Buenos Aires LSY3		Argentina	32.71	Lawrenceville WNA		United States
16.81	Bandoeng PLF		Java	32.79	Maracay YVQ		Venezuela
16.85	Kootwijk PCV		Holland	32.88	Szekesfehervar HAT4		Hungary
16.86	Daventry Empire GSG		Great Britain	33.26	Rugby GCS		Great Britain
16.878	Boundbrook W3XAL (WJZ)		United States	33.59	Rocky Point (N.J.) WEC		United States
16.88	Eindhoven PHI		Holland	34.68	London VE9BV		Canada
16.89	Königswusterhausen DJE		Germany	36.65	Rio de Janeiro PSK (PRA3)		Brazil
19.47	Riobamba PRADO		Ecuador	37.04	Quito HCJB		Ecuador
19.55	Schenectady W2XAD (WGY)		United States	37.33	Rabat (CNR)		Morocco
19.61	La Paz CP4		Bolivia	37.41	Suva VPD		Fiji Isles
19.63	New York W2XE (WABC)		United States	38.07	Tokio JIAA		Japan
19.67	Coytesville N.J. WIXAL (WEEL)		United States	38.47	Radio Nations HBP		Switzerland
19.67	Tashkent (Rim)		U.S.S.R.	38.65	Kootwijk PDM		Holland
19.68	Radio Colonial FYA		U.S.S.R.	39.34	Tashkent RIM		U.S.S.R.
19.72	Saxonburg W8XK (KDKA)		United States	39.76	Moscow RKI		U.S.S.R.
19.93	W8XK, Saxonburg (KDKA)		United States	39.82	Riobamba PRADO		Ecuador
19.737	Zeesen DJB		Germany	40.3	Radio Nations HBQ		Switzerland
19.815	Daventry (Empire) GSF		Great Britain	40.5	Bogota HJ3ABB		Colombia
19.84	Rome (Vatican) HVJ		Italy	40.54	Rocky Point WEN		U.S.A.
19.88	Moscow (RKI)		U.S.S.R.	41.55	Bogota HKE		Colombia
20.27	Rocky Point WQV		United States	41.6	Las Palmas EA8AB		Canary Isles
20.31	Rocky Point N.Y. (WEB)		United States	41.67	Singapore VSIAB		Sta. Sett'l.mts.
21.43	Cairo SUV		Egypt	41.84	Grenada YN6RD		Nicaragua
21.53	Rocky Point WIK		United States	41.9	Manizales HJ4ABB		Colombia
21.58	Rocky Point WQP		United States	43	Madrid EA4AQ		Spain
21.605	Rocky Point WQT		United States	43.86	Budapest HAT2		Hungary
21.83	Drummondville CJA8		Canada	44.61	Rocky Point WQO		United States
22.26	Rocky Point WAJ		United States	44.96	Maracay YVQ		Venezuela
22.48	Santa Rita YVQ		Venezuela	45	Constantine FM8KR		Tunis
22.684	Zeesen (DHB)		Germany	45	Guatemala City		S. America
23.39	Radio Maroc (Rabat) CNR		Morocco	45.02	Guayaquil HC2RL		Ecuador
24.41	Rugby GBU		Great Britain	45.38	Moscow RW72		U.S.S.R.
24.9	Kootwijk PDV		Holland	46.53	Barranquilla (HJ1ABB)		Colombia
25	Moscow RNE		U.S.S.R.	46.69	Boundbrook W3XL (WJZ)		United States
25.25	Radio Colonial, Paris (FYA)		France	46.7	Boston WIXAL		United States
25.25	Saxonburg (Pa.) W8XK (KDKA)		United States	47	Cali HJ5ABB		Colombia
25.28	Daventry (Empire) GSE		Great Britain	47.5	S. Domingo HIZ		Dominican R.
25.34	Wayne W2XE (WABC)		United States	47.8	Domingo HIAA		Dominican R.
25.4	Rome ZRO		Italy	48.75	Winnipeg CJRO		Canada
25.45	Boston WIXAL (WEEL)		United States	48.78	Caracas YV3BC		Venezuela
25.51	Zeesen DJD		Germany	48.86	Saxonburg (Pa.) W8XK (KDKA)		United States
25.532	Daventry (Empire) GSD		Great Britain	49	Moscow (RKK)		U.S.S.R.
25.63	Radio Coloniale FYA		France	49.02	Johannesburg ZTJ		South Africa
26.83	Funchal CT3AQ		Madeira	49.08	Wayne W2XE (WABC)		United States
27.65	Nauen DFL		Germany	49.1	Caracas YVIBC		Venezuela
27.86	Rugby GBP		Great Britain	49.1	Halifax VE9HX (CHNS)		Canada
27.88	Marapicu PSG		Brazil	49.18	Boundbrook W3XAL (WJZ)		United States
28.28	Rocky Point (N.J.) WEA		United States	49.22	Chicago W9XF (WENR)		United States
28.5	Sydney VLK		N.S. Wales	49.22	Bowmanville VE9GW (CRCT)		Canada
28.98	Buenos Aires LSX		Brazil	49.26	St. John VE9BJ (CFBL)		N. Brunswick
29.03	Bermuda ZFD		West Indies	49.3	La Paz CP5		Bolivia
29.04	Ruysselede (ORK)		Belgium	49.34	Chicago W9XAA (WCFL)		United States
29.16	Zeesen (DIQ)		Germany	49.39	Maracaibo V5BMO		Venezuela
29.35	Marapicu PSH		Brazil	49.4	Vienna OER2		Austria
29.59	Leopoldville OPM		Belgian Congo	49.43	Vancouver VE9CS (CKFC)		Brit. Columbia
29.64	Marapicu PSI		Brazil	49.47	Nairobi VQ7LO		Kenya Colony
29.84	Abu Zabel, Cairo SUV		Egypt	49.5	Philadelphia W4XAU (WCAU)		United States
30	Radio Excelsior LRS		Argentina	49.5	Cincinnati W8XAL (WLW)		United States
30.1	Rome IRS		Italy	49.586	Daventry (Empire) GSA		Great Britain
30.4	Lawrenceville WON		United States	49.6	Bogota HJ3ABI		Colombia
30.43	Tokio JIAA		Japan	49.67	Boston WIXAL (WEEL)		United States
30.77	Madrid EAQ		Spain	49.83	Zeesen DJC		Germany
30.9	Lawrenceville WOF		United States	49.9	Singapore ZHI		F.M. States
30.9	Rugby GCA		Great Britain	49.92	Havana COC		Cuba
31.3	Daventry (Empire) GSC		Great Britain	49.96	Drummondville VE9DN (CFCF)		Canada
31.23	Mexico City XETE		Mexico	50.8	Barcelona EA3AB		Spain
31.26	Radio Nations HBL		Switzerland	50.26	Moscow RNE		U.S.S.R.
31.28	Philadelphia W3XAU (WCAU)		United States	50.26	Rome (Vatican) HVJ		Italy
31.28	Sydney VK2ME		N.S. Wales	50.26	Vatican		Rome
31.35	Millis W1KAZ (WBZ)		United States	50.42	Domingo HIX		Dominican R.
31.38	Zeesen DJA		Germany	50.6	Medellin HJ4ABE		Colombia
31.40	Lisbon CT1AA		Portugal				

(Continued on page 292)

THE FINEST OF ALL RADIO



on your terms

ONLY
11
GNS
OR LESS THAN **5!** A WEEK

THE VERY LATEST

MARCONI

5 VALVE SUPERHET

This is really a magnificent up-to-the-minute super-het with glorious tone and in a beautifully made walnut cabinet. You should inspect it immediately. Post us this coupon and we will place you in touch with

YOUR LOCAL MARCONI-MAN

Model 262 is a 5-valve, (incl. rect.) Superhet with proved circuits . . . balanced band-pass tuning . . . illuminated wide vision scale with clearly marked wave-lengths . . . energised moving-coil speaker . . . mains aerial (A.C.) . . . adjustable tone control . . . latest high-efficiency Marconi valves . . . etc., etc. Handsome and solidly built cabinet of figured and inlaid walnut. D.C. model (4 valves) £1.1. extra.



ENQUIRY COUPON

To The Marconiphone Company Ltd.,
Radio House, 210 Tottenham Court Rd.,
London, W.1.

NAME _____

ADDRESS _____

Prices do not apply to I.F.S.



THE MARCONIPHONE CO. LTD., RADIO HOUSE, 210 TOTTENHAM COURT ROAD, LONDON, W.1.

Better service results from mentioning "Wireless Magazine" when writing to advertisers

WORLD'S BROADCAST WAVELENGTHS Continued from page 290

Wave-length	Name of Station	Dial Readings	Country	Wave-length	Name of Station	Dial Readings	Country
56.9	Königswusterhausen (DTG)		Germany	307.1	West Regional		Great Britain
57.03	Rocky Point WQN		United States	309.9	Grenoble PTT		France
58.03	Bandoeng PMY		Java	312.8	Poste Parisien, Paris		France
58.31	Prague		Czechoslovakia	315.8	Breslau		Germany
60.3	Rugby GBC		Great Britain	318.8	Goteborg		Sweden
62.5	Long Island (N.J.) W2X		United States	321.9	Algiers		North Africa
62.56	London		Ontario	321.9	Brussels (2)		Belgium
65.93	Rocky Point WAD		United States	325.4	Brno		Czechoslovakia
68.18	Moscow (RFCK)		U.S.S.R.	328.6	Radio Toulouse		France
69.44	Rugby GDB		Great Britain	331.9	Hamburg		Germany
70.2	Khabarovsk RV15		U.S.S.R.	335.2	Limoges PTT		France
73	Quito (HCJB)		Ecuador	335.2	Helsinki		Finland
76	Maracay (YV11AM)		Venezuela	338.6	Graz		Austria
80	Lisbon CTICT		Portugal	342.1	London Regional		Great Britain
84.5	Berlin D4AGE		Germany	345.6	Poznan		Poland
84.67	Mozambique CR7AA		East Africa	349.2	Strasbourg		France
85.9	Boston WIXAL		United States	352.9	Bergen		Norway
203.5	Plymouth		Great Britain	352.9	Valencia		Spain
203.5	Bournemouth		Great Britain	356.7	Berlin		Germany
204.8	Pecs		Hungary	360.6	Moscow (4)		U.S.S.R.
206	Fécamp		France	362.8	Radio LL Paris		France
207.3	Miskolcz		Hungary	364.5	Bucharest		Roumania
209.9	Beziers		France	368.6	Milan		Italy
211.3	Newcastle		Great Britain	373.1	Scottish Regional		Great Britain
214	Tampere		Finland	373.1	Salonika		Greece
214	Sofia		Bulgaria	377.4	Lvov		Poland
215.4	Radio Lyon		France	377.4	Barcelona (EAJ1)		Spain
216.8	Warsaw No. 2		Poland	382.2	Leipzig		Germany
218.2	Basle, Berne		Switzerland	386.6	Toulouse PTT		France
219.6	Lorun		Poland	391.1	Midland Regional		Great Britain
221.1	Turin (2)		Italy	395.8	Katowice		Poland
222.5	Milan (2)		Italy	400.5	Marseilles PTT		France
222.5	Dublin		Irish F. State	405.4	Munich		Germany
222.6	Bordeaux S.O.		France	405.4	Seville		Spain
222.6	Königsberg		Germany	410.4	Tallinn		Estonia
224	Montpellier		France	410.4	Madrid (España)		Spain
224	Lodz		Poland	415.5	Kiev		U.S.S.R.
224	Hanover		Germany	415.5	Rome		Italy
224	Bremen		Germany	420.8	Stockholm		Sweden
225.6	Flensburg		Germany	426.1	Paris PTT		France
225.6	Stettin		Germany	431.7	Belgrade		Yugoslavia
225.6	Magdeburg		Germany	437.3	Sottens		Switzerland
230.2	Danzig		Germany	443.1	North Regional		Great Britain
230.2	Linz		Austria	449.1	Langenberg		Germany
231.8	Salzburg		Austria	455.9	Lyons PTT		France
231.8	Dornbirn		Austria	463	Prague (1)		Czechoslovakia
233.5	Aberdeen		Great Britain	470.2	Trondheim		Norway
233.5	Dresden		Germany	476.9	Brussels (1)		Belgium
235.1	Stavanger		Norway	492.6	Florence		Italy
236.8	Nurnberg		Germany	491.8	Sundsvall		Sweden
238.5	San Sebastian		Spain	499.2	Rabat		Morocco
238.5	Rome (3)		Italy	506.8	Vienna		Austria
240.2	Juan-les-Pins		France	506.8	Agen		France
242	Cork		Irish F. State	514.6	Riga		Latvia
243.7	Gleitwitz		Germany	522.6	Mühlacker		Germany
245.5	Trieste		Italy	531	Athlone		Irish F. State
247.5	Lille PTT		France	539.6	Beromünster		Switzerland
249.2	Prague Stranice (2)		Czechoslovakia	550.5	Budapest		Hungary
249.2	Frankfurt-am-Main		Germany	550.5	Wilno		Poland
249.2	Trier		Germany	559.7	Bolzano		Italy
251	Freiburg-im-Breisgau		Germany	559.7	Viiipuri		Finland
251	Cassel		Germany	569.3	Ljubljana		Yugoslavia
251	Kaiserlautern		Germany	569.3	Innsbruck		Austria
253.2	Kharkov (2)		U.S.S.R.	578	Hamar		Norway
255.1	Copenhagen		Denmark	578	Oulu		Finland
257.1	Monte Ceneri		Switzerland	696	Moscow		U.S.S.R.
259.1	Moravska-Ostrava		Czechoslovakia	748	Geneva		Switzerland
261.1	London National		Great Britain	765	Boden		Sweden
261.1	West National		Great Britain	765	Ostersund		Sweden
263.2	Turin (1)		Italy	824	Smolensk		U.S.S.R.
265.3	Horby		Sweden	845	Fuimark		Norway
267.4	Belfast		N. Ireland	1,107	Moscow (2)		U.S.S.R.
267.4	Nyiregyhaza		Hungary	1,144.2	Madona		Latvia
269.5	Kosice		Czechoslovakia	1,153.8	Oslo		Norway
269.5	Radio Vitus (Paris)		France	1,224	Leningrad		U.S.S.R.
271.7	Naples		Italy	1,261	Kalundborg		Denmark
274	Madrid EAJ7		Spain	1,304	Luxembourg		Luxembourg
276.2	Falun		Sweden	1,345	Warsaw		Poland
276.2	Zagreb		Yugoslavia	1,354	Motala		Sweden
278.6	Bordeaux PTT		France	1,395	Eiffel Tower		France
280.9	Tiraspol		U.S.S.R.	1,442	Minsk		U.S.S.R.
283.3	Bari		Italy	1,500	Droitwich National		Great Britain
285.7	Scottish National		Great Britain	1,312.9	Ankara		Turkey
288.5	Leningrad (2)		U.S.S.R.	1,571	Deutschlandsender		Germany
288.5	Rennes PTT		France	1,571	Istanbul		Turkey
291	Königsberg		Germany	1,612.3	Radio Paris		France
291	Paredé		Portugal	1,648	Moscow No. 1		U.S.S.R.
293.5	Barcelona (EAJ15)		Spain	1,724	Lahti		Finland
296.2	North National		Great Britain	1,807	Kootwijk		Holland
298.8	Bratislava		Czechoslovakia	1,875	Huizen		Holland
301.5	Hilversum		Holland	1,875	Brasov		Roumania
304.3	Genoa		Italy	1,935	Kaunas		Lithuania
304.3	Cracow		Poland	1,935			

Exide



THE L.T. BATTERY FOR BIG SETS

A FEW SIZES

- In glass containers:*
- CZG 2, 2 volt, 20 a.h. - 8/6
 - CZG 4, 2 volt, 40 a.h. - 11/6
 - CZG 6, 2 volt, 60 a.h. - 14/6
- In celluloid containers:*
- CZ 2, 2 volt, 20 a.h. - 9/-
 - CZ 4, 2 volt, 40 a.h. - 13/-
 - CZ 6, 2 volt, 60 a.h. - 17/-

★ These prices do not apply to the Irish Free State

If your set draws heavily from the low tension battery choose Exide "C" Type. This is designed for such sets and supplies the heavy demand easily. Into it are built Exide Long Life Plates, famous for their strength

and stamina. Treated wood separators preserve the plates and prevent shorting. Available in strong leak-proof celluloid or glass containers. For sets that need much current you can always rely on the Exide "C" Type Battery.

For wireless H.T. get

Drydex

the Exide dry battery

"Still keep going when the rest have stopped"

From Exide Service Stations or any reputable dealer. Exide Service Stations give service on every make of battery Exide Batteries, Exide Works Clifton Junc., nr. Manchester. Branches: London, Manchester, Birmingham, Bristol, Glasgow, Dublin, Belfast R81

Better service results from mentioning "Wireless Magazine" when writing to advertisers

In Tune with the Trade

FETTER LANE'S Review of the Latest Catalogues



"GOLTONE"

RADIO COMPONENTS

A CATALOGUE in the true sense of the word, and one which should be secured by every home constructor, is now available from the Goltone people. There are sixty pages of most interesting reading and illustrations, covering in a most extensive manner all amateurs' requirements.

It would be impossible to enumerate all the items in the space available, therefore I must confine my remarks to a rapid survey of the contents. Crystals; coils, screened and un-screened; condensers and charging boards and last, but by no means least, several pages on aerial equipment and wires of all kinds and sizes.

A catalogue which should find a home in every amateur's file! **422**

ATLAS 7-5-8 RECEIVER

ATLAS have sent me a neat folder devoted entirely to their latest product, the 7-5-8 Super-het at

£14 14s. The makers claim that it is a super super-het possessing seven tuned circuits, and five valves.

The technical specification certainly leaves nothing to be desired as every modern development seems to be embodied. The spectrum-tuning device prevents any confusion or guesswork and it is so arranged that it can be tilted to any angle for easy reading.

When the long wavelengths are being received 13 are visible, illuminated in red. On switching over to the medium wavelength 36 stations are shown illuminated in green.

One feature, which should have a wide appeal, is the self-contained aerial which allows the set to be used as a transportable if desired. If you or your friends are interested in an all-electric receiver with the capabilities of the 7-5-8, why not drop me a postcard for the leaflet.

423

HEAYBERD MAINS GEAR

HEAYBERD'S new list caters for all the requirements of the amateur concerned with deriving his high and/or low tension from the mains. Among the components mentioned are mains units, chokes, transformers and battery chargers, all carrying the maker's guarantee for twelve months.

It is interesting to note that only the finest material is used in the construction of these items, as reliability becomes an important factor when using any part connected with the electric mains. Mains transformers to enable small electric models to be worked from the electric light are also described. **424**

FERRANTI RADIO

A BOOKLET describing the full range of Ferranti receivers is now available, the various models being illustrated in colours, which enables a much better idea of their true beauty to be obtained.

The range includes battery-, universal- and A.C.-operated receivers, varying in price from £15 15s. for the Battery Console to £31 10s. for the Arcadiagram. A six-valve battery-operated portable is also described, this costing £16 16s. Each model is fitted with the "All-in" visible control dial that shows you at a glance everything you want to know.

For instance, it shows station names and wavelengths, whether on long or medium wavelengths, by indicator whether set is tuned correctly, position of tone control, whether set is on or off and position of volume control.

By this unique tell-tale device there is no need to wonder what is happening as you turn the controls, you can see for yourself on the dial. The last two pages of the booklet are devoted to extension loud-speakers and the range of Ferranti electric clocks. **425**

"PUT POWER INTO RADIO"

WITH this announcement the makers of the C.A.V. radio accumulators introduce you to their latest folder concerning low-tension and high-tension accumulators and dry batteries. The original non-spillable jelly-acid cells are discussed in detail, the prices and dimensions being given in each case. **426**

A REVELATION!

For quality reception, Greater Output, and Current Economy, Ostar-Ganz H.F. Pentode and Pentagrid Valves (Austria) are revelations of efficiency. Made on the famous Universal High Voltage System, they build BETTER Sets at LESS cost. Performance unapproachable by any other Universal or D.C. Valves. Indirectly heated cathodes. NO Mains Transformers, NO Barretters, NO cut-down Resistances. SUPREME FOR SHORT-WAVE RECEIVERS. Manufacturers! Constructors! Write for interesting leaflet "F."

UNIVERSAL KITS

The only up-to-date proposition for home constructors is to build up a Universal All-wave Receiver Kit for A.C./D.C. or Universal Amplifier Kits for Dance Halls or public address.

We also offer you the finest value in Radiograms. Write for particulars of all our models to:—

EUGEN J. FORBAT, 28/29 Southampton Street, Strand, London, W.C.2

'Phone: Temple Bar 8608.

OSTAR-GANZ
UNIVERSAL HIGH VOLTAGE VALVES



THE LAST WORD IN RADIO

Universal ALL WAVES SUPERHET SEVEN. The set that works on any mains, any voltage, any waveband, truly Universal. Receives all important stations in the world from 13 to 2,000 metres. Employs delayed A.V.C. fluid-light tuning indicator, and all the other latest refinements in radio design. Table Radiogram Model, 31 Gms. Table Model, 28 Gms. Chassis complete with Valves, 22 Gms. Universal ALL WAVES SUPERHET FIVE. For any mains, any voltage, any waveband. Covers a range from 19 to 2,000 metres. Reception obtainable from any part of the world to any part of the world. The sets with easy control for perfect quality. Table Radiogram Model, 24 Gms. Table Model, 18 Gms. Chassis complete with Valves, 14 Gms. Special Features: Great Output. Most economical in cost. No barretters, resistances, mains transformers. Completely hum-free. Mains insulated.

Write for interesting leaflet "F" to:

UNIVERSAL HIGH VOLTAGE RADIO LTD.,

28-29, Southampton Street, London, W.C.2. 'Phone: TEMple Bar 4985

HUMLESS



MARCONI MH41 is an A.C. Triode with exceptional characteristics (M=80, M/R=6) combined with the added advantage of completely hum-free operation. The hum-inducing magnetic field has been eliminated by the use of a double helical spiral heater and vastly improved heater-cathode insulation, making the MH41 particularly suitable for use as a grid rectifier or in the initial stages of high gain L.F. amplifiers.

POPULAR MARCONI A.C. TYPES

MX 40 Heptode	20/-	MH41 Triode	13/6
VMP4 Var. Mu. H.F. Pen.	17/6	MH4 Triode	13/6
MSP4 H.F. Pentode	17/6	MHD4 D.D. Triode	15/6
VMS4B Var. Mu. S.G.	17/6	MPT4 Power Pentode	18/6
MS4B Screen Grid	17/6	PX4 Power Triode	16/6

A card to the Marconiphone Co. Ltd., Radio House, Tottenham Court Road, W.1, will bring you a copy of the comprehensive new catalogue of Marconi valves.

MARCONI



VALVES

THE CHOICE OF THE EXPERTS

HERE ARE THE SPECIFIED

WEARITE COMPONENTS

Regd. Trade Mark

for the

NEW SUPER SENIOR

- 1 Superhet Coil, type OT2, 7s. 6d.
- 1 Oscillator Coil, type O2, 18s. 6d.
- 1 H.F. Choke, type HFP, 3s. 6d.

... and HERE IS THE "UNIVERSAL" COIL
Tunes 180-550 & 850-1950 metres

Specially designed to cover the Lucerne Plan. One Price type of Coil suitable for H.F., Aerial and Band-pass Tuning. per Coil **5/-**



COUPON To MESSRS. WRIGHT & WEAIRE, LTD., 740 High Road, Tottenham, London, N.17.

Please send me a copy of your new booklet No. F1833 giving full technical details of coils, transformers, chokes, etc., and also circuit diagram and constructional details of the "Teamster" (L.P.) Circuit, for which I enclose three penny stamps,

NAME.....

ADDRESS.....

W.M. 11/34.....

for

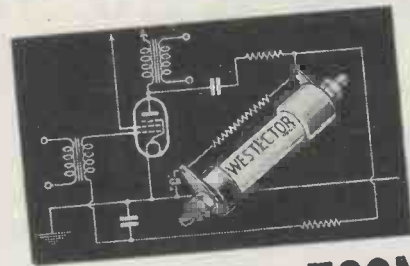

TRUE BATTERY ECONOMY

You need a reliable and efficient rectifier. One that will reduce your current consumption, yet, at the same time, introduce no distortion. Use the best... none other is good enough. Use a Westinghouse Westector and halve your high-tension bill. The attached coupon and 3d. in stamps will bring you full particulars.

WESTINGHOUSE WESTECTORS

Full details of battery economy schemes please. 3d. in stamps enclosed.

Name

Address

W.M.11

THE WESTINGHOUSE BRAKE & SAXBY SIGNAL CO. LTD., 82, YORK ROAD, KING'S CROSS, LONDON, N.1.

Advertisers like to know you "saw it in the 'Wireless Magazine'"



A section of the "His Master's Voice" factories at Hayes, showing the large window space and frequent ventilation tunnels. Light and fresh air help to ensure reliable work.

Men who are not machines!

The men and women, over 10,000 of them, who work in the "His Master's Voice" factories at Hayes have unrivalled technical equipment to help them in their work, for "His Master's Voice" factories are the largest of their kind in the Empire. They have behind them the experience of research workers and engineers who have been engaged in the science of sound reproduction since the beginning.

But there is something else that contributes to the excellence of "His Master's Voice" instruments: the freedom from fatigue and the comfort in which these operatives work. Everything that can be done is done to lessen physical effort and relieve mental strain, so that the men and women who are responsible for the production and testing of "His Master's Voice" instruments work with vigour and fresh minds!

Which accounts for the superlative quality of "His Master's Voice" instruments and why they give such flawless service for the years they do.



The standard valves are mounted in pulleys to facilitate handling when the radio chassis are being tested for H.F. characteristics.



When the various sections of a radio receiver are connected together, lifts enable the operatives to bring the radio units to a comfortable height.

"His Master's Voice"

THE GRAMOPHONE COMPANY LIMITED 98-108 CLERKENWELL ROAD LONDON E.C.1

Choosing That New Set!

BY THE "WIRELESS MAGAZINE"
TECHNICAL STAFF



A really handsome set is the Charlton Higgs 55T twin-speaker outfit—and a charming companion too!

EVERYBODY knows nowadays that there are hundreds of new radio sets from which a choice can be made when it comes to buying a new receiver.

But it is not at all easy for the prospective purchaser to trace all these sets for himself.

types of sets will best meet his particular needs; most readers of "Wireless Magazine" will already have made up their minds on that score. The object of this supplement is to indicate what sets the more important manufacturers produce, so that comparisons regarding price and specification can easily be made.

just what the tabulated guide on pages 300 to 306 will tell you.

This guide gives details of more than 320 sets made by fifty-eight different manufacturers—sufficient choice to meet everybody's needs! Of these sets, over 100 are for battery operation; some 150 are for A.C. mains; and about fifty are for either A.C. or D.C. mains.

Many A.C./D.C. Sets

There are only a score of sets suitable only for D.C. mains, but when A.C./D.C. sets are taken into consideration this means that D.C. users have the choice of some seventy models all told. Approximately sixty radio gramophones are also listed.

We shall confine ourselves in these notes to a complete explanation of what our tabulated list is designed

For instance, you may think that a set of the type of the Blank Model XYZ is what you want; but you also want to know what other makers have to offer on similar lines. And that is



The motorboard of the H.M.V. model 580 autoradiogram. A neat layout with the visual tuner at the top of the tuning scale

For that reason "Wireless Magazine" this month takes pleasure in presenting a very complete list of the most important of the new season's designs. With the coming of winter and the consequent increased interest in radio thousands of listeners are thinking of changing their present sets for something more up-to-date; this Comprehensive Set Buyers' Supplement will make the choice of a new outfit easy for them.

It is not our object here to tell the listener what



This battery set with handsome looks is from the Lissen range

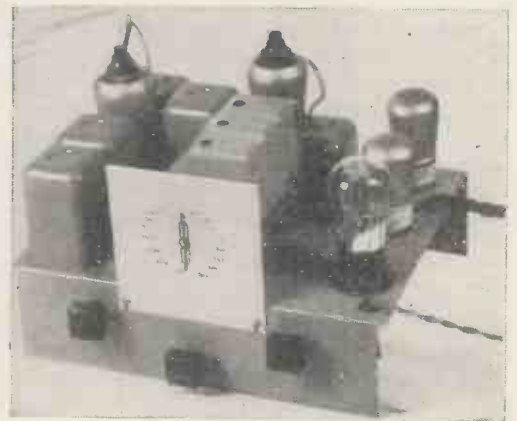

The chassis of the Burgoyne battery super-het. The clock dial is marked in metres



Enjoying the Children's Hour with the Ekco AD65 super-her. An everyday occurrence, but charming, nevertheless!

to show and how the best possible use can be made of it.

Rather than tabulate the sets in any technical groupings we have listed them in the ranges made by the various manufacturers. In this way you can see at a glance just how many models each maker has to offer.

Only Problem

For one reason or another many people are "sold" on some particular make of set and their only problem is to find the model in that particular range which best meets their individual needs; this arrangement gives them all the information they need in a nutshell.

We believe that set-buyers as a class are sufficiently enlightened nowadays not to buy a set just because they like the look of the cabinet; although, other things being equal, the question of cabinet design and finish will be the deciding factor in many cases.

About Cabinets

For this reason, therefore, we have given no indication as to cabinet finishes, although it will be clear from many model names that the sets in question are portables, table models or consoles.

In order to save space we have



The cheapest set in the H.M.V. range, the battery "Long Three." Walnut is used for this typical H.M.V. cabinet



A 10-valve straight set for the connoisseur made by Hacker's of Maidenhead. Note the large tuning dial

we do suggest that this guide will tell the reader what makers' catalogues are worth getting for further perusal.

We have already said that sets are listed in complete ranges; in their respective ranges they are listed by price. Here two points should be noted.

The use of an asterisk (*) against the model name or

number of a set indicates that it is a complete radio gramophone.

The use of a dagger (†) against the price indicates that, in case of battery sets, the price is inclusive of batteries. Some makers are not very explicit on this point and the omission of a dagger does not necessarily mean that the price does not include batteries.

Valve Combination

The next item of information to be gleaned from this guide is the valve combination actually employed; no tabulated list of reasonable simplicity can be perfect in this respect, but we have effected what we believe to be the best working compromise.

We have grouped valves under the headings "H.F." (preliminary high-frequency stages); "Det." (first detector in super-hets and the only detector in straight sets); "Osc." (oscillator in super-hets); "I.F." (intermediate-frequency stages in super-hets); "Det." (second detectors in super-hets); "L.F." (intermediate low-frequency stages); and "P" (power output stage).

Rectifiers

The column marked "Rectifier" indicates, in the case of A.C. sets, whether a valve (V) or metal (M) rectifier is used. In one or two cases the letter M is used in the "Det" columns to indicate the use of a metal rectifier for high-frequency rectification.

In those super-hets in

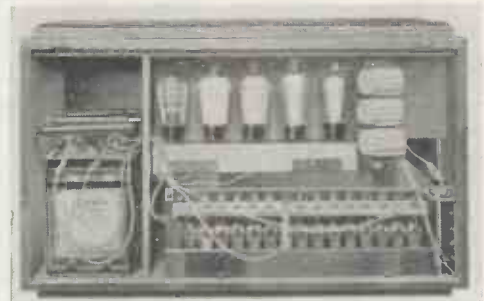

The Milnes Battery super-her is specially designed to accommodate this firm's wet battery in the bottom of the cabinet

which the functions of first detector and oscillator are combined in one valve the letter "C" is used in both the "Det" and "Osc" columns.

It is important to note that only the actual number of valves in any particular set are designated in this classification; so that by adding up the numbers printed horizontally in the "Valve Combination" section



Every set-maker's works throughout the country are busy turning out sets for Christmas. This busy scene was taken in the chassis-wiring department of the Portadyne factory

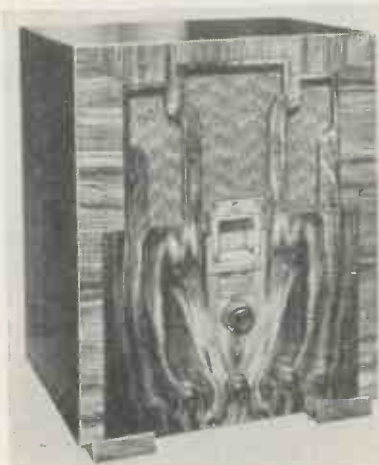

The most popular set in the G.E.C. range, the AVC Super-het, of which a battery version has just been released

it is possible to tell at once how many valves are used in a set.

There are objections to this system, we know, for it does not take count of the fact that several functions are carried out by multiple valves in some receivers. For instance, a double-diode-triode may be used for three different stages,

but in our classification it is listed as only one valve.

But, as we have pointed out, tabulated details of this kind must be arranged on a compromise. Complete details of every stage used in a set would make the table difficult to understand, and would at once reduce its utility to many listeners.

A few examples taken from the tabulated guide will help the non-technical reader to understand how the classification works out in practice.

Take the Alba model 79 A.C. The asterisk against the name shows that it is a radio gramophone. The classification "C" shows that it is a super-het with a combined detector-

oscillator; it has five valves, excluding the mains rectifier, which is of the valve type.

On the other hand the B.S.R. model R3W is not a radio gramophone and, as it has no second detector or intermediate-frequency stages, it is a straight set and not a super-het; further inspection of the details will reveal that it is a four-valver with two high-frequency stages, with an additional valve for mains rectification.

"Yes" in the column headed "Pick-up Terminals" is self-explanatory, but this column is left blank in the case of complete radio gramophones.

There is no difficulty about the column headed "Extension Loud-speaker Terminals," but it should be remembered that some sets provided with such terminals also have a switch to cut the internal loud-speaker out of circuit when an external reproducer is in use.

The use of a double-dagger (‡) in "Dial Calibration" column means that the set is provided with a visual or shadow-tuning type of tuning indicator.

The last step is to turn to page 370, look up the makers' addresses and send them postcards asking for further details of the sets listed in the "Wireless Magazine" Set-Buyers' Guide!



For neatness it would be hard to beat this five-valve Philips' all-mains radiogram

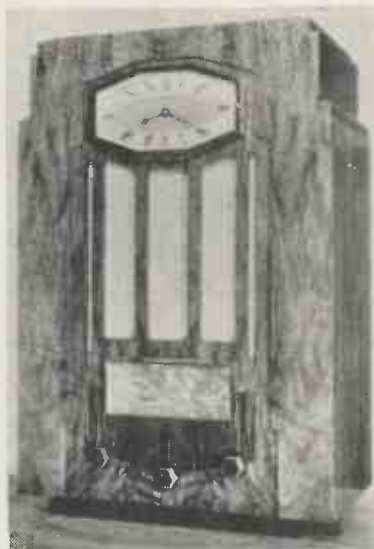

A typical example of the trend in modern cabinet work, the Ferranti Arcadia console set complete with synchronous electric clock

Your Guide to the New Sets

In order to get the maximum amount of utility from this guide, it is as well that the reader should understand exactly on what basis it has been built up. The following notes will make everything clear:—

Brand Names.—This is the name by which the set is usually known. It does not always coincide with the name of the manufacturing firm and a guide to the letters, names, and addresses will be found on page 370.

Model.—This is the descriptive name or type number of individual sets. An asterisk (*) against names in this column means that the model is a complete radio gramophone.

Price.—A dagger (†) against prices in this column means that the price includes batteries.

Valve Combination.—Straight sets are distinguished from super-hets by the fact that they have no second detector. "H.F." indicates preliminary high-frequency stages; "Det.," first detector in super-hets or the detector in straight sets; "Osc.," separate oscillator in super-hets (note that "C" indicates combined first detector/oscillator); "I.F.," intermediate-frequency stage; "Det.,"

second detector (in super-hets only); "L.F.," intermediate low-frequency stages; and "P.," power output valves. Under "Rectifier" (for A.C. sets only) "V" indicates valve and "M" a metal rectifier.

Pick-up Terminals.—Where sets which are not complete radio gramophones are provided with terminals for the connection of a pick-up, "Yes" is indicated in this column.

Extension Loud-speaker.—In this column "H" indicates that the set is for headphone reception. Some sets provided with terminals for the use of an external loud-speaker also have a switch to cut the internal loud-speaker out of circuit.

Dial Calibrations.—Here "W" indicates calibrations in wavelengths; "N," actual names of stations; "D," degrees; and "F," frequencies. A double-dagger (‡) indicates that the set is provided with a visual or shadow-tuning device.

Power Supply.—Most A.C. sets are suitable for mains of 40 to 100 cycles frequency. "A.C./D.C." indicates that a set can be used on either A.C. or D.C. mains without any alteration whatever. "A.C. or D.C." means that a separate D.C. model is available at the same price as the A.C. model.

Brand Name	Model	Price £ s. d.	Valve Combination							Pick-up Terminals	Extension Loud-speaker	Dial Calibration	Power Supply		
			H.F.	Det.	Osc.	I.F.	Det.	L.F.	Power Rectifier						
Adey ..	1-v. Portable	3 17 6†	—	1	—	—	—	—	—	—	—	H	—	Batteries	
	3-v. Portable	5 5 0†	2	1	—	—	—	—	—	—	—	H	—	Batteries	
	4-v. Portable	7 10 0†	2	1	—	—	—	—	1	—	—	Yes	—	Batteries	
Aerodyne ..	Raven ..	5 5 0	—	1	—	—	—	1	1	—	Yes	—	D	Batteries	
	Wren ..	7 7 0	1	1	—	—	—	—	1	—	Yes	Yes	W	Batteries	
	Merlin ..	9 9 0	1	1	—	—	—	—	1	—	Yes	Yes	W	Batteries	
	Drake ..	10 10 0	1	1	—	—	—	—	1	—	Yes	Yes	W	A.C. 200-250v.	
	Blackbird ..	10 10 0	1	1	—	—	—	—	1	1	—	Yes	Yes	W	Batteries
	Curlew ..	10 19 6	1	1	—	—	—	—	1	V	Yes	Yes	W	A.C./D.C. 200-250v.	
	Swallow ..	12 12 0	—	—	C	1	1	—	1	V	Yes	Yes	W	A.C. 200-250v.	
*Cardinal ..	21 0 0	—	—	C	1	1	—	1	V	—	—	W	A.C. 200-250v.		
Alba ..	21 ..	6 19 6†	1	1	—	—	—	—	1	—	Yes	Yes	W	Batteries	
	52 ..	9 19 6	1	1	—	—	—	—	1	V	Yes	—	W	A.C. 200-260v. or D.C. 200-250v.	
	*43 ..	12 12 0†	1	1	—	—	—	—	1	—	Yes	Yes	W	Batteries	
	57 AC ..	12 12 0	—	—	C	1	1	1	1	V	Yes	Yes	W	A.C. 200-260v.	
	57 Universal	13 13 0	—	—	C	1	1	1	1	V	Yes	Yes	W	A.C./D.C. 200-250v.	
	*72 AC ..	16 16 0	1	1	—	—	—	—	1	V	—	Yes	W	A.C. 200-260v.	
	*72 DC ..	17 17 0	1	1	—	—	—	—	1	—	—	Yes	W	D.C. 200-250v.	
	*79 AC ..	21 0 0	—	—	C	1	1	1	1	V	—	Yes	W	A.C. 200-260v.	
	*79 Universal	23 2 0	—	—	C	1	1	1	1	V	—	Yes	W	A.C./D.C. 200-250v.	
Allwave ..	Short-wave	12 10 0	1	1	1	—	—	—	1	—	—	Yes	WF	Batteries	
	Table ..	35 0 0	—	—	C	2	1	1	1	V	Yes	Yes	WF†	A.C./D.C.	
	*Radiogram	52 10 0	—	—	C	2	1	1	1	V	—	Yes	WF†	A.C./D.C.	
Atlas ..	7-5-8 Table	14 14 0	—	—	C	1	1	—	1	V	Yes	Yes	WN	A.C. 200-250v.	
	7-5-8 Console	16 16 0	—	—	C	1	1	—	1	V	Yes	Yes	WN	A.C. 200-250v.	
Austin ..	Super-het	16 16 0	—	—	C	1	1	1	1	—	Yes	Yes	W	Batteries	
	Super-het	18 18 0	—	—	C	1	1	—	1	V	Yes	Yes	W	A.C.	
	*Radiogram	30 9 0	—	—	C	1	1	—	1	V	—	Yes	W	A.C.	
		33 12 0	—	—	C	1	1	—	1	V	—	Yes	W	A.C.	
		37 16 0	—	—	C	1	1	—	1	V	—	Yes	W	A.C.	
	*Grandfather	44 12 6	—	—	C	1	1	—	1	V	—	Yes	W	A.C.	
	47 15 6	—	—	C	1	1	—	1	V	—	Yes	W	A.C.		
	50 18 6	—	—	C	1	1	—	1	V	—	Yes	W	A.C.		

Brand Name	Model	Price £ s. d.	Valve Combination								Pick-up Terminals	Extension Loud-speaker	Dial Calibration	Power Supply
			H.F.	Det.	Osc.	I.F.	Det.	L.F.	Power	Rectifier				
Beethoven	75 Portable	7 10 0	1	1	-	-	-	1	1	-	Yes	Yes	-	Batteries
	53	7 19 6	1	1	-	-	-	-	1	-	Yes	Yes	W	Batteries
	54 Trans. . .	9 19 6	1	1	-	-	-	1	1	-	Yes	Yes	W	Batteries
	85 Portable	9 19 6	1	1	-	-	-	1	1	-	Yes	Yes	-	Batteries
	56	13 13 0	-	C	-	1	1	1	1	V	Yes	Yes	-	A.C. 100-250v.
Betterset	Portable . .	9 9 0	1	1	-	-	-	1	1	-	-	Yes	W	Batteries
	Transportable	16 16 0	1	1	-	-	-	-	1	V	Yes	Yes	W	A.C./D.C.
B.S.R.	R3W . .	47 5 0	2	1	-	-	-	-	1	V	Yes	Yes	W†	A.C. 200-250v.
	VS8 . .	89 5 0	1	C	-	2	1	1	1	V	Yes	Yes	W†	A.C. 200-250v.
Burgoyne	Olympic 3..	4 4 0	-	1	-	-	-	1	1	-	Yes	-	D	Batteries
		5 5 0	-	1	-	-	-	1	1	-	-	-	W	Batteries
	Portable . .	5 5 0	2	1	-	-	-	1	1	-	-	-	W	Batteries
	2 Pentode 3	5 17 6	1	1	-	-	-	-	1	-	Yes	-	W	Batteries
	Class-B 3 . .	6 10 0	-	1	-	-	-	1	1	-	Yes	Yes	W	Batteries
	7 9 6	-	1	-	-	-	1	1	-	-	-	W	Batteries	
	S.G. 4 . .	6 17 6	1	1	-	-	-	1	1	-	-	-	W	Batteries
	Super-het . .	10 10 0	-	C	-	1	1	1	1	-	-	-	W	Batteries
Bush	SB1 . .	10 19 6	-	1	-	-	-	1	1	-	-	-	W	Batteries
	SAC1 . .	10 19 6	-	1	-	1	1	-	-	V	-	Yes	W	A.C. 200-250v.
	SAC5 . .	13 13 0	-	C	-	1	1	-	1	V	Yes	Yes	W†	A.C. 200-250v.
	SAC7 . .	16 16 0	1	C	-	1	1	-	1	V	Yes	Yes	W†	A.C. 200-250v.
Consolidated Radio	Trans. 4 . .	8 19 6	1	1	-	-	-	1	1	-	Yes	Yes	WD	Batteries
	All-wave 4	11 11 0	1	1	-	-	-	-	1	V	-	Yes	WD†	A.C./D.C.
	Super-het . .	14 14 0	-	C	-	1	1	1	1	V	-	Yes	WD†	A.C./D.C.
	Super-het . .	18 18 0	1	C	-	1	1	1	1	-	Yes	Yes	WD	Batteries
Cossor	350 . .	5 12 6	1	1	-	-	-	-	1	-	Yes	Yes	WN	Batteries
	353 . .	6 17 6	1	1	-	-	-	-	1	-	Yes	Yes	WN	Batteries
	3455 . .	7 15 0	1	1	-	-	-	-	1	-	Yes	Yes	WN	Batteries
	355 . .	8 15 0	1	1	-	-	-	-	1	-	Yes	Yes	WN	Batteries
	453B . .	8 15 0	1	1	-	-	-	-	1	1	Yes	Yes	WN	Batteries
	358 . .	8 15 0	1	1	-	-	-	-	1	V	Yes	Yes	WN	A.C. 200-250v.
	439A . .	9 15 0	1	1	-	-	-	-	1	V	Yes	Yes	WN	A.C. 200-250v.
	3469 . .	9 15 0	1	1	-	-	-	-	1	-	Yes	Yes	WN	D.C. 200-250v.
	634 . .	10 10 0	-	C	-	1	1	-	1	-	Yes	Yes	WN	Batteries
	356 . .	10 15 0	1	1	-	-	-	-	1	V	Yes	Yes	WN	A.C. 200-250v.
	535 . .	12 12 0	-	C	-	1	1	-	1	V	Yes	Yes	WN†	A.C. 200-250v.
*536 . .	16 16 0	1	1	-	-	-	-	1	V	-	Yes	WN	A.C. 200-250v.	
Drummer	B3 . .	7 17 6	1	1	-	-	-	-	1	-	-	-	W	Batteries
	B44 . .	11 11 0	-	C	-	1	1	-	1	-	Yes	Yes	W	Batteries
	M45 . .	12 12 0	-	C	-	1	1	-	1	V	-	Yes	W	A.C. 200-250v.
	M55M . .	14 14 0	-	C	-	1	1	-	1	V	Yes	Yes	W	A.C. 200-250v.
	M55C . .	14 14 0	-	C	-	1	1	-	1	V	Yes	Yes	W	A.C. 200-250v.
	M56 . .	18 18 0	-	C	-	1	1	-	1	V	Yes	Yes	W	A.C. 200-250v.
Dynatron	A33 . .	13 13 0	1	1	-	-	-	-	1	V	Yes	Yes	W	A.C.
	AC52 . .	21 0 0	2	1	-	-	-	1	1	V	Yes	Yes	WN†	A.C.
	U52 . .	21 0 0	2	1	-	-	-	1	1	V	Yes	Yes	WN†	A.C./D.C.
	*NA52 . .	34 13 0	2	1	-	-	-	1	1	V	-	Yes	WN†	A.C./D.C.
	*K106T . .	78 15 0	3	1	-	-	-	5	1	V	-	Yes	WN†	A.C.
	*K106M . .	81 18 0	3	1	-	-	-	5	1	V	-	Yes	WN†	A.C.
	*L136 . .	110 5 0	3	1	-	-	-	8	1	V	-	Yes	WN†	A.C.

For Explanatory Notes see previous page

Brand Name	Model	Price £ s. d.	Valve Combination								Pick-up Terminals	Extension Loud-speaker	Dial Calibration	Power Supply
			H.F.	Det.	Osc.	I.F.	Det.	L.F.	Power	Rectifier				
Dynatron Cont.	*E1712 ..	136 10 0	3	1	-	-	-	11	2	V	-	Yes	WN†	A.C.
Eddystone ..	All-world 4	22 10 0	1	1	-	-	-	1	1	-	Yes	Ext	D	Batteries
	Sphinx ..	23 0 0	1	1	-	-	-	1	1	-	Yes	Yes	W	Batteries
	Sphinx A.C.	27 10 0	1	1	-	-	-	1	1	V	Yes	Yes	W	A.C. 100-125v. and 200-250v.
Ekco ..	B54 ..	10 10 0	1	1	-	-	-	1	1	-	Yes	-	WN	Batteries
	AD65 ..	11 6 0	-	C	1	1	-	-	V	-	-	WN	A.C./D.C. 200-250v.	
	B85 ..	13 2 6	-	C	1	1	-	1	-	-	Yes	Yes	WN	Batteries
	AC85 ..	13 2 6	-	C	1	1	1	1	V	Yes	Yes	WN	A.C. 100-130v. and 200-250v.	
	BT95 ..	15 15 0	1	C	1	1	-	1	-	-	-	WN	Batteries	
	ADT95 ..	15 15 0	1	C	1	1	1	1	V	-	-	WN	A.C./D.C. 200-250v.	
Eldeco ..	2P7C ..	17 0 0	1	C	1	1	-	1	-	-	-	WD	Batteries	
	QP75 ..	19 0 0	1	C	1	1	-	1	-	-	-	WD	Batteries	
	ES1 ..	25 0 0	1	1	1	1	1	-	1	V	Yes	Yes	WD†	A.C.
Ferranti ..	Lancastria ..	12 12 0	-	C	1	1	-	-	V	Yes	Yes	WN†	A.C. 200-250v.	
	Universal ..	14 14 0	-	C	1	1	-	1	V	-	-	WN†	A.C./D.C. 200-250v.	
	Consolette ..	15 15 0	-	C	1	1	1	1	-	Yes	Yes	WN†	Batteries	
	Arcadia ..	15 15 0	-	C	1	1	1	-	1	V	Yes	Yes	WN†	A.C. 200-250v.
	Portable ..	16 16 0	1	C	1	1	1	1	-	Yes	Yes	WN†	Batteries	
	Gloria ..	23 2 0	1	C	1	1	1	1	V	Yes	Yes	WN†	A.C. 200-250v.	
	*Arcadiagram	31 10 0	-	C	1	1	-	1	V	Yes	Yes	WN†	A.C. 200-250v.	
G.E.C. ..	BC3536 ..	5 17 6	-	1	-	-	-	1	1	-	Yes	Yes	D	Batteries
	BC3520 ..	7 15 0	-	1	-	-	-	-	1	V	-	-	D	A.C./D.C. 200-250v.
	BC3546 ..	9 17 6	1	1	-	-	-	1	1	-	Yes	Yes	W	Batteries
	BC3545 ..	13 13 0	-	C	1	1	-	1	-	Yes	Yes	WN	D.C. 200-250v.	
	BC3540 ..	14 14 0	-	C	1	1	-	1	V	Yes	Yes	WN	A.C. 190-250v.	
	BC3544 ..	17 17 0	-	C	1	1	-	1	V	Yes	Yes	WN	A.C. 190-250v.	
	BC3548 ..	23 2 0	-	C	1	1	-	1	V	-	Yes	WN	A.C. 190-250v.	
	BC3460 ..	25 4 0	1	1	1	1	1	-	1	V	Yes	Yes	F	A.C. 100-150v. and 190-250v.
Halycon ..	301 ..	8 19 6†	1	1	-	-	-	1	-	Yes	Yes	W	Batteries	
	401 ..	11 11 0†	1	1	-	-	-	1	-	Yes	Yes	W	Batteries	
	4501 ..	14 14 0	1	C	1	1	-	1	M	Yes	Yes	W†	A.C./D.C. 200-260v.	
	6701 ..	19 19 0	1	C	1	1	1	1	V	Yes	Yes	W†	A.C. 200-260v.	
	6701C ..	22 1 0	1	C	1	1	1	1	V	Yes	Yes	W†	A.C. 200-260v.	
	*4501G ..	22 1 0	-	C	1	1	-	1	M	-	Yes	W†	A.C./D.C. 200-260v.	
		31 10 0												
*6701G ..	40 19 0	1	C	1	1	1	1	V	-	Yes	W†	A.C. 100-110v. and 200-260v.		
Halford ..	2SW ..	4 4 0	-	1	-	-	-	1	-	-	H	D	Batteries	
	U7 ..	16 16 0	-	C	1	1	1	1	V	Yes	Yes	DN	A.C./D.C.	
	All-wave 10	34 13 0	1	C	1	1	1	2	V	Yes	Yes	N†	A.C./D.C.	
	*8-v. R/G ..	42 0 0	1	C	1	1	1	2	V	-	Yes	N†	A.C./D.C.	
	*Empyrean ..	105 0 0	1	C	1	1	1	2	V	-	Yes	N†	A.C./D.C.	
Harken ..	S.W. Super	20 0 0	1	C	1	1	-	-	V	Yes	Yes	D	A.C.	
	S.W. Super	22 0 0	1	C	1	1	-	1	-	Yes	Yes	D	Batteries	
	S.W. & Med.	24 15 0	1	C	1	1	-	1	-	Yes	Yes	D	Batteries	
Hartley Turner	S7 ..	28 10 0	1	1	-	-	-	1	2	V	Yes	-	WD†	A.C.
	S12 ..	30 10 0	1	1	-	-	-	1	2	V	Yes	-	WD†	A.C.
	M12 ..	40 19 0	2	1	-	-	-	1	2	V	Yes	-	D†	A.C.
	*RGS12 ..	63 0 0	1	1	-	-	-	1	2	V	-	-	WD†	A.C.
	*RGM12 ..	73 10 0	2	1	-	-	-	1	2	V	-	-	D†	A.C.

For Explanatory Notes see page 300

Brand Name	Model	Price £ s. d.	Valve Combination										Power Supply	
			H.F.	Det.	Osc.	I.F.	Det.	L.F.	Power	Rectifier	Pick-up Terminals	Extension Loud-speaker		Dial Calibration
Higgs ..	A55R and .. D55R ..	12 12 0	1	C	-	1	-	1	V	Yes	Yes	W	A.C. or D.C. 190-265v.	
	A55T and D55T ..	15 15 0	1	C	-	1	-	1	V	Yes	Yes	W†	A.C. or D.C. 190-265v.	
	*A55TG and *D55TG ..	27 6 0	1	C	-	1	-	1	V	-	Yes	W†	A.C. or D.C. 190-265v.	
His Master's Voice	148.. ..	7 19 6	1	1	-	-	-	1	-	Yes	Yes	W	Batteries	
	146.. ..	11 11 0	-	C	1	1	-	1	-	Yes	Yes	WN	Batteries	
	440AC ..	11 11 0	-	C	1	1	-	1	V	Yes	Yes	WN	A.C. 200-250v.	
	440DC ..	12 12 0	-	C	1	1	-	1	-	Yes	Yes	WN	D.C. 200-250v.	
	442.. ..	14 3 6	-	C	1	1	-	1	V	Yes	Yes	WN†	A.C. 200-250v.	
	462.. ..	15 15 0	1	C	1	M	1	2	-	Yes	Yes	WN	Batteries	
	463.. ..	16 16 0	1	C	1	1	-	1	V	Yes	Yes	WN†	A.C. 200-250v.	
	467AC ..	17 17 0	1	1	1	1	1	-	1	V	Yes	Yes	W	A.C. 200-250v.
	467DC ..	17 17 0	1	1	1	1	1	-	2	-	Yes	Yes	W	D.C. 200-250v.
	*540AC ..	21 0 0	-	C	1	1	-	1	V	-	Yes	WN	A.C. or D.C. 200-250v.	
	*540DC ..	22 1 0	-	C	1	1	-	1	V	-	Yes	WN	A.C. or D.C. 200-250v.	
	*540A ..	23 2 0	-	C	1	1	-	1	V	-	Yes	WN	A.C. 200-250v.	
	*542.. ..	28 7 0	-	C	1	1	-	1	V	-	Yes	WN	A.C. 200-250v.	
	*570.. ..	34 13 0	-	C	1	1	-	1	V	-	Yes	WN†	A.C. 200-250v.	
*580.. ..	47 5 0	1	C	2	1	1	2	V	-	Yes	WN†	A.C. 200-250v.		
*800.. ..	115 10 0	1	1	1	3	1	2	2	V	-	Yes	WN†	A.C. 200-250v.	
Hyvoltstar ..	Table Model	8 18 6	1	M	-	-	-	1	V	Yes	-	W	A.C./D.C. 200-260v.	
	*Miniature ..	15 15 0	-	C	1	1	-	1	V	Yes	Yes	W	A.C./D.C. 109-260v.	
	All-wave 5	18 18 0	-	C	1	1	-	1	V	Yes	-	W	A.C./D.C. 109-260v.	
	*All-wave 5	25 4 0	-	C	1	1	-	1	V	Yes	-	W	A.C./D.C. 109-260v.	
	Table ..	27 6 0	1	C	1	1	-	2	V	-	Yes	W†	A.C./D.C. 100-260v.	
	*Table ..	31 10 0	1	C	1	1	-	2	V	-	Yes	W†	A.C./D.C. 100-260v.	
*Console ..	42 0 0	-	C	1	1	-	2	V	-	-	-	-		
Invicta ..	D3	4 10 0†	-	1	-	-	-	1	1	-	-	D	Batteries	
	BS4MI ..	6 17 6†	1	1	-	-	-	1	-	Yes	Yes	WN	Batteries	
	Bandpass T	8 17 6†	1	1	-	-	-	1	-	Yes	Yes	W	Batteries	
	FS35 ..	9 19 6	1	1	-	-	-	1	-	-	Yes	D	Batteries	
	Multi mains	10 15 0	-	C	-	1	-	1	V	-	Yes	W	A.C./D.C.	
	635.. ..	12 19 6	-	C	1	1	1	1	V	Yes	Yes	W	A.C.	
Kolster Brandes	362.. ..	5 15 0	-	1	-	-	-	1	1	-	-	DN	Batteries	
	393.. ..	6 6 0	1	1	-	-	-	1	-	Yes	-	D	Batteries	
	397.. ..	6 17 6	-	1	-	-	-	1	V	-	-	DN	A.C. 200-250v.	
	333A ..	8 19 6	1	1	-	-	-	1	-	Yes	-	W	Batteries	
	364.. ..	9 19 6	1	1	-	-	-	1	-	Yes	-	W	Batteries	
	363.. ..	10 10 0	1	1	-	-	-	1	1	-	Yes	W	Batteries	
	337.. ..	10 10 0	1	1	-	-	-	1	1	-	Yes	Yes	D	Batteries
	381.. ..	10 10 0	-	C	1	1	-	1	V	-	-	WN	A.C./D.C. 200-250v.	
	444.. ..	12 12 0	-	C	-	1	-	1	V	Yes	Yes	W	A.C. 100-130v. and 200-250v.	
	405.. ..	15 15 0	1	C	1	1	-	1	V	-	-	WN†	A.C./D.C. 200-250v.	
	398.. ..	16 16 0	1	C	1	1	1	1	-	Yes	-	WN	Batteries	
	666.. ..	16 16 0	1	C	1	1	-	1	V	Yes	Yes	W	A.C. 100-130v. and 200-250v.	
	666B ..	18 18 0	1	C	1	1	-	1	V	Yes	Yes	W	A.C. 100-130v. and 200-250v.	
	383.. ..	19 19 0	-	C	1	1	1	2	V	Yes	-	WN	A.C./D.C. 200-250v.	
	*379.. ..	23 2 0	1	1	-	-	-	1	1	-	-	W	Batteries	
	*365.. ..	23 2 0	-	C	1	1	-	1	V	-	Yes	W	A.C. 100-130v. or 200-251v.	
	383A ..	26 5 0	-	C	1	1	1	2	V	Yes	-	WN	A.C./D.C. 200-250v.	
	888.. ..	26 5 0	1	C	1	1	1	2	V	Yes	Yes	WN	A.C. 100-130v. or 200-250v.	
888B ..	29 8 0	1	C	1	1	1	2	V	Yes	Yes	WN	A.C. 100-130v. or 200-250v.		

For Explanatory Notes see page 300

Brand Name	Model	Price £ s. d.		Valve Combination								Pick-up Terminals	Extension Loud-speaker	Dial Calibration	Power Supply	
				H.F.	Det.	Osc.	I.F.	Det.	L.F.	Power	Rectifier					
K. B. (Cont.)	*378.. ..	28	7	0	1	C		1	1	-	1	V	-	Yes	W	A.C. 100-130v. or 200-250v.
Lampex ..	Minx ..	3	19	6†	-	1	-	-	-	1	1	-	-	Yes	D	Batteries
	Minx de luxe	5	5	0	1	1	-	-	-	-	1	-	Yes	Yes	W	Batteries
	S.G.3 ..	7	7	0	1	1	-	-	-	-	1	V	Yes	Yes	W	A.C.
	Triple Pen	7	17	6	1	1	-	-	-	-	1	V	Yes	Yes	W	A.C.
	Unifive ..	10	19	6	2	1	-	-	-	-	1	V	Yes	-	W	A.C./D.C.
	*Unifive de luxe ..	16	16	0	1	1	-	-	-	-	1	V	-	-	W	A.C.
Triple Pen RG ..	15	15	0	1	1	-	-	-	-	1	V	-	-	W	A.C.	
*Unifive RG de luxe ..	28	7	0	2	1	-	-	-	-	1	V	-	-	W	A.C./D.C.	
Lissen ..	8100 ..	4	10	0	-	1	-	-	-	1	1	-	Yes	-	WD	Batteries
	8044 ..	5	15	0	-	1	-	-	-	-	2	-	-	Yes	D	Batteries
	8098 ..	7	7	6	1	1	-	-	-	-	1	-	Yes	Yes	W	Batteries
	8099 ..	7	15	0	1	1	-	-	-	-	1	-	Yes	Yes	W	Batteries
	8073 ..	8	10	0	1	1	-	-	-	-	1	-	Yes	Yes	W	Batteries
	8043 ..	9	9	0	1	1	-	-	-	-	1	-	-	Yes	W	D.C. 200-250v.
	8093 ..	9	15	0	1	1	-	-	-	-	1	V	Yes	Yes	W	A.C. 200-250v.
	8095 ..	9	15	0	1	1	-	-	-	-	1	V	Yes	Yes	W	A.C. 100-150v.
Lotus ..	33	4	17	6	-	1	-	-	-	-	1	V	Yes	-	D	A.C./D.C. 150-250v.
	22	7	10	0	1	1	-	-	-	1	1	-	Yes	-	W	Batteries
	44	7	19	6	1	1	-	-	-	-	1	V	Yes	-	W	A.C./D.C. 150-250v.
	66	12	12	0	-	C		1	1	1	1	V	Yes	Yes	W†	A.C.
Magnum ..	Yacht ..	11	10	0	1	1	-	-	-	-	1	-	Yes	Yes	W	Batteries or generator
M.R.G. ..	BP75 ..	9	9	0	1	1	-	-	-	-	1	V	Yes	Yes	W	A.C.
	B775 Univ. R5/50 .. R5/50 Univ.	11	19	6	-	C		1	1	-	1	V	Yes	Yes	W	A.C./D.C. A.C. A.C./D.C.
Marconi- phone	284.. ..	7	19	6	1	1	-	-	-	-	1	-	Yes	Yes	W	Batteries
	257.. ..	11	11	0	-	C		1	1	-	1	-	Yes	Yes	WN	Batteries
	262.. ..	11	11	0	-	C		1	1	-	1	V	Yes	Yes	WN	A.C. or D.C.
	296.. ..	13	13	6	-	C		1	1	-	1	V	Yes	Yes	WN†	A.C.
	269.. ..	15	15	0	1	C		1	1	-	2	-	Yes	Yes	W	Batteries
	273.. ..	15	15	0	1	C		1	1	-	1	-	Yes	Yes	W	Batteries
	279.. ..	16	16	0	1	C		1	1	-	1	V	Yes	Yes	WN†	A.C.
	276.. ..	17	17	0	1	1	1	1	1	-	1	V	Yes	Yes	W	A.C. or D.C.
	*Q286 ..	23	2	0	-	C		1	1	-	1	V	-	Yes	WN	A.C.
	*289 Auto ..	34	13	0	-	C		1	1	-	1	V	-	Yes	WN†	A.C.
	*291.. ..	36	15	0	1	1	1	1	1	-	1	V	-	Yes	W	A.C.
	*291 Auto ..	44	2	0	1	1	1	1	1	-	1	V	-	Yes	W	A.C.
	*292 Auto ..	50	8	0	1	C		2	1	1	2	V	-	-	WN†	A.C.
McMichael	Duplex trans.	14	14	0	1	1	-	-	-	2	1	-	Yes	Yes	W	Batteries
	AC Super-het	14	14	0	-	C		1	1	-	1	M	Yes	Yes	W	A.C.
	Suitcase ..	15	15	0	1	1	-	-	-	1	1	-	-	Yes	W	Batteries
	Super-het Trans.	16	16	0	1	C		1	1	-	1	M	Yes	Yes	W	A.C.
	Twin Super- het	18	18	0	-	C		2	1	-	1	M	Yes	Yes	W	A.C.
Midgley ..	110.. ..	11	11	0	1	1	-	-	-	-	1	V	Yes	Yes	W	A.C.

For Explanatory Notes see page 300

Brand Name	Model	Price £ s. d.	Valve Combination								Pick-up Terminals	Extension Loud-speaker	Dial Calibration	Power Supply
			H.F.	Det.	Osc.	I.F.	Det.	L.F.	Power	Rectifier				
Milnes ..	589.. ..	14 19 0	-	C		2	1	-	1	-	Yes	Yes	W	Batteries
Mullard ..	MB3 ..	8 8 0	1	1	-	-	-	-	1	-	-	-	W	Batteries
Multitone ..	BA	21 0 0	1	1	-	-	-	2	1	-	Yes	Yes	W	Batteries
	MA	25 4 0	2	1	-	-	-	1	1	V	Yes	Yes	W	A.C.
Northampton	SG3 ..	4 19 0	1	1	-	-	-	-	1	-	-	-	W	Batteries
	SG3 ..	6 19 0	1	1	-	-	-	-	1	V	-	Yes	W	A.C.
Ormond ..	601.. ..	6 10 0	-	1	-	-	-	1	1	-	Yes	Yes	W	Batteries
	602.. ..		-	1	-	-	-	1	1	-	Yes	Yes	W	Batteries
	603.. ..	7 10 0	-	1	-	-	-	1	1	-	Yes	Yes	W	Batteries
	605.. ..	7 10 0	1	1	-	-	-	-	1	-	Yes	Yes	W	Batteries
	604.. ..	7 10 0	-	1	-	-	-	-	1	V	Yes	Yes	W	A.C. or D.C.
Pegasus ..	1660 ..	8 8 0	1	1	-	-	-	1	1	-	Yes	-	WN	Batteries
	1770 ..	9 9 0	2	1	-	-	-	-	1	V	Yes	-	WN	A.C./D.C.
	1990 ..	9 9 0	2	1	-	-	-	-	1	V	Yes	-	WN	A.C.
	Short-wave	21 0 0	1	1	-	-	-	1	1	-	-	-	D	Batteries
	254	25 4 0	2	1	-	-	-	-	1	V	-	-	D	A.C.
Philco ..	233.. ..	8 8 0	1	1	-	-	-	-	1	-	-	-	F	Batteries
	264.. ..	10 10 0	-	C		1	1	-	1	V	-	-	F	A.C.
	260 ..	12 12 0	-	C		1	1	-	1	V	Yes	-	F	A.C.
	1260 ..	14 14 0	-	C		1	1	-	1	V	Yes	-	F†	A.C.
	263.. ..	15 15 0	-	C		1	1	-	1	V	Yes	-	F†	A.C./D.C.
	1263 ..	16 16 0	-	C		1	1	-	1	V	Yes	-	F†	A.C./D.C.
	238.. ..	17 17 0	-	C		1	1	1	1	-	-	-	F	Batteries
	16B ..	36 15 0	-	1	1	2	1	3	2	V	-	-	F†	A.C.
	Philips ..	274A ..	9 9 0	2	1	-	-	-	-	1	V	Yes	Yes	W
372B ..		11 11 0	2	1	-	-	-	2	1	-	Yes	Yes	W	Batteries
588A ..		12 12 0	-	C		1	1	1	1	V	Yes	Yes	W	A.C.
588U ..		13 13 0	-	C		1	1	1	1	V	Yes	Yes	W	A.C./D.C.
472A ..		15 15 0	-	C		1	1	1	1	V	Yes	Yes	WN	A.C.
472U ..		16 16 0	2	1	-	-	-	1	1	V	Yes	Yes	WN	A.C./D.C.
*538A ..		24 3 0	-	C		1	1	1	1	V	-	Yes	W	A.C.
Portadyne ..	B37.. ..	12 12 0	-	C		1	1	1	1	-	Yes	Yes	W†	Batteries
	A37 ..	12 12 6	-	C		1	1	-	1	V	Yes	Yes	W†	A.C. 200-250v.
	PB6 ..	13 13 6	1	C		1	1	1	1	-	Yes	Yes	W†	Batteries
	PA6 ..	14 14 6	1	C		1	1	-	1	V	Yes	Yes	W†	A.C. 200-250v.
Pye	S/Q ..	11 0 0	1	1	-	-	-	1	1	-	Yes	Yes	WN	Batteries
	SP/B ..	15 15 0	1	C		1	1	-	2	-	-	Yes	WN	Batteries
	SE/B ..	15 15 0	1	C		1	1	1	1	-	Yes	Yes	WN	Batteries
	SE/AC ..	15 15 0	1	C		1	1	-	-	M	Yes	Yes	WN†	A.C. 100-110v. and 200-250v.
	SP/AC ..	16 16 0	1	C		1	1	-	-	M	Yes	Yes	WN†	A.C. 100-110v. and 200-250v.
	SE/DC ..	16 16 0	1	1	1	1	1	-	1	-	Yes	Yes	WN	D.C. 200-250v.
	CR/AC ..	21 0 0	1	C		1	1	-	1	M	Yes	Yes	WN†	A.C. 100-110v. and 200-250v.
	CR/DC ..	21 0 0	1	1	1	1	1	-	2	-	Yes	Yes	WN†	D.C. 200-250v.
Radiolux	AC Table	12 12 0	1	C		1	-	1	V	Yes	Yes	W†	A.C. 110v. and 190-265v.	
	DC Table	13 13 0	-	1	1	-	1	-	1	-	Yes	Yes	W†	D.C. 190-265v.
	*AC Radio-gram	22 1 0	-	1	1	-	1	-	1	V	-	Yes	W†	A.C. 110v. and 190-265v.
	*Autogram ..	52 10 0	-	1	1	-	1	-	1	V	-	-	W†	A.C. 110v. and 190-265v.

For Explanatory Notes see page 300

Brand Name	Model	Price £ s. d.	Valve Combination								Pick-up Terminals	Extension Loud-speaker	Dial Calibration	Power Supply	
			H.F.	Det.	Osc.	I.F.	Det.	L.F.	Power	Rectifier					
Radiophone	409.. ..	25 4 0	-	1	1	2	1	1	1	-	Yes	-	F	Batteries	
	ETM306 ..	42 0 0	1	1	1	1	1	1	1	V	Yes	Yes	F†	A.C. 200-250v.	
	AWT501 ..	47 5 0	1	1	1	1	1	1	1	V	Yes	Yes	F†	A.C. 200-250v.	
	*AWG101 ..	105 0 0	1	1	1	1	1	1	2	V	-	Yes	F†	A.C. 200-250v.	
Regentone..	B/35 ..	7 15 0†	1	1	-	-	-	-	1	-	Yes	-	FN	Batteries	
	BS/35 ..	12 12 0†	-	C	-	1	1	-	1	-	Yes	-	FN	Batteries	
	AS/35 ..	12 12 0	-	C	-	1	1	-	1	V	Yes	Yes	FN	A.C. 100-130v. and 200-250v.	
	DS/35 ..	13 13 0	-	C	-	1	1	-	-	-	Yes	Yes	FN	D.C. 200-250v.	
	AS/45 ..	14 14 0	1	C	-	1	1	-	-	V	Yes	Yes	FN†	A.C. 100-130v. and 200-250v.	
R.G.D. ..	*700.. ..	52 10 0	1	1	1	1	1	-	1	V	-	Yes	W†	A.C. 195-245v.	
	*703.. ..	66 3 0	1	1	1	1	1	-	1	V	-	Yes	W†	A.C. 195-245v.	
	*1202 ..	105 0 0	Total of 10 valves							V	-	-	W†	A.C.	
R.I. ...	Micrion ..	8 18 6	1	1	-	-	-	-	1	-	-	-	WN	Batteries	
	Bat 4 ..	13 13 0	-	C	-	1	1	-	1	-	Yes	Yes	WN	Batteries	
	AC Superhet	15 15 0	-	C	-	1	1	-	1	V	Yes	Yes	WN	A.C.	
	Airflo ..	16 16 0†	-	C	-	1	1	-	1	V	Yes	Yes	WN	A.C.	
	Twin Speaker	17 17 0†	-	C	-	1	1	-	1	V	Yes	Yes	WN	A.C.	
	*Duotone ..	27 6 0	-	C	-	1	1	-	1	V	-	Yes	WN	A.C.	
*Moderne ..	44 2 0	-	C	-	1	1	-	1	V	-	Yes	WN	A.C.		
Shalless & Evans	P/3 ..	5 0 0	-	1	-	-	-	-	1	1	-	Yes	Yes	D	Batteries
	PM/3 ..	5 17 6†	-	1	-	-	-	-	1	1	-	Yes	Yes	D	Batteries
	PB/3 ..	6 10 0†	-	1	-	-	-	-	1	1	-	Yes	Yes	D	Batteries
	AC/3 ..	6 17 6	-	1	-	-	-	-	1	V	Yes	-	W	A.C. 200-250v.	
	B/14 ..	8 8 0†	1	1	-	-	-	-	1	-	Yes	Yes	W	Batteries	
	AC/14 ..	8 19 6	1	1	-	-	-	-	1	V	Yes	Yes	W	A.C. 200-250v.	
	U/44 ..	11 11 0†	2	1	-	-	-	-	1	M	Yes	Yes	W	A.C./D.C.	
	*U/44 ..	19 19 0†	2	1	-	-	-	-	1	M	Yes	Yes	W	A.C./D.C.	
	SB/6 ..	14 3 6	-	C	-	1	1	1	1	-	Yes	Yes	W	Batteries	
SB/6 ..	14 14 0†	-	C	-	1	1	1	1	V	Yes	Yes	W	A.C. 200-250v.		
Standard ..	540.. ..	12 17 6	-	C	-	1	1	-	1	V	Yes	Yes	W	A.C. 100-125v. and 200-250v.	
	S60 ..	16 17 6	1	C	-	1	1	1	1	V	Yes	Yes	W	A.C. 100-125v. and 200-250v.	
Sunbeam ..	32 ..	8 15 0	-	C	-	1	1	-	-	V	-	-	N	A.C./D.C. 200-250v.	
	22 ..	9 9 0	-	C	-	1	1	-	-	V	-	-	W	A.C./D.C. 200-250v.	
	55 ..	10 10 0	-	C	-	1	1	-	1	V	Yes	-	N	A.C./D.C. 200-250v.	
Telsen ..	474.. ..	9 19 6	1	1	-	-	-	-	1	V	Yes	Yes	W	A.C. 200-250v.	
	474 AC/DC	11 11 0	1	1	-	-	-	-	1	M	Yes	Yes	W	A.C./D.C. 200-250v.	
	3435/BH ..	14 14 0	1	C	-	1	1	1	1	-	Yes	Yes	WN†	Batteries	
	3435/MH ..	14 14 0	1	C	-	1	1	-	1	V	Yes	Yes	WN†	A.C. all voltages	
	*1240 ..	18 18 0	1	1	1	-	-	-	1	V	-	Yes	W	A.C. 200-250v.	
	*3550RG ..	25 4 0	1	C	-	1	1	-	1	V	-	Yes	WN†	A.C. all voltages	
Ultra ..	55 ..	8 15 0	1	1	-	-	-	-	1	V	-	Yes	W	A.C./D.C. 200-250v.	
	22 ..	12 12 0	-	C	-	1	1	-	1	-	-	Yes	W	Batteries	
	22AC ..	12 12 0	-	C	-	1	1	-	-	V	-	Yes	W	A.C. 200-250v.	
	22DC ..	13 13 0	-	C	-	1	1	-	-	-	-	Yes	W	D.C. 200-250v.	
	44 ..	15 15 0	-	C	-	1	1	-	-	V	Yes	Yes	W†	A.C. 200-250v.	
	*22 ..	21 0 0	-	C	-	1	1	-	-	V	-	-	W	A.C. 200-250v.	
		22 0 0	-	C	-	1	1	-	-	-	-	-	W	D.C. 200-250v.	
Wurlitzer ..	471.. ..	21 0 0	1	1	1	1	1	-	1	V	Yes	-	F†	A.C. 90-250v.	

For Explanatory Notes see page 300

The Stenode Hits the Mark!

Results of an Extended Test
on the "W.M." A.C. Stenode

By Capt. E. H. ROBINSON



Captain E. H. Robinson is famed for other things as well as his frank tests of radio sets. Here he is seen at the Bisley ranges; he is a past winner of the famous King's Prize.

WHEN I tell you that on one Saturday night in October I received and logged eighty-four stations on the A.C. Stenode, you can take this statement as a general indication of the sensitivity and selectivity of the set; but beyond that it means precisely nothing.

Any decent modern super-het should bring in a whole hatful of stations. When a very big log is produced one wants to know how much time and trouble was taken in searching out and pinning down the smaller stations; the dimensions and situation of the aerial; and, above everything else, what the man who is making the test calls "receiving a station."

Conditions of the Test

First of all, then, the conditions of the tests on which this report was based must be defined as precisely as possible. My aerial is on a slight hill, about 200 ft. above sea-level, and about forty-five miles southwest of Brookmans Park. It is of ordinary 7/22 copper wire, 45 ft. at the far end and about 40 ft. at the house end above the ground. The lead-in is well away from the walls of the house, and the set was about 20 ft. under the house end of the

aerial. The aerial is very little screened.

To the actual tests I gave one hour during daylight and three hours on each of two separate nights—seven hours in all. I took no particular pains to search for the small stations, and only logged those which were identified. On the first night I definitely located and logged about twenty of the more powerful stations.

On the second night I started at the bottom of the scale on the medium waves, and worked steadily upwards, noting the stations as they came in, and spending some minutes in listening to each station that seemed worth attention from the point of view of quality.

Each of these is marked with a star on my list. This part of the job took about two hours; from Bournemouth at the bottom of the medium-wave list to Brasnov at the top of the long-wave list.

When I checked the list over I was amazed to find that I had starred no less than thirty-two stations as coming in with good volume and quality, and having a really satisfactory programme value. Quite frankly this seemed an impossible result.

No set I have yet tested has given me more than about ten stations to

which I could listen with an degree of pleasure. Now I seemed to have thirty at least.

Back to the dial I went, and brought in each station in turn, giving three or four minutes to those which seemed likely to be doubtful. In just over an hour I was completely satisfied. The stations I had starred were all worth the distinction I had awarded. Willingly would I have given half an hour or more to any one of them, except those which were being used for talks in a language I do not understand.

Quality from Thirty!

As most of my readers know, I care only for quality. If I can only get natural reproduction from two stations then I will listen to two stations only, and listen only when one or the other is putting out something which interests me. When I say that I could listen with pleasure to at least thirty stations brought in by the Stenode, I am making a statement which amazes me so much that I can still hardly believe it.

Paul Tyers, working on the principle invented by my illustrious namesake, Dr. J. Robinson—alas, he is no relation—has achieved a marvel. My previous acquaintance

84 STATIONS ON OUR STENODE IN AN EVENING'S TEST!



A corner of Paul Tyers' laboratory where the "W.M." Stenode receivers were designed. Here one of Mr. Tyers' assistants is measuring the permeability of alloy transformer stampings at 50 cycles under normal operating conditions

with the Stenode high-selectivity tuner and the subsequent tone correction, which is necessary, has been more than just unfortunate. It has been disastrous in that it has led me to condemn not only Stenode tuning but tone correction also.

I have previously tested three Stenodes, and in each of them heterodyne whistles and unpleasant noises of all kinds were more noticeable than tunable stations, and the quality on stations which could be received clear of noise was extremely poor.

Marks for Quality!

The quality on at least fifteen of the stations I have starred on my list was "very good" and "good" or a trifle better on the rest of the thirty-two. I could not give it my top marks, "excellent," but truly excellent reproduction. In my classification, "excellent" is so rare that I seldom have the supreme pleasure of awarding it.

As a guide to what I mean, I would say that most mass production sets costing between about £12 and £15 give, in my scale, "good" quality on the local and perhaps two or three other stations. Some of the commercial sets between £20 and £25 give "very good" quality on the local station.

All this is just to indicate how very good I think the quality of the "Wireless Magazine" A.C. Stenode is.

Some of this goodness in the matter of quality may be due to the

specially designed loud-speaker. I tried the set out in a great hurry after my main tests, on two other loud-speakers, and the quality was nothing like so good. In fact, it was barely "good" in my scale.

Don't, therefore, when you build this wonderful receiver, be tempted to put in any old loud-speaker, you may happen to have around doing nothing, to earn its keep. If you do you will be very dissatisfied with the results—presuming you have anything of an ear for quality.

Last month Mr. Tyers warned intending constructors of the necessity of using the valves he specified. I would like to add to this warning one on the necessity of using exactly the components he has specified in every particular.

The design of a high-efficiency set is a very complicated business. It is carefully thought out, and the characteristics of all the essential parts are calculated to work in certain specified conditions, usually laid down by the choice of valves for the work to be done in each part of the circuit.

When the circuit is hooked up for the first tests there are always troubles, any amount of them, and the final "sealed pattern" is full of compromises, these being, so far as is possible, so arranged that they will not interfere with the main original idea laid down. The constructor cannot know where these compromises are.

About Alternative Parts

I have known the behaviour of a circuit completely upset by using a type of change-over switch different from the one specified. When the designer gives you no alternatives in the choice of components, believe him that there are no alternatives.

The Stenode is a very high-efficiency set. In building it don't spoil the ship for a ha'porth of tar.

In his original article Mr. Tyers is a little apologetic on the subject

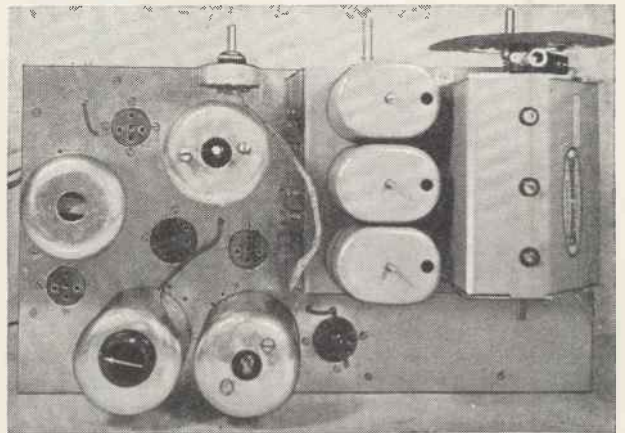

A plan view of the A.C. version of the "W.M." Stenode. This is the receiver that Captain Robinson declares to set a new standard

of heterodyne whistles. Quite rightly, he says, that they depend very largely on local conditions. Well, I found a few, but very few. Far less than I am accustomed to discover in ordinary super-hets.

Few Unpleasant Noises

Perhaps I am fortunate; but remember I am talking about the same local conditions of test when I say that the Stenode Mr. Tyers has designed gives fewer of these unpleasant noises than I usually find in super-hets. Our good Paul Tyers need not apologise.

A point which struck me very favourably, also in comparison with other super-hets, was the absence of valve noise and other atrocities of a similar kind. On one or two stations there was a curious buzz, the cause of which I could not locate;

but as they were weak stations it did not matter.

You remember that curious kind of rapid "wobble" some of us experience on the wavelength London National has to share with West National when the frequency control is not quite right? I had it at first, but it has now disappeared. Others still get it, maybe. At any rate, you know what I mean. Well, it was there on Genoa. Now Cracow is, or should be, on exactly the same wavelength. Same cause, same effect! Very curious; but again Genoa does not matter. It relays Milan, and Milan is one of the star stations on the Stenode's list.

Easy to Use

The Stenode is remarkably easy to use, provided one remembers that it is extremely selective and that the tuning must be exactly on the peak. It seemed to me that some sort of a tuning indicator would be an improvement, indeed the only improvement I can suggest. The ear is, of course, a good guide; but not so good as the eye when very minute movements on the tuning knob make a great difference.

Selectivity a Revelation

The extreme selectivity of this set will be a revelation to those who have not previously used a Stenode. The way stations come in and go out as the knob is moved is a revelation. An adjustment that hardly shows on the scale is sometimes sufficient to get rid of a station and another

Capt. Robinson's Log of Stations Heard in One Night on the "W.M." A.C. Stenode

LONG WAVES (14)

Brasov
*Huizen
*Lahti
Moscow
*Radio Paris
*Berlin
*Droitwich
Eiffel Tower
Motala
Warsaw No. 1
*Luxembourg
*Kalundborg
Oslo
Moscow No. 2

MEDIUM WAVES (70)

*Budapest No. 1
*Beromünster
*Athlone
Mühlacker (Stuttgart)
*Vienna
Sundsvall
Florence
*Brussels No. 1
Lisbon
*Prague No. 1
Lyons P.T.T.
Langenberg

*North Regional
Sottens
Paris P.T.T.
Stockholm
*Rome No. 1
Tallinn
*Munich
Marseilles
Katowice
Midland Regional
Toulouse
*Leipzig
Lwow
*Scottish Regional
*Milan
Bucharest
Moscow No. 4
*Berlin
Strasbourg P.T.T.
*London Regional
Graz
*Hamburg
*Toulouse
Brno
*Brussels No. 2
Breslau
*Poste Parisien
*West Regional
Genoa

Hilversum
Bratislava
*North National
Königsberg
Scottish National
*Bari
Bordeaux
Madrid
*Madona
Naples
Belfast
Horby
Turin No. 1
*London National
Moravska-Ostrava
Monte Ceneri
Copenhagen
Frankfurt
Prague No. 2
Lille P.T.T.
*Trieste
Gleiwitz
Cork
Nurnberg
Danzig
Dublin
Turin No. 2
*Fecamp
Bournemouth

* Denotes good volume and quality and a definitely satisfactory programme value at night.

equally minute movement brings in another.

I found that I had to make but two adjustments on the set. I had to move the trimmer on the aerial-tuning inductance a little to compensate for my very big aerial, and I had to make a very small adjustment on the long-wave trimmer. When those two adjustments were made stations came in exactly on their

wavelengths on the scale and at excellent strength.

The A.V.C. part of the circuit seems to work well; but I do not think there was much fading on the two nights I was able to give to tests.

Returning again to quality. On most of the stations I started I found that I had the best tone with the adjustable portion of the corrector in the position which gave the maximum high-frequency response. This is to be expected; but it is not often that one is able to get those very necessary overtones without bringing in noises and a very objectionable hardness—I am talking, of course, of high-efficiency sets and super-hets in particular.

Sets a New Standard

But now I am beginning to wonder whether, against the "Wireless Magazine" Stenode, any other set can be called "high efficiency." A new standard for these words has been put to us.

Here is my final table of results:—

Sensitivity: Excellent.

Selectivity: Excellent, plus.

Ease of handling: Excellent.

Quality of reproduction: Very good on about fifteen stations. Good on another seventeen.

Sideband splash: Very little.

Heterodyne whistles: Few and not important.



IT WORKS AS GOOD AS IT LOOKS!

Two members of the "W.M." Technical Staff find listening with the Stenode a particularly fascinating pastime



B.B.C. photo
This is the aerial-transformer house at Droitwich. The wires from the transmitter are carried on small poles (seen on the left). In the foreground is the aerial-tensioning device which keeps steady the download from the huge Droitwich aerial

can be dropped, thus releasing two valuable wavelengths—not three, because, of course, London and West National work on a common wavelength.

What minorities are there? Well, North Scotland, for one; and North-Eastern England is pretty badly off, being just on the fringe of North Regional's service area. Two new Regionals are contemplated for these localities.

Meanwhile, though, not all the existing Regions are too well served. Take Midland Regional, for example. Listeners have to put up with the old and admittedly only experimental 5GB plant, which is only half as powerful as a full-blown

And Now for

ALAN HUNTER Talks About—

WHETHER you are revelling for the first time in a robust National signal or overwhelmed by a colossal signal you don't want, the B.B.C. is satisfied.

Satisfied beyond its most sanguine hopes with the performance of Droitwich National, with its 150-kilowatt giant shaking the European ether from a 700-ft. high T-type aerial.

And—let us be fair—most of us share that feeling. In most parts of the British Isles Droitwich is far and away the finest B.B.C. signal today. It is strong enough to reduce background; on a long enough wavelength to avoid night fading except in very remote parts; and its frequency response goes up so high that modern sets can do justice to its excellent quality.

In taking over Daventry 5XX's job Droitwich has only just begun to fulfil its ultimate destiny. So powerful a signal, so good a quality signal, is not going to be allowed to us just as an "extra."

We have got to get used to the idea of Droitwich as our one and only National programme source. Londoners are to lose their London National; Northern listeners their North National; and West Country listeners their West National. All the medium-wave Nationals are to go in the fullness of time—which means within the next few months.

You see, Droitwich is just the focal point in a quite revolutionary change in British broadcasting.

Overboard has gone the original grandiose conception of twin transmitters for both the Regional and National Programmes.

A variety of good reasons account for this. I will mention only two: firstly, the high power now permitted for Droitwich was not possible when the original scheme came into being; secondly, since the early days wavelengths have become very scarce, and the final satisfaction of minority claims in this country waits on extra stations that cannot be built or set up until wavelengths are released within the B.B.C.'s system.

Now that Droitwich gives the whole country a good strength signal the medium-wave Nationals

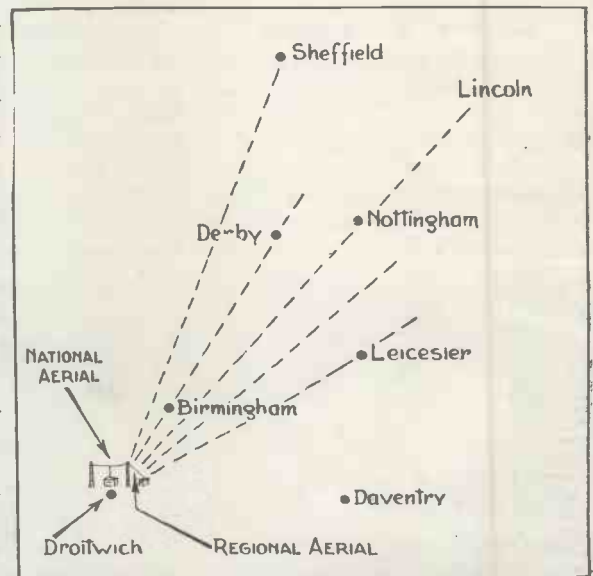

A map showing Droitwich, Daventry and surrounding towns. The Midland Regional aerial at Droitwich will be directional to the East Midlands to ensure them a good service

Regional transmitter, and not very wonderful in many other ways.

Before any new stations are put up, therefore, the B.B.C. has wisely decided to modernise existing centres. The Midlands get a brand-new Regional in a very few months. Similarly, long-suffering Belfast listeners will rejoice in a full

70-kilowatt Regional in about a year's time, when the 1-kilowatt station is replaced by the new transmitter now being built at Lisburn.

In order of happening, Midland Regional will open up at Droitwich; then London will shut down as a National; followed by the others in due course; leaving North Ireland, North-Eastern and North Scottish Regionals to take their turn in the new scheme of things.

Our immediate concern is, then, about the new Midland station. Assuredly, Midland listeners are having a somewhat trying time at the moment. They are struggling, I gather, with an enormous signal from

instead of at Daventry that doubts begin to assail us—whether justifiably remains to be seen, or rather heard.

Let us clear up one or two points about the new station, as confirmed during my conversations with B.B.C. officials and engineers.

To begin with, they hope to be testing the new station before this Christmas—so that it is all excitingly near at hand. Tests are likely to be fairly lengthy—much more so than with Droitwich. It is always the way when the centre of radiation is radically changed. There must of necessity be a reasonably long sliding-in period so that those who are getting a weaker signal can readjust

masts, now supporting the Droitwich T-aerial between them, instead of being held up by a mere 500-ft. mast as at Daventry.

Higher power, higher masts . . . then why talk about weaker signals? Afraid we must, though. Droitwich is west, if you come to look at a map. It is the Eastern Midlands that are going to feel a draught, perhaps, when the changeover occurs.

Droitwich is about 20 miles from Daventry—that much farther from such places as Leicester and Nottingham. These highly industrial centres are entitled to the greatest possible consideration. The B.B.C. recognises this, of course, and at the moment of writing—in mid-October—is experimenting with various directional aerials.

The idea is to make the new Midland Regional aerial directional in its propagation to the East Midlands—to elongate the polar diagram that way, as the engineers say.

Birmingham itself is, of course, much nearer to Droitwich than it is to Daventry, so that listeners in this important city need not fear any loss. As a matter of fact it is because this very large centre of Midland population is so much nearer to Droitwich than to Daventry that the B.B.C. has decided the new Midland Regional can work on a shorter wavelength than at present.

Its existing channel is considered too precious for Midland Regional. *Continued on page 314*

Droitwich Junior!

—the New 70-kilowatt Midland Regional

Droitwich National, complaining that apparatus is overloaded and the tuning dial swamped.

At first there is bound to be some trouble up there. Unselective sets—and a vast number of sets that work well enough on medium waves are very unselective on long waves—will have to be overhauled.

After all, Droitwich actually takes up only 18 kilocycles of frequency in the long-wave gamut. If you still hear the giant when you are de-tuned by 50 kilocycles you cannot justly condemn Droitwich for "spreading," for actually it is the set's frequency response that is at fault.

So very few letters of complaint have been received at Broadcasting House that the B.B.C. feels confident Droitwich is not seriously upsetting anyone. Possibly the German station Königswusterhausen may be more difficult to get clearly—though even in the Daventry era there was splash-over on most sets. Normally, though, such stations as Luxembourg and Radio Paris ought to be quite clear of any trace of Droitwich.

So far, then, the Midlands have no real kick against Droitwich. It is when we begin to think about Midland Regional at Droitwich

their reception conditions to make up for the loss.

But what is all this worry about loss of signal strength? You may as well ask when I remind you that the new Midland station will have a power of 70 kilowatts, which is just twice that of the present 5GB transmitter. Its vertical aerial will be suspended from one of the 700-ft.

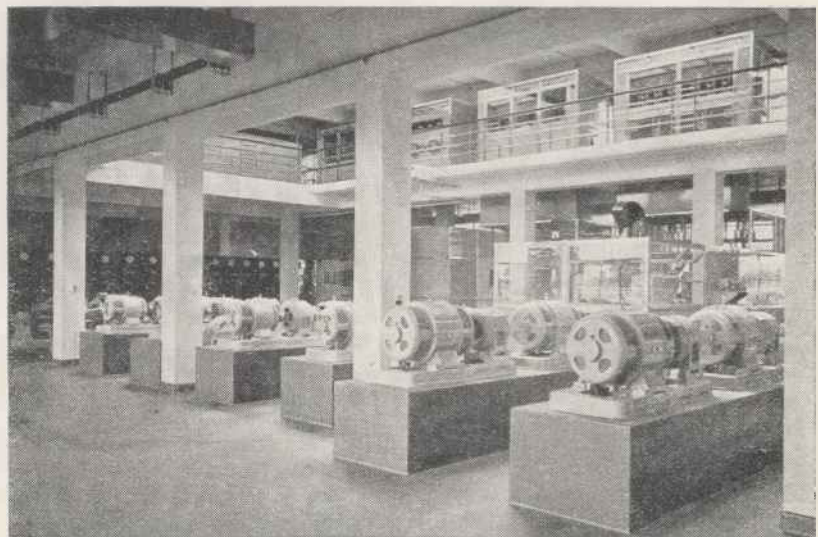

B.B.C. photo
This is the main transmitting hall at Droitwich. On the floor is the battery of small generators which supply the filament current to the National and Regional transmitters. On the far side of the balcony is seen the Droitwich transmitter. The Midland Regional transmitter is now being erected on the other side



H.M.V. photo

Geraldo, the well-known orchestral leader, is a keen radio enthusiast. Here he is seen interested in the technicalities of a new H.M.V. radiogram

THE magnifying valve is now twenty-seven years old, and it has been known to be alive for twenty years and yet there are a host of basic problems concerned with it which we have not solved properly.

Any person who is using valves for various purposes is constantly up against difficulties due to defects in valves. Slowly new ideas are enabling us to get results which we could not obtain previously, but somehow I think progress is a bit slow in certain directions.

Distortion

Valves are still non-linear and only by push-pull and other such tricky devices can we obtain anything like their maximum output without serious distortion. The rectifier in a radio set is particularly under question, and I very much doubt whether in an average radio set the rectifier will take more than 60 per cent modulation without distortion.

It is possible, ideally, to obtain more than this, but the ideal conditions do not lend themselves to economical construction.

Distortionless Modulation

Transmitters to my mind should not radiate at more than 60 per cent modulation until an easy way has been discovered of rectifying up to 90 or 100 per cent modulation without distortion.

Low-frequency amplification is, chiefly, the place where distortion

can occur. Unfortunately, the average ear does not easily recognise this distortion until it is large, or unless a demonstration of the effect of removing the distortion is given, when the improvement is at once noted.

Push-pull amplification, if carefully done—with the use of instruments to take curves—undoubtedly

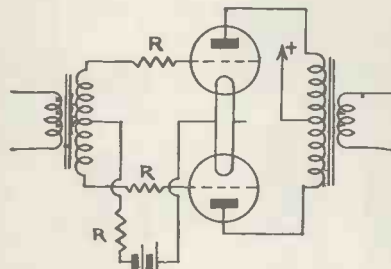

Fig. 1.—A battery push-pull circuit with resistances in each grid lead

gives the best results, but the difficulty of exactly matching triodes or pentodes under practical conditions is quite great, and the trick of valves in push-pull of trying to oscillate amongst themselves, particularly with the modern high-conductance valves, is always a nuisance.

We have pleasure in presenting readers with another article from the pen of Captain H. J. Round, M.I.E.E. It is many months since he contributed an article to these pages. His article this month is more or less a popular chat on valves and distortion. This will be followed by another contribution shortly on triodes and pentodes in the output stage

A Chat About Your Valves

Captain H. J. ROUND, M.I.E.E.

By the way, this oscillation business of push-pull valves is not always easy to detect. I had a case of it only the other day.

Two P2 valves were being used in push-pull; the input transformer winding to the grids was fed at the centre through a large resistance, and resistances were placed in each grid circuit (Fig. 1). This stopped any apparent oscillation.

An Experiment

Alternating-current voltage applied to the grids through the transformer gave a certain current in the loud-speaker transformer secondary, when grid current first started. Because my output transformer did not quite match these two valves I placed two more valves in parallel with them, connected as shown in Fig. 2.

Much to my surprise, I could not get as much current out of the four valves as out of the two without gridding. Rough tests with the fingers did not indicate any oscillation, but altering the circuit to Fig. 3 instantly put things right. A weak oscillation was using up some of my curve without being at all evident.

Push-pull has a variety of advantages which makes it invaluable—simpler smoothing circuits are possible, and when used in the quiescent manner it gives greater efficiency.

I wonder whether someone will some day devise a valve which at zero grid has zero plate current, which with positive grid potential gives current in one direction to the plate and with negative grid potential gives current in the other direction to the plate circuit. It is not impossible!

Class-B amplification is an inefficient attempt to use our valves at a better part of their curve, but it is inefficient due to heavy grid current. If there were no such thing as grid current then grid bias could go, except for special effects like quiescent circuits.

Strange Curve

Fig. 4 shows what the curve of a valve would be like if there were no such thing as grid current. With a negative voltage on the plate, positive grid potential would still give us a plate current. Instead of this ideal we get the curves twisted round as shown in the drawing, and the current instead of going to the plate goes to the grid.

Some time ago I showed how this absorption by the grid could be

overcome and valves improved both from the output-power point of view and for increased linearity, but so far no valve manufacturer has put my principle (which I am not sure was original with me) into direct operation, although the pentode contains a modification of the idea.

I suggested making up the grids as two coplanar spirals (Fig. 5), one of these to be the active grid and the other to take up grid current. Consider the diagram just a moment. If +10 volts from a battery are put on grid A, and -10 volts on grid B, then the action on the electrons near the filament is approximately the same as though zero no-grid volts were applied to both grids, and the anode current is as though zero volts are applied.

Consequently grid B has got 10 volts more swing possible without grid current than if

there were no grid present. Experiments proved that very much more power and more linear reproduction were possible with these valves, without any increase in grid power.

Class-B results were obtainable without the low impedance input circuits necessary for that type of amplification.

This gets us no further, of course, in the direction of working negative plate currents—but in which this plate current alteration did not react on the electrons—we should have a very important improvement. We should always know where we were.

One would say right away that if we could get a valve in which alteration of grid current altered the plate current—but in which this plate current alteration did not react on the electrons—we should have a very important improvement. We should always know where we were.

Shottke in 1916 suggested the solution of this problem by putting a fine mesh grid outside the operating grid and then a plate outside that. To the fine mesh grid he applied a high voltage which, however, was fixed, there being no outside circuit attached to this.

Then he used the plate in a normal way. Due to the fine mesh of the second grid practically no reaction was possible between the plate volts and the electrons inside the first grid, and apparently an ideal tube was obtained.

Shottke's idea was not at all connected with the capacity action

and (b) I have drawn the power triangle for a valve with and without a subsidiary grid. Not only is there much more power available, but there is a much better linearity of power output.

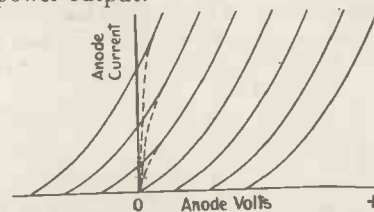

Fig. 4.—What the curve of a valve would look like if there were no such thing as grid current

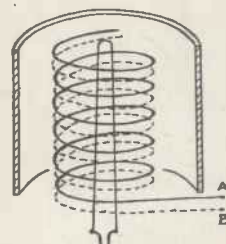

Fig. 5.—A suggestion of the author's for making up the grids as two coplanar spirals

This leads up to the subject of tetrode and pentodes, the latter being, of course, only a tetrode with another electrode in it, to correct a defect of the tetrode.

A triode is really a very mixed-up affair. Any voltage we put on the grid alters the plate current, which alters

the plate volts if there is an output circuit, and this alteration of plate volts gets mixed up with the applied grid volts in the action on the electrons round the filament; a nasty mixture, but curiously enough it seems to have very distinct advantages.

Important Improvement

One would say right away that if we could get a valve in which alteration of grid current altered the plate current—but in which this plate current alteration did not react on the electrons—we should have a very important improvement. We should always know where we were.

Fine Mesh Grid

Shottke in 1916 suggested the solution of this problem by putting a fine mesh grid outside the operating grid and then a plate outside that. To the fine mesh grid he applied a high voltage which, however, was fixed, there being no outside circuit attached to this.

Then he used the plate in a normal way. Due to the fine mesh of the second grid practically no reaction was possible between the plate volts and the electrons inside the first grid, and apparently an ideal tube was obtained.

Shottke's idea was not at all connected with the capacity action

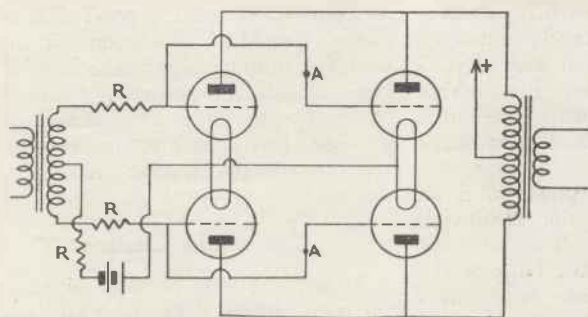

Fig. 2.—Similar to Fig. 1 with two more valves placed in parallel

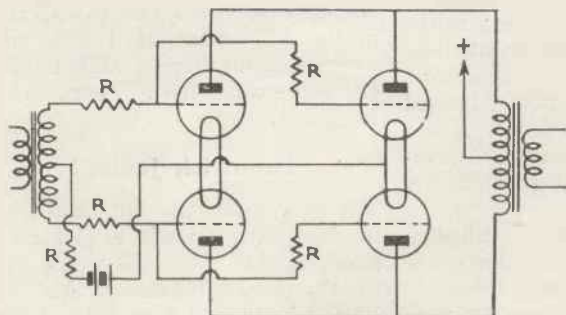

Fig. 3.—Similar to Fig. 2 but with resistances placed at the points marked A (in Fig. 2)

which makes tubes oscillate. He only wanted to separate the actions of the grid and anode circuits, but incidentally his valve had at least two other valuable properties.

It introduced in a modified form the principle I have explained with coplanar grids, that is a greater swing of grid potential in the positive

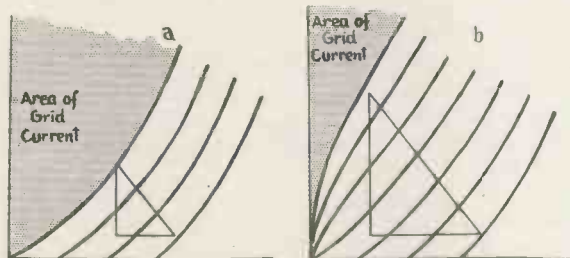

Fig. 6(a) and (b).—Showing the power triangle for a valve with and without a subsidiary grid

direction could be used and, of course, the electrical shielding effect between grid and plate was of enormous importance in high-frequency amplifiers. A third benefit of the shielded valve is now beginning to be of value.

Miller Effect

If we put alternating current on the grid of a triode and insert a plate load (say a resistance), measurements of the effective capacity of the grid give us values of capacity which are far above those given by the manufacturers. Due to this capacity a heavy load is put on the grid—the grid voltage having to do work on the plate circuit.

In very resonant circuits this Miller effect is a distinct nuisance.

An easy way of seeing how this measured capacity can be much greater than the real capacity is shown in Fig. 7. Suppose the grid G is charged to zero volts and we then change its voltage to A volts—a quantity of electricity AC, where C is the capacity of the grid, will flow into the grid.

If the plate was connected to earth, then the quantity of electricity flowing in to the grid would be an exact measure of the static capacity of the grid, that is, the value given by the manufacturer; but see what happens if there is a load circuit on the plate.

Change of voltage A on the grid makes a change of MA on the plate, where M is the effective magnification of the circuit. And although we only changed the voltage by A on the grid, the relative changes of voltage of

plate and grid is $MA+A$, so that the quantity of electricity flowing into the grid will be $A(M+1)C$, and to us measuring that quantity we should at once say the capacity has been greatly increased.

This enlarged capacity makes the grid circuit have to do large work on the plate circuit, which helps to destroy good resonance effects.

The introduction of the screen-grid valve, which, of course, is effectively earthed for A.C., obviously removes this Miller effect completely.

I came across an interesting case of this effect in practice some time ago. I had a very resonant circuit

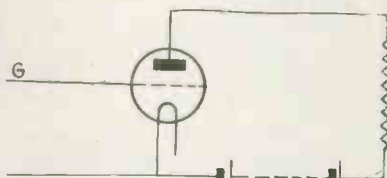

Fig. 7.—An easy way of showing how the measured capacity of the grid can be greater than the real capacity

AND NOW FOR DROITWICH JUNIOR!

Continued from page 311

A general re-shuffle of B.B.C. wavelength allocations may be expected when Midland Regional *chez* Droitwich really gets going. Presumably one of the new Regionals is destined to take over Midland Regional's present wavelength.

With double the power and an aerial 700 ft. high the Droitwich Midland Regional will serve most of the area very well. Only in the eastern districts is any fear entertained—and even there the directional aerial ought to do the trick.

Incidentally, though, if this aerial does specially favour listeners in the Eastern Midlands, what about those in the south who like to eavesdrop? Will they find the new Midland Regional weaker than now? It is a bit of a gamble—with power, wavelength and aerial propagation as the inter-playing factors.

Although it must be called a gamble, the B.B.C. engineers are not likely to back a loser.

That brings me to another very important point, by the way. Down

connected to a rectifier of the anode-bend type.

It does not matter exactly how this very resonant circuit was produced—actually it was obtained by reaction.

I had means of measuring the damping of the resonant circuit, and I found that as my amplitude was varied so my damping varied—giving me a serious distortion. Due to the valve being used as a rectifier its plate resistance was varying with amplitude, and this varying plate resistance was being thrown back into the resonant grid circuit giving the variable damping. I replaced the triode by a tetrode, and all variation of damping with amplitude at once stopped.

Where the Triode Wins

It is, however, a very peculiar thing that notwithstanding all these apparent gains of the tetrode or pentode over the triode, the pentode has still not won out over the triode for power output tubes.

Everything seems to be in favour of the pentode, and in my next article I shall try to give a more exact analysis of what is happening when we have triodes and pentodes for power output.

in London we make a good deal of use of the Midland station for the sound accompaniment to the London National television signals. I understand Droitwich will continue to provide this accompaniment—but will the strength be good and reliable enough?

The Main Chance

Again, we must not lose sight of the main chance. The new Midland Regional is being designed and erected at Droitwich to give a more equitable service signal to listeners in the Midlands. If it does that we outside the Region cannot really grumble—we have our own Regionals.

Droitwich Junior!

Anyway, let us not anticipate troubles but get ready to give a big hand, as the Americans would say, to the new 70-kilowatt Midland Regional, or, as I have dubbed it—Droitwich Junior.

News of the Short Waves

By **KENNETH JOWERS**

ONE of the first letters I received this month was from a despairing reader in Southport who says, "I have a two-valve short-wave set with which I can get Zeesen and Moscow at amazing strength on the loud-speaker, but except for a few odd Morse stations I cannot get anything else."

This letter is typical of those sent in by inexperienced short-wave amateurs. There are many reasons for the poor results, but have you realised just how much trouble is caused by using a *very lengthy aerial*.

You must have noticed how people sling up aerials with the lead-in wire trailing around the house. I have seen some aerials with the lead-in wire actually anchored to a metal drainpipe, while it is not unusual for the lead-in wire to be tacked around the picture rail.

What results can you expect with a heavily damped aerial of this kind. Probably the receiver will refuse to oscillate below 40 metres, and all the weak long distance stations will be conspicuous by their absence.

Don't Be Deceived!

Far too many readers have the idea that if they can get the locals such as Rome, Zeesen or Moscow, then the set must be working in tip-top condition, and the only reason for not hearing New York or Sydney at good strength is that short waves are not any good.

This is all wrong. Short waves provide the only medium for good American reception. I shall most probably get pulled up for that, for many readers have sent me in the most amazing logs of American reception on the medium waves, but even so there is no medium-wave set made that will bring in New York during the afternoon and early evening like my short-wave super-het.

I have just been experimenting with an aerial that is almost universal. It is not difficult to erect. In fact, to the average amateur it may appear to be almost the same as a standard broadcast aerial.

From time to time I have mentioned that to get the maximum volume from your set you should use an aerial that has a natural wavelength something similar to that of the wavelength of the stations you wish to receive. Of course, this is all very well in theory, but in prac-

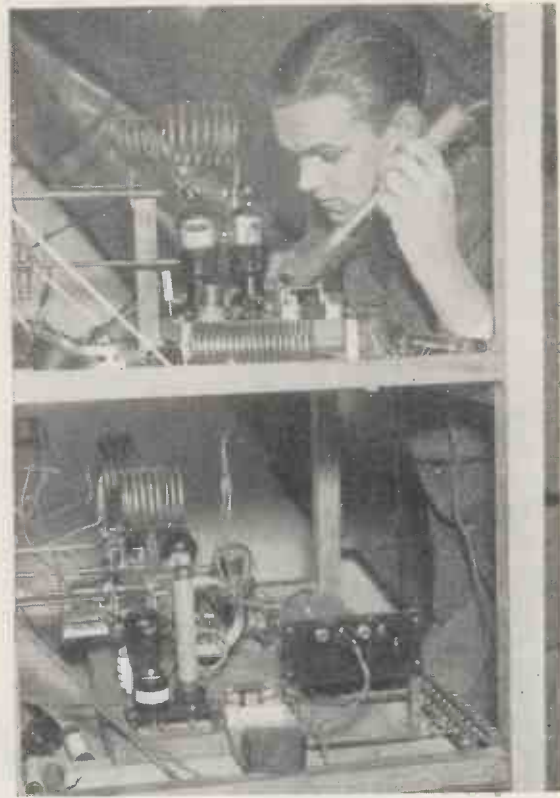

N.P. photo

A German member of the International Amateur Radio Union making sure that his short-wave transmitter is right up to scratch

tice you cannot very well stick up a different aerial for each wave-band.

However, I have come across a happy medium that gives really good results on all the usual commercial wavebands, such as 19, 25, 31 and 49 metres, while at the same time it will be almost as good as if you had put up a separate aerial for each band. The length of the aerial from A to B, that is, including the down-lead, should be about 75 ft. (see figure).

The earth lead must be very short, preferably under 10 ft. With C, C₁ and L you can tune this aerial to any of the wavebands I have mentioned above, so that the aerial will peak at any frequency you require, giving the maximum volume.

On some wavebands it will work as a simple Hertz aerial, and on others as a straightforward Marconi type.

Take the 49-metre band, for example. For this wavelength it will work as a Hertz aerial and should be approximately 80 ft. long. By setting the condenser C to its minimum capacity the aerial system is not earthed.

In that case the coil L and the condenser C₁ are used for tuning the aerial up to an effective length of 80 ft. On the 31-metre band the aerial works as a three-quarter wave Marconi, then C should be adjusted to approximately half its capacity and tuned with the condenser C₁.

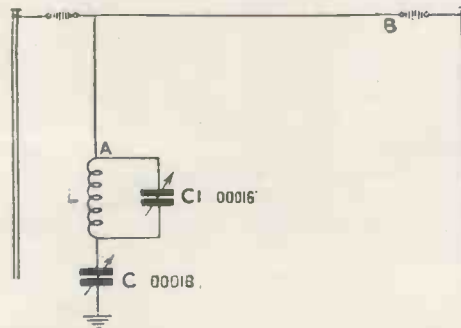

You can bring in the short-wavers quite satisfactorily if you fix your aerial up like this. C and C₁ have capacities of .00016 microfarad

On the 25-metre band, for the aerial to work as a three-quarter length Marconi, it should have an effective length of 50 ft. To do this the condenser c_1 should be set at minimum capacity, tuning being done with the condenser c .

To use a 75-ft. aerial on the 19-metre band would perhaps seem a little unwise, but if you set c_1 at minimum capacity and tune with c , the effective length of the aerial is cut down, while of course the amount of damping on the grid circuit of the first valve is of a negligible quantity.

There you have a simple aerial which, if you are prepared to take a little trouble, will give you the maximum results you can possibly expect from your short-waver.

What Are QSL Cards ?

After all this time I have received a letter from a

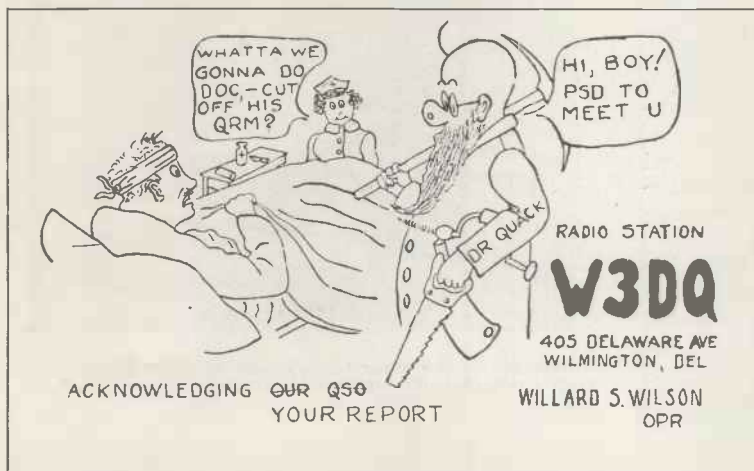

This amusing QSL card was sent by the American amateur W3DQ to Mr. Eric Cooper of Kidderminster

reader who wants to know what a QSL card is. Well, a QSL card is the only means that amateur transmitters have of verifying the fact that they have operated with other amateur stations in different parts of the world. To give you an example, an English amateur station sends out his test call, which is picked up by an American station. The American then calls up the English amateur and they conduct tests either by means of telephony or Morse. These stations then exchange their identification, or QSL cards, which are kept to prove that they actually were heard in America or Australia, as the case may be.

Not for Short-wave Listeners

QSL cards are not intended for short-wave listeners, but if a listener should hear some particularly distant station and can give a worth-while report, then usually the transmitting man will send a QSL card so that the receiving man can claim to have heard his station. Some amateurs get the idea that if they hear a transmitter round the corner, about five miles away, they should immediately receive a QSL card confirming the reception. This should not be done, but if you should hear Cuba at full loud-speaker strength on a one-valve set, then you have some reason to be proud of your receiver.

BRS1327, Eric Cooper of Kidderminster, has sent me a very interesting QSL card which he has received from W3DQ of Wilmington, U.S.A. This is a most

amusing card. I won't try to explain it as you can see it for yourself. W3DQ is on 75 metres and comes through at very good strength. BRS1327 tells me that the 20-metre band is very unreliable at the moment.

Logging Stations with a Straight Two

A Mr. Railton, of Loughton, Essex, has sent me an interesting letter about the stations he has heard on his straight two, a screen-grid detector transformer coupled to a pentode. I can't possibly give you a log of all the stations he has heard, but they include VE2BX, CM2RA, W4IS, WIDES on 80 metres, etc. He thinks that W. A. Clemenson's idea about a competition is very good and wants to hear more about it. Any interested amateur or R.S.G.B. member in the Loughton area is requested to get in touch with Mr. Railton, who would like to swap notes.

E. E. Baker, known as G50Q, spent a recent Sunday listening to the Melbourne Centenary International DX contest on the 40-metre band and logged a great number of DX stations. This contest was held from 00.01, Saturday, October 6, until Sunday, October 7, at 23.59, and the four following week-ends in October at the same times. He logged some twenty-two Australian stations, varying from R2 to R7. Don't forget that these stations were heard on a two-valver.

40-metre Reports

From time to time I have asked for reports on 40-metre reception, and I have certainly got one that is worth having from A. W. Godden, of Canterbury. He uses a simple screen-grid detector with pentode output, and on the 40-metre band has logged eleven German stations, four W's, four SP's, two OK's, nine F's, three LA's, five HB's, three CT's, two ON's, six EA's, and several others. These were all heard before 22.00.

H. H. Gent, of Harlesden, has a few words to say about receivers. I will quote a small excerpt.

"I venture to disagree with Mr. Everard when he says that C.W. is not a fair test for a receiver. He seems to think that a set needs only eight valves to be good. I guarantee that the user of an efficiently designed two-valver hears many stations that would not be heard on an eight-valve super, owing to the background noise. As a rule I use my two-valver to bring in distant stations and not to listen to the high-power Americans."

Which is the More Efficient Set ?

What do other readers think about this? Are the big short-wave stations better on a two-valver with a pair of headphones, or would you rather hear them on a super short-wave super-het?

Anyhow, whether you have a large super-het or a simple two-valver, you will have noticed that during the past fortnight the 20-metre American fone stations have been coming in surprisingly well.

In the afternoon, after 4 o'clock, several of the first and second district stations have been brought in on the loud-speaker on my large super-het. After about 6 p.m. the same stations have been heard on a screen-grid, detector and pentode arrangement, using the loud-speaker all the time, of course.

All About Pick-up Response Curves

By P. Wilson, M.A.

P. Wilson wrote several articles on pick-up design for "W.M." last winter. Unfortunately he was prevented by illness from finishing this series. We are, therefore, pleased to present an article from his pen this month. He talks about the many practical difficulties of pick-up design and of the reliability of response curves besides giving a summary of the points stressed in previous articles.



H.M.V. photo

IN the articles on pick-ups that I wrote before my illness last winter, I reached the point where a check of somewhat theoretical reasoning from actual practical experiments was imperatively called for.

Of course, the explanations I gave were not purely the result of abstract calculation.

One rarely finds out things of value in that way. The most satisfactory process is always a curious mixture of experiment and a mental groping for an explanation of observed facts.

Without experiments one would have no clue to what in practice prove to be the most important characteristics; without the theoretical explanation the chance of making modifications to remove unwanted characteristics would be very small indeed.

Points to Remember

In resuming the discussion perhaps I had better summarise, first of all, the more important points I have already mentioned.

(1) It is impossible in a pick-up, as indeed in any other mechanical vibrating instrument, to avoid resonances; all we can hope to do is either to place them at points in the musical scale where they do not matter

much, or, alternatively, damp them in such a way that they are not so objectionable.

(2) The best way of visualising what are the effects of various component parts of the vibrating mechanism is to draw a mechanical circuit diagram similar in appearance to the familiar electrical circuit diagram with mass substituted for inductance, compliance (which is the reciprocal of springiness) for capacity, and friction, viscosity or any other mechanical heat-absorbing device, for resistance.

(3) To damp a resonance one of these resistance analogies is required and *not* a spring, which only shifts it to a different frequency.

(4) We must remember that the mechanical circuit diagram we shall be able to draw is not a perfect

picture of the mechanism since it assumes that the various elements are lumped together at particular points, whereas in practice they are distributed.

Thus, for example, the springiness of a metal bar is distributed along the length. We may design the bar so that the greater part of the springiness is situated at one end or the other, or at both—we actually do that in a pick-up armature—but there are bound to be secondary effects due to the distribution of the remainder.

Mechanical Characteristics

(5) In our simplified picture of the mechanical characteristics of a pick-up the important features are: the compliance at the needle-point, the compliance at the fish-tail of the armature, both of which are shunt compliances; the series compliance at the pivot; the needle-arm transformer, due to the transfer of motion by lever action of the armature; and the effective mass of the armature.

This effective mass is not the weight, as measured in a balance, or the moment of inertia about the axis. It is the latter divided by the square of the distance between the fish-tail and the axis, so that quite a large armature may have a small *effective* mass if leverage is big enough.

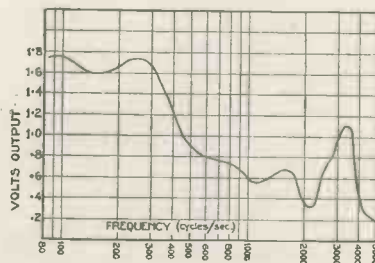

TYPICAL RESPONSE CURVE

*Do you know what this curve really means?
P. Wilson in this and a further article will
explain its real significance*

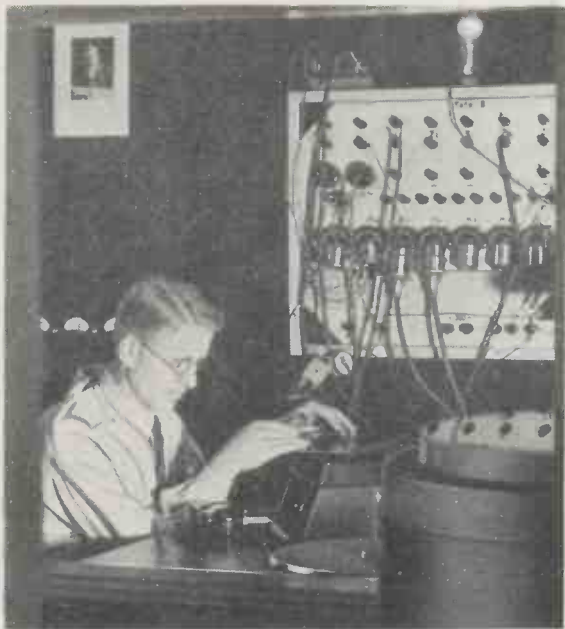

Gulliland photo

YOUR RECORDS ARE MADE VERY CAREFULLY
 A German recording engineer balancing up the output from the various microphones in the recording studio before the minute currents reach the recording apparatus

You can think of this on the analogy of a crowbar by the use of which quite massive bodies may appear to be relatively light at the point of application of the effort.

Negative Compliance

(6) In an ordinary moving-iron pick-up the armature is magnetically in a state of unstable equilibrium. If it is displaced from its central position the magnet tends to pull it farther over. The effect mechanically is the opposite of that of a spring and theoretically is regarded as a *negative compliance*.

(7) The production of an electrical voltage at the terminals of the pick-up coil (which in its turn of course will produce a tiny current in any electrical circuit connected to those terminals) throws back a load on to the mechanical circuit.

Generally speaking, this load will not be a purely resistive load. The more nearly resistive it can be made, however, the more effective it will be in damping mechanical resonances. But it may also be used to shift those resonances to other parts of the scale.

This part of the subject, as well as No. 6 above, has not yet been fully discussed. Here I

will just remark that the nature of the load depends principally on the strength of the magnet, the nature of the magnetic gaps, the number of turns in the coil, and the nature of the circuit connected across the pick-up terminals.

(8) There are two principal mechanical resonances, due to leverage motion of the armature, which usually are close together. It is bad practice to put these resonances very high in the scale since that inevitably leads to a high impedance motion to low notes, where the walls of the record groove are weakest. In that case record wear is pronounced.

The best designs put these resonances very low in the scale; the armature in consequence has a generous freedom of motion which is quite clear to the touch. The disadvantage of this is that the response to high notes is much weakened and a compensation must be found in some other way. The weakening, however, is reduced by the use of purely resistive damping.

In that case the motion of the armature between the fingers feels not springy, but smooth and sticky—perhaps treacly is the best word.

(9) It has been remarked that the design of the carrying arm also has a marked effect. But it is best to

leave over this part of the discussion until the major features have been checked.

When I first designed and made a pick-up on these principles, I was gratified, and somewhat surprised, to find that on the whole the performance was much as I had expected. There was, however, one disappointment and one special feature of interest.

High-note Reduction

The disappointment lay in the fact that reduction of high notes was greater than I had bargained for; the special feature was that although the response was much smoother than that of any other pick-up I had come across, there was a trace of an additional resonance high up in the scale.

It was quite small, but not high enough in the scale for my fancy. I therefore tried to shift it by the readiest means, which was to alter the pivot compliance. But it didn't! It only made it more prominent.

Curious Features

Evidently one of the hidden factors I have spoken about at (4) was involved. Although the explanation is simple enough it took me a long time and the drawing of many response curves before I found it. And in this process I discovered quite a number of curious features about response curves themselves.

Obviously in a research of this kind it is necessary to have some quantitative measurements. To trust to the ear alone is not nearly good enough. Nowadays I can guess at the salient features of the response by listening carefully, but at the time I am talking about the faculty was quite undeveloped.

In order to draw a frequency response curve, we want to measure

the behaviour of the pick-up to different frequencies throughout the musical scale. For this purpose we should impress mechanical vibrations on the needle point at the various frequencies; the amplitude of these vibrations should be such as would be produced by notes of equal strength recorded under the standard recording system, which is known as the constant velocity system.

This means that the

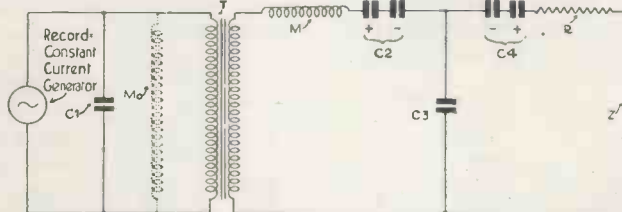

MECHANICAL CIRCUIT OF A PICK-UP

This circuit was reproduced in an article on the mechanics of the pick-up by P. Wilson, published in the March, 1934 issue of "W.M." C1—Needle-point compliance. M0—Pick-up head mass. T—Armature transformer, ratio $n=l_1/l_2$, where l_1 =distance from needle point to pivot, l_2 = distance from pivot to fish-tail. M—Equivalent mass of armature= $1/I$ where I is moment of inertia. C2—Net pivot compliance, after taking account of overbalancing effect on armature due to pressure on record. C3—Compliance of fish-tail plus any compliance due to lateral "give" of rubber pivot bearings. C4—Net compliance of damping and magnetic overbalance. R—Resistance of damping. Z—Reflected mechanical impedance of electrical circuit

amplitude should be inversely proportional to the frequency of vibration: at 50 cycles it should be 10 times as big as at 500 cycles, and 100 times as big as at 5,000 cycles.

If the input to the pick-up departs from this rule, we should know the precise amount of the departure and be able to correct for it.

And by input I mean actual mechanical vibration of the armature measured at the needle point.

Constant-frequency Records

Nowadays the universal method of providing the input is by means of "constant-frequency records." There are quite a number of these records. From time to time I use at least four different types, some of which, however, are not generally available.

I have a complete set of thirty-five Victor records calibrated by the Western Electric Company of America and extending in frequency from 25 cycles to over 8,000 cycles. Then I have the ordinary red label H.M.V. set of a similar number of sides and frequency range.

There are also the Parlophone sound test records consisting of gliding tones and howling tones from 6,000 cycles to 100 or 150 cycles.

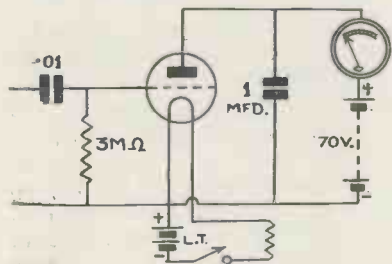

MEASURING PICK-UP VOLTAGE
The circuit of a Moullin voltmeter, which consists of a rectifying valve with a galvanometer in its anode circuit to measure the amount of rectified current

Unfortunately I have no accurate calibrations for these, though I am fully aware that they do not by any means give a constant input. There are also the octave records (i.e. records which go up the scale in steps of an octave) issued by the same company, and for these calibrations are supplied.

Finally, I am the fortunate possessor of special gliding tone and octave records from 6,000 to about 30 cycles, which have been very carefully calibrated. I value these most of all for they enable one to make a continuous and comprehensive test in quick time.

Moreover, they do not depart very

much from constant input at any point so that the calibration corrections are small, and in fact need not be applied in the first instance when only rough measurements are required.

The gliding tone record is a specially interesting one since by holding it up to the light in such a way that a parallel beam falls upon it, one can see a band of light across the record which actually shows by its width at different points the calibration response curves of the recording.

The reason for this is too involved to explain here; it is dealt with fully in a paper by Buchmann and Meyer in the German periodical *Electrische Nachrichten Technik* for April, 1930.

It is a very useful characteristic, since not only does it enable one in testing pick-ups to see at a glance whether any striking feature is due to a peculiarity of the record; but also by making a gliding tone record immediately before a recording session begins, the recording engineer is able to check up his recording instrument and to adjust it as may be necessary.

In taking a pick-up response curve, then, the pick-up is set to play either a gliding tone record or a series of constant-frequency records and the voltage output is measured.

An ordinary voltmeter, however, is of no use for this purpose—not so much because the voltage output is alternating, because one could use an A.C. voltmeter if that were the only trouble. Its real disability is that it imposes a load on the pick-up and therefore alters its characteristics.

There are, however, a number of methods of measuring voltage which are not subject to this disadvantage.

The first, and that most usually employed, is the valve voltmeter—or Moullin voltmeter as it is often called. This really consists of a rectifying valve with a galvanometer in its anode circuit to measure the amount of rectified current.

No power is taken in the grid circuit to which the pick-up is

connected—in fact, the pick-up may be connected up to an amplifier in the ordinary way whilst the voltmeter readings are being taken—so that no abnormal load is imposed on the pick-up. The galvanometer reading is a measure of the voltage output of the pick-up.

A second method is to connect the pick-up to a calibrated amplifier, of which the characteristics and amplifi-



EXAMPLE OF MODERN PICK-UP DESIGN
The new model 25 Marconiphone pick-up is completely housed in a brown bakelite moulding. The tone-arm lifts up vertically to facilitate the easy change of needles

cation are known, ending in a power stage. The current in the power stage, or a known fraction of it, can then be measured by means of a thermojunction and an ordinary meter.

Oscillograph Method

A third method is to use a cathode-ray oscillograph in the form of an electrostatic voltmeter. The oscillograph also has the advantage that it can be used to show the waveform of the output from the pick-up. If necessary a full analysis of the output can be made, though this is a long process.

This consideration illustrates one of the serious disadvantages of the other two methods of measurement.

Particular care is taken to ensure that the frequency records give a constant note input, that is that the vibrations are of the particular frequency under consideration at the moment *and no others*. No care whatever is taken that the voltage output, as measured, is of the same frequency or that there are no extraneous frequencies superimposed on it.

In practice there always are, for even if the pick-up does not produce harmonics of the input frequency—

and most of them do—it always produces a certain amount of surface noise, particularly at resonance points. This surface noise goes into the common pot and is responsible for its quota of voltage output as measured.

It is a fairly common experience when testing pick-ups for high-frequency response to find that one pick-up, which gives a larger reading than another, actually has less high-note response as judged by the ear in actual reproduction, coupled as a rule with a most objectionable surface noise.

Response Curves with Caution

I shall have something more to say later about the necessity for taking response curves with caution, if not with a few grains of common salt.

This illustration, however, will serve to show to begin with that too much reliance must not be placed on the actual *magnitude* of the voltage output at different frequencies.

A frequency-response curve is not, and cannot be, an accurate quantitative measure of the performance of a pick-up. Its value lies in the fact that it can be a useful qualitative measure: it can show the general nature of the response and where the peaks and troughs lie.

Misleading

Even here, however, it may be misleading unless one is aware of certain pitfalls and takes precautions to avoid them.

Here are a few of the snags.

(1) Should one use the same needle throughout the test or should one change it for another of the same type? The answer is that either course leads to trouble. One finds after a few trials that a needle gives slightly different readings at different stages of wear. On the other hand, two needles of the same type (i.e. loud tone or medium tone of the same brand) may give substantially different readings even when new. The reason is not only that needles vary, but also that they may not be inserted in the needle socket in precisely the same way.

My own practice is to use a single semi-permanent needle throughout the test and to take a second set of measurements with another needle. If the two sets are appreciably different I take a third set and so on until I am satisfied that I have reached some sort of consistency in my results.

Before taking each set of readings I allow a needle to play a few grooves of a record so as to ensure a closer fit. The reverse of my gliding-note record has plain unrecorded grooves on it, and these I use to wear in the needle and also to give me a rough measure of the amount that surface noise is contributing to the voltage output.

The amount obtained in this way will be a minimum correction, as one can readily tell by listening that surface noise is louder on a recorded groove than on an unrecorded one.

(2) In what order should one play the frequency records? At first sight it might seem best to have two tests, reversing the order of playing in the second one, and then to average the readings.

There are good reasons, however, why the high notes should always be taken first. The curvature of the record groove for high-note frequency records is greater than that normally encountered in ordinary records.

I shall discuss the effect of this more fully later. Here it is only necessary to notice that if the high notes are played with a worn needle the readings will be less than they should be.

On the gliding-tone record the high notes are recorded on the outside grooves, so one is bound to take the right order.

(3) This fact also avoids another oddity. On the standard frequency records three or four frequencies are recorded on one side of the disc. Now on all the discs one finds that the voltage output progressively decreases from the outside to the inside of the record, only to jump up again at the outside of the next disc.

The result is that the response curves taken with these records present a saw-tooth appearance.

This effect is only related to the particular method of taking the readings and has no bearing on pick-up characteristics. It is not produced by the gliding-tone record, the response curve in that case being smooth.

For this reason when I am using the standard frequency records I only use the outside grooves in one test, the second lot in a second test, and so on, never mixing them all up in one test. This means that my frequency gaps are bigger, but the gliding-tone record tells me whether

I have missed anything of importance.

(4) At some low frequencies it commonly happens that the readings are unsteady and increase considerably as soon as one adds to the pressure between pick-up and record, either by means of a weight added to the pick-up head or by pressing down on the pick-up with one's fingers.

Correct Reading

What is the correct reading in such a case? The answer is the greatest reading—but with some reservations.

The reason for this particular feature is either carrying-arm resonance or an inability of the pick-up to respond freely to large amplitudes of vibration. Usually it is both.

NEXT MONTH

P. Wilson M.A., will be contributing another article on pick-ups.

Make certain of your copy by ordering now.

"W.M."—November 28.

In ordinary playing conditions, however, one does not meet with such large amplitudes as the low-note frequency records exhibit and therefore the pick-up has less difficulty in responding. But in any case this feature indicates that the pick-up is subject to amplitude distortion in this part of the scale which will result almost certainly in frequency doubling.

Oscillograph Record

This is borne out by taking an oscillograph record of the waveform. Very few pick-ups give anything like a pure waveform on low notes.

Suppose, however, we have taken what precautions we can to guard against these snags and have obtained a series of measurements of output voltage at different frequencies. What is the best way of exhibiting them on a curve?

Clearly we want a horizontal base to record frequency and a vertical base to record output.

What scales shall we use?

There is more possibility of conscious or unconscious deception in this little question than in most of the other snags put together. How this arises I will explain later.

Mantovani, the well-known orchestral conductor, congratulating a member of the "W.M." Technical Staff on the production of the Mantovani A.C. Three—a reasonably priced three-valver that gives really good quality

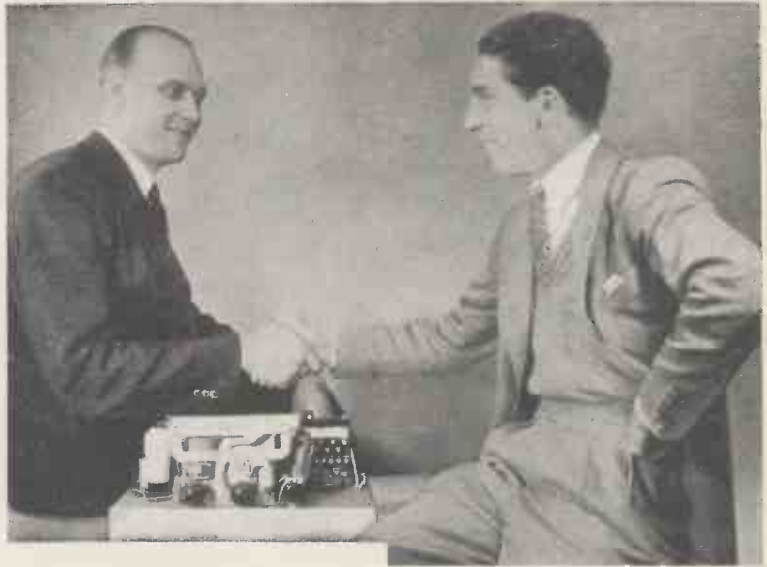

Designed by the
"W.M." Technical
Staff

The Mantovani A.C. Three

Here we present details of a very efficient A.C.-operated three-valver which has been designed by the "Wireless Magazine" Technical Staff to satisfy the wants of the modern generation at station-getting, and to please those who want tip-top quality of reproduction. Mantovani, the well-known orchestral conductor, has given the set a quality test. He declared that quality was "really superb"

YOU must all know his name—he broadcasts with his orchestra so frequently from the London stations. It is now about five years since he first came over the air from the Hotel Metropole with his Tipica Orchestra.

Mantovani is, of course, the leader of an orchestra that plays *real* music; so we had no hesitation in asking him to try out the set described in these pages and comment on it from the point of view of whether or not it is suitable for those who want a

reasonable selection of stations at really good quality.

Mantovani's tests in the "Wireless Magazine" laboratories convinced him that the set does meet these requirements: so here we are able to present details of a receiver that has the recommendation of a well-known musician as far as its reproduction is concerned. The "Wireless Magazine" is able to vouch for the technical merits of the design.

Points About the Set

Briefly, the set is an A.C. three-valver, plus a valve rectifier for the mains supply.

This set also has most of the features to be found in the modern commercial three-valve set, thus:—

(1) One-knob tuning, the three-gang condenser controlling a band-

THE CIRCUIT

The circuit of the Mantovani Three is typical of modern commercial practice. The valve combination consists of a high-frequency pentode as high-frequency amplifier, another high-frequency pentode as detector, which is resistance-capacity coupled to a pentode output. A valve is used for mains rectification

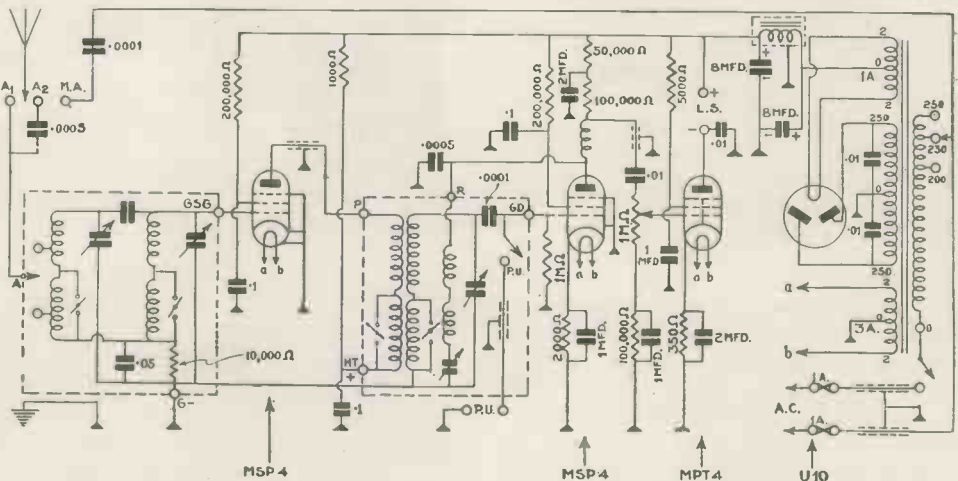

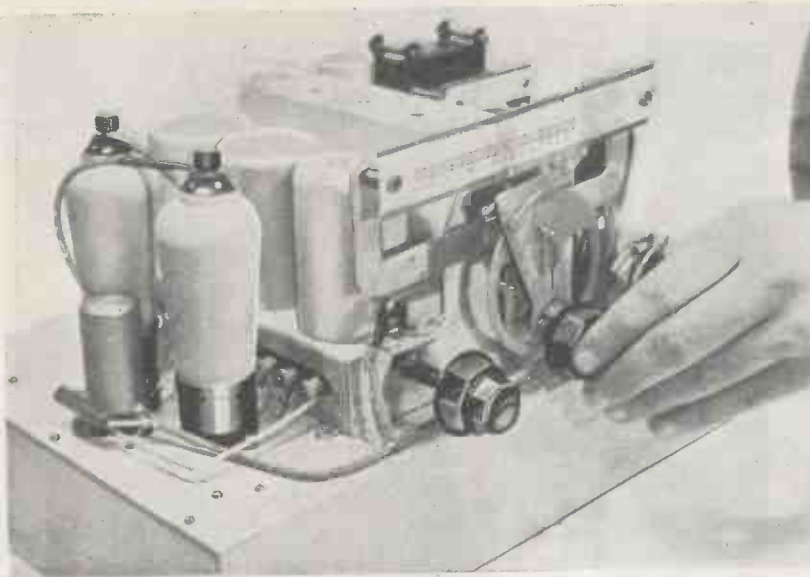

COMPACT AND EFFICIENT OUTFIT

Every necessary control is to be found in the three knobs grouped round the front of the tuning unit. On the extreme left is seen the high-frequency and detector pentodes

pass input circuit and the high-frequency intervalve coupling.

(2) Optional mains-aerial arrangement, of great utility when it is desired for some reason or other to use the set in a room not provided with any kind of indoor or outdoor aerial.

(3) Wavelength-calibrated scale, making the reception of foreign stations a matter of ease if a list of wavelengths is consulted when the set is being tuned-in.

(4) Resistance-capacity coupling between the screen-grid detector and the pentode output valve; the latter, by the way, gives an output of 2.5 watts.

(5) Standard form of chassis construction, simpler than usual because there are so few components in the set.

(6) Pick-up terminals are provided so that gramophone records can be played whenever desired.

(7) Valve rectifier for the mains supply: this gives 60 milliamperes at 250 volts, of which 50 milliamperes are taken by the valves.

(8) Primary of the mains transformer is tapped at every 10 volts for mains voltages between 200 and 250 volts, thus ensuring the best regulation.

(9) Mains hum is reduced to an absolute minimum by a low-frequency choke of 30 henries at the working load and two 8-microfarad electrolytic condensers.

(10) There are only three control knobs—tuning and reaction being combined in one dual knob; wave-

change and pick-up and on-off switching being combined in another dual knob; while volume is controlled by the third. The last works on both radio and gramophone.

It is not possible to use a visual tuning indicator or self-adjusting volume control with a circuit of this type. It is necessary to emphasise these points because so many listeners are under a misapprehension as to the application of these two features of modern radio design; they can only be applied successfully to multi-valve super-hets or large straight-circuit sets.

Prominent Feature

The most prominent feature of the design, as will be at once apparent from a glance at the photographs accompanying this article, is a tuning pack. It will be remembered that the suggestion for tuning packs was originated by BM/PRESS in "Wireless Magazine" some four years ago, but that is by the way.

What is more important now is that the pack used in the Mantovani Three is one of the best that has yet come our way. Not only are the coils of great efficiency, but they are so well matched up with the variable condenser that ganging presents no difficulties at all—and the ganging holds good over a much wider sector of the tuning band than is usual. On the score of tuning, we feel that this set is more than up to standard.

Continued on page 324



CLOSE-UP OF MAINS TRANSFORMER

This photograph shows clearly how the various wires are taken to the terminal board of the mains transformer. The set is suitable for any A.C. mains voltage between 200 and 250

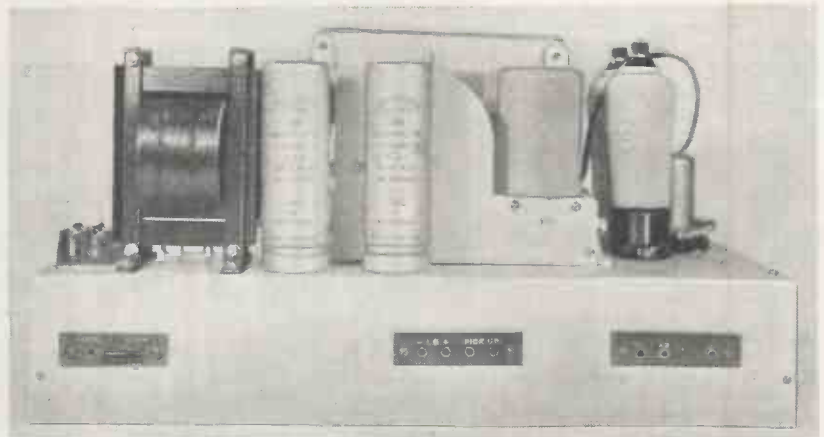

NEATNESS AND SIMPLICITY A FEATURE

This set is very typical of modern commercial practice. The mains aerial connection is seen on the extreme left, sockets for loud-speaker and pick-up in the centre, and those for aerial and earth are on the right

Testing the Set with Mantovani

JUST as I had completed the initial tests on the Mantovani Three, Mantovani came in to see how it was getting on. He remarked that it sounded very pleasant. The reproduction was very clear, but you cannot tell what a receiver will do when tuned to the local station.

After I had checked the ganging of the Linacore tuning unit I showed him just what the Mantovani Three would do during daylight. The local National and Regional came in at colossal strength with a good 2.5 watts output from the mains aerial. No reaction was needed, and to prevent overloading of the output valve the volume control had to be slightly reduced.

Good Daylight Results

Midland Regional wanted a little reaction, while with careful tuning the North Regional programme could be brought in at quite good loud-speaker strength. Not bad for Fetter Lane!

This is very good when you consider that the receiver is only a conventional three-valver, and that the test had taken place in the middle of the day. Of course, directly the external aerial was connected the four stations previously tuned in could all be received with almost equal strength and, in addition, Brussels, Poste



Mantovani spending a pleasant time in the "W.M." laboratories listening to the London programme on the new A.C. three-valver. He said that the "quality from this set is really superb." Such a recommendation is worth having!

Parisien, Hilversum, Radio Paris, Eiffel Tower and Luxembourg were also received.

A point that we noticed was that the ganging was perfectly accurate over both wavebands so the volume was more or less constant.

Mantovani commented on the simple tuning, there being only three knobs, and again remarked on the quality which, he said, "left nothing to be desired."

Being a musician, Mantovani knows what to expect from an orchestra, and he made a special point of listening to an orchestral concert. He said that the violins

were very lifelike, while all percussion instruments were clear and well defined.

Coming from a musician of such repute there is no need for me to tell you any more about it. It is not really surprising in view of the design, for resistance-capacity coupling has always been recognised as being the only form of coupling which gives really lifelike reproduction.

Some Thirty-five Stations

Later in the day I was able to give the receiver a more extensive test, but still under very poor conditions. With the volume-control at maximum and without any reaction some thirty-five stations were tuned in without any difficulty. The selectivity was remarkably good.

This amazing selectivity is most probably due to the combination of efficient band-pass coils and accurately ganged condensers, but even so it is very good to be able to cut out the local Regional in one degree under and one and a half degrees above maximum.

I feel that Mantovani's final comments fully sum up the capabilities of the receiver. He said: "I think quality from this set is really superb. It should satisfy any critical musician even if he is listening to foreigners." *K.J.*

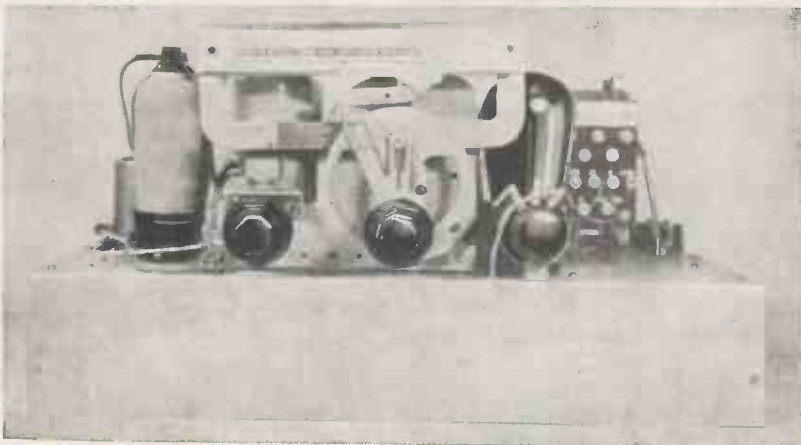

SHOWING THE TUNING CONTROLS

In the centre is the main tuner with a small concentric knob for reaction. On the left is the on-off switch with a concentric knob for wave-change and gramo-radio. On the right is the volume control which works on both radio and record reproduction

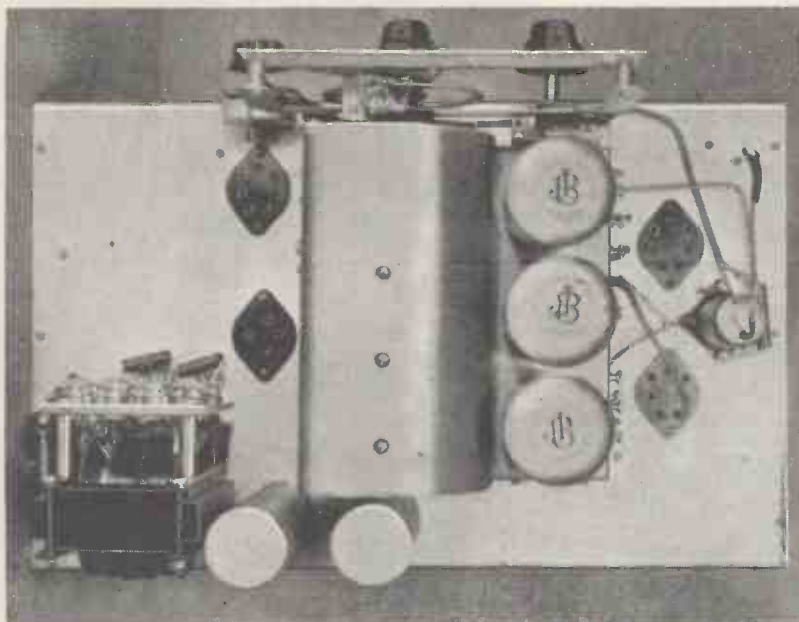

PLAN VIEW OF THE UPPER SIDE

As you can plainly see, there is little mounted on the top of the chassis besides the special tuning unit. Note the positions of the three seven-pin and one four-pin valve holders

Continued from page 322

It will be seen from the circuit diagram that there is nothing unusual about the electrical arrangement of the tuning circuits.

Mains Aerial

Alongside the usual aerial connection we show the mains aerial arrangement; it will be seen that this lead goes through a .0001-microfarad fixed condenser direct to one side of the mains-transformer primary.

In this way the house wiring is used as an aerial. Not of the most

efficient kind, it must be admitted, but nevertheless very useful when nothing else is available.

Before we go any further we had better explain that the small triangular blobs in the diagram indicate connections that are taken direct to the chassis. In this way the circuit diagram coincides exactly with the wiring guide, where certain component terminals are earthed direct to the chassis.

It will be noted that the high-frequency intervalve coupling takes the form of a tuned transformer, a

system that is coming back into favour for a number of reasons.

The most important practical effect is that high-frequency chokes and coupling condensers are not needed in the anode circuits of high-frequency valves so coupled, and thus the constructor saves time and money.

The pick-up switching is also incorporated in the tuning unit, this again saving the constructor the trouble of mounting a separate switch on the set.

Combination Switches

Perhaps one of the most interesting points about this tuning pack is the arrangement of the combination switches already referred to. On the left is the wave-change, pick-up and on-off switch. This has a dual knob, one part being behind the other, as is common practice nowadays.

The front part of the switch gives wave-changing and control of the pick-up circuit; it is marked with three coloured spots—red, green and white. On red the set is adjusted for long-wave reception; on green for medium waves; and on white the pick-up is brought into circuit. The back part of the knob switches the whole set on and off.

Then there is the main tuning knob in the centre. This again is of the dual variety, the back part giving the main tuning control and the front part controlling the reaction condenser. It will thus be clear that the constructor is saved the maximum amount of trouble. The only other control to be fitted is the volume control, and this is quite separate from the tuning pack.

Improved Quality

The only reason for using a high-frequency pentode valve as a detector is that if resistance-capacity coupling to the output valve is used sufficient magnification can be obtained to obviate the need for a transformer coupling.

In this way quality of reproduction is improved and money is saved; for, of course, a resistance-capacity-coupling is cheaper than a good quality low-frequency transformer.

Resistance-capacity coupling has been out of favour for so long that some will doubt its advantages over the more usual form of coupling; but the proof of the pudding is in the eating—and Mantovani was

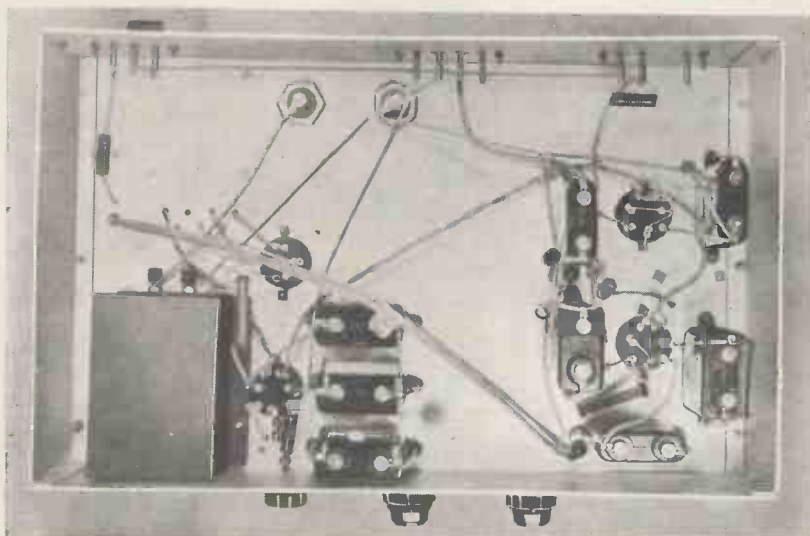

PLAN VIEW OF THE UNDERSIDE

The Mantovani Three is notable for the few components that are used, and consequently it is remarkably easy to build. In the bottom left-hand corner is the low-frequency choke

Third-scale Layout and Wiring Plan

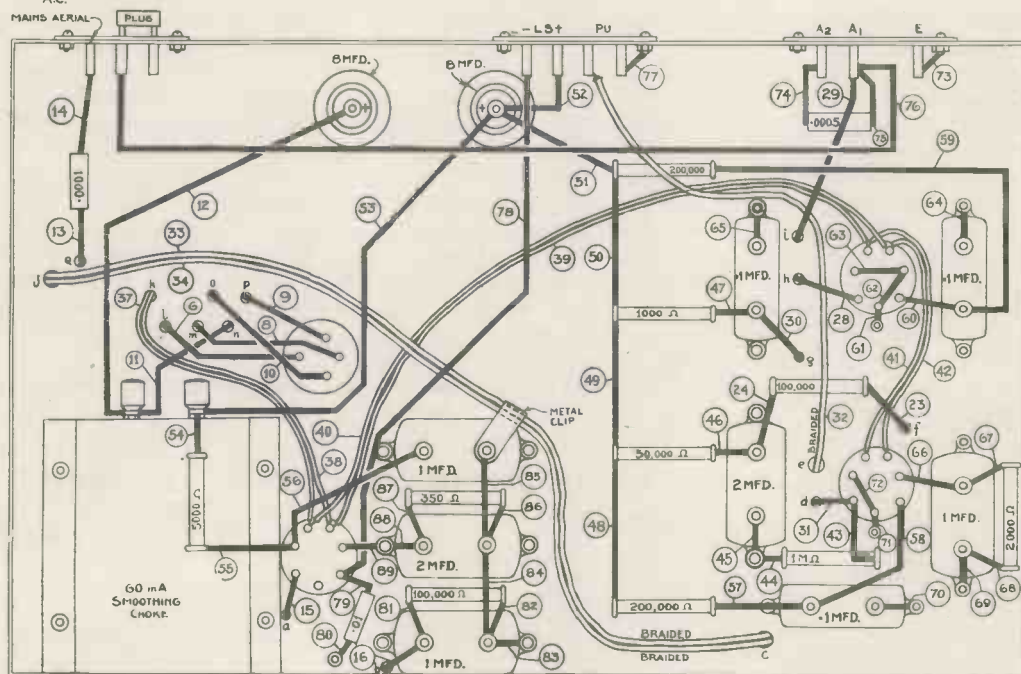
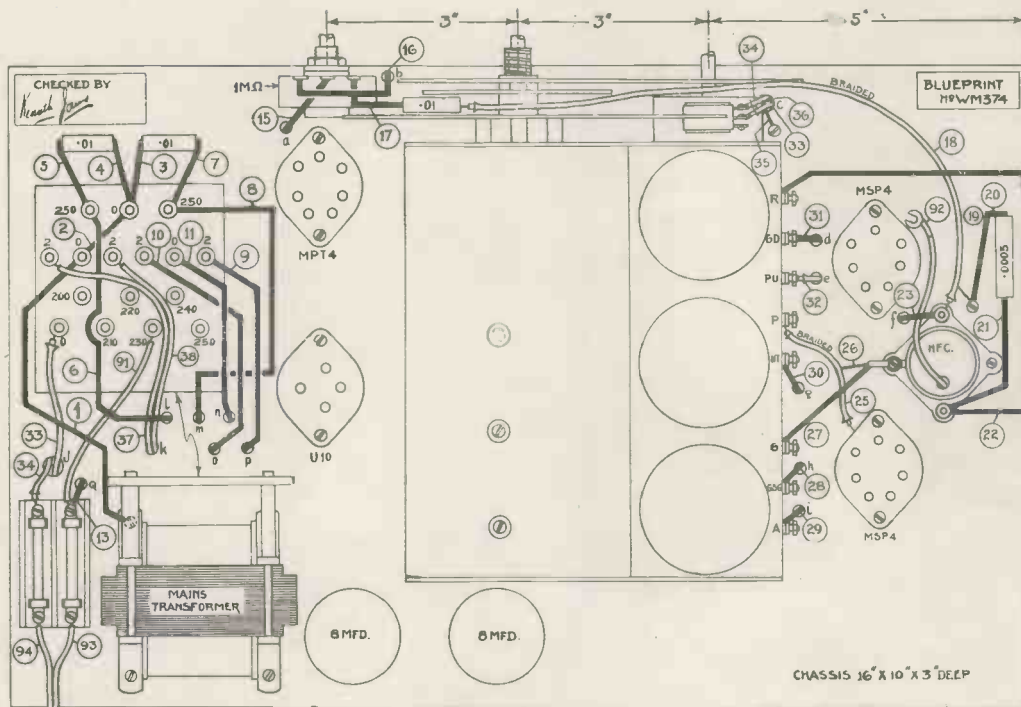

SPECIAL HALF-PRICE BLUEPRINT OFFER

If desired, a full-size blueprint of the Mantovani Three can be obtained for half price, that is 6d. post paid, if the coupon, to be found on the last page, is used before November 30. Address your application to the "Wireless Magazine" Blueprint Dept., 58-61 Fetter Lane, London E.C.4 asking for No. WM374



IN THE COURSE OF CONSTRUCTION
A member of the constructional staff at the "W.M." Fetter Lane laboratories hard at work building the Mantovani A.C. Three—one of the best and neatest A.C. three-valvers yet produced for the home constructor

held in position automatically by the wiring.

Then, of course, the way in which the usual full-size blueprint is prepared makes the assembly and wiring of the set quite a straightforward job even to the beginner. Every wire is numbered separately in the best order of assembly, and all the holes in the chassis through which wires pass from the top to the underside are indicated by small letters.

Thus, having found the hole in the drawing of the top of the chassis it is no trouble at all to pick it out by its indicating letter on the drawing on the underside.

can obtain the chassis already drilled for a few shillings, but in this case remember that the drillings will be for the actual components used in the original "Wireless Magazine" receiver; if any substitutions are made it is very likely that some extra holes will have to be made to accommodate parts of different shapes and sizes.

Trimmers Already Adjusted

The trimmers on the tuning unit are already adjusted when the pack is dispatched from the factory, but most constructors will want to check up the settings to make certain that they are getting the maximum efficiency.

The makers suggest that it is advisable not to turn the trimmers too far away from the original setting. Apart from that the procedure should be as follows:—

Ganging Instructions

Tune-in a reasonably loud station on some wavelength between about 250 and 325 metres, and then reduce the volume control until the signal is only just audible. Then adjust the middle trimmer until the strength comes up to maximum; follow with the rear trimmer; and finally adjust the trimmer right at the front of the tuning pack. Once these adjustments have been made there should be no need to change them unless a different aerial is used.

The Mantovani Three is one of the best value-for-money and efficient sets of its type that "Wireless Magazine" has been able to place before its readers. It will meet the requirements of most families and can be relied on to give a reasonable selection of British and foreign programmes at really good strength and with notable quality.

particularly impressed with the clean-cut quality obtained from this set. This is very largely due to the intervalve low-frequency coupling and to the choice of a first-class loud-speaker.

But quite apart from the merits of the circuit we are sure that the Mantovani Three will attract the interest of a large number of constructors on account of its simplicity in assembly. The components that have actually to be screwed to the chassis are few in number to start with; and all the fixed resistances and some of the fixed condensers are of the tubular type that are

In these pages we reproduce a third-scale layout and wiring diagram of the set, but those who desire one can obtain a full-size blueprint for half price, that is, 6d., post paid, if the coupon on the last page of this issue is used by November 30. Send your application to "Wireless Magazine" Blueprint Dept., 58/61 Fetter Lane, London, E.C.4; a copy will be sent by return of post.

For ease in working it is advisable that the chassis should be made of aluminium or copper; many manufacturers use mild steel, but this is too difficult for the amateur to drill.

Those who fight shy of metalwork

COMPONENTS NEEDED TO BUILD THE MANTOVANI A.C. THREE

CHASSIS		HOLDER, FUSE		RESISTANCE, VARIABLE	
1—Peto-Scott, 16 in. by 10 in. by 3 in. ...	8 6	1—Bulgin, type F11 ...	2 0	4 doz. 1/2-in. 6BA nuts and bolts (round head steel), say ...	1 0
CHOKE, LOW-FREQUENCY		PLUGS, TERMINALS, ETC.		TRANSFORMER, MAINS	
1—National Radio Service, 60-milliampere type ...	12 6	3—Clix chassis-mounting strips, one, type 27, marked A1, A2, E.; one, type 26, marked LS+, LS—, PU; one, type 28, marked Mains, Aerial; one shorting bar, type 29 ...	2 0	1—Varley, type EI20 ...	1 7 6
CHOKE, HIGH-FREQUENCY		RESISTANCES, FIXED		TUNING UNIT	
1—Wearite, type HFPA ...	4 0	7—Franklin type tubular, values: .0001-, .0005- (2), .01-microfarad (4) ...	4 2	1—J.B. Linacore, type BU ...	3 5 0
CONDENSERS, FIXED		SUNDRIES		ACCESSORIES	
7—Franklin type tubular, values: .0001-, .0005- (2), .01-microfarad (4) ...	4 2	Connecting wire and sleeving (Goltone), say ...	1 6	CABINETS	
8—Dubilier type BB, values: .1- (3), 1- (3), 2-microfarad (2) ...	1 0 0	3 yd. thin flex (Goltone), say ...	3	1—Peto-Scott, Classic type ...	
2—Dubilier 8-microfarad, type dry electrolytic ...	11 0	6 ft. screened sleeving (Goltone), say ...	1 6	1—Peto-Scott 193E loud-speaker type ...	
HOLDERS, VALVE				LOUD-SPEAKER	
4—Ferranti chassis-mounting, 7-pin (3), 4-pin (1) ...	6 0			1—W.B. type Stentorian Senior ...	
				VALVES	
				2—Marconi MSP4... ...	
				1—Marconi MPT4... ...	
				1—Marconi U10	

£ 3 6 2

326 £ 0.17.3

£ 12 0.0

A professional worker making final adjustments to a record-changing mechanism before it is installed in a radiogram at the H.M.V. factory at Hayes

By R. W. HALLOWS
M.A.



Wireless Jobs Made Easy for Mr. Everyman

A MONTH or two ago I referred to the sad habit possessed by tin shears of the kind seen in Fig. 1(a) of biting their user in the palm of the hand when the might of his grip brought the curved ends of the handles together. As an alternative tool I suggested tin snips, made after the manner of scissors, with looped handles for the thumb and finger of the right hand.

Such snips are all very well for lightish work, but many people use rather heavy gauge metal nowadays for chassis building and they cannot deal satisfactorily with this.

To a Wallingford reader, himself a tinsmith, I am indebted for a hint which I now pass on to readers. It is a worth-while tip and quite easy to put into practice.

Improving Tin Shears

If you possess a pair of tin shears of the type that is liable to bite, here is the way to deal with them. Begin by using your hacksaw to cut off the hooked ends of the handles as shown in Fig. 1(a). Next procure two lengths of the tubing that is used for electrical conduits. File up the ends

of the handles as may be necessary and then drive the conduit tubing on to them as shown in Fig. 1(b). Be careful to drive on far enough to ensure a really firm grip.

This done, take a piece of wire, push it down the open end of the tubing and measure the distance to the end of the handle inside. Just clear of the handle drill and countersink a $\frac{3}{16}$ -in. hole as shown in Fig. 1(b). Insert a $\frac{3}{16}$ -in. bolt $1\frac{1}{2}$ in. long with countersunk head and lock it into place with a nut. The bolt, of course, goes through one extension handle only and its point rests against the other.

The last process is to file down the bolt until its length just suits your own grip. When tin shears have been treated in this way they will be found delightfully easy to use. The palm of the operator's hand is safe and the extension handles give such fine leverage that heavy sheet metal can be tackled readily.

Loud-speaker Problem

A problem often put up to me by readers concerns the use in double harness of two loud-speakers of different impedances.

Here's a typical case: a reader who already possesses a loud-speaker with an impedance of, say, 10 ohms builds or buys a set which contains a

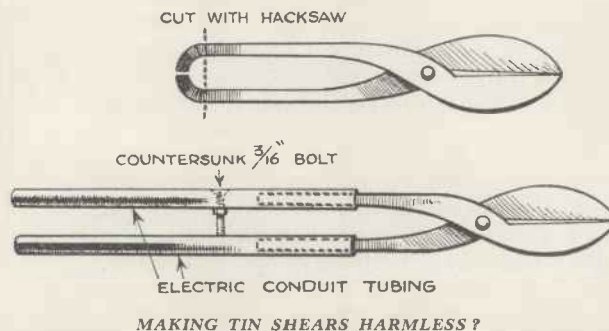

MAKING TIN SHEARS HARMLESS?
Fig. 1 (a) shows an ordinary pair of tin shears; Fig. 1 (b) shows the same shears with the ends cut and fitted with electric conduit tubing

2-ohm loud-speaker. He wants to be able to use the 10-ohm instrument either for dual working or as an extension loud-speaker.

In most cases the best way out of the difficulty is to have a separate output valve for each loud-speaker. If only one output valve is used matching becomes a very tricky business and it is extraordinarily difficult to obtain good results. When, though, separate output valves are used, each with its own

extension instrument. Since in most cases LS_1 's transformer will be part of the instrument, all that we have to find room for in the set is an additional valve holder. Should there not be sufficient space on baseboard or chassis for this, a small shelf can usually be arranged somewhere inside the cabinet.

Cutting Out One Loud-speaker

Another problem often put to me

is that of cutting the loud-speaker in the set out of action when the extension instrument is working. A glance at Fig. 3 will show how easily this can be done when each loud-speaker is provided with its own output valve. All that is required is a double-pole change-over switch. Any well-made type will do, but a small toggle switch is the neatest and handiest for the purpose.

The positive filament lead of v_1 is broken, one part being taken to the moving arm of the switch and the other to a fixed contact. To the other fixed contact on the same side is connected the grid of v_1 . The grid terminal of the input transformer is connected to the vacant moving arm contact of the switch and to the grid of v_2 .

When the switch, as arranged in the drawing, is turned to the left both the filament and the grid circuits of v_1 are broken. LS_1 therefore goes entirely out of action, though LS_2 is unaffected.

On turning the switch over in the other direction the filament of v_1 lights up, its grid circuit is completed and it brings LS_1 into action as well as LS_2 .

The circuit diagrams have been drawn for battery-operated valves, but exactly the same principle can be used in any kind of mains-operated receiving set. The idea is simple and well worth trying.

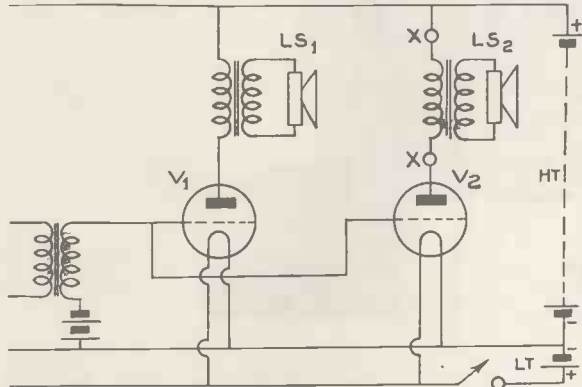

TWO OUTPUT VALVES FOR TWO LOUD-SPEAKERS
Fig. 2.—The author suggests that the best way of working loud-speakers of different impedances is to use two output valves. XX is the extension terminals

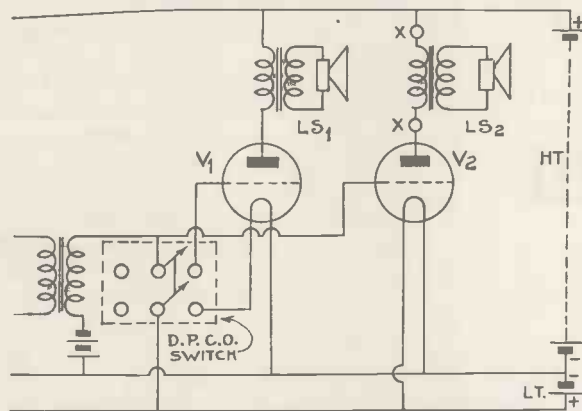

CUTTING OUT THE INTERNAL LOUD-SPEAKER
Fig. 3.—By means of a double-pole change-over switch the built-in loud-speaker can be cut out whilst the extension reproducer is working. XX is again the extension terminals

matching transformer, everything becomes straightforward.

Since each loud-speaker will in nine cases out of ten have its own output transformer the only extra expense entailed is for a valve holder and a valve.

Fig. 2 shows how the scheme is carried out. The grids of the two valves are connected together and wired to the grid terminal of the same make and type must be used since they receive the same grid-bias voltage.

In the diagram LS_1 is the set's built-in loud-speaker and LS_2 the

Fitting Toggle Switches

Talking of toggle switches reminds me that there are one or two rather important points about fitting them to your panel. A typical switch is seen in Fig. 4. On the threaded bush there are two nuts, a hexagon, A, and a milled locking ring, B. The proper use of these is not made clear in the directions which accompany the switch.

This is an omission which should be rectified by manufacturers, for if the nuts are wrongly used one can easily wreck the component—as I did some long time ago when I fitted my first toggle switch.

Look Before You Leap!

One natural inclination before fixing the switch into the hole prepared for it in the panel is to turn the hexagonal nut A hard down against the shoulder C, so as to make all ship-shape. If this is done in a misguided moment the nut will pull the bush clean out of the body of the switch—and that will be just that!

It is most important that the hexagon nut should be clear of the shoulder and that the switch should be secured by pressure between the hexagon nut at the back of the panel and the locking ring at the front.

The way in which I came to spoil my first toggle switch was this. With both nuts in use the bush was rather too short for the panel. I therefore removed the hexagon nut and sought to secure the switch by means of the locking ring only. The result was that the bush came adrift and the switch was of no further use.

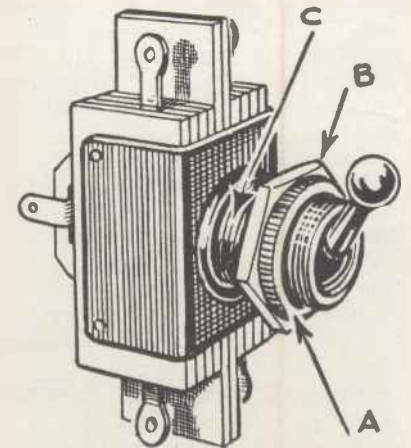

TYPICAL TOGGLE SWITCH
Fig. 4.—A typical toggle switch. B is the hexagon nut, A the backing ring, and C the shoulder

Toggle switches can be obtained in two types with short and long bushes. If you are mounting the switch on a metal chassis or a very thin panel then use the short bushed type. For thicker material the long bushed switch is suitable.

When the Bush is Too Short

What is to be done when even the longer bush is too short to go properly through the panel? You must countersink the hold made for the bush deeply on the inner side of the panel. This will allow the hexagon nut to enter some distance into the panel; the bush will then protrude far enough for the locking ring to bite its thread.

Drilling Large Holes

One little problem that will present itself to the constructor who essays to fit a toggle switch to his set is that of drilling a hole

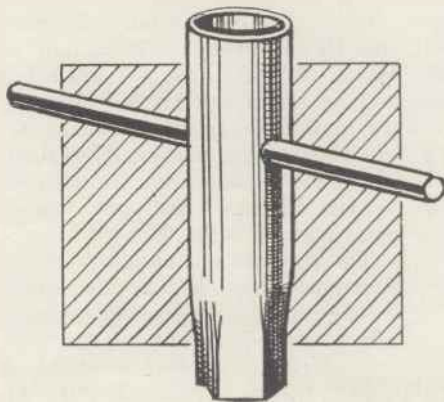

TOMMY BAR EXPLAINED

Fig. 7.—A tommy bar, as you can see, is a piece of metal rod passing through two holes in the round part of a box spanner

large enough to take its bush, for the required diameter is always a good deal greater than $\frac{3}{8}$ in. and a $\frac{3}{8}$ -in. drill is usually the largest in his tool kit.

Some time ago I described that very useful tool the tapered D-bit, which allows holes to be enlarged, and I mentioned also that in default of a D-bit an old half-round file mounted in the jaws of the brace could be pressed into service for doing similar jobs.

Here's the way to use either for mounting a toggle switch.

Having made a $\frac{3}{8}$ -in. hole in the right place insert the enlarging tool

at the inner side and give it several turns. Now see whether the bush will enter. If it goes about half way through, well and good; if not, continue until it does.

Don't go on until the bush will go right through. If you do it will be a loose fit since, owing to the shape of the enlarging tool, the hole is somewhat tapered.

Instead, when the bush

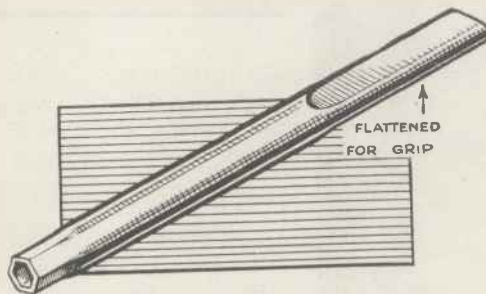

FINISHED BOX SPANNER

Fig. 6.—The finished box spanner with one end flattened out to form a handy grip for the fingers

will go about half way through from the back, restart your enlarging operations from the front. Work carefully until the hole is just a nice push fit for the bush.

Home-made Box Spanners

Box spanners to fit nuts of the various B.A. sizes are amongst the most useful tools in the wireless constructor's kit. It is very easy to make one's own box spanners for such nuts, or to improvise them for other sizes should the need arise, from odd bits of tubing from the junk box.

Fig. 5 illustrates the first process in making a box spanner. The diameter of the tubing must be such that it is a very tight fit for the nut. Insert a small piece of studding—or a fairly long screw—into the nut and push it into the end of the tube as shown in the drawing.

Now lay the tubing on the jaws of the vice or a block of metal so that one of the flats of the nut is uppermost. Take a light hammer, preferably with a ball-pane, and shape the tubing by gentle tapping. Remember that in hammering many light taps are always much better than a few hefty ones.

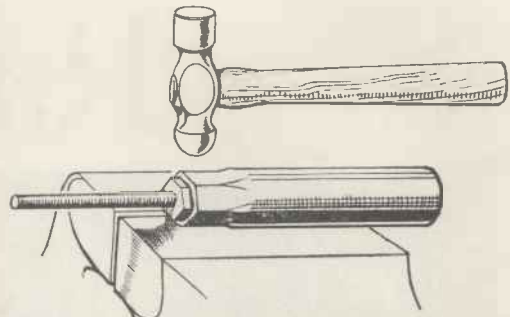

MAKING A BOX SPANNER

Fig. 5.—Showing the necessary tools and gear for making your own box spanner. The diameter of the tubing must be a tight fit for the nut

Once you have made your first flat, turn the tubing and make another. Continue until you have drawn the tubing into hexagon shape at its mouth. Then push your nut a little further in and continue the shaping until the hexagoned portion of the tubing is about a $\frac{1}{4}$ in. in length. The business end of the box spanner is now finished.

Remodelling as Well

In passing I may mention that besides its usefulness for making box spanners this process is excellent for remodelling any that have become somewhat out of shape as a result of long use.

Cut off your tubing to the required length and then flatten out the far end as shown in Fig. 6 to form a grip for the fingers. Trim up the flattened end with a file if necessary and there is your box spanner complete.

The Tommy Bar

Suppose that the box spanner is of a largish size and intended for heavy work such as tightening down the securing nuts of one-hole fixing components the flattened end will not enable you to apply sufficient force to get the nuts thoroughly home. In such cases you require what is known as a tommy bar. If you don't know what this is a glance at Fig. 7 will show you.

It consists simply of a piece of metal rod passing through holes in the body of the box spanner. Don't bother about flattening the end of large box spanners; just pass a $\frac{3}{16}$ -in. drill right through as shown in Fig. 7 and use any suitable piece of metal rod as a tommy bar.

Let me repeat again; take your time over jobs like this. Do them thoroughly and it will pay in the long run.

Radio Medley



Sunbeam Electric photo

THERE IS A VOGUE FOR MIDGET SETS!
One of the great advantages of midget sets is that they can easily be moved about from room to room when required. And quite a number of them can be used on either A.C. or D.C. mains at will

Band-passed!

CAN anybody tell me why band-pass tuning has gone so much out of favour? Can it be that the system didn't really do in practice all that it could be proved to do on paper? Or is it that a single iron-core coil is so much more effective?

Whatever the reason, there is no doubt about the decline in popularity of this much-vaunted tuning system. I was never convinced that it was the right circuit for the amateur; most of the complaints about ganging up a set started when band-pass tuning came into general use.

It is quite a difficult matter to trim two band-pass tuners so that they really do give a "band" characteristic; and in any case the band width did not remain constant over anything like a substantial portion of the waveband. On the other hand, it is certain that most users of band-pass tuned both circuits to the peak.

Now that we have gone back to single circuits the ganging of a set is very much simplified. Almost anybody

can trim three single circuits so that each is working at its peak.

Long-wave Fading

Listening to Radio Luxembourg on Sunday last I was surprised to hear it fade right off for several minutes;

in fact it became almost inaudible. This strange phenomenon actually happened two or three times in about half an hour.

That in itself is rather surprising on the long waveband, isn't it? But what is even more surprising is that the set on which this phenomenon occurred is one of the best and latest super-hets provided with full self-adjusting volume control.

It just shows, doesn't it?

How Radio Made History

We all know that there is a great deal of romance about wireless; and that is particularly true of the very early days. Quite a number of books have been published on the history of radio, and one of the best I have seen has just been published by the Science Museum, that amazingly interesting institution at South Kensington.

I can recommend all of you to get a copy of this book, which is entitled "Radio Communication: History and Development." The author is W. T. O'Dea, B.Sc., A.M.I.E.E., and he traces the history of radio communication from what were inexplicable phenomena in 1780 right up to the present day. (Published by His Majesty's Stationery Office, price 2s. 6d.).

The contents include chapters on electromagnetic waves, detectors, early wireless-telegraphy experiments, development of wireless telegraphy, the thermionic valve, further developments in transmission, wireless-telephony receivers, television and picture telegraphy, and miscellaneous developments, including microphones, loud-speakers and the measurement of wavelength.

For its kind the book is well illustrated and if you live in London you will gain great benefit by reading it and then going along to the Science Museum to have a look at some of the historical apparatus for yourself.

You may see me there when I have quite finished reading my copy!

That won't be for some time yet; there is far too much to read!



H.M.V. photo
ONE-MAN BAND AND THE FIFTEEN-VALVER
Toni (the one-man band) and his monkey, Yento, try out one of the most ambitious British sets yet produced, a fifteen-valve radio gramophone with automatic record changer

Too Many Records

Lately I have done rather more listening than is my wont and I have heard a good many home and foreign stations that I have not tuned-in previously for some long time. What strikes me most forcibly about present-day broadcasting is that too much use is being made of records. I deplore this tendency.

Perhaps it is not very logical, but I also get the impression that I am being had. If I want records I can play my own—and so can you. When we listen to radio transmissions let us at least have something original every time.

There is some excuse, perhaps, for foreign stations that are handicapped by lack of funds, but there is no excuse for such a body as the B.B.C. Of course, organised programmes of records, when the records themselves are the focus of interest as in Christopher Stone's (late) broadcasts, are all right; what I object to are odd half-hours of records at times when decent first-hand broadcasts could well be made.

But, there, mine is probably a voice crying in the wilderness. So many people think that the quality of broadcast records is better than the real thing!

What discrimination! What perception!

Those Good Old Days

Recently Kenneth Jowers (the short-wave fan who tops over 6 ft. in his socks) stayed with me for a few days and, as is inevitable when two radio men are together for any length of time, we talked over the early days—when it was no uncommon thing to pick up Cardiff on a crystal set in London and there was nothing at all to hear except morse.

Lots of us even in those days couldn't read morse at any speed at all (yes, I confess!), but we knew all the stations that we picked up nevertheless. There was no mistaking the note of the Air Ministry station GFA, for example (by the way, that was the station that came in at half a dozen places round our dials circa 1922-3); we also knew at once the difference between GNF, the Post Office spark station at the North

Foreland, and its companion GNI, at Niton, Isle of Wight.

In the middle of our chat I fished out from my bookcase a book of circuits published in 1923 and we spent an interesting half hour going through them again.

What weird and wonderful contraptions they were! All plug-in coils—we had only just come to that stage in 1923!—headphones, filament rheostats (one for each valve) and key switches that performed the most elaborate functions!

And yet fundamentally the circuits we are using to-day bear a

striking resemblance to those of ten and more years ago. Nearly all the improvements that have taken place in the meantime have been in matters of detail and the fundamentals remain more or less unchanged.

It seems to me that something really revolutionary will be discovered in the next ten years.

Licence Increases

The total number of increases in the number of licensed listeners for August was 32,000 odd, London accounting for nearly 3,000 and Birmingham for over 1,000.

But what is the story behind the fall in the numbers of listeners in certain districts? Is it because some people are so fed up with the programmes that they have given up radio in disgust? Or, as I think it must be on looking into the figures closely, is it that the areas affected are all places where industry is doing badly and where the population consists chiefly of poorly-paid workers who simply cannot afford to go buying licences



Columbia and H.M.V. photo
MAKING RECORDS ON THE STAGE
Charles Prentice, Esmond Knight, Meg Lemonnier, Florence Desmond and C. B. Cochran making a record of "Streamline" at Manchester



H.M.V. photo
HAVING A GOOD LOOK AT THE "WORKS"
Nowadays even the fair sex is beginning to have more than a superficial knowledge of radio—which explains why this young lady is glad of the opportunity to have a peep at the inside of a new super all-mains radio gramophone



H.M.V. photo
WHERE THE SUN STILL SHINES!
 No, this is not a belated "summer" picture, but is a scene taken at a small coast resort on the French Riviera

at ten shillings a time?

If that is the case, what a shame, for these are the very people to whom radio can give the greatest benefits, both in the way of entertainment and "uplift."

Here is a list of the towns where the licence figures have fallen off; have a look through them and see if you can find any better solution to the mystery than mine:

South-west London, -8; Abingdon (Berkshire) -4; Maidenhead (Berkshire), -5; Holsworthy (Devon), -65; Chelmsford (Essex), -3; Saffron Walden (Essex), -3; Cheltenham (Gloucestershire), -52; Lymington (Hampshire), -2; Hemel Hempstead (Hertfordshire), -2; Ulverston (Lancashire), -13; Scunthorpe (Lincolnshire), -17; Sleaford (Lincolnshire), -7; Uxbridge (Middlesex), -10; Cromer (Norfolk), -2; Banbury (Oxfordshire), -11; Huddersfield (Yorkshire), -30; Brecon (Brecknockshire), -1; Porth (Glamorgan), -286; Barmouth (Merionethshire), -2; Blaenau-Festiniog (Merionethshire), -2; Tenby (Pembrokeshire), -11; Lang-

holm (Dumfriesshire), -17; and Stirling (Stirlingshire), -17.

Piezo-Electric Possibilities.

I had lunch the other day with Mr. P. Wilson, who probably knows as much about the technicalities of acoustic and radio gramophones as any man in the country. He is very enthusiastic about the new piezo-electric pick-ups, which

gramophone development should certainly look into the merits of the piezo-electric method.

Post Office Limitations

You have probably heard how helpful the Post Office engineering department is in so many cases of external interference. They trace the trouble to the source for you—free of all charge—and then do their best to make the owner of the offending gear instal anti-interference gadgets on the machine itself. They do not always succeed in that, of course, but they are very tactful and their efforts are frequently crowned with success.

But have you heard that they will do nothing for you if you complain of interference with foreign stations? That seems rather amazing, but it is true. A friend tells me that an acquaintance has a lot of trouble on wavelengths between about 1,000 and 1,500 metres.

He applied to the Post Office for assistance, but they refused him on the grounds that the interference ceased just below Daventry's (now Droitwich's) wavelength.

Although you pay 10s. a year to the Post Office for a broadcast licence they don't care what happens provided you can hear the British stations!

Stenode Developments?

A few days ago I had the pleasure of renewing my acquaintance with Dr. James Robinson, the inventor of the Stenode principle. He is very glad to know that the "Wireless Magazine" Stenodes have aroused so much interest—and that this is the case you can easily check up for yourself.

Without giving away any secrets I think I can say that Dr. Robinson has something up his sleeve that will cause as much interest as did the original announcement of the Stenode.

London, W.C.1

BM/PRESS

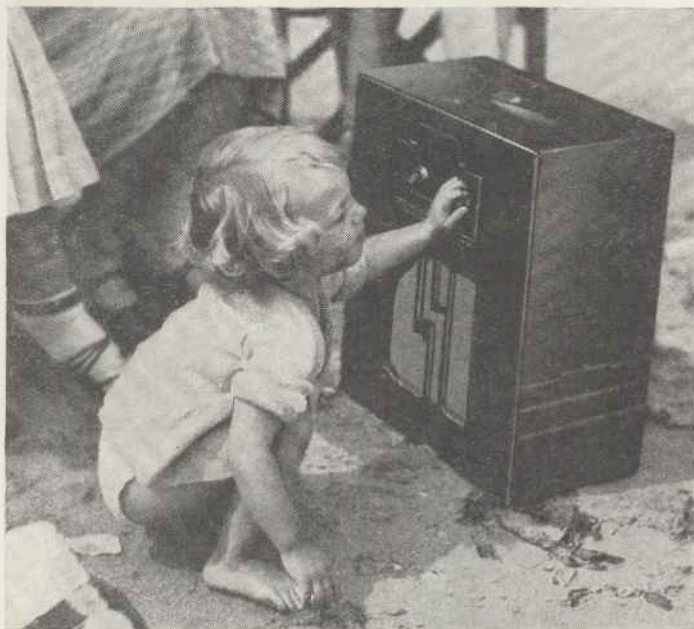

H.M.V. photo
HOW DIFFERENT FROM OUR CHILDHOOD TOYS
 Even the youngest child nowadays takes to radio like a duck takes to water. There will be no wonder about television to the coming generation!

are amazingly sensitive. He is also particularly impressed with the latest piezo-electric microphones, which are just as sensitive as the pick-ups in their particular sphere.

Of course, the feature of a piezo-electric pick-up is the use of a Rochelle-salt crystal to convert the mechanical vibrations into electrical impulses. The weight of the crystal is almost infinitesimal and thus a high degree of sensitivity is obtained.

Those who are interested in radi-

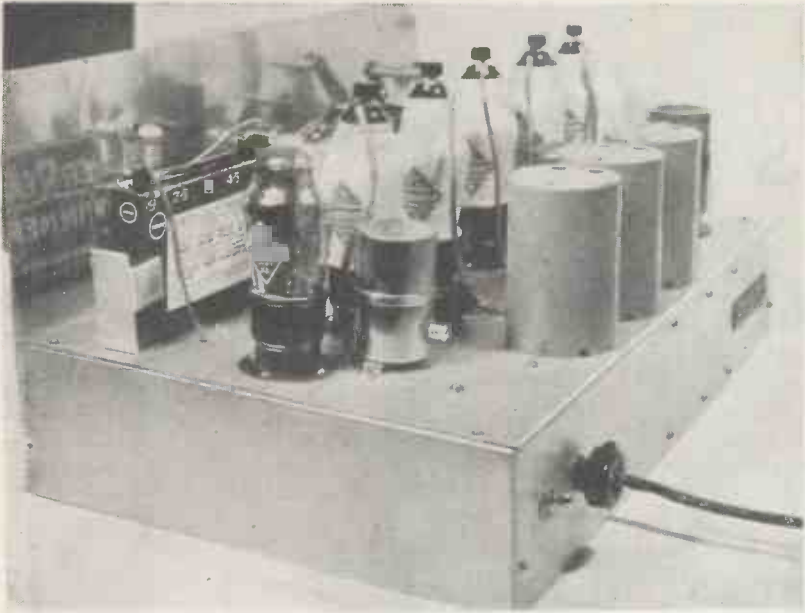

The appearance of the Quartz-crystal Super is really businesslike. The switch on the back is the static suppressor and next to it is the loud-speaker plug.

coil in circuit, the oscillator condenser will bring in stations such as Winnipeg, Pittsburg and Zeesen, all on 25 metres odd, at about 8 degrees on the oscillator dial.

The 31-metre band comes in at approximately 45 degrees and the 40-metre amateur band at 75. The 50-metre commercial band can just about be dragged in at the far end of the tuning dial, but here again, unless the stations are very powerful indeed they will not be of much use.

The 50-metre Band

It is the third coil that covers this waveband. Actually it is supposed to tune between 41 and 94 metres, but you will find that several amateurs working on about 40 metres come in quite strongly at approximately 2 degrees on the oscillator condenser dial.

Most of the 50-metre stations come in very well indeed at approximately

show a very slight drop in voltage.

You will find it rather difficult to calibrate the receiver owing to its high selectivity unless you have some idea as to where the stations come in on the tuning dial. Even though the first detector valve is isolated from the aerial the reading on the grid tuning condenser is not sufficiently constant to be of any use, so I will give you instead several readings taken from the oscillator (right hand) tuning condenser.

Maximum Volume

This does not vary, and then all you have to do is to bring into resonance the grid-tuning condenser to give maximum volume.

First, using the smallest coil, there are four waveband groups that can be tuned in. This coil tunes between 12 and 26 metres. The 13.5-metre band, covering stations such as Pittsburg and Daventry, comes in round about 12 degrees.

Finding Stations

The next important group is to be found on 16 metres. Tune the oscillator condenser to about 42 degrees, when you will find such stations as W3XAL, Daventry and Eindhoven. At the present time, pay careful attention to the 19-metre band between 75 and 80 degrees on the oscillator dial. Although the coil tunes to 26 metres, its efficiency falls off above 20 metres.

For the 25-metre band, use the second coil, which covers wavelengths between 22 and 47 metres. With this

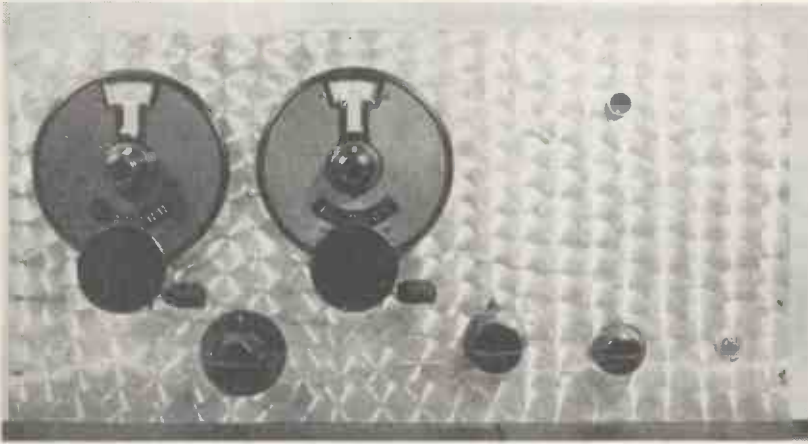

Underneath the two tuning dials from left to right are reaction control, crystal cut-out, volume control and on-off switch.

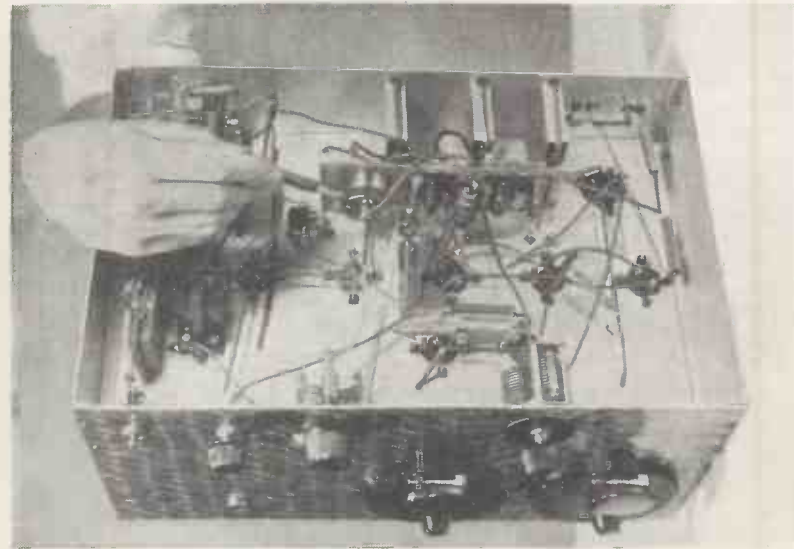

Although an ambitious design, the construction of the Quartz-crystal Super is particularly easy. The pencil is seen pointing to the quartz crystal.

20 degrees while ships on 72 metres can be brought in between 65 and 70 degrees.

The only other waveband on this coil that will be of interest is the 80-metre amateur band which spreads between 89 and 93 degrees on the oscillator dial.

That really is the end of the short-wave section, but to make the receiver

FULL-SIZE BLUEPRINT

You will find construction of the Quartz-crystal Super much easier, and you will avoid the chance of mistakes, if you use a full-size blueprint. A blueprint of the Quartz-crystal Super, No. WM372, can be obtained for 1s. 6d. post paid from the "Wireless Magazine," Blueprint Department, 58-61 Fetter Lane, London, E.C.4.

LIST OF STATIONS HEARD ON THE QUARTZ-CRYSTAL SUPER DURING AN EVENING'S TEST

Station	Wavelength	Station	Wavelength
Moscow	50	Springfield (Mass.) ...	31.35
Montreal	50	Philadelphia	31.28
Boston (Mass.)	49.67	Lisbon	31.25
Daventry	49.59	Eindhoven (Holland) ...	25.57
Cincinnati	49.59	Zeeseu	25.51
Philadelphia	49.5	Boston (Mass.)	25.45
La Paz (Bolivia)	49.34	Winnipeg	25.4
Boundbrook (N.J.)	49.22	Pittsburgh	25.27
Caracas (Venezuela)	49.08	Moscow	25
Johannesburg (S.A.)	49	Lisbon	24.83
Pittsburgh	48.86	Vatican City	19.84
Boundbrook	46.69	Radio Colonial (Paris) ...	19.68
Radio Nations (Swit'd.) ...	40.3	Schenectady	19.56
Rio de Janeiro	36.65	Zeeseu	16.89
Schenectady (N.Y.)	31.48	Eindhoven	16.88
Zeeseu (Germany)	31.38	Boundbrook (N.J.)	16.87

of universal appeal three other coils can be used. The first tunes between 76 and 170 metres and for English and European listeners will bring in trawlers, commercial aviation and amateurs on 160 metres.

Users all over the world will be able to hear the amateurs on this waveband provided that they are not jammed out with static.

The final two coils are purely for broadcast reception.

One point that really should be borne in mind is the voltage on the oscillator valve. With the original set I used a resistance of 10,000 ohms in series with the anode of that valve and high-tension positive.

I had occasion to use a different make of oscillator valve with the result that the set refused to oscillate on the first two sets of coils.

To overcome this, the 10,000-ohm resistance in series with the anode had to be reduced to 2,500 ohms. This was probably due to the valve being of high impedance.

The same remarks will apply the other way round.

You will remember last month, that I mentioned very briefly the optional reaction control. Occasionally when listening to amateurs you do come across some very faint signals which cannot be brought up to loud-

speaker strength. By connecting the negative side of the coil to the anode of the second detector, you can obtain a measure of reaction which will boost up signal strength.

This arrangement is not to be recommended for general use as it adds another control and sometimes makes the receiver a little unstable, but I do use it myself when listening on the amateur bands.

I haven't told you anything about the high-tension voltages. They are not really very important, but you must have a minimum of 120 volts on H.T. + 2 and about 60 to 80 volts on H.T. + 1.

LIST OF PARTS NEEDED FOR THE QUARTZ-CRYSTAL SUPER

CHASSIS	£ s. d.	HOLDERS, VALVE	£ s. d.	1—Pair Bulgin grid-bias battery clips, type No. 1	6
1—Peto-Scott aluminium, 16 in. by 10 in. by 3 in., with 16 in. by 8 in. panel	14 0	8—Chx. type chassis-mounting, without terminals, four-pin (7), five-pin	3 5	SWITCHES	
CHOKES, HIGH-FREQUENCY		RESISTANCES, FIXED		1—Bulgin on-off toggle, type S80	1 3
3—Eddystone screened, type 983 ...	11 3	14—Claude Lyons, type 1-watt, values: 5,000- (2), 10,000- (3), 25,000-, 50,000- (2), 100,000-ohm, 1- (4), 5-megohm	7 0	1—Bulgin three-point on-off toggle, type S87	1 9
1—Eddystone, type 948	2 9	RESISTANCES, VARIABLE		TRANSFORMERS, INTERMEDIATE-FREQUENCY	
COILS		1—Erie, 25,000-ohm	3 6	3—Eddystone 450-kilocycle, type 974	1 11 6
1—Set of five Eddystone six-pin, type 959 (12-510 metres)	1 10 6	SUNDRIES		TRANSFORMER, LOW-FREQUENCY	
1—Set of five B.T.S. four-pin oscillators (12-510 metres)	1 0 0	6 doz. ½-in. 6B.A. nuts and bolts say	2 0	1—Bulgin, type Senator	6 0
CONDENSERS, FIXED		6 doz. shake-proof washers, say	1 0	ACCESSORIES	
8—T.C.C. type tubular, values: .0001-, (2), .0005- (2), .005-, .006-, .01-microfarad (3)	10 0	1—Ohmic nine-way resistance strip, and crystal support	3 0	BATTERIES	
6—T.M.C. Hydra, type 25, values: 1- (5), 2-microfarad	14 3	1—Clix terminal strip, marked: A1, A2, E	7	2—Ever Ready 60-volt high-tension, type High-power 60	1 10 0
CONDENSERS, VARIABLE		1—Goltone five-way battery cord	1 3	1—Ever Ready 9-volt grid-bias	1 0
2—Eddystone .00016-microfarad, type 922	17 0	1—Igranite loud-speaker jack	1 3	1—Evide 2-volt accumulator, type CZ96	16 6
1—Eddystone .0001-microfarad, type 900	5 0	1—Igranite pick-up jack, type P74	1 9	LOUD-SPEAKER	
1—Eddystone .0002-microfarad, slow-motion reaction type	6 0	2—Bulgin plugs, type P15	3 0	1—Ferranti, type MST, cabinet model	3 10 0
CRYSTAL, QUARTZ		1—Eddystone six-pin coil base, type chassis-mounting	1 6	HEADPHONES	
1—Brookes 450-kilocycles with holder	1 10 0	3 ft. screened sleeving, say	9	1—Pair Brown A	2 10 0
DIALS, SLOW-MOTION		Oiled sleeving (Peto-Scott), say	1 6	VALVES	
2—Igranite, type micro-vernier	15 0	Round tinned copper wire, No. 20 gauge for connecting, say	1 0	3—Cossor 210VPT, metallised	2 0 6
		1—Bulgin signal lamp, type C19	1 3	2—Cossor 210SPT, metallised	1 7 6
		1—Bulgin 2-volt pilot bulb	6	1—Cossor 210Det, metallised	5 6
				1—Cossor 220PT	13 6

WHAT THEY THINK *of* WIRELESS



Five Radio Episodes by Jay Coote

YOU *must* have noticed it; when three or four listeners get together and discuss the radio programmes, within two minutes of the start of the conversation somebody mentions the Man in the Street. "Now, what the Man in the Street wants," he or she says, as the case may be, "is . . .", and then follows a description of some kind of entertainment specially appreciated by the speaker.

I have often wondered; who *is* the Man in the Street and what it is he *really* requires? Yesterday, to secure a reply to these questions, I grabbed at a fountain-pen, a notebook, my hat, a packet of cigarettes, slammed the front door and set forth in search of a solution.

EPISODE NUMBER ONE

SCENE: Road under repair. TIME: Midday. Three navvies sitting around a coke fire frying steaks.

1ST LABOURER: "D'jer listen on the wireless lars' night Bill?"

BILL: "Yus, chronic! The old woman was gitting my tea so I shoved on the set. Some bloke was talkin' abaht variations on a team by Andle."

3RD LABOURER: "Never 'eard of 'im. Which team is it?"

BILL: "T'wosn't no team at orl; 'e was gassin' abaht old music. After that a gel played the pianner for a spell but the toons was so slow I giv it up."

1ST LABOURER: "Shuv over that there steak, Bill, it's done by now."

(Bill digs his knife into the pieces of meat and hands both over to the speaker.)

3RD LABOURER: "You don't git the full benefit of your licence, Bill. If you don't like wot's on, there's the alter-alter-nation programme."

BILL: "Well, I tried that; I 'eard the man say 'The Magic Flute,' but I didn't 'ear no blinkin' flute."

1ST LABOURER *(to his neighbour)*: "Bill ain't moosical. *(To Bill.)* Wot is it you want any'ow?"

BILL: "I'll tell yer. They giv' yer the noos, don't they?"

CHORUS: "Yus, wor there is of it."

BILL: "And they giv' yer the winner of the three-thirty; don't they?"

CHORUS: "Yus, but . . ."

BILL: "Well, wot I wants to know is, why don't they giv' it to yer before the race; any bloomin' fool can tell you who won afterwards. Wot do we pay our ten bob for?"

1ST LABOURER: "I don't."

3RD LABOURER: "It's orl on account of these ere noospapers, the Press thungummy and copyright and wot not. Wot I sez is . . ."

FOREMAN *(suddenly appearing)*: "And wot I sez is . . ." *(the rest is deleted.—ED.)*

I left.

EPISODE NUMBER TWO

So far as I could see, old James Higgins—Blob-nosed Jim to his friends—with one shoulder was holding up his pet post outside *The Pig and Whistle*. In his mouth was an empty clay pipe at which he sucked steadily and noisily. In a friendly way, as I passed him, I nodded.

"Hot?" I said, just to break the ice so to speak.

"Wot?"

"'ot . . . I mean, hot?"

"Wot is?"

"The weather," I explained.



"Old James Higgins—Blob-nosed Jim to his friends—with one shoulder was holding up his favourite resort, 'The Pig and Whistle'."

"Ah, ruddy dry!" was the reply. I took out my notebook.

"Now, as a man of intelligence," I asked, "what do you think of the wireless programmes?"

He ignored my question, spat effusively, wiped his dirty forehead with the back of an even dirtier hand and countered with: "Wot's the time, guv'nor?"

I told him, whereupon he hitched up his belt and leant more firmly against the public-house lighting.

"Anuvver blinkin' ten minutes," he muttered; then, to me, "Wot was you a asking of, guv'nor?"

I repeated: "I should like to know what you think about—"

"Wot I things abaht? Wot I thinks abaht? Why, BEER!" and, as the potman opened the door, Jim Higgins rapidly disappeared within its portals.

No luck. I trudged on.

EPISODE NUMBER THREE

SCENE: Not in the street but in the "Tube" this time.

The only vacant seat was the one next to him, and I slid into it as the train started. He seemed strangely immersed in the weekly broadcast programme paper, and through his spectacles anxiously scanned the pages.

"Good programmes next week?" I enquired, tentatively. "I am also a radio enthusiast."

He looked at me over his glasses, only then realising that I was sharing the same seat.

"Piffle, sir!" he snapped. "Music, classical, chamber, wind, a lot of cacophony, sundry talks and



"My hobby is paleontology; I make an ardent study of this science"

discussions and not one on any subject of interest to me."

"But, surely," I interrupted, "they cover such a wide field that—"

"No, sir," he retaliated, "they do not cater for all sections of the community. I am a unit of it and I pay my licence. Am I considered?"

"My hobby is paleontology; I make an ardent study of this science. When, sir, may I ask you, have I ever been given the opportunity of hearing an authoritative discourse on the atlantosaurus, the diplodocus or on any of the herbivorous dinosaurs?" I staggered.

"Again, I would welcome for my annual contribution some enlightening facts anent the Cambrian trilobites or on the Devonian cephalopods. A few words regarding the hippotherium or the carboniferous echinoderms would awaken my interest in broadcasting. Have you ever heard the cotylosauria mentioned or any

allusion made to the mastodonosaurus or to the paleozoic crossopterygians? Why, sir . . ."

The train pulled up with a jerk and, my brain reeling, I stumbled on to the platform.

EPISODE NUMBER FOUR

SCENE: Another hole in the road. The "minder," a bleary-eyed old fossil of some seventy and umpteen odd winters was sitting outside his hut. In front, the usual blazing coke brazier.

When I stopped to get a light for my cigarette, he ceased stirring a cocoa-looking mixture in an old paint tin and looked up. I nodded.



"A bleary-eyed old fossil of some seventy and umpteen odd winters was sitting outside his hut"

"Lonely work, eh?" He mumbled some response but I could not hear it.

"A fine night." I started all over again.

"Eh?" He leant forward with one hand to his ear.

"A fine night," I repeated; anything to induce him to talk.

"Ah!" he answered. He picked up a glowing cinder and threw it back into the fire. Apparently conversation was not his strong point.

A peal of bells rang out from a neighbouring church; a peal of bells of which, for some reason, the residents are inordinately proud. Perhaps. . . I leant towards him.

"A fine set of bells," I shouted, "worth listening to."

"What's that?" he retorted. "Speak up."

"Very fine bells," I repeated in an even louder tone.

"Fine what?" he shrieked. "'ow d'yer expec' me to 'ear wot you sye wiv all the rah from those ruddy bells."

However, he was a Man in the Street. He made room on the small bench and I sat down beside him. I tendered my cigarette case.

"Lonely work this, isn't it?" Another start.

"Not so dusty. Might be wuss. I've bin a night watchman come fifteen year now and I don't 'anker after any company yet."

"What you want," I continued, "is something to cheer you up. Now, what about wireless?"

"Wot abaht wot?" Again he cupped his ear with his hand.

"Wireless," I reiterated. "You could listen to—er—things until midnight every day. It would kill time. Music and—er—things, you know." A pause.

"Who wants ter?" was the reply.

"Well," I explained. "Supposing I gave you a crystal set to put up here, with your headphones you could—"

"Me?" he interrupted savagely. "I'm a night watchman, I am. 'Ow d'yer think I could sleep with them things around my ears? Bad enough as it is now



"We shall say one pound. Please pack it up"

with orl them 'eavy lorries coming along the road and shaking yer to bits w'en yer trying ter git a rest. Wireless, pah!"

I left him muttering to himself; two words I caught sounded like "blinkin' idjits," but I may have been mistaken.

FINAL EPISODE

The young couple corkscrewed their way out of the baby saloon as it drew up to the pavement outside a radio shop. She made straight for the entrance; he followed. So did I. If necessary I could always buy a cat's-whisker or some trivial, inexpensive but equally obsolete gadget.

SHE (to assistant): "My husband and I have decided to take that wireless set you showed us yesterday."

HE: "You mean, dear, that he showed you."

SHE: "Yes, darling, but don't interrupt, it's the same thing, isn't it?"

ASSISTANT: "Certainly, Madam." (He slid the instrument along the counter.)

SHE (to Husband): "Isn't it a beauty, George? And look at the case; it just matches Aunt Jane's cabinet, doesn't it?"

HE: "Yes dear, al-most."

SHE (to Assistant): "And it does work well and after all you said about it yesterday you can guarantee it, of course?"

ASSISTANT (inwardly doubtful but outwardly emphatic): "Quate, Madam, quate, in every way."

SHE (beaming): "Oh, George, won't it be lovely! Just think of it! We can have it on all the evening and all day when I'm working. And, I can get all my cooking recipes from it." (He shudders.) "And, just think . . ."

HE: "Ye-es, darling. It's your birthday, so, of course, you must. . . ."

(In the meantime, his eyes have rested on a much cheaper-looking instrument stuck away on a shelf.)

HE (to Assistant, while his wife is closely examining the new toy): "What's that one over there, in the corner?"

ASSISTANT (truly doubtful): "Oh, that—er . . . I couldn't recommend you to buy it, sir, it's—in fact (confidentially) it's one we took in part exchange."

(Leaning across counter, sotto voce): "It doesn't work, you see."

HE (making sure his wife cannot hear, in an equally hushed voice): "How much?"

ASSISTANT (aghast): "I beg your pardon?"

HE (insistent): "How much?"

ASSISTANT: "Oh . . . shall we say one pound, but it doesn't work, sir."

HE (in decided tones): "We shall say one pound. Please pack it up."

ASSISTANT: "But I'm afraid it's useless, sir."

HE: "Useless? Nonsense. At least with it we can cut out the Sunday programme. That'll make it a day of rest, anyway."

ASSISTANT (somewhat taken aback but recovering smartly, to me): "And what can I do for you, sir?"

"Oh, nothing," I replied. "I've got what I want, thank you," and I walked out of the shop. I had, you see, solved the problem. What the Man in the Street wants is a dumb receiver on Sundays!

What Readers Say About "W.M." Sets

ALL-WAVE THREE (January, 1934)

Kensington (London, W.14).—On an outward passage to New Zealand I built the All-Wave Three. To date I have had 127 stations. In New Zealand I heard all the Australian stations on medium waves. On short waves the best station was Pontoise; Daventry was poor, but Zeesen was strong.

I have made one or two slight alterations to the original design. I have raised the detector valve, high-frequency choke and condenser $\frac{1}{2}$ in. from the baseboard. I have also put a .0001-microfarad fixed condenser in series with the tuning condenser. With this in circuit dozens of short-wave stations come in that could not be found with the ordinary tuning.

LUCERNE BATTERY SUPER (March, 1934)

Knowle (Warwickshire).—On returning from abroad early in the summer I built your Lucerne Battery Super.

I am more than pleased with the results. As to selectivity, I consider the fact that I can receive Deutschlandsender entirely free from the new Droitwich station—although I live only seven miles from the latter—speaks for itself. Sensitivity is, of course, all that can be desired, and the tone with a Baker energised loud-speaker has been admired by all who have heard the set.

SEVENTY-SEVEN SUPER (December, 1932)

Plympton (Devon).—I am writing to convey my appreciation of the Seventy-Seven Super. I am enclosing a photograph of the set and also a complete log of stations. I hope it is not too late for me to praise this set, as I am sure it is still up to modern standards of design, although it is a two-year-old. (The log referred to in this letter contains fourteen long-wave and forty-five medium-wave stations.—Ed.)

ARGENTINE REPUBLIC

ALTHOUGH this country operates a number of stations, the majority are of less than 1 kilowatt in power.

Buenos Aires owns eighteen transmitters and of these several have recently considerably increased their energy. The best heard on this side of the Atlantic are LS2, Radio Prieto, 20 kilowatts, 252.1 metres; LR4, Radio Splendid, 16 kilowatts, 303 metres; LR3, Radio Nacional 13.9 kilowatts, 315.8 metres; LR2, Radio Argentina, 9.6 kilowatts, 329.7 metres; LR6, La Nacion, 37 kilowatts, 344.8 metres, and LR5, Radio Excelsior, 20 kilowatts, 361.4 metres.



Gulliland photo

A view of the Zeesen station, near Berlin, which houses the long-wave and twin short-wave transmitting plant. One of the masts of the long-wave transmitter is seen on the right of the building

ON THE CREST OF THE WAVES

Radio News From All the World :: By JAY COOTE

Most of these studios broadcast entertainment suited to the Spanish, French and English speaking communities and consequently make announcements in these three languages. The stations are on the air from G.M.T. 2100 to 0330 or 0400 daily.

CANADA

In view of improving conditions for DX listening note should be made of the fact that some alterations have been made in the wavelengths of Canadian stations, namely, CKLW, Windsor (Ont.), 291.1 metres; CRCT, Toronto, 356.9 metres and CKY, Winnipeg, 312 metres.

Broadcasts from these stations last winter were as easily picked up as those from the higher powered and better known transmitters in the United States.

CZECHOSLOVAKIA

In addition to its usual interval signal, Prague and the other Czech stations broadcast regularly before the time signal a tuning note which represents the normal A of the musical scale. This has been done

to permit musicians to tune their instruments.

FRANCE

Although one hears little about the new State transmitters which the French Government is putting up in provincial cities, we may expect to hear tests from at least five or six of them by the end of this year. Nice, Lyons, Toulouse, Marseilles and the high-power Ecole Superieure station near Paris are rapidly nearing completion.

Rennes, for which a powerful station is being constructed at Thouries, may have to wait another twelve months, but in the meantime the station now working will have its output increased to 40 kilowatts.

In view of interference suffered from both Poste Parisien and West Regional, P.T.T. Grenoble has abandoned the 968-kilocycle frequency and now transmits on 514.6 metres (583 kilocycles), a wavelength allotted to Madona and since taken over by Riga (Latvia).

The presence of the French station in that position, however, may mar the Vienna broadcasts.

HOLLAND

Since its introduction in Holland, the broadcasting service has always been a free one to listeners and the transmitters have been financed by voluntary donations only. The question of a tax, however, is now being discussed in the Dutch Parliament, and it is anticipated that with a view to a better service the authorities may require the registration of all wireless apparatus and the payment by owners of receivers of an annual licence fee.

There is a strong feeling that if an income can be derived from this source, assistance would be obtained from the State for the erection of two super-power stations.

In the meantime, the Dutch Government proposes to increase the power of Kootwijk from 60 to 100—120 kilowatts.

ITALY

In addition to the proposed 50-kilowatt station which the E.I.A.R. has decided to erect at Bologna as a tribute to the birthplace of Marchese Marconi, the power of the Rome (Santa Palomba) medium-wave transmitter is to be increased to 120 kilowatts. Further, with a view to an alternative programme, another station is also to be erected near the capital.

Bolzano, in the Tyrol, which so far has only possessed a short range, is to be endowed with a 10-kilowatt plant and will then be definitely linked up with the North Italian group of broadcasters.

How To Start Television

Television is now possible with your ordinary wireless receiver and the simplest of apparatus, as this article explains

QUESTIONS asked by the public at Radiolympia regarding television showed that comparatively few people—probably less than 5 per cent.—had any idea of the requirements to take up this fascinating addition to ordinary broadcast reception. With most the idea prevailed that apparatus which was worth while was extremely costly and complicated. Even though they had some knowledge of the simple disc machine, very few had seen pictures produced by this type of apparatus and there seemed to be the general opinion that results were extremely indifferent.

Photographic Reproduction

Some of these ideas have been formed as the result of seeing published photographs of televised images. Actually, there has never been a photograph published, or even taken, that has done justice to a received television picture and expert photographers admit that there is no more difficult subject to reproduce photographically. There are many reasons for this, the principle one being that the picture is in motion, and as it is made up of a quickly travelling spot of light, it is impossible to give a very short exposure. Movement in the picture is a very important asset and does a great deal to reduce the theoretical imperfections which admittedly exist. A correct idea of a televised picture cannot be obtained from a photograph.

The very simplicity of the disc receiver puts many people off, but actually, in some respects, it is the most efficient type of apparatus so far produced; as a matter of fact the principle is being used at the transmitting end for the high-definition systems which are now being developed. Its disadvantages are that the picture is somewhat small and the use of a lens to magnify the image makes it difficult for more than a couple of persons to view it in comfort at the same time. A recent development, how-

ever, has made it possible to project a picture from this type of apparatus upon a screen and obtain an image about 4 in. by 2½ in., which can be comfortably viewed by a number of people. The requirement for this is a compara-

accompanying sound, and this, of course, is desirable, as it lends realism and increased interest.

Provided that your wireless receiver will receive the London National programmes at good loud-speaker strength, it can be assumed

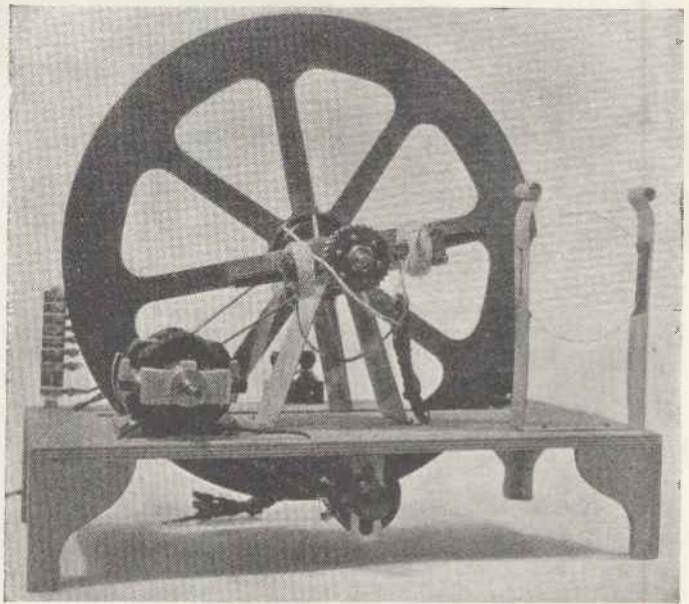

An indirectly-driven low-priced disc machine which is available in kit form —The B.T.S.

tively simple unit, which can be added to any disc receiver.

The disc apparatus provides a very cheap and simple introduction to home television, for the only requirements are the motor-driven disc, a neon lamp, and your own wireless receiver. This combination will not give both vision and sound;

that it will be suitable for operating the neon of the disc machine. A slight modification may be necessary in order to obtain an increased H.T. supply, but in nearly every case this can be done without interfering with the internal wiring of the set. A.C. mains supply is desirable, though television reception is by no means beyond the scope of the battery-operated set. Naturally, there is the current necessary to drive the motor to be considered, but 6-volt motors suitable for battery working are available for the purpose.

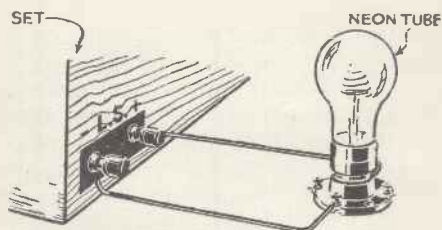

Providing that the high-tension is sufficient the lamp can be connected directly to the set

an additional wireless receiver will be required if you wish to have the

built for as little as fifty shillings and the only other expense may

be the provision of a little extra high tension. Complete kits ready for home assembly may be had for a little more than this figure.

Simple Operation

The veriest novice can operate a disc machine; the only difficulty is in maintaining the motor at the correct speed and this can soon be accomplished with a little practice.

the most usual being shown here. One, it will be observed, adds to the voltage on the last valve and the other merely increases the voltage applied to the neon lamp. Either is quite simple to arrange with practically any receiver.

Now supposing that the lamp is caused to glow. The motor can be connected to the mains supply and set running.

On looking through the lens it will be seen that a screen of light is produced, divided into a series of thirty fine lines. When no transmission is being received, this field of light will appear practically even; but if a station is tuned in a constantly varying pattern will be seen, caused by the light of the lamp being modulated by the received impulses.

This state of affairs indicates that the apparatus is in order to receive the televised pictures.

number of revolutions is the most difficult part of the whole business, but it is greatly facilitated by having a small neon lamp, which is lighted from 50-cycle A.C. mains placed so that the light from it falls on the eight spokes of the disc. When the speed is correct, these appear to stand still. There are other indications of the correct speed. For instance, when the speed is too low black bands appear which seem to be travelling towards the right-hand bottom corner, and the reverse if the speed is too great.

Speed Control

If the machine is not fitted with synchronising gear (and most disc receivers are not), then the simplest method of control, once the approximate speed has been obtained by means of the variable resistance, is by light friction on the motor spindle. The response is quicker by this means than when adjustments are made to the electrical control.

Simple After Experience

Once the picture has been secured, it will be found quite a simple matter to get results on future occasions, and it will be

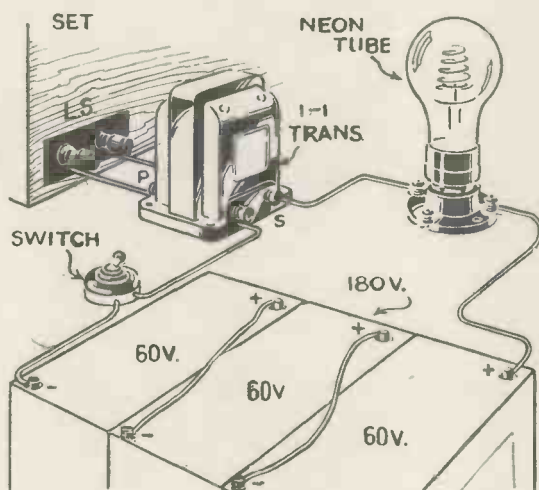

Method of using a separate source of H.T. for the neon

The rest is simply a matter of feeding the output, which would ordinarily go to the loud-speaker, to the neon lamp, and arranging that the H.T. voltage is sufficient; once this is arrived at, then there is no further trouble.

Adding to High-tension

Assume that you have either built or purchased a disc receiver and that you intend operating it from your ordinary wireless set. The first thing to do is to disconnect the loud-speaker and connect the speaker leads to the neon lamp terminals. When the set is switched on, irrespective of whether a programme is being received, the lamp may light up with the familiar red glow. If it does not, then it may be assumed that the high-tension voltage is insufficient. Actually, this should be round about 185 volts, so some idea may be formed of how much extra high-tension voltage is required to that which is being used.

There are several ways of adding to the existing high tension, two of

About twenty minutes before a transmission is due to commence the motor should be started in order that it can warm up and settle down to a steady speed; then a short time after London National should be tuned in on the loud-speaker and when this has been obtained at its loudest (without the use of much reaction) the speaker leads should be transferred to the neon lamp and the start of the programme awaited.

When the vision transmissions commence it is probable that the screen will be seen to be covered with flying splashes of light which have no resemblance to a picture, a state of affairs which indicates that the speed of the disc is either too fast or too slow. Maintaining the speed of the disc at the correct

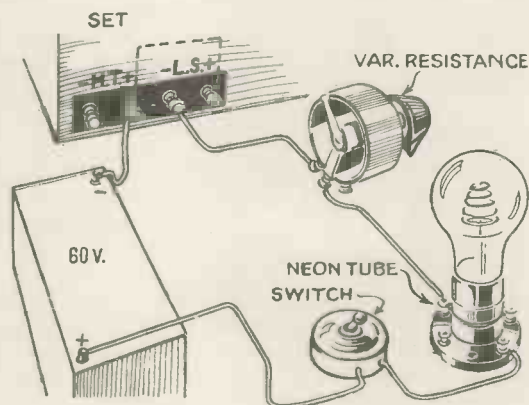

This diagram shows a simple method of adding to the H.T. voltage of the receiver

appreciated how simple the whole matter really is after a little experience has been gained.

A great deal can be learnt from the simple disc machine, for it employs all the main principles which are used in more elaborate apparatus, and it will be found to provide an excellent introduction to television, with but trifling expenditure.

Cathode-ray Television Simply Explained

THE principal feature of cathode-ray television is that there are no moving parts which have weight. The only mechanical movement is that of a weightless beam of electrons which may be likened to a jet of water which, as it is projected against a wall, is moved about and so caused to trace a pattern.

Actually, therefore, the picture

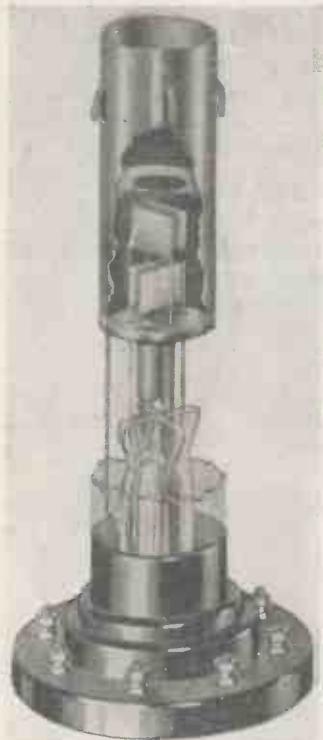

Fig. 1. A cut-away view of the bottom of a cathode-ray tube showing the electrodes

is produced by causing a beam of electrons to strike a special chemically coated surface of a type which will fluoresce under the impact, the beam being moved about so that a pattern is produced.

Variation of the intensity of the beam and its resultant effect on the coated screen is the usual method of producing the light and shade of the picture, but there is also another way in which the

speed of travel of the beam from instant to instant is varied; if the beam passes over a certain area in a very small space of time then the effect on the eye is a reduction of light and vice versa.

As the beam of electrons is weightless it possesses no inertia and therefore it can be moved at practically any speed and be stopped and started in the most minute fraction of a second. In television high speeds are absolutely essential, and it is this feature which gives the cathode-ray system so much promise.

One of its principal disadvantages is that it is difficult to make cathode-ray tubes of a greater diameter than about ten inches, and this restricts the size of the picture.

What the Cathode-ray Tube is

In many respects the cathode-ray tube is similar to an ordinary power valve. Like the valve, the tube has a cathode and anode, but the place of the grid is taken by a cylinder (see Fig. 1) which is placed around the cathode and is negatively biased. The purpose of this cylinder is to compress the electron beam into a fine pencil so that it can pass through a hole in the centre of the anode which is in the form of a circular metal plate.

The variation of the intensity of the stream of electrons is brought about by the value of the voltage on the anode. Increased voltage will allow more electrons to pass and so produce a brighter spot on the screen.

The method by which the movement of the beam is controlled will best be understood if it is remembered that to all intents and purposes it is a conductor carrying a current and therefore it can be deflected by a magnetic field in its vicinity. So sensitive is it, in fact, that it can be deflected by the magnetic field of the earth and it is usually necessary to compensate for this when operating the tube.

The means employed in the tube to produce the deflection are two pairs of metal plates, one pair being mounted at right angles to the other pair, and it will be understood that as the beam is a collection of negatively charged particles these will be attracted by a positively charged plate and repelled by one that is negatively charged.

Under ordinary conditions, that is, without any potential being applied to the plates, the beam will pass up between them centrally, but as soon as a potential is applied it will be deflected.

It will be clear that the resultant effect of potentials applied to the two pairs of plates will enable the beam of electrons to be moved so that it can be caused to impinge on any part of the screen at the end of the tube.

Furthermore, as the beam is weightless it can be moved at incredible speeds and therefore

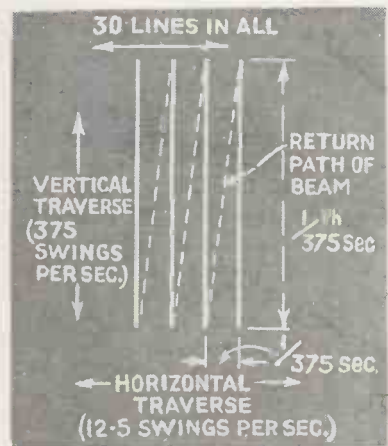

Fig. 2. How the screen on the cathode-ray tube is built up by the movement of the beam in two directions

owing to persistence of vision effects the spot will leave a trace on the screen which will appear as a pattern.

Most people are now aware that a television picture, whether the system used be mechanical or purely electrical, is produced by

causing a spot of light to travel in a series of straight lines up, down, or across a screen and varying the intensity of this spot in the course of its travel.

In order that the image on the screen may appear practically flickerless, this spot must cover the whole of the screen in a minimum time of a twelfth part of a second, or in other words the screen must be covered or scanned twelve times in one second. Actually in the case of the B.B.C. 30-line transmissions the screen is covered twelve and a half times in a second but it will be appreciated that higher frequencies, such as twenty-five times per second, are desirable in order to produce flickerless pictures.

The first requisite then is to cause the light spot to travel over the screen in a succession of lines. The most convenient way of doing this is to make the beam describe a saw-tooth path, that is, a straight vertical travel and then make the return journey at an angle so that

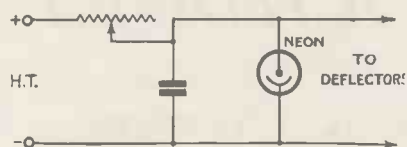

Fig. 3. A simple time-base circuit using a neon lamp

it finishes at the point where the next line must commence, as shown in Fig. 2.

The Pattern on the Screen

The trace in this case would be a compressed zig-zag, but obviously it is only the vertical lines which are required to be seen, so this difficulty is overcome by making the beam complete its return journey at such a speed that it is not visible. The result to the eye is a series of parallel lines of light, the number depending upon the degree of definition that is desired and which, of course, must correspond to that of the transmitter.

Clearly, then, if such a screen is produced it is only necessary to cause the intensity of the light spot to vary in the correct degree and at the correct instant of time to produce a picture.

In order to produce such a screen on the end of the cathode-

ray tube it is obvious that we must have some means of applying potentials to the deflecting plate of the tube at exactly the correct instants of time—one to cause the vertical movements and the other the shifting of the light spot in a horizontal direction at the conclusion of the travel of the vertical direction.

In the case of 30-line television with a picture frequency of $12\frac{1}{2}$ a second each new line must commence at every succeeding $\frac{1}{375}$ part of a second, and the problem therefore is the application of suitably timed potentials to the deflector plates of the tube.

A simple way of causing the time deflection of the beam is shown by Fig. 3. A small condenser is connected to a high-tension supply in series with a variable resistance, and in parallel with the condenser is a neon lamp. The condenser is charged from the high-tension supply at a rate depending upon the value of the resistance and its own capacity.

When the voltage of the condenser has risen to a certain value it discharges through the neon, which has a critical striking voltage. The condenser voltage will then fall below that of the extinguishing voltage of the neon and the latter will go out and the sequence start again.

As stated before, the speed at which this will take place will depend upon the values of resistance and condenser, and it can be suitably arranged.

In practice the neon lamp is found to have certain defects, for this purpose, and it is customary to employ a mercury relay valve in its place, and also to substitute a saturated diode for the resistance, the arrangement being as shown in Fig. 4. The advantage of using a saturated diode is that the current remains constant over a wide range of anode voltage, which means that the charging current will not vary with change of condenser voltage and therefore the condenser will charge at a perfectly uniform rate. The result, of course, is a more uniform movement of the beam.

The objections to the use of a neon lamp are that the difference between the striking and extinguishing voltages is very small, and

also that the curve of condenser voltage between this small range is not straight; so it is found better to use a mercury-relay or Thyatron, as it is called, in its place.

The mercury relay looks like a valve, but the bulb contains mercury vapour. When the grid is suitably biased and the cathode is switched on nothing happens until the anode voltage is raised to a certain value, when the valve

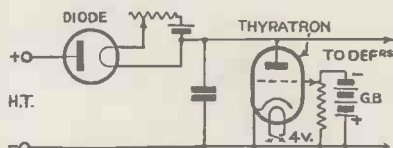

Fig. 4. In this time-base circuit the Neon is replaced by a Thyatron

blue glows and the grid will lose all control.

The Thyatron

The Thyatron therefore fulfils the same purpose as the neon, but the range between extinguishing and striking voltage is much greater, in fact, it may amount to as much as 160 volts.

Reception Requirements

In conclusion, it will perhaps be helpful briefly to review the requirements of cathode-ray television reception. Firstly, of course, there is the cathode-ray tube itself. Secondly, there is the necessity of supplying the filament with suitable current.

The voltage required is two, and it is usual to use a two-volt accumulator. Thirdly, there is high-tension for the tube, and this approximates 900 volts, but as the current requirements are very small quite small high-tension batteries can be used, or alternatively high-tension can be from the mains.

Finally, there are the two time bases, one for causing the vertical movement of the beam, and the other for the horizontal; each time base, of course, contains a diode and mercury relay, and except for component values are practically the same. Naturally, a wireless receiver is required, but the input energy necessary for the operation of the cathode-ray tube is quite small, and at reasonable distances a high-frequency and detector will answer quite well.



Gulliland photo
Early morning gymnastics at a Berlin school
to the tune of a radio set

Radiogram for Schools

By Captain E. H. ROBINSON

Here we present a brief outline of a reliable and well-tested radio gramophone for use in schools or similar institutions. The circuit embodies a straightforward three-valve arrangement and makes use of a 10-watt output pentode. A list of suggested parts will be found at the bottom of page 346

CONDITIONS under which a wireless receiver or gramophone amplifier are required to work in a school or other public institution differ considerably from those of the average home. Usually reception is not required from stations other than the local or national transmitters.

Necessary Requirements for Schools

Power must be considerably in excess of anything likely to be required in domestic use, and must be capable of considerable variation as the apparatus may have to be used in either a small classroom or a large hall.

It goes without saying that quality must be above reproach and speech, particularly, must be clean cut with all available high frequencies and no suspicion of boominess. The apparatus must be easy to operate and substantially built to avoid any likelihood of breakdown.

In the instrument now to be described, adequate selectivity for all ordinary circumstances is provided by the use of a band-pass arrangement and a tuned-grid circuit, all with iron-core coils.

These coils, in association with a high-frequency variable- μ pentode, provide a high degree of amplification of the incoming signal and diode rectification prevents any detector distortion.

Quality at any Volume Level

An output up to 10 watts of undistorted power is available if required; but the two volume controls provide that quite low sound intensities can be used without any deterioration of quality.

Within about fifty miles of a Regional station, or about 200 or more miles of the new Droitwich transmitter, the output valve can be fully loaded if an outdoor aerial about 60 ft. long is used. For classroom work an indoor aerial can be used and quite sufficient sound energy is then available for a large room.

An ordinary 30 ft. indoor aerial gives more than sufficient input energy at distances up to forty miles from Brookmans Park. A pleasing characteristic is the complete absence of hum. The gramophone amplifier can be used, if required, without any earth connection.

Points About the Circuit

The current consumption on the high-tension side is about 90 milliamperes. The output valve requires an anode voltage of about 400. These values govern the mains apparatus and a transformer delivering 425-0-425 volts to the rectifying valve is adequate.

To prevent excessive voltages across condensers and resistances while the indirectly-heated valves are warming up and, particularly, to ensure that there will not be an excessive voltage on the directly-heated output valve, an indirectly-heated rectifier, the Osram MU14 is used.

Consideration of the characteristic curves of this valve show that when working across a 4-microfarad condenser and fed from a 425-0-425 volts secondary, the voltage

available after rectification will be about 475 volts D.C. when the load is 90 milliamperes.

The first smoothing choke has a resistance of 320 ohms and 27 volts will therefore be dropped across it.

24 volts are absorbed in the bias resistance of the output valve which gives us 424 volts for the anode of this valve. Some volts will be deleted by the voltage drop across the primary of the output transformer, and as the current of the pentode valve is governed by the voltage on the screen we have got our voltages quite in order.

Getting the Right Voltages

The screen, which takes about 10 milliamperes, is fed from the 436-volt line through a 30,000-ohm resistance. This is rated at 10 watts for safety's sake, though 5 watts would be adequate. The screen is tied to earth through a 1-microfarad condenser.

The first two valves require 200 volts on their anodes. A few volts are dropped in the 40-henry choke; CH₂ in the diagram. The anode of the double-diode-triode valve is taken care of by a 30,000-ohm de-coupling resistance and a 30,000-ohm anode resistance. For the high-frequency pentode a separate voltage-dropping resistance of 30,000 ohms, rated at 10 watts, is used giving the 200-volt line for the first valve, which is the voltage specified by the makers.

Portability an Essential Feature

An instrument of this kind must be reasonably portable, and any large cabinet of the type usually associated with a radio gramophone is out of the question. As a microphone can be connected to the pick-up terminals and used for making announcements at sports and other functions, the loud-speaker should certainly be an entirely separate unit so that it can be put in the most convenient position.

The best arrangement is probably to build the mains unit separate from the set proper, connecting them with a two-line cable connected to non-reversible plugs, so that the positive and negative high-tension leads cannot be crossed. The filament heating leads can be connected by a four-line cable plugged into valve holders.

The radio-frequency side is inherently stable and only ordinary care is necessary in layout and con-

struction. Variable condenser, coils and valves are the only components which need appear on top of the chassis. All other components and all wiring is carried out beneath the baseboard.

Any good loud-speaker that will handle a large output can be used with the radiogram. When made up, as suggested, as three separate units the loud-speaker can, if desired, be of the permanent-magnet type. This gets over the difficulty of exciting the field



Photopress photo

BUILT BY THE SCHOLARS
This radiogram outfit, in use at a Wanstead, Essex, school was built by the boys under the supervision of the science and woodwork masters

out of doors or when it is used in a large hall at some distance from the set.

Though the radio side was designed particularly for daylight use, the set has been in operation constantly at night to bring in London National and Regional at a distance of over forty miles away. There has been little trace of interference.

A list of suggested components for an outfit of this kind will be found at the foot of page 346.

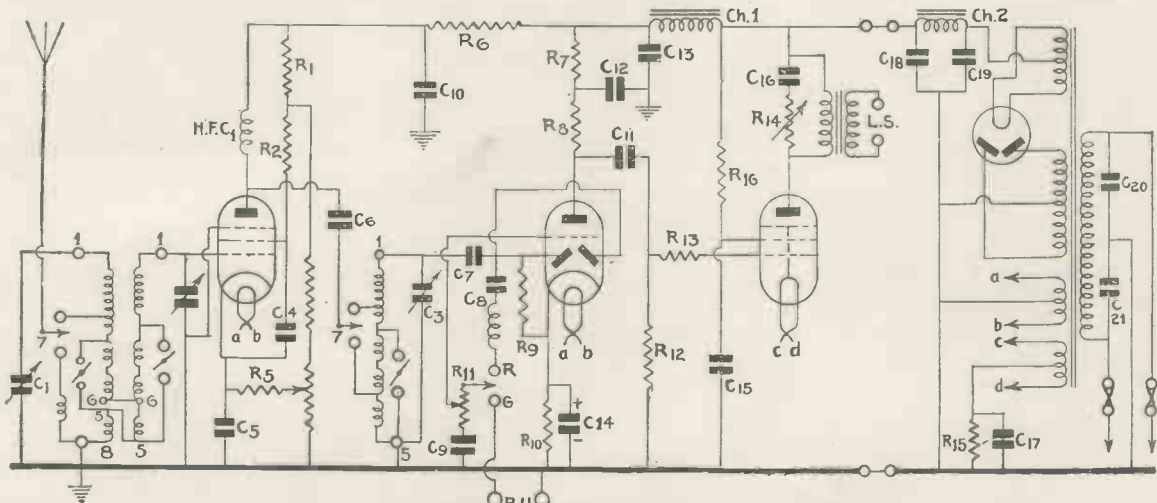

CIRCUIT OF CAPTAIN ROBINSON'S SCHOOL RADIO GRAMPHONE

A straightforward circuit is used by the author for his special school radiogram. Three valves are used: a variable- μ high-frequency pentode, double-diode-triode and output pentode with a valve for mains rectification. Good selectivity is assured by the use of a band-pass input circuit using iron-core coils

Mobile Radio at British Airports



Marconi photo

AIRCRAFT TRANSMITTER IN A LORRY!

One of the new Marconi installations consisting of transmitter, receiver and direction-finder, which is being installed at British airports, undergoing tests in its "lorry" home

A REMINDER of the progress that has been made by the Air Ministry in equipping new civil airports with efficient wireless apparatus was demonstrated quite recently when Lord Londonderry opened the new airport at Newtownards, near the famous race track, close to Belfast.

Lord Londonderry made his speech in an aeroplane flying over the aerodrome. It was transmitted by radio, picked up at the aerodrome and relayed to the crowds by means of loud-speakers.

Belfast, like Heston, Portsmouth, Lympne, Pulham and Manchester, just to mention a few, has up-to-date equipment consisting of Marconi transmitters suitable for either telephone or telegraph operation, besides

receiving and direction-finding gear of the latest type.

An important point to note is that all this gear, together with the necessary running machinery to provide current and with all switchboards and batteries, can be accommodated in special motor lorries or trailers to facilitate rapid transport from one airport to another.

Civil aviation in this country is developing very rapidly and the airports which need these up-to-date installations have yet to be finally determined.

In the illustration is seen one of the motor trailers fitted up with Marconi transmitting and receiving apparatus of the type now being used at Belfast, Hull and Portsmouth aerodromes. It is important to remember that under normal conditions the gear is taken out of the trailer when in permanent use.

The transmitter shown at the far end of the trailer has a rated power of 500 watts. It is specially suitable for aerodrome work as it is arranged so that the operator can quickly change from one wavelength to another.

To Cope with All Kinds of Work

The modern aircraft transmitter has to be designed to cope with all kinds of work and to operate on many wavelengths. Among some of the duties that may be mentioned are telephone and telegraph (morse) communication with 'planes in flight, contact with other aerodromes for the exchange of traffic information, the regular transmission of weather reports besides direction-finding aid to 'planes in flight.

Direction-finders at the coast aerodromes of Hull, Portsmouth and Belfast can be used for general reception and for direction-finding by the Bellini-Tosi system.

Control of these aircraft stations together with those at Croydon, Heston, Lympne, Pulham and Manchester are under the control of the Air Ministry. S. T. P.

RECOMMENDED PARTS FOR A SCHOOL RADIO GRAMOPHONE (See page 344)

CHOKES, HIGH-FREQUENCY

RFC1 1—Wearite, type HFPA.
RFC2 1—Wearite, type HFPA.

CHOKES, LOW-FREQUENCY

CH1 1—Parmeko, 40-henry, 40-milli-ampere.
CH2 1—Parmeko 20-henry, 120-milli-ampere.

COILS

1—Set of Colvern Ferrocart, Nos. 1, 2 and 4.

CONDENSERS, FIXED

C4 1—.25-microfarad non-inductive (T.C.C. or Telsen).
C5 1—.1-microfarad non-inductive (T.C.C. or Telsen).
C6 1—.0005-microfarad (T.C.C. or Dubilier).
C7 1—.0001-microfarad (T.C.C. or Dubilier).
C8 1—.1-microfarad non-inductive (T.C.C. or Telsen).
C9 1—.02-microfarad non-inductive (T.C.C. or Telsen).
C10 1—.4-microfarad, 250-volt working (T.C.C. or Dubilier).
C11 1—.1-microfarad mica type (T.C.C. or Dubilier).
C12 1—.2-microfarad 800-volt working (T.C.C. or Dubilier).
C13 1—.4-microfarad, 800-volt working (T.C.C. or Dubilier).
C14 1—.10-microfarad, 50-volt working (Dubilier, type 410).
C15 1—.1-microfarad, 250-volt working (T.C.C. or Dubilier).
C16 1—.01-microfarad (T.C.C. or Dubilier).
C17 1—.50-microfarad dry electrolytic, 50-volt working (T.C.C.).

C18 1—.8-microfarad, 800-volt working (T.C.C. or Dubilier).

C19 1—.4-microfarad, 800-volt working (T.C.C. or Dubilier).

C20 and C21 1—.01±.01 750-volt working (T.C.C. or Dubilier).

CONDENSERS, VARIABLE

C1, 2 and 3 1—Midget-type .0005-microfarad, three-gang (British Radiophone or Utility).

HOLDERS, VALVE

1—Four-pin, baseboard mounting (W.B. or Formo).
1—Five-pin, chassis-mounting (Clix).
2—Seven-pin chassis-mounting (Clix).

FUSE

1—Combined twin fuseholder and mains connector (Bulgin, type F15).

PLUGS AND SOCKETS

2—Bulgin four-pin valve holders with plugs, type P (for heater-wire connections).
4—Terminals, marked Aerial, Earth, Pick-up (2) (Clix or Ealex).
2—Bulgin non-reversible small mains plugs and sockets, type P21.

RESISTANCES, FIXED

R1 1—20,000-ohm 1-watt type (Erie).
R2 1—600-ohm 1-watt type (Erie).
R3 1—25,000-ohm 1-watt type (Erie).
R5 1—300-ohm 1-watt type (Erie).
R6 1—30,000-ohm 10-watt type (Dubilier Spirohms).
R7 1—30,000-ohm 1-watt type (Erie).
R8 1—30,000-ohm 1-watt type (Erie).
R9 1—5-megohm grid lead (Erie).
R10 1—1,000-ohm 1-watt type (Erie).
R12 1—100,000-ohm 1-watt type (Erie).

R13 1—10,000-ohm 1-watt type (Erie).

R15 1—330-ohm (4-watt), 100-ohm and 500-ohm (2-watt type) in parallel (Erie).

R16 1—30,000-ohm 10-watt type (Dubilier Spirohms).

RESISTANCES, VARIABLE

R4 1—5,000-ohm potentiometer (Erie or Centralab).

R11 1—Centralab, type M500, .5 megohm.

R14 1—50,000-ohm (Erie or Centralab).

SUNDRIES

1—Metal or metal-covered wood chassis, 15 in. by 10 in. by 3 in. for set chassis and baseboard 15 in. by 10 in. for mains unit (Peto Scott).
1—Piece of finished plywood for panel 15 in. by 9 in. (Peto Scott).
Length of red and black twisted flex.
Lengths of 20-gauge round tinned copper wire for connecting with oiled sleeving.
1—Eight-way battery-connection lead (connected in pairs to make four leads for filament-heater connections).
1 yard of screened sleeving.

TRANSFORMER, MAINS

1—Parmeko with the following windings:
425-0-425 volts, 100 milliamperes;
4 volts, 2.5 amperes; 4 volts, 2 amperes;
4 volts, 2 amperes.

ACCESSORIES

LOUD-SPEAKER

1—Celestion dual, type S20.

VALVES

1—VMP4 (Marconi or Osram).
1—MHD1 (Marconi or Osram).
1—PT25 (Marconi or Osram).
1—MU14 (Marconi or Osram).

Visual Indicators for Better Tuning

Here we present an informative article by MORTON BARR on the various systems that can be used for visual indication of tuning. The article covers a wide field and explains in a very simple and practical manner how these various systems work

WHEN a set is fitted with automatic volume control (A.V.C.) the ordinary method of tuning-in to a station—by listening for the peak of sound—can no longer be relied upon to produce the best results.

Purpose of A.V.C.

The purpose of A.V.C. is to prevent fading, that is, it keeps the loud-speaker output at constant volume—for a given setting of the tuning dial—irrespective of changes in the strength of the voltage picked up by the aerial.

So long, therefore, as the “control” is working properly, it acts automatically to wipe out the rise and fall in signal strength which is heard on a non-A.V.C. set as the dial is moved slowly past the tuning point.

Difficult to Judge

In other words, the audible responses of the set follows a flat-topped instead of a peaked curve. This makes it difficult to judge by ear alone whether one is at the critical point of resonance—or some way above or below it.

For high-quality reproduction it is essential to have the high-frequency circuits dead on tune, otherwise there will be a certain amount of sideband loss and consequent distortion in the low-frequency stages. After some practice, one can learn to overcome this difficulty, but a visual indicator makes it easy for unskilled members of the family to get the best out of the set at all times.

Even when there is no automatic volume control, visual tuning is well worth while, because it serves as

a useful check on the ear. Unless a set is operated under proper conditions it does not get a fair chance so far as quality of reproduction is concerned.

The various kinds of light tuners now being used with A.V.C. all depend on the fact that when the circuits are correctly in tune with the received signal, the A.V.C. is operating to apply a large negative grid-bias to the controlled valve.

Under these conditions, the plate current of the valve falls to a minimum and it is the business of the visual indicator to show clearly when this is the case. Usually the indicating lamp is operated by the voltage drop across a resistance in the output circuit of the A.V.C. valve.

Since this represents only a comparatively small control voltage, the favourite plan is to use a gas-filled tube, such as a Neon lamp, which is biased just below the glow point. The extra voltage is then applied as a “trigger” in order to produce the largest possible change in illumination.

For instance, the Neon lamp indicator shown in Fig. 1 is provided with one long cathode marked *k* and two short anodes marked *A* and *A*₁, respectively. The anode *A*₁ is connected to the high-tension supply through a high resistance *R*, which

applies a priming voltage, but only allows a very small discharge current to pass.

The small arc set up between *A*₁ and the base of the cathode *k* primes the tube so that it will respond rapidly to the small voltage changes which occur across the resistance *R*₁ in the output circuit of the controlled valve *v*. The second anode *A* is connected to the point

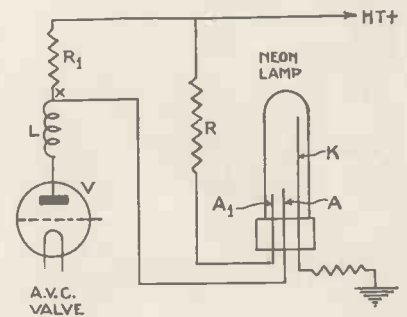

NEON-LAMP INDICATOR
Fig. 1.—A simple circuit showing a Neon lamp with its two short anodes and long cathode

x between this resistance and the intervalle coupling coil *L*.

In the absence of a signal, no A.V.C. bias will be developed and the amplifier is therefore operating at maximum sensitivity—doing its best to bring in any signal that may come into range. In this condition, it is passing a comparatively large plate current, which in turn creates a large voltage drop across the resistance *R*₁ so that the point *x* is many volts below the full high-tension supply.

As soon as a signal comes in, A.V.C. bias starts to be developed and reaches its maximum value at the critical point of resonance. At this moment, a large negative grid bias is being applied to the valve *v*, and the D.C. current through it falls to a minimum.

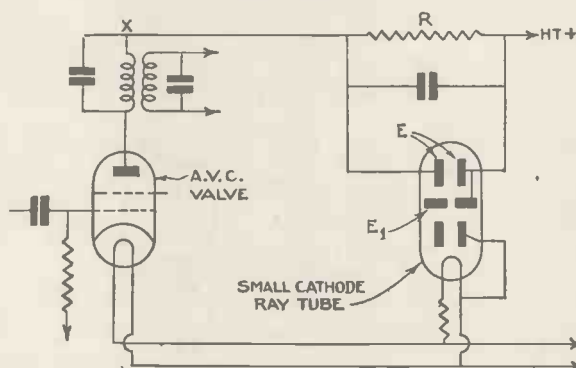

CATHODE-RAY INDICATOR
Fig. 2.—A circuit showing the use of a cathode-ray tube as a visual indication of tuning

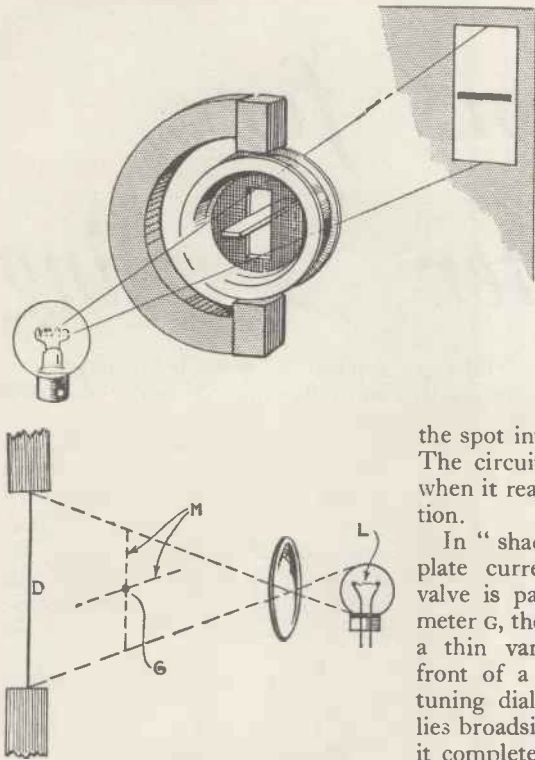

SHADOW TUNING

Fig. 3.—Here the plate current from the controlled valve passes through a galvanometer G, the spindle of which carries a thin vane or disc placed in front of a lamp

The voltage drop across the resistance R_1 follows suit so that the point X gradually rises in potential until it is very nearly equal to the full high-tension voltage.

Correct Tuning Point

At a certain point on this upward course, the voltage on the anode A of the Neon tube (assisted by the priming action of the anode A_1) begins to "take charge" and the discharge glow rises up the long cathode K, until it reaches its maximum height at the exact point of correct tuning.

Same Volume

The slightest movement of the tuning dial in either direction will then cause the column of light to fall, although the volume of signal strength as judged by the ear alone may seem to remain unaltered.

The action of the Neon lamp indicator gives a clue to most other forms of visual tuning. For instance, in Fig. 2 the voltage change across the resistance R is applied to the control electrodes E of a small cathode-ray tube T so as to shift the position of the spot of light formed where the beam strikes against a fluorescent screen.

The perforated anode of the cathode-ray indicator is connected to the full high-tension voltage. The value of the resistance R is such, that when no signal is being received, the bias across the electrodes E is sufficient to deflect the spot right off the screen.

As a signal comes in and the voltage across R falls off, the electrodes E gradually move the spot into view across the screen. The circuits are accurately in tune when it reaches its maximum deflection.

In "shadow" tuning, Fig. 3, the plate current from the controlled valve is passed through a galvanometer G, the spindle of which carries a thin vane or disc M, placed in front of a lamp L illuminating the tuning dial D. Normally the vane lies broadside on to the lamp so that it completely overshadows the scale aperture or window.

But as a signal is tuned in, the spindle of the galvanometer rotates and gradually turns the vane end-on to the lamp until it produces a clear-cut line shadow which indicates the true point of resonance.

A third anode can be inserted in the Neon lamp indicator shown in Fig. 1, for the purpose of shutting-out the loud background of noise heard when an A.V.C. set is being tuned between stations. The extra anode spills over when the column of light reaches a certain level and allows a current to pass through a series resistance.

The voltage drop across this resistance is applied to paralyse the grid of one of the valve amplifiers so that, in effect, it acts as a noise gate and cuts the loud-speaker temporarily out of action. As soon, however, as a worth-while signal comes along, the paralysing bias is removed and the path to the loud-speaker is again restored.

Neon lamps are favoured as visual indicators for much the same reason as they are used in television, namely, because they can produce a large change of illumination for a

comparatively small change of control voltage.

It is possible to utilise an ordinary incandescent lamp for this class of work. For instance Fig. 4 shows an indicator lamp fed from a 4-volt tapping across the A.C. supply and coupled to a coil L in the output circuit of an anode-bend detector valve forming part of an ordinary straight set.

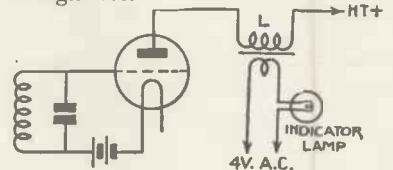

INDICATOR FOR A STRAIGHT SET
Fig. 4.—Showing how an ordinary incandescent lamp can be used as a visual indicator in a straight set

In this particular case an increase in signal strength will produce an increase in plate current. Under no-signal conditions, the inductance of the coil L is sufficiently high to choke down the current passing through the lamp. But as the circuits are tuned to resonance, the rising plate current through L saturates the coil so that its

Continued on the last page

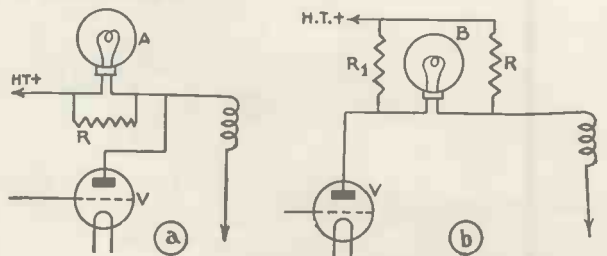
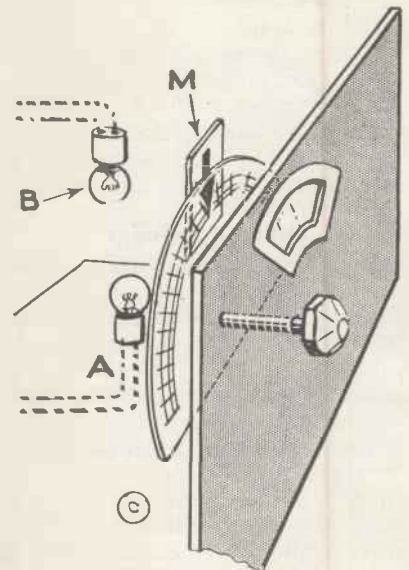

GLOW-LAMP TUNER

Fig. 5.—(a) shows a circuit whereby when the lamp goes out, the set is correctly tuned. In (b) the opposite is the case; when the set is correctly tuned, the lamp is at maximum brilliance. (c) shows a combination of both lamps

Details of the first Stenode receivers specially designed by Paul Tyers for the constructor, which have appeared in the last two issues of "Wireless Magazine," have aroused more interest than any other radio development this year. Constructors who have built either the battery or A.C. models will find the hints on trimming and operating, given in this article, of great practical value. For the convenience of new readers we have reprinted the list of parts for both battery and A.C. models and would remind them that full-size blueprints are available at 1s. 6d., post paid

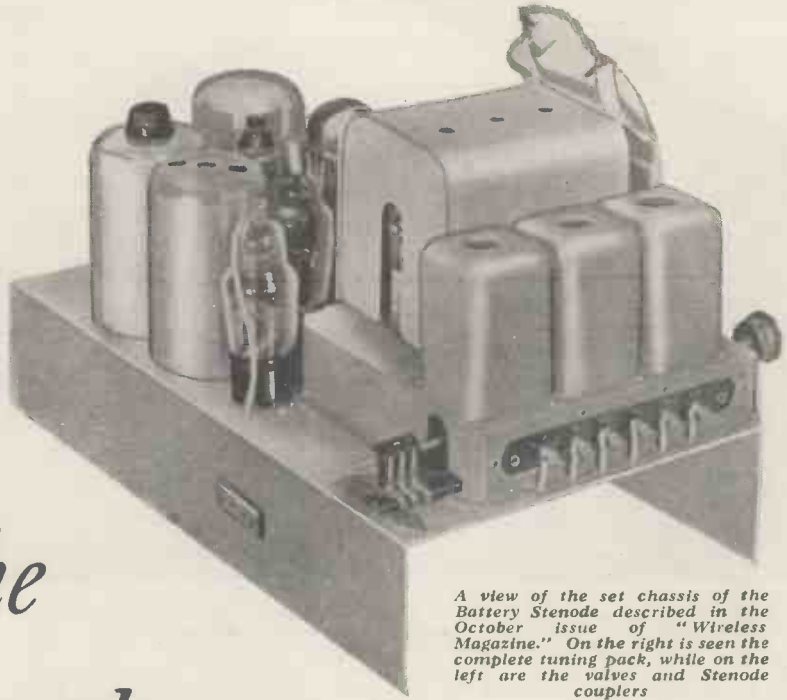

A view of the set chassis of the Battery Stenode described in the October issue of "Wireless Magazine." On the right is seen the complete tuning pack, while on the left are the valves and Stenode couplers

Getting the Best from the "W.M." Stenodes

By PAUL D. TYERS

THERE is definite similarity between tuning a motor-car for racing and adjusting a receiver to give the best performance. Maximum efficiency is not obtained by just doing something to one particular part of a set or spending a lot of money on one component.

It is exactly the same with a racing car. Maximum speed is only obtained when everything is working in perfect harmony and everything is adjusted so that it is just right. Retard the ignition, fit small jets to the carburettor, change the chokes, lower the compression ratio, and your racing car behaves as a perfectly respectable touring motor.

Now, it is just the same with a wireless set. If you have made those alterations

to your racing car it still remains just as good a car, but the performance is very mediocre. However well a Stenode receiver may have been built, it obviously cannot give a high-efficiency performance



SPECIAL STENODE COUPLERS

This photograph of part of the A.C. Stenode shows the valves and special Stenode couplers—all part of the most selective A.C. set yet presented to the home constructor

unless everything is correctly adjusted.

Now an expert radio designer can usually tell within two minutes just how well a set is working and he knows immediately what can be done, if anything, to improve the performance. The home constructor, unfortunately, is not in such a happy position, and he must of necessity set about his "high-efficiency tuning" more or less by rule of thumb.

Checking Over

One should certainly have available a very good voltmeter and milliammeter.

When a Stenode, or for that matter any set, has been built, after making sure that the continuities are correct, the various anode currents and voltages should be checked immediately the valves have been inserted.

If the anode current and the voltages are correct throughout the set, nine times out of ten half the troubles are over. If this is not the case, one must immediately look for two major troubles.

The first is the possibility of a defective valve, and the second is a defective resistance or condenser or even a battery connection.

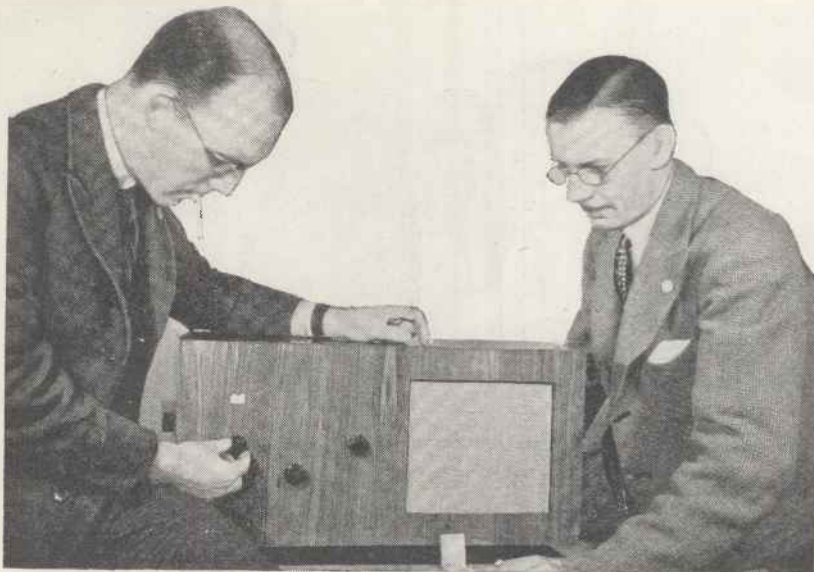

In spite of its ambitious design, the "W.M." Stenode has only three controls on the panel—tuning, wave-change, and volume. Photograph shows the set in its modern horizontal cabinet. The Stenode is the set for 1935!

If the anode current is found to be excessive (the value can always be checked by referring to the makers' leaflet), it is best to test the valve out of the set, measuring the anode current at a given grid voltage.

If the value is within about 20 per cent. one can regard the valve as possibly being quite satisfactory. If, however, on inserting the valve in the set it is found that the current is much larger or much smaller, then one must immediately look for a set fault.

Straightforward Tests

Too heavy a current is generally due to too large an anode or screen voltage or too low a bias. Too low a bias may be due to a leaking condenser which is allowing positive potential to reach the grid. Too high an anode or screen voltage may be due to a defective resistance having far too low a value.

Tests such as these are perfectly straightforward and call for no skill. It is useless, however, to attempt to obtain the best from a set until one is satisfied that the fundamentals are correct.

Ganging Problems

Attention is then turned to the matter of ganging, upon which the ultimate success of the whole set definitely depends. The ganging of a super-het is by no means a simple matter, particularly when no test oscillators are available.

Provided, however, that the tunable components, that is, the tuning

pack and the high-frequency intermediate valve couplers, are received reasonably well adjusted, ganging then becomes far less difficult.

I would strongly advise any constructor who wishes to get the best out of his set to make a very simple form of oscillator. Fig. 1 shows how simply this can be accomplished. All that is required is a dual-range tuning coil connected so that it operates permanently with a fixed reaction condenser.

The oscillator is tuned by an ordinary condenser connected across the grid circuit. It can be calibrated

very easily simply by checking against some reliable broadcast station. In order to cover the intermediate band it is only necessary to increase the tuning range on the long-wave section by adding some more turns or shunting it with a fixed condenser connected by a switch.

High-note Buzzer

Modulation is simply obtained by means of a high-note buzzer worked from a small dry cell. This can be connected in the high-tension supply through a transformer, or it can be connected directly in the grid return. More elaborate modulated oscillators have been described in past issues of "Wireless Magazine" and, of course, if such are available the problem is simplified.

It is absolutely essential that the intermediate Stenode couplers are correctly matched, as sent out; that is, adjusted to 110 kilocycles—because stray wiring capacities and variation in coupling affects the tune point to a certain extent.

Beginning Adjustments

Simply by bringing a wire near the grid of the first intermediate-frequency amplifier and the oscillator, sufficient pick-up is generally obtained to give a good note in the loud-speaker. The trimmers on the coupler should be adjusted until this note is at maximum.

If no oscillator is available, then a test can be made with a reasonably

COMPONENTS FOR THE "W.M." BATTERY STENODE

	£ s. d.		£ s. d.
CHASSIS		SUNDRIES	
1—Peto Scott 16 in. by 9 in. by 3 in. with two resistance strips ...	12 6	Oiled sleeving (Peto Scott), say ...	1 0
CHOKE, HIGH-FREQUENCY		Round tinned copper wire, No. 25 gauge for connecting (Peto Scott), say ...	9
1—Wearite screened type H.F.P....	3 6	2 ft. screened sleeving (Peto Scott) say ...	3
CONDENSERS, FIXED		5 yds. thin flex (Peto Scott), say ...	5
13—T.C.C. tubular type, values: .0002 (3), .0003, .001, .002, .01, .1-microfarad (6) ...	13 9	2—Bulgin 2-volt pilot bulbs ...	1 0
2—T.C.C. type 65, values: 2-mfd.	5 4	2—Clix metal anode connectors ...	3
HOLDERS, VALVE		1—Varley Power Puncher ...	15 6
5—Clix type chassis mounting 5-pin (3), 7-pin (2) ...	3 0	TUNING UNIT	
PLUGS, TERMINALS, ETC.		1—C.A.C. type Super Tuning Pak	2 12 6
5—Clix wander plugs, marked HT+, HT-, GB-1, GB-2, GB+ ...	7 ½	ACCESSORIES	
2—Clix spade terminals marked LT+, LT- ...	4	BATTERIES	
1—Belling Lee socket strip, marked Aerial, Earth ...	9	1—Full o' Power 120-volt high-tension, type H4 ...	19 0
RESISTANCES, FIXED		1—Full o' Power 16-volt grid bias	1 9
10—Claude Lyons, type 1-watt, values: 15,000-, 20,000-, 25,000-, 50,000-, 100,000-ohm ½ (2), 1-megohm (3) ...	5 0	1—Smiths 2-volt accumulator type 2RGN9 ...	12 6
RESISTANCE, VARIABLE		CABINET	
1—Wearite ½-megohm type Q22...	4 0	1—Peto Scott type Stenode B ...	1 2 6
STENODE COUPLING UNITS		LOUD-SPEAKER	
2—Belling-Lee high-frequency ...		1—Gramplan type GC3/FE ...	1 15 0
1—Belling-Lee 1st tone-correcting low-frequency,		VALVES	
1—Belling-Lee 2nd tone correcting low-frequency. Set of four	3 5 0	1—Osram X21 ...	18 6
		1—Osram HD21 ...	9 0
		1—Hivac VP215 ...	10 6
		1—Hivac HL210 ...	3 9
		1—Hivac Z220 ...	10 6

weak signal. These tests should always be made at a low intensity as the accuracy of the adjustment is far greater. It will be found that the signal builds up to quite a large value with a very critical setting of all the trimmers.

If the ganging of the three-gang condenser is not correct, then the results will be very poor. With an oscillator adjustment is quite easy, but without, the method of trial and error must be used.

Condenser Ganging

Fécamp (206 metres) is one of the best stations upon which to work. Before making the adjustment, however, it is essential to see that the set is working fairly well, which will be indicated by the reception of the local stations and one or two of the stronger distant transmitters.

First of all adjust the tuning dial accurately to the wavelength of Fécamp, then adjust the oscillator trimmer very slightly in either direction until the station is heard. After

wavelength of 206 metres might actually show 210 on the dial. If this is anticipated the set should be readjusted to receive Fécamp by properly ganging the oscillator and band-pass trimmers, but with the scale indicating the wrong wavelength.

It should be realised that it is impossible to mass-produce a scale to really fine limits, and this accounts for the apparent maladjustment.

A second test against a mid-point or top-scale station should then give correct conditions. In fact, it is essential to continue readjust-



LOOKS ARE VERY DECEPTIVE!
At first sight the underside of the battery Stenode appears to be a complicated business. Actually construction is very simple—all the resistances and condensers are mounted separately on sub-assemblies



HOW THE SET FITS IN ITS CABINET
Showing the A.C. Stenode in its cabinet. There is plenty of room. Note that the mains unit—on the left—has been built to fit round the energised moving-coil loud-speaker

this the aerial and band-pass coil trimmers should be varied until maximum intensity is obtained.

Scale Calibration

Tests should then be made at the other end of the scale, or, if preferred at a mid point. If the correct oscillator setting has been obtained it will be found that some well-known station is tuning correctly. If this is not it indicates that the whole tracking is completely out of adjustment and the setting of the wavelength as indicated by the dial is actually incorrect.

For example, a station with a

ing the scale until proper tracking is obtained everywhere. Only very minute movements of the oscillator condenser are necessary for this adjustment.

It is very important to remember that when adjusting the long-wave section the various trimmers must not be touched.

The method of adjusting the long-wave section is simply to tune the set in to 1,500 metres or thereabouts on the dial and adjust the long-wave padding condenser until the station is correctly tuned in. A check should be made on stations such as Deutschlandsender.

It may be found that if there is a slight inaccuracy on the dial, complete freedom from sideband splash will only be obtained with the set adjusted to a few metres off tune, according to the dial reading, but it will actually be the correct position.

Variation of the Coupling

I have already pointed out that when the tuning unit is ganged, final adjustment should only be made to the high-frequency couplers when the degree of coupling is varied. If the general field strength of all stations is low, stronger coupling may be used and less tone correction. Variation of the coupling, however, tends to shift the tune point very slightly, and a minute adjustment of the trimmers will then be necessary.

Increasing Gain

It is generally possible with any receiver to improve the gain slightly at the expense of increased anode current. Those who are fortunate enough to have available a power battery supply or mains unit may care to increase the anode current. The valves which are critical in this direction are the mixing valve and the intermediate-frequency amplifier.

Increase in the screen voltage of the intermediate-frequency amplifier will give a greater gain, and is obtained by lowering the value of

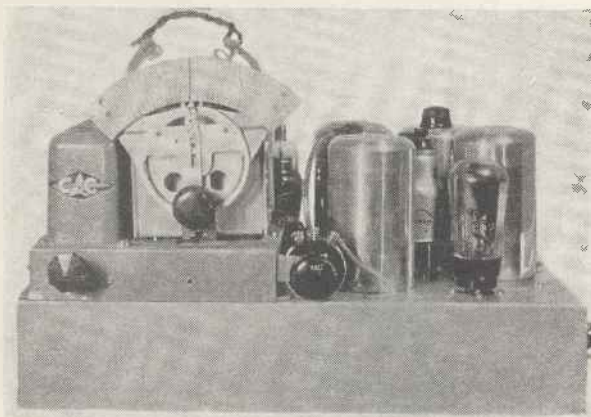

A SET YOU WILL BE PROUD OF!
Every constructor who builds a "W.M." Stenode will have just cause to be proud of his set—the most selective yet offered to home builders. Our photograph shows the business-like appearance of the battery model

the resistance used to feed the screen. The oscillator anode and screen voltage of the mixing valve should not be made too high, as this will tend to give rise to unsuitable oscillating conditions and increase the background noise. It will, however, affect the gain, and experiment can always be made with the resistance which feeds these two points.

The home constructor may actually be surprised at the great increase in gain which is obtained with a slight variation of the voltages on the mixing and intermediate-frequency valves.

The economiser unit used in the battery set is so designed that it introduces no dis-

tical running conditions consistent with maximum output.

If a lower output is only required it is then quite permissible to increase the bias to a point where distortion would begin on really large peak voltages.

Owing to the tremendous variation in field strength between daylight and night conditions it is certainly advisable to carry out adjustments

tortion trouble, but careful handling of the bias is necessary. From a real economy point of view, perhaps, the best method of adjustment is to increase the bias at the point where distortion actually begins on good room-strength passages and then decrease it until it just disappears. This represents the most economical

on the set at night, as this gives a far greater number of stations for test purposes.

In initially adjusting the receiver tests should always be made on the strong signals. It will be found that the set can be adjusted to a satisfactory point on the loud signals.

Search should then be made for a station which is just audible, and it is surprising how the strength of this can very frequently be brought up to good programme value as a result of really accurate adjustment which is impossible to obtain on a loud signal.

Sweeping Statement!

Home constructors who build a Stenode, or for that matter a super-het of any type, for the first time should not be disappointed if they do not succeed in obtaining the maximum performance of the receiver at the outset. It should be remembered that half a turn on a trimmer may reduce the gain of the set to something comparable with that of a two-valve receiver.

Such a sweeping statement as this, however, should not frighten the constructor, because there is nothing really very difficult in obtaining the correct adjustment providing one control is touched at a time.

Haphazard twisting of trimmers will lead to a greater state of chaos and confusion. Systematic, logical adjustment with careful consideration of each observation is the keynote of success in building any type of receiver, and in the case of a super-het it is a vital necessity.

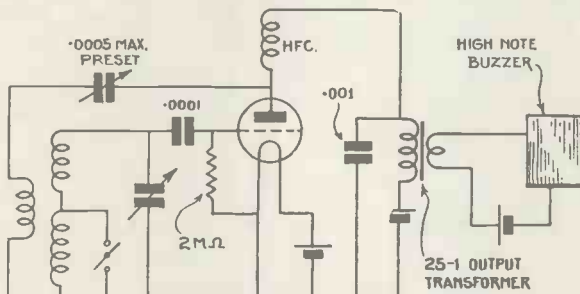

Fig. 1.—A simple form of oscillator recommended by Paul Tyers for use with the "W.M." Stenodes

COMPONENTS NEEDED FOR THE "W.M." STENODE-A.C. VERSION

	£ s. d.		£ s. d.		£ s. d.
CHASSIS		STENODE COUPLING UNITS		CONDENSERS, FIXED	
1—Peto-Scott aluminium, 16 in. by 9 in. by 3 in., complete with two resistances holders ...	12 6	2—Belling-Lee high-frequency; 1 Belling-Lee 1st tone-correcting low-frequency; 1 Belling-Lee 2nd tone-correcting low-frequency; set of four ...	3 5 0	4—T.C.C. electrolytic, type S02, values: 4- (2), 8-microfarad (2) 1 2 0	
CHOKE, HIGH-FREQUENCY		SUNDRIES		RECTIFIER	
1—Wearite, type HFP ...	3 6	1—Belling-Lee terminal strip, marked: Aerial, Earth ...	9	1—Westinghouse, type HT9 ...	1 1 0
CONDENSERS, FIXED		1—1½-ft. aluminium strip, ½ in. wide, say ...	3	SUNDRIES	
17—T.M.C. Hydra, type tubular, values: .0001- (3), .001- (2), .002-, .01-, .1-microfarad (10) ...	16 6	3 ft. screened sleeving, say ...	3	1—ebonite strip 6 in. by 2¼ in., say ...	6
3—Ferranti, type CE91, value 25-microfarad ...	0 0	Round-tinned copper wire, No. 20 gauge, for connecting, say ...	9	1—aluminium screen, 6 in. by 5¼ in. to specification, say ...	9
2—T.M.C. Hydra, type 30, values: 2-, 4-microfarad ...	8 9	Oiled-sleeving, say ...	1 6	6—aluminium brackets, say ...	6
HOLDERS, FUSE		1—British Radiogram 3-in. metal mounting bracket ...	4	2—supporting wood blocks, 2½ in. by 1 in. by 1 in., say ...	2
1—Bulgin twin, type F11 with 1-ampere fuses ...	2 0	5 doz. 6BA ½-in. bolts and nuts, say ...	1 6	TRANSFORMER, MAINS	
HOLDERS, VALVE		SWITCH		1—Sound Sales, type HT9, with following windings: 240 volts—200 milliamperes; 2-0-2 volts—5 amperes ...	1 17 6
5—Clix, type chassis-mounting, five-pin (3), seven-pin (2) ...	3 0	1—Bulgin on-off toggle, type S91LB ...	2 0	ACCESSORIES	
RESISTANCES, FIXED		TUNING UNIT		CABINET	
18—Claude Lyons, type 1-watt, values: 200-, 250-, 300-, 1,000- (2), 10,000- (3), 20,000- (2), 40,000-, 50,000-, 80,000-ohm, .5-, 1-megohm (4) ...	15 9	1—British Radiophone band-pass super-het Radiopak, type 110 kilocycles ...	3 15 0	1—Peto-Scott, type Stenode ...	1 2 6
1—Claude Lyons, type FW60, value 60-ohm ...	1 6	BASEBOARD		LOUD-SPEAKER	
RESISTANCE, VARIABLE		1—three-ply, 9 in. by 7 in., say ...	4	1—Gramplan, type E1/Stenode ...	1 5 0
1—Erie, 5-megohm ...	3 6			VALVES	
				1—Cossor 41MPG ...	1 0 0
				1—Cossor MSV/Pen. ...	17 6
				1—Cossor DDT ...	15 6
				1—Cossor 41MHL ...	13 6
				1—Marconi or Osram MPT4 Catkin ...	18 6

DESIRING a change from the usual fixed and planned holiday, we packed the bags, put them on the back of the car, filled the tank to the brim, and started off down the hill.

"Where are we going?" asked my wife, feeling with perhaps some slight justification that as it was her holiday as well as mine it wouldn't be a bad idea if she were told.

"We are stopping at Exeter tonight!" I replied.

"I know! But after that."

"I haven't the slightest idea!" I said, noticing with annoyance that the traffic in front of me did not move when the lights changed, for the simple reason that I had pulled up behind a taxi rank.

And that was precisely how the holiday started. After a lot of tiring work it seemed a good idea to take things very quietly and to follow out any line of thought that suggested itself. The car radio was

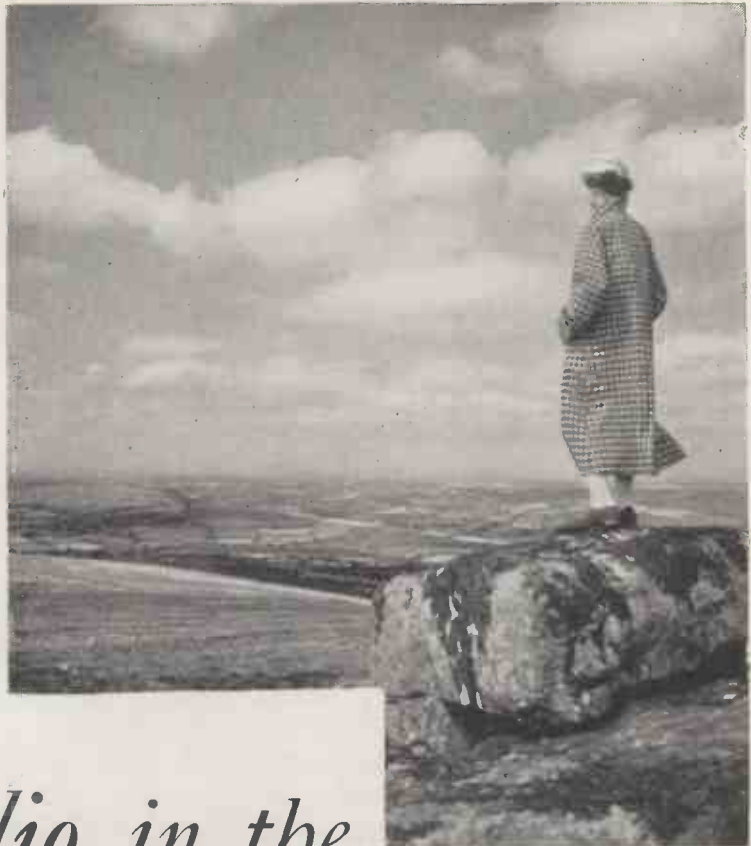

High up on Dartmoor where the author made many of his tests

Car Radio in the West Country

PERCY W. HARRIS, M.Inst.Rad.E., has already recounted in these pages his experiences with car radio among the hills and valleys of Surrey and Sussex. This month he takes us farther afield and describes his recent experiments in Devon and Cornwall. He is disappointed in West Country conditions and contends that "Westerners have had a raw deal" from the B.B.C. The author devotes part of his article to practical hints on designing a simple car-radio set. Photographs of the West Country were taken by the author.

turned on almost immediately—that is to say, as soon as we got clear of the towns and out on to the open road for the purpose of a quick check-up of reception conditions from time to time.

Electrical Exploration

Most of the country I had, so to speak, electrically explored before, at least so far as the first sixty or seventy miles of the Exeter road were concerned. Just after lunchtime (we had reached Salisbury Plain)

an idea occurred which gave a motive for the tour.

Thinking back over my correspondence and of what I had read regarding reception conditions in the west of England—in particular Devon and Cornwall—it suddenly flashed on me, why should I not use the car radio to find out just what reception conditions were like in those districts from which so many complaints had come.

Thus, by the time we reached the Devonshire border I was taking

careful note and it was not long before I grew bitterly disappointed with the performance of the West National and Regional stations. Town dwellers, as so many of us are, have become accustomed to first-class reception from such stations as the London, Midland, Northern and Scottish Nationals and Regionals, with genuine alternatives in our own district.

Does the B.B.C. Know?

The B.B.C. talk a great deal about the rights of minorities in country districts, but after this West of England tour, I wonder whether those who control that policy are fully acquainted with the reception conditions they profess to understand.

So far as I am personally concerned you will find me any evening in an Underground train studying the evening paper before I get home, for both in London and locally there are more entertainments at reasonable prices available to me than I am ever likely to patronise. Wireless reception, then, is not a really vital part in my life so far as news and amusement are concerned, although

I prefer it to a lot of the so-called entertainments available elsewhere in town.

Put yourself in the place of the resident in a West of England village with a simple and efficient wireless set, which has been running for a year or two quite satisfactorily and the purchase of which has called for quite a little bout of saving and sacrifice.

You do not have to spend much time in country districts before you realise how much the morning service is appreciated by elderly people, while

poor reception conditions, but remember that with agriculture as it is and the small fixed income that many of the elderly people are dependent upon, the expenditure of anything like three-hundred shillings is entirely out of the question. The sets they own were bought in the belief that the B.B.C. was giving a good service all over the country for comparatively simple sets. The B.B.C. said so, anyway!

In practically all the districts covered by my holiday, medium-wave reception was exceedingly poor.



A CORNER OF THE HARBOUR AT ST. IVES, CORNWALL

In many populous West Country districts the long-wave station is the only hope in daylight so far as the simple types of sets are concerned

farmers and stock breeders make good use of the talks.

In summer time—particularly in Devon and Cornwall—it is full daylight until quite late in the evening and after-dark listening for several months is practically negligible.

Daylight Listeners

We are thus faced with the fact that it is the *daylight* and not the after-dark reception that largely affects these thousands of country residents. They feel, quite rightly, that with the vast B.B.C. income, growing at such a pace that the Government feels entitled to lift large portions of it for other purposes (thereby changing over part of our licence money to an amusement tax which was never intended by Parliament), they cannot see why a good, honest, daylight service should not be provided in their area.

They know, some of them, that for about £15 they can buy a new and modern set with enough valves and magnification to overcome the

I particularly noted conditions in small country towns and villages where, from the number of aerials displayed, it was obvious that wireless reception was playing an important part in the community.

At this point, by the way, I should interpose a note to the effect that the *proportion* of aerials to the houses was much smaller than I expected, and this is certainly not to be accounted for in many parts by the use of indoor aerials for even a large outdoor one is scarcely good enough.

In most cases where medium-wave reception was possible, the degree of amplification required brought out far more background noise, interference sounds and the like, than is advisable for comfortable programme reception. Long-waves seem the only hope down there and, of course, with the opening of Droitwich conditions will improve. I do consider, however, that in this country and with the funds available, single station reception without any decent alternative should be a thing

of the past, for the sturdy and independent West Country folk have quite definite ideas on what constitutes a good and entertaining programme and are by no means content with the National programmes as they are.

They have my sympathy. You have no idea how silly and futile some of the programme items sound when listened to in the heart of the country.

At the "Angel" Hotel

A very pleasant interlude occurred while I was stopping at the old *Angel* Hotel at Helston. The *Angel* has been an inn since about 1700, and for goodness knows how long before that it was a local country house of the Earls of Godolphon. The large cobbled yard, which not so very many years ago echoed with the clattering of horses' hoofs, the jingle of harness and the rumble of coach wheels, is now a convenient parking place for visitors' cars.

One morning after breakfast, when engines were being warmed up, radiators filled, and luggage strapped and secured, I fell into conversation with another visitor who turned out to be a constant reader of my articles for many years. As he had read the article in the August 1934 issue about my experiences with car radio, he was more than ordinarily interested, and that evening he and I and another friend took the car out just to show off its radio paces.

"Inventions of the Devil"

While we were driving through the country lanes, my radio friend told me how, years ago, he had built one of my sets for an elderly aunt of his—a Cornish woman—who lived not far away from where we were at the time. The set worked very well—so well in fact that the old lady immediately informed my friend that the set in question was an invention of the devil!

On the Penzance road, a few miles from Helston, we called to see another old lady, also a relation of my friend, who has been blind since a child and who, in spite of this great affliction, retains a charm and spirit which many in full possession of their senses might well envy.

She came out and sat in the car and listened with an attention and pleasure, which was quite touching to see, to an excellent operatic

programme from Milan. She told me how much her own wireless set in the house meant and from her remarks about reception in the locality—the interference noises, background mush, and so forth—I had still further confirmation of what I have told you previously.

A Pleasant Memory

The memory of the old lady's pleasure at this programme will remain with me for a long time, and if this article is read by my Cornish friend—and I am sure it will be, for he spoke very appreciatively of "Wireless Magazine" and *Amateur Wireless*—it will serve once more to thank him for the very pleasant evening for which he was responsible.

Electrical power is being more and more used in these country districts now that the grid scheme is widespread. Farmers use electrically driven milk separators, chaff cutters and naturally the interference caused by these machines is often very marked in long-wave reception.

On Dartmoor

Readers will remember that in the previous article I referred to investigations in Surrey and Sussex with regard to reception on hill-tops and in valleys. My West of England test still further confirms what I have written on the subject, but I must confess to considerable surprise at the relatively poor reception on the high ground of Dartmoor where I spent several days making extensive tests.



MISS BETTY COMPTON ENJOYS HER CAR RADIO

Miss Betty Compton, the famous film actress, has had a Philco Transitone outfit installed in her open tourer. You will notice the neat remote control unit fitted on the steering column

I remember driving on to very high ground near Princetown one evening for the double purpose of getting a blow before dinner and hearing the "First News". Reception was exceedingly poor and *North Regional* came in at least as well as, if not better than, *West Regional*, which remark applies to many other districts where I tested the two stations comparatively.

Along winding lanes, in hollows or on open hilltops free from any obvious screening, reception was just about uniformly poor, judged by modern standards. Although my receiver has automatic volume con-

trol, there are several ways of checking up relative field strength, particularly by noticing the proportion of mush to signals.

Puzzling Dead Spots

There were many "dead spots," just as before and just as puzzling to account for, and there were also those lively stretches where a most misleading impression of what wireless conditions are. On more than one occasion—and on high ground at that—reception conditions in Cornwall were so poor where the car happened to be that I could not get the "First News" intelligibly.

I remember, one occasion in particular, when we were spending the afternoon by the side of the road about a dozen miles from Perranporth. We were on a high ridge of ground, falling away gently in most directions and affording a view of at least half a dozen miles most ways.

Only Athlone

Starting at one end of the wavelength scale, I went steadily and slowly to the other; and then, just as carefully and steadily, back again. The only station from which I could get a reasonably good programme was Athlone, and that came in very well indeed.

In places such as hotels, where one would expect a fairly modern receiver to be used, my inquiries almost invariably showed that only the long-wave station was considered of any use in daylight. When it is



ANOTHER CORNER OF THE CORNISH COAST AT ST. IVES

If you look carefully you will see the tall wireless poles on the tops of houses. Percy Harris says that judging by the number of aeriols the B.B.C. must get a considerable revenue from fishing villages in the West Country

realised that in the West of England it remains light much longer than in the London area, it is apparent that through a good deal of the year the wireless set is only used in daylight. Altogether, to use an American phrase, "The Westerners have had a raw deal."

Experimental Work

A number of readers are interested in experimental work with car radio, and as the general principles of set design have been discussed in a recent series of articles, a few suggestions on this line may be found helpful.

It is not by any means essential—or, perhaps, even advisable—to copy commercial car-radio sets. Not only are these made in specialised factories from designs which are by no means easy to reproduce at home, but their conventions are not necessarily the best.

Car radio, nowadays, is rather coming to be standardised as something which is fitted under the fascia-board against the engine bulkhead and controlled by flexible wires from the dial attached either to the fascia-board or to the steering column.

About the Aerial

The aerial may either be wires or network in the roof of the car, or, quite frequently, a scheme of wires under the running board. Mr. J. H. Reyner dealt with these points in last month's "Wireless Magazine," therefore I need not refer to them again.

The next important difference between car radio and ordinary sets relates to the power supply. In many of these sets the types of valve used are similar to those used in the so-called universal receivers, and the whole of the power to operate the set (both filament heaters and high tension) comes from the high-tension D.C. side of a motor generator or converter run from the car battery.

It is certainly useful to have a complete power supply in the car, and to be rid of high- and low-tension batteries, for in this way one gets all the

advantages of mains-operated radio out on the road.

Experimenters will be interested to know that it is possible to obtain one of these motor generators as a basis for their experiments.

Many of the less expensive car receivers operate with a vibrator form of converter and a valve rectifier, but while these work satisfactorily with apparatus designed for them, it is not easy for the amateur to use the vibrator in his experiments. If he can afford it, it is much better to start off with the motor generator to which I have referred.

One such generator I have in mind is available in two models for either 6- or 12-volt input respectively, and both models are also available with two different degrees of output, one giving 180 volts 30 milliamperes D.C. and the other 250 volts 50 milliamperes D.C. All four models sell for £5 5s. each.

Let us imagine we desire to experiment with the lower power of the two. If 30 milliamperes at 180 volts are available, let us see how we can use it. Obviously, we cannot use the ordinary indirectly-heated valves which take 1 ampere at 4 volts, for even in a 3-valve set this would account for 12 watts and our total output is only just over 5 watts.

Even with a larger model, the output of which is 12½ watts, this

scheme would be impracticable. Obviously, our valve-heater current must come from some other way, the output from the generator being reserved for high tension.

The machines I have in mind enable one to design a special kind of car set which may appeal to many readers. Thousands of people still use wireless sets with battery valves, utilising for high tension one of the many popular mains units. The set works satisfactorily, the quality is good, and the power output quite sufficient for their purpose.

Small Motor Generators

Now these small motor generators are supplied in metal boxes, measuring about 6 in. by 6 in. by 3 in., with either a 6- or 12-volt input and a D.C. smoothed output of either 30 or 50 milliamperes at 180 or 250 volts, the lower output models having an intermediate tap at 90.

The motor generator runs on ball bearings and requires no attention in the way of lubrication, while in the same metal box is built a complete smoothing outfit, so that no further filtering is required. The outfit thus provides a complete means of getting your smoothed high-tension from the car battery and thus the set itself is relieved of the necessity of including a heavy high-tension battery, which, as everyone knows, makes for

both bulk and weight in portable sets.

At first thought it seems a simple matter to use the car accumulator for the low-tension supply, but there is a practical problem here which hinders the normal application of battery valves. In the case of, let us say, a 6-volt accumulator, the voltage of this accumulator fully charged (which it practically always is) is six or a fraction over, provided the charging dynamo is not connected to it.

When the battery is being charged, during the running of the car, the voltage will rise considerably above this, and so one has to legislate for a fluctuating battery voltage which can easily spoil your battery valves. One solution is to use three indirectly-

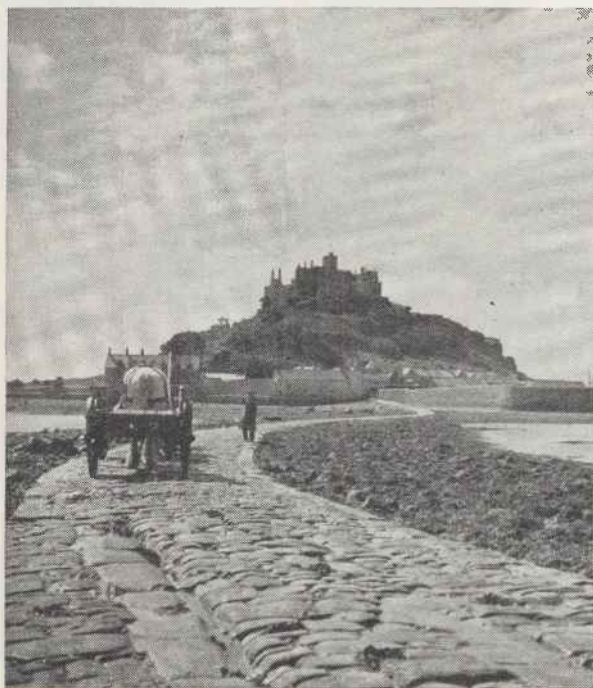

THE ROAD TO MOUNT MICHAEL

Another fine photograph taken by Percy Harris during his recent West-country car-radio tour. Mount Michael is near Penzance, the people of which are often complaining about the B.B.C.'s poor service

heated 4-volt mains valves in series, for their heaters will stand fluctuations in voltage much better than those battery valves.

Another suggestion, and one which I think will appeal to many readers in view of the ability to transfer the set to the house when desired, is to use 2-volt battery valves, a 2-volt accumulator, and a simple device which will charge this small accumulator from the car battery when the set is not in use.

Charging the Battery

All that is needed in this case is a pair of leads from the car battery (connected, for example, to the inspection-lamp plug) and in series with this a resistance which will limit the charging current to the right figure for the particular cell in question. A double-pole double-throw change-over switch can be arranged to disconnect completely the accumulator from the car when it is desired to use the set.

Some readers may have been wondering why the same motor

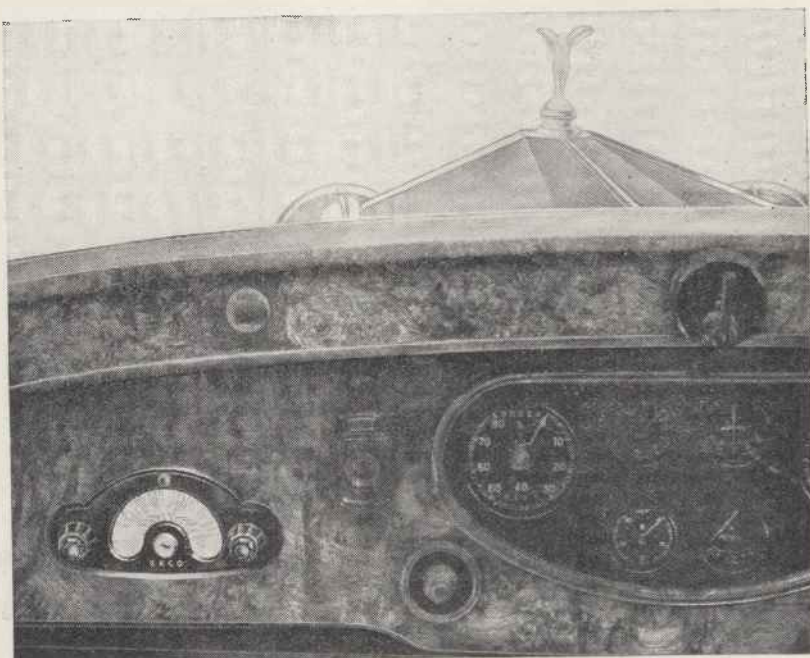

CAR RADIO—DIAL CALIBRATED IN WAVELENGTHS AND STATIONS
The control unit for the Ekco car-radio outfit fits neatly on the fascia board of the car. It is one of the few—if not the only—installations to have a dial calibrated in station names and wavelengths. And a very neat dial, too!

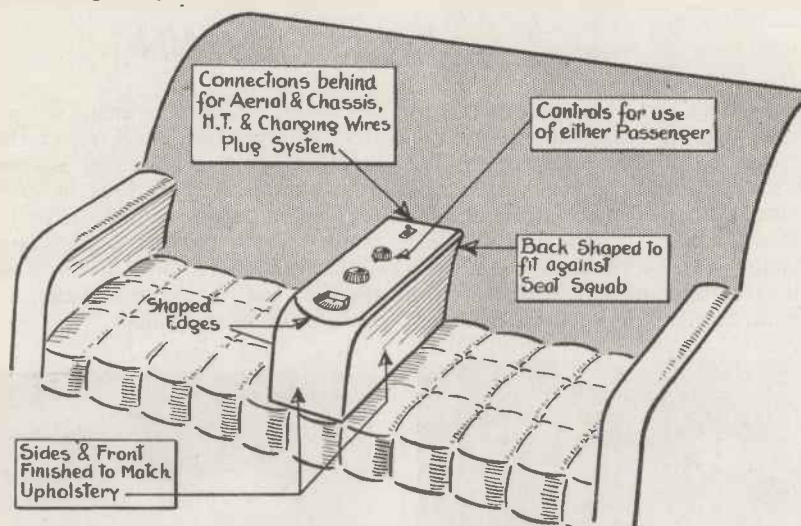

SUGGESTED LAYOUT FOR CAR-RADIO OUTFIT

Percy Harris gives a deal of practical information for building a car set on the lines shown in this drawing. A motor generator supplies high-tension and a small accumulator is used for low tension. The author suggests a three-valve circuit

generator is not used to supply the necessary current for the valves. Actually, in many of the professionally built sets, special valves are used with heaters through which the whole of the high-tension current is passed, as in the case of a so-called universal set, and the 30 milliamperes provided is sufficient. I do not recommend experimenters to use this type of valve, however, as the technique required is a special one.

The motor generator can be mounted beneath the floorboard or

anywhere convenient. It will be necessary to fit suppressors to the plugs and distributor. Sets of these can be purchased from a number of manufacturers and fitted quite easily.

A screen-grid high-frequency valve, a detector and a pentode set can be made up in a special form of case on the lines suggested in the sketch. With this set used in the back of the car, it can be controlled by either passenger.

Incidentally, it can easily be made of such a shape for the particular car

so that it will form a central arm-rest, if necessary being matched in colouring and covering to the car upholstery. After use in the car it can be carried into the house and connected to the usual high-tension mains unit and the aerial and earth in the regular fashion.

A Little Problem

Here, then, is a very interesting little problem for you, following up the articles on principles of set design. Take any one of the previously published screen-grid, detector, and pentode sets in this magazine and work it out for such a case as that shown, assuming that it will be driven from a motor generator for high-tension supply.

A Final Word!

Only because modern sets are so sensitive is it possible to have good car radio at all. The restrictions of size of aerial, the effect of the steel framework (often steel bodies) and several other factors, all conspire against good reception.

The car radio enthusiast who does much reception by the wayside should take a length of well insulated aerial wire with him.

This can be draped along a hedge or thrown over a tree when stationary reception is indulged in, and reception will be greatly improved.



A new photograph of Billy Mayerl, the syncopated pianist and broadcaster with his wife, recording in the Columbia studios at St. John's Wood

have the opportunity of hearing Ambrose every Saturday during the next few months.

By the way, you have probably heard that Henry Hall has shifted his headquarters to the riverside wharf at Waterloo Bridge. I do not think he will be long there; for one thing, the acoustics are hardly suitable for a comparatively small dance band and, secondly, there will be studio accommodation available at Maida Vale shortly.

The first of the new studios there was opened officially at the beginning of last month. The big

PROGRAMME NOTES and NEWS

By T. F. HENN

YOU remember that last month I gave you the outline of the B.B.C.'s new autumn entertainment drive. Now you have heard part of the scheme in practice and you have, no doubt, formed your own ideas about it. Unfortunately, I have to correct one statement made last month.

I said that the B.B.C. was not holding public chamber-music concerts in the Concert Hall at Broadcasting House this year. Something untoward has happened, and the B.B.C. has changed its mind. There are to be five altogether; three this year and two next. They are of a modern character with works by Hindemith, Prokofiev and Janacek.

About those Bach cantatas! Last month I said that they would still be held, though no one seemed to know when. The latest news is that the B.B.C. people consider them a good alternative to the late dance music, for I note that one is down for performance on November 2—a Friday—between 10.15 and 11.15 p.m. And so the perfect alternative programme—Bach . . . Harry Roy. Make your choice carefully!

Don't run away with the idea that these late entertainments are all going to be as bad as this. On the previous day the Café Collette Orchestra is taking the late period. Good variety, anyway!

A real spot of bright news is that

Ambrose and his orchestra are returning to the microphone on November 3—a Saturday—in the late dance-music period. They will take alternative Saturday nights with Henry Hall. Incidentally, they are taking turns with Henry Hall with the tea-time dance music, also on Saturdays. So, in effect, you will

orchestral studio, which is the first, is larger than the Concert Hall at Broadcasting House. It is some 125 ft. long by 72 ft. wide by 26 ft. high. There is plenty of room on the floor to accommodate the large orchestra and National Chorus, while there is seating accommodation for 150 people in the gallery.



Good fun is always assured by listening to Ronald Gourley's piano mix-ups. He is a regular broadcaster.



This famous wireless comedian is back from the seaside ready for winter broadcasting, Leonard Henry

I have been spending a few minutes looking through the prospectus of the B.B.C. Symphony Concerts, which are being held at Queen's Hall this winter. I think that they are the most interesting and ambitious yet. There are two of these concerts in November.

The first, on the fourteenth, is notable for the appearance of Pablo Casals—one of the world's finest 'cellists—who is playing Haydn's *Concerto in D*. In the same programme is Richard Strauss' symphonic poem, *Don Quixote*, a work which I strongly recommend you all to hear.

About the second—if I am to be really truthful—I must advise you to be careful. The whole of this concert—on November 28—is taken up with three big works of Stravinsky, the great modern composer.

The first work is called *Persephone* and is described as a melodrama in three parts. This will be the first performance in England and it will be conducted by the composer. The other two works, which will be conducted by Sir Henry Wood, are the *Capriccio* for piano and orchestra and the now-famous *L'Oiseau de Feu* (the Fire Bird Suite). A real high spot this for those listeners with a flair for music of a strikingly original kind!

I rather admire the B.B.C.'s idea of arranging for its 119-member orchestra to visit Bristol, Manchester, Birmingham and Dundee during the season. It certainly will give provincial listeners the opportunity of hearing first hand the fine team playing of the B.B.C. Orchestra

Not only is there a treat in store for English listeners, but Belgians will have the same opportunity, for the orchestra is visiting Brussels on March 12 of next year. The twelve Queen's Hall concerts, all the provincial and the Brussels concert will be broadcast, so in effect there will be seventeen broadcasts by this orchestra during the season.

While on the subject of serious music broadcasts I would like to make special mention of the Delius Memorial Concert, which is being given at Queen's Hall on November 8 by the London Philharmonic Orchestra and the London Select Choir under the conductorship of Sir Thomas Beecham.

Delius, who you remember died in his French home early this year,

was undoubtedly one of the greatest of modern British composers. His living champion, Sir Thomas Beecham, has chosen a fine programme for this concert, including the suite *Hassan*, *Eventyr*, and *Sea Drift*.

Don't forget the date—it will be a concert well worth hearing.

About those Sunday-evening con-



The conductor of the famous Cafe Collette Orchestra, Walford Hyden—a provider of real lively tunes

certs. These will be starting again very shortly and, for the time being, will be relayed from No. 10, Waterloo Bridge studio. Programmes for these concerts are, like the rest of the B.B.C.'s autumn plans, of an ambitious nature.

At the time of writing, nothing



Mamie Soutter, the well-known comedienne, whose child imitations are a feature of her broadcasts

definite has been fixed, but among the good things to be heard are Elgar's *The Spirit of England*, Honneger's *King David*, *Song of Songs* by Granville Bantock, and Stravinsky's *La Rossignol*.

Just one other point about so-called good music. I have read that following the great success of the broadcast presentation of *Wozzeck* last year, the B.B.C. has plans for presenting three more studio operas on a large scale. The first is Strauss' *Salome* on November 6 and 7, with Oda Slobodskaya in the title rôle and with Albert Coates as conductor.

Now this is an outstanding work, but please remember it is not like *Wozzeck*. Listen to *Salome*!



Two broadcasters we all know and appreciate, Layton and Johnstone were heard in October programmes. Their charming duets are, you will agree, a real light-music treat



W. James' Super Senior in 1932 have asked us to bring that design up-to-date. In the set presented here, therefore, we have adopted a compromise; in other words, we have used as many as possible of the old parts from the original Super Senior, but the set is not antiquated in any way and those who want to build it up from "scratch," as it were, will have no difficulty in getting any of the parts needed.

Features of the Old Set

The chief features of the Super Senior were a preliminary stage of high-frequency amplification before the first detector and the use of an assembly of three intermediate-frequency coils and valve holders built up as one unit and supplied complete by the manufacturer.

This particular unit is not now available and the new set is built up with separate parts. But those who want to convert their existing Super Seniors to this new design should note that next month we shall pub-

The Modern

Designed by the "WIRELESS"

USERS of battery sets who are particularly keen about radio complain nowadays—and, it must be admitted, with some justification—that they are not adequately catered for in the way of big sets. The truth is that small sets, that is sets with three or four valves, will do all that most people require of a receiver.

But there are quite a good number of listeners who know the great thrill that is to be obtained from a really large and powerful battery set.

"Wireless Magazine" has to cater for the needs of the majority of its readers, but it recognises that there is a considerable demand for an up-to-date set of much more ambitious design than it usually presents. In particular we have had numerous requests for a really powerful battery-operated super-het.

The problem of producing such a set has been complicated by the fact that scores of readers who built

the corresponding connections for the old unit. They will have plenty to do in the meantime in the way of dismantling their old sets and starting on the construction of the new one up to the point of inserting the old unit in place of the three separate intermediate-frequency coils and valve holders used in the Modern Super Senior.

Although this set conforms generally speaking to the best modern

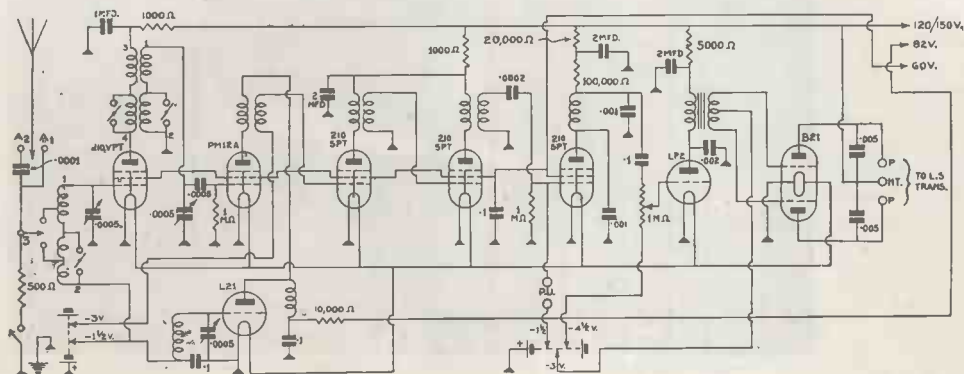

THE CIRCUIT

Undoubtedly the last word in battery super-hets! The valve combination consists of a preliminary high-frequency amplifier, first detector, separate oscillator, two intermediate-frequency amplifiers, second detector, driver, and class-B output stage. The small black solid triangles in the circuit indicate connections to earth

technique there are a number of details that have been omitted on the score of simplicity; for this reason self-adjusting volume control has not been incorporated and no multi-purpose valves are used. By this means the owner of the original Super Senior will be able to convert to the new model easily and cheaply.

Eight Valves in All

This new set uses eight valves and they are arranged in the following sequence: (1) preliminary stage of high-frequency amplification; (2) first detector; (3) separate oscillator; (4) two intermediate-frequency amplifiers; (5) second detector; (6) low-frequency driver valve; and (7) class-B output valve.

It will be noted from the circuit diagram that high frequency pentodes are used in the high-frequency, intermediate frequency and second detector stages; but we wish to point out at once that, as these are four-pin types, they can be replaced without any alteration by the ordin-



Owners of original Super 60 and Super Senior sets can use up many of their present components. The valves, from left to right, are class-B, driver, second detector, oscillator behind the two intermediate-frequency amplifiers, first detector and H.F. amplifier.

ary type of screen-grid valve. In other words, those who are building the set for the first time are recommended to use high-frequency pentodes, but those who already have a stock of valves can use ordinary screen-grids without any alteration to the circuit or to the wiring of the receiver. That is a point to remember!

that will stand a steady drain of about 25 milliamperes and a peak current of the order of 40 milliamperes. Thus if batteries are to be

used it must be designed for the heavy peaks of class-B working. Granted that the high-tension supply is adequate the output of the Modern Super Senior will compare favourably with that of many mains-operated receivers—and, of course, there will be no trace of mains hum in the background.

Super Senior

MAGAZINE " TECHNICAL STAFF

High-efficiency Coils

Iron-core coils are used for aerial and high-frequency intervalve coupling; there are two, and they are tuned by a two-gang condenser. The original type of Super Senior oscillator coil is utilised, and this is

used they should be of the triple-capacity type, and if a mains unit is

used they should be of the triple-capacity type, and if a mains unit is

Class-B Output Stage

The first detector, however, must be of the type specified and, of course, a class-B valve must be used for the output stage. Here a choice of two types is available: with an L21 driver and a B21 output valve the output is about 1,250 milliwatts, but with an LP2 type of driver and a 240B output valve as much as 2,000 milliwatts can be obtained.

Of course, it will be appreciated that outputs of this order cannot be obtained without the consumption of a fairly heavy high-tension current. It is essential to use a power supply

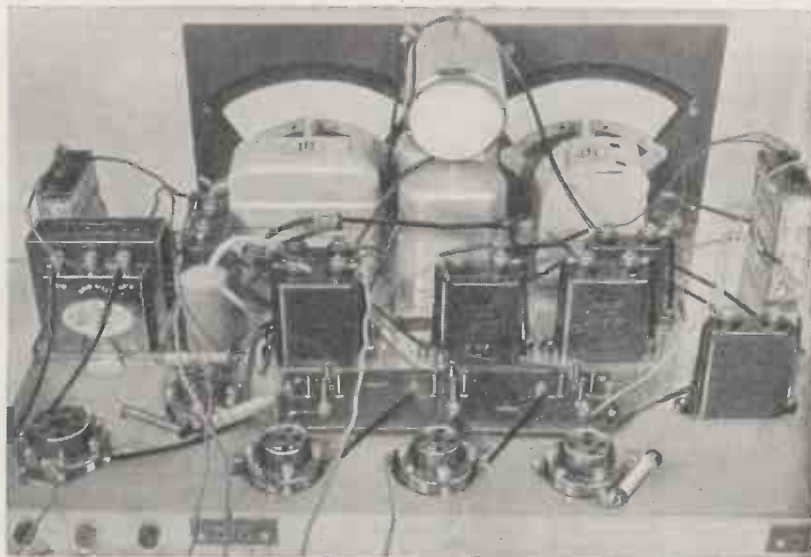

ON TOP OF THE METAL BASEPLATE

The major portion of the Modern Super Senior is built on the top of the shallow baseplate. There are only a few wires underneath, as will be seen from the illustration on page 364. Construction is quite a straightforward job.

Third-scale Wiring Plan

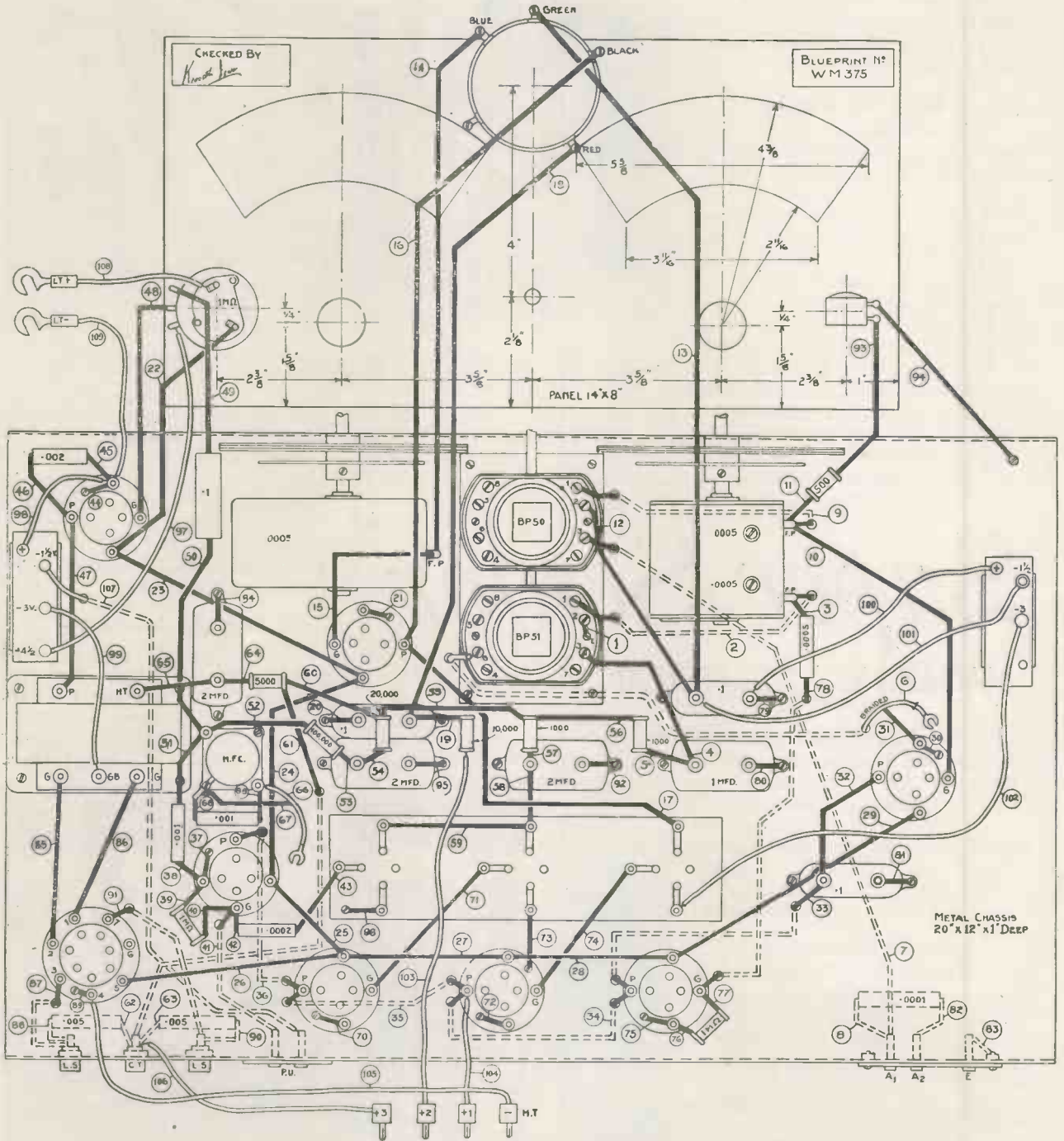

FULL-SIZE BLUEPRINT FOR HALF PRICE!
 If desired, a full-size blueprint can be obtained for half price, that is 9d., post paid, if the coupon to be found on the last page is used before November 30. Address your application to the "Wireless Magazine" Blueprint Department, 58-61 Fetter Lane, London, E.C.4. Ask for No. WM375. Remember that a full-size blueprint shows the position and correct length for every wire; in fact the blueprint can be used as a template

tuned by a separate condenser. Thus there is a two-gang and a single .0005-microfarad condenser, with two separate tuning dials. The tuning scales of the condensers used are marked in wavelengths and degrees: unfortunately the coils do not match up with the wavelength calibrations with any accuracy, and the set should be calibrated by the degree markings. Both condensers, however, tune at about the same point for any given station, although the difference may amount to 10 degrees.

Selectivity

All over the medium waveband the selectivity is about 9 kilocycles, and on the long waveband a selectivity of about 10 kilocycles is obtained. Careful tests show that the set is capable of bringing in all the stations that are worth hearing, and not more than five sources of second-channel interference have been traced.

No Short Waves

It will be remembered that the original oscillator coil had three wave ranges—long, medium and short. In this set only the long- and medium-wave sections can be utilised. Many constructors would like to use the short-wave

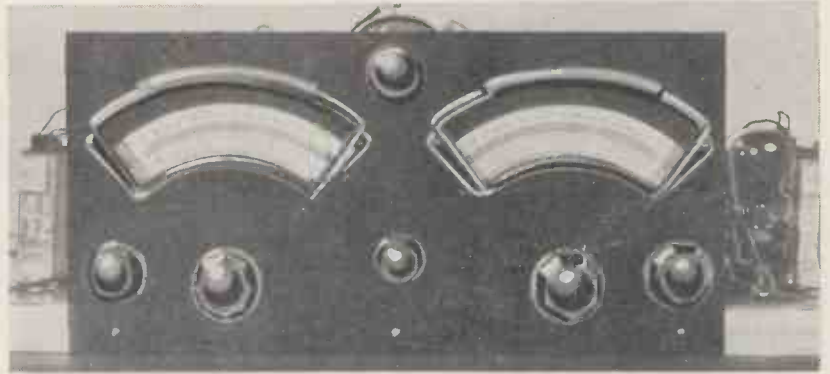

From left to right are local-distance switch, aerial tuner, wave-change switch, oscillator tuning, combined on-off and volume control. The knob at the top is for oscillator switching.



GLOSE-UP OF THE L.F. SIDE
A few hints on construction will be obtained by a close examination of this close-up view of the low-frequency side of the set

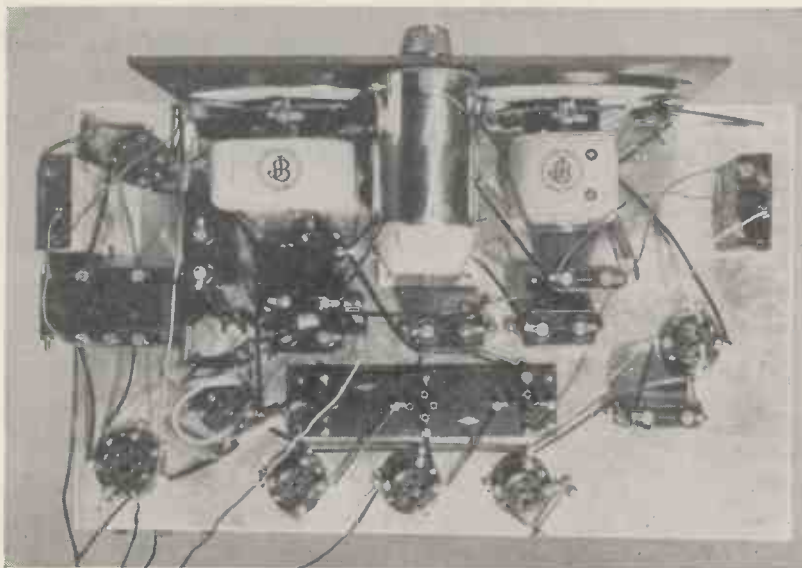

PLAN VIEW OF THE MODERN SUPER SENIOR
In spite of its very ambitious design, the actual amount of work involved is really quite small. This plan view should be consulted in conjunction with the wiring plan on the opposite page

section, but this is full of difficulties.

It should also be remembered that the oscillator coil is designed for 126-kilocycle intermediate frequency, so it is not possible to use 110-kilocycle intermediate coils.

The oscillator circuit is arranged to give a simple form of anode coupling, and it should be noted that the oscillator valve is given the same grid bias as the first intermediate-frequency valve.

Resistance-capacity Coupling

In order to save space and also expense the second detector is coupled to the class-B driver by the resistance-capacity method: as a high-frequency pentode or screen-grid valve is used as second detector this gives adequate amplification.

With such a powerful set it is obvious that serious overloading would be experienced from the local stations unless some precaution were taken to avoid it. We have incorporated in the set a local-distance switch: when operated this puts a 500-ohm resistance across the aerial-earth circuit and thus cuts down the input.

Combined Volume Control

By doing this we have dispensed with the need for a high-frequency volume control. Actually we have used a low-frequency control: this takes the form of a variable grid leak to the resistance-coupled stage, and is therefore equally suitable for radio and gramophone working.

In all there are six controls on the set. At the top in the centre is the oscillator wave-change knob: remember that only the long- and medium-wave sections are used. In the middle of the panel are the two tuning controls, the two-gang condenser for aerial and high-frequency tuning on the left, and the oscillator

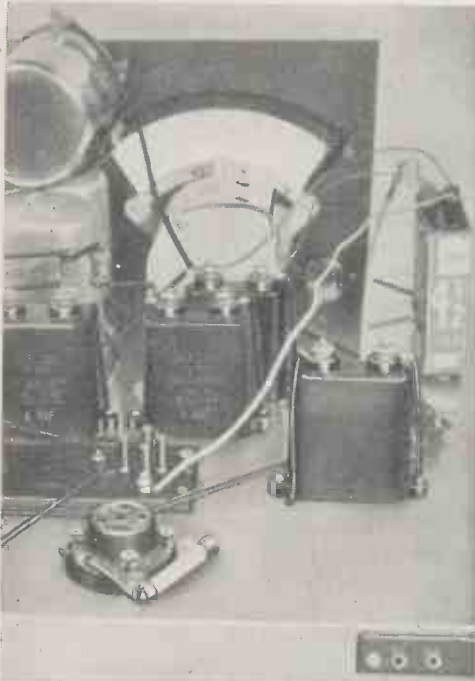

CLOSE-UP VIEW
A close-up of the set showing the method by which the small resistances are carried in the wiring

tuning condenser on the right.

The three knobs along the bottom of the panel are the local - distance switch, the wave-change switch for the iron-core coils, and the combined volume control and on-off switch.

Those who already have the Super Senior mounted in a cabinet will probably find that if they cut a hole in the front they will be able to accommodate the

whole of the ebonite panel used in the new set. In other words, by cutting a hole large enough to allow all the control knobs to project through they will be able to fit the set up without buying a complete new cabinet.

For the sake of simplicity, baseboard construction has been adopted as for the original set, and it is not anticipated that any snags will crop up during the actual assembly of the parts. In these pages is produced a third-scale layout and wiring diagram, but if desired, of course, the usual full-size blueprint is available.

This can be obtained for half price, that is 9d. post paid, if the coupon on the last page of this issue is used by November

30 and sent to "Wireless Magazine" Blueprint Dept., 58-61 Fetter Lane, London, E.C.4; ask for No. WM375. As we have already mentioned, connections for using the original intermediate-frequency coil assembly will be published in the next issue.

About Suitable Valves

When it comes to putting the set into operation our previous remarks about the use of screen-grid valves in place of high-frequency pentodes should be borne in mind. This type of valve—it does not matter how old provided they still retain their characteristics—can be used in the high-frequency, intermediate-frequency and second-detector stages. Any ordinary low-frequency valves can be used in the oscillator and class-B driver stages, unless the 240B class-B valve is employed, in which case the driver must be of the small power type. Many constructors will have only to buy the first detector and output valves.

We found that on H.T. +1 82 volts was sufficient to make the receiver lively without being unstable.

As a general rule apply 60 volts to the screen of the high-frequency pentode, but if you intend to use your original screen grid valves then it is more than likely that this voltage will have to be increased.

The bias applied to the first intermediate-frequency valve is inclined to be critical. Adjust this carefully!

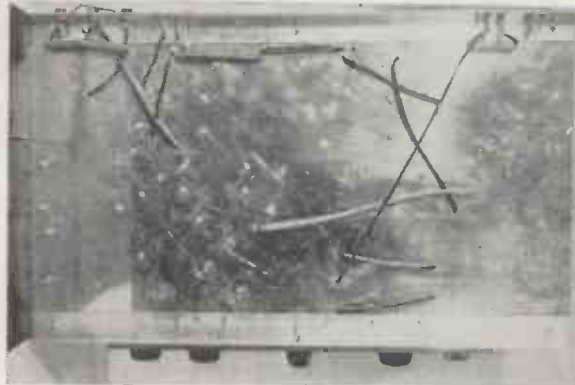

UNDERNEATH THE CHASSIS
As you can see, there is little work to be done underneath the chassis. The set, therefore, is very simple to build

COMPONENTS NEEDED FOR THE MODERN SUPER SENIOR

BASEBOARD		£ s. d.	2—Clix spade terminals marked: LT+, LT—		£ s. d.	TRANSFORMER, INTERMEDIATE-FREQUENCY		£ s. d.	
1—Aluminium 20 in. by 12 in. with two aluminium angle strips 20 in. by 3/4 in. by 3/4 in.	say	4 6	3—Clix insulated sockets, marked: black(2), red	...	6	3—Wearite, type OT2	...	1 2 6	
CONDENSERS, FIXED			1—Clix terminal strip, marked: pick-up	...	6	TRANSFORMER, LOW-FREQUENCY			
9—T.C.C. type tubular valves: .0001-, .0002-, .0005-, .001-(2), .002-, .005-, 1-microfarad (2)	...	9 4	1—Clix terminal strip, marked: A1, A2, E	...	7	1—Ferranti class-B input, type AF17C	...	15 0	
7—Dubilier, type BB, valves: 1-(3), 1-, 2-microfarad(3)	...	18 6	RESISTANCES, FIXED			ACCESSORIES			
CONDENSERS, VARIABLE			9—Franklin, type 1/2-watt: 500-, 1,000-(2), 5,000-, 10,000-, 20,000-, 100,000-ohm, 1-megohm(2)	...	4 6	BATTERIES			
1—J.B. .0005-microfarad, type Nugang with Arcuate drive	...	13 9	RESISTANCE, VARIABLE			1—Anodex 120-volt, type TSA120	1	4 0	
1—J.B. .0005-microfarad twin-gang, type Baby Gang with arcuate drive	...	16 3	1—Erie 1-megohm with switch	...	4 6	2—EverReady 4.5 volt grid-bias, type UW6	...	2 0	
COILS			SUNDRIES			1—Exide, 2-volt accumulator, type 1-CZG4	...	18 0	
1—Varley twin unit, coil types BP50, BP51	...	1 2 0	1—Peto Scott triple coil holder	...	2 9	CABINET			
1—Wearite oscillator, type O2	...	18 6	Round tinned copper wire, No. 20 gauge, for connecting (Goltone),	...	9	1—Osborn, type 228 in oak			5 5 0
1—Wearite, type HFFA	...	4 0	Oiled sleeving (Goltone)	...	1 3	GRAMMOPHONE MOTOR			
HOLDERS, VALVE			4 yd. thin flex (Goltone)	...	4	1—Garrard, type No. 30 with automatic stop and 12 in. turntable	...	1 10 6	
7—Telsen four-pin	...	3 6	2 ft. screened sleeving (Goltone)	...	6	NEEDLE CUPS			
1—Telsen seven-pin	...	1 6	2—Bulgin grid-bias battery clips, type No. 2	...	9	1—Bulgin Duplex, type NC1	...	2 0	
PANEL			5 doz. 6BA 1/2 in. round head steel bolts and nuts (Adams)	...	1 6	PICK-UP			
1—Ebonite 14 in. by 7 in.	...	5 0	6—Bulgin knobs, types K44(2), K46(4) with one 3/16 in. reducing sleeve	...	3 5	1—Ediswan Minor	...	1 1 0	
PLUGS, TERMINALS, ETC.			SWITCH			VALVES			
10—Clix wander plugs, marked: GB-1(2), GB-2(2), GB+(2), HT+1, HT+2, HT+3, HT-	...	1 3	1—Bulgin rotary on-off, type S91	...	1 9	3—Cossor 210SPT I.F.'s an 1 second detector	...	2 0 6	
						1—Cossor 210VPT H.F. stage	...	13 6	
						1—Mullard PM12A First detector	...	12 6	
						1—Osram LP2 Driver	...	7 0	
						1—Osram B21 Class-B	...	14 0	
						SUITABLE MAINS UNIT			
						Atlas, type T10/30 for A.C. mains	...	3 9 6	

What I Think of the New German Radio

By J. H. REYNER, B.Sc., A.M.I.E.E.

In this article our Technical Editor, who paid a flying visit to the Berlin Radio Exhibition, puts forward his views on the efficiency of German radio. He believes that competition in Germany is directed towards technical improvements and not towards a continual cheapening of the product as is seemingly so in this country. He also deals with the position of television in Germany



Keystone photo
Televising the opening of the German Radio Exhibition. On the left is seen the bottom of the Funkturn, the radio tower

AS the Berlin radio exhibition coincided with our own, and as I wanted to have a good look at both, I saved time by flying over. On this journey I had a striking demonstration of the efficiency of German commercial radio. On the last part of the journey from Hanover the pilot climbed high above the clouds and we flew "blind" in brilliant sunshine for over an hour.

Flying by Radio Control

At the end of that time, during which we had covered over 100 miles without seeing the ground, the pilot simply dropped gently through the clouds and there we were over Potsdam, Berlin's inland seaside resort, and we soon landed at Tempelhof aerodrome. I discovered later that this snappy navigation was accomplished largely by radio directional control.

I had a momentary setback when trying to find the Exhibition. The magic word "radio" produced no response in the taxi-driver's breast however I pronounced it. Suddenly I remembered that radio in Germany is called "*funk*."

"Ach——" said the taxi-driver, "*die funkausstellung. Jawohl.*" And off we went.

One exhibition is very much like another, but there were several points which struck me right at the outset. The first, I think, was the absence of the noise which one always finds at Olympia. Not that the place was silent. Far from it, but one did not find every stand blaring forth canned music of doubtful quality from multiple loud-speakers.

There were some loud-speakers, operated by the exhibition authorities, on which announcements were made from time to time. Outside in the grounds music was broadcast continuously from the special street-lamp type of loud-speaker which is quite a familiar sight over there.

Talking about the grounds, one is, of course, impressed by the layout of the exhibition. The various halls are grouped round three sides of a square. This central portion is laid out as a garden, and on the terraces at the side are tiers of tables where one can drink beer or have an alfresco meal.

In the centre, and dominating the whole situation, rises the Funkturn, the radio tower. From the top of this tower, incidentally, the seven-metre television programmes were being radiated.

To return to the inside, the next feature that arrests one's attention is the absence of elaborate display. The stands are attractively laid out, and one feels that they are there to display wireless receivers and that the public is there to look at radio sets.

There is an absence of distraction, which was in rather marked contrast with our own exhibition.

I could not help drawing rather invidious distinctions when I returned to our own exhibition at Olympia. The first thing that greeted one inside the doors was: "This way for the B.B.C. theatre—get your tickets now."

B.B.C. Box Office

In fact, coming in from the main entrance in Hammersmith Road, you could see no sign of the exhibition until you had passed the B.B.C. theatre, the B.B.C. box office, and numerous other distractions.

If you did by any chance deviate a little to the right, you passed into the Post Office exhibit, where a bored-looking individual was running a model train round and round a track. To this day I am not quite clear what this has to do with wireless.

It was only when you had braved all these perils that you came to the Radio Exhibition proper, and there is perhaps some excuse for the girl who was overheard to say, as she came out of the B.B.C. theatre: "What shall we do now, Bert?"

In Berlin you paid to go into a wireless exhibition, and you jolly well did. Nor did I see any signs of dissatisfaction. In fact, everybody seemed thoroughly interested.

Ingenious Dials

As I walked round the exhibition certain other impressions began to form. I think the outstanding one was the excellence of the dials. Many ingenious arrangements were shown, but in almost every case the dial was a large one, usually rectangular in shape and at least 8 in. long.

It was marked with station names, and was so arranged that the veriest novice could not fail to find the station required.

With very few exceptions the only sets showing the usual small window dials were the Volksempfänger—the People's Receivers, which every firm makes to government contracts. This is the simplest and cheapest possible form of set which is capable of meeting the general requirements, and there is, of course, no use for an elaborate dial here.

The next impression was that the majority of sets were fitted for short-wave receiving as well as the ordinary broadcast bands. The same clear marking on the dials was used, and in many cases the principal stations were also indicated by name.

Higher Prices

Prices generally were definitely higher than over here, even with the mark at par. There was also a somewhat surprising unanimity of price in the various categories, and it was not until I got into conversation with one of the manufacturers that I discovered the reasons.

The fact is that the German radio industry is controlled, partly by its own organisations and partly by the Government, so that the haphazard and almost suicidal methods which are so common in this country

are not allowed. Receivers are divided into categories, and there is a minimum selling price fixed for each category.

This price is one which allows the manufacturer to make a living—rather a surprising thought. Competition among the various manufacturers has to be on the grounds of technical performance, which acts as an incentive to the development of better circuits.

My manufacturer friend showed me his main line for the season—a reflex super-het using only four valves, but actually doing the work of five. This set came within the four-valve category and therefore could be sold in competition with a straight four, but it had just that little extra performance which enabled him to meet competition.

It cost him little more to make than the straightforward super. I actually heard the set—of course, in Berlin one can hear any of the sets demonstrated in special audition rooms—and its performance was rather remarkable.

I remarked to my friend on the absence of mediocre sets. There seemed to be little between the people's set at a very cheap rate and the quite expensive long-range receivers. He told me that this is so, the reason being that information in Germany at the present time is rather restricted.

Newspapers are censored, and the broadcast news is similarly limited. Hence many people like to use powerful receivers on which they can obtain the news from abroad. Good long-distance reception, free from interference and fading, is very much at a premium at the present moment. For the same reason, short-wave reception is becoming an increasingly popular feature.

He also told me a number of interesting technical points. For one thing, there has been a valve holiday, and valve-makers have not put out any new types for about a year, at least as far as the home market was concerned.

German Sets Ahead?

Yet despite this, I should consider the modern German set rather ahead of the British one in performance and design. He also told me that the standard intermediate-frequency for super-hets in Germany was 473 kilocycles.

Now this frequency is one which I have advocated myself on many occasions since it has the advantage that a band-pass aerial tuning circuit is not required and a simple two-gang condenser can be used in place of the usual three-gang arrangement necessary for 110- or 126-kilocycle arrangements.

There are certain difficulties connected with the aerial circuit, but he told me how these had been overcome by concerted effort on the part of the set manufacturers, and that in order to give the greatest possible assistance to the set maker the Government had kept the region around 473 kilocycles free of any commercial radio-telegraphy stations, so that there should be no difficulty through interference. Truly a little co-operation can achieve a great deal.

General Impressions

I cannot detail the various interesting ideas that I saw at the stands, but must content myself with general impressions. As readers will probably have gathered, television was featured to a much larger extent than over here, a special hall being devoted to the purpose.

Continued on next page.

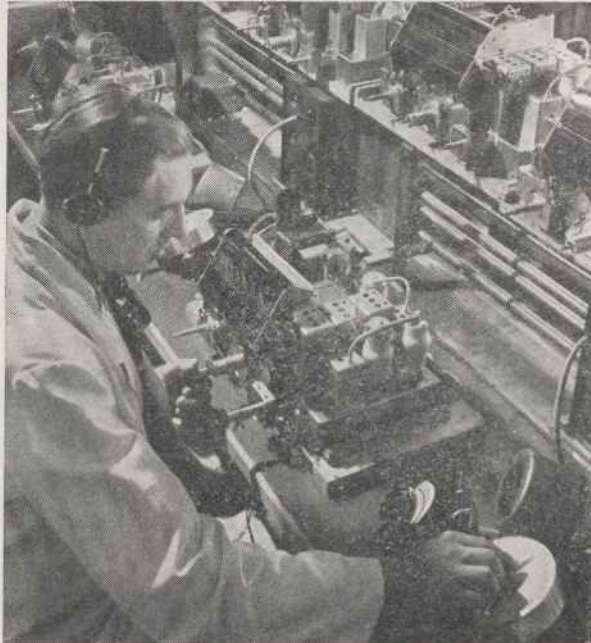

Gulliland photo

STRINGENT TESTS FOR GERMAN SETS
An engineer in the Siemens works at Berlin testing the sensitivity of a multi-valve super-het. A small transmitter operating on various wavelengths is used for these tests

Is Delayed A.V.C. Worth While? P. Wilson's Reply

A short article under the above title, which appeared on page 136 of the September "Wireless Magazine," has brought an expression of disagreement from Marcus G. Scroggie, A.M.I.E.E., who is a regular contributor to these pages. Mr. Scroggie's letter, and an answer to it by P. Wilson, M.A., are presented on this page

The Editor.

In your September issue, on page 136, P. Wilson asks "Is Delayed A.V.C. Worth While?" and then proceeds to show, to his own satisfaction, that it is not. But what sublime self-confidence! "I see no reason why everybody does this; therefore there is no reason; and everybody (except myself) is a nit-wit. Q.E.D." is what his argument amounts to.

Lest there should be any misunderstanding about this, Mr. Wilson says (about delayed A.V.C.) "every designer seems to adopt it without thinking." Does he really believe that commercial sets are designed in this way? When every fraction of a penny spent counts in the keen competition?

Some readers who were bewildered by his outburst may be interested in the following brief explanation.

The drawing on this page shows a characteristic taken from a typical modern receiver at present on the market. It shows (to a logarithmic scale) the milliwatts output available for the loud-speaker corresponding

to signals ranging from the very weak (a few microvolts) to the very strong (over 100,000 microvolts).

It will be noted that the graph has two distinct parts: AB with a steep slope, where a small increase in signal strength causes a large increase in volume; and BC, where the signal strength can change enormously with but a small change in volume.

AB is the normal condition of a receiver without A.V.C., and it is obvious that if not checked at B it would cause gross overloading of the

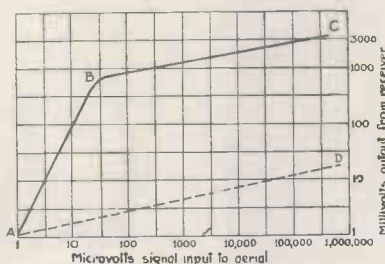

output valve with any except very weak signals. Therefore A.V.C. is put into use to give the part BC.

On the other hand, if A.V.C. were adopted from the start, as Mr. Wilson would have us do, the result would be AD, in which full output is never obtained, except perhaps within sight of the Droitwich aerial.

This is only an everyday commonplace of every designer's job; so it would be interesting to know who are the "scores of knowing folk" Mr. Wilson consulted on the matter.

Marcus G. Scroggie, A.M.I.E.E.

What I Think of the New German Radio—continued.

Here actual production models of receivers could be seen working. In some cases the transmissions were generated by the firms themselves, and in others they were picked up from the German Post Office transmissions on ultra short wavelengths being radiated from the exhibition grounds.

Really brilliant pictures with surprising detail were obtained, mostly with cathode-ray systems, although one mechanical system—the Te-Ka-De—was giving very pleasant results. Television sets are not yet on the market, nor is the service properly under way, but the exhibition was used for its legitimate purpose of showing the public the present state of the art and what they could expect in a comparatively short time.

As regards actual set construction, the German methods are interesting. There were numerous little points of detail of which I made a note, but I felt here that the British manufacturer was not so far behind, if he was behind at all.

There was, however, all the time an undercurrent of development. Considerably greater use was made of iron cores for high-frequency coils, and the material used was in such a form that it could be worked mechanically into very pleasing assemblies.

Competition in Germany is directed towards *improvement*. In this country, at the present time, it is directed towards a continual cheapening of the product. The reader will have his own ideas on this point.

MR. SCROGGIE must forgive me if I do not follow him into the realm of personalities. I *did* consult scores of knowing folk, including quite distinguished technicians, because I was afraid that there must be something about delayed A.V.C. that I had missed.

Mr. Scroggie must also forgive me if I am frankly incredulous when I am confronted with his conclusion that "if A.V.C. were adopted from the start . . . the result would be . . . full output is never obtained, except perhaps within sight of the Droitwich aerial."

Full Output from Rennes

For I happen to be able, here in South London, to get full output even from Rennes!

The proof of the pudding is evidently not in Mrs. Beeton. What Mr. Scroggie means, of course, is that with one particular design the substitution of non-delayed for delayed A.V.C., *without any other modification*, reduces amplification.

Anyone who makes a few experiments, however, will soon discover that with non-delayed A.V.C. a number of substantial modifications are possible. Thus the controlled valves are inherently stable and no permanent bias is really necessary.

What the resulting sensitivity curve is I am unable to say offhand, but it is certainly more favourable than the line AD of Mr. Scroggie's diagram.

This diagram, which, by the way, bears a family likeness to one I used in my article on "Squelch," some fifteen months ago, is apt to be somewhat misleading in another respect. At first sight one would be tempted to say that it clearly shows that there is a bigger *proportionate* change of output for the same change of input (say, between 10,000 and 1,000 microvolts) in the case of the line AD than for BC. But work it out and you will find that both are about 30 per cent.

The illusion is created by the fact that logarithmic scales are used. Although the diagram does not actually show it, however, I believe that it is true that by the non-delayed A.V.C. method one can get a more nearly complete anti-fading characteristic.

P. Wilson. M.A.



Columbia photo
Ay! some lad this! It is Stanley Holloway suitably attired for "The Beekeeper," recorded by Columbia this month

YOU know Tchaikovsky's *Nutcracker Suite*. No! Well, there is no excuse for your appalling ignorance any longer. The most rhythmical tunes ever. Decca, with the Berlin State Opera Orchestra, has made three really fine records of the work. You can't beat these "numbers." Tchaikovsky would resent the term, all the same. CA8182, 3, 4 (4s.).

H.M.V. has produced a *Streamline* selection. Fairly good—I mean the music. Orchestra—the New Mayfair—very good. Conductor—Ray Noble—he certainly knows what he is about. C2691 (4s.).

Parlophone has done quite a nice selection (via the Grand Hotel Orchestra at Eastbourne, under Leslie Jeffries) of *The Balkan Princess* with a pleasing *Springtime Serenade* on the reverse.

I think the Grand Hotel is an ideal place both for broadcasting and recording (same thing, really). Get this; you will like it. R1887 (2s. 6d.).

Another selection comes from the House of Columbia, *Chu Chin Chow*. This disc has Malcolm McEachern (Jetsam) as the soloist, accompanied by the Gaumont-British Orchestra under Louis Levy. The numbers he sings are *Behold* and, on the reverse, *I am Chu Chin Chow* and *Olive Oil*. DX598 (4s.). A good disc, this!

A further issue of *Chu Chin Chow* appears on DX599. This is mainly choral, with Columbia's own Light Opera Company and a light orchestra.

These two discs should make a valuable addition to any record library.

H.M.V. give us selections from *Tosca* with Marek Weber and his orchestra on C2671 (2s. 6d.). You know the orchestra, and probably you have some knowledge of the opera. I can sincerely recommend this record to your notice.

A sort of selection is produced on Columbia DX595 (4s.), in which Turner Layton plays what are termed *Piano Show Memories*. Very effective. Introduces *Rose Marie*, *New Moon*, *Bitter Sweet*, *No, No, Nanette*, etc. Quite worth having!

I think you ought to ask to hear Miliza Korjus singing arias of Mozart and Puccini (C2688, 4s.), accompanied by the Berlin State Opera Company. Really fine! There is a sonority about that orchestra that should appeal to most people. It is an H.M.V. disc.

H.M.V. turns out a splendid celebrity record by Richard Crooks. You have to pay a good price for it,

Choosing

New Records Reviewed by

but you get good value, of course. On DA1386 he sings *The Prayer Perfect*, which I like immensely, and *So We'll Go No More A-roving*, which I think everyone will like. Definitely a fine production!

Another celebrity record, at a lower figure, is dear old Ben Davies singing *Songs of Araby* and *I Know of Two Bright Eyes*. Well worth having to hear how he sings them.

Jan Kiepura—a tenor of quality—sings *My Song*



Columbia photo

"Yes, Sir! I Love Your Daughter" just about to be recorded by Bobby Howes (left) and Carroll Gibbons (centre) while Raymond Langley, the Columbia impresario, looks on

For You, from the film of that name, and also *With All My Heart* from the same source. Some of these theme-songs are being very well written. They used *not* to be. Kiepura will surprise you, I imagine. Try him. Parlophone RO2061 (4s.).

It is not often we get a massed orchestra of 'cellos, but Columbia (DB1429, 2s. 6d.) has dared to produce the *Andante Pastorale* from the *William Tell* overture with Schumann's *Träumerei* on the reverse. A successful experiment. The celeste makes a little variation in tone. Those 'cellos are really top-hole. I hope Columbia will issue further records of this kind.

The Columbia Dramatic Players, with Raymond Newell and chorus,



Harry Roy is seen immersed in reading a fan letter measuring some 30 by 22 in. from a Newcastle listener. He records on Parlophone

Your Records

WHITAKER-WILSON

orchestra and effect, have let themselves go on a descriptive ballad called *Anchored*.

I think I had better suggest you hear it. You may like it very much, or . . .

Well, the number is DX601 (4s.).

We do not get too much humour these days. Stanley Holloway can generally be relied upon to give good quality. On Columbia DX603, he does *The Beefeater*

and *With Her Head Tucked Underneath Her Arm* (the woman must be an acrobat). He is very good, and Wolseley Charles plays an effective accompaniment for him.

Ravel's *Bolero* is in the news again. A film with that title has recently been made and it has been and is a tremendous success. Ravel's work features in this film. Now Decca has released a version of the tune played by Harold Ramsay and his Rhythm Symphony Orchestra. It is an eighteen-penny disc worth getting! (Decca F5236).

LIGHT SONGS

(a) *Dinah*, (b) *Diga Diga Doo*, The Four Aces, 1s. 6d.

DECCA F5198

The Four Aces imitate a dance band, as do the Mills Brothers. Just as successful, I think, although they are not so famous. The chief point of recommendation is that they get more variation. A really cheap record this for eighteenpence!

(a) *Judy*, (b) *Isle of Capri*, Al Bowilly with Monia Litter at the piano, 1s. 6d.

DECCA F5188

(b) seems, from correspondence, a tune that has taken on; though, frankly, I cannot see why. Anyway, Al Bowilly fans will go into raptures over this disc. Recording is remarkably well done. Decca is releasing some winners these days!

LIGHT SELECTIONS

All the Latest, No. 2, Debroy Somers' Band, 2s. 6d.

COL DB1431

I want to pay this band a compliment first of all. I heard them broadcast on the Saturday night when Henry Hall was on holiday. That broadcast was, in my opinion, the most entertaining dance-music session I have yet heard. I would like to hear more of this band on the radio. Their

Record Reviews by Chopstick

selection here—up to equally good standards—contains many old favourites, such as "Nasty Man," "Arlene," "Dancing in the Moonlight," and "Inka-dinka-doo." A splendid disc for parties!

(a) *Cockchafers Tea Party*, (b) *Electric Girl*, Bravour Dance Orchestra, 2s. 6d.

PARLO R1913

Two light orchestral works, more suited for the Commodore Grand Orchestra than a dance band. Nevertheless, this German band does turn out good tuneful stuff. I thought the bass in this record was rather weak.

(a) *Rhythm in Riffs*, (b) *College Stomp*, piano duets by Depiane and Rossi, 2s. 6d.

BRUNS 1846

Worth having, this! Very original piano duets, both of them, and they are recorded particularly well. Modern really; but enjoyable all the same. I recommend them without hesitation.

Streamline (d.s.), piano selection by Patricia Rossborough, 2s. 6d.

PARLO R1917

All you want to know is in the title. It is well recorded and should satisfy those who want *Streamline*

tunes as a syncopated piano medley.

Twenty Million Sweethearts—selection (d.s.), Brian Lawrence and the Quaglino Quartet, 1s. 6d.

DECCA F5184

A selection of tunes from the film, played by a snappy modern foursome. I thoroughly enjoyed it, considering that I am not too enthusiastic about the tunes themselves

DANCE MUSIC

(a) *Kiss Me, Dear* (f.), (b) *You Turned Your Head* (f.), Jack Jackson and His Orchestra, 2s. 6d.

H.M.V. B6522

I am not too keen on these two tunes, which are from the new Palace show, *Streamline*. (a) is the better of the two; Jack Jackson has made a good number out of it and especially the vocal chorus, which is sung in the form of a duet. As a mere dancing record it will be hard to beat; I must give all the praise to the band.

(a) *Love in Bloom* (f.), (b) *Straight from the Shoulder* (f.), Club Carolina Orchestra, 2s. 6d.

BRUNS 1840

Rather disappointed in this. The Club Carolina is reputed to be one of New York's social centres, and I expected a band above the ordinary run of commercial American standard. (a) is a good tune when played with a little of that so-called "feeling." A friend who was with me when I was trying out this disc put the matter in a nutshell. He described it as "cool and callous."

★(a) *Miss Otis Regrets* (f.), (b) *Judy* (f.), Lew Stone and His Band, 1s. 6d.

DECCA F5152
Lew Stone is at his best in (a). It is a comedy number taken to decent limits. In other words, it is not overdone. "Judy"—just an ordinary fox-trot—has been made interesting by clever orchestration. I can see this band reaching even greater heights in the dance-music world.

★(a) *Nasty Man* (f.), (b) *My Dog Loves Your Dog* (f.), Harry Roy and His Orchestra, 2s. 6d.

PARLO R1865
This, in my mind, is Harry Roy's masterpiece. "Nasty Man" is the snappiest piece of work from this band yet. I like the cheerful atmosphere, the noisy choruses, and, best of all, the fine piano interludes. (b) has exactly the same recommendations. Starred as the best dance record of the month.



If appearance matters, this Marconiphone eight-valve super-het auto-radiogram should merit consideration

Directory of Brand Names

(See also pages 297—306)

Adey.—Adey Portable Radio, 99 Mortimer Street, London, W.1.
Aerodyne.—Aerodyne Radio, Ltd., Aerodyne Works, Walthamstow, London, E.17.
Alba.—A. J. Balcombe, Ltd., 52-58 Tabernacle Street, London, E.C.2.
Allwave.—Allwave International Radio and Television, Ltd., 242 High Street, Bromley, Kent.
Atlas.—H. Clarke & Co (M/cr.) Ltd., Atlas Works, Patricroft, near Manchester.
Austin.—City Accumulator Co., Ltd., 18-20 Normans Buildings, Central Street, London, E.C.1.
Beethoven.—Beethoven Radio Ltd., 24 Great College Street, London, N.W.1.
Betterset.—Betterset Radio, Ltd., Clarendon Works, Montague Street, Worthing, Sussex.
B.S.R.—Birmingham Sound Reproducers Ltd., Claremont Street, Old Hill, Staffs.
Burgoyne.—Burgoyne Wireless (1930) Ltd., Great West Road, Brentford, Middlesex.
Bush.—Bush Radio, Ltd., Woodger Road, London, W.12.
Consolidated.—Consolidated Radio Co., Ltd., Worpole Way, Acton, London, W.3.
Cossor.—A. C. Cossor, Ltd., Highbury Grove, London, N.5.
Drummer.—Edge Radio, Ltd., Salop Street, Bolton, Lancs.
Dynatron.—H. Hacker & Sons, Ray Lea Road, Maidenhead, Berks.
Eddystone.—Stratton & Co., Ltd., Bromsgrove Street, Birmingham.
Ekco.—E. K. Cole, Ltd., Ekco Works, Southend-on-Sea, Essex.
Eldeco.—Eldeco Radio, Ltd., 62 Conduit Street, London, W.1.
Ferranti.—Ferranti, Ltd., Hollinwood, Lancs.

Higgs.—Charlton Higgs (Radio) Ltd., Westbourne Place, Hove, Sussex.
His Master's Voice.—The Gramophone Co., Ltd., 98-108 Clerkenwell Road, London, E.C.1.
Hyvolt Star.—Universal High-Voltage Radio, Ltd., 28-29 Southampton Street, London, W.C.2.
Invicta.—United Radio Manufacturers, Ltd., 79a Parkhurst Road, London, N.7.
Kolster Brandes.—Kolster Brandes, Ltd., Cray Works, Sidcup, Kent.
Lampex.—Lampex Radio & Electric Co., 62 Brewery Road, London, N.7.
Lissen.—Lissen, Ltd., Worpole Road, Isleworth, Middlesex.

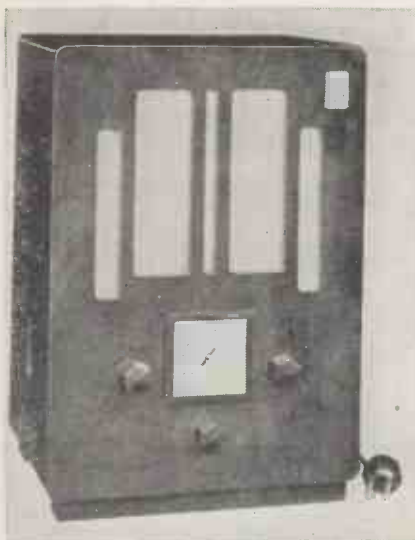

This year's version of the now famous Pup from the Kolster Brandes range. This is the A.C. model

G.E.C.—General Electric Co., Ltd., Magnet House, Kingsway, London, W.C.2.
Halycon.—Halycon Radio, Ltd., Valetta Road, London, W.3.
Halford.—Halford Radio, Ltd., 39 Sackville Street, London, W.1.
Harken.—Harke Electrical Co., Ltd., 18a South End, Croydon.
Hartley Turner.—Hartley Turner Radio Ltd., Thornbury Road, Isleworth, Middlesex.
Lotus.—Lotus Radio (1933) Ltd., 105 Judd Street, London, W.C.1.
Magnum.—Burne Jones & Co., Ltd., 296 Borough High Street, London, S.E.1.
M.R.G.—Mains Radio Gramophones Ltd., Vaughan Street, Bradford, Yorks.
Marconiphone.—Marconiphone Co., Ltd., 210-212 Tottenham Court Road, London, W.1.
McMichael.—McMichael Radio, Ltd., Wexham Road, Slough, Bucks.
Midgley.—Midgley Hamer, Ltd., Dukes Road, North Acton, London, W.3.
Milnes.—Milnes Radio Co., Ltd., Church Street, Bingley, Yorks.
Mullard.—Mullard Wireless Service Co., Ltd., 111 Charing Cross Road, London, W.C.2.
Multitone.—Multitone Electric Co., Ltd., 95-98 White Lion Street, London, N.1.
Northampton Plating.—Northampton Plating Co., Northampton.
Ormond.—Ormond Engineering Co., Ltd., Rosebery Avenue, London, E.C.1.
Pegasus.—Pegasus, Ltd., Low Mills, Nursery Mill Lane, Lower Wortley, Leeds.
Philco.—Philco Radio & Television Corporation of Great Britain, Ltd., Aintree Road, Perivale, Middlesex.
Philips.—Philips Lamps, Ltd., 145 Charing Cross Road, London, W.C.2.
Portadyne.—Portadyne Radio (Whittingham, Smith & Co., Ltd.), Gorst Road, London, N.W.10.
Pye.—Pye Radio, Ltd., Cambridge.
Radiolux.—Amplion (1932) Ltd., 82-84 Rosoman Street, London, E.C.1.
Radiophone.—British Radiophone, Ltd., Aldwych House, Aldwych, London, W.C.2.
Regentone.—Regentone, Ltd., Worton Road, Isleworth, Middlesex.
R.G.D.—Radio Gramophone Development Co., Ltd., 18-20 Frederick Street, Birmingham.
R.I.—Radio Instruments, Ltd., Purley Way, Croydon, Surrey.
Shallers & Evans.—Shallers & Evans, Havelock Street, Forest Hill, London, S.E.23.
Standard.—Standard Telephones and Cables, Ltd., 364 Grays Inn Road, London, W.C.1.
Sunbeam.—Sunbeam Electric, Ltd., Park Royal Road, North Acton, London, N.W.10.
Telsen.—Telsen Electric Co., Ltd., Thomas Street, Aston, Birmingham.
Ultra.—Ultra Electric, Ltd., Erskine Road, London, N.W.3.
Wurlitzer.—Wurlitzer Lyric Radio Ltd., 33 King Street, London, W.C.2.

Let your ear and
your pocket decide!

First came wrapped
cells for longer life
-then came stabilised
electrolyte for purity
and power



G.E.C. H.T.

MADE IN ENGLAND

SOLD BY ALL RADIO DEALERS

PRICES:

60v: 5/6, 99v: 9/-, 108v: 10/- 120v: 11/-,
124½v: 11/6, 139v: 12/9, 150v: 14/-. Also
Triple Capacity—60v: 8/6, 120v: 17/6.

GUARANTEED 120 VOLT • 144,000
MILLIWATT HOURS

A TRIAL MEANS YOU'LL ALWAYS USE G.E.C. H.T.

Advt. of The General Electric Co. Ltd., Magnet House, Kingsway, London, W.C.2.

TESTS OF NEW APPARATUS

Blue Spot Permanent-magnet Moving-coil Loud-speaker :: Atlas A.C. Mains Unit :: T.C.C. Anti-interference Unit :: Clix Electric-light Adaptor :: Anacos Earthing Rod



A new Star loud-speaker by Blue Spot which gives well-balanced reproduction

BLUE SPOT LOUD-SPEAKER

APPARATUS : Permanent-magnet loud-speaker.
MAKERS : British Blue Spot Co. Ltd.
PRICE : £1 15s.

BLUE SPOT have produced another loud-speaker with their new magnet system, this model being known as the Star Junior. The efficiency is naturally slightly lower than that of their larger model, as one would expect since this has only two magnet units instead of four, but the field strength is nevertheless higher than many more massive magnets of the older pattern.

The unit carries its own transformer as is usual practice to-day, and a series of tappings is provided to enable the best matching to be found. Both primary and secondary of the transformer are tapped, giving a flexible arrangement suitable for a variety of loads.

On test we found the reproduction even except for a certain shrillness in the region of 4,000 cycles. On the

other hand, the resonance so often found in loud-speakers at around 2,500 to 3,000 cycles was absent.

Since all small loud-speakers have an upper frequency resonance somewhere this is clearly an attempt to shift the undesirable effect to a point where it will do least damage.

There is a rather sharp cut-off at about 5,000 cycles, which is helpful in these days of over crowding on the air, since high-pitched heterodynes are not reproduced.

Incidentally the instrument is provided with special sockets which enable it to be used as an extension loud-speaker if required. Altogether this can be considered a good job.

ATLAS MAINS UNIT

APPARATUS : Mains unit.
MAKERS : Atlas (H. Clarke & Co., Ltd.).
PRICE : £3 9s. 6d.

IT was with pleasure that we tested one of the new Atlas mains units, for they are always of a reliable nature.



The panel of the Atlas A.C. mains unit showing the voltage tappings at the top and the trickle-charger switch below

This new Atlas T10/30 model mains unit is intended to supply high-tension voltages for the modern receiver, and also to trickle charge the accumulator when the set is not in use. There are two power taps giving nominal voltages of 120 and 150 respectively, three detector taps ranging from 50 to 90 volts, and two screen-grid tappings giving 60 to 80 volts.

An ingenious feature is the arrangement whereby the unit is adjusted to suit the set in use. At the bottom of the front panel is a small plug with three positions, marked 10, 20 and 30 respectively. The current consumption on the power tap is estimated beforehand, and the plug is adjusted to correspond to the load.

The plug actually operates by altering the tap on the rectifier transformer, adjusting the voltage so that the output from the unit, on full load, is up to the rating.

A metal rectifier is employed with a small electrolytic condenser block for the smoothing. There is, of course, no smoothing on the low-tension supply, which is purely for trickle charging when the set is switched off.

On test the unit operated quietly and efficiently. The output on the power tap (nominally 150 volts) was 158, 150 and 145 on the 10, 20 and 30-milliampere tappings when taking the full load current in each case. The various subsidiary voltages were satisfactorily in line.

SEE
THIS?

T.C.C.

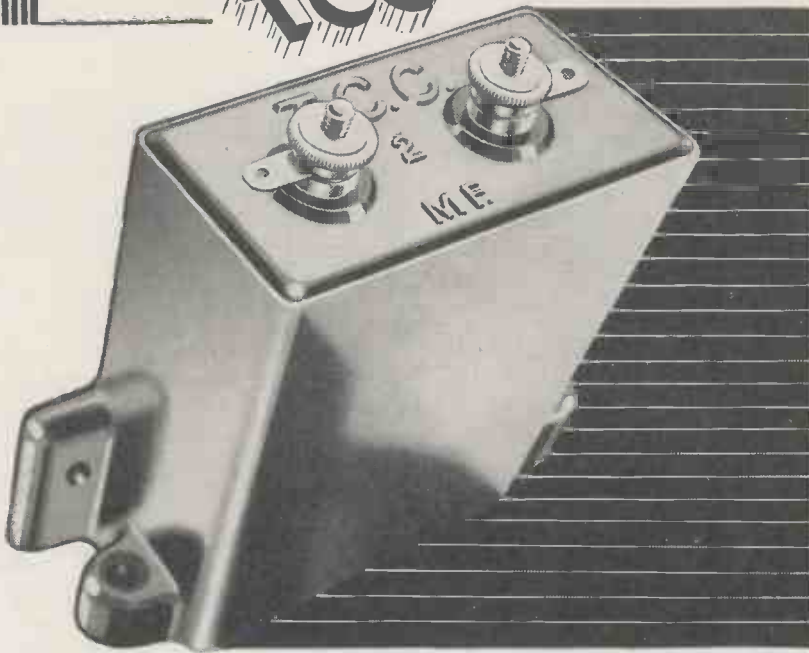

it means **SAFETY**
at no extra cost

Here's a 2 mfd. T.C.C. Type 50 paper condenser—specified for 200v. D.C. Working. D'you see the initials T.C.C.? . . . they mean perfect safety. Use it with 200v. D.C. across it (and, unofficially, shall we whisper?—a little more too!) and you know it won't let you down. The condenser plus this security costs you 3s. 6d.—not much to be sure.

It's the same throughout the T.C.C. range; the Type 141 is specified for 2,500v. D.C. Working—and it will—it bears the initials "T.C.C." Look to it that the condensers you buy are rated at the right voltage—then look to it that they carry the T.C.C. initials—then you've got the world's finest condensers—and at no extra cost,

T.C.C.
ALL-BRITISH
CONDENSERS

There is a new illustrated price list—just ready. If you have not received a copy from your Dealer a p.c. to us will bring you one.

THE TELEGRAPH CONDENSER CO. LTD., WALES FARM ROAD, N. ACTON, W.3.

**PILOT
AUTHOR
KITS**

Exact to Specification

**SEND US YOUR ENQUIRIES
FOR EVERYTHING RADIO**

Miscellaneous Components, Parts, Kits, Finished Receivers or Accessories for Cash or C.O.D. or H.P. on our own system of Easy Payments. Send us a list of your wants. We will quote you by return. C.O.D. orders value over 10/- sent carriage and post charges paid (GREAT BRITAIN ONLY). Hire Purchase Terms are NOT available to Irish and Overseas customers.

PAUL D. TYER'S STENODE

Described in September issue

RECEIVER KIT

Cash or C.O.D. Carriage Paid, £11/3/6. Or 12 monthly payments of 20/6.

MAINS UNIT KIT

Cash or C.O.D. Carriage Paid, £4/5/8. Or 12 monthly payments of 7/3.

COMPLETE KIT

Cash or C.O.D. Carriage Paid, £20/19/3. Or 76/8 deposit and 11 monthly payments of 34/-.

NEW £6/6/0 BATTERY THREE

Described in last month's issue

KIT Comprising all specified components, including Cash or C.O.D. Peto-Scott ready-drilled **£3/0/0**

Aluminium Chassis, less valves and cabinet.

Or 12 monthly payments of 5/6.

Peto-Scott Universal Console Cabinet . . . £1 1 0
Peto-Scott Universal Table Cabinet . . . £0 15 0
Set of Specified Valves . . . £1 5 0

MANTOVANI A.C. THREE

KIT "A" Author's Kit of First Specified parts, including Aluminium Chassis, less valves, cabinets and speaker. Cash or C.O.D. **£9/0/0**

or 12 monthly payments of 16/5 Carriage Paid.

KIT "B" As for Kit "A" but including specified valves, less cabinets and speaker. Cash or C.O.D. Carriage Paid, £12/8/3. Or 12 monthly payments of 22/8.

KIT "C" As for Kit "A" but including valves and Peto-Scott receiver cabinet, less speaker cabinet and speaker. Cash or C.O.D. Carriage Paid, £13/8/6. Or 12 monthly payments of 24/6.

If W.B. Speaker is required with any of above kits, add £2/2/0 to cash or C.O.D. prices, or 4/- to each monthly payment.

KIT BITS

You pay the Postman. We pay post charges on orders value over 10/- GREAT BRITAIN ONLY

Peto-Scott Ready Drilled Aluminium Chassis, 16 in. by 10 in. by 3 in. 8 6

J.B. Linacore Tuning Unit £3 5 0

Varley Mains Transformer £1 7 6

Peto-Scott Receiver Cabinet £1 2 6

Peto-Scott Loud-speaker Cabinet 15 0

BATTERY STENODE

Described in last month's issue

KIT "A" Author's Kit of first specified parts, less valves and cabinet. Cash or C.O.D. **£9/13/6**

Or 12 monthly payments of 17/3. Carriage Paid.

KIT "B"—As for Kit "A" but including set of specified valves only. Cash or C.O.D. Carriage Paid, £12/8/6. Or 12 monthly payments of 22/8.

KIT "C"—As for Kit "A" but with set of specified valves and Peto-Scott Type Stenode "B" cabinet. Cash or C.O.D. Carriage Paid, £12/3/0. Or 12 monthly payments of 24/6.

PETO-SCOTT CO. LTD.

77 (W.M.11) CITY ROAD, LONDON, E.C.1

Telephone: Cle.kenwll 9406/7

West End Showrooms: 62 High Holborn, London, W.C.1 EST. 1919

Advertisers like to know you "saw it in the 'Wireless Magazine'"



An almost certain cure for interference troubles, the T.C.C. anti-interference unit

Smoothing condensers are provided on the two power taps, and on the minimum detector and screen taps, but not on the others. This may give a certain tendency to instability in some sets, but on our tests no difficulty was experienced.

The low-tension gave 2.2 volts at .25 ampere, which is ample for charging all ordinary accumulators. The unit is finished in the familiar olive-green enamel with a mottled brown bakelite panel. It measures 8 in. by 6 in. by 3 3/4 in. high—remarkably small considering the output.

T.C.C. INTERFERENCE UNIT

APPARATUS : Anti-interference unit.
MAKERS : Telegraph Condenser Co., Ltd.
PRICE : 10s. 6d.

THE T.C.C. anti-interference unit is a neat assembly of two condensers in a small bakelite containing case. By connecting the unit across the source of disturbance, or even across the mains at some convenient point and earthing the centre point, the greater part of the interference will be found to disappear.

An interesting feature in this unit is the inclusion of two fuses in series with the condensers. Thus if one of the condensers should break down due to a sudden surge on the line or a fault on the system the fuse will blow and protect the house-lighting system. These fuses are carried in a neat little holder which plugs into the top of the unit.

At the same time the liability to breakdown is minimised by the use of high-grade condensers having a working voltage of 250 volts A.C. (or 450 volts D.C.), so that the unit is suitable for all average requirements of the ordinary listener.

It is housed in the familiar green bakelite standard for T.C.C. products, and measures 3 in. by 2 3/4 in. by 3 3/4 in. high.

CLIX DUAL ADAPTOR

APPARATUS : Electric light adaptor.
MAKERS : Lectrolinx, Ltd.
PRICE : 1s. 3d.

AN adaptor which enables connection to be made to either a bayonet lamp socket or a power plug at will is a useful accessory, and this handy little component introduced by

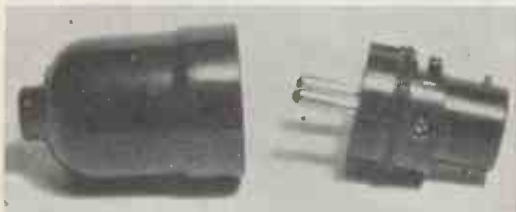

A useful accessory is the new Clix two-way electric-light adaptor. (Right) Our artist's impression of the new Anacos copper earthing rod

Clix should find a ready market.

It is in the form of a double-ended plug, one end having the customary bayonet fitting and the other terminating in two pins for a power socket. The connections are made in the middle, while a bakelite cover screws over the end not in use, thereby avoiding any danger of shock.

The fact that the whole unit is self-contained and that there are no connections to be changed when altering the unit over will both appeal to the prospective

user. This adaptor is strongly made and will stand "any amount of knocking about."

ANACOS EARTHING ROD

APPARATUS : Earth rod.
MAKERS : Frederick Smith & Co.
PRICES : 18 in. type, 1s. 8d.; 24 in. type, 2s.

THE new Anacos earth rod is both simple and inexpensive. It consists of a piece of copper having a cross section in the form of a cross. The end of the rod is tapered to a point so that it can easily be driven into the ground, even when the soil is dry.

At the top is a small clip to which the earth lead is attached and this screw for the connection is so arranged that the act of tightening it up also pulls the clip tight against the earth rod, thus ensuring a firm contact.

The rod is 18 in. long and can be driven in practically the whole way. As it is made of high conductivity copper and as it presents a large surface owing to its cross-shaped section, it should be capable of giving a good earth under all normal conditions.

This rod, which is made by a firm who have been specialising in copper work for over seventy years, is made in a single piece and has no iron attachments to rust or set up corrosion. The makers say that the rod is made like a girder. It is mechanically strong and can be driven into the ground without fear of buckling.



NEW BRITISH VALVE FACTORY

A corner of the new Tungram valve factory which has just been opened at Tottenham, North London. Some of the new Tungram valves will be reviewed in these pages next month.



ERIE

RESISTORS and
VOLUME CONTROL
SPECIFIED
for the
MANTOVANI
A.C. THREE

Again! Eries specified for their quality. The ten resistors for this set are all Eries because they are safest, permanently silent, accurate, and guaranteed against breakdown.

Eries are also an economy. All 1-watt values 1/2-. Each resistor hand-tested, colour-coded and labelled. COLOUR CODE CHART POST FREE.

1/2 THE NEW ERIE VOLUME CONTROL being specified for set after set. Its construction is an achievement. Tested for a life-time's use. See it at your dealers. **3/6**

Send for the Free Erie Service Instruction Booklet.

THE RADIO RESISTOR CO., LTD.
1 Golden Square, Piccadilly Circus, London, W.1



There was a young lady named Det
Owned a marvellous radio-set
But reception was bad—
It made her quite sad—
NOW it's soldered with FLUXITE—you bet!

See that FLUXITE is always by you—in the house—garage—workshop—anywhere where simple speedy soldering is needed. Of all Ironmongers—in tins 4d., 8d., 1/4 and 2/8. Ask to see the Fluxite Pocket Soldering Set, complete with full instructions—7/6. Ask also for Leaflet on CASE HARDENING and HARDENING TOOLS with FLUXITE.

THE FLUXITE GUN

is a handy and economical tool that enables you to put the Fluxite exactly where you want it on the soldering job. Also used to project grease into bearings, etc.—like a miniature grease gun.

Just fill the nozzle portion—half fill the cap—put together and press as required. PRICE 1/6



ALL MECHANICS WILL HAVE

FLUXITE

IT SIMPLIFIES ALL SOLDERING

Fluxite Ltd. (Dept. 332), Dragon Works, Permondsey Street, S.E.1.



"There you are, my dear..as good as new. You can't deceive a PIFCO ROTAMETER"

There's no doubt about a Pifco ROTAMETER. It traces faults in no time—any kind of radio fault. There are 9 distinct meters in one handy-sized polished bakelite case. The new De-Luxe model moving-coil ROTAMETER has a resistance of 200,000

ohms, ensuring absolute accuracy, whilst the scale reading for voltage tests goes up to 400 volts. With these ranges available there is no test you cannot make with a Pifco ROTAMETER.

9 SEPARATE METERS IN ONE ROTAMETER-DE-LUXE

1. 0-5 volts.
2. 0-20 volts.
3. 0-100 volts.
4. 0-400 volts.
5. 0-10 milliamperes.
6. 0-50 milliamperes.
7. 0-250 milliamperes.
8. Resist/valve test.
9. Plug-in test for valves.



ROTAMETER

- 1—0-8 volts. For low tension voltage test.
- 2—0-30 volts. For grid-bias voltage test.
- 3—0-250 volts. For high-tension voltage test.
- 4—BATTERY TEST.
- 5—0-20 M.A. For individual valve test.
- 6—0-100 M.A. For testing current taken by total valves in set.
- 7—0-250 M.A.
- 8—FILAMENT AND RESISTANCE TEST (4,000 ohms). For D.C. and Rectified A.C.
- 9—Plug-in test for valves.

Ask your dealer to show you one now, or write for the new Pifco Testmeter Folder, describing all instruments to: PIFCO, LTD., SHUDEHILL, MANCHESTER, or 150 Charing Cross Road, London, W.C.2.

29/6

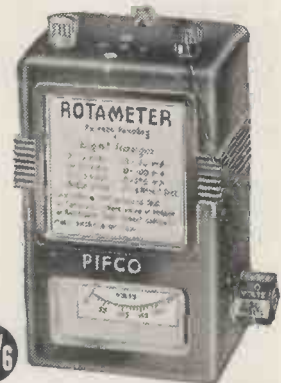

PIFCO ROTAMETERS

PIFCO ON THE SPOT WILL TRACE YOUR TROUBLES LIKE A SHOT

A.C./D.C. TELEVISION 3-VALVER

In the November issue of TELEVISION, now on sale, there are constructional details of an A.C./D.C. receiver, which drives either mirror-drum or cathode-ray apparatus.

There is also a description of the simplest cathode-ray television receiver, instructions how to make home-made Nicol Prisms. Below are some of the other contents of the November issue:—

The whole problem of synchronising. A method of improving quality of television pictures.

The equipment of a television laboratory. Screen pictures with a disc machine. Special section for the beginner.

If you are in any way interested in television, you should not miss this remarkably fine November issue. Your newsagent will supply it. Price 1/-.

TELEVISION

NOVEMBER Price 1/-



B.B.C. photo

A scene in Queen's Hall with the full B.B.C. Symphony Orchestra, National Chorus and soloists on the platform

MOST of you know what a concert at Queen's Hall sounds like whether it is a Prom or a Symphony Concert. Music, applause, more music!

This article is not so much for London listeners (who may have seen it all for themselves) as for provincial and overseas listeners who have possibly not been so fortunate.

I say *fortunate* advisedly. There is a good deal of mild amusement to be had out of it all, especially when you happen to know all or most of the orchestra, not forgetting Sir Henry Wood himself.

First of all, a little description of the hall. Rectangular, with two galleries and a wide floor-space. At one end a large platform the front of which is ablaze with flowering plants. At the farther end and fairly high up, the organ.

This has a gallery in front where the organist sits. There is a medallion of some unknown face on the front of the gallery. I have asked everyone who is likely to know who it is supposed to be. Nobody seems to know. It looks like a cross between Julius Caesar and Franz Liszt.

For the Prom season the floor is cleared of all its chairs with the exception of a line of them running

What is this Queen's Hall Atmosphere?

round the back, along the stage, and round the fountain which is placed in the centre and is full of ice blocks, coloured lights, and all sorts of ferns. The goldfish are evidently musical because they swim about unconcernedly even during the noisiest moments of the Wagner concerts.

You are accustomed to hearing the concert announced to a background of general chatter and instruments being tuned up. The Promsters group themselves gracefully until the Prom is full. Then they stand on their own plot of nine inches and remain there until the interval.

The first applause you hear is for the leader. This is Charles Woodhouse, one of the most knowledgeable musicians in London. This season he has been away owing to illness, and Marie Wilson has taken his place. Very ably, too!

The next applause is for Sir Henry. He runs on and bows his acknowledgements with the same personal

technique he has employed for forty years. At least he has not varied it during the last twenty-five, since I first got to know him.

I need hardly discuss any particular programme. So long as it does not contain works down for first performance or very recently written, you can take it there are hundreds in that Prom who know every note that is played.

This is the *real musical public of London*. Three or four thousand of them out of a floating population of eight millions is not a great number. On the other hand, it is certain they are there for the music and for nothing else. A man does not stand stock still for an hour and forty minutes unless he wants to hear music. He is not there just because it is the thing to be there.

Promsters are critical. If you are used to them you can tell whether a performance goes down with them or not. They will always recall

You All Know How
a Queen's Hall
Concert Sounds on
Your Set. Here
WHITAKER-
WILSON
Tells You What
it Looks Like

ACCURACY



If you could use a micrometer gauge to test the capacity of condensers But why suppose? You have to take condensers on trust. The trouble is that condensers sometimes do not agree with the ratings stamped on their containers. That is one of the reasons why you should insist on T.M.C.-HYDRA condensers. Every one is tested carefully and thoroughly to ensure that it is accurate—and remains accurate.

T.M.C.
BRITISH MADE
HYDRA
CONDENSERS



The special method of sealing employed in T.M.C.-HYDRA condensers absolutely prevents the penetration of moisture and so maintains their high electrical properties. Your radio dealer sells them, but if you have any difficulty in obtaining supplies write to the Sole Distributors:

T.M.C.-HARWELL (SALES) LTD
Britannia House, 233 Shaftesbury Avenue
London, W.C.2. (A few doors from New Oxford-Street)
Telephone: Temple Bar 0055 (3 lines)

Made by TELEPHONE MANUFACTURING Co.Ltd.

If You Own a Battery Set

these are the batteries you need

To ensure the efficient working of your radio set you must have good batteries. Our experience in this field, allied to the reputation for quality shared by all Smith products, is your surest guarantee of satisfaction.



From the point of view of quality or price you will not find a better battery than the new "Anodex." Backed with super abundant power they maintain a steady output for a very satisfying period.

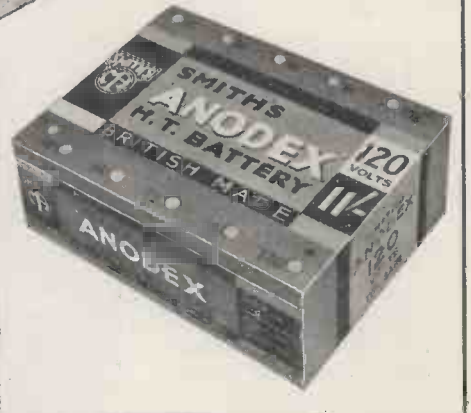

SMITH'S
WIRELESS BATTERIES

S. SMITH & SONS (Motor Accessories), LTD
CRICKLEWOOD, LONDON, N.W.2

Advertisers like to know you "saw, it in the 'Wireless Magazine'"

an artist twice or thrice, but that is their politeness. If they are really impressed they yell their loudest and it takes four to five minutes for the player or singer finally to retire.

No reputable Promster intends it to be thought he is trying to get an encore. Such things are not allowed in the first half of the Prom programme. In the second it is a different matter. They penalise a favourite for three or four encores before they let him go.

In the interval it is possible to see a sight that cannot be seen anywhere else in the world, probably—this year in particular, owing to the hot summer. There is a rush for ices as soon as the Promsters have finished cheering the pianist after the concerto. He gets cheered *in ratio to his interpretation*, for every classic concerto is well known. Pianists affected by what I have diagnosed as the *crashbangococcus* germ get off lightly in the matter of cheers. The ices are more important.

If you come up Regent Street at 9.40, when you would normally be listening at home to the news, you will see hundreds of Promsters sitting on the steps of All Souls' Church, Langham Place, eating ices. You cannot see such a sight anywhere else in England—probably in Europe. They saunter back as soon as the bell goes.

There is a free and easy style in the Proms totally absent from the Symphony Concerts, which follow in less than a month after the Proms have finished.

If you were a Promster good and true, you went into the Prom in country dress. In other words, in any old rags you liked to rake out of your wardrobe. You paid two shillings and you stood. Neither did you think of the pains in your calves, much less *complain* of them.

In less than a month you pay half a guinea to sit where you used to stand for a florin. You turn up

in a boiled shirt, or, if not, in something dark and respectable-looking. You do not wander about smoking that pipe you ought to have cremated last year. Neither do you shout your approval—at least very rarely. You applaud like a perfect little gentleman.

Yet it is the same orchestra and probably the same concerto. It may not be the same conductor, though Sir Henry is often asked to conduct a B.B.C. winter Symphony Concert.

If it is, there is something different about him difficult to define. He wears his buttonhole—the only man of my acquaintance who can do that with evening dress and get away with it. He makes the same movements—but there is a difference between Sir Henry at a Prom and Sir Henry at a Symphony Concert.

Or is it that the whole atmosphere is different? Is it that there are a few, here and there, who go because there is an element of fashion totally absent from the Proms? Is it that you speak in hushed whispers and in pure and dignified English instead of Promeranian, the language of the Promsters?

For three months you go on a Wednesday evening expensively dressed and expensively seated in rather uncomfortable chairs. Then,

after Christmas—this year, at all events—you play at pretending summer has been a-comin' in for a fortnight, and you become a Promster once again.

You dress disgracefully but more warmly, and you do not eat your ices on the chilly steps of All Souls'. You drink coffee on the stairs or in the passages. You feel free but not *quite* so free. The hall develops draughts you would have paid money for during August. If the fountain is there they do not put ice-blocks in it, but the goldfish swim there as usual.

And in three weeks' time, the fountain goes wherever fountains go in winter time, and the seats come back again. You go next Wednesday because you are a member of society once more and remain so until next August.

You who perhaps live a long way from London—possibly with a few hundred miles of ocean between you and Queen's Hall—listen to what you consider a broadcast concert. It does not matter to you whether it is a Prom or Symphony so long as you hear it. These subtle differences are lost on the ether. That is why I have begged for a couple of pages to describe it all to you as fully as I can.

If you are ever in London at the right season you should see all this for yourself. You will certainly not know a dull moment. There is an atmosphere about Queen's Hall that will assail your senses every moment you are in it. I have been going there for twenty-five years and have never failed to sense it yet.

I get it when I hear the concerts broadcast which, of course, I mostly do. Consequently, I feel I am getting the next best thing to the real thing.

Take the opportunity and listen to the Symphony Concerts during this month and next, and then to the fortnight of Proms, and then to the Symphonies again, and see if you can detect the differences in atmosphere.



B.B.C. photo

WHERE THE SOUND IS CONTROLLED

Between the microphones at Queen's Hall and Broadcasting House switchboard is this control room where qualified musicians balance up the output from the microphones in the Hall



SPECIFIED AGAIN!



The Mantovani Three is one of the best and neatest A.C. three-valvers yet produced for the home constructor. It is significant that for such an important part of the circuit as the tuner unit, Jackson Brothers 'Linacore' tuning condenser was given solus specification. This J.B. 'Linacore' (BPU) is listed at £3.5.0. It is essential for the Mantovani A.C. Three.

Send 4d. in stamps for a copy of "VIVIDRADIO"—a large broadsheet containing three fullsize blueprints—to help you incorporate a "LINACORE" in your circuit.

MANTOVANI A.C. THREE



Solving your radio troubles

★ N.R.S. is the foremost radio repair and service organisation. During the past two years we have completed over 117,000 repairs, as well as helping amateur constructors and supplying special components. If you have a radio problem of any kind we can solve it for you. Collection and delivery anywhere in the British Isles. Estimates on request.

SPECIFIED SOLE SUPPLIERS FOR THE
MANTOVANI A.C. III
L.F. SMOOTHING CHOKE
 TYPE NRS 63 — 12/6

Supplied exclusively by N.R.S., who are also sole manufacturers under licence of S. G. Brown headphones for ultra short wave reception and all purposes.

The NATIONAL RADIO SERVICE

Technical Consultant, S. G. Brown, F.R.S., M.I.E.E. Co.,
 15-16 Alfred Place, Tottenham Court Rd., London, W.C.1.
 Telephone: Museum 7651



FOR THE
"MANTOVANI"
A.C. 3

FRANKLIN TUBULAR CONDENSERS

★ Specified for their QUALITY

THE 7 CONDENSERS AS SPECIFIED
 One .0001, Two .0005,
 Four .01 Mfd.
TOTAL PRICE 4/2

The first non-inductive Tubular Condensers ever produced—absolutely the foremost. Very small, accurate; the best and cheapest obtainable. Ask for them definitely.

● If any difficulty, send for lists of Franklin Tubular Condensers, Electrolytic and Variable Condensers, Wire-wound Resistors, etc. POST FREE.

FRANKLIN ELECTRIC CO., LTD.
 Gray House, 150 Charing Cross Road, London, W.C.2
 *Phone Temple Bar 5834.

Mention of the "Wireless Magazine" will ensure prompt attention



This is the Super 60 outfit built by a Leigh, Tonbridge, reader. He has had it in constant use for over three years and says that he wishes for nothing better

WE should really like to know exactly how many Super 60 sets have been built since the description first appeared in the March, 1931, issue of "Wireless Magazine."

Since about that time never a week has gone by without us having received at least one or two letters from readers saying how pleased they are with the selectivity and sensitivity. The photograph at the top of this page arrived only a few days ago.

It comes from a reader at Leigh, near Tonbridge, Kent, who says "that this receiver has been in incessant use for three years, giving no trouble whatsoever all this time."

We believe that the details of the "W.M." Stenodes published in the last two or three issues of "Wireless Magazine" will start another stream of constant correspondence from satisfied readers. These sets are worthy successors to the famous battery and A.C. Super 60's.

Dr. Adrian Boulton, the B.B.C.'s Music Director, has accepted an invitation to visit Boston, U.S.A., and conduct the Boston Symphony Orchestra in the absence of Dr. Koussevitsky early in the new year. Dr. Boulton will sail for the states soon after Christmas, returning in time for the orchestral rehearsals for the big concert on February 6.

The G.E.C. has announced the introduction of a new six-valve battery set. The set has been released as a battery counterpart to this firm's already popular AVC5. The new set employs a Class-B out-

News from All Quarters

put stage, automatic volume control, and is in the form of a table set with built-in loud-speaker and space for all batteries.

A feature of the circuit is that it employs a high-frequency stage before the frequency-changer, so ensuring a satisfactory performance in daylight and a minimum of background noise.

The wave-ranges covered are from 200 to 550 metres, and from 1,000 to 2,000 metres. It is not expensive for a set of its kind. With all batteries, valves, etc., it costs only £14 17s. 6d.

Burne Jones & Co., Ltd., of 296 Borough High Street, London, S.E.1, has sent us a copy of the latest list describing Magnum components. There is plenty of useful information here to interest the home constructor.

Magnum list several forms of potentiometer at very reasonable

prices, and show by simple diagrams how they can be used in the circuit. In addition this firm list such components as high-frequency chokes, variable condensers, chassis assemblies, and a multitude of switches. Serious-minded constructors should ask for a copy of this list; it is free on request.

There is nothing like the right time! And a good way—that is, if you are on 50-cycle A.C. mains—is to use a synchronous electric clock. They are not expensive, and you can always rely on them being right to the minute. These clocks are made by such firms as Ferranti, Synchronome and Philips. The latter firm has just entered the field with a wall pattern clock costing £2 7s. 6d.

Another model for adorning the mantelpiece is type 4201, which costs £2 2s. 6d. This model is 12 in. wide, 5 in. high, and is obtainable in either walnut, ebony, or red bakelite material.

A Quick and Reliable Service

THERE are times, as every home constructor knows, when a nasty snag or fault will develop in a receiver, and no amount of work will make it respond to the tests and remedies available. Apart from causing frayed tempers, loss of enjoyment, and a general dissatisfaction with radio, it often brings home with a jar the fact that a reliable and efficient radio service would be a blessing to the baffled ones.

There is also that distressing habit some components have of breaking down. This always seems to happen when they are most urgently wanted or the radio portion of the budget is low. In many cases a repair could be effected, thus saving the cost of a new component, if a quick and satisfactory service, at low costs, were available to the amateur. This

applies chiefly to items employing wound coils or bobbins such as mains transformers, chokes, loud-speakers, headphones, and intervalve transformers.

No longer need the amateur tear his hair or bemoan the loss of a trusty old component that has cracked up as there is now a service within the reach of all to attend to these little misfortunes. One might say that the National Radio Service Co.—for that is the name of the firm who offer these facilities—enjoy your troubles as much as you hate them.

They employ all the latest devices and equipment, together with qualified radio engineers to handle every form of fault, repair, and/or construction of components to individual design.

SPECIFIED IN THE MANTOVANI A.C. THREE

One out of the extensive range of Varley mains transformers—the E.P.20 multi-volt type—is specified in the Mantovani A.C. Three. Take the designer's advice, use the Varley E.P.20 for your Mantovani Three and get the best results!



**E.P.
20**

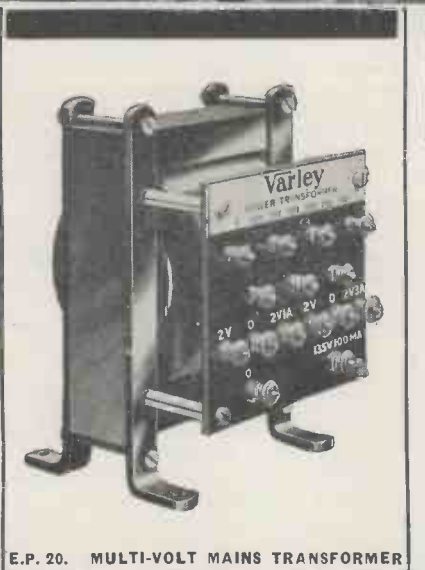

E.P. 20. MULTI-VOLT MAINS TRANSFORMER



LISTEN to the WORLD!

Only those who have handled the new 1935 Kilodyne can appreciate its wonderful capabilities. Unlike many "All Wave" receivers, the Kilodyne is not an ordinary set adapted afterwards for short-wave working, but an instrument designed for efficient short-wave reception as a first consideration and adapted later for the higher wavelengths. The features of the design are ease of operation, an excellent slow-motion open vision tuning control, freedom from objectionable body capacity effects, even on the shortest waves, no spots in any wave-range, and smooth and definite reaction everywhere. Ideal for reception of the British Empire station programmes.



Showing three views of the battery model KILODYNE.

Price—Battery Model £6:19:6
A.C. All-Mains Model £13:0:0
Folder K.W.5 free on request.

STRATTON & CO. LTD.
Bromsgrove Street, BIRMINGHAM
London Service Depot: WEBBS'
RADIO STORES, 14 Soho Street,
Oxford Street, W.1.
Telephone: GERRARD 2089.

EDDYSTONE KILODYNE 4

"CRYSTAL-GATES"

FOR SUPER-HET RECEIVERS

Frequency Price

110 to 130 Kc/s. 23/6 each

*450 Kc/s. 40/- each

Holders (enclosed) 15/- each

* Specified for the "Crystal-Gate Super"

BROOKES MEASURING TOOLS,
51-53 Church Street, Greenwich, London, S.E.10
Telephone: Greenwich 1828

Are you using
THE SUPER SENIOR?
If you are using the Super Senior, see the article on page 360 on the **MODERN SUPER SENIOR** It will tell you how to make that fine set right up to date. Make sure you read the article on page 360.

Piano Tone CABINETS
65/- Radio-Gram Cabinet for 35/-
NO MIDDLE PROFITS
Finest Radio Furniture as supplied to B.B.O.
PICKETT'S
Piano Tone
Cabinet (M.G.) Works, Boxleystratn, near London.

LIST FREE

Listen to "Radio Pictorial," Celebrity Concerts from Paris (Poste Parisien) and Radio Normandy.

When replying to advertisements, please mention "Wireless Magazine"

YOU CANNOT GO WRONG IF YOU USE A



FULL-SIZE BLUEPRINT

Each blueprint shows the position of each component and every wire and makes construction a simple matter. Copies of "Wireless Magazine" and of "Amateur Wireless" containing descriptions of most of these sets can be obtained at 1s. 3d. and 4d., respectively, post paid. Index letters "A.W." refer to "Amateur Wireless" sets and "W.M." to "Wireless Magazine" sets. Send, preferably, a postal order (stamps over sixpence unacceptable) to "Wireless Magazine," Blueprint Dept., 58-61 Fetter Lane, London, E.C.4.

CRYSTAL SET (6d.)

- 1931 Crystal Set AW308
- 4 Station Crystal Set AW427

ONE-VALVE SETS (1s. each)

- Easy to Build One AW304
- Portable Short-wave One AW354
- B.B.C. One-valve AW387
- Short-wave One-valve AW429

TWO-VALVE SETS (1s. each)

- A Two for 7 Metres (D, Trans) WM295
- A.C. Quality Gem (D, Trans) WM312
- The Companionette (D, Pen-A.C./D.C.) ... WM358
- "W.M." Band-spread Short-waver (D, Fen) WM367



SPECIAL HALF-PRICE OFFER

Blueprints of the following "Wireless Magazine" sets described in this issue are obtainable at the special price, given below, if the coupon on last page is used before Nov. 30, 1934.

- Mantovani A.C. Three, WM374 ... 6d.
- Modern Super Senior, WM375 ... 9d.

- "A.W." Iron-core Two (D, Trans) ... AW395
- "A.W." Iron-core Two with Q.P.P. ... AW396
- Big Power Melody Two, with Lucerne Coils (SG, Trans) ... AW338A
- B.B.C. National Two, with Lucerne Coils (D, Trans) ... AW377A
- Lucerne Minor (Det, Pen) ... AW426
- Home Station A.C. 2 (D, Pen) ... AW374
- B.B.C. National Two (D, Trans) ... AW377
- Melody Ranger Two (D, Trans) ... AW388
- Consolectric Two (D, Pen) A.C. ... AW403
- Lucerne Minor (D, Pen.) ... AW426

THREE-VALVE SETS (1s. each)

- C.B. Three (D, LF, Class-B) ... WM333
- Duo-tuned Three (SG, D, Pen) ... WM341
- A.C. Transportable (SG, D, Pen) ... WM347
- All-wave Three (D, 2LF) ... WM348
- "W.M." 1934 Standard Three (S.G., Det, Pen) ... WM351
- Emigrator (A.C. set : 14-500m.) (S.G., D., Pen) ... WM352
- £3 3s. Three (SG, D, Trans) ... WM354
- Heptode Super Three (A.C. Super-het) ... WM359
- Iron-core Band-pass Three (SG, D, QP 21) ... WM362
- £6 6s. A.C./D.C. Three (SG, D, Pen) ... WM364
- All-wave Battery Three (SG, D, Pen) ... WM365
- 1935 £6 6s. Three (SG, D, RC.) ... WM371
- James Push-push Three (SG, D, Q.P.P.) (1/6) ... AW378
- Everybody's Home Radiogram (SG, D, Trans) ... AW381
- Home-lover's New All-electric 3 for A.C. mains (SG, D, Trans) ... AW383
- Our Up-to-the-Minute Three. (SG, Westector, LF, Trans) ... AW384
- Class-B Three (D, Trans, class B) ... AW386
- A.C. Triodyne (SG, D, Pen) ... AW399
- Home-built Coil Three (SG, D, Trans) ... AW404
- Fan and Family Three (D, 2LF) ... AW410
- £5.5s. S.G.3 (SG, D, Trans) ... AW412

- 39/- Lucerne Ranger (SG, D, Trans) ... AW422
- Penta-quester (S.G., D, Pen) ... AW431

FOUR-VALVE SETS (1s. 6d. each)

- Calibrator (SG, D, RC, Trans) ... WM300
- Table Quad (SG, D, RC, Trans) ... WM303
- "Words and Music" Radiogram (2 SG, D, Trans) ... WM307
- "Words and Music" Radiogram de Luxe (SG, D, RC, Q.P.P.) ... WM307a
- Home Short-waver (SG, D, RC, Trans) ... WM311
- Calibrator de Luxe (SG, D, RC, Trans) ... WM316
- All-metal Four (2 SG, D, Pen-A. C. Mains) ... WM329
- Self-contained Four (SG, D, LF, Class B) ... WM331
- All-progress Four (Battery Super-het) ... WM335
- Merrymaker Super (A.C. Super-het) ... WM345
- 1934 A.C. Quadradyne (2SG, D, Pen) ... WM349
- Lucerne Straight Four (SG, D, LF, Trans) ... WM350
- Universal Merrymaker (A.C./D.C. Super-het) ... WM356
- "A.C. Melody Ranger" (SG, D, RC, Trans) ... AW380
- "A.W." Ideal Four (2SG, D, Pen) ... AW402
- 2 H.F. Four (2 SG, D, Trans) ... AW421
- Lucerne Major (256 SG, Trans) ... AW433
- Crusaders' A.V.C. Four (SG, D, LF, Class-B) ... AW445

FIVE-VALVE SETS (1s. 6d. each)

- New Class-B Five (SG, D, LF, Class-B) ... WM340
- Class-B Quadradyne (2 SG, D, LF, Class-B) ... WM344
- "W.M." A.C. Stenode ... WM370
- Battery Stenode (Super-het) ... WM373
- James Short-wave Super (Super-het) ... AW328
- Simple Super (Super-het) ... AW340
- The Etherdyne (Super-het) ... AW406
- 1934 Century Super (Battery super-het) ... AW413

SIX-VALVE SETS (1s. 6d. each)

- 1932 Super 60 (Super-het) ... WM269
- 1932 A.C. Super 60 (A.C. Super-het) ... WM272
- "W.M." D.C. (Super-het) ... WM321
- James Class-B Super (Super-het with iron-cored coils) ... WM326
- Welcome Portable with class-B output stage ... WM325
- Connoisseurs' Super (A.C. Super-het) ... WM334
- James Super Straight Six (2 SG, D, LF, Push-pull) ... WM339
- Lucerne Super (battery super-het) ... WM355

SEVEN-VALVE SETS (1s. 6d. each)

- Super Senior (Super-het) ... WM256
- Seventy-seven Super (A.C. Super-het) ... WM305
- Q.P.P. Super 60 (Super-het) ... WM319
- Quartz-crystal Super (Short wave superhet) ... WM372

EIGHT-VALVE SET (1s. 6d.)

- "W.M." Radiogram Super (A.C. Super-het) ... WM366

PORTABLES (1s. 6d. each)

- Town and Country Four (SG, D, RC, Trans) ... WM282
- Everybody's Portable (five-valve Super-het) ... WM291
- Welcome Portable (six-valve Super-het) ... WM322
- Spectrum Portable (SG, D, QP21) ... WM357
- "Two H.F." Portable (2SG, D, QP21) ... WM363
- Tyers' Portable (SG, D, 2LF) ... WM367
- General-purpose Portable (SG, D, RC, Trans) ... AW351

AMPLIFIERS (1s. each)

- 10-watt A.C. Amplifier ... WM360
- "W.M." Electric Gramophone (1s. 6d.) ... WM369
- Universal Push-pull Amplifier ... AW300
- "A.W." Record Player (LF, Push-pull) ... AW319
- Battery-operated Amplifier ... AW362
- "A.W.'s" Push-push Amplifier ... AW376
- Class-B Gramophone Amplifier ... AW391
- Universal A.C. Amplifier (3-valve) ... AW411
- Five Q.P.P. Output Circuits ... AW315

MISCELLANEOUS (1s. each)

- A.C. Short-wave Converter ... WM353
- "A.W." Trickle Charger ... AW352
- Experimenters' D.C. Mains Unit ... AW430
- Experimenters' A.C. Mains Unit ... AW432
- Add-on Band-pass Unit ... AW359
- Plug-in Short-wave Adaptor ... AW382

You can always rest assured that if you build your set with a "W.M." full-size blueprint, it will work first time and work well!



FULL DETAILS of ENGLISH PROGRAMMES from TWELVE CONTINENTAL STATIONS

Every week RADIO PICTORIAL devotes seven pages in giving full details of the English-speaking programmes from Continental stations for the coming week.

These programmes are exclusive to RADIO PICTORIAL.

RADIO PICTORIAL always contains forty pages revealing in pictures and in words the latest news and gossip about radio stars and well-known personalities of the microphone.

RADIO PICTORIAL appears every Friday and is sold by all newsagents and bookstalls—price 3d.

RADIO PICTORIAL



LISTEN TO THE "RADIO PICTORIAL" CONCERTS FROM
RADIO NORMANDY AND PARIS (POSTE PARISIEN)

Full details of Programmes etc. in the current issue.

40 PAGES EVERY FRIDAY - PRICE 3d.

BLUEPRINT COUPON

Valid only until Nov. 30, 1934 (or until Dec. 31, 1934, for overseas readers)

FOR ONE BLUEPRINT ONLY

If you want a full-size blueprint of any ONE of the sets constructionally described in this issue for half price, cut out the above coupon and send it, together with a postal order, to Blueprint Department, WIRELESS MAGAZINE, 58-61 Fetter Lane, London, E.C.4.

This coupon is valid for a blueprint of any ONE only of the following sets at the prices indicated:—

MANTOVANI A.C. THREE (page 321), No. WM374, price 6d., post free.

MODERN SUPER SENIOR (page 360), No. WM375, price 9d., post free.

INFORMATION COUPON

Valid only until Nov. 30, 1934 (or until Dec. 31, 1934, for overseas readers)

If you want to ask any questions, cut out the above coupon and send it, together with a postal order for 1s. and stamped addressed envelope, to the Information Bureau, WIRELESS MAGAZINE, 58-61 Fetter Lane, London, E.C.4.

Note that not more than two questions may be asked at a time and that queries should be written on one side of the paper only.

Under no circumstances can questions be answered personally or by telephone. All inquiries must be made by letter so that every reader gets exactly the same treatment.

Alterations to blueprints or special designs cannot be undertaken: nor can readers' sets or components be tested.

If you want advice on buying a set, a stamped addressed envelope only (without coupon or fee) should be sent to the Set Selection Bureau, WIRELESS MAGAZINE, 58-61 Fetter Lane, London, E.C.4.

Visual Indicators for Better Tuning

Continued from page 348

impedance is reduced and the indicator lamp increases in brilliance.

If an ordinary incandescent lamp A, Fig. 5, is inserted in series with high-tension supply to the plate of an A.V.C. valve V, then, as previously explained, the current falls off as signal strength increases, and the lamp will therefore indicate the correct tuning-point by going out. The shunt resistance R is inserted in order to preserve the high-tension supply to the valve in case the lamp burns out.

On the other hand, if the same lamp is arranged as shown at B, in Fig. 5, then it will indicate the correct tuning point by rising to maximum brilliance, because as the plate current through the valve V falls off, the potential drop across the resistance R₁ follows suit, and a

higher voltage is applied to the lamp from the high-tension supply.

Fig. 5 shows a visual tuner based on a combination of both lamps. The lamp A, which throws a general illumination over the dial, is arranged in circuit as in diagram (a). It gives full light so long as the circuits are out of tune, but grows dim at the point of resonance.

The lamp B, which is placed just behind a tuning slot or arrow head M, is arranged as in diagram (b) and increases in brilliance with signal strength.

As the signal is tuned in, the general illumination of the dial gradually fades away, whilst the light thrown on to the window suddenly increases to a maximum. The net result is, I can assure you, both striking and effective.

MANTOVANI A.C.3

Complete Specified Kit £6 or 12/11 p.m. MELFO-RAD, Queen's pl., HOVE



for

Repairs - Rebuilding

Overhauls to all "Wireless Magazine" Sets

and to all

Commercial Sets

OUTSIDE SERVICING. Engineers sent or sets collected immediately in London and 40 miles around.

★ It costs no more in the end to have your set properly examined and repaired by Scott Sessions' qualified radio engineers. Send your set or 'phone now to

SCOTT-SESSIONS & CO.,

Radio Engineers and Consultants,

Muswell Hill, London, N.10.

Contractors to H.M. Govt. Depts., etc., etc.

Telephone: **TUDOR 4101**
(2 lines)

INDEX TO ADVERTISERS

	Page
Amplion (1932) Ltd.	
Automatic Coil Winder Co., Ltd.	Cover iii
British Inst. of Eng. Tech.	
Brookes Instrument Co., Ltd.	381
Bulgin, A. F., & Co., Ltd.	
Clarke, H., & Co. (M/cr.), Ltd.	Cover iv
Drydex	293
Ever Ready Co., Ltd.	
Exide	293
Ferranti, Ltd.	
Fluxite, Ltd.	375
Franklin Electric Co., Ltd.	379
Garrard Eng. Co., Ltd.	Cover ii ¹
General Electric Co., Ltd.	Cover ii, 371
Gramophone Co., Ltd., The	296
Gramphon Reproducers Ltd.	
High Vacuum Valve Co., Ltd.	
Jackson Bros.	379
Kolster Brandes, Ltd.	
Keates & Co.	
Lectro Linx, Ltd.	
Lyons, Claude, Ltd.	
Marconiphone Co., Ltd.	291, 295
McMichael Radio, Ltd.	
Melfo-rad	384
National Radio Service, Ltd.	379
Ostar Ganz	294
Pertrix, Ltd.	
Peto Scott, Ltd.	373
Pickett Bros.	381
Pifco	375
Regent Fittings	
Radio Resistor Co.	375
Scott-Sessions & Co.	384
Stratton & Co.	381
Siemens Bros.	
Smith (M/A), Ltd.	377
Telegraph Condenser Co., Ltd.	373
Telephone Mfg. Co., Ltd.	377
362 Valve Co., Ltd.	
"Television"	375
Varley (Oliver Pell Control, Ltd.)	381
Westinghouse Brake & Saxby Signal Co., Ltd.	295
Wright & Weaire, Ltd.	295

A New GARRARD Quality Product



A Unit for the Small Set

FOR assembling to a small cabinet, enabling you to enjoy your own musical selections at will, the Garrard Type B Radio-Gram Unit is ideal.

It can be fitted in a space $14\frac{1}{2}'' \times 13\frac{1}{4}''$ and incorporates Garrard Electric Motor, 12" Turntable, and Pick-up and Arm with automatic starting and stopping.

- TYPE B. Radio-Gram Unit with A.C.4 Induction Motor **62/6**
- TYPE B. Radio-Gram Unit with 202A Induction Motor **69/-**
- TYPE B. Radio-Gram Unit with U.5 Universal Motor **87/-**

Send for full particulars:

GARRARD ENGINEERING & MANUFACTURING Co., Ltd.,
SWINDON, WILTS. **17, GRAFTON ST., W.1**

Telephone: Swindon 534 and 535 (2 lines).

Telephone: Regent 7596



QUICKLY TURNS THE TRUTH

A sudden noise—or an equally aggravating silence . . . inefficiency somewhere in your set! Take your AvoMinor and find out at once. The AvoMinor is an investment in permanent security, for it is a precision instrument, accurate to a critical degree, and made to stand up to hard usage and even abuse. It is, in fact, a younger brother of the famous Avometer, the instrument used by all the leading manufacturers and their service engineers. With the AvoMinor you can test circuits, valves, components, batteries and power units with the dependable accuracy of the technical expert.

There is no substitute for the AvoMinor. It is a moving-coil combination testing meter—ten accurate instruments in one. Supplied in convenient case with leads and interchangeable testing prods and crocodile clips, and complete instruction booklet adequately illustrated.

Fully descriptive folder post free from:

THE AUTOMATIC COIL WINDER & ELECTRICAL EQUIPMENT CO., LTD.
Winder House, Douglas Street, London, S.W.1.
Telephone: Vic. 3404/7.

TEN ACCURATE METERS IN ONE

CURRENT	VOLTAGE
0-6 milliamps	0-6 volts
0-30 "	0-120 "
0-120 "	0-300 "
RESISTANCE	
0-10,000 ohms	0-60,000 ohms
0-1,200,000 ohms	0-3 megohms

40/- Size 4 by 3 by $1\frac{1}{4}$ in.
Total Resistance: 100,000 ohms.
Full scale deflection on 3 milliamps.

Deferred Terms if desired.

THE D.C.

AVOMINOR

REGD. TRADE MARK

TELLS THE WHOLE TRUTH

"Radio Servicing Simplified"
 Everyone should have this invaluable new book. It explains every phase of fault-tracing step by step in non-technical language. The comprehensive make testing and numerous diagrams forward procedure.

2/6
post free
219

IT STANDS ALONE

10, 20 or 30 m/A
AT EITHER
120 or 150 VOLTS



THIS NEW "ATLAS" UNIT HAS 6 OUTPUTS AND GIVES THE MOST POWER at the LOWEST COST

A MODEL FOR EVERY SET.

TRY ONE FREE ON YOURS.

There is an "ATLAS" Unit to make any Battery Receiver Mains-operated without alteration to set or valves; giving vastly improved performance for one-fiftieth the running cost of dry batteries. Prices from 39/6 cash or 10/- deposit.

THE new "ATLAS" Model T10/30 is the last word in Mains Unit design. In power, output, and value, it surpasses any mains unit ever made. No other unit in the world provides tapped alternative outputs of 10, 20, or 30 milliamps with alternative voltages of 120 or 150 for only 69/6 cash.

WHAT THIS MEANS TO YOU

You can run your battery radio set of any type or size from the mains and cut running costs from 50s. a year to less than ONE SHILLING A YEAR. Moreover, it means that no matter what battery set you may buy or construct in future years, you are assured of the correct voltages and outputs you require.

If you buy the "ATLAS" T10/30 and insist on it, you put an end for ever to the expenses and annoyances of battery replacements and accumulator charging.

SPECIFICATION

H.T. Tappings—60/80 v. (min. and max.), 50/90 v. (min., med., and max.), 120 v., and 150 v.

H.T. Outputs—10, 20, or 30 m/A, at either 120 or 150 v.

L.T. Trickle Charger—2 v. at 0.5 A.

For A.C. Mains 100/125 or 200/250 v., 40/120 cycles. Model for 25-cycle mains at same price.

Guaranteed for 12 months. Westinghouse Rectifiers.

NO OTHER UNIT GIVES SO MUCH FOR SO LITTLE.

Ask your dealer for a FREE demonstration to-day.

POST THIS COUPON NOW!

Messrs. H. CLARKE & Co.
(M/cr) Ltd., Patricroft,
Manchester.

Please send me full details of the unique new T10/30 and other "ATLAS" Mains Units.

Name.....

Address.....

33/7.....

ATLAS

CLARKE'S
ATLAS

MAINS UNITS

H. CLARKE & CO. (M/CR) LTD., PATRICROFT, MANCHESTER

7 London: Bush House, W.C.2.

Glasgow: G.E.S. Co., Ltd., 38 Oswald St.

I.F.S. Dist'rs.: R. Marks, 27 Upper Liffey St., Dublin.