

SOMETHING NEW - PHOTOCCELL EXPERIMENTS FOR ALL

# Wireless Magazine

1

AUGUST



*Class-B Four-valve Portable :: New System of Television  
Watching a Set at Work :: First Constructors' A.C.-D.C. Set  
Getting the Best Out of Class B :: About Summer Reception*

# GARRARD

## QUALITY PRODUCTS



Garrard Record-Changing Unit, automatically changes any number of records up to eight  
A.C. £10  
D.C. £10 17s. 6d.



Garrard Universal Electric Radio Gram. Unit, manufactured completely universal on all usual current supplies £6 8s. 6d.



Garrard No. 30 Double-Spring Radio Gram. Unit. The silent motor with the silent wind £3 3s.

Garrard products make for purity of tone and perfect gramophone and radio reception.

Motor, turntable, combined pick-up and tone arm, needle cups and volume control, if required, are mounted to a bronzed steel unit plate, making fitting simplicity itself.

All-electric models are suitable for 100 to 130 and 200 to 250 volt mains. Spring models are silent and regular in operation.

SEND FOR FURTHER DETAILS  
OR ASK YOUR DEALER TO  
GIVE YOU A DEMONSTRATION

**GARRARD ENGINEERING  
& MANUFACTURING Co.,  
LTD.**  
**SWINDON, WILTS.**

Telephone: Swindon 534 & 535 (2 lines)  
or 17 Grafton Street, London, W.1.  
Telephone: Regent 7596





Editor :  
BERNARD E. JONES

# Wireless Magazine

Assistant Editor :  
D. SISSON RELPH

Technical Editor :

J. H. REYNER,  
B.Sc. (Hons.), A.M.I.E.E.

The Best Shillingsworth in Radio

Vol. XVII : AUGUST, 1933 : No. 103

Research Consultant :

W. JAMES

Published by BERNARD JONES PUBLICATIONS, LTD., publishers of "Wireless Magazine," and "Amateur Wireless." Editorial and Advertisement Offices: 58/61 Fetter Lane, London, E.C.4. Telephone : City 3733 (four lines). Telegrams : "Beejapsee, Fleet, London." Subscription : Great Britain and abroad, 15s. 6d. a year, post paid (Canada only, 13s. 6d.). Next issue published on Tuesday, August 15

## From Sound to "Light" Radio

At school we learnt about heat, light and sound; it now seems that in radio the order will be reversed. We learnt first how to handle sound, and now we are learning how to transmit and work with light by radio; in a few years we may be dealing with heat and power.

There is no question that "light" radio is developing rapidly. In this issue we are able to announce preliminary details of a new television system called "Scophony," and Morton Barr has something to say about cathode-ray methods. Both articles give hope that television "for the masses" may arrive at any moment.

Then we have Percy Harris explaining just how interesting simple photoelectric experiments can be. Here is a new field into which every amateur can enter; the cost is not great and the possibilities are tremendous. You will not much longer be able to consider yourself up to date if you do not know something about the radio transmission and reception of light.

If you are still puzzled by the working of the cathode-ray tube, which seems destined to play an increasingly important part in radio development, you must read very carefully Paul D. Tyers' article on watching a set at work.

He takes you into his laboratory and shows you on a glass screen (the article is illustrated by special un-touching photographs) the wave formation of the currents being dealt with by every stage of the receiver. In this way you can see for yourself how closely theory is borne out by practice.

Class B seems rapidly to have become accepted as the standard output system for battery-operated receivers.

There are certain snags to be avoided, however, and those who are fitting this form of output to an existing set should read J. H. Reyner's notes on the subject under the title "Getting the Best from Class B."

In response to many requests, we present this month details for the construction of a straight portable with class-B output. This set also incorporates an iron-core coil. With the Self-Contained Four you will be able to enjoy really good quality of radio reception wherever you happen to be.

Another set that is very suitable for moving about from one locality to another, although it is not in the ordinary sense portable, is the A.C.-D.C. Three, a type of set that is quite new to the constructor.

This set can be used without any alteration whatsoever on either A.C. or D.C. mains, provided the voltage is between 200 and 250 volts. It is particularly useful to those, at present on D.C. mains, who may at any moment be changed over to an A.C. supply.

Finally, a word about our next issue. First of all, will you please note that it will be published on Tuesday, August 15, to coincide with the opening of the Radio Exhibition at Olympia? The Exhibition is again very early this year, but radio enthusiasts are so keen that there is certain to be a good attendance.

Of course, when you go to Olympia (which remains open from August 15 to August 24, by the way) you will visit the "Wireless Magazine" stand—No. 10 on the ground floor of the Grand Hall. We shall have a number of interesting things to show you, and every reader is assured of a warm welcome.

D. S. R.

### FOR THE CONSTRUCTOR

THE "W.M." A.C.-D.C. THREE. By the "W.M." Technical Staff ..	20
THE A.C.-D.C. SET ON TEST ..	24
PHOTOCELL EXPERIMENTS FOR ALL. By Percy W. Harris, M.Inst.Rad.E. ..	25
BEST RESULTS FROM THE IRON-CORE THREE. By Paul D. Tyers ..	30
THE SELF-CONTAINED FOUR—WITH IRON-CORE COIL AND CLASS-B OUTPUT. By the "W.M." Technical Staff ..	54
THE SET ON TEST ..	56
MY TEST OF THE ALL-METAL FOUR. By Capt. E. H. Robinson ..	68

### TECHNICAL FEATURES

VALVES TO USE IN YOUR SET ..	2
SCOPHONY: ITS BASIC PRINCIPLES. By a Special Correspondent ..	16
ADVANTAGES OF TONE CONTROL ..	23
NEW A.C.-D.C. MAINS VALVES ..	32
HOW TO DESIGN A D.C. SET. By G. S. Scott ..	37
HOW TO GET REAL QUALITY. By Noel Bonavia-Hunt, M.A. ..	42
WATCHING A SET AT WORK. By Paul D. Tyers ..	46
WAVE RANGE OF TUNING COILS ..	53
THE NEW TELEVISION BY CATHODE-RAY TUBE. By Morton Barr ..	60
CONDENSER CONFUSION ..	62

## Contents

GETTING THE BEST OUT OF CLASS B. By J. H. Reyner, B.Sc., A.M.I.E.E. ..	63
CONTROL OF VOLUME ..	69
WE TEST BEFORE YOU BUY. By the "W.M." Set Selection Bureau ..	73
COLUMBIA MODEL 631 ..	74
VARLEY FOUR-VALVE SUPER ..	74
PORTADYNE MODEL PB5 ..	75
COSSOR MODEL 3456 ..	75
SMURTHWAITE RADIOGRAM ..	76
SUNBEAM MODEL B37 ..	76
TONE-COMPENSATED VOLUME CONTROL. By Capt. H. J. Round, M.I.E.E. ..	79
SOME QUALITY HINTS ..	81
TESTS OF NEW APPARATUS ..	82
A NEW LOUD-SPEAKER ..	86

### GENERAL ARTICLES

GUIDE TO THE WORLD'S BROADCASTERS. By Jay Coote ..	6
WORLD'S BROADCAST WAVELENGTHS ..	8
IN TUNE WITH THE TRADE. By Fetter Lane Radio "Scophony." By Capt. E. H. Robinson ..	12
THE LUCERNE PLAN: HOW IT WILL AFFECT YOU. By Alan Hunter ..	18
FROM HERE AND THERE ..	29
INCIDENTAL MUSIC TO RADIO PLAYS: WHAT SHOULD IT ACCOMPLISH? By Watson Lyle ..	33

OVER THE COUNTER. Short Story by J. Godchaux Abrahams ..	40
STORIES OF THE OPERAS: <i>The Flying Dutchman</i> ..	41
MUSICAL TERMS EXPLAINED. By Whitaker-Wilson ..	51
A NEW IDEA IN SPONSORED PROGRAMMES. By Our Special Commissioner ..	52
THE WIRELESS ZOO: THE SULKER. Verse ..	53
ABOUT SUMMER RECEPTION. By Percy W. Harris, M.Inst.Rad.E. ..	59
OPERAS AND ORATORIO ..	62
PROGRAMME NOTES AND NEWS. By T. F. Henn ..	65
NEWS OF THE SHORT WAVES. By Kenneth Jowers ..	70
SETS THAT CHANGE THEIR HABITS. By Percy W. Harris, M.Inst.Rad.E. ..	77
RADIO MEDLEY. By BM/PRESS ..	78
THE WIRELESS ZOO: THE STICKER. Verse ..	81
ELECTRONIC MUSIC ..	86
ON THE CREST OF THE WAVES. By Jay Coote ..	88
CHARGING WITHOUT MAINS ..	94
NOTES AND NEWS ..	94
BLUEPRINT AND INFORMATION COUPONS ..	96
INDEX TO ADVERTISERS ..	96

### GRAMOPHONE FEATURES

GRAMOPHONE-MOTOR HINTS. By P. Wilson, M.A. ..	45
CHOOSING YOUR RECORDS. By Whitaker-Wilson and Chopstick ..	72
A NIGHT WITH THE ELIZABETHANS ..	92

VISIT US AT OLYMPIA—STAND 10—AUGUST 15 to 24

# VALVES TO USE IN YOUR SET

Make	Type	Impedance	Amplification Factor	Mutual Conductance	Anode Current at 120 volts	Make	Type	Impedance	Amplification Factor	Mutual Conductance	Anode Current at 120 volts	Make	Type	Impedance	Amplification Factor	Mutual Conductance	Anode Current at 120 volts
<b>2-volt Three-electrode Valves</b>						<b>2-volt Pentode Valves</b>						<b>6-volt Screen-grid Valves</b>					
Cossor	210RC	50,000	40	.8	.5	Marconi	VS2	—	—	1.25	—	Osram	HL610	30,000	30	1.0	1.0
Osram	H210	50,000	35	0.7	1.0	Mullard	PM12V	—	—	.75	—	Lissen	HLD610	21,000	25	1.2	2.5
Six-Sixty	210RC	45,400	50	1.1	.7	Six-Sixty	215VSG	—	—	—	—	Cossor	610HF	20,000	20	1.0	1.75
Lissen	H2	45,000	50	1.1	2.0	Six-Sixty	SS218V561	—	—	1.4	—	Mullard	PM5D	20,000	26	1.3	1.0
Mazda	H2	45,000	50	1.1	.6	<b>2-volt Class-B Valves</b>						Mullard	607HF	15,200	17	1.1	2.0
Mullard	PM1A	41,600	50	1.2	.75	Lissen	PT225	71,000	100	1.4	7.0	Mullard	PM5X	14,700	17.5	1.2	1.6
Marconi	H2	35,000	35	1.0	1.0	Six-Sixty	230PP	64,000	80	1.25	10.0	Six-Sixty	610D	9,250	18.5	2.0	2.0
Osram	H2	35,000	35	1.0	1.0	Lissen	PT240	28,000	64	2.3	12.5	Mullard	PM6D	9,000	18	2.0	2.0
Six-Sixty	210HF	25,000	19	.75	1.0	Cossor	220PT	—	—	2.5	13.5	Lissen	L610	8,000	16	2.0	2.0
Osram	HL210	23,000	20	.87	1.0	Cossor	220HPT	—	—	2.5	6.5	Cossor	610LF	7,500	15	2.0	3.4
Mullard	PM1HF	22,500	18	.8	1.5	Cossor	230PT	—	—	2.0	10.0	Marconi	L610	7,500	15	2.0	3.0
Cossor	210HL	22,000	24	1.1	1.5	Lissen	PT2A	—	—	1.8	6.5	Osram	L610	7,500	15	2.0	3.0
Lissen	HL2	22,000	35	1.6	3.0	Marconi	PT2	—	—	2.5	5.0	Mullard	PM6	3,550	8	2.25	7.0
Mazda	HL2	21,000	32	1.5	1.5	Mazda	Pen.220A	—	—	2.5	10.0	Cossor	610P	3,500	8	2.28	8.0
Marconi	HL210	20,000	24	1.2	2.0	Mazda	Pen.220	—	—	2.5	5.0	Marconi	P610	3,500	8	2.28	6.0
Mullard	PM1HL	20,000	23	1.4	1.2	Micromesh	Pen B1	—	—	2.5	4.5	Osram	P610	3,500	8	2.28	6.0
Six-Sixty	210HL	20,000	13	1.4	1.0	Mullard	PM22A	—	—	2.5	4.0	Lissen	610P	3,400	7.8	2.3	8.0
Mazda	HL210	18,500	26	1.4	2.0	Mullard	PM22	—	—	1.3	12.0	Cossor	P625P	3,200	8	2.5	6.0
Osram	HL2	18,000	27	1.5	1.0	Osram	PT2	—	—	2.5	5.0	Lissen	P625	2,500	7.5	3.0	8.0
Marconi	HL2	18,000	27	1.5	1.0	Six-Sixty	220Pen.	—	—	2.5	—	Marconi	P625	2,400	6	2.5	11.0
Micromesh	HLB1	16,000	24	1.5	2.0	<b>4-volt Three-electrode Valves</b>						Osram	P625	2,400	6	2.5	11.0
Cossor	210HF	15,800	24	1.5	2.2	Mazda	FD220	—	—	—	—	Cossor	610XP	2,000	5	2.5	15.0
Cossor	210Det	13,000	15	1.15	2.5	Mullard	PM2B	—	—	—	—	Mullard	PM256	1,850	6	3.25	8.0
Six-Sixty	210LF	12,500	10.6	.85	2.5	Cossor	240B	—	—	—	—	Six-Sixty	625SP	1,780	5.8	3.25	8.0
Mullard	PM1LF	12,000	11	.9	2.6	<b>6-volt Pentode Valves</b>						Marconi	P625A	1,600	3.7	2.3	20.0
Osram	L210	12,000	11	.92	2.0	Marconi	H410	60,000	40	.66	5	Osram	P625A	1,600	3.7	2.3	16.0
Marconi	L210	12,000	11	.92	2.0	Osram	H410	60,000	40	.66	35	Lissen	P625A	1,500	4.9	3.0	12.0
Mullard	PM2DX	12,000	18	1.5	2.0	Lissen	H410	60,000	40	.66	1.0	Six-Sixty	625SPA	1,500	3.9	2.6	20.0
Six-Sixty	210D	10,000	18	1.6	2.0	Six-Sixty	4075RC	58,000	37	.64	.55	Mullard	PM256A	1,400	3.6	2.6	20.0
Cossor	210LF	10,000	14	1.4	3.0	Mullard	PM3A	55,000	38	.66	3	Mazda	P650	1,300	3.5	2.7	20.0
Lissen	L2	10,000	20	2.0	3.0	Cossor	410RC	50,000	40	.8	.6	<b>6-volt Screen-grid Valves</b>					
Mazda	L2	10,000	19	1.9	3.0	Lissen	HLD410	21,000	25	1.2	2.5	Six-Sixty	SS6075SG	210,000	190	.9	—
Marconi	P215	5,000	7	1.4	6.0	Osram	HL410	20,800	25	1.2	1.25	Cossor	610SG	200,000	200	1.0	—
Osram	P215	5,000	7	1.4	6.0	Marconi	HL410	20,800	25	1.2	1.25	Mullard	PM16	200,000	200	1.0	—
Six-Sixty	220P	4,800	7.2	1.5	5.0	Cossor	410HF	20,000	22	1.1	1.0	Osram	S610	200,000	210	1.05	4.0
Mazda	P215	4,400	7.5	1.7	5.0	Mullard	PM3	13,000	14	1.05	2.0	Marconi	S610	200,000	210	1.05	4.0
Mullard	PM2	4,400	7.5	1.7	5.0	Six-Sixty	4075HF	12,500	13.5	1.1	3.0	Marconi	PT625	43,000	80	1.85	10.0
Lissen	P220	4,000	7	1.75	5.0	Cossor	410LF	10,000	17	1.7	2.5	Osram	PT625	43,000	80	1.85	10.0
Cossor	220P	4,000	9	2.25	6.0	Lissen	L410	8,500	15	1.8	3.5	Six-Sixty	SS617PP	28,500	54	1.9	15.0
Cossor	215P	4,000	9	2.25	5.0	Marconi	L410	8,500	15	1.77	3.0	Lissen	PT625	24,000	60	2.5	14.0
Cossor	220P A	4,000	16	4.0	5.5	Osram	L410	8,500	15	1.77	3.0	Cossor	615P I	—	—	2.0	17.0
Micromesh	PB1	4,000	16	4.0	5.0	Mullard	PM4DX	7,500	15	2.0	2.0	Mullard	PM26	—	—	2.0	15.0
Marconi	LP2	3,900	15	3.85	6.0	Six-Sixty	410D	7,250	14.5	2.0	4.0	<b>6-volt Pentode Valves</b>					
Osram	LP2	3,900	15	3.85	6.0	Marconi	P410	5,000	7.5	1.5	6.0	Marconi	PT625	43,000	80	1.85	10.0
Mazda	P220	3,700	12.5	3.4	5.0	Osram	P410	5,000	7.5	1.5	6.0	Osram	PT625	43,000	80	1.85	10.0
Six-Sixty	220PA	3,700	13	3.5	6.0	Six-Sixty	410P	4,100	7.8	1.9	7.5	Six-Sixty	SS617PP	28,500	54	1.9	15.0
Mullard	PM2A	3,600	12.5	3.5	6.5	Cossor	410P	4,000	8	2.0	8.0	Cossor	PT625	24,000	60	2.5	14.0
Lissen	LP2	3,500	12.0	3.5	9.0	Mullard	PM4	4,000	8	2.0	7.5	Osram	615P I	—	—	2.0	17.0
Marconi	P2	2,150	7.5	3.5	12.0	Lissen	P410	4,000	8	2.0	7.0	Mullard	PM26	—	—	2.0	15.0
Osram	P2	2,150	7.5	3.5	10.0	Marconi	P425	2,300	4.5	1.95	14.0	<b>A.C. Three-electrode Valves</b>					
Six-Sixty	220SP	2,060	7	3.4	13.5	Mullard	PM254	2,150	6.5	3.0	9.0	Six-Sixty	4DX AC	36,000	7.5	2.1	3.0
Mullard	PM202	2,000	7	3.5	14.0	Six-Sixty	420SP	2,150	6.5	3.0	10.0	Mullard	904V	34,000	75	2.2	1.8
Mullard	PM252	1,900	7	3.7	14.0	Marconi	P415-	2,080	5.0	2.4	14.0	Cossor	41MRC	19,500	50	2.6	2.7
Six-Sixty	240SP	1,900	6.6	3.5	14.0	Osram	P415	2,080	5	2.4	14.0	Cossor	41MH	18,000	72	4.0	2.0
Mazda	P220A	1,850	6.5	3.5	11.0	Cossor	425XP	2,000	7	3.5	13.0	Cossor	41MHF	14,500	41	2.8	3.0
Lissen	P220A	1,700	6	3.5	12.0	Lissen	P425	1,500	4.5	3.0	14.0	Six-Sixty	41MP	12,000	36	3.0	4.0
Lissen	PX240	1,500	4.5	3.0	12.0	Cossor	415XP	1,500	4.5	3.0	15.0	Mullard	35AV	12,000	36	3.0	4.0
Cossor	230XP	1,500	4.5	3.0	18.0	Osram	PX25	1,265	9.5	7.5	—	Mullard	AC/HL	11,700	35	3.0	6.0
<b>2-volt Double-grid Valves</b>						<b>4-volt Screen-grid Valves</b>						Lissen	AC/HL	11,700	35	3.0	3.0
Marconi	DG2	3,750	4.5	1.2	—	Lissen	SG410	950,000	120	.9	—	Mazda	AC/HL	11,700	35	3.0	3.0
Osram	DG2	3,750	4.5	1.2	—	Cossor	410SG	803,000	800	1.0	—	Cossor	41MHL	11,500	52	4.5	4.0
Cossor	210DG	3,400	2.7	.8	—	Mullard	PM14	230,000	200	.87	—	Mazda	AC2HL	11,500	75	6.5	3.5
Mullard	PM1DG	—	—	.8	—	Six-Sixty	4075SG	220,000	190	.87	3.0	Marconi	MH4	11,100	40	3.6	4.75
Six-Sixty	210DG	—	—	.8	—	Marconi	S410	200,000	180	.9	3.5	Osram	MH4	11,100	40	3.6	4.75
<b>2-volt Screen-grid Valves</b>						<b>4-volt Pentode Valves</b>						Osram	MH4	11,100	40	3.6	4.75
Lissen	SG215	900,000	1,000	1.1	—	Marconi	FT425	50,000	100	2.0	8.0	Micromesh	HLA1	10,000	80	8.0	6.0
Mazda	SG215A	727,000	800	1.1	.8	Osram	FT425	50,000	100	2.0	8.0	Mullard	4HLAC	9,500	25	2.65	—
Mazda	SG215	455,000	500	1.1	1.6	Marconi	FT4	42,000	120	2.85	—	Marconi	MHL4	8,000	20	2.5	10.0
Six-Sixty	2185G	357,000	500	1.4	—	Osram	FT4	42,000	120	2.85	—	Osram	MHL4	8,000	20	2.5	10.0
Mazda	SG215B	334,000	700	2.1	1.0	Osram	FT4	42,000	120	2.85	—	Cossor	41MLF	7,900	15	1.9	9.0
Micromesh	5B1	333,000	500	1.5	.5	Lissen	PT425	28,000	70	2.5	15.0	Six-Sixty	4L AC	5,000	16.0	2.0	8.0
Mullard	PM12A	330,000	500	1.5	—	Six-Sixty	415PP	27,000	60	2.2	15.0	Mullard	164V	4,850	16	3.3	8.5
Cossor	215SG																



## The "NORFOLK" CABINET-DE-LUXE



SPECIALLY DESIGNED FOR and EXCLUSIVELY SPECIFIED BY the Designer of the "TYERS IRON-CORE 3"

We are in a position to supply all the Components specified for this Receiver at Manufacturers' List Prices. In anticipation of the phenomenal demand for these Components, we have acquired adequate stocks to ensure immediate delivery. By placing their orders direct with us, readers of "Wireless Magazine" can rest assured of all orders being despatched the same day as receipt.



Once again a "C.A.C." Cabinet has been exclusively specified for this excellent Receiver. The above illustration cannot do justice to the handsome appearance of the cabinet which is soundly constructed in selected Walnut of dignified design and irreplaceable finish. Special care has been taken to ensure that Cabinet resonances are eliminated.

PRICE, carriage paid 35/-  
TERMS: CASH WITH ORDER.

Showrooms: 4, Surrey Street, Strand, London, W.C.2.  
Telephone: Temple Bar 8620.

Advt. of The City Accumulator Co. Ltd.

Office and Works: 7 Angel Court, 173, Strand, London, W.C.2.  
Telegrams: Citacco, Estrand, London.

# ACCURACY -that's the reason

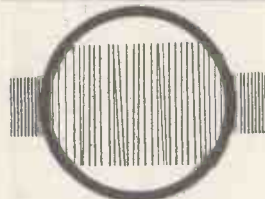

This shows what might happen without careful inspection.

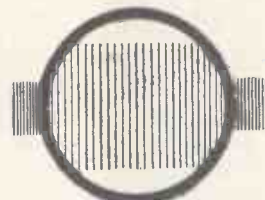

Microscopic examination ensures absolute perfection for all Radiophone products.

At every stage in the production of British Radiophone Components exactitude with regard to detail is the rule. Take this combined switch and volume control, for example. Every detail is examined through a microscope to ensure perfection. Without this care it is very easy for fine wire windings to become crossed and destroy the efficiency of the whole. Radiophone matched perfection methods ensure perfect winding and perfect results—always. Buy Radiophone components and be sure of satisfaction.

AS SPECIFIED EXCLUSIVELY FOR THE WIRELESS MAGAZINE "SELF-CONTAINED FOUR"

British Radiophone Combined Volume Control, with 3-point switch, 50,000 ohms, type 484. Price, 8/6.

Send for catalogue of Radiophone Components.

# RADIOPHONE Products

THE BRITISH RADIOPHONE LTD.  
Aldwych House, Aldwych, London, W.C.2



Use **GLAZITE** REGD. CONNECTING WIRE for Perfect Circuit Wiring

The popularity of Glazite is attributable to the superior craftsmanship and superb raw materials used in its manufacture and it is damp proof.

Glazite Connecting Wire is made in six colours at sixpence per ten foot coil by a firm with over 50 years experience in the manufacture of wire.

**BEWARE OF IMITATIONS!**

Made by THE LONDON ELECTRIC WIRE COMPANY AND SMITHS, LIMITED  
CHURCH ROAD LEYTON LONDON E.10

There is news in the "Wireless Magazine" advertisements

# VALVES TO USE IN YOUR SET—Continued from page 2

Make	Type	Impedance	Amplification Factor	Mutual Conductance	Anode Current at 200 volts	Make	Type	Impedance	Amplification Factor	Mutual Conductance	Anode Current at 200 volts	Make	Type	Impedance	Amplification Factor	Mutual Conductance	Anode Current at 200 volts
<b>A.C. Three-electrode Valves—Continued</b>						<b>A.C. Screen-grid Valves</b>						<b>D.C. Three-electrode Valves</b>					
Mullard	.. O54V	1,250	5	4.0	30.0	Marconi	.. MS4B	350,000	1,120	3.2	3.5	Mazda	.. DC3HL	11,700	35	3.0	2.5
Mullard	.. AC044	1,150	4	3.5	30.0	Osram	.. MS4B	350,000	1,120	3.2	3.5	Mazda	.. DC2P	2,650	10	3.75	15.0
Micromesh	.. PA1	1,050	12.6	12.0	35.0	Lissen	.. AC/SG	340,000	1,100	4.0	8.0	<b>Filament Current .25 Ampere</b>					
Mazda	.. PP3/250	1,000	6.5	6.5	40.0	Six-Sixty	.. 4YSGAC	300,000	900	3.0	—	Marconi	.. DH	10,800	40	3.7	6.0
Marconi	.. PX4	830	5	6.0	35.0	Mullard	.. S4V	257,000	750	2.5	9.5	Osram	.. DH	10,800	40	3.7	6.0
Osram	.. PX4	830	5	6.0	35.0	Cossor	.. MSGLA	200,000	750	3.75	5.2	Marconi	.. DL	2,660	12	4.5	25.0
<b>All-metal A.C. Valves</b>						<b>A.C. Variable-mu Valves</b>						<b>Filament Current .5 Ampere</b>					
<b>Three-electrode type</b>						<b>A.C. Pentode Valves</b>						<b>Filament Current 2.5 Ampere</b>					
Marconi	.. MH4	11,000	40	3.6	—	Lissen	.. AC/SGV	300,000	—	—	—	Mazda	.. DC/HL	13,000	35	2.7	3.0
Osram	.. MH4	11,000	40	3.6	—	Cossor	.. MVSG	200,000	—	2.5	7.8	Mazda	.. DC/P	2,220	10	4.5	15.0
<b>A.C. Screen-grid Valves</b>						<b>A.C. Screen-grid Valves</b>						<b>D.C. Screen-grid Valves</b>					
Marconi	.. MS4B	350,000	1,120	3.2	—	Marconi	.. VMS4	—	—	3.0	—	<b>Filament Current .1 Ampere</b>					
Osram	.. MS4B	350,000	1,120	3.2	—	Mazda	.. AC/SG.VM	—	—	14.0	—	Mazda	.. DC2SG	—	1,200	2.2	4.5
<b>A.C. Variable-mu Valves</b>						<b>A.C. Pentode Valves</b>						<b>Filament Current .2 Ampere</b>					
Marconi	.. VMS4	—	—	2.6	—	Micromesh	.. VSGA1	—	—	6.5	5.5	<b>Filament Current .25 Ampere</b>					
Osram	.. VMS4	—	—	2.6	—	Mullard	.. MM4V	—	—	3.0	10.0	Osram	.. DS	550,000	500	1.1	2.5
<b>A.C. Pentode Valves</b>						<b>A.C. Screen-grid Valves</b>						<b>Filament Current .5 Ampere</b>					
Marconi	.. MPT4	40,000	120	3.0	—	Mullard	.. VM4V	—	—	1.2	8.2	Marconi	.. DS	540,000	500	1.1	2.5
Osram	.. MPT4	40,000	120	3.0	—	Osram	.. VMS4	—	—	2.4	—	Osram	.. DSB	350,000	1,120	3.2	3.5
<b>A.C. Double-grid Valves</b>						<b>A.C. Screen-grid Valves</b>						<b>Filament Current 2.5 Ampere</b>					
Sixty-Sixty	.. 4DGAC	70,000	7.0	.1	—	Marconi	.. PT4	42,000	120	2.85	32.0	Marconi	.. DSB	350,000	1,120	3.2	3.5
Cossor	.. 4IMDG	40,000	10	.25	—	Osram	.. MPT4	35,000	100	3.0	32.0	Marconi	.. VDS	—	—	2.4	—
<b>A.C. Screen-grid Valves</b>						<b>A.C. Pentode Valves</b>						<b>Filament Current 5 Ampere</b>					
Six-Sixty	.. 4SGAC	1,000,000	1.0	1.0	1.5	Cossor	.. MS.Pen.A	—	—	4.0	9.0	Mazda	.. DC/SG	—	1,000	2.75	4.0
Mullard	.. S4V	909,000	1,000	1.1	2.5	Cossor	.. MP.Pen.	—	—	2.5	30.0	<b>D.C. Pentode Valves</b>					
Mazda	.. ACS2	600,000	3,000	5.0	4.0	Mazda	.. AC/Pen.	—	—	3.1	40.0	<b>Filament Current 2 Ampere</b>					
Cossor	.. MSC/HA	500,000	1,000	2.0	2.1	Micromesh	.. TA2	—	—	3.0	—	Mazda	.. DC/2Pen.	—	—	12.5	13.0
Cossor	.. MS4	500,000	1,500	1.1	2.5	Six-Sixty	.. SS4Pen.AC	—	—	3.0	—	<b>Filament Current .25 Ampere</b>					
Marconi	.. MS4	500,000	1,500	1.1	2.5	Mullard	.. Pen.4V	—	—	2.6	30.0	Marconi	.. DPT	30,000	90	3.0	40.0
Micromesh	.. SGA1	500,000	2,200	4.5	3.8	Lissen	.. AC/PT	—	—	3.0	30.0	Osram	.. DPT	30,000	90	3.0	40.0
Osram	.. MS4	500,000	1,500	1.1	2.5	Cossor	.. PT41	—	—	3.0	30.0	<b>Filament Current 5 Ampere</b>					
Six-Sixty	.. 4XSGAC	485,000	1,600	3.3	—	Cossor	.. PT41B	—	—	2.25	30.0	Mazda	.. DC/Pen.	—	—	13.5	3.0
Mullard	.. S4VA	—	1,000	2.0	4.5	Micromesh	.. PenA1	—	—	3.0	30.0	<b>D.C. Three-electrode Valves</b>					
Mullard	.. S4VA	—	1,000	2.0	4.5	Mullard	.. PM24A	—	—	2.0	20.0	<b>Filament Current .18 Ampere</b>					
Cossor	.. 4MSG	400,000	1,000	2.5	3.0	Mullard	.. PM24B	—	—	2.1	30.0	Triotron	.. P440N	50,000	175	3.5	24.0
Mazda	.. AC/SG	400,000	1,700	3.0	4.0	Mullard	.. PM24C	—	—	3.0	30.0	Dario..	.. Poly.	50,000	175	3.5	24.0
						Mullard	.. PM24M	—	—	3.0	30.0	Tungstram	.. APP4120	33,000	100	3.0	32.0
						Mullard	.. PM24M	—	—	3.0	30.0	Tungstram	.. APP4100	20,000	60	3.0	20.0
						Mullard	.. PM24M	—	—	3.0	30.0	Triotron	.. P430	22,000	75	3.5	30.0
						Mullard	.. PM24M	—	—	3.0	30.0	Triotron	.. P440	25,000	100	4.0	45.0

## SUPPLEMENTARY VALVE TABLE

<b>2-volt Three-electrode Valves</b>						<b>6-volt Three-electrode Valves</b>						<b>A.C. Pentode Valves</b>					
Tungstram	.. R208	50,000	35	0.7	1.0	Tungstram	.. HR607	15,000	30	2.0	1.5	Triotron	.. P440N	50,000	175	3.5	24.0
Triotron	.. WD2	25,000	25	1.0	1.0	Tungstram	.. LG607	8,250	16.5	2.0	3.0	Dario..	.. Poly.	50,000	175	3.5	24.0
Dario	.. Detector	25,000	25	1.0	1.0	Tungstram	.. P610	3,300	6.6	2.0	8.0	Tungstram	.. APP4120	33,000	100	3.0	32.0
Tungstram	.. H210	25,000	25	1.0	1.5	Tungstram	.. P615	3,300	10	3.0	8.0	Tungstram	.. APP4100	20,000	60	3.0	20.0
Tungstram	.. HR210	20,000	32	1.6	1.5	Tungstram	.. SP614	2,300	6	2.6	12.0	Triotron	.. P430	22,000	75	3.5	30.0
Dario..	.. Sup. H.F.	20,000	32	1.6	1.5	<b>6-volt Pentode Valve</b>						Triotron	.. P440	25,000	100	4.0	45.0
Tungstram	.. L210	16,000	16	1.0	2.0	Tungstram	.. PP610	40,000	60	1.5	3.0	<b>D.C. Three-electrode Valves</b>					
Tungstram	.. LD210	14,000	18	1.25	1.8	<b>A.C. Three-electrode Valves</b>						<b>Filament Current .18 Ampere</b>					
Triotron	.. HD2	12,500	15	1.2	1.5	Triotron	.. A440N	30,000	120	4.0	.5	Triotron	.. A2030N	14,500	38	2.6	4.0
Triotron	.. SD2	11,000	20	1.8	2.5	Triotron	.. W415N	25,350	38	1.5	.5	Tungstram	.. R2018	13,300	40	3.0	2.0
Triotron	.. TD2	7,500	9	1.2	3.0	Dario	.. Sup/HF.	20,000	40	2.0	3.0	Dario	.. Sup. Det.	11,000	38	3.5	6.0
Triotron	.. LC210	10,000	10	1.0	2.5	Tungstram	.. AR495	17,000	85	5.0	3.5	Tungstram	.. G2018	7,000	25	3.5	4.0
Tungstram	.. PD220	10,000	17	1.7	2.5	Tungstram	.. AR4101	13,300	40	3.0	2.0	Triotron	.. E2020N	3,000	6	2.0	10.0
Dario	.. Un. Biv.	8,000	10	1.25	2.5	Triotron	.. AR430N	7,000	24	3.5	6.0	Tungstram	.. P2018	2,800	7	2.5	20.0
Dario..	.. Sup. Det.	7,500	15	2.0	3.0	Dario..	.. SuperDet.	7,500	24	3.2	6.0	Dario..	.. Sup. Pwr.	2,400	6	2.5	15.0
Triotron	.. YD2	3,600	9	2.5	8.0	Tungstram	.. AG495	6,250	24	4.0	5.0	<b>D.C. Screen-grid Valves</b>					
Triotron	.. ZD2	4,200	5	1.2	7.0	Triotron	.. YN4	4,800	12	2.5	8.0	<b>Filament Current .18 Ampere</b>					
Triotron	.. E235	3,500	12.5	3.5	9.0	Dario	.. Sup. Pow.	3,000	9	3.0	14.0	Dario	.. SG	360,000	400	1.1	4.0
Tungstram	.. P215	3,500	5	1.5	8.0	Triotron	.. E430N	3,000	9	3.0	10.0	Tungstram	.. S2108	333,000	400	1.2	1.5
Dario..	.. Sup. power	3,000	6	2.0	9.0	Tungstram	.. AP495	2,500	10	4.0	15.0	Tungstram	.. S2010N	400,000	400	1.0	4.0
Triotron	.. UD2	2,800	5	1.8	8.0	Triotron	.. K435/10	1,000	3.5	3.5	35.0	Triotron	.. S2030N	300,000	900	3.0	3.0
Tungstram	.. LP220	2,600	7.8	3.0	6.0	<b>A.C. Double-grid Valves</b>						<b>D.C. Variable-mu Valve</b>					
Tungstram	.. SP230	2,500	5	2.0	15.0	Tungstram	.. DG4100	5,000	5	1.0	3.0	<b>Filament Current .18 Ampere</b>					
Dario..	.. Hyp. Pwr.	2,400	7	3.0	12.0	Triotron	.. D410N	—	—	1.0	—	Tungstram	.. SE2018	360,000	500	1.4	3.0
Tungstram	.. E235	2,600	9	3.5	12.0	<b>A.C. Screen-grid Valves</b>						Triotron	.. S2012N	—	—	1.0	—
Triotron	.. SP2	2,000	3	1.5	12.0	Tungstram	.. AS494	667,000	1,000	1.5	1.5	<b>D.C. Pentode Valves</b>					
<b>2-volt Double-grid Valves</b>						<b>A.C. Variable-mu Valves</b>						<b>Filament Current .18 Ampere</b>					
Tungstram	.. DG210	5,000	5	1.0	1.0	Tungstram	.. AS4100	400,000	550	1.3	4.0	Triotron	.. P2020N	40,000	80	2.0	15.0
Tungstram	.. DG210/0	5,000	10	2.0	1.5	Dario	.. VMSG	300,000	300	1.0	6.0	Tungstram	.. PP2018	31,250	80	2.5	20.0
Triotron	.. D210	—	—	1.0	—	Tungstram	.. AS4100	208,000	250	1.2	3.5	Dario..	.. D.C. Poly.	30,000	75	2.5	20.0
<b>2-volt Screen-grid Valves</b>						<b>A.C. Screen-grid Valves</b>						<b>Universal A.C.-D.C. Valves</b>					
Tungstram	.. S210	333,000	400	1.2	1.5	Tungstram	.. AS494	667,000	1,000	1.5	1.5	<b>20 volt, .18 ampere</b>					
Triotron	.. S207	200,000	200	1.0	3.0	Dario	.. SG	600,000	700	1.1	1.5	Tungstram	.. SE2018	360,000	500	1.4	5.0
Dario..	.. SG	200,000	200	1.0	2.0	Tungstram	.. AS495	428,000	1,500	3.5	1.0	Tungstram	.. S2018	333,000	400	1.2	1.5
<b>2-volt Variable-mu Valves</b>						<b>A.C. Screen-grid Valves</b>						<b>Filament Current .18 Ampere</b>					
Tungstram	.. SV20	—	—	1.5	3.0	Triotron	.. S412N	584,000	700	1.2	1.5	Triotron	.. P2020N	40,000	80	2.0	15.0
Triotron	.. S208	—	—	0.8	—	Triotron	.. S410N	400,000	400	1.0	4.0	Tungstram	.. G2018	6,500	25	3.5	4.0
<b>2-volt Pentode Valves</b>						<b>A.C. Screen-grid Valves</b>						<b>Filament Current .18 Ampere</b>					
Tungstram	.. PP200	150,000	300	2.5	6.0	Dario..	.. Super SG	300,000	900	3.0	3.0	Triotron	.. P2018	2,800	7	2.5	20.0
Dario	.. Poly	40,000	60	1.5	12.5	Triotron	.. AS430N	300,000									



# NICORE TUNING COILS



B.P.30. Aerial or Tuned Grid with reaction 10/6  
 B.P.31. H.F. Intervalve Transformer with Reaction 10/6  
 For the ALL-METAL FOUR Set of 3 coils ganged on base - - 33/-

Varley again! Leaders in the new tuning technique as in the old . . . The release of Varley NICORE Coils marks the biggest advance in radio tuning since the introduction of "Square Peak" Coils.

The use of powdered metal cores is not new to Varley. As far back as 1926 Varley were producing Constant Inductance Chokes with powdered iron cores. The new Varley NICORE Coils are an outstanding result of years of research.

Consistency has been the great aim, and has been attained with an even greater efficiency than was thought possible. Selectivity, with these new Varley coils, is a maximum. Write to-day for FREE illustrated literature.

# Varley

FOREMOST AS PIONEERS

Advt. of Oliver Pell Control Ltd., 103 Kingsway, London, W.C.2

## at last— UNIVERSAL VALVES ONE VALVE FOR BOTH A.C. AND D.C. MAINS



"They should prove a blessing alike to the trade and the private owner."—SUNDAY REFEREE, May 21 . . . May 28.

"Success has come with the advent of the new type TUNGSRAM MAINS VALVE."—AMATEUR WIRELESS, June 17.

"No mains transformer required."—WIRELESS WORLD, June 9.

Any circuit can be built with these Universal D.C. - A.C. Valves. All valves, including rectifier, indirectly heated—less hum than with ordinary A.C. Valves. Economical—only 35 watts mains consumption.

Full range available—Variable Mu, Screen grid, High-slope Detector, L.F., Multi Grid Output, Double Grid Frequency Changer, Rectifier, H.F. Pentodes. Also Barretter (current regulator).

Type	Use	Ampl. F.	Imped.	Output	Price
R 2018	Detector	40	13,000	—	10/6
G 2018	G.P.—L.F.	25	7,000	350	10/6
P 2018	Power	10	2,500	750	13/-
PP 2018	Multigrad output	80	30,000	1,400	17/-
S 2018	Screen grid	400	333,000	—	14/6
SE 2018	Vari-mu Screen grid	—	—	—	14/6
HP 2018	H.F. Pentode (Slope—1.2mA/V)	5,000	2,000,000	—	14/6
HPE 2018	H.F. Pen. Vari-mu	2,000	1,000,000	—	14/6
V 2018	Half-Wave Rectifier	—	—	70 mA	10/6

All Tungram Universal Valves are Indirectly Heated and take 0.18 ampere at 20 volts.

A Barretter Type 180 R is also available, which has—

Normal Voltage Drop . . . 100 volts.  
 Normal Working Limits . . . 80-120 volts.  
 Transient Limits . . . 70-140 volts.  
 Current 180 mA + - 2½% Price 5/6

Write for particulars

## UNIVERSAL TUNGSRAM VALVES

'PHONE: MUS. 5053

TUNGSRAM ELECTRIC LAMP WKS. (G.B.) LTD  
 72 OXFORD STREET, LONDON, W.

Advertisers like to know you "saw it in the 'Wireless Magazine'"







“My friends are  
simply amazed at  
the performance”

(Sgd.) C.J.D., Weaste

Columbia, Philco, K.B., Marconi-  
phone, H.M.V., Burgoyne, to  
mention only a few leading set-makers,  
fit Exide Batteries for L.T. or Drydex  
Batteries for H.T.

# Drydex

by Exide

**DRY BATTERIES  
FOR WIRELESS**

Obtainable from Exide Service Stations and all reputable dealers. Exide Service Stations give service on every make of battery  
Exide Batteries, Exide Works, Clifton Junction, nr. Manchester. Branches: London, Manchester, Birmingham, Bristol,  
Glasgow, Dublin and Belfast. DX 501

Better service results from mentioning "Wireless Magazine" when writing to advertisers



# WORLD'S BROADCAST WAVELNGTHS

Stations best received in the British Isles are indicated in bold type



Wave-length	Name of Station	Dial Readings	Country	Wave-length	Name of Station	Dial Readings	Country
13.93	W8XK, Saxonburg ...		United States	30.2	Leopoldville ...		Congo
13.95	Chicago W9XF ...		United States	30.4	Lawrenceville (N.J.) WQN ...		United States
14.47	Buenos Aires LSY ...		Argentina	30.77	Lawrenceville WOF ...		United States
14.87	Rocky Point WQX ...		United States	30.89	Rugby GCA ...		Great Britain
14.97	Leopoldville OPL ...		Belgian Congo	31.0	Heredia T14NRH ...		Costa Rica
15.576	Rio de Janeiro PPU ...		Brazil	31.25	Lisbon CT1AA ...		Portugal
15.61	Lawrenceville (N.J.) WKF ...		United States	31.28	Philadelphia W3XAU ...		United States
15.625	Ruysselede (Bruges) ORG ...		Belgium	31.25	Sydney VK2ME ...		New South Wales
15.82	Buenos Aires LSR ...		Argentina	31.297	Daventry (Empire) GSC ...		Great Britain
15.86	Rocky Point (N.J.) WQE ...		United States	31.31	Radio Nations HBL ...		Switzerland
15.93	Bandoeng PLE ...		Java	31.35	Springfield W1XAZ ...		United States
16.10	Rugby GBJ ...		Great Britain	31.33	Zeesen DJA ...		Germany
16.26	Bogota HKD ...		Columbia	31.48	Schenectady W2XAF ...		United States
16.3	Kootwijk PCK ...		Holland	31.545	Daventry (Empire) GSB ...		Great Britain
16.36	Lawrenceville (N.J.) WLA ...		United States	31.55	Melbourne VK3ME ...		Victoria
16.38	Rugby GBS ...		Great Britain	31.58	Rio de Janeiro PRBA ...		Brazil
16.39	Maracay YVO ...		Venezuela	31.6	Poznan SR1 ...		Poland
16.56	Bandoeng PMC ...		Java	31.7	Rio de Janeiro PPU ...		Brazil
16.57	Chicago W9XAA ...		United States	31.71	Rocky Point WKJ ...		United States
16.66	Rocky Point WAJ ...		United States	31.86	Bandoeng PLV ...		Java
16.72	Rocky Point (N.J.) WQB ...		United States	32.26	Rabat ...		Morocco
16.76	Rocky Point WLL ...		United States	32.71	Lawrenceville WND ...		United States
16.81	Bandoeng PLF ...		Java	32.93	Olivos LST ...		Argentina
16.85	Kootwijk PCV ...		Holland	33.59	Rocky Point (N.J.) WEC ...		United States
16.878	Boundbrook W3XAL ...		United States	34.68	Long Island W2XV ...		United States
16.88	Eindhoven PHI ...		Holland	35.55	Rio de Janeiro PRDA ...		Argentina
16.89	Daventry Empire GSG ...		Great Britain	36.92	Bandoeng PLW ...		Java
16.89	Königswusterhausen DJE ...		Germany	37.80	Doberitz DOA ...		Germany
17.38	Norddeich DAN ...		Germany	38.07	Tokio J1AA ...		Japan
17.44	Maracay YVG ...		Venezuela	38.476	Radio Nations HBP ...		Switzerland
17.51	Budapest HAT ...		Hungary	38.65	Kootwijk PDM ...		Holland
18.37	Sydney VLR ...		N.S.W.	39.58	Shanghai XGD ...		China
18.4	Kootwijk PCL ...		Java	39.58	Calgary (Alb.) CKS ...		Canada
18.44	Lawrenceville WLO-WLK ...		United States	40.5	New Brunswick WEN ...		United States
19.3	Leopoldville ...		Belgian Congo	40.54	New York WEM ...		United States
19.36	Kemikawoa (Tokio) J1AA ...		Japan	41.1	Amateur Band ...		Canary Isles
19.56	Schenectady W2XAD ...		United States	41.6	Las Palmas EAR58 ...		Sts. Settlements
19.61	La Paz ...		Bolivia	41.7	Singapore V5IAB ...		United States
19.64	New York W2XE ...		United States	43.11	Rocky Point (N.J.) WEQ ...		United States
19.67	Coytesville N.J. W2XAL ...		United States	44.51	Rocky Point (N.Y.) WEJ ...		United States
19.68	Radio Coloniale ...		France	44.61	Rocky Point WQO ...		United States
19.72	Saxonburg W8XX ...		United States	44.61	Nauen DCK ...		Germany
19.8	Taschkend ...		U.S.S.R.	45	San Sebastian EAR TBO ...		Spain
19.737	Zeesen DJB ...		Germany	45.31	Constantine FM8KR ...		Tunis
19.815	Daventry (Empire) GSF ...		Great Britain	45.31	Rio Bamba PRADO ...		Ecuador
19.84	Rome (Vatican) HVJ ...		Italy	45.38	Moscow REN ...		U.S.S.R.
20.0	Drummondville CGA ...		Canada	45.5	Bucharest ...		Roumania
20.13	Manila KAY ...		Philippine I.	46.87	London (Ont.) VE9BY ...		Canada
20.3	Rocky Point WQV ...		United States	46.89	Boundbrook W3XL ...		United States
20.49	Deal (N.J.) WND ...		United States	46.7	Newark W2XA1 ...		United States
20.5	Chapultepec XDA ...		Mexico	46.73	Minsk RW62 ...		U.S.S.R.
20.7	Rocky Point WKJ ...		United States	48	Casablanca CN8MC ...		Morocco
20.97	Amateur Band ...			48.35	Bogota HKC ...		Colombia
21.53	Rocky Point (N.J.) WIK ...		United States	48.54	Shanghai XGKO ...		China
21.62	Rocky Point (N.Y.) WIY ...		United States	48.8	Winnipeg VE9CL ...		Canada
21.85	Drummondville CGA ...		Canada	48.86	Saxonburg (Pa.) W8XK ...		United States
21.93	Szekesfehervar HAT ...		Hungary	48.9	Kuala Lumpur ZGE ...		F.M.S.
22.36	Rocky Point WMA ...		United States	48.92	New York W2XA ...		United States
22.4	Rocky Point WMA ...		United States	48.95	Maracaibo YV1BMO ...		Venezuela
22.58	Drummondville CGA ...		Canada	48.93	Halifax VE9HX ...		Canada
23.28	Radio Maroc (Rabat) ...		Morocco	49.0	Johannesburg ZTJ ...		Sth. Africa
23.7	Drummondville VE9AP ...		Canada	49.02	Wayne W2XE ...		United States
24.41	Rugby GBV ...		Great Britain	49.08	Caracas YVIBC ...		Venezuela
24.9	Kootwijk PDV ...		Holland	49.1	Calcutta VUC ...		Br. India
25.20	Pontoise FYA ...		France	49.18	Boundbrook W3XAL ...		United States
25.24	Chicago W9XF ...		United States	49.22	Bowmanville VE9GW ...		Canada
25.27	East Pittsburgh (Pa) W8XK ...		United States	49.3	La Paz ...		Bolivia
25.284	Daventry (Empire) GSE ...		Great Britain	49.34	Chicago W9XAA ...		United States
25.34	Chicago (Ill.) W9XAO ...		United States	49.4	Skamlebaek ...		Denmark
25.36	Wayne W2XE ...		United States	49.43	Vancouver VE9CS ...		British Columbia
25.4	Rome ZRO ...		Italy	49.5	Philadelphia W3XAU ...		United States
25.42	Bowmanville VE9GW ...		Canada	49.5	Havana CMCI ...		Cuba
25.45	Boston W1XAL ...		United States	49.5	Cincinnati W8XAL ...		United States
25.51	Zeesen DJD ...		Germany	49.586	Nairobi VQ7LO ...		Kenya Colony
25.532	Daventry (Empire) GSD ...		Great Britain	49.59	Daventry (Empire) GSA ...		Great Britain
25.57	Eindhoven (PHI) ...		Holland	49.6	Halifax VE9GX ...		Nova Scotia
25.6	Radio Coloniale ...		France	49.6	Vienna UOR2 ...		Austria
26.30	Winnipeg VE9JR ...		Canada	49.67	Miami Beach W4XB ...		United States
26.39	Cerrito CWG ...		Uruguay	49.67	Boston W1XAL ...		United States
25.72	Rio de Janeiro PPB ...		Brazil	49.83	Chicago W9XF ...		United States
26.83	Funchal CT3AQ ...		Madeira	49.83	Königswusterhausen DJC ...		Germany
27.5	Kootwijk PCP ...		Holland	49.96	Drummondville VE9DR ...		Canada
27.65	Nauen DFL ...		Germany	50	Moscow RV59 ...		U.S.S.R.
28.28	Rocky Point (N.J.) WEA ...		United States	50.26	Rome (Vatican) HVJ ...		Italy
28.5	Sydney VK2ME ...		New South Wales	51	St. Denis ...		Reunion
28.83	Funchal CT3AQ ...		Madeira	52.7	Tananarive FIQA ...		Madagascar
28.98	Buenos Aires L5X ...		Argentina	54.52	New York W2XBH ...		United States
29.04	Ruysselede ORG ...		Belgium	56.9	Königswusterhausen DTG ...		Germany
29.13	Buenos Aires L5O ...		Argentina Repub.	57.03	Rocky Point WQN ...		United States
29.58	Leopoldville OPM ...		Congo	58.3	Bandoeng PMY ...		Java
30.0	Radio Excelsior LR5 ...		Argentina Repub.	58.31	Prague ...		Czechoslovakia
30.0	Madrid EAQ ...		Spain	60.3	Long Island (N.J.) W2XV ...		United States

Continued on page 10



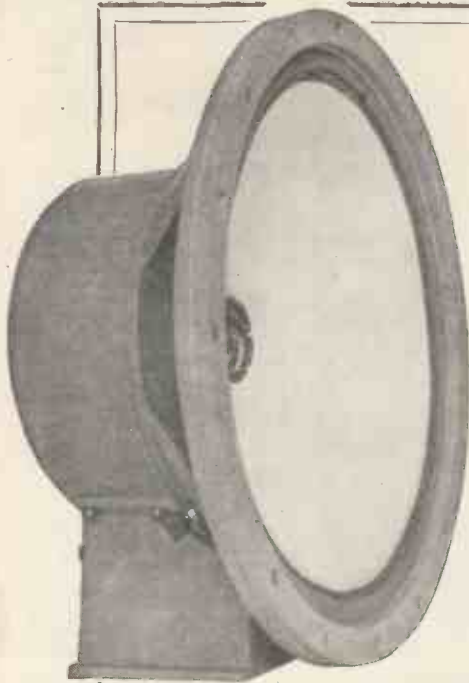

PARMEKO

## NEW "SENIOR" MODEL LOUD SPEAKER

In order to meet the demand of those who prefer a Loud Speaker of the large cone type, we have recently introduced our "SENIOR" MODEL. This Speaker will be found similar in all respects to our "STANDARD" MODEL, with the exception that it has a 12" diameter diaphragm with a cone angle of 120°.

CATALOGUE AND FULL PARTICULARS FREE ON REQUEST

It is capable of handling a large input without distortion. Supplied complete with Unit, base and Transformer, giving Ratios of 11.1 and 22.1.  
PRICE **£7**

## PARTRIDGE & MEE LTD

"PARMEKO" WORKS,  
AYLESTONE PARK,  
LEICESTER

74 NEW OXFORD STREET,  
LONDON, W.C.1  
Mus. 5070

## COLVERN FERROCART COILS

COLVERN . . . . . always associated with all that is best in radio frequency coils.

FERROCART Coils are synonymous for outstanding selectivity, compactness and efficiency.

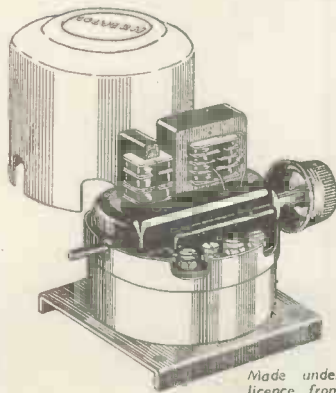

Made under licence from the patentee, Hans Vogt.

### TYPES F1 F2 F3

For single S.G.H.F. stage receivers

**37/6** per set.

Mounted on sub base with ganged wave change switches.

### TYPES F10 F11 F12 F13

Suitable for 2 S.G.H.F. stage receivers

**50/-** per set.

## COLVERN LIMITED, ROMFORD, ESSEX.

London Wholesale Depot, 150 King's Cross Road, W.C.1.

## YOU SHOULD CHOOSE

### this Camco Radio-Gram CABINET



Just the thing for converting your set into a Radio-gram. It's a very handsome piece of furniture that incorporates the outstanding workmanship and finish for which Camco Cabinets are famous. Ample room for set, speaker, motor, pick-up, needle tray, etc. Price, including baffleboard, £6.



CARRINGTON  
Manufacturing Co., Ltd.  
Showrooms: 24 Hatton  
Garden, London, E.C.1.  
Holborn 8202.  
Works: S. Croydon.

See the complete range of Camco Cabinets at our Showrooms, open 9.15 to 5.45 (Sat. 12.30), and send coupon for copy of Camco Cabinet Catalogue—it's FREE.

Post in ½d. envelope.

Name.....

Address.....

12 W.M. ....

There is news in the "Wireless Magazine" advertisements

# WORLD'S BROADCAST WAVELENGTHS Continued from page 8

Wave-length	Name of Station	Dial Readings	Country	Wave-length	Name of Station	Dial Readings	Country
62.56	London (Ont.) VE9BY	...	Canada	360.6	<b>Mchlack</b>	...	Germany
66	Rocky Point WAD	...	United States	363.6	Algiers	...	North Africa
67.65	Doerberitz DFK	...	Germany	365.5	Bergen	...	Norway
70.17	Rocky Point (N.J.) W1R	...	United States	367.5	Bolzano	...	Italy
70.2	Khabarovsk RV15	...	U.S.S.R.	368.1	Frederikstaad	...	Norway
79.5	Salisbury ZEA	...	South Africa	370.1	Helsinki	...	Finland
84.5	Berlin D4AGE	...	Germany	372.2	Kharkov	...	U.S.S.R.
92.31	Doerberitz	...	Germany	376.4	Seville	...	Spain
208.3	Liege (Wallonie)	...	Belgium	381.7	Radio LL	...	France
209.8	Magyarovar	...	Hungary	385	Hamburg	...	Germany
211.3	Pecs	...	Hungary	385.6	<b>Scottish Regional</b>	...	Great Britain
214.3	Miskolcz	...	Hungary	395.2	Lvov	...	Poland
214.9	<b>Newcastle</b>	...	Great Britain	398.9	Radio Toulouse	...	France
215.6	Warsaw (No. 2)	...	Poland	403.8	Stalino	...	U.S.S.R.
217	<b>Aberdeen</b>	...	Great Britain	408.7	Leipzig	...	Germany
218	Antwerp	...	Belgium	413	<b>Bucharest</b>	...	Roumania
218.5	Chatelineau	...	Belgium	416	<b>Midland Regional</b>	...	Great Britain
220	<b>Königsberg</b>	...	Germany	419.5	<b>Sottens</b>	...	Switzerland
223.2	Salzburg	...	Austria	424.3	<b>Katowice</b>	...	Poland
224	<b>Plymouth</b>	...	Great Britain	430.4	<b>Athlone</b>	...	Irish Free State
225.9	Beziere	...	France	435.4	Radio Maroc	...	North Africa
227.4	Swedish Relays	...	Sweden	439.6	Berlin	...	Germany
230.6	<b>Cork</b>	...	Irish Free State	441.2	Madrid (España)	...	Spain
231.3	Fécamp	...	France	447.1	<b>Madrid EAJ7</b>	...	Spain
235	Flensburg	...	Germany	450.3	Belgrade	...	Yugoslavia
235.5	Malmö	...	Sweden	453.2	Makhatch-Kala	...	U.S.S.R.
236.2	Kiel	...	Germany	458	Stockholm	...	Sweden
236.2	Lodz	...	Poland	458.8	Rome	...	Italy
237.9	Kristiansand	...	Norway	459	Paris PTT	...	France
239	<b>Bordeaux-Sud-Ouest</b>	...	France	461.5	Dantzig	...	Poland
240.1	Nimes	...	France	465.8	Klagenfurt	...	Austria
242	<b>Nurnberg</b>	...	Germany	472.4	Odesa	...	U.S.S.R.
244.1	Stavanger	...	Norway	476	Porsgrund	...	Norway
245.9	<b>Belfast</b>	...	Ireland	483	Milan Vigentino	...	Italy
247.7	Basle	...	Switzerland	488	San Sebastian	...	Spain
249.5	Linz	...	Austria	495.9	<b>Beromuenster</b>	...	Switzerland
250	Berne	...	Switzerland	500.8	Archangel	...	U.S.S.R.
250.9	<b>Trieste</b>	...	Italy	501.7	Lyons PTT	...	France
253.1	Juan-les-Pins	...	France	509	<b>Langenberg</b>	...	Germany
254.7	Prague (No. 2)	...	Czechoslovakia	509.3	Simferopol	...	U.S.S.R.
254.7	Radio SchaarLeeck	...	Belgium	517	<b>North Regional</b>	...	U.S.S.R.
256.7	Barcelona EAJ15	...	Spain	517	Ivanovo-Vosnesensk	...	U.S.S.R.
259.3	<b>Gleiwitz</b>	...	Germany	525	Prague	...	Czechoslovakia
259.3	Toulouse PTT	...	France	533	Troldheim	...	Norway
261.0	Hörby	...	Sweden	540.6	Florence	...	Italy
263.8	<b>Frankfurt</b>	...	Germany	541.5	Gorky	...	U.S.S.R.
265.7	London National	...	Great Britain	550	Astrakhan	...	U.S.S.R.
267.4	West National (Tests)	...	Great Britain	559.7	<b>Brussels No. 1</b>	...	Belgium
269.8	Moravska Ostrava	...	Czechoslovakia	563	Vienna	...	Austria
271.2	Lille	...	France	566	Riga	...	Latvia
273.5	Valencia	...	Spain	568	<b>Munich</b>	...	Germany
275	<b>Bremen</b>	...	Germany	574.7	Palermo	...	Italy
276.5	<b>Bari</b>	...	Italy	583	<b>Sundsvall</b>	...	Sweden
277.5	Cointe-Liége	...	Belgium	587.1	<b>Budapest</b>	...	Hungary
278.5	Rennes	...	France	597.5	Tampere	...	Finland
280	<b>Turin</b>	...	Italy	1,000	Kaiserslautern	...	Germany
281	Hellsberg	...	Germany	1,000	Augsberg	...	Germany
281	<b>Cracow</b>	...	Poland	1,071	Wilno	...	Poland
282.2	<b>Copenhagen</b>	...	Denmark	1,083	Hanover	...	Germany
283.0	Lisbon CT1AA	...	Portugal	1,107	Freiburg	...	Germany
284.3	Berlin	...	Germany	1,153.8	Grenoble	...	France
286	Innsbruck	...	Austria	1,140	Ljubljana	...	Yugoslavia
288.3	Magdeburg	...	Germany	1,190	Lausanne	...	Switzerland
291	Stettin	...	Germany	1,200	Moscow PTT	...	U.S.S.R.
293	Radio Lyons	...	France	1,229	<b>Geneva</b>	...	Switzerland
293.7	Montpellier	...	France	1,237	Ostersund	...	Sweden
296.1	Bournemouth	...	Great Britain	1,304	Petrozavodsk RV29	...	U.S.S.R.
298.8	<b>Scottish National</b>	...	Great Britain	1,354	<b>Heston Airport</b>	...	Great Britain
301.5	Viipuri	...	Finland	1,380	Budapest (2)	...	Hungary
304.3	Kosice	...	Czechoslovakia	1,411.8	Leningrad	...	U.S.S.R.
304.3	Limoges PTT	...	France	1,445.7	Kharkov	...	U.S.S.R.
306.8	Hilversum	...	Holland	1,481	Moscow	...	U.S.S.R.
307	Tallinn	...	Esthonia	1,538	<b>Scheveningen-Haven</b>	...	Holland
308.5	North National	...	Great Britain	1,554.4	Tiflis	...	U.S.S.R.
309.9	<b>Bordeaux PTT</b>	...	France	1,634	<b>Oslo</b>	...	Norway
312.8	Zagreb	...	Yugoslavia	1,725	Minsk	...	U.S.S.R.
313.9	Falun	...	Sweden	1,796	<b>Kalundborg</b>	...	Denmark
315	Vitus-Paris	...	France	1,875	Monte Ceneri (tests)	...	Italy
318.8	West Regional	...	Great Britain	1,910	<b>Luxemborg</b>	...	Luxemburg
319.7	Cracow	...	Poland	1,935	Reykjavik	...	Iceland
321.9	Genoa	...	Italy	2,025	Istanbul	...	Turkey
325	Marselles	...	France	2,650	Boden	...	Switzerland
328.2	Naples	...	Italy	2,650	Vienna	...	Austria
335	Sofia	...	Bulgaria	2,650	<b>Moscow</b>	...	U.S.S.R.
338.2	Dresden	...	Germany	2,650	<b>Motala</b>	...	Sweden
341.3	<b>Goteborg</b>	...	Sweden	2,650	Novosibirsk	...	U.S.S.R.
345.2	<b>Breslau</b>	...	Germany	2,650	Warsaw	...	Poland
348.2	Poste Parisien	...	France	2,650	<b>Paris (Eiffel Tower)</b>	...	France
352.8	Milan	...	Italy	2,650	Moscow (RV1)	...	U.S.S.R.
356.9	Poznan	...	Poland	2,650	Ankara	...	Turkey
356.9	<b>Brussels (No. 2)</b>	...	Belgium	2,650	<b>Daventry National</b>	...	Great Britain
356.9	<b>Brno</b>	...	Czechoslovakia	2,650	<b>Königswusterhausen</b>	...	Germany
356.9	<b>Strasbourg</b>	...	France	2,650	<b>Radio Paris</b>	...	France
356.9	Leningrad	...	U.S.S.R.	2,650	<b>Lahti</b>	...	Finland
356.9	Barcelona EAJ1	...	Spain	2,650	<b>Hülzen</b>	...	Holland
356.9	Graz	...	Austria	2,650	Svendlovst	...	U.S.S.R.
356.9	Tifraspool	...	U.S.S.R.	2,650	<b>Kaunas</b>	...	Lithuania
356.9	<b>London Regional</b>	...	Great Britain	2,650	<b>Königswusterhausen</b>	...	Germany
					<b>Eiffel Tower</b>		France



# Radio's Best

for

## £6.17.6

Complete



An outstanding example of modern Battery receiver design and technique. The Sunbeam B.37 three-valve model offers you the finest alternatives to a mains driven set.

Particularly sensitive and selective it provides a wide choice of programmes. A powerful output circuit and an accurately matched moving-coil speaker reproduce these at fine volume and with pleasurable tone.

Specification: 3 valves: S.G., D., Triode output to P.M. Moving Coil Speaker. Current consumption only 7.5 m.A. Sockets at rear for Aerial and Earth, extra loud-speaker and Pick-up.

See test report of Battery Model B.37 in this issue (page 76).

### SUNBEAM MODEL B 37

£6: 17: 6 Complete

The Sunbeam B.37 is only obtainable through our appointed agents. (Name and address of nearest agent, also literature, sent on request)

For those with electric supply there is the Sunbeam U.35 which works equally well on either A.C. or D.C. supply without any alteration whatever. Price £9: 9: 0. Details on request

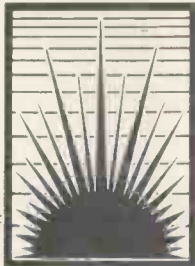

SUNBEAM ELECTRIC LTD., Sunbeam Road, London, N.W.10

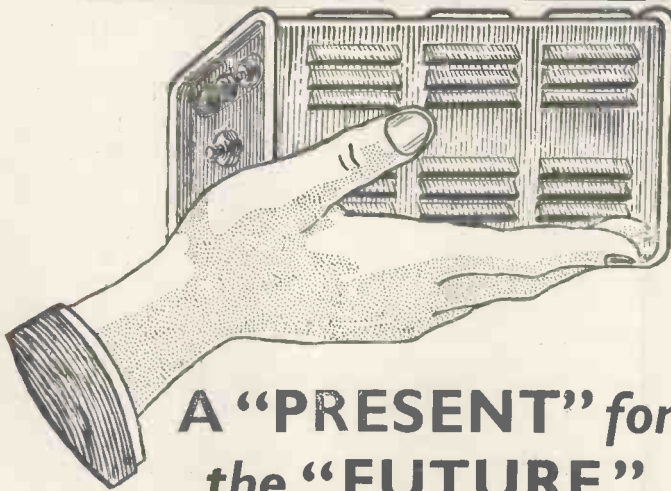

## A "PRESENT" for the "FUTURE"

Now is the time to make provision for a permanent, ample and constant power supply throughout the winter—and for many winters to come—by giving your A.C. set a reliable rectifier. Give it a

### WESTINGHOUSE METAL RECTIFIER

and remove all worry and periodical renewal.

THE WESTINGHOUSE BRAKE & SAXBY SIGNAL CO. LTD.,  
82, YORK ROAD, KING'S CROSS, LONDON, N.1.

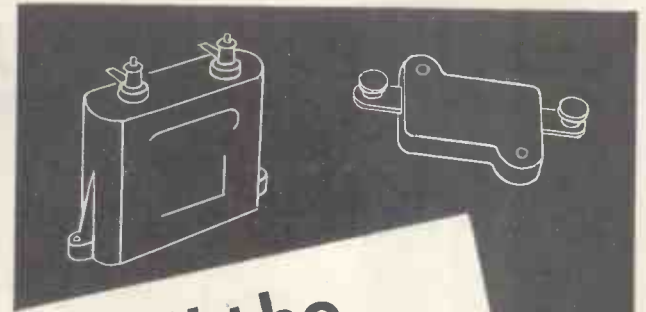

All the  
fixed Condensers  
specified for the  
SELF CONTAINED 4  
AND THE  
ALL METAL FOUR  
are  
**DUBILIER**  
CONDENSERS

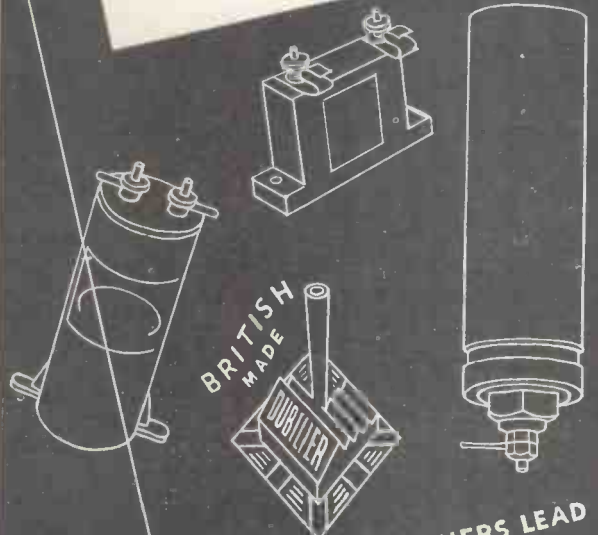

FOLLOW THE DESIGNERS LEAD  
AND BUILD WITH DUBILIER  
FOR THE FINEST RESULTS

Dubilier Condenser Co. (1925) Ltd., Ducon Works, Victoria Rd., North Acton, W.3

# In Tune with the Trade

FETTER LANE'S Review of the Latest Catalogues

## SEND TO US FOR THESE CATALOGUES!

Here we review the newest booklets and folders issued by six manufacturers. If you want copies of any or all of them just cut out this coupon and send it to us. We will see that you get all the literature you desire.

Just indicate the numbers (seen at the end of each paragraph) of the catalogues you want below:—

My name and address are:—

Send this coupon in an unsealed envelope, bearing ½ d. stamp, to "Catalogue Service," WIRELESS MAGAZINE, 58/61 Fetter Lane, E.C.4. Valid till Aug. 31

## A FEW WORDS . . . !

HERE's a folder from Wilburn and Co. They call it *A Few Words About Condensers*. Fairly useful words, too, even if they are more figures than words. It deals, of course, with Peak condensers and is just the sort of thing you'll like to have by you when building or renovating a set.

It's the very latest Peak production and deals with the new type W electrolytic condensers.

By the way, I wonder if you know that Wilburn make some very useful little 5-, 6-, and 10-way connectors of bakelite, having moulded-in brass insets which are numbered. These too, are described in *A Few Words*. **331**

## MAKING 'EM MUSEUM PIECES

THE Milnes people are going all out with their very clever high-tension supply unit. All knowledgeable radio fans are talking about them and on the road I keep meeting the nippy cars of the Milnes travelling stud.

The latest Milnes folder is a very clever effort in which mains units, dry batteries, and high-tension accumulators are shown as "museum pieces circa 1920-193?"

The Milnes unit certainly has a number of advantages of its own. It is basically a high-tension accumulator of the nickel-cadmium cell

type, with an alkaline electrolyte, and it is virtually everlasting. An ingenious switching arrangement is fitted so that the unit recharges itself automatically from a low-tension accumulator.

The Milnes unit can, of course, be charged direct from the mains, and it is claimed that the unit gives better voltage regulation and a more silent background than a mains unit.

**332**

## FOR THE MAINS MAN

IT'S very handy to have lists of mains transformers and smoothing chokes by you in the wireless den, but most thin paper charts get torn all too easily. So Rawswood deserve a note of congratulation on their latest data sheet of mains transformers and smoothing chokes.

It is a comprehensive folder, giving practical and technical details, enclosed in a stout cardboard cover. Rawswood make very good power apparatus and this folder includes a description of three fine complete power packs, as well as details of power transformers, filter chokes, and low-frequency transformers. **333**

## ENTERPRISING IGRANIC

IGRANIC are catering for the up-to-date amateur in a very wholehearted fashion. Seems to me that almost every other day I get a leaflet describing some new component which Igranic have just put on the market.

For instance, here are the latest Igranic sheets before me as I write—three of them. There is a new Igranic class-B driver transformer, costing only 11s. 6d. It has a number of terminals, so that the secondary is tapped and two alternative ratios are provided, 1 to 1 and 1.5 to 1.

Then there is the CH4 choke, which costs only 9s. 6d.

The third Igranic folder is devoted to something which will interest the keen experimenter—a buttonhole transverse-current microphone. I won't go into details as all technicalities are given in the folder. **334**

## WHY NOT BUILD ONE?

WHY not make up your own mains unit? It's simpler even than building a set. There is no need to take any risks if you get a complete kit of parts. Heayberd, for instance, has published a very helpful thirty-six-page book, included in which are full particulars of a large number of useful kits for mains units.

The new Heayberd book—you can get a copy of it free—gives circuits and facts which make your choice an easy one. Don't forget that all Heayberd models are covered by a comprehensive guarantee against breakdown, so that you are just as safe in building your own unit as you are in buying one.

A point-to-point diagram is given with each kit, and the components are ready assembled and mounted on the base; all you have to do is wire up.

**335**

## FULL O' POWER

IT seems to me that class B and Q.P.P. have given a new lease of life to the dry battery as a provider of high tension. If you have a really good battery you can, with a modern set, get amazingly economical running and yet have an undistorted power output of about 2 watts.

But you must have a good battery. Siemens, as one of the oldest electrical firms in the industry, can certainly claim to make good batteries, and so I was particularly interested to get their latest folder and see how they have dealt with the class-B question.

In the very wide range of types they make a triple-capacity power battery recommended for sets taking 10-20 milliamperes for class-B receivers. There is a double-capacity power battery also suitable if, on account of bulk and weight, the triple-capacity type is unsuitable.

Anyway, if you get the new Siemens folder you will be able to see the voltage ranges, dimensions, weights, types, and prices of all the Siemens batteries. **336**



# The ONLY SPEAKER

## Specified for the

# WIRELESS MAGAZINE

# AC/DC THREE

Only the best was good enough for a set like this. The best speakers in the world are Blue Spot—and so 99 P.M. was chosen by the designers to ensure perfect reproduction.

### TECHNICAL DETAILS

Special magnet of exclusive design, ensuring powerful and permanent energy ● De Luxe transformer, with special plugs and sockets, for easy valve matching ● Available for all output stages, including class B ● Specially designed moisture-proof cone and speech coil ● No danger of warping or fouling in the gap ● Moulded side plates to protect air gap from dust or magnetic particles ● Perfect and even response over the whole musical scale ● A superb instrument

PRICE, CHASSIS ONLY, 59/6

CABINET MODEL (32 P.M.), in walnut, 87/6

*Catalogue W.M. 308, giving full Blue Spot range sent post free on request*

**THE BRITISH BLUE SPOT COMPANY LTD.**

Blue Spot House, 94-96 Rosoman Street, Rosebery Avenue, LONDON, E.C.1

Phone: Clerkenwell 3570. Grams: "Bluospot, Isling, London."

Distributors for Northern England, Scotland, and Wales: H. C. Rawson (Sheffield and London), Ltd., 100 London Road, Sheffield; 22 St. Mary's Parsonage, Manchester; 177 Westgate Road, Newcastle-upon-Tyne; 37-39 Clyde Place, Glasgow.

BRITISH MADE



**99 PM**  
**59/6**

## PURITY · DEPENDABILITY · ECONOMY

Only one form of H.T. Supply gives all three—The

The dream of all wireless enthusiasts is of H.T. Supply as dependable as the mains, but without their noisy background; as pure as a new dry battery or newly-charged H.T. accumulator, but without the annoyance and expense of their periodical replacement or recharging. The dream becomes reality in the Milnes H.T. Supply Unit. It delivers H.T. current perfectly smooth and noiseless, and the voltage shows practically no variation.

The Milnes Unit comprises cells with nickel-cadmium plates in an

## MILNES H.T. SUPPLY UNIT

alkaline electrolyte. It is left permanently coupled to the L.T. accumulator and recharges itself from this automatically and without wasting a milli-watt of current, merely by turning a switch. The Unit is always on charge when the receiving set is not in use. Consequently it is always fully charged, and equal to the demands of the

largest set. The plates are definitely improved with hard work, and cannot be harmed by overcharging, dead shorting, or neglect. There is no sulphation or corrosion. The Milnes Unit is practically indestructible, and will give at least twenty years' faithful service. Five-year-old units (some of the first made) are working better to-day than when new.

Have done with replacement and recharging expenses. Enjoy pure reception for a lifetime. Fit a Milnes Unit and finish with H.T. troubles for ever.

Ask your radio dealer, or send the coupon for Free descriptive book.

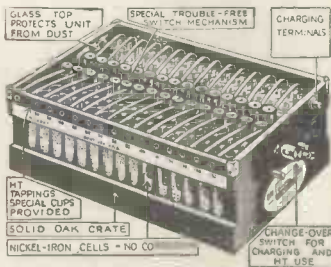

Keir Dawson—Bradford

### PRICES IN GT. BRITAIN.

90 volt ...	£3 3 0
100 volt ...	3 9 5
120 volt ...	4 2 3
150 volt ...	5 1 6

Hire Purchase terms available

MILNES RADIO CO., CHURCH ST., BINGLEY, YORKS

Please send full particulars of the Milnes Unit. No obligation.

Name .....

Address .....

V.I.

Advertisers like to know you "saw it in the 'Wireless Magazine'"

# WEARITE-NUCLEON

Reg. Trade Mark

Patents pending 31376/32, 31377/32,  
15746/33, 15747/33  
Pending Registration Trade Mark 542011



Special Nucleon Wearite Iron Core H. F. Chokes are available for use in this Receiver. They are specially screened complete with pigtail. Leaflets covering these new chokes and also the new coils are now available.

IRON - CORE COILS  
are essential for the

## TYERS IRON-CORE THREE

REPORTS are to hand of the amazing performance of the "Tyers Iron-core Three." The faith of the designer in the new Wearite Coils has been amply justified. Never before has such an efficient combination of range, selectivity, and perfect reproduction been attained. Build this wonderful set and realise what the combined efforts of Mr. Paul Tyers and the Wearite manufacturing organisation have done for better radio—for you!

**BETTER SELECTIVITY — WIDER WAVE-BAND RANGE — PERFECT MATCHING**

WEARITE NUCLEON Senior. Type B.P.1 12/6  
WEARITE NUCLEON Senior. Type B.P.2 12/6  
WEARITE NUCLEON Senior. Type T.G. 12/6

**HERE ARE OTHER SETS IN THIS ISSUE IN WHICH WEARITE COMPONENTS ARE USED**

### "THE ALL-METAL FOUR"

One Wearite T.21A Mains Transformer Price 25/-  
(Reg. Design 780272)

### "THE A.C.-D.C. THREE"

Two Wearite H.F.8 Chokes Price, each, 10/6

### "THE SELF-CONTAINED FOUR"

One Wearite H.F.P.A. Choke Price 4/-  
One Wearite H.F.P. Choke Price 3/6

Send for appropriate Leaflet.

# WEARITE

Reg. Trade Mark

WRIGHT & WEARE LTD., 740 HIGH RD., TOTTENHAM, N.17. Phone : Tottenham 3847/8/9

Better service results from mentioning "Wireless Magazine" when writing to advertisers

3233



# RADIO "SCOPHONY"

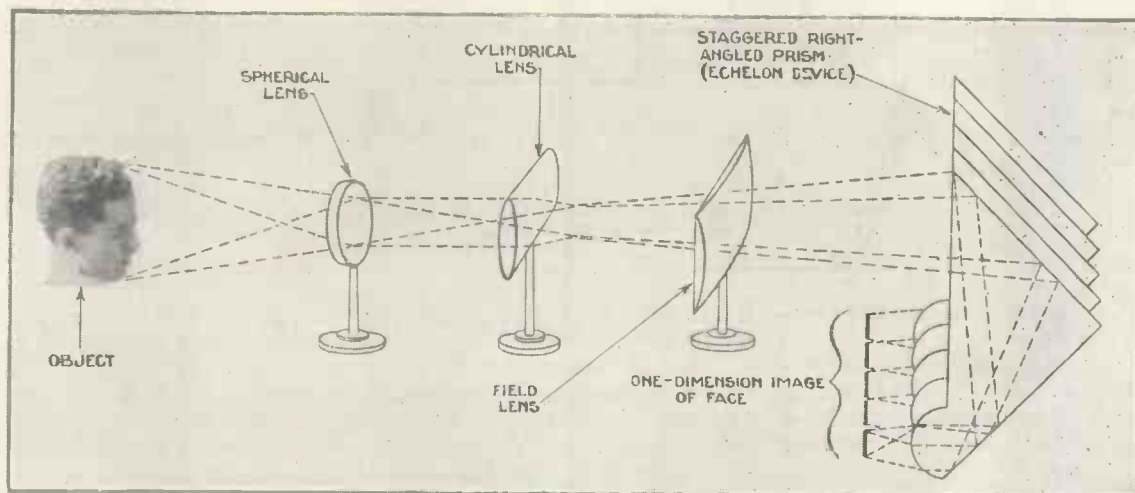

**HOW THE SCOPHONY SYSTEM SPLITS UP A PICTURE FOR TRANSMISSION**

By means of a special formation of staggered prisms, called an echelon, the picture to be transmitted is split up into a series of horizontal strips which effectively constitute a straight line. This can easily be scanned by a simple oscillating mirror

WHEN Mr. G. W. Walton showed me his new vision receiver I picked the whole thing up and put it in my coat pocket. I was stopped before I reached the door of the laboratory; but, anyhow, I had demonstrated the smallness and neatness of the apparatus.

Subsequently I found that the moving parts of this remarkable new invention would go into my waistcoat pocket and make hardly any bigger bulge than my watch.

Those who have used the vision receivers hitherto available will realise the great advance Mr. Walton has made after over ten years of hard work on the problems of television.

## Negligible Power

He has done away with the unwieldy Nipkow disc and the heavy mirror drum and substituted a tiny thing which looks like a crystal ornament for a lady's dress. The power required to work it is negligible—less than a tenth of a watt.

The Scophony vision receivers are shortly to be put on the market by Ferranti, Ltd. There will be two types, a junior and a senior. The junior will, I understand, be sold at a price which will put it within the reach of everybody. The size of the

pictures given is bigger than anything yet attained from the B.B.C. thirty-line transmissions.

In the junior model the maximum size is 8.26 in. by 3.16 in., and in the senior model 17.32 in. by 6.32 in. Really no useful purpose is served by making the pictures bigger than this. It is not worth while with a thirty-line transmission.

The light source is an important thing in any vision receiver. The Scophony receivers are very flexible in this respect and can be used with any gas-discharge tube—neon, sodium, or mercury-vapour lamps, for instance.

In the successful demonstration I recently saw the junior model had a mercury lamp giving a bluish-white picture and the senior a sodium lamp giving a yellowish-white picture.

The thing which impressed me most about these remarkable little receivers was, first, the clarity of the pictures, considering that only thirty lines were being sent out by the B.B.C., and, secondly, the ease with which the apparatus could be used.

The picture came in at a touch or two on the controls, evolving out of the customary whirl of spots and bars, and, once there, remained without any trouble for as long as the transmission continued.

This was when the apparatus was

In these notes Capt. E. H. ROBINSON discloses the imminent release of a new type of television receiver to be put on the market by Ferranti, Ltd. The new principle is due to G. W. Walton, whose system is called "Scophony."

In the following pages a special correspondent discusses the basic features of the Scophony television system and has something to say about the possible form the receiver will take.

It is understood that Scophony television receivers will be on show at Olympia on August 15.

coupled to a simple two-valve broadcast receiver with a 2-watt output. A big contrast, this, to my present receiver with which I can only get a steady picture when I use a valve delivering 10 watts speech output, though I can get fairly good results with a 5-watt valve and 500 volts.

The Scophony vision receivers will work with ordinary output valves and no higher voltages than are customary with commercial sets. This is a great triumph, and it does bring television within the reach of all.

# Scophony—Its Basic Principles

By A Special Correspondent



Fig. 1.—Picture divided into horizontal strips for analysis by the mirrors or prisms

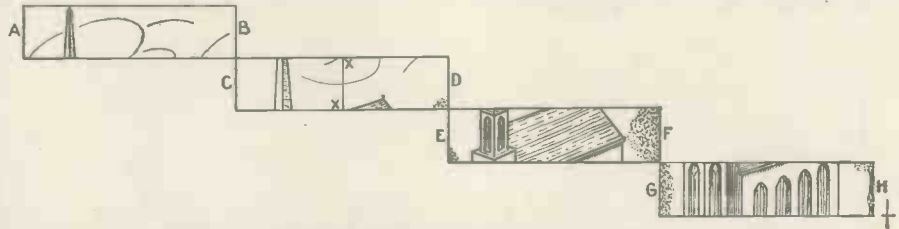

Fig. 2.—How the echelon device staggers the horizontal strips into what amounts to a single straight line that can be easily scanned by an oscillating mirror

THE announcement that Ferranti's are about to market a new type of television receiver cannot fail to arouse interest, especially amongst those who are convinced that radiovision must sooner or later come into its own.

Although precise details of the new instrument are not yet available, it is clear that the usual rotating-disc method of scanning has been replaced by a vibrating-mirror arrangement, which reduces the whole unit to very compact dimensions.

The "Scophony" system of scanning—the name presumably being derived from a Greek verb meaning "to see or view"—has been associated for some years with the name of G. W. Walton. It presents certain ingenious features quite unlike anything that has yet been put into practice.

Whilst its merits have still to be publicly demonstrated, one may feel reasonably sure that Ferranti's have satisfied themselves on this point and that they regard the new receiver as marking a definite advance in the art of radiovision.

It is generally admitted that the quality of the pictures reproduced by the well-known rotating-disc type of instrument falls considerably below the standard required to give the

B.B.C. television programmes a real entertainment value.

This is not altogether surprising in view of the fact that the rotating-disc "scanner" is at least forty years old and, although its modern equivalents—including the mirror-drum—have naturally been made more efficient in action, they still form the weakest link in the whole chain of television transmission and reception.

An improvement in this direction being long overdue, many designers have recently turned their attention

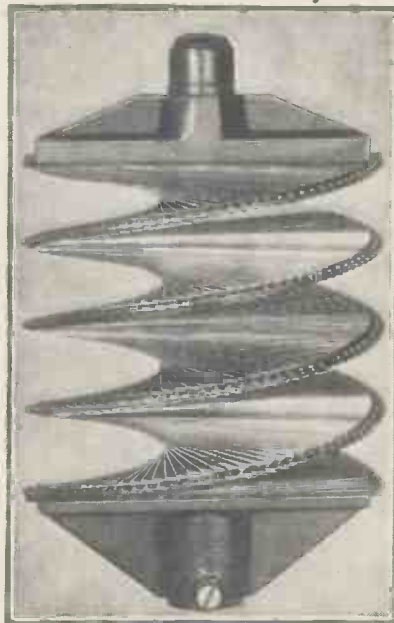

AN AMBITIOUS MIRROR  
This ambitious mirror is a German attempt to get 180-line scanning

limitations of the disc as regards the size and definition of the scene to be reproduced.

Now in the

Scophony system we are presented with a further alternative, both to the rotating-disc method and to the use of the cathode-ray tube.

As originally conceived, Mr. Walton's scheme is based on the idea of using an arrangement of stationary mirrors, prisms, or lenses which automatically and *instantaneously* convert the picture to be transmitted into a single "straight line" of equivalent light and shade values.

### No Moving Parts

This is done without the use of any moving parts or mechanism. Once the original has been converted into an equivalent "line" picture, it is ready for scanning.

It is this feature which forms the outstanding merit of the invention, because the scanning operation can now be performed by a simple vibrating mirror, arranged to swing to and fro across the "line."

As each swing traverses the whole picture, a vibration rate of fifteen cycles per second is sufficient to produce the kinematographic effect



### COMPARISON OF SCANNING DISCS

On the left is seen a scanning disc for 30-line pictures, and on the right a disc for 100-line pictures, which, of course, give greater definition.



required for "living" pictures; in other words, fifteen cycles per second gives complete persistence of vision.

Any image or picture is naturally seen in two dimensions, as, for instance, the area shown in Fig. 1. But if the picture is reflected from an optical grating or echelon mirror, each of the horizontal sections marked *ab*, *cd*, *ef*, and *gh*, will be displaced relatively, so that they fall more or less into a single line, as shown in Fig. 2.

### Single-line Equivalent

In other words, a two-dimensional picture has been automatically transformed into what is, practically speaking, a single-line equivalent. In this form the complete picture can be completely explored by a single lateral movement of a mirror used as the scanning device.

The number of horizontal subdivisions *ab*, *cd*, etc. (Fig. 1) can, of course, be increased to give any desired degree of definition by suitably increasing the number of "steps" on the reflecting mirror.

### Average Centre

The actual appearance of the resolved picture "line" is perhaps more clearly shown in Fig. 3, where the track of the scanning mirror passes diagonally across the average centre, as shown by the lines *ss*.

If one considers a typical vertical line, such as *xx*, in Figs. 2 and 3, any point along that line will represent

representative of the whole picture.

In Scophony television, therefore, there is no necessity for using the comparatively large rotating disc typical of ordinary systems. In fact, the moving parts of the apparatus can, as Capt. Robinson points out, be carried without discomfort in one's pocket.

In transmission the picture, after being converted into its "line" equivalent, is scanned by the vibrating mirror which throws the consecutive light-and-shade values in sequence across a photoelectric cell or "eye," so as to transform them into corresponding electric currents. After suitable amplification, these are used to modulate the outgoing carrier wave from a transmitter.

In reception, the process is reversed. The light from a lamp is swept by a vibrating mirror across the face of a stationary "stepped" mirror, which automatically restores the picture into its original two-dimensional form.

One method described by Mr. Walton for driving and synchronising

axis under the control of a chronometer spring *s*.

The "drive" control, for synchronising and for limiting the amplitude of swing to a steady value, is applied through a cross-pivoted rocker *R*, which is coupled to a shaft

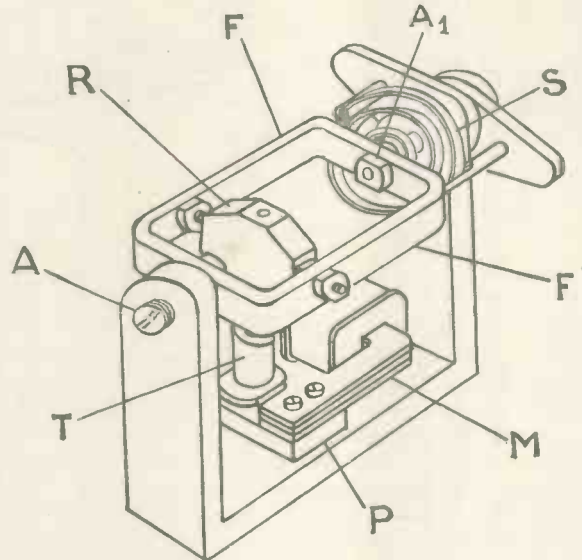

Fig. 4.—A device developed by G. W. Walton for driving and synchronising his vibrating mirror. It is likely that such a mirror could be used instead of a rotating drum or disc in picture reproduction

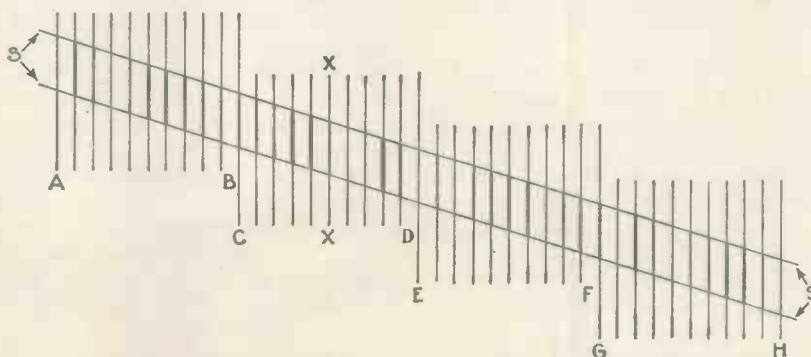

Fig. 3.—Appearance of the resolved picture "line." Compare with the staggered strips of Fig. 2. The track *ss* represents the "average" centre of all the lines

the average intensity of all the points along the corresponding line *xx* in the original picture shown in Fig. 1.

It follows that the effect of scanning along the "average" centre of all the lines, that is, along the track *ss*, gives a result which is truly

his vibrating mirror is shown in Fig. 4.

The mirror itself is omitted for the sake of clearness, but it is actually carried in a frame *F* which is mounted in jewel bearings at *A* and *A*<sub>1</sub> so as to swing steadily about that

*T* connected to the armature of a synchronous motor *M*.

The resultant motion of the mirror may be adjusted so as to compensate for the brighter edges of the "line" picture so as to ensure a uniform illumination.

The drive may be arranged so as to give a "saw-tooth" wave motion to a spot of light reflected by it from the lamp, thereby adapting the instrument to receive the standard type of picture transmission.

The necessary phase-control required for perfect synchronisation is obtained by rotating the platform *P* carrying the stator of the motor *M*.

### Receiver Possibilities

It is not at present certain how far the new receiver will incorporate the precise details of the scanning system set out above.

For instance, by making suitable adjustments, a mirror mounted as shown in Fig. 4 could no doubt be used as a substitute for the usual rotating disc, so as to throw the varying light from a lamp direct on to the viewing-screen, without the intervention of the special "stepped" or echelon mirror arrangement.

# THE LUCERNE PLAN

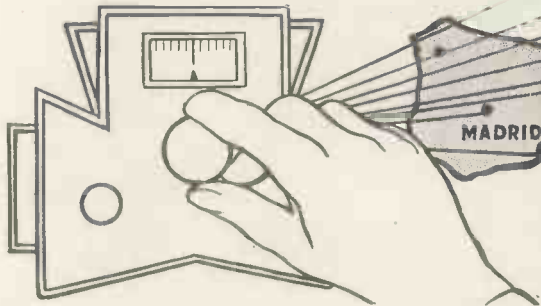

## How It Will Affect You

by ALAN HUNTER

Every listener has heard of the recent conference of broadcasting authorities at Lucerne. In this article Alan Hunter explains just how the decisions reached at the conference will affect the ordinary listener. There is no doubt that we are on the eve of a revolution as far as wavelength distribution is concerned and early in the new year listeners will have plenty of excitement sorting out the new positions of Europe's broadcasting stations

ON January 15, 1934, will be staged the biggest re-shuffle of European broadcasting wavelengths ever known. Many of the best-known foreigners will disappear from familiar positions on your set's tuning scale. That is the first indication you will note when Plan de Lucerne takes charge of the ether.

Meanwhile, it is interesting to see just what this new wavelength plan is all about, so that you will be quite prepared for its consequences in the new year ahead.

### Europe's House in Order

It is, firstly, a plan tabled to put Europe's broadcasting house in something like order; a plan that visualises not only the host of existing stations, but the innumerable stations projected for the immediate and more distant future by the various countries of Europe.

In brief, it is a plan designed to regulate the present stations' transmissions and to control the progress of each country's broadcasting organisation in the future.

For this reason alone the Lucerne Plan is the most important wavelength arrangement that has ever been made. Backed up as it is by the governments of all the countries that have subscribed to the new protocol, it is a plan that will command the loyal support of practically all the broadcasting organisations responsible for the programmes we receive.

A few countries have not yet signed, notably Holland, Poland and Finland, but as no less than twenty-seven countries *did* sign it looks as though the dissentients will have to fall in with the new plan even if they do not graciously approve of it.

Let us look into the basis of the new plan. The first point that will strike you is the creation of a *new broadcasting waveband*, in addition to the expansion of the medium and long wavebands already familiar to listeners.

Band No. 1 extends from 2,000 down to 1,000 metres. Band No. 2, the new band, extends from 1,000 down to 600 metres. Band No. 3, the medium waveband, extends from 600 down to 200 metres.

Virtually, then, broadcasting of the future covers a complete waveband from 2,000 to 200 metres without a break, though it must be said that the new band No. 2 takes in only a few stations, mostly Central Europeans that will not be likely to interfere with the shipping wavelengths into which they are really encroaching.

These extensions of the existing wavebands, and the setting up of the new waveband, do something to relieve the present squeeze. Unfortunately, all this is not enough to cope with the number of stations

in existence and those projected, and other means had to be found to give everyone a fair share of the ether.

Expediency has beaten idealism, as usual, so that we now find stations with *reduced frequency separation*, particularly on the long waves, where the average separation seems to be only 7 or 8 kilocycles. On the medium waves the average separation is 9 kilocycles, although where stations are sharing wavelengths a 10-kilocycle separation has been arranged.

### Top-note Response

The effect on reception of this reduction in station separation will be to reduce the permissible amount of top-note response.

If your set is designed to bring in much above 4,500 cycles it looks as though it will have a bad time under the Lucerne Plan—heterodyne whistles and such-like noises will prove too much for the average listener, who will have to resign himself to a bare shadow of the real high frequencies.

Even then, with extended wavebands, an additional waveband, and stations working more closely together, the demands for wavelengths could not be met, so the conference had to resort to extensive *sharing* of wavelengths.

### Three Groups

Three kinds of wavelengths figure under the Lucerne Plan; Exclusive, National Common, and International Common, the last category being further sub-divided into Types One and Two according to the power.

By these various means it has been found possible to find room for no less than 232 stations, which will



work on 130 channels, only 55 of which are exclusive. Fortunately, most of the worth-hearing foreigners are among these exclusives, so there will be plenty of programmes clear of mush—if the rest of the plan works out, anyway!

Power of transmission has been an important factor in the new wavelength distribution. Medium-wave stations are limited to 100 kilowatts, except where stations of 120 kilowatts already exist or are in process of being built, such as Prague, Vienna, Budapest, Leipzig, Rennes PTT, Toulouse PTT.

On the long waves power is limited to 150 kilowatts, exception being made for Moscow No. 1, which, for some extraordinary reason, insists on having 500 kilowatts—perhaps to tell us how the second Five Year Plan is getting along?

### Modulation Question

Wrapt up in this power limitation is the question of modulation, of course. In the past we have suffered a great deal from stations of high power over-modulating, particularly on speech, producing that all-too-familiar whispering sound known as "sideband splash."

High power is not in itself impossible to cope with at the receiving end, but over-modulation of high-power stations presents insuperable difficulties, even for a super-selective super-het.

It is therefore a good thing that under the Lucerne Plan modulation must also be restricted—or the International Broadcasting Union "policemen" will tell the offending countries all about their evil deeds!

National Common wavelengths must be limited to 5 kilowatts and International Common wavelengths to 2 kilowatts for Type 1 and 2 kilowatt for Type 2.

The success of the new plan depends to a very large degree on the strict observance of wavelength allocations. Tolerances allowed by Lucerne are much more severe than in the past. For example, stations on exclusives may vary *only 50 cycles* one way or the other, while stations on shared wavelengths must keep within plus or minus 10 cycles!

Looking through the official

list of the stations as they will line up under the Lucerne Plan we find that some of the well-known stations are in for quite drastic moves.

Mühlacker, for example, that uneasy ether neighbour of London Regional, goes from his present 360.5 metres right up to 522.5 metres. In spite of such spectacular changes a surprising number of stations will be found in the same juxtapositions as now.

The effect on British wavelengths is not very marked. We had ten official wavelengths under the old plan, and under Lucerne we get eleven, though not all are exclusives.

As a matter of fact, it is not easy to see how they will be arranged in a year's time if you merely look at the published Lucerne list, because that does not take into account the quite drastic effect of the opening of Droitwich National.

Here, though, is the present arrangement, tentatively fixed for January 15 when the Lucerne Plan comes into general operation; we shall have twelve different channels, then, the stations being located as follows:—

Daventry National, 1,500 metres;  
North Regional, 449.1 metres;  
Midland Regional, 391.1 metres;  
Scottish Regional, 373.1 metres;  
London Regional, 342.1 metres;  
West Regional, 307.1 metres;  
North National, 296.2 metres;

Bournemouth, 285.7 metres; Scottish National the same—that is synchronised; London National and West National, 261.1 metres; Aberdeen, 222.6 metres; Newcastle, 209.9 metres; and Plymouth, 203.5 metres.

When Droitwich opens, which cannot be for at least six months after the start of Lucerne Plan, our wavelength arrangements will be completely altered, somewhat on the following lines:—

Droitwich National, 1,500 metres; North Regional, 449.1 metres; Scottish Regional, 391.1 metres; West Regional, 373.1 metres; London Regional, 342.1 metres; North Ireland Regional, 307.1 metres; Midland Regional, 296.2 metres; North-eastern Regional, 285.7 metres; North Scottish Regional, 267.4 metres; Scottish National, 261.1 metres; and Plymouth, 203.1 metres.

### Effect of Droitwich

This list reveals the true import of Droitwich, the coming of which will close down London, North and West Nationals, redundant with the high-power long-wave National signal covering the whole of the country.

It also shows *three new stations*: North-eastern Regional, which is designed to serve the populous Tyneside districts not adequately covered by North Regional; then there is North Scottish Regional, to placate the unceasing agitators of the North of Scotland, who have rightly complained of bad service from Scottish Regional; and lastly there is North Ireland Regional, which will be the high-power successor to Belfast.

Plymouth, by the way, will go up to 5 kilowatts and will serve the west in parts not well reached by West Regional.

Within the next year or thereabouts, then, we are in for two ether upheavals; firstly, the general re-shuffle with the rest of Europe next January, and secondly, in about a year's time, another re-arrangement to meet the changed conditions brought about by the opening of Droitwich.

A full calendar for ether searchers!



TAKING A RESPITE IN THE LOUNGE  
Two of the British representatives taking a rest from the conference in the lounge of the Hotel Nationale at Lucerne. They are Admiral Sir Charles Carpendale (in the background) and Noel Ashbridge

The "W.M."

A.C.-D.C.  
THREE

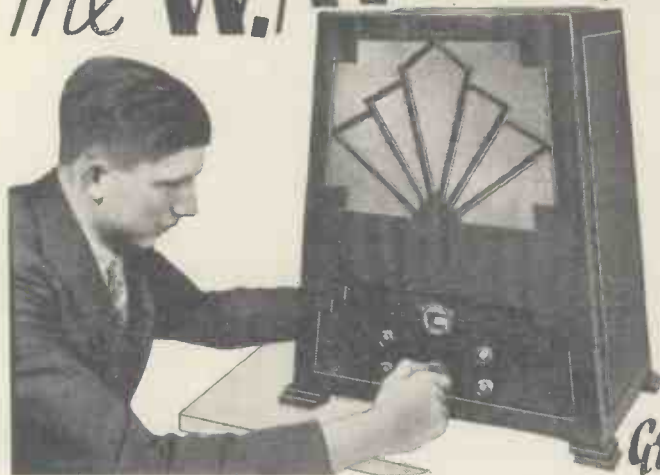

As a  
Table  
Model  
or Radio  
Gramophone



Designed by the "Wireless Magazine" Technical Staff

IN these pages the "Wireless Magazine" Technical Staff is able to describe something quite new in the constructional line—a three-valve set that will work equally well on A.C. and on D.C. mains without any alteration whatever.

"That sounds all very well," you may say, "but what practical use is it?" Well, there are two answers to that question.

The first and most important is that those who are at present on D.C. mains and likely to be changed over to A.C. at any moment will find such a set as this to be the best proposition. When the change-over is made there will be no need to make drastic alterations in the design of the set, which gives the same results whether run from A.C. or D.C.

Then there is a large number of people who, for one reason or another, are constantly changing their place of residence. For instance, an R.A.F. officer recently wrote to us for the design of an A.C.-D.C. set as he is constantly having his quarters changed and wants a mains set that will have universal application.

These examples show that there is a need for receivers

that will work from all kinds of mains; knowing that the need existed "Wireless Magazine" has taken the first opportunity of designing a really satisfactory receiver for the job.

By means of a compromise it has been possible to make A.C.-D.C. sets for some time past, but we have waited until a proper range of A.C.-D.C. valves became available. The valves actually used in our original set are foreign; an announcement of the production of British A.C.-D.C. valves appears on page 32.

#### Valves with 20-volt Filaments

The valves are of the indirectly-heated type, the filaments consuming only .18 ampere (180 milliamperes) at 20 volts. Thus any number can be run in series up to the limit imposed by the actual voltage of the mains, and the consumption for any number of valves will be about 40 watts, or at the most 50 watts, if high tension is taken into account as well.

One of the most interesting points about the set is that, as a high-voltage rectifier is used for A.C. working, there is no need for a mains transformer. It should be noted



ALL READY FOR USE  
Here is the A.C.-D.C. Three assembled as a console table model with built-in moving-coil loud-speaker

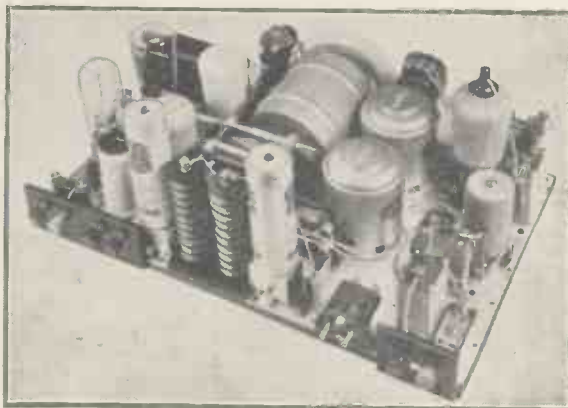

A SET FOR ALL-ELECTRIC MAINS  
This three-valve set can be used without any alteration at all on either A.C. or D.C. mains provided the voltage is between 200 and 250 volts



that the cathode is the positive high-tension source and that the anode corresponds to high-tension negative.

The sequence used in this three-valver is a variable- $\mu$  high-frequency stage, detector and a power valve. Note in particular that the last is not a pentode, although it looks something like it from the circuit diagram. Actually, it is a special type of triple-grid valve giving an output of the order of 1.5 watts.

### Ganged Tuning of Iron-core Coils

In the main the circuit follows standard practice. Iron-cored coils are used for aerial and high-frequency coupling; these are tuned simultaneously by means of a two-gang condenser, but trimming difficulties are non-existent as the condenser is provided with a front-panel control for trimming on each station as it is received.

The arrangement of the variable- $\mu$  valve follows usual practice, the volume being controlled by a 5,000-ohm potentiometer. The screening-grid circuit is decoupled by means of a 20,000-ohm resistance and a .01-microfarad condenser. A .05-microfarad by-pass condenser is provided across the potentiometer.

The usual high-frequency choke appears in the anode circuit of the first valve, which is decoupled by a 1,000-ohm resistance and a 1-microfarad condenser.

### Fixed Condenser in Earth Lead

It should be noted that a 2-microfarad condenser is inserted in the earth lead of the set and it is of the utmost importance that this component should be included. The reason will be clear from a glance at the article "How to Design a D.C. Set" that appears on page 37.

The detector is arranged as a leaky-grid device. Grid bias is supplied by a resistance of 1,000 ohms, by-passed by a 2-microfarad electrolytic

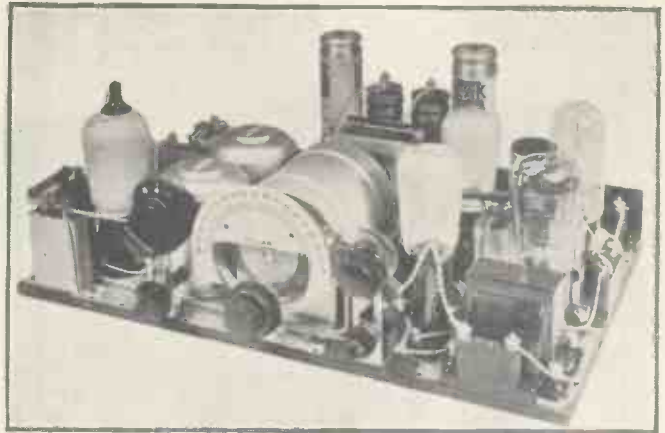

**FIVE "LAMPS"—BUT ONLY THREE VALVES**  
From this photograph it certainly looks as if the A.C.-D.C. Three were a five-valver, but the fourth and fifth "lamps" are the mains rectifier and a barretter tube

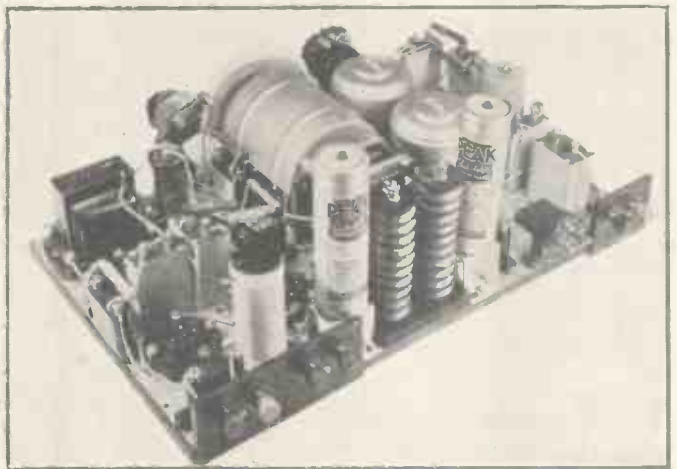

**ELECTROLYTIC CONDENSERS SAVE SPACE**  
For smoothing large-capacity electrolytic condensers are used; these save considerable space and are mounted on special aluminium brackets for convenience

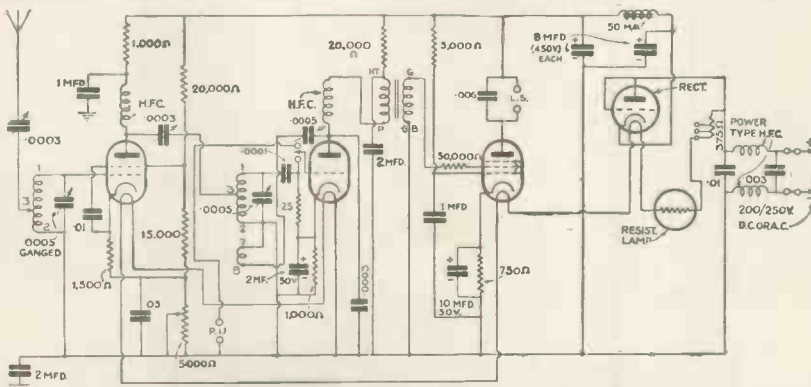

**CIRCUIT OF SET FOR USE ON A.C. OR D.C. MAINS**

Three indirectly-heated high-voltage valves are used in the sequence of variable- $\mu$  high-frequency amplifier, detector and power output stage, the last valve being a special triple-grid type

condenser. Reaction is controlled by a .0005-microfarad variable condenser and a fixed condenser of .0003 microfarad is used across the anode and cathode to improve the detector efficiency.

Between the detector and the power valve is the usual low-frequency transformer coupling, the primary

importance, by the way, that all the electrolytic condensers shown in this circuit should be connected up the proper way round; they are polarised and serious damage will be done if the polarity is reversed.

The current through the valves is controlled by a 375-ohm mains resistance, which must be capable

being decoupled by a 20,000-ohm resistance and a 2-microfarad condenser.

The priming grid of the triple-grid power valve is decoupled by a 5,000-ohm resistance and a 1-microfarad condenser. The operating grid is provided with a stopper of 50,000 ohms. It will also be noted that the valve is provided with automatic bias by a 750-ohm resistance, this being by-passed with a 10-microfarad electrolytic condenser.

### Mains Smoothing

Smoothing of the mains supply is accomplished by a low-frequency choke and two 8-microfarad electrolytic condensers. It is of the utmost





that the connections numbered 81, 83 and 85 are made with metal-braided flex. The metal braiding should in each case be turned well back from the actual wire and should then be earthed.

There are five control knobs in all on the front of the set, that in the centre being the dual knob of the two-gang condenser.

**Fine-tuning Device**

The main part of this knob adjusts both sets of vanes, but the smaller projection in front actuates only the trimmer, so that the set can be ganged up on any particular station without any trouble. The front knob, in other words, is simply used as a fine-tuning device.

On the left of the main tuning control, arranged one above the other, are the volume control (top) and wave-change switch. On the right are the reaction condenser (top) and the gram-radio switch. Nobody will have any difficulty about working these controls to get the best results from the receiver.

**Console or Radiogram**

It will be noticed from the photographs that the set lends itself equally well for construction as a simple table model with built-in loud-speaker or as a complete radio gramophone with a universal motor that works from A.C. or D.C. mains.

There may still be some readers who do not appreciate the fact that this set can be used on either A.C. or D.C. mains *without any alteration whatsoever*, provided that the voltage is between 200 and 250 volts.

As long as that condition is met there will be no trouble and the receiver will give perfect hum-free reception wherever it is used.



**SPACE FOR STORING GRAMOPHONE RECORDS**  
Here is the set assembled as a complete radio gramophone. Note that at each end of the motorboard there are slots for storing records

**COMPONENTS YOU WILL NEED FOR THE "W.M." A.C.-D.C. THREE**

	£	s.	d.		£	s.	d.
<b>CHOKES, HIGH-FREQUENCY</b>							
1—Goltone screened, type SHF (or Kinva, Wearite) ...	0	4	0	3—Sovereign terminal blocks ...	0	1	6
1—Peto-Scott, standard type (or Graham-Farish, Ready Radio) ...	0	3	6	1—Bulgin combined twin fuse-holder and mains connector, type F15 ...	0	3	6
2—Wearite heavy-duty, type HF8 (or Goltone) ...	1	1	0	<b>RESISTANCES, FIXED</b>			
<b>CHOKE, LOW-FREQUENCY</b>							
1—Parmeko, type A40/50 (or Davenset, Wearite) ...	1	1	0	10—Erie, 1-watt type, values 750, 1,000 (2), 1,500, 5,000, 15,000, 20,000 (2), 50,000 ohms and .25-megohm (or B.A.T., Dubilier) ...	0	10	0
<b>COILS</b>							
2—Varley screened dual-range iron-cored, type Nicore BP30 ...	1	1	0	1—Wearite tapped 375-ohm, mains type ...	0	3	6
<b>CONDENSERS, FIXED</b>							
1—T.C.C. .0001-microfarad, type 34 (or Graham-Farish, Telsen) ...	0	1	3	<b>RESISTANCES, VARIABLE</b>			
1—T.C.C. .0003-microfarad, type 34 (or Graham-Farish, Telsen) ...	0	1	3	1—Preh 5,000-ohm potentiometer, standard type with knob (or Lewcos, Watmel) ...	0	4	6
1—T.C.C. .003-microfarad, 1,000 D.C. test (or Dubilier) ...	0	3	0	<b>SUNDRIES</b>			
1—T.C.C. .006-microfarad, type 34 (or Graham-Farish, Telsen) ...	0	2	0	Tinned-copper wire for connecting ...	0	1	0
1—T.C.C. .01-microfarad, type 40 (or Dubilier) ...	0	1	9	Lengths of oiled-cotton sleeving, say ...	0	1	0
1—T.C.C. .05-microfarad, type 40 (or Dubilier) ...	0	1	9	3—Bulgin type K14 knobs ...	1	1	4
1—T.C.C. .01-microfarad, 1,000-volt test (or Dubilier) ...	0	3	6	1—Bulgin type K13 knob ...	4	4	
2—Peak 1-microfarad, type A4 (or Lissen, Telsen) ...	0	4	4	<b>SWITCHES</b>			
2—Peak 2-microfarad, type A4 (or Lissen, Telsen) ...	0	5	6	1—Bulgin rotary radiogram, type S86 ...	0	1	9
1—T.C.C. 2-microfarad electrolytic, 200-volt, type 561 ...	0	3	0	<b>TRANSFORMER, LOW-FREQUENCY</b>			
2—Peak 8-microfarad electrolytic, type W, with holders (or T.C.C., Dubilier) ...	0	10	6	1—Ferranti AF8 (or R.I., Lissen) ...	0	11	6
1—T.C.C. 10-microfarad electrolytic, 50-volt, type 521 ...	0	3	0	<b>ACCESSORIES</b>			
<b>CONDENSERS, VARIABLE</b>							
1—Polar .0005-microfarad two-gang Uni-knob with disc drive (or Utility) ...	0	19	6	*CABINET			
1—Polar .0005-microfarad reaction, Compax type (or Utility) ...	0	2	9	1—Osborn table model, type 300 ...	2	10	0
2—Colvern preset .0003-microfarad maximum (or Formo, Igranio) ...	0	3	6	<b>LOUD-SPEAKER</b>			
<b>HOLDERS, VALVE</b>							
5—Benjamin five-pin (or W.B., Ready Radio) ...	0	10	0	1—Blue Spot permanent-magnet moving-coil, type 99PM ...	2	19	6
<b>PLUGS AND TERMINALS</b>							
6—Bulgin, marked: Aerial, Earth, Pick-up (2), L.S+, L.S.— (or Clix, Eelex) ...	0	1	6	<b>VALVES</b>			
				1—Tungsram SE2018 (screen-grid) ...	0	14	6
				1—Tungsram G2018d (detector) ...	0	10	6
				1—Tungsram PP2018d (power) ...	0	17	0
				1—Tungsram R2018 (rectifier) ...	0	10	6
				1—Tungsram 180R (resistance lamp) ...	0	5	6
				<b>Additional Parts Needed for Radio-gramophone Version</b>			
				<b>CABINET</b>			
				1—Osborn radiogram, type 243 in mahogany ...	6	5	0
				<b>GRAMOPHONE MOTOR</b>			
				1—Garrard universal A.C.-D.C. ...	5	5	0
				<b>PICK-UP</b>			
				1—B.T.H. minor with volume control ...	1	7	6
				*Not required for radiogram version.			

**Advantages of Tone Control**

IT is admitted on all sides that a tone control is a most useful refinement. It cannot be said that a receiver which gives perfectly good results in one room will also give the best results in another, for the simple reason that the sound waves will receive different treatment in the two rooms, owing to the differences in the walls and general furnishing.

Then, again, the results will vary according to whether speech or music is being transmitted. The chief thing with speech is to have it as clear as possible. But with music, all I can say is that some people seem to like a lot of bass and others want a fair amount of treble.

When a tone control is fitted, the user has the means for best adapting the output to suit his conditions. The bass can be strengthened or speech can be made more clear, perhaps, by strengthening the treble notes and so on.

Not many sets have a useful tone-control arrangement. The general idea of connecting condensers across a loud-speaker is not very satisfactory, and is rather wasteful.

It is much better to include immediately after the detector a device by means of which the tone may be adjusted, and in this connection a proper transformer and tone-control potentiometer (such as may now be obtained) is of considerable value.

The position in which a tone control is connected is obviously a matter of some importance, as it is wasteful to amplify notes which are afterwards reduced in strength.

W. James.

# The A.C.-D.C. Set on Test

We believe that this set will arouse considerable interest among constructors generally. Apart from the obvious advantages of a combined A.C.-D.C. set for those who are likely at any moment to be changed over from D.C. to A.C., there is much interest to be obtained by trying the same set out in different districts on different mains.

In accordance with our usual plan we have arranged for the original "Wireless Magazine" set to be on view in Selfridge's Somerset Street windows during the currency of this issue

I TOOK delivery of this set for test purposes on the test benches at the "Wireless Magazine" offices in Fetter Lane, where there are both A.C. and D.C. mains supplies. Having no D.C. mains at home, I gave the set a preliminary test under very bad conditions.

### Good Quality

At the laboratories I managed to log a fair number of stations without difficulty. The quality was especially good and there was absolutely no trace of mains hum.

At my home in South London I put the set on to A.C. mains—the set will work on A.C. or D.C. mains without any constructional alteration—and got to work to find out its capabilities.

Again, the first point I noticed was the absence of mains hum. Admittedly, there was a small ripple, but so slight that one had to put an ear to the loud-speaker to hear it.

### Stations Rolling In

Between 6 and 8 p.m. I logged about twenty stations at fair strength, using my normal outdoor aerial. Between 9 and 11 p.m. the stations simply rolled in. London Regional was the strongest station and, naturally with a set with only two tuned circuits, there was bound to be some spread on the tuning dial. It was rather surprising to find that the spread was only 15 degrees and that Scottish Regional and Brussels No. 2 could

be tuned-in with negligible interference.

The spread of London National was only six or seven degrees and there was no difficulty in logging Trieste or Bari entirely free.

Selectivity on the long waveband was even better. Eiffel Tower was completely free from Daventry National and one could listen to Königswusterhausen—the German sandwiched between Daventry and Radio Paris—with only negligible interference from Daventry National.

Back on the medium waveband I was rather surprised to find that it was easily possible to receive Prague, North Regional, and Langenberg quite well, the only interference being a slight twittering of Langenberg when the set was tuned to North Regional.

Some idea of the set's sensitivity can be gauged from the list of stations accompanying this report. At this time of the year one does not expect to record a huge list of stations, but you will agree that the log of this set is highly satisfactory.

Such stations as Budapest, Florence, Rabat, and Katowice were heard at fair listening strength, by which I mean that their pro-

grammes could be enjoyed in a moderate-sized room.

Early in the morning I found that quite good entertainment could be obtained from Langenberg, Huizen, Hilversum, and Radio Paris.

### Twenty-five Good Stations

During my test I received about twenty-five stations at full strength, fifteen at moderate or weak strength and probably a dozen others mixed up with noise and atmospherics that were not worth hearing.

One of the features of this set is the extreme simplicity of tuning. There are no ganging troubles; the two circuits being kept in gang by a small knob superimposed on the single tuning control.

### Definite Action

All the controls worked with a definite action; reaction was, however, a little fierce.

The impression I gained of the "W.M." A.C.-D.C. Three during my short tests was that its performance is satisfactory for a three-valver, the tuning is very simple, and that it is an ideal set for those, living in D.C. areas, who may shortly be changed over to A.C. mains. *T. F. Henn.*

## LIST OF STATIONS RECEIVED

### LONG WAVEBAND

Station	Dial Reading	Station	Dial Reading
Luxembourg .. ..	76	Poste Parisien .. ..	70
Warsaw .. ..	106	Milan .. ..	74
Eiffel Tower .. ..	112	Brussels No. 2 .. ..	78
Daventry .. ..	130	London Regional .. ..	86
Königswusterhausen .. ..	140	Scottish Regional .. ..	94
Radio Paris .. ..	152	Leipzig .. ..	100
Huizen .. ..	174	Midland Regional .. ..	105
		Sottens .. ..	108
		Katowice .. ..	110

### MEDIUM WAVEBAND

Fécamp .. ..	15	Athlone .. ..	113
Trieste .. ..	31	Rabat .. ..	115
Frankfurt .. ..	36	Rome .. ..	126
London National .. ..	38	Paris .. ..	129
Bari .. ..	42	Beromuenster .. ..	138
Turin .. ..	45	Langenberg .. ..	142
Heilsberg .. ..	47	North Regional .. ..	145
Scottish National .. ..	50	Prague .. ..	148
Hilversum .. ..	54	Florence .. ..	156
North National .. ..	57	Brussels No. 1 .. ..	159
West Regional .. ..	61	Vienna .. ..	163
Breslau .. ..	67	Munich .. ..	171
		Budapest .. ..	180



# PHOTOCELL EXPERIMENTS FOR ALL

By **PERCY W. HARRIS** *M. Inst. Rad. E.*

WITH television, the telegraphic transmission of pictures, burglar alarms, automatic counting devices, and dozens of other interesting applications of photoelectric cells the wireless experimenter will find a practical knowledge of the cells of the greatest interest and use.

Last month we discussed the general principles of photoelectric devices and some of their characteristics. This month I want to describe to you some practical experiments of an interesting nature which you can perform with apparatus well within the reach of the average amateur.

## Electric Variations

It will have been gathered from last month's article that, no matter what form the photoelectric cell may take, its purpose is to provide, in a suitable circuit connected with it, variations of voltage and current.

Most of the photoelectric cells in use are not self-generating; that is to say, they need some voltage source connected to them. The action of light on the cell controls the flow of electrons across the space between the two electrodes and thus causes the cell to act as if it were a variable resistance controlled by the light.

It is interesting in this connection to refer to Fig. 1, which shows how a photoelectric cell can be connected to the grid of a valve for magnification purposes.

The anode of the cell is connected to a tapping on the high-tension battery and the resultant electronic flow passes through the

high resistance connected to low-tension negative.

This varying current (varying, that is, if the light varies) in passing through the resistance sets up a varying voltage across it. These voltages are applied to the grid of the valve via the blocking condenser, which is necessary to prevent the grid of the valve becoming positive.

In practice a very important point to bear in mind, when we begin to experiment with photoelectric cells of this type, is that they have a very high internal resistance as well as a very low output. This means that the first valve, at least, of our amplifier must be placed as close as possible to the photoelectric cell and in practical working apparatus all leads most carefully shielded.

If you have experimented much with gramophone pick-ups and gramophone amplifiers you will know how easy it is to pick up a hum on long leads going from the pick-up to the amplifier, even when the pick-up is of relatively low resistance. With resistance-coupled amplifiers such a tendency is parti-

Last month Percy W. Harris explained what a photoelectric cell is and what it can be made to do. This month he gets down to more practical matters and tells the amateur how he can start simple experiments with a photo-cell. There are many interesting things that can be done and the expense will not be great

cularly to be guarded against and the higher the impedance of the input device the more care you have to take.

One of the largest uses of photoelectric cells is, of course, in talking-picture apparatus, and it so happens that photoelectric cells of the type used in this way are obtainable at reasonable prices.

## Buying Cells Cheaply

Certain models, too, have been abandoned by the firms concerned, not through any particular electrical defect (at least none that will affect our experiments, but merely from alterations of design) and these are obtainable quite cheaply from Electradix; I have had several from them for experimental work.

Some of these cells (you will see them illustrated in this article) are made to fit American valve holders, which, as you may know, have a different socket arrangement from ours. In the English valve holders all the sockets are the same size and take the same size pins, but in American valves the two filament prongs are much thicker than the grid and plate prongs.

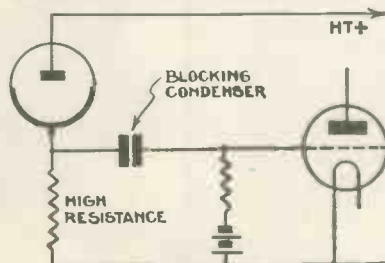

Fig. 1.—How a photoelectric cell is connected to the grid of a valve for magnification purposes

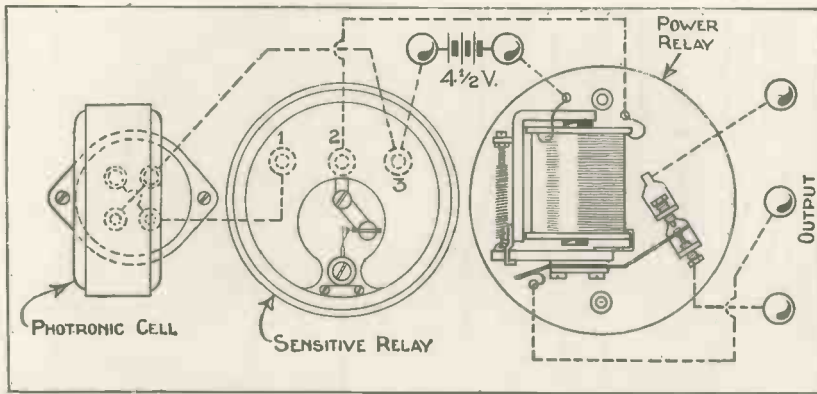

Fig. 2.—Connections of the Weston photronic system. The photronic cell is on the left, the sensitive relay in the centre, and the power relay on the right.

In my last article I made it clear that with photoelectric cells of the type most commonly used it is the total amount of light which reaches the emitting surface that is of importance and therefore you will realise the importance of concentration of the available modulated light on to the active cell surface.

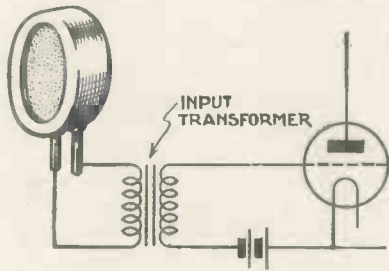

Fig. 3.—How the Weston cell is connected through an intervalve transformer

Lenses for concentrating this light are easily picked up, and almost any secondhand optical dealer will be able to provide a small stand with the universal joint carrying a lens of the kind used by microscopists.

The optical constructional set sold as Construments is also very useful for an experiment of this kind. The Construments outfit is a kind of optical Meccano and all kinds of lenses, prisms, light boxes, lens mounts and so forth are provided.

### Photronic Cell

For those who want comparatively simple apparatus of the above type for general photoelectric experimentation I can strongly recommend the Weston photronic cell made by the Weston Electrical Instrument Co., Ltd., whose meters are so well known to all experimenters. There is a very important difference between

the Weston photronic cell and the bulb type of photoelectric cell we have been discussing.

It is, for example, completely self-generating, requiring no batteries whatever for its functioning (save, of course, when amplification is required); it has practically an unlimited life and even light as intense as sunlight has no permanent deteriorating effect upon it.

A very important point for general experimenting is that the current output is relatively high. For those who are accustomed to work with light units it may be said that this cell delivers nearly  $1\frac{1}{2}$  microamperes per foot candle of light intensity.

The complete cell in its casing is about the same size as an ordinary panel-mounting Weston meter and is about an inch thick. The active surface, which is protected by a glass window, is an area of about  $1\frac{1}{2}$  to  $1\frac{3}{4}$  in. in diameter and the connections are brought out to two pins, one thick and one thin, of such a size and spacing that they fit into two of the sockets of an American valve holder.

Amateurs who possess a microammeter will be interested to know that sitting in my laboratory on a dull day the light falling on the cell from the window was sufficient to produce a current of 250 microamperes!

It will thus be seen that with an output of this kind a lot of useful work can be done without any valve amplification. Indeed, the Weston people supply a

most interesting and practical experimental board consisting of their photronic cell, a special sensitive relay operated directly from the current generated by the cell, and a still larger relay operated by the small one so as to bring into operation any apparatus desired (Fig. 2).

### Small Battery

The only accessory required in the way of batteries is a  $4\frac{1}{2}$ -volt supply, connected to a pair of terminals, and the current supplied by this battery when triggered off by the miniature relay operates the larger relay with the greatest ease.

The large or "power" relay will handle 100 watts satisfactorily provided the voltage does not exceed 120.

Practical applications of this little experimental board are, of course, innumerable. The connections to the input side are so made that by pulling out the photronic cell from one pair of holes in the American valve holder and plugging it into the other pair, the connections can be reversed. In this way light falling upon the cell can be made to keep the relay contacts open or keep them shut.

### Simple Experiment

Thus, if we connect a 100-volt 60-watt lamp in series with the electric mains and the terminals of the power relay, place the apparatus in a dark room and project a beam of light on to the surface of the cell in the form of a ray from one side of the room to the other, anybody walking past the apparatus and thus intercepting the beam of light will switch on the electric light referred to and thus illuminate the room.

Immediately the person has passed through the beam of light the electric light will be switched off again. For valve amplification the Weston cell is connected through an ordinary intervalve transformer, as shown in Fig. 3.

The amplifier shown in Fig. 4

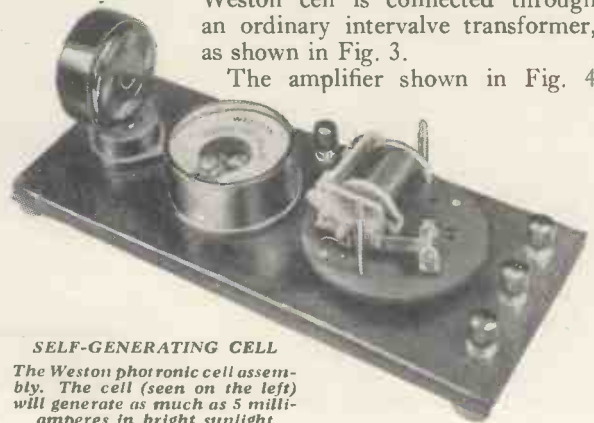

SELF-GENERATING CELL  
The Weston photronic cell assembly. The cell (seen on the left) will generate as much as 5 milliamperes in bright sunlight



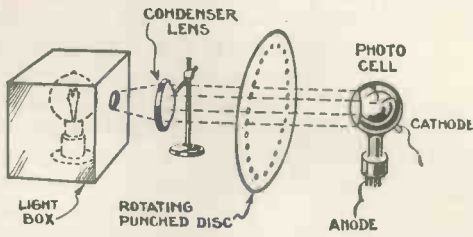

Fig. 5.—Making sounds from a beam of light interrupted by a rotating disc. Many such experiments can be made without difficulty

has been specially designed for experimental use with photoelectric cells and consists of two valves, resistance-coupled to one another, with a transformer output.

Readers will wish to make various modifications to suit themselves and I do not suggest that everyone will like my particular arrangement. It will, however, give a basis for experimental work and that very necessary start which is usually so difficult when new work is attempted.

**Input Arrangements**

On the input side you will notice I have two terminals and two valve holders. The terminals are so arranged that any photoelectric cell connected to them is placed in series with a high-tension battery tapping and a ¼-megohm grid leak joined to filament.

flexible lead for the grid-bias battery.

It will thus be seen that any voltages set up across the ¼-megohm grid leak are applied to the grid of

the first valve and there amplified in the usual way.

The output transformer should be chosen according to the work you propose to do. If, as is likely, for some of your experiments you would like to add another valve, it can be an ordinary intervalve transformer, the secondary of which is taken to the output terminals.

If this is done you can always listen-in with telephones on the secondary terminals, using a high-magnification valve in the second socket or, if the input to the amplifier is strong enough, you can replace it by an ordinary output transformer, using a small power valve.

For this reason, then, it is convenient to use an ordinary intervalve transformer, the secondary of which can be connected to the pick-up terminals of an ordinary wireless set when desired.

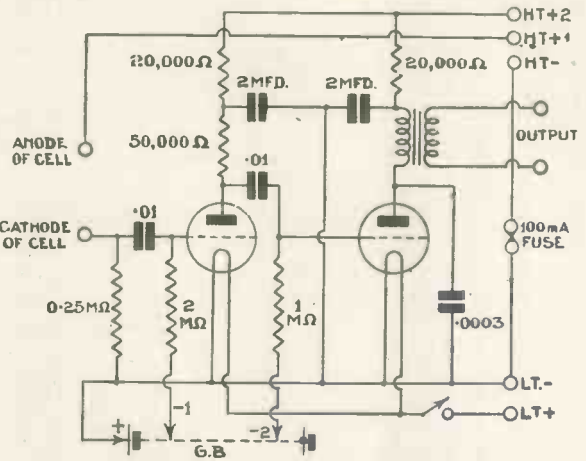

Fig. 4.—Circuit of simple amplifier for experimental photoelectric work. A list of parts appears on page 28 and a layout guide appears below

Decoupling by the use of a pair of 20,000-ohm resistances and a pair of 2-microfarad condensers is adopted, and a 50,000-ohm resistance is used as the coupling resistance.

If a power valve is used in the second socket with an ordinary output transformer the second 20,000-ohm resistance should be short-circuited, otherwise it will cut down the voltage applied to the output valve too much. It is advisable always to connect low-tension negative to earth and so stabilise the outfit.

**Cost of Cells**

The arrangements on the input side should be mentioned. It is, for example, possible to obtain at reasonable prices (about £1 5s.) obsolete types of the R.C.A. caesium cells, which are mounted on American valve bases.

The American valve holder comes in very useful here and a flexible lead connected to the plate socket can be connected to the input terminal which is joined to the positive battery lead.

The other terminals of the valve holder are not used and so a second flexible lead with a clip at the end can be kept for joining the projecting cathode terminal of the photoelectric cell to the other input terminal.

British-made photoelectric cells are available on the British valve-pin

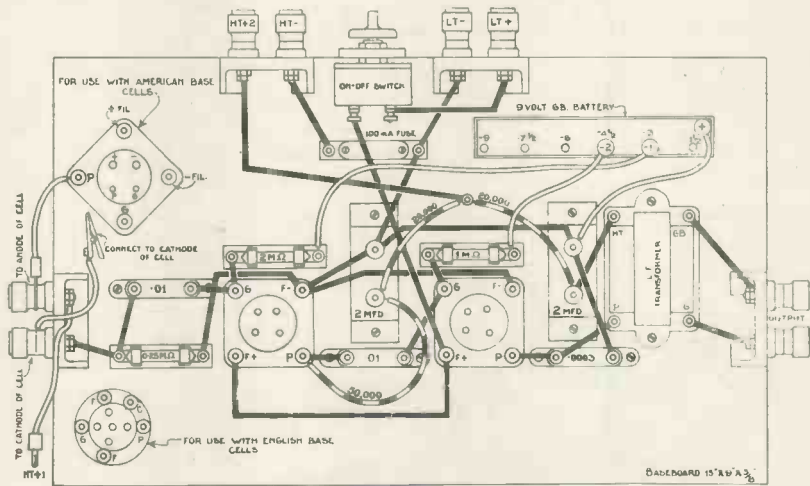

**QUARTER-SCALE LAYOUT AND WIRING DIAGRAM**

The layout and wiring of the amplifier shown in Fig. 4. Most constructors will be able to rig this up from parts they already have lying about

The end of the grid leak away from the filament is connected through a .01-microfarad mica condenser to the grid of the first valve which, of course, has its own grid leak attached to it, terminating in a

It must be remembered that the output of the ordinary photoelectric cell is quite small and it will rarely be found possible to operate a loud-speaker successfully without further amplification.

**PARTS NEEDED FOR EXPERIMENTAL AMPLIFIER**

**CONDENSERS, FIXED**

- 1—.0003-microfarad, upright.
- 2—.01-microfarad, upright.
- 2—2-microfarad.

**HOLDERS, GRID-LEAK**

- 3—Baseboard holders.

**HOLDERS, VALVE**

- 2—Four-pin.
- 1—Five-pin.
- 1—American type.

**PLUGS AND SOCKETS**

- 4—Wander plugs, marked: H.T.+, G.B.+, G.B.—1, G.B.—2.
- 2—Spade terminals.
- 8—Large insulated terminals.
- 4—Terminal blocks.

**RESISTANCES, FIXED**

- 2—20,000-ohm spaghetti.
- 1—50,000-ohm spaghetti.
- 1—25-megohm grid leak.
- 1—1-megohm grid leak.
- 1—2-megohm grid leak.

**SUNDRIES**

- Tinned-copper wire for connecting.
- Length of rubber-covered flex.
- 1—Crocodile clip.
- 1—Filament fuse (100 milliamperes).
- 1—9-volt grid-bias battery.

**SWITCH**

- 1—Rotary on-off.

**TRANSFORMER, LOW-FREQUENCY**

- 1—Standard Interval.

base and similar connections can then be made from the British valve holder. The actual pin connections vary with the different cells.

Another type of obsolete cell available at a reasonable price (about 15s.) is a potassium cell originally made for British talkie-picture companies. These are supplied, as will be seen in one of the photographs, with two flexible leads and are therefore joined to the input terminals.

**Weston Experiments**

You may also care to experiment with the Weston photonic cell using this amplifier. In such a case, however, the connections will be somewhat different, although you will use the American valve holder. The Weston cell, as previously explained, has two pins, one thin and one thick, which fit into a pair of the holes in the American holder.

The Weston cell, as we have seen above, is self-generating and of comparatively low resistance. For this reason the two connections (one goes to the plate pin and the other to the filament pin) from the American valve holder should be taken to the primary winding of an ordinary interval transformer, the secondary of which should be connected to low-tension negative on one side and to the lower input terminal (that connected to the .01-microfarad condenser) on the other.

The wander plug for joining the high-tension battery will not be used in such a case.

Before experimenting with any of the photoelectric cells you can test out the amplifier

with a gramophone pick-up to see that it works satisfactorily. This is done by connecting two leads from the pick-up to the same positions as the secondary of the transformer just mentioned.

If all is well, join one of the photoelectric cells requiring a high-tension supply to the input terminals, taking care that the anode lead goes to the input terminal, which is

point where the interior of the cell starts to glow.

The glow will probably be intermittent at the rate of two or three times a second as the glow is really a "flash-over" or a kind of arcing effect. As, however, we have in series with the cell the  $\frac{1}{4}$ -megohm resistance the sudden rush of current caused by the flash-over brings about a very big drop in voltage and the flash ceases.

The voltage then rises again and the occurrence is repeated. Directly the flashing point is reached you should withdraw the plug and reduce the voltage so as to keep it below the flash point.

As an example, with the potassium cell referred to, the intermittent



**TYPICAL PHOTOCELLS**

All kinds of photoelectric cells are now available for experimental purposes, the prices ranging from about 15s. upwards. A large stock of cells of all kinds is kept by Electradix Radios, of 218 Upper Thames Street, London, E.C.4

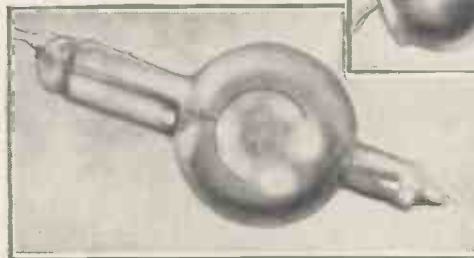

joined to the high-tension wander-plug. Then, with light switched on to the photocell, try various positions of the wander plug, starting at a fairly low voltage, until you reach a

glow started at about 170 volts and with the R.C.A. caesium cell the voltage was considerably above this.

Cells usually have the most sensitive point just below the flash point, but it is not necessary to get near to this figure in order to get very interesting experimental results. An ordinary 125-150 volt battery will be found quite suitable in the great majority of cases.

When ordinary daylight is falling upon a photoelectric cell you will probably hear nothing at all unless you arrange some form of interrupter to interrupt the light reaching the photoelectric cell at an audible frequency. This is as it should be, and if the amplifier hums, buzzes or howls



**EXPERIMENTAL AMPLIFIER FOR PHOTOCELL WORK**

This photograph shows the amplifier suggested by Percy W. Harris for simple photoelectric experiments, which open up an entirely new field for the amateur



it is either unstable or you are picking up stray voltages on the input leads.

I find it advisable in my own laboratory always to carry out experiments of this kind with the baseboard on a sheet of metal which is earthed or else on a sheet of Konductite similarly earthed, but you must find for yourself whether this is necessary in your case.

### Baseboard Covering

You can do no harm whatever by working on an earth plate of this kind, and you can very conveniently cover the underside of the baseboard with copper foil, bringing it out to the low-tension negative terminal, which, as I have said above, should be earthed.

After dark, however, if you are living in a house with an alternating-current supply, you will have ample material for experiment! Stand a bright metal-filament lamp in front of the photoelectric cell and you will get a loud 100-cycle hum, which should stop dead immediately you place your hand or any opaque object between the source of light and the photocell.

Even flicking your finger across it will be audible in the telephone connected to the output or in the loud-speaker if you are giving further amplification.

The next thing you may care to try is a simple light box, which can consist of any convenient tin which will hold an electric lamp, and a hole in one side of the box allowing for the release of a beam of light whenever desired.

### Holes Round Periphery

Now take a disc of cardboard and punch a number of holes round this disc as shown in Fig. 5, a belt punch being a very convenient method of making neat round holes.

Mount this disc on any convenient stand, switch on the amplifier and the light inside the box, and place the disc on a stand in front of a hole in the box in such a way that the only light reaching the photocell from the box comes through holes in the disc (Fig. 5).

Now spin the disc and you will get a whine from the loud-speaker due to the varying frequency at which the ray of light falls upon the cell as the disc slows down.

Once you have this apparatus in operation you will find numerous

experiments which can be done with it.

If you want an absolutely steady source of bright light and you are in a house with an alternating-current supply—in fact, wherever you are—an automobile headlamp bulb or a motor-cycle headlamp complete with reflector will be found most useful, as this can be run from an accumulator which will be completely free from the slightest fluctuation.



**VERY SENSITIVE PHOTOCELL**  
By far the most sensitive of the standard commercial cells is the Weston photronic arrangement, seen here complete with relays for controlling a power circuit

You can then arrange rotating discs with holes in any other suitable apparatus to interrupt the light beams, experimental apparatus for elementary television and so forth, just as you please.

## From Here and There

**M**ANY people with battery sets will be wanting to convert their output stage to class B in readiness for the winter months. One of the best designed class-B converter units we have yet handled is that made by the Multitone Electric Co., Ltd., of 93/98 White Lion Street, London, N.1. By means of this unit, which can be

B.B.C.'s autumn radio-drama festival in the autumn, was first broadcast on January 4, 1924.

Small reductions were made in the prices of valves on July 3. Battery screen-grids and variable-mu's are down to 15s. 6d. and pentodes to 16s. 6d. A.C. screen-grids and variable-mu's are down to 17s. 6d., while power types are 16s. 6d. and pentodes 18s. 6d. D.C. valves vary in price from 14s. to 18s. 6d.

Amateurs who are thinking of converting their sets for the use of iron-core tuning coils should send to Wright & Weaire, Ltd., of 740 High Road, Tottenham, London, N.17, for a copy of their latest folder dealing with Nucleon coils.

With reference to the article, "What the Overseas Listener Needs," in the July issue of "Wireless Magazine," the caption at the foot of page 583 should read: "As regards the automatic grid-bias unit..." instead of "mains unit." And here are more elaborate instructions for adjusting it: With  $P_3$  set at X, and with the aerial disconnected, adjust  $P_3$  to give 6.5 milliampères plate current for  $V_1$ . Then set  $P_3$  to Y and adjust  $P_1$  to again bring the plate current of  $V_1$  to 6.5 milliampères. When this has been done  $P_1$  and  $P_2$  should not be touched again unless V is changed.



**CONVERTER UNIT**  
The Multitone unit for converting any existing battery set for the use of a class-B output valve. Tone correction is incorporated

used with any class-B valve, and which incorporates tone correction, an existing set can be converted to the new form of output simply by plugging in. The price, without valve, is £1 17s. 6d.

We learn from Richard Hughes that his play *Danger*, referred to last month in connection with the

# Best Results from the Iron-core Three



**COMPLETE SET**  
The Tyers Iron-core Three completely assembled in its C.A.C. cabinet

TO a designer, the task of building and successfully adjusting so simple a set as a three-valve receiver seems almost child's play. This is because one lives in a 100 per cent. technical atmosphere all day long.

Resistances, condensers, coils, and valves literally surround one in hundreds, and one grows accustomed to handling them with just as little apparent care as the window cleaner runs up his ladder, or the bank clerk counts his pile of silver.

## Use and Custom

It is all a matter of use and custom. If I had to run up ladders all day long, or count piles of silver and copper, I should be, perhaps, a little apprehensive at every turn. I feel that this is probably the case with the home constructor who builds a three-valve set.

Accordingly, I have tried to think of all the little points which may give rise to hesitation or even difficulty.

First of all, a word regarding the coils. In the original set and, in fact, on the actual blueprint, you will notice that the earth wire to the coils is taken by means of a wire fastened to the fixing-down screws.

The coils are now supplied with a separate earthing terminal on each can. This is terminal No. 6 and, accord-

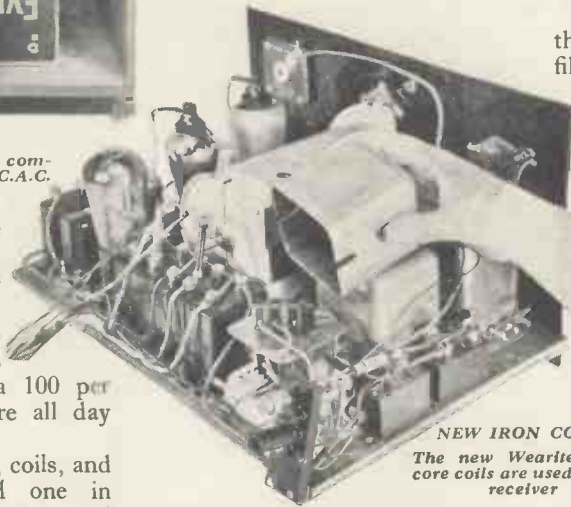

**NEW IRON COILS**  
The new Wearite iron-core coils are used in this receiver

ingly, it is quite in order to connect all the No. 6's together and take them to the nearest earth point.

Next, a word or two about the valves. It is a very difficult matter to produce valves to fine limits, and ordinary B.V.A. valves vary quite appreciably in their characteristics. First of all, let us consider the detector valve, which is the most important.

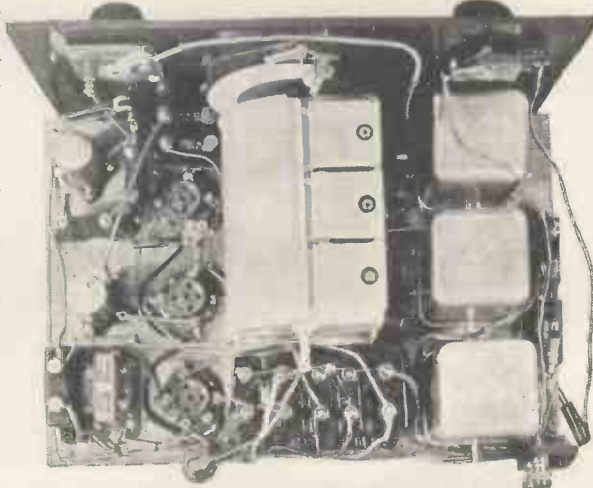

**PLAN VIEW OF THE RECEIVER**  
This photograph shows the compact layout employed by Paul D. Tyers in the Tyers Iron-core Three

In these notes PAUL D. TYERS gives some further hints on the operation of the set he described in "Wireless Magazine" last month. It incorporates the latest type of iron-core coils

Before determining the value of the condensers in the high-frequency filter, and also the reaction condenser, tests were made with a large number of samples of the detector valve, which is a Mullard PM12A (metallised).

I found that all my samples were very similar in their ratings. Should you by any chance obtain a valve



**A NEAT-LOOKING JOB**  
Another view of the set in its cabinet

which has a slightly lower amplification factor or mutual conductance than the average, it is conceivable that you might find one or two spots on the reaction setting at which the set will just fail to oscillate.

## By-pass Condenser

If this is the case, do not try to overcome the trouble by increasing the high-tension voltage. Instead of this, alter the value of the fixed condenser which goes between the anode and earth.

The correct rating is .0003 microfarad. I would suggest decreasing this value to about .0002 microfarad or, in an extreme case, .0001 microfarad. If this condenser is made too small the set



may tend to oscillate very furiously at the end of the medium wave-band.

Much of the success of the set depends upon the correct operation of the detector valve and, in particular, the voltage on the screen. On no account should this be made too high; a value of about 60 volts is suitable.

### Dropping Resistance

Should you by any chance use a battery which is not provided with a 60-volt tapping, the lead may be connected to a higher voltage tapping through a fixed resistance. The value you will, of course, have to find by trial until the loudest signals are obtained.

No doubt many of you will have a Mullard PM12A of the plain type. This may be used in place of the metallised type, and you will probably find that you will obtain greater sensitivity but a little less selectivity.

The loss of selectivity can be compensated for by using a lower aerial tapping. In fact, to the reader who lives very much in the heart of the country, where selectivity is of less importance, I would almost recommend the use of the clear type PM12A.

### Trimming the Set

I do not anticipate that anyone will have any difficulty in stabilising the set, providing that the wiring diagram is adhered to fairly strictly. I would, however, refer to the screens, and particularly those on the trimmers. Trimming must be carried out with these screens in position, and a small



**FINE RESULTS**  
Tests prove that the Tyers Iron-core Three does everything that a set with iron-core coils can be expected to do

COMPONENTS YOU WILL NEED FOR THE TYERS IRON-CORE THREE			
<b>CHOKES, HIGH-FREQUENCY</b>	£	s.	d.
2—Wearite screened, iron-core type	0	8	0
<b>COILS</b>			
1—Set of Wearite Nucleon iron-cored coils, types BP1, BP2, TG, senior models	1	17	6
<b>CONDENSERS, FIXED</b>			
3—T.C.C. .0003-microfarad, type 34	0	3	9
1—T.C.C. .001-microfarad, type 34	0	1	6
1—T.C.C. .002-microfarad, type 34	0	1	6
1—T.C.C. .02-microfarad, non-inductive type	0	1	9
1—T.C.C. .1-microfarad, type 65	0	1	8
4—T.C.C. 1-microfarad, type 50	0	10	0
2—T.C.C. 2-microfarad, type 50	0	7	0
<b>CONDENSERS, VARIABLE</b>			
1—Utility .0005-microfarad three-gang with disc drive, and trimmer screens type W314/3	1	7	6
1—Magnum .0005-microfarad aerial condenser	0	2	6
1—Utility .0003-microfarad reaction, type W298	0	2	0
<b>EBONITE</b>			
1—Peto-Scott 13½ in. by 8 in. by ¼ in. panel	0	5	0
<b>HOLDERS, VALVE</b>			
2—W.B. four-pin, miniature type	0	1	0
1—W.B. five-pin, miniature type	0	0	8
<b>PLUGS AND TERMINALS</b>			
2—Belling-Lee, type M, marked: Aerial and Earth	0	0	9
3—Belling-Lee insulated sockets, type 1071, marked: Aerial, Aerial 1, Aerial 2	0	0	6
2—Belling-Lee spade terminals, marked: L.T.+, L.T.—	0	0	4
1—Belling-Lee banana plug	0	0	2
1—Set Belling-Lee eight-way battery cord, 30-in. type	0	3	6
<b>RESISTANCES, FIXED</b>	£	s.	d.
1—Packet of 8—B.A.T., 1-watt type, consisting of two 500-ohm, two 5,000-ohm, one 20,000-ohm, one 50,000-ohm, one 100,000-ohm and one 1-megohm	0	7	0
<b>SUNDRIES</b>			
Tinned-copper wire for connecting, say	0	0	0
Length of oiled-cotton sleeving, say	0	1	0
Small length of rubber-covered flex, say	0	0	6
1—Small ebonite strip for terminals and sockets, 1 in. by 3 in., say	0	0	4
<b>SWITCH</b>			
1—Bulgin junior on-off, type S38	0	0	10
<b>TRANSFORMER, LOW-FREQUENCY</b>			
1—R.I. Hypermite, ratio 1 to 6, type DY20	0	12	6
<b>ACCESSORIES</b>			
<b>BATTERIES</b>			
1—Ever Ready 120-volt high-tension, Popular type	0	15	6
1—Ever Ready 9-volt grid-bias, Winner type	0	1	0
1—Smith's 2-volt accumulator, type 2RGN11	0	14	6
<b>CABINET</b>			
1—C.A.C. Norfolk model	1	15	0
<b>LOUD-SPEAKER</b>			
1—Rola permanent-magnet moving-coil, type F5PM-PDT	1	12	6
<b>VALVES</b>			
1—Osram S22	0	16	6
1—Mullard PM12A metallised	0	16	6
1—Osram PT2	0	17	6

box spanner is very suitable for adjusting the nuts.

If there is any tendency for a low-frequency howl, make quite sure that you have not omitted to connect any of the by-pass condensers. Should you by any chance use a non-standard cabinet with an external loud-speaker, then I would advise fitting the condenser which goes across the loud-speaker at the set end of the leads and not across the loud-speaker terminals as it has been arranged in the cabinet.

Now a word about the low-frequency side. I have used a 6:1 transformer of a fairly small type. Should you by any chance have utilised a lower ratio model, you must expect slightly less signal strength. A higher ratio can be used without running into any difficulties and, in this case,

you may obtain just a slight increase in overall gain, but it will not be tremendously marked.

Finally, make quite sure that your set is really in gang. A set which is not in gang will give you bad reaction overlap, bad quality, and it may reduce the number of stations which you can receive to about half. Ganging is perfectly easy if you follow the suggested method.

### Critical Back Trimmer

Remember that the back trimmer, that is the one connected to the first band-pass coil, is the most critical. Ganging should be carried out with the aerial-series condenser in the maximum position, so that you obtain good signal strength, and you should utilise a station which is not too strong.

You will find that the reaction control has little effect upon the setting of the back trimmer and it is advisable to adjust the third trimmer with a reasonable amount of reaction in use.

Don't forget that the selectivity can be increased by connecting the coupling lead to terminal No. 3 on the tuned-grid coil.

# New A.C.-D.C. Mains Valves

**I**N this country it is very difficult for the set-designer to cope with the spread of the national grid system of electricity distribution. In this interim period, when some supplies are still D.C., and in imminent expectation of becoming A.C., the set-buyer is often perplexed.

If he buys a D.C. mains set he knows he will have to scrap it when the grid comes along, and not always can he depend on the supply company footing the bill for the new set.

Indeed, several companies have warned listeners on their supplies that any D.C. apparatus bought after the present date will have to be scrapped within a year or so—at the owner's expense.

## Way Out of Trouble

The obvious way out of this trouble is to design a universal mains set, one that will function equally well on A.C. and D.C. supplies. This can be done quite easily—and cheaply, too—if you go the right way about the design.

It is well known that an A.C. set makes use of low-voltage indirectly-heated valves to eliminate the accumulator, and derives its high tension from the mains through a valve or metal rectifier.

Equally well known is the basic idea of a D.C.-mains set design, where high-voltage valves are connected in series with a current-limiting resistance across the supply, the high tension being obtained without an intermediate rectifier, simply through a smoothing circuit inserted between the mains and the anode impedances.

What we want to stress here is that there is nothing at all difficult about designing a mains set that will be equally suitable for both supplies—A.C. and D.C. It is largely a question of having suitable valves at your disposal.

The only part that can be considered wasteful is the rectifier which, when the set is on D.C., is not, of course, actually wanted. But this is more than off-set by the great saving and in the obvious convenience of universal application.

At the present time there is only one make of valve that we have so far come across for this universal function. We refer to the Tungram range.

There are two screen-grids, one with a fixed and the other with a variable grid base, a high-impedance detector, a medium-impedance low-frequency valve, a low-impedance power valve, and a multi-grid power valve.

These valves all have 20-volt filaments and need only 180 milliamperes of filament current. They can all be connected in series in a similar way to that shown in the set described elsewhere in this issue.

The voltage from the mains is dropped by means of a special resistance, which is itself in series with a special barretter stabilising resistance.

So far everything is quite simple for D.C. mains, but when you are on A.C. mains the anode voltage has, of course, to be rectified to provide uni-directional current.

A valve is made by the Tungram people, again with a 20-volt .18-ampere heater. This half-wave rectifier comes into operation when the supply is A.C., the positive half-cycles being passed on as uni-directional surges in the usual way to the smoothing circuit. When the mains are D.C. the rectifier passes

the current all the time, not rectifying it as with A.C., but acting simply as a conductor.

As yet, the British valve makers have not come to any agreement over the ratings of universal mains valves. So far none have been produced in this country, but we now have some advance information of the Mullard D.C. valves, and we understand Cossor D.C. valves will be available before the Radio Show.

These valves have 20- and 16-volt heaters respectively, so they can be used in the same way as the Tungram valves but there is the snag that no rectifier has been produced.

## Other Forms of Rectification

We therefore have to think of some other form of rectification. From our experiments we find that a small metal rectifier works as well as a valve. Although not specially designed for the job the metal rectifier can definitely be used in a universal mains set.

Mazda's have been issuing D.C. valves for some time, but they do not appear to have any standard voltage rating for the filament heaters. We have the DC2SG, with a 20-volt .1-ampere filament. Then we have the DC2Pen, which has a 35-volt .1-ampere filament.

The voltage does not much matter provided that the *current* of each valve is the same. You can therefore have 20- and 30-volt valves in the same set provided that they pass the same current.

There are also good valves with low-voltage filaments, such as the Mazda DC10, which has an 8-volt .5-ampere filament. When you compare this valve's consumption with the 35-volt .1-ampere filament you will agree that the low-voltage type of filament is hardly best for a universal mains set—the consumption is too high.

The Mullard D.C. valves, which will be available quite soon, will have the 20-volt .1-ampere heater, and will be on the market in four types; two high-frequency valves, one fixed and one variable grid base, a high-efficiency detector, and a normal pentode power output.



**BROADCAST ENTERTAINER**  
A caricature of Harry S. Pepper, the broadcast entertainer



# INCIDENTAL MUSIC to RADIO PLAYS

*WHAT SHOULD IT ACCOMPLISH ?*

In this exclusive contribution to "Wireless Magazine" WATSON LYLE relates the views expressed to him on this important question by the following composers: Lord Berners, Herbert Howells, Sir Granville Bantock, Igor Stravinsky, Paul Hindemith and Maurice Jacobson

**F**OR those who cherish the hope of plays being broadcast with a feeling of actuality for listeners, in a way to make us forget that we are not seeing, although hearing the piece, the creation of a realistic background of sound, whether of music or "noises off," or both, is likely to be important.

Of course, this is where a type of play suited to broadcasting has been chosen and when it is broadcast with full regard for characterisation. The value of these two points in the production of broadcast plays emerged from the consensus of opinions expressed in my article in "Wireless Magazine" last September.

### Actors and Playwrights

There, prominent actors and playwrights, in spirit with the distinguished musicians giving their views here, placed their sound, practical knowledge at the disposal of the public for the benefit of art.

It is for the public, the vast listening public, to criticise the radio plays offered it in the light of the specialised knowledge of actors, playwrights and musicians thus conveyed to it by "Wireless Magazine."

The B.B.C. welcomes criticisms of its productions by the public. But these expressions of opinion by letter to Broadcasting House should be more than a mere statement that A liked such and such a play, or that B disliked it.

Really, when you come to think of it, that sort of thing is but vaguely helpful, isn't it? Of no more real assistance to Mother B.B.C. in her maternal yearnings over her nurslings, the listening public, than the whimperings to his mother of Tommy who hates syrup pudding and says that Johnny, who likes it, can jolly well have the lot, and he hopes he'll bust!

To rise above such immature expression of taste both A and B should state in what respects they liked, and disliked, the play about which they have been sufficiently interested to write to Broadcasting House.

While the views here given as to the place filled by incidental music in broadcasts of plays are in no sense to be taken as critical of B.B.C. productions, individually or collectively, they are the views of composers who have done notable work of the kind in the theatre itself, and they should therefore (like the opinions of actors and dramatists in my former article) be helpful to the radio public in writing to the B.B.C. criticisms likely to be of real practical assistance to its producers in their experiments towards the solution of the problem of this barrier of sightlessness of the audiences listening to broadcast plays.

According to the laws of evolution, which apply to art as to nature, it seems certain the problem of "sightlessness" will be solved sooner

or later. This is most likely to happen if the inventors and artists look upon each other as companions in arms in the warfare against imperfection, which is the impelling force at the back of evolutionary processes, rather than if they regard each other as members of opposing forces.

For weal or woe, radio is here. Like fire, it can be a good servant, but a bad master. In the matter of the radio play that can give us an illusion of being present at the performance, of holding our attention to the extent of making us forget our immediate surroundings (and this is the acid test for the success of a piece in the theatre) this facet of broadcasting remains in a state of slow combustion.

### Bright Flame of Pure Art

It cannot be expected to break forth into the bright flame of pure art unless it is tended by those influences—the artists and the public—vital to the life of any art effort.

Radio is not apart from art. It is a part of art. But only a part. Without the allure of art it would be as unattractive to the normal mind as riding to hounds on a mettlesome billy goat!

However, coming to the firm groundwork of basic facts without delay, it occurs to me to relate first a conversation, or rather part of a conversation, bearing upon the sub-

ject of this article, with Lord Berners in the music room of his house in town.

We had talked of various musical subjects, of methods of work, of sources of inspiration, and of his work in connection with ballet when I recollected that with his practical knowledge of music for the stage, his views on the questions involved in this article (with which my mind was then beginning to be busied) would be of interest and assistance to all concerned.

### Approaching the Problem

So I said, from the depths of the comfortable settee where I sat near a blazing fire: "What would be the best way, do you think, to approach the question of writing incidental music to a play to be broadcast?"

From the corner where he sat in a large easy chair the expression of his pleasant, fresh-coloured face became focused in his sensitive lips and large, dark brown eyes, and he remained for a little in thought.

Then he answered: "In music of that kind I think one would have to pay special attention to the suggestive uses of rhythm. Not only the rhythm of the sentences, of the literary phrasing, but to underline, one might say, the rhythm of certain words."

### Opera Recitative

"After the style of recitative in opera?"

"To a certain extent it seems to me that is how one would manage. A close connection would have to be maintained between the text of the play and the music. But just how to do this would depend upon the piece. Without a concrete example to work upon one can scarcely go further, hypothetically. But I certainly feel the solution of the problem lies through the maintenance of a correspondence of rhythm between the music and the words."

This point of sustaining the connection throughout between the text of a play and the incidental music written to it to be broadcast was also insisted upon by Herbert Howells, whose opinions, as teacher of composition at the Royal College of Music, and

adjudicator at musical festivals all over the country, in addition to his achievements as composer, have a comprehensive significance.

Knowing the condition of well-ordered busy-ness in which he lives (I have a suspicion his holidays are energetically lived, too) I arranged our meeting by telephone, and when I arrived at his familiar studio (a little late—I am afraid that is me!) he came forward at once and announced, briskly, possibly mindful of the fact that my tongue is hung in the middle, as the vulgar say—"Well, we must be quick this time. I've only about twenty minutes."

Inwardly forswearing deviations of any kind I sank down upon a hard form, praying that the position might generate in me a student-like attentiveness to the matter in hand. I said: "We'll start right off on the subject. Here's your poser. Supposing you were asked to write music to a broadcast play, what would you do?"

Feeling this would give me some respite, I relaxed and inhaled leisurely. Alas! It was not to be. Mentally, at any rate, I was to be kept at it. He moved off from me towards the piano.

"That is a bit of a poser," he objected. Ruefully I submerged my subconsciousness; or, shall we say, extenuatingly?—my "receptivity"—and whipped up a retort. "Well, then, differently. Do you feel that music can help much towards the appeal of a broadcast play?"

"Yes; if it is something beyond a few isolated chords here and there which do not seem to me to be of the slightest use in creating atmosphere. No more than two or three chords, taken from their context in

a Mozart symphony would be, merely because that music happened to belong to the period of the play.

"If, for instance, we take *The School for Scandal*: rather, I think, than try to fit music of the same period to Sheridan's comedy, it would be better for the composer asked to supply incidental music to broadcast with it to seek to express the moods, the emotion, of the play in terms of the music of to-day."

### Suggesting the Action

"Should the music, do you think, seek to underline the words, suggest the action, as the play progresses; or should it have its own continuity of idea and construction, in emotional agreement naturally with the play?"

"I feel all in favour of the continuity of idea, the leit-motif plan; otherwise, we have the more or less senseless succession of sounds, of isolated groups of chords, which distract attention from the play."

"Of course, the musically-educated listener will find the leit-motif plan helpful in suggestion throughout the play, as his mind will take in subconsciously the emotional significance of the music, linking it up, as the broadcast proceeds, with the action of the play; but one feels he represents only about twenty-five per cent of the sightless audience. What of the other seventy-five per cent?"

### No Middle Course

He had been walking slowly about the studio, and when I said this he turned rather sharply and faced me, gravely.

"In such a matter," he said, "there can be no middle course. It is useless trying to study the seventy-five per cent. You either have incidental music worth while, of value to the broadcast, or you have none at all. A good play could only be spoilt by incidental music conceived on any lower level. I feel that music should be composed with special attention to the fact that it will be broadcast to succeed."

"But, in that case, a composer could not expect the same financial returns from his art. Obviously, music written very specially to be broadcast would be unsuited to concert-hall or private use."



Herbert Howells is teacher of composition at the Royal College of Music and adjudicator at musical festivals all over the country



He looked down at me where I sat beside the students' work-table, his back to one of the high windows, resting against the sill, his eyes grave, and a little surprised at my expression of an economic viewpoint.

"In twenty years time, or so, the position of music may be, probably will be, very different from what it is to-day. The individual is a mere unit in the development of art. In that time what will the tiny, personal interests of you, or I, matter? What of us then?"

And whilst privately endorsing his sentiments, it did not occur to me until afterwards that, of course, in twenty years time he and I will be turning sixty and neither of us, I hope, the victims of senile decay yet awhile!

When I spoke about the subject of this article to Sir Granville Ban-



M. Igor Stravinsky, whose compositions cause so much controversy, felt that the subject of incidental music to broadcast plays is too big to discuss in a short conversation

tock, whose opera *The Song of Songs* was, I believe, the first new work of the kind by a British composer to be broadcast (December 11, 1927) he said: "I think a good play does not require incidental music. It should make its appeal direct, and hold the interest of listeners, unaided."

"But don't you think that in the suggestion of atmosphere . . . ? I remember the vivid way in which the incidental music you wrote for Sybil Thorndike's production of *Macbeth* at the New Theatre some years ago emphasised the piece

without one becoming unduly conscious of the music."

"That music was written for the theatre, of course. Possibly tone-colour may have its uses in broadcast plays; but, really, I feel that a good play would be spoilt by incidental music."

It should be remembered, however, that no contemporary composer has a more gracious flow of melody than Bantock, whose delicate sense of colour, and sensitive response to the programmatic suggestion of words, is shown in his many lovely songs, and in his beautifully written and effective choral works. His brief opinion thus carries weight.

By the kindly intervention of various friends, for I was, personally, quite a stranger to him, M. Igor Stravinsky arranged to see me at short notice; to be

exact, in the artists' room of the concert hall at Broadcasting House at the conclusion of a performance of his music.

The occasion proved unpropitious, and the circumstances, which shaped themselves into an informal levée to old friends, apparently, and to those anxious to shake hands with this famous "modern," were all against anything in the nature of a talk. But there was no choice, for he would be off to France again next morning.

Replying to my question in German, he said, in that language (for his English is of the most meagre) that the subject was far too big altogether to talk about just now; then applied himself with much evident relief to the imbibing of still more strong, black tea, and a continuance of the levée.

Need I say I was disappointed? I had felt, naturally, that such an avowed "modernist" would be keen to tackle this very modern problem of music.

My notion about the reasonableness of these expectations was supported by the readiness with which that most talked-of German modern in music, Paul Hindemith, expressed himself on the question at issue.

Whatever his detractors may say about his art—and this is neither the time nor place to discuss it—his personality has that leaven of a



Sir Granville Bantock was the first British composer to have an opera broadcast; "*The Song of Songs*" was put over by radio in December, 1927

delicious sense of humour in his fundamental absorption in his work which is generally helpful towards clear thinking, whatever the occupation of the individual.

Said he: "In writing the music for a play to be broadcast I do not see it would be necessary to pay attention to the fact that it would be heard on the radio. It is not for me, the composer, to think of how the music will reproduce. That is a matter for the mechanics—for the engineers to attend to.

"My concern would be with the words and the dramatic situations; and with the emotion of the piece. It is wrong to think, as many people appear to do in this country, that there is no emotion in my music."

#### The Right Emphasis

"That does not seem possible, unless the composer restricts himself to mere noises off. Yet, even then, what emphasis might be put into a good hang on the big drum, or the cymbals, at the right instant!"

"Exactly!" he laughed, "there is emotion in my music, as there must be in all music. But my music reflects the reaction of our emotions in the world of to-day to life around us. Therefore, in writing incidental music to a play to be broadcast my music would express, I hope, this attitude to the text."

"But as regards the instrumentation; would it not be best perhaps to use the sound of the lower strings *pizzicate* (plucked) instead of tympani for radio? This plan

has been found effective for reproduction, I believe."

But this great little man, with his smooth, pleasant face, lambent blue eyes, and indomitable knack of getting things carried out exactly as he wants them, when these things concern his work, would not



Maurice Jacobson is the composer of the very effective incidental music used for "Julius Caesar" at the Old Vic last winter

budge from his initial expression of opinion.

"No," said he, "if the radio does not reproduce the sounds of the percussion faithfully that is a matter for the engineers to remedy."

"You believe in invention being the servant of art; not in art being the handmaid of invention?"

"Certainly." He smiled genially. "But, of course, most music can be arranged for performance by a smaller or bigger orchestra than it was written for originally, as we know. As when one writes a concert-hall version of a work written for the stage.

#### General Readjustment

"But that has been done by composers for centuries, and means a general readjustment of the instrumentation. Not just in altering the tone-colour of one section, and upsetting the balance of the ensemble, to suit unusual conditions of reproduction which are not the concern of the composer."

Remembrance of the very effective incidental music to *Julius Caesar* I had heard at an Old Vic performance last winter prompted me to write

to its composer, Maurice Jacobson. After my letter had chased him half way round the country—he was festival adjudicating—we at length fixed up a meeting in town to talk for this article.

Other plays of Shakespeare to which he has written incidental music for Old Vic and Queen's Theatre productions are, by the way, *Hamlet*, *Anthony and Cleopatra*, and *Macbeth* within the last few years; and one knows him, too, as a composer of much piano music and many songs, a fine pianist, and an unusually sympathetic accompanist.

Our long and (for me) interesting conversation, of which, unfortunately I have no space to give more than a condensed version, revealed the hitherto unsuspected trait in his individuality of setting out categorically all the data for a pow-wow!

"What is to be done, in the way of incidental music, to help the sightlessness of audiences at broadcast plays?" I asked, a bit plaintively I'm afraid, because, by then (he was the sixth you shall hear, but by no means the sixth I sought out in solemn converse, only the answers of the others were useless, or unprintable) I was heavily aware of the ailments of this puling infant of the B.B.C., the radio play.

"To help the sightlessness?" he said in his quick, staccato way. "Now, let's see." Quite absorbed with the problem, he gazed upwards through thick-lensed spectacles at as much of what the poets call "Heaven's blue" as one may hope to see on a wintry afternoon from a third floor London window with the next block some forty feet distant.

Whatever was there helped tremendously. Drawing a piece of paper towards him on his writing desk he began to jot down his "pros," resuming his conversation as he did so.

"First, there is the question of 'atmosphere.' The general atmosphere of the play; the situations—drama—comedy. These would be suggested by the emotion of the music. Then there is what we might call the local atmosphere . . ."

I vaguely wondered if

the soot outside was influencing his train of thought; but no!—bells, and similar musical noises; then, as might be suggested by unmusical sounds, like carriage wheels, coconut shies, and so on.

"How about the leit-motif business—characterisation, and so forth!"

"Characterisation?"

#### Musical Gestures

"Characterisation," he repeated, writing it out as heading number two in this agenda of our talk, "the mise-en-scène; here would be the consideration of the period of the play; then the individual characterisation, first the musical indication of characters in the piece; then the suggestions, musically, of gestures."

"Impressions of all these occurrences in a play might be conveyed by means of well-written, incidental music, I think, to make listeners to a radio play forget their sightlessness."

#### Voices of Experience

Taken in conjunction with my article of September last these, then, are the voices of experience, of expert experience from the theatre itself, the voices of the playwrights, the actors, and the musicians. Given the observance of certain essentials in production indicated at various places in these informal conclaves several of the artists think it quite possible for the radio play to come very near indeed to a sense of actual occurrence, at first-hand, for listeners. Does it?



Paul Hindemith, the most-talked-of modern German composer, has very definite views on incidental music for broadcast plays



# How to Design A D.C. Set

By G.S. Scott.

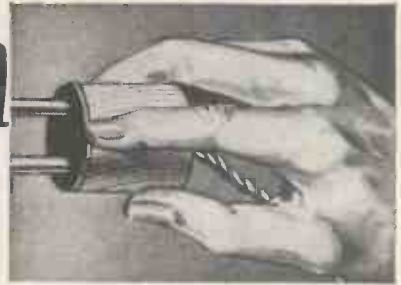

CONSIDERABLE misconception still seems to exist as to the use of wireless sets on D.C. mains. Quite recently one saw a report of a meeting (whose members ought to have known better) where some remarkably inaccurate ideas appear to have been expressed.

It is true that the D.C. set languishes in popularity and in demand compared with his A.C. brother. This is, of course, due to the fact that the greater part of the electrical supply of the country is now on A.C. and that, in the future, with development of the "grid" system, this will be increasingly the case.

## Immense Switch-over

Incidentally, also, the development in the past few years of the indirectly-heated cathode valve caused an immense switch-over to all-mains operation on A.C. supplies, and encouraged manufacturers to cater for a popular and increasing market.

This led to an almost complete neglect of the D.C. mains set, and it is only within the past year or so that comparable valve developments have been made in the way of using well-designed valves on D.C. mains.

It is true, of course, that there are great technical differences and, indeed, even difficulties in the use of D.C. as compared with A.C. The first is that the interposition of a transformer between the mains and the set immediately gives us a most desirable separation which is possible only with the A.C. set. This same transformer also gives us great flexibility of the voltages that can be taken off from various secondary windings—a fact of which set designers have not been slow to take advantage.

In the case of D.C. the mains *must* be directly connected to the set, and the only voltage available is that of the mains. With a suitably designed valve this may be quite adequate for high-tension supply to give a good power output, but it is not so convenient for filament or heater supply.

This last difficulty is greatly minimised by the D.C. mains valves now available, taking only .25 ampere, so that the mains load on a 200-volt supply is only of the order of 50 watts.

Perhaps the most real difficulty which has caused people—manufacturers and home constructors alike—to be chary of D.C. mains is the fact that the mains must be connected directly to the set.

As a result, parts of the set may be dangerously live, and accidents have certainly occurred in the past due entirely to the absence of safeguards that ought to have been taken to meet these cases.

Looking back, one is often surprised that there was not more trouble from the casual manner in which high-tension mains units were

*Certain difficulties attend the use of wireless receivers and similar apparatus on direct-current mains, especially on that side which has the earthed neutral wire as its positive lead. This article explains these difficulties and discusses practical precautions that make a D.C. set perfectly safe to use*

used in the early days of their domestic popularity.

The conditions of wireless operation on D.C. mains are shown in Fig. 1. As all readers know, a D.C. supply is normally distributed on the "three-wire system." A voltage of, say, 400 is developed at the generating station, the centre of the system is earthed, and a three-wire cable is carried to the consumers' area.

The supply to each consumer is then on two wires, one of which is the *neutral already earthed at the power station*, and the other is a live outer wire which is either 200 volts positive or 200 volts negative to the earthed neutral.

Thus in Fig. 1, the three wires are shown proceeding as from the power station with the neutral earthed. The two wireless sets are supposed to be on the premises of two different consumers—possibly next door to each other.

In the right-hand house the incoming live wire is positive, and in the left-hand house it is negative. For purposes of illustration, only a single-valve stage is shown in each case, that of the aerial circuit, with its associated tuning, being most convenient for our purpose.

A typical skeleton high-tension supply arrange-

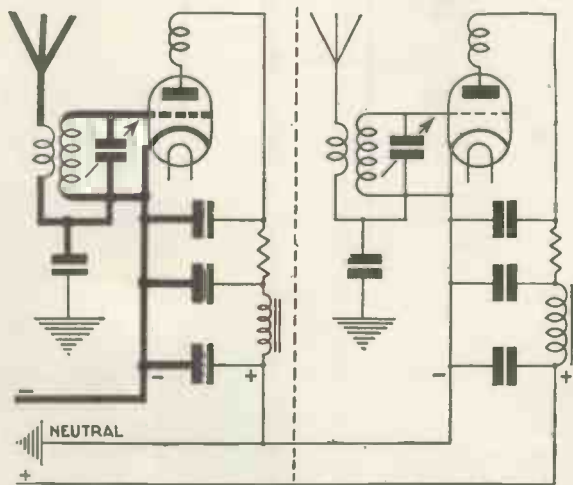

Fig. 1.—Radio receivers on each side of three-wire D.C. lighting mains

ment—smoothing and decoupling—is also shown in each case, and filament or cathode heating arrangements are ignored.

### “Earthy” Source

It has been shown in a previous article by the present author that so far as the high-tension supply to a valve is concerned, the *whole* of the high-tension source is earthy to the alternating currents set up in the operation of the valve, and that if one end is directly earthed we effectively earth the other end by a suitable condenser.

Thus so far as the mere supply to the anode is concerned, it does not matter whether the negative or positive is already earthed. The conditions in the right-hand set are, therefore, quite conventional.

The incoming live main is positive and goes to the anode circuit in the usual way, being by-passed for alternating currents by the decoupling scheme, which is all quite normal.

The negative wire of this supply is the neutral and goes straight to the filament or cathode circuit. This wire is already earthed at the power station, and therefore makes the filament side earthy, as normally it is.

The set would thus most probably work quite well without an earth at all, but any hum or noise from the mains is likely to be reduced enormously by a local earth at the set.

By Board of Trade regulations, the mains must *not* be connected to earth except at the power station or similar distributing point on the supply authority's system.

### Use of Condenser

Thus it is not permitted to earth the neutral directly at the consumer's wireless set, but since the “earthiness” that is required is only for alternating currents, this is adequately provided by earthing the set *through a condenser* as shown.

In the left-hand set conditions are very different. The incoming positive wire is the earthed neutral and must go to the anode circuit. The live conductor, which is 200 volts negative to earth, must therefore go to the filament.

Quite adequate earthing of the set (for alternating current, especially of high frequency) will be obtained by earthing the set through the condenser on which Board of Trade regulations insist in any case.

But it will be seen that the filament

circuit and *all things which are in metallic connection with it*, are then at the 200 volts of the live mains wire and therefore dangerous to touch.

This will normally include any filament rheostat or switch and the grid circuit, including its tuning condenser. All of these have metal parts which are liable to be touched in the ordinary operation of the set.

Sets built on a metal chassis connected directly to a metal panel are thus particularly dangerous, and

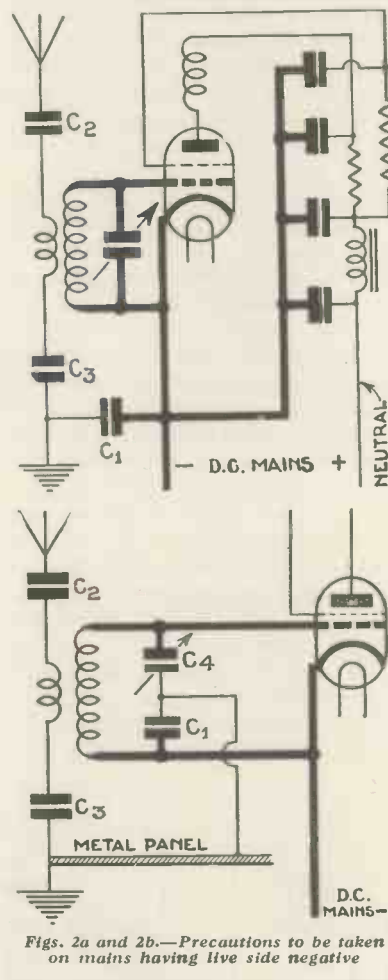

Figs. 2a and 2b.—Precautions to be taken on mains having live side negative

should on no account be joined to this side of the D.C. mains or, at least, not without considerable precautions amounting to partial reconstruction.

With the arrangement of aerial transformer shown—a fairly usual scheme—the whole of the aerial is also connected to the live main, so that if it is touched there is great danger of shock, while there is also danger of the aerial coming into contact with earthy things if lowered or blown down.

The whole of the parts affected

in this way are shown in extra-heavy lines in the left of Fig. 1. Even if the aerial transformer has its coils completely separate from each other the aerial would still be dangerous, as the average high-frequency transformer is not designed for high voltages and might readily permit leakage or even breakdown and give conditions approximately like those of Fig. 1.

### Another Danger

If a second tuned stage coupled by high-frequency transformer is used, its secondary will be substantially the same as that shown in Fig. 1 and therefore another point of danger.

Several precautions must therefore be taken, both in the interests of the set, the user, and the mains themselves. Fortunately these precautions are all fairly simple, and can easily be effected by any practical man, when the set can be made perfectly safe.

First of all, the set should be arranged with an automatic switch which deadens all the interior when the set is opened. This switch should be of double-pole pattern to ensure that the live main is broken irrespective of any wall plug or switching.

External operating switches should be of insulated pattern so that no live metal can be touched. Condenser spindles or any other control spindles protruding through the front of the set should be of minimum length and should have insulated knobs of such size as to make the spindles themselves inaccessible in operation.

### Insulated Controls

The control knobs must all be, as already stated, of insulating material, and their fixing screws should be well sunk in and impossible to touch while handling the knob. Indeed, once the grub-screws are tightened up, it is a good plan to fill the holes with insulating compound lest moist hands should ever provide a conducting path.

Cobbler's “heel-ball” is a suitable material, and is better for this purpose than Chatterton's compound or anything that goes “tacky.”

At least one reputable maker has an extra screw-on cover for such knobs when used on D.C. mains to ensure that the grub-screws cannot possibly be touched.

The live mains wire must not, as



already stated, be directly earthed, nor indeed must any part of the set be earthed otherwise than via a condenser as shown at  $c_1$  in Fig. 2. This diagram also shows the generic arrangement of high-tension feed and decoupling.

For reasons already given the aerial should be completely isolated from the rest of the set by the condenser  $c_2$ , which should be of about .1 microfarad capacity and should be of the non-inductive type.

### Commoned Connections

If the high-frequency transformer has its aerial and grid coils commoned at the earthy end (as in Fig. 1) the condenser  $c_1$  will suffice to earth the aerial for high frequencies.

If, however, the transformer has its windings separate as shown in Fig. 2, the extra condenser  $c_3$  should be inserted in its earth lead in case the aerial coil should become live to the mains through low insulation or breakdown between its windings.

### Metal Panels

In the case of a set which has a metal front panel on which spindles are commoned, a somewhat different method can be adopted, but it calls for slight modifications within the set.

This is illustrated in Fig. 2b, where  $c_2$  and  $c_3$  are the same as in Fig. 2a. The tuning condenser  $c_4$  is assumed to have its earthy rotor plates on the lower side of the diagram.

It will then be seen that the condenser  $c_1$  (inserted as shown) now serves to break the mains from the lower side of  $c_4$  and that this side of  $c_4$  with its spindle can be directly connected to the metal panel and earth, as in the diagram.

In this case, however, it must be noted that the full mains voltage

is across the tuning condenser  $c_4$ , so that it must be of a good pattern suitable to withstand such voltage without danger of shorting or breakdown. This arrangement therefore calls for good components and should only be adopted if this is assured.

The same arrangement can, of course, be adopted in the case of any succeeding tuned grid circuit. In all the cases shown, the condensers  $c_1$  and  $c_3$  should be of not less than 2 microfarads.

Another "touchy" external point which is handled in the normal course of operation has also to be considered. This is a gramophone pick-up if used with a set on the live-negative D.C. mains.

Many pick-ups in use are metal-cased, and this case is frequently earthed in the normal way. The precaution to be taken is to feed the pick-up into the set through a 2-microfarad condenser in each lead. In the case of a set which has a potentiometer volume control in the set the arrangement shown in Fig. 3a will be suitable.

In the case of a pick-up which has its volume control incorporated or otherwise inseparable from the pick-up itself, the arrangement of Fig. 3b can be used, the extra leak resistance shown being necessary in order to preserve the continuity of the grid circuit and to apply negative bias.

This arrangement has also the advantage of isolating the volume control from the mains.

A loud-speaker external to the set is also, of course, liable to be handled, and should only be joined to a D.C. set by such a means as transformer or choke-condenser coupling to isolate the loud-speaker from the anode circuit.

This is particularly necessary in the case where the negative side is earthy, since the loud-speaker would otherwise be joined to the live positive main. Most modern sets use such an isolating device; indeed most loud-speakers require it, so this provision is likely to be included in any case.

One last point on the use of D.C. mains. It is often found that a set works well and silently on one supply but not on another. This may readily be due to the nature of the D.C. supply, a supply

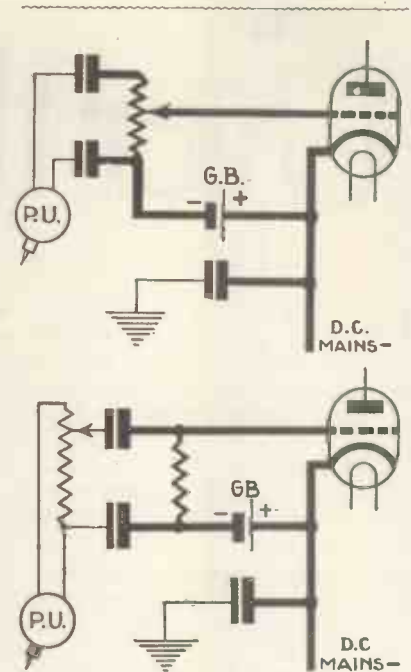

Figs. 3a and 3b.—Protection of gramophone pick-up on live negative mains

from mercury-arc rectifiers being particularly noisy.

The typical noise which is produced is a 300-cycle note which, of course, lands right in the middle octave of the piano and of most music, and is therefore very annoying.

In using a wireless set or reproducer on a supply of this sort greatly increased smoothing—both condenser and choke—is often necessary. This is true with either side live, but is particularly true with the live-negative side.

### Extra Smoothing

This is due to the fact that with the positive earthed and the smoothing choke in the positive lead, the choke may be less effective than on the other side of the mains, and extra choke-smoothing may be advantageous in the negative side.

In conclusion, it will be seen from these remarks that the D.C. mains should only be used with discrimination, and following lines of sound design.

In this respect the constructor can be assured that the designs which appear in "Wireless Magazine" are carefully thought out to take due regard of the points raised above, and the D.C. circuits shown in this magazine are designed to cover the precautions in the simplest manner while still conforming to the requirements of "safety first."

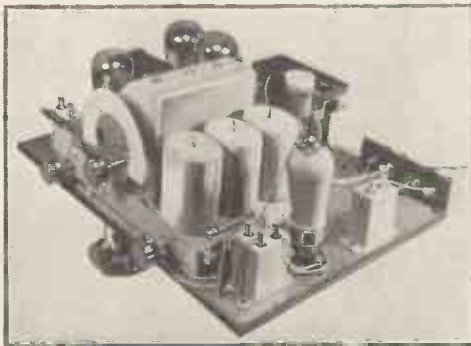

A FINE D.C. RECEIVER

Full constructional details were included in the July issue of "Wireless Magazine" of a four-valver called the D.C. Calibrator

# Over the Counter

In this short story J. GODCHAUX ABRAHAMS relates another adventure of Albert Goodger, "Portable Wireless Expert"

TO my kindly inquiry regarding his general welfare, Albert Goodger retorted: "Well, sir, it's like this 'ere, I've never felt more like doing murder in all my born days."

Albert Goodger? Of course, how ridiculous! You don't know him? Well, he's our local radio dealer, and styles himself, on the shop-front, a "Portable Wireless Expert." "Portable," believe me, is hardly the word, as he must turn the scale at fourteen stone.

What he was in the dim ages of the past I should not like to guess; possibly a plumber. In addition, he may have dabbled in the installation of electric bells, and perhaps repaired a switch or so, or even replaced a bulb, or a fuse.

Something of that kind, anyway. To-day, he is our local wireless expert; I ought to know, as he told me so.

Now and again, I have walked into his shop in an attempt to buy some oddment or other—not that I have often been successful; in fact, as a rule, he has been "just out" of what I wanted. His stock of components reminds me of nothing less than a cemetery of shattered hopes.

On his counter you will see a motley collection of wireless receivers—half-finished sets—sets which, started with a full meed of enthusiasm, have been given up in despair and, conversely, finished receivers which, when put to the final test, have sadly disappointed their original constructors.

It is in this collection of junk that Albert Goodger delves when requested to produce a component

needed by a customer. His actual stock is sadly depleted; in fact, if an inventory were deemed necessary all that is needed is to count the few items of dust-covered wreckage which he considers are attractive features of his shop-window.

He is, by the way, a confirmed pessimist. In his own words, Albert Goodger is always "up against" some knotty problem, and every set which is brought in to him for diagnosis and, possibly, subsequent treatment, is always the worst he has ever handled.

For some reason—not far to seek, in my opinion—his clients never entrust to his care any receivers of reputable make, but submit for repair, alteration, or completion weird contraptions built either to their own ideas or, if copied from some blueprint, so far departing in form and character from the original that they would be unrecognised by their designers.

Most of the instruments displayed on his work bench may be classed as

the pariahs of the radio world. But according to his lights he is a wireless doctor and expert—and now you know him.

"Murder?" I inquired; I could scent a story.

"Yes," he replied, as he gave a final twist to the last screw holding down the ebonite panel of one of his sickly looking portables.

"Not but wot they could always guess that I 'adn't done nothing to their set," he continued, "but some of these folks are never satisfied. Take, f'r instance, the case of the Elms. Why, that set of their's is a regular come-back to me once a month regular. Sometimes hit's a valve wot's gone west; sometimes hit's a knob wot's come off; there's always something the matter with it.

"I'm sick of the very sight of it, but between you and me and the gatepost, I wouldn't part with hit for anything and—"

"But murder?" I repeated.

"Yes," he said, "that's hanother story." (Although, figuratively, dropped aitches littered the floor, he condescended now and again to pick one up and use it in a word possessing no initial aspirate.)

Fortunately, I was not pressed for time; the man interested me. He was of a *genus* which had sprung up since the advent of broadcasting. I have since found that there are many Albert Goodgers in the wireless trade.

He slammed down the lid of a portable regardless of any ulterior effect upon the valves, and pushed it to one side. "It isn't often," he began, "I sell a' nalmost noo wireless set, but I got rid of one for a friend of mine at Easter. It was a five-



"The old gal wasn't a bit surprised or taken aback like. 'My man,' she sez to me, 'hit's playing all the wrong tunes'"



valver, you know; one of those things which they say can bring in anything from Mucklacker to Wheezing [apparently Huizen], not but wot the old gal would 'ave understood anything of their outlandish lingo when she got there but, it 'elps to sell 'em."

"What old woman?" I asked.

"Oh, the old geezer I sold it to down near Slough. I delivered the set m'self by train, rigged up a' nariel and a' nearth for 'er, and set the whole caboodle going to 'er full satisfaction."

"Well, that was nothing to grumble at," I interjected.

Albert Goodger spat scornfully. "Not," he retorted, "after wot 'appened last night?" He held me with his eye and wagged a dirty forefinger at me. I waited expectantly.

"Last night! Lovely night it was, too" (I remembered it—foggy and damp; I had sat by the fireside all the evening). "It 'ad gone six when she rang up—I was just putting up the shutters. 'Would I go down and see the set as it wasn't working properly'—I ask yer? I tried to put it off, but she wouldn't 'ave none; 'er nephew was back 'ome and 'e wanted to 'ear something on the wireless—and the set was going all wrong."

"Did you go?"

"Did I go? I 'ad ter. She 'adn't paid up and 'ad kept it on appr—on appr—well, she 'ad it on test. It took me close on a couple of hours to get down to the place and to find the 'ouse and when I did find the 'ouse wot d'yer *think* hi found?" Goodger was positively aggressive.

"The house, obviously," I volunteered.

"Well, I'll tell yer. The thing was where I'd left it, in the droring-room. So I got out my tools all set for trouble. The old lady switched on and there was that five-valver bursting with music fit ter blow yer 'ead off. I turns to 'er and sez, 'Wot's the matter with it? You 'phoned as 'ow hit was all wrong. You couldn't get anything sweeter than that.' The old gal wasn't a bit surprised or taken aback like. 'My man,' she sez to me, 'hit's playing all the wrong tunes.'"

Goodger, at this juncture, gave a dramatic pause. "The *wrong* tunes? Hurry along," I interrupted, "this is getting interesting."

"The wrong tunes?" I sez. "What of it, mum?" "Well," she

sez, 'London Regional, according to my programme, is supposed to be doing a concert by the Wireless Military Band and here, on this station there's a piano reci—well, a piano's playing.' I twirled the knob and got on the National, but there wos a talk on, so I 'ad a good squint at 'er dial to see if it 'ad slipped."

"'Er—I mean, her dial?" I queried.

"Yes, the dial on the set. I once had a lady with a slipped dial—Mrs. Bagwash, of The Nook. Well, believe it or not, I twirled that knob round and round and couldn't get a military band nowhere no 'ow, and the old lady was getting uppish. 'I want *this* programme,' she said nasty like, 'and an expensive set like this one should give it to me. Per'aps your valves are weak.' 'Ave a' neart, lidy,' I sez, 'my valves is all right, they're noo.' I got them out of another customer's set, and 'e 'ad only just bought 'em. I couldn't 'elp telling 'er straight, but polite like. You see 'ow you're always 'aving trouble in this 'ere business—"

I foresaw that Goodger would soon be sliding over into a dissertation on the vicissitudes of a radio dealer, and, in particular, of those besetting a wireless doctor, so tactfully shunted him back to the main line.

"Well, what was your diagnosis?" I knew the word would flatter him. He jumped at the tit-bit offered him.

"I'll tell yer. My dia—wot yer said—was all wrong, and when hi did find out it struck me all hof a' neap. 'Pardon me,' hi said, after hi 'ad wasted well over a' narf hour, 'would you mind me seeing that paper hin your 'and.' Hi just squinted at it and there hit was. 'Lidy,' I said, as polite as kiss yer hand, 'that's last week's programmes!'"

I tried to make a sympathetic noise; to have laughed outright would have lacked diplomacy.

"It took me over four hours to get back 'ome hin the fog. I lost the last bus to the blinkin' station and 'ad ter walk about three miles. She never offered me as much as a drink and to-day she writes and sez she wants the set hon instalments!"

Albert Goodger, with a deep sigh, turned to another of his dumb patients awaiting a drastic operation. Words would have been superfluous; in fact, I was too full to speak.

Poor Albert! The tribulations of a small radio dealer—and yet, very cruelly, perhaps, I roared with laughter as I walked home.

### Stories of the Operas

## The FLYING DUTCHMAN

(Wagner)

### CHARACTERS

Daland, a Norwegian Sea Captain.....Bass  
Senta, his Daughter.....Soprano  
Eric, a Huntsman.....Tenor  
Mary, Senta's Nurse.....Contralto  
Daland's Steersman.....Tenor  
The Dutchman.....Baritone

Time: Eighteenth Century.

Place: A Norwegian fishing village.

### ACT I

A wild and stormy sea. Daland's ship has sheltered in a little cove formed by the cliffs. Sailors furl sails and coil ropes. Daland is looking about trying to determine where they are. He finds they have missed their port on account of the storm, and curses his bad luck that it should have driven him away from his home and daughter.

Suddenly the ship of the Flying Dutchman looms in the distance. She glides the waves as though no storm existed, and anchors near the Norwegian, the spectral crew furling the sails in complete silence. The Dutchman goes ashore. He is leaning against a rock in contemplation when Daland comes out of his cabin and sees the Dutchman's ship.

He questions the Dutchman, who tells a story of bad luck and disaster, and asks Daland to take him home and allow him to pay his attentions to his beautiful daughter.

### ACT II

A room in Daland's house. Pictures and charts relative to a seaman's work grace the walls. Also a portrait of a pale man with a dark beard—the Flying Dutchman. Senta is reclining in a chair and looking at this picture. Her old nurse Mary is there.

Eric enters at that moment and announces the arrival of Daland's ship. Mary and the girls go to meet the sailors. Eric prevents Senta going and proclaims his love for her. She gives him no definite answer.

Senta looks at the picture again when the Dutchman appears at the door followed by Daland. Turning from the picture to him she is rendered motionless. Daland, seeing she does not greet the stranger, asks her to remember her manners. She greets him stiffly.

### ACT III

A bay with a rocky shore, Daland's house in the foreground at one side, the two ships in the distance. Daland's is lighted up; the Dutchman's is in gloom. Sailors and girls call to the Dutchman's crew to join them in a revel. There is no reply.

Then the sea begins to rise and the wind whistles through the cordage of the strange vessel. Dark, bluish flames flare up in the rigging. The crew appear and sling a wild chorus, terrifying the simple Norwegians. They rush away in terror and the Dutchman's crew disappear with fiendish laughter. The sea calms down. Senta, followed by Eric, comes out of the house.

The Dutchman bids Senta farewell. Eric and others try to prevent her following, but she tears herself loose.

WHITAKER-WILSON.

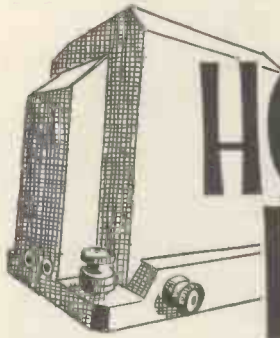

# HOW TO GET REAL QUALITY

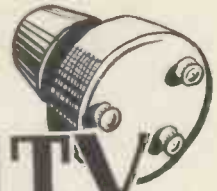

By Noel Bonavia-Hunt, M.A.

IN a previous article\* we discussed the question of the most suitable frequency-response curve for a low-frequency amplifier. The conclusion arrived at was that the curve should be as straight as possible between 100 and 8,000 cycles. A fall above this point, providing it is not too sudden, would not appear to cause much anxiety. This is for the amplification of radio signals, of course. To get the best results from gramophone records, which vary enormously, as everyone knows, it is quite necessary to provide special tone and volume controls acting on the bass and treble ends.

The signals "tainted at their source." Leaky-grid rectification has no attractions whatever for me. The only safe rule is to give the detector its own job to do, and that is rectification. We know that the diode fulfils this purpose admirably, and we have merely to make our choice between a hot and a cold valve, a choice which can be safely left to the reader, since both are so very good.

different methods are shown in the accompanying diagrams (see Fig. 1).

## Experimental Results

Nos. 1 and 2 fail in the treble, No. 3 fails in the bass, while No. 4 fulfils all requirements provided a small transformer is used with a secondary winding of not more than 6,000 ohms D.C. resistance. Readers will, I hope, appreciate the fact that in a short sentence I have condensed the results of many months of experimental work in this connection.

The first low-frequency valve should be of the type that is easily loaded by signals impressed upon its grid from a diode (with suitable high-frequency amplification preceding it). A valve having an amplification factor of 20 to 35 with an impedance of between 8,000 to 12,000 ohms will be found to work best in this position.

High- $\mu$  valves with an amplification factor of 70 to 80 are to be avoided here until the manufacturers can produce one that amplifies the higher frequencies uniformly with the middle and lower.

## Further Couplings

Now as to the next stage. Should there be only one more stage? That depends on two things. First, the average strength of rectified signals impressed on the first low-frequency valve and, secondly, the type of coupling used between the first low-frequency valve and the output valve.

Assuming that the signal input is adequate and that the first low-frequency valve is well loaded, we can easily load a super-power output valve by using transformer coupling between the first low-frequency and output valve. Transformer coupling can be carried out in various ways:

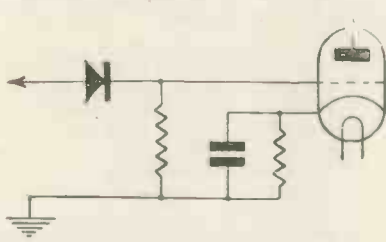

Fig. 1a.—A low-frequency coupling that fails in the treble

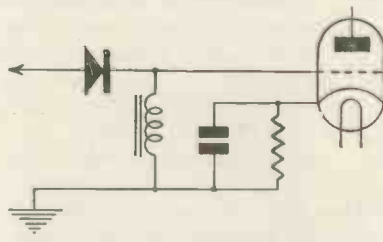

Fig. 1b.—Another low-frequency coupling that fails in the treble

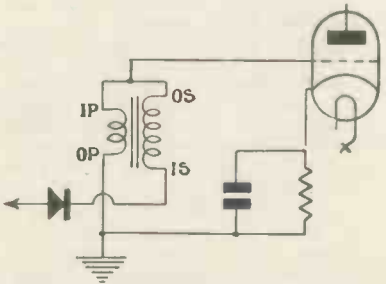

Fig. 1c.—A low-frequency coupling that fails in the bass

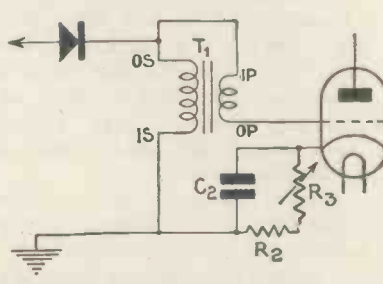

Fig. 1d.—A coupling that fulfils all requirements

phone records, which vary enormously, as everyone knows, it is quite necessary to provide special tone and volume controls acting on the bass and treble ends.

In the case of radio transmission a note of warning must be sounded. Every care must be taken to avoid faulty rectification. We do not want

Shall it be half- or full-wave rectification? The latter has its advantages where sensitivity and automatic volume control are required, but from the point of view of high quality the half-wave rectifier is as good as any other type.

How should the diode be coupled to the first low-frequency valve? One may have resistance, choke, or auto-transformer coupling. Four

\*"When We Don't Need Straight-line Amplification," page 586 of "W.M. for July 1933"



(a) by transformer alone, (b) by "parafeeding" with resistance or choke, and (c) by "push-pulling."

All these methods possess one common and fatal defect. It is not possible to obtain a really satisfactory bass and by this I mean bass in which the characteristic curve shows a distinct and clear rise below 90 cycles down to at least 40. It can be definitely proved that to secure even a straight-line characteristic an inductance of no less than 900 henries is required, while for a rising curve an inductance of at least 2,000 henries is indicated.

**Secondary Inductance**

No transformer primary can be wound to such an inductance. The secondary winding, however, can be so designed, and this is a point which we cannot afford to overlook. To employ such a large winding as a separate choke would rob us of the higher frequencies which are so important to seekers after real quality.

Furthermore, one stage of low-frequency would give insufficient amplification. A great many people think that pure resistance coupling is still the best form, with as many stages in cascade as are required to meet the circumstances. But this system of coupling fails in high-frequency response and definition when it is called upon to deal with complex wave-forms. And it also fails to produce the necessary rising characteristic below 90 cycles.

**Fine Performance**

What, then, is the best solution for those who are unable to avail themselves of the special de-luxe

type of coupling device referred to in my article on "Real Quality" (see March number), and who would like to utilise easily procurable components? Well, I can promise an exceptionally fine performance to any reader who cares to follow my advice as set forth in the remaining paragraphs of this article.

In the majority of cases it would be wisest to decide on three stages of low-frequency, namely, diode coupled to first low-frequency as already shown, then a further stage employing a low-amplification power valve, and a final stage employing two super-power valves in parallel with an anode voltage of not less than 300 and more if possible.

This necessitates the adoption of three couplers, the first being the auto-transformer between diode and first low-frequency, the second forming the coupling device between first and second low-frequency valves, and the third coupling up the last stage. We will call these couplers 1, 2, 3. What form shall couplers 2 and 3 take? On this question the whole success of the amplifier depends.

We have already made sure of a good high-note response from the rectifier and first low-frequency valve, and coupler 2 must maintain it as efficiently as possible. This means that we cannot afford to boost the bass register here, though it is at the same time imperative to produce a straight-line amplification curve down to at least 40 cycles.

A gradual fall below this point to 23 cycles is easily arranged. Thus the complete range from 23 to 8,000 cycles (at least) is covered. Incidentally it is possible to raise the lower portion of the curve for gramophone amplification if required, and to control the degree of curvature very nicely, as I shall show.

On coupler 3 we depend for a good bass register, rising below 90 cycles to 23 cycles,

and maintaining the straight-line curve above 90 to 7,000 cycles with graduated fall (not a cut-off) above this to 8,000 cycles or higher.

Let us go back to coupler 2. The only way to fulfill the required conditions here (obviating recourse to specially-made components, which are costly) is to employ a transformer with a 900- to 1,000-henry secondary winding, a coupling condenser of the correct capacity, and a suitable grid resistance. To ensure

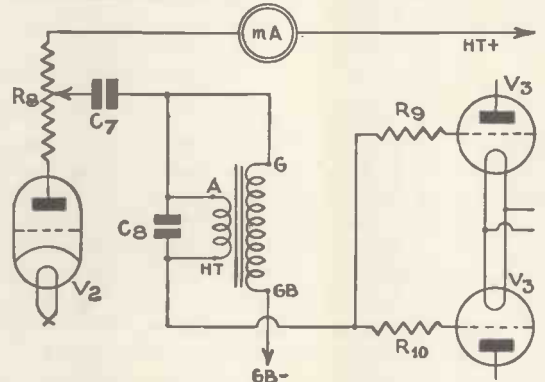

Fig. 3.—Circuit of the second stage of an amplifier for high quality of reproduction

good high-note response under all conditions it will be desirable to incorporate a high-frequency choke coil of 600 turns of No. 40 gauge wire. The circuit is now given and should be closely followed (see Fig. 2).

**Reversed Auto-transformer**

Here we have an auto-transformer connected in the reverse manner in the anode circuit of the first low-frequency valve, coupled through a .05 microfarad condenser (C4) to a .25-megohm resistance in the grid circuit of the second low-frequency valve.

Only one milliampere of current must be allowed to pass through the secondary winding of the transformer and the biasing resistance should accordingly be in the neighbourhood of 20,000 ohms (all or part of which may conveniently be variable) with an anode voltage of 150 applied to the high-potential end of the winding.

**No Errors in Wiring**

The terminals of the transformer, which may be of the AF3 type, are marked in the diagram, so that there should be no excuse for errors in wiring. Any alteration in the connections here will spell certain failure.

A very wonderful tone control,

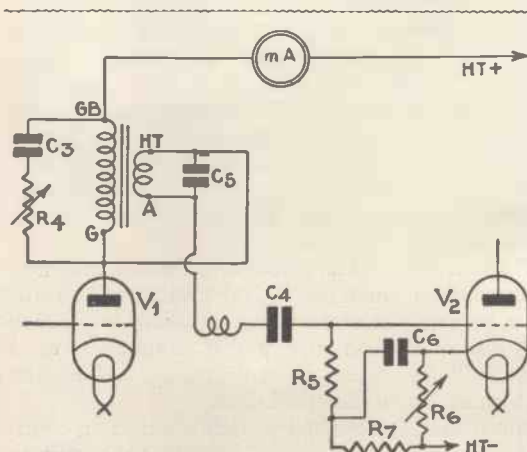

Fig. 2.—Ideal form of coupling between two low-frequency amplifying valves

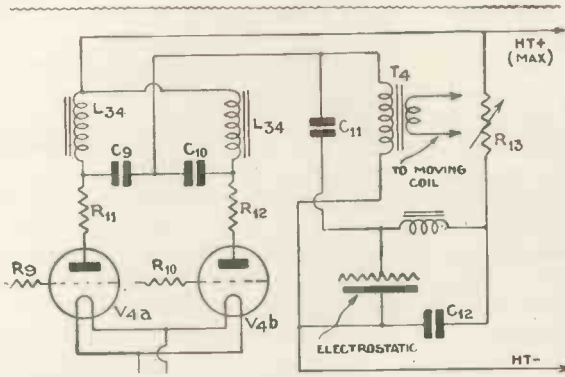

Fig. 4.—Complete circuit diagram of the output stage, arranged to work into two loud-speakers

which enables the manipulator to adapt the amplifier at this stage to the varying requirements of gramophone reproduction and at the same time without upsetting radio reproduction, is shown in the diagram. This consists of a .02-microfarad condenser ( $C_9$ ) and a variable .25-megohm resistance in shunt across the secondary winding of the auto-transformer.

### Boosting the Bass

The effect of this arrangement is to boost the 50 to 100 cycle band, while the high-note response is controlled by the variable resistance ( $R_4$ ). If desired, a switch can be incorporated for the purpose of removing this control out of circuit.

The value of this special bass-boosting device is brilliantly demonstrated in the reproduction of such a record as Bucalossi's "Grasshoppers' Dance" (H.M.V. B39 70) and also on Jessel's "Wedding of the Rose," which is recorded on the other side.

An even greater increase of bass is provided by substituting a .05-microfarad condenser for the .02-microfarad shown in the diagram, but the upper frequencies are not so well controlled in relation to the lower. The small condenser shunted across the primary winding of the transformer is optional.

The next stage is now given (see Fig. 3). Here we have in the anode circuit of the second low-frequency valve (which should be of the AC/P1 class) a .25-megohm potentiometer, with its centre terminal connected to a coupling condenser for purposes of volume and tone control. The capacity of the condenser ( $C_7$ ) is

somewhat critical, and in no circumstances should it be more than .006 microfarad. Values from .004 to .006 microfarad will be found to give the desired result.

The condenser must be of mica and capable of withstanding a high voltage peak, the working voltage being equal to the maximum employed for the last stage.

In the grid circuit of the output valves we have a large auto-transformer with a 2,000-henry inductance winding. An AF5 will serve the purpose quite well.

The tuned circuit of  $C_7$  and this winding produces a resonance in the extreme bass. The shunting condenser  $C_8$  must not be omitted. The anode current passed through the potentiometer ( $R_8$ ) must not exceed 2 milliamperes. The chief value of the sliding control will be seen when speech items are being reproduced.

The grid-bias circuit for the last stage is not given, since the method employed depends on the available

to the loud-speaker. In cases where anode voltages of 400 and upwards are available it is best to employ two output valves in parallel, with an impedance of 1,000 ohms or thereabouts. If this is done it is essential to use a separate choke and condenser circuit for each of the valves thus paralleled. The complete circuit diagram of the output stage is shown in Fig. 4.

### Common Output

Note that the common output is taken from the middle point of the two filter condensers,  $C_9$  and  $C_{10}$ , and is connected to the primary of the matching transformer  $T_4$  (or direct to the speech coil if this happens to be a high-resistance one) for the purpose of transferring speech currents to a moving-coil reproducer; while the same lead is also taken via another coupling condenser ( $C_{11}$ ) of .5 microfarad to the positive plate of an electrostatic loud-speaker, which is polarised in the special manner shown in the diagram.

With reference to the pick-up connections for gramophone reproduction, the circuit of Fig. 5 will be found very satisfactory. Personally I prefer a needle-armature type of pick-up, with its minimum of resonances, followed by a type J Novotone compensator.

Across the output of the latter is shunted a 500,000-ohm potentiometer for volume control, while the variable condenser  $C_1$  is invaluable for controlling the intensity of the bass register. The capacity of this condenser is decreased to reduce the bass, and vice versa. A Formodensor type H answers the purpose quite well.

In conclusion, what are the points of excellence which this special amplifier is able to offer? The answer may be very briefly given. First, we have a response curve that can be made straight from 40 to 8,000 cycles, or modified at will to give a rising characteristic.

The actual response extends up as high as 10,000 cycles, as the electrostatic loud-speaker will show. And the lowest frequency of 23 cycles is easily passed. The curve is also peak-free.

Secondly, there is sufficient control of tone and balance to satisfy the most enthusiastic and fastidious connoisseur!

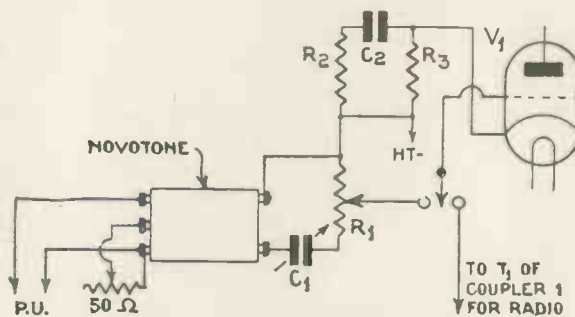

Fig. 5.—Arrangement for the use of a pick-up for reproducing gramophone records

anode voltage. Automatic biasing is not recommended unless the maximum anode voltage can be maintained at 500 or more.

It is surely absurd to rob the all-important anode pressure supply for the sake of obtaining the correct characteristic from the valve, when far superior results can be secured by using dry-battery bias or a second eliminator for the purpose. This, however, is a matter which must be left to the good sense of the reader, who has hereby been duly warned!

We now come to the output stage by which the last valves are coupled



# Gramophone-motor Hints

## Interference—

THESE are a number of electric gramophone motors on the market which radiate interference. Sometimes this is in the form of a hum which varies according to the angle at which the pick-up is held; sometimes it is a crackling which invades the amplifier all the time the pick-up is playing.

In these cases the interference is clearly of audio frequency, and is electromagnetic in origin in the first case and electrostatic in the second.

A more common type of interference, however, with those motors that have commutators is of radio frequency. In this case the owner may not discover the trouble for himself for quite a long time, but every neighbour will.

It is not unknown for radio-frequency interference of this kind to be picked up by an aerial 300 or 400 yards away from the offending motor.

Such motors are a public nuisance and if the radiation cannot be cured, and in many cases it cannot by any simple means, it ought to be scrapped.

### Possible Cures

Here are a few notes on methods of dealing with these types of interference that have been found to be successful from time to time. They are not put down as universal cures, but at any rate they are all worth trying.

In this connection it may be said for a start that A.C. induction and synchronous motors, which have no brushes, are much less liable as a rule to cause trouble than D.C. or A.C. commutator motors.

Practically all the electrostatic (audio-frequency) and the radio-frequency interference come from sparking brushes:

**Magnetic** (audio frequency). Complete screening of the motor in an iron box below the motorboard is the only sure cure; and the iron has

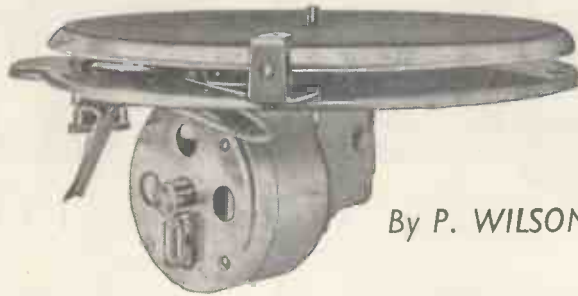

By P. WILSON

to be fairly thick, say,  $\frac{1}{8}$  in. or more. Sometimes, however, facing the underside of the motorboard with iron-sheet is sufficient.

These are somewhat troublesome methods and before embarking on them it is always well to try the effect of a different orientation of the motor in relation to the pick-up; that is, try turning the motor frame round, the spindle being kept in the same position; or, alternatively, try mounting the pick-up arm at different places at the same distance from the turntable spindle.

The frame of the motor and the pick-up head and carrying arm should always be "earthed." Sometimes "earthing" one or other of the two through a condenser and the other directly improves matters, but these occasions are rare.

**Electrostatic** (audio-frequency). Here, again, complete metallic screening, with the screen and the pick-up head and carrying arm earthed, is the surest method. In the case of commutator motors, however, the connection of a 2-microfarad condenser between the frame and one of the brushes often works wonders; which of the two brushes to connect to has to be found by trial.

In one instance (an expensive, yet deservedly popular motor) wrapping the spindle with stamp paper, so as to insulate the turntable from it, was equally successful!

**Radio-frequency.** The methods described for electrostatic are applicable, but not always successful.

The best counsel of all is that you should choose a motor which gives none of these troubles. Nowadays there are many good ones.

## —and Oiling

MOTORS are so reliable in these days that one is apt to forget that they repay a little regular attention in the matter of oiling.

Apart from the lubrication of spring barrels, best done by an expert

since it may be dangerous for the inexperienced, the same rules apply both to spring motors and to electric motors. There is, however, just this difference: an electric motor runs warm and therefore demands more frequent attention.

The parts to look to are the following:—

(1) **Spindle bearings:** a single ball bearing, as a rule, at the foot of the spindle and a sleeve bearing at the top where it goes through the motor frame. Use light oil (say, Wakefield's Oilit) rather sparingly (three or four drops a month).

(2) **Drum bearings in spring motors:** light oil—three or four drops.

(3) **Armature bearings in electric motors:** light oil—one or two drops.

(4) **Governor spindle bearings:** light oil—one or two drops.

(5) **Governor Worm:** On no account use liquid lubricant; it has the knack of penetrating and distorting the fibre worm wheel. Non-gritty motor grease is best.

### Free from Grit

(6) **Governor brake-pad.** This is the part most often ill-treated, yet it is perhaps the most important. The pad and disc on which it operates should be kept scrupulously free from grit.

The pad should be soft and uniform, not shaggy, and should occasionally be lubricated with light oil. Try to squeeze out any old oil before putting on the new and clean the disc with soft rag.

The so-called "squaring" of the governors is almost invariably due to a poor or dry governor pad. In this case, the governor takes up a set pattern and operates in noisy jerks.

# Watching a Set at Work

By PAUL D. TYERS

I EXPECT nearly everyone has heard of the oscillograph, although, no doubt, only a few of my readers know very much about it. The oscillograph to the radio engineer serves somewhat the same purpose as the X-ray tube does to the doctor.

## Finger-bone Shadows

The simile is not altogether true, because with the X-ray tube we can see the shadow of an actual thing. If we hold our hand up to the X-ray tube and view it on the florescent screen, we can see the shadow of the finger bones.

Now the oscillograph does not show us the actual electrons moving, because electrons are invisible, but it will trace out for us the relative movement and the extent of the movement.

As this tells us almost all we want to know about an electric circuit, and particularly those dealing with alternating currents, the oscillograph is an invaluable asset.

Nearly every writer has at some time or other endeavoured to explain in simple language just how a wireless set works.

It is a very difficult task to explain a highly technical subject in simple language, and what I am going to do is not to give lengthy explanations of just what happens in your set, but instead show you actual photographs of what really takes place.

First of all, I think it will be as well to explain exactly what an oscillograph is, and in particular give you a very brief description of the oscillograph which I use in my laboratory. There are several types, but the one which I use for these

experiments is of the cathode type.

My actual tube is a Cossor model, which you can see in the photograph. It is a long conical glass tube with a white, almost opaque, screen at one end, while the various electrodes are at the other end.

The tube contains a small filament, very similar to that used in an ordinary battery valve. This is heated by an accumulator and a stream of electrons is given off by the filament, again in exactly the same way as it is in a valve.

Instead of drawing all the electrons

and in many cases it is far smaller. The size depends upon the actual construction of the tube.

Inside the tube there are four more electrodes in the form of two pairs of parallel deflecting plates. This electron beam is extremely sensitive to electrostatic and electromagnetic fields. If we apply a voltage to one of the plates, the beam is deflected, and the spot will move across the screen. A horizontal plate will, of course, move the spot vertically, while a vertical plate will move the spot horizontally.

Now an electron stream has substantially no inertia, which means that the spot instantaneously takes up a new position on the screen whenever the voltage is altered on one of the deflecting plates.

If we apply an alternating-current voltage to the plates, the spot will move backwards and forwards in exact sympathy with the alternating-current voltage. This alone would not get us very much further because, instead of seeing a spot, we should simply see a line, due to the spot moving backwards and

forwards at exactly the same rate as the alternating voltage.

## Value of Voltage

We should see, however, the value of this voltage, because the spot moves a definite amount for a definite voltage and, therefore, the larger the voltage the more will the spot move, and the longer will become the line.

We know that an alternating voltage is one in which the value periodically increases and decreases with time according to some law. What we want to do, therefore, is to

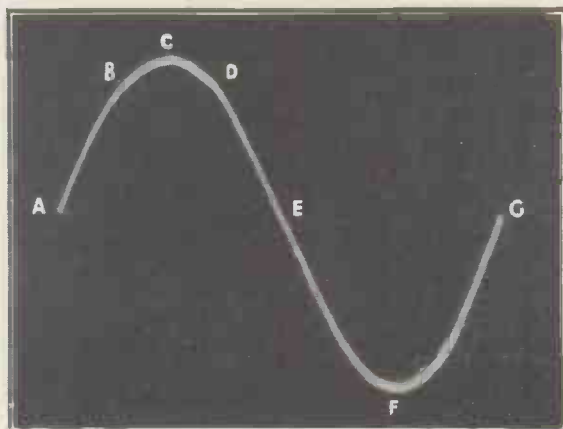

Fig. 1.—Oscillogram of an alternating-current mains supply, very like the symbol used to represent A.C.

away to an anode as we do in a valve, there is a special electrode in the form of a cylinder which shoots the electrons out in a stream. This electrode is sometimes called a gun, and it works at quite a high voltage, in the region of 2,000 to 3,000 volts.

This stream or beam of electrons can be focused by means of another electrode which is usually called a shield, and the stream is actually focused by varying the bias voltage on the shield electrode.

Where the stream impinges on the screen, a florescent spot is produced. This spot is only about  $\frac{1}{16}$  in. wide,



make the spot move in two directions. We want to try to make it traverse perhaps right across the screen at a constant speed, while at the same time we want to try to make it rise and fall vertically in sympathy with the alternating current.

If we do this, we can find out just what value the alternating current or voltage has at any given instant. For example, we can make our spot go right across the screen in one-fiftieth of a second.

### Constant Speed

As the spot is travelling at a constant speed, equal distances along the horizontal line correspond to equal amounts of time. While, however, the spot is travelling from one side of the tube to the other it is rising and falling vertically, and the picture we should then see would be called the wave form.

We are next confronted with another little trouble. How are we going to see what happens in one-fiftieth of a second? The obvious way is to repeat the operation so that a steady picture is obtained which we can look at at leisure.

This can actually be done by a

rather complicated electrical circuit. You will see in the photograph the panel which controls the tube. There are twelve different controls, and five valves are used; two are of very special types, one being filled with helium.

It would take far too long to explain how the time base, as it is generally called, operates. Its function is simply to make a spot traverse from one side of the screen to the other at a constant rate, and as soon as it reaches the end of its travel at one side it repeats the process instantaneously. It is by this means that we can obtain a steady repeating picture.

What I am going to do now is to consider a perfectly straightforward mains receiver consisting of a tuner, detector, and output valve, the high tension being derived from a valve rectifier and the usual smoothing circuit, because this is really the basis

of any receiver, however complicated.

I am going to connect the tube to various parts of the set, so that we can see exactly what happens from the time the current enters the set from the mains to the final form it takes as the speech currents are fed into the loud-speaker.

### A.C. Supply

Our set is supplied from the ordinary alternating-current mains. Here the voltage may be perhaps 230 volts, and the supply in this country is almost always at a frequency of 50 cycles. A 50-cycle supply is one in which the current alternates fifty times a second.

First of all then, we must connect the tube to the mains and see what the mains supply is really like. In Fig. 1 we have an oscillogram of the mains supply. It resembles the standardised symbol for alternating current with which, no doubt, everyone is familiar. Our oscillogram shows that our symbol is most apt and it is, in fact, a true representation.

### Photo of One Cycle

When I took this oscillogram, I arranged the spot to travel so that it took one-fiftieth of a second, and therefore I have obtained a photograph of what is known as 1 cycle. Let us examine the form which the current takes.

It starts at A from a zero value. It rises very rapidly until B, when the increase in current is not so rapid. It reaches a maximum value at c, and it then begins to diminish until D at a rate which is just the same as between B and C.

It then diminishes far more rapidly until it reaches a zero value again at E. From D to E is identical with A to B. Now you will see that it repeats itself, but in exactly the

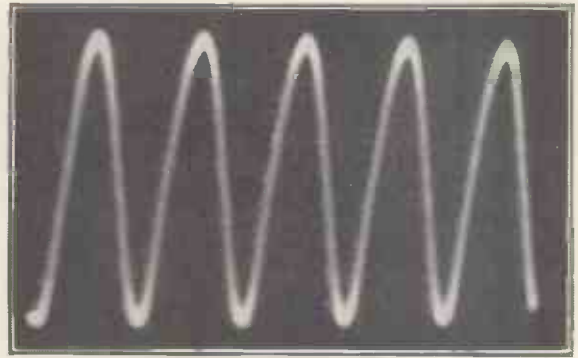

Fig. 2.—Oscillogram of mains supply, which has the same form as the single cycle shown in Fig. 1

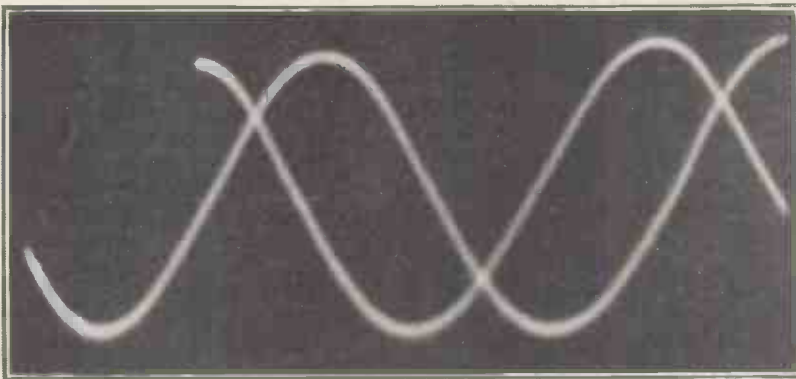

Fig. 3.—Oscillogram showing current and voltage out of phase, but of equal value

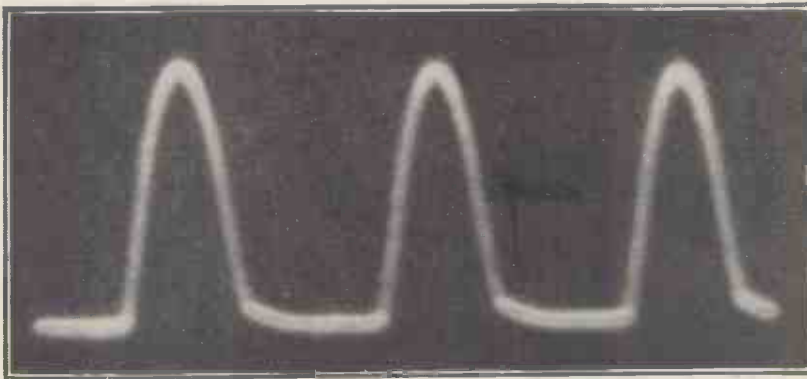

Fig. 4.—Oscillogram of current after it has been rectified by a valve; this is half-wave rectification

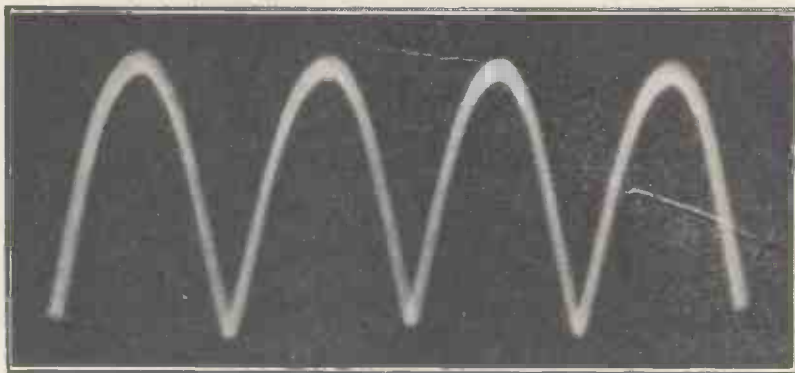

Fig. 5.—Oscillogram of current after full-wave rectification, as employed in many mains sets

opposite direction, reaching the same value of peak current at F, and returning again to zero at G. From A to G is a complete cycle or period.

This particular wave form is known as a sine wave, and it is that met with in all uniformly generated currents.

#### Most Important

This is the most important oscillogram in the whole series, as it is the fundamental basis of all alternating-current electrical problems. If you can obtain a true mental conception of what happens by looking at this figure, you will have gone a very long way in understanding far more complicated problems when they arrive elsewhere in advanced receiving circuits.

The alternating current is therefore composed of a continued series of waves having the form shown in Fig. 1. Fig. 2 shows the mains supply, and gives a number of successive cycles. They have the same form as the single cycle of Fig. 1, and it is this current which is applied to the mains transformer in our typical set.

#### Three Secondaries

This transformer has three secondary windings. The first winding supplies current for the heaters of the valves, the second heats the filament of the rectifying valve, and the third winding provides the necessary high voltage for the rectifier valve, from which we obtain our finally smoothed or direct-current output.

The voltage as supplied by these three secondary windings has exactly the same wave form as that in Fig. 1 or Fig. 2.

You will notice that I have mentioned both current and voltage.

Now the current and voltage usually have exactly the same wave form, and it does not matter very much which we examine.

I think it would be as well at this point to say a word about what is known as phase relationship. When an alternating voltage is applied to a resistance, a current flows which depends upon the value of the resistance. The current which flows at any given instant is, of course, directly proportional to the voltage.

the current has a much smaller value. Sometimes the current is actually in advance of the voltage, and sometimes it lags behind it. Clearly, then, the peak values or maximum values and the zero values do not occur at the same instant, and this is referred to as phase displacement.

#### Out of Phase

Fig. 3 is an oscillogram which I have specially arranged to illustrate two waves which are out of phase. Here both the current and the voltage actually have the same numerical value, because the curves are of the same height above the datum line or abscissa, to give it its correct scientific term.

I do not propose to try to explain how a current and voltage can be out of phase, but I think the oscillogram which shows it actually occurring may help you to obtain a better appreciation of what, on the face of it, is very difficult to understand and is invariably a stumbling block.

Before our set can actually receive any signals, we have to obtain the



Fig. 6.—Mains current with poor smoothing following half-wave rectification; the ripples cause mains hum in the loud-speaker



Fig. 7.—Another example of a poorly smoothed mains supply, which will also cause hum. This is from a full wave rectifier

As the voltage begins to rise, so, of course, does the current and when the voltage has completed the first half-cycle and got back to zero the current does exactly the same.

In some circuits, when an alternating voltage is applied to an inductance or a condenser, a somewhat extraordinary condition arises in which the voltage and current are not together. They are said to be out of phase.

When the voltage is at maximum,

necessary high-tension supply which, of course, must be from a direct-current source.

Let us see first of all then how we obtain direct current from the secondary of the mains transformer with the aid of the rectifier valve.

Let us turn for a moment to Fig. 2, which shows the wave form of our supply and, of course, the wave form from the secondary of our mains transformer. Here we have a number



of peaks of current or half-cycles all in one direction on one side of the datum line, and a number on the other side.

### Removing the Peaks

If we were by some means to remove all the peaks on one side of the line, we should be left with a series of peaks of current all flowing in the same direction. The various peaks of current would start from nothing, rise to a maximum value, and fade away again to nothing, and there would be quite an appreciable gap between them.

In any case, it is clear that to obtain a direct current we must definitely remove any current which flows in the opposite direction. It is this cutting off of one half of the wave which is actually known as rectification, and this is the function of our rectifier valve.

Everyone knows, I expect, that current can only pass between the filament and the plate when the plate has a positive potential with respect to the filament.

If, then, we connect our transformer secondary to the rectifier valve, the current will only flow when the anode of the valve is positive with respect to the filament. In other words, the valve is acting as a rectifier.

### After Rectification

Fig. 4 is an oscillogram of the current after it has been rectified by the valve. Here we see that we have actually cut off all the peaks on one side of our datum line. This is known as half-wave rectification.

If we use full-wave rectification, then where we now have gaps between the peaks, we have another series of peaks interposed. This is shown in the oscillogram of Fig. 5.

Even in this form the current is still unsuitable for our high-tension supply because it must be perfectly smooth and comparable with the output obtained from a battery. It is for this reason that we use a smoothing circuit, which consists of condensers and chokes.

A condenser acts somewhat in the nature of a reservoir. When connected to a supply the condenser becomes charged and it is from this reser-



Fig. 8.—Oscillogram of properly smoothed mains supply. It is practically a straight line and there are no ripples to cause hum

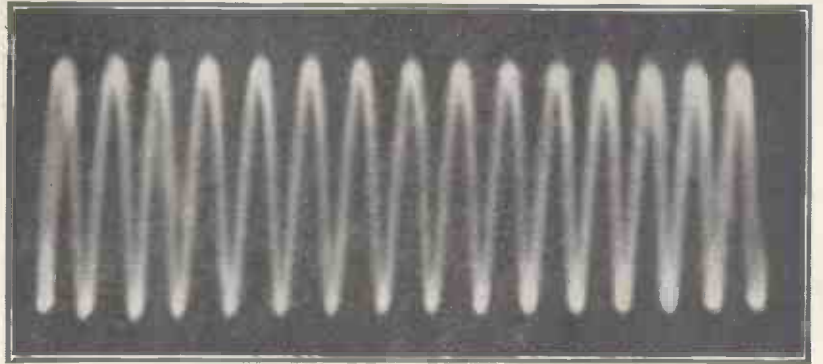

Fig. 9.—Oscillations as received in the aerial circuit of a radio receiver. Note the similarity to the low-frequency wave forms

voir that we draw our current supply.

Now a choke offers a high impedance to a fluctuating or alternating current, while a condenser offers a low impedance, or has the effect of short-circuiting any small alternating-current voltages.

This is a very simple if not wholly accurate way of regarding a smoothing circuit. Let us see the effect of adding a conventional smoothing circuit to our output which is shown in the oscillograms of Figs. 6 and 7. I have taken these with only a very small smoothing circuit, using condensers which are far too small.

You will see that our oscillogram is a wavy line. It is this wavy line that gives rise to the ripple or mains hum, and it is invariably due to

insufficient smoothing. In the next oscillogram (Fig. 8) I have added the requisite amount of smoothing and here we see a straight line.

Now we must turn to the other end of the receiver, that is, the tuning circuit. The object of the tuner is to provide an oscillatory circuit, that is, an inductance and condenser in parallel which resonates or is in tune with the frequency or wavelength of the station we wish to hear.

### Tuning Receiver

Suppose, for example, we wish to listen to a transmission on 300 metres or 1,000 kilocycles, we have to tune our inductance and capacity to this frequency. An ordinary tuning coil has an inductance of about 170 microhenries, and we have to adjust our condenser to almost exactly .00015 microfarad.

The effect of a carrier wave at this frequency is to produce alternating-current voltages across our tuned circuit. Here you will realise that I was faced with a little difficulty in dealing with carrier waves and modulated carrier waves from ordinary transmissions and, accordingly, the subsequent photographs have been taken from laboratory

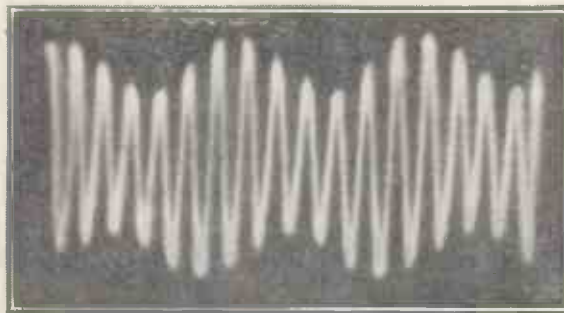

Fig. 10.—Modulated carrier wave, of the same form as Fig. 9, but with speech currents superimposed. Note that a line drawn through the peaks forms another sine wave, representing the modulation frequency

transmitters and modulators, as these enabled me to obtain sufficiently strong and constant signals to give a good photograph, particularly in the case of the modulated carrier or speech currents, which are extremely difficult to photograph under transient conditions.

The oscillogram in Fig. 9 shows the form of our received oscillations. If we compare this

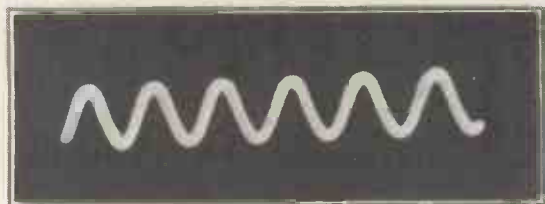

Fig. 11.—Oscillogram of detector output, which is applied to the low-frequency stages. Again note the same characteristic wave form

with the original oscillograms of our mains supply we see that we have the same general characteristic.

When no carrier wave is being radiated, we know that we hear nothing at all from our loud-speaker. The reason for this is obvious, because we know that when we rectify the wave of Fig. 9, all we are left with is the top half, which is a whole series of peak voltages.

You may wonder why these do not give rise to a ripple hum in exactly the same way as the ripple did in the case of the unsmoothed rectified output. The reason is very simple.

There are so many peaks occurring in a given interval of time that their pitch is far above the limit of audibility and, accordingly, your ear would hear nothing.

Actually, however, in our receiver we carefully filter out any high-frequency energy long before it can reach the loud-speaker or the low-frequency amplifier.

What happens when the carrier is modulated? The answer is clearly shown by our next oscillogram (Fig. 10). Here we see that the

carrier is still of the same form as that in the previous oscillogram showing the received carrier but there is what is in effect a superimposed wave.

All the consecutive peaks are the same distance apart but they are of different height or amplitude or intensity. This figure shows a carrier modulated at about 1,000 cycles, such as the familiar tuning note.

When we rectify the current this time, we are left with the top half of the curve which is now an alternating current of audible frequency and, accordingly, we hear a 1,000-cycle note.

We have now got as far as the detector and we must next see what happens in the amplifier. We know that if we apply an alternating voltage from the detector output (Fig. 11) to the grid of a valve, we obtain a similar but magnified voltage from the anode circuit.

The next oscillogram (Fig. 12) shows our amplified detector output; it will be seen that the wave form of the two is the same, showing

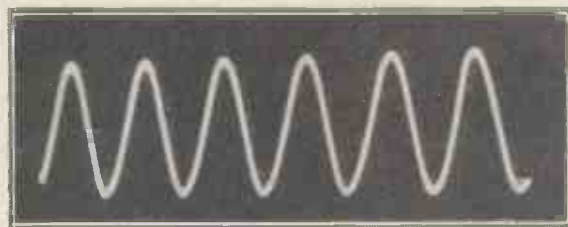

Fig. 12.—Oscillogram of magnified detector output, showing that there is no distortion

that there is no distortion. When distortion does occur in ordinary sets we know only too well; it is generally due to the overloading of a valve.

I expect many readers wonder what happens in the case of a complicated sound wave such as that due to the instantaneous effect of a large orchestra. This, of course, is something which it is not possible

to photograph using a repeating picture with a "time base," and a photograph of this type necessitates the use of the moving-strip system.

By this method I have been able to give you a photograph of a sustained complex wave form due to ordinary speech or music. This wave form is shown in the last photograph (Fig. 13). Actually this is taken not with a cathode tube but by means of another type of oscillograph in which a light spot is moved in sympathy with the applied A.C. voltage.

### Photographic Film

The spot is focused on a moving strip of photographic film which passes behind a narrow slit. This type of record is used for sound films. However many may be the contributory sounds to a given resultant note, they can be expressed in the form of a single wave, which in some cases is tremendously complicated.

When we examine a complicated wave form we begin to see how difficult is the task of the loud-speaker in giving really faithful reproduction, because the loud-speaker has a diaphragm which has really appreciable inertia and to give faithful reproduction the diaphragm must be capable of vibrating in exact sympathy and accordance with the most minute variations or fluctuations in the wave form.

The applications of the cathode tube to the functioning of a broadcast receiver are immense. I have touched merely on the simple fundamentals and endeavoured to explain just how the essential parts of a receiver functions.

I hope that the oscillograms which I have taken will give the non-technical reader a far greater insight into the functioning of his receiver than he would obtain by reading many chapters of elementary textbooks.

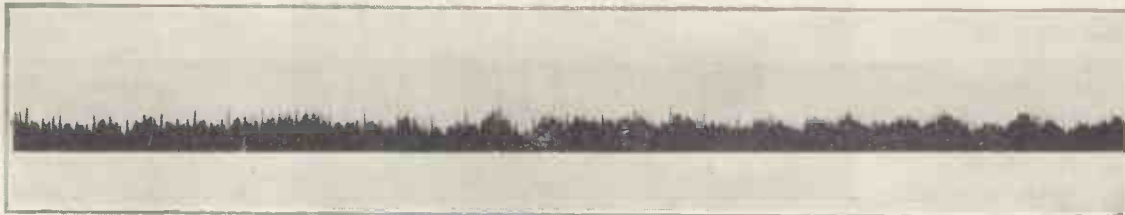

Fig. 13.—Sustained complex wave-form due to speech or music. (This photograph was not taken with a cathode-ray tube, but by another method explained in the article)



# Musical Terms Explained

**Adagio:** An Italian adjective meaning *slow*. In music it is loosely used as a noun. We speak of an *Adagio*, meaning a slow movement or passage in music.

**Allegretto:** Another Italian word used to determine the speed of a movement in music. It is generally thought of as a diminutive of *Allegro*, which is decidedly on the quick side, even though the word itself only means *joyous* or *gay*.

**Allegro:** As given above, it is *quick, joyous, and gay*. In Bach, Handel, Haydn, Mozart, or Beethoven it does not amount to a great speed. In Chopin and Mendelssohn, however, there is a tendency to treat the term as being significant of a somewhat quicker speed relatively.

**Alt:** Very high notes. Those reached, for instance, by sopranos, whose voices enable them to soar higher than what we call "top C."

**Alto:** Strictly speaking, the high notes of a male voice. As such the term should be distinguished from *contralto*, which is the lowest voice of a woman. Male altos are employed in church and cathedral choirs, obviously because the Church does not admit women into its choirs, as a rule. The real alto is a voice that has not broken from boyhood's days. These are comparatively rare. The usual alto is formed by a training the "falsetto" notes of a baritone voice.

**Andante:** Another Italian term used to suggest the pace of a movement in music. The word comes from the Italian verb *andare*, which means *to walk*. Thus the *tempo*, or speed, is leisurely. The word is used as a title to a movement. We can write an "Andante in F minor."

**Andantino:** Some confusion of thought has arisen about this word. By its diminutive meaning it should be a trifle *quicker* than *Andante*, but, strangely enough, nearly all composers have regarded it as being slightly *slower*.

**Bach Trumpet:** A trumpet constructed for the production of high notes found in the scores of Bach and Handel. The trumpet of Bach's time was

quite a different instrument. This is merely a makeshift for the purpose. It acts very well.

**Baritone, Barytone:** Use the former spelling, by the way; the other is rather affected. A male voice intermediate between bass and tenor. Many baritones can reach notes almost as high as tenors. It is not the height, nor the range generally, that determines what a voice is. It is the quality, and that alone.

**Bass:** The deepest voice of man. The best specimens of a bass commonly heard by wireless is, of course, Jetsam. He possesses all the qualities of a true bass voice.

**Bassoon:** One of the wood-wind family in an orchestra. It is a bass instrument played with a double reed and is capable of descending to the low B flat. Its highest notes are not unlike those of a French horn, being round and not at all reedy. The bassoon forms the bass of the ordinary wind quartet: flute, oboe, clarinet, bassoon.

**Brass Band:** A collection of players of brass instruments, to which are sometimes added saxophones, which, though metal, have reeds and should, therefore, be classed amongst the wood-wind instruments. A brass band generally consists of saxhorns of varying pitch, cornets, and trombones. Also it

Whitaker-Wilson, the "Wireless Magazine" music critic, here gives a glossary of terms and expressions commonly used in broadcasting. You will also find information on musical instruments, both singly and as used in well-known groups

employs snare-drums, a bass drum, and cymbals. *To be distinguished from a military band.*

**Cadenza:** A term signifying a passage in a work employing a solo instrument in which the player appears to be improvising with a view to showing off the capabilities of his instrument. Sometimes soloists have actually improvised, but it is more common that the composer has written down the music to be played. *Cadenzas* need not be only instrumental. It is just as easy to have them vocal. Sopranos, particularly, seem to enjoy them, using the syllable *ah* for the purpose of executing a series of runs and trills.

**Cantata:** Originally, it meant something to *sing* as opposed to something to *play*, indicated by the term *sonata*. Nowadays it means a short vocal work, not necessarily on a sacred subject, but it is more often than not.

**Carillon:** A set of bells, tuned either in tones or semitones. The orchestral instrument is now composed of steel plates, which are struck with hammers.

**Celeste or Celesta-mustel:** Now quite a common orchestral instrument. It looks like a small harmonium and has ordinary pianoforte keys which strike steel bars. A variation of this is the *Typophone*, which uses tuning forks instead of steel bars.

**Choir Organ:** If an organ has three manuals, or keyboards, the choir organ is the lowest of them. Originally the stops on a choir organ were of such a quality as was thought necessary for the accompaniment of the choir in a cathedral service.

(To be continued)



An impression of Lionel Tertis, the well-known viola player



FINE AERIAL SYSTEM

This photograph shows the fine aerial system at the Athlone broadcasting station; it was built by Marconi's Wireless Telegraph Co., Ltd.

# A New Idea in Sponsored Programmes

Our special commissioner describes the latest arrangements for broadcasting sponsored programmes from the Athlone station—the only English-speaking station on this side of the Atlantic giving programmes sponsored by advertisers

**I**F you want to give your own "sponsored" programme through a broadcasting station, then now's the time!

The Irish Free State broadcaster at Athlone, the only English-speaking station on this side of the Atlantic to give advertising sponsored programmes, has started a new idea in this connection.

Advertisers pay for approximately 90 per cent. of the programmes broadcast by American stations, and, in Europe sponsored advertising programmes of special interest to British listeners have been heard through Radio Paris, Radio Toulouse, Radio Normandie and other stations.

## English-speaking Station

But until the Irish Free State authorities opened the new high-power station at Athlone—in place of the small 1.5-kilowatt Dublin station—there was no English-speaking transmitter on this side of the Atlantic through which British listeners could hear sponsored programmes.

At its inception, the directors of the Athlone station stated that sponsored programmes would be given to defray the cost of Free State broadcasts, and for several

months listeners in this country looked forward to something new in the way of sponsored programmes. Athlone on 413 metres and Cork on 225 metres both take the same programme from the Dublin studio in the Post Office building of the Free State's capital, and now a new idea in sponsored programmes will be run by a specially formed Irish company operating from the Dublin studio centre.

Athlone Radio Publicity, Ltd., with which the Free State Department of Posts & Telegraphs has placed the contract for the advertisers' programmes, has some strong ideas about the way in which broadcast material should be sponsored.

W. J. Hernan, who is in charge of the Dublin office, realises that Athlone is in competition with the best stations in Europe giving sponsored material. He is going to make a strong attempt to get real artistic programme value into the Athlone sponsored broadcasts.

He thinks it is insufficient to announce "Here is an orchestral programme coming to you by courtesy of the X Manufacturing Company . . ." and then to put over only a second-rate concert which, apart from the advertisers' announcements, has no personal appeal.

And he believes that sponsored programmes given by gramophone-record manufacturers should not rely only on the fact that the programmes are "canned" and that the records are the latest releases. This sort of news value

is misplaced in broadcasting, and the Athlone publicity organisation is out to get good programmes at all costs.

These strong views about the Free State sponsored broadcasts have been transmitted to me through Messrs. Frank L. McIlraith and E. W. MacAlpine, who are in charge of the London office opened in Fleet Street to direct the Athlone broadcasts from this end.

You can hear the Athlone publicity broadcasts from 9.45 to 10.45 p.m. The ordinary station news bulletins follow.

The Athlone people possess an option for all further time "on the air," and in view of the popularity gained by the Radio Paris Sunday broadcasts, we may soon get British sponsored programmes on Sundays from Athlone.

## Sixty-seven Concerts

One large radio manufacturer already sponsoring programmes through French stations has arranged sixty-seven high-class concerts through Athlone. A group of prominent British advertising agents have prepared a report which is favourable to sponsoring, and so it is unlikely that there will be shortage of material.

In brief, the men behind the Athlone publicity scheme have had experience of broadcasting in Europe and Australia; and they are out to give the best radio entertainment through Athlone—to make it as widely known in the British Isles as are the French stations through which we already get sponsored programmes.

Athlone's wavelength of 413 metres has the advantage that it does not



necessitate switching to the long waves.

It would be a big setback to the sponsored programmes if there were constant morse interference round about 400 metres. So it is good news that the Saorstad Department of Posts & Telegraphs was represented at the Lucerne Conference of the International Broadcasting Union. It means that Athlone will get a new wavelength which will be suitable for good reception all over the country, instead of only in certain areas as at present.

#### British Built

The Athlone transmitter is British built by the Marconi organisation. With its power of 60 kilowatts it is a strong signal in this country. It is crystal-controlled to ensure a constant wavelength, is modulated up to 80 per cent. and has a 300-ft. high T-type aerial.

In general appearance the Athlone broadcaster is exactly like one side of a B.B.C. transmitter. There are the six familiar units — aluminium panels and glass fronts. There is a control desk fitted with relays and indicator lights.

It can work on any wavelength between 300 and 550 metres, so that there is plenty of room for modification under the new Lucerne scheme. It works on 413 metres as this was the wavelength formerly used by the Dublin broadcasting station.

The sponsored programmes, of course, will be given in the English language, but announcements will undoubtedly be made from Athlone in Gaelic. It is conceivable, therefore, that the sponsored programmes will be a "bright spot" in the evening broadcasts from Athlone and will please Free State listeners as much as the British listeners for whom a large proportion of the sponsored programmes will be intended.

#### Separate Company

Incidentally, the Athlone publicity organisation is an entirely separate company having the whole rights for the Athlone publicity broadcasts and having no connection with the publicity concern which has run sponsored programmes through Paris, Normandie and elsewhere.

So we may look to some friendly rivalry between the owners of the sponsored space "on the air"!

## Wave Range of Tuning Coils

CONSTRUCTORS are often puzzled to know why a particular set has a somewhat restricted wavelength range; in extreme cases, for instance, it may not go down below 230 metres, and a large number of stations below that wavelength cannot be heard.

It is interesting, therefore, to glance at some wavelength and capacity figures supplied by Wilkins and Wright, Ltd., for their types W313 and W314 Utility gang condensers. These figures show how important it is to choose a coil of the right inductance; and how it is equally important to keep down the stray capacities in the circuit if a good wavelength range is to be covered.

With a medium-wave coil of 146 microhenries inductance, for instance, and a stray capacity of 30 micromicrofarads the condensers referred to give a wavelength range of 176 to 532 metres, that is a total spread of 356 metres. With a stray capacity of 40 micromicrofarads the range is from 191 to 537, a spread of only 346 metres; while with 60 micromicrofarads the range is 216 to 547 metres, the spread being reduced to 331 metres.

With a coil of 158 microhenries inductance a capacity of 30 micromicrofarads gives a range of from 183 to 552 metres, a spread of 369 metres; 40 micromicrofarads gives 197 to 558 metres, a spread of 361; and 60 micromicrofarads gives 225 to 566 metres, a spread of only 341 metres.

If the inductance of the coil is

raised to 165 microhenries, 30 micromicrofarads gives a range of from 187 to 565 metres, a spread of 378; 40 micromicrofarads gives 202 to 570 metres, a spread of 368; and 60 micromicrofarads gives 229 to 580 metres, a spread of 351 metres.

#### Long-wave Effects

Coming to the long-wave band, the stray capacities (which, incidentally, include the self-capacities of the coils) are, of course, higher, and the following figures are obtained:—

A coil of 2,100 microhenries with a capacity of 40 micromicrofarads gives 722 to 2,030 metres, a spread of 1,308 metres; 60 micromicrofarads gives 818 to 2,075 metres, a spread of 1,257; and 80 micromicrofarads gives 905 to 2,110 metres, a spread of 1,205 metres.

If the inductance is raised to 2,200 microhenries a stray capacity of 40 micromicrofarads gives 740 to 2,080 metres, a spread of 1,340 metres; 60 micromicrofarads gives 840 to 2,110 metres, a spread of 1,270; and 80 micromicrofarads gives 925 to 2,160 metres, a spread of 1,235 metres.

#### A Great Help

It would, of course, be a very great help to set constructors and designers if all condenser manufacturers were to provide such complete figures as these Utility examples; but the data for condensers is of no use unless our coil manufacturers also provide accurate inductance figures for their products and self-capacity. D.S.R.

### The Wireless Zoo: The Sulker

*The Sulker, it has oft been said,  
Must have the very sorest head,  
He is a bear who fumes and frets  
And simply hates all Wireless Sets.  
He rails against the travel talks,  
And sneers at plans for week-end walks,  
Growls at the news and snaps with rage  
When "vaudevillers" take the stage.  
Each Broadcast drives him to despair—  
To-day this beast is very rare!*

LESLIE M. OYLER

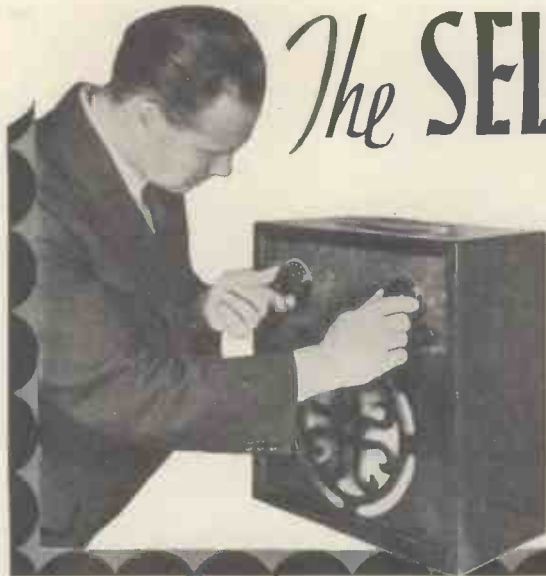

# The SELF-CONTAINED FOUR

## with Iron-core Coil & Class-B Output

This modern portable set has been specially designed by the "Wireless Magazine" Technical Staff to meet present-day requirements for selectivity, quality and volume. It will prove a revelation when compared with old-style portable receivers

EVERYBODY with a car will find it useful to have a portable set as a stand-by. Not so much to use in the car itself, but to take about from place to place—for instance, a

sensitivity and selectivity as much as possible in order to get a reasonable bag of foreign stations. In this case we have used one of the new iron-cored tuning coils as a coupling

between the high-frequency stage and the detector. As is well-known by now, iron-cored coils have the merit of being particularly selective, and they also give greater amplification than the usual air-core coils.

A modern variable- $\mu$  valve used in conjunction with an iron-core coil is almost as efficient as two high-frequency stages were two or three years ago. Moreover, the use of a single stage of high-frequency amplification results in simplification of construction and also of operation.

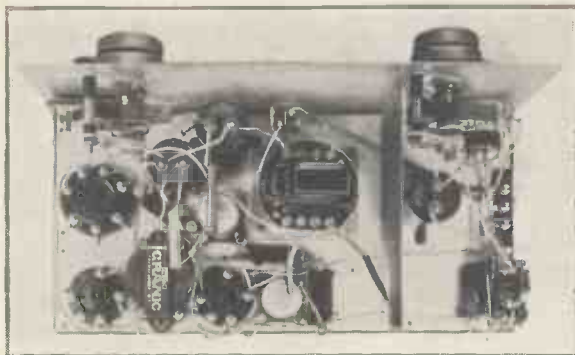

COMPACT AND EFFICIENT DESIGN

This plan view of the Self-contained Four shows how compactly the components are arranged on the panel and baseboard

portable is extraordinarily useful at holiday times and when going away for weekends.

All kinds of portables have been described in "Wireless Magazine" from time to time, including straight models and super-hets.

This particular receiver is a straight four-valver, the combination being a variable- $\mu$  high-frequency stage, leaky-grid detector, driver, and class-B output valve.

For a small set this arrangement of valves gives excellent results; there is sufficient range for most purposes and, of course, the class-B output valve does give amazing quality and volume for a small self-contained outfit.

With only one high-frequency stage it is desirable to conserve

tion of construction and also of operation.

The class-B output valve gives the finishing touch that will appeal to a large number of listeners. With a comparatively small drain on the high-tension battery this stage gives an output of between 1 and 2 watts, which is comparable with the output of the average mains receiver.

### "Mains" Results

Indeed, it is not too much to say that this portable will give results as good as can be obtained from a large number of three-valve mains receivers. (And remember that it is working from a small self-contained frame aerial included in the cabinet.)

Those who two years ago gave up portables as useless on the grounds of poor quality and volume will find this new design a revelation. Full advantage is taken of the class-B output valve by using an efficient moving-coil reproducer.

Even if you already have a perfectly satisfactory permanent re-

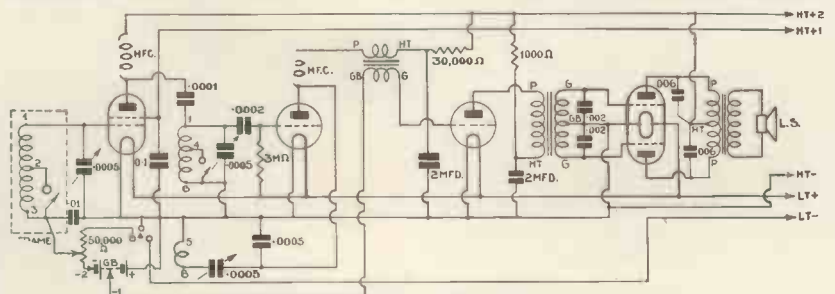

THEORETICAL CIRCUIT OF THE SET

The valve combination used is a screen-grid high-frequency stage, detector, driver valve, and class-B output



ceiver, we do suggest that there is a great deal of fun to be obtained from a second set of the sort shown in these pages.

### Of Great Utility

Being completely self-contained, it is useful for invalids; for moving from one room to another; and for all kinds of outdoor excursions. If some members of the family want to listen to a particular programme on the permanent set the "odd man out," as it were, can take the portable into another room to listen to a different station—and everybody is happy.

The construction of the set, although some of the parts are fitted to the underside of the baseboard, is not difficult.

As regards the cost of construction, this will not be heavy if the amateur can use up some of the spare parts most experimenters have lying about. It will be a simple matter for any prospective constructor to estimate the cost of building the set as all the parts are priced individually in the list on page 58.

It will be seen from the circuit diagram that every precaution has been taken to ensure complete stability of operation. Starting from the beginning, it will be seen that the dual-range frame aerial (wound with Litz wire, by the way) is tuned by a .0005-microfarad condenser. Volume is controlled by varying the bias on the variable- $\mu$  valve; this is accomplished by means of a 50,000-ohm potentiometer. A .01-microfarad condenser is provided as a high-frequency by-pass.

### Tuned-grid Coupling

The coupling between the high-frequency valve and the detector is arranged on the tuned-grid principle, which means that there is a high-frequency choke in the first anode circuit. This must be of an efficient type, and it is convenient for it to be provided with a flexible screened lead for connection to the anode terminal of the first valve.

A high-frequency by-pass con-

denser of .1 microfarad is connected between the screening grid and filament of the variable- $\mu$  valve. The coupling between the first anode circuit and the second grid circuit is made through a .0001-microfarad condenser.

The iron-core coil, which is, of course, provided with a reaction

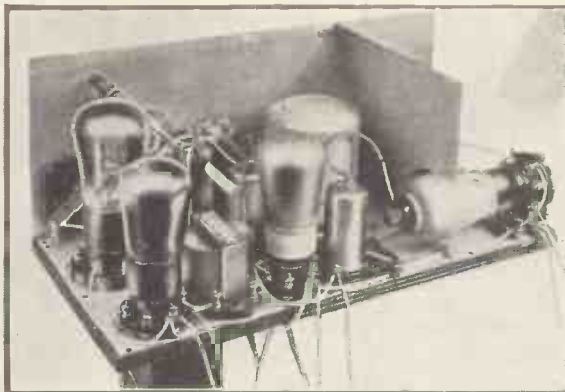

FOLLOWS LATEST PRACTICE

With its iron-core coil and class-B output stage, the Self-contained Four is right up to the minute in every respect

winding, is tuned by a second .0005-microfarad condenser. Reaction is also controlled by a .0005-microfarad condenser, but this is of the bakelite-dielectric type and not an air condenser as used for the two tuned circuits.

Usual values—.0002 microfarad



ALL READY FOR USE

Space is saved by tapping off the grid-bias voltages from the high-tension batteries in the Self-contained Four



A FINE SET FOR THE SUMMER

If you build up the Self-contained Four you will never regret it—it will be useful for all kinds of outdoor excursions

and 3 megohms—are used for the grid condenser and leak. It will also be noted that a .0005-microfarad by-pass condenser is used across the anode and filament of the detector valve to increase its efficiency.

### Low-frequency Coupling

The low-frequency transformer coupling between the detector and the class-B driver valve is of the ordinary type. A decoupling resistance of 30,000 ohms and a 2-microfarad by-pass condenser are included in series with the primary.

The second transformer between the driver valve and the class-B valve is of a special type, of course. That is to say, the secondary is centre-tapped, each half being connected to one side of a class-B valve, which contains two sets of electrodes. The primary is decoupled by means of a 1,000-ohm resistance and a 2-microfarad condenser.

In order to prevent self-oscillation in the grid circuits of the class-B valve two high-frequency by-pass condensers of .002 microfarad are placed across the windings.

### Across the Loud-speaker

There are also two .006-microfarad condensers across the primary of the output transformer, also to prevent oscillation. Although these condensers are shown in the circuit diagram they are not shown in the layout and wiring guide, being placed directly across the three terminals on the loud-speaker transformer.

All the details of construction will be clear from the quarter-scale layout and wiring guide reproduced on page 57. If desired, a full-size blueprint can be obtained for half price, that is, 9d., post paid, if the

# The Set on Test

**T**HIS new portable, which has had a stringent test under bad conditions, has given results much above what I expect from a portable with one high-frequency stage.

I was much impressed during the first few minutes of the test by the fine quality and volume. So much, in fact, that I immediately measured the anode current, expecting to find that the set was very heavy on batteries.

### Economical Running

The total anode current when no signals were being received was only 8 milliamperes, and with London Regional switched on at full strength it peaked to 15 milliamperes. The average anode current was about 11 milliamperes, a figure well within the capabilities of the specified high-tension batteries.

A word about the controls. I found the set extremely simple to handle. Except for the very weak foreign stations there was no need to use the reaction control—the knob on the extreme right of the panel. On London Regional the best results were obtained with the reaction control at zero and the variable- $\mu$  potentiometer in about the half-way position.

The frame aerial has very marked directional properties, and it was essential when receiving foreign stations to turn the set about until the best results were obtained.

Selectivity is reasonably good. With the frame aerial pointing in the direction of London Regional the spread was 16 degrees on the left-hand dial and 14 degrees on the right-hand dial.

When the set was turned so that the frame aerial was at right angles to London Regional, the spread was only two or three degrees. I received Strasbourg at good strength and absolute freedom from London Regional.

Long-wave selectivity was such that Radio Paris and Eiffel Tower were completely free from interference by Daventry National.

There was no difficulty in separating adjacent stations provided correct use was made of the set's directional properties, and the volume and reaction controls.

### Increasing Selectivity

To get the best selectivity when tuning in foreign stations, the reaction control should be advanced as far as possible and the volume adjusted by the variable- $\mu$  control.

Sensitivity is really good. The log at the end of this report was compiled during an hour's test. Several other stations were heard but not identified.

Conditions were extremely bad during my test, but nevertheless I managed to pick up about a dozen stations that gave real entertainment. *T. F. H.*

## Stations Received on the Self-contained Four

LONG WAVEBAND					
Station	Left-hand Dial	Right-hand Dial	Station	Left-hand Dial	Right-hand Dial
Luxembourg.....	40	46	North National ..	72	70
Eiffel Tower ....	84	94	West Regional ...	78	74
Daventry National	92	112	Post Parisien.....	86	88
Radio Paris .....	112	122	Strasbourg .....	92	92
Huizen .....	130	148	London Regional.	98	98
			Leipsig .....	113	113
			Midland Regional	116	116
			Sottens .....	118	118
			Athlone .....	124	126
			Rome.....	132	142
			Paris .....	133	144
			Langenberg .....	136	146
			North Regional ..	138	148
			Prague .....	142	154
MEDIUM WAVEBAND					
Fécamp .....	26	6			
Turin.....	38	24			
London National	52	40			
Bari .....	59	48			
Heilsberg .....	64	54			
Hilversum.....	70	68			

coupon on the last page is used.

Address your application to "Wireless Magazine" Blueprint Dept., 58-61 Fetter Lane, London, E.C.4, and ask for No. WM331.

The set is built up in the conventional way on a baseboard and panel, the latter in this case being of aluminium. A few parts are also mounted on the underside of the baseboard.

For this reason the blueprint is divided into three parts. At the top is an elevation of the back of the panel, in the centre is a plan of the top of the baseboard, and at the bottom is a plan of the underside of the baseboard.

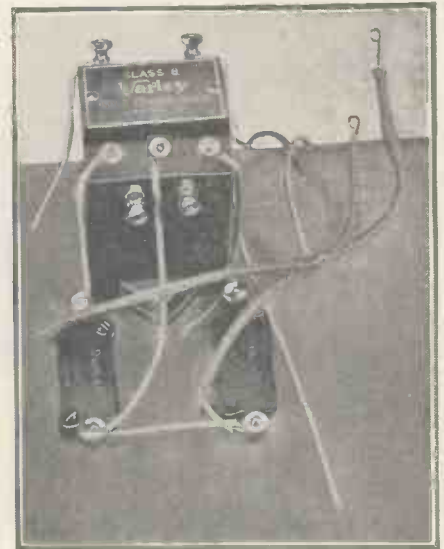

UNDERNEATH THE BASEBOARD

This photograph shows how the sub-baseboard parts are arranged and wired up. There is no difficulty about it

There will be no difficulty about fixing the panel components in position, for the metal can be obtained already drilled. When the parts mounted on the top of the baseboard have been fixed in position the holes needed for passing connections through to the underneath should be made. Finally the sub-baseboard components can be screwed down.

Wiring should be done in the numerical order indicated by the figures in circles. These are so arranged that the leads are automatically made in the best and most convenient order.

There is also the advantage that if the numbers are crossed through on the blueprint as the corresponding connections are made, there will be no chance of making a mistake or omitting a lead.

Care should be taken with the wires that come through the base-



board to the driver transformer and the two .002-microfarad condensers.

Three special points should be noted:—

(1) The loud-speaker transformer has three terminals, two being connected to the anode terminals on the class-B valve holder and the third (wire No. 67 on the layout) to the high-tension battery. Connections Nos. 55 and 56, from the valve holder, should be made with metal-covered flex, the metal braiding being earthed.

### Condensers Across the Loud-speaker

(2) Do not forget the two .006-microfarad condensers to be connected directly between the centre terminal and the two outer terminals on the loud-speaker transformer.

(3) The spindle of the reaction condenser (on the right of the panel looking from the front) must be insulated from the metal panel by means of an insulating bush.

The cabinet used for the set is provided with an inner framework round which the aerial is wound. The dimensions of this frame are 14 $\frac{1}{2}$  in. by 13 $\frac{1}{8}$  in. by 6 $\frac{1}{2}$  in. Holes should be drilled in the front of the cabinet to allow for the projection of the controls.

Those who intend to make up their own cabinets can dispense with a wooden front panel, if they

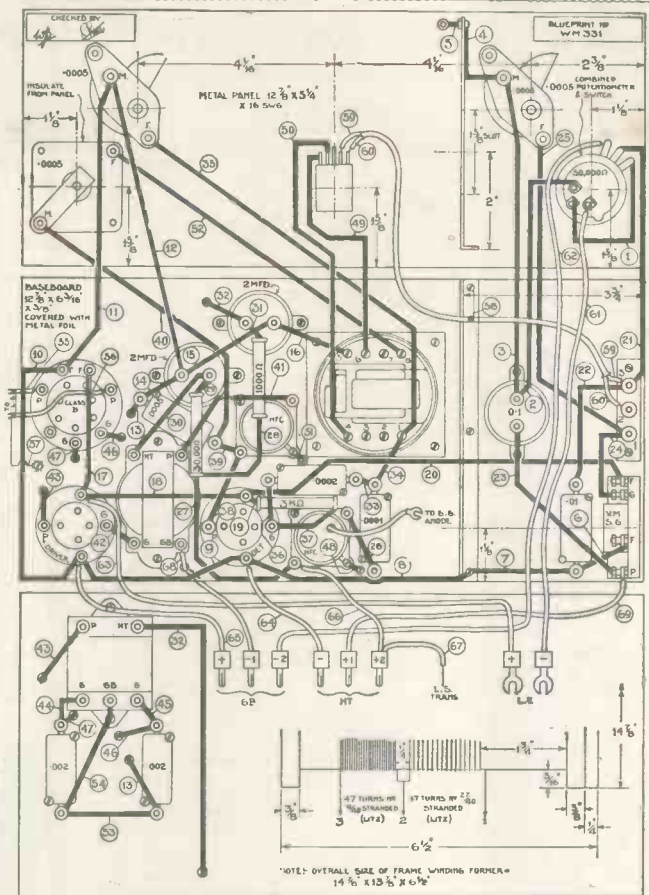

### QUARTER-SCALE LAYOUT AND WIRING DIAGRAM

If desired, a full-size blueprint can be obtained for half price, that is 9d., post paid, if the coupon on the last page is used by August 31. Ask for No. WM331



### HOW THE SET IS PLACED IN THE CABINET

The set itself is built up on a framework that can easily be slipped into the cabinet proper. The aerial is wound round the inner framework



### FOUR VALVES FOR PUNCH AND SELECTIVITY

Although it is a straight set, the Self-contained Four gives remarkably good results and will meet the requirements of many listeners

so desire, and simply use the aluminium panel.

There are only two windings on the frame aerial, and their arrangement will be clear from the blueprint. The medium-wave winding consists of 47 turns of No. 9/40 Litz and the long-wave winding is of 17 turns of No. 27/40 Litz. If desired, ordinary stranded wire of the same gauges can be used but it will not be quite so efficient.

If Litz wire is used it should be remembered that each individual strand is insulated from its neighbours, so before the connections are made it will be necessary to bare the insulation from all the strands. This trouble is avoided if ordinary stranded wire is used as the individual strands are not separately insulated.

### Connecting Up the Batteries

It will be noted, when finally connecting up the set, that there are two high-tension tappings and two grid-bias tappings (there is no bias on the class-B valve).

For the sake of convenience high-tension batteries tapped at every 1.5 volts for the first 9 volts are used; in this way a separate grid-bias battery can be dispensed with. The connections should therefore be made as follows:—

Place the G.B.—2 plug in the negative socket of the first 60-volt battery; place the G.B.—1 plug in the 6-volt socket; and the G.B.+ plug in the 9-volt socket. Then connect the 60-volt socket of the first battery to the negative socket of the second battery. H.T.+1 is

**PARTS REQUIRED FOR THE SELF-CONTAINED FOUR**

	£	s.	d.		£	s.	d.
<b>CHOKES, HIGH-FREQUENCY</b>				1—B.A.T. 30,000-ohm, 1-watt type (or Erie, Dubilier)	0	0	10½
1—Wearite, type HFPA	0	4	0	1—B.A.T. 3-megohm, 1-watt type (or Erie, Dubilier)	0	0	10½
1—Wearite, type HFP (or Bulgín)	0	3	6				
<b>COIL</b>				<b>RESISTANCE, VARIABLE, COMBINED WITH SWITCH</b>			
1—Colvers Ferrocort, type F3	0	12	6	1—British Radiophone 50,000-ohm, combined with three-point switch, type 484	0	8	6
<b>CONDENSERS, FIXED</b>				<b>SUNDRIES</b>			
1—Dubilier .0001-microfarad, type 670 (or Graham-Farish, Goltone)	0	1	0	Tinned-copper wire for connecting, say	0	1	0
1—Dubilier .0002-microfarad, type 670 (or Graham-Farish, Goltone)	0	1	0	Lengths of oiled-cotton sleeving, say	0	1	6
1—Dubilier .0005-microfarad, type 670 (or Graham-Farish, Goltone)	0	1	0	1—Peto-Scott metal assembly; drilled panel, 12¼ in. by 5¼ in.; screen, 6 in. by 5 in.; metal foil, 12¼ in. by 6 in.	0	6	0
2—Dubilier .002-microfarad, type 670 (or Graham-Farish, Goltone)	0	2	6	1—100-yd. packet of Lewcos No. 9/40 d.w.s. Litzendraht frame-aerial wire	0	6	6
2—Dubilier .006-microfarad, type 670 (or Graham-Farish, Goltone)	0	2	6	1—50-yd. packet of Lewcos No. 27/40 d.w.s. Litzendraht frame-aerial wire	0	9	6
1—Dubilier .01-microfarad, type 670 (or Graham-Farish, Goltone)	0	2	0	<b>SWITCH</b>			
1—Dubilier 1-microfarad, type 9200 (or Lissen, Ashley)	0	2	0	1—Bulgín double-pole on-off toggle switch, type S88	0	2	9
2—Dubilier 2-microfarad, type 9200 (or Lissen, Ashley)	0	7	6	<b>TRANSFORMER, LOW-FREQUENCY</b>			
<b>CONDENSERS, VARIABLE</b>				1—Igranlic midget, ratio 1 to 5 (or Ferranti, R.I.)	0	10	6
2—Ormond .0005-microfarad, type No. 5-R/416, with slow-motion dials	0	10	0	1—Varley class-B driver, type DB40 (or Multitone, R.I.)	0	15	0
1—Graham-Farish .0005-microfarad reaction (or Ormond, Polar)	0	2	0	<b>ACCESSORIES</b>			
<b>HOLDERS, VALVE</b>				<b>BATTERIES</b>			
1—W.B. universal type	0	1	0	2—Pertrix 60-volt high-tension, ultra-capacity type, model 237	0	16	0
2—W.B. four-pin, miniature type (or Benjamin, Telsen)	0	1	0	1—Exide 2-volt accumulator, type 1—CO3 (or Lissen, C.A.V.)	0	8	0
1—W.B. seven-pin (or Wearite, Ferranti)	0	2	3	<b>CABINET</b>			
<b>PLUGS AND TERMINALS</b>				1—Camco Carrier portable	1	15	0
8—Belling-Lee wander plugs, marked H.T.+2, H.T.+1, H.T.—, G.B.+ , G.B.—1, G.B.—2, and 2 plain (red and black); midget type (or Clix, Ealex)	0	1	4	<b>LOUD-SPEAKER</b>			
2—Belling-Lee spade terminals, marked L.T.+ , L.T.— (or Clix, Ealex)	0	0	4	1—W.B. permanent-magnet moving coil, Mansfield class-B type	1	7	6
3—Small brass terminals, say	0	0	6	<b>VALVES</b>			
<b>RESISTANCES, FIXED</b>				1—Cossor 220VSG metallised	0	16	6
1—B.A.T. 1,000-ohm, 1-watt type (or Erie, Dubilier)	0	0	10½	1—Cossor 210HL metallised	0	7	0
				1—Mullard PM2DX	0	7	0
				1—Mullard PM2B class-B	0	14	0

The prices mentioned are those for the parts used in the original set; the prices of alternatives as indicated in the brackets may be either higher or lower

then tapped at about 9 volts on the second battery and the H.T.+2 plug is placed in the 60-volt socket.

The controls of the set are quite straightforward and can be mastered in a few minutes. The two controls on the left are for frame-aerial tuning (top) and volume control. With the latter is incorporated a three-point on-off switch; this is used to cut the potentiometer out of circuit when the set is not in use and also to switch the set on and off.

In the centre of the panel is the wave-change switch, of the toggle type. This is pushed up for medium-wave reception and pulled down for long-wave working.

On the right of the panel are the grid-tuning condenser (top) and the reaction control.



**A HANDSOME SET**  
Housed in its Camco cabinet, the Self-contained Four looks all that a good portable should be

Whether the set is to be used indoors or out of doors, it will be found convenient to screw a small turntable to the bottom of the cabinet. Such a turntable can be obtained from most radio dealers for a few shillings and will prove a real boon. By swinging the set the selectivity can be controlled within very fine limits.

When you have had the set in use for a reasonable time, don't forget to let us know what results you get—all such reports are very helpful.



**TRYING THE SET OUT**  
A member of the "W.M." staff putting the set through its final tests before publication. Every precaution is taken to prevent snags

There is no need to go into a long explanation regarding the manipulation of these controls, which are quite standard in every way. The set is switched off by turning the knob of the volume-control potentiometer back to the left (that is, in an anti-clockwise direction) as far as it will go.

**Getting the Hang of Things**

A few minutes experimenting will soon give the operator the hang of the set, which should prove a source of real radio enjoyment under all conditions.

If the set is taken out in a car outstanding results must not be expected whilst the vehicle is in motion. Unless a passenger is going to sit by the set and turn it round so that the frame aerial is always pointing in the right direction irrespective of the curves of the road pronounced fading must be expected.

Another trouble to be expected is interference from the ignition system on the car. This can be overcome, however, by the simple expedient set out in the article, "Motor-car Radio," that appeared on page 574 of the July issue of "Wireless Magazine."

**Value of Turntable**



# ABOUT SUMMER RECEPTION

By PERCY W. HARRIS M. Inst. Rad. E.

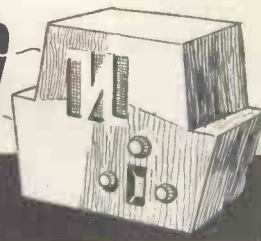

**T**HIS article is written for the new listener, by which I mean the man who built or bought his first set not earlier than last autumn. Probably he is now wondering just why things are not quite so good as they were and is puzzling as to just what has gone wrong with the set.

Maybe, too, listeners of longer experience may find a little useful information here, for the facts relating to the difference between winter- and summer-time listening cannot be too often pointed out.

Just to show what I mean, let us take a typical case. The set, we will say, was bought last autumn. On the first night home—quite early evening at that—the set brought in a “string of stations” and a few nights’ listening showed that many of these were so regular that they could be relied upon for entertainment value.

Some nights these stations came in more strongly than others but, generally speaking, we could say that certain stations would be “there” whenever we switched on.

Now it is characteristic of wireless reception that most of us have no time for it till after tea. All the winter this typical set has been working well but lately, since daylight saving came in and it has been daylight until well after nine o’clock, the set seems to have gone “dead.”

## Weak Foreigners

The locals seem to come in quite well and no difference can usually be detected, but all those foreigners upon whom we used to rely for variety when the local stations bored us are either unobtainable or so weak as to be scarcely worth listening to.

And then, in the last week or two, the local has been varying strangely, sometimes in jerks, going right off for several minutes; at other times giving long, very weak periods, alternated with bursts of strength.

If it is a home-built set the user quite likely thinks his valves are wrong, that his battery wants charging, that he needs a new high-

tension battery, or that something has come “unstuck.” In many cases money has been needlessly wasted in buying new valves and batteries, the result after these purchases being exactly the same as before.

You will see why, in many cases, it is waste of money when we consider the true facts.

Although enormous improvements have been made in wireless apparatus, both for transmission and reception, Nature goes on in its own sweet way and will not change its habit for any international convention.

It is one of the peculiarities of wireless that the wave can (and does) reach the receiving station in two ways.

There is what we call the “direct ray,” the wave that sweeps along the earth’s surface (where, by the way, it is subjected to many absorbing effects) and the indirect or reflected ray which proceeds from the transmitter upwards to an electrically reflecting layer in the sky from which it is shot down again, earthwards.

In daylight a kind of electrical fog pervades the space surrounding the earth. You cannot see it, for it does not affect the eye, but it is there nevertheless as far as the wireless waves are concerned. It does not much affect the direct ray or ground wave, but in the upper atmosphere it takes charge of things and prevents this reflecting layer operating.

Thus in daytime we get only the direct ray, which carries for a comparatively short distance, and this is why foreign-station reception in daylight is so difficult.

Every regular listener who uses his set as much in daylight as after dark knows that dozens of low-power Continental stations which come in quite well at night (even if erratically) are absolutely inaudible even on a most powerful set during the daytime.

Only when the foreign stations are comparatively near or equipped with very high-power transmitters do we get satisfactory reception from them in daylight. The reason

is that their direct waves are insufficiently powerful to reach us, and we have to rely upon the indirect ray or reflected wave, which is only available after dark.

And that is why you notice such a difference now that much of your reception is done in daylight. Up till quite recently all your listening has been done after dark and you were getting both direct and reflected waves, and altogether quite a good collection of programmes.

Now until darkness settles over us you are getting only the direct waves and your programmes are thereby reduced in number. Do not blame the set; it is a natural condition and is nothing whatever to do with your valves and batteries falling off. When it is really dark the set will work quite well.

Even the reception of the reflected waves is generally poorer in summer than in winter and the atmosphere does not seem entirely to lose the daylight opacity to these waves after dark. Experienced listeners never expect summer conditions to be as good as winter and are, therefore, prepared for the changes which occur.

## Local-station Fading

There is, however, another form of variation occurring at this time of the year, and that is the sudden and jerky changes or very big falling off in reception from the local stations. You can generally remedy this, as there are several causes well within reach.

First of all make sure that the pretty virginia creeper round the back of the house has not extended its tendrils and reached hold of the aerial lead-in or insulator! Vegetation must be kept well away from all insulators and lead-in wire or you will have trouble.

Maybe, too, your earth connection has become thoroughly dry after a spell of fine weather. This will not occur if your earth wire is soldered to a water pipe, but it may easily do so if you are depending upon a buried metal plate or earth tube.

Cossor Cathode-ray Tube



# The New Television by Cathode-ray Tube

by MORTON BARR

Although cathode-ray television is still very much in its infancy it already shows great promise and development is likely to be rapid. "Wireless Magazine" has been able to see a demonstration of the system sponsored by Ediswan and cathode-ray tubes for amateur use are now available. The mirror-drum method is also being given considerable attention and a complete receiver is now on sale. In these notes Morton Barr runs through the main difficulties that are encountered and discusses the different methods of reception — by disc, mirror drum and cathode ray

TELEVISION has been so long in the making that one is inclined to wonder whether the problem is not proving a little too much, even for the resources of modern science. By comparison with broadcasting, the record of progress made seems to fall definitely below that which might have been expected.

### Amazingly Clear

One remembers how amazingly clear and distinct the early broadcast programmes were, even on a simple crystal set. The B.B.C. came in with a bang—one might say, without much advertisement—and almost fully fledged from the start.

Ten years have naturally brought some progress in their train, for instance, the super-het and other highly selective types of receiver, but the essentials of transmission and

reception are practically the same now as they were then.

On the other hand, one has been hearing hints and whispers of television for the last seven years, though very little of practical value has been produced for the public. Each year it forms an interesting side show at the exhibition—a little better and a little clearer, perhaps, each time—but still a long way behind what one had hoped for.

Those who have tried it out at home on the B.B.C. transmissions may get an occasional scientific thrill, but would hardly dare to offer the programme as a means of entertaining the family circle—at least, not more than once.

And yet the purely technical problems of television have been solved, one cannot say completely, because perfection is always outside our reach, but under laboratory conditions it is now quite possible to produce televised pictures comparable in clearness and interest with the "home-movie" type of kinema projector.

But this involves two conditions. In the first place, it cannot be done cheaply, and in the second place transmission must take place either over line wires, or at times when the ether is free from other traffic. Both these limitations are serious, though neither is insuperable.

To take the "channel" difficulty first, no one wishes to see the present broadcast service interfered with in any way by television. We want

them both if possible, and the solution may be found in developments that are now taking place in the ultra-short wavelengths.

In the region around 7 to 12 metres, television could find plenty of elbow room in the ether without trespassing in any way on the existing broadcast services.

Alternatively, there is the possibility of a wired-wireless system of television, the programme being distributed in high-frequency form over wires. This would permit a medium wavelength to be used as a "carrier" without causing any interference in the ether.

### Limited Subscribers

A wired relay service is not, of course, an ideal solution for the ordinary householder, but it is quite on the cards that the first public television service will be launched in this way, for the benefit of a more or less limited circle of subscribers.

The second problem is that of producing a receiver capable of presenting a clear-cut picture, of definite interest value, at a reasonable cost. Here definite progress is also being made.

### Correct Alinement

The essential difference between television and broadcasting lies in the fact that "picture" signals have not only to be received in a time sequence, but must also be distributed in correct alinement, that is, in proper space sequence on a viewing screen.

In broadcasting syllables and words follow each other automatically from the loud-speaker. But suppose one had to spell each message out, letter by letter, say, by focusing a lamp, from square to square, on a screen containing the

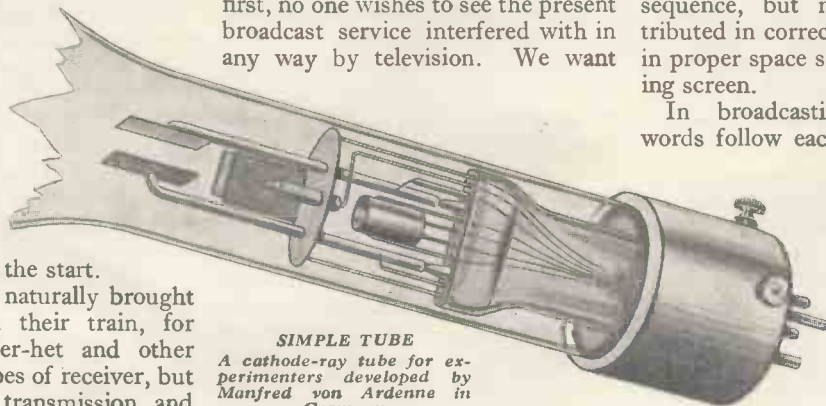

**SIMPLE TUBE**  
A cathode-ray tube for experimenters developed by Manfred von Ardenne in Germany



alphabet arranged in the usual order from A to Z.

That would be a very different matter, and broadcasting under such conditions would probably still be "in the doldrums," struggling along with television, because it is just such a problem that the latter has to solve.

The actual procedure is to "scan" the picture at the transmitting end, but cutting it up into a series of strips or lines, which are transmitted one after the other. At the receiving end the strips are re-assembled in their original order by a second scanning device, synchronised with the first.

### Rotating Disc

Up to the present "scanning" has usually been effected by means of a rotating disc, provided with a series of peripheral holes, or by a drum fitted with lenses or mirrors, which divide the picture up into strips and throw them in sequence on to a photo-sensitive cell or electric "eye."

In the new television this work is carried out by means of a cathode-ray tube. The mechanically rotating disc or drum disappears altogether and is replaced by a fine stream of electrons which, because they have no inertia, can be sprayed from side to side over the picture, or viewing screen, at enormous speed.

The cathode-ray receiver can be used in co-operation with any form of television transmitter, whether of the cathode-ray type or not. It reproduces the picture by throwing the ray against a viewing screen made of fluorescent material. Wherever the ray strikes, it produces a luminous spot, and its speed is so rapid that it covers the entire surface of the screen approximately twenty times a second.

### Constant Illumination

The result is that, to an observer, the whole of the screen appears to be constantly illuminated, though to a varying extent at different points. The different light-and-shade values are, of course, distributed so that they reproduce the effect of the original picture.

A typical cathode-ray tube, as used for television, is shown in Fig. 1.

It is necessary first of all to concentrate the electrons given off by the filament into a narrow pencil or "ray." This is done by forcing them to pass through a cylindrical or

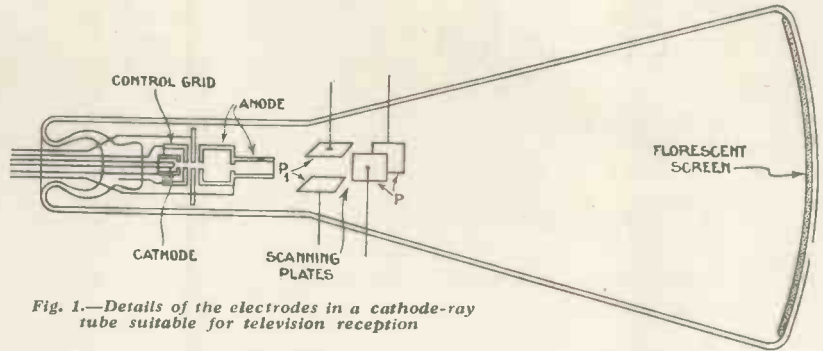

Fig. 1.—Details of the electrodes in a cathode-ray tube suitable for television reception

"gun-shaped" anode, which carries a high positive potential.

Next the ray must be sprayed swiftly from side to side of the viewing screen at the end of the tube, so that it makes from sixty to ninety successive traverses. Each line is displaced slightly below the preceding one, so as to cover the screen from top to bottom, as well as from side to side. The whole operation is repeated at least twenty times in each second.

This part of the operation is controlled by two pairs of plates marked P and P<sub>1</sub>. A rapidly alternating

The picture signals are, therefore, applied to the control grid shown in Fig. 1, so that, during a dark spot most of the stream is deflected away from the narrow passage through the "gun anode" and does not reach the screen. For a bright spot, on the other hand, the whole stream is shot through to give the maximum effect.

A disadvantage of this method of control lies in the fact that the full effect of the ray is not available at all times, so that the average intensity or brightness of the reproduced picture is less than it might be.

Accordingly, a second system of

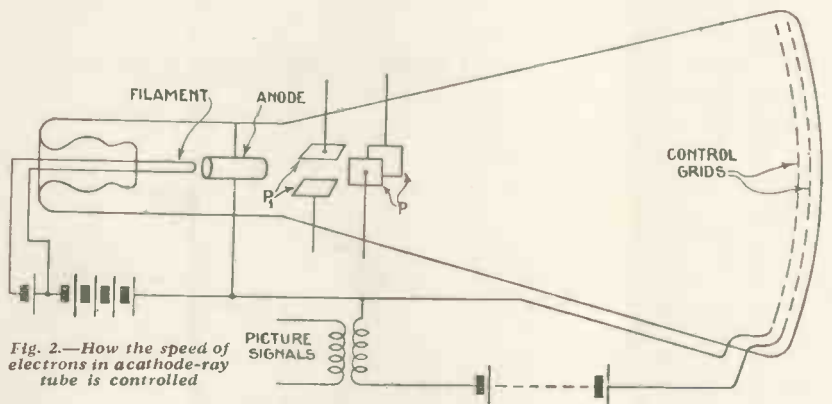

Fig. 2.—How the speed of electrons in a cathode-ray tube is controlled

voltage applied to the plates P sweeps the ray from side to side, whilst a voltage of lower frequency applied to the plates P<sub>1</sub> gradually and simultaneously moves the ray from top to bottom of the screen.

Finally it is necessary to apply the picture signals so as to continually change the intensity of the luminous spot created when the ray strikes against the viewing screen.

Now this can be done in one of two ways. Obviously, if a part of the electron stream is diverted by the incoming signal, the resulting spot of light will be less intense than if the whole stream were utilised.

control has recently been introduced in which the full stream is utilised at all times, but its speed is regulated so that when reproducing a high light it is shot against the viewing screen with greater velocity than for a low light.

As shown in Fig. 2, a speed-control grid is located near the viewing screen, the incoming picture signal being applied to it through a coupling coil. A strong signal, corresponding to a high light, increases the positive bias and throws the ray against the viewing screen at high speed.

For a low-light signal the velocity of impact is correspondingly reduced.





# Getting the Best Out of Class B

By J.H. REYNER, BSc. AM.I.EE.

THE class-B valves now on the market will all give an output of  $1\frac{1}{2}$  to 2 watts under suitable conditions.

Some people are asking why it is necessary to provide for such a large power. The output from the ordinary battery set is usually about half a watt. The maximum undistorted output is still less than this, probably about 200 to 300 milliwatts, but the set is invariably overloaded.

## A Large Jump

Even supposing the 500 milliwatts were obtainable without distortion, as is possible with certain valves and fairly high anode voltages, there seems to be rather a large jump between half a watt and 2 watts.

The great advantage of any class-B system is the economy of high-tension consumption. Instead of having a large steady current flowing all the time, whether the signal is loud or soft, the current with no signal is very small and it rises according to the strength of the signal, so that we only take from the high-tension battery just as much current as is required under any particular condition.

## Cutting Down the Current

It is suggested that the present-day class-B valve does not make the best use of this possibility and that it should have been designed from a different point of view, namely that of cutting down the anode-current consumption to the minimum and limiting the output to a figure somewhere about the present value of half a watt.

Is this a fair criticism or is the valve as at present designed satisfactory? The point is one of some

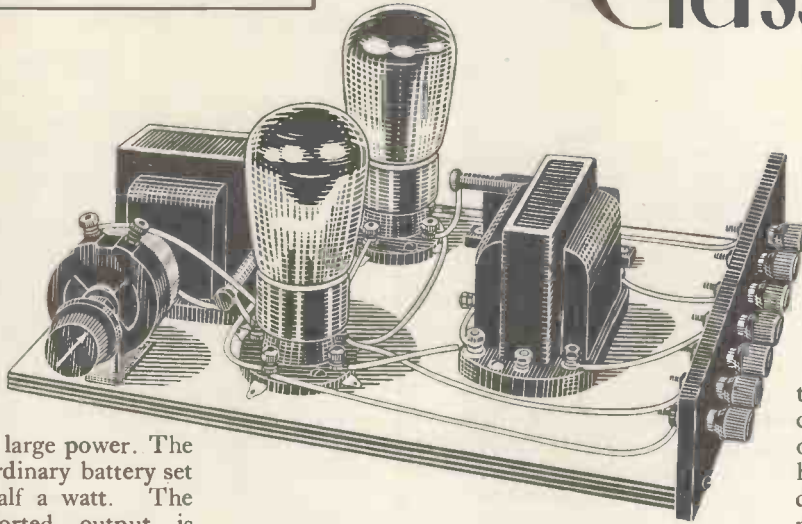

importance, because it seems that the class-B valve will in time completely replace existing battery output valves.

The first point which strikes one on thinking the problem over is that for some years now we have been accustomed to mains sets capable of giving 2 watts output and even more. Yet there has not been any marked outcry that these sets are much too powerful.

This rating of 2 watts has been forced upon the manufacturers by public taste and mains sets with an output of less than 1 watt are practically non-existent.

You may object that it is easy to provide the 2 watts in a mains set where battery consumption does not concern us. That is true.

On the other hand, it is accepted that the reproduction from a mains set is far ahead of the average battery set and I submit that this is not due to any mysterious property of mains valves as a class, but simply the fact that this 2-watt output is available.

In an article which appeared in these columns a short time ago entitled "Where Do the Watts Go?" I described some experiments showing the difference between the average power and the peak power during ordinary reproduction.

I showed that if the loud-speaker were arranged to radiate 100 milliwatts during normal passages the

output required in order to reproduce the peaks without distortion would be twenty or twenty-five times as great, requiring an output of 2 to  $2\frac{1}{2}$  watts. In some cases an average level of 100 milliwatts is too high, but if one cuts down the figure to 50 milliwatts the power required is still well over 1 watt.

## Modulation Percentage

Confirmation of these figures is afforded by the modulation percentages of various transmitting stations. In this country the average modulation depth is about 20 per cent. rising on peaks to slightly over 80 per cent.; a change of 4:1 which involves a power change of 16:1.

It is well known that the B.B.C. engineers deliberately compress the modulation, possibly in order to give more pleasing reproduction on small power sets which are incapable of "stretching their shoulders" sufficiently.

## Continental Practice

Many Continental transmissions, on the other hand, do not adopt this policy, in which case the average depth of modulation is about 12 or 15 per cent., rising again to 80 per cent. or even more, which gives a change of over 6:1.

The fact is that the output valve requires elbow room. If it is allowed freedom of movement the quality sounds full and rich without by any means being overpoweringly loud. No one suggests that the average power output should approach 2 watts. It is only on peak signals that it is required.

On the other hand the small power valve, such as we have been

forced to use in the past for battery sets, is capable of giving an increase of only about 4 : 1 over the average power, which means a change in the signal strength of 2 : 1 instead of about 5 : 1.

So much for the first point. The next question is whether the battery will stand it. The driver valve and class-B valve together take a standing current of 3 to 5 milliamperes, but in order to give outputs of 2 watts it is necessary for the current to rise momentarily to 30 or even 40 milliamperes. Some people feel that this is much too heavy a load on the average battery and that it will not stand up to the heavy drain.

This might be true if the drain were anything like continuous, but it is not. The peaks occur only at comparatively infrequent intervals and the average current which the battery has to supply is very much less than this. In fact it is only some 60 or 70 per cent. greater than the standing current. This is a factor that is very often overlooked.

#### Effective Consumption

The effective consumption is checked by using a device called a silver voltameter. This consists of two silver electrodes in a solution of silver nitrate and if current is passed through it from one electrode to the other the liquid is decomposed and solid silver is deposited on one of the plates.

The amount of silver deposited is proportional to the current and, therefore, by weighing the electrodes before and after the experiment the total quantity of current which has flowed can be estimated and this, divided by the time, gives the *average* current in milliamperes.

## Radiolympia !

The doors of Olympia open for the Radio Exhibition on Tuesday, August 15, and close again on Thursday, August 24. Every reader will receive a warm welcome at the "Wireless Magazine" stand, where there will be a number of special attractions to interest him.

In order that our readers may keep abreast with the latest developments the exhibition number of "Wireless Magazine"—dated September—will be on sale all over the country on August 15.

It will be as well to order from your newsagent in advance.

This has been done on a class-B amplifier adjusted so that on the peak signals it was giving a full output of 2 watts. The amplifier was connected to a broadcast receiver and was left tuned-in to an ordinary broadcast programme for several evenings in succession.

The standing anode current with no signal was  $5\frac{1}{2}$  milliamperes for the driver and output valve combined, and the average current for the sametwovalves was 8.9 milliamperes, an increase of only 62 per cent.

We must add to this the current taken by the other valves, but a four-valve set can be made to take an average current of 12 milliamperes (standing current  $8\frac{1}{2}$  milliamperes) quite easily. This is certainly more than the recommended discharge for a single-capacity battery, but most existing sets overload a small-sized battery.

#### Special Batteries

The figure is well within the capabilities of the double-capacity size, which indeed will do for five- or even six-valve sets, while for simple three-valve sets most of the battery manufacturers are producing special class-B batteries capable of an economical discharge at about 10 milliamperes. Any doubt on the score of battery life is thus dispelled.

To sum up, your class-B valve will give you depth of tone with full volume when you want it, but its average level need not—in fact, should not—be much above that from a normal power valve.

Under these conditions you may expect long life and good service from both valve and batteries.



#### SUMMER PLEASURES ENHANCED BY RADIO!

These two photographs show to what good use a portable set can be put in the summer months—even in England! There are many opportunities for taking a radio set out of doors, and nowadays no river picnic or camping party can be considered fully equipped unless radio reception is available at will. Both of these charming scenes feature the well-known Marconi model 255 portable



# PROGRAMME NOTES and NEWS

By T. F. Henn

THERE will be a chance for some thousands of enthusiastic listeners to be present during an actual broadcast of a revue and variety turns at the next Radio Exhibition, which opens at Olympia for nine days on August 15.

The B.B.C. are co-operating with the Radio Manufacturers' Association in a rather novel entertainment scheme for exhibition visitors. A miniature theatre will be built at Olympia capable of seating some 1,500 people. A special revue will be given at this theatre every night, together with variety turns by well-known broadcasting artists.

The revue will be broadcast once on the regional and once on the national wavelengths, and several relays of the variety turns, which will be changed every day, will also be heard by listeners.

The first revue will be broadcast on August 19, from 8 to 9.15 p.m., on the regional wavelengths. Do not forget that "silence is requested in the studio when the red light is showing."

It will be worth a visit to Olympia if only to be present at one of the "studio performances."

A rumour has been current to the

effect that there will be no alternative programmes on Sundays until late in the evening. This rumour is not correct. In fact, the B.B.C. is actually extending its Sunday programmes in the autumn.

There is, however, one little atom of truth in the rumour. The new arrangement is that there will be a single programme service from 12.30 to 4.30 p.m. and a *continuous* alternative service from 4.30 to 10.30 p.m.

Although we are losing an hour's alternative programme between 3.30 and 4.30 p.m. we are gaining two hours of alternative programmes between 6 and 8 p.m.

The period between 8 and 9 p.m. will still be reserved for religious services. Of course, the B.B.C. make it quite clear that there will be no departure in their policy of barring "undesirable" light entertainment. We are to continue with chamber music, oratorio programmes, relays



Three special recitals were given in June by Morton Downey, the famous American radio tenor. He is also known to gramophone fans



Duke Ellington, the American negro jazz exponent, has aroused more controversy than any other broadcaster for years

from hotels, and orchestral concerts as the main outline of the Sunday programmes.

It is no use pleading for drastic programme changes. We may get them in years to come!

Judging by comments I have heard and read, there has been some distinct differences of opinion on the hot-rhythm music which was recently played by Duke Ellington and His Orchestra. An analysis of the correspondence received by the B.B.C. shows that only a third of the letters were in favour of "hot" music.

### In Person and by Radio

I was one of the fortunate few who heard the "Duke" rehearsing at Broadcasting House, and again on a loud-speaker during the evening broadcast.

Many of the intricate solo instrumental passages were lost in the loud-speaker reproduction and I did not experience that vivid interest in the music at home that I did in the broadcasting studio.

Whether you liked the music or not, you are almost bound to agree that there was more to attract one's attention than in the monotonous plugging of many of



Three famous syncopated singers—the Boswell Sisters. Hailing from the United States, the Boswell Sisters were known in this country by their records before their broadcast



One of the earliest of broadcast stars is Geoffrey Dams, the well-known tenor. He has broadcast consistently for many years

our English broadcasting dance bands.

Ellington is a little over thirty years of age. He was trained as a commercial artist, but his extraordinary natural gift for music asserted itself. He joined amateur orchestras in Washington, his home town, and then graduated through other orchestras until he met Irving Mills, the New York music publisher and agent.

#### Night-Club Début

Mills realised the genius of Ellington and installed him at the Cotton Club—the night-club centre of the coloured people of New York, which is better known as Harlem.

It was soon after Ellington had become a success at the Cotton Club that he first began to get really famous for his startling compositions and clever orchestration. He is now one of the best-known figures in the dance-music world.



Olive Groves, the charming soprano, has a voice that is exceedingly well suited to the microphone, as most listeners know

Those readers who are interested in his music should make a note that H.M.V. have issued a special album of six records consisting of tunes by which Ellington has made his name. None of the records have been issued in this country before.

While on the subject of broadcast



Yvette Darnac is one of our best-known radio stars, famous both as an actress and as a singer

dance bands, did you hear Jack Payne's broadcast late in June? I thought that the show was excellent. There is no doubt that Payne has got the real knack of putting over dance music in a way that attracts one's keenest attention.

Every tune is so varied that an hour always passes too quickly. Although I thoroughly enjoyed Payne's last broadcast, I do hope that next time he will play a few more dance tunes and not so many symphonic and fancy numbers.

Another band that is worth hearing is Charles Kunz and His Orchestra, who play at the Casani Club. They

are one of the few bands that keep really good time. Although only a small band, they have the happy knack of varying their programmes.

The new season of Promenade Concerts at Queen's Hall opens on August 12. As usual, the B.B.C. Orchestra of ninety players will be led by Charles Woodhouse and conducted by Sir Henry Wood. Sir Henry Wood has been seriously ill with pneumonia, but, you will be pleased to hear, he is making a splendid recovery in health.



The conductor of the Buxton Municipal Orchestra—Horace Fellowes. He recently broadcast the great Concerto Grosso of Corelli

The first half of every concert will be broadcast except on the first and last nights, when the complete performance will be relayed in the National programmes. The scheme of devoting different nights to different composers will be much the same as last year.

Monday nights will be Wagner night, the works of Bach and Brahms will be heard on Wednesdays, and Fridays will be devoted to Beethoven. Tuesdays and Thursdays will be set aside for the performance of miscellaneous and new works, and also for single concerts of other composers. Popular concerts will be given on Saturdays.

#### New B.B.C. Organ

Judging by the advance details I have seen of next month's programmes, the B.B.C. do not intend to make frequent use of their new organ in the Concert Hall.

The only arrangements made at present are two half-hour recitals on July 31 and August 15. The organist at the first recital will be Sir Walter



The leader of a dance band that started broadcasting in July—Percival McKay. He made his name in "No, No, Nanette"



Alcock, the B.B.C.'s organ consultant.

It is probable that in August the midday recitals on Fridays will be on the new organ and not from outside. I am glad to see that the recital on August 15 is to be given at 10 p.m. An organ recital as the final item in the National programmes, or better still as alternative to the Regional dance music, would, I believe, be appreciated by many listeners.

I have only one criticism to level against the sound of the new organ. On my loud-speaker I missed the roll and echo that one associates with big church and concert-hall organs.

This may be fancy, but during the

DISCUSSED IN THESE PAGES

Olympia Attraction :: Sunday Programme Extension :: Ellington and Others :: Promenade Concerts :: B.B.C. Organ Recitals :: Those Boswell Sisters :: Future Events

It will be worth while making a special effort to get to Olympia this year in order to be present at one of the "studio" broadcasts. And don't forget to visit the "Wireless Magazine" stand!



Director of the New Victoria Cinema Orchestra, Bradford, Sidney Phasesy is heard every week through Midland Regional. He makes a forte of unusual music

first broadcasts I frequently thought the instrument sounded like an overgrown harmonium.

The intelligent use of the "echo" room would probably remedy this trifling defect.

Following close on the startling

broadcast by Duke Ellington, we had the pleasure of hearing those three famous syncopated singers, the Boswell Sisters, also from the United States.

It is surprising how many trios have tried to imitate these sisters, but most of them—if not all—have never succeeded in finding that distinctive "something" that has made the Boswell Sisters world famous.

Unique Harmonies

Martha, Connie, and Vet Boswell developed their unique harmonies when they were in their early 'teens and soon became favourites in vaudeville and radio in the Southern States.

Their radio career began as the result of their winning a contest, sponsored by the *Times-Picayune*. Their story, however, bears resemblance to the old familiar hard-luck tale. Although they were successful in their home town of New Orleans their first shows in Chicago ended in failure.

Later they got an engagement in Chicago, which took them westward to Los Angeles. Here they got their chance on a big radio network, and from then, as the story always ends, they became famous.

They are well known in this country, primarily for their Brunswick recordings and for the fine show they gave in the film, *The Big Broadcast*.

A relay of Act 2 of Gluck's opera, *Orpheus and Eurydice*, from the



All ready for a Cockney impersonation—Violet Lorraine. She had a great success in "Business As Usual"



Everybody has heard of Billy Cotton and his band; well, here he is. He is announced to play on the National wavelength

Salzburg Musical Festival, is one of the high-spots in next month's programmes. Interesting for those who are fond of operatic relays.

Stanford Robinson is conducting a performance of Handel's *Alcis and Galatea* on a Sunday evening in August. Hardly summer fare!

August 6 is a date worth remem-



Cleo Nordi, the famous dancer who has been associated with Pavlova, took part in a television programme early in July

bering. In the early evening there will be a concert by the band of the Grenadier Guards, and from 9.25 to 11 p.m. there will be community singing from the studio and relays of musical excerpts from the Tidworth Tattoo. The evening will conclude with the finale from the tattoo at 11.20. Good entertainment, you will agree!

A final word! Are you listening to the Leipzig programmes from 10.30 to midnight? They are one of the most interesting of all Continental broadcasts.

# My Test of the All-metal Four

By Capt. E.H. ROBINSON

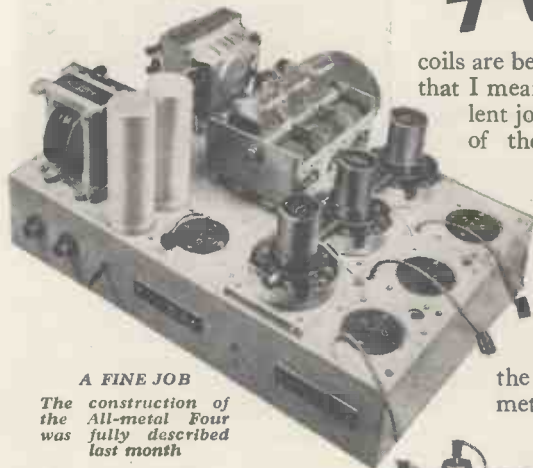

**A FINE JOB**  
The construction of the All-metal Four was fully described last month

coils are being used. But don't think that I mean the tuning in this excellent job is flat. It isn't anything of the sort. There is some spreading on local and very powerful stations which prevents the reception of faint ones on near-by wavelengths; but there is no real interference of one big station with another except in the neighbourhood of 328 metres, where Milan, Poste



**COMPLETELY ASSEMBLED**  
Here is the All-metal Four completely housed in its Camco cabinet. It is not difficult to build

**IRON-CORED** tuning coils I have experimented with, and also the new Catkin valves; but this is the first opportunity I have had of working with the two new developments in a set designed to get the best out of both. I can say, at once, that the results are very good.

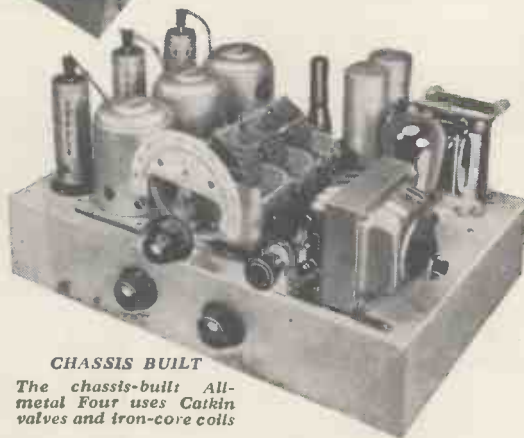

**CHASSIS BUILT**  
The chassis-built All-metal Four uses Catkin valves and iron-core coils

Parisien, and Breslau are close together and all working on 50 kilowatts or over.

Even here I managed to separate the Italian and French stations, though I was working on 100 ft. of aerial wire 40 ft. high. In my

The two things which impressed me most on my first test of the All-metal Four were the excellent quality and the entire absence of hum. There is no background at all either on radio or gramophone. The set might be working from batteries. This, in itself, is a fine achievement.

### Good Quality

With regard to quality, I can only say that I first noticed some very good drums, without any over-stressing of the bass, and then became aware that all the higher frequencies were there as well in something like proper proportion.

Naturally enough, when you are getting really good quality, such as will appeal to the musician, you cannot have so-called "knife-edge selectivity." The two things do not go together, even when iron-cored

### List of Stations Received

Long Waves			
Station	Degrees	Station	Degrees
Kaunas .....	165	Eiffel Tower.....	104
Huizen .....	160	Motala .....	83
Lahti .....	150	Moscow WZSPS.....	75
Radio Paris .....	140	Luxembourg.....	60
Berlin .....	128	Oslo (not identified) .....	30
Daventry .....	117		
Medium Waves (Full strength and uninterfered with)			
Station	Degrees	Station	Degrees
Munich .....	170	*London Regional .....	75
Vienna .....	156	Brussels No. 2. ....	64
*Brussels No. 1. ....	148	Milan .....	62
*North Regional .....	134	*Post Parisien .....	60
*Langenberg .....	130	*West Regional .....	49
Beromuenster.....	121	North National .....	45
Rome .....	117	Scottish National .....	40
Stockholm .....	114	Heilsberg .....	38
Athlone .....	104	Bari .....	31
Katowitz .....	100	*London National .....	25
*Midland Regional .....	97	*Trieste.....	17
Toulouse.....	91	*Bordeaux.....	12
Scottish Regional .....	85	*Fécamp .....	6

\*Received in daylight at good or full strength



opinion 50 ft. of wire is quite enough for this set and would greatly improve the selectivity.

I had twenty-five stations at full strength on the medium band quite free from interference, and ten faint but fairly good. On the long waves performance is excellent, and all the usual stations were received free from one another.

Conditions were extremely difficult during my tests, which took place during the weekend of June 17-18. Thunder storms were chasing one another all round me for three days, and the crashes and bangs in the loud-speaker were more than distressing.

### Roar of Statics

There was not a quiet period day or night, and for hours on end the roar of statics was continuous. Even in such bad test conditions I formed a very high opinion of the set.

Control is delightfully easy; but I thought a bigger and more slowly moving tuning dial would have been an advantage, and would have helped in getting a bigger bag of stations. The volume control is smooth and continuous, as it should be, and the auxiliary tuning knob is a delight. I have met this before on sets from "Wireless Magazine," and I am all for it.

The switches are all positive in

## COMPONENTS YOU WILL NEED FOR THE ALL-METAL FOUR

<b>CHOKES, HIGH-FREQUENCY</b> £ s. d.		<b>RESISTANCES, FIXED</b> £ s. d.	
1—Goltone, binocular type	0 2 9	1—Packet of 15 Eric 1-watt type, consisting of 1- 350; 4- 500; 2- 7,500; 1- 10,000; 1- 15,000; 2- 25,000; 2- 75,000; 1- 100,000 ohm, 1- 1 megohm	0 15 0
1—McMichael, junior binocular type	0 4 0	<b>RESISTANCES, VARIABLE</b>	
1—Wearite screened, type HFP	0 3 6	1—Preh 100,000-ohm potentiometer combined with switch, type Luxus 6004PCS/GI/K	0 7 0
<b>CHOKES, LOW-FREQUENCY</b>		1—Magnum 4,000-ohm potentiometer, type 1120	0 7 6
1—Parmeko, type A40/50	1 1 0	<b>SUNDRIES</b>	
<b>COILS</b>		1—Tinned-copper wire for connecting, say	0 1 0
3—Varley screened dual-range iron-cored, type Nicore BP30	1 11 6	Lengths of oiled-cotton sleeving, say	0 2 0
<b>CONDENSERS, FIXED</b>		Length of rubber-covered flex, say	0 0 6
1—Dubilier .0001-microfarad, type 620	0 2 0	Length of Goltone shielded cable	0 0 9
2—Dubilier .0002-microfarad, type 670	0 2 0	4—Bulgin matched knobs, type K12 (2), K13, K14	0 1 9
1—Dubilier .001-microfarad, type 620	0 2 0	A quantity of 6BA round-head bolts with nuts, length ½ in. and ¾ in. assorted, say	0 3 0
1—Dubilier .01-microfarad, type 620	0 3 0	2—Belling-Lee 1-amp. panel mounting fuses	0 3 0
1—Dubilier 2-microfarad centre-tapped, type BE31L	0 3 0	Small bracket for mounting mains switch, say	0 0 6
2—Dubilier .25-microfarad, type BB	0 4 6	<b>SWITCH</b>	
1—Dubilier .5-microfarad, type BB	0 2 6	1—Bulgin mains on-off rotary, type S91	0 1 9
2—Dubilier 1-microfarad, type BB	0 5 0	<b>TRANSFORMER, LOW-FREQUENCY</b>	
4—Dubilier 2-microfarad, type BB	0 14 0	1—R.I. Parafed, type DY28	0 8 6
2—Dubilier 8-microfarad, electrolytic, 450-volt peak working type	0 11 0	<b>TRANSFORMER, MAINS</b>	
<b>CONDENSERS, VARIABLE</b>		1—Wearite, type T21A	1 5 0
1—J.B. Unitune three-gang with disc drive, type 2070	1 7 0	<b>ACCESSORIES</b>	
3—British Radiophone .0001-microfarad preset condensers	0 6 0	<b>CABINET</b>	
<b>HOLDERS, VALVE</b>		1—Camco Empire table model, in walnut or mahogany	1 15 0
4—Clix 5-pin, chassis-mounting, type B	0 3 0	<b>LOUD-SPEAKER</b>	
1—Clix 4-pin chassis-mounting, type B	0 0 8	1—Igranic permanent-magnet moving-coil, type D9	1 12 6
<b>METAL CHASSIS</b>		<b>VALVES</b>	
1—Magnum special metal chassis, ready drilled for the All-metal Four	0 7 0	2—Marconi or Osram VMS4, Catkin type	1 18 0
<b>PLUGS AND SOCKETS</b>		1—Marconi or Osram MS4B, Catkin type	0 19 0
1—Clix 4-socket chassis-mounting strip with plugs, marked: L.S.+, L.S.—, Pick-up (2)	0 1 4	1—Marconi or Osram MPT4, Catkin type	1 0 0
1—Clix 3-socket chassis-mounting strip with plugs, marked: A1, A2, E	0 1 1	1—Marconi or Osram U10 rectifier	0 12 6
4—Belling-Lee anode connectors	0 1 4		



TESTING OUT THE SET

A member of the "W.M." staff trying out the All-metal Four, which has two screen-grid stages

action and work with a good snap.

Gramophone reproduction is very good. The volume control cuts the high notes a little, but as they are not reduced in any other part of the circuit this does not matter.

Altogether the All-metal Four is a fine example of the "family" set. Anyone can use it and it will please everyone.

but the result of adding this may well be that on the local stations the detector valve would be grossly overloaded. In a set of this sort, therefore, we must put the control before the detector.

If, now, we connect it to the input of the detector, using, for example, a potentiometer across the intervalve coupling, we shall certainly avoid

## Control of Volume

THIS depends very largely upon the type of set. What we must do is to avoid overloading.

In a simple three-valve receiver we can certainly control the volume by connecting a suitable device to the output of a detector circuit,

overloading the detector, but now we may seriously overload the high-frequency valve when tuning to the stronger stations.

It will be seen, therefore, that in this case it is better to go straight to the first high-frequency valve and to vary the volume at this point. Now, if we vary the input to the high-frequency valve, we should avoid overloading everywhere, but each valve would then be working at its maximum amplification.

### Variable-mu Stage

This may not be necessary, and so it is usually found that the best results are obtained when a variable-mu high-frequency valve is used in the first stage, and the bias of this valve is adjusted.

Then, when receiving a strong signal, the bias is considerable, and the valve not only handles the signal without distortion, but its amplification is reduced. *W. James*

# NEWS of the SHORT WAVES

By KENNETH JOWERS

*There are very definite indications that more and more listeners are taking an interest in the short waves; this applies more particularly to the more knowledgeable constructor.*

*It is for this reason that, as and when space permits, we shall in these notes include information about short-wave transmitting gear.*

**M**OST amateurs would get a lot more fun out of short waves if they really knew exactly where they were on the various short-wave bands.

It seems that most listeners are content merely to twiddle the tuning dial from zero to maximum; some stations may have several wavelengths—W8XK, for example, has at least four different outlets on short waves—so they don't know where they are!

Now and then a real enthusiast is found who takes the trouble to calibrate his short-waver, drawing up a pretty curve co-relating scale readings with wavelengths. This is all very well and is, indeed, sufficiently accurate for most amateurs. But what is to happen when you change, say, the detector valve?

## Not Trustworthy

In my set, for example, when I change this valve it alters the tuning reading by 5 degrees at 15 metres! Obviously, this sort of calibration is not trustworthy, because it is below 20 metres that real accuracy is so essential.

An absorption wavemeter is the simplest type of wavelength check you can have. It consists of a coil tuned by a condenser, with a large tuning scale calibrated in wavelengths. All you do is to hold the coil reasonably close to the tuning coil of the receiver and then, by tuning the condenser of the meter, you can hear a distinct click when you reach the resonant point.

Here, again, below 20 metres the

variation in the coupling between the meter coil and the coil in the receiver tends to upset the calibration.

In view of these difficulties, I think perhaps you may be interested to know about the circuit of my own wavemeter. It is a single-valve dynatron oscillator, using a screen-grid type of valve.

There is a single tuning condenser and coil, which is the Colvern KSW, tuning from 17 to 85 metres. Any type of coil will do here really, provided it covers the tuning range. I strongly advise a *fixed* coil and not a range of plug-in coils.

You will see from the accompanying circuit diagram (Fig. 1) that the maximum voltage is applied to the screening grid and not to the anode, as is usual. This is not a mistake! In fact, the working of the valve as an oscillator depends on the rather unusual voltages shown.

This oscillator should be placed a fair distance from the set, otherwise the oscillation will be too strong and you will not get a sharp peak when tuning—the signal will “spread.” I suggest about 10 ft. will do.

There was a small snag when I first tried this unit. When I put on a fresh accumulator the anode current varied and so upset the calibration. I therefore fixed a meter in the negative lead of the high-tension battery, with a 1,000-ohm potentiometer between low-tension negative and high-tension negative, enabling me to vary the current as I desired.

All you have to do is to decide on what current consumption will give you a sufficiently strong oscillation, and then to keep the current at that figure when you change any part of the power supply. You will then find the calibrations keep constant.

If you put this meter in a metal box, as you might be tempted to do, there will not be any radiation, but should you find the oscillations too strong the whole unit can be enclosed in a metal box about 6 or 7 in. square and to obtain sufficient radiation you can use a little aerial,

about 1 ft. high, a copper wire of No. 12 or 14 gauge being suitable.

## Among the Transmitters

I am glad to hear G5SN on the air again; he has been silent for at least two years. He is to be congratulated on his transmissions—at least so far as his record broadcasts are concerned.

He is situated at Westcliff-on-Sea, which is about sixty miles from my receiving point. He works on the 1.75-megacycle band and his early-morning test records are certainly well worth hearing. The strength is very good, but the most remarkable thing is the really excellent quality.

## Improved Signals

During the past two or three months his signal strength has improved very much, although when he re-appeared a month or so ago his speech was much weaker than his music.

G2KT has just changed over to an all-electric amplifier, and I think that if he were to use some good-quality records the reproduction would be very much improved.

G6KV is also consistent and, in fact, he very rarely varies, except when he has a transformer burn-out. Hi! Hi! as my American friends would say.

## On 80 and 160 Metres

G2LZ is a fair 160-metre transmission, but he cannot be compared with G5RD, who is, so far as I am concerned, the loudest station on this band. It is on the 80-metre band that G2LZ excels. His Sunday morning signals to PAOASD, the Dutchman, are really worth listening to.

I have been hearing G2RA lately. He hails from Swinton, near Manchester, I believe. He tells me that he is using only 5 to 7 watts, on 1,970 kilocycles, but he comes over very well at R6 strength.

The 40-metre band, so far as the “G” stations are concerned, does not seem to be much good just now, the interference being truly awful,



mainly through the over-modulation of the French stations.

The Marconiphone Co., Ltd., has just lent me a new valve that will be on the market very shortly. It is designated DET5—what a valve! It has a special bombarded grid, making it very suitable for 56-megacycle work—a really good valve at last for 5-metre fans.

**Output of 32 Watts**

Although rated to give 25 watts at 400 volts on the anode, I have had 32 watts without any difficulty. What is more important to the amateur with a lean purse, it costs only £1 15s. At 400 volts on the anode it passes 62.5 milliamperes.

I have just obtained a lot of interesting dope from Cossors' about using small valves as oscillators and modulators. I cannot possibly give all the details here, but if anyone would like to know more I will send them a copy.

For those using batteries and accumulators for the power supply of the transmitter, I have an excellent circuit of a class-B valve used as a modulator, which is giving fine results.

**Portable Transmitter**

I had a letter the other day from W9BHT, who, as you all know, hails from Illinois, telling me of the closing down of his station for three months as from July 1. In the meantime he will be operating W9DXJ, a portable outfit, using up to 200 watts.

His power supply will be derived from an A.C. "genny" driven by a small gasoline motor! He is fifty miles from the nearest power main.

You may think he is a great optimist trying to work Europe on this gear, but I have heard W5AE, also

from Texas, at R4, and he uses only 90 watts on 20 metres.

I used to hear quite regularly W1CAA, from Lynn, Mass. He came over R6 to R8 for the first three months of this year, but lately there has not been a trace of him. Now comes a letter from him explaining that, as he is a U.S. naval reserve officer, he had to go to sea for training, but he will be on the air again as from July 27, and hopes to renew contacts with friends in Europe.

**With the Short-wave Listener**

Apart from picking up amateur stations and "locals" such as Rome, the short-wave listener is not having a lot of luck just now.

These lovely summer days are calling me out quite frequently, so I am not able to keep a very regular schedule. I do find, though, that conditions above 20 metres are not at all reliable for D.X. work.

The static on 50 metres is bad up to at least 1 a.m., while on the 31-metre band reception conditions are definitely poor. I have heard a 25-metre relay from W8XK quite frequently and when I have gone after W2XAD I have always heard him.

My biggest trouble at the moment is GSG, the Empire station on 16.86 metres. He comes through extremely well in the afternoon just when I want to listen to W3XAL on 16.87 metres, and I find that the 10-kilocycle separation is barely sufficient.

There seems to be no end to the phone stations between 14 and 16 metres. There are at least three from Buenos Aires, and two from Rio, all of which come over at amazing strength, irrespective of prevailing conditions. I have also heard some of the test transmissions from Tokio on about 15 metres, but the strength was only about R3 at the most. I notice that W1XAL has been coming through very nicely on the 48-metre band, even better than Pittsburgh. I have also heard him on about 22 metres, but not reliably.

The Empire transmissions are proving very satisfactory and their success is leading other countries to emulate the B.B.C., so that now Germany has half a dozen Zeesen relays, France three or four Paris relays, and even Belgium, which sends out short-wave stuff to the Belgian Congo, has an "Empire" station.

I suppose we cannot claim to be the first country to link its colonies and possessions by short-wave radio; Holland proved quite conclusively some years ago through Eindhoven that they could transmit programmes of entertainment value to Dutchmen in the East Indies and elsewhere. In fact programmes were exchanged between Eindhoven and Bandoeng, Java.

I have just been trying, by the way, three receivers, one an American super-het, the second a home-made six-valve all-electric super-het, and

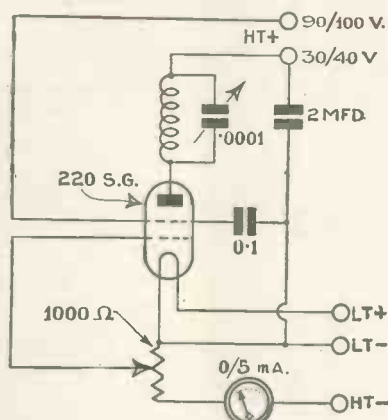

Fig. 1.—Reliable wavemeter to check the wavelength of any station received. Calibration remains constant even though the voltages change

the third a four-valve all-electric screen-grid set with a straight circuit.

I gave all these sets a long test and, believe me, the four-valver was the best of the lot.

The American super-het was calibrated in frequencies, which I found a great help, and had automatic volume control that really worked. But by the time I had reduced the volume to cut down intermediate-frequency-amplifier hiss the signal strength was no better than with the four-valver.

**Too Much Morse**

The six-valve super-het had a wonderful 6-in. tuning dial and each band was spread very widely, so the set was easier to tune. The background noise was low, but for some reason the set brought in a tremendous number of morse stations, so that you could hardly find the telephony stations.

On reverting to the four-valver most of the morse stations had gone, proving, as I so often maintain, that the super on short waves picks up a lot of stuff that originates on the medium- and long-wave bands.

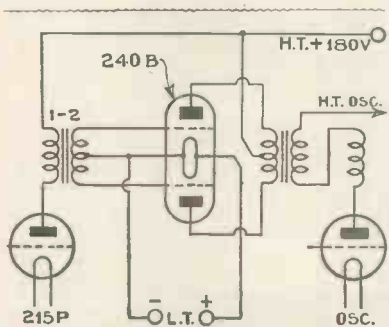

Fig. 2.—How to use a class-B valve as a modulator in order to get a high output from a low-voltage supply

# Choosing Your Records

Outstanding records are denoted by an asterisk (★)

By **WHITAKER-WILSON**

## SACRED MUSIC

- (a) **My Heart Ever Faithful** (Bach), (b) **With Verdure Clad** (Haydn), Master Raymond Kinsey, 4s. **H.M.V. C2571**  
Quite good, but neither work was written for a boy and somehow neither fits a boy's voice. While I do not wish to suggest that the singing is bad on either side, I simply do not feel I can recommend either of these works unless sung by a woman. Tradition is too strong, I fear.

## CLASSICAL ORCHESTRAL MUSIC

- ★ **Brandenburg Concerto No. 5 in D Major (D Dur)** (Bach) (d.s.), Ecole Normale Chamber Orch., Paris, 6s.

**H.M.V. DB1784**

This is perfectly delightful. Whenever you see a record of a Brandenburg Concerto you know you are in for something delicate, refined, and *chock-full of tune*. This is one of the most attractive of all of them, so you can safely invest in and you will never tire of it.

- ★ **Preciosa Overture** (Weber) (d.s.), Berlin State Opera Orch., 4s.

**DECCA-POLY CA8160**

Weber makes excellent records because of his sharply defined effects. The Preciosa Overture, to my mind, is one of his most attractive works. This is, as far as I can remember, the first time I have heard it on a record. I recommend it as being a good rendering, but all those that do Berlin Orchestra are. So there you are—*buy it!*

## CHAMBER MUSIC

- ★ (a) **Air from Suite in D—Transcription** (Bach), (b) **Quartet No. 1 in D Major—Finale Allegro** (Dittersdorf), Lener String Quartet, 2s. 6d. **COL DB 1133**

Of the two, I prefer the Bach, because of the quality of the tone. The Dittersdorf is "well together"—one would hardly expect anything else of the Lener people—but the tone is a little too brilliant. However, turn them down a trifle and I think you will find a good rendering of a beautiful work. A fine record, really.

## LIGHT ORCHESTRAL

- (a) **Irish Medley**, (b) **Welsh Medley**, Debroy Somers Band, 2s. 6d. **COL DB1130**  
A characteristic production of this well-known band. It contains many melodies you know and the whole record can be danced to as a one-step. The production is good throughout.

- (a) **Fairy Tale**, (b) **Play of Butterflies**, Albert Sandler and His Orch., 2s. 6d. **COL DB1131**  
Good reproduction distinguishes both sides of this record. Sandler's tone—so well known to wireless listeners—comes out splendidly. Also, incidentally, does the pizzi-

cato of the double-bass. Try it as a test record!

- ★ **Caucasian Sketches** (d.s.), Berlin Philharmonic Orch., 3s. 6d. **DECCA-POLY P05070**

These are very charming. There are two discs, both worth having. (1) "In the Mountain" (d.s.). (2) "In the Village." (3) "In the Mosque." These three scenes are beautifully orchestrated. The mosque scene attracts me very much. I think, after hearing them, you will agree with me that you get your value for your money, so to speak, in the opportunity you have of hearing various orchestral instruments playing solo.

- Lehar Melodies** (d.s.), Ilja Livschakoff's Orch., 2s.

**DECCA F3575**

Reminiscent of most cinemas. You feel there ought to be a picture supplied with the music, which is quite attractive, but rather sugary. This is not intended to be a negative review at all; it is that sort of music!

- (a) **In Old Vienna**, (b) **Old Spinning Wheel**, Alfredo Campoli and His Salon Orch., 2s.

**DECCA F3580**

Quite attractive music of the lunch-time variety. (a) is (as you will expect) in waltz rhythm. (b) is not too good. It is practically in fox-trot rhythm, with nothing very wonderful to relate about the tunes in it.

- ★ **Viennese Memories of Lehar** (d.s.), B.B.C. Dance Orch., 4s. **COL DX472**

Henry Hall playing: Merry Widow waltz, Gypsy Love waltz, and plenty of others you will like. You can safely invest in this, I assure you.

## MILITARY BAND MUSIC

- Aldershot Command Searchlight Tattoo** (d.s.), Massed Bands of the Aldershot Command, 2s. 6d. **H.M.V. B4446**

Very much like the general run of these records. The workmanship leaves nothing to be desired, so if you are keen on this sort of thing—either because you have seen the Tattoo or because you have not seen it—you cannot go far wrong in purchasing this.

## SONGS

- (a) **Friends Once More**, (b) **Gypsy, Sing for Me**, Alfred Piccaver, ten., 3s. 6d. **DECCA M436**

The gypsy song appeals to me—rather well written. I do not remember having heard this singer before, but I hope to do so again. His tone and phrasing are good and he takes the trouble to pronounce his words. I should like Decca to get him to record some better songs. He is rather a find!

- ★ (a) **'L Canzone 'E Napule (A Song of Naples)**, (b) **Lucia, Lucia**, Beniamino Gigli, ten., 4s. **H.M.V. DA1292**

Accompanied by the members of the Scala Orchestra, Milan, this has a thorough operatic atmosphere about it, hard to define but easy to appreciate. His voice is of the robust type and his effects are those of the stage. Very enjoyable.

- ★ (a) **In My Garden**, (b) **Neapolitan Love Song (T'Amo)**,

Richard Crooks, ten., 6s.

**H.M.V. DB1876**

Outstanding in every conceivable vocal way. Simply a fine singer giving you something light and simple, but doing it as only a fine singer can. Understand me? Well, get it; you will not blame me for misleading you afterwards.

## LIGHT SONGS

- (a) **Danny Boy**, (b) **My Ould Irish Mother**, Danny Malone, 2s. 6d. **H.M.V. B4453**

Quite entertaining and rather cute. He does one bit one day, presumably, and then the other part the next. Not always together with himself. That comes of leading a double life, of course. There seems to be no end to fake in records—as in films.

- (a) **Many Happy Returns**, (b) **Sam's Medal**, Stanley Holloway, 4s. **COL DX474**

Dealing with (b) first, as I happened to have it on, I think I hardly need say anything about it, as you will have heard it by wireless. Both sides are remarkably clear. I was rather struck with that point. I think I can honestly recommend the record, because both sketches are recognised. (a) was written by de Bear and (b) by Hogan and Constanduros.

## LIGHT SONGS AND BALLADS

- ★ (a) **My Sheepdog and I**, (b) **With a Song**, Harold Williams, bar., 2s. 6d. **COL DB1134**

Both sides are excellently sung. I am not too keen on the songs personally, but that is because I am used to hearing Mr. Williams sing things I like better and with which I associate him. If you, like I, like his voice, I do suggest you get this.

## PIANO SOLO

- (a) **Aragonesa**, (b) **Tango**, William Murdoch, 2s. **DECCA F3584**

Do not think the tango is a dance piece, or you will be disappointed. It is evidently an arrangement by Godovoski. I think the disc is worth getting for the Aragonese, which is a delightful work of a light character. Murdoch's playing on both sides is first rate. The Aragonese is going on while I write. Yes, you will like it; it is a very attractive piece of writing.

- ★ (a) **Mazurka in C Sharp Minor** (Chopin), (b) **Nocturne in E Flat Major** (Chopin), Ignace Jan Paderewski, 6s. **H.M.V. DB1763**

This ought not to be missed. "Paddy's" renderings of Chopin have an authority behind them which cannot be gainsaid, much less ignored. Blood is thicker than water and he is a Pole, just as Chopin was. Very beautiful it all is.

- ★ (a) **Partita No. 1 in B Flat Major** (Bach), (b) **Romance in F Sharp Major, Op. 28, No. 2** (Schumann), John Hunt, 2s. 6d. **H.M.V. B4438**

The Bach is very attractive—I mean to every reasonably intelligent listener—because it is simple in construction. The Romance is well known, of course. Both are attractively and simply played by John Hunt. A very pleasing record I call it!

By **CHOPSTICK**

## DANCE MUSIC

- ★ (a) **Decca Stomp** (f.), (b) **Vladivostock** (f.), Ramblers Dance Band, 2s. **DECCA F3588**

The Ramblers Band is acknowledged to be the finest dance band in Holland. These numbers were recorded at the Hotel Hamdorff, Laren. Their style is best described as being hot and tuneful with fine instrumental solos and no vocal choruses. This is a new band to Decca.

- (a) **Maybe I Love You Too Much** (f.), (b) **Meet Me in the Gloaming** (f.), Rudy Vallee and His Connecticut Yankees, 2s. 6d. **COL CB624**

I can always safely recommend a Rudy Vallee disc. He has the gift of making even a poor number sound attractive. Here the tunes are good, so the result can be easily guessed.

- ★ (a) **My Love Song** (f.), (b) **Talking to You About Me** (f.), R.M.S. Homeric Dance Band, 2s. 6d. **COL CB634**

Quite a novelty, this! This disc was recorded on board the White Star liner *Homeric* at Southampton. The band is quite a tuneful combination; they play in a perfectly straight fashion without any attempt at ambitious orchestration effects. The acoustic properties of the liner's ballroom are ideal for recording.

- ★ (a) **Spanish Eyes** (tango f.), (b) **That's What Life is Made Of** (f.), Ray Noble and His Orch., 2s. 6d. **H.M.V. B6361**

Two new compositions by Ray Noble. There is quite a Spanish touch to the orchestration of (a). Castinets and accordion play the major part but, unfortunately, the vocalist is too English. I wish Ray would record a few numbers without vocals. (b) is an outstanding number; the way in which the piano is weaved into the general orchestration is particularly effective.

- ★ (a) **Wear a Great Big Smile** (quickstep), (b) **All Over Italy** (w.), B.B.C. Dance Orch., 2s. 6d. **COL CB630**

You know the style of the B.B.C. band and it is unnecessary for me to describe it. Both tunes are played well and there are some interesting instrumental solos. I will give this band the credit for having produced the best version of (b). They have not let cheap effects spoil the orchestration. A good record!

- ★ (a) **What Have We Got to Lose**, (b) **Shuffle Off to Buffalo**, Carroll Gibbons and His Boy Friends, 2s. 6d. **COL DB1137**

A record well worth your attention, especially if you like syncopated piano work. Carroll Gibbons is the leader and pianist of the Savoy Orpheans and his boy friends are selected members of the band. This record is best described as a couple of piano solos with dance-band accompaniment. I recommend it!



# We Test Before You Buy

By the "W.M."

Set Selection Bureau



#### PRACTICAL USE FOR YOUR PORTABLE

If you have a car you can put your portable set to very practical use in the fine weather. Here you see a happy couple with a Marconiphone receiver

WITHOUT exaggeration we can say that a new era is opening up for the much neglected battery-set user. Up to this season he has been sadly neglected but now, with class-B and Q.P.P. systems of power output, it is possible to provide ample volume—comparable with mains-set volume—without having to overrun the high-tension battery to an uneconomic extent.

While the tendency in mains sets seems to be towards a deterioration in quality output, thanks to a rather short-sighted competition to cut prices to the barest minimum, there is a marked upward trend in battery products.

#### Inappreciable Difference in Quality

In fact, the coming season may well prove a leveller of mains and battery apparatus, so that for ordinary sets the difference in quality will probably be inappreciable.

This is all to the good because, fast though electricity is spreading throughout the country, there are still more listeners without mains than with them, so that a vast all-round improvement in the general standard of quality of reception seems imminent.

One of the most gratifying examples of the new trend will be found in radio gramophones. This month we report on a good instrument that makes excellent use of class B to provide fine volume with a very moderate battery-current consumption.

We now have some advance details of the battery radio gramophones to be marketed by the Columbia Co.

We are particularly impressed with the specification of the Columbia CQA Battery Radiograph, which will sell for the modest price of 20 guineas complete. Its circuit comprises a variable- $\mu$  high-frequency stage, a detector, and two pentodes in push-pull.

The letters CQA stand for "constant-quality amplification", the idea being that the quality does not vary with the volume output, being

just as good when large volume is wanted as with a more moderate volume of sound.

A speech output of over 1 watt is delivered to the loud-speaker, and the anode current varies from 6 to 14 milliamperes. It is interesting to note that a 166-volt high-tension battery will be provided, in order to work the pentodes at their maximum volume efficiency.

\* \* \*

At this time of the year, set buying is naturally at a fairly low ebb, though there is not really any justification for assuming that a set bought now will be out of date by the time the Radio Show opens in August.

If you really need a new set there is no need to delay because many of the leading firms are adopting the policy of bringing out their new products during the slack days of summer, so as to level up production as much as possible, and in order to avoid the delay in delivery that used inevitably to follow the exhibition orders.

\* \* \*

One of the most distinctive types of set for family use is the four-valve super-het, which will undoubtedly take the place of the erstwhile ubiquitous three-valver. Some very clever technical ideas are going into these four's, and in the coming months you will learn to appreciate what wonderful selectivity and sensitivity can be obtained without any second-channel interference with a quite modest team of valves arranged in super-het sequence.

Another set that is likely to be very popular with those who can spend a little more is the five- or six-valver with automatic volume control. So far the indications are that A.V.C. is being only cautiously adopted by British set-makers, but it will have to come in all big sets before long.

#### FREE ADVICE TO PROSPECTIVE SET BUYERS

To make the most of this free advice service, we ask you to answer the following questions:—

(1) The maximum price you wish to pay, and whether you are prepared to exceed this if there is no suitable set at your desired price.

(2) The locality in which the set will be installed.

(3) The stations required, that is, locals only or a selection of foreigners.

(4) Whether you want an entirely self-contained set or one with external aerial and earth.

(5) Whether battery or mains driven. If the latter, whether A.C. or D.C.

A stamped-addressed envelope for our reply is your only expense. Address your inquiry to Set Selection Bureau, "Wireless Magazine," 58-61 Fetter Lane, E.C.4. Tell your friends about this useful service, exclusive to "W.M."

## Columbia Model 631

MAKERS: Columbia Graphophone Co., Ltd.

PRICE: £45 3s.

VALVE COMBINATION: Six-valve super-het sequence, with PX4 power output and seventh valve for mains rectification.

POWER SUPPLY: A.C. mains.

TYPE: Pedestal radio gramophone with automatic-record changer.

REMARKS: A fine all-round instrument—remarkable value for money at new reduced price.

FORMING the nucleus of this instrument is a well-tried six-valve chassis, with a super-het sequence that has already won high praise from us in reviews on other products of the Hayes factory.

The selectivity could hardly be improved upon, a fair 9-kilocycle separation being readily obtained, even when dealing with the locals.



**AUTOMATIC RECORD CHANGER**  
This fine Columbia radio gramophone is fitted with an automatic record changer—a great boon to the user

the limit. The mains aerial picks up many of these stations quite well, though some form of external aerial was found preferable for reducing the background.

When the lid is shut down the volume control on the front can still be worked on radio or gramophone records. With the lid open you find the controls on a neat panel on the right, knobs being for tuning, switching, and tone control—that is, high-note cutting.

On the left is the familiar automatic-record-changing mechanism, which is now notable for a number of detailed refinements.

Needle-scratch can be cut out entirely by adjusting the tone control, which also has the effect of cutting down crackles when on the radio side.

Mains hum is negligible, and even without the earth cannot be heard a few feet from the loud-speaker. The earth improves the strength, but a large aerial is quite unnecessary; in fact, 10 ft. of wire proved ample to bring in all that was going.

The tuning scale is wonderfully easy to read, the calibrations rotating with the wave-change switch knob, so that only the wanted wavelengths are in view at any given setting of this knob.

Quite apart from the selectivity the range is phenomenal, and it is just for these summer days and long, light evenings that the reserve of power of this type of instrument is so useful. We were able to get more than half a dozen foreigners at full strength on the medium waves, even with an indoor aerial.

After dark the usual twenty-five to thirty good programmes were available without forcing the volume control to

## Varley Four-valve Super

MAKERS: Oliver Pell Control (Varley), Ltd.

PRICE: £15 15s.

VALVE COMBINATION: Super-het sequence, with AC/Pen output and DW3 mains valve rectifier.

POWER SUPPLY: A.C. mains.

TYPE: Table-cabinet set with self-contained moving-coil loud-speaker, needing external aerial and earth—no mains aerial.

REMARKS: Quality above the average, and plenty of stations without interference.

OF the new four-valvers employing the super-het system this Varley is one of the most interesting, as it includes a hitherto untried idea—reaction applied to the intermediate-frequency amplifier. The resulting improvement is not only found in increased signal strength on foreigners but in a remarkable sharpening up of the selectivity.

The circuit is full of novelties: For example, there are two high-frequency pentodes for the first two stages, a VP4 variable- $\mu$  being used as a first high-frequency stage and an SP4 functioning as frequency changer.

Follows the "reactionised" intermediate coil, coupled to a triode detector, which is, in turn, coupled by a special tone-compensating low-frequency transformer to the pentode output valve.

## Only Three Control Knobs on Front

Control is simplified as much as possible, only three knobs being fitted on the front. The centre one is for tuning, the left for volume control, and the right for reaction. The wave-changing is done with a most ingenious form of tuning escutcheon, which moves bodily up and down, thus exposing which ever set of scale calibrations you need. The scales are marked in stations.

On switching on from a knob at the back of the cabinet we were impressed with the quiet background—practically no mains hum, with or without the earth. The locals roared in, and even at large volume a fine reproduction was maintained.

We were pleased with the amount of good bass from the small loud-speaker.

Selectivity is very good indeed for such a limited sequence of valves. No sideband splash to speak of.

Sensitivity with a 60-ft. indoor aerial is all you need—most of the high-power foreigners, such as Langenberg and Prague, coming through well even in daylight. Long waves satisfactory also, only the German between Daventry and Paris being on the weak side. Huizen and Luxembourg very strong.



**NEW SET IN A FAMILIAR CABINET**

The general lines of the Varley "ship" cabinet must be familiar to many listeners. It now houses a new four-valve super-het



## Portadyne Model PB5

MAKERS : Portadyne Radio, Ltd.  
PRICE : £14 14s.

VALVE COMBINATION : Screen-grid (Mullard PM2A), detector (Mullard PM2DX), low-frequency (Mullard PM2DX), driver (Mullard PM2DX) and class-B output (Mullard PM2B).

POWER SUPPLY : Self-contained batteries.

ANODE CURRENT : Varies with volume, but average is 10 to 11 milliamperes.

TYPE : Portable set with moving-coil loud-speaker. Needs no extras.

REMARKS : Very fine volume with good quality.

**T**HIS is an ideal portable for music lovers. It gives a full, rich tone, with plenty of bass and as much top as you like—the amount of high-note response being controlled by a special tone filter switch at the back.

The ample volume and fine quality of this portable are due to the use of class-B amplification for the power output. The complete circuit consists of a screen-grid high-frequency stage, a power-grid detector, a low-frequency stage, a transformer-coupled driver valve and finally a class-B output, making five valves altogether.

The chassis fits into the lower part of a good-looking figured-walnut cabinet, the top part being taken up with a permanent-magnet moving-coil loud-speaker at the front and the usual high- and low-tension batteries on a shelf at the back.

An on-off battery switch is located at the back of the chassis, as is the tone-control switch and a local-distance switch to avoid overloading on the powerful nearby stations. An external loud-speaker can be used.

The cabinet rotates easily on a sub-mounted turntable and the set is, of course, entirely self-contained, no aerial or earth being needed as there are frame windings inside for the medium and long waves.

Control is very simple, there being only three knobs, a centre one with super-imposed trimmer for tuning—this works the gang condenser and the wavelength-calibrated scale—the left knob for wave changing and the right for reaction and volume. The scale is wide and easy to read, with a large pointer travelling over the wavelength markings.



A PORTABLE THAT GIVES GOOD QUALITY  
Many people listened to the Wimbledon tennis results on this set in the "W.M." offices and remarked on its good quality

On test the set showed its great powers, bringing in plenty of foreigners, after dark, at full volume. The locals were reproduced with marvellous quality considering the very great volume that was obtained. Selectivity is good enough for present-day conditions, the locals not spreading unduly and the frame helping still further to improve the selectivity of the two tuned circuits. Running costs are low.

## Cossor Model 3456

MAKERS : A. C. Cossor, Ltd.  
PRICE : £9 19s.

VALVE COMBINATION : Variable-mu screen-grid (Cossor 220VS), detector (Cossor 210HL), driver (Cossor 215P) and class-B output (Cossor 220B)

POWER SUPPLY : Self-contained batteries.

ANODE CURRENT : Varies with volume—10 to 12 milliamperes average.

TYPE : Pedestal-cabinet set with moving-coil loud-speaker, only externals being aerial and earth.

REMARKS : Very good quality; ample range; can be made extremely selective by adjustment of volume and reaction.

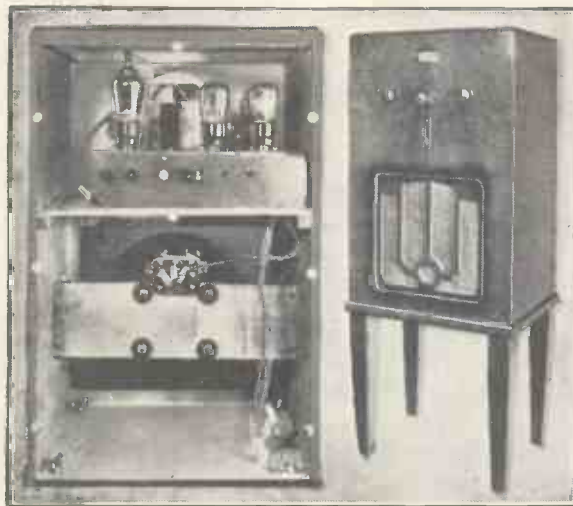

CAN YOU BEAT THIS FOR VALUE?  
At £9 19s. this pedestal model of the Cossor Melody Maker will be hard to beat. On test it gave excellent results

**T**HIS is a Melody Maker that admirably lives up to the long line of excellent sets bearing the name. It is a class-B set, with variable-mu screen-grid, detector, small power driver and class-B output—making use of the new "economy" class-B valve, Cossor 220B.

A very compact little metal chassis has been built up, with a two-gang tuning condenser and the four valves mounted above it, most of the remaining components being fitted below.

This chassis is fitted in the top part of a pedestal cabinet—rather unusual in these days of the ubiquitous table cabinet. This leaves plenty of room below for the batteries and for the moving-coil loud-speaker.

We were gratified with the reproduction, which is certainly the best so far in the Melody Maker range. There seems an almost unlimited amount of undistorted volume, thanks to the class-B valve. Of course, you have to pay in anode current for really loud volume, but you do only pay for what you get!

Control is effectively arranged. There is a centre knob for the tuning, with a trimmer knob that, once adjusted at about 250 metres, does not need further touching for the whole wave range. There is good reaction on the left and a really smooth variable-mu volume control on the right.

Selectivity depends, as the makers stress, on the use of reaction against volume with this type of circuit. We got quite amazingly sharp tuning by reducing volume on the variable-mu and increasing reaction to the limit, Mühlacker being almost clear of London Regional!

The makers provide a very comprehensive chart giving calibrations for many foreigners.

## Smurthwaite Radiogram

**MAKERS:** F. W. Smurthwaite, Ltd.  
**PRICE:** £22 1s.  
**VALVE COMBINATION:** Variable-mu high-frequency (Mazda S215VM), detector (Mazda HL2), driver valve (Mazda L2), and class-B power output (Mullard PM2B).  
**POWER SUPPLY:** Self-contained batteries, with 120-volt high-tension.

**ANODE CURRENT:** Varies with volume, but 10 to 12 milliamperes average with good volume.

**TYPE:** Pedestal radio gramophone with clockwork motor for driving turntable.

**REMARKS:** Fine quality with more volume than normally obtainable from a battery instrument.

**A** NOTHER very interesting set this month is this radiogram with Ferrocart coils for selectivity and class-B output for good volume with economical battery running. It is an admirable instrument to demonstrate these two new developments, both of which provide a

marked improvement in performance.

The Smurthwaite is a battery radiogram meeting a need that has long gone unsatisfied — the need of the listener without a mains supply for really good quality in gramophone and radio reproduction with ample volume.

Our tests show that quality of reproduction is excellent. Full, round tone, with clean-cut top and enough bass for most people. Tone control gives more bass if you want it or more treble,

which most people will not want, we think.

Gramophone reproduction is done with good accessories. A double-spring motor is wound by a handle on the right-hand side of the cabinet.

Controls seem numerous, but are easy to work; six knobs altogether. Centre top knob for tuning the three-gang condenser and 0-to-100 degree scale, which lights up when the set is on. Top left is the wave-range switch and top right the tone control. The lower row of knobs are: Left, radio-gramophone switch; centre, reaction; and right, combined volume and off switch. It is a very selective circuit.

Locals we cut out quickly, only one channel on each side being swamped. Almost up to super-het standard! Same on long waves—no trace of Daventry on Paris. Reaction builds up foreigners, but is not intended to cause oscillation. Volume control on the variable-mu very smooth.

Total anode current is, of course, dependent on the volume output. Only 10 milliamperes for quite loud volume, peaking to 14 or 15 milliamperes on louder passages. Good volume on records.



**NEW BATTERY RADIOGRAM**

This Smurthwaite radio gramophone is a welcome addition to the range of battery-operated models at present on the market

## Sunbeam Model B37

**MAKERS:** Sunbeam Electric, Ltd.  
**PRICE:** £6 17s. 6d.

**VALVE COMBINATION:** Screen-grid (Tungsram Barium S210), detector (Tungsram Barium P0220) and power output (Tungsram LP220).

**POWER SUPPLY:** Self-contained Exide high- and low-tension batteries.

**ANODE CURRENT:** 10 milliamperes.

**TYPE:** Table-cabinet set with moving-coil loud-speaker, needing only aerial and earth externally.

**REMARKS:** Very good value for money. Pleasing tone and plenty of stations.

**F**OR such a cheap set this Sunbeam is remarkably good. Its performance on test pleased us very much, the quality from the self-contained moving-coil loud-speaker being much more satisfying than the output of the average output derived from the moving-iron type of loud-speaker that used to be inseparable from the inexpensive battery set.

Moreover, although a straight power-output stage is used, there is enough volume for average needs and no rattling develops in the loud-speaker up to the useful maximum output of the power valve.

It is a perfectly simple circuit, comprising a tuned-aerial circuit in front of a screen-grid high-frequency stage, which is tapped tuned anode coupled to the detector, which is arranged for "power-grid," and transformer coupled to the power output, this last valve being also transformer coupled to the loud-speaker.

### Attractive Cabinet with Space for Batteries

The chassis fits into the bottom of the attractive, square-shaped cabinet, leaving ample room for the speaker and batteries. Only an aerial and earth are needed externally, though you can fix another loud-speaker and a pick-up if you like.

Control is normal, with a centre knob for tuning a two-gang condenser and a trimmer superimposed to make up for mis-ganging at the extremities of the tuning ranges. This control works well and plenty of stations come in without much fiddling with the trimmer. On the left is the wave-change and battery switch. On the right is the reaction control, which certainly brings up the foreigners.

Locals came in at very great volume, and even with the reaction at zero were really too strong, although the power valve handled them quite cleanly.

These local stations did not unduly spread on the wavelength calibrated scale which, by the way, is lit up by a bulb. Medium waves are marked in steps of 20 metres and long waves in steps of 100 metres.

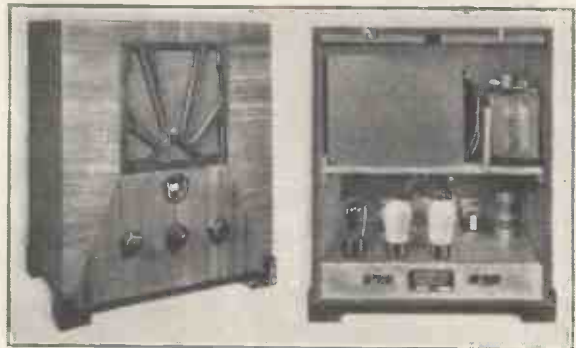

**MORE GOOD VALUE FOR MONEY**

Sunbeam is a name that is becoming associated with good value for money. That impression is backed up by this new model B37



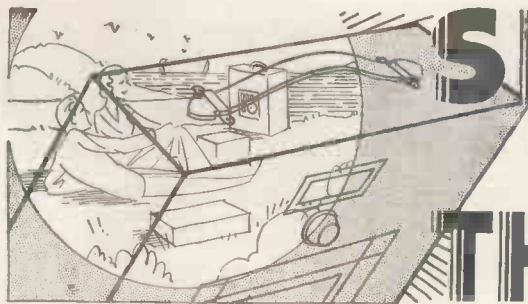

# SETS THAT CHANGE THEIR HABITS

By  
PERCY W. HARRIS,  
M. Inst. Rad. E.

**T**HAT set of yours on the table over there, with its aerial taken to the tree at the bottom of the garden—how much of its good performance is due to the set and how much to your locality?

I doubt whether you can tell me. If you can, you know more about wireless than most experts.

The point is of considerable interest at this time of year, when portable sets are taken afield—mostly in cars, of course, for the old idea that a portable set can be comfortably carried by hand for any distance is retained only by those who have never tried to carry one!

The chief point about a portable set is that it can be set down anywhere and made to operate without the necessity of connecting an aerial and an earth to it—the frame of wire which is the equivalent of the outside aerial for pick-up purposes being contained within the case.

Ever since portable—or, better expressed, self-contained sets—became popular, I have had a regular flow of letters from readers who have been puzzled by certain matters connected with their performance, and for this reason it occurred to me that a few notes on the subject might be helpful.

## Many Vicissitudes

The wireless waves sent out from any broadcasting station experience many vicissitudes before they finally affect your wireless set. They may be reflected and absorbed, partially at any rate, in half a dozen different places before they reach your receiver and, occasionally, due to certain contours of the land, they may actually be concentrated at a point where you happen to be.

If you draw a circle fifty miles in radius around a broadcasting station and try out your portable set at a hundred different places on this circle, you may get a hundred different strengths of signal.

So do not get worried if, on the

one hand, when you take your transportable set with you in the car and use it on some high ground or common, you find that reception conditions are either much better or much worse than at home.

If they are much better than at home, this may be due to the fact that buildings or high trees are electrically shading your reception area. Big buildings, such as the Crystal Palace, for example, may “shade” a considerable area in the immediate vicinity.

On the other hand, you may be so situated that your house is on the top of a hill with no trees about, no big buildings, no visible sign of electrical obstruction to the waves, and yet—I have known several such cases—your reception may be definitely poorer than some districts in a valley nearby which seems to be badly screened.

I have even known two districts in the same town, one at the top of a hill and one at the bottom, differ so much that reception is ten or fifteen times as good at the bottom of the hill as at the top.

If you have an outside aerial and it is reasonably high you may find little difference in reception whether you have the set itself in an upstairs room or one downstairs, provided you have a sound earth connection in each case.

With a portable or transportable set, however, with the small frame contained in the case or lid, there may be a tremendous difference in strength between reception in two such rooms. A big difference will occur even in the same room, for a gas pipe, electric-light conduit, or a metal fireplace may be quite sufficient to absorb the waves or screen them when the set is immediately adjacent.

I remember one year having a portable set ready to listen to an

important broadcast of a sporting event (the scene was a large office) and finding that only in one part of the room could any reception at all be obtained!

So far, I have not mentioned the point that is known to most readers—that sets with built-in frame aerials are acutely directional in their receiving properties—that is to say, if the set will receive excellently from a station when it is placed in one position, turning the set through a right-angle may reduce reception to zero.

The direction of best reception from one station is not necessarily the best direction from another, for which reason the non-directional properties of the ordinary aerial (or the mains type) has made this latter the more popular.

## Rejuvenating An Old Set

Many a portable set which has been put by as being insufficiently sensitive can be made useful again by connecting to it a small aerial of the ordinary type. When a set has to cover both medium and long wavebands and has reaction on both, there are usually a number of connections to the frame, but one of these connections will be found to go to the grid of the first valve.

To this connection join one side of an aerial compression condenser with a maximum of about .0001 microfarad capacity, the other terminal of which should be connected to a length of wire.

This can be joined to an ordinary outside aerial and an earth connection can be made to the negative terminal of the accumulator.

With such an arrangement you will get much stronger signals than you obtained with the frame with the additional advantage that the set will no longer be directional. On the other hand, the tuning position may be quite different for a particular station and the set will be far less selective than with the frame.

# RADIO MEDLEY

\* A RADIO FAN'S CAUSERIE CONDUCTED BY BM/PRESS \*

Cooling the Air at Olympia ::  
Doing Away with the Variable  
Condenser :: Rival Television  
Systems and Receivers :: New  
Musical Instrument for the  
Home :: Why Were Valves  
Reduced in Price? :: A Ship  
without Wireless!

## The Exhibition

AS far as I have been able to observe, the radio trade is not a particularly pious body of men, but I should think that everybody who has to go to Olympia from August 15 to 24—the dates of this year's exhibition—is praying for a cold spell.

This year the show is about a week earlier than it was last year—and then on several days it was unbearably hot. I have heard rumours that special cooling arrangements are to be put into operation. Let us hope that they are effective!

By the way, although I have not heard any details, I gather that there will be something rather out of the ordinary to interest visitors to the "Wireless Magazine" stand—which is No. 10.

## Permeability Tuning

Personally, I am very much interested in the possibilities of permeability tuning. In case you do not already know, I had better explain that this system is based on the fact that an iron core moved about inside a coil will vary its inductance—and therefore its wavelength—just as effectively as will a variable condenser.

It seems to me that it should be possible to make a movable iron core in a very much neater and more compact mechanical form than even the smallest of variable condensers—and it should also, in the long run, prove to be cheaper.

By the way, at Olympia you will see a number of really midget gang condensers. Some of these have

been produced primarily to meet the needs of car-radio designs, but they will also be useful in ordinary sets when one is pressed for space.

## Television Tangles

Just where are we getting to in television? Last month I referred to a cathode-ray demonstration I had attended, and now comes news of a new system under the name Scopphony.

I am wondering what is the position of anybody buying a television receiver at the present moment. The B.B.C. is sending out 30-line pictures by the Baird system, and receivers have to be arranged to pick up those particular signals.

As far as I know, there is no guarantee that the B.B.C. might not suddenly go over to an entirely different system, in which case all existing television receivers might become useless and obsolete.

Still, I admit that it seems almost impossible to avoid something of the kind happening until television really does become standardised.

## Howls That Make Music

Very luckily, I was able to be present at the recent demonstration in London of a new form of apparatus for getting music out of an oscillating circuit. The new unit is plugged into any existing set, whether battery or mains operated.

I gather that within a few weeks these machines will be put on the market at a price within the region of five guineas. Anybody with a little musical sense (but not your humble servant!) should, I think, be able to get passably good effects out of the arrangement after a few hours' practice.

To play it you move your hand towards or away from a short rod that looks like a small vertical aerial. The nearer you get to the rod the higher is the frequency of the note emitted from the loud-speaker.

I was told that it is possible to send the instruments out tuned to any particular timbre that may be

desired. The model I heard demonstrated had a foot pedal to control the volume.

I can see that any family buying one of these instruments will be able to have great fun amongst themselves and their friends!

## Valve Price Reductions

Have you noticed that certain valves were reduced in price on July 3? Valves made by members of the British Valve Association—commonly called the "ring"—are probably the best in the world, but they are also the most expensive, I believe.

This recent reduction in price was not announced to the public at all. In fact, the reductions are so small that one cannot help wondering why they were made.

Still, there is hope for us yet. I expect that most readers of these notes will live to see the time when no valve costs more than 5s.—except that by that time the thermionic valve as we know it now will probably have become completely obsolete!

## Completely Cut Off

Since I last wrote these notes I have made a journey to Bordeaux and back in a tramp steamer. The voyage took about three days each way; and what I particularly liked about it was the fact that we were completely cut off from civilisation for that time.

The boat had no wireless on board. No member of the crew, even, had troubled to fix up a receiver. The old "Chief" used to have a one-valve set on another ship about six years ago, but it gradually fell to pieces and he has never troubled to build another.

Still, I did get him to say that he would think about trying a new single-valver with modern parts to see what it would do. It is no use having a loud-speaker as it interferes too much with men trying to get a rest when they are not taking watch.

London, W.C.1

BM/PRESS



# Tone-compensated Volume Control

By Capt. H. J. ROUND, M.I.E.E.

A VERY interesting American development has recently been made in tone-corrector circuits for broadcasting, and actually the same principles can be applied to any circuit for delivering speech and music energy through a loud-speaker.

In the past, tone correction has been made for several purposes. It has often been done to correct serious errors in loud-speakers. The well-known peak in a moving-coil loud-speaker at about 3,000 cycles can be toned down considerably by means of condensers, inductances, and resistances suitably used.

### Correcting Records

The tone correction of gramophone records, in which the bass is put back to its correct amplitude, is also well known and apparatus for doing this has been on the market for some time.

Tone correction to produce pleasing musical effects, regardless of whether such effects are true reproductions of the original, is also often done, usually in a simple manner by shunting condensers across the low-frequency amplifier in some position.

The new American scheme, however, is based on the question of the audibility of the various frequencies of the musical scale.

If speech takes place in front of a microphone and that speech is reproduced on a loud-speaker of high quality at the same strength as the original, the naturalness of it should be at a maximum, but we have all had the experience that when the loud-speaker is turned up to ten or twenty times the strength the result is usually displeasing and a mental analysis of where the displeasure lies indicates that both the lower and higher frequencies seem to be exaggerated.

Conversely, when the set is turned down, so that the speech level is considerably lower than the original strength, the result appears that both high and low frequencies are missing.

It is not so easy to detect these results on music because we are so used to hearing musical items in a great variety of strength conditions, but there is no doubt that reproduction of music from broadcasting always seems more natural and more pleasing when the volume is quite high.

In these notes Capt. H. J. ROUND has something to say about a new system of tone-compensated volume control, which is likely to be of increasing importance in the future. There is sufficient data in this article to enable a keen experimenter to try the scheme out for himself without much trouble

This is when one appears to be listening to something of the same order of strength one would hear from the original orchestra.

The reason for this follows from the measurements that have been made of the apparent strengths of different frequencies. If we put energy at differing frequencies into a loud-speaker—assuming, for the moment, that this loud-speaker is a really first-class article—and then we reduce the strength of each frequency until just audible, we should obtain a curve like that of Fig. 1, representing the strength required just to supply audibility at each frequency.

### Strength at 1,000 Cycles

It should be noted from this curve that the middle frequencies round about 1,000 cycles require very, very much less strength than the frequencies at the extreme limits.

Now estimates have been made on a very large number of people at all the different frequencies of what is meant by "twice as strong" and from these measurements a series of curves (shown in Fig. 1) have been drawn to indicate the strength required to produce one-hundred times the audibility, 10,000 times the audibility, and so on.

It has been found that these curves gradually become more and more horizontal as the strength of the sound begins to arrive at normal level and that the curve is nearly level when the speech is at about human volume.

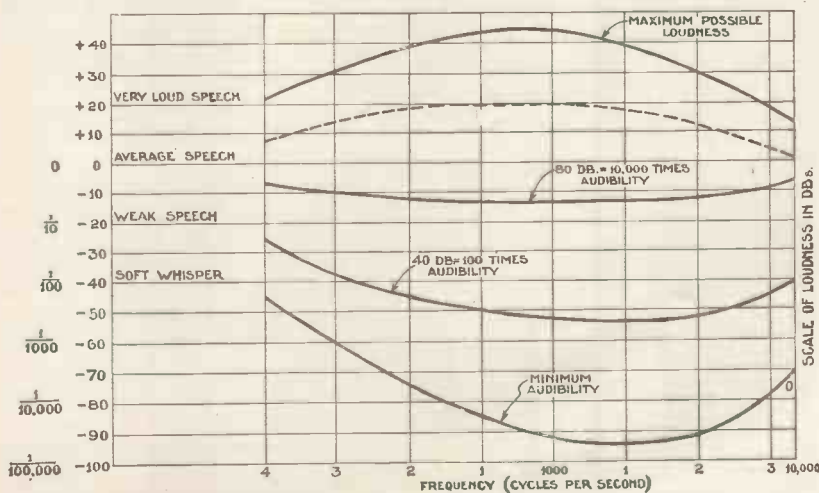

Fig. 1.—How audibility varies with frequency. These curves show the strengths needed to give different audibilities

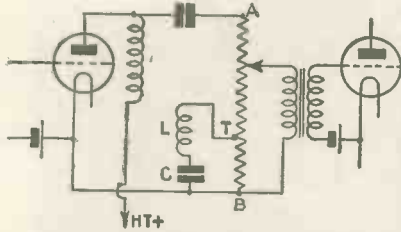

Fig. 2.—Skeleton circuit for tone-compensated volume control. Note the following values: AB, 30,000-ohm potentiometer (tap T at 6,000 ohms from bottom); L, air-core coil of 50 millihenries and 500 ohms; and C, .5 microfarad

There is also a tendency for these curves to become convex upwards as the strength increases above its natural level, until a limit is arrived at where all sounds begin to be felt.

Working on this basis, the Americans have devised correction circuits so that whatever level of output we wish to have, a correction for the loud-speaker can be chosen which makes the output follow the correct curve.

**No Hard-and-fast Rule**

One can see at once that there is no hard-and-fast rule as to the choice of a particular curve because whatever position one is in a room, one gets a different strength, but, given such a correction adjustable at will and also another adjustment for pure strength, one could play about with these until the most pleasing result is obtained.

There seems to be no doubt that, particularly when we want to hear weak stuff, a definitely more pleasing effect can be obtained by making the output curve one of these scooped-out characteristics.

**Talking-picture Work**

The idea is of considerable importance on work outside radio. I have noted in talking-picture work that if one is sitting in a projection theatre, and the projected picture is of a certain size, to obtain the illusion that the people on the screen are actually talking the size of the picture must be matched with the volume of the sound moderately accurately.

A serious divergence from the best strength takes away the illusion and then we do not properly connect the speech with the picture.

If home talkies ever seriously come into vogue the chances are that the average household will never be able to have more than quite a small picture with quite small figures of

actors thrown on the screen. These figures will, no doubt, be considerably less than the actual figures in real life, and consequently it will be necessary to reduce the volume of sound to match these figures. In this case, undoubtedly the American tone correction will render the result more natural.

Probably a still more important field for this tone correction will be in television. It is very unlikely that when television does arrive the figures on the screen will be more than quite small miniatures of the originals because great difficulty will be experienced in getting cheaply sufficient light to throw a picture on a large screen.

In such circumstances this tone correction will be very necessary, and it will partly solve the difficulty that is certain to occur when watching such small pictures.

I think it will be agreed that plain television without sound would not be a success in these days when the public has been educated to sight and sound combined.

In fact, I am surprised that this sight-and-sound education, which is being given in every cinema in the world at the present time, is not making people less and less able to listen to broadcast talks and plays where the picture would greatly add to the interest, but the music, of course, does not suffer to anything like the same extent and television is not really essential for it.

I am attaching a sketch (Fig. 2) of the circuit and the quantities used in these arrangements that has been published in America. It would probably be best to eliminate the transformer input to the second valve and from rough tests I doubt whether the values of L and C are the best possible. The following is an extract from an article in a recent number of *Electronics* :—

The volume-control and compensation systems consist of a potentiometer having a total resistance of 30,000 ohms with a tap of 6,000 ohms. The compensation circuit is

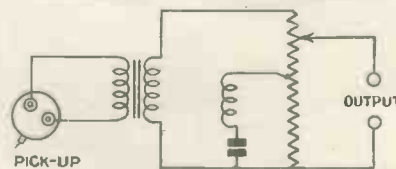

Fig. 4.—Tone-compensated volume control system for use in conjunction with gramophone pick-up

connected in parallel with the 6,000-ohm section and comprises an air-core inductance of 50 millihenries and a .5-microfarad condenser. The resistance of the choke is approximately 520 ohms.

The inductance and capacity are broadly resonant to frequencies in the neighbourhood of 1,000 cycles, as shown in Fig. 3, the upper curve of which shows the frequency characteristic of the volume-control system with the movable arm set at the high-potential end or point of maximum output.

The lower curve is the frequency characteristic for the point of maximum compensation. The response characteristic of the system for other adjustments will be located between these limit curves, approaching, in shape, the curve to which it is more adjacent.

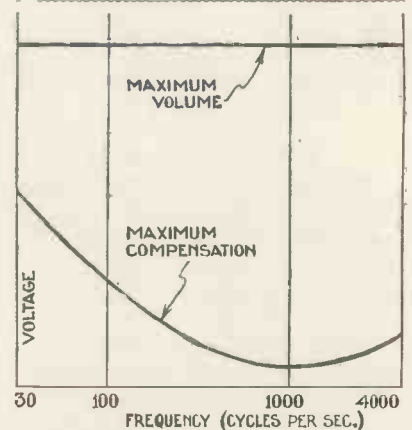

Fig. 3. Frequency characteristic for various settings of the potentiometer in the tone-compensated volume control system

When the arm of the potentiometer is at the top maximum compensation occurs and the voltage/frequency characteristic is determined by the impedance/frequency characteristic of the compensation circuit.

Here the signal frequencies in the mid-range are highly attenuated in comparison with the low- and high-frequency registers and the degree of compensation is determined by the constants of the shunt network.

In the circuit described above the attenuation of voltage, with the arm at the top, is 14 decibels with the compensation circuit disconnected. Connecting the compensation circuit results in an additional attenuation.

Reducing the volume-control setting below the point of maximum



## Some Quality Hints

compensation has little effect on the shape of the voltage/frequency characteristic of the volume-control circuit.

Care must be exercised in determining the value of the tapped portion of the volume control in order that subsequent circuit constants are not affected when the volume control is adjusted to positions below the point of maximum compensation.

### Low-volume Levels

A practical difficulty experienced with this system at low-volume levels, where the low frequencies are exaggerated to give the desired acoustical effect, has been that of disagreeable low-frequency distortion introduced from certain broadcast signals; this has necessitated the addition of a suitable filter to attenuate frequencies below 70 cycles in order that such disturbances as interchannel beat and station-generator noises do not mar the quality of the programme being received.

It is apparent that if audio compensation becomes a standard feature in broadcast-receiver design, care will have to be exercised in broadcast transmitters in order to minimise these low-frequency disturbances.

### Gramophone Use

The problem of using the acoustically-compensated volume control with a gramophone is much simpler. Most discs are recorded with the average intensity maintained close to some standard level and any adjustment of the frequency compensation of one record holds for practically all other records. The volume control can, therefore, be compensated without difficulty.

A typical circuit used in a commercial gramophone design is shown in Fig. 4. This system also incorporates a tapped control, using a shunt resonant circuit, characteristics of which are similar to those previously described.

It may be said that listening tests have substantiated the theoretical considerations as regards the effect of changes in intensity on the apparent frequency characteristic and that considerable improvement is obtained with the acoustically compensated volume control.

A POINT to be noted by those who build their own receivers is that the quality of the output may be rather different from that of the original designer's set.

Even though the recommended values are used throughout, it is possible for differences to occur. In the first place there is the loud-speaker and, secondly, the intervalve transformer.

Loud-speakers have their own characteristics, no two being exactly alike, and the resonances of the loud-speaker will certainly depend to an extent upon the box used with it.

A transformer has a frequency characteristic which depends, to some extent at least, upon the amount of current flowing through its primary windings. The current flowing depends in turn upon the valve to which its primary is connected—the value of the high tension and grid bias.

Some small transformers are rather sensitive to changes in the steady current flowing through them, and it is the higher frequencies which often seem to be most greatly affected.

It is within my own experience that the higher notes may be quite noticeably increased in strength by alteration in the anode current, which may be brought about by adjusting the grid bias. Some transformers

### THE WIRELESS ZOO

#### THE STICKER

*The Sticker is, as you will note,  
A most intrusive sort of goat,  
A cross between a goat and  
ass,*

*For when I'm listening, alas!  
He constantly comes butting in,  
Chatters and makes a fearful  
din.*

*He brays, "Now will you give  
a sub,*

*To help the Duffers' Cricket  
Club?"*

*And when I try to hush him  
down*

*He says, "But—well, just half a  
crown?"*

*Leslie M. Oyler.*

have a peak in the high frequencies and the position of the peak and its magnitude varies with the anode current.

A change in the current, therefore, affects the results, and when it is remembered that it is not unusual for the anode current to be perhaps 1.5 milliamperes in one case and, say, 3 in another, it will be realised that a difference in the quality is to be expected.

Then, again, there is often a coupling through the power valve, and the characteristics of the loud-speaker influence, to a certain extent, the transformer coupling.

However, there may be a coupling through the power-supply circuit, whether a battery or mains unit, and this often allows feedback to occur, which may have the effect of strengthening certain notes or of weakening them.

The whole point is that it is up to the amateur to adjust quality to suit his own idea, and this is most easily done by making a few experiments with resistances and condensers. *W. James.*



**CONSTANT-OUTPUT TONE GENERATOR**

*A constant-output tone generator. This instrument is made by Technical and Research Processes, Ltd., of which Capt. H. J. Round is the head*

# TESTS OF NEW APPARATUS

Ostar Ganz Rectifiers : : Wearite Class-B Transformer : : Preh Valve Holder : : Lissen Intermediate-frequency Transformer : : Goltone Metocel Lead-in : : Mazda Class-B Valve : : Peak Condensers

## OSTAR GANZ RECTIFIERS

APPARATUS : High-voltage rectifying valves.  
TYPE : (a) VG45, (b) NG40.  
PRICE : (a) £2 2s., (b) £1 19s. 6d.  
IMPORTER : Eugen Forbat.

**T**WO Ostar Ganz rectifiers have made their appearance. These valves, in common with the rest of

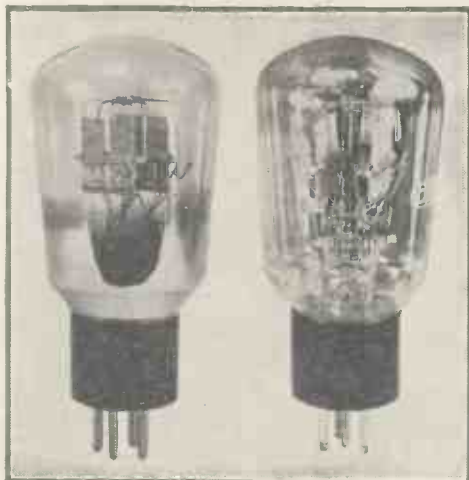

**HIGH-VOLTAGE RECTIFYING VALVES**  
This photograph shows the types VG45 and NG40 Ostar Ganz high-voltage rectifying valves; they can be used without a mains transformer

the series, are intended for running directly off the mains without any transformer, and the methods adopted are ingenious.

The VG45 is a double-wave rectifier that is capable of operating direct from the supply without a centre-tapped transformer, such as is usually required. This apparently impossible feat is accomplished by arranging what are virtually four valves in one bulb.

### Common Cathodes and Anodes

Two of these valves have a common cathode, while the other two have a common anode.

When one mains lead is positive the current flows in one direction, while during the next half cycle the direction of the current changes. It is thus made to go through the load in the same direction each time and gives double-wave rectification.

The heater also runs direct off the mains, being composed of a very fine filament running through a cylinder of refractory material which is coated with the electron-emitting substance.

The NG40 is a similar rectifier intended for low-voltage supplies from 100/110 or 120/150 volts. Here a double-wave rectifier is inadequate, since it will not give enough voltage. The valve is made up, therefore, as a standard double-wave rectifier, but the two cathodes are brought out separately so that the valve may be connected up in a voltage-doubler circuit similar to that made popular by the metal rectifier.

Both the valves worked well on test, the voltage output at various currents being quite satisfactory.

## WEARITE CLASS-B TRANSFORMER

APPARATUS : Class-B transformer.  
TYPE : B<sub>1</sub>.  
PRICE : 8s. 6d.  
MAKERS : Wright & Weaire, Ltd.

**W**RIGHT & WEAIRE, LTD., have entered the class-B market with a neat driver transformer. This is a multi-ratio instrument giving 2:1 and 3:1 step down, obtained by tapping the secondary and not the primary.



**ATTRACTIVE PROPOSITION**  
The new Wearite class-B transformer, with its tapped secondary for use with different valves, is very good value

The windings are enclosed in shrouds which also form part of the clamping system for the whole transformer, while two pressed-metal feet are provided with holes for fixing.

Special hexagon-headed terminals are provided which can be tightened up either with a spanner or a screw-driver.

### Good Results

We found the instrument behaved well on test. The resistances of the windings were 425 ohms for the primary and 250 and 180 for the secondary, according to the ratio.

The inductance of the primary was 23½ henries with 3 milliamperes D.C. flowing, the efficiency at full load being 84.5 per cent.

We should like to see the secondary terminals marked according to the ratio in use.

## PREH VALVE HOLDER

APPARATUS : Seven-pin skeleton valve holder.  
PRICE : 1s.  
MAKERS : Preh Manufacturing Co., Ltd.

**A**SKELETON valve holder which will be useful to the constructor is the Preh component shown herewith. The sample submitted was a seven-pin holder, various



**FOR CHASSIS MOUNTING**  
Metal-chassis enthusiasts will be interested in this Preh valve holder. The sample shown is a seven-pin type

sockets being securely located in a bakelite moulding approximately 1/8 in. thick.

To fit, it is only necessary to drill an appropriate sized hole in the chassis or baseboard and screw the valve holder down.

Continued on page 84



# OSBORN CABINETS

SPECIFIED for "W.M." A.C.-D.C. THREE



**MODEL No. 300**  
 Unique Futuristic Super Table Model, 2 ft. high by 1 ft. 7 in. wide by 12 in. deep. Takes set 18 in. by 8 in. or smaller. Ample room for speaker and batteries. Any size hole in baffle board cut free.

**PRICES:** Machined Ready to Assemble. Kit of Parts, Oak, £5s.; Mahogany, £1; Walnut, £1 5s. Assembled Ready to Polish, Oak, £1 5s.; Mahogany, £1 10s.; Walnut, £1 15s. Assembled and Polished, Oak, £1 15s.; Mahogany, £2; Walnut, £2 5s.

**ALL MODELS CARRIAGE PAID**

**MODEL No. 243**

Beautiful Queen Anne Style Radio-gram. Cabinet, 3 ft. 3½ in. high by 2 ft. 6½ in. wide by 1 ft. 6 in. deep. Takes panel 19 in. by 12 in. or smaller. Ample room for any type gramophone motor, including Garrard automatic record changer and largest H.T. and L.T. batteries made. Accommodation for 35 records each side of set. Takes panel 27 in. long by omitting records storage.

**PRICES:** Machined Ready to Assemble. Kit of Parts, Oak, £3 10s.; Mahogany, £3 15s.; Walnut, £4 10s. Assembled Ready to Polish, Oak, £4 10s.; Mahogany, £4 15s.; Walnut, £5 10s.; Assembled and Polished, Oak, £5 10s.; Mahogany, £6 5s.; Walnut, £7 5s.



**OSBORN SUPER ACOUSTIC BAFFLE BOARD**

Prevents 90 per cent. speaker worry. Any size hole cut FREE. Guarantee no vibration. 18 in. by 18 in., 3/-; 24 in. by 24 in., 5/-; 30 in. by 30 in., 8/-; 36 in. by 36 in., 11/3. Carriage paid U.K.

SEND FOR FREE SAMPLE

Write for Free Catalogue

CHAS. A. OSBORN, Regent Works, Arlington Street, New North Road, London, N.1  
 Tel.: Clerkenwell 5095. Showrooms: 21 Essex Road, Islington, N.1. Tel.: Clerkenwell 5634.

# DAVENSET CHOKE

SPECIFIED FOR THE D.C. CALIBRATOR



Illustration shows the "DAVENSET" Choke, supplied complete with Screw-driver.

The incorporation of the "DAVENSET" Choke in the "D.C. Calibrator" is typical of the high reputation "DAVENSET" Mains Transformers and Chokes enjoy amongst experts in radio design.

The home-set constructor will find in them thoroughly reliable and sound equipment of the highest quality and most original design, which will make a material contribution to the success of his set.

WRITE FOR

a copy of "Mains Transformers and Power Smoothing Chokes for Radio and Industrial Purposes."

**PARTRIDGE, WILSON & CO.**

Dept. 31, Davenset Works, Leicester.  
 Scottish Branch: 200 Vincent Street, Glasgow, C.2.

# UTILITY Tunes the 'TYERS IRON-CORE THREE'

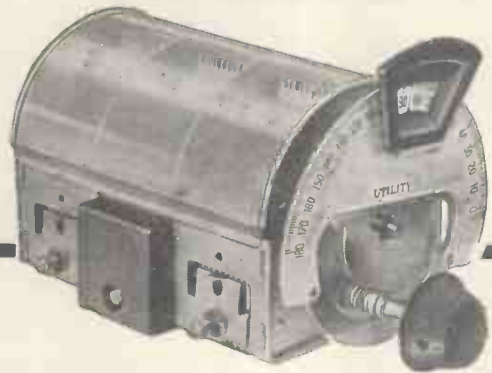

Again Utility condensers are specified by "Wireless Magazine" designers, this time for the Tyers Iron-core Three. The high efficiency of the new coils employed in this wonderful three-valver makes it imperative that ganged condensers of equal efficiency are used if satisfactory results are to be ensured. Mr. Tyers specifies Utility condensers because he knows that they are the best for the purpose. Follow his guidance, therefore, and insist on being supplied with the correct types.

- W314/3 Ganged condensers complete with disc drive **27/6**
- W298 .0003 Reaction condenser **2/-**

★ From your dealer or post free from the makers.

**WILKINS & WRIGHT LTD.,**  
 UTILITY WORKS, HOLYHEAD, BIRMINGHAM

London Agent: E. R. MORTON Ltd., 22 Bartlett's Buildings, Holborn Circus, E.C.4.



Belmont

Better service results from mentioning "Wireless Magazine" when writing to advertisers

TESTS OF NEW APPARATUS  
Continued from page 82

LISSEN INTERMEDIATE-FREQUENCY TRANSFORMER

APPARATUS: Intermediate-frequency transformer.  
TYPE: LN5305.  
PRICE: 7s. 6d.  
MAKERS: Lissen, Ltd.

A NEAT and inexpensive intermediate-frequency transformer has recently been placed on the market by Lissen, Ltd. The transformer is of the conventional type,



FOR THE MODERN SUPER-HET

As the Lissen intermediate-frequency transformer is tuned to 126 kilocycles it is suitable for any "Wireless Magazine" super-het

having tuned primary and tuned secondary, the coupling between the two being arranged to give band-pass characteristics.

The coils themselves are wound in two thin slots and are separated by a paxolin tube acting as a spacer.

A moulded base is provided, in the underside of which are mounted the two trimming condensers, while over the whole is a screening can with slots to allow access for the leads.

Tuned to 126 Kilocycles

The transformer is tuned to 126 kilocycles, and it is interesting to note that the factory adjustment is made by means of a cathode-ray tube which actually traces out the resonance curve.

The user should avoid any temptation to experiment with the trimmers himself.

Our tests showed that the matching was accurate, and that the transformer is well up to standard.

GOLSTONE METOCCEL LEAD-IN

APPARATUS: Shielded lead-in cable.  
TYPE: Metocel.  
PRICE: 8d. per foot.  
MAKERS: Ward & Goldstone, Ltd.

WE recently reported on a special form of shielded lead-in cable made by Ward & Goldstone, Ltd. They have now introduced a cheaper and less bulky version known as the Metocel lead-in. This con-

sists of a rubber tube, approximately 1/2 in. in diameter, in the centre of which is another much smaller tube held to the outer one by three ribs. The construction is thus very largely air-spaced.

Through the centre tube runs the lead-in wire, while around the outside is a layer of metal foil covered with braiding. This outer case is earthed, so that the lead-in is shielded from external disturbance.

The capacity between the centre wire and outer casing is of the same order as with the more elaborate type, being 18 micromicrofarads per foot, as far as we could estimate from a short length.

MAZDA CLASS-B VALVE

APPARATUS: Class-B valve.  
TYPE: PD220.  
PRICE: 14s.  
MAKERS: Edison Swan Electric Co., Ltd.

AN interesting new class-B valve is the Mazda PD220. This takes only .2 ampere at 2 volts, and gives an output of 1.4 watts at 120 volts.

By increasing the anode volts to 135 an output of 2 watts can be obtained, or 2.35 watts with an anode voltage of 150.

The anode load varies according to the circumstances, but is in the neighbourhood of 12,000 to 17,000 ohms for general requirements. Lower values than this should not be used, or the anode current will peak to too high a value and there will be a danger of shortening the life of the valve.

The maximum peak current for which the valve is rated is 40 milliamperes, although we understand that this is a very conservative estimate.

The standing current of the valve with no signal is 2 milliamperes, and our tests show that it operates under conditions which give over 70 per cent. efficiency, a great improvement over the ordinary triode, which is

usually under 20 per cent. efficient. This achievement is the more remarkable since the valve takes no more filament current than an ordinary power valve of to-day. A summary of the operating conditions is appended:—

Driver valve.	H.T. volts.	Anode load (total).
L2	120	17,000
P220	120	11,500
P220	135	12,500

Watts output.	Input to driver.	Driver ratio (overall).
1.0	2.65	2:1
1.4	4.16	1.5:1
2.35	4.8	1.6:1

PEAK ELECTROLYTIC CONDENSERS

APPARATUS: (a) 4-microfarad wet electrolytic condenser. (b) 8-microfarad wet electrolytic condenser.  
TYPE: W.  
PRICE: (a) 4s. 3d., (b) 4s. 9d.  
MAKERS: Wilburn & Co.

WE have received two Peak electrolytic condensers. These are conventional in appearance, being housed in aluminium cans which act as negative electrodes. The bottom of the can is finished in a large diameter screw thread with a locking washer suitable for mounting direct on a metal chassis.

The positive connection comes through the centre of this bush, being insulated therefrom by a bakelite washer. A small rubber-sealed vent at the top is provided to allow any gas to escape.

The condensers are rated at 450 volts peak and withstood a voltage slightly in excess of this quite satisfactorily. The capacities of the two samples, nominally 8 and 4 microfarads, were found to be 7.7 and 3.3 microfarads respectively. Leakage current was 1.5 and .5 milliamperes respectively, with 400 volts,



NEAT MOUNTING

A Peak electrolytic condenser mounted on a special Wilburn aluminium bracket, which is available for 6d. and is suitable for any ordinary type of electrolytic condenser



FROM THE EXTENSIVE  
**POLAR**  
RANGE

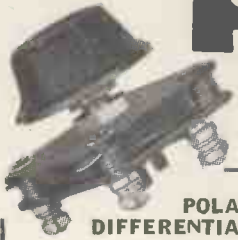

**POLAR DIFFERENTIAL**

The condenser with an Insulated spindle. Constructed with the highest quality materials. Smooth action. Complete with knob. .0001, .00015, .0003 **3/-**

**POLAR NO. 2.S.M.**

A condenser with Fast and Slow ball-bearing action. Rigid construction and bonded rotor vanes ensure long service, with permanent accuracy. .0005, .0003 **6/6**

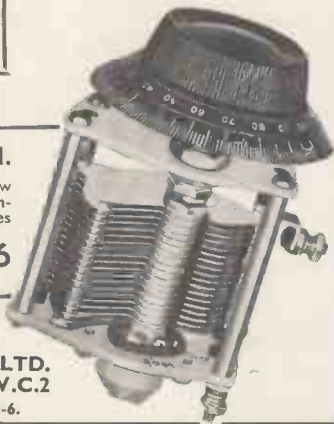

WINGROVE & ROGERS, LTD.  
188-9 Strand, London, W.C.2

'Phone: Temple Bar 2244-5-6.

9234

LIST OF INTERESTING PRODUCTS FREE ON REQUEST



ACTUAL SIZE

A PERFECT CHOKE AT LOW COST.

"KINVA" STANDARD TYPE SCREENED H.F. CHOKE,

for H.F. or DET. Anodes,

**2/9**  
or 3/- post free

POSTLETHWAITE BROS., KINVER, STOURBRIDGE.

**Your Old Components . . .**

are worth money. Sort out the spare radio parts you no longer require and advertise them in the "Miscellaneous Columns" of AMATEUR WIRELESS. You will be surprised how quickly they will be snapped up.

Your announcement will cost you 3d. a word. Send your list of parts, together with your name, address and remittance, to:

SMALL ADVERTISEMENT DEPARTMENT,  
"AMATEUR WIRELESS,"  
58-61, FETTER LANE, LONDON, E.C.4

Resistance life  
is all important



1 WATT TYPE  
**1/-** EACH  
2 WATT  
**2/-** EACH  
3 WATT  
**3/-** EACH

when you build the

**ALL METAL FOUR**

OR THE

**SELF CONTAINED 4**

build with

**DUBILIER RESISTANCES**

Dubilier Condenser Co. (1925) Ltd., Ducon Works, Victoria Rd., North Acton, W.3

There is news in the "Wireless Magazine" advertisements

# Electronic Music



### MAKING ELECTRONIC MUSIC

By moving the hand the sound from the loud-speaker can be controlled through a range of nine octaves. This instrument can be connected to any ordinary receiver

MOST "Wireless Magazine" readers will be familiar with the idea that by the suitable control of an oscillating circuit it is possible to make a kind of synthetic music. The first practical demonstration of this effect was given at the Albert Hall by Theremin in 1927.

Since then the apparatus has been very much simplified and can now be handled by any musician after a little practice.

We were recently able to hear a demonstration of such instruments arranged by the Electronic Music Development Co., Ltd., of 16a

Whyteleafe Road, Purley, Surrey.

At present a hundred or so instruments are being sent out to musicians all over the country, so that they can give their opinions as to the controls, etc.

As soon as the musicians have indicated to the makers the best form the new musical instrument can take it will be put on the market in a form that will allow of its being connected and played through an ordinary receiver, whether battery or mains operated.

During the demonstration we recently heard, the Electronic instrument was played by Martin Taubmann. Accompanied as it was by a piano, the effect was surprisingly good.

Obviously there are very great possibilities in such instruments, which in this case is played by bringing the hand towards or pulling it away from a short vertical wire. The arrangement of this will be clear from the photograph.

The machine illustrated is only the oscillating device and it has to be connected to some kind of amplifier in order to drive a loud-speaker.

It is hoped by the makers that the instruments will be available to the public in a few months and that the price will bring them within the reach of everybody.

Well, I waited for some special passages I knew. Having heard the B.B.C. orchestra play the *Mastersingers Overture* at least twenty times, both at home by wireless and in the hall itself, I was in a position to detect the slightest deviation in tonal reproduction.

The level sonority of the strings keeps up for some minutes and I became thoroughly used to them in that particular room. The entry of the three woodwind instruments passed quite a severe mental test on my part.

### Woodwind Alone

The best, however, was to come. During the *Mastersingers Overture* there is a spot at which practically the full orchestra suddenly gives way to a very well-known passage for woodwind alone. We were talking as they were nearing the passage in question and we landed into the middle of it before I had picked up the threads again.

Therefore I was mentally shocked, so to speak—taken unawares—and for a moment the illusion was so perfect that a mental picture of the orchestra in Queen's Hall seemed to blot out the surroundings of the room in which I sat.

### Nearly Perfect

If you can realise what I mean you may take it that this loud-speaker underwent a supreme test at that moment. I am satisfied that *under present conditions* nothing will get *nearer* to the exact sounds of an orchestra. You can take it from me that Hartley and Turner between them have *very nearly* evolved the perfect loud-speaker.

## A New Loud-speaker

Whitaker-Wilson's Musical Report on the Hartley-Turner Instrument

AT Mr. Hartley's invitation I visited him (and the loud-speaker) at his home (and its) in order to make a musical test. It must be a year or even more since I visited Mr. P. K. Turner with the same object in view. My first impression was that a great improvement had taken place during that year.

Mr. Hartley wanted me to hear something I knew so well that I could apply the severest test. I chose a night during the London

Musical Festival week to enable me to apply the most acid of all tests—reproduction of the full B.B.C. Symphony Orchestra *on works I knew by heart.*

There is no point in my dwelling too much on the *Mastersingers Overture* or the *Siegfried Idyll*. Mr. Hartley wanted me to say I thought the reproduction near to the original. Naturally that was what any designer of a loud-speaker *would* want, but he did not want me to say it if I did not think it.

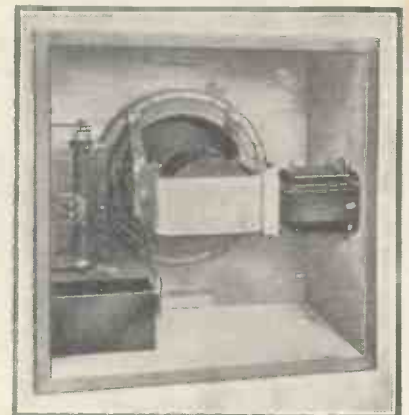

FOR EXPERIMENTAL WORK  
One of the new type Hartley-Turner loud-speakers, made by Hartley Turner Radio, Ltd., of Thornbury Road, Isleworth, Middlesex



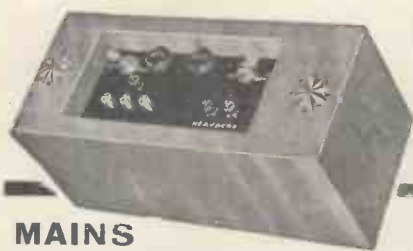

## MAINS UNITS and KITS

Run your present battery set from the mains—with a Heayberd Complete Mains Unit or Kit. Models available for all types of receivers for A.C. or D.C. The above illustration is of the Heayberd D.150 Mains Unit. This is a popular model suitable for the majority of receivers in general use. Perfect smoothing incorporating Double Chokes, 16 mf. Condensers, Westinghouse Rectifier etc. Guaranteed Three Years.

**ALTERNATIVE OUTPUTS : 25 m.a. at 120v. or 150v. TAPPINGS : 40/110v. Var., 60/130v. Var. and 150v. Price 86/-**

L.T. 4v 4 amps. A.C. 8/- extra, or L.T. 2v ½ amp Trickle Charger can be fitted for 27/6 extra.

Send 3d. stamps NOW for 36 page Handbook packed with useful data, hints and circuit diagrams on mains working.

**HEAYBERD**  
MONARCH OF THE MAINS.

F. C. HEAYBERD & CO.,  
10 Finsbury St.,  
London, E.C.2.  
(Minute from Moor-gate Und. Stn.)

**ROLA**  
the World's Finest Reproducers

**ROLA**  
Model F5-PM-PDT  
32/6

Is Used and Specified  
Exclusively for the  
**TYERS IRON-CORE  
THREE**

The knife-edge selectivity and high amplification attendant upon the use of the amazingly efficient new Nucleon coils used in this receiver have called for a specially designed Rola speaker. Rola have produced a special speaker exactly suited to the characteristics of this outstanding set. Write to-day.

**THE BRITISH ROLA CO., LTD.**  
Minerva Rd., Park Royal, N.W.10.  
Phone: Willesden 4322-3-4-5.

**ROLA**  
SPEAKERS  
for better  
Radio Reception

- What size Eliminator do I need?
- How can I cut out Mains Hum?
- How can I eliminate Interference?
- When should I use an Electrolytic?
- How do I build an A.C. Power Pack?
- What special precautions for D.C.?
- What resistance do I need?

**YOUR MAINS PROBLEMS!** — this Book answers them all

**GET YOUR COPY**

COUPON To The Publicity Dept., The Telegraph Condenser Co. Ltd., Wales Farm Rd., N. Acton, London, W.3.

Please send me a copy of your book "The Design and Construction of Radio Power Units," for which I enclose six penny stamps to cover cost and postage.

NAME.....

ADDRESS.....

W.M. 8/33

Please write in block letters

**T.C.C.**  
ALL-BRITISH  
CONDENSERS

Better service results from mentioning "Wireless Magazine" when writing to advertisers

# ON THE CREST OF THE WAVES

Radio News from All the World : : By JAY COOTE

## ARGENTINE REPUBLIC

**DX SEARCHERS** are now given an opportunity of hearing another Buenos Aires broadcast as the new super-power Radio Excelsior transmitter has been brought into daily operation. Temporarily it is working on 361 metres, but the wavelength may possibly be altered. The call, in Spanish, will be picked up as "Ella Air Cinco (LR5) Radio Excelsior, Buenos Aires." It is the most powerful station in the Argentine Republic and, for the present, of the entire American Continent, namely 200 kilowatts.

## AUSTRIA

The initial broadcasts of the high-power Vienna Bisamberg station appear to have brought disappointment to many listeners in the British Isles, inasmuch as it had been hoped that with its power of 100 kilowatts the signals would have proved at least equal in volume to those of, say, Warsaw.

The reason for their comparative weakness is that so far the station is not working with its full aerial system as the specially designed reflector tower has not yet been built. The station was erected to provide an adequate service to the Western portion of Austria, and to achieve this a beam effect is necessary.

Tests are now being carried out, and the aerial system will be completed towards the end of September. When in full swing the station will radiate 120 kilowatts.

## BELGIUM

Belgian listeners are very perturbed at the news that the government will shortly raise the annual tax on radio receivers. So far the amount paid yearly has been sixty Belgian francs (roughly 10s.), but as a deficit in the balance sheet of the Institut National de

Radio-diffusion is foreseen, an extra forty francs (6s. 8d.) may be exacted.

Up to the present, but few States in Europe, subsequent to the establishment of their stations, have increased the annual tax; on the contrary, in most instances, in order to further the development of the system they have decided to reduce it.

♦ ♦ ♦

Notwithstanding the fact that the greater part of the country is covered by the two Brussels transmitters, Belgium, during the past three years, has been overrun by a number of small privately-owned stations, mostly situated in the Liege district.

As the State does not wish to take the drastic measure of compelling the majority to suspend their transmissions, a proposal has been put forward to the effect that the most active should amalgamate into one organisation, to which the authorities might eventually be willing to grant a licence.

## BOLIVIA

A 10-kilowatt has been installed on a hill overlooking La Paz : it works on 500 metres and is said to be the highest station in the world—13,500 ft. above sea level ! The programmes in the Spanish language and Indian dialects consist of news

bulletins, typical Bolivian music and native songs.

In order that these transmissions should be heard in other parts of the world they are also broadcast on short waves, namely, 19.61 metres during daylight hours, and on 49.3 metres at night. Bolivian local time is four hours *behind* British Summer Time.

## EGYPT

The small privately-owned stations which have been operating in and around Cairo during the past two years—mainly for publicity purposes—will be replaced in the course of the year by a 20-kilowatt transmitter now nearing completion at Abu Zabal. It will broadcast on 483.9 metres (620 kilocycles).

The Egyptian government also proposes to install a 5-kilowatt station in the neighbourhood of Ras-el-Tin, near Alexandria, to work on 267.4 metres. Should these not suffice, two smaller relays will be built.

## FRANCE

With the passing of the Wireless Bill by the French Chamber of Deputies and Senate, and the consequent steady income to be derived from a tax imposed on owners of wireless sets, the State has decided to hurry on the re-organisation of the broadcasting system, according to the Ferrié plan.

Work has already begun on the 120-kilowatt station to be erected at Thourie, near Nantes, as well as on the station destined to serve the French Riviera. In addition to the installation of new high-power transmitters to work on the broadcast band, the authorities have decided to reconstruct the Poste Colonial (Pontoise) in order to increase the radiation from 15 to 50 kilowatts.

♦ ♦ ♦  
Although appeals have been addressed to the

Continued on page 90



**NEW AUSTRIAN STATION**  
A general view of the new broadcasting station at Bisamberg, Austria. The giant mast is nearly 500 ft. high



# AGAIN exclusively specified

for the TYERS IRON-CORE THREE



## SMITH'S ACCUMULATOR

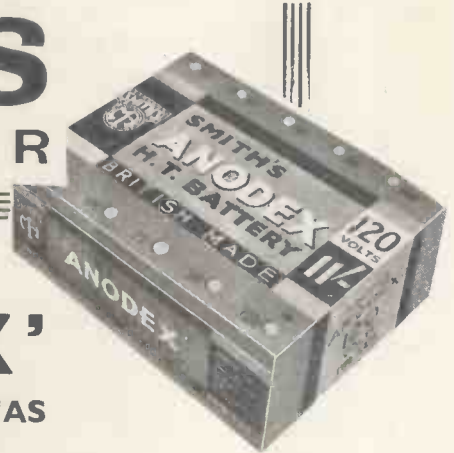

see it with—

## 'ANODEX'

H.T. BATTERIES AND GRID BIAS

# on Stand No. 51 OLYMPIA

S. SMITH & SONS (Motor Accessories) LTD, CRICKLEWOOD, LONDON, N. W. 2.



### ELECTRADIX BARGAINS

**PHOTO CELLS.** We have some talkies, light tests, timing controls, etc., at bargain prices. Light response, 50 microamps per lumen. King B.T.P. type, 15/-. R.C.A., as illustrated, 25/-. Holders, 1/-. Beck Prisms, 5/6. Focus Lens, 3/6.

**SELENIUM CELLS.** Light sensitive resistance, gold grids, moisture proof. L to D ratio 5-1, at 5/-. Mounted in bakelite, 7/6. Super Model in oxy-brass body, with window, 10/-.  

**MICROPHONES.** Button Units, 1/-. Solo No. 11, as illustrated, 5/6. Pedestal Ring, 18/6. Announcers Talkie Mikes, £3.10, £5, £12, and £14. Microphone Carbon Granules. In glass capsule, enough for four buttons. Grade No. 1, 8d.; No. 2, Medium, 1/-; No. 3, Fine, 1/6; Carbon, solid back, blocks, 3d. Mouthpieces, curved or straight, 10d. Carbon Diaphragm, 65 m/m, 4d. Panel Brackets, pivoted, 5/-. Reed Receiver Unit for amplifier making 3/-.  

**TELESCOPES.** Cooke Monocular Prism, R.F. 9-mile scale, 7 1/2 in. long, 3 1/2 lbs., 17/6. Navy Gunsight Telescopes, inter focus, 24 in. by 2 in., 6 lbs. Mag. 6. Cost £25; sale, 17/6. Spotting Telescopes. 17 in. by 1 1/2 in., Watsons, 25/-.

Send for Bargain List "M"

**ELECTRADIX RADIOS.**  
218, Upper Thames Street, E.C.4



**BULGIN**  
HINTS TO BETTER RECEPTION

**24 PAGES**  
full of simple, pictorial diagrams which anyone can follow, showing easy alterations to make your wireless set right up to date at minimum cost. Illustrates numerous "gadgets" of use to every set owner and constructor.

**SEND NOW FOR THIS NEW RADIO GUIDE FREE ON APPLICATION**

Write Dept. "B,"  
**A. F. BULGIN & CO. LTD.,**  
Abbey Road, Barking, Essex.



**RA & REPRODUCERS**  
for better reproduction

The instruments which have made possible a re-creation of the original performance. There is a type for every output.  
Reproducers & Amplifiers Ltd., Wolverhampton.

### HOME STUDY MEANS more money

**CAPITALIZE** your spare time. Make yourself more valuable in your present work—prepare yourself for the bigger positions ahead. You can do these things by taking an I.C.S. Course. All instruction by correspondence. Complete information and advice free. Write, or use the coupon.

**INTERNATIONAL CORRESPONDENCE SCHOOLS LTD**

Dept. 89, International Bldgs., Kingsway, London, W.G.2

Please send me particulars of Courses marked X

<input type="checkbox"/> Wireless Engineering	<input type="checkbox"/> Advertising
<input type="checkbox"/> Radio Servicing	<input type="checkbox"/> Salesmanship
<input type="checkbox"/> Radio Operating	<input type="checkbox"/> Commercial

Name.....Age.....  
Address.....

## 10 to 1 You Will Remember !

Remember what? Why, that "10" is the number of the "Wireless Magazine" stand at Olympia, which opens its doors on Tuesday, August 15 for nine days. Come along and see us, will you?

There is news in the "Wireless Magazine" advertisements

ON THE CREST OF THE WAVES

Continued from page 88

authorities in respect of a licence for the Toulouse (St. Agnan) 80-kilowatt station built some months ago, no permit has yet been given for its use.

If French unofficial reports are to be believed, the State has no intention of granting such an authority to private owners, but may make a bid for the purchase of the plant, in which case the transmitter, drawn into the PTT network, would become the official broadcasting station of the Toulouse area.

According to the *Journal Officiel*, questions have been recently raised in the Paris Chamber of Deputies in respect to the purchase by the State of the new Radio Paris transmitter. It is alleged that thirteen million francs were paid for this transmitter although in the opinion of a committee of experts the installation was not worth half that amount!

Villebon-sur-Yvette, some twenty miles from the French capital, has been selected as the site of the new Paris PTT 120-kilowatt station, which is destined eventually to replace the present *École Supérieure* station. Work has already been started on the buildings necessary to house the plant, and it is hoped to start the first tests towards the end of the year. The exclusive channel reserved for this station is 431.7 metres (695 kilocycles).

GERMANY

Most of the German studios, since the advent of the Hitler government, have abandoned their original interval signals and replaced them by snatches of military marches or old German folk songs. Chimes are no longer heard from Langenberg: the HA morse call from Hamburg has been cancelled and the ticking metronomes have been cast aside.

The North German group of stations (Hamburg, Bremen, Kiel, etc.) has adopted a phrase from the *Deutschlandlied*; Frankfurt-am-Main between items gives a short excerpt of *The Watch on the Rhine*; Nurnberg, a five-note phrase from *The Mastersingers* (Wagner), an opera which brought fame to the city; and

Munich, a few notes from this composer's opera *Parsifal*.

Each German station in turn, in the near future, will identify itself to listeners by a distinctive musical signal; most of them are easy to memorise.

To counteract propaganda broadcast by the Russian and Polish stations, the director of the Königsberg studio has intimated that measures are to be taken without delay to increase the power of Heilsberg to 100 kilowatts. Moreover, an additional relay at Goerlitz is to be provided for the Breslau programmes.

Far from reducing the number of transmitters there is every possibility that new stations may be built during 1934. The power of Bremen is being raised to 1.5 kilowatts and, according to a recent



TEA TIME RADIO—THE KIDDIES' DELIGHT  
Just before bedtime all children like to listen to the radio. Here is a happy group getting much enjoyment from a Marconiphone 252 portable receiver

report, Muenster is to be re-opened and another relay installed at Osnabrueck. Although she has not been able to obtain more than her quota of exclusive channels, Germany intends to use the national wavelengths allotted to her to their full extent.

Every effort is to be made to complete, if at all possible, the installation of the new Berlin high-power station in time for the opening of the Radio Exhibition in the German capital in September. The channel provided for this station is 355.7 metres (841 kilocycles).

GREECE

The small Salonika station, which was temporarily operating during the period of the Exhibition in that city, following a series of mishaps,

has suspended its transmissions. Greece, so far, has not possessed a regular broadcasting service, but it is now reported that the authorities will take steps to open stations at both Athens and Salonika.

HUNGARY

The first monument erected to the memory of a director of broadcasting will be unveiled this year at Budapest. Its aim is to commemorate the work of Dr. Ernő Szóts, the founder and first director of the Hirmondo broadcasting company, whose sudden death took place last December. The official ceremony, which is to be relayed to listeners, will take place on the first anniversary of his death.

ROUMANIA

Bucarest, following the lead given by other Continental studios, uses a folk song as an interval signal; it consists of the first four bars of *Hai Lelitzo*, which for many years has enjoyed popularity throughout the country. Similarly to other transmitters, it reproduces the sounds by means of a musical box. The Bucarest studio has a woman announcer.

SPAIN

A sum of some four million pesetas has been voted for the construction of a 100-kilowatt transmitter at Madrid and a move is to be made towards improving the broadcasting service. Although originally it had been intended to erect

powerful stations in various provincial cities, including Barcelona and San Sebastian, according to the latest reports economic conditions at present ruling in the country may prevent the realisation of a complete scheme.

To satisfy listeners, however, the first step to be taken will be to increase the power of some of the existing transmitters to 20 or 25 kilowatts.

SWITZERLAND

As Switzerland was unable to secure a long-wave channel, the authorities have decided that the power of the Sottens and Beromuenster stations must be increased if good service is to be given throughout the country.

Alterations to the plant will be

Continued on page 92



**LISTEN TO AUSTRALIA TO-NIGHT!**



**Short-wave reception now possible with most receivers!**

Short-wave stations can be tuned in with practically every receiver when fitted with an Ealex Short-wave Converter. Programmes from Australia, America, and other distant countries are brought in without trouble even by those with little or no experience of Short-wave reception. You can spend many thrilling hours tuning in distant countries, and your friends will be amazed at the remarkable increase in the range of your set.

**with an EELEX Short-Wave Converter**

Supplied for mains or battery receivers. Ealex Short-wave Convertors have a range between 15 and 60 metres and will receive, among others, the new B.B.C. Empire Short-wave Station. Duplex Type for mains or battery sets £2 12s. 6d., valve extra. Why not ask your dealer to demonstrate. Or send now for the Ealex Short-wave booklet number K19 free.

**J. J. EASTICK & SONS**  
 EELEX HOUSE, 118 Bunhill Row, LONDON E.C.1  
 Phone: Metropolitan 0314 (6 lines)

We're Fluxite and Solder the reliable pair: Famous for soldering known everywhere!

Use your RADIO with you —without any qualms: For if WE are near you —music still hath her charms!

See that Fluxite and Solder are always by you—in the house—garage—workshop—anywhere where simple, speedy soldering is needed.

**ALL MECHANICS WILL HAVE FLUXITE IT SIMPLIFIES ALL SOLDERING**

All Ironmongers sell Fluxite in tins: 4d., 8d., 1s., 4d., and 2s. 8d. Ask to see the FLUXITE POCKET SOLDERING SET—complete with full instructions—7s. 6d. Ask also for our leaded on HARDENING STEEL with Fluxite.

Fluxite Ltd., 'Dep'. 332, Rotherhithe, S.E.16

**FOR ALL REPAIRS!**

**"UTMOST SATISFACTION" in Ferrocart Circuits**

READ THIS TESTIMONIAL

Dear Sirs,  
 I feel impelled to write you upon the utmost satisfaction I have had by the use of your "Nugang" Condensers.

It may interest you to learn that I have made up a Ferrocart receiver using a screened grid valve and one of your Nugang 3 type condensers, and at the above address in North London I find no difficulty in separating Königswusterhausen from Radio Paris and Daventry, with a similar performance on the Short Waves.

I shall be pleased to demonstrate the above statement at any time if you are interested.

Again thanking you for a first-class condenser.

Yours faithfully,  
 (Signed).

**NUGANG**  
 Advt. of Jackson Bros. (London), Ltd., 72, St. Thomas' St., London, S.E.1. Phone: Hop 1837

**SPECIFIED**  
 for the "Wireless Magazine"  
**"SELF-CONTAINED FOUR"**

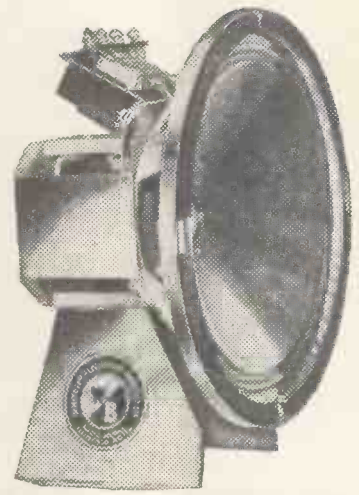

Again the expert's sole choice is the speaker with the revolutionary Mansfield System. It makes an amazing difference to ANY set. The magnet is 30 per cent more efficient than good cobalt steel of same weight and 10 per cent more efficient than chrome steel of three times the weight.

The "MANSFIELD" Senior PM4 CLASS B Permanent Magnet Moving-Coil Speaker  
 42/- including Class B Transformer or complete with Cabinet 67/-

Write for 1933 list.



WHITELEY ELECTRICAL RADIO CO. LIMITED, Radio Works, Mansfield, Notts.

Better service results from mentioning "Wireless Magazine" when writing to advertisers

# A Night with the Elizabethans

THE gramophone (or, more properly, the record) has an advantage which is not properly valued—that as an annihilator of time.

Supposing one plays a record of Duke Ellington and makes a tremendous effort (this will certainly be necessary) to project one's faculties a thousand years ahead, it is not unlikely that from the welter of noise may emerge some understanding—some symphonic picture of bizarre structure, yet meaning something in the scheme of musical art.

It would be entirely guesswork, of course, but here and there landmarks would emerge. But only the gramophone record can help with its facility for repetition and re-grouping of phrases.



TETRAZZINI AND CARUSO

Madame Tetrazzini was heard singing with one of the new H.M.V. records of Caruso in a recent edition of British Movietone News

After Duke Ellington—one week after—I went backwards, some three centuries, to spend an hour with the Elizabethans. One learns many things. First, as a nation we were undoubtedly very fond of music. This is very clearly established in a collection of sixteenth-century songs by English composers sung (unaccompanied) by the St. George's Singers\*.

It seemed that anything would do to make a song about and everybody joined in. The words were mostly pastoral, often with flattering allusions to a lady (Good Queen Bess,

\* "16th Century Songs—Typical Examples of Early English Composers." A series of six Columbia records sung by the St. George's Singers, with descriptive leaflet by the Rev. Dr. E. H. Fellows; £1. 2s. complete.

for example) and were what are known as madrigals. That musical skill in some degree or other was present is proved by the involved framework.

And yet, we are told, these pieces were attempted and sung at sight by many of the cultured families, whose Master of Music had composed them.

The second important feature to note is the relatively restricted style of these songs. Nearly all were madrigalian: sustained melody by one voice was rare. Discords were not disdained, the tempo varied, but syncopation was not used.

There are some really delightful things amongst them, and whilst they require several hearings to enable their beauty to show itself, the atmosphere becomes stronger with each playing, and the simple folks' enjoyment seem very real and near.

If these journeys backward appeal (and they are extraordinarily restful) start by hearing *I Follow, Lo, The Footing* (record 9877), by Thomas Morley (1558-1603), and get breathless with the singer on the line "Will run me out of breath till I have caught her."

Then *Sweet Suffolk Owl* (record 5549), by Vautour (circa 1619), complete with calls. And, more serious and very lovely, *Lullaby, My Sweet Little Baby* (record 5546), by William Byrd (1543-1623). A sacred carol, this last, of unusual beauty.

Frankly, these records are really refreshing in their innate simplicity and sincerity, and should be kept as a refuge from the staleness and occasional exasperation which modern music often engenders.

Try the gramophone record as a magic carpet for journeys through time—there is abundant scenery as you travel. C.

## ON THE CREST OF THE WAVES

Continued from page 90

carried out in the autumn, in the hope that when the new wave plan comes into operation the stations may broadcast with an energy of respectively 50 and 100 kilowatts. According to the new Lucerne wave plan, the channels allocated to them are 443.1 metres (677 kilocycles) and 539.6 metres (556 kilocycles).

Monte Ceneri, which announces itself as "Radio Svizzera Italiana," and broadcasts solely in the Italian language, will continue to work on 1,143 metres until January 15, 1934, when, following the new Lucerne plan it must lower its wavelength to 257.1 metres. The station may be recognised by the fact that a woman presides at the microphone and that the intervals are filled by the playing of a gramophone record reproduction of the bells of the Campana di Pazzalino, an historic church situated at Lugano.

### TRIPOLITANIA

Experiments have been carried out in Tripoli and other centres in relays of the Rome programmes (on short waves) for the benefit of white residents in the colony. In order to encourage listeners instructions have been given to Italian military posts to assist their nationals by charging accumulators.

The authorities are considering the installation of a broadcasting station at Benghazi (Cyrenaica) to which the international wave of 222.6 metres has been allotted.

### UNITED STATES

When the new 500-kilowatt transmitter at Cincinnati is launched on the ether in October or November, its engineers anticipate that the WLW programmes will be picked up anywhere in the world. They estimate that the range will be twenty-five times that of the present plant.

### URUGUAY

Short-wave listeners should search for signals emanating from Radio Cerrito, near Monte Video, now broadcasting on 11,370 kilocycles (26.39) metres. They are daily experimental broadcasts of Uruguayan programmes originating from the capital. The call sign of the station is CWG, all announcements being made in the Spanish language.



# MOTOR CAR RADIO WITHOUT BACKGROUND NOISES

## OUR "HUSH-HUSH" KIT

as illustrated, enables you to enjoy perfect reception even when travelling at 50 miles per hour . . . See article by Kenneth Ulyett in "W.M." of July, pp 574/5

**PRICES:**

- Spark Plug Suppressors - 3/6 ea.
- Distributor Suppressor - 3/6 "
- Fixed Condenser - - - 4/6 "

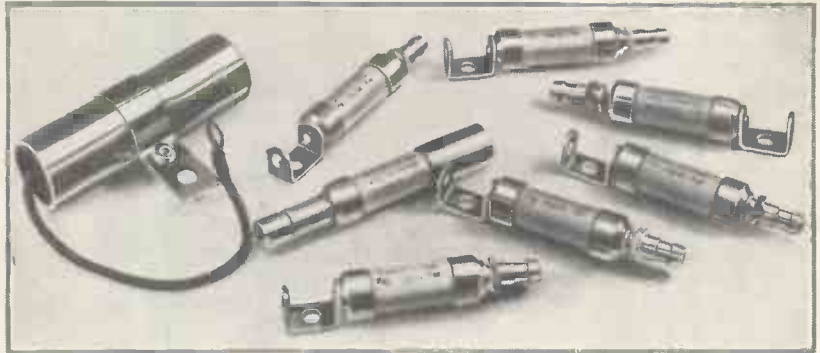

## CLAUDE LYONS, LTD.

76 OLDHALL ST. LIVERPOOL 3 AND 40 BUCKINGHAM GATE, S.W.1

Send for our Wonder Booklet "OHMS LAW WITHOUT TEARS," Post Free



**Famous Maker's Offer!**  
**£5 Radio-Gram for 65/-**  
**SEVEN DAYS' FREE TRIAL**  
 (OR 10/- MONTHLY)  
 Polished Oak 1 and Piano built! The acoustic Tone brings a fine thrill. Makers to Radio-Press, B.B.C., 3,000 clientele.  
**MODELS FROM 35/- to £15.**  
 Photographs and List FREE.  
**PICKETTS** Piano-Tone, Cabinets  
 M.G., Albion Road, Bexleyheath.

**"ALL-METAL FOUR"** Drilled Chassis  
 only 7/-. Drilled Chassis with 5 Clix Valveholders and 2 Clix strips with sockets, 13/2. 4000, ohm. Magnum Pot., 5/-.  
**BURNE-JONES & CO., LTD.**  
 296, Borough High St., London, S.E.1

## ERIE-VISE it!

Don't wait until your set breaks down through faulty resistances. ERIE-vise it NOW. Replace those indifferent resistances with

## ERIE RESISTORS

1/-  
 per watt in all values. Write for Colour-code Chart

THEY will not let you down!

THE RADIO RESISTOR CO.,  
 1, Golden Square, Piccadilly Circus, London, W.1.

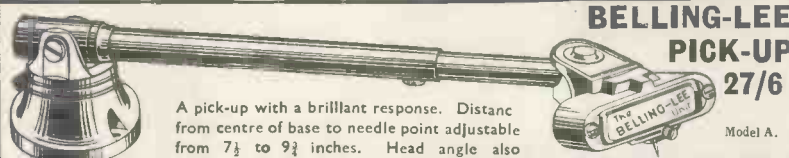

A pick-up with a brilliant response. Distanc from centre of base to needle point adjustable from 7 1/2 to 9 1/2 inches. Head angle also adjustable. Ball bearing swivel. Supplied complete with length of copper screened flex.

Write for Publication P218

**BELLING & LEE LTD**  
 CAMBRIDGE ARTERIAL ROAD, ENFIELD, MIDD.X.

**THE IMPROVED "TONIC"**  
 Self-generating Trickle-charger Kit keeps 2-volt accumulators fully charged. Electric mains and charging stations unnecessary. Ideal for remote places. 7/- each; postage 9d. Particulars, testimonials, with pleasure.  
**WILLIAMS, Netherend, Cradley, Birmingham**

# PEAK CONDENSERS

Specified for "THE A.C.-D.C. THREE"

It was obvious that the sterling quality of the PEAK Electrolytic condensers would speedily commend themselves to the attention of all enterprising technicians. That they are, together with certain other Peak condensers, chosen for the very interesting "A.C.-D.C. Three" is therefore not surprising. Follow the lead of these authorities and say PEAK.

Complete new list sent on request.

**WILBURN & CO.,**  
 WHEATSHEAF HOUSE, CARMELITE ST., E.C.4

Telephone No. Central 6810

NORTHERN AGENTS: W. ANDREW BRYCE & CO., TILE ST., BURY, LANCs.



Type W

8 mfd.

450 volts D.C. Peak Working

4/9 each

- TYPE A4**
- 1 ... 1 mfd. @ 1/10 each ... 1/10
  - 3 ... 1 mfd. @ 2/2 each ... 6/6
  - 2 ... 2 mfd. @ 2/9 each ... 5/6
- ELECTROLYTIC**
- 2 ... 8 mfd. @ 4/9 each ... 9/6
  - 2 ... Holders @ 6d. each ... 1/-

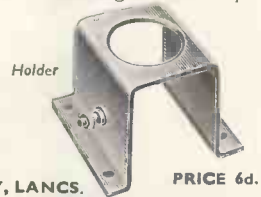

PRICE 6d.

## PILOT AUTHOR KITS

## CASH - C.O.D. - H.P.

Any items supplied separately. If value over 10/- send cash or C.O.D. carriage paid

### SELF-CONTAINED 4

YOURS FOR

11/3

**KIT "A"** Author's Kit of first specified components including Peto Scott metal assembly. Less Valves, wood Chassis and Cabinet, Batteries and Speaker. Cash or C.O.D. £6/2/0 carriage paid. Balance in 11 monthly payments of 11/3

1 Set of Valves ... £2/3/6. 1 Camco Carrier Portable Cabinet ... £1/15/0.

### IMPORTANT

Parts, Kits, Miscellaneous Components, Finished Receivers or Accessories for Cash C.O.D., or H.P., on our own system of Easy Payments. Send us a list of your wants. We will quote you by return.

### TYERS IRON-CORE 3

YOURS FOR

13/4

**KIT "A"** Complete Kit of Specified Parts with ready-drilled Panel less Baseboard, Valves, Speaker and Cabinet. Cash or C.O.D., Carriage paid, £7/2/0. Balance in 11 monthly payments of 13/4

1 Set of Valves ... £2/7/6.

1 Peto-Scott Cabinet ... 19/6.

**PETO-SCOTT CO. LTD.** 77 CITY ROAD, LONDON, E.C.1. 62 HIGH HOLBORN, LONDON, W.C.1.

Tel.: Clerkenwell 9406/7 Holborn 3248

It helps us if you mention "Wireless Magazine"

# Charging without Mains

THOSE who want to charge their accumulators, but who have no electric-light mains available for the purpose, will be interested in the Tonic trickle-charging device manufactured by R. T. P. Williams, of Netherend, Cradley, near Birmingham.

The outfit consists of materials needed to set up four cells that will



**CHARGING PLANT**  
This is the Tonic kit for trickle charging of accumulators. All the parts are provided, except for four jam jars and copper-sulphate crystals. On test the results were satisfactory

keep a 2-volt accumulator fully charged without trouble. Full instructions are provided with each kit.

A cell already assembled is shown on this page, and the parts are also illustrated. Everything is provided except for four 2-lb. jam jars and 3 lb. of large copper-sulphate crystals.

Two different kits are available. The cheapest has cardboard covers for the cells and costs 7s. (postage 9d.), while with bakelite covers the kit costs 8s. 6d. (postage 9d.).

This trickle charger works quite satisfactorily and should particularly interest those in remote country places who have no ordinary facilities for accumulator charging.

When a small grub screw, fitted to the side of the wander plug, is turned, the prongs of the plug are forced apart, thus making the plug adaptable for the many sizes of socket on the market.

“Class-B Amplification—What It Does—How to Use It” is the title of a leaflet we have received from A. C. Cossor, Ltd., of Highbury Grove, N.5. The constructor will find plenty of useful information in its pages. Free copies can be obtained.

Marconiphone, Ltd., announce reductions in the prices of three receivers. The model 253—a four-valve table set for A.C. or D.C.—has been reduced from £16 16s. to £11 11s. and the radiogram version—model 254—from £33 12s. to £24 3s. The six-valve battery-operated portable receiver—model 255—has been reduced from £17 17s. to £13 13s. These sets will remain in the Marconiphone catalogue throughout the next season.

From the Electro Dynamic Construction Co., Ltd., of 733 Old Kent Road, S.E.15, we have received two interesting leaflets dealing with high-tension converters for incorporation in a car-radio outfit. The converter is designed for working from the car battery—either 6- or 12-volt type—and gives an output of 200 volts at 40 milliamperes. Full details and copies of the leaflets can be obtained from the makers.

## Notes and News

A NEW four-valve super-het radio gramophone—model 274—has recently been marketed by the Marconiphone Co., Ltd. The cabinet is of figured and inlaid walnut in an attractive modern style; it is for use on A.C. mains.

From Ferranti, Ltd., we have received a chart dealing with the construction of a four-valve battery receiver with class-B output. Details and a constructional chart can be obtained on application to Hollinwood, Lancs; letters should be accompanied by a 1½d. stamp to cover return postage.

Listeners who have one of the standard commercial receivers will be interested in a leaflet dealing with the choice and fixing of extension loud-

speakers that has been issued by the British Rola Co., Ltd., of 179 High Road, Kilburn, N.W.6. The leaflet gives the correct type of Rola loud-speaker for use as an extension loud-speaker with over 200 well-known commercial sets.

We have received particulars of the new Mullard 2-volt class-B valve, known as the PM2B. The steady anode current of this new valve when no signals are being received is only 3 milliamperes. Full details can be obtained from the Mullard Wireless Service Co., Ltd., of 111 Charing Cross Road, W.C.2, on mention of “Wireless Magazine.”

A new type of wander plug has been marketed by J. J. Eastick and Sons, of 118 Bunhill Row, E.C.1.

Owing to an oversight, the Beethoven set reported on in the July issue of “Wireless Magazine” (page 615) was referred to in the heading and in the caption to the illustrations as a three-valver, whereas it is obviously a four-valver from the valve combination quoted. With this fact brought to their attention, prospective buyers will appreciate that the set is even better for money at 11 guineas than they may have realised.

As the first step in the re-organisation of the Norwegian broadcasting system, a new Marconi transmitter of 20 kilowatts power has been ordered for erection at Trondheim.

Continued on page 96



YOU CANNOT GO WRONG IF YOU USE A

# FULL-SIZE BLUEPRINT

Each blueprint shows the position of each component and every wire and makes construction a simple matter. Copies of "Wireless Magazine" and of "Amateur Wireless" containing descriptions of most of these sets can be obtained at 1s. 3d. and 4d., respectively, post paid. Index letters "A.W." refer to "Amateur Wireless" sets and "W.M." to "Wireless Magazine" sets. Send, preferably, a postal order (stamps over sixpence unacceptable) to "Wireless Magazine," Blueprint Dept., 58-61 Fetter Lane, London, E.C.4.

## The CALIBRATOR

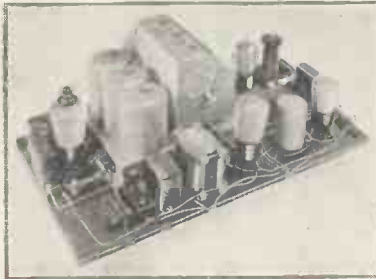

Circuit: SG, Detector, L.F. and Power output (4 valves). Price of set: £6, less valves.

Blackpool (Lancs).—I thought you might be interested to know how pleased I am with the Calibrator. I have adapted the set for all-mains working and am extremely satisfied with the results obtained. I can log over forty-five stations at good loud-speaker strength.

## The TABLE QUAD

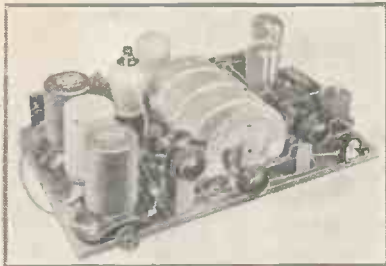

Circuit: SG., Detector, L.F., and power output (4 valves). Price of set: £5, less valves.

Clapham (London, S.W.).—I am pleased with the results I am getting from the Table Quad. It is undoubtedly the best battery four-valver I have handled. Up to the time of writing, I have identified over forty stations—your log only differs by one or two degrees at the most. Thank you!

## The W.M. SHORT-WAVE SUPER



Designed by W. G. Hill. Circuit: 5-valve short-wave super-het. Price of set: £6 10s. without valves.

Walthamstow (Essex).—I wish to commend the "W.M." Short-wave Super. This set is the ninth short-waver I have built, and I am convinced that it is the real "easytune" short-wave set. I did not realise that there were so many languages in the world until I toured on the "W.M." Short-wave Super. The log to date is twenty-three stations, all at good strength. WBXK provides a real good programme from 9 p.m. onwards. It is truly the last word in short-wave sets.

## The WIZARD 3



Circuit: SG., D., Trans. Designed by Percy W. Harris. A simple battery three-valver, a fine station-getter, and an ideal family set. Approximate cost, less valves, £4.

Swansea.—Have built up the Wizard from a kit of parts, and have pleasure in giving the results I have had with this truly magical three-valver. Have already logged thirty-seven stations at good loud-speaker strength and an American station, also at loud-speaker volume. I must say that, for a three-valver, this one takes top score.—D. R.

**SPECIAL HALF-PRICE OFFER**

Blueprints of the following "Wireless Magazine" sets described in this issue are obtainable at the special price, given below, if the coupon on page 96 is used before August 31, 1933.

Self-contained Four (SG, D, RC, Trans) No. WM331 ... .. 9d.

"W.M." A.C.-D.C. Three (SG, D, Pen) No. WM332 ... .. 6d.

And here are over 50 more to choose from—

CRYSTAL SET (6d.)		
1931 Crystal Set	...	AW308
ONE-VALVE SETS (1s. each)		
Easy to Build One	...	AW304
B.B.C. One-valver	...	AW387
Portable Short-wave One	...	AW354
TWO-VALVE SETS (1s. each)		
A Two for 7 Metres (D, Trans)	...	WM295
New-Style Radiogram (D, Trans)	...	WM299
A.C. Quality Gem (D, Trans)	...	WM312
Ideal Regional 2 (D, Trans)	...	AW357
Quality 30s. Two (D, Trans)	...	AW361
Ether Music Two (D, Trans)	...	AW364
Clarion-voice 2 (SG, D, Pen)	...	AW371
Home Station A.C. 2 (D, Pen)	...	AW374
B.B.C. National Two (D, Trans)	...	AW377
Melody Ranger Two (D, Trans)	...	AW388
THREE-VALVE SETS (1s. each)		
Multi-mag Three (D, 2 Trans)	...	WM288
Percy Harris A.C. Radiogram (D, RC, Trans)	...	WM294
Prosperity Three for Batteries (SG, D, Trans)	...	WM296
1933 Economy S.G. Three (SG, D, Trans)	...	WM306
Harris Ethergram (SG, D, Trans)	...	WM308
A.C. Calibrator (SG, D, Trans)	...	WM309
Narrow-pass Three (SG, D, Trans)	...	WM314
£6 6s. Radiogram (D, RC, Trans)	...	WM318
Simple-tune Three (SG, SG Det, Trans)	...	WM327
D.C. Calibrator (SG, D, Trans)	...	WM328
Tyers Iron-core Three (SG, D, Pen)	...	WM330
£8 Radiogram (D, RC, Trans)	...	AW343
Wizard (SG, D, Trans)	...	AW360
£2 2s. Family Three (D, 2 Trans)	...	AW368
Build As You Learn Three	...	AW366
Build As You Learn SG3 (SG, D, Trans)	...	AW372
James Push-Push Three (SG, D, Q.P.P.) (1/6)	...	AW378
Everybody's Home Radiogram (SG, D, Trans)	...	AW381
Home-Lover's New All-electric 3 for A.C. mains (SG, D, Trans)	...	AW383
Our Up-to-the-Minute Three (SG, West-ector, L.F, Trans)	...	AW384
Class-B Three (D, Trans, class B)	...	AW386
FOUR-VALVE SETS (1s. 6d. each)		
Quadradyne (2 SG, D, Pen)	...	WM273
A.C. Quadradyne (2 SG, D, Pen)	...	WM279
Ideal A.C. Home Super (Super-het)	...	WM290
Gold Coaster (A.C. Short-waver)	...	WM292
Triple-tune Four (2 SG, D, Trans)	...	WM295
Calibrator (SG, D, RC, Trans)	...	WM300
Table Quad (SG, D, RC, Trans)	...	WM303
"Words and Music" Radiogram (2 SG, D, Trans)	...	WM307
Home Short-waver (SG, D, RC, Trans)	...	WM311
"Words and Music" Radiogram de Luxe (SG, D, RC Q.P.P.)	...	WM307a
Empire Short-waver (SG, D, RC, Trans)	...	WM313
Calibrator de Luxe (SG, D, A.C. Trans)	...	WM316
All-metal Four (2 SG, D, Pen-A. C. Mains)	...	WM329
Melody Ranger (SG, D, RC, Trans), with copy of "A.W." 4d. postage	...	AW375
"A.C. Melody Ranger" (SG, D, RC, Trans)	...	AW380
FIVE-VALVE SETS (1s. 6d. each)		
Super-quality Five (2 HF, D, RC, Trans)	...	WM320
James Short-wave Super (Super-het)	...	AW328
Simple Super (Super-het)	...	AW340
SIX-VALVE SETS (1s. 6d. each)		
1932 Super 60 (Super-het)	...	WM269
1932 A.C. Super 60 (A.C. Super-het)	...	WM272
Ideal Home Super (Super-het)	...	WM280
Easytune 60 (Super-het)	...	WM284
"W.M." D.C. (Super-het)	...	WM321
James Class-B Super (Super-het with Iron-cored coils)	...	WM326
Welcome Portable with class-B output stage	...	WM325
New Century Super (Super-het), with copy of "A.W." 4d. post free	...	AW363
New A.C. Century Super (A.C. Super-het)	...	AW365
SEVEN-VALVE SETS (1s. 6d. each)		
Super Senior (Super-het)	...	WM256
Seventy-Seven Super (A.C. Super-het)	...	WM305
Q.P.P. Super 60 (Super-het)	...	WM319
PORTABLES (1s. 6d. each)		
Town and Country Four (SG, D, RC, Trans)	...	WM282
Everybody's Portable (five-valve Super-het)	...	WM291
Welcome Portable (six-valve Super-het)	...	WM322
General-purpose Portable (SG, D, RC, Trans)	...	AW351
MISCELLANEOUS (1s. each)		
Voltage Regulator	...	WM287
Class-B Mains Unit	...	WM324
"A.W." Trickle Charger	...	AW352
Add-on Band-pass Unit	...	AW359
Plug-in Short-wave Adaptor	...	AW382

## BLUEPRINT COUPON

Valid only until August 31, 1933 (or until Sept. 30, 1933, for overseas readers)

### FOR ONE BLUEPRINT ONLY

If you want a full-size blueprint of any ONE of the sets constructionally described in this issue for half price, cut out the above coupon and send it, together with a postal order, to Blueprint Department, WIRELESS MAGAZINE, 58-61 Fetter Lane, London, E.C.4.

This coupon is valid for a blueprint of any ONE only of the following sets at the prices indicated:—

THE SELF-CONTAINED FOUR (page 54), No. WM331, price 9d., post paid.

THE A.C.-D.C. THREE (page 20), No. WM332, price 6d., post paid.

## INFORMATION COUPON

Valid only until August 31, 1933 (or until Sept. 30, 1933, for overseas readers)

If you want to ask any questions, cut out the above coupon and send it, together with a postal order for 1s. and stamped-addressed envelope, to the Information Bureau, WIRELESS MAGAZINE, 58-61 Fetter Lane, London, E.C.4.

Note that not more than two questions may be asked at a time and that queries should be written on one side of the paper only.

Under no circumstances can questions be answered personally or by telephone. All inquiries must be made by letter so that every reader gets exactly the same treatment.

Alterations to blueprints or special designs cannot be undertaken: nor can readers' sets or components be tested.

If you want advice on buying a set, a stamped-addressed envelope only (without coupon or fee) should be sent to the Set Selection Bureau, WIRELESS MAGAZINE, 58-61 Fetter Lane, London, E.C.4.

### NOTES AND NEWS Continued from page 94

From Ferranti, Ltd., we have received a 52-page booklet dealing with the building of amplifiers and receivers of a more powerful and ambitious type than can normally be obtained commercially. Listeners who are interested can obtain copies on application to Hollinwood, Lancs. A charge of 6d. is made for this publication.

H.M.V. announce the release of a five-valve (including rectifier) super-heterodyne receiver for A.C. mains at £15 15s. A feature of the set, which is called the Super-het Five, is the fine tuning scale marked in stations and wavelengths. A radio-gramophone version, priced at £30 9s., is available.

Two new valves have recently been released by A. C. Cossor, Ltd., of Highbury Grove, London, N.5. One is the 220VS, a variable-mu screen-grid valve, taking a low anode current and having the additional advantage that a 9-volt grid-bias battery is sufficient to control the stage gain. The other is the 220B, a class-B output valve, with the low filament consumption of .2 ampere.

From July 1 the manufacture and sale of Magnavox loud-speakers was taken over by the Benjamin Electric Co., Ltd., of Tariff Road, Tottenham.

In the list of parts for the All-metal Four last month the price of the Magnum 4,000-ohm potentiometer was incorrect. The price of this component is 5s.

A new range of Yellow Triangle Drydex batteries has recently been released. These batteries are primarily for use with commercial sets employing a class-B output stage.

Further orders have been placed with Burne-Jones & Co., Ltd., of 296 Borough High Street, S.E.1, for wireless sets for the use of blind people. These

## INDEX TO ADVERTISERS

B	Page
Belling & Lee, Ltd.	93
British Blue Spot Co.	13
British Radiophone, Ltd.	3
British Rola Co.	87
Bulgin, A. F., & Co.	89
Burne-Jones & Co., Ltd.	93
C	
Carrington Mfg. Co., Ltd.	9
City Accumulator Co.	3
Colvern, Ltd.	9
Columbia Graphophone Co., Ltd.	Cover iv
D	
Drydex	7
Dubilier Condenser Co., Ltd.	11, 85
E	
Eastick, J. J., & Sons	9
Edison Swan	Cover iii
Electradix	89
F	
Fluxite, Ltd.	91
G	
Garrard Eng. Co., Ltd.	Cover ii
H	
Heayberd, F. C., & Co.	87
I	
International Correspondence Schools, Ltd.	89
J	
Jackson Bros.	91
L	
London Electric Wire Co. & Smiths	3
Lyons, Claude, Ltd.	93
M	
Milnes Radio Co.	13
O	
Osborn, Chas.	83
P	
Partridge & Mee, Ltd.	9
Partridge, Wilson & Co.	83
Peto-Scott Co., Ltd.	93
Pickett Bros.	93
Postlethwaite Bros.	85
R	
Reproducers & Amplifiers, Ltd.	89
Radio Resistor Co.	93
S	
Smith, S. & Sons, M/A, Ltd.	89
Sunbeam Electric, Ltd.	11
T	
Telegraph Condenser Co., Ltd.	87
Tungram Electric Lamp Works (G.B.), Ltd.	5
V	
Varley	5
W	
Westinghouse Brake & Saxby Signal Co., Ltd.	11
Whiteley Electric Radio	91
Wilburn & Co.	93
Wilkins & Wright, Ltd.	83
Williams, T. R. T.	93
Wingrove & Rogers, Ltd.	85
Wright & Weaire, Ltd.	14

sets comprise one-, two-, and three-valvers, with either loud-speakers or headphones.

Since W. James first built up the James Class-B Super, described on pages 455-459 of "Wireless Magazine" for June, the connections on the Varley type BP24 oscillator have been altered. Terminal "X," originally shown as being between terminals Nos. 1 and 5 on the coil base, is now between terminals Nos. 3 and 6, as will be clear from the diagram reproduced on this page.

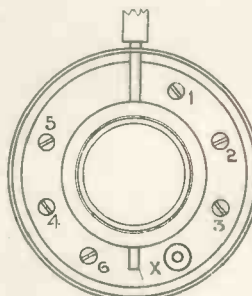

**NEW CONNECTIONS**  
The latest connections for the Varley type BP24 oscillator coil used in the James Class-B Super





Purveyors of  
Electric Lamps  
By Appointment



Manufacturers  
and Purveyors  
of Electric Lamps  
By Appointment

# EDISWAN

The name that means 'EXCELLENCE'

★ THE NEW MAZDA 'CLASS B' VALVE IS READY!



**YOUR DEALER  
HAS AMPLE  
STOCKS!**

MAZDA  
PD220  
(with standard  
7-pin base)

PRICE 14/-

The new Mazda PD220 is a 2-volt low consumption valve for a "Class B" ("positive drive") output stage. It is designed for use with 135v. H.T., but batteries of 120v. or 150v. may be used. No bias is necessary with any value of H.T. voltage. *No special driver valve is required,* a Mazda L2 supplying sufficient power for the PD220 to operate a small M.C. speaker.

# MAZDA THE BRITISH VALVES

The Edison Swan Electric Co. Ltd.



155 Charing Cross Road, W.C.2

Mazda Radio Valves are manufactured in Great Britain for The British Thomson-Houston Co. Ltd., London and Rugby

**RECOMMENDED BY ALL GOOD RADIO DEALERS**

v.210

# CQQA

makes possible

FIRST BATTERY operated

## Columbia RADIO-GRAPHOPHONE

Until to-day Columbia has never made a battery radio-gramophone—for until to-day it was impossible to provide an instrument in keeping with the high Columbia standards of tonal quality and strict economy unless it was operated from the electric mains.

**CQA**—Constant Quality Amplification is a new principle applied to this radio-gramophone. Firstly, it makes it possible to provide tone and volume equal to an all-mains set. Secondly, the life of the battery is considerably lengthened as the current is automatically reduced when the set is playing quietly or during an interval.

Learn all about this wonderful new Columbia instrument at once, the coupon below makes this easy.

### Surprising new features

- Three-stage band pass receiver.*
- Quiescent push-pull pentode amplification.*
- Moving coil speaker.*
- Pick-up of entirely new design.*
- Double-spring motor.*
- Walnut cabinet.*



**P**LEASE send me fullest particulars of the new Columbia Radio-Gramophone Model 1003.

Name.....  
 Address.....

W.M. Aug. 1933

MODEL  
1003

20 gns.

